

# Relationships between Surface, Volume, and Thickness of Iliac Trabecular Bone in Aging and in Osteoporosis

## IMPLICATIONS FOR THE MICROANATOMIC AND CELLULAR MECHANISMS OF BONE LOSS

A. M. PARFITT, C. H. E. MATHEWS, A. R. VILLANUEVA, M. KLEEREKOPER, B. FRAME, and D. S. RAO, *Bone and Mineral Research Laboratory, Department of Medicine, Henry Ford Hospital, Detroit, Michigan 48202*

**ABSTRACT** We devised a new method for examining the structural changes that occur in trabecular bone in aging and in osteoporosis. With simultaneous measurement of total perimeter and bone area in thin sections, indirect indices of mean trabecular plate thickness (MTPT) and mean trabecular plate density (MTPD) can be derived, such that trabecular bone volume = MTPD  $\times$  MTPT. MTPD is an index of the probability that a scanning or test line will intersect a structural element of bone, and is the reciprocal of the mean distance between the midpoints of structural elements, multiplied by  $\pi/2$ . We applied this method to iliac bone samples from 78 normal subjects, 100 patients with vertebral fracture, and 50 patients with hip fracture. The reduction in trabecular bone volume observed in normal subjects with increasing age was mainly due to a reduction in plate density, with no significant decrease in plate thickness. The further reduction in trabecular bone volume observed in patients with osteoporotic vertebral fracture was mainly due to a further reduction in plate density. There was a relatively smaller reduction in plate thickness that was statistically significant in males but not in females. Only in patients with hip fracture did trabecular thinning contribute substantially to the additional loss of trabecular bone in osteoporosis relative to age. These data indicate that age-related bone loss occurs principally by a process that removes entire structural elements of bone; those that remain are more widely sep-

arated and some may undergo compensatory thickening, but most slowly become reduced in thickness. We propose that the process of removal is initiated by increased depth of osteoclastic resorption cavities which leads to focal perforation of trabecular plates; this is followed by progressive enlargement of the perforations with conversion of plates to rods. The resulting structural changes are more severe in osteoporotic patients than in normal subjects, but have been completed in most patients before they develop symptoms.

### INTRODUCTION

Iliac bone biopsies are frequently performed in patients with osteoporosis, both for diagnosis and for research, but most investigators have examined the process of trabecular bone loss solely in terms of the amount of bone, giving no attention to its spatial distribution or microscopic structure (1-8). The amount of bone, usually expressed as a fraction or percentage of the volume of trabecular tissue and referred to as trabecular bone volume (TBV)<sup>1</sup>, is a useful index, since it differs significantly between old and young persons, between elderly males and females, and between patients with vertebral compression fractures and healthy subjects of the same age (1-3), but no single index can adequately describe the structural effects of aging and disease on trabecular bone. Low power stereoscopic

---

This work was presented in preliminary form at the University of Utah Workshop on Morphological Aspects of Bone Biology, Sun Valley, 1981.

Received for publication 1 October 1982 and in revised form 17 June 1983.

---

<sup>1</sup> *Abbreviations used in this paper:* MTPD, mean trabecular plate density; MTPS, mean trabecular plate separation; MTPT, mean trabecular plate thickness; S/V, bone surface area per unit volume of bone; S<sub>v</sub>, bone surface area per unit volume of tissue; TBV, trabecular bone volume.

light microscopy and scanning electron microscopy of unembedded thick sections of trabecular bone disclose a complex three-dimensional network of curved plates and bars (9, 10). The size, shape, orientation, distribution, and connectivity of these structural elements can substantially affect both the biomechanical properties of trabecular bone (11, 12) and its internal surface area (12, 13), which is an important determinant of hormone responsiveness and of remodeling activity.

Since direct examination of three-dimensional structure requires removal of soft tissues and precludes the preparation of thin undecalcified sections, it is incompatible with most of the purposes for which bone biopsies are performed. Fortunately, considerable insight into three-dimensional structure is possible by making better use of the two-dimensional information available in thin sections and by applying the principles of stereology (13–15), which require only that perimeter and area measurements in a section are made on the same structures at the same magnification, and that the measurement device is calibrated. Using this approach, we confirmed and extended earlier reports that, in the normal bone loss of aging, entire structural elements are removed, with increased separation between, but little change in the thickness of, those remaining (13, 16–20), and we show for the first time that these structural characteristics are more evident in patients with osteoporosis and fractures, a fact with important implications for the cellular mechanism involved.

## METHODS

Transiliac bone biopsies with cortex at each end were obtained with a trephine of 7.5 mm i.d. (21, 22) from 100 patients with at least one nontraumatic vertebral compression fracture and 50 patients with at least one hip fracture without severe trauma. Those who had sustained fractures of both types were assigned according to the most recent one. Demographic data are given in Table I. Vertebral fracture cases satisfied the following criteria: definite radiographic osteopenia; nonblack race; no clinical evidence of any cause of secondary osteoporosis; no other disease or drug administration with known adverse effects on bone; no treatment for osteoporosis other than calcium; normal plasma levels of calcium, inorganic phosphate, alkaline phosphatase, and creatinine; technically satisfactory unfragmented biopsy specimens; no histologic evidence of osteitis fibrosa (23); and values for osteoid volume not greater than 5% of total bone volume and for mean osteoid seam width not greater than 15  $\mu\text{m}$ . These histologic criteria excluded other forms of metabolic bone disease and provided additional assurance that conditions such as intestinal malabsorption or hyperthyroidism had not been overlooked, but did not jeopardize the validity of the sample; in our experience, <5% of patients with a clinical diagnosis of uncomplicated age-related osteoporosis have osteoid measurements outside the limits specified. Female cases were eligible only if studied within the previous 3 yr, but all available male cases were included.

Because of the high frequency of associated disease in hip fracture patients (8), admission criteria were necessarily less

stringent and the group included 13 blacks, 11 patients with diabetes, seven with a history of excess alcohol intake, three on replacement thyroxine (including two with previous hyperthyroidism), two with rheumatoid arthritis, two with asymptomatic primary hyperparathyroidism, one each with myeloma and mild chronic renal insufficiency, and four with values for relative osteoid volume between 5 and 10% but with normal osteoid seam width. The 24 cases with none of these complicating conditions fulfilled the same admission criteria as the vertebral fracture cases, except for the inclusion of black subjects; data from this subset were analyzed separately. Because values for plasma calcium, inorganic phosphate, alkaline phosphatase, and creatinine are commonly abnormal in hip fracture patients regardless of their previous metabolic state (8), these values were not used as exclusion criteria.

Reference values were derived from iliac bone samples from 78 healthy white subjects, including 41 of age range comparable to the compression fracture patients; age-matched reference values for the hip fracture patients were not available. The samples included bone biopsies on 16 normal volunteers from Denmark, the embedded blocks being generously supplied by Dr. F. Melsen (4), 14 normal volunteers from Michigan, and 15 patients without metabolic bone disease or abnormal mineral metabolism in whom bone biopsies were done either because of a mistaken radiologic report of osteopenia or a nonvertebral traumatic fracture. With these exceptions, the subjects met the same criteria as the patients with compression fractures. In the remaining 33 cases, bone was obtained at autopsy after sudden death in previously healthy persons; the embedded blocks being kindly supplied by Dr. S. Teitelbaum (7).

The previously unembedded biopsy specimens were placed in 70% ethanol, prestained by the Villanueva method, embedded in polymethylmethacrylate, and sectioned with a Jung-K microtome (24). Sections prepared from previously embedded blocks were stained after sectioning with toluidine blue. In accordance with normal stereologic practice, no attempt was made to control the plane of sectioning. Trabecular bone area as a fraction of total trabecular tissue area (marrow and bone) and the perimeter of marrow-bone interface (in millimeters per square millimeter of tissue area) were measured in the same microscopic field, either by counting point hits and line intercepts with a Zeiss integration plate II eyepiece graticule (15) or by the Zeiss MOP 3 digitizing system (25) (Carl Zeiss, Inc., New York). For both methods, calibration was performed with a stage micrometer. In 32 cases (including 12 from the present study), measurements were made by both methods in the same sections, with good agreement. Trabecular bone area (mean $\pm$ SD) was 15.12 $\pm$ 7.19 mm<sup>2</sup> with the graticule and 14.98 $\pm$ 7.78 mm<sup>2</sup> with the MOP, and marrow-bone interface perimeter was 2.99 $\pm$ 1.18 mm with the graticule and 2.94 $\pm$ 1.15 mm with the MOP. These pairs of values are not significantly different and the correlation coefficients were 0.969 and 0.957, respectively, with slopes not significantly different from unity and intercepts not significantly different from zero. The measurements were not confined to the central region of the section (2, 13) but included the entire trabecular tissue area in the section. The demarcation between trabecular and cortical bone was made according to a previously described rule (26), and the endosteal border of the cortex was not included in the perimeter measurements. All measurements were made at a total magnification, including both eyepiece and objective, of  $\times 25$ , since the apparent perimeter length increases at higher magnification because of increased resolution of surface irregularities (27).

TABLE I  
Sex and Age of Subjects Studied

	Sex	n	Age	
			Range	Mean±SD yr
Young normal subjects (<50 yr)	Female	18	20-46	32.2±9.4
	Male	19	15-49	32.2±10.3
	Combined	37	15-49	32.2±9.7
Old normal subjects (>50 yr)	Female	30	52-80	62.7±7.4
	Male	11	51-73	64.0±7.1
	Combined	41	51-80	63.1±7.3
Vertebral fracture	Female	70	48-80	66.2±7.6
	Male	30	23-72	50.6±11.9
	Combined	100	23-80	61.5±11.4
Hip fracture	Female	33	54-94	75.0±10.2
	Male	17	48-95	72.5±12.8
	Combined	50	48-95	74.2±11.1

All subjects were white except for five females and eight males with hip fracture who were black.

Several three-dimensional quantities were derived from the primary two-dimensional area and perimeter length measurements. TBV expressed as a percentage of total tissue volume is identical with the two-dimensional percentage area (15). Bone surface density (bone surface area in square millimeters per cubic millimeter of tissue;  $S_v$ ) is obtained as follows: (two-dimensional perimeter)/(unit tissue area)  $\times 1.199$ ; this value was experimentally determined for iliac trabecular bone (28) and is slightly smaller than the value  $4/\pi$  (1.273) used for structures without preferred spatial orientation (15). Bone surface to volume ratio (bone surface area in square millimeters per cubic millimeter of bone  $S/V$ ) is given by  $S/V = (S_v/TBV)100$ . Normal trabecular bone consists mainly of interconnecting plates (9, 10) and it is conceptually useful to partition the total TBV into an index of the thickness of individual plates and an index of the number of plates. An indirect estimate of mean trabecular plate thickness (MTPT) in micrometers is given by  $MTPT = 2,000/(S/V)$  (13-15). Values for MTPT obtained by this method correlate significantly with, and do not differ in mean value from, values obtained by direct measurement of the width of individual trabecular profiles (14, 29). Unlike the direct method, however, the indirect method gives no information on the variability of thickness within a single sample. A notional expression of trabecular plate number can be derived by dividing volume by mean thickness according to the equation: Mean trabecular plate density (MTPD; per millimeter) =  $TBV(\text{percent}) \times 10/MTPT$  (in micrometers). From previously given relationships, it follows that  $MTPD = S_v/2$ , but, although numerically related and dimensionally equivalent, MTPD and  $S_v$  are expressed in different units and represent different concepts; the relationship between them is shown in Fig. 1. When divided by  $\pi/2$ , MTPD is an estimate of the frequency with which a scanning line will intersect a structural element of bone (number of intersections per millimeter) averaged over all directions of scanning (Fig. 2 and reference 15). Finally, an index of the distance between trabecular plates is given by: Mean trabecular plate separation (MTPS; in micrometers)

=  $1,000/MTPD - MTPT = MTPT (100/TBV - 1)$ . This expression gives the shortest distance between the plates, on the assumption that they are parallel (Fig. 1); when multi-

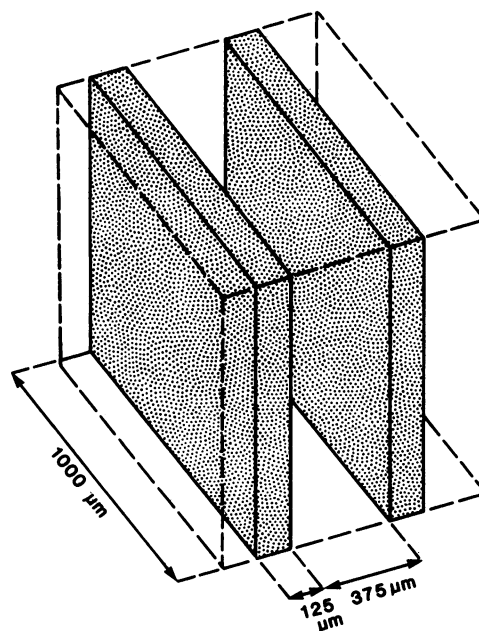

FIGURE 1 Diagram to show relationships between calculated three-dimensional quantities. A cube of tissue with sides of length 1 mm contains two parallel plates of bone, each with a surface area of 1 mm<sup>2</sup> on each side. With the distances shown, TBV = 25%,  $S_v = 4.0 \text{ mm}^2/\text{mm}^3$ ,  $S/V = 16.0$ ,  $MTPT = 125 \mu\text{m}$ ,  $MTPD = 2.0/\text{mm}$ , and  $MTPS = 375 \mu\text{m}$ .

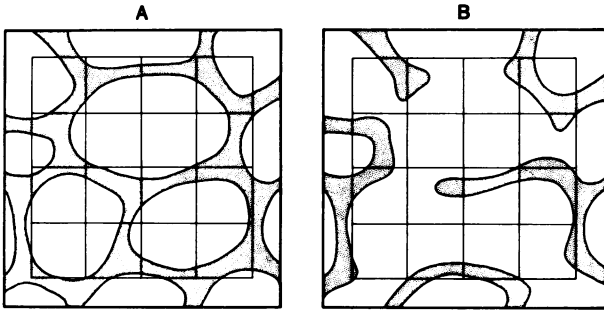

FIGURE 2 Diagram to demonstrate the significance of MTPD and MTPS in a bone section. On the left (A) is shown the continuous trabecular profile characteristic of a young person, and on the right (B) the discontinuous trabecular profiles characteristic of an elderly person. Superimposed on each field of area 6.25 mm<sup>2</sup> is the image of an eyepiece graticule consisting of five horizontal and five vertical lines each of length 2 mm, so that each small square has sides of 500  $\mu$ m and the total length of test lines is 20 mm. By direct measurement on the original print using the Zeiss MOP 3 digitizing system, the following values were obtained:

	TBV	$S_v$	S/V	MTPT	MTPD	MTPS
A	27.2	3.48	12.8	156	1.74	418
B	19.8	2.62	13.2	151	1.31	613

The number of intersections of test lines on bone, counting one-half if the test line does not extend all the way across, is 21.5, or 1.075/mm, in A and 16.5, or 0.825/mm, in B. Corresponding values for MTPD ( $2/\pi$ ) are 1.108 for A and 0.833 for B. The mean length of test lines overlying marrow cavities is 751  $\mu$ m for A and 911  $\mu$ m for B, with corresponding values for MTPS ( $\pi/2$ ) of 657 and 963  $\mu$ m. This indicates that a lower value for MTPD corresponds to a decreased probability that a test line (or scanning line) will intersect a bone profile, and that a greater value for MTPS corresponds to an increase in the size and connectivity of the marrow cavities. It is also evident that, if the same reduction in TBV is a result of a reduction in trabecular plate thickness with no change in plate density, the probability of intersection would be virtually unchanged.

plied by  $\pi/2$ , it is an estimate of the mean marrow cavity width averaged over all directions of scanning (Fig. 2 and reference 15).

To clarify the relationships between the derived three-dimensional quantities, each can be expressed solely in terms of the primary measurements. Denoting the total bone perimeter length in millimeters as  $P_B$ , the total bone area in square millimeters as  $A_B$ , and the total section area in square millimeters (treated as a constant) as  $A_T$ , then  $TBV = (A_B/A_T)100$ ,  $S_v = (P_B/A_T)1.199$ ,  $S/V = (P_B/A_B)1.199$ ,  $MTPT = (2,000/1.199)(A_B/P_B)$ ,  $MTPD = (1.199/2)(P_B/A_T)$ , and  $MTPS = (2,000/1.199)(A_T - A_B)/P_B$ . For statistical calculation, comparison of means was performed with an unpaired *t* test or one-way analysis of variance as appropriate (30, 31), comparison of proportions by the chi-squared test (30), comparison of standard deviations by the *F* (variance ratio) test (31), and linear regression and correlation coefficients computed by the method of least squares (30).

## RESULTS

In the control subjects, there was no significant difference in age or in any primary measurement or derived index between the autopsy and biopsy cases. The results of all indices in the control subjects classified by sex and by age with division at 50 yr are given in Table II. In females, TBV was significantly lower in the older subjects, with an approximately proportional decrease in  $S_v$  and in plate density, and a significant increase in plate separation. There was no change in S/V or trabecular thickness. The same directional changes were observed in the male subjects, but they were of smaller magnitude than in females and attained statistical significance only for plate separation.

The relationships of the principal structural indices to age in the female control subjects are shown in Fig. 3 and the parameters of the regression equations for both sexes are given in Table III. In females, both TBV and plate density showed a highly significant negative regression on age, but for plate thickness the slope did not differ significantly from zero. The dispersion of the data increased with age for plate thickness (with a suggestion of bimodality), but decreased with age for plate density, with corresponding changes in the standard deviations (Table II). In males, results were similar, except that the slopes and *r* values for TBV and MTPD were smaller than in females. Even when data from the two sexes were pooled, the fall of MTPT with age did not attain statistical significance, but there was a higher proportion of both high and low values, and the increase in standard deviation was more significant than in females alone (Table II). If age-predicted values for TBV and MTPD are obtained from the regression equations, a notional predicted value for MTPT is given by  $(\text{predicted TBV})10/(\text{predicted MTPD})$ ; this calculated quantity declines only by  $\sim 1\%$  per decade in both sexes. The relationship between TBV and plate thickness and density in individual cases is shown in Fig. 4, and corresponding regression equations are given in Table IV. In keeping with the changes in standard deviation with age, the contribution of plate density to the variation in TBV was greater in the younger subjects and the contribution of plate thickness was greater in the older subjects, most likely because of compensatory increase in plate thickness with age in some subjects.

Mean values of all indices in the osteoporotic patients classified by type of fracture and by sex are given in Table V, and observed mean values are compared with age predicted mean values in Table VI. There was no correlation of TBV, MTPT, or MTPD with age in any subgroup of fracture patients or in the whole group. The relationships of these indices to age in female patients with vertebral fractures are shown in

TABLE II  
Structural Indices of Trabecular Bone in Control Subjects

	Female		Male		Combined	
	≤50 yr	>50 yr	≤50 yr	>50 yr	≤50 yr	>50 yr
TBV, %	25.71±5.47	19.43*±6.16	24.42±6.81	20.08±7.84	25.05±6.14	19.60*±6.55
S <sub>v</sub> , mm <sup>2</sup> /mm <sup>3</sup>	3.560±0.820	2.785*±0.552	3.404±0.716	2.880±0.822	3.48±0.762	2.811*±0.625
S/V, mm <sup>2</sup> /mm <sup>3</sup>	14.05±2.56	15.38±4.24†	14.39±2.69	15.13±3.24	14.23±2.60	15.31±3.96§
MTPPT, μm	147.0±24.9	140.3±40.6†	143.6±26.8	138.5±34.2	145.3±25.6	139.8±38.6§
MTPD, /mm	1.780±0.410	1.393*±0.276†	1.702±0.358	1.440 <sup>  </sup> ±0.411	1.740±0.381	1.405*±0.313
MTPS, μm	444.1±132.8	605.2*±151.2	470.7±138.5	602.4 <sup>  </sup> ±196.6	457.7±134.5	604.4*±161.1

Subjects classified by sex and age; number of cases and ages in Table I. Values given as mean±SD in each group. Location of footnotes indicates whether comparison is between means (unpaired *t* test) or between standard deviations (variance ratio or *F* test); groups compared are older and younger subjects in each category.

\* *P* < 0.001.

† *P* < 0.05.

§ *P* < 0.01.

<sup>||</sup> *P* < 0.05 for one-tailed test.

Fig. 5. Most values for TBV were in the lower half of the 95% confidence range of the regression established in normal subjects, but only 10% of the values were below the lower limit; by contrast, 40% of the values

for MTPD were below the lower descriptive boundary for normal subjects (Fig. 5). Mean TBV was 40% lower than expected for the patients' age (Tables V and VI), with a corresponding increase in plate separation of 71% (Table V), but plate thickness was reduced by only 8% (Table VI). In contrast to density, the change in thickness as not significant (Table V); furthermore, the relative deviation from age-predicted values was significantly smaller for thickness than for density (Table VI).

The same directional differences were present in males with compression fracture (Table V). Compared with age-predicted values (Table VI), the deficit in TBV was larger than in females (48%), even though the absolute values were similar. As in females, most of this difference was due to a reduction in plate density of 35% (Table VI), with a corresponding increase in plate separation of 56% (Table V). In contrast to females, there was also a significant reduction in plate thickness of 18%, which made a relatively greater contribution than in females to the low TBV, but the relative deviation from age-predicted values was still significantly less than for plate density (Table VI). The relationship between TBV and plate thickness and density in individual cases is shown in Fig. 6 and corresponding regression equations are given in Table IV. In contrast to normal subjects, variation in plate density and in plate thickness made approximately equal contributions to the variation in TBV, but most individual values for plate thickness were normal, whereas many individual values for plate density were reduced.

The clinical heterogeneity of the hip fracture patients had no discernible effect on the results. There was no significant difference in any measurement or

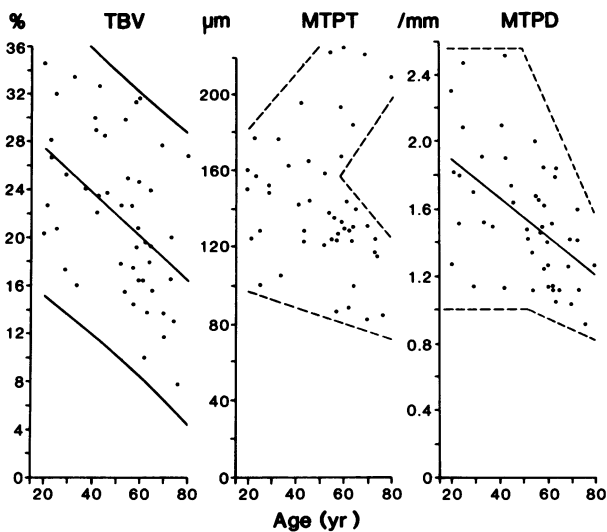

FIGURE 3 Relationships of the principal structural indices to age in female control subjects. For TBV, the regression line and 95% confidence limits for individual values are shown. For MTPPT, there was no significant regression on age; the interrupted lines are the descriptive boundaries of the data determined by inspection. For MTPD, the regression line is shown, but the confidence limits are omitted because the dispersion of the data declines significantly with age. The descriptive boundaries are partly based on the SD for the subjects younger than 50 yr. Parameters of regression equations given in Table III.

TABLE III  
Regressions of Bone Structural Indices on Age

y	x	Group	n	Regression equations	r
TBV	Age	Females	48	$y = 31.2 - 0.184x$	0.474*
		Males	30	$y = 29.3 - 0.148x$	0.357†
		Combined	78	$y = 30.3 - 0.168x$	0.430*
MTPT	Age	Females	48	$y = 152.9 - 0.197x$	0.095
		Males	30	$y = 149.6 - 0.184x$	0.112
		Combined	78	$y = 150.8 - 0.176x$	0.094
MTPD	Age	Females	48	$y = 2.126 - 0.0115x$	0.515*
		Males	30	$y = 2.003 - 0.0090x$	0.406†
		Combined	78	$y = 2.069 - 0.0104x$	0.478*

Data from control subjects.

\*  $P < 0.001$ .

†  $P < 0.005$ .

derived index between males and females (Table V) or between blacks and whites (not shown). There was also no significant difference between the 26 patients who had one or more of the listed additional conditions (such as diabetes) and the 24 patients who did not (Table VII). Neither did subgroups with diabetes, alcoholism, or miscellaneous conditions differ significantly in any measurement, either between themselves or with the 24 uncomplicated patients, except that

patients with alcoholism were significantly younger than the other patients. Because of the demonstrated morphologic homogeneity between the subgroups, they were combined for further analysis. However, none of the major conclusions of the study would be altered if the analysis was based solely on the 24 uncomplicated patients.

Taken together, the hip fracture patients showed the same directional changes in all structural indices as the

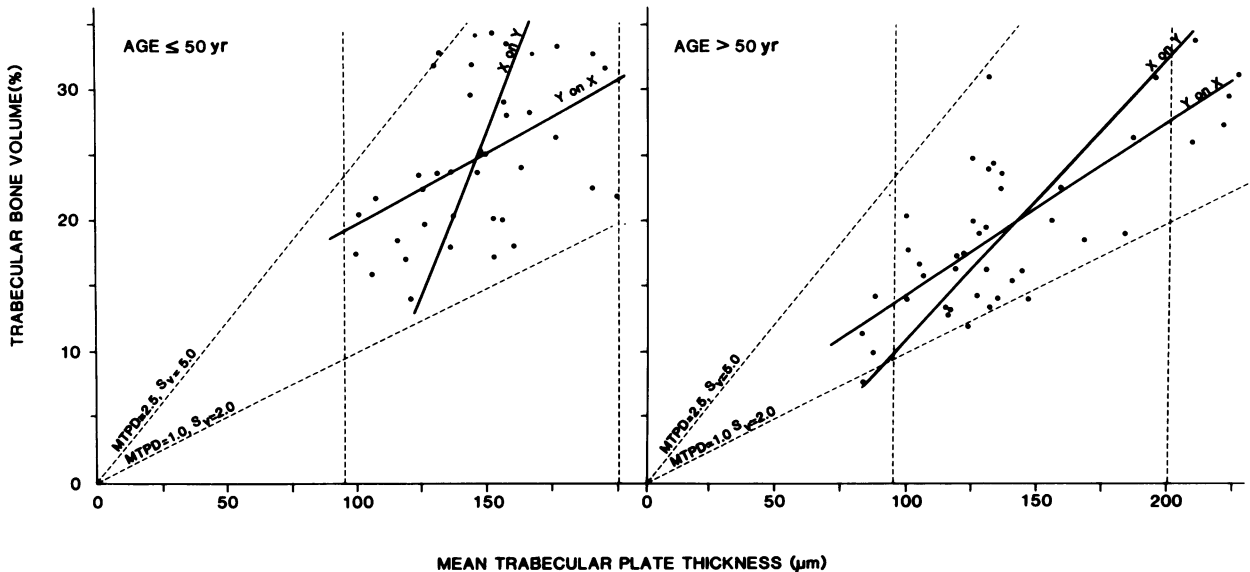

FIGURE 4 Relationship between TBV and MTPT in control subjects, with younger subjects on the left and older subjects on the right. The interrupted lines radiating from the origin represent equal values for MTPD and  $S_v$ . Vertical interrupted lines indicate ranges for MTPD in the young subjects. Solid lines are least-square regression lines; parameters for  $y$  on  $x$  (Table IV) indicate a fall in intercept but not in slope in older subjects.

TABLE IV  
Regressions of TBV on Its Components

y	x	Group	n	Regression equation	r	r <sup>2</sup>
TBV	MTPT	Young normal subjects	37	$y = 8.82 + 0.112x$	0.466*	0.217
		Old normal subjects	41	$y = 1.08† + 0.132x$	0.779§	0.606
		Vertebral fracture	100	$y = 3.50 + 0.065x^{  }$	0.597§	0.356
		Hip fracture	50	$y = 3.07 + 0.083x^{  }$	0.543§	0.294
		Combined	228	$y = -0.99 + 0.127x$	0.599§	0.359
TBV	MTPD	Young normal subjects	37	$y = 3.95 + 12.1x$	0.742§	0.552
		Old normal subjects	41	$y = 2.36 + 12.3x$	0.585§	0.342
		Vertebral fracture	100	$y = 3.56 + 8.5x$	0.602§	0.362
		Hip fracture	50	$y = 1.11 + 10.3x$	0.736§	0.542
		Combined	228	$y = -1.24 + 13.99x$	0.828§	0.686

Data from all subjects.

\*  $P < 0.001$ .

† Intercept significantly lower than in young normal subjects ( $P < 0.001$ ).

§  $P < 0.001$ .

|| Slope significantly lower than in old normal subjects ( $P < 0.001$ ).

¶ Slope significantly lower than in old normals ( $P < 0.05$ ).

compression fracture patients (Table V), but the deviations from age-predicted values showed significant differences between the two fracture types (Table VI). In white, nonalcoholic, hip fracture patients, TBV was only 27% less than expected, a smaller deficit than in those with compression fractures. Trabecular plate thickness was significantly lower in the combined hip fracture patients than in the older normal subjects ( $P < 0.02$ ). Furthermore, the reduction in plate thickness of ~20% made a greater contribution to the additional loss of trabecular bone than the reduction in plate density of ~8% (Table VI); compared with compression

fracture, this represents a reversal in the relative importance of these structural changes. However, the absolute deficit in hip fracture patients compared with young adults was still greater for plate density (-37%) than for plate thickness (-21%). The relationship between TBV and plate thickness and density in individual cases is shown in Fig. 5 and corresponding regression equations are given in Table IV. Compared with patients with compression fractures, there was more variability in TBV and plate density and less variability in plate thickness.

The relationship between surface density and TBV

TABLE V  
Structural Indices of Trabecular Bone in Osteoporotic Subjects

	Vertebral fracture			Hip fracture		
	Female	Male	Combined	Female	Male	Combined
TBV, %	11.69*±3.55	11.33±2.72	11.58*±3.31	12.12*±4.50	13.29±5.16	12.52±4.71
$S_v, mm^2/mm^3$	1.830*±0.436	2.018†±0.526	1.886*±0.470	2.104§±0.616	2.402±0.744	2.206  ±0.670
$S/V, mm^2/mm^3$	16.40±4.02	18.19  ±3.79	16.94  ±4.17	18.90±3.69	18.29±4.55	18.50  ±4.25
MTPPT, $\mu m$	128.6±31.0	115.3±27.6	124.6  ±30.5	117.2±34.1	110.3±24.7	114.8  ±31.1¶
MTPD, per mm	0.915*±0.218	1.009†±0.263	0.943*±0.235	1.052§±0.308	1.201±0.372	1.103*±0.335
MTPS, $\mu m$	1034.2*±319.7	941.1±267.3	1006.3*±306.6	931.3§±359.5	819.8±380.5	893.4†±366.8

Patients classified by type of fracture and by sex. Numbers of cases and ages in Table I.  $P$  values refer to differences between the fracture patients and controls (columns 1, 3, and 4), between sexes (columns 2 and 5), or between fracture types (column 6).

\*  $P < 0.001$ .

†  $P < 0.0$  for one-tailed test.

§  $P < 0.01$ .

||  $P < 0.05$ .

¶ Comparison with female vertebral fractures; other comparisons with combined group.

TABLE VI  
*Deviations from Age-predicted Values in Osteoporotic Subjects*

	Vertebral fracture			Hip fracture		
	Female	Male	Combined	Female	Male	Combined
TBV, %						
Abs.	-7.4±0.4	-10.5±0.5	-8.3±0.4	-4.8*±1.0	-4.1†±2.0	-4.7†±0.9
%	-38.3±2.3	-48.0±2.2	-41.2±1.8	-26.8±5.6	-23.0±11.7	-28.0±5.0
MTPD, /mm						
Abs.	-0.45±0.03	-0.5±0.05	-0.48±0.02	-0.16‡±0.06	+0.04‡±0.18	-0.12‡±0.06
%	-32.9±1.9	-34.7±3.0	-33.4±1.6	-11.1±5.3	+4.6±15.2	-7.9±5.2
MTPT, μm						
Abs.	-10.7±3.7	-25.7±5.0	-15.1±3.1	-23.7§±6.4	-38.4±7.0	-26.7  ±5.4
%	-7.7‡±2.7	-18.1‡±3.6	-10.8‡±2.2	-17.3±4.7	-28.3§±5.1	-19.5±3.9

Data are means±SE of individual differences between observed values and values predicted from regressions on age in normal subjects and individual ages, expressed in absolute (Abs.) or relative (%) terms. (Note difference from percentage as the unit of TBV). Predicted values for MTPD are given by (predicted TBV × 10)/(predicted MTPD). Only white, nonalcoholic, hip fracture patients included (27 female, seven male), since the regressions on age were established only in white subjects and the relationship to age was different in alcoholic subjects. The four footnoted probability values in bottom line refer to comparison of percentage deviations between MTPD and MTPT; all other footnoted probability values refer to comparison between fracture types for different subsets based on sex, determined in both cases by unpaired *t* test applied to the individual differences.

\* *P* < 0.01.

† *P* < 0.001.

§ *P* < 0.05 for one-tailed test.

|| *P* < 0.05.

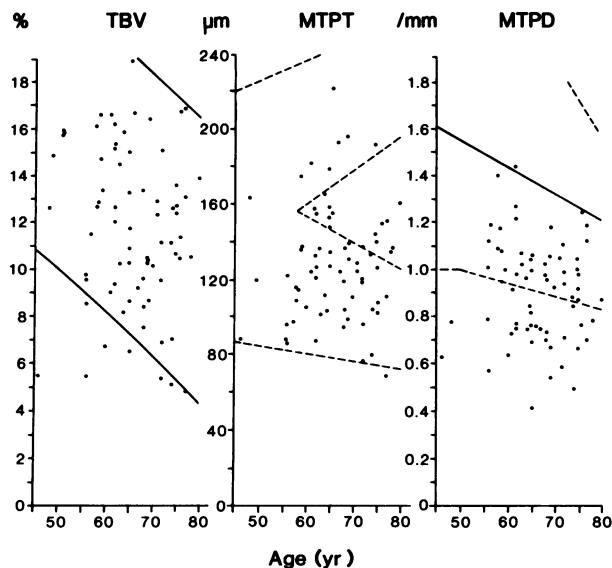

FIGURE 5 Relationships of principal structural indices to age in female patients with vertebral fractures. Layout as for Fig. 3, except for differences in scale. Solid and interrupted lines denote regression lines, confidence limits, or descriptive boundaries, as in Fig. 3; note that MTPD discriminates between normal and osteoporotic subjects more effectively than TBV.

in the entire study population, subdivided into those with and without fractures is shown in Fig. 7. There was a highly significant correlation between these two conceptually independent measurements in each group and in the two groups combined ( $r = 0.828$ ,  $P < 0.001$ ). Over a wide range, the individual points conform reasonably well to a theoretical model of the relationship between the surface density and porosity of bone (12), with porosity for trabecular bone defined as  $100 - \text{TBV}$ . This relationship will no longer hold when porosity falls much below 60% (TBV > 40%).

## DISCUSSION

The concept of MTPD that we have originated is central to the interpretation of our data and to the inferences that we will draw concerning the mechanisms of bone loss. MTPD must be distinguished from the number of isolated trabecular profiles observable in a histologic section. This number can increase, even though MTPD as we have defined it is reduced, as is evident from Fig. 2. We reemphasize that MTPD is an index of the probability that a test or scanning line will intersect a structural element of bone, whether plate or bar. Others have observed a proportional reduction in surface density and bone volume with age,



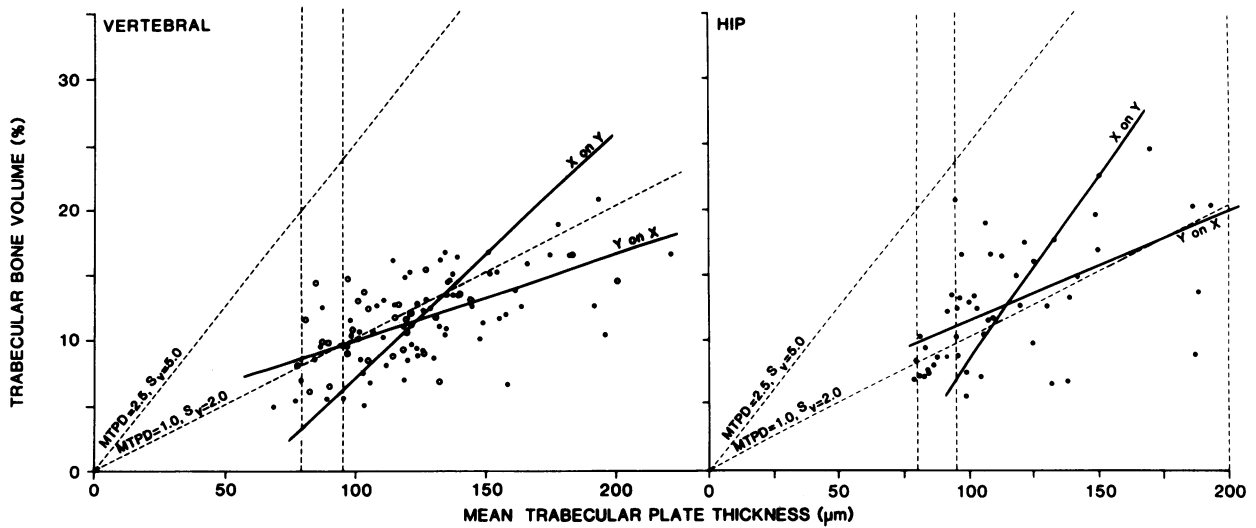

FIGURE 6 Relationship between TBV and MTPD in patients with osteoporosis. Vertebral fracture patients are on the left; females, ●; males, ○. Hip fracture patients are on the right; sexes, races, and clinical subgroups are combined, because there were no significant differences among them. Oblique and vertical interrupted lines as in Fig. 4, with additional vertical line to indicate lower limit for MTPD in the older normal subjects. Parameters of regression lines ( $y$  on  $x$ ) in Table IV indicate reduction in slope in both groups compared with older normals.

but the dependence of total surface on the frequency of intersection and so on the distance between structural elements has not previously been demonstrated. MTPD, which is the reciprocal of the mean distance between the midpoints of structural elements, multiplied by  $\pi/2$  (Figs. 1 and 2 and Table VIII) accurately reflects the structural changes and enables the reduction in TBV both in aging and in osteoporosis to be

partitioned into its two principal structural components.

Our normal subjects were relatively few in number and diverse in origin, but the changes we observed with age are similar to those found by other investigators. The values for TBV were slightly higher than in other series (1, 2, 4); this was possibly because we included the peripheral zone of the trabecular space.

TABLE VII  
Comparison between Hip Fracture Patients with and without a Coexisting Condition

Association	None (n = 24)	Combined (n = 26)	Diabetes (n = 11)	Alcoholism (n = 7)	Miscellaneous (n = 13)
Age, yr	77.71±10.50	70.88*±10.73	73.64±10.81	61.00†±8.62	74.08±10.58
TBV, %	12.61±5.28	12.43±4.23	13.59±4.26	11.07±4.41	12.43±4.66
$S_v$ , $mm^2/mm^3$	2.240±0.702	2.146±0.650	2.220±0.422	1.999±0.812	2.192±0.686
$S/V$ , $mm^2/mm^3$	18.95±4.61	18.13±3.97	17.92±4.51	18.07±3.36	18.68±4.58
MTPD, $\mu m$	113.3±33.9	116.1±28.9	118.8±32.3	113.5±19.1	114.9±36.0
MTPD, per $\mu m$	1.120±0.351	1.073±0.325	1.110±0.211	1.000±0.406	1.096±0.343
MTPS, $\mu m$	876.8±362.7	905.8±367.8	792.1±187.5	1088.0±590.4	877.6±262.8

Column 1 includes patients without diabetes, alcoholism, or other specified condition. The combined group includes 11 patients with diabetes, seven with chronic alcoholism, three receiving thyroxine, two with rheumatoid arthritis, two with asymptomatic hyperparathyroidism, one each with myelomatosis and mild chronic renal insufficiency, and four with values for relative osteoid volume between 5 and 10%; five patients had more than one of these conditions. The diabetic group includes one patient with alcoholism, and the alcoholism group includes one patient with diabetes. The miscellaneous group includes all cases with a condition other than diabetes or alcoholism; four had diabetes as well. None of the differences between the groups is significant, except that the combined group and the alcoholism group were significantly lower in age than the group without other conditions.

\*  $P < 0.01$ .

†  $P < 0.001$ .

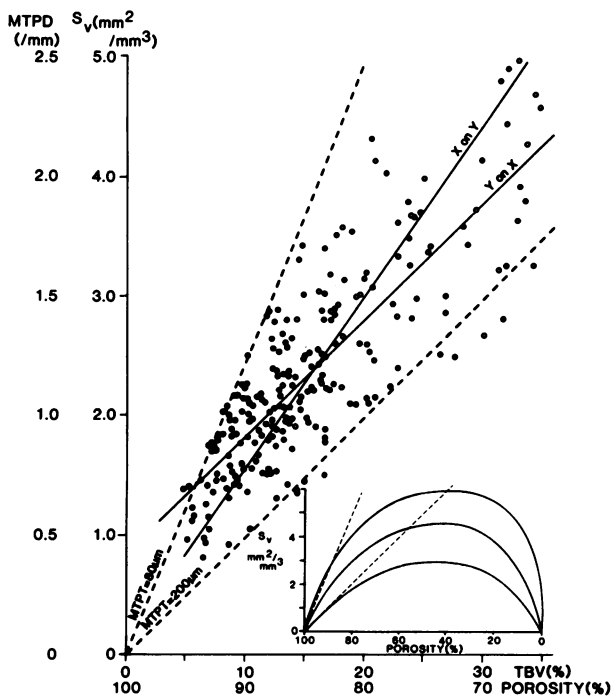

FIGURE 7 Relationship between  $S_v$  and TBV in entire study population ( $n = 228$ ). Normal subjects,  $\circ$ ; patients with fracture,  $\bullet$ . Oblique interrupted lines denote values for MTPD of 80 and 200  $\mu\text{m}$ . Solid lines are least-square regression lines. Scales are also shown for mean trabecular plate density ( $=S_v/2$ ) and porosity ( $=100 - \text{TBV}$ ). Figure in inset shows theoretical relationship between  $S_v$  and porosity of bone derived by Martin (12).

The same difference in method probably contributes to the smaller decline with age we have found in mean trabecular thickness, since we may have included some thicker trabecular plates at the periphery that have arisen by subendosteal tunneling of the cortex (32). Moreover, the indirect method of measuring mean thickness may conceal a fall in some regions offset by an increase in other regions of the same biopsy. Nevertheless, each of our conclusions is supported by much other evidence. Previous anatomic studies have demonstrated a proportional reduction in total surface and trabecular bone volume with age (13, 19), and a relatively much smaller reduction in trabecular thickness, whether measured directly (16) or indirectly (13, 19). Direct measurement of trabecular spacing (17) showed an increase with age with which our indirect measurements agree remarkably well (Table VIII).

The reduction in TBV we observed in all three groups of osteoporotic patients was of magnitude similar to that reported in vertebral fracture cases by other investigators (1, 2, 6). The separation between subjects with and without compression fractures was not quite

so clear as others have found (2), probably because of our inclusion of the entire trabecular space; only 10 of 70 females and none of 30 males exceeded the upper limit of 16% for TBV in patients with compression fracture found by Courpron et al. (2). Some of the most severely affected patients were probably excluded by the need for an unfragmented specimen, but the lower limit of TBV was only slightly higher than in other series (2). Among patients with compression fractures, males were significantly younger than females; most would be classified as having idiopathic osteoporosis, a condition that differs in several respects from the much more common postmenopausal and age-related osteoporosis (33). In the patients with hip fracture, our mean value for TBV of 12.77 is similar to the mean value of 13.44 reported recently from the Netherlands (34), with a similar lack of sex difference in the absolute values. In that study, TBV was lower than in age-matched control subjects in males with hip fracture, but not in females. However, using the regressions of TBV on age determined in younger control subjects (Table VI), we did not observe such a sex difference.

All the data lead to the conclusion that the normal loss of trabecular bone with age occurs predominantly by a process that removes entire structural elements of bone, leaving those that remain more widely separated but only slightly reduced in thickness, thus transforming the mainly continuous trabecular network characteristic of a young person into the mainly discontinuous network characteristic of the elderly (Fig. 2). These structural changes are more severe in patients with compression fractures, in whom the additional deficit in TBV compared with normal subjects of the same age was the result mainly of a further reduction in trabecular plate density and further increase in trabecular plate separation. Unfortunately, we cannot determine from our data whether these

TABLE VIII  
Mean Interplate Distance: Comparison between Measurements Made in Two Ways

Sex	Age	Interplate distance	
		Indirect	Direct
		$\mu\text{m}$	
Female	<50	928	947
	>50	1,207	1,166
Male	<50	945	994
	>50	1,092	1,093

Data from normal subjects. Mean interplate distance measured between midpoints either indirectly as  $(\text{MTPS} + \text{MTPD}) \pi/2$  (Table II) or directly (17).

patients had lost more trabecular plates than normal or whether they had fewer to start with; most likely both factors contributed. In males, MTPT was significantly reduced, but in females the reduction was much smaller, and did not attain statistical significance. Only in the patients with hip fracture, in whom mean age was significantly higher than in any other subject group, could a significant fall in MTPT be demonstrated and only in this group did trabecular thinning make a major contribution to the additional loss of trabecular bone relative to age. These structural characteristics of osteoporosis have not hitherto been identified explicitly, although they are implicit in some preliminary data from other laboratories (29, 35, 36).

One reason for distinguishing between density and thickness of trabecular plates is that the possibilities of change with time are different. Normally, all trabeculae are made by the process of endochondral ossification, so that new trabeculae cannot appear after epiphyseal fusion, unless some pathologic process such as Paget's disease or metastatic cancer leads to *de novo* formation of woven bone within the marrow cavity (1, 33). Consequently, trabecular plate density can decrease with age but can never increase. Trabecular plate thickness, however, can change in either direction, as is evident from the increased frequency of both higher and lower mean values with increasing age (Fig. 3). This distinction has important implications for the treatment of osteoporosis. An increase in TBV, however produced, can only occur by thickening of existing trabeculae. The compressive strength of trabecular bone depends more on preservation of connections between the structural elements than on the amount of bone present (11); the thickened trabeculae produced by treatment would remain disconnected, so that increasing TBV even to normal would not restore a biomechanically normal skeleton. Once lost, trabecular plates can never be replaced. Consequently, prevention of bone loss is much more important than attempting to repair the damage once it has occurred.

Possible cellular mechanisms for loss of bone must be considered in relation to the intermediary organization of the skeleton (37) and the quantum concept of bone remodeling (38). According to this concept, a finite amount of bone is removed from a surface by osteoclastic resorption and the resultant cavity is then more or less completely refilled by osteoblasts appearing in the same location to form a new bone structural unit, which is separated from older bone by a cement line. The focal imbalance between the amounts of bone resorbed and formed, which is both a necessary and a sufficient condition for bone loss, can arise because either the cavity eroded is too large or the new structural unit formed within the cavity is too small. An index of the size of new bone structural units is the

mean distance between quiescent bone surfaces and the cement line, referred to as mean wall thickness (39). This quantity declines with age and is lower in patients with osteoporosis than in normal subjects of the same age (40), indicating a defect either in the recruitment of osteoblasts or in their individual activity (41). However, the mean thickness of interstitial bone separating structural units on opposite sides of a trabecular plate increases with age (29, 42), indicating that the mean depth of resorption cavities also declines with age, although by a lesser amount than mean wall thickness.

It is reasonably well established that this cellular mechanism underlies the slow reduction in trabecular plate thickness with increasing age (29, 42), but it is highly unlikely that the same mechanism is responsible for the reduction in trabecular plate density. First, if complete loss of a trabecular plate was the end result of progressive trabecular thinning, then the reduction in plate thickness would occur at an earlier age than the reduction in plate density, which is the opposite of what happens (Tables II and V). Second, there would be progressive accumulation of plates that were thinner than normal plates, representing the transitional stages before complete removal (Fig. 8 A). But

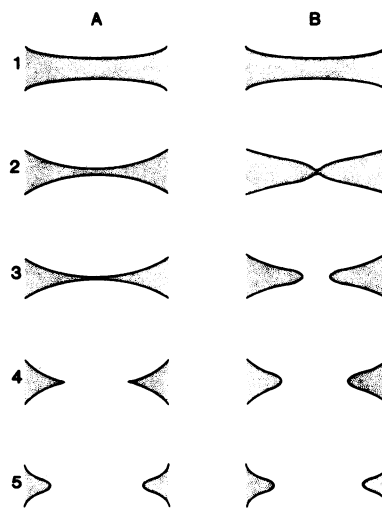

FIGURE 8 Two hypothetical mechanisms for the structural changes illustrated in Fig. 2. In sequence A, a trabecular plate becomes progressively thinner before being removed completely. In sequence B, a trabecular plate undergoes focal perforation which progressively enlarges. Note that stages 1 and 5 are the same for both sequences and that the intervening stages are purely illustrative; they are not meant to represent equal intervals of time or the same intervals of time for the two sequences. The necessary intermediate stages for sequence B are more commonly observed than for sequence A.

the frequency distribution of directly measured trabecular plate thickness at different ages indicated no such accumulation; in fact, structural elements thinner than 50  $\mu\text{m}$  represented less than 4% of the total at all ages (17).

If complete loss of a trabecular plate is not due to a defect in osteoblast function and consequent reduction in mean wall thickness, the obvious alternative is an abnormality in osteoclast function leading to increased depth of resorption cavities. With such a defect, successive cycles of remodeling could quickly lead to focal perforation of a trabecular plate, and progressive enlargement of the perforation could ultimately remove the plate completely (Fig. 8 B). Currently, active perforation is difficult to find, as would be expected if it was a rapid and so short-lived process, but it has been directly observed in the vertebral bodies by Arnold (43), who assigned to this process a central role in the conversion of trabecular plates to bars and rods (44). Serial computed tomography of the spine after bilateral oophorectomy discloses focal defects consistent with trabecular plate perforation after  $\sim 2$  yr (45). Finally, exaggerated depth of resorption cavities has been demonstrated directly in the vertebral bodies of monkeys immobilized in a plaster jacket for 2 wk (46), establishing the existence in a primate species of the defect in osteoclast function that is proposed to account for the main structural component of age-related bone loss.

On the basis of the data presented here, the inferences drawn from these data, and supporting data from numerous other studies, we give a tentative description of the microstructural and cellular basis of age-related bone loss, which can serve as the basis of future research. In the first 5 yr after menopause in women, there is a period of rapid bone loss (33) brought about by perforation of trabecular plates and progressive enlargement of the perforations and eventual conversion of the plates to bars and rods (44). This is initiated both by an increase in the overall rate of bone remodeling (47), and by augmentation of individual osteoclast function, so that resorption cavities are eroded to a greater depth than normal. In time, the rate of bone turnover falls and resorption cavities get progressively shallower, but there is continuing slow bone loss due to thinning of residual structural elements as a result of the decrease in the number and/or stamina of osteoblasts described earlier. Clinical osteoporosis could occur because bone mass at maturity was too low (whether as a result of too few trabecular plates, thinner than normal plates, or both), because of exaggerated loss of trabecular plates, or because of excessive thinning of residual trabecular plates. Varying combinations of these different factors in individual patients with compression fractures would con-

tribute to the histologic heterogeneity in their bone biopsies (7, 48).

Such conclusions are independent of the state of bone remodeling at the time of the biopsy. Based on in vivo double tetracycline labeling, the mean bone formation rate is substantially reduced in patients with postmenopausal osteoporosis (48). Most such patients are no longer losing bone faster than normal persons of the same age, whether judged by serial dual photon absorptiometry of the spine (49), by external calcium balance (50, 51), or by serial metacarpal morphometry (52). Moreover, mean TBV in patients with compression fractures is the same at all ages (reference 3 and Fig. 5). Consequently, it can be inferred that the bone resorption rate must also be reduced in the majority of osteoporotic patients. The methods we devised for examining the wreckage of the skeleton enabled us to reconstruct what must have happened in the past, even if it came to an end a decade or longer before the biopsy. The previous episodes of increased bone resorption that we have inferred are supported by much biochemical (53) and calcium radiokinetic (47) data obtained in normal postmenopausal females, and are entirely consistent with a reduced rate of bone resorption at the time of the biopsy.

#### ACKNOWLEDGMENTS

We thank F. Melsen and S. Teitelbaum for provision of bone samples from normal subjects, C. Schock and R. Wixsom for obtaining bone biopsies from hip fracture patients, S. Aswani and M. Kujawa for preparation of microscopic sections, the Medical Art and Photography Departments of Henry Ford Hospital for preparing the illustrations, J. Miller for secretarial assistance, P. Meunier for making available unpublished data from his laboratory, and J. Arnold for helpful discussions.

#### REFERENCES

1. Rasmussen, H., and P. J. Bordier. 1974. *The Physiological and Cellular Basis of Metabolic Bone Disease*. The Williams and Wilkins Co., Baltimore, MD.
2. Courpron, P., P. Meunier, C. Bressot, and J. M. Giroux. 1977. Amount of bone in iliac crest biopsy. Significance of the trabecular bone volume. Its values in normal and in pathological conditions. *In Bone Histomorphometry. Second International Workshop*. P. J. Meunier, editor. Armour Montague, Paris. 39-53.
3. Meunier, P. J., S. Sellami, D. Briancon, and C. Edouard. 1981. Histological heterogeneity of apparently idiopathic osteoporosis. *In Osteoporosis: Recent Advances in Pathogenesis and Treatment*. H. F. DeLuca, H. M. Frost, W. S. S. Jee, C. C. Johnston, Jr., and A. M. Parfitt, editors. University Park Press, Baltimore. 293-301.
4. Melsen, F., B. Melsen, L. Mosekilde, and S. Bergmann. 1978. Histomorphometric analysis of normal bone from the iliac crest. *Acta Pathol. Microbiol. Scand. Sect. A Pathol.* 86:70-81.
5. Baron, R., A. Vignery, and R. Lang. 1981. Reversal phase and osteopenia: defective coupling of resorption to for-

- mation in the pathogenesis of osteoporosis. *In* Osteoporosis: Recent Advances in Pathogenesis and Treatment. H. F. DeLuca, H. M. Frost, W. S. S. Jee, C. C. Johnston, Jr., and A. M. Parfitt, editors. University Park Press, Baltimore. 311-320.
6. Nordin, B. E. C., J. Aaron, R. Speed, and R. G. Crilly. 1981. Bone formation and resorption as the determinants of trabecular bone volume in postmenopausal osteoporosis. *Lancet*. II:277-279.
  7. Whyte, M. P., M. A. Bergfeld, W. A. Murphy, L. V. Avioli, and S. L. Teitelbaum. 1982. Postmenopausal osteoporosis. A heterogeneous disorder as assessed by histomorphometric analysis of iliac crest bone from untreated patients. *Am. J. Med.* 72:193-202.
  8. Lips, P. Metabolic Causes and Prevention of Femoral Neck Fractures. 1982. University of Amsterdam, Amsterdam.
  9. Amstutz, H. C., and H. A. Sissons. 1967. The structure of the vertebral spongiosa. *J. Bone Jt. Surg. Br. Vol.* 51B:540-550.
  10. Whitehouse, W. J. 1977. Cancellous bone in the anterior part of the iliac crest. *Calcif. Tissue Res.* 23:67-76.
  11. Pugh, J. W., R. M. Rose, and E. L. Radin. 1973. Elastic and viscoelastic properties of trabecular bone: dependence on structure. *J. Biomech.* 6:475-485.
  12. Martin, R. B. Porosity and Specific Surface of Bone. CRC Press, Inc., Boca Raton, FL. In press.
  13. Merz, W. A., and Robert K. Schenk. 1970. Quantitative structural analysis of human cancellous bone. *Acta Anat.* 75:54-66.
  14. Whitehouse, W. J. 1974. The quantitative morphology of anisotropic trabecular bone. *J. Microsc. (Oxf.)*. 101:153-168.
  15. Parfitt, A. M. 1983. The stereologic basis of bone histomorphometry. Theory of quantitative microscopy and reconstruction of the 3rd dimension. *In* Bone Histomorphometry. Techniques and Interpretations. R. Recker, editor, CRC Press, Inc., Boca Raton, FL.
  16. Sissons, H. A., K. J. Holley, and J. Heighway. 1967. Normal bone structure in relation to osteomalacia. 1967. *In* L'Ostéomalacie. D. J. Hioco, editor. Masson & Cie., Paris. 19-37.
  17. Wakamatsu, E., and H. A. Sissons. 1969. The cancellous bone of the iliac crest. *Calcif. Tissue Res.* 4:147-161.
  18. Arnold, J. S., and L. T. Wei. 1972. Quantitative morphology of vertebral trabecular bone. *In* Radiobiology of Plutonium. B. Stover and W. S. S. Jee, editors. The J. W. Press, Salt Lake City, UT. 333-354.
  19. Delling, G. 1978. Age-related bone changes. *Pathology*. 58:117-147.
  20. Pesch, H.-J., H.-P. Scharf, G. Lauer, and H. Seibold. 1980. Der altersabhängige Verbundbau der Lendenwirbelkörper. Eine Struktur- und Formanalyse. *Virchows Arch. A Pathol. Anat. Histol.* 386:21-41.
  21. Byers, P., and R. Smith. 1967. Trepine for full-thickness iliac crest biopsy. *Lancet*. I:682-683.
  22. Rao, D. S. 1983. Practical approach to bone biopsy. *In* Bone Histomorphometry. Techniques and Interpretations. R. Recker, editor. CRC Press, Boca Raton, FL.
  23. Parfitt, A. M., I. Oliver, and A. R. Villanueva. 1979. Bone histology in metabolic bone disease. The diagnostic value of bone biopsy. *Orthop. Clin. North Am.* 10(2):329-346.
  24. Mathews, C. H. E., and L. Mehr. 1979. Staining and processing bone specimen for simultaneous tetracycline-osteoid seam assessment and histomorphometric quantitative analysis. *J. Histotechnol.* 2:23-24.
  25. Smith, J. M., and W. S. S. Jee. 1983. Automated skeletal histomorphometry. *In* Bone Histomorphometry. Techniques and Interpretations. R. Recker, editor. CRC Press, Boca Raton, FL.
  26. Duncan, H. 1976. Cortical porosis: a morphological evaluation. *In* Proceedings of the First Workshop on Bone Morphometry. Z. F. G. Jaworski, editor. University of Ottawa Press, Ottawa, Canada. 78-83.
  27. Olah, A. J. 1977. Influence of microscopic resolution on the estimation of structural parameters in cancellous bone. *In* Bone Histomorphometry. Second International Workshop. P. J. Meunier, editor. Armour Montagu, Paris. 55-61.
  28. Schwartz, M. P., and R. R. Recker. 1981. Comparison of surface density and volume of human iliac trabecular bone measured directly and by applied stereology. *Calcif. Tissue Int.* 561-565.
  29. Courpron, P., P. M. Lepine, and P. J. Meunier. 1982. Analyse pour l'histomorphométrie osseuse des mécanismes de l'ostéopenie due spongieux iliaque humain. University of Lyon, Lyon.
  30. Colton, T. 1974. Statistics in Medicine. Little Brown & Co., Boston.
  31. Sokal, R. R., and F. J. Rohof. 1969. Biometry. The Principles and Practice of Statistics in Biological Research. W. H. Freeman & Co., San Francisco, CA.
  32. Parfitt, A. M. 1977. Some problems in measuring the amount of bone by histologic methods. *In* Bone Histomorphometry. Second International Workshop. P. J. Meunier, editor. Armour Montague, Paris. 103-110.
  33. Parfitt, A. M., and H. Duncan. 1982. Metabolic bone disease affecting the spine. *In* The Spine. R. Rothman and F. Simeone, editors. W. B. Saunders Co., Philadelphia, PA. Second ed. 775-905.
  34. Lips, P., J. C. Netelenbos, M. J. M. Jongen, F. C. van Ginkel, A. L. Althuis, C. L. van Schaik, W. J. F. van der Vijgh, J. P. W. Vermeiden, and C. van der Meer. 1982. Histomorphometric profile and vitamin D status in patients with femoral neck fracture. *Metab. Bone Dis. Relat. Res.* 4:85-93.
  35. Schenk, R. 1976. Trabecular bone volume in iliac crest biopsies. *In* Proceedings of the First Workshop on Bone Morphometry. Z. F. G. Jaworski, editor. University of Ottawa Press, Ottawa, Canada. 97-99.
  36. Dambacher, M. A., M. Langlotz, A. J. Olah, and P. Rueggesser. 1982. Differential diagnosis of metabolic bone diseases. *Orthopäde.* 11:35-46.
  37. Frost, H. M. 1983. The skeletal intermediary organisation: a review. *Metab. Bone Dis. Relat. Res.* 4:281-290.
  38. Parfitt, A. M. 1979. The quantum concept of bone remodelling and turnover: implications for the pathogenesis of osteoporosis. Editorial. *Calcif. Tissue Int.* 28:1-5.
  39. Lips, P., P. Courpron, and P. J. Meunier. 1978. Mean wall thickness of trabecular bone packets in the human iliac crest: changes with age. *Calcif. Tissue Res.* 26:13-17.
  40. Darby, A. J., and P. J. Meunier. 1981. Mean wall thickness and formation periods of trabecular bone packets in idiopathic osteoporosis. *Calcif. Tiss. Int.* 33:199-204.
  41. Parfitt, A. M. 1982. The coupling of bone resorption to bone formation: a critical analysis of the concept and of its relevance to the pathogenesis of osteoporosis. *Metab. Bone Dis. Relat. Res.* 4:1-6.
  42. Courpron, P. 1981. Bone tissue mechanisms underlying osteoporoses. *Orthop. Clin. North Am.* 12:513-545.
  43. Arnold, J. S. 1970. Focal excessive endosteal resorption

- in aging and senile osteoporosis. *In Osteoporosis*. U. S. Barzel, editor. Grune and Stratton Inc., New York. 80-100.
44. Arnold, J. S. 1981. Trabecular pattern and shapes in aging and osteoporosis. *In Bone Histomorphometry*. Third International Workshop. W. S. S. Jee and A. M. Parfitt, editors. Armour Montagu, Paris. 297-308.
  45. Cann, C. E., and H. K. Genant. 1980. Precise measurement of vertebral mineral content using computed tomography. *J. Comput. Assist. Tomogr.* 4:493-500.
  46. Mathews, C. H. E., S. P. Aswani, and A. M. Parfitt. 1981. Hypogravitational effects of hypodynamics on bone cell function and the dynamics of bone remodeling. *In A 14-Day Ground-Based Hypokinesia Study in Nonhuman Primates. A Compilation of Results*. NASA Technical Memorandum 81268.
  47. Heaney, R. P., R. R. Recker, and P. D. Saville. 1978. Menopausal changes in bone remodeling. *J. Lab. Clin. Med.* 92:964-970.
  48. Parfitt, A. M., C. Mathews, D. Rao, B. Frame, M. Kleerekoper, and A. R. Villanueva. 1981. Impaired osteoblast function in metabolic bone disease. *In Osteoporosis: Recent Advances in Pathogenesis and Treatment*. H. F. DeLuca, H. Frost, W. Jee, C. Johnston, and A. M. Parfitt, editors. University Park Press, Baltimore, MD. 321-330.
  49. Krølner, B., and S. Pors Nielsen. 1982. Bone mineral content of the lumbar spine in normal and osteoporotic women: cross-sectional and longitudinal studies. *Clin. Sci.* 62:329-336.
  50. Heaney, R. P., R. R. Recker, and P. D. Saville. 1978. Menopausal changes in calcium balance performance. *J. Lab. Clin. Med.* 92:953-963.
  51. Reeve, J., J. R. Green, R. Hesp., and P. Hulme. 1982. Rates of new bone formation in patients with crush fracture osteoporosis. *Clin. Sci.* 63:153-160.
  52. Crilly, R. G., A. Horsman, M. Peacock, and B. E. C. Nordin. 1981. The vitamin D metabolites in the pathogenesis and management of osteoporosis. *Curr. Med. Res. Opin.* 7(5):337-348.
  53. Crilly, R. G., A. Horsman, D. H. Marshall, and B. E. C. Nordin. 1978. Postmenopausal and corticosteroid-induced osteoporosis. *Front. Horm. Res.* 5:53-75.