

Kinetic Model for Production and Metabolism of Very Low Density Lipoprotein Triglycerides

EVIDENCE FOR A SLOW PRODUCTION PATHWAY AND RESULTS FOR NORMOLIPIDEMIC SUBJECTS

LOREN A. ZECH, SCOTT M. GRUNDY, DANIEL STEINBERG, and MONES BERMAN,
*Laboratory of Theoretical Biology, Division of Cancer Biology and Diagnosis,
National Cancer Institute, National Institutes of Health, Bethesda, Maryland
20205; and Division of Metabolic Disease, Department of Medicine, La Jolla,
California 92093*

ABSTRACT A model for the synthesis and degradation of very low density lipoprotein triglyceride (VLDL-TG) in man is proposed to explain plasma VLDL-TG radioactivity data from studies conducted over a 48-h interval after injection of glycerol labeled with ^{14}C , ^3H , or both. The curve describing the radioactivity of plasma VLDL triglycerides reaches a maximum at about 2 h, after which the decay is biphasic in all cases; the late curvature becoming evident only after 8–12 h. To fit the complex curve, it was necessary to postulate two pathways for the incorporation of plasma glycerol into VLDL-TG, one much slower than the other. A process of stepwise delipidation of VLDL in the plasma compartment, previously proposed for VLDL apoprotein models, was also necessary. Predicted VLDL-TG synthesis rates calculated with this model can differ significantly from those based on experiments of shorter duration in which the slow VLDL-TG component is not apparent. The results of these studies strongly support the interpretation that the late, slow component of the VLDL-TG activity curve is predominantly due to the slowly turning-over precursor compartment in the conversion pathway and is not due either to a slow compartment in the labeled precursor, plasma free glycerol, or to an exchange of plasma VLDL-TG with an extravascular compartment. It also cannot, in these studies, be attributed to a slowly turning-over VLDL-TG moiety in the plasma. The model was

tested with data from 59 studies including normal subjects and patients with obesity and/or various forms of hyperlipoproteinemia. Good fits were obtained in all cases, and the estimated parameter values and their uncertainties for 13 normolipemic nonobese subjects are presented. Sensitivity testing was carried out to determine how critical various parameter estimations are to the assumptions introduced in the modeling.

INTRODUCTION

A number of methods have been employed for estimating the transport of the triglyceride (TG)¹ (1, 2) moiety and the protein moieties (3, 4) of very low density plasma lipoproteins (VLDL) in man. Each method implies certain assumptions about the physiology of the processes, and the results can be highly sensitive to these assumptions.

One approach for estimating transport of VLDL-TG is to inject labeled TG precursors and to analyze the resulting plasma VLDL-TG specific radioactivity curves. Some investigators (5, 6) have used labeled glycerol as precursor and concluded that the specific activity curve of VLDL-TG, after an initial build-up, decayed essentially as a single exponential over the short duration of their studies. They assumed that the exponential rate constant of this early disappearance curve could be taken to represent the fractional

This work was presented, in part, at the 49th Scientific Session of the American Heart Association, Miami Beach, Fla., November 1976.

Received for publication 19 June 1978 and in revised form 21 February 1979.

¹Abbreviations used in this paper: apoB, apoprotein B; FCR, fractional catabolic rate; HDL, high density lipoprotein; IDL, intermediate density lipoprotein; LDL, low density lipoprotein; TG, triglyceride; VLDL, very low density lipoprotein.

catabolic rate (FCR)² of VLDL-TG. Eaton et al. (7), Shames et al. (1), and Quarfordt et al. (8) used labeled FFA as a precursor for VLDL-TG and kinetic curves were analyzed using a compartmental model. In these studies the disappearance curve after the peak did not remain monoexponential and showed a decided decrease in slope beginning at about 8 h. Several compatible models were proposed and examined to account for the observed kinetics. Alternative features considered in these models included two pathways for incorporation of FFA into VLDL-TG, an extravascular compartment exchanging with plasma VLDL-TG, and two VLDL-TG moieties within the plasma (Fig. 1 and [8]). The calculated secretion rates of VLDL-TG were shown to be highly dependent on the model used.

Subsequent to the FFA studies of Shames et al. (1), salient, adjunct studies of the turnover and heterogeneity of VLDL labeled in the apoprotein B and C moieties were subjected to rigorous analyses by Phair et al. (9, 10) and Berman et al. (3) with compartmental models. Features contained in these models included a chain of VLDL compartments to represent the progressive modification of these plasma lipoproteins (due to the action of lipoprotein lipase) and a slowly turning-over plasma VLDL component, especially prominent in patients with Type III hyperlipoproteinemia (10). A somewhat less analytical discussion of the turnover and heterogeneity of VLDL apoprotein B (apo B) moiety has been presented by Reardon et al. (11).

In these studies, radiolabeled glycerol was used as a precursor for VLDL-TG and the kinetics were followed for 48 h, both in normal and hyperlipidemic subjects. 13 normolipemic, nonobese subjects and 46 obese and/or hypertriglyceridemic subjects were studied. In every case the radioactivity curve after the initial peak showed at least a bi-exponential decay. These studies together with the VLDL-apoB

studies constitute a new body of data that permit a sharper discrimination between the previously proposed models for the synthesis and degradation of VLDL-TG. The proposed model is used to estimate parameter values for normal subjects. Results of this noninvasive technique are compared favorably with more direct techniques, as discussed in our companion paper (12).

METHODS

Patients. All patients were studied as in-patients under metabolic ward conditions on the Special Diagnostic and Treatment Unit of the Veterans Administration Hospital, San Diego, Calif. Informed consent was obtained from each patient. A total of 59 patients was studied. Of these, 13 were normolipemic and nonobese and results for these subjects are presented here. The other 46 included obese and hypertriglyceridemic nonobese patients. Clinical characteristics of these patients and TG turnover results are presented in our companion paper (12).

Study design. To insure steady state at the time of study, patients were admitted at least 7 d previously and put on measured weight-maintenance diets (40% of calories as fat [mostly lard], 40% carbohydrate, and 20% protein). These diets before study consisted of solid foods, liquid formula, or a combination of the two. Because studies had to extend 48 h after injection of the labeled glycerol, it was not practicable to have the subjects fasting and probably not desirable, because with prolonged fasting patients are not in a true steady state with regard to lipoprotein levels, and plasma lipoprotein secretion will fall. On the other hand, continuation of their prestudy, fat-containing diet would introduce ambiguities due to the presence of dietary chylomicrons and their degradation products. The solution was to establish a steady state on a regimen of fat-free liquid formula feedings given every 3 h around the clock beginning 36 h before injection of labeled glycerol. The formula provided 1.25 cal/g, 75% of calories as glucose, and 25% as protein (RI-5, Ross Laboratories, Columbus, Ohio). In preliminary studies the formula feedings were started only 12 h before injection and in some of these subjects VLDL-TG levels showed a slight rise during the study. With 36 h of preparation VLDL-TG levels were remarkably constant over the study period. The weight of the patients and their plasma VLDL cholesterol levels were also stable over the 48-h period of the study. The liquid formula intake was calculated to provide 60% of the calories needed to maintain weight during the prestudy period, i.e., the calories from fat were deleted for the reasons given above. This technique, which was developed (13) has been employed recently by Reardon et al. (11) for measuring turnover of apoB. As mentioned, this technique insured constant levels of VLDL-TG throughout the study.

On the day of study, labeled glycerol (New England Nuclear, Boston, Mass.) dissolved in 0.15 M NaCl was injected rapidly via an antecubital vein: [1,3-¹⁴C]glycerol (100 μ Ci), [2-³H]glycerol (300 μ Ci), or both. Blood samples (7 ml) were drawn into EDTA through an indwelling needle in the opposite antecubital vein at 15 and 30 min and at 1.0, 1.5, 2.0, 2.5, 4, 5, 6, 7, 9, 11, 13, and 15 h and then every 3–48 h.

Analysis of samples. VLDL was isolated by preparative ultracentrifugation (14). A known volume of plasma (2–3 ml) was mixed with a solution of sodium chloride of density 1.006 to a total volume of 6 ml in a 6.5-ml cellulose nitrate

²Special terms used in this paper: b_i , slope of a line tangent to the log of the tracer curve at region i ($i = \text{IP}$ designates the inflection point, $i = \text{T}$ designates the tail, and $i = \text{I, II, III}$ designates the phase of the curve); FCR_i^f , fractional catabolic rate of substance x relative to subsystem i . $\text{FCR}_i^f = 1/T_i^f$ (h^{-1}); D_{10} , delay of component 10 in the TG synthesis pathway (h); $L_{i,j}$, fractional rate of transport of activity or mass to compartment i from compartment j (h^{-1}); $L_{j,i}$, fractional rate of irreversible and reversible transport of activity or mass out of compartment j (h^{-1}); $L_{o,j}$, fractional rate of irreversible transport of activity or mass out of system or subsystem from compartment j (h^{-1}); $R_{i,j}^s$, steady-state transport of substance x to compartment i from compartment j (mg/h); R_j^s , steady-state transport of substance x out of or into subsystem j (mg/h); $R_{j,i}^r$, irreversible and reversible steady-state transport of substance x out of compartment j (mg/h); $R_{o,j}^r$, irreversible steady-state transport of substance x out of a system or subsystem from compartment j (mg/h); T_i^f , average time substance x resides in subsystem i (h).

tube (Beckman Instruments, Inc., Spinco Div., Palo Alto, Calif.). Samples were centrifuged for 16 h at 40,000 rpm and 5°C in a Beckman L2-65B preparative ultracentrifuge (40.3 rotor). The top 1.33 ml from each tube was removed quantitatively by tube slicing. This fraction was extracted with 20 ml isopropanol, and phospholipids were removed by adsorption onto zeolite. A portion of the lipid extract was taken for measurement of TG and cholesterol on an Auto-Analyzer II (Technicon Instruments Corp., Tarrytown, N. Y.). The remainder was evaporated and dissolved in toluene phosphor for analysis of radioactivity in a liquid scintillation counter (Mark II, Searle Radiographics Inc., Des Plaines, Ill.)

Numerous experiments were carried out to develop a method to maximize recovery of VLDL-TG for individual samples. This procedure was found to consistently give >95% recovery on individual samples. Each individual value for VLDL-TG, in each set of 25 samples, was corrected by the mean ratio of VLDL-TG per total plasma TG obtained from the 5 samples with the highest ratios, according to this equation: VLDL-TG (on an individual sample) = total plasma TG (on the same sample) × maximum VLDL-TG per total plasma TG. This value corrects for small losses that inevitably occur with some samples during the tube-slicing procedure. The correction assumes that the ratio of VLDL-TG per total plasma TG remains constant throughout the study. Careful examination of all our data has confirmed this assumption.

In several studies the FFA were examined and in no case was there detectable radioactivity.

Analysis of data. The data were analyzed using a linear, first-order compartmental model.³ Such a model can be described mathematically by a simultaneous set of ordinary first-order differential equations with constant coefficients (15). The solution of these equations and the adjustment of the model parameters to yield a least-squares fit of the data were carried out with the aid of the Simulation, Analysis, and Modeling (SAAM) computer program (16). For in-patients subjected to more than one study the parameter values were determined with greater precision because they were arrived at by the simultaneous fitting of all their data.

Weighted averages for population values were determined using the equation

$$\bar{x} = \frac{\sum_i \frac{x_i}{v_i + \bar{v}}}{\sum_i \frac{1}{v_i + \bar{v}}}, \quad (1)$$

where v_i is the variance of the parameter x_i , and \bar{v} is the estimated population variance (17).

RESULTS

Model development. The model proposed for the analysis of the data is based on the features of the kinetic data collected, on steady-state masses of plasma VLDL-TG, and on information previously published (1–10). A typical activity curve for VLDL-TG is plotted in Fig. 1 as fraction of the injected dose of tracer per milliliter of plasma. It contains three phases:

³ For a single compartment model having an input $u(t)$ and a first-order loss process characterized by a constant k , the implied differential equation is: $df(t)/dt = -kf(t) + u(t)$, where $f(t)$ is the amount of substance in the compartment at time t .

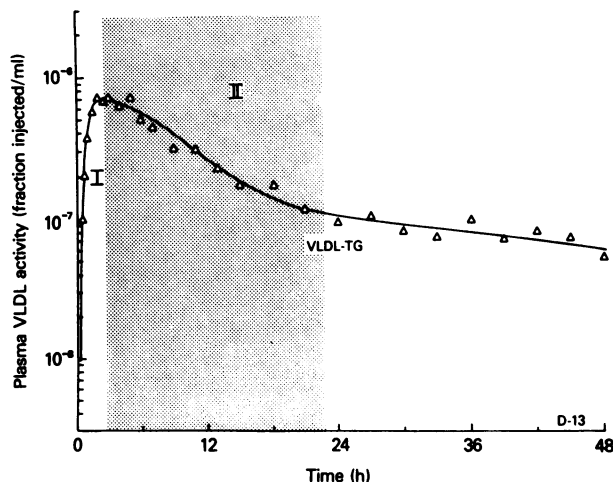

FIGURE 1 Typical VLDL-TG tracer curve after the injection of labeled glycerol. Three phases are identified: initial rise (I), early fast decay (II), and late slow decay (tail) (III).

an early rising phase, a rapidly decaying phase after the peak, and a late, more slowly decaying phase forming the “tail” of the curve. The exact shape varied from subject to subject. The multicompartmental model finally arrived at to explain these data is shown in Fig. 2. It contains three subsystems: the free glycerol precursor subsystem, an intermediate subsystem where the conversion of glycerol to VLDL-TG takes place, and the plasma VLDL-TG subsystem. The justification for the components of each of these subsystems is presented in the following paragraphs. In developing the model, advantage was taken of previous studies of glycerol and plasma lipoprotein kinetics.

Malmendier et al. (18) studied the kinetics of intravenously injected glycerol in plasma and found that a two-compartment model fit the data. They showed that about 90% of the glycerol leaving the plasma could be accounted for by conversion to glucose and CO_2 , which is consistent with the results of these studies which require <10% for TG synthesis. This plasma glycerol model was incorporated (Fig. 2, compartments 4 and 5) in the present model.

Usually plasma VLDL-TG is modeled as a single compartment. This, however, was found to be inadequate. It was necessary to introduce a stepwise delipidation chain (compartments 1, 6, 7, and 8) and an extra slowly turning-over compartment, marked 21, as proposed by Phair et al. (4, 9, 10). A stepwise delipidation process is supported by earlier data (19–22), and more recently from Steiner and Streja (23). The slow turning-over compartment was necessary to evaluate the potential role of heterogeneity of catabolism in explaining the slow decay component of the VLDL-TG curve.

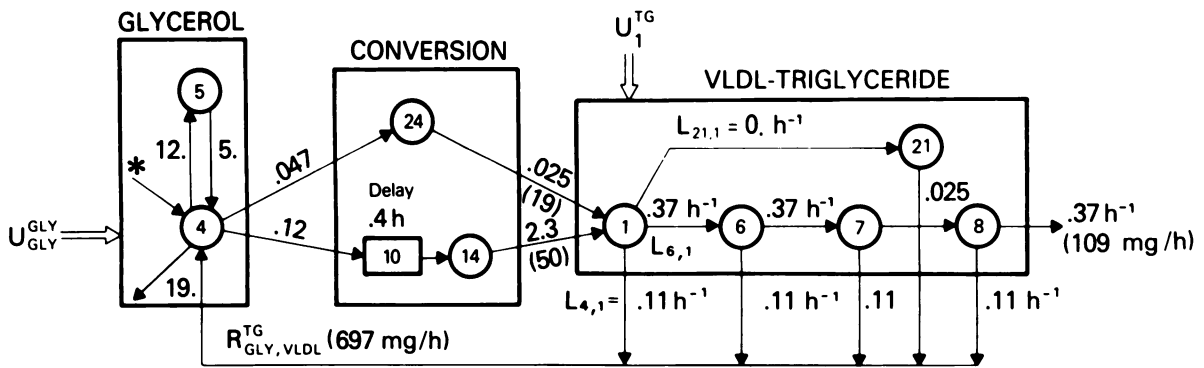

FIGURE 2 Detailed compartmental model for subsystems. Average fractional transport rates, $L_{i,j}$, (per hour) for normolipemic, nonobese subjects are given with the transport rates, $R_{i,j}$, (milligrams per hour) in parentheses. U_1^{TG} is VLDL-TG synthesis rate from nonplasma glycerol sources, and $R_{GLY,VLDL}^{TG}$ is glycerol recycling from VLDL-TG to plasma glycerol.

Four compartments were necessary and sufficient to describe the delipidation chain. Each compartment is characterized by two parameters: $L_{6,1}$ and $L_{4,1}$, representing, respectively, the fractional rate of transfer of TG to the next lower VLDL product and the fraction leaving the VLDL-TG pool irreversibly. These parameters are assumed to be the same at each of the four steps.

The residence time⁴ of VLDL particles in the chain, T_C^{VLDL} , and the residence time of TG molecules in the chain, T_C^{TG} , are related to the model parameters in the following equations which have been derived elsewhere (24):

$$T_C^{VLDL} = \frac{4}{L_{1,1}}, \quad \text{where } L_{1,1} = L_{6,1} + L_{4,1}, \quad (2)$$

and

$$T_C^{TG} = \frac{1 - (L_{6,1}/L_{1,1})^4}{L_{4,1}}. \quad (3)$$

The total residence time of VLDL-TG in the plasma is a weighted average of times spent in the chain and in compartment 21. If T_{21}^{TG} is the residence time of TG in compartment 21, and if P_{21} is the fraction of VLDL-TG diverted to that compartment, then

$$\begin{aligned} T^{TG} &= (1 - P_{21})T_C^{TG} + P_{21}T_{21}^{TG} \\ &= \left(1 + \left[\frac{T_{21}^{TG}}{T_C^{TG}} - 1\right]P_{21}\right)T_C^{TG}. \end{aligned} \quad (4)$$

$(T_{21}^{TG}/T_C^{TG} - 1)P_{21}$ is thus a correction term for the residence time of plasma VLDL-TG when a fraction, P_{21} , of the labeled TG contributes to the tail of the VLDL-TG curve in the form of compartment 21.

Usually,⁵ $T_{21}^{TG}/T_C^{TG} \cong 10$, and therefore the correction factor is very sensitive to the value of P_{21} .

The plasma glycerol to plasma VLDL-TG conversion subsystem is a modification of the one proposed by Shames et al. (1) for FFA. It consists of a fast pathway (Fig. 2, through delay component 10 and compartment 14) and a slow pathway (through compartment 24). Channeling of isotope through the former fits the rapid initial rise in VLDL-TG activity (after a short delay); channeling through the latter fits the final slope of the VLDL-TG curve. There are equivalent ways of modeling this subsystem that cannot be distinguished kinetically. For example, compartment 24 (the slow pathway compartment) could be introduced as a compartment in exchange with compartment 14 (the fast pathway compartment). Alternatively, compartment 24 could be fed from plasma glycerol, as shown in Fig. 2, but release its material into compartment 14 rather than into plasma VLDL-TG. A variant of this has been suggested by Nikkila and Kekki (25). The important point is that these alternatives neither alter the fit of the experimental data nor the calculated fractional or absolute catabolic rates for VLDL-TG.

In a number of our studies a "hump" in the VLDL-TG activity curve appears between 12 and 30 h (Fig. 3). The model proposed does not account for this hump. The hump has previously been noticed by Nikkila and Kekki (5) in studies on normal adults, and they proposed that recirculation from liver glycogen may be the source. This, however cannot be an adequate explanation because the hump is also present in studies with ³H-labeled glycerol which would lose its ³H label in the glycogen pathway. The same argument would also apply against recycling through

⁴ Residence time as used here equals the reciprocal of the FCR.

⁵ The value of T_{21}^{TG} is given by Eq. 3 and the value for $T_C^{TG} = 1/L_{1,1}$ which equals the reciprocal of the slope of the tail of the VLDL-TG curve (b_{III} , Fig. 1).

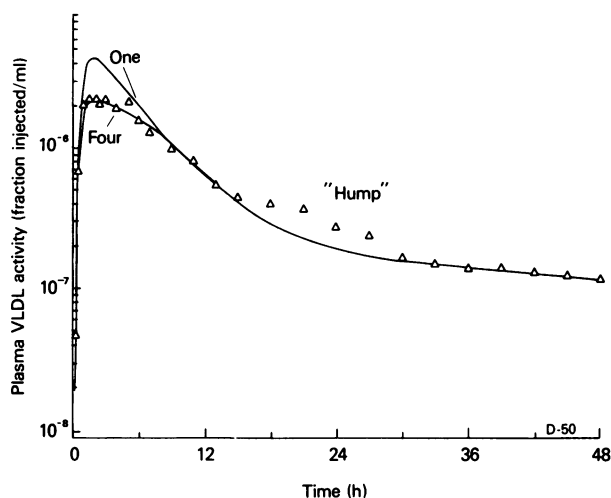

FIGURE 3 A representative set of plasma VLDL-TG data (Δ) with a hump between 800 and 1,800 min. Two curves are drawn through the observed values. The curve labeled "four" was generated with a delipidation chain in the plasma VLDL subsystem (Fig. 2) containing four compartments; the other, labeled "one", was generated by replacing the four compartments with a single one. The parameters of both models were adjusted to best fit the data shown.

the glucose pathway. Because various recycling or delay pathways, such as through phospholipid pools, could be proposed to account for the hump, and our data are not sufficient to differentiate between them, no effort is made to fit it at this time. Because the hump represents at most 5% of the area under the VLDL-TG activity curve, its neglect in modeling the data introduces an error of <5% in the calculation of synthesis rates or FCRs. It is of interest to note that a hump is probably also present in VLDL-TG curves labeled in the fatty acid moiety (Fig. 4 in [26]).

The model shown in Fig. 2 contains too many parameters to allow a determination of all their values with confidence from a single set of VLDL-TG kinetic data and so an additional assumption was necessary. The rate constants for the glycerol subsystem ($L_{5,4}$, $L_{4,5}$, and $L_{4,4}$) were set equal to those determined by Malmendier et al. (18) for normals. This assumption did not impose constraints on the fractions of glycerol that entered the fast and slow conversion pathways. P_{21} , the fraction of VLDL-TG converted to the slowly decaying VLDL-TG population represented by compartment 21, could not be determined with confidence. Other data, however, such as cholesterol: TG ratios, permit independent estimations of its value for individuals and for populations. These will be considered more fully later.

The sensitivity of calculated model parameter values to the assumptions introduced for the model are discussed in the next section.

Sensitivity testing. To what extent would the calculated values of model parameters be altered if one of the assumptions upon which the model is based were changed in a particular way? Similarly, how critical are the parameter values to changes in shapes of the kinetic curves?

Fig. 4 contains simulated curves to demonstrate the effect of glycerol recycling (i.e., reuse of labeled glycerol released during breakdown of VLDL-TG) on the VLDL kinetics. As can be seen, the VLDL-TG curve is relatively insensitive to recycling. This insensitivity is due predominantly because <10% of plasma glycerol is used for the synthesis of VLDL-TG (compared to $\approx 35\%$ for FFA [1]). Thus, results for VLDL-TG transport would be changed little if at all by assuming that all of the glycerol leaving VLDL-TG were to enter adipose tissue and other peripheral tissues rather than being reused. It also shows that the slow component in VLDL-TG radioactivity cannot be generated by such a recycling path.

To test the effects of a delipidation chain vs. a single compartment VLDL subsystem the two cases were simulated. Fig. 3 shows that the only region where the two are clearly distinguishable is at the peak.

The sensitivity of model parameter and function values to changes in the values of other parameters in the model was tested by calculating corresponding partial derivatives (27). The results are expressed as ratios of fractional changes and are given as sensitivities in Table I. Sensitivity, then, reflects the percentage of change in one parameter as the result of a 1% change in some other parameter. In

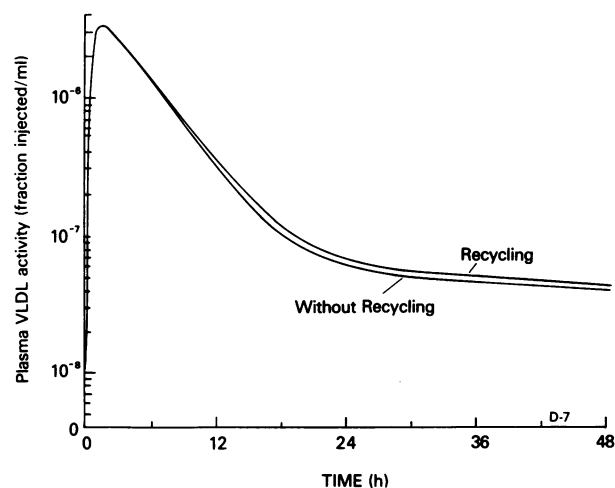

FIGURE 4 Theoretical curves generated with and without glycerol recycling from VLDL-TG back to plasma free glycerol. The "recycling" curve was obtained by fitting a set of observed data. The "without recycling" curve was obtained by diverting the recycling ($L_{4,1}$, $L_{4,6}$, $L_{4,7}$, and $L_{4,8}$) to the outside.

TABLE I
Typical Parameter Values and Sensitivities*†

(1)	(2)	(3)	(4)	(5)	(6)	(7)	(8)	(9)
Parameter‡	Value	Fractional SD	FCR _{gly} h ⁻¹	P ₂₁	Magnitude of tail	Late slope h ⁻¹	Early slope h ⁻¹	Time of inflection point h
R _{VLDL} ^{TG}	646 mg/h	0.14	0.18	7.68	0.97	0.01	0.21	0.57
R _{i,14} ^{TG}	23 mg/h	0.14	0.93	0.37	0.13	0.01	1.66	0.05
R _{i,24} ^{TG}	31 mg/h	0.16	0.92	10.02	1.80	1.06	0.02	0.50
U _i ^{TG}	591 mg/h	0.14	0.23	7.87	0.96	0.07	0.30	0.06
FCR _C ^{TG}	0.18/h	0.14	0.18	7.68	0.97	0.01	0.21	0.57
L _{1,1}	0.31/h	0.67	0.14	7.58	2.97	0.34	8.51	0.80
L _{4,1} /L _{1,1}	0.52	0.83	0.05	6.48	3.25	0.43	6.75	1.63
L _{10,4}	0.060/h	0.14	0.93	3.64	0.12	0.01	1.63	0.05
L _{24,4}	0.78/h	0.16	0.92	10.02	1.79	1.06	0.11	0.50
L _{1,14}	1.08/h	0.32	0.27	2.52	0.18	0.11	3.30	0.46
L _{1,24}	0.018/h	0.47	0.15	0.23	0.81	1.83	2.57	0.26
D ₁₀	0.37/h	0.17	0.01	2.77	0.10	0.02	0.78	0.44
R _{gly,VLDL} ^{TG} ‡	625 mg/h	0.20	0.19	7.22	0.69	0.08	4.06	0.96

* All values are based on curves shown in Figs. 1 and 6. The approach is discussed in (27).

† Sensitivity = (percentage of change in parameter value/percentage of change in perturbed parameters).

‡ The parameters perturbed (one at a time) were: column 4: FCR of plasma glycerol (h⁻¹); column 5: Fraction of VLDL-TG shunted into slowly-metabolized VLDL (compartment 21); column 6: Activity of VLDL-TG in the late part of the curve relative to that at the peak; column 7: Slope of the late part of the curve (h⁻¹); column 8: Slope of the early fast decaying part of the curve (h⁻¹); column 9: Time after injection at which the inflection point in decay curve occurs.

‡R_{gly,VLDL}^{TG} = ∑ R_{i,i}^{TG}; i = 1, 6, 7, and 8.

calculating sensitivities, the curve in Fig. 1 and the parameters related to it were used as a base of reference. Thus, for example if the FCR for free glycerol, FCR_{gly}, were to be increased by 1% and the data for Fig. 1 refitted subject to this constraint, the calculated TG transport would only be changed by 0.18% (Table I, column 4, line 1).

A similar procedure was followed for determining the sensitivities of calculated parameters to changes in the shape of the experimental curve (27). A given change was introduced in the curve and the model parameters were allowed to readjust to fit the new curve. The changes introduced into the curve of Fig. 1 are shown to scale in Figs. 5A and B and are expressed as a fraction of a slope, intercept, etc. Examination of Table I allows insights into the strengths of "linkages" or interdependencies within the model.

Parameter values in normolipidemic subjects. The mean values and fractional standard deviations of the model parameters for 13 normolipidemic subjects are given in Table II. The mean FCR for this total VLDL-TG pool was 0.19/h. Total transport (28) of TG averaged 806 mg/h. Only a small fraction of plasma glycerol (R_{i,14}^{TG} plus R_{i,24}^{TG}) was used for VLDL-TG

synthesis. Input from unlabeled sources, U_i^{TG} (glycogenolysis, glycolysis, and glyceroneogenesis) accounts for about 90% of the total. Plasma glycerol used for VLDL-TG via the slow pathway (R_{i,24}^{TG}) is about one-half of that via the fast pathway (R_{i,14}^{TG}).

Simultaneous ¹⁴C and ³H studies. In about a dozen individuals simultaneous responses to labeled ([2-³H]- and [1,3-¹⁴C]glycerol) were obtained as shown in Fig. 6. The two responses were not identical (29). The initial VLDL-TG uptakes were comparable for the two labels, but the slow exponential component was about 40% lower for [³H]- compared to [¹⁴C]glycerol. These results are highly significant because of their implication with respect to the slow synthesis pathway which is discussed below.

DISCUSSION

In a series of papers published by Shames et al. (1), Quarfordt et al. (8), and Berman et al. (3), a number of models have been investigated for the study of VLDL metabolism and the calculation of its turnover. Data collected over a 24-h interval showed that specific activity curves of VLDL-TG and VLDL-apoB consistently had a slow component in the later portion of

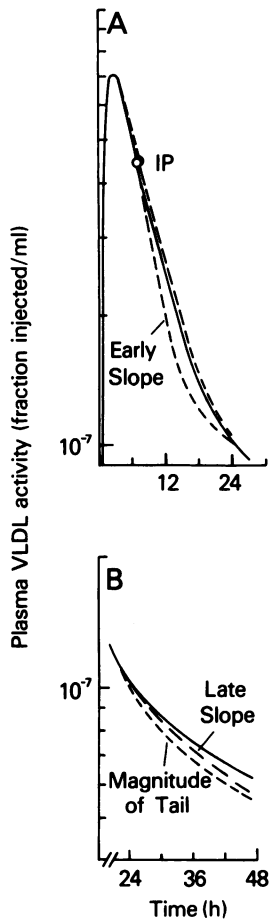

FIGURE 5 The tracer curve of Fig. 1 separated into an early portion (A) and a late portion (B). The dashed curves represent 10% changes in: the magnitude of the tail, the late slope, the early slope, and the time at which the inflection point occurs. The parameter values for the solid and dashed line solutions were used to calculate the sensitivities shown in Table III (columns 3, 4, 5, and 6, respectively).

the curves. This response could be simulated with compartmental models in a number of ways which implied various physiological interpretations. Unfortunately, the value calculated for VLDL-TG synthesis greatly depends on the model chosen. It is therefore essential that the correct mechanisms for the generation of the tail of the curve be known. We present here a series of arguments for the existence of a slow pathway for conversion of plasma glycerol to VLDL-TG which is a major contributor to the tail seen in most of our VLDL-TG tracer curves. There may be exceptions, however, particularly for patients with relatively large amounts of slowly turning-over VLDL (β -VLDL), or for subjects in which the tail of the VLDL tracer curve is very small. Although it is fully appreciated that a model is only one hypothesis and that many models may be proposed to explain

TABLE II
Estimated Parameter Values for Normal Population

(n = 13)			
Phrase	Parameter	Weighted mean*	FSD†
FCR (Chain)	FCR_{TC}^{TG}	0.19/h	0.065
Chain residence time	T_C^{TG}	5.16 h	0.065
VLDL-TG synthesis	$R_{419,VLDL}^{TG}$	805.8 mg/h	0.15
Recycling	$R_{419,VLDL}^{TG}$	697.2 mg/h	0.20
Fractional transport of compartment 1	$L_{1,1}$	0.48/h	0.051
Delipidation fraction per state	$L_{4,1}/L_{1,1}$	0.22	0.16
	$L_{10,4}$	0.12/h	0.11
	$L_{24,4}$	0.047/h	0.20
	$L_{1,14}$	2.32/h	0.25
Fractional transport rate of slow compartment	$L_{1,24}(b_T)$	0.025/h	0.062
Delay	D_{10}	0.41 h	0.085
Fast TG transport	$R_{1,14}^{TG}$	50.2 mg/h	0.095
Slow TG transport	$R_{1,24}^{TG}$	18.8 mg/h	0.20
Nonplasma TG transport	U_1^{TG}	666.8 mg/h	0.13
Fast slope	b_{11}	0.18/h	0.11
VLDL-CH/VLDL-TG	CH/TG	0.21	0.072
VLDL-TG mass	M_{VLDL}^{TG}	112.9	0.089
$M_{21}^{TG}/M_{VLDL}^{TG}$	a	0.046	0.072

* The mean values are calculated using Eq. 1.

† Fractional standard deviation.

data, we feel that the weight of the evidence makes the conclusions about the major metabolic features independent of the models proposed. A more complete validation of the proposed pathways must come, as always, from additional direct experimental evidence.

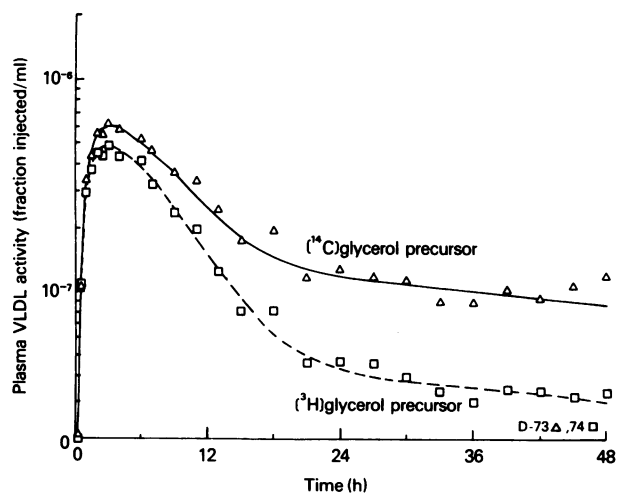

FIGURE 6 Plasma VLDL-TG tracer data for [1,3- ^{14}C]glycerol (Δ) and [2- 3H]glycerol (\square) precursors. The tail of the 3H curve is about one-third of that for the ^{14}C curve.

In general, the following are potential contributors to a slow decaying tail of the VLDL-TG activity curve:

Exchanges of VLDL with extra-plasma spaces, or of TG with non-VLDL lipoproteins in plasma. The strongest argument against these mechanisms being responsible for most of the tail comes from the doubly labeled experiments in these studies. These subjects received both ^{14}C - and ^3H -labeled glycerol and, on the average, the ^3H -labeled glycerol precursors produced VLDL-TG tails about one-third as large as those produced by ^{14}C -labeled glycerol, whereas the magnitude of the initial peaks were comparable (Fig. 6). If the tails were largely due to a VLDL-TG exchange processes there is no reasonable explanation for the discrimination between ^{14}C and ^3H .

An argument against exchange of plasma VLDL with extravascular VLDL can be made from the published data of Phair et al. (10) who studied the decay of exogenously labeled VLDL-apoB in man. Although the decay curve exhibited a tail, these workers excluded an exchange process mainly because radioactivity in the tail could not serve as a precursor for intermediate density lipoprotein (IDL)-apoB as could that in the early part of the curve. Reardon et al. (11) have also noted a slow component from exogenously labeled VLDL-apoB. They suggested that a two-compartment exchange model could account for this, but they did not claim it was the only explanation. From the work of Phair et al. (10) we suggest that two metabolically distinct, intravascular moieties of VLDL more likely explain their data. It should be pointed out that the tail on the VLDL-apoB curve caused by the slowly turning-over moiety in exogenously labeled VLDL is much larger than would be produced by endogenous labeling. This is because even a small pathway for generation of such a moiety with a slow removal produces a rather large steady-state mass (24); the external labeling of this mass and its reinjection thus accentuates the size of the tail. When VLDL-apoB is labeled endogenously the size of the tail due to the slow removal pathway is much smaller (30).

Direct evidence for low concentrations of VLDL in extravascular spaces is contained in the studies of Reichl et al. (15, 31, 32) who found little or no VLDL in human peripheral lymph. In our laboratory,⁶ studies have been carried out on pleural transudates from eight patients, and we found essentially no VLDL despite the presence of low density lipoprotein (LDL) and high density lipoprotein (HDL) at levels of $\approx 25\%$ of their plasma concentrations. Therefore, it seems

unlikely that a significant portion of the tail could be explained by exchange with extravascular VLDL.

Independent exchange of TG between VLDL and other plasma lipoproteins could add to the tail of the VLDL-TG curve. The possibility for such exchange has been demonstrated by in vitro studies on rabbit plasma by Havel et al. (33). If such an exchange were to take place in man, LDL-TG, because of its greater mass compared to HDL-TG, would be the more likely candidate. However, certain considerations suggest that exchange between labeled VLDL-TG and LDL-TG probably does not contribute significantly to the tail of the VLDL-TG activity curve. For instance, Havel et al. (33) found in rabbits that in vivo exchange of TG between VLDL and LDL was only about 20–25% of the transfer noted in vitro. Furthermore, Malmendier and Berman (34) found that over 80% of TG that is transferred to LDL during degradation of VLDL is rapidly hydrolyzed with recovery of labeled FFA in plasma. Thus <20% of LDL-TG derived from VLDL-TG would be available for transfer back into VLDL, and with the much larger pool of VLDL-TG, such exchange could have only a small effect on the size of the VLDL-TG tail.

A slow component in the decay of the precursor, in this case, glycerol. The glycerol subsystem used in this model is that proposed by Malmendier et al. (18) which has been shown not to contain any significant slow component. The recycling of glycerol from VLDL-TG is already contained in the model, but in contrast to what has been observed for labeled fatty acids (1, 8), it only accounts for a small fraction of the VLDL-TG tail, as discussed above and shown in Fig. 4.

Contamination of the VLDL fraction with a slowly metabolized plasma lipoprotein of higher density, such as LDL. Although a small contribution from such contamination cannot be excluded, it cannot be large enough to account for the very large slow components seen in many of our subjects, especially because only a small fraction of the labeled TG is found in LDL (34).

A slowly metabolized species of VLDL, such as that found in protein-labeling studies of patients with dysbetalipoproteinemia (Type III phenotype) and modeled previously as compartment 21 (VLDL₂) (3, 10). For instance, Quarfordt et al. (35) presented evidence that most of the tail of radiolabeled TG in patients with Type III hyperlipoproteinemia is due to β -mobility VLDL. The FCR of VLDL-apoB in compartment 21, which probably corresponds to that of β -VLDL, is in fact similar to the slope of the tail of the VLDL-TG curve, and hence this theoretically could account for the latter. However, we put forth the following three arguments against such an explanation

⁶ Unpublished observations.

in normal subjects and in most of the hyperlipidemic patients presented in this study.

First, in the study of Berman et al. (3) patients with Type III hyperlipoproteinemia had a much larger tail, or slow component, than did other types of patients (normal and Types I, II, and IV). In the latter patients, the slow component was usually <5% of the peak of the curve which was presumably due to a paucity of β -VLDL in these patients. Even this small component would have been accentuated by external labeling of VLDL-apoB as noted above. A similar small tail was also observed by Reardon et al. (11) in their study of patients with the Type IV phenotype. In this study, our patients were either normolipidemic or Type IV, and therefore should have shown similar curves for VLDL-apoB as the patients of Berman et al. (3) and Reardon et al. (11). The size of these tails should be even smaller for VLDL-TG. This is in contrast to the magnitude of the tail (frequently 30–50% of the peak of the curve) actually seen for VLDL-TG in our studies.

Second, if VLDL₂₁ were to account for the tail, its turnover rate would have to equal the slope of the tail. This rate constant is about one-tenth that of VLDL-TG in the chain. Thus, any labeled VLDL-TG diverted to compartment 21 would generate, in the steady state, a mass at least 10 times greater than that it would generate if metabolized along the regular VLDL-TG delipidation chain (Eq. 4). In our studies the magnitude of the tail averages $\cong 20\%$ of the peak value. This would require a diversion of $\cong 20\%$ of the labeled TG to compartment 21. Such a diversion generates at steady state a mass of TG in compartment 21 (M_{21}^{TG}) that is 50–70% of the total VLDL-TG mass (M_{VLDL}^{TG}). This is nearly twice the mass observed for TG in β -mobility VLDL even in patients with type III phenotypic patterns. We can therefore be reasonably confident that in normal subjects and in most subjects with Type IV patterns the VLDL₂₁ compartment is not large enough to account for the magnitude of the tail.

A third argument can be made by considering cholesterol:triglyceride ratios for β -VLDL and VLDL from normals. The cholesterol:triglycerides ratio (CH/TG) for VLDL in normals is 0.18 ± 0.05 SD (C36), and for β -mobility VLDL is $\cong 0.83$ (37, 38). For any mixture of these two, involving a fraction (a) of β -VLDL and fraction ($1 - a$) of VLDL from normals, the CH/TG ratio is given by:

$$\text{CH/TG} = 0.83a + 0.18(1 - a), \quad (5)$$

hence

$$a = \frac{\text{CH/TG} - 0.18}{0.83 - 0.18}, \quad (6)$$

and

$$\frac{a}{1 - a} \frac{M_{21}^{TG}}{M_C^{TG}} = \frac{P_{21}}{1 - P_{21}} \frac{T_{21}^{TG}}{T_C^{TG}} = \frac{\text{CH/TG} - 0.18}{0.83 - \text{CH/TG}}. \quad (7)$$

Eq. 6 is plotted as a straight line in Fig. 7 with a on the left ordinate. The straight line also gives the relation between CH/TG and P_{21} through the right ordinate for the representative case. A value of CH/TG = 0.41 is found in populations with broad β -disease (36, 37) and is higher than that observed in all our subjects. Moreover, even for a CH/TG ratio of 0.41 only 5.1% of the VLDL-TG is diverted to compartment 21 to form the tail of the curve (Fig. 7). This is much lower than the magnitude of the tail seen in most of our curves.

A slowly turning-over component in the conversion pathway of plasma glycerol to plasma VLDL-TG. Although the multiple factors discussed above could each play a small role in formation of the tail, they seem inadequate to account for its large size in many of our patients. However, direct evidence in support of a slow component in the conversion path comes from double labeling experiments. As pointed out above, for each individual the slow component of the VLDL-TG activity curve was always lower for $[2\text{-}^3\text{H}]\text{glycerol}$ compared to $[1,3\text{-}^{14}\text{C}]\text{glycerol}$, but there was no significant change in the faster component of the curve (Fig. 6). It is most unlikely that there would be any discrimination between ^{14}C - and ^3H -labeled TG once a VLDL particle is secreted into the plasma. Such discrimination, however, can readily occur in the initial glycerol metabolic pathways (29). When $[2\text{-}^3\text{H}]\text{glycerol}$ is converted to gluconeogenic precursors via dihydroxyacetone phosphate, the ^3H is lost. Only material transformed directly to α -

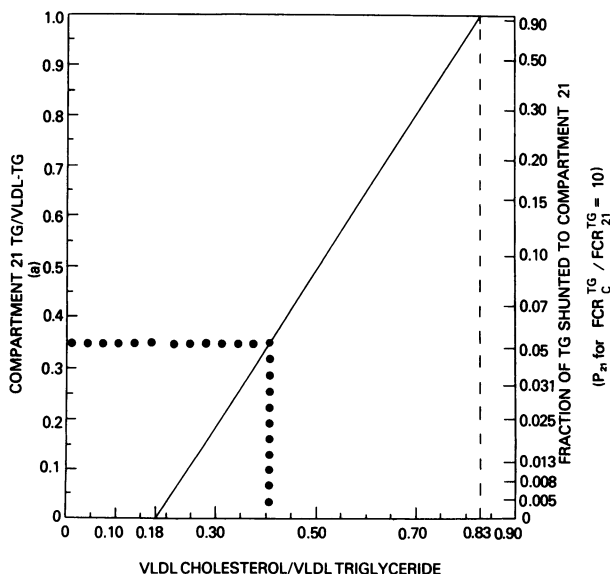

FIGURE 7 A plot of Eq. 7; fraction (a) of VLDL-TG mass in compartment 21 as a function of VLDL CH/TG ratio. The fraction of VLDL-TG transport diverted through compartment 21 (P_{21}) is also plotted as a function of CH/TG ratio. The ordinate value for P_{21} is derived from Eq. 7 assuming $(T_C^{TG}/T_{21}^{TG}) = 10$ (notice the nonlinear scale for P_{21}). The dotted line indicates the CH/TG ratio of 0.41 with the corresponding value of a which is 0.35, and P_{21} , which is 0.051.

glycerol phosphate for TG synthesis retains the ^3H . In contrast, $[1,3-^{14}\text{C}]$ glycerol could be transformed to gluconeogenic precursors and still retain its label. If there were only a single rapid synthesis pathway, a preferential loss of ^3H in it would result in a proportional decrease of the entire VLDL-TG curve, which is contrary to the observed responses as shown in Fig. 6.

Two labels can generate different VLDL-TG curves because of differences in the catabolism of the labeled TG, or differences in the secretion of VLDL-TG into the plasma. In the first case there would usually be a difference in the FCR and hence in the calculated total VLDL-TG transport rates. In the second case the FCR and, hence, total transport rate would have the same values for both tracers, which implies that a change in the area under the VLDL-TG curve is accompanied by a corresponding proportional change in the total plasma glycerol label that is incorporated into VLDL-TG. The joint ^{14}C and ^3H studies were fitted under the assumption that once in plasma, labeled VLDL-TG is catabolized the same way for both labels.

The "slow" and "fast" pathways are derived strictly for glycerol which originated in the plasma compartment. The partitioning of input from other precursors of glycerol (U_T^{G}) cannot be assessed but has no influence on calculating VLDL-TG FCR and synthesis. The existence of the slow pathway, however, has definite implications for the interpretation of the kinetic curves based on plasma glycerol and FFA precursors in that it affects the proposed model for the VLDL-TG subsystem and the calculated values of VLDL-TG FCR and synthesis rate.

When any part of the tail of the labeled VLDL-TG curve can be attributed to a slowly metabolizing VLDL (VLDL_{21}), there will be a corresponding decrease in the calculated VLDL-TG FCR and synthesis rate. Hence, when P_{21} is zero the calculated values represent maximal estimates. A correction of $\text{FCR}_{\text{VLDL}}^{\text{TG}}$ ($1 = 1/T^{\text{G}}$) when P_{21} is not zero can be made using Eq. 4; and an estimate for the value of P_{21} can be made using the CH/TG ratio as given by Eq. 7 or using Fig. 7.

It is interesting to note that the presence of a slow conversion pathway can also be inferred from the results of Havel and Kane (26). They reported studies on four subjects to whom both labeled FFA and endogenously labeled VLDL-TG (obtained from two donors) were administered. The kinetics of labeled plasma VLDL-TG were followed for 24 h. In all their studies the tails of the VLDL-TG curves were considerably higher for the FFA label than for the VLDL-TG label. This could only be explained by a contribution generated by the FFA precursor: either a slow component in the plasma or in the conversion pathway to VLDL-TG. An argument against the former has been advanced by Shames et al. (1), on the basis

that such a component would require a nonplasma FFA source for TG.

Some direct support for the stepwise delipidation model with newly synthesized VLDL-TG entering the first stage comes from recent studies of Streja et al. (39) and Steiner and Streja (23). They separated plasma VLDL-TG into three density fractions and determined the specific activities of each fraction as a function of time after the administration of radio-labeled glycerol. We analyzed both sets of data for two patients (B.M. and B.V.) using a three stage model as implied by them, with nascent VLDL-TG free to enter into each of the fractions. The results of this analysis showed that about two-thirds of the newly synthesized VLDL-TG entered the lightest fraction, with most of the remainder entering the middle fraction. Only about 5% entered the heaviest fraction. The turnover rate for each fraction was found to be the same. We also fitted the sum of their data for the three fractions using our model and found that the FCR calculated was nearly the same as the one calculated using the three stage model (B.V. 0.18/h vs. 0.20/h and B.M. 0.24/h vs. 0.22/h).

The physiological site or sites of the model VLDL-TG synthesis pathways remain unknown; however, the calculated size of the slow compartment for our normals is 750 mg, well within the values for liver TG concentration.

It has been the practice in the past to determine the FCR of VLDL-TG by using the slope of the fast decaying portion of the activity curve, (Fig. 1, phase

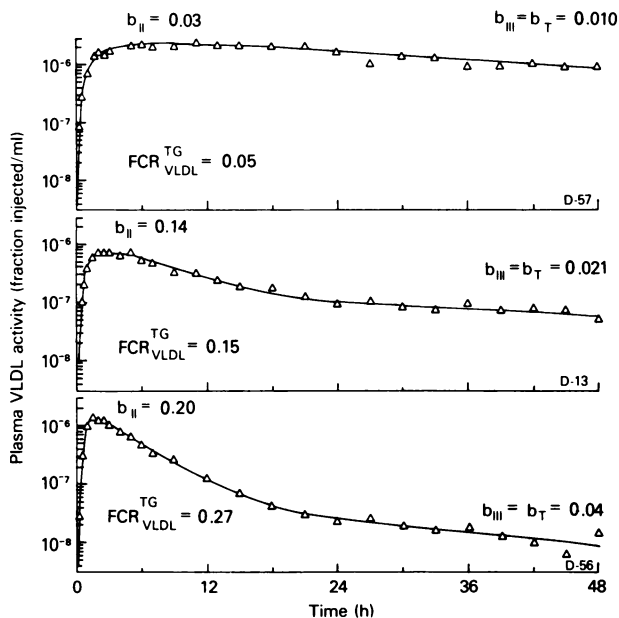

FIGURE 8 A comparison of three studies in which specific activity of VLDL-TG in the late part of the curve, relative to that at the peak, was high, medium, and low. The slopes of phase II (b_{II}) and of phase III (b_{III}) are shown for comparison with the FCR values derived by analysis of the entire curve using the model of Fig. 2.

II). Fig. 8 illustrates three activity curves with values for the fast slopes (b_{II}), the slow slopes (b_{III}), and our model-determined FCRs. As can be seen, the fast decay slopes, b_{II} , can differ significantly from the true FCR values. It is clear from our model development that when labeled glycerol is used as a precursor to determine VLDL-TG turnover and synthesis rates it is necessary to take into consideration the details of the kinetic behavior of the synthesis pathways as well as the metabolic pathways of plasma VLDL-TG.

ACKNOWLEDGMENTS

The authors wish to express their appreciation to Dr. F. K. Millar for her assistance with this project and to Mrs. Sue Smith and Miss Sandra Taylor for their support in the preparation of this manuscript. They are also grateful to Elliott Groszek, Peter McGough, Suzan Butler, Richard Earl, Warren May, and Avon Drummond for their excellent technical assistance.

This research was supported in part by the Medical Research Service of the Veterans Administration and by National Institutes of Health research grants HL-14197, awarded by the National Heart, Lung, and Blood Institute and AM-16667 from the National Institute of Arthritis, Metabolism, and Digestive Diseases, U. S. Public Health Service, Department of Health, Education, and Welfare.

REFERENCES

- Shames, D. M., A. Frank, D. Steinberg, and M. Berman. 1970. Transport of plasma free fatty acids and triglycerides in man: A theoretical analysis. *J. Clin. Invest.* **49**: 2298-2314.
- Farquhar, J. W., R. C. Cross, R. M. Wagner, and G. M. Reaven. 1965. Validation of an incompletely coupled two-compartment nonrecycling catenary model for turnover of liver and plasma triglyceride in man. *J. Lipid Res.* **6**: 119-134.
- Berman, M., M. Hall, R. I. Levy, S. Eisenberg, D. W. Bilheimer, R. D. Phair, and R. H. Goebel. 1978. Metabolism of apoB and apoC lipoproteins in man: Kinetic studies in normal and hyperlipoproteinemic subjects. *J. Lipid Res.* **19**: 38-56.
- Phair, R. D., M. G. Hammond, J. A. Bowdes, M. Fried, M. Berman, and W. R. Fisher. 1972. Kinetic studies in human lipoprotein metabolism in type IV hyperlipoproteinemia. *Fed. Proc.* **31**: 421. (Abstr.)
- Nikkila, E. A., and M. Kekki. 1971. Polymerphism of plasma triglyceride. Kinetics in normal human adult subject. *Acta. Med. Scand.* **190**: 49-59.
- Reaven, G. M., D. B. Hill, R. C. Cross, and J. W. Farquhar. 1965. Kinetics of triglyceride turnover of very low density lipoproteins of human plasma. *J. Clin. Invest.* **44**: 1826-1833.
- Eaton, R. P., M. Berman, and D. Steinberg. 1969. Kinetic studies of plasma free fatty acid and triglyceride metabolism in man. *J. Clin. Invest.* **48**: 1560-1579.
- Quarfordt, S. H., A. Frank, D. M. Shames, M. Berman, and D. Steinberg. 1970. Very low density lipoprotein triglyceride transport in type IV hyperlipoproteinemia and the effects of carbohydrate-rich diets. *J. Clin. Invest.* **49**: 2281-2297.
- Phair, R. D., M. G. Hammond, J. A. Bowdes, M. Fried, W. Fisher, and M. Berman. 1975. A preliminary model for human lipoprotein metabolism in hyperlipoproteinemia. *Fed. Proc.* **34**: 2263-2270.
- Phair, R. D., M. Hall, D. W. Bilheimer, R. I. Levy, R. H. Goebel, and M. Berman. 1976. Modeling lipoprotein metabolism in man. In Proceedings of the 1976 Summer Computer Simulation Conference, Washington, D. C. Simulation Councils, Inc., La Jolla, Calif. 486-492.
- Reardon, M. F., N. H. Fidge, and P. J. Nestel. 1978. Catabolism of very low density lipoprotein B apoprotein in man. *J. Clin. Invest.* **61**: 850-860.
- Grundy, S. M., H. Y. I. Mok, L. Zech, D. Steinberg, and M. Berman. 1979. Transport of very low density lipoprotein-triglycerides in varying degrees of obesity and hypertriglyceridemia. *J. Clin. Invest.* **63**: 1274-1283.
- Grundy, S. M., P. J. Nestel, R. Monell, H. Moh, K. von Bergmann, and D. Steinberg. 1975. Kinetics of very low density lipoprotein-triglycerides (VLDL-TG) following radioglycerol. *Circulation.* **52**(Suppl. II): 39.
- Havel, R. J., H. A. Eder, and J. H. Bragdon. 1955. The distribution and chemical composition of ultracentrifugally separated lipoproteins in human serum. *J. Clin. Invest.* **34**: 1345-1353.
- Reichl, D., N. B. Myant, and J. J. Pflug. 1977. Concentration of lipoproteins containing apolipoprotein B in human peripheral lymph. *Biochim. Biophys. Acta.* **489**: 98-105.
- Berman, M., and M. Weiss. 1977. SAAM Manual. U. S. Government Printing Office, Department of Health, Education, and Welfare Publication No. 78-180. National Institutes of Health, Washington, D. C. 200 pp.
- Pettigrew, K. D. 1964. Estimation of a parameter from observations with unequal precisions in the presence of nuisance parameters. Master's Thesis, George Washington University, Washington, D. C. 74 pp.
- Malmendier, C. L., C. Delcroix, and M. Berman. 1974. Interrelations in the oxidative metabolism of free fatty acids, glucose, and glycerol in normal and hyperlipemic patients. *J. Clin. Invest.* **54**: 461-476.
- Shore, V. G., and B. Shore. 1973. Heterogeneity of human plasma very low density lipoproteins. Separation of species differing in protein components. *Biochemistry.* **12**: 502-507.
- Barter, P. J., and P. J. Nestel. 1972. Precursor-product relationship between pools of very low density lipoprotein. *Biochim. Biophys. Acta.* **260**: 212-221.
- Higgins, J. M., and C. J. Fielding. 1975. Lipoprotein lipase. Mechanism of formation of triglyceride-rich remnant particles for VLDL and chylomicrons. *Biochemistry.* **14**: 2288-2292.
- Hazzard, W. R., and E. L. Bierman. 1976. Delayed clearance of chylomicron remnants following vitamin-A-containing oral fat loads in broad- β disease (type III hyperlipoproteinemia). *Metab. Clin. Exp.* **25**: 77-80.
- Steiner, G., and D. Streja. 1977. Kinetics of VLDL subfractions. In Atherosclerosis IV. G. Schettler, Y. Goto, Y. Heta, and G. Klose, editors. Springer-Verlag, Berlin, East Germany. 129-132.
- Berman, M. 1979. Analysis of kinetic data. In Progress in Biochemical Pharmacology: Lipoprotein Metabolism. S. Eisenberg, editor. S. Karger AG. Basel, Switzerland.
- Nikkila, E. A., and M. Kekki. 1971. Measurement of plasma triglyceride turnover in the study of hypertriglyceridemia. *Scand. J. Clin. Lab. Invest.* **27**: 97-104.
- Havel, R. J., and J. P. Kane. 1975. Quantification of triglyceride transport in blood plasma: a critical analysis. *Fed. Proc.* **34**: 2250-2257.

27. Mason, S. J., and H. J. Zimmerman. 1960. *Electronic circuits, signals, systems*. John Wiley and Sons Inc., New York. 580.
28. Brownell, G. B., M. Berman, and J. S. Robertson. 1968. Nomenclature for tracer kinetics. *Int. J. Appl. Radiat. Isot.* **19**: 249-262.
29. Gurr, M. I., and A. T. James. 1975. *Lipid Biochemistry*. Chapman and Hall Ltd. London, England. 90.
30. Eaton, P. R., S. Crespino, and D. M. Kipnis. 1976. Incorporation of ⁷⁵Se-Selenomethionine into human apoproteins in man. *Diabetes*. **25**: 679-690.
31. Reichl, D., N. B. Myant, J. J. Pflug, and D. N. Rudra. 1977. The passage of apoproteins from plasma lipoproteins into the lipoproteins of peripheral lymph in man. *Clin. Sci. Mol. Med.* **53**: 221-226.
32. Reichl, D., L. A. Simons, N. B. Myant, J. J. Pflug, and G. L. Mills. 1973. The lipid and lipoproteins of human peripheral lymph, with observations on the transport of cholesterol from plasma and tissues into lymph. *Clin. Sci. Mol. Med.* **45**: 313-329.
33. Havel, R. J., J. M. Felts, and C. M. Van Duyne. 1962. Formation and fate of endogenous triglycerides in blood plasma of rabbits. *J. Lipid Res.* **3**: 297-308.
34. Malmendier, C., and M. Berman. 1978. Endogenously labeled low density lipoprotein triglyceride and apoprotein B kinetics. *J. Lipid Res.* **19**: 978-984.
35. Quarfordt, S. H., R. I. Levy, and D. S. Fredrickson. 1973. The kinetic properties of very low density lipoprotein triglyceride in type III hyperlipoproteinemia. *Biochim. Biophys. Acta.* **296**: 572-576.
36. Kushwaha, R. S., W. R. Hazzard, C. Gagne, A. Chait, and J. J. Albers. 1977. Type III hyperlipoproteinemia: paradoxical hyperlipemic response to estrogen. *Ann. Intern. Med.* **87**: 517-525.
37. Quarfordt, S., R. I. Levy, and D. S. Fredrickson. 1971. On the lipoprotein abnormality in type III hyperlipoproteinemia. *J. Clin. Invest.* **50**: 754-761.
38. Pagnan, A., R. J. Havel, J. P. Kane, and L. Kotite. 1977. Characterization of human very low density lipoproteins containing two electrophoretic populations: double pre-beta lipoproteinemia and primary disbeta-lipoproteinemia. *J. Lipid Res.* **18**: 613-622.
39. Streja, D., M. A. Kallai, and G. Stiner. 1977. The metabolism heterogeneity of human very low density lipoprotein triglyceride metabolism clinical and experimental. *Metab. Clin. Exp.* **26**: 1333-1344.