

# Genetics of the Low Density Lipoprotein Receptor

## DIMINISHED RECEPTOR ACTIVITY IN LYMPHOCYTES FROM HETEROZYGOTES WITH FAMILIAL HYPERCHOLESTEROLEMIA

DAVID W. BILHEIMER, Y. K. HO, MICHAEL S. BROWN, RICHARD G. W. ANDERSON, and JOSEPH L. GOLDSTEIN, *Departments of Molecular Genetics, Internal Medicine, and Cell Biology, University of Texas Health Science Center at Dallas, Dallas, Texas 75235*

**ABSTRACT** Using circulating mononuclear cells as a readily available tissue and using the rate of high affinity degradation of  $^{125}\text{I}$ -labeled low density lipoprotein (LDL) as an index of cell surface LDL receptor activity, we have measured receptor activity in cells from 53 individuals. This group includes 32 healthy subjects, 15 subjects with the heterozygous form of familial hypercholesterolemia, and 6 subjects with hyperlipidemic disorders other than familial hypercholesterolemia. 7 of the healthy subjects and 10 of the heterozygotes were members of a single large kindred with five-generation transmission of the mutant familial hypercholesterolemia gene. LDL receptor activity was assayed in blood mononuclear cells under two sets of conditions. First,  $^{125}\text{I}$ -LDL degradation was measured in purified lymphocytes that had been incubated for 3 days in the absence of lipoproteins so as to induce a high level of LDL receptor activity. Phase-contrast autoradiograms of cells incubated with  $^{125}\text{I}$ -LDL and electron micrographs of cells incubated with ferritin-labeled LDL confirmed the existence of LDL receptors on lymphocytes. Second,  $^{125}\text{I}$ -LDL degradation was measured in mixed mononuclear cells (85–90% lymphocytes and 5–15% monocytes) immediately after their isolation from the bloodstream. This assay represented an attempt to assess the number of receptors actually expressed on the cells when they were in the circulation. Under both sets of conditions, cells from the familial hypercholesterolemia heterozygotes expressed an average of about one-half the normal number of LDL receptors. The current findings are consistent with the conclusion that heterozygotes with familial hypercholesterolemia possess only one functional allele at the

LDL receptor locus and that the consequent deficiency of LDL receptors produces the clinical syndrome of heterozygous familial hypercholesterolemia.

### INTRODUCTION

The primary genetic defect in familial hypercholesterolemia (FH)<sup>1</sup> involves the gene encoding a cell-surface receptor that normally binds the plasma cholesterol transport protein low density lipoprotein (LDL) (reviewed in refs. 1–4). Binding of LDL to the receptor is the initial event in a process by which human cells internalize the lipoprotein through adsorptive endocytosis and degrade it within cellular lysosomes (5). The genetic defect in the LDL receptor in FH was originally elucidated through studies of fibroblasts cultured from patients with the receptor-negative form of homozygous FH (2, 5). Cells from these subjects lack detectable LDL binding and hence they fail to take up and degrade  $^{125}\text{I}$ -labeled LDL with high affinity.

In normal fibroblasts, the production of functional LDL receptors is regulated so that the number of receptors is highest when the cells are deprived of cholesterol by incubation in medium containing lipoprotein-deficient serum. Conversely, the number of LDL receptors is lowest when fibroblasts have been incubated continuously in the presence of high levels of LDL (6). Fibroblasts from FH heterozygotes have been shown to express about one-half the normal number of LDL receptors when incubated under culture conditions that elicit a maximal rate of receptor synthesis (1, 7). Moreover, FH heterozygote cells suppress their receptor activity in parallel with normal cells so that these mutant cells continue to express half the number of LDL receptors that are expressed by normal cells even under

Doctors Bilheimer and Brown are Established Investigators of the American Heart Association.

Received for publication 7 September 1977 and in revised form 4 November 1977.

<sup>1</sup>Abbreviations used in this paper: FH, familial hypercholesterolemia; LDL, low density lipoprotein.

regulatory conditions in which the number of LDL receptors in cells from both genotypes is made to vary widely (7).

Recently, LDL receptors have been demonstrated on the surface of peripheral blood lymphocytes isolated from normal subjects (8, 9). As predicted from the studies of receptor regulation in fibroblasts, lymphocytes express only a relatively small number of receptors immediately after their isolation from the bloodstream where they have been exposed to high levels of LDL. However, when the freshly isolated lymphocytes are incubated *in vitro* in lipoprotein-deficient serum, the number of LDL receptors increases up to 30-fold and the cells thereby acquire an increased ability to rapidly ingest and degrade  $^{125}\text{I}$ -LDL (8). Lymphocytes from subjects with homozygous FH express less than 5% of the normal amount of LDL receptor activity after incubation for 72 h in lipoprotein-deficient serum (8, 9).

The present studies were designed to compare the LDL receptor activity in lymphocytes from normal subjects and FH heterozygotes. Using the rate of high affinity degradation of  $^{125}\text{I}$ -LDL as an index of LDL receptor activity, and using a new set of rigidly standardized assay conditions, we have found that lymphocytes from FH heterozygotes express only about one-half the normal number of LDL receptors after incubation for 3 days in lipoprotein-deficient serum. Moreover, the data indicate that this twofold difference in LDL receptor activity between normal and FH heterozygote cells is also present when the cells are studied within 3 h after their isolation from the bloodstream. This latter finding may have implications for the pathogenesis of the elevated plasma LDL-cholesterol level in heterozygous FH.

## METHODS

**Materials.**  $^{125}\text{I}$ -Sodium iodide (carrier-free) and [2- $^{14}\text{C}$ ]acetic acid, sodium salt (59 mCi/mmol) were purchased from Amersham/Searle Corp. (Arlington Heights, Ill.). Lymphoprep was obtained from Accurate Chemical & Scientific Corp. (Hicksville, N. Y.). Plastic flasks and dishes were obtained from Falcon (Div. of Becton, Dickinson, and Co., Oxnard, Calif.). Polystyrene (latex) particles, 1.1  $\mu\text{m}$  in diameter, were obtained from Sigma Chemical Co. (St. Louis, Mo.). Tissue culture supplies and chemicals for assays were obtained from sources as previously reported (8).

**Subjects and family studies.** Clinical and biochemical data for each of the 53 subjects whose lymphocytes were studied are summarized in Table III. 28 of these subjects were members of four families with familial forms of hyperlipidemia. One of these, the D family, is a large kindred with heterozygous FH; it spans five generations and includes 176 descendants of one couple (Fig. 5). 90% of all living blood relatives in the D family were available for plasma lipid measurements. For those relatives living outside of the Dallas area, fasting blood samples for lipid measurements were obtained and mailed to Dallas as previously described (10). The B family is a small family in which three subjects have the heterozygous form of FH. The C family comprises individuals with

the heterozygous and homozygous forms of FH; the pedigree of this family has been published previously (11). The S family is a large kindred with familial dysbetalipoproteinemia in which the hyperlipidemic subjects show either a type 3 or type 4 lipoprotein pattern. Blood for lymphocyte studies was obtained with the informed consent of each subject or his or her parents.

**Lipoproteins.** Human LDL ( $d$  1.019–1.063 g/ml) and human lipoprotein-deficient serum ( $d > 1.215$  g/ml) were obtained from the plasma of individual healthy subjects and prepared by differential ultracentrifugation (12). The concentration of LDL is expressed in terms of its protein content.  $^{125}\text{I}$ -labeled LDL (200–400 cpm/ng of protein) (13) and LDL-ferritin (two to three ferritin cores per LDL particle) (14) were prepared by the referenced methods.

**Proteolytic degradation of  $^{125}\text{I}$ -LDL by lymphocytes after incubation in the absence of lipoproteins (method A).** Heparinized venous blood specimens (20–120 ml) were obtained from each subject after an overnight fast. Mononuclear cells were isolated from these blood specimens under sterile conditions by a previously described method in which Lymphoprep is used as the separation medium (8, 9). The resulting mononuclear cells were washed three times by repeated centrifugation, and the washed cell pellets were suspended in medium A (RPMI 1640 medium with penicillin [100 U/ml] and streptomycin [100  $\mu\text{g}/\text{ml}$ ]) containing 10% (vol/vol) human lipoprotein-deficient serum (final protein concentration, 5 mg/ml). An aliquot of this suspension was used to count the number of mononuclear cells, and the volume was adjusted so that the final concentration of mononuclear cells was approximately  $2 \times 10^6$  cells/ml. Aliquots (14 ml) of this cell suspension were placed in 75-cm<sup>2</sup> plastic culture flasks that were incubated in a horizontal position for 67 h at 37°C in a humidified (5% CO<sub>2</sub>) incubator. After this incubation period, 2-ml portions of the cell suspension (containing about  $1.6$ – $1.8 \times 10^6$  nonadherent lymphocytes/ml) were removed from the 75-cm<sup>2</sup> flask and transferred directly to 25-cm<sup>2</sup> plastic culture flasks. Each of these 25-cm<sup>2</sup> flasks then received 10  $\mu\text{l}$  of solution containing 20  $\mu\text{g}$  of  $^{125}\text{I}$ -LDL to achieve a final concentration of 10  $\mu\text{g}$  of protein/ml. Half of the flasks also received a 26-fold excess of unlabeled LDL delivered in 25  $\mu\text{l}$  (final concentration, 260  $\mu\text{g}$  of protein/ml). The flasks were incubated in a horizontal position for 6 h at 37°C, after which the medium was removed, the cells were sedimented by centrifugation, and the content of  $^{125}\text{I}$ -labeled trichloroacetic acid-soluble (noniodide) material that had been formed by the cells and released into the medium was determined as previously described (8, 15). A blank value due to the presence of small amounts of noniodide acid-soluble material (<0.05% of total added radioactivity) in the  $^{125}\text{I}$ -LDL preparations was determined by parallel incubation of appropriate concentrations of the lipoprotein at 37°C in flasks containing medium A, lipoprotein-deficient serum, and no cells (8, 15). Total degradation of  $^{125}\text{I}$ -LDL represents the amount of  $^{125}\text{I}$ -LDL degraded by the cells to noniodide acid-soluble material in the absence of excess unlabeled LDL. High affinity (i.e., receptor-mediated) degradation of  $^{125}\text{I}$ -LDL is defined as that component of the total that was inhibited competitively by the presence of an excess of unlabeled LDL (8). This latter value was calculated by subtracting the amount of  $^{125}\text{I}$ -LDL degraded in the presence of 260  $\mu\text{g}/\text{ml}$  of unlabeled LDL (nonspecific degradation) from the amount of  $^{125}\text{I}$ -LDL degraded in the absence of unlabeled LDL (total degradation). The data are expressed as the nanograms of  $^{125}\text{I}$ -LDL degraded in 6 h per milligram of total cell protein, the latter determined on the cell pellet after washing (8). Values for replicate assays of  $^{125}\text{I}$ -LDL degradation varied by less than 5%.

Since the cells were transferred from stock 75-cm<sup>2</sup> flasks to

the 25-cm<sup>2</sup> incubation flasks before incubation with <sup>125</sup>I-LDL, the mononuclear cells that had adhered to the plastic stock flask during the initial 67-h incubation were left behind. As a result, more than 98% of the nonadherent cells incubated with <sup>125</sup>I-LDL were identifiable as lymphocytes on the basis of the following criteria: (a) failure to ingest polystyrene particles or India ink (16); (b) morphological examination using Wright-stained smears or phase-contrast microscopy (see Fig. 2); and (c) ultrastructural appearance as assessed by electron microscopy (see Fig. 1). More than 90% of the cells were viable by the criterion of erythrosin B exclusion.

**Proteolytic degradation of <sup>125</sup>I-LDL by mononuclear cells immediately after isolation from the bloodstream (method B).** Mononuclear cells were isolated from heparinized blood and washed three times as described above. The washed cell pellets were resuspended in medium A containing 30% (vol/vol) human lipoprotein-deficient serum (final protein concentration, 15 mg/ml), and the volume was adjusted so that the final concentration of mononuclear cells was 4 × 10<sup>6</sup> cells/ml. Portions (1 ml) of this cell suspension were placed into 35 × 10 mm petri dishes. Each dish received 10 μl of solution containing 25 μg of <sup>125</sup>I-LDL (final concentration, 25 μg of protein/ml) in the absence or presence of a 20-fold excess of unlabeled LDL (final concentration, 500 μg of protein/ml). After incubation at 37°C for the indicated interval, the medium and cells were separated by centrifugation and the content of <sup>125</sup>I-labeled trichloroacetic acid-soluble (noniodide) material formed by the cells and released into the medium was determined as described above for method A. The data are expressed as the nanograms of <sup>125</sup>I-LDL degraded in 4 h per dish (4 × 10<sup>6</sup> cells). Values for replicate assays varied by less than 5%.

By the functional criterion of polystyrene particle ingestion (16), the mononuclear cells used for the above studies consisted of a mixture of lymphocytes (85–95% of total cells) and monocytes (5–15% of total cells).

**Electron microscopy.** Mononuclear cells were isolated from venous blood obtained from a healthy subject (no. 21) and incubated for 67 h in lipoprotein-deficient serum according to method A. Aliquots (2 ml) of the nonadherent lymphocytes were then transferred to 25-cm<sup>2</sup> flasks and the cells were incubated with LDL-ferritin at an LDL-protein concentration of 50 μg/ml for 3 h at 37°C in the absence or presence of 500 μg of protein/ml of unlabeled LDL. After incubation the cells were collected by centrifugation (1,700 rpm, 5 min, 4°C) in a siliconized plastic tube (12 × 75 mm). Each cell pellet was then suspended in 75 μl of an albumin-containing buffer (140 mM NaCl; 3 mM KCl; 50 μM CaCl<sub>2</sub>; 1 mM KH<sub>2</sub>PO<sub>4</sub>; 8 mM Na<sub>2</sub>HPO<sub>4</sub>; and 20 mg/ml of bovine serum albumin, pH 7.2). The cell suspension was then layered onto 1 ml of 100% fetal calf serum in a siliconized plastic tube (12 × 75 mm) and

centrifuged (1,700 rpm, 5 min, 4°C). The resulting cell pellet was fixed with 1 ml of 2% glutaraldehyde in 0.1 M sodium phosphate (pH 7.3), postfixed with 1% osmium tetroxide, dehydrated, and embedded in Araldite. The fixed pellets were sectioned, stained with uranyl acetate and lead citrate, and viewed with a Philips 300 electron microscope (Philips Electronic Instruments, Inc., Mahwah, N. J.). The number of membrane-bound ferritin cores was counted by a modification of the quantitative methods previously described (14, 19).

**Phase-contrast autoradiography.** Mononuclear cells were isolated from venous blood obtained from a healthy subject (no. 16) and incubated for 67 h in lipoprotein-deficient serum according to method A. Aliquots (2 ml) of the nonadherent lymphocytes were then transferred to 25-cm<sup>2</sup> flasks, and the cells were incubated with 10 μg of protein/ml of <sup>125</sup>I-LDL (272 cpm/ng) either in the absence or presence of 470 μg of protein/ml of unlabeled LDL for 2 h at 37°C. After incubation the cells were collected by centrifugation (1,700 rpm, 5 min, 4°C) in a siliconized plastic tube (12 × 75 mm). Each cell pellet was then resuspended in 0.2 ml of medium A containing 10% fetal calf serum. The cell suspension was then layered onto 1.5 ml of 100% fetal calf serum in a siliconized plastic tube (12 × 75 mm) and centrifuged (1,700 rpm, 5 min, 4°C). Each resulting cell pellet was washed with 2 ml of medium A, and the final pellet was suspended in 0.6 ml of medium A containing 1% fetal calf serum so that the concentration of lymphocytes was 2 × 10<sup>6</sup> cells/ml. About 10<sup>6</sup> cells was then spun onto a glass microscope slide in a Shandon Elliott Cyto-centrifuge (Model SCA-0025, Shandon Southern Instruments, Ltd., Camberley, Surrey, England). The slides were immersed in 2% glutaraldehyde in 0.1 M sodium phosphate buffer (pH 7.3) for 10 min at room temperature, washed with distilled water, air dried, and dipped in a 1:2 dilution of Ilford L-4 liquid photographic emulsion (Polysciences, Inc., Warrington, Pa.) in the darkroom and allowed to air dry. The emulsion-coated slides were stored in light-tight boxes containing Drierite dessicant at 4°C for 3 mo. The slides were then developed with D19-B developer, rinsed in distilled water, fixed with Rapid-Fix (Eastman Kodak Co., Rochester, N. Y.), and examined and photographed under phase optics using an American Optical Microstar 10 equipped with a Polaroid camera.

**Other assays.** The concentration of total cholesterol and total triglycerides in plasma and in isolated lipoprotein fractions was determined by enzyme methods (Boehringer Mannheim Biochemicals, Indianapolis, Ind., catalog nos. 124087 and 124966 for cholesterol and triglycerides, respectively). Precilip control serum (Boehringer Mannheim, Catalog no. 125059) was used for standardization. Lipoprotein-cholesterol concentrations in plasma were determined by

**FIGURE 1** Electron micrographs of normal lymphocytes incubated in lipoprotein-deficient serum for 67 h and then exposed to LDL-ferritin. Nonadherent lymphocytes were isolated and incubated with LDL-ferritin at an LDL-protein concentration of 50 μg/ml for 3 h at 37°C as described in Methods. After incubation, the cells were prepared for electron microscopy as described in Methods. (A) A low magnification view of nonadherent lymphocytes. These cells exhibit the typical size and appearance of small and medium-size lymphocytes (20). ×7,000. (B) A high magnification view of the lymphocyte cell surface. Typically, LDL-ferritin was observed to localize in indented regions of the plasma membrane (arrow). The dark area at the bottom of the micrograph is nuclear chromatin. ×112,500. (C) A more deeply invaginated segment of the lymphocyte plasma membrane, showing the localization of LDL-ferritin within these indented regions. ×97,000. (D) A newly formed endocytic vesicle that contains LDL-ferritin. This endocytic vesicle has a well-defined cytoplasmic coat (arrows). ×154,000. (E) A lymphocyte lysosome that has accumulated ferritin cores derived from the binding and uptake of LDL-ferritin. The ferritin cores are located on the right side of this organelle. The left side contains electron-dense material that is characteristic of lysosomes and is not related to LDL-ferritin. ×74,500.

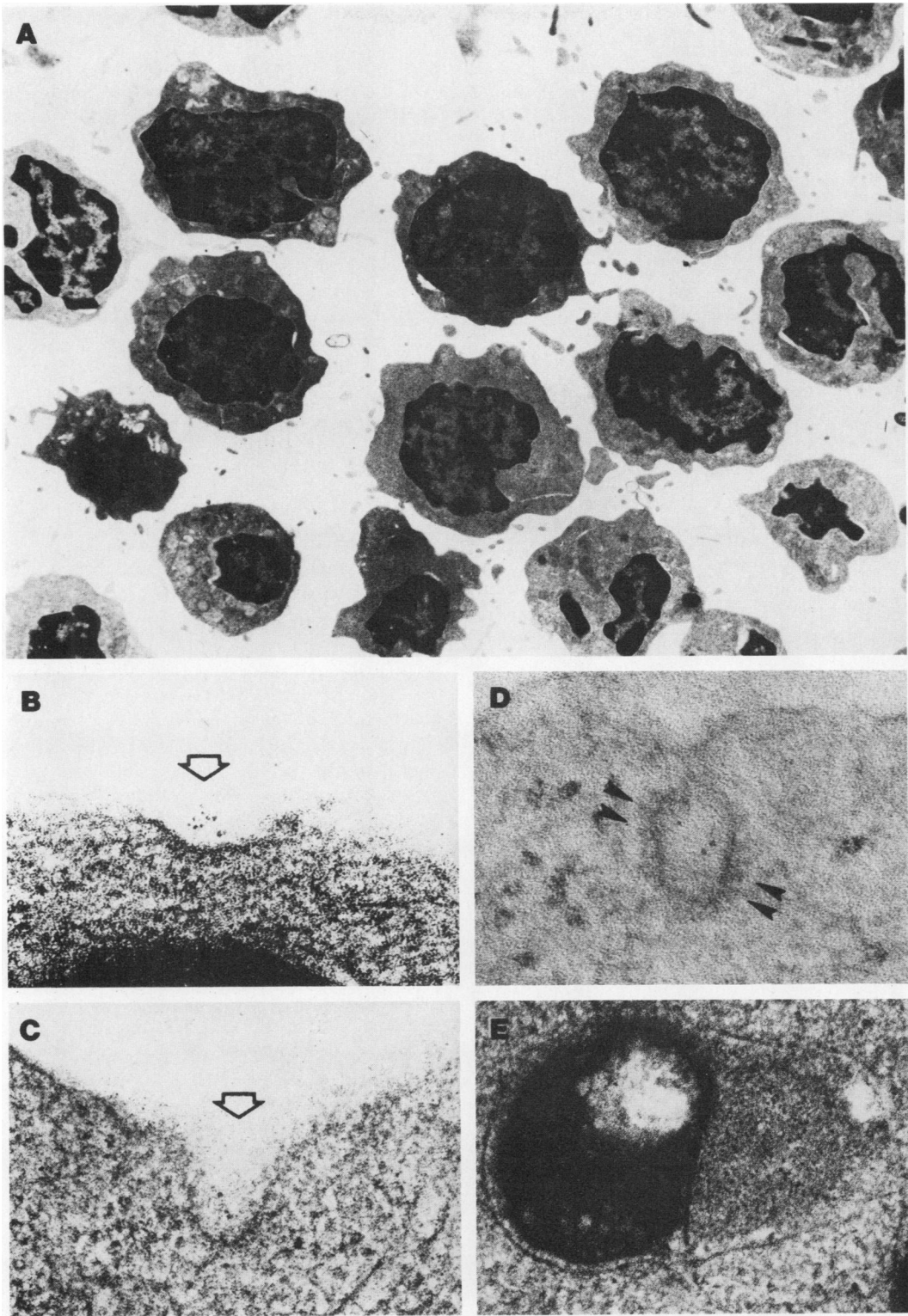

standard ultracentrifugation techniques combined with heparin-manganese precipitation (17).

Total and differential leukocyte counts in blood specimens were performed according to standard clinical hematology techniques using a Coulter counter and Wright-stained smears.

The rate of incorporation of [2-<sup>14</sup>C]acetate into cholesterol by lymphocytes was measured by method 2, as previously described (9).

Protein was determined by the method of Lowry et al. (18), with bovine serum albumin as a standard.

## RESULTS

To measure the ability of cells to produce LDL receptors in response to lipoprotein deprivation, we established a standard set of conditions in which mononuclear cells were isolated from blood by differential sedimentation and incubated in stock flasks for 67 h in medium containing lipoprotein-deficient serum. At the end of this interval, replicate aliquots of cells from the stock flasks were transferred to small flasks and incubated with <sup>125</sup>I-LDL. This transfer step served to remove the monocytes from the cell preparation since the latter adhered to the plastic surface of the stock flask and were left behind. As a result, the <sup>125</sup>I-LDL degradation studies were performed on a population of cells that consisted almost entirely of nonadherent lymphocytes (8, 9).

*Visualization of LDL binding and uptake in nonadherent lymphocytes.* To demonstrate visually that the nonadherent lymphocytes were capable of binding LDL at the specific receptor site, we incubated the nonadherent cells with LDL that had been covalently coupled to ferritin. LDL-ferritin has been shown previously to bind to the LDL receptor in fibroblasts and to be a useful probe for electron microscopic studies (14, 19). Fig. 1A shows the appearance at low magnification of a preparation of lymphocytes isolated and incubated in the above manner. The cells exhibit the characteristic morphology of small and medium-sized lymphocytes (20). Fig. 1B shows that the plasma membrane of these lymphocytes contains binding sites for LDL-ferritin. As in fibroblasts (14, 19), the LDL binding sites on lymphocytes were not uniformly distributed over the cell surface, but rather they were found in discrete clusters whether the incubation with LDL-ferritin was conducted at 37°C (Fig. 1B) or at 4°C (data not shown). In lymphocytes, as in fibroblasts, these clusters of LDL binding sites tended to occur in regions where the plasma membrane was indented (Fig. 1B and C). However, in contrast to the findings in fibroblasts (14, 19), these indented regions in lymphocytes did not possess a distinct cytoplasmic coat that could be visualized by the staining methods employed. In addition to its appearance on the lymphocyte cell surface, the LDL-ferritin was found within endocytic vesicles after incubation at 37°C. Although most of these vesicles

appeared smooth-surfaced, an occasional one showed the classic appearance of a coated vesicle (Fig. 1D). Abundant LDL-ferritin particles were also found within lysosomes of the lymphocyte after incubation at 37°C (Fig. 1E).

To ensure that the LDL-ferritin was binding to the physiologic LDL receptor, we incubated the lymphocytes with LDL-ferritin in the absence or presence of an excess of unlabeled native LDL. The number of membrane-bound LDL-ferritin particles was counted using a modification of a previously described quantitative technique (14). Table I shows that more than 90% of the LDL-ferritin binding was abolished when the LDL receptors were occupied by the excess native LDL in the incubation medium, indicating that the ferritin-labeled lipoprotein was binding to the physiologic LDL receptor.

We also used the technique of autoradiography to visualize LDL receptor activity on lymphocytes. Fig. 2 shows a series of phase-contrast micrographs of autoradiograms of nonadherent lymphocytes that were exposed to <sup>125</sup>I-LDL in the absence (Fig. 2A–D) or presence (Fig. 2E) of an excess of unlabeled LDL. White-appearing silver grains were located over most of the lymphocytes in the preparation, indicating that these cells had taken up <sup>125</sup>I-LDL (Fig. 2A–D). When the incubations were conducted in the presence of an excess of unlabeled LDL, the number of silver grains appearing over the cells was markedly reduced (Fig. 2E), confirming that the visualized silver grains were attributable to uptake of <sup>125</sup>I-LDL through the saturable receptor mechanism. Fig. 2D and E show some of the rare monocytes that were present in this preparation (<2% of total cells). Whenever these monocytes were observed, they were surrounded by clusters of small

TABLE I  
*Quantitation of the Binding of LDL-Ferritin to the Plasma Membrane of Normal Lymphocytes That Had Undergone Prior Incubation in the Absence of Lipoproteins*

Addition to flask	Ferritin cores bound number/mm of cell surface
LDL-ferritin	330
LDL-ferritin + excess unlabeled LDL	20

Nonadherent lymphocytes were isolated and incubated with LDL-ferritin at an LDL-protein concentration of 50 µg/ml for 3 h at 37°C either in the absence or presence of 500 µg of protein/ml of unlabeled LDL as described in Methods. After incubation, the cells were prepared for electron microscopy, and the number of membrane-bound ferritin cores was counted as described in Methods. Each value represents the average of duplicate incubations. A total of 10 randomly chosen cells (corresponding to about 0.2 mm of cell surface) was counted for each incubation.

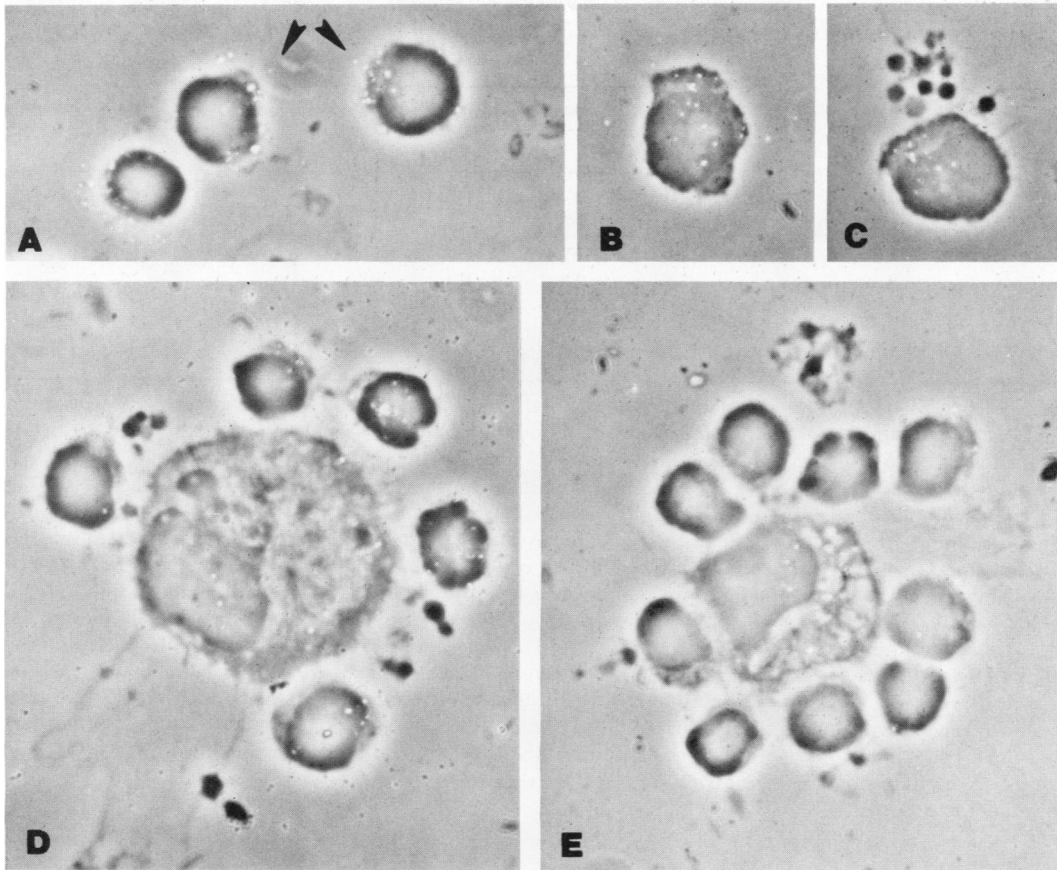

FIGURE 2 Phase-contrast micrographs of autoradiograms of normal lymphocytes incubated in lipoprotein-deficient serum for 67 h and then exposed to  $^{125}\text{I}$ -LDL. Nonadherent lymphocytes were isolated and incubated with  $10\ \mu\text{g}$  of protein/ml of  $^{125}\text{I}$ -LDL (272 cpm/ng) either in the absence (A–D) or presence (E) of  $470\ \mu\text{g}$  of protein/ml of unlabeled LDL for 2 h at  $37^\circ\text{C}$ , as described in Methods. After incubation, the cells were prepared for autoradiography and examined by phase-contrast microscopy as described in Methods. In these whole cell preparations, the developed silver grains are located in the photographic emulsion above the cells. Therefore, when the cell is in focus, the silver grains, which usually have a dark appearance, are out of focus and appear as bright white dots. All of the pictures described below were taken so that the cell-associated silver grains appear white. (A–C) A series of micrographs that demonstrate the localization of  $^{125}\text{I}$ -LDL in lymphocytes. Silver grains are indicated by the arrows.  $\times 1,000$ . (D) This micrograph shows one of the rare monocytes in this preparation. This large cell is surrounded by several small lymphocytes. Silver grains are localized over both types of cells, but appear more concentrated over the lymphocytes.  $\times 1,000$ . (E) These cells were incubated with  $^{125}\text{I}$ -LDL in the presence of an excess of unlabeled LDL. The field consists of one of the rare monocytes surrounded by small lymphocytes. The appearance is similar to that in Fig. 2D except that the number of silver grains located over the lymphocytes is markedly reduced.  $\times 1,000$ .

lymphocytes. The monocytes appeared to take up somewhat less  $^{125}\text{I}$ -LDL than did the lymphocytes (Fig. 2D). Occasional platelets were observed, but these were never associated with silver grains (Fig. 2C).

**$^{125}\text{I}$ -LDL degradation in nonadherent lymphocytes.** The above ultrastructural and autoradiographic studies, coupled with previous biochemical studies (8, 9), demonstrate directly that cells that have the morphologic appearance of lymphocytes and that neither ad-

here to plastic nor ingest polystyrene particles express LDL receptors when incubated in the absence of lipoproteins. To obtain a quantitative estimate of the relative LDL receptor activity in such nonadherent lymphocytes as compared with the activity in the population of blood monocytes and other mononuclear cells that adhere to plastic, we performed the experiments shown in Table II. A preparation of mixed mononuclear cells isolated from peripheral blood was incubated for

TABLE II  
*LDL Receptor Activity in Mononuclear Cells Fractionated by Differential Adherence to Plastic and Incubated in the Absence of Lipoproteins*

Subject*	Initial cell inoculum	Cell fraction	<sup>125</sup> I-LDL degradation (ng/6 h)				<sup>14</sup> C]acetate → <sup>14</sup> C]cholesterol (pmol/4 h)			
			Total		High affinity		-LDL		+LDL	
			per dish	per mg of protein	per dish	per mg of protein	per dish	per mg of protein	per dish	per mg of protein
19	4 × 10 <sup>6</sup>	Adherent	22	1,469	19	1,250	—	—	—	—
		Nonadherent	52	1,080	47	980	—	—	—	—
10	7 × 10 <sup>6</sup>	Adherent	89	920	75	780	170	1,800	24	250
		Nonadherent	120	1,150	117	1,110	1,020	9,700	130	1,200

Mononuclear cells were isolated from venous blood obtained from the indicated healthy subject. The washed cell pellets were suspended in medium A containing 10% human lipoprotein-deficient serum, and the indicated inoculum of cells was added to each 60 × 15 mm petri dish in a final volume of 2.3 ml. The cells were incubated at 37°C for 2 h, after which a portion of the nonadhering cells from each dish (2 ml of cell suspension) were transferred to a 25-cm<sup>2</sup> flask. The adherent cells remaining on the plastic dish were washed four times with 3 ml of medium A, after which was added 2 ml of medium A containing 10% human lipoprotein-deficient serum. For assays of <sup>125</sup>I-LDL degradation, the adherent and nonadherent cells were incubated for 66 h at 37°C, after which each dish or flask received 10 μg of protein/ml of <sup>125</sup>I-LDL (141 cpm/ng for subject 19 and 241 cpm/ng for subject 10) in the absence or presence of 260 μg of protein/ml of unlabeled LDL. After incubation for 6 h at 37°C, the content of <sup>125</sup>I-labeled acid-soluble material in the medium was determined as described in Methods. Values for high affinity degradation of <sup>125</sup>I-LDL were calculated as described in Methods. For assays of cholesterol synthesis, the adherent and nonadherent cells were incubated for 57 h at 37°C, after which each dish or flask received either no LDL or 25 μg of protein/ml of LDL as indicated. The incubations were continued for an additional 9 h, after which the cells were pulse-labeled with 2.5 mM [2-<sup>14</sup>C]acetate (29 cpm/pmol) for 4 h at 37°C and the amount of [<sup>14</sup>C]acetate incorporated into [<sup>14</sup>C]cholesterol was measured as described in Methods. Each value for <sup>125</sup>I-LDL degradation and [<sup>14</sup>C]acetate incorporation into cholesterol represents the average of duplicate incubations.

\* Refers to subject number in Table III.

2 h at 37°C in a plastic culture dish, and the cells that remained in suspension were transferred to separate flasks. Fresh medium was added to the adherent cells that remained in the culture dish, and both the adherent and nonadherent cells were incubated separately for 67 h at 37°C in lipoprotein-deficient serum. At the end of this interval, the ability of the monocyte-rich adherent cells<sup>2</sup> to degrade <sup>125</sup>I-LDL was roughly the same as that of the nonadherent lymphocytes (Table II).

To demonstrate that the LDL receptor was functional in both adherent and nonadherent cells, we measured the ability of LDL to suppress the synthesis of [<sup>14</sup>C]cholesterol from [<sup>14</sup>C]acetate (9). After the cells had been incubated in the absence of lipoproteins for 57 h, the subsequent addition of LDL to the incubation medium led to a 90% reduction in the rate of cholesterol synthesis when measured 9 h later (Table II). The reduction was similar in both the nonadherent and adherent cells, indicating that the LDL receptors that developed in lymphocytes and monocytes were capable of supplying cholesterol to the cells.

The rate at which nonadherent lymphocytes de-

graded <sup>125</sup>I-LDL after incubation in the absence of lipoproteins was influenced by the number of cells present in the initial 67-h incubation flask. Up to a concentration of 2.5 × 10<sup>6</sup> cells/ml, the rate of <sup>125</sup>I-LDL degradation was linearly proportional to the number of cells (Fig. 3). Above this concentration, the rate of <sup>125</sup>I-LDL degradation was reduced. Hence, in all experiments in which nonadherent lymphocytes were incubated for 67 h, the number of mononuclear cells added to the initial incubation flask was adjusted to a final concentration of about 2 × 10<sup>6</sup> cells/ml.

The data in Fig. 4 compare the saturation curves for <sup>125</sup>I-LDL degradation in lymphocytes from a normal subject and an FH heterozygote after incubation for 67 h in the absence of lipoproteins. As previously demonstrated (8, 15), at low <sup>125</sup>I-LDL concentrations the bulk of this degradation is attributable to a high affinity process that achieves saturation in the range of 50 μg of LDL-protein/ml. Above this level, the rate of degradation rises in a more gradual fashion as the <sup>125</sup>I-LDL concentration is increased. The shapes of the curves in Fig. 4 resemble those previously obtained in cultured fibroblasts in which total <sup>125</sup>I-LDL degradation is the sum of the receptor-mediated, saturable uptake process and a second uptake process that is non-saturable and is attributable to bulk fluid endocytosis

<sup>2</sup> Approximately 70% of the adherent cells could be identified as monocytes by the functional criterion of polystyrene particle ingestion (16).

(15). Saturation of the high affinity process for the degradation of  $^{125}\text{I}$ -LDL occurred at about the same LDL concentration in the normal and FH heterozygote lymphocytes. However, at each concentration of  $^{125}\text{I}$ -LDL the rate of degradation was lower in the FH heterozygote cells than in the normal cells.

To evaluate the quantitative difference between the FH heterozygote and normal cells in more detail, we established a set of standardized incubation conditions that permitted the study of lymphocytes from a large number of heterozygotes with FH. In this standardized assay the cells were incubated for 67 h in the absence of lipoproteins and then incubated for 6 h with  $^{125}\text{I}$ -LDL at a concentration that was below saturation for the receptor-mediated uptake process ( $10\ \mu\text{g}$  of LDL protein/ml). The rate of high affinity  $^{125}\text{I}$ -LDL degradation was estimated by measurement of susceptibility of the degradation process to competition by unlabeled LDL.

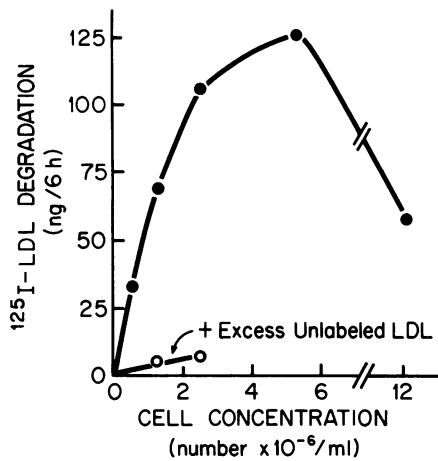

FIGURE 3 Rate of degradation of  $^{125}\text{I}$ -LDL in normal lymphocytes as a function of cell concentration. Mononuclear cells were isolated from 120 ml of venous blood obtained from a healthy subject (No. 7). Aliquots of the final suspension were diluted to 2.3 ml in medium A containing 10% human lipoprotein-deficient serum to give the indicated cell concentration. Each suspension of cells was then placed in a  $25\text{-cm}^2$  plastic flask and incubated for 67 h at  $37^\circ\text{C}$ . After this incubation period, 2-ml aliquots of the nonadherent lymphocytes were transferred to a new  $25\text{-cm}^2$  plastic flask. Each flask then received  $10\ \mu\text{g}$  of protein/ml of  $^{125}\text{I}$ -LDL (217 cpm/ng) in the absence (●) or presence (○) of  $260\ \mu\text{g}$  of protein/ml of LDL. After incubation for 6 h at  $37^\circ\text{C}$ , the content of  $^{125}\text{I}$ -labeled acid-soluble material in the medium was determined as described in Methods. Each value represents the average of duplicate incubations. The data are expressed as the nanograms of  $^{125}\text{I}$ -LDL degraded in 6 h per flask. Over the entire range from 0 to  $12 \times 10^6$  cells/ml, the concentration of total cell protein in the nonadherent lymphocytes when measured after 73 h of incubation was proportional to the concentration of mononuclear cells added to the flasks at zero time. Each inoculum of  $10^6$  mononuclear cells yielded about  $35\ \mu\text{g}$  of cellular protein for the nonadherent lymphocytes.

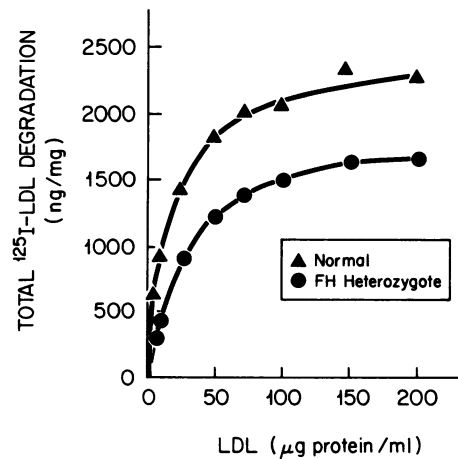

FIGURE 4 Rate of degradation of  $^{125}\text{I}$ -LDL in normal (▲) and FH heterozygote (●) lymphocytes as a function of the  $^{125}\text{I}$ -LDL concentration. Mononuclear cells isolated from 40 ml of venous blood obtained from a normal subject (No. 7) and from an FH heterozygote (No. 50) were incubated for 67 h in lipoprotein-deficient serum according to method A. Aliquots (2 ml) of the nonadherent lymphocytes were transferred to  $25\text{-cm}^2$  flasks. Each flask then received the indicated concentration of  $^{125}\text{I}$ -LDL (53 cpm/ng). After incubation for 6 h at  $37^\circ\text{C}$ , the total content of  $^{125}\text{I}$ -labeled acid-soluble material in the medium was determined as described in Methods. Each value represents the average of duplicate incubations.

Most of the FH heterozygote lymphocytes were obtained from members of the D family whose pedigree is shown in Fig. 5. The D family is a classic example of a large kindred with familial hypercholesterolemia as indicated by the following characteristics: (a) the mutant gene is transmitted in a dominant fashion through five generations; (b) tendon xanthomas and premature coronary atherosclerosis are present in a large proportion of the hypercholesterolemic adult relatives (see legend to Fig. 5); and (c) eight children under 10 yr of age have plasma cholesterol levels greater than 245 mg/dl (mean, 306 mg/dl; range 246–400 mg/dl). As in other large families with FH (21, 22), the members of the D family could be clearly separated into affected and unaffected relatives on the basis of total plasma cholesterol levels alone, thus giving a population of patients that could be independently identified as FH heterozygotes and a population of control subjects from the same family. When its members were so classified, the D family was found to contain a total of 28 living FH heterozygotes as defined by the plasma cholesterol cut-off values described in the legend to Fig. 5. 3 of the 28 heterozygotes in the D family had plasma triglyceride levels above 200 mg/dl. Hypertriglyceridemia has been repeatedly observed in occasional subjects with heterozygous FH from other large families (3, 10, 21, 22). 10 of the FH heterozygotes in



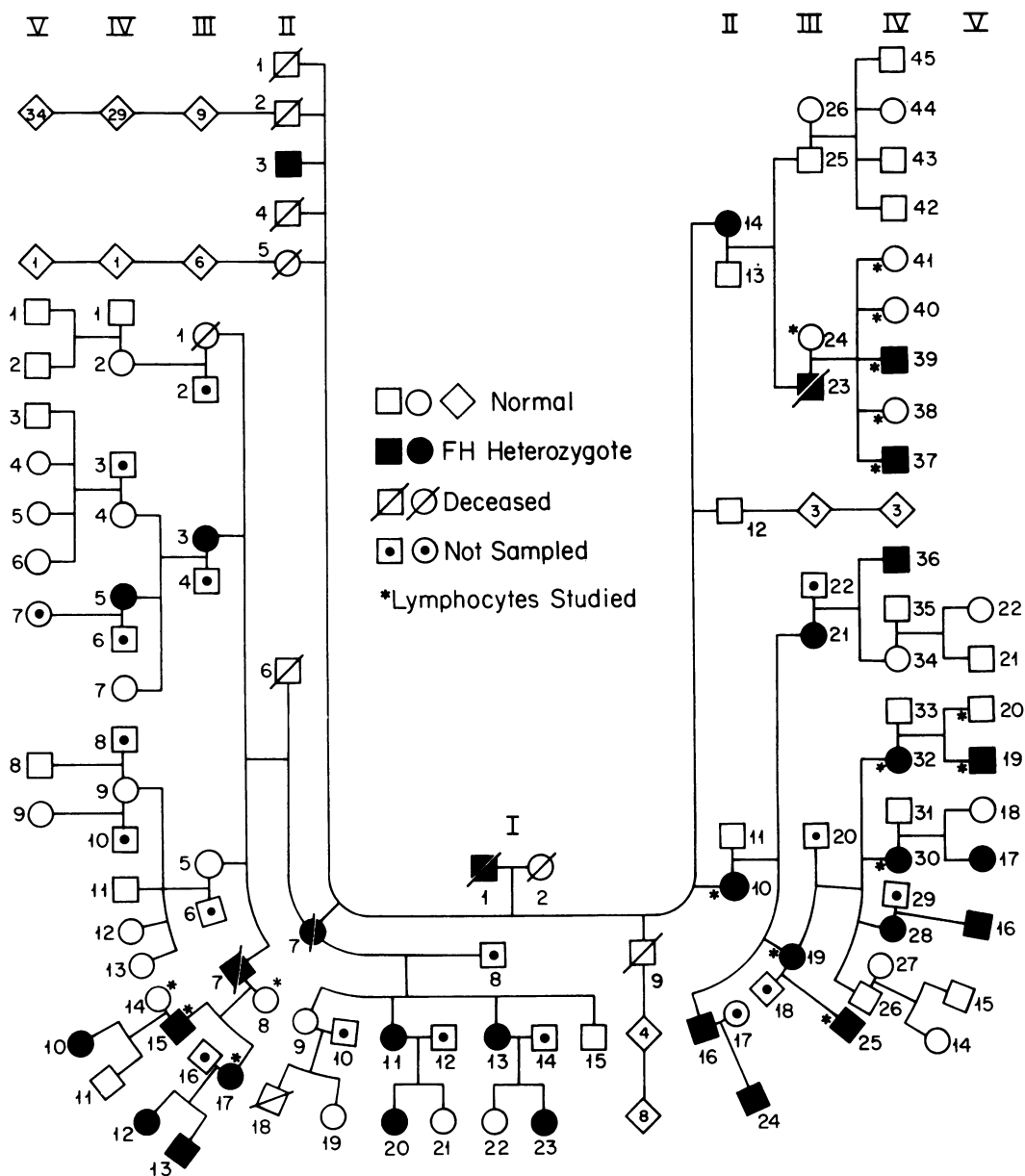

FIGURE 5 Pedigree of D family. Square symbols ( $\square$ ,  $\blacksquare$ ) refer to males; circles ( $\circ$ ,  $\bullet$ ) refer to females. Family members above age 20 with a total plasma cholesterol level above 285 mg/dl were considered to be FH heterozygotes ( $\blacksquare$ ,  $\bullet$ ). For subjects below age 20 the cut-off value for plasma cholesterol was 245 mg/dl (22, 26). Subjects with plasma cholesterol levels below these values were considered normal ( $\square$ ,  $\circ$ ). Tendon xanthomas were present in the following family members: II-10, III-11, III-16, III-19, III-21, and IV-15. The following hypercholesterolemic subjects, 20 yr of age and older, were not available to be examined for tendon xanthomas: II-3, II-14, III-13, IV-5, and IV-36. Since all of the living descendants of II-2, II-5, II-9, and II-12 (indicated by  $\diamond$ ) had normal plasma cholesterol levels, these branches of the pedigree have been truncated. The total number of normal descendants in each of these branches is indicated within the symbol  $\diamond$ .

the D family were available for lymphocyte studies (Table III).

In addition to the FH heterozygotes from the D family, lymphocytes from five other FH heterozygotes

were studied (Table III). One of these (subject 49 in Table III) came from the B family, a small family with classic heterozygous FH. Two heterozygotes came from the C family, one of whom (subject 48) is the

mother of a patient with the receptor-negative form of homozygous FH and is thus an obligate heterozygote for this disease. The other heterozygote from the C family (subject 40) is the sister of the homozygote; she is a 14-yr-old girl whose plasma LDL-cholesterol level is consistently elevated and whose fibroblasts have been shown to contain a half-normal number of LDL receptors (unpublished observations). Subject 52 is the father of a receptor-defective FH homozygote and is therefore an obligate heterozygote. Subject 51 is an FH heterozygote on the basis of classic clinical findings (see Table III); his relatives were not available for study.

A series of healthy subjects was selected from among unaffected family members of the above families and also from a population of normal volunteers. In addition, we studied a separate group of control subjects that consisted of patients who have hyperlipidemia of a type different from FH. Two of these latter subjects (subjects 33 and 34) had LDL levels above the normal range for the healthy subjects, but none of them had LDL levels as high as the population of FH heterozygotes. The clinical and biochemical data for all of the subjects whose lymphocytes were studied are given in Table III. In addition, body weight and height were measured for each subject in groups I-III, and total and differential blood leukocyte counts were obtained. No correlations were observed between any of these values and the parameters of LDL metabolism that were studied.

The data in Table III show the values for the rate of  $^{125}\text{I}$ -LDL degradation in lymphocytes from each of the 53 subjects. All measurements were made under the standardized assay conditions described above after the cells had been incubated for 67 h in lipoprotein-deficient serum. The mean value  $\pm$ SD for the rate of  $^{125}\text{I}$ -LDL degradation by the high affinity process in the 32 healthy subjects was  $892 \pm 314$  ng/6 h per mg protein. In the 6 hyperlipidemic control subjects with disorders other than FH, the mean value  $\pm$ SD was  $972 \pm 335$ , a value that was not significantly different from the healthy subjects. However, among the 15 FH heterozygotes, the mean value  $\pm$ SD for the rate of high affinity  $^{125}\text{I}$ -LDL degradation was  $309 \pm 105$  ng/6 h per mg protein. This value is approximately 35% of the mean value observed in normal subjects ( $P < 0.0001$ ).

Fig. 6 shows the plasma LDL-cholesterol values in each of these subjects plotted against the rate of high affinity degradation of  $^{125}\text{I}$ -LDL as measured in lymphocytes. Values for the FH heterozygotes are clustered in the upper left corner of this plot and are encompassed by two lines. All of the FH heterozygotes had a rate of high affinity  $^{125}\text{I}$ -LDL degradation that was less than 500 ng/6 h per mg protein. The data in Fig. 6 also demonstrate that among the subjects contained within each group there was no direct relation

between the plasma LDL-cholesterol level and the capacity of lymphocytes to produce LDL receptors as measured by the rate of high affinity degradation of  $^{125}\text{I}$ -LDL after incubation of the cells in lipoprotein-deficient serum for 67 h.

The capacity of lymphocytes to produce LDL receptors was independent of the age of the subjects (Table III). At all ages, the rate of high affinity  $^{125}\text{I}$ -LDL degradation was higher in cells from the normal subjects than in cells from the FH heterozygotes.

An estimate of the reproducibility of the lymphocyte assay was obtained by studying lymphocytes from the same subject on two different occasions. When lymphocytes from 8 normal subjects were each assayed on two different days (47–355 days apart), the average variation between the two values for high affinity  $^{125}\text{I}$ -LDL degradation was 16%.

*$^{125}\text{I}$ -LDL degradation in freshly isolated cells.* In all of the above studies, the lymphocytes were incubated for 67 h in the absence of lipoproteins to stimulate the cells to produce a relatively large number of LDL receptors. Thus, these studies do not indicate how many LDL receptors were actually expressed on these cells while they were in the body. This latter measurement is more difficult since lymphocytes normally express only a small percentage of their maximal LDL receptor activity when they are initially isolated from the bloodstream (8). This suppression of LDL receptor activity in vivo presumably results from the presence of LDL in the plasma in which the lymphocytes have been circulating (8).

Because of the regulation of LDL receptors, reliable measurement of the level of LDL receptor activity in freshly isolated cells from normal subjects and FH heterozygotes necessitated the development of a second protocol. In order to shorten the isolation procedure, lymphocytes were not separated from monocytes. Rather, degradation activity was measured in a mixed population of mononuclear cells. The sensitivity of the assay was increased by incubating a larger number of mononuclear cells with  $^{125}\text{I}$ -LDL at a 2.5-fold higher concentration ( $25 \mu\text{g}$  of protein/ml) in a final incubation volume that was reduced by 50% (1 ml). The data in Fig. 7 show that when mononuclear cells from a normal subject were isolated and incubated in this fashion, they degraded  $^{125}\text{I}$ -LDL by a process that could be competitively inhibited by the presence of an excess of unlabeled LDL. After a brief initial lag phase, the rate of degradation was essentially linear for the first 6 h, after which it increased somewhat over the subsequent 6 h. Because of the relatively short incubation time involved, a larger number of cells could be used while at the same time maintaining a linear rate of degradation. Thus, as shown in Fig. 8, the rate of degradation in these freshly isolated mononuclear cells was linear up to a concentration of at least  $4 \times 10^6$  cells/ml.

TABLE III  
 Summary of Clinical and Biochemical Findings in Subjects Whose Blood Lymphocytes Were Studied

Subject	Family	Age yr	Sex	Plasma cholesterol			HDL	Plasma triglycerides mg/dl	Degradation of <sup>125</sup> I-LDL			Comments
				Total	LDL	HDL			Total	High affinity*		
Group I: Healthy subjects												
1	D (V-20)†	6	M	187	132	53	54	905	858			
2	C	12	M	174	97	66	46	1,327	1,242			
3	D (IV-41)	12	F	193	82	73	131	778	681			Methenamine mandelate.
4	D (IV-40)	14	F	160	99	37	137	818	727			
5	D (IV-38)	19	F	209	117	39	217	638	569			
6		22	M	152	68	61	128	900	767			
7		23	F	203	117	64	96	999	878			Oral contraceptives.
8	B	23	M	275	159	71	149	775	705			
9		24	M	196	125	39	91	1,333	1,125			
10		24	M	188	121	55	35	1,182	1,082			
11	B	26	F	190	112	71	46	2,025	1,870			
12		26	M	131	89	31	66	889	778			
13		27	M	186	108	67	69	641	577			
14		27	F	181	104	59	70	662	553			
15		27	F	123	44	56	60	1,007	913			
16		28	F	154	68	65	66	794	713			
17		28	M	161	99	35	140	925	797			
18		29	M	187	90	79	42	2,047	1,771			
19		30	M	195	125	31	110	1,052	956			
20	D (IV-14)	30	F	192	108	67	83	800	671			
21		31	F	161	104	50	43	824	757			
22		32	M	225	154	41	76	785	637			Oral contraceptives.
23		33	F	240	161	38	98	1,013	868			
24		34	M	183	111	41	74	649	559			
25		35	M	206	141	54	52	1,047	886			
26	D (III-24)	36	F	190	130	34	155	812	724			
27		36	M	244	159	53	107	598	516			
28		36	M	139	86	32	88	1,192	1,069			
29	S	41	F	226	132	33	199	1,073	980			
30	B	45	M	190	125	31	180	1,325	1,215			
31	D (III-8)	52	F	212	125	63	70	1,098	1,011			
32	S	69	M	197	126	42	109	1,225	1,092			
		29§		189	113	51	97	1,004 ± 342 <sup>  </sup>	892 ± 314			

Group II: Hyperlipidemic subjects without FH											
33	26	M	242	161	62	112	1,650	1,496	Nonfamilial hypercholesterolemia (persistent type 2a pattern for 4 yr with plasma LDL-cholesterol levels of 204–238 mg/dl before drug treatment); normal LDL receptor activity in fibroblasts; clofibrate.		
34	37	F	250	181	34	2,051	1,213	1,119	Familial hypertriglyceridemia (type 5 pattern); diabetes mellitus; insulin.		
35	49	M	281	139	30	573	609	522	Hypertriglyceridemia (type 4 pattern, family status unknown); clofibrate, para-aminosalicylic acid.		
36	50	F	261	49	35	405	853	744	Familial dysbetalipoproteinemia (type 3 pattern); tuberous xanthomas and xanthoma striata palmaris; clofibrate, L-thyroxine.		
37	52	F	451	24	30	1,111	1,195	1,046	Hypertriglyceridemia (type 5 pattern, family status unknown); clofibrate, nicotinic acid.		
38	56	M	257	52	43	290	964	902	Familial dysbetalipoproteinemia (type 3 pattern).		
	45	§	290	102	39	757	1,081 ± 358 <sup>¶</sup>	972 ± 335			
Group III: FH heterozygotes											
39	D (V-19)†	7	M	308	248	43	453	400	Dextrothyroxine.		
40	C	14	F	269	198	46	457 <sup>¶</sup>	430	Clofibrate.		
41	D (IV-25)	15	M	299	248	27	103	334	Pregnant (6 mo).		
42	D (IV-39)	17	M	331	216	38	174	111	Tendon xanthomas; cholestyramine.		
43	D (IV-37)	21	M	321	241	24	274	138	Mother of FH homozygote.		
44	D (IV-32)	22	F	430	350	52	162	329	Tendon xanthomas; cholestyramine.		
45	D (IV-30)	25	F	252 <sup>**</sup>	177	55	49	498	Tendon xanthomas; cholestyramine, clofibrate.		
46	D (IV-17)	28	F	320	204	86	77	412	Tendon xanthomas; father of FH homozygote; cholestyramine, nicotinic acid.		
47	D (IV-15)	31	M	361	277	53	68	192	Tendon xanthomas.		
48	C	33	F	301	233	42	91	298			
49	B	42	F	290	209	51	119	453			
50	D (III-19)	49	F	581	371	35	230	301 <sup>¶</sup>			
51		49	M	303	200	45	289	305 <sup>¶</sup>			
52		53	M	350	246	75	94	413 <sup>¶</sup>			
53	D (II-10)	66	F	497	314	25	308	366			
	32	§	348	249	47	146	358 ± 106 <sup>¶</sup>	309 ± 105			

\* Mononuclear cells were isolated from 20 ml of venous blood and incubated for 67 h at 37°C in lipoprotein-deficient serum according to method A. Aliquots (2 ml) of the nonadherent lymphocytes were transferred to 25-cm<sup>2</sup> flasks. Each flask then received 10 µg of protein/ml of <sup>125</sup>I-LDL (200–300 cpm/ng) in the absence or presence of 260 µg of protein/ml of unlabeled LDL. After incubation for 6 h at 37°C, the content of <sup>125</sup>I-labeled acid-soluble material in the medium was determined as described in Methods. The high affinity values were obtained as described in Methods. The content of cellular protein in each flask varied among subjects from 50 to 110 µg/flask. Each value represents the mean of triplicate incubations.

† Refers to pedigree position in Fig. 5.

§ Mean.

¶ Mean ± SD.

¶¶ Subjects in whom the number of LDL receptors has been measured in cultured fibroblasts. In each case the number of receptors was in the range of 40–60% of normal.

\*\* Although this subject had a borderline elevated plasma cholesterol level on the day her blood lymphocytes were assayed, she is classified as an FH heterozygote on the following grounds: (1) her previous total plasma cholesterol levels were greater than 285 mg/dl, and (2) her 5-yr-old daughter has a plasma cholesterol level of 261 mg/dl.

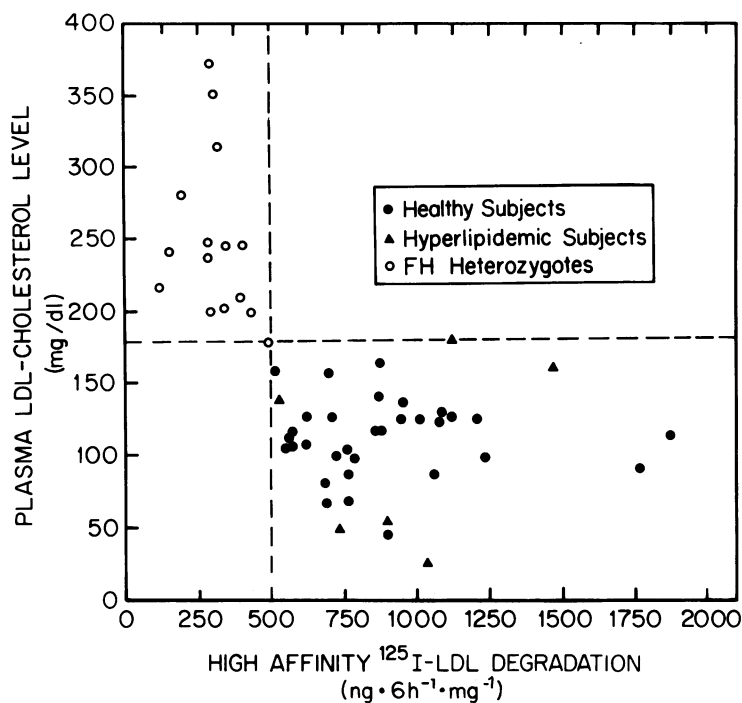

FIGURE 6 Relation between the plasma LDL-cholesterol level and the rate of high affinity degradation of  $^{125}\text{I}$ -LDL in lymphocytes incubated in the absence of lipoproteins. The values plotted are obtained from the data in Table III: (●) healthy subjects; (▲), hyperlipidemic subjects with disorders other than FH; and (○) FH heterozygotes. Blood samples for lymphocyte isolation and for measurement of plasma LDL-cholesterol level were obtained simultaneously.

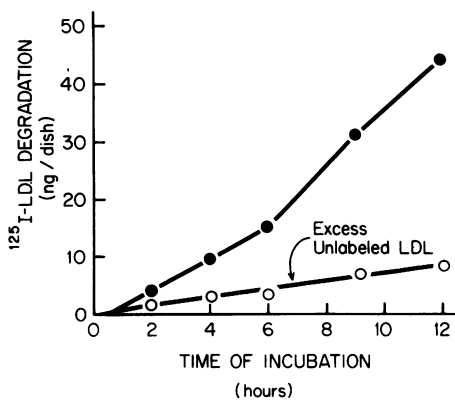

FIGURE 7 Time course of degradation of  $^{125}\text{I}$ -LDL by mononuclear cells immediately after their isolation from the bloodstream. Mononuclear cells were isolated from 90 ml of venous blood obtained from a healthy subject (No. 12). Replicate dishes of cells ( $4 \times 10^6$  cells/ml; 1 ml/dish) were prepared according to method B and incubated with  $25 \mu\text{g}$  of protein/ml of  $^{125}\text{I}$ -LDL (219 cpm/ng) in the absence (●) or presence (○) of  $500 \mu\text{g}$  of protein/ml of unlabeled LDL. After incubation at  $37^\circ\text{C}$  for the indicated interval, the content of  $^{125}\text{I}$ -labeled acid-soluble material in the medium was determined as described in Methods. Each value represents the mean of triplicate incubations.

The experiment shown in Table IV was performed to test the hypothesis that the number of LDL receptors measured under the above assay conditions reflected the number actually present when the cells were initially isolated and was not attributable to receptors synthesized during the 3 h required for isolation of the mononuclear cells. In this experiment a blood specimen from one subject was divided into two portions immediately after removal from the body. The mononuclear cells were isolated from one portion according to the standard procedure (method B) in which the cells are not exposed to LDL during the isolation procedure. The other portion of blood was treated differently in that all solutions with which the cells came into contact during the isolation procedure contained  $100 \mu\text{g}$  of protein/ml of LDL. This concentration of LDL is fully saturating for the LDL receptor, and its presence has been shown previously to prevent the induction of LDL receptors that otherwise occurs when lymphocytes are deprived of the lipoprotein (8). Immediately after the isolation procedure was completed (about 3 h after removal of the cells from the bloodstream), the cells were centrifuged to remove the unlabeled LDL and then incubated for 4 h in the presence

of 25  $\mu\text{g}$  of protein/ml of  $^{125}\text{I}$ -LDL. The rate of high affinity  $^{125}\text{I}$ -LDL degradation was the same in the cells isolated in the absence and presence of unlabeled LDL (Table IV), indicating that the LDL receptors had not been synthesized in response to deprivation of LDL during the isolation procedure. To confirm that the added LDL was sufficient to suppress the synthesis of new LDL receptors, a portion of the mononuclear cells isolated in the absence or presence of LDL was further incubated for 9 h in the absence or presence of LDL, respectively. The cells were then isolated by centrifugation and incubated for 4 h with  $^{125}\text{I}$ -LDL. In the cells that had been incubated in the absence of LDL, the rate of  $^{125}\text{I}$ -LDL degradation increased by fourfold during the 9-h interval (23 vs. 5.6 ng of  $^{125}\text{I}$ -LDL degraded in 4 h per  $4 \times 10^6$  cells). In the cells incubated in the presence of LDL, this induction of LDL receptor activity was prevented, and the rate of  $^{125}\text{I}$ -LDL degradation actually declined somewhat (3.6 vs. 5.7 ng of  $^{125}\text{I}$ -LDL degraded in 4 h per  $4 \times 10^6$  cells).

The initial lag in the rate of degradation that was observed when freshly isolated mononuclear cells were incubated with  $^{125}\text{I}$ -LDL (Fig. 7) raised the possibility that the observed LDL receptors were actually being synthesized during the time in which the cells were incubated with  $^{125}\text{I}$ -LDL. To examine this ques-

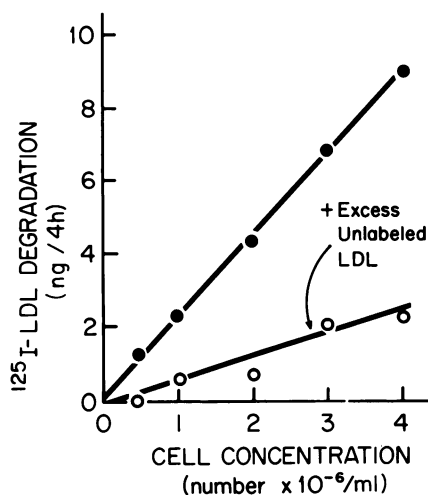

FIGURE 8 Degradation of  $^{125}\text{I}$ -LDL by mononuclear cells immediately after their isolation from the bloodstream plotted as a function of the concentration of cells in the incubation medium. Mononuclear cells were isolated from 50 ml of venous blood obtained from a healthy subject (No. 16). Dishes of cells were prepared according to method B, except that the concentration of cells in each dish was varied from 0.5 to  $4 \times 10^6$  cells/ml. The cells were incubated with 25  $\mu\text{g}$  of protein/ml of  $^{125}\text{I}$ -LDL (340 cpm/ng) in the absence (●) or presence (○) of 500  $\mu\text{g}$  of protein/ml of unlabeled LDL. After incubation for 4 h at 37°C, the content of  $^{125}\text{I}$ -labeled acid-soluble material in the medium was determined as described in Methods. Each value represents the mean of triplicate (●) or duplicate (○) incubations.

TABLE IV  
LDL Receptor Activity in Mononuclear Cells Isolated in the Absence and Presence of Exogenous LDL

Blood sample	Addition	Time of incubation with $^{125}\text{I}$ -LDL h	$^{125}\text{I}$ -LDL degraded	
			Total	High affinity
			ng $\cdot$ h $^{-1}$ $\cdot$ dish $^{-1}$	
A-1	None	0-4	6.8	5.6
B-1	LDL	0-4	6.7	5.7
A-2	None	9-13	26	23
B-2	LDL	9-13	3.8	3.6

Venous blood was obtained from a healthy subject (No. 15) and divided into two equal portions, A and B. To the B sample was added unlabeled LDL to a final concentration of 100  $\mu\text{g}$  of protein/ml. Mononuclear cells were then isolated from the two blood samples according to method B, except that all solutions used for isolation of sample B contained 100  $\mu\text{g}/\text{ml}$  of LDL. The final cell pellets were suspended in medium A containing 30% human lipoprotein-deficient serum without LDL and the concentration of cells was adjusted to  $4 \times 10^6$  cells/ml. One portion of this cell suspension (1 ml) was placed into petri dishes and incubated with 25  $\mu\text{g}$  of protein/ml of  $^{125}\text{I}$ -LDL (205 cpm/ng) either in the absence or presence of 500  $\mu\text{g}$  of protein/ml of unlabeled LDL (A-1 and B-1). After incubation for 4 h at 37°C (0-4 h incubation), the content of  $^{125}\text{I}$ -labeled acid-soluble material in the medium was determined as described in Methods. A second portion of the cell suspension (1 ml) was placed into petri dishes and incubated at 37°C for 9 h in the absence (A-2) or presence (B-2) of 100  $\mu\text{g}$  of protein/ml of unlabeled LDL. After this incubation, the medium was removed, each dish was washed once with 2 ml of medium A containing 30% human lipoprotein-deficient serum, and the wash was pooled with the original medium. The nonadherent cells were collected by centrifugation of the medium and wash. Each cell pellet was then suspended in 1 ml of medium A containing 30% lipoprotein-deficient serum and added back to the original dish so that the original adherent and nonadherent cells were present in the final incubation. Each dish was then incubated with 25  $\mu\text{g}$  of protein/ml of  $^{125}\text{I}$ -LDL (205 cpm/ng protein) either in the absence or presence of 500  $\mu\text{g}$  of protein/ml of unlabeled LDL. After incubation for 4 h at 37°C (9-13 h incubation), the content of  $^{125}\text{I}$ -labeled acid-soluble material in the medium was determined as described in Methods. Each value represents the average of triplicate incubations.

tion, we compared the time course of high affinity  $^{125}\text{I}$ -LDL degradation in freshly isolated mononuclear cells incubated with  $^{125}\text{I}$ -LDL at 25  $\mu\text{g}/\text{ml}$  and 100  $\mu\text{g}/\text{ml}$ . As demonstrated above (Table IV) and in previous studies (8), the latter concentration of LDL is sufficient to completely prevent the induction of LDL receptors. Fig. 9A shows that the rate of high affinity degradation and the apparent lag phase were similar at the two concentrations of  $^{125}\text{I}$ -LDL, suggesting that the lag phase was not due to the induction of new LDL receptors during the

incubation. To confirm this conclusion, we compared the initial time course in freshly isolated cells (Fig. 9A) with the initial time course of  $^{125}\text{I}$ -LDL degradation in lymphocytes that had been incubated for 67 h in the absence of lipoproteins so as to induce a large number of LDL receptors (Fig. 9B). The lag phase in the induced cells was similar to that in the freshly isolated cells. The length of this lag phase is similar to the 30–60-min lag phase observed for  $^{125}\text{I}$ -LDL degradation in cultured human fibroblasts (6, 15). In fibroblasts, this lag has been shown to be due to the time required for the binding, internalization, and delivery of  $^{125}\text{I}$ -LDL to cellular lysosomes and the subsequent release of  $^{125}\text{I}$ -monoiodotyrosine into the culture medium (15, 19, 23).

Using the conditions of a 4-h incubation, a cell concentration of  $4 \times 10^6/\text{ml}$  and an  $^{125}\text{I}$ -LDL concentration of  $25 \mu\text{g}$  of protein/ml, we compared the rate of  $^{125}\text{I}$ -LDL degradation in freshly isolated mononuclear cells from a group of 13 healthy subjects, 4 subjects with hyperlipidemia other than FH, 6 FH heterozygotes, and 1 FH homozygote. The data in Table V demonstrate that the

mean  $\pm$ SD rates of high affinity LDL degradation among the healthy subjects and the hyperlipidemic subjects without FH were not significantly different ( $5.7 \pm 1.3$  and  $5.6 \pm 1.1$  ng in 4 h per  $4 \times 10^6$  cells, respectively). However, the mean  $\pm$ SD rate of high affinity LDL degradation among the FH heterozygotes ( $3.1 \pm 0.5$ ) was significantly lower than that of both the healthy subjects and the hyperlipidemic subjects without FH ( $P < 0.001$ ). The lowest value for high affinity degradation (0.9) was observed in the one subject with homozygous FH.

## DISCUSSION

In the current studies, LDL receptor activity in blood lymphocytes from normal subjects and FH heterozygotes was compared under two different assay conditions. First, the activity in isolated lymphocytes was measured after the cells had been incubated for 3 days in lipoprotein-deficient serum. This assay measures the genetic capacity of the cells to produce high levels of receptor activity in response to a strong stimulus. Sec-

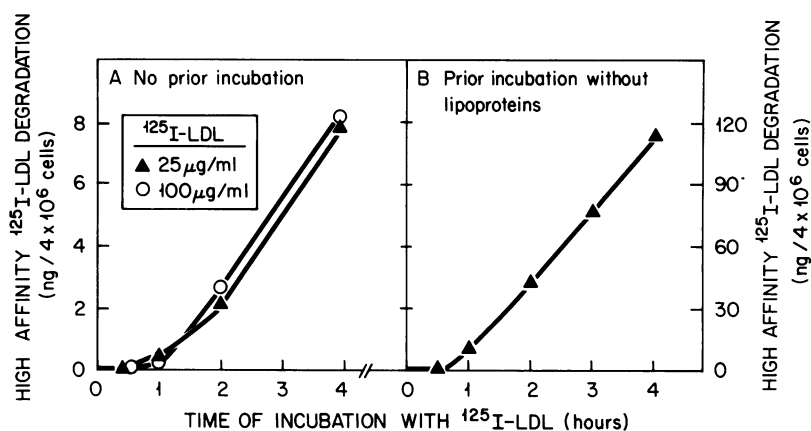

FIGURE 9 Comparison of the time course of high affinity degradation of  $^{125}\text{I}$ -LDL by freshly isolated mononuclear cells (A) and by lymphocytes that had undergone prior incubation in lipoprotein-deficient serum for 67 h (B). *Experiment A*: Mononuclear cells were isolated from 100 ml of venous blood obtained from a healthy subject (No. 14). Replicate dishes containing  $4 \times 10^6$  cells in 1 ml of medium were prepared according to method B and incubated with  $^{125}\text{I}$ -LDL (300 cpm/ng) at  $25 \mu\text{g}$  of protein/ml ( $\blacktriangle$ ) or  $100 \mu\text{g}$  of protein/ml ( $\circ$ ). The incubations were conducted in the absence or presence of 1 mg of protein/ml of unlabeled LDL. After incubation at  $37^\circ\text{C}$  for the indicated interval, the content of  $^{125}\text{I}$ -labeled acid-soluble material in the medium was determined as described in Methods. *Experiment B*: Mononuclear cells isolated from 15 ml of venous blood obtained from a normal subject (No. 7) were incubated for 67 h in lipoprotein-deficient serum according to method A. Aliquots of 1 ml containing  $1.4 \times 10^6$  nonadherent lymphocytes were transferred to  $35 \times 10$  mm petri dishes. Each dish then received  $25 \mu\text{g}$  of protein/ml of  $^{125}\text{I}$ -LDL (142 cpm/ng) in the absence or presence of 1 mg of protein/ml of unlabeled LDL. After incubation at  $37^\circ\text{C}$  for the indicated interval, the content of  $^{125}\text{I}$ -labeled acid-soluble material in the medium was determined as described in Methods. For *Experiments A and B*, the amount of high affinity degradation of  $^{125}\text{I}$ -LDL was calculated by subtracting the amount of  $^{125}\text{I}$ -LDL degraded in the presence of unlabeled LDL from the amount of  $^{125}\text{I}$ -LDL degraded in the absence of unlabeled LDL. Each value represents the average of duplicate incubations. For comparative purposes, both sets of data are expressed as nanograms of  $^{125}\text{I}$ -LDL degraded per  $4 \times 10^6$  cells.

TABLE V  
*Degradation of <sup>125</sup>I-LDL in Freshly Isolated Mononuclear Cells from Healthy Subjects, Hyperlipidemic Subjects Other Than FH, and from FH Heterozygotes*

Subject providing cells	<sup>125</sup> I-LDL degraded	
	Total	High affinity
	<i>ng · 4 h<sup>-1</sup> · dish<sup>-1</sup></i>	
<b>Healthy subjects</b>		
6*	8.5	5.7
7	4.9	4.1
10	8.5, 9.7‡	5.8, 6.9
12	7.3, 8.7, 9.2	5.1, 7.4, 6.0
13	4.6	3.1
14	7.5, 9.3, 8.7	6.4, 7.9, 7.0
15	6.7	5.7
16	8.9	6.6
17	5.5	4.1
18	5.8	4.2
19	6.0	5.1
21	5.4	4.6
26	8.8	6.3
	Mean ± SD	7.4 ± 1.7      5.7 ± 1.3
<b>Hyperlipidemic subjects without FH</b>		
33§	7.5	4.1
35	10.9	6.8
37	10.1	5.7
E. F.¶	7.1	5.6
	Mean ± SD	8.9 ± 1.9      5.6 ± 1.1
<b>FH heterozygotes</b>		
40	3.6	2.3
41	3.6	3.0
42	4.9	2.9
48	5.0	3.1
50	5.6	3.9
53	4.6	3.3
	Mean ± SD	4.6 ± 0.8      3.1 ± 0.5
<b>FH homozygote</b>		
M. C.¶	1.7	0.9

Mononuclear cells were isolated from 30 ml of venous blood from the indicated subject. Dishes of cells ( $4 \times 10^6$  cells/ml, 1 ml/dish) were prepared according to method B. The cells were incubated with 25  $\mu$ g of protein/ml of <sup>125</sup>I-LDL (291–312 cpm/ng) in the absence or presence of 500  $\mu$ g of protein/ml of unlabeled LDL. After incubation for 4 h at 37°C, the content of <sup>125</sup>I-labeled acid-soluble material in the medium was determined and the amount of total and high affinity degradation was calculated as described in Methods. Each value represents the mean of triplicate incubations.

\* Refers to subject number in Table III.

‡ Where two or more values are shown, the values represent the results of repeated assays on the same individual performed on different days.

§ At the time of this study, this subject had not taken clofibrate for 2 mo. His plasma lipid values were: total cholesterol, 329 mg/dl; LDL-cholesterol, 263; triglycerides, 79.

¶ E. F. is a 57-yr-old female with familial combined hyperlipidemia (type 2b pattern). At the time of this study, her plasma lipid values were the following: total cholesterol, 299 mg/dl; LDL-cholesterol, 178; HDL-cholesterol, 31; triglycerides, 407.

¶ M. C. is a 9-yr-old female with the receptor-negative form of homozygous FH (8).



ond, receptor activity was measured in a mixed population of mononuclear cells (consisting of 85–95% lymphocytes and 5–15% monocytes) immediately after their isolation from the bloodstream. This assay represents an attempt to measure the number of LDL receptors that were functional in these cells while they were in the body. Under both sets of assay conditions, the rate of high affinity  $^{125}\text{I}$ -LDL degradation was used as an index of the number of functional LDL receptors. In both cases, the number of LDL receptors in the FH heterozygote cells was reduced as compared with that of the normal cells.

The data in Fig. 6, which reflect the capacity of lymphocytes to produce LDL receptors after incubation in lipoprotein-deficient serum, support the conclusion that the number of functional genes at the LDL receptor locus is one of the major factors determining the plasma LDL-cholesterol level in man (23). As a group, lymphocytes from the FH heterozygotes, which express only one functional gene at the LDL receptor locus, produced less than 50% of the normal number of LDL receptors. Likewise, the mean LDL-cholesterol level in the FH heterozygote group was 2.5-fold above the mean LDL-cholesterol of the normal subjects (Table III). However, among individual persons within both the normal and FH heterozygote groups, the plasma LDL-cholesterol level varied by as much as two- to threefold. Moreover, the number of LDL receptors varied threefold within each group, even though the number of functionally active genes for the LDL receptor is presumably the same among all members within the same group (i.e., two per cell for the normals and one per cell for the heterozygotes). Within each group no relation was observed between the capacity of lymphocytes to produce LDL receptors and the plasma LDL-cholesterol level (Fig. 6). In other words, those normal subjects whose cells can develop the highest numbers of LDL receptors *in vitro* do not necessarily manifest the lowest levels of plasma LDL-cholesterol. These data are consistent with previous studies of receptor-negative FH homozygotes, which have shown a twofold variation in plasma LDL-cholesterol levels (450–960 mg/dl) even among a group of subjects whose fibroblasts show no detectable ability to produce LDL receptors (4). Thus, the genetic capacity to produce LDL receptors dictates the general range of the plasma LDL-cholesterol level (i.e., 60–180, 180–400, and 450–1,000 mg/dl in normals, FH heterozygotes, and FH homozygotes, respectively [3, 4]), but other factors determine the precise LDL-cholesterol level within a given range. It is known that diet, obesity, and age are among the nongenetic factors that influence plasma LDL-cholesterol levels among both normals and FH heterozygotes (24).

The second set of assay conditions that was used in the current studies represented an attempt to estimate

the number of LDL receptors actually produced by lymphocytes while they were circulating in the bloodstream. We have previously demonstrated that this number is much less than the number of receptors produced by cells when they are incubated *in vitro* in the absence of lipoproteins (8). This is presumably because circulating lymphocytes are continuously exposed to high levels of LDL in the bloodstream and the resultant availability of cholesterol keeps LDL receptor activity suppressed (8, 9). Because of this regulation of the LDL receptor, it has been difficult to obtain an accurate estimate of the number of LDL receptors on freshly isolated lymphocytes. It has also been difficult to exclude the possibility that the measured receptor activity in freshly isolated cells represents receptors that have developed in the cells during the time required for their isolation from the bloodstream (which takes about 3 h) or during their incubation with  $^{125}\text{I}$ -LDL.

In the current studies, we have modified our methods in two ways in an attempt to get around these problems. First, we shortened the isolation procedure by omitting any attempt to separate monocytes from lymphocytes. Instead, we studied a mixed population of mononuclear cells, 85–95% of which were lymphocytes. Second, we increased the sensitivity of the assay by increasing the number of cells per assay, increasing the concentration of  $^{125}\text{I}$ -LDL, and decreasing the incubation volume.

Two types of experiments were conducted to test the possibility that the observed LDL receptors were induced during the time required for the isolation of the cells or were produced during the time of incubation of the cells with  $^{125}\text{I}$ -LDL. In the first experiment, cells were kept in contact with a saturating level of LDL (100  $\mu\text{g}$  of protein/ml) throughout the isolation procedure. The presence of this concentration of LDL was sufficient to prevent the induction of LDL receptors that otherwise occurred when the lymphocytes were incubated for a further 9 h in the absence of lipoproteins. However, the presence of this unlabeled LDL during the isolation procedure did not affect the  $^{125}\text{I}$ -LDL degradation activity that was measured immediately after the cells were isolated, indicating that this activity was not induced as a result of the deprivation of the cells from LDL during this isolation procedure.

In the second experiment, we compared the time course of high affinity  $^{125}\text{I}$ -LDL degradation in freshly isolated cells and in cells that had been incubated for 67 h in the absence of lipoproteins so as to induce a high level of receptor activity. In both cases, the rate of degradation was essentially linear for 3 h after a 30- to 60-min lag period that corresponds to the time required to bind, take up, and degrade the  $^{125}\text{I}$ -LDL. Considered together, these two validation experiments suggest that the measured  $^{125}\text{I}$ -LDL degradation activity in freshly isolated blood mononuclear cells does reflect the num-

ber of LDL receptors that were present on these cells while they were in the circulation. However, ultimate proof that these measurements do in fact represent LDL receptors expressed *in vivo* will require the development of sensitive methods for measuring the low levels of  $^{125}\text{I}$ -LDL binding activity in lymphocytes immediately after their isolation from the bloodstream.

When assayed by the above method, the activity of the LDL receptor in lymphocytes at zero time was less than one-twentieth of the activity that developed after 3 days of incubation in lipoprotein-deficient serum. When the data are expressed on a per cell basis and normalized to an  $^{125}\text{I}$ -LDL concentration of  $10\ \mu\text{g}/\text{ml}$ , the  $^{125}\text{I}$ -LDL degradation activity averaged  $0.14\ \text{ng}/\text{h}$  per  $10^6$  cells initially (Table V), as compared with  $3\ \text{ng}/\text{h}$  per  $10^6$  cells in the induced state (Table III).

Mononuclear cells from FH heterozygotes as a group expressed only 55% of the normal number of LDL receptors when initially isolated from the bloodstream (Table V). This 45% reduction in LDL receptor activity correlates with the 50% reduction in the total-body fractional catabolic rate for  $^{125}\text{I}$ -LDL in FH heterozygotes as originally measured by Langer et al. in studies of plasma LDL turnover (25). The current data lend support to the conclusion previously drawn from studies in fibroblasts that the reduction in LDL receptors in familial hypercholesterolemia produces a relative block in the catabolism of LDL and that this defect is of fundamental importance in causing the high plasma LDL levels in heterozygotes and homozygotes with this disease (2-4).

A word of caution should be expressed with regard to the ability of the lymphocyte  $^{125}\text{I}$ -LDL degradation assay to distinguish between normal subjects and FH heterozygotes if such an assay were to be applied to large-scale studies of the general population. The current studies primarily involved heterozygotes in one large family. Moreover, the number of normal subjects and FH heterozygotes studied was roughly comparable. Under these conditions, there was little overlap between the values for  $^{125}\text{I}$ -LDL degradation obtained from FH heterozygotes and normal subjects (Fig. 6). However, among the general population, the ratio of normal subjects to FH heterozygotes is of the order of 500:1 (3, 26). Hence, among the general population a borderline low  $^{125}\text{I}$ -LDL degradation value will more likely be attributable to a normal subject who is at the extreme lower limit of the Gaussian distribution for normal subjects rather than to an FH heterozygote. Thus, as pointed out by Kirkman (27), it is likely that some normal subjects would be misdiagnosed as heterozygotes if the assay were applied to the population at large. However, using both the level of plasma LDL-cholesterol (which is a good discriminant in its own right) and the level of LDL receptor activity in incubated lymphocytes as diagnostic criteria, one should

be able to distinguish between FH heterozygotes and normal subjects in the general population.

## ACKNOWLEDGMENTS

Michael Funk, Scott Madison, and Lynda Lopez provided excellent technical assistance. We thank Dr. Stephen Shell and Thomas Clayton for their help with the clinical evaluation of the D family.

This research was supported by grants from the National Foundation-March of Dimes and the National Institutes of Health (HL 15949, PO1-HL-20948, and RR 00633).

## REFERENCES

1. Goldstein, J. L., M. S. Brown, and N. J. Stone. 1977. Genetics of the LDL receptor: evidence that the mutations affecting binding and internalization are allelic. *Cell*. **12**: 629-641.
2. Brown, M. S., and J. L. Goldstein. 1976. Familial hypercholesterolemia: a genetic defect in the low-density lipoprotein receptor. *N. Engl. J. Med.* **294**: 1386-1390.
3. Fredrickson, D. S., J. L. Goldstein, and M. S. Brown. 1978. The familial hyperlipoproteinemias. In *Metabolic Basis of Inherited Disease*. J. B. Stanbury, J. B. Wyngaarden, and D. S. Fredrickson, editors. McGraw Hill Book Company, New York. 4th edition. 604-655.
4. Havel, R. J., J. L. Goldstein, and M. S. Brown. 1978. Lipoproteins and lipid transport. In *Diseases of Metabolism*. P. K. Bondy and L. E. Rosenberg, editors. W. B. Saunders Company, Philadelphia. 8th edition. In press.
5. Brown, M. S., and J. L. Goldstein. 1976. Receptor-mediated control of cholesterol metabolism. *Science (Wash. D. C.)*. **191**: 150-154.
6. Brown, M. S., and J. L. Goldstein. 1975. Regulation of the activity of the low density lipoprotein receptor in human fibroblasts. *Cell*. **6**: 307-316.
7. Goldstein, J. L., M. K. Sobhani, J. R. Faust, and M. S. Brown. 1976. Heterozygous familial hypercholesterolemia: failure of normal allele to compensate for mutant allele at a regulated genetic locus. *Cell*. **9**: 195-203.
8. Ho, Y. K., M. S. Brown, D. W. Bilheimer, and J. L. Goldstein. 1976. Regulation of low density lipoprotein receptor activity in freshly isolated human lymphocytes. *J. Clin. Invest.* **58**: 1465-1474.
9. Ho, Y. K., J. R. Faust, D. W. Bilheimer, M. S. Brown, and J. L. Goldstein. 1977. Regulation of cholesterol synthesis by low density lipoprotein in isolated human lymphocytes: comparison of cells from normal subjects and patients with homozygous familial hypercholesterolemia and abetalipoproteinemia. *J. Exp. Med.* **145**: 1531-1549.
10. Goldstein, J. L., W. R. Hazzard, H. G. Schrott, E. L. Bierman, and A. G. Motulsky. Hyperlipidemia in coronary heart disease. I. Lipid levels in 500 survivors of myocardial infarction. *J. Clin. Invest.* **52**: 1533-1577.
11. Goldstein, J. L., and M. S. Brown. 1974. Expression of the familial hypercholesterolemia gene in heterozygotes: model for a dominant disorder in man. *Trans. Assoc. Am. Physicians Philadelphia*. **87**: 120-131.
12. Brown, M. S., S. E. Dana, and J. L. Goldstein. 1974. Regulation of 3-hydroxy-3-methylglutaryl coenzyme A reductase activity in cultured human fibroblasts: comparison of cells from a normal subject and from a patient with homozygous familial hypercholesterolemia. *J. Biol. Chem.* **249**: 789-796.
13. Brown, M. S., and J. L. Goldstein. 1974. Familial hypercholesterolemia: defective binding of lipoproteins to cul-

- tured fibroblasts associated with impaired regulation of 3-hydroxy-3-methylglutaryl coenzyme A reductase activity. *Proc. Natl. Acad. Sci. U. S. A.* **71**:788-792.
14. Anderson, R. G. W., J. L. Goldstein, and M. S. Brown. 1976. Localization of low density lipoprotein receptors on plasma membrane of normal human fibroblasts and their absence in cells from a familial hypercholesterolemia homozygote. *Proc. Natl. Acad. Sci. U. S. A.* **73**: 2434-2438.
  15. Goldstein, J. L., and M. S. Brown. 1974. Binding and degradation of low density lipoproteins by cultured human fibroblasts: comparison of cells from a normal subject and from a patient with homozygous familial hypercholesterolemia. *J. Biol. Chem.* **249**: 5153-5162.
  16. Bloom, B. R., Z. A. Cohn, J. David, M. F. Greaves, M. Jondal, H. G. Kunkel, V. Nussenzweig, H. G. Remold, S. F. Schlossman, H. Wigzell, and R. J. Winchester. 1976. Evaluation of *in vitro* methods for characterization of lymphocytes and macrophages. In *In Vitro Methods in Cell-Mediated Tumor Immunity*. B. R. Bloom and J. R. David, editors. Academic Press, Inc., New York. 3-26.
  17. Manual of Laboratory Operations. Lipid Research Clinics Program. 1974. Lipid and Lipoprotein Analysis. U.S. Department of Health, Education, and Welfare publication No. 75: 628.
  18. Lowry, O. H., N. J. Rosebrough, A. L. Farr, and R. J. Randall. 1951. Protein measurement with the Folin phenol reagent. *J. Biol. Chem.* **193**: 265-275.
  19. Anderson, R. G. W., M. S. Brown, and J. L. Goldstein. 1977. Role of the coated endocytic vesicle in the uptake of receptor-bound low density lipoprotein in human fibroblasts. *Cell*. **10**: 351-364.
  20. Rhodin, J. A. G. 1974. *Histology: a Test and Atlas*. Oxford University Press, London. 94-106.
  21. Harlan, W. R., Jr., J. B. Graham, and E. H. Estes. 1966. Familial hypercholesterolemia: a genetic and metabolic study. *Medicine (Baltimore)*. **45**: 77-110.
  22. Schrott, H. G., J. L. Goldstein, W. R. Hazzard, M. M. McGoodwin, and A. G. Motulsky. 1972. Familial hypercholesterolemia in a large kindred: evidence for a monogenic mechanism. *Ann. Intern. Med.* **76**: 711-720.
  23. Goldstein, J. L., and M. S. Brown. 1977. The low density lipoprotein pathway and its relation to atherosclerosis. *Annu. Rev. Biochem.* **46**: 897-930.
  24. Connor, W. E. 1976. Dietary lipids, hyperlipidemia, and atherosclerosis. In *Cerebrovascular Diseases*. P. Scheinberg, editor. Raven Books, New York. 121-135.
  25. Langer, T., W. Strober, and R. I. Levy. 1972. The metabolism of low density lipoprotein in familial type II hyperlipoproteinemia. *J. Clin. Invest.* **51**: 1528-1536.
  26. Goldstein, J. L., H. G. Schrott, W. R. Hazzard, E. L. Bierman, and A. G. Motulsky. 1973. Hyperlipidemia in coronary heart disease. II. Genetic analysis of lipid levels in 176 families and delineation of new inherited disorder, combined hyperlipidemia. *J. Clin. Invest.* **52**: 1544-1568.
  27. Kirkman, H. N. 1972. Enzyme defects. In *Progress in Medical Genetics*. Vol. 8. A. G. Steinberg and A. G. Bearn, editors. Grune & Stratton, Inc., New York. 125-168.