

Life Cycle of the Budding Yeast *Saccharomyces cerevisiae*

IRA HERSKOWITZ

Department of Biochemistry & Biophysics, University of California, San Francisco, San Francisco, California 94143

INTRODUCTION	536
PROLIFERATION: THE MITOTIC CELL CYCLE	537
TRANSITIONS: MATING AND SPORULATION	538
Specialized Cell Types	538
Cell Specialization: Explicit Programming and Environmental Response	539
α cells	539
a cells	540
a/ α cells	540
Initiation of Sporulation	541
Assaying Mating and Sporulation	541
Mating	541
Sporulation	542
HOMOTHALLISM AND HETEROHALLISM: MATING-TYPE INTERCONVERSION	542
Mating-Type Interconversion	542
Genetic Rearrangement by Cassette Transposition	543
Biological Significance of Mating-Type Interconversion and Pattern of Switching	544
VARIATIONS ON THE <i>S. CEREVISIAE</i> LIFE CYCLE: DIFFERENT TYPES OF	
HETEROHALLISM	545
A THEORETICAL DISCUSSION OF HOMOTHALLISM: ARE OTHER MECHANISMS POSSIBLE?	546
LIFE CYCLES OF SOME OTHER ORGANISMS	547
<i>Schizosaccharomyces pombe</i>	547
<i>Neurospora crassa</i> and Other Filamentous Ascomycetes	548
Basidiomycetes	548
Ciliates and Algae	548
CONCLUDING COMMENTS AND MAJOR CONCLUSIONS	549
ACKNOWLEDGMENTS	549
LITERATURE CITED	549

INTRODUCTION

The purpose of this article is to review essential features of the life cycle of the budding yeast *Saccharomyces cerevisiae* as a starting point for learning about *S. cerevisiae* and its cell types. This review is intended for people who are being exposed to the study of *S. cerevisiae* for the first time and also for specialists who work on other organisms such as filamentous fungi. There will be no attempt to be comprehensive, but considerable efforts to be comprehensible! The life cycle of *S. cerevisiae* and, in particular, its cell types have provided rich ground for studying molecular mechanisms governing gene expression and programmed genetic rearrangement and for addressing numerous problems in cell biology, including the workings of a receptor-signalling system. Several reviews that focus on these aspects have been written (48, 49, 51, 52, 76, 105, 139). The main characters of this review are the cell types of *S. cerevisiae*, with a focus on the life cycle and an accent on biological aspects of the subject.

By "life cycle," I refer to two broad aspects of the life of *S. cerevisiae*. The first is cell proliferation, the process by which a cell of one type gives rise to two cells that are essentially identical (discussed briefly in the next section). The second aspect has to do with changes in the ploidy of the organism, i.e., transitions in the life cycle. Both haploid and diploid forms exist: haploids mate to form diploids, and diploids undergo meiosis to form haploids (discussed in the section, "Transitions: Mating and Sporulation"). These

processes, mating (which involves cell fusion) and meiosis, are fundamental biological processes and also occur in multicellular organisms. The life cycle of *S. cerevisiae* has an additional aspect beyond proliferation, mating, and meiosis: haploid yeast cells can change their cellular type by a programmed deoxyribonucleic acid (DNA) rearrangement. This allows some *S. cerevisiae* strains to exhibit a homothallic life cycle (a life cycle in which a single haploid cell can give rise to diploid cells capable of meiosis and spore formation). Other strains of *S. cerevisiae* exhibit a heterothallic life cycle (a life cycle in which a single haploid cell is unable to produce diploid cells) (discussed in the section, "Homothallism and Heterothallism: Mating-Type Interconversion"). Understanding the homothallic and heterothallic life cycles is important for understanding many organisms (including filamentous fungi) and raises issues concerning how cellular diversity can be generated (discussed in sections, "Variations on the *S. cerevisiae* Life Cycle" and "A Theoretical Discussion of Homothallism"). To put *S. cerevisiae* into context and to call attention to interesting features of other organisms, I briefly review aspects of the life cycles of the fission yeast *Schizosaccharomyces pombe* and some other organisms. Throughout this article, I shall sometimes refer to *S. cerevisiae* as "yeast," realizing, of course, that other yeasts such as *Schizosaccharomyces pombe* do some things somewhat differently from *S. cerevisiae*.

What does one want to know about the life cycle of an organism? What kind of useful information can come from

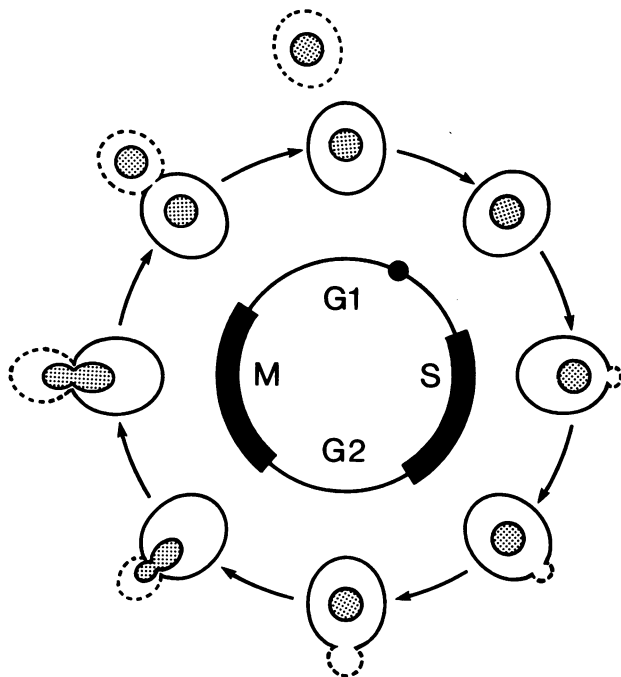

FIG. 1. *S. cerevisiae* mitotic cell cycle. The phases of the cell cycle are drawn in approximate proportion to their length. The mother cell is drawn with a solid line; the daughter bud and cell are drawn with a dotted line. The shaded material represents the cell nucleus. S, DNA synthesis; M, mitosis (nuclear division). The circle within G1 indicates the position at which yeast cells are arrested by mating factors. (Modified from reference 120 with permission.)

this understanding? Studies with *S. cerevisiae* have explained at a molecular level why haploids mate but do not sporulate and why diploids sporulate but do not mate. The answers to these questions involve understanding the properties of the specialized cells that participate in these processes. As we shall see, cell specialization arises because the different types of yeast cell synthesize different proteins involved in mating and sporulation. All of these differences are governed by a cellular "master regulatory locus," the mating-type locus, which is ultimately responsible for programming these differences. Thus, studies of the life cycle of *S. cerevisiae* have revealed a considerable amount about the molecular mechanisms that determine cell specialization and control gene expression in eucaryotes. Understanding the genetic and molecular determinants of a life cycle can also explain the ways in which different life cycles are related to each other, in some cases, simply as variations on a theme. I do not assume that other organisms will necessarily be like *S. cerevisiae*. But I do hope that this article will make clear the questions that can be posed, the route for gathering information, and the present state of the answers for *S. cerevisiae*.

PROLIFERATION: THE MITOTIC CELL CYCLE

Given sufficient nutrients, yeasts cells double in number every 100 min or so. During the mitotic cell cycle, the 17 chromosomes of the haploid cell are duplicated and then distributed to each cell (reviewed in reference 120). *S. cerevisiae* grows by budding, which means that the original, "mother" cell gives rise to an ellipsoidal daughter cell made of entirely new cell surface material (Fig. 1). This is to be

contrasted with the process of fission, in which the initial cell enlarges and then pinches off into two daughter cells. The daughter cell produced by *S. cerevisiae* is a bit smaller than the mother cell and must increase in size before it initiates chromosome duplication.

Yeast cells abandon the proliferation mode under certain environmental circumstances. For example, if they run out of nutrients, they arrest as unbudded cells in the G1 phase of the cell cycle (Fig. 1), where they survive well and resume growth when nutrients are available.

The other environmental influence that interrupts the proliferation mode is the presence of another yeast cell in the vicinity with which it can mate. If cells of different mating type are near each other, the mating partners transiently arrest each other's cell cycle in the G1 phase (Fig. 1) and then undergo cell fusion. The next section describes these cell types and the mating process in some detail.

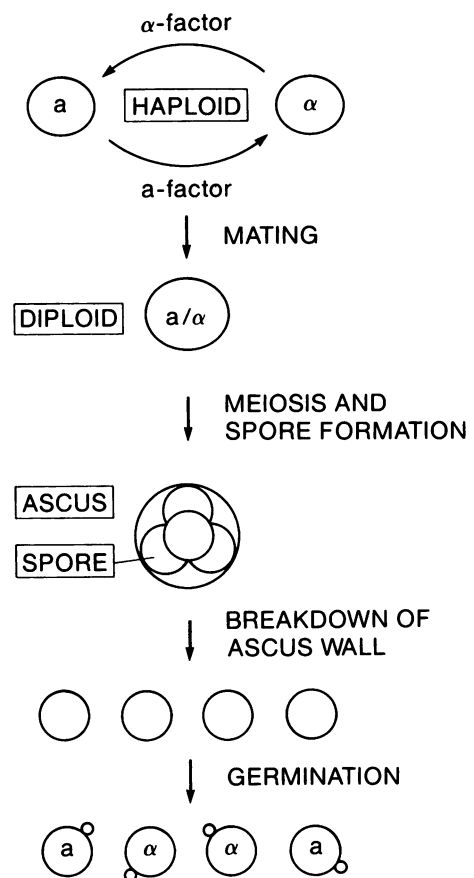

FIG. 2. Transitions in the life cycle of *S. cerevisiae*. All three cell types of *S. cerevisiae* (a, α , and a/ α) are capable of undergoing mitotic cell division (Fig. 1). This diagram shows the transitions in ploidy that occur in the life cycle: mating of haploids yields a diploid, and meiosis of a diploid yields haploid cells. a/ α cells produce an ascus, which contains the four haploid products (spores) that result from the meiosis of the diploid cell. To analyze the individual spores, the ascus wall is digested with degradative enzymes, and the individual spores are separated from each other by micromanipulation. The spores begin growing on nutrient media (the process of germination) and form colonies that can be tested for their mating type and for other markers. Dimensions of a yeast cell (which is ellipsoidal) are approximately 4.76 (long axis) by 4.19 (short axis) μm for haploids and 6.01 by 5.06 μm for diploids (100). Diploids thus have a volume nearly twice that of haploids (83% larger).

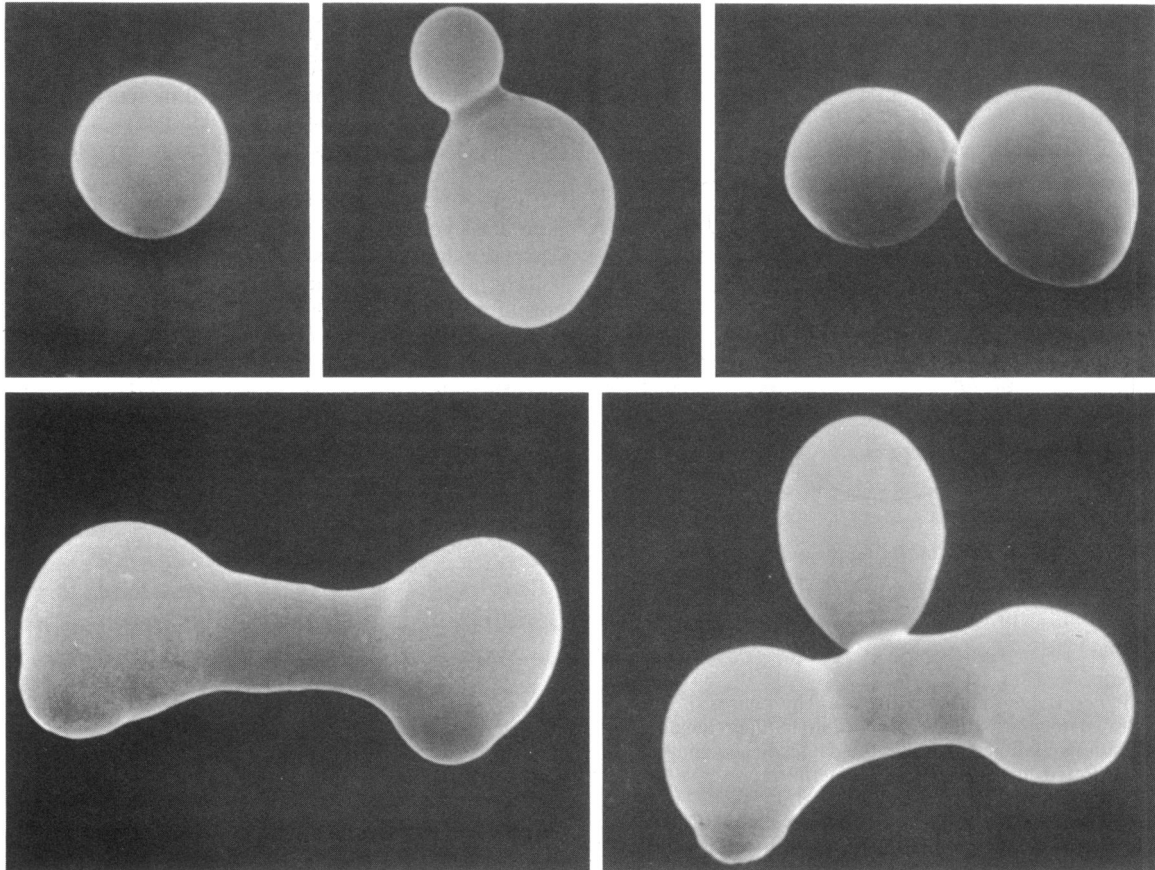

FIG. 3. Morphology of budding and unbudded *S. cerevisiae* cells and zygotes. Top row shows an unbudded cell (upper left) and cells with buds of different sizes. The size of the bud indicates roughly the position of the yeast cell in the cell cycle (Fig. 1). For example, unbudded cells are in G1. The zygote (lower left) was formed by mating between an *a* and an α cell. It produces daughter *a*/ α cells by budding, often from the neck of the zygote (lower right). Both the daughter diploid and the original zygote continue to produce daughter cells. Photo was taken by Eric Schabtach, University of Oregon, Eugene. Magnification, approximately $\times 6,000$.

TRANSITIONS: MATING AND SPORULATION

Specialized Cell Types

Although *S. cerevisiae* is a unicellular organism, it can exist in any of three specialized cell types which play distinctive and important roles in the life cycle (Fig. 2). The different cell types all undergo mitotic cell divisions (one cell giving rise to two). Two of the specialized cell types are the mating types *a* and α , which mate efficiently with each other: *a* and α cells placed adjacent to each other mate with nearly 100% efficiency. Because the mating process results in both cell and nuclear fusion, mating produces a diploid cell (with one nucleus) and not a dikaryon (a cell with two haploid nuclei). The product of mating (the zygote; Fig. 3) has a distinctive shape and gives rise to daughter diploid cells of the usual shape by budding. The *a*/ α diploid cell formed by mating is the third specialized cell type: it is unable to mate with either *a* or α cells, but it is capable of undergoing meiosis. Upon nutritional starvation, it gives rise to four haploid meiotic progeny, each of which is encased in a spore coat. All four products from a single meiosis are wrapped up together in a sac, the ascus.

A close look at the events of mating shows that *a* and α cells produce specific signalling molecules and receptor systems that facilitate the mating process. Cells of each haploid type produce a secreted peptide mating factor that

prepares cells for mating. Because these signalling molecules are responsible for communication between organisms (*S. cerevisiae* being a unicellular organism) and not between cells within a multicellular organism, these mating factors are properly termed pheromones rather than hormones. α cells produce α -factor (22, 81), a peptide of 13 amino acids (143), and *a* cells produce *a*-factor (161), a peptide of 12 amino acids (10; T. Brake, personal communication, cited in reference 34) (which has some incompletely characterized modifications). The mating factors cause cells to arrest in the G1 phase of the cell division cycle, just before the initiation of DNA synthesis (16, 47). The mating factors are thus negative growth factors: they inhibit cell growth. Growth inhibition caused by the mating factors is the basis for assaying the factors (see Fig. 6). As a result of cell cycle arrest, cell and nuclear fusion of the mating partners occurs when cells have exactly one copy of each chromosome and, hence, leads to formation of a diploid. The mating factors also activate synthesis of proteins essential for mating. For example, they stimulate cells to produce proteins necessary for cell (91, 156) and nuclear (127) fusion. Thus, the mating pheromone systems act to synchronize the cell cycles of mating partners and to allow the appropriate fusion events.

The precise sequence of events that occurs when cells respond to the mating factors is not known, but some of the components have been identified (reviewed in references 51

TABLE 1. Genes distinct from the mating-type locus that are necessary for mating^a

Genes	Gene function
α-Specific <i>STE</i> genes (needed for mating by α cells but not by a cells)	
<i>STE3</i>	Receptor for a-factor (39, 101)
<i>STE13</i>	Dipeptidyl aminopeptidase (processing enzyme for α-factor precursor) (67; Rine, Ph.D. thesis)
<i>KEX2</i>	Processing enzyme for cleavage of α-factor precursor (68)
<i>MFA1, MFA2^b</i>	Structural genes for α-factor precursor (80, 81, 137)
a-Specific <i>STE</i> genes (needed for mating by a cells but not by α cells)	
<i>STE2</i>	Receptor for α-factor (62, 101)
<i>STE6, STE14, STE16^c</i>	Posttranslational processing of a-factor precursor (162, 163; Blair ^d ; K. Kubo and S. Michaelis, unpublished observations)
<i>MFA1, MFA2^b</i>	Structural genes for a-factor precursor (Brake et al., cited in reference 34; 95)
Nonspecific <i>STE</i> genes (needed for mating by both a and α cells)	
<i>STE4</i>	Beta subunit of G protein (V. MacKay, personal communication)
<i>STE5, STE12</i>	Unknown
<i>STE7, STE11</i>	Protein kinases (153; B. Errede, personal communication)
<i>STE18</i>	Gamma subunit of G protein (M. Whiteway, personal communication)

^a All of these genes are essential for mating and code for proteins that are known (or thought) to play a direct role in mating or in its regulation. Other genes in which mutations can cause a mating defect are *SIR2*, *SIR3*, and *SIR4* (44, 73, 123, 160). In these cases, the mating defect results because the cassettes at *HMLα* and *HMRa* are no longer repressed; hence, the cell exhibits the nonmating phenotype of an a/α cell.

^b Both genes must be inactivated to cause a mating defect.

^c Also called *RAM* (119).

^d L. Blair, Ph.D. thesis, University of Oregon, Eugene, 1979.

and 125). The receptor that a cells use to respond to α-factor is the product of the *STE2* gene (12, 62, 90); the receptor that α cells use to respond to a-factor is the product of the *STE3* gene (39). Remarkably, these receptors appear to have the same general structure as receptors used in various sensory transduction systems, such as the receptor of visual cells, rhodopsin, and the receptor for epinephrine, beta-adrenergic receptor (17, 39, 101; reviewed in reference 150). All of these receptors are integral membrane proteins with seven potential membrane-spanning regions, and all appear to interact with similar intracellular components (G proteins) (21, 99). How binding of the peptide ligand to receptor ultimately leads to arrest of the yeast cell division cycle or induction of expression of various genes is not known.

The *STE2* and *STE3* genes, as well as many of the other genes that are necessary for mating, have been identified by the isolation of mutants defective in mating or that are insensitive to arrest by mating factors (44, 86, 163). The wild-type genes are termed *STE* genes (because the mutants are sterile). Some *STE* genes are involved in response to pheromones (*STE2* and *STE3*); others are involved in synthesis of the pheromones (*STE6*, *STE14*, and *STE16* for a-factor; *STE13* and *KEX2* for α-factor; Table 1). Some of these genes (such as *STE2*) are needed for mating only by a cells, and others (such as *STE3*) are needed for mating only by α cells. A third group of genes (*STE4*, *STE5*, etc.; Table 1) is needed for mating by both a and α cells and codes for products that must function in both a and α mating processes.

Some genes required for mating were not identified in hunts for mutants defective in mating. Because there are two functional genes coding for the α-factor precursor, a mutant phenotype was seen only when both genes are inactivated (80). There are also two functional genes coding for the a-factor precursor; again, both must be inactivated to see a mutant phenotype (95). The genes coding for the pheromone precursors were identified by cloning them: the major α-factor gene was isolated on a plasmid that overproduces

α-factor (81); the minor α-factor gene and the two a-factor genes were isolated by use of a synthetic probe designed against the mating-factor amino acid sequences (137; Brake, personal communication, cited in reference 34).

Cell Specialization: Explicit Programming and Environmental Response

a and α cells produce only the mating factors and receptors that they need for mating. a/α cells do not mate and do not produce any of the mating paraphernalia. The differences exhibited by the three cell types reflect differences in ribonucleic acid (RNA) synthesis from the corresponding genes (63, 141, 162). I refer to the genes that are transcribed in α cells but not in the other cell types as α-specific genes (*αsg*), to those transcribed only in a cells as a-specific genes (*asg*), and to those transcribed in both a and α cells but not in a/α cells as haploid-specific genes (*hsg*) (summarized in Table 2). The gene sets that are active in the different cell types are determined by the mating-type locus, which acts as a master regulatory locus governing cell specialization (87, 144). Cells that have the α allele of *MAT* (*MATα*) exhibit the phenotype of α cells; cells with the a allele (*MATa*) exhibit the phenotype of a cells; and cells with both alleles exhibit the a/α cell phenotype (Fig. 4).

I next summarize how the three regulatory activities specified by the *MAT* alleles control RNA synthesis from the three different gene sets to confer the properties of these three cell types.

α cells. α cells produce their appropriate receptor and mating factor because they contain an activator protein, α1, that activates transcription of the corresponding α-specific genes (141). α cells do not produce the inappropriate receptor and mating factor because they contain a repressor protein, α2, that blocks transcription of the corresponding a-specific genes (43, 162). Recent studies have demonstrated that the α1 and α2 proteins are DNA-binding proteins that

TABLE 2. Differentially expressed sets of genes

Gene set and members	Expression ^a in:		
	α cells	a cells	a/ α cells
α -Specific genes <i>STE3</i> (141); <i>MFα1</i> and <i>MFα2</i> (27, 28)	+	-	-
a-Specific genes <i>STE2</i> (43), <i>STE6</i> (162), <i>MFA1</i> and <i>MFA2</i> (27, 95), <i>BAR1</i> (79)	-	+	-
Haploid-specific genes ^b <i>STE4</i> (MacKay, personal communication), <i>STE5</i> (Freedman and Thorner, personal communication), <i>STE12</i> (29), <i>STE18</i> (Whiteway, personal communication), <i>MATα1</i> and <i>MATα2</i> (75, 108), <i>KAR1</i> (Rose, personal communication), <i>FUS1</i> (91, 156), <i>SCG1</i> (<i>GPA1</i>) (21, 99), Ty1 (retrotransposon) (24), <i>RME1</i> (98)	+	+	-
Diploid-specific genes ^c <i>SGA</i> (166), <i>SPO11</i> (3), <i>SPO13</i> (159), <i>SPS1,2,3</i> (116), <i>SPS4</i> (33), <i>SPS100</i> (82)	-	-	+

^a + or - indicates production of transcripts; - indicates a reduction of at least fivefold.

^b A defining characteristic of this gene set is that its members are repressed by a1- α 2. Hence, *MAT α 1* and *MAT α 2* genes are members of this set even though they, of course, are not expressed in a cells.

^c These genes are expressed only when cells are undergoing sporulation (20, 115).

recognize specific sites upstream of the genes that they regulate (9, 65, 70).

a cells. Although one might have imagined that a cells would contain activator and repressor proteins analogous to those of α cells, they contain neither (144). a cells produce their appropriate receptor and mating factor because they lack the a-specific repressor protein of α cells, α 2. The inappropriate receptor and mating factor are not produced because a cells lack the α -specific activator protein of α cells, α 1. *MATa* does code for two polypeptides, a1 (69), which has an important role in a/ α cells, and a2 (2), whose role is unknown.

a/ α cells. a/ α cells produce neither type of receptor and neither type of mating pheromone. The α 2 product has a key role in conferring these properties to an a/ α cell. It represses the synthesis of products that are characteristic of a cells, just as it does in α cells (see reference 37). In addition, in combination with the a1 product of *MATa*, it forms a regulatory species denoted a1- α 2, which is responsible for many important properties of a/ α cells (144). First, a1- α 2 represses synthesis of α 1; consequently, the products characteristic of α cells are not synthesized. Second, a1- α 2 represses the haploid-specific genes, which include genes necessary for mating (such as *STE4*, *STE5*, and *STE12*) and other genes (Table 2). Thus, in a/ α cells, synthesis of specialized proteins does not occur in some cases because transcription is blocked by a repressor and in other cases because a regulatory protein necessary for transcription is absent. Recent analysis (37) demonstrates that a1- α 2 binds to the upstream regions of genes that it represses, at distinctive binding sites (96, 134, 135).

We now have a picture of how the three yeast cells are specialized with respect to one of the important transitions in the life cycle, mating. a, α , and a/ α cells have the appropriate genes expressed depending on the constitution of the mating-type locus. Thus, a and α cells produce the necessary proteins for synthesis of the mating pheromones and for response to them. There are several other points worth noting. (i) Successful completion of the mating process, i.e., formation of an a/ α diploid, is monitored not by assessment of ploidy but by the creation of a novel regulatory activity, a1- α 2 (126). Diploids that are *MATa/MATa* or *MAT α /MAT α* , which lack a1- α 2 activity, mate as their respective haploids

(126). The presence of a1- α 2 provides a signal to indicate that mating has been successful; this signal turns off expression of genes for mating and turns on the process of sporulation (see below). (ii) The inability of a/ α cells to mate is due to a block of mating at several levels. First, these cells

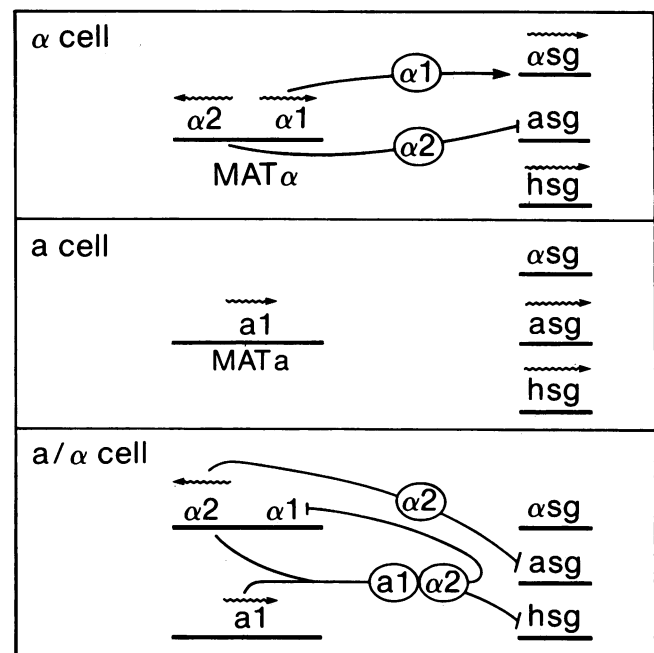

FIG. 4. Control of expression of cell-type-specific gene sets by regulatory proteins coded by the mating-type locus. The mating-type locus is drawn to the left, and the cell-type-specific gene sets (*asg*, α -specific genes; *asg*, a-specific genes; and *hsg*, haploid-specific genes) are drawn to the right. The mating-type locus codes for three regulatory activities, α 1, α 2, and a1- α 2, that govern expression of the indicated gene sets. Wavy arrows indicate transcription. Arrowheads indicate stimulation of gene expression; lines with blunt ends indicate inhibition of gene expression. The members of the three gene sets are described further in Tables 1 and 2 and in the text. Regulation of meiosis and sporulation by the mating-type locus is depicted in Fig. 5.

lack $\alpha 1$ protein and hence cannot mate as α . In addition, several other genes necessary for mating (*STE4*, *STE5*, and *STE12*) are turned off in a/α cells (29; V. MacKay, personal communication; R. Freedman and J. Thorner, personal communication; see also reference 1). Hence, there is a multiple block to the ability of a/α cells to mate as α . (iii) Some genes required for mating only in one cell type are, nevertheless, expressed in all cell types. An example is the *STE13* gene, which is required for mating only in α cells (J. Rine, Ph.D. thesis, University of Oregon, Eugene, 1979), but whose product is found in all cell types (67). (iv) Although the specialized properties of a and α cells are ultimately under control by the mating-type locus, the final differentiation of a and α cells is induced by the mating factors. When a cells are exposed to α -factor (or α cells are exposed to a -factor), their specialized gene sets (the a - and α -specific genes) are hyperactivated three- to fivefold (40, 149; K. Kubo, S. Michaelis, and I. Herskowitz, unpublished observations). Thus, the most highly differentiated state of a and α cells reflects a combination of two processes: explicit programming directed by the products of the mating-type locus; and environmental response induced by the mating pheromones, which triggers additional gene expression (see also reference 50).

We next turn to the question of what governs the other important transition in the life cycle, the reduction of ploidy, i.e., meiosis.

Initiation of Sporulation

There are two requirements for yeast cells to initiate meiosis and spore formation (collectively called sporulation). First, there must be an appropriate environmental stimulus: cells must be starved for both nitrogen (by removal of nitrogen source) and carbon (by utilization of a poor carbon source, such as acetate) (25, 97). Although it is not entirely clear how this nutritional starvation is monitored, it is thought that cyclic adenosine 3',5'-monophosphate levels are somehow involved. (Mutants that have reduced cyclic adenosine 3',5'-monophosphate activity due to a mutation in adenylyl cyclase are able to undergo meiosis and sporulation in some types of rich media.) The second requirement for cells to enter meiosis is that they be diploid and have the appropriate genotype. It is not diploidy itself that is required for sporulation: diploids that are *MATa/MATa* or *MAT α /MAT α* do not sporulate (126). Rather, the requirement is that cells be *MATa/MAT α* and have $a1$ - $\alpha 2$ activity (69): somehow $a1$ - $\alpha 2$ activates sporulation. We saw in the previous section that $a1$ - $\alpha 2$ is a repressor of a variety of different genes (the haploid-specific genes). It stimulates meiosis by repressing another haploid-specific gene, *RME1*, which codes for an inhibitor of meiosis (98, 124). a and α cells produce the inhibitor and cannot initiate meiosis, whereas a/α cells do not produce the inhibitor and thus can initiate meiosis (Fig. 5). Our working view is that nutritional starvation brings cells to the G1 phase of the cell cycle, where the cells make a decision that is influenced by *RME1* product: if it is present, the cells remain arrested. If *RME1* product is absent, the cells can exit from the normal mitotic cell cycle and enter the first step of meiosis, meiotic DNA synthesis. How the *RME1* protein works (for example, whether it is a repressor, protein kinase, or protease) is not known, nor are its targets known.

Assaying Mating and Sporulation

To give some idea of how different aspects of the life cycle are measured and how some of the conclusions described

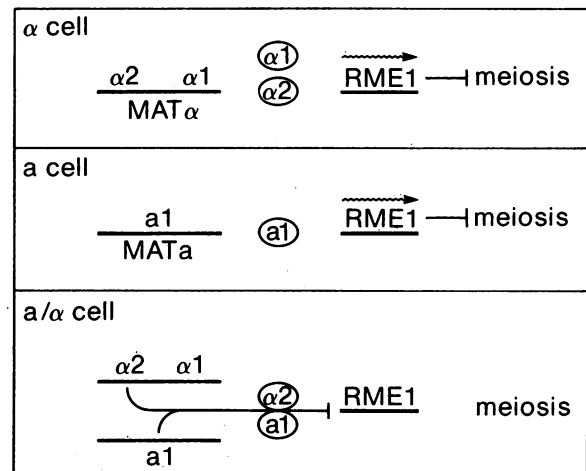

FIG. 5. Regulation of meiosis and spore formation by the mating-type locus. Haploid cells are not able to initiate meiosis because they express the *RME1* (regulator of meiosis) gene (69, 98, 124). The mechanism by which the *RME1* protein inhibits meiosis is not known. a/α cells are able to initiate meiosis because they turn off synthesis of the *RME1* product, which is repressed by $a1$ - $\alpha 2$. Haploid cells defective in the *RME1* gene are capable of initiating meiosis when they are nutritionally starved (69).

above have been reached, I present here brief descriptions of the ways in which various aspects of the life cycle are assayed. In general, three types of assays are used: colony formation on petri plates, direct microscopic observation, and biochemical assays of enzyme activity or RNA content.

Mating. Mating is routinely scored by a plate assay for nutritional complementation. A strain of unknown genotype is mixed with strains of known mating type. These strains carry auxotrophic mutations (for example, an *ade* mutation in the strain being tested and a *lys* mutation in the known strains). A prototrophic diploid (able to grow on minimal medium) is formed only if mating occurs. Mating with the α tester strain indicates that the unknown strain has a mating type. Mating can also be scored directly by looking for formation of zygotes in the microscope.

Cell specializations can be measured by both plate and microscopic assays. Particularly valuable is the "halo assay" for mating factors (30), in which production of, for example, α -factor is assayed on a lawn of a cells (see Fig. 6 for additional information). A patch of cells that produces α -factor causes a zone of inhibition of growth in the a cell lawn. Production of α -factor can also be assayed by microscopic observation on agar slabs (the "confrontation assay") (22, 54). In this case, a cells are placed very near a thick streak of cells to be tested. Response of cells is indicated by arrest of the a cells in G1 (as unbudded cells) followed by production of aberrant cell shape (the "shmoo" morphology). Production of a -factor can also be assayed by halo and confrontation procedures (Fig. 6B).

Other assays for cell specialization utilize cloned genes. Two such assays can be demonstrated with the *STE6* gene (one of the genes necessary for mating only by a cells). In one case, the *STE6* gene was fused to the *Escherichia coli lacZ* gene, which codes for beta-galactosidase, to form a hybrid *STE6-lacZ* protein that has beta-galactosidase activity (162). This hybrid gene was used to determine that *STE6* is expressed only in a cells (Fig. 7). The *STE6* DNA was also used to assay for the presence of the *STE6* RNA directly by DNA-RNA hybridization (Fig. 8). These studies showed that

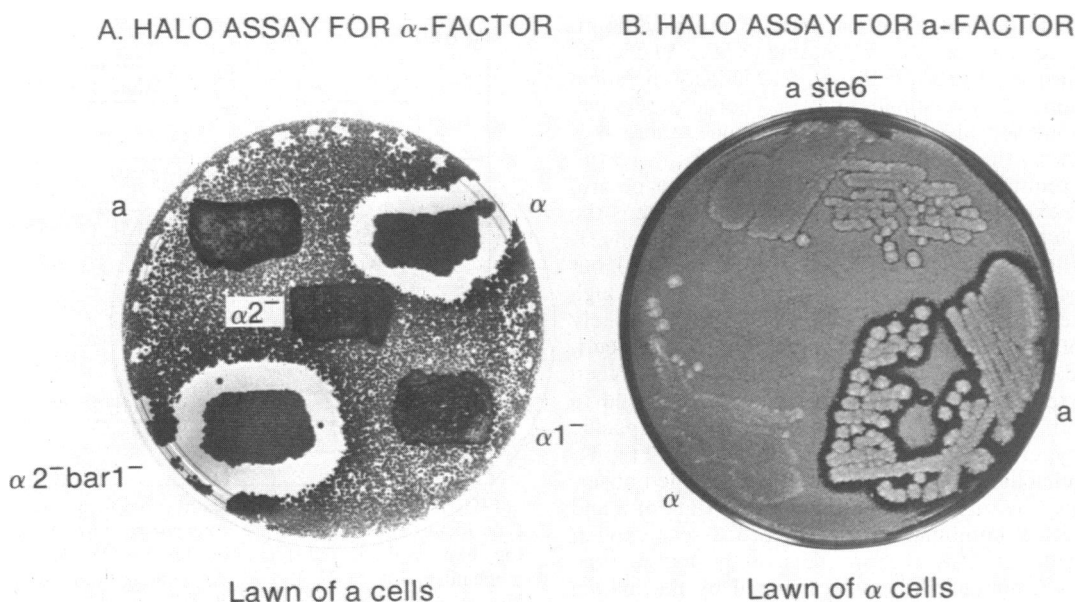

FIG. 6. Halo assay for mating factors. Production of α -factor (A) and a-factor (B) by wild-type and various mutant strains is shown. For assaying α -factor, a lawn of a cells was produced by spreading approximately 10^7 a cells on the petri plate prior to transferring cells of strains to be tested. For assaying a-factor, plates were first spread with approximately 10^7 α cells. Production of the mating pheromone causes inhibition of cells in the lawn, resulting in a zone of inhibition (halo) around cells that produce the pheromone. Strains supersensitive to mating factors (18, 19, 140) are often used to form the lawns. The halos are different in the two panels because different photographic techniques were used for these photos. Additional information on the two panels follows. (A) α cells produce α -factor, whereas a cells and two mutants (defective in the *MAT α 1* or the *MAT α 2* gene) do not. The $\alpha 1^-$ mutant fails to produce α -factor because it does not transcribe the genes coding for the α -factor precursor (27, 28). The $\alpha 2^-$ mutant does not produce α -factor because this strain produces the *BAR1* protein, whose synthesis is ordinarily repressed by $\alpha 2$. The *BAR1* protein degrades α -factor (54, 88, 140). Hence, α strains defective in $\alpha 2$ simultaneously produce α -factor and degrade it. This figure is from reference 140. (B) a cells produce a-factor, whereas α cells do not. The *ste6* mutant (which in this case is inactivated because it carries an insert of the *E. coli lacZ* gene within it) is severely deficient in production of a-factor. The *STE6* gene is thought to be necessary for a post-translational step in a-factor biosynthesis, perhaps processing from a precursor. This figure is from reference 162.

the *STE6* transcript is present only in a cells and is repressed in α cells by the $\alpha 2$ protein (162). Subsequent studies (65) showed that the $\alpha 2$ protein binds to the upstream region of *STE6*.

Sporulation. Sporulation is scored most simply by looking in the microscope for the presence of asci. It is also possible to score sporulation by a plate assay. This method uses a diploid strain that is sensitive to two drugs but produces haploid segregants that are resistant to these two drugs. (This strain is heterozygous for two different drug resistance mutations, e.g., canavanine resistance [*canR*] and cycloheximide resistance [*cyhR*], both of which are recessive to the sensitive alleles.) This method has been used to score sporulation ability of colonies and to clone the *RME1* gene by a functional assay (98). Another way to assay sporulation exploits genes whose expression is activated only during meiosis (3, 20, 82, 115–117, 159, 166). Thus, it is now possible to assay progression through sporulation by using fusions between a sporulation-specific gene and the bacterial *lacZ* gene (116).

HOMOTHALLISM AND HETEROHALLISM: MATING-TYPE INTERCONVERSION

Mating-Type Interconversion

The terms *homothallism* and *heterothallism* are used to describe two different types of life cycle in fungi. In a homothallic life cycle, a single haploid cell (in particular, a spore) gives rise to diploid progeny that are capable of

undergoing meiosis. In a heterothallic life cycle, diploid progeny are formed only by matings between cells derived from separate spores that have opposite mating types. (Homothallic strains are sometimes referred to as “self-fertile” and heterothallic strains are referred to as “self-sterile,” terms that I shall not use.) Homothallic and heterothallic behavior of strains can be assayed in *S. cerevisiae* simply by allowing a single haploid cell to grow into a colony and then determining whether it contains cells able to sporulate (which is done by transferring the colony to sporulation-inducing medium) (55).

How is it possible for a single (haploid) cell to give rise to cells that are a/ α diploids? One possibility is that a homothallic strain has some type of “universal” mating type, which allows any haploid to mate with any other haploid. In actuality, homothallic strains produce an a/ α diploid by mating between the usual two mating types. Homothallic haploid strains have the remarkable ability to produce progeny cells of both mating types during mitotic cell divisions (46, 55; reviewed in reference 52). A spore that is, for example, α produces some progeny that are like itself, having α mating type, but also progeny of the opposite mating type! By the time a cell has divided three or four times (to form a microcolony of 8 to 16 cells), the colony contains both α and a cells. At this point, a and α siblings mate to produce a/ α diploids. In contrast, α spores that are heterothallic grow into colonies that contain only α cells.

Both homothallic and heterothallic strains of *S. cerevisiae* are found in nature, and they differ from each other in a



FIG. 7. Assay of *STE6* gene expression, using a *STE6-lacZ* fusion. A hybrid between the *S. cerevisiae STE6* and *E. coli* β -galactosidase (*lacZ*) genes was constructed in vitro (162). This gene codes for a polypeptide that contains the amino terminus of the *STE6* protein in place of the amino terminus of β -galactosidase. Its upstream regulatory region is from *STE6*. The *STE6-lacZ* hybrid gene was introduced into *S. cerevisiae* strains of different mating type as indicated. Beta-galactosidase activity was assayed by cleavage of a substrate present in the agar which yields an insoluble blue dye upon cleavage. (Photo courtesy of Katherine Wilson.)

single gene, denoted *HO* ('homothallism') (164). Homothallic strains have the functional version of the gene, *HO*; heterothallic strains have the defective version of the gene, *ho*. (*ho* is typically present in laboratory strains so that they will not switch mating types, give rise to *a/α* diploids, and in general create confusion.) In *HO* strains, cells switch from one mating type to the other as often as every cell division (55, 145). In *ho* strains, cells switch from one mating type to the other only at low frequency, approximately 10^{-6} (45, 55).

In summary at this point, cells with *HO* exhibit the homothallic life cycle because they produce cells of both mating types among their progeny.

Genetic Rearrangement by Cassette Transposition

Although the progeny of a single cell typically have the same genotype as the parent cell, homothallic cells have the ability to change the information at the mating-type locus: homothallic α cells (which have an α mating-type locus) give rise to progeny that have an *a* mating-type locus and which thus exhibit an *a* cell phenotype. This change in the mating-type locus occurs by a programmed genetic rearrangement in which silent genetic information becomes activated by moving it from one genomic position to another (56, 58, 114; reviewed in reference 52) (Fig. 9). The information located at the mating-type locus is expressed and, as we have discussed above, it determines yeast cell type. The *S. cerevisiae* genome also contains two other genetic loci (*HML* and *HMR*) that contain silent versions of this information. In most strains, the *HML* locus contains silent information

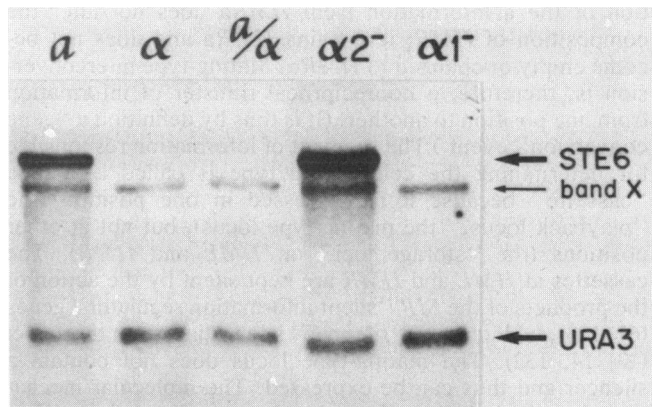

FIG. 8. Assay of *STE6* gene expression by RNA-DNA hybridization (Northern analysis). RNA (containing polyadenylic acid) was isolated from wild-type *a*, α , and *a/α* cells and from mutants defective in the *MATα1* or *MATα2* gene and fractionated on an agarose gel. The *STE6* transcript was identified by hybridization to a radioactively labeled probe produced using the *STE6* gene. The level of *URA3* transcript, which is not expected to vary in the different strains examined, was assayed as a control to ensure that equal amounts of RNA were added to each lane. Band X is an uncharacterized transcript that hybridizes to the probe. This figure is from reference 162.

equivalent to what is expressed at *MATα* (the *HMLα* allele). The *HMR* locus contains silent information corresponding to *MATa* (the *HMRa* allele). The switch from α to *a* comes about by removing the mating-type locus of the α cell and replacing it by the information located at *HMR*. Transposi-

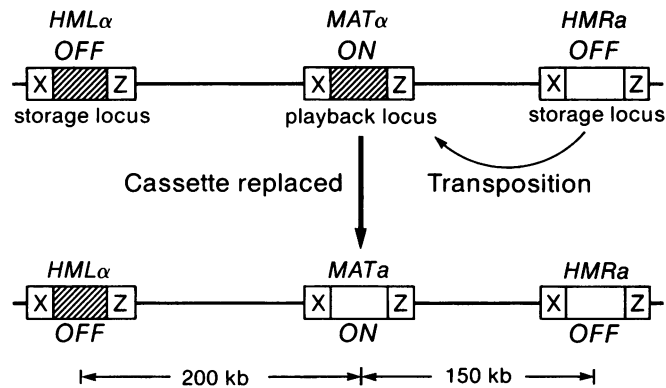

FIG. 9. Cassette mechanism for mating-type interconversion. The top line shows the arrangement of cassettes on chromosome III in an α cell. The cassette at *MAT* is expressed; those located at *HML* and *HMR* are repressed by Sir. Switching to *a* occurs by removing the α cassette from *MAT* and replacing it by information from *HMRa*. The central regions of the cassettes (shown as striped or open rectangles) represent distinct nucleotide sequences. The region from the α cassette (the so-called *Yα* region) is 747 base pairs; the region from the *a* cassette (the *Ya* region) is 642 base pairs (2, 107, 148). The regions adjacent to the *Y* region (the *X* and *Z* regions, which are approximately 700 base pairs) are involved in the recombination between cassettes at *HML* or *HMR* loci and the mating-type locus. Mating-type interconversion is initiated by the product of the *HO* gene, which codes for an endonuclease that produces a double-strand break at *MAT* (78, 146). Subsequent repair of the double-strand break leads to a duplicative transposition of information from *HML* or *HMR* to *MAT*. The distance between *MAT* and *HML* is approximately 200 kilobases (kb) (110, 147); the distance between *MAT* and *HMR* is approximately 150 kilobases (110).

tion of the a information from $HMRa$ does not alter the composition of HMR : it remains $HMRa$ and does not become empty or changed to $HMR\alpha$. Mating-type interconversion is, therefore, a nonreciprocal transfer of information from one position to another. (It is thus by definition a "gene conversion" event.) The segment of information responsible for determining the cell mating type is called a genetic "cassette" because it is expressed in one position (the "playback locus," the mating-type locus), but not at other positions (the "storage loci," at HML and HMR). The cassettes at HML and HMR are kept silent by the action of the products of the SIR ("silent information regulator") genes (61, 123), which act at "silencer" sites adjacent to these loci (13, 14, 132). The mating-type locus does not contain a silencer and thus can be expressed. The molecular mechanism by which SIR products block expression of the silent cassettes is under intensive study (15, 133).

Movement of the genetic cassette information from HML or HMR to MAT is catalyzed by the product of the HO gene, which codes for a site-specific endonuclease that initiates mating-type interconversion (77, 78, 146). The HO protein recognizes a site that spans 18 base pairs (111) at the mating-type locus and makes a double-strand break at this position. Subsequent steps in mating-type interconversion utilize enzymatic machinery (for example, the $RAD52$ product) that also participates in other types of double-strand break repair (89). After the double-strand break has occurred, a DNA segment from the mating-type locus is deleted (which results in the removal of the old cassette at MAT), and the damaged mating-type locus is repaired by a process in which the information from either HML or HMR is copied into it. The choice of HML versus HMR is not random (64, 74, 145): α cells preferentially repair their broken chromosome with the cassette from HMR , an a cassette, in more than 90% of switching events; likewise, a cells preferentially utilize the α cassette from HML . How all of this is orchestrated is not known, but *S. cerevisiae* is very good at doing it: in wild-type cells, a break at MAT is repaired with nearly 100% efficiency (55, 145).

In summary, mating-type interconversion is a process in which the master regulatory locus responsible for cell specialization is itself regulated. In this case, cells switch their regulatory program by replacing one segment of coding information with another.

Biological Significance of Mating-Type Interconversion and Pattern of Switching

Given this molecular understanding of homothallism, we can put the phenomenon of mating-type switching into a biological context and can suggest some of the biological consequences of switching. Perhaps the most important thing to stress is that mating-type interconversion produces stable diploids from haploids (Fig. 10). Even though the a/α diploid thus formed is homozygous for HO , it remains a stable a/α diploid cell because the HO gene is turned off in a/α cells by $a1-\alpha2$ (63). The HO gene is thus like several genes involved in mating: "on" in haploid cells, and "off" in diploid cells (a/α diploid, of course). Mating-type interconversion provides an excellent example in which the success of a complex process is monitored by feedback regulation. The first step in this process occurs in a haploid cell, where mating-type interconversion changes the genotype of the cell. The cell next must express the new mating phenotype, which requires removal of proteins that it no longer needs (such as the old mating-factor receptor) and synthesis of

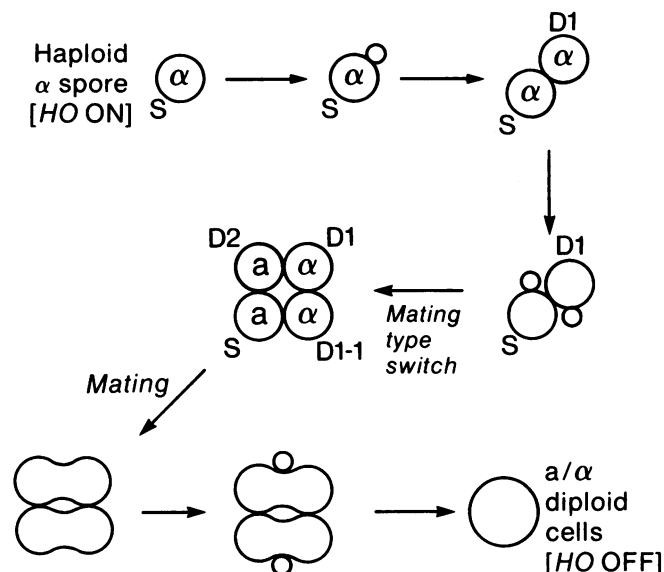

FIG. 10. Diploidization and negative feedback control of mating-type interconversion. The end product of mating-type interconversion is formation of stable a/α diploid cells (164). The diagram shows the first two cell divisions of a spore that is initially $MAT\alpha$ and carries the HO gene. After its second cell division, two of the cells (the original spore cell, S, and its second daughter cell, D2) have now switched to a mating type (55). Consequently, at the four-cell stage, siblings can mate to form two a/α diploid zygotes. These cells grow into colonies containing only a/α cells and do not undergo subsequent mating-type interconversion because the HO gene is turned off in a/α cells (63). Thus, formation of the end product of mating-type interconversion, the a/α diploid, provides a signal ($a1-\alpha2$) to turn off the mating-type interconversion system. The HO gene remains turned off until cells become haploid once again.

proteins appropriate to the new mating type (such as a new receptor). Then, if all of this has been done correctly, the cell is ready to engage in the mating process itself. Success of the entire process (genotypic change, phenotypic change, and finally, mating) is monitored by the production of the novel regulatory activity, $a1-\alpha2$, which then shuts off HO . Its job is done, and it is no longer needed until meiosis generates haploid segregants, which once again have an active HO .

Is diploidization beneficial to *S. cerevisiae*? One useful feature is that diploid cells are better than haploid cells in coping with DNA damage leading to recessive mutations and chromosome loss (100) because they have a "backup" copy of each chromosome. A second useful feature of diploidization results from the fact that the *S. cerevisiae* diploids are not simply diploid; they are a/α cells and thus are a distinctive cell type, different from a or α cell types. In fact, the a/α diploids exhibit increased recombination and repair abilities not seen in a/a or α/α diploids (31, 32, 84, 100). The argument that diploidy is beneficial to *S. cerevisiae*, of course, does not address the question of whether mating-type interconversion is necessary to form diploids. Because asci contain spores of both mating types, diploids can be produced readily in nature simply by mating between sister spores. Mating-type interconversion would not be necessary to form a diploid under these circumstances. One can imagine, however, a different situation (the "lonely spore" scenario), in which a given meiosis produces only one viable spore. This can occur because the efficiency of germination can be low and because some asci contain less than four spores. In this case, mating-type interconversion would allow the lonely

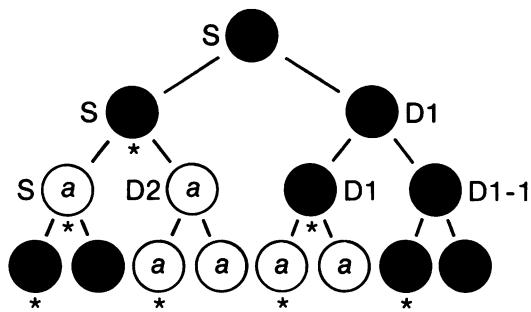

FIG. 11. Switching pattern of homothallic *S. cerevisiae*: a mitotic cell lineage. Filled circles indicate α cells; open circles indicate *a* cells. Asterisks indicate cells that are competent to switch mating type in their next cell division. Only cells that have previously budded (cells that have been mothers) are competent (145). The initial cell, S, is a spore that carries the *HO* gene. This cell is allowed to germinate and then undergo one cell division cycle to yield two cells, S (the spore cell) and D1 (the spore's first daughter), both of which have α mating type. In the next cell division, the S cell gives rise to two cells that have *a* mating type. This change in cell type occurs because the original mating type locus (*MAT α* in this case) has been removed and replaced with *MAT a* as a result of genetic rearrangement. *a* and α cells are distinguished from each other by their sensitivity to α -factor (55). Note that the cells depicted to the right at each cell division (S at the one-cell stage, D1 at the two-cell stage, D1-1 at the four-cell stage, etc.) comprise a stem cell lineage, a line of cells that is always α . The rules of switching were determined in references 55 and 145.

spore to produce cells of opposite mating type and thus to diploidize.

Formation of *a*/ α diploids by mating between siblings, of course, results in inbreeding. Because cells of opposite mating type mate so efficiently with each other, I expect that mating-type interconversion would not directly increase opportunities for outbreeding: an *a* cell produced by switching of an α cell would probably mate with its α -cell sibling before encountering another α cell. It is important to note, however, that mating-type switching does not occur with 100% efficiency. Although some homothallic strains switch at very high frequency (in at least 75% of cell divisions; see below), homothallic spores do not usually produce colonies composed exclusively of *a*/ α cells (55). A spore that is *MAT α* *HO* will generate a colony that is a mixed population, containing both *a*/ α cells and α cells that have not switched or that have not found an *a* mating partner. Thus, the presence of *HO* does not commit a yeast cell to inbreeding.

Homothallic strains switch mating types in a characteristic pattern with respect to their mitotic cell lineages (55, 145) (Fig. 11). There are two main "rules" of switching deduced by examining lineages of *HO* cells (145): first, cells are always observed to switch in pairs; second, only cells that have undergone one cell division cycle (in other words, mother cells) are competent to switch mating types. Switching in pairs and switching only by mother cells both occur because of regulation of the *HO* gene itself: *HO* is expressed only at one phase of the cell division cycle and only in mother cells (103, 104). The molecular mechanisms responsible for these types of regulation are under intensive investigation (106, 142).

Is there any biological significance to the switching pattern, to the differences between mother and daughter cells? The consequence of this difference is that it guarantees that cells of the original type are always present in the population: the daughter cells comprise a stem cell lineage (Fig. 11).

Consequently, if a switch does occur, there are always cells of both mating types present. Although it is not appropriate to go into great detail here, one can imagine a situation in which switching by a spore cell would not lead to diploid formation. In particular, this could occur if a spore cell of genotype *HML a* *MAT α* *HMR a* switched to *a* in its first cell division.

VARIATIONS OF THE *S. CEREVISIAE* LIFE CYCLE: DIFFERENT TYPES OF HETEROTHALLISM

Given our understanding of the genetic and molecular basis of homothallism, it is possible to understand several different types of variant yeast life cycles. In actuality, it was analysis of these life cycles, notably by Y. Oshima and colleagues (41), as well as by Santa Maria and Vidal (130) and Naumov and Tolstorukov (109), which led to identification of the *HML* and *HMR* loci. The four different heterothallic life cycles described next all result from naturally occurring mutations ("natural variant alleles") affecting the components of the mating-type interconversion system.

The "standard" type of heterothallic life cycle is due to a defect in *HO*. The *ho* allele, which is present in many laboratory strains and in nature, is recessive to *HO* (57) and thus appears to be a defective version of *HO*. Hybridization analysis with the cloned *HO* gene demonstrates that *ho* is not simply a deletion of *HO* (63; R. Jensen, Ph.D. thesis, University of Oregon, Eugene, 1983); it may differ from *HO* in one or a few point mutations. It is not known whether the product coded by *ho* has any physiological role: thus far, no differences between *ho* strains and those carrying null mutations in *HO* have been detected (Jensen, Ph.D. thesis).

Heterothallic behavior can also result from a mutation of the mating-type locus itself. *Saccharomyces diastaticus* is a close relative of *S. cerevisiae* (one that can interbreed with it) which maintains a stable α mating type even though it contains a functional *HO* gene (151). It turns out that *S. diastaticus* has an alteration of *MAT α* , denoted *α -inc* ("inconvertible"), which affects the cleavage site for the endonuclease coded by the *HO* gene. *α -inc* is thus a naturally occurring version of the type of mutations that have been created in vitro to identify the *HO* endonuclease cleavage site (111).

The third and fourth types of naturally occurring heterothallic behavior result from alterations at *HML* and *HMR*. For example, certain strains of *S. oviformis* exhibit a stable mating behavior as *a* even though they contain *HO*. Likewise, *S. norbensis* strains exhibit a stable mating behavior as α even though they contain *HO*. Genetic analysis (41, 109, 114, 130, 152; summarized in reference 53) showed that the *S. oviformis* strain differs from homothallic strains in that it lacks the genetic determinant that is necessary for *a* cells to switch to α : they lack what is now known as *HML α* . These strains are not simply deleted for *HML α* . Rather, they contain an *a* cassette at *HML*. Consequently, the genotype of these strains is *HML a* *MAT α* *HMR a* *HO*: they have *a* cassettes everywhere. They cannot switch to α , but instead futilely replace their *a* cassette at *MAT* with another *a* cassette from *HML* or *HMR*, with no change in mating type. The situation for the stable α strain, *S. norbensis*, is analogous: its genotype is *HML α* *MAT α* *HMR α* *HO*. The altered *HML* and *HMR* alleles in these yeasts appear to have occurred by recombination between the normal allele at these loci and the opposite type of allele present at *MAT* or at the other *HM* locus. These amount to aberrant mating-type interconversion events in which the cassette at the *HM*

TABLE 3. Segregation patterns for different types of mutations affecting homothallism^a

		<i>ho</i> , a defective version of <i>HO</i>		<i>MATa HO HMLα HMRa</i> <i>MATα ho HMLα HMRa</i>	
Genotype	Phenotype	Genotype	Phenotype	Genotype	Phenotype
<i>MATa HO</i>	D	<i>MATa ho</i>	a	<i>MATa HO</i>	D
<i>MATa HO</i>	D	<i>MATa ho</i>	a	<i>MATa ho</i>	a
<i>MATα ho</i>	α	<i>MATα HO</i>	D	<i>MATα HO</i>	D
<i>MATα ho</i>	α	<i>MATα HO</i>	D	<i>MATα ho</i>	α
		<i>HMRα</i> , an alteration of <i>HMR</i> , as in <i>S. norbensis</i>		<i>MATa HO HMLα HMRa</i> <i>MATα HO HMLα HMRα</i>	
Genotype	Phenotype	Genotype	Phenotype	Genotype	Phenotype
<i>MATa HMRa</i>	D	<i>MATa HMRα</i>	D	<i>MATa HMRα</i>	D
<i>MATa HMRa</i>	D	<i>MATa HMRα</i>	D	<i>MATa HMRa</i>	D
<i>MATα HMRα</i>	α	<i>MATα HMRa</i>	D	<i>MATα HMRα</i>	α
<i>MATα HMRα</i>	α	<i>MATα HMRa</i>	D	<i>MATα HMRa</i>	D
		<i>HMLa</i> , an alteration of <i>HML</i> , as in <i>S. oviformis</i>		<i>MATa HO HMLα HMRa</i> <i>MATα HO HMLa HMRa</i>	
Genotype	Phenotype	Genotype	Phenotype	Genotype	Phenotype
<i>MATa HMLα</i>	D	<i>MATa HMLa</i>	a	<i>MATa HMLα</i>	D
<i>MATa HMLα</i>	D	<i>MATa HMLa</i>	a	<i>MATa HMLa</i>	a
<i>MATα HMLa</i>	D	<i>MATα HMLα</i>	D	<i>MATα HMLα</i>	D
<i>MATα HMLa</i>	D	<i>MATα HMLα</i>	D	<i>MATα HMLa</i>	D
		<i>MATαinc</i> , a natural inconvertible allele of <i>MATα</i> , as in <i>S. diastaticus</i>		<i>MATa HO HMLα HMRa</i> <i>MATαinc HO HMLα HMRa</i>	
Genotype	Phenotype				
<i>MATa</i>	D				
<i>MATa</i>	D				
<i>MATαinc</i>	α				
<i>MATαinc</i>	α				

^a A wild-type *MATa/MATα* diploid that is homozygous for *HO*, *HMLα*, and *HMRa* produces tetrads in which all four spores diploidize. Shown here are the types of segregation observed when one of the loci involved in mating-type interconversion is altered as indicated. The genotypes of different diploids are shown with heterozygous markers boldfaced. Genotypes and phenotypes are presented for the different tetrad types: ditely tetrads are listed in columns 1 through 4; tetratype tetrads are listed in columns 5 to 6. (The *MATa/MATα inc* diploid produces only parental ditely tetrads.) Phenotypes: a and α, heterothallic behavior (mating as a or α, respectively); D, homothallic behavior ("diploidization"), scored in general as formation of a/α diploid cells. Further description of these segregations is given in the text and in references 41 and 53.

locus is replaced instead of the cassette at *MAT*. Such events can be obtained readily in the laboratory as derivatives of an *HO HMLα HMRa* strain (11, 113).

Table 3 shows the characteristic segregation patterns of a/α diploids that are heterozygous for these natural mutations affecting *HO*, *HMLα*, *HMRa*, or *MATα*. Strains that are homozygous for the variant alleles, such as a/α *HO/HO HMLα/HMLα HMRa/HMRα*, give a very distinctive segregation pattern: 2 heterothallic (α) and 2 homothallic (diploidizing) segregants in each ascus.

There are other types of heterothallic behaviors that have been observed in the laboratory and which might occur in nature. For example, consider a strain that contains a mutation in a gene (such as *STE3*) that is necessary for mating by α cells but not by a cells but which otherwise has the full set of genes and sites necessary for homothallic behavior: its genotype is *HMLα MATa* (or *MATα HMRa HO ste3*). A cell of this genotype would produce a colony that contains two types of cells: *MATa ste3*, which mates as a, and *MATα ste3*, which does not mate. Thus, the colony exhibits a mating behavior of a and does not contain a/α cells (because the members of the colony cannot mate with each other (see references 63 and 141).

A THEORETICAL DISCUSSION OF HOMOTHALLISM: ARE OTHER MECHANISMS POSSIBLE?

Before we plunge into this discussion, let us remind ourselves that homothallism is the ability of a single haploid cell to give rise to a diploid cell and that this diploid cell has the novel property of being able to undergo meiosis. In *S. cerevisiae*, the single cell gives rise to cells of two different mating types; this diversity is generated by genetic rearrangement. These cells mate to form the diploid. The diploid has novel properties (ability to sporulate) because it contains the novel regulatory species a1-α2, which turns off synthesis of the *RME1* product. Can one imagine homothallic behavior of *S. cerevisiae* as occurring in any other way? In this section, I discuss ways in which homothallism might conceivably occur. This section will serve as a reminder that the phenomenon of homothallism does not automatically imply a specific molecular mechanism. In addition, it will bring up some issues bearing on the generation of diversity.

I shall discuss two classes of mechanism for homothallism; one involving alteration of DNA, and one which invokes no DNA alterations. In the *S. cerevisiae* case, diversity is generated by a genetic rearrangement which moves information from one position to another. Prior to the

elucidation of this mechanism, various models which could account for mating-type interconversion were entertained. For example, it was conceivable that both a and α regulatory information is located at the mating-type locus and that a regulatory region located between the a and α regulators determines which is expressed (45, 56; see also reference 53). The regulatory region might be an invertible segment of DNA, like that seen in bacterial phase variation, which directs transcription one way or the other (136). Another possibility was that the regulatory region contains DNA sequences that are subject to DNA methylation (or other type of modification), which can be stably inherited, and which would likewise direct transcription of one or the other regulatory genes (D. Hawthorne, personal communication, cited in reference 59).

Let us now turn to mechanisms for generating homothallic behavior that do not involve alterations of the DNA at the mating-type locus. How then are diploid cells formed? How is a novel cell type generated? There are several ways in which a haploid cell might become diploid. For example, there might be a failure of chromosome segregation during a mitotic cell division: both chromosome sets would migrate to the same cell (as occurs in certain cell cycle mutants of *S. cerevisiae*; 131, 154). Another possibility is that identical cells can fuse with each other. A third possibility is that cells in a population, although identical genotypically, differ phenotypically. For example, imagine a regulatory locus whose level of expression is on the borderline with respect to conferring one phenotype and another. A specific version of this situation can be readily concocted from what we know about *S. cerevisiae*. Consider a cell with a mutation at $MAT\alpha$ such that its products are synthesized either at a low level or not at all in any given cell division cycle. In the latter case, the cell will be phenotypically $\alpha 1^- \alpha 2^-$ and will exhibit a phenotype of an a cell (144). If expression of $MAT\alpha$ is adequate, then of course the cell will exhibit a phenotype of an α cell. Thus, a genotypically homogeneous population will contain two phenotypically distinct types of cells which can mate efficiently with each other.

Mating yields a diploid cell. How does this cell know that it is a diploid and therefore capable of undergoing meiosis? In the case of *S. cerevisiae*, cells know that they are diploid because they contain a novel regulatory activity that is not present in either of the mating partners. Furthermore, this novel regulatory species is present in all progeny of the original zygote, because it is encoded by distinct alleles, $MATa$ and $MAT\alpha$. It is important to note that a novel regulatory species might have only a short lifetime and be present only in the original zygote. For example, cells of one mating type might produce polypeptide X because they are genotypically $MATX$, and cells of the other mating type might produce polypeptide Y because they lack $MATX$ (which ordinarily represses synthesis of Y). The zygote cell that results from mating will contain the novel regulatory species X-Y, even though diploid progeny derived from the zygote will produce only polypeptide X. Zygotes of *Chlamydomonas reinhardtii* may be of this sort. Whether this explanation accounts for some homothallic strains of *Neurospora* spp. that have only one type of mating-type locus allele (35) is discussed below.

Another way of assessing cell ploidy might be to determine whether chromosomes are capable of pairing. Perhaps successful pairing of homologous chromosomes can provide a signal to continue through meiosis and into sporulation. Diploids would be capable of generating such a signal whereas haploids would not.

LIFE CYCLES OF SOME OTHER ORGANISMS

Mating type loci with naturally-occurring alleles provide a rich starting point for studying aspects of the life cycle of many filamentous fungi as well as algae and ciliates. In several cases, the mating type loci have been cloned and potential target genes have been identified. The purpose of this section is to review briefly the status of some of these organisms, in order to call attention to differences from budding yeast and to special interesting aspects of the different organisms.

Schizosaccharomyces pombe

The fission yeast *Schizosaccharomyces pombe* has two mating types, h^+ and h^- , which are conferred by two alleles of the *mat1* locus (*mat1-P* and *mat1-M*, respectively). As in the case of budding yeast, the mating-type locus alleles contain nonhomologous blocs of DNA: *mat1-P* contains 1,104 unique base pairs, and *mat1-M* contains 1,128 unique base pairs (71). Each allele codes for two open reading frames: one product from each *mat* allele is required for mating and sporulation, and one product from each is required only for sporulation. It is imagined that these products are transcriptional regulatory proteins. Data for transcriptional regulation have thus far been reported for only one gene (*mei3*, which is activated in *mat1-M/mat1-P* strains but not in haploids; discussed further below [93]). At least 12 genes necessary for mating have been identified, including those that are specific to h^+ or h^- cells (see reference 94). One difference between *Schizosaccharomyces pombe* and *S. cerevisiae* is that fission yeast cells do not exhibit mating-type specializations until they are nutritionally starved. Starvation increases transcription of the *mat* locus and induces cellular differentiation. For *Schizosaccharomyces pombe*, the mating-type locus confers the potential to be one mating type or another, a potential realized only after the appropriate environmental trigger. Another difference between fission and budding yeasts is that the diploid formed by mating of *Schizosaccharomyces pombe* h^+ and h^- cells is transient: zygotes proceed immediately into meiosis. (Other notable differences between these two yeasts are discussed in reference 129).

A considerable amount is known about how *Schizosaccharomyces pombe* governs entry into meiosis. There are some overall similarities and some fascinating mechanistic differences. As in *S. cerevisiae*, there are two requirements for entering meiosis: nutritional starvation and heterozygosity at the mating-type locus. In both cases, this heterozygosity causes inhibition of an inhibitor of meiosis. In the case of *S. cerevisiae*, synthesis of *RME1* is turned off. In the case of *Schizosaccharomyces pombe*, the activity of the *ran1* protein, a protein kinase, is blocked (92). This occurs because h^+/h^- cells produce the *mei3* protein, which inhibits the activity of the *ran1* protein kinase. The targets of the *ran1* protein kinase have not been identified but should provide great insights into regulation of meiosis. (The *RME1* product does not appear to be a protein kinase, based on its nucleotide sequence [A. Mitchell, personal communication].)

Schizosaccharomyces pombe is homothallic and undergoes mating-type interconversion in a process very similar to that for *S. cerevisiae* (6-8). It contains silent M and P cassettes at *mat2* and *mat3* loci, respectively. Mating-type switching is initiated by a double-strand break at *mat1*; the analog of *HO* has not been identified. *Schizosaccharomyces pombe* has a characteristic switching pattern in mitotic cell

lineages that is thought to be governed by some type of modification of the DNA strands of the *mat1* locus, in other words, by modification of the substrate of the double-strand endonuclease which initiates mating-type switching (72). (This is to be contrasted with the case for *S. cerevisiae*, in which the pattern of switching results from regulation of the *HO* gene, coding for the endonuclease, and not from regulation of its substrate.) Mutants defective in mating-type interconversion include those that appear to identify machinery involved in recombinational resolution (23). Such mutants have not yet been found for *S. cerevisiae*.

Neurospora crassa and Other Filamentous Ascomycetes

Filamentous ascomycetes such as *N. crassa* have a mating-type locus, with alleles *A* and *a*, that governs both fruiting-body formation (including meiosis and ascospore formation) and vegetative functions (heterokaryon incompatibility). One notable difference between mating in *N. crassa* and that in yeasts is that the mating-type locus of *N. crassa* does not govern cell fusion: fusion can occur between cells of like mating type. After fusion of *A* and *a* cells to form a heterokaryon, subsequent events may be triggered by a novel regulatory species present in these cells that is composed of products from both mating partners (perhaps products of the *A* and *a* alleles themselves). Such a novel species would be analogous to $\alpha 1$ - $\alpha 2$ of budding yeast.

The alleles of the mating-type locus have recently been cloned: each allele contains a unique DNA sequence of approximately 4,400 base pairs (35). The mating-type locus alleles of *N. crassa* are thus like those of budding and fission yeasts in being nonhomologous blocks. (The *MAT* alleles of the yeasts are approximately 700 and 1,100 base pairs, respectively [2, 71].) A mutational analysis of *A* has identified one gene product that is essential for both mating and incompatibility properties (R. Metzenberg and L. Glass, personal communication). One of the mating-type locus alleles of the ascomycete *Cochliobolus heterostrophus*, a pathogen of corn, has also recently been cloned (G. Turgeon and O. Yoder, personal communication).

Although mating-type switching has never been seen in *N. crassa*, homothallic *Neurospora* species do exist (35, 118). (Mating-type switching in filamentous ascomycetes is reviewed in reference 118.) By using the cloned mating-type locus alleles as probes, it has recently been shown that a number of the homothallic isolates contain only the *A* allele (35; Metzenberg and Glass, personal communication). Apparently, the homothallic life cycle of these *Neurospora* species does not occur by genetic rearrangement to activate storage forms of the mating-type locus. As noted above, it seems possible that a hybrid regulatory species produced in *A a* heterokaryons of heterothallic strains is necessary for completion of fruiting-body formation and other processes. The homothallic strains containing only the *A* allele might have an alteration of *A* that somehow mimics the presence of both alleles or might have mutations distinct from the mating-type locus so that the novel regulatory species is not needed to trigger fruiting-body formation. A different type of explanation for the homothallic strains that contain only the *A* allele has been presented in the preceding section. According to this explanation, failure to express *A* would lead to the phenotype of an *a* cell. This prediction does not appear to be borne out from analysis of mutations in *A* (38).

Basidiomycetes

For the organisms described above, a single locus with two alleles determines the two different mating types. Basi-

diomycetes such as the wood-rotting fungus *Schizophyllum commune* and the corn smut *Ustilago maydis* have two loci responsible for conferring mating type. Matings are productive (yielding fruiting bodies in the case of *Schizophyllum commune* and pathogenic dikaryons in the case of *U. maydis*) only if the mating partners are different at both of these loci. An intriguing feature of these loci (also referred to as "incompatibility loci") is that some have multiple alleles. The *A* and *B* loci of *Schizophyllum commune* have at least 32 and 9 different alleles, respectively (see references 122 and 157); the *a* and *b* loci of *U. maydis* have 2 and at least 25 alleles, respectively (121, 128; reviewed in reference 4). How cells recognize whether the alleles are the same or different is an intriguing molecular problem. Alleles of the *Schizophyllum commune* and *U. maydis* incompatibility loci have been cloned (R. Ullrich, personal communication; S. Leong, personal communication). Their sequence should provide much information on the nature of this recognition process (discussed in references 4, 122, and 157). Genes that may be targets of action of the mating-type loci have been identified by isolation of mutants defective in fruiting-body formation or in the mating reaction (4, 122).

A "conventional wisdom" has developed concerning the mating process of *U. maydis*, in which the *a* locus is believed to govern fusion between yeast-like cells; the *b* locus governs subsequent events such as growth of the mycelium. Although it is not possible to make a definitive statement about the role of the *a* locus in cell fusion, we have been unable to see fusion by microscopic observation and thus unable to ascertain whether *a* governs this step (4). *U. maydis* may thus be quite different from yeasts in this aspect of its mating process. In contrast, the *a* locus has been shown to be required for *U. maydis* to undergo filamentous growth: thus, cells must be different at both *a* and *b* for filamentous growth (4). This requirement of *U. maydis* for two different alleles (and similar requirements in *Neurospora* spp. and other ascomycetes and also in *Schizophyllum commune*) all raise the specter of a novel regulatory species, analogous to $\alpha 1$ - $\alpha 2$, which monitors formation of a distinctive cell type.

Ciliates and Algae

Mating-type loci are also found in organisms other than fungi. For example, ciliated protozoans such as *Paramecium* and *Tetrahymena* species have a locus that determines the mating type of the cell. Many *Paramecium* species have two mating types (reviewed in reference 138). *Tetrahymena pyriformis* (also known as *T. thermophila*) has seven different mating types (I through VII) (102). An interesting aspect is that the mating-type locus alleles of *T. thermophila* determine the possible mating types. For example, *mat-1* strains can exhibit mating types I, II, III, V, and VI, and *mat-2* strains can exhibit any mating type except I. Development of the specialized macronucleus involves a choice of one or another mating type from the menu specified by the *mat* locus. Molecular models for this process are discussed by Orias (112).

Many algae, for example, *C. reinhardtii*, have a single locus that determines mating type. *C. reinhardtii* has two alleles, *mt*⁺ and *mt*⁻, that are hypothesized to code for regulatory proteins that govern expression of unlinked genes or activity of their gene products (26; reviewed in reference 36). Genetic evidence indicates that there are several genes at the mating-type locus. It should be possible to clone the mating-type locus in the near future because a DNA segment

tightly linked to *mt* has recently been identified (26). (Physical DNA markers near the mating-type locus are also known for the closely related colonial alga *Volvox carteri* [42]). Genes distinct from the mating-type locus that are necessary for mating by one type and not by the other may be the targets of regulation by the *mt* products. A set of genes whose transcription is activated soon after zygote formation has been identified (26). It has been suggested that expression of these genes may be triggered by a novel regulatory species that is produced upon cell fusion. Homothallic *Chlamydomonas* species (*C. monoica*) exist; nothing is known about the basis for their homothallism (158).

CONCLUDING COMMENTS AND MAJOR CONCLUSIONS

Having taken some major forays into topics such as a theoretical discussion of homothallism and variant life cycles, I thought that it might be valuable to conclude by highlighting certain points of this article. We have seen that the key genetic regulator of the life cycle of *S. cerevisiae* is the mating-type locus, which is known through the naturally occurring alleles, *MATa* and *MAT α* . The studies of the life cycle of this organism have revealed the molecular mechanisms by which *MAT* controls the different facets of the life cycle (to program mating and sporulation) and the molecular mechanism by which *MAT* is controlled (to create homothallic behavior).

(i) The mating type locus codes for proteins that govern gene transcription: these regulatory proteins activate or repress transcription of sets of dispersed genes that are themselves responsible for the specialized properties of yeast cells. Among the proteins that are regulated is another regulatory protein (the *RME1* product) which governs entry into meiosis.

(ii) It was not preordained that the mating-type locus would code for proteins that govern transcription. *MAT* might have encoded protein kinases, proteases, or RNA splicing components. Analysis of loci that govern the life cycles of other organisms is revealing regulators (such as *ran1* and *mei3* in *Schizosaccharomyces pombe*) that do not directly regulate transcription.

(iii) We imagine that master regulatory loci of various sorts exist in other organisms and stress that there are a variety of mechanisms by which these loci and their products can be regulated. For example, small molecules such as galactose or steroid hormones influence the activity of regulators such as the *S. cerevisiae* *GAL4* protein (66, 85, 155) and the mammalian steroid receptor (165), respectively; proteases govern the stability of key regulatory proteins such as LexA (83) and cII (5, 60). Control of the *S. cerevisiae* master regulators is brought about by moving the genetic information coding for the regulatory proteins themselves.

ACKNOWLEDGMENTS

I acknowledge the many contributions from an exceptional group of graduate students and postdoctoral fellows in my laboratory. I thank Lorraine Marsh, Flora Banuett, Olen Yoder, Bob Metzberg, and Louise Glass for comments on the manuscript.

The research from my laboratory has been supported in large part by research grants from the National Institute of Allergy and Infectious Diseases of the U.S. Public Health Service.

I dedicate this paper to the talented and devoted technical staff at the University of Oregon (Sylvia Crump and associates) and at the University of California, San Francisco (Joe Bourassa, Amparo de los Rios, and Gloria Reynolds), whose efforts made this work possible.

LITERATURE CITED

1. Ammerer, G., G. F. Sprague, Jr., and A. Bender. 1985. Control of yeast α -specific genes: evidence for two blocks to expression in *MATa/MAT α* diploids. *Proc. Natl. Acad. Sci. USA* **82**: 5855-5859.
2. Astell, C. R., L. Ahlstrom-Jonasson, M. Smith, K. Tatchell, K. A. Nasmyth, and B. D. Hall. 1981. The sequence of the DNAs coding for the mating type loci of *Saccharomyces cerevisiae*. *Cell* **27**:15-23.
3. Atcheson, C. L., B. DiDomenico, S. Frackman, R. E. Esposito, and R. T. Elder. 1987. Isolation, DNA sequence, and regulation of a meiosis-specific eukaryotic recombination gene. *Proc. Natl. Acad. Sci. USA* **84**:8035-8039.
4. Banuett, F., and I. Herskowitz. 1988. *Ustilago maydis*, smut of maize, p. 427-455. In G. S. Sidhu (ed.), *Genetics of plant pathogenic fungi*. Academic Press, Inc. (London), Ltd., London.
5. Banuett, F., M. A. Hoyt, L. McFarlane, H. Echols, and I. Herskowitz. 1986. *hflB*, a new *Escherichia coli* locus regulating lysogeny and the level of bacteriophage cII protein. *J. Mol. Biol.* **187**:213-224.
6. Beach, D., P. Nurse, and R. Egel. 1982. Molecular rearrangement of mating-type genes in fission yeast. *Nature (London)* **296**:682-683.
7. Beach, D. H. 1983. Cell type switching by DNA transposition in fission yeast. *Nature (London)* **305**:682-688.
8. Beach, D. H., and A. J. S. Klar. 1984. Rearrangements of the transposable mating-type cassettes of fission yeast. *EMBO J.* **3**:603-610.
9. Bender, A., and G. F. Sprague, Jr. 1987. *MAT α 1* protein, a yeast transcription activator, binds synergistically with a second protein to a set of cell-type-specific genes. *Cell* **50**:681-691.
10. Betz, R., J. W. Crabb, H. E. Meyer, R. Wittig, and W. Duntze. 1987. Amino acid sequences of α -factor mating peptides from *Saccharomyces cerevisiae*. *J. Biol. Chem.* **262**:546-548.
11. Blair, L. C., P. J. Kushner, and I. Herskowitz. 1979. Mutations of the *HMa* and *HMa α* loci and their bearing on the cassette model of mating type interconversion in yeast, p. 13-26. In T. Maniatis and R. Axel (ed.), *Eucaryotic gene regulation*. Academic Press, Inc., New York.
12. Blumer, K. J., J. E. Reneke, and J. Thorner. 1988. The *STE2* gene product is the ligand-binding component of the α -factor receptor of *Saccharomyces cerevisiae*. *J. Biol. Chem.* **263**: 10836-10842.
13. Brand, A. H., L. Breeden, J. Abraham, R. Sternglanz, and K. Nasmyth. 1985. Characterization of a "silencer" in yeast: a DNA sequence with properties opposite to those of a transcriptional enhancer. *Cell* **41**:41-48.
14. Brand, A. H., G. Micklem, and K. Nasmyth. 1987. A yeast silencer contains sequences that can promote autonomous plasmid replication and transcriptional activation. *Cell* **51**:709-719.
15. Buchman, A. R., W. J. Kimmerly, J. Rine, and R. D. Kornberg. 1988. Two DNA-binding factors recognize specific sequences at silencers, upstream activating sequences, autonomously replicating sequences, and telomeres in *Saccharomyces cerevisiae*. *Mol. Cell. Biol.* **8**:210-225.
16. Bücking-Throm, E., W. Duntze, L. H. Hartwell, and T. R. Manney. 1973. Reversible arrest of haploid cells at the initiation of DNA synthesis by a diffusible sex factor. *Exp. Cell. Res.* **76**:99-110.
17. Burkholder, A. C., and L. H. Hartwell. 1985. The yeast α -factor receptor: structural properties deduced from the sequence of the *STE2* gene. *Nucleic Acids Res.* **13**:8463-8475.
18. Chan, R. K., and C. A. Otte. 1982. Isolation and genetic analysis of *Saccharomyces cerevisiae* mutants supersensitive to G1 arrest by a factor and α factor pheromones. *Mol. Cell. Biol.* **2**:11-20.
19. Chan, R. K., and C. A. Otte. 1982. Physiological characterization of *Saccharomyces cerevisiae* mutants supersensitive to G1 arrest by a factor and α factor pheromones. *Mol. Cell. Biol.* **2**: 21-29.
20. Clancy, M. J., B. Buten-Magee, D. J. Straight, A. L. Kennedy,

- R. M. Partridge, and P. T. Magee. 1983. Isolation of genes expressed preferentially during sporulation in the yeast *Saccharomyces cerevisiae*. Proc. Natl. Acad. Sci. USA **80**:3000-3004.
21. Dietzel, C., and J. Kurjan. 1987. The yeast *SCG1* gene: a G α -like protein implicated in the a- and α -factor response pathway. Cell **50**:1001-1010.
 22. Duntze, W., V. L. MacKay, and T. R. Manney. 1970. *Saccharomyces cerevisiae*: a diffusible sex factor. Science **168**:1472-1473.
 23. Egel, R., D. H. Beach, and A. J. S. Klar. 1984. Genes required for initiation and resolution steps of mating-type switching in fission yeast. Proc. Natl. Acad. Sci. USA **81**:3481-3485.
 24. Elder, R. T., T. P. St. John, D. T. Stinchcomb, and R. W. Davis. 1981. Studies on the transposable element Ty1 of yeast. I. RNA homologous to Ty1. Cold Spring Harbor Symp. Quant. Biol. **45**:581-584.
 25. Esposito, R. E., and S. Klapholz. 1981. Meiosis and ascospore development, p. 211-287. In J. N. Strathern, E. W. Jones, and J. R. Broach (ed.), The molecular biology of the yeast *Saccharomyces*: life cycle and inheritance. Cold Spring Harbor Laboratory, Cold Spring Harbor, N.Y.
 26. Ferris, P. J., and U. W. Goodenough. 1987. Transcription of novel genes, including a gene linked to the mating-type locus, induced by *Chlamydomonas* fertilization. Mol. Cell. Biol. **7**:2360-2366.
 27. Fields, S., D. T. Chaleff, and G. F. Sprague, Jr. 1988. Yeast *STE7*, *STE11*, and *STE12* genes are required for expression of cell-type-specific genes. Mol. Cell. Biol. **8**:551-556.
 28. Fields, S., and I. Herskowitz. 1985. The yeast *STE12* product is required for expression of two sets of cell-type-specific genes. Cell **42**:923-930.
 29. Fields, S., and I. Herskowitz. 1987. Regulation by the yeast mating-type locus of *STE12*, a gene required for cell-type-specific expression. Mol. Cell. Biol. **7**:3818-3821.
 30. Fink, G. R., and C. A. Styles. 1972. Curing of a killer factor in *Saccharomyces cerevisiae*. Proc. Natl. Acad. Sci. USA **69**:2846-2849.
 31. Friis, J., and H. Roman. 1968. The effect of the mating-type alleles on intragenic recombination in yeast. Genetics **59**:33-36.
 32. Game, J. C. 1983. Radiation-sensitive mutants and repair in yeast, p. 109-137. In J. F. T. Spencer, D. M. Spencer, and A. R. W. Smith (ed.), Yeast genetics, fundamental and applied aspects. Springer-Verlag, New York.
 33. Garber, A. T., and J. Segall. 1986. The *SPS4* gene of *Saccharomyces cerevisiae* encodes a major sporulation-specific mRNA. Mol. Cell. Biol. **6**:4478-4485.
 34. Gething, M.-J. 1985. Protein transport and secretion. Cold Spring Harbor Laboratory, Cold Spring Harbor, N.Y.
 35. Glass, N. L., S. J. Vollmer, C. Staben, J. Grotelueschen, R. L. Metznerberg, and C. Yanofsky. 1988. DNAs of the two mating-type alleles of *Neurospora crassa* are highly dissimilar. Science **241**:570-573.
 36. Goodenough, U. W., and P. J. Ferris. 1987. Genetic regulation of development in *Chlamydomonas*, p. 171-189. In W. F. Loomis (ed.), Genetic regulation of development. Alan R. Liss, Inc., New York.
 37. Goutte, C., and A. D. Johnson. 1988. a1 protein alters the DNA binding specificity of $\alpha 2$ repressor. Cell **52**:875-882.
 38. Griffiths, A. J. F. 1982. Null mutants of the *A* and *a* mating type alleles of *Neurospora crassa*. Can. J. Genet. Cytol. **24**:167-176.
 39. Hagen, D. C., C. McCaffrey, and G. F. Sprague, Jr. 1986. Evidence the yeast *STE3* gene encodes a receptor for the peptide pheromone, a factor: gene sequence and implications for the structure of the presumed receptor. Proc. Natl. Acad. Sci. USA **83**:1418-1422.
 40. Hagen, D. C., and G. F. Sprague, Jr. 1984. Induction of the yeast α -specific *STE3* gene by the peptide pheromone a-factor. J. Mol. Biol. **178**:835-852.
 41. Harashima, S., Y. Nogi, and Y. Oshima. 1974. The genetic system controlling homothallism in *Saccharomyces* yeasts. Genetics **77**:639-650.
 42. Harper, J. F., K. S. Huson, and D. L. Kirk. 1987. Use of repetitive sequences to identify DNA polymorphisms linked to *regA*, a developmentally important locus in *Volvox*. Genes Dev. **1**:573-584.
 43. Hartig, A., J. Holly, G. Saari, and V. L. MacKay. 1986. Multiple regulation of *STE2*, a mating-type-specific gene of *Saccharomyces cerevisiae*. Mol. Cell. Biol. **6**:2106-2114.
 44. Hartwell, L. H. 1980. Mutants of *S. cerevisiae* unresponsive to cell division control by polypeptide mating hormones. J. Cell Biol. **85**:811-822.
 45. Hawthorne, D. C. 1963. A deletion in yeast and its bearing on the structure of the mating type locus. Genetics **48**:1727-1729.
 46. Hawthorne, D. C. 1963. Directed mutation of the mating type alleles as an explanation of homothallism in yeast, p. 34-35. In Proceedings of the 11th International Congress on Genetics, vol. 1.
 47. Hereford, L. M., and L. H. Hartwell. 1974. Sequential gene function in the initiation of *Saccharomyces cerevisiae* DNA synthesis. J. Mol. Biol. **84**:445-461.
 48. Herskowitz, I. 1985. Master regulatory loci in yeast and lambda. Cold Spring Harbor Symp. Quant. Biol. **50**:565-574.
 49. Herskowitz, I. 1986. Specialized cell types in yeast: their use in addressing problems in cell biology, p. 625-656. In J. B. Hicks (ed.), Yeast cell biology. Alan R. Liss, Inc., New York.
 50. Herskowitz, I., and D. Hagen. 1980. The lysis-lysogeny decision of bacteriophage lambda: explicit programming and responsiveness. Annu. Rev. Genet. **14**:399-445.
 51. Herskowitz, I., and L. Marsh. 1987. Conservation of a receptor/signal transduction system. Cell **50**:995-996.
 52. Herskowitz, I., and Y. Oshima. 1981. Control of cell type in *Saccharomyces cerevisiae*: mating type and mating type interconversion, p. 181-209. In J. N. Strathern, E. W. Jones, and J. R. Broach (ed.), The molecular biology of the yeast *Saccharomyces*: life cycle and inheritance. Cold Spring Harbor Laboratory, Cold Spring Harbor, N.Y.
 53. Herskowitz, I., J. Rine, G. Sprague, Jr., and R. Jensen. 1980. Control of cell type in yeast by genetic cassettes, p. 133-151. In W. A. Scott, R. Werner, J. Schultz, and D. R. Joseph (ed.), Mobilization and reassembly of genetic information. Academic Press, Inc., New York.
 54. Hicks, J. B., and I. Herskowitz. 1976. Evidence for a new diffusible element of mating pheromones in yeast. Nature (London) **260**:246-248.
 55. Hicks, J. B., and I. Herskowitz. 1976. Interconversion of yeast mating types. I. Direct observations of the action of the homothallism (*HO*) gene. Genetics **83**:245-258.
 56. Hicks, J. B., and I. Herskowitz. 1977. Interconversion of yeast mating types. II. Restoration of mating ability to sterile mutants in homothallic and heterothallic strains. Genetics **85**:373-393.
 57. Hicks, J. B., J. N. Strathern, and I. Herskowitz. 1977. Interconversion of yeast mating types. III. Action of the homothallism (*HO*) gene in cells homozygous for the mating type locus. Genetics **85**:373-393.
 58. Hicks, J. B., J. N. Strathern, and I. Herskowitz. 1977. The cassette model of mating type interconversion, p. 457-462. In A. Bukhari, J. Shapiro, and S. Adhya (ed.), DNA insertion elements, plasmids and episomes. Cold Spring Harbor Laboratory, Cold Spring Harbor, N.Y.
 59. Holliday, R., and J. E. Pugh. 1975. DNA modification mechanisms and gene activity during development. Science **187**:226-232.
 60. Hoyt, M. A., D. M. Knight, A. Das, H. I. Miller, and H. Echols. 1982. Control of phage lambda development by stability and synthesis of cII protein: role of the viral *cIII* and host *hflA*, *himA* and *himD* genes. Cell **31**:565-573.
 61. Ivy, J. M., A. J. S. Klar, and J. B. Hicks. 1986. Cloning and characterization of four *SIR* genes of *Saccharomyces cerevisiae*. Mol. Cell. Biol. **6**:688-702.
 62. Jenness, D. D., A. C. Burkholder, and L. H. Hartwell. 1983. Binding of α -factor pheromone to yeast a cells: chemical and genetic evidence for an α -factor receptor. Cell **35**:521-529.

63. Jensen, R., G. F. Sprague, Jr., and I. Herskowitz. 1983. Regulation of yeast mating-type interconversion: feedback control of *HO* gene expression by the yeast mating type locus. *Proc. Natl. Acad. Sci. USA* **80**:3035-3039.
64. Jensen, R. E., and I. Herskowitz. 1984. Directionality and regulation of cassette substitution in yeast. *Cold Spring Harbor Symp. Quant. Biol.* **49**:97-104.
65. Johnson, A. D., and I. Herskowitz. 1985. A repressor (*MAT α 2* product) and its operator control expression of a set of cell type specific genes in yeast. *Cell* **42**:237-247.
66. Johnston, M. 1987. A model fungal regulatory mechanism: the *GAL* genes of *Saccharomyces cerevisiae*. *Microbiol. Rev.* **51**:458-476.
67. Julius, D., L. Blair, A. Brake, G. Sprague, and J. Thorner. 1983. Yeast α -factor is processed from a larger precursor polypeptide: the essential role of a membrane-bound dipeptidyl aminopeptidase. *Cell* **32**:839-852.
68. Julius, D., A. Brake, L. Blair, R. Kunisawa, and J. Thorner. 1984. Isolation of the putative structural gene for the lysine-arginine-cleaving endopeptidase required for processing of yeast prepro- α -factor. *Cell* **37**:1075-1089.
69. Kassir, Y., and G. Simchen. 1976. Regulation of mating and meiosis in yeast by the mating-type region. *Genetics* **82**:187-206.
70. Keleher, C. A., C. Goutte, and A. D. Johnson. 1988. The yeast cell-type-specific repressor $\alpha 2$ acts cooperatively with a non-cell-type-specific protein. *Cell* **53**:927-936.
71. Kelly, M., J. Burke, M. Smith, A. Klar, and D. Beach. 1988. Four mating-type genes control sexual differentiation in the fission yeast. *EMBO J.* **7**:1537-1547.
72. Klar, A. J. S. 1987. Differentiated parental DNA strands confer developmental asymmetry on daughter cells in fission yeast. *Nature (London)* **326**:466-470.
73. Klar, A. J. S., S. Fogel, and K. MacLeod. 1979. *MAR1*, a regulator of *HMa* and *HMa* loci in *Saccharomyces cerevisiae*. *Genetics* **92**:759-776.
74. Klar, A. J. S., J. B. Hicks, and J. N. Strathern. 1982. Directionality of yeast mating-type interconversion. *Cell* **28**:551-561.
75. Klar, A. J. S., J. N. Strathern, J. R. Broach, and J. B. Hicks. 1981. Regulation of transcription in expressed and unexpressed mating type cassettes of yeast. *Nature (London)* **289**:239-244.
76. Klar, A. J. S., J. N. Strathern, and J. B. Hicks. 1984. Developmental pathways in yeast, p. 151-195. *In* R. Losick and L. Shapiro (ed.), *Microbial development*. Cold Spring Harbor Laboratory, Cold Spring Harbor, N.Y.
77. Kostriken, R., and F. Heffron. 1984. The product of the *HO* gene is a nuclease: purification and characterization of the enzyme. *Cold Spring Harbor Symp. Quant. Biol.* **49**:89-96.
78. Kostriken, R., J. N. Strathern, A. J. S. Klar, J. Hicks, and F. Heffron. 1983. A site-specific endonuclease essential for mating-type switching in *Saccharomyces cerevisiae*. *Cell* **35**:167-174.
79. Kronstad, J. W., J. A. Holly, and V. L. MacKay. 1987. A yeast operator overlaps an upstream activation site. *Cell* **50**:369-377.
80. Kurjan, J. 1985. α -factor structural gene mutations in *Saccharomyces cerevisiae*: effects on α -factor production and mating. *Mol. Cell. Biol.* **5**:787-796.
81. Kurjan, J., and I. Herskowitz. 1982. Structure of a yeast pheromone gene (*MFA*): a putative α -factor precursor contains four tandem copies of mature α -factor. *Cell* **30**:933-943.
82. Law, D. T. S., and J. Segall. 1988. The *SPS100* gene of *Saccharomyces cerevisiae* is activated late in the sporulation process and contributes to spore wall maturation. *Mol. Cell. Biol.* **8**:912-922.
83. Little, J. W., and D. W. Mount. 1982. The SOS regulatory system of *Escherichia coli*. *Cell* **29**:11-22.
84. Livi, G. P., and V. L. MacKay. 1980. Mating-type regulation of methyl methanesulfonate sensitivity in *Saccharomyces cerevisiae*. *Genetics* **95**:259-271.
85. Ma, J., and M. Ptashne. 1987. The carboxy-terminal 30 amino acids of *GAL4* are recognized by *GAL80*. *Cell* **50**:137-142.
86. MacKay, V., and T. R. Manney. 1974. Mutations affecting sexual conjugation and related processes in *Saccharomyces cerevisiae*. I. Isolation and phenotypic characterization of nonmating mutants. *Genetics* **76**:255-271.
87. MacKay, V. L., and T. R. Manney. 1974. Mutations affecting sexual conjugation and related processes in *Saccharomyces cerevisiae*. II. Genetic analysis of nonmating mutants. *Genetics* **76**:273-288.
88. MacKay, V. L., S. K. Welch, M. Y. Insley, T. R. Manney, J. Holly, G. C. Saari, and M. L. Parker. 1988. The *Saccharomyces cerevisiae* *BAR1* gene encodes an exported protein with homology to pepsin. *Proc. Natl. Acad. Sci. USA* **85**:55-59.
89. Malone, R. E., and R. E. Esposito. 1980. The *RAD52* gene is required for homothallic interconversion of mating types and spontaneous mitotic recombination in yeast. *Proc. Natl. Acad. Sci. USA* **77**:503-507.
90. Marsh, L., and I. Herskowitz. 1988. The *STE2* protein of *Saccharomyces kluyveri* is a member of the rhodopsin/beta-adrenergic receptor family and is responsible for recognition of the peptide ligand alpha factor. *Proc. Natl. Acad. Sci. USA* **85**:3855-3859.
91. McCaffrey, G., F. J. Clay, K. Kelsay, and G. F. Sprague, Jr. 1987. Identification and regulation of a gene required for cell fusion during mating of the yeast *Saccharomyces cerevisiae*. *Mol. Cell. Biol.* **7**:2680-2690.
92. McLeod, M., and D. Beach. 1988. A specific inhibitor of the *ran1*⁺ protein kinase regulates entry into meiosis in *Schizosaccharomyces pombe*. *Nature (London)* **332**:509-514.
93. McLeod, M., M. Stein, and D. Beach. 1987. The product of the *mei3*⁺ gene, expressed under control of the mating-type locus, induces meiosis and sporulation in fission yeast. *EMBO J.* **6**:729-736.
94. Michael, H., and H. Gutz. 1987. Sterility (*ste*) genes of *Schizosaccharomyces pombe*. *Yeast* **3**:5-9.
95. Michaelis, S., and I. Herskowitz. 1988. The *a*-factor pheromone of *Saccharomyces cerevisiae* is essential for mating. *Mol. Cell. Biol.* **8**:1309-1318.
96. Miller, A. M., V. L. MacKay, and K. A. Nasmyth. 1985. Identification and comparison of two sequence elements that confer cell-type specific transcription in yeast. *Nature (London)* **314**:598-603.
97. Mitchell, A. P. 1988. Two switches govern entry into meiosis in yeast, p. 47-66. *In* F. Haseltine and N. First (ed.), *Meiotic inhibition: molecular control of meiosis*. Alan R. Liss, Inc., New York.
98. Mitchell, A. P., and I. Herskowitz. 1986. Activation of meiosis and sporulation by repression of the *RME1* product in yeast. *Nature (London)* **319**:738-742.
99. Miyajima, I., M. Nakafuku, N. Nakayama, C. Brenner, A. Miyajima, K. Kaibuchi, K. Arai, Y. Kaziro, and K. Matsumoto. 1987. *GPA1*, a haploid-specific essential gene, encodes a yeast homolog of mammalian G protein which may be involved in mating factor signal transduction. *Cell* **50**:1011-1019.
100. Mortimer, R. K. 1958. Radiobiological and genetic studies on a polyploid series (haploid to hexaploid) of *Saccharomyces cerevisiae*. *Radiat. Res.* **9**:312-326.
101. Nakayama, N., A. Miyajima, and K. Arai. 1985. Nucleotide sequences of *STE2* and *STE3*, cell type-specific sterile genes from *Saccharomyces cerevisiae*. *EMBO J.* **4**:2643-2648.
102. Nanney, D. L., and P. A. Caughey. 1953. Mating type determination in *Tetrahymena pyriformis*. *Proc. Natl. Acad. Sci. USA* **39**:1057-1063.
103. Nasmyth, K. 1983. Molecular analysis of a cell lineage. *Nature (London)* **302**:670-676.
104. Nasmyth, K. 1985. A repetitive DNA sequence that confers cell-cycle *START* (*CDC28*)-dependent transcription of the *HO* gene in yeast. *Cell* **42**:225-235.
105. Nasmyth, K., and D. Shore. 1987. Transcriptional regulation in the yeast life cycle. *Science* **237**:1162-1170.
106. Nasmyth, K., D. Stillman, and D. Kipling. 1987. Both positive and negative regulators of *HO* transcription are required for mother-cell-specific mating-type switching in yeast. *Cell* **48**:579-587.

107. Nasmyth, K. A., and K. Tatchell. 1980. The structure of transposable yeast mating type loci. *Cell* **19**:753-764.
108. Nasmyth, K. A., K. Tatchell, B. D. Hall, C. Astell, and M. Smith. 1981. A position effect in the control of transcription at yeast mating type loci. *Nature (London)* **289**:244-250.
109. Naumov, G. I., and I. I. Tolstorukov. 1973. Comparative genetics of yeast. X. Reidentification of mutators of mating types in *Saccharomyces*. *Genetika* **9**:82-91.
110. Newlon, C. S., R. P. Green, K. J. Hardeman, K. E. Kim, L. R. Lipchitz, T. G. Palzkill, S. Synn, and S. T. Woody. 1986. Structure and organization of yeast chromosome III, p. 211-223. *In* J. B. Hicks (ed.), *Yeast cell biology*. Alan R. Liss, Inc., New York.
111. Nickloff, J. A., E. Y. Chen, and F. Heffron. 1986. A 24-base-pair DNA sequence from the *MAT* locus stimulates intergenic recombination in yeast. *Proc. Natl. Acad. Sci. USA* **83**:7831-7835.
112. Orias, E. 1981. Probable somatic DNA rearrangements in mating type determination in *Tetrahymena thermophila*: a review and a model. *Dev. Genet.* **2**:185-202.
113. Oshima, T., and I. Takano. 1980. Duplicated genes producing transposable controlling elements for the mating-type differentiation in *Saccharomyces cerevisiae*. *Genetics* **94**:859-870.
114. Oshima, Y., and I. Takano. 1971. Mating types in *Saccharomyces*: their convertibility and homothallism. *Genetics* **67**:327-335.
115. Percival-Smith, A., and J. Segall. 1984. Isolation of DNA sequences preferentially expressed during sporulation in *Saccharomyces cerevisiae*. *Mol. Cell. Biol.* **4**:142-150.
116. Percival-Smith, A., and J. Segall. 1986. Characterization and mutational analysis of a cluster of three genes expressed preferentially during sporulation of *Saccharomyces cerevisiae*. *Mol. Cell. Biol.* **6**:2443-2451.
117. Percival-Smith, A., and J. Segall. 1987. Increased copy number of the 5' end of the *SPS2* gene inhibits sporulation of *Saccharomyces cerevisiae*. *Mol. Cell. Biol.* **7**:2484-2490.
118. Perkins, D. D. 1987. Mating-type switching in filamentous ascomycetes. *Genetics* **115**:215-216.
119. Powers, S., S. Michaelis, D. Broek, S. Santa Anna-A., J. Field, I. Herskowitz, and M. Wigler. 1986. *RAM*, a gene of yeast required for a functional modification of *RAS* proteins and for production of mating pheromone α -factor. *Cell* **47**:413-422.
120. Pringle, J. R., and L. H. Hartwell. 1981. The *Saccharomyces cerevisiae* cell cycle, p. 97-142. *In* J. N. Strathern, E. W. Jones, and J. R. Broach (ed.), *The molecular biology of the yeast Saccharomyces: life cycle and inheritance*. Cold Spring Harbor Laboratory, Cold Spring Harbor, N.Y.
121. Puhalla, J. E. 1970. Genetic studies of the *b* incompatibility locus of *Ustilago maydis*. *Genet. Res.* **16**:229-232.
122. Raper, C. A. 1988. *Schizophyllum commune*, a model for genetic studies of the Basidiomycotina, p. 511-522. *In* G. S. Sidhu (ed.), *Genetics of plant pathogenic fungi*. Academic Press, Inc. (London), Ltd., London.
123. Rine, J., and I. Herskowitz. 1987. Four genes responsible for a position effect on expression from *HML* and *HMR* in *Saccharomyces cerevisiae*. *Genetics* **116**:9-22.
124. Rine, J., G. F. Sprague, Jr., and I. Herskowitz. 1981. *rmel* mutation of *Saccharomyces cerevisiae*: map position and bypass of mating type locus control of sporulation. *Mol. Cell. Biol.* **1**:958-960.
125. Rine, J. D. 1986. Regulation of cell division by peptide hormones of *Saccharomyces cerevisiae*. *Trends Genet.* **2**:276-277.
126. Roman, H., M. M. Phillips, and S. M. Sands. 1955. Studies of polyploid *Saccharomyces*. I. Tetraploid segregation. *Genetics* **40**:546-561.
127. Rose, M. K., B. R. Price, and G. R. Fink. 1986. *Saccharomyces cerevisiae* nuclear fusion requires prior activation by alpha factor. *Mol. Cell. Biol.* **6**:3490-3497.
128. Rowell, J. B., and J. E. DeVay. 1954. Genetics of *Ustilago maydis* in relation to basic problems of its pathogenicity. *Phytopathology* **44**:356-362.
129. Russell, P., and P. Nurse. 1986. *Schizosaccharomyces pombe* and *Saccharomyces cerevisiae*: a look at yeasts divided. *Cell* **45**:781-782.
130. Santa Maria, J., and D. Vidal. 1970. Segregación anormal del "mating type" en *Saccharomyces*. *Inst. Nac. Invest. Agron. (Spain) Cuad.* **30**:1-21.
131. Schild, D., H. N. Ananthaswamy, and R. K. Mortimer. 1981. An endomitotic effect of a cell cycle mutation of *Saccharomyces cerevisiae*. *Genetics* **97**:551-562.
132. Schnell, R., and J. Rine. 1986. A position effect on the expression of a tRNA gene mediated by the *SIR* genes in *Saccharomyces cerevisiae*. *Mol. Cell. Biol.* **6**:494-501.
133. Shore, D., and K. Nasmyth. 1987. Purification and cloning of a DNA binding protein from yeast that binds to both silencer and activator elements. *Cell* **51**:721-732.
134. Siliciano, P. G., and K. Tatchell. 1984. Transcription and regulatory signals at the mating type locus in yeast. *Cell* **37**:969-978.
135. Siliciano, P. G., and K. Tatchell. 1986. Identification of the DNA sequences controlling the expression of the *MAT α* locus of yeast. *Proc. Natl. Acad. Sci. USA* **83**:2320-2324.
136. Simon, M. I., and M. Silverman. 1983. Recombinational regulation of gene expression in bacteria, p. 211-227. *In* J. Beckwith, J. Davies, and J. A. Gallant (ed.), *Gene function in prokaryotes*. Cold Spring Harbor Laboratory, Cold Spring Harbor, N.Y.
137. Singh, A., E. Y. Chen, J. M. Lugovoy, C. N. Chang, R. A. Hitzeman, and P. H. Seeburg. 1983. *Saccharomyces cerevisiae* contains two discrete genes coding for the α -factor pheromone. *Nucleic Acids Res.* **11**:4049-4063.
138. Sonneborn, T. M. 1977. Genetics of cellular differentiation: stable nuclear differentiation in eukaryotic cells. *Annu. Rev. Genet.* **11**:349-367.
139. Sprague, G. F., Jr., L. C. Blair, and J. Thorner. 1983. Cell interactions and regulation of cell type in the yeast *Saccharomyces cerevisiae*. *Annu. Rev. Microbiol.* **37**:623-660.
140. Sprague, G. F., Jr., and I. Herskowitz. 1981. Control of yeast cell type by the mating type locus. I. Identification and control of expression of the α -specific gene, *BARI*. *J. Mol. Biol.* **153**:305-321.
141. Sprague, G. F., Jr., R. Jensen, and I. Herskowitz. 1983. Control of yeast cell type by the mating type locus: Positive regulation of the α -specific *STE3* gene by the *MAT α* product. *Cell* **32**:409-415.
142. Sternberg, P. W., M. J. Stern, I. Clark, and I. Herskowitz. 1987. Activation of the yeast *HO* gene by release from multiple negative controls. *Cell* **48**:567-577.
143. Stötzler, D., H.-H. Kiltz, and W. Duntze. 1976. Primary structure of α factor peptides from *Saccharomyces cerevisiae*. *Eur. J. Biochem.* **19**:397-400.
144. Strathern, J., J. Hicks, and I. Herskowitz. 1981. Control of cell type in yeast by the mating type locus: the α 1- α 2 hypothesis. *J. Mol. Biol.* **147**:357-372.
145. Strathern, J. N., and I. Herskowitz. 1979. Asymmetry and directionality in production of new cell types during clonal growth: the switching pattern of homothallic yeast. *Cell* **17**:371-381.
146. Strathern, J. N., A. J. S. Klar, J. B. Hicks, J. A. Abraham, J. M. Ivy, K. A. Nasmyth, and C. McGill. 1982. Homothallic switching of yeast mating type cassettes is initiated by a double-stranded cut in the *MAT* locus. *Cell* **31**:183-192.
147. Strathern, J. N., C. S. Newlon, I. Herskowitz, and J. B. Hicks. 1979. Isolation of a circular derivative of yeast chromosome III: implications for the mechanism of mating type interconversion. *Cell* **18**:309-319.
148. Strathern, J. N., E. Spatola, C. McGill, and J. B. Hicks. 1980. The structure and organization of transposable mating type cassettes in *Saccharomyces cerevisiae*. *Proc. Natl. Acad. Sci. USA* **77**:2839-2843.
149. Strazdis, J. R., and V. L. MacKay. 1983. Induction of yeast mating pheromone α -factor by α cells. *Nature (London)* **305**:543-545.
150. Stryer, L., and H. R. Bourne. 1986. G proteins: a family of signal transducers. *Annu. Rev. Cell Biol.* **2**:391-419.
151. Takano, I., T. Kusumi, and Y. Oshima. 1973. An α mating-type

- allele insensitive to the mutagenic action of the homothallic gene system in *Saccharomyces diastaticus*. *Mol. Gen. Genet.* **126**:19–28.
152. Takano, I., and Y. Oshima. 1967. An allele specific and a complementary determinant controlling homothallism in *Saccharomyces oviformis*. *Genetics* **57**:875–885.
 153. Teague, M. A., D. T. Chaleff, and B. Errede. 1986. Nucleotide sequence of the yeast regulatory gene *STE7* predicts a protein homologous to protein kinases. *Proc. Natl. Acad. Sci. USA* **83**:7371–7375.
 154. Thomas, J. H., and D. Botstein. 1986. A gene required for the separation of chromosomes on the spindle apparatus of yeast. *Cell* **44**:65–76.
 155. Torchia, T. E., R. W. Hamilton, C. L. Cano, and J. E. Hopper. 1984. Disruption of regulatory gene *GAL80* in *Saccharomyces cerevisiae*: effects on carbon-controlled regulation of the galactose/melibiose pathway genes. *Mol. Cell. Biol.* **4**:1521–1527.
 156. Trueheart, J., J. D. Boeke, and G. R. Fink. 1987. Two genes required for cell fusion during yeast conjugation: evidence for a pheromone-induced surface protein. *Mol. Cell. Biol.* **7**:2316–2328.
 157. Ullrich, R. C. 1978. On the regulation of gene expression: incompatibility in Schizophyllum. *Genetics* **88**:709–722.
 158. Van Winkle-Swift, K. P., and C. G. Burrascano. 1983. Complementation and preliminary linkage analysis of zygote maturation mutants of the homothallic alga, *Chlamydomonas moenica*. *Genetics* **103**:429–445.
 159. Wang, H.-T., S. Frackman, J. Kowalisyn, R. E. Esposito, and R. T. Elder. 1987. Developmental regulation of *SPO13*, a gene required for separation of homologous chromosomes at meiosis. I. *Mol. Cell. Biol.* **7**:1425–1435.
 160. Whiteway, M., R. Freedman, S. Van Arsdell, J. W. Szostak, and J. Thorner. 1987. The yeast *ARD1* gene product is required for repression of cryptic mating-type information at the *HML* locus. *Mol. Cell. Biol.* **7**:3713–3722.
 161. Wilkinson, L. E., and J. R. Pringle. 1974. Transient G1 arrest of *Saccharomyces cerevisiae* of mating type α by a factor produced by cells of mating type a . *Exp. Cell Res.* **89**:175–187.
 162. Wilson, K. L., and I. Herskowitz. 1984. Negative regulation of *STE6* gene expression by the $\alpha 2$ product of *Saccharomyces cerevisiae*. *Mol. Cell. Biol.* **4**:2420–2427.
 163. Wilson, K. L., and I. Herskowitz. 1987. *STE16*, a new gene for pheromone production by a cells of *Saccharomyces cerevisiae*. *Genetics* **155**:441–449.
 164. Winge, Ö, and C. Roberts. 1949. A gene for diploidization in yeasts. *C. R. Trav. Lab. Carlsberg Ser. Physiol.* **24**:341–346.
 165. Yamamoto, K. R. 1985. Steroid receptor regulated transcription of specific genes and gene networks. *Annu. Rev. Genet.* **19**:209–252.
 166. Yamashita, I., and S. Fukui. 1985. Transcriptional control of the sporulation-specific glucoamylase gene in the yeast *Saccharomyces cerevisiae*. *Mol. Cell. Biol.* **5**:3069–3073.