

Insights into post-translational processing of β -galactosidase in an animal model resembling late infantile human GM₁-gangliosidosis

R. Kreutzer^{a, *}, M. Kreutzer^a, M. J. Pröpsting^b, A. C. Sewell^c,
T. Leeb^d, H. Y. Naim^b, W. Baumgärtner^a

^a Department of Pathology, University of Veterinary Medicine, Hannover, Germany

^b Department of Physiological Chemistry, University of Veterinary Medicine, Hannover, Germany

^c Department of Pediatrics, University Children's Hospital, Frankfurt am Main, Germany

^d Institute of Genetics, Vetsuisse Faculty, University of Berne, Berne, Switzerland

Received: September 26, 2007; Accepted: December 9, 2007

Abstract

GM₁-gangliosidosis is a lysosomal storage disorder caused by a deficiency of β -galactosidase activity. Human GM₁-gangliosidosis has been classified into three forms according to the age of clinical onset and specific biochemical parameters. In the present study, a canine model for type II late infantile human GM₁-gangliosidosis was investigated 'in vitro' in detail. For a better understanding of the molecular pathogenesis underlying GM₁-gangliosidosis the study focused on the analysis of the molecular events and subsequent intracellular protein trafficking of β -galactosidase. In the canine model the genetic defect results in exclusion or inclusion of exon 15 in the mRNA transcripts and to translation of two mutant precursor proteins. Intracellular localization, processing and enzymatic activity of these mutant proteins were investigated. The obtained results suggested that the β -galactosidase C-terminus encoded by exons 15 and 16 is necessary for correct C-terminal proteolytic processing and enzyme activity but does not affect the correct routing to the lysosomes. Both mutant protein precursors are enzymatically inactive, but are transported to the lysosomes clearly indicating that the amino acid sequences encoded by exons 15 and 16 are necessary for correct folding and association with protective protein/cathepsin A, whereas the routing to the lysosomes is not influenced. Thus, the investigated canine model is an appropriate animal model for the human late infantile form and represents a versatile system to test gene therapeutic approaches for human and canine GM₁-gangliosidosis.

Keywords: animal model • GM₁-gangliosidosis • β -galactosidase • post-translational processing

Introduction

GM₁-gangliosidosis (OMIM 230500; OMIA ID: 000402) is a rare autosomal recessive disease characterized by lysosomal storage of GM₁-ganglioside due to deficiency of β -galactosidase activity (GLB1; EC 3.2.1.23) [1]. In humans, the consequence of GM₁-ganglioside accumulation in the central nervous system is a progressive cerebellar dysfunction [2–4]. The clinical phenotypes depend on the type of mutations and can be correlated with

defects in GLB1 maturation [5, 6]. Over 20% of the humans suffering from GM₁-gangliosidosis display mutations in the exon 15 of the *GLB1* gene. Exon 2 is only affected in 6% of the cases [7, 8]. The three forms of GM₁-gangliosidosis in humans: infantile (type I), late infantile/juvenile (type II) and adult (type III) are characterized by a different age of onset and temporal evolution [9–12]. The precise molecular mechanisms behind these three forms are not clearly understood. Thus, to develop specific therapies for human GM₁-gangliosidosis it is vital to use appropriate animal models for each form of the disease. Canine GM₁-gangliosidosis resembles the human disease with respect to genetic defects, biochemical abnormalities, clinical and pathological findings [3, 13–15]. GM₁-gangliosidosis occurs naturally in five dog breeds: mixed-breed beagles, English springer spaniels,

*Correspondence to: Dr. Robert KREUTZER

Department of Pathology, University of Veterinary Medicine, Buenteweg 17, D-30559, Hannover, Germany.

Tel.: +495119538620

Fax: +495119538675

E-mail: robert.kreutzer@tiho-hannover.de

Portuguese water dogs, Shiba Inu dogs and Alaskan huskies. The molecular defects responsible for G_{M1} -gangliosidosis in dogs were described only for the last three breeds [4, 16, 17, 18]. Thus, in Portuguese water dogs with G_{M1} -gangliosidosis exon 2 of *GLB1* gene is mutated, while for Shiba dogs the mutation occurs in exon 15 [16, 18]. In Shiba dogs the disease is milder than the late infantile G_{M1} -gangliosidosis in humans with slightly later onset and longer survival period [3, 8, 16]. In the present study, we describe at the molecular level a canine Alaskan husky model for the late infantile type II G_{M1} -gangliosidosis.

The genetic defect in Alaskan huskies with G_{M1} -gangliosidosis is represented by a 19 bp duplication, in exon 15 of the canine *GLB1* gene, which partially disrupts a potential exon splicing enhancer (ESE) leading to exon 15 skipping in a fraction of the transcripts. The other transcripts retained the mutated exon 15, which generates a premature termination codon [4, 17]. As a result of these genetic modification a severe deficiency in the *GLB1* enzymatic activity (only 1–10% compared to homozygous healthy dogs) can be found and results in a massive accumulation of G_{M1} -gangliosides in various cells especially in neurons of the central nervous system in affected homozygous individuals [14, 17]. Clinically, the first disease signs are present at 6–8 weeks after birth and progressed steadily until death of the affected individuals at the 9–12 months of age. The diseased animals show signs of progressive cerebellar dysfunctions including ataxia and spasticity similar to those observed in humans with late infantile G_{M1} -gangliosidosis [13, 14, 17].

Like all lysosomal enzymes, human *GLB1* is transported to its final destination along the secretory pathways [19, 20]. Thus, the 84 kDa human *GLB1* precursor synthesized on ribosomes contains an N-terminal signal sequence (ss) which targets its co-translational translocation in the endoplasmic reticulum (ER) [21, 22]. After the proteolytic cleavage of this signal sequence, the nascent protein undergoes glycosylation in the ER and further in Golgi compartments [23, 24]. Subsequently, the precursor protein is phosphorylated and mannose-6-phosphate targeted to the lysosomes [20, 25]. Here, in an acidic environment, the human *GLB1* precursor protein is processed to a mature enzyme by proteolytic modification at the C-terminal region. The resulting proteolytic fragments (64 and 22 kDa) generate the fully active *GLB1* [26]. Finally, the 64 kDa fragment of *GLB1* is degraded to an 18 and respectively 50 kDa fragments by cathepsin-B like thiol proteases [24].

Along these secretory pathways, the human *GLB1* forms complexes with protective protein/ cathepsin A (PPCA) and N-acetyl- α -neuraminidase (NEU.1; EC 3.2.1.18) which are essential for intracellular routing and maintenance of *GLB1* activity [26, 27]. Without PPCA, human *GLB1* is abnormally cleaved to inactive 80 and 72 kDa peptides [24].

For a better understanding of the molecular mechanisms underlying G_{M1} -gangliosidosis in both the canine disease and human late infantile type II form, the present study focused on the analysis of the molecular events which connect the genetic defects to the lack of *GLB1* activity. Therefore, the possible association

between the absence of *GLB1* activity and the abnormal processing of the canine *GLB1* mutants or impaired transport to the lysosomes was investigated. This was accomplished by following the *GLB1* proteins from the synthesis on the ribosomes until their final destination, the lysosomes.

Materials and methods

Computer-aided analyses

The canine N-terminal signal sequence necessary for *GLB1* translocation into the ER was predicted using the SignalP 3.0 software [28, 29]. To identify the putative *N*-linked glycosylation sites the amino acid sequence of *GLB1* was screened with the NetNGlyc software [30]. The Protein Calculator v3.3. was used to estimate the molecular weight of the proteins.

RNA isolation and cDNA synthesis

Total RNA was isolated from skin fibroblasts of healthy and affected dogs using the RNeasy Mini Kit (Qiagen, Hilden, Germany). A DNase (Qiagen, Hilden, Germany) treatment was performed according to the manufacturer's instructions. The synthesis of full length wild-type and mutant canine *GLB1* cDNAs was performed using the SMARTTM RACE method (Clontech, Palo Alto, CA, USA).

Expression vector construction

The obtained cDNAs were amplified by PCR using the proof-reading KOD HotStart[®] polymerase (Novagen, Darmstadt, Germany). The N-terminal signal sequence was amplified using 5'-atatggctagctccaccatggcggggttcctggttcgcatcctc-3' upstream and 5'-ggtggcgaccggctccctgggtggcattgcgcaa-3' downstream primers which include the recognition sites for *NheI* and *AgeI*, respectively. For amplification of the wild-type (*GLB1*) and the mutant sequence lacking exon 15 (*GLB1-delEx15*), the 5'-atatcgactcaactgcggaatgctcccagagg-3' upstream and 5'-atccgcccggctcagtggtggtggtggtgga-catagtcagctctcaa-3' downstream primers were used. For the mutant sequence harboring the 19 bp duplication in exon 15 (*GLB1-19bpdupl*), the following downstream primer 5'-ccgcccggctcagtggtggtggtggtgatcaccaacctgaccttg-3' was applied. Both downstream primers contained a nucleotide tag encoding six histidine residues (6xHis).

The constructs designed to encode *GLB1* proteins contained the enhanced cyan fluorescent protein (ECFP) sequence flanked at the 5' end by the canine N-terminal signal sequence and at the 3' end by the wild type or the mutant *GLB1* sequences without their internal N-terminal signal sequence (-iss). The ss was cloned in the *NheI/AgeI* site of the pECFP-C1[®] Vector (Takara Bio Europe, Saint-Germain-en-Laye, France) while the wild-type and the mutant *GLB1* sequences harboring the 6xHis tag at their C-terminus were introduced between the *SacI* and *XmaI* sites. Thus, three vectors ss-ECFP(-iss)-*GLB1*-His, ss-ECFP(-iss)-*GLB1delEx15*-His and ss-ECFP(-iss)-*GLB1-19bpdupl*-His were produced (Fig. 1). The identity of all obtained constructs was confirmed by sequencing (Agowa GmbH, Berlin, Germany).

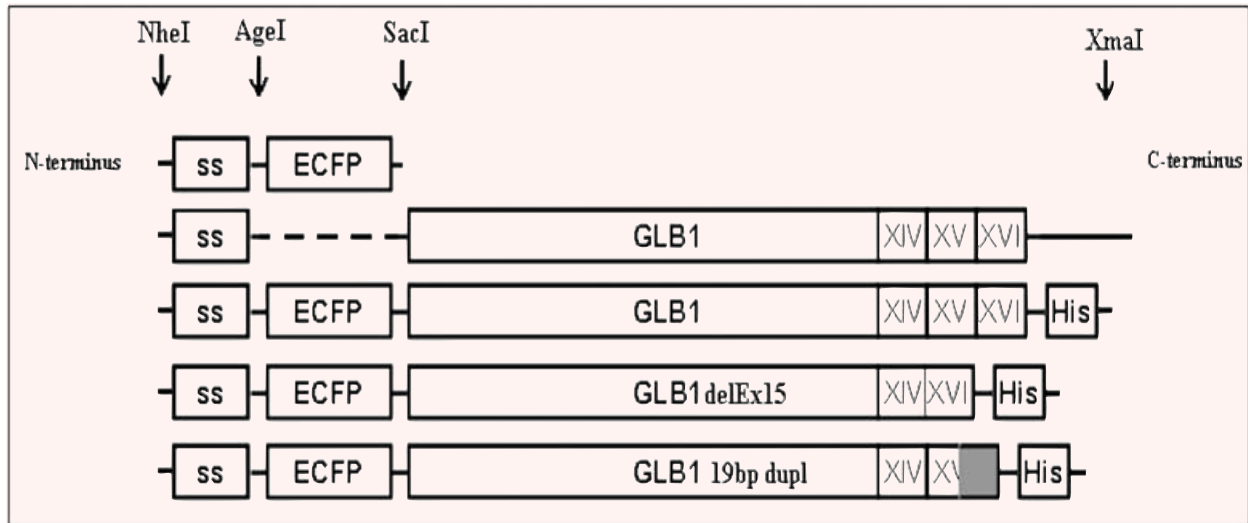

Fig. 1 Cloning strategy for generating fusion proteins used in the enzymatic assays and intracellular localization analyses; ss: signal sequence for translocation in endoplasmic reticulum; ECFP, nucleotide sequence encoding the enhanced cyan fluorescent protein; XIV, XV, XVI, nucleotide sequences corresponding to exon 14, 15, 16 from the canine GLB1 gene; His, tag encoding for six histidine residues (6xHis tag).

Cell culture procedures and transfection

The primary canine *GLB1*^{+/+} and *GLB1*^{-/-} fibroblasts obtained from healthy and respectively from affected Alaskan huskies and Madin-Darby Canine Kidney (MDCK) cells (ATCC CCL-34) were maintained in Modified Eagle's Medium (MEM) with 10% foetal calf serum (FCS), 1 mM sodium pyruvate and 1% penicillin/streptomycin at 37°C in a water-saturated 5% CO₂ environment [14]. All reagents were purchased from PAA Laboratories GmbH, Pasching, Austria. Subsequently, the cells were plated in 6-well plates (Nunc GmbH & Co. KG, Wiesbaden, Germany) before transfection. For lysosomal staining procedures and confocal microscopy analyses, cells were grown on cover slips. Subsequently, the cells were transfected with Lipofectamine 2000® (Invitrogen, Karlsruhe, Germany) according to the manufacturer's instructions after they reached 60–70% confluence.

Protein extractions

Twenty-four hours after transfection, cells were collected by scraping on ice, centrifuged at 4°C and then resuspended in 50 µl distilled water. To obtain the total protein extracts three cycles of freezing in liquid nitrogen and thawing at 37°C in a water bath were performed. All steps were done in the presence of 1 mM phenylmethylsulfonyl fluoride, 1 µg/ml pepstatin, 5 µg/ml leupeptin, and 5 µg/ml aprotinin (Sigma-Aldrich, Taufkirchen, Germany).

GLB1 enzymatic assays

GLB1 activity was measured using 4-methylumbelliferyl-β-D-galactopyranoside (4-MU-G, Sigma-Aldrich, Taufkirchen, Germany) as previously described [14, 31–33]. Briefly, GLB1 cleaves 4-MU-G to galactose and the

fluorescent compound (4-MU). The 4-MU released is measured at 365 nm and 455 nm and the GLB1 activity is given in mU/mg protein. Fibroblasts from Alaskan huskies *GLB1*^{+/+} dogs were used as positive controls.

Normalization of GLB1 activities

The GLB1 activities were normalized by using the amount of total protein and transfection efficiency. The transfection efficiencies were expressed as the percentage of ECFP-expressing cells [(ECFP-expressing cells / total number of cells) × 100]. Then, the GLB1 activity of the transfected cells was extrapolated to 100% of transfection efficiency. For detection of GLB1 activity in transfected and non-transfected cells, the same number of cells was used. Finally, the GLB1 activity was presented as mU/mg total protein. All experiments were performed in triplicates.

SDS/PAGE and immunoblotting

Aliquots (10 µl) of total protein extracts were subjected to SDS-PAGE analysis using a 10% (w/v) gel, followed by transfer to a nitrocellulose membrane (Amersham Hybond™ ECL™, GE Healthcare, Freiburg, Germany). Non-specific binding sites were blocked with 5% (w/v) skim milk (Merck KGaA, Darmstadt, Germany) in PBS (phosphate buffered saline) [34]. Then, the membrane was incubated either with BD Living Color™ A.v. Monoclonal Antibody (anti-ECFP antibody) (Clontech- Takara Bio Europe, Saint-Germain-en-Laye, France) or with Penta-His antibodies (anti-His antibody) (Qiagen, Hilden, Germany). After washing three times with PBS, the membrane was incubated for 2 hrs with the secondary antibody, horseradish peroxidase-conjugated goat antimouse IgG (Sigma-Aldrich, Taufkirchen, Germany). For protein visualization the ECL System (GE Healthcare, Freiburg, Germany) was used.

Lysosomes staining and imaging

Acidic organelles were labelled with the acidotropic dye LysoTracker® Red DND-99 (Invitrogen, Karlsruhe, Germany) or with anti lysosomal-associated membrane protein 1 (LAMP-1) antibody (Acris Antibodies GmbH, Hiddenhausen, Germany). For LysoTracker staining, cells were pre-incubated for 30 min. with 50 nM LysoTracker dye 24 hrs after transfection. For immunostaining with LAMP-1, the cells were washed with PBS and then fixed with 4% paraformaldehyde for 30 min. at room temperature (RT). After an additional washing step, the cells were permeabilized with 0.25% Triton-X (Sigma-Aldrich, Taufkirchen, Germany) in PBS (PBST) for 15 min.. To block unspecific binding sites, the cells were kept in 5% goat serum (Sigma-Aldrich, Taufkirchen, Germany) in PBST for 30 min.. The cells were then incubated overnight at 4°C with the LAMP-1 antibody diluted 1:1000 in PBST. After 10 min. washing in PBST, cells were incubated for 30 min. with Cy3 conjugated AffiniPure goat antimouse (Dianova GmbH, Hamburg, Germany) diluted 1:200 in PBST. Then, the cells were washed with and kept in PBS until embedded with Fluorescent mounting medium® (Dako Deutschland GmbH, Hamburg, Germany). The cells labeled with LysoTracker or with LAMP-1 followed by Cy3 were imaged with an inverted microscope Leica DM IRE2 (Leica, Wetzlar, Germany) using a HeNe 543 nm laser. For visualization of ECFP-fused proteins an Ar-Ion 488 nm laser was used. Full-frame images (1024 pixels × 1024 pixels) were taken with an oil immersion objective (Plan-Apochromat 63×/1.40 Oil DIC, Leica, Wetzlar, Germany), with an interval of 0.5µm and a flattened z-stack image of the confocal images was generated.

Results

Predicted characteristics of canine compared to human GLB1

Screening of the amino acid sequence with the SignalP 3.0 software revealed a potential signal sequence at the N-terminus of the canine GLB1 precursor protein. The identified potential signal sequence was similar to the signal sequence for translocation in the ER present in the human GLB1. To determine whether the 29 amino acid long hydrophobic sequence has the ability to drive the protein to the ER, the corresponding nucleotide sequence was cloned in front of the ECFP sequence for generating the ss-ECFP vector. Then, MDCK cells were transfected with ECFP and ss-ECFP plasmids and the location of these proteins was visualized by confocal microscopy. As shown in Figure 2, those proteins containing the 29 amino acid sequence at the N-terminus were driven into the ER and further into the Golgi apparatus, whereas the proteins without this sequence remained in the cytosol. For the human GLB1, the cleavage site used for lysosomal maturation of the enzyme was located in the amino acid sequence encoded by exon 15 (S⁵⁴³F⁵⁵⁵). A similar cleavage locus (S⁵⁴⁴F⁵⁵⁶) was identified in the amino acid sequence encoded by exon 15 of the canine *GLB1* gene. This cleavage site is missing in the canine GLB1-delEx15 mutant protein. Furthermore, by screening the canine

GLB1 amino acid sequence with the NetNGlyc software, six putative N-glycosylation sites at positions N²⁷, N²⁴⁸, N⁴⁶⁵, N⁴⁹⁹, N⁵⁴⁶ and N⁵⁵⁶ in the wild-type canine GLB1 and the canine GLB1-19bpdupl mutant protein and only three sites (N²⁷, N²⁴⁸, N⁴⁶⁵) in the canine GLB1-delEx15 mutant protein were identified.

Similarly, the human GLB1 contains a cleavage site at A⁵⁹⁴R⁵⁹⁵ which was involved in abnormal degradation in the absence of PPCA [24]. In the canine GLB1 amino acid sequence this presumptive cleavage site is also present at positions A⁵⁹⁵R⁵⁹⁶. The predicted size of glycosylated canine GLB1 precursor was 84 kDa. After proteolytic cleavage in lysosomes, the putative sizes of the resulting two fragments resulted were 64 and 20 kDa. Without the internal signal sequence (-iss), the corresponding sizes for the mutant precursor proteins (GLB1-delEx15 and GLB1-19bpdupl) were 74.5 and 75.2 kDa respectively.

Intracellular localization, processing and enzymatic activity of wild type and mutant canine GLB1

For the analysis of intracellular routing of the canine GLB1, ECFP-fused canine GLB1-His-tagged proteins were used. To demonstrate that the ECFP and His sequences do not modify the normal behavior of GLB1 in the cells, the GLB1 activities from MDCK, *GLB1*^{-/-} and *GLB1*^{+/+} fibroblasts transfected with ss-ECFP(-iss)-GLB1-His and ss(-iss)-GLB1 constructs were compared. The GLB1 activity was similar in all transfected cells (Fig. 3), therefore the ss-ECFP(-iss)-GLB1-His plasmids were used for further experiments. To investigate if the canine GLB1 protein encoded by ss-ECFP(-iss)-GLB1-His reached the lysosomes, the MDCK cells were transfected with the ss-ECFP(-iss)-GLB1-His construct. The intracellular location of the GLB1 was assessed by confocal microscopy. After a specific staining of the lysosomes with LysoTracker. Thus, as shown in Figure 4, ECFP and LysoTracker fluorescence co-localized, indicating that GLB1 protein reached the lysosomes. Similar results were obtained after staining the lysosomes with LAMP-1 antibody (data not shown).

To determine if the canine GLB1 undergoes similar lysosomal proteolytic modifications as the human GLB1, Western blot analyses were performed with antibodies against the ECFP and 6 x His tag. As shown in Figure 5A line 1, the 110 kD (84 kD GLB1 + 26 kD ECFP protein) ECFP-GLB1-His precursor protein is partially processed to a 90 kD fragment (64 kD GLB1 + 26 kD ECFP protein) which represents the ECFP fused N-terminus proteolytic fragment of the mature form of the enzyme produced in the lysosomes after cleavage at the S⁵⁴⁴F⁵⁵⁶ locus. Moreover, as a result of further normal N-terminus degradation of GLB1 by resident proteases a fragment of 44 kD (18 kD GLB1 + 26 kD ECFP protein) was observed. Furthermore, beside the ECFP-GLB1-His precursor protein of 110 kD (84 kD GLB1 + 26 kD ECFP protein), Western blot analyses using an anti-His antibody revealed the presence of a 20 kD specific polypeptide (Fig. 5B; line 1). This represents the

Fig. 2 Localization of ECFP and ss-ECFP proteins in MDCK cells, 24 hrs after transfection; A: uniform cytoplasmic distribution of ECFP protein; B: endoplasmic reticulum and Golgi apparatus (arrows) distribution of ss-ECFP protein.

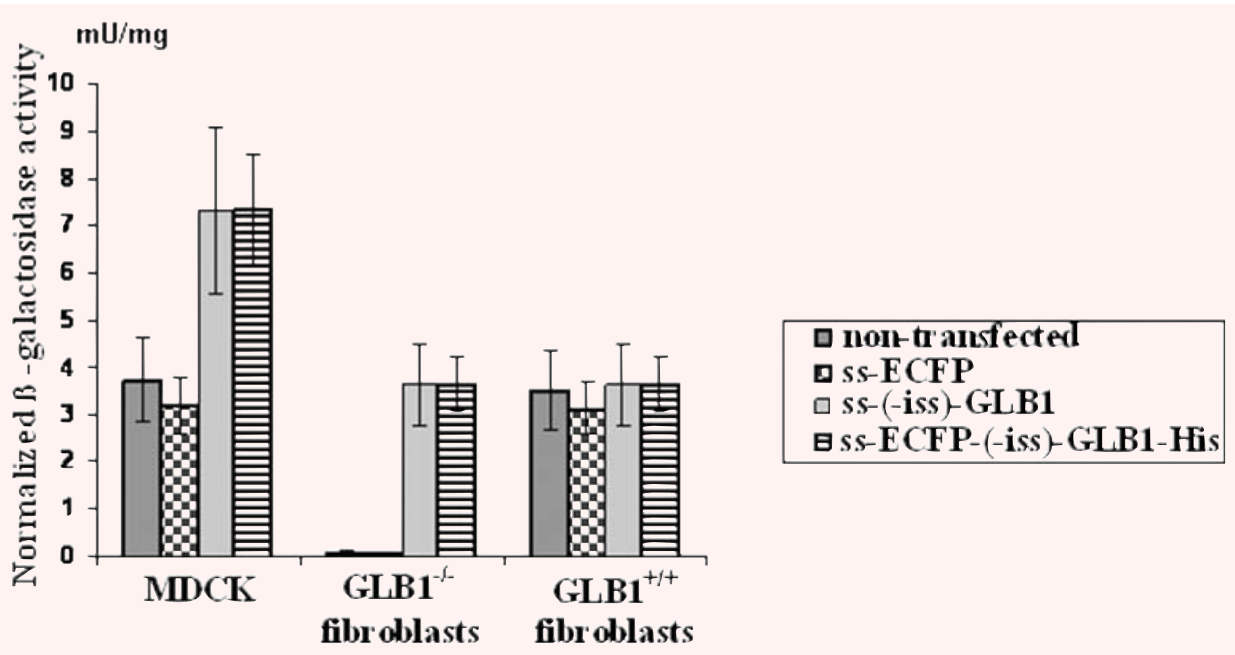
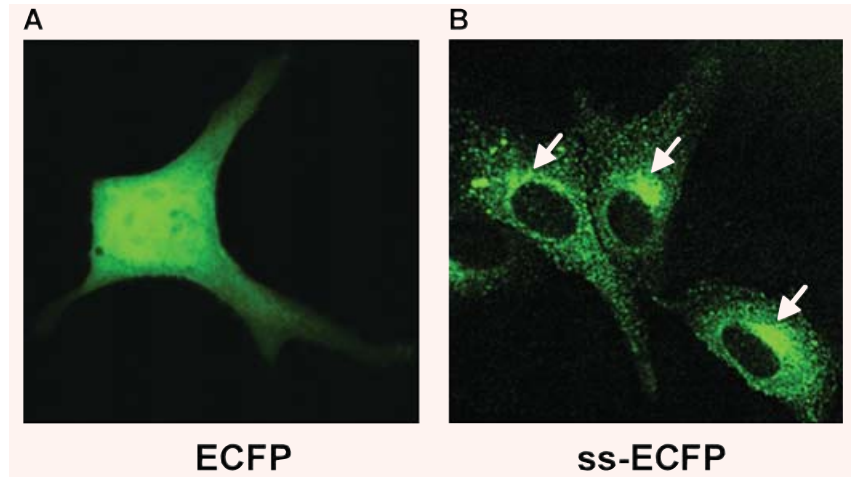

Fig. 3 Influence of ECFP and His tag on canine GLB1 activity in MDCK cells, GLB1^{-/-} and GLB1^{+/+} fibroblasts; the data shown that GLB1 activity (mU/mg) increased after transfection with the wild-type GLB1 containing vectors, while no difference in GLB1 activity was detected between those cells transfected with ss-(-iss)-GLB1-His or ss-ECFP-(-iss)-GLB1-His vectors; non-transfected - endogenous GLB1 activity in MDCK cells, GLB1^{-/-} and GLB1^{+/+} fibroblasts; ss-ECFP - GLB1 activity in cells transfected with the ss-ECFP construct; ss-(-iss)-GLB1 - GLB1 activity in cells transfected with the wild-type GLB1 without ECFP and His tag; ss-ECFP-(-iss)-GLB1-His - GLB1 activity in cells transfected with the construct containing a signal sequence (ss) for internalization into the ER, before ECFP sequence and the wild-type GLB1 without its signal sequence (-iss), fused to 6xHis at C-terminus.

C-terminus proteolytic fragment of the mature GLB1 produced after cleavage at the S⁵⁴⁴⁻⁵⁵⁶ locus. To examine whether this fragment is generated by lysosomal processing, a canine GLB1 protein designed to be retained in the ER was also analysed (ss-ECFP-(+iss)-GLB1). This protein showed neither processing to

the 90 and 44 kD fragments (Fig. 5A; line 2), nor to the 20 kD fragment (Fig. 5B; line 2). This result confirmed the lysosomal origin of the 20 kD fragment. To further determine whether possible processing differences between the wild type and the mutant proteins are responsible for the lack of the GLB1 activity in the

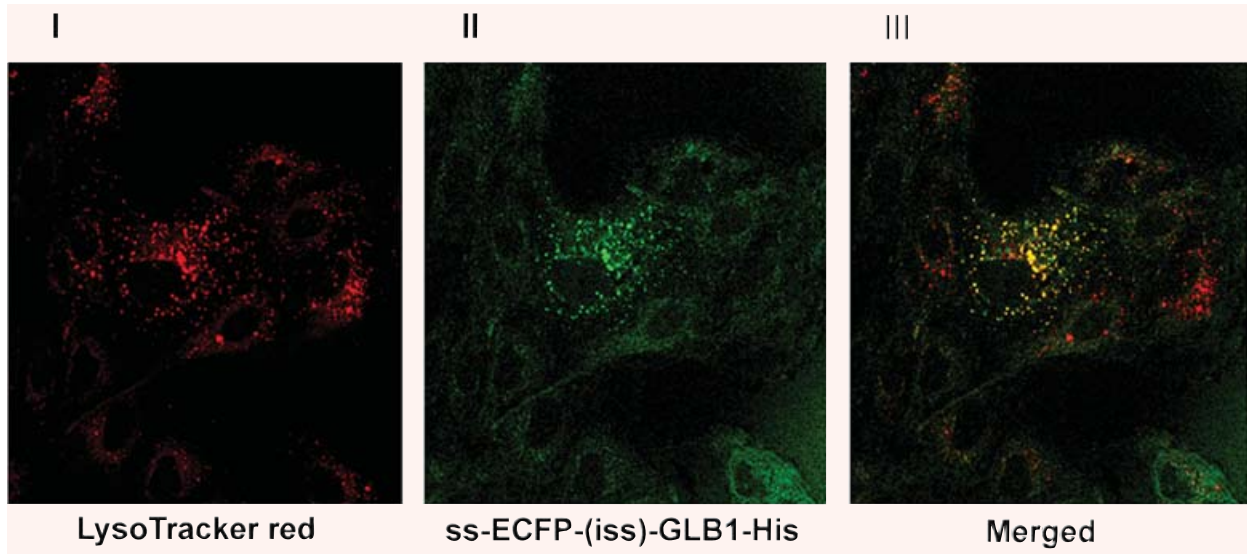

Fig. 4 Localization of wild-type canine GLB1 in MDCK cells transfected with ss-ECFP-(*iss*)-GLB1-His construct; confocal microscopy analyses revealed the lysosomal localization of wild-type GLB1; I, lysosomes stained with LysoTracker (red); II, wild-type canine GLB1 detected by ECFP fluorescence (green); III, co-localization of LysoTracker and GLB1 (amber); magnification 630 \times .

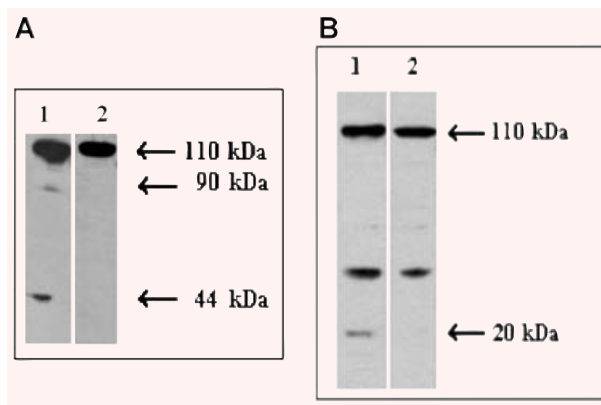

Fig. 5 Processing of wild-type ECFP fused GLB1 in MDCK cells; the Western blot images shown the lysosomal maturation of wild-type GLB1 as indicated by the presence of the 90 kD (A, line 1) and 20 kD (B, line 1) bands, in comparison with the ER resident GLB1 protein (A, B, lines 2) (A) 110 kD canine GLB1 precursor protein (84 kD precursor GLB1 + 26 kD ECFP), 90 kD processed fragment (64 kD mature GLB1 + 26 kD ECFP) and 44 kD fragment (18 kD GLB1 fragment + 26 kD ECFP) were detected using anti-ECFP antibody; (B) 110 kD canine GLB1 precursor protein (84 kD precursor GLB1 + 26 kD ECFP) and 20 kD polypeptide was observed using anti-His-antibody; an unspecific band of ~40 kD appeared in Figure 5B line 1 and 2.

homozygous individuals carrying the 19 bp duplication, the intracellular routing and the processing of the mutant proteins was investigated. MDCK cells and *GLB1*^{-/-} fibroblasts were transfected with ss-ECFP-(*iss*)-GLB1delEx15-His and ss-ECFP-(*iss*)-GLB1-19bpdupl-His vectors. In comparison with the wild type GLB1 protein, the mutant GLB1 proteins were inactive (Fig. 6). Moreover, the intracellular localization of these mutant proteins was observed by confocal microscopy after specific staining of the lysosomes with LysoTracker. For this purpose, MDCK cells were transfected with ss-ECFP-(*iss*)-GLB1delEx15-His and ss-ECFP-(*iss*)-GLB1-19bpdupl-His vectors. As the wild type protein, a fraction of the mutant proteins was also located in the lysosomes (Fig. 7A and B). Similar results were obtained after staining the lysosomes with LAMP-1 antibody (data not shown).

To determine whether the mutant proteins are proteolytically modified at the lysosomal level Western blot analyses with antibodies against ECFP and His-tag were performed. It was observed that the N-terminal processing of the mutant proteins and wild type protein was identical. Thus, the mutant precursor proteins of 100,5 kD and 101,2 kD respectively were both processed to the 90 kD and 44 kD fragments like the wild type precursor protein (Fig. 8A; lines 1,2 and 3). In contrast, the C-terminal processing of the mutant proteins differed from the wild type protein as assessed by variations in the small polypeptide bands, 20 kD for the wild type protein (Figure 8 B; line 1) compared to a 11 kD for the GLB1delEx15 (Fig. 8B; line 2) and no polypeptide for the GLB1-19bpdupl mutant (Fig. 8B; line 3).

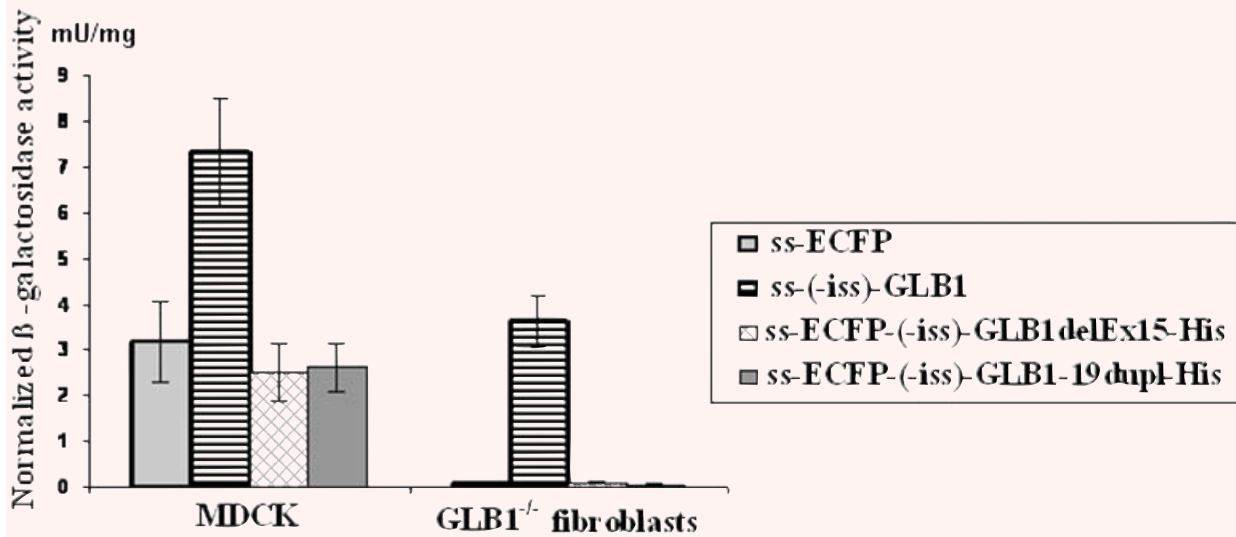

Fig. 6 Comparison between the enzymatic activities of wild-type and mutant GLB1 proteins in MDCK cells and *GLB1*^{-/-} fibroblasts; the data shown that GLB1 activity (mU/mg) increased after transfection with the wild type GLB1 containing vector, whereas in cells transfected with the constructs which encodes for mutant GLB1 proteins the GLB1 activity decreased under the levels of non-transfected cells. ss-ECFP – GLB1 activity in cells transfected with the ss-ECFP construct; ss-ECFP-(-iss)-GLB1-His - GLB1 activity in cells transfected with ss-ECFP-(-iss)-GLB1-His construct which encodes for the wild-type GLB1; ss-ECFP-(-iss)-GLB1delEx15-His - GLB1 activity in cells transfected with ss-ECFP-(-iss)-GLB1delEx15-His construct which encodes the mutant GLB1 without the sequence encoded by exon 15; ss-ECFP-(-iss)-GLB1-19dupl-His - GLB1 activity in cells transfected with ss-ECFP-(-iss)-GLB1-19bpdupl-His construct which encodes the mutant GLB1 harboring the 19 bp duplication inside the exon 15 sequence.

Discussion

In the present study, the intracellular localization, processing, and enzymatic activity of the wild type and two mutant GLB1 proteins were investigated in a canine model of *G_{M1}*-gangliosidosis with the ultimate goal to elucidate the patho-mechanism of *G_{M1}*-gangliosidosis [4, 14].

Using clinical and biochemical data it was demonstrated that *G_{M1}*-gangliosidosis in dogs resembled its human counterpart to a higher extent than *G_{M1}*-gangliosidosis in genetically engineered mice [12, 16, 35–37]. Unlike in humans, a regulatory mechanism in the murine brain involving an active desialylating enzyme reduces the *G_{M1}*-ganglioside accumulation thus leading to high levels of asialo-*G_{M1}* (*G_{A1}*). In this model it is difficult to differentiate the phenotypic effects of *G_{M1}* from those of *G_{A1}* accumulation. Moreover, due to this molecular system, high levels of *G_{M1}*, typical for types I and II *G_{M1}*-gangliosidosis are attained in genetically engineered mice only at an adult age [38–40].

For further therapeutic approaches, the similarities between canine and human GLB1 were investigated at the molecular level. Furthermore, the role of canine GLB1 mutants in onset of *G_{M1}*-gangliosidosis was also elucidated.

Firstly, structural features, lysosomal transport and maturation of canine GLB1 were investigated and compared to human GLB1.

Both enzymes have an identical cleavage sequence for proteolytic maturation in lysosomes ($N^{542}S\downarrow SNYT LPAFYMGGNPF^{555}$) [22, 26]. This demonstrated that the canine *G_{M1}*-gangliosidosis resembled its human counterpart not only at the clinical, but also at the molecular level.

To determine whether the lack of GLB1 activity observed in affected dogs is the result of an abnormal transport through the cell or is a consequence of abnormal proteolytic processing of the C-terminus, the influence of two distinct genetic modifications in the *GLB1* mRNA on the intracellular trafficking of the corresponding proteins was investigated.

Both cell types analysed, MDCK cells and canine *GLB1*^{+/-} fibroblasts, revealed a similar high level of endogenous GLB1 activity, in comparison with canine *GLB1*^{-/-} canine fibroblasts, that had almost undetectable levels of GLB1 [14]. After transfection with ss-ECFP-(-iss)-GLB1-His vector, the GLB1 activity in canine *GLB1*^{-/-} fibroblasts as well as in MDCK cells increased substantially. In transfected canine *GLB1*^{-/-} fibroblasts, the GLB1 activity reached the level of non-transfected canine *GLB1*^{+/-} fibroblasts. Interestingly, in the immortal MDCK cells transfected with the ss-ECFP-(-iss)-GLB1-His construct, the GLB1 activity exceeded that of non-transfected MDCK cells. In *GLB1*^{-/-} fibroblasts transfected with the same construct the GLB1 activity did not increase above the GLB1 activity found in primary non-transfected *GLB1*^{+/-} fibroblasts. The observed differences between the immortal cell

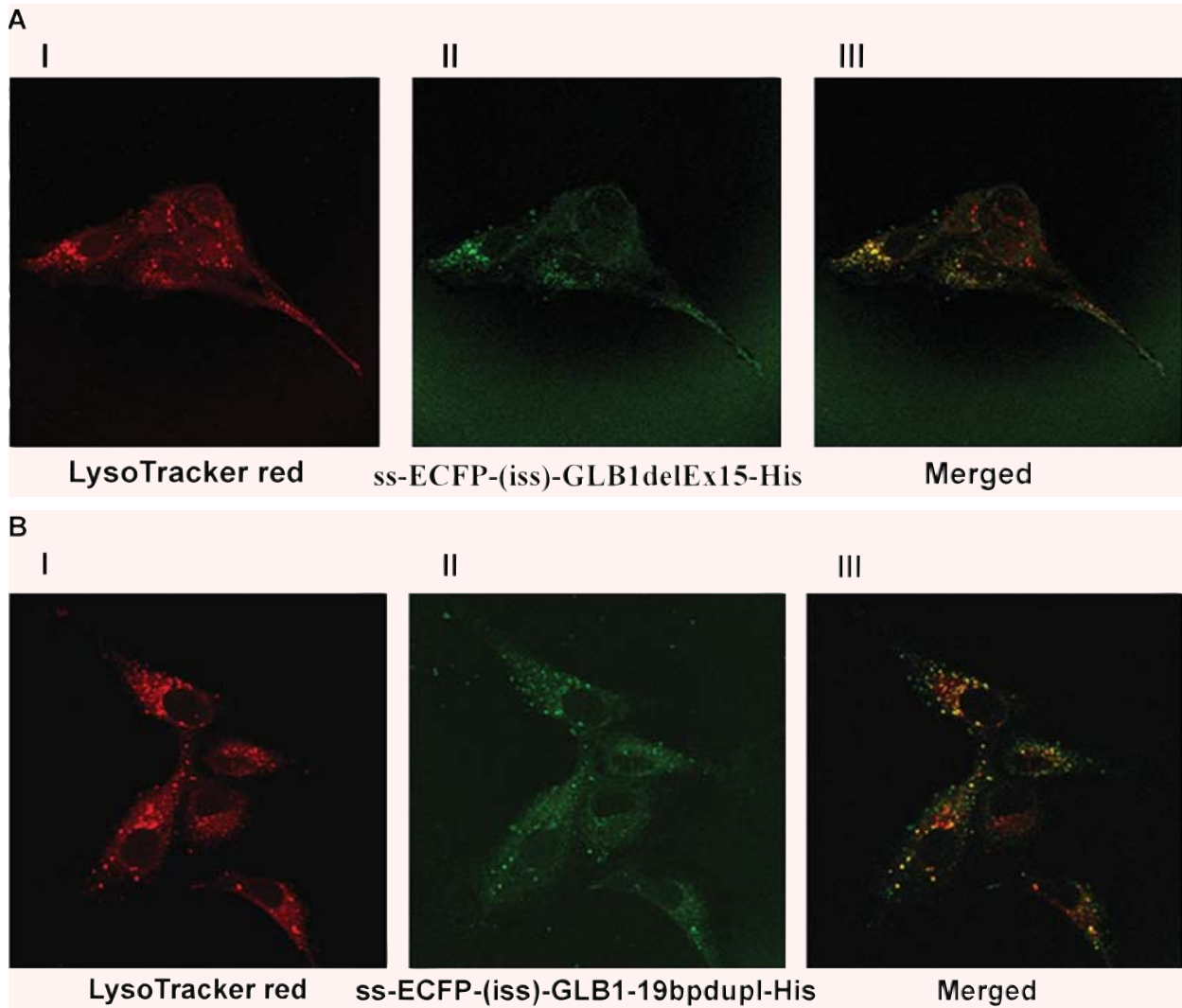

Fig. 7 Intracellular localization of the canine GLB1-delEx15 (A) and GLB1-19bpdupl (B) mutant proteins in MDCK cells; the confocal images show lysosomal localization of the mutant GLB1 proteins. IA, IB, lysosomes stained with the LysoTracker (red); IIA, IIB, mutant GLB1 lacking the nucleotide sequence encoded by exon 15 (GLB1-delEx15) and mutant GLB1 containing exon 15 with the 19 bp duplication (GLB1-19bpdupl), respectively (green); IIIA, IIIB, co-localization of LysoTracker with GLB1-delEx15 or GLB1-19 bpdupl (amber); magnification 630 \times .

line (MDCK) and the primary cells (*GLB1*^{+/+} fibroblasts) suggested the presence of an intracellular restrictive factor which protects the primary cells from entering into premature cellular senescence by limiting an increase in GLB1 activity over the level of primary *GLB1*^{+/+} fibroblasts [41–43]. Differences between immortalized and primary cells regarding senescence-associated GLB1 (wild type GLB1) activities were already described [44]. The activity of GLB1 depends largely on protective protein/cathepsin A (PPCA) which forms oligomers with GLB1 in a strict regulated molecular ratio of 8 to 4. These complexes are essential for the correct

folding and the transport of human GLB1 into the lysosomes, hereby acting as a possible GLB1 activity restrictive factor [45–47]. In view of the great similarity between the human and canine GLB1 it is plausible to propose a similar complex formation between GLB1 and PPCA with a comparable molecular ratio for the canine lysosomal multienzymic complex [18, 35]. Interestingly, when MDCK cells were transfected with ss-ECFP-(iss)-GLB1delEx15 and ss-ECFP-(iss)-GLB1-19bpdupl vectors the GLB1 activity decreased. This could be due to dimer formation between wild type and mutant protein forms. Alternatively, it is

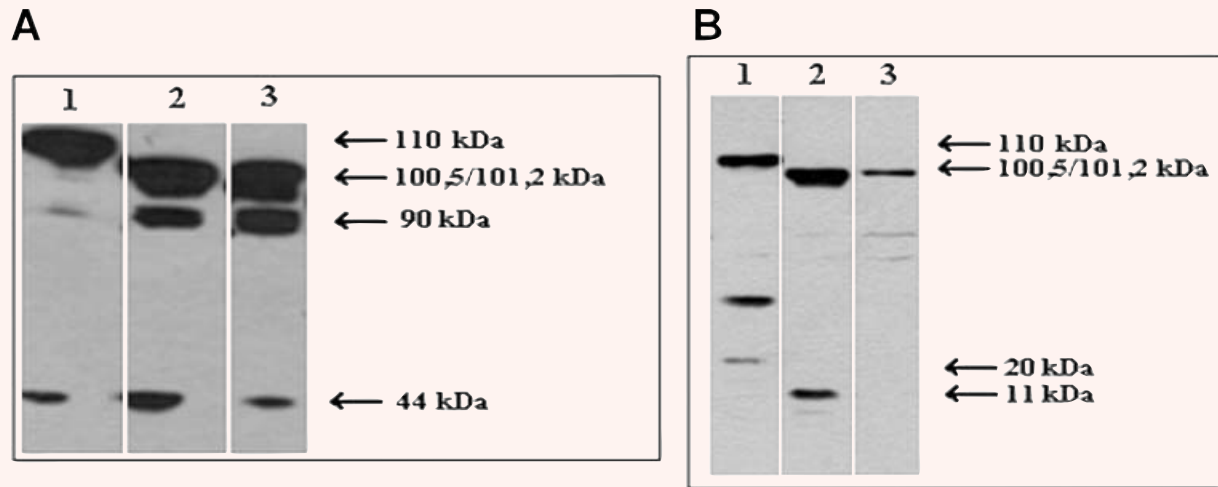

Fig. 8 Processing of wild-type canine GLB1 (lane 1) and mutant GLB1delEx15 (lane 2) and GLB1-19bpdupl (lane 3) proteins; the Western blot images shown that all GLB1 proteins are similar processed at the N-terminal end (A), but differentially cleaved at the C-terminal end. A - 110 kD (84 kD GLB1 + 26 kD ECFP), 100.5 kD (74.5 kD GLB1delEx15 + 26 kD ECFP) and 101.2 kD (75.2 kD GLB1-19bpdupl + 26 kD ECFP) precursor proteins; 90 kD processed fragments (64 kD mature GLB1/ GLB1delEx15/ GLB1-19bpdupl + 26 kD ECFP) and 44 kD proteolytic fragments (18 kD GLB1/ GLB1delEx15/ GLB1-19bpdupl + 26 kD ECFP) were observed with anti-ECFP antibody; (B) 110 kD (84 kD GLB1 + 26 kD ECFP), 100.5 kD (74.5 kD GLB1delEx15 + 26 kD ECFP) and 101.2 kD (75.2 kD GLB1-19bpdupl + 26 kD ECFP) precursor proteins were observed with His antibody; using the same antibody in lane 1 was observed a 20 kD cleavage product while in lane 2 a 11 kD cleavage product was detected.

likely that the transport behavior of the wild-type endogenous enzyme is substantially hampered due to the reduction in the number of PPCA molecules, since part of these associated also with the mutant proteins. Subsequently, these abnormal complexes may decrease the activity of the wild type protein [26, 27]. Moreover, canine GLB1 localization analyses showed that only a fraction of the wild-type protein was found in lysosomes suggesting an inefficient transport into the lysosomes, probably due to an insufficient concentration of PPCA [46]. Similar results were observed after Western blot analyses, where only a fraction of wild type precursor protein was processed at the C-terminal end to a mature form of the enzyme. The processing occurs in analogy to the situation in humans [20, 26].

As expected, analyses of GLB1 levels in *GLB1*^{-/-} fibroblasts transfected with constructs encoding the mutant proteins revealed that the abnormal precursor proteins did not result in detectable enzymatic activity. Similar to humans the amino acid sequence encoded by exon 15 and 16 is essential for the activity of canine GLB1 [26]. In humans, modifications in the polypeptide region encoded by these exons have shown to induce major conformational changes and impair the maturation of the GLB1 [5, 20, 24, 26]. Based on the obtained results using both abnormal canine GLB1 variants (GLB1delEx15 and GLB1-19bpdupl) it was demonstrated that in dogs, similar to humans, a correct amino acid sequence in the C-terminal region is a prerequisite for correct processing and precursor

maturation. Surprisingly, the lack of these amino acid sequences is not important for the further transport of both mutant proteins to the lysosomes. These observations indicated that the mannose-6-phosphate signal for lysosomal trafficking of canine GLB1 is not located on the asparagine residues 499, 546 and 556 within exon 15. The significant modifications at the C-terminus resulted in a different processing of the mutant proteins in the lysosomes as compared to the wild-type species. Thus, deletion of exon 15 in the canine GLB1delEx15 mutant and the subsequent elimination of the canonic cleavage site do not block cleavage. In fact, cleavage takes place *via* an alternative cleavage recognition sequence that is presumably located on the sequence encoded by the exon 14. Moreover, due to the presence of a proteolytic fragment with an apparent molecular weight of 18 kD (as a 44 kD hybrid molecule with the 26 kDa ECFP protein) in all GLB1 variants, it can be assumed that a recognition cleavage site is located in the amino acid sequence encoded by exon 4. The present results differ significantly from previous reports, showing diverse proteolytic fragments of canine GLB1 of 32 kDa and 60 kDa. Our results more closely resemble the proteolytic cleavage described for the human GLB1 [20, 24, 35, 48]. Altogether, the results of the present study revealed that canine GM1-gangliosidosis is an appropriate animal model for the human late infantile form. Both mutant protein precursors are enzymatically inactive, but are transported to the lysosomes indicating that the amino acid sequences encoded by exons 15 and 16 are necessary for correct folding and

association with PPCA, whereas the routing to the lysosomes is not influenced. In addition the present study showed that the investigated canine model represents a suitable platform for developing therapeutic strategies in both human late infantile (type II) and canine GM1-gangliosidosis.

Acknowledgements

We thank Kerstin Rohn and Brigitte Behrens for excellent technical assistance. The present work was supported by a research grants from the German Research Society (DFG Grant BA815/7-1 and BA815/7-2).

References

1. Suzuki K. Cerebral GM1-gangliosidosis: chemical pathology of visceral organs. *Science* 1968; 159: 1471–2.
2. De Maria R, Divari S, Bo S, Sonnio S, Lotti D, Capucchio MT, Castagnaro M. Beta-galactosidase deficiency in a Korat cat: a new form of feline GM1-gangliosidosis. *Acta Neuropathol.* 1998; 96: 307–14.
3. Yamato O, Masuoka Y, Yonemura M, Hatakeyama A, Satoh H, Kobayashi A, Nakayama M, Asano T, Shoda T, Yamasaki M, Ochiai K, Umemura T, Maede Y. Clinical and clinico-pathologic characteristics of Shiba dogs with a deficiency of lysosomal acid beta-galactosidase: a canine model of human GM1 gangliosidosis. *J Vet Med Sci.* 2003; 65: 213–7.
4. Kreutzer R, Leeb T, Müller G, Moritz A, Baumgärtner W. A duplication in the canine beta-galactosidase gene GLB1 causes exon skipping and GM1-gangliosidosis in Alaskan huskies. *Genetics* 2005; 170: 1857–61.
5. Zhang S, Bagshaw R, Hilson W, Oho Y, Hinek A, Clarke JT, Callahan JW. Characterization of beta-galactosidase mutations Asp332→Asn and Arg148→Ser, and a polymorphism, Ser532→Gly, in a case of GM1 gangliosidosis. *Biochem J.* 2000; 3: 621–32.
6. Caciotti A, Donati MA, Procopio E, Filocamo M, Kleijer W, Wuyts W, Blaumeiser B, d'Azzo A, Simi L, Orlando C, McKenzie F, Fiumara A, Zammarchi E, Morrone A. GM1 gangliosidosis: molecular analysis of nine patients and development of an RT-PCR assay for GLB1 gene expression profiling. *Hum Mutat.* 2007; 28: 204.
7. Santamaria R, Chabás A, Coll MJ, Miranda CS, Vilageliu L, Grinberg D. Twenty-one novel mutations in the GLB1 gene identified in a large group of GM1-gangliosidosis and Morquio B patients: possible common origin for the prevalent p.R59H mutation among gypsies. *Hum Mutat.* 2006; 27: 1060.
8. Santamaria R, Chabás A, Blanco M, Grinberg D, Vilageliu L. Identification of 14 novel GLB1 mutations, including five deletions, in 19 patients with GM1 gangliosidosis from South America. *Clin Genet.* 2007; 71: 273–9.
9. Caciotti A, Bardelli T, Cunningham J, d'Azzo A, Zammarchi E, Morrone A. Modulating action of the new polymorphism L436F detected in the GLB1 gene of a type-II GM1 gangliosidosis patient. *Hum Genet.* 2003; 113: 44–50.
10. Caciotti A, Donati MA, Bardelli T, d'Azzo A, Massai G, Luciani L, Zammarchi E, Morrone A. Primary and secondary elastin-binding protein defect leads to impaired elastogenesis in fibroblasts from GM1-gangliosidosis patients. *Am J Pathol.* 2005; 167: 1689–98.
11. Saunders GK, Wood PA, Myers RK, Shell LG, Carithers R. GM1 gangliosidosis in Portuguese water dogs: pathologic and biochemical findings. *Vet Pathol.* 1988; 25: 265–9.
12. Alroy J, Knowles K, Schelling SH, Kaye EM, Rosenberg AE. Retarded bone formation in GM1-gangliosidosis: a study of the infantile form and comparison with two canine models. *Virchows Arch.* 1995; 426: 141–8.
13. Müller G, Baumgärtner W, Moritz A, Sewell A, Kustermann-Kuhn B. Biochemical findings in a breeding colony of Alaskan Huskies suffering from GM1-gangliosidosis. *J Inherit Metab Dis.* 1998; 21: 430–1.
14. Müller G, Aildinger S, Moritz A, Zurbruggen A, Kirchhof N, Sewell A, Baumgärtner W. GM1-gangliosidosis in Alaskan huskies: clinical and pathologic findings. *Vet Pathol.* 2001; 38: 281–90.
15. Alroy J, Orgad U, DeGasperi R, Richard R, Warren CD, Knowles K, Thalhammer JG, Raghavan SS. Canine GM1-gangliosidosis A clinical, morphologic, histochemical, and biochemical comparison of two different models. *Am J Pathol.* 1992; 140: 675–88.
16. Yamato O, Endoh D, Kobayashi A, Masuoka Y, Yonemura M, Hatakeyama A, Satoh H, Tajima M, Yamasaki M, Maede Y. A novel mutation in the gene for canine acid beta-galactosidase that causes GM1-gangliosidosis in Shiba dogs. *J Inherit Metab Dis.* 2002; 25: 525–6.
17. Kreutzer R, Müller G, Leeb T, Brenig B, Moritz A, Baumgärtner W. Genetic testing for GM1-gangliosidosis in the Alaskan Husky. *Tierärztl Prax.* 2007; 35 (K): 193–9.
18. Wang ZH, Zeng B, Shibuya H, Johnson GS, Alroy J, Pastores GM, Raghavan S, Kolodny EH. Isolation and characterization of the normal canine beta-galactosidase gene and its mutation in a dog model of GM1-gangliosidosis. *J Inherit Metab Dis.* 2000; 23: 593–606.
19. Oshima A, Yoshida K, Itoh K, Kase R, Sakuraba H, Suzuki Y. Intracellular processing and maturation of mutant gene products in hereditary beta-galactosidase deficiency (beta-galactosidosis). *Hum Genet.* 1994; 93: 109–14.
20. Callahan JW. Molecular basis of GM1 gangliosidosis and Morquio disease, type B. Structure-function studies of lysosomal beta-galactosidase and the non-lysosomal beta-galactosidase-like protein. *Biochim Biophys Acta.* 1999; 1455: 85–103.
21. Chu TH, Martinez I, Olson P, Dornburg R. Highly efficient eukaryotic gene expression vectors for peptide secretion. *BioTechniques* 1995; 18: 898–9.
22. Meacock SL, Greenfield JJ, High S. Protein targeting and translocation at the endoplasmic reticulum membrane—through the eye of a needle? *Essays Biochem.* 2000; 36: 1–13.
23. Hoogeveen AT, Graham-Kawashima H, d'Azzo A, Galjaard H. Processing of human beta-galactosidase in GM1-gangliosidosis and Morquio B syndrome. *J Biol Chem.* 1984; 259: 1974–7.
24. Okamura-Oho Y, Zhang S, Hilson W, Hinek A, Callahan JW. Early proteolytic cleavage with loss of a C-terminal fragment underlies altered processing of the beta-galactosidase precursor in galactosialidosis. *Biochem J.* 1996; 313: 787–94.

25. **Zhang S, McCarter JD, Okamura-Oho Y, Yaghi F, Hinek A, Withers SG, Callahan JW.** Kinetic mechanism and characterization of human beta-galactosidase precursor secreted by permanently transfected Chinese hamster ovary cells. *Biochem J.* 1994; 304: 281–8.
26. **van der Spoel A, Bonten E, d'Azzo A.** Processing of lysosomal beta-galactosidase. The C-terminal precursor fragment is an essential domain of the mature enzyme. *J Biol Chem.* 2000; 275: 10035–40.
27. **Malvagia S, Morrone A, Caciotti A, Bardelli T, d'Azzo A, Ancora G, Zammarchi E, Donati MA.** New mutations in the PPBG gene lead to loss of PPCA protein which affects the level of the beta-galactosidase/neuraminidase complex and the EBP-receptor. *Mol Genet Metab.* 2004; 82: 48–55.
28. **Nielsen H, Engelbrecht J, Brunak S, von Heijne G.** A neural network method for identification of prokaryotic and eukaryotic signal peptides and prediction of their cleavage sites. *Int J Neural Syst.* 1997; 8: 581–99.
29. **Bendtsen JD, Nielsen H, von Heijne G, Brunak S.** Improved prediction of signal peptides: SignalP 3.0. *J Mol Biol.* 2004; 340:783–95.
30. **Gupta R, Brunak S.** Prediction of glycosylation across the human proteome and the correlation to protein function. *Pac Symp Biocomput.* 2002; 7: 310–22.
31. **Norden AG, Tennant LL, O'Brien JS.** GM1 ganglioside beta-galactosidase. A. Purification and studies of the enzyme from human liver. *J Biol Chem.* 1974; 249: 7969–76.
32. **Halley DJ, de Wit-Verbeek HA, Reuser AJ, Galjaard H.** The distribution of hydrolytic enzyme activities in human fibroblast cultures and their intercellular transfer. *Biochem Biophys Res Commun.* 1978; 82: 1176–82.
33. **Young DC, Kingsley SD, Ryan KA, Dutko FJ.** Selective inactivation of eukaryotic beta-galactosidase in assays for inhibitors of HIV-1 TAT using bacterial beta-galactosidase as a reporter enzyme. *Anal Biochem.* 1993; 215: 24–30.
34. **Laemmli UK.** Cleavage of structural proteins during the assembly of the head of bacteriophage T4. *Nature* 1970; 227: 680–5.
35. **Hubert JJ, O'Brien JS.** Dog and human acid beta-D-galactosidases are structurally similar. *Biochem J.* 1983; 213: 473–8.
36. **Ahern-Rindell AJ, Kretz KA, O'Brien JS.** Comparison of the canine and human acid beta-galactosidase gene. *Am J Med Genet.* 1996; 63: 340–5.
37. **Suzuki Y.** Beta-galactosidase deficiency: an approach to chaperone therapy. *J Inherit Metab Dis.* 2006; 29: 471–6.
38. **Hahn CN, del Pilar Martin M, Schröder M, Vanier MT, Hara Y, Suzuki K, Suzuki K, d'Azzo A.** Generalized CNS disease and massive GM1-ganglioside accumulation in mice defective in lysosomal acid beta-galactosidase. *Hum Mol Genet.* 1997; 6: 205–11.
39. **Matsuda J, Suzuki O, Oshima A, Ogura A, Noguchi Y, Yamamoto Y, Asano T, Takimoto K, Sukegawa K, Suzuki Y, Naiki M.** Beta-galactosidase-deficient mouse as an animal model for GM1-gangliosidosis. *Glycoconj J.* 1997; 14: 729–36.
40. **Sano R, Trindade VM, Tessitore A, d'Azzo A, Vieira MB, Giugliani R, Coelho JC.** G(M1)-ganglioside degradation and biosynthesis in human and murine G(M1)-gangliosidosis. *Clin Chim Acta.* 2005; 354: 131–9.
41. **Severino J, Allen RG, Balin S, Balin A, Cristofalo VJ.** Is beta-galactosidase staining a marker of senescence in vitro and in vivo? *Exp Cell Res.* 2000; 257: 162–71.
42. **Lee BY, Han JA, Im JS, Morrone A, Johung K, Goodwin EC, Kleijer WJ, DiMaio D, Hwang ES.** Senescence-associated beta-galactosidase is lysosomal beta-galactosidase. *Aging Cell* 2006; 5: 187–95.
43. **Unterluggauer H, Hütter E, Voglauer R, Grillari J, Vöth M, Bereiter-Hahn J, Jansen-Dürr P, Jendrach M.** Identification of cultivation-independent markers of human endothelial cell senescence in vitro. *Biogerontology* 2007; 8: 383–97.
44. **Dimri GP, Lee X, Basile G, Acosta M, Scott G, Roskelley C, Medrano EE, Linskens M, Rubelj I, Pereira-Smith O, Peacocke M, Campisi J.** A biomarker that identifies senescent human cells in culture and in aging *in vivo*. *Proc Natl Acad Sci USA.* 1995; 92: 9363–7.
45. **Pshezhetsky AV, Potier M.** Stoichiometry of the human lysosomal carboxypeptidase-beta-galactosidase complex. *Biochem Biophys Res Commun.* 1993; 195: 354–62.
46. **Hiraiwa M.** Cathepsin A/protective protein: an unusual lysosomal multifunctional protein. *Cell Mol Life Sci.* 1999; 56: 894–907.
47. **Ostrowska H, Krukowska K, Kalinowska J, Orowska M, Lengiewicz I.** Lysosomal high molecular weight multienzyme complex. *Cell Mol Biol Lett.* 2003; 8: 19–24.
48. **Hotamisligil S, Hale S, Alroy J, Fischer I, Raghavan S.** Purification and immunological characterization of acid beta-galactosidase from dog liver. *Comp Biochem Physiol.* 1993; 106: 373–82.