

Quality and position of the three *lac* operators of *E.coli* define efficiency of repression

Stefan Oehler, Michèle Amouyal¹, Peter Kolkhof, Brigitte von Wilcken-Bergmann and Benno Müller-Hill²

Institut für Genetik der Universität zu Köln, Weyertal 121, D-50931 Köln, Germany and ¹Unité de Recherches en Génétique et Pathologie moléculaires, INSERM U129, Institut Cochin de Génétique moléculaire, 24 rue du Faubourg-Saint-Jacques, 75014 Paris
²Corresponding author

Communicated by B.Müller-Hill

Repression of the *lac* promoter may be achieved in two different ways: either by interference with the action of RNA polymerase or by interference with CAP activation. We investigated cooperative repression of the *Escherichia coli lac* operon by systematic conversion of its three natural operators (O1, O2 and O3) on the chromosome. We find that cooperative repression by tetrameric Lac repressor increases with both quality and proximity of the interacting operators. A short distance of 92 bp allows effective repression by two very weak operators (O3, O3). The cooperativity of *lac* operators is discussed in terms of a local increase of repressor concentration. This increase in concentration depends on flexible DNA which allows loop formation.

Key words: cooperativity/DNA loops/*lac* operator/Lac repressor/local concentration

Introduction

Cooperation between two distant DNA sites is frequently observed in transcriptional regulation in pro- and eukaryotic organisms. It occurs in both negative and positive regulation. For *Escherichia coli*, it has been shown that at least two operators are necessary for full repression of the *araBAD* operon (Dunn *et al.*, 1984), the *deo* operon (Dandanell *et al.*, 1987), the *gal* operon (Haber and Adhya, 1988) and the *lac* operon (Oehler *et al.*, 1990). In the *glnALG* operon, activation depends on at least two NR binding sites (Reitzer and Magasanik, 1986).

The effect of a repressor on expression from a particular promoter may be increased by cooperative interaction. This implies that deletion or inactivation of a distant operator may have a negative effect on the action of a promoter-proximal operator. A simple quantitative explanation for such an observation is that a promoter-distal operator increases the occupation of the proximal operator by DNA looping (Mossing and Record, 1986; Schleif, 1988, 1992; Adhya, 1989, Law *et al.*, 1993). The regulatory protein, which possesses two independent DNA binding sites, is then trapped in a 'chelate-like' complex (Hammer and Dandanell, 1989) between the two operators

while the intervening DNA loops out. DNA loops have been shown to form *in vitro* for all of the above mentioned regulatory systems (Krämer *et al.*, 1987, 1988; Ninfa *et al.*, 1987; Amouyal *et al.*, 1989; Lobell and Schleif, 1990), except for the *gal* operator–Gal repressor interaction (Brenowitz *et al.*, 1990).

We have previously shown that the auxiliary operators O2 (Reznikoff *et al.*, 1974), which lies 401 bp downstream of O1, and O3 (Gilbert *et al.*, 1976), which lies 92 bp upstream of O1, contribute significantly to the repression of the *lac* operon, by cooperation with O1 (Eismann *et al.*, 1987; Oehler *et al.*, 1990; see Figure 1). Simultaneous binding of one Lac repressor tetramer to two *lac* operators (Borowiec *et al.*, 1987) is necessary for full repression of ~1000-fold (Oehler *et al.*, 1990). A DNA loop with either O1 and O2 or O1 and O3 is formed. Interestingly, the cooperative effect of each of the two auxiliary operators is about equally high, despite their different quality: O2 is weaker than O1 (Pfahl *et al.*, 1979; Winter and von Hippel, 1981; this work) and O3 is weaker than O2 (Pfahl *et al.*, 1979; Fried and Crothers, 1981; Winter and von Hippel, 1981; this work). The repression exerted by a particular operator depends on its affinity for Lac repressor and on the concentration of Lac repressor.

It has been shown that Lac repressor binds to the *lac* promoter region simultaneously with RNA polymerase (Schmitz and Galas, 1979; Straney and Crothers, 1987). Thus, the occupancy of an operator by Lac repressor at the position of O1 is directly correlated with its affinity for Lac repressor. For the influence of competition on binding by RNA polymerase see Lanzer and Bujard (1988). Repression of expression is defined as constitutive expression divided by expression under negative control of repressor. In a simple model, assuming that expression is proportional to the fraction of operator molecules free from repressor, the repression value F is related to the occupancy ($[RO]/[O]$) of an operator in the following way: $F = 1 + ([RO]/[O])$ (Sadler and Novick, 1965). Thus, repression values of 10 or greater can in practice be seen as directly correlated with the occupancy of an operator.

Here we present a detailed analysis of the influence of the qualities and distances of the *lac* operators on cooperative repression which, in our interpretation, depends on DNA loop formation.

Results

We constructed plasmids which put the *lacZ* gene under control of the natural *lac* promoter and the three *lac* operators (O1, O2 and O3). They were either unchanged or altered by site-directed mutagenesis. Each construct was cloned in phage λ IP1 (Sieg *et al.*, 1989). Single lysogens of an *E.coli* strain carrying deletions of the *lacZ*

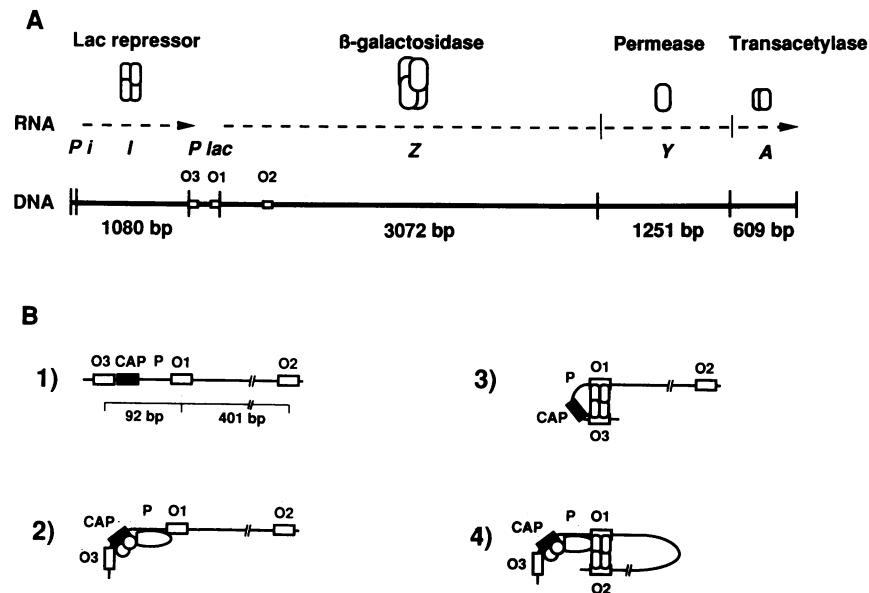

Fig. 1. The organization and control of the *E. coli* *lac* operon. (A) The *lacZ* (β -galactosidase), *lacY* (Lac permease) and *lacA* (Lac transacetylase) genes are transcribed from the *lac* promoter (*P lac*) as a polycistronic mRNA. Expression from the *lac* promoter is negatively controlled by the three *lac* operators O1, O2 and O3. The *lacI* gene, coding for Lac repressor is expressed from its own promoter (*Pi*) and lies upstream of the *lac* promoter. The length of the coding sequence (including the start codon) of each gene is given in bp. (B) The control elements of the *lac* promoter (1). The *lac* promoter is flanked upstream by a CAP binding site and downstream by O1. O3 lies immediately upstream of the CAP binding site and O2 is located in the coding region of *lacZ*. The distances from centre to centre of the *lac* operators are given in bp. Transcription, which is activated by the CAP protein, is constitutive in the absence of Lac repressor (2). Tetrameric Lac repressor forms DNA–protein–DNA loops in the absence of inducer. It binds simultaneously to O1 and O3 (3) or to O1 and O2 (4) and thereby blocks transcription efficiently.

and *lacI* genes (BMH 8117 F') were then generated with these phages. Specific β -galactosidase activities were determined in bacteria grown in the absence and in the presence of different amounts (five times or 90 times i^+) of plasmid-encoded Lac repressor.

Comparison of the relative *in vivo* affinities of *lac* operators for Lac repressor

In order to evaluate the relationship between operator quality and its contribution to DNA loop formation *in vivo*, the relative quality of the operators had to be determined *in vivo*. To that purpose, we measured repression of β -galactosidase expression by Lac repressor in the presence of just O3, O2 or O1 at the position of O1 (O2 and O3 have been destroyed at their natural positions; see legend to Figure 2).

The natural auxiliary operators (O2 and O3) were inactivated by site-directed mutagenesis to make any cooperative interaction impossible. The first *lac* operator O1 was replaced by O2 or O3 or the fully symmetric 'ideal' *lac* operator (Sadler *et al.*, 1983; Simons *et al.*, 1984; Lehming *et al.*, 1987). See Figure 2 for the operator sequences. Figure 3 gives the repression values when about five times or ~ 90 times the i^+ amounts of dimeric or wild-type tetrameric repressor respectively are present. Dimeric Lac repressor is not encoded by the *i^{adi}* allele here, which we have described previously (Lehming *et al.*, 1988; Oehler *et al.*, 1990). Preliminary experiments indicate that *i^{adi}*-encoded dimeric Lac repressor dissociates into monomers at low concentrations (data not shown). We therefore constructed another more stable (data not shown) Lac repressor variant (Lac R 331 Stop), by the introduction of a stop codon at position 331 of the coding sequence of the *lacI* gene. This removes the 30 C-terminal

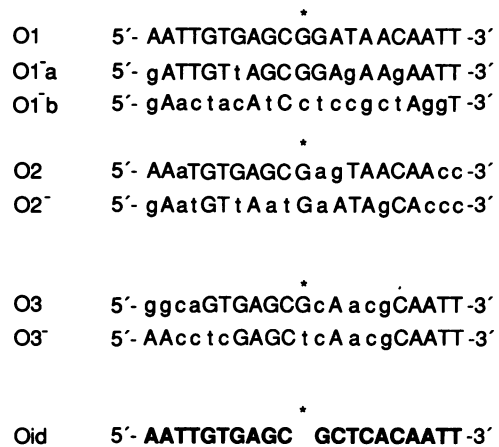

Fig. 2. The sequences of the wild-type *lac* operators (O1, O2, O3) and of the 'ideal' *lac* operator Oid are aligned with the sequences of the destroyed operators (O1⁻a, O1⁻b, O2⁻, O3⁻). The destroyed operator O1⁻b has been introduced into construct λ Ewt 001 (Figure 5), but not λ Ewt 003 (Figure 5). Asterisks mark the centres of symmetry. The O2 sequences are written as the sequences of the lower strand of *lacZ* to align them with O1 and O3. Exchanges to create O2⁻ were restricted to silent mutations of the *lacZ* coding sequence. Of the possible exchanges, those that are most deleterious to repressor binding (Lehming *et al.*, 1987) were introduced. Lower case letters mark the positions in which the operators deviate from O1, except for Oid, which is shown in bold letters.

residues of Lac repressor which encompass both leucine heptad repeats (Oehler *et al.*, 1990; Alberti *et al.*, 1991). The heptad repeats of wild-type Lac repressor form a four helical bundle and thus enable wild-type Lac repressor to aggregate to tetramers (Alberti *et al.*, 1993).

The repression values of Figure 3 show that the affinity of O2 for Lac repressor is on average ~ 10 -fold lower and

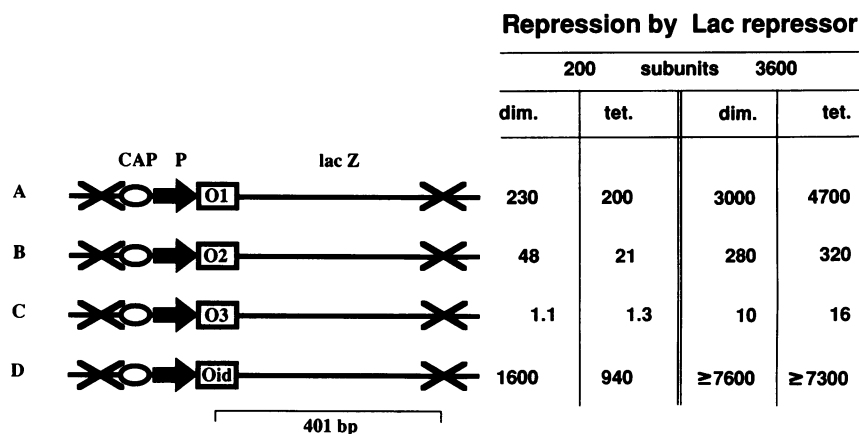

Fig. 3. Repression values for chromosomal (see Materials and methods) *lacZ* genes. The source of low amounts of Lac repressor (~200 monomers/cell) was pSO 331 Stop for dimeric (dim.) and pSO 1010-P1 for wild-type tetrameric (tet.) Lac repressor. The source of high amounts of repressor (~3600 monomers/cell) was pSO 3310 Stop for dimeric (dim.) and pSO 1000 for wild-type tetrameric (tet.) Lac repressor. Plasmid pSO 1000 ΔA carries an i^- allele (see Materials and methods). The combination of operators in each construct is shown schematically. The arrow represents the *lac* promoter. The ovoid symbolizes the CAP binding site. The active *lac* operators are drawn as open boxes, inactivated operators are indicated by crossed bars. Repression is defined as specific activity of β -galactosidase in the absence of active Lac repressor divided by the specific activity in the presence of the indicated Lac repressor (Miller, 1972). A, λ Ewt 100; B, λ Ewt 200; C, λ Ewt 300; D, λ Est i00.

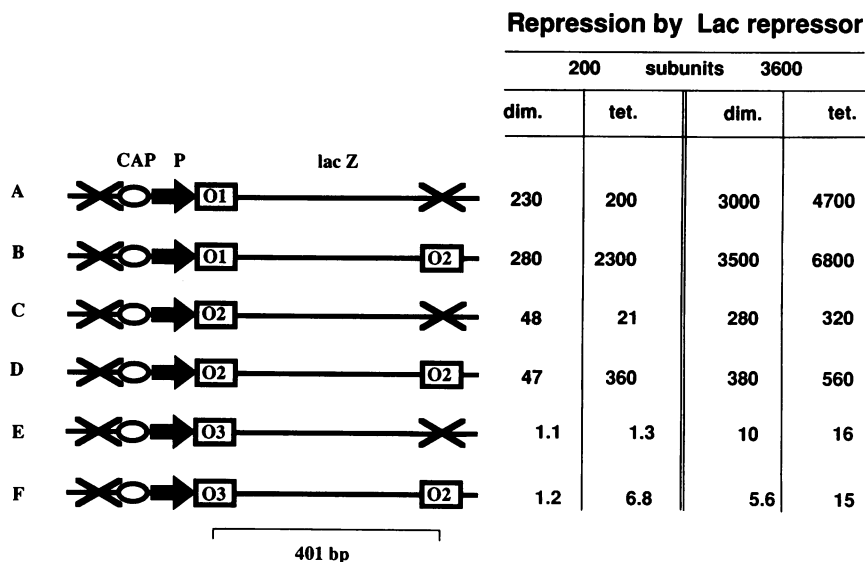

Fig. 4. Repression values for chromosomal (see Materials and methods) *lacZ* genes. Repression values are given as the specific β -galactosidase activity in the absence of active Lac repressor divided by the specific activity in the presence of the indicated Lac repressors. For details see legend to Figure 3. A, λ Ewt 100 (from Figure 3); B, λ Ewt 120; C, λ Ewt 200 (from Figure 3); D, λ Ewt 220; E, λ Ewt 300 (from Figure 3); F, λ Ewt 320.

that of O3 is ~300-fold lower than that of O1. In contrast, Oid binds repressor ~6-fold better than wild-type O1. These results are in general agreement with *in vitro* measurements. The *in vitro* affinity of O2 has been determined to be 1/10 of that of O1 (Pfahl *et al.*, 1979; Winter and von Hippel, 1981). The *in vitro* affinity of O3 has been determined to be between 16- and 1000-fold lower than that of O1 (Pfahl *et al.*, 1979; Fried and Crothers, 1981; Winter and von Hippel, 1981). The *in vitro* affinity of the ideal operator was found to be ~8-fold greater than that of O1 (Sadler *et al.*, 1983; Simons *et al.*, 1984).

The role of O2 in repression

We have shown that the natural O2 alone, in the absence of O1 and O3, works very inefficiently, if at all, as a

roadblock for RNA polymerase (Oehler *et al.*, 1990). Therefore, the effect which O2 exerts in the presence of a second operator at the position of O1 is predominantly due to cooperative interaction, i.e. DNA loop formation. An observed increase in repression by the addition of O2 should result from cooperative increase of occupation of O1 or any other operator at the position of O1. Figure 4 gives the repression values of O1, O2 and O3 at the natural location of O1 in the presence of O2. For comparison, the values for the constructs without the natural O2 from Figure 3 are also listed.

Dimeric Lac repressor is not able to form DNA loops (Oehler *et al.*, 1990). Consequently, it shows virtually the same repression with and without the second operator, at both low and high Lac repressor concentrations. In contrast, repression by wild-type tetrameric Lac repressor

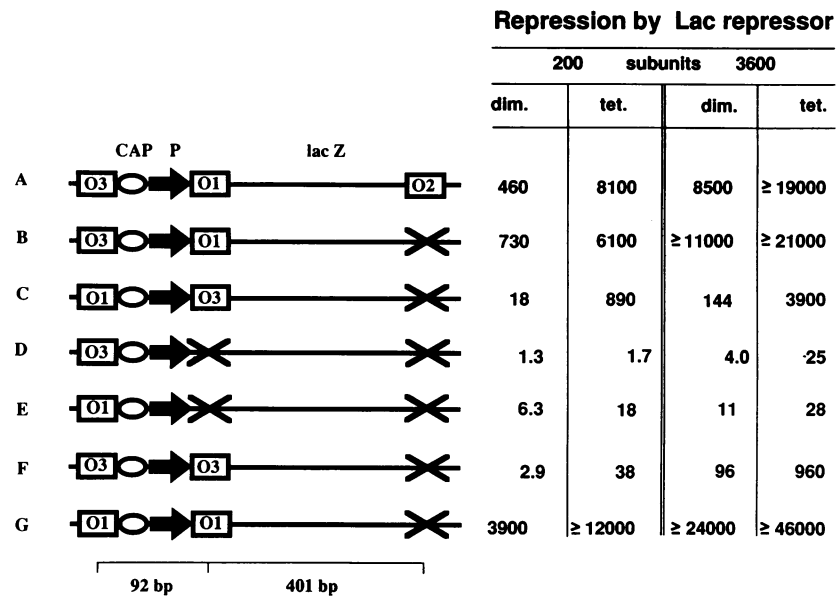

Fig. 5. Repression factors for chromosomal (see Materials and methods) *lacZ* genes. Repression values are given as the specific β -galactosidase activity in the absence of active Lac repressor divided by the specific activity in the presence of the indicated Lac repressors. For details see legend to Figure 3. A, λ Ewt 123; B, λ Ewt 103; C, λ Ewt 301; D, λ Ewt 003, this construct carries the operator mutant O1^{-a}; E, λ Ewt 001, this construct carries the operator mutant O1^{-b} which has been inserted to exclude any residual operator activity; F, λ Ewt 303; G, λ Ewt 101.

increases at low concentration with the addition of the second operator. With high concentrations of repressor, little effect of O2 can be seen. This is in agreement with the fact that at high repressor concentrations, DNA loops break up and cooperativity is lost (Krämer *et al.*, 1987).

The cooperative effect of the second operator on O1 or O2 at the position of O1 is quite similar, namely 12- and 18-fold. The increase of repression by O3 at the position of O1 through cooperation with O2 cannot be directly determined, since repression of construct λ Ewt 300 (Figure 4, line E) by five times i^+ amounts of repressor is too low to be accurately measured. Ninety times i^+ amounts give a 16-fold repression with O3 at the position of O1 (λ Ewt 300, Figure 4, line E). Since the occupancy $[RO]/[O]$ of an operator will increase linearly with an increase of Lac repressor, we can estimate that repression with five-fold i^+ amounts should be 1.8. Then, the cooperativity of the second operator with O3 is ~ 7 -fold, which is not far from the effect with O1 or O2.

The role of O3 in repression

When O2 at its natural position is inactivated, repression by low amounts of tetrameric repressor does not drop, because of the interaction between O1 and O3 (λ Ewt 123, Figure 5, line A and λ Ewt 103, Figure 5, line B). Naively, one might expect that, since cooperation is mutual, O1 and O3 could be exchanged without any effect on repression. But Figure 5, line C (λ Ewt 301) shows that repression drops ~ 6 -fold, although it still remains relatively high compared with repression with dimeric Lac repressor. Repression of λ Ewt 001 (Figure 5, line E) reveals that part of the repression of λ Ewt 301 (Figure 5, line C) is obviously due to interference with CAP activation by Lac repressor bound at the position of O3.

This construct (λ Ewt 001, Figure 5, line E) indeed illuminates the difference between true repression and deactivation. While repression increases linearly with

increasing amounts of Lac repressor, deactivation can maximally abolish the effect of an activator. In this case, deactivation by high amounts of Lac repressor is ~ 30 -fold, which is close to the 50-fold reported value of CAP activation of *lac* promoter (Hopkins, 1974). Interestingly, dimeric repressor deactivates less well than wild-type tetrameric Lac repressor at both low and high concentration. This could be explained by reduced steric hindrance of CAP binding by the smaller repressor protein. We have previously shown that high amounts of Lac repressor exert repression even with the natural O3 in the absence of both O1 and O2 (Oehler *et al.*, 1990). This apparent repression is in fact deactivation by competition with binding of CAP to its target site immediately downstream of O3. In the absence of the CAP protein there is no repression of construct Ewt 001 by Lac repressor (Sundarp, 1993). If we take an ~ 20 -fold deactivation into account, an ~ 40 -fold true repression of construct λ Ewt 301 (Figure 5, line C) remains. Obviously, in a DNA loop the operator which blocks polymerase, rather than the overall strength of the cooperative interaction, determines repression. This reflects the fact that the loop is asymmetrically breathing. When O1 is now restored to its natural position (λ Ewt 101, Figure 5, line G), repression is increased with respect to the natural situation (λ Ewt 103, Figure 5, line B). Repression by dimeric repressor, where there should be no cooperativity, is also considerable here. Thus, in construct λ Ewt 101 also (Figure 5, line G), both real repression and deactivation contribute to apparent repression. What if O3 is now restored to its natural position and combined with another O3 at the position of O1 (λ Ewt 303, Figure 5, line F)? Cooperativity can still be observed.

It is interesting to note that while each O3 alone exerts no measurable effect (λ Ewt 300, Figure 4, line E and λ Ewt 003, Figure 5, line D), repression by the combination of both (38-fold) is even better than the effect of one O2

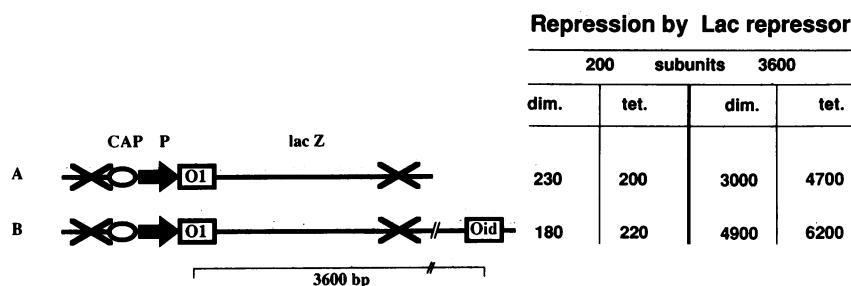

Fig. 6. Repression values for chromosomal (see Materials and methods) *lacZ* genes. Repression values are given as the specific β -galactosidase activity in the absence of active Lac repressor divided by the specific activity in the presence of the indicated Lac repressors. For details see legend to Figure 3. A, λ Ewt 100 (from Figure 3); B, λ Ewt 100i.

in the absence of auxiliary operators (21-fold). Recall that the affinity of O2 for repressor is ~ 30 times higher than that of O3. With high amounts of repressor, cooperativity does not occur. Repression is not much higher than the product of repression by λ Ewt 300 (Figure 4, line E) and deactivation by λ Ewt 003 (Figure 5, line D).

No cooperativity over long distances

If cooperativity between operators works exclusively by local increase of repressor concentration, one would not expect to observe an interaction between even completely occupied operators, if they lie too far apart. To test this assumption for the *lac* system, we inserted an ideal *lac* operator behind the *lacZ* gene at a distance of ~ 3600 bp from O1 (λ Ewt 100i, Figure 6, line B). Figure 6 shows that this additional operator has very little, if any, effect on repression.

Discussion

DNA binding and cooperativity

Many transcription factors enhance their specificity and strength of DNA binding by aggregating to dimers (Freemont *et al.*, 1991). The monomers touch each other with the same surface and the DNA binding motifs come to lie adjacent to each other. This is then reflected in palindromic target sites. The two subunits cooperate with each other in binding to the two target half-sites. The mechanism of this cooperativity can be described as an increase in local concentration of the second monomer (Schleif, 1988). Once one of the subunits has properly bound to one target half-site with the association rate R_1 , the other subunit is brought into correct orientation extremely close to the second half-site. This proximity determines the extremely high association rate $R_2 \gg R_1$.

In an analogous manner, one can envisage how the extensive network of contacts between one protein monomer and its target (Pabo and Lewis, 1982; Pabo and Sauer, 1984; Chuprina *et al.*, 1993) could have evolved. Once two strong interactions exist, the orientation of the protein along the DNA is fixed and every additional contact strengthens the complex, ideally with its whole energy. The interacting functional groups will be brought into proper orientation close together.

The increase of local concentration

Here, we would like to outline the idea of a local increase of repressor concentration. This discussion does not take

into account the constraints exerted by the DNA between two operators.

The possibility of locally increasing the concentration of repressor with respect to an operator by DNA loop formation depends on both the quality and position of the auxiliary operator, as well as on the cellular concentration of repressor. Closure of the loop takes place when the free binding region of a DNA-bound tetrameric repressor molecule has a higher concentration with respect to the second target site than the repressor free in solution. A repressor molecule bound to an auxiliary operator is, with respect to a second operator, trapped in a sphere whose radius is given by the length of the DNA between the two operators. The quotient of fractional occupancy of the auxiliary operator with the volume of the sphere in which it is trapped divided by the quotient of the number of repressor molecules per cell with the cell volume gives the cooperative increase of occupancy of the other operator.

DNA looping

If a dimeric DNA binding protein gains the ability to form tetramers, it will be able to increase its binding strength and specificity by cooperativity. Lac repressor dimers gained the capability to form tetramers through the addition of two suitable leucine heptad repeats to their C-termini (Alberti *et al.*, 1991). They are then capable of forming a four helical bundle (Alberti *et al.*, 1993). Since the Lac repressor tetramer can bind independently to two operators (Kania and Müller-Hill, 1977; O'Gorman *et al.*, 1980; Culard and Maurizot, 1981; Krämer *et al.*, 1987, 1988), cooperative binding will only depend on whether binding of one dimer brings the second dimer close enough to a second target site. Since the two DNA binding regions of the tetramer point in opposite directions [the angle between two bound DNA molecules is unknown, but electron micrographs (Krämer *et al.*, 1988) seem to indicate that they are not parallel], the protein or the DNA have to bend to enable the second dimer to reach the additional target. This requires energy and determines the maximal proximity of the second binding region of the protein and the additional DNA target. The interacting partners are pre-oriented, at least over short distances, by the DNA which lies between the target sites. Both the amount and direction of a possible intrinsic curvature and the stiffness of the intervening DNA depend on its sequence. For effective loop formation, the target sites must lie on the same side of the DNA. Cooperative interaction between two *lac* operators and wild-type Lac repressor occurs

Table I. Percentage occupancy of *lac* operators *in vivo* in the absence of auxiliary operators

	Lac repressor subunits			
	200		3600	
	dim.	tet.	dim.	tet.
O1	99.6	99.5	99.97	99.98
O2	98	95	99.6	99.7
O3	(33)	(45)	90	94
Oid	99.94	99.89	≥99.986	≥99.986

The values are calculated from the repression factors of Figure 3. The occupancy of O3 in the presence of 200 subunits of Lac repressor (in parenthesis) is extrapolated from the occupancy in the presence of 3600 subunits of Lac repressor. Percent occupancy is: $100 \times (F-1)/F$, where F is the repression factor.

in vivo even at a distance of only 70 bp (J.Müller, unpublished results).

The reality of the *lac* system

Table I lists the occupancy of O1, O2, O3 and the ideal *lac* operator *in vivo* in the presence of five times and 90 times wild-type amounts of tetrameric or dimeric Lac repressor. The values are calculated from the repression factors of Figure 3. Their relatively low affinity for Lac repressor and their distance from the *lac* promoter caused the belief that the *lac* auxiliary operators O2 and O3 have little or no impact on repression of the *lac* operon (Pfahl *et al.*, 1979). At low concentrations of Lac repressor, they indeed do not work efficiently in blocking polymerase at the position of O1 (Figure 3), but together with O1 they exert a large cooperative effect from their natural positions (Figure 4, line B and Figure 5, line B). With wild-type amounts of Lac repressor (1×10^{-8} M; Gilbert and Müller-Hill, 1966), each of the auxiliary operators enhances repression by O1 to about the same extent (Oehler *et al.*, 1990). The quality of the auxiliary *lac* operators corresponds inversely to their position relative to O1. O2 binds Lac repressor just ~10-fold less well than O1 and is separated from O1 by 401 bp. O3 lies at a distance of only 92 bp from O1 (Figure 1), but its affinity for Lac repressor is about another 30-fold lower than that of O2. This observation fits into the model of cooperative repression by DNA loop formation. At a concentration of 50 molecules of tetrameric Lac repressor per cell (2×10^{-12} cm³; see Figure 7), there is on average one molecule per 4×10^{-14} cm³. If one molecule of repressor is bound to O2, it is trapped in a volume of 1×10^{-14} cm³ around O1 (Figure 7). Neglecting the resistance of the intervening DNA to bending, the Lac repressor concentration should be correspondingly elevated with respect to O1. Experimentally, we observe an ~10-fold increase of repression by an operator at the position of O1 through addition of O2 (Figure 4).

A bad operator (O3), which is not frequently occupied, has to lie very close to O1 in order to enhance repressor concentration. While at the i^+ concentration of Lac repressor, O3 is ~10% occupied, occupancy at five times i^+ is ~50% (Table I). One Lac repressor tetramer bound half of the time to O3 gives an average concentration of one molecule in 2×10^{-16} cm³. Lac repressor concentration with respect to O1 is then 200-fold above the cellular

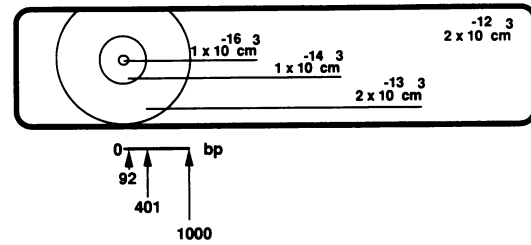

Fig. 7. The concept of local increase of repressor concentration by DNA loop formation is illustrated schematically, but approximately drawn to scale for the *lac* operon. A cross-section through an *E. coli* cell is symbolized by the rectangle. An *E. coli* cell is assumed to be cylindrical with a height of ~3 μ m and a width of ~0.6 μ m. The cut goes through O1, which lies in the centre of the circles. The circles have radii which correspond to a distance from O1 of: 92 bp (O3), inner circle; 401 bp (O2), second inner circle; and 1000 bp, outer circle (assuming maximal extension of the intervening DNA). Thus, one Lac repressor tetramer which is bound to O3 or O2 or at a distance of 1000 bp from O1 is trapped in the respective spheres. To achieve a 2-fold increase of repressor concentration in the wild-type situation with 10 Lac repressor tetramers per cell, the volume of a sphere must be 10-fold smaller than the volume of the cell, which is $\sim 2 \times 10^{-12}$ cm³.

concentration. Experimentally, with five times i^+ amounts of tetrameric Lac repressor, an ~30-fold increase of repression by O1 upon addition of O3 is observed (λ Ewt 100, Figure 3, line A and Figure 5, line B). This discrepancy fits with the fact that a relatively high amount of energy is needed to bend a 92 bp DNA, which reduces the effective local concentration of Lac repressor. The length of the Lac repressor molecule that connects the two operators should reduce the extent to which the short intervening DNA has to bend. But the orientation of the two DNA binding regions of Lac repressor is not known. Thus, it is not clear if the Lac repressor tetramer really decreases the extent to which the DNA has to bend or asks for simultaneous bending of the intervening DNA in two directions.

We could not find cooperativity between operators separated by a distance of >3000 bp, where no increase of local Lac repressor concentration is expected. In contrast, at the distance of 92 bp, even two O3 operators, which individually lead to no detectable effect, repress the *lac* promoter efficiently with five times i^+ amounts of wild-type tetrameric Lac repressor (Figure 5, line F). A similar cooperation has been reported for synthetic weak *lac* operators (Amouyal and von Wilcken-Bergmann, 1992). O2 enhances repression by O1 ~10-fold at five times i^+ amounts of Lac repressor. This factor corresponds to a local increase of Lac repressor concentration relative to O1 or any operator in its place. Thus, in a background of ~20-fold more cellular Lac repressor, the repressor molecule bound to O2 should exert a barely detectable effect. This is exactly what is observed (Figure 4).

A simple model for DNA loop formation as the basis of a locally increased concentration for Lac repressor is given in Figure 7. What our model does not account for is the observation of interactions between target sites for transcription factors over long (>1000 bp in prokaryotes) or very long (>10 000 bp in eukaryotes) distances. It will be interesting to know how the topology of the out-looping DNA or the action of multiple binding sites can make this long-range cooperation possible.

Materials and methods

Chemicals, media and enzymes

[³²P]Deoxyribonucleoside triphosphates were obtained from Amersham Buchler (Braunschweig, Germany); 5-bromo-4-chloro-3-indolyl- β -D-galactoside (X-Gal) was from Bachem fine chemicals (Torrance, USA); ATP, deoxyribonucleoside triphosphates, dithiothreitol, ethidium bromide and 'Trisma base' from Sigma Chemie (München, Germany); β -mercaptoethanol from Fluka AG (Buchs, Switzerland); *o*-nitrophenyl- β -D-thiogalactoside (ONPG) from Serva Feinbiochemika (Heidelberg, Germany); urea from Bethesda Research Laboratories (Neu-Isenburg, Germany); and the chemicals for automatic DNA synthesis from Applied Biosystems (Pfungstadt, Germany). All other chemicals were obtained from Merck (Darmstadt, Germany) or Sigma Chemie (München, Germany). Agarose, acrylamide and *N,N'*-methylenebisacrylamide were obtained from Bethesda Research Laboratories (Neu-Isenburg, Germany).

All enzymes were purchased from New England Biolabs (Bad Schwalbach, Germany) or Boehringer (Mannheim, Germany). T7 polymerase sequencing kits were obtained from Pharmacia (Freiburg, Germany). Oligonucleotides were synthesized by Karin Otto and Gudrun Zimmer on an Applied Biosystems Synthesizer model 394 and were purified on denaturing polyacrylamide gels.

Bacteria, plasmids and λ phages

E. coli strain BMH 8117 F' has the genotype: (*lac pro*) Δ *nal thi supE F' lac I^q - Z⁺ Y⁺ pro A⁺ B⁺*. The episome has been described by Gho and Miller (1974). It carries an *I-Z* deletion, leaving the 5' end of the *I* gene intact.

Plasmids were constructed according to standard procedures (Maniatis *et al.*, 1982). Plasmid pSO 1010-P1 codes for about five times *i*⁺ amounts of wild-type tetrameric Lac repressor, plasmid pSO 1000 codes for ~90 times *i*⁺ amounts of Lac repressor, plasmid pSO 1000 Δ A carries an *i*⁻ allele. These plasmids have been described previously (Oehler *et al.*, 1990). Plasmid pSO 331 Stop codes for about five times *i*⁺ amounts of dimeric Lac repressor and plasmid pSO 3310 Stop codes for ~90 times *i*⁺ amounts of dimeric Lac repressor. These plasmids were derived from plasmids pSO 1010-P1 and pSO 1000 respectively. A *SpeI* restriction site has been introduced in codons 329 and 330 (Alberti *et al.*, 1991) by site-directed PCR mutagenesis (Kadowaki *et al.*, 1989). This led to an exchange of amino acid 330 from Leu to Ser. Then, a synthetic piece of DNA was cloned between the *SpeI* site and a *PstI* site which is located C-terminally of the *lacI* coding sequence. The synthetic DNA introduces an ochre stop codon after codon 330. The resulting mutant protein is dimeric, since it lacks the 30 C-terminal residues of wild-type tetrameric Lac repressor, which carries the two leucine heptad repeats that enable Lac repressor dimers to aggregate to tetramers (Alberti *et al.*, 1991, 1993). The pEwt plasmids carry a *lacZ* gene under control of the wild-type *lac* promoter and different combinations of *lac* operators. Plasmids pEwt 123, 103, 120, 100 and 003 have been described (Oehler *et al.*, 1990). The numbers 1, 2 and 3 stand for the presence of the first, the second or the third *lac* operator respectively, whereas the 0 indicates the absence of a particular operator. The name of a particular operator is given by its position. The first number designates the natural position of the first *lac* operator (O1), the second number the natural position of the second operator (O2) and the third number the natural position of the third operator (O3). Thus the combinations X00, 0X0 and 00X indicate the presence of only one operator X at the position of O1 or O2 or O3 respectively. Plasmids pEwt 200, 220, 300, 320, 301, 303, 101, 103 and 001 were generated by PCR mutagenesis of the respective wild-type operator. Plasmid pEwt 100i was constructed by the insertion of a 20 bp synthetic ideal operator into the unique *AatII* restriction site behind the *lacZ* gene of pEwt 100, at a distance of ~3600 bp from O1.

To introduce the ideal *lac* operator into λ Est i00, we first replaced O1 with a *SpeI* restriction site. Then, a double-stranded synthetic 20mer encoding the Oid, with compatible 5' protruding ends, was cloned into the *SpeI* site. The introduction of the *SpeI* site lowered the expression from *lac* promoter ~20-fold. Repression values higher than 4000-fold could not be reliably determined for λ Est i00. The *XbaI* fragments that contain the *lacZ* gene and the ampicillin resistance gene, but neither the tetracycline resistance gene nor the pBR-derived origin of replication, were isolated and ligated into the unique *XbaI* restriction site of phage λ IP1 (Sieg *et al.*, 1989) to generate the respective λ Ewt phages. *In vitro* packaging of λ DNA and infection of bacteria were performed according to standard procedures (Maniatis *et al.*, 1982). Lysogenic colonies were isolated and checked on X-Gal indicator plates for stable integration of the Z⁺ prophage. For each construct, several lysogenic isolates were tested for constitutive β -galactosidase expression. Sporadic isolates with

\geq two-fold higher expression than the others were considered to bear more than one prophage and were put aside. λ DNA was isolated from the lysogenic bacteria and the *XbaI* fragments with the *lacZ* genes were recloned into the pOT plasmid (Sieg *et al.*, 1989). The operator status of the recloned DNAs was verified by sequence analysis.

β -Galactosidase assays

The determination of specific β -galactosidase activities was performed according to Miller (1972). Minimal medium contained 0.4% glycerol and 20 μ g/ml thiamine. For strains harbouring one of the pSO plasmids, 8 μ g/ml tetracycline was added. The lysogenic strains were grown at 32°C to an OD₆₀₀ of between 0.8 and 1.2 and then harvested by centrifugation. Repression is given as specific β -galactosidase activity in the presence of pSO 1000 Δ A (*i*⁻), divided by specific β -galactosidase activity in the presence of pSO 1010-P1, 331 Stop, 1000 or 3310 Stop. The repression factors are the mean values of at least three independent determinations. Repression factors obtained from different isolates of the same prophage could differ from each other by up to 30%.

Acknowledgements

We thank Ruth Ehring and Andrew Barker for discussions. This work was supported by BMFT through Genzentrum Köln.

References

- Adhya, S. (1989) *Annu. Rev. Genet.*, **23**, 227–250.
- Alberti, S., Oehler, S., von Wilcken-Bergmann, B., Krämer, H. and Müller-Hill, B. (1991) *New Biol.*, **3**, 57–62.
- Alberti, S., Oehler, S., von Wilcken-Bergmann, B. and Müller-Hill, B. (1993) *EMBO J.*, **12**, 3227–3236.
- Amouyal, M., Mortensen, L., Buc, H. and Hammer, K. (1989) *Cell*, **58**, 545–551.
- Amouyal, M. and von Wilcken-Bergmann, B. (1992) *C. R. Acad. Sci. Paris*, **315**, 403–407.
- Borowiec, J., Zhang, L., Sasse-Dwight, S. and Gralla, J. D. (1987) *J. Mol. Biol.*, **196**, 101–111.
- Brenowitz, M., Jamison, E., Majumdar, A. and Adhya, S. (1990) *Biochemistry*, **29**, 3374–3383.
- Chuprina, V. P., Rullmann, A. C., Lamerichs, R. M. J. N., van Boom, J. H., Boelens, R. and Kaptein, R. (1993) *J. Mol. Biol.*, **234**, 446–462.
- Culard, F. and Maurizot, J. C. (1981) *Nucleic Acids Res.*, **9**, 5175–5184.
- Dandanell, G., Valentin-Hansen, P., Løve-Larsen, J. E. and Hammer, K. (1987) *Nature*, **325**, 823–826.
- Dunn, T., Hahn, S., Ogden, S. and Schleif, R. F. (1984) *Proc. Natl Acad. Sci. USA*, **81**, 5017–5020.
- Eismann, E. R., von Wilcken-Bergmann, B. and Müller-Hill, B. (1987) *J. Mol. Biol.*, **195**, 949–952.
- Freemont, P. S., Lane, A. N. and Sanderson, M. R. (1991) *Biochem. J.*, **278**, 1–23.
- Fried, M. and Crothers, D. M. (1981) *Nucleic Acids Res.*, **9**, 6505–6525.
- Gho, D. and Miller, J. H. (1974) *Mol. Gen. Genet.*, **131**, 137–146.
- Gilbert, W. and Müller-Hill, B. (1966) *Proc. Natl Acad. Sci. USA*, **57**, 2415–2421.
- Gilbert, W., Majors, J. and Maxam, A. (1976) In *Dahlem Workshop on Chromosomes*. Abakon Verlagsgesellschaft, Berlin, pp. 167–178.
- Haber, R. and Adhya, S. (1988) *Proc. Natl Acad. Sci. USA*, **85**, 9683–9687.
- Hammer, K. and Dandanell, G. (1989) In Eckstein, F. and Lilley, D. M. J. (eds), *Nucleic Acids and Molecular Biology*. Springer Verlag, Berlin, Vol. 3, pp. 79–91.
- Hopkins, J. D. (1974) *J. Mol. Biol.*, **87**, 715–724.
- Kadowaki, H., Kadowaki, T., Wondisford, F. E. and Taylor, S. I. (1989) *Gene*, **76**, 161–166.
- Kania, J. and Müller-Hill, B. (1977) *Eur. J. Biochem.*, **79**, 381–386.
- Krämer, H., Niemöller, M., Amouyal, M., Revet, B., von Wilcken-Bergmann, B. and Müller-Hill, B. (1987) *EMBO J.*, **6**, 1481–1489.
- Krämer, H., Amouyal, M., Nordheim, A. and Müller-Hill, B. (1988) *EMBO J.*, **7**, 547–556.
- Lanzer, M. and Bujard, H. (1988) *Proc. Natl Acad. Sci. USA*, **85**, 8973–8977.
- Law, S. M., Bellomy, G. R., Schlax, P. J. and Record, M. T., Jr (1993) *J. Mol. Biol.*, **230**, 161–173.
- Lehming, N., Sartorius, J., Genenger, G., von Wilcken-Bergmann, B. and Müller-Hill, B. (1987) *EMBO J.*, **6**, 3145–3153.
- Lehming, N., Sartorius, J., Oehler, S., von Wilcken-Bergmann, B. and Müller-Hill, B. (1988) *Proc. Natl Acad. Sci. USA*, **85**, 7947–7951.

- Lobell,R.B. and Schleif,R.F. (1990) *Science*, **250**, 528–532.
- Maniatis,T., Fritsch,E.F. and Sambrook,J. (1982) *Molecular Cloning. A Laboratory Manual*. Cold Spring Harbor Laboratory Press, Cold Spring Harbor, NY.
- Miller,J.H. (1972) *Experiments in Molecular Genetics*. Cold Spring Harbor Laboratory Press, Cold Spring Harbor, NY.
- Mossing,M.C. and Record,M.T.,Jr (1986) *Science*, **233**, 889–892.
- Ninfa,A.J., Reitzer,L.J. and Magasanik,B. (1987) *Cell*, **50**, 1039–1046.
- O’Gorman,R.B., Dunaway,M. and Matthews,K.S. (1980) *J. Biol. Chem.*, **255**, 10100–10106.
- Oehler,S., Eismann,E.R., Krämer,H. and Müller-Hill, B. (1990) *EMBO J.*, **9**, 973–979.
- Pabo,C.O. and Lewis,M. (1982) *Nature*, **298**, 443–447.
- Pabo,C.O. and Sauer,R.T. (1984) *Annu. Rev. Biochem.*, **53**, 293–321.
- Pfahl,M., Gulde,V. and Bourgeois,S. (1979) *J. Mol. Biol.*, **127**, 339–344.
- Reitzer,L.J. and Magasanik,B. (1986) *Cell*, **45**, 785–792.
- Reznikoff,W.S., Winter,R.B. and Hurley,C.K. (1974) *Proc. Natl Acad. Sci. USA*, **71**, 2314–2318.
- Sadler,J.R. and Novick,A. (1965) *J. Mol. Biol.*, **19**, 305–327.
- Sadler,J.R., Sasmor,H. and Betz,J.L. (1983) *Proc. Natl Acad. Sci. USA*, **80**, 6785–6789.
- Schleif,R. (1988) *Science*, **241**, 1182–1187.
- Schleif,R. (1992) *Annu. Rev. Biochem.*, **61**, 199–223.
- Schmitz,A. and Galas,D.J. (1979) *Nucleic Acids Res.*, **6**, 111–127.
- Sieg,K., Kun,J., Pohl,I., Scherf,A. and Müller-Hill,B. (1989) *Gene*, **75**, 261–270.
- Simons,A., Tils,D., von Wilcken-Bergmann,B. and Müller-Hill,B. (1984) *Proc. Natl Acad. Sci. USA*, **81**, 1624–1628.
- Straney,S.B. and Crothers,D.M. (1987) *Cell*, **51**, 699–707.
- Sundarp,R. (1993), PhD thesis, University of Cologne.
- Winter,R.B. and von Hippel,P.H. (1981) *Biochemistry*, **20**, 6948–6960.

Received on February 15, 1994; revised on April 14, 1994