

## Mechanism of Nitrogen Fixation by Nitrogenase: The Next Stage

Brian M. Hoffman,<sup>\*,§</sup> Dmitriy Lukoyanov,<sup>§</sup> Zhi-Yong Yang,<sup>†</sup> Dennis R. Dean,<sup>\*,‡</sup> and Lance C. Seefeldt<sup>\*,†</sup>

<sup>†</sup>Department of Chemistry and Biochemistry, Utah State University, 0300 Old Main Hill, Logan, Utah 84322, United States

<sup>‡</sup>Department of Biochemistry, Virginia Tech, 900 West Campus Drive, Blacksburg, Virginia 24061, United States

<sup>§</sup>Departments of Chemistry and Molecular Biosciences, Northwestern University, 2145 Sheridan Road, Evanston, Illinois 60208, United States

### S Supporting Information

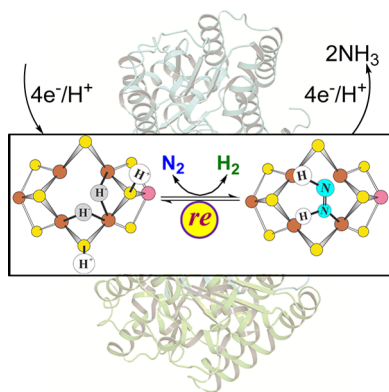

### CONTENTS

1. Introduction	4041
2. Background	4043
2.1. Kinetics and Stoichiometry	4043
2.2. Trapping and Characterization of Substrates	4044
3. Intermediates of Nitrogenase Activation	4044
3.1. E <sub>1</sub> –E <sub>3</sub>	4044
3.2. E <sub>4</sub> : The “Janus Intermediate”	4044
3.3. Redox Behavior and Hydride Chemistry of E <sub>1</sub> –E <sub>3</sub> : Why Such a Big Catalytic Cluster?	4046
3.4. Why Does Nitrogenase Not React with H <sub>2</sub> /D <sub>2</sub> /T <sub>2</sub> in the Absence of N <sub>2</sub> ?	4047
4. “Dueling” N <sub>2</sub> Reduction Pathways	4047
5. Intermediates of N <sub>2</sub> Reduction: E <sub>n</sub> , n ≥ 4	4048
5.1. Intermediate I	4048
5.2. Nitrogenase Reaction Pathway: D versus A	4048
5.3. Intermediate H	4049
6. Unification of the Nitrogenase Reaction Pathway with the LT Kinetic Scheme	4050
7. Obligatory Evolution of H <sub>2</sub> in Nitrogen Fixation: Reductive Elimination of H <sub>2</sub>	4050
7.1. Hydride Protonation (hp) Mechanism	4051
7.2. Reductive Elimination (re) Mechanism	4051
7.3. Mechanistic Constraints Reveal That Nitrogenase Follows the re Mechanisms	4051
8. Test of the re Mechanism	4052
8.1. Predictions	4053
8.2. Testing the Predictions	4053
9. Completing the Mechanism of Nitrogen Fixation	4054
9.1. Uniqueness of N <sub>2</sub> and Nitrogenase	4055

9.2. Structure of the E <sub>4</sub> (N <sub>2</sub> ) Intermediate: Some Implications	4056
10. Summary of Mechanistic Insights	4056
10.1. Catalytic Intermediates of N <sub>2</sub> Fixation	4056
10.2. re Mechanism	4056
10.3. Turnover under N <sub>2</sub> /D <sub>2</sub> /C <sub>2</sub> H <sub>2</sub> as a Test of the re Mechanism	4057
11. Conclusions	4057
Associated Content	4057
Supporting Information	4057
Author Information	4057
Corresponding Authors	4057
Notes	4058
Biographies	4058
Acknowledgments	4058
References	4058

### 1. INTRODUCTION

Nitrogen is an essential element contained in many biomolecules necessary to sustain life.<sup>1,2</sup> This element is abundantly available in Earth’s atmosphere in the form of dinitrogen (N<sub>2</sub>) gas, yet most organisms are unable to metabolize N<sub>2</sub> because it is relatively inert.<sup>3,4</sup> Instead most organisms must obtain their N from “fixed” forms such as ammonia (NH<sub>3</sub>) or nitrate (NO<sub>3</sub><sup>−</sup>).<sup>5–7</sup> Because fixed forms of N are continuously sequestered into sediments, rendering them unavailable for metabolism, and because they are also continuously converted to N<sub>2</sub> through the combined processes of nitrification and denitrification, life can only be sustained by conversion of N<sub>2</sub> to NH<sub>3</sub>.<sup>6,7</sup> This latter process is known as N<sub>2</sub> fixation<sup>8</sup> and is a critical step in the biogeochemical N cycle.<sup>5,7,9</sup> N<sub>2</sub> fixation occurs in three different ways: (i) through geochemical processes such as lightning,<sup>9</sup> (ii) biologically through the action of the enzyme, nitrogenase,<sup>10,11</sup> found only in a select group of microorganisms,<sup>12,13</sup> and (iii) industrially through the Haber–Bosch process.<sup>2,14,15</sup> From the evolution of nitrogenase, approximately two billion years ago<sup>16</sup> until the widespread use of the Haber–Bosch process in the 1950s, all life derived N from biological nitrogen fixation, with geochemical processes representing a minor contributor to the

**Special Issue:** 2014 Bioinorganic Enzymology

**Received:** November 5, 2013

**Published:** January 27, 2014

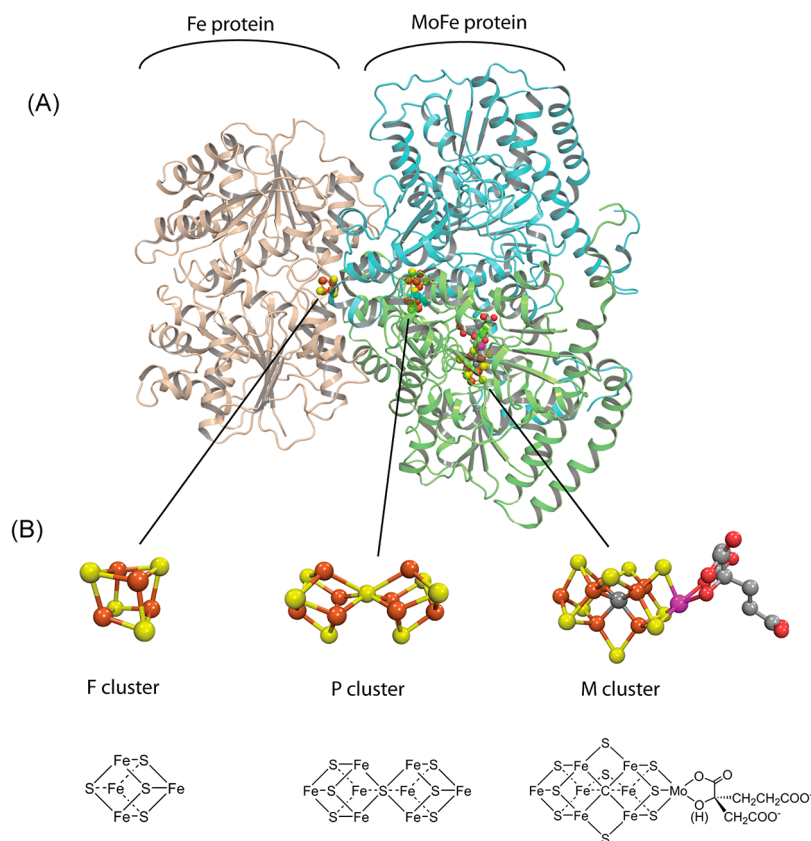

**Figure 1.** Molybdenum nitrogenase. (A) One catalytic half of the Fe protein:MoFe protein complex with the Fe protein homodimer shown in tan, the MoFe protein  $\alpha$  subunit in green, and the  $\beta$  subunit in cyan. (B) Space filling and stick models for the 4Fe–4S cluster (F), P-cluster (P), and FeMo-co (M). Made with Pymol and ChemDraw using PDB:2AFK.

supply of fixed nitrogen.<sup>2,7</sup> Since the increase in use of the Haber–Bosch process, the biological and industrial processes contribute comparably to  $N_2$  fixation.<sup>5,7,9</sup>

Nitrogen fixation has a profound agronomic, economic, and ecological impact owing to the fact that the availability of fixed nitrogen represents the factor that most frequently limits agricultural production throughout the world.<sup>2</sup> Indeed, nearly half of the existing human population could not exist without application of the Haber–Bosch process for production of nitrogen fertilizers.<sup>2,5</sup> Given that over half of the fixed nitrogen input that sustains Earth’s population is supplied biologically, there has been intense interest in understanding how the nitrogenase enzyme accomplishes the difficult task of  $N_2$  fixation at ambient temperature and pressure.<sup>17,18</sup> An understanding of biological  $N_2$  fixation may further serve as the foundation for achieving two highly desirable, although so far unmet, goals: genetically endowing higher plants with the capacity to fix their own nitrogen,<sup>19–21</sup> and developing improved synthetic catalysts based on the biological mechanism.<sup>3,4,22–25</sup>

It has been over 150 years since Jodin first suggested that microbes could “fix”  $N_2$ ,<sup>26</sup> and more than a century since the first isolation of  $N_2$ -fixing bacteria around 1900. In 1934, Burk coined the term “nitrogenase”<sup>10,11</sup> for the enzyme that catalyzes the conversion of  $N_2$  to a bioaccessible form of nitrogen, and initiated the first meaningful studies of nitrogenase in living cells. Methods for extracting nitrogenase in an active form were developed in the early 1960s,<sup>27–29</sup> opening the way for serious mechanistic investigations. The next 35 years witnessed intensive efforts by numerous investigators to reveal the

structure and catalytic function of nitrogenase.<sup>30–34</sup> These developments were summarized in the magisterial review by Burgess and Lowe in 1996.<sup>17</sup> Key advances in understanding nitrogenase structure and function during those intervening years included the following: (i) It was determined that nitrogenase is a two-component system<sup>35–37</sup> composed of the MoFe protein (also called dinitrogenase or component I) and the electron-transfer Fe protein (also called dinitrogenase reductase or component II).<sup>34,38–41</sup> (ii) A reducing source and MgATP are required for catalysis.<sup>42–45</sup> (iii) Fe protein and MoFe protein associate and dissociate in a catalytic cycle involving single electron transfer and MgATP hydrolysis.<sup>38</sup> (iv) It was discovered that the MoFe protein contains two metal clusters: the iron–molybdenum cofactor (FeMo-co),<sup>30,46</sup> which provides the active site for substrate binding and reduction, and P-cluster, involved in electron transfer from the Fe protein to FeMo-co.<sup>39,47–50</sup> (v) Crystallographic structures were solved for both Fe<sup>51</sup> and MoFe<sup>32,48,52–54</sup> proteins. (vi) Also, the alternative V- and Fe-type nitrogenases, in which the Mo of FeMo-co is replaced by V or Fe, were discovered.<sup>18</sup> Despite this accumulation of functional and structural information, the catalytic mechanism remained elusive.

The years since the Burgess and Lowe review<sup>17</sup> have seen profound advances in understanding many aspects of nitrogenase structure and function. For example, the solutions of a number of high-resolution X-ray structures of the nitrogenase component proteins<sup>55–69</sup> have provided insights into the nature of the active site FeMo-cofactor, most recently identifying the presence of an interstitial C atom,<sup>70–77</sup> while structures of the two proteins in the complex<sup>78–81</sup> have identified their binding

interface (Figures 1 and 2) and its alterations with the state of the bound nucleotide.<sup>67</sup> Likewise, great strides have been made

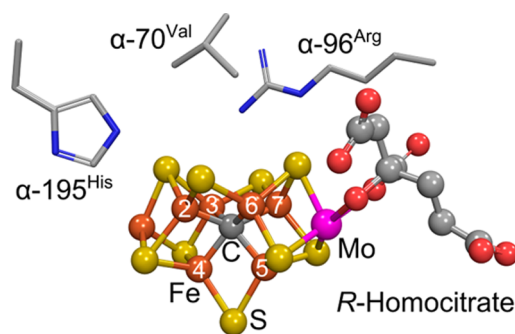

**Figure 2.** FeMo-cofactor and the side chains of selected amino acid residues of the MoFe protein. Numbering of iron atoms is according to the structure PDB coordinate 2AFK. Iron is shown in rust, molybdenum in magenta, nitrogen in blue, sulfur in yellow, carbon in gray, and oxygen in red.

in understanding the biosynthesis and insertion of the metal clusters of nitrogenase to form the mature proteins,<sup>21,82–89</sup> and the properties of the V-type nitrogenase.<sup>90–98</sup> Recent studies have begun to shed light on the order of events during the catalytic cycle,<sup>99–103</sup> including the nature of electron transfer between the metal clusters<sup>62,104–111</sup> and the roles of ATP binding and hydrolysis in these processes.<sup>55,68,99,112–121</sup> Considerable progress has been made in the application of theoretical methods to various aspects of the nitrogenase mechanism.<sup>122–140</sup> Finally, progress has been made in expanding in the substrates of nitrogenases<sup>93,141–149</sup> to include CO<sup>95,96,98,150,151</sup> and CO<sub>2</sub>.<sup>148,152</sup>

The present narrative focuses on recent progress in understanding the mechanism of N<sub>2</sub> activation and reduction to ammonia by Mo-nitrogenase. The discussion begins with a short reminder of the kinetic scheme that describes nitrogenase catalysis.<sup>33,103</sup> It then turns to the successes in trapping catalytic intermediates of the MoFe protein by rapid freezing of turnover mixtures of Fe protein and of MoFe proteins, both wild-type and variants containing selected amino acid substitutions as a means to modulating reactivity.<sup>146,148,153,154</sup> The use of EPR/ENDOR/ESEEM spectroscopic techniques applied to isotopically substituted trapped intermediates has allowed the identification and characterization of key intermediates along the N<sub>2</sub> reduction pathway.<sup>154–156</sup> This led to the formulation of a reaction mechanism based on the properties of catalytic intermediates and grounded in the reaction of hydrides associated with FeMo-co.<sup>156</sup> The mechanism not only satisfies all constraints on the mechanism provided by earlier studies, but has suggested *and passed* a stringent test.<sup>157</sup> This report recounts these advances, *and expands* on them.

## 2. BACKGROUND

Two issues require consideration as a basis for discussion of recent advances in nitrogenase mechanism.<sup>155,156</sup> The first is the kinetic model that has been developed to describe the multistep reduction of N<sub>2</sub> to two NH<sub>3</sub>, and its implications for the stoichiometry of this reaction,<sup>33,103</sup> implications that were mutually supported by experiment.<sup>158</sup> The second is the strategies and procedure that at last enabled the trapping of catalytic intermediates whose characterization by advanced

paramagnetic resonance techniques underlies the progress in mechanism described here.

### 2.1. Kinetics and Stoichiometry

A “kinetic” foundation for a nitrogenase mechanism was developed by extensive studies in the 1970s and 1980s by many groups, especially Lowe and Thorneley and their co-workers.<sup>17,33,103</sup> The culmination of these extensive kinetic studies, which involved steady-state, stopped-flow, and freeze–quench kinetics measurements, was the Lowe–Thorneley (LT) kinetic model for nitrogenase function,<sup>17,33,103</sup> which describes the kinetics of transformations among catalytic intermediates (denoted E<sub>*n*</sub>) where *n* is the number of steps of electrons/protons delivery to MoFe protein, Figure 3. Electron transfer

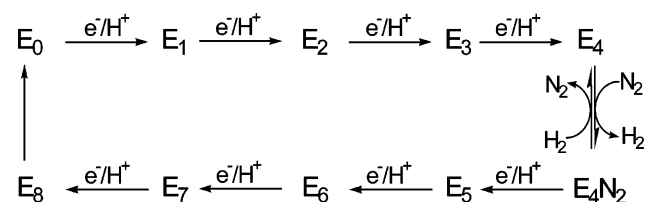

**Figure 3.** Simplified LT kinetic scheme that highlights correlated electron/proton delivery in eight steps. Although in the full LT scheme N<sub>2</sub> binds at either the E<sub>3</sub> or E<sub>4</sub> levels, the pathway through E<sub>3</sub> is de-emphasized here. LT also denotes the protons bound to FeMo-co (e.g., E<sub>1</sub>H<sub>1</sub>); for clarity we have omitted these protons in this scheme.

from Fe protein to MoFe protein is driven by the binding and hydrolysis of two MgATP species within the Fe protein;<sup>99</sup> the *release* of the Fe protein after delivery of its electron is the rate-limiting step of catalysis.<sup>33</sup>

A central consequence of the kinetic measurements and defining feature of this scheme, Figure 3, is that the limiting enzymatic stoichiometry for enzyme-catalyzed nitrogen fixation is not what would be given by the simple balanced equation for reduction of N<sub>2</sub> to two NH<sub>3</sub> by six electrons/protons, but is given by eq 1

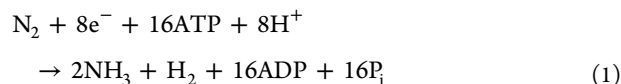

This is a conclusion that is in agreement with stoichiometric experiments by Simpson and Burris.<sup>158</sup> This equation highlights several key aspects of the nitrogenase mechanism, including the involvement of ATP hydrolysis in substrate reduction and the obligatory formation of 1 mol of H<sub>2</sub> per mole of N<sub>2</sub> reduced, an apparent “waste” of two reducing equivalents and four ATP per N<sub>2</sub> reduced.<sup>17,33</sup>

Although the close of the previous millennium saw the accumulation of a vast breadth and depth of information about the reduction of N<sub>2</sub>, H<sup>+</sup>, and a variety of other nonphysiological substrates,<sup>17</sup> it was not until recently that studies have succeeded in characterizing E<sub>*n*</sub> intermediate states beyond the resting-state E<sub>0</sub>.<sup>154–156</sup> Thus, the early studies provided little direct experimental evidence regarding a reaction pathway, and hence, there was no possibility of integrating a reaction pathway and kinetic scheme, as is central to development of a mechanism based on the properties of catalytic intermediates.<sup>156</sup>

## 2.2. Trapping and Characterization of Substrates

The first 40 years of study of purified nitrogenase did not see the definitive characterization of any intermediates associated with the binding and reduction of  $N_2$ ,<sup>159</sup> leaving the identity of the reaction pathway unresolved. The way forward was provided by studies of nitrogenases with individual amino acid substitutions, which revealed that the residue at position  $\alpha$ -70 within the MoFe protein, a valine, acts as a “gatekeeper” that sterically controls the access of substrate to the active site FeMo-co (Figure 2).<sup>146,154</sup> The side chain of this amino acid residue is located over one FeS face of FeMo-cofactor (that includes Fe atoms 2, 3, 6, and 7) thereby also implicating Fe as the site of substrate binding, while the  $\alpha$ -19S<sup>His</sup> was inferred to be involved in proton delivery (Figure 2).<sup>160–165</sup>

Use of MoFe protein substituted at one or both of these residues enabled freeze–quench trapping of a number of nitrogenase turnover intermediates, almost all of which show an EPR signal arising from an  $S = 1/2$  state of FeMo-co, rather than the  $S = 3/2$  state of resting-state FeMo-co.<sup>153,154</sup> The procedures developed with these variants even enabled  $N_2$ –intermediate trapping with enzyme.<sup>166</sup> The first fruit of this approach was the trapping of a state during reduction of the alkyne propargyl alcohol to the corresponding alkene.<sup>145,167</sup> An intermediate trapped using MoFe protein variants was shown by ENDOR studies to be a wholly novel bio-organometallic structure in which the alkene product of alkyne reduction by nitrogenase binds as a  $\pi$ -complex/ferracycle to a single Fe ion of FeMo-cofactor, presumed to be Fe<sup>0</sup>.<sup>168</sup> This was followed by characterization of intermediates formed during the reduction of  $H^+$  under Ar,<sup>169</sup> and, finally, identification of four associated with  $N_2$  reduction itself.<sup>147,153,160,166,170,171</sup>

Paramagnetic resonance methods have proven to be uniquely advantageous for characterization of trapped nitrogenase intermediates.<sup>155</sup> At the most basic level, FeMo-co in the  $E_0$  resting-state of MoFe protein is an odd-electron (“Kramers”; half-integer spin,  $S = 3/2$ <sup>172</sup>), EPR-active cluster, and therefore, intermediate states that have accumulated an even number of electrons also will be EPR-active. Focusing on nitrogen fixation, FeMo-co then will be EPR-active in the  $E_n$  states,  $n = 2, 4, 6, 8$ , formed along the pathway for accumulation of the stoichiometrically required eight  $[e^-/H^+]$ , eq 1. In contrast,  $E_n$  states  $n = 1, 3, 5, 7$  will be even-electron, and FeMo-co will either be diamagnetic or in an integer-spin (“non-Kramers” spin-state)<sup>173</sup> cluster, which also can be EPR-active under appropriate conditions.<sup>173,174</sup>

As will be illustrated below, electron–nuclear double-resonance (ENDOR) spectroscopy,<sup>175,176</sup> supported by related techniques ESEEM and HYSCORE,<sup>177</sup> is uniquely suited for the study of freeze–quench trapped intermediates. These techniques give NMR-like spectra of nuclei that are hyperfine-coupled to the electron spin of an EPR-active cluster. The importance of the techniques rests on several aspects. ENDOR is *broad-banded*: with isotopic enrichment it can monitor *every* atom in a metalloenzyme active site. Thus, when interpreted in the context of the X-ray structure of the resting-state, it can reveal the electronic and metrical structure of a catalytic intermediate. It is *selective*: it interrogates only EPR-active states. It is *high-resolution*: it can resolve and interrogate the signals from multiple distinct EPR-active centers. It is *sensitive*: we have successfully analyzed the properties of intermediates present in  $\sim 20\%$  abundance in a sample containing  $\sim 100 \mu M$  MoFe protein. Viewed another way, ENDOR is capable of

selecting and characterizing a small fraction of the MoFe protein in a sample. In contrast, for example, Mössbauer and X-ray absorption techniques, which have made enormous contributions to the study of resting-state nitrogenase, interrogate all FeMo-co in a sample, and if the state of interest is a small minority, its signal is buried and lost. Recently, however, an X-ray spectroscopic study has given information about a freeze–quenched nitrogenase intermediate.<sup>178</sup>

## 3. INTERMEDIATES OF NITROGENASE ACTIVATION

According to the simplified LT kinetic scheme of Figure 3, the first four of the eight  $[e^-/H^+]$  of nitrogen fixation accumulate *prior* to  $N_2$  binding, which occurs at the  $E_4$  stage. The complete scheme<sup>17,33,103</sup> allows for  $N_2$  binding at  $E_3$  as well, but  $E_4$  uniquely places the enzyme on the pathway to  $N_2$  hydrogenation.

### 3.1. $E_1$ – $E_3$

The  $E_1$  state contains one-electron reduced cofactor, and has been assigned as an integer-spin species on the basis of Mössbauer studies of MoFe protein trapped during turnover under  $N_2$ .<sup>179,180</sup>

High-spin EPR signals ( $S = 3/2$ ), denoted as 1b and 1c, thought to be associated with  $E_n$  states,  $n \leq 4$ , were first observed 35 years ago for samples of wild-type nitrogenase trapped during turnover using a variety of conditions,<sup>181</sup> and more recently were studied by rapid freeze–quench EPR.<sup>182</sup> The kinetics of appearance of 1b and 1c demonstrated that they must be assigned to reduced states of cofactor,  $n > 1$ , rather than just as conformers of the FeMo-co resting-state. However, the kinetics of appearance of the stronger 1b signal was a puzzle: they were best described by assigning 1b to the  $E_3$  state, which would seem to require that FeMo-co be in an integer-spin (non-Kramers) state, contrary to observation. Most likely, this apparent contradiction reflects uncertainties in the rate constants used in the kinetics analysis, and 1b represents an  $E_2$  state. During cryoannealing experiments<sup>183</sup> discussed below, we definitively observed that FeMo-co of  $E_2$  is in a high-spin ( $S = 3/2$ ) state, but at least in the  $\alpha$ -70<sup>Ile</sup> variant its  $g$ -values were distinct from those of 1b. The spectrum of the 1c species is weaker in intensity. It may represent a conformer of the resting or 1b states, or may correspond to even more reduced states, as its effective formation requires a high molar ratio of Fe protein to MoFe protein, corresponding to higher electron flux.

### 3.2. $E_4$ : The “Janus Intermediate”

In this subsection we describe the trapping and EPR/ENDOR characterization of the  $E_4$  intermediate as activated by the accumulation of four  $[e^-/H^+]$  for binding and reduction of  $N_2$ . The structure of  $E_4$  as determined by ENDOR spectroscopy, and integrated into the LT kinetic scheme, has been the key to recognizing the central role of hydrides in the mechanism for nitrogen fixation.<sup>156</sup> We then discuss the  $E_1$ – $E_4$  states associated with electron accumulation by MoFe protein; subsequent sections discuss the trapped states associated with the  $N_2$  reduction pathway following  $N_2$  binding.

Early in the search for intermediates,<sup>146</sup> the  $\alpha$ -70<sup>Val→Ile</sup> substitution in the MoFe protein was shown to deny access of all substrates to the active site, except protons.<sup>169,184</sup> Samples of this substituted MoFe protein freeze–quenched during turnover under Ar exhibited a new  $S = 1/2$  EPR signal,<sup>169</sup> which also can be observed at lower concentrations during turnover of wild-type MoFe protein under Ar.<sup>181,185</sup>  $^1H$  ENDOR spectroscopic analysis of this trapped state<sup>169</sup> revealed the

presence of two strongly hyperfine-coupled, metal-bridging hydrides  $[M-H-M']$ : (i) The finding that the bound hydrides have a large isotropic hyperfine coupling,  $a_{\text{iso}} \approx 24$  MHz, led to their assignment as hydrides bound to metal ion(s) of the core. (ii) The anisotropic hyperfine contribution,  $T = [-13.3, 0.7, 12.7]$  MHz, exhibits almost complete rhombicity, as defined by the form  $T_{\text{rh}} \approx [t, 0, -t]$ . This form rules out terminal hydrides, which would have a roughly axial  $T$ ,<sup>186</sup> and is precisely the form first predicted<sup>187</sup> and then confirmed<sup>188</sup> to be associated with a hydride bridging two paramagnetic metal ions, namely as  $[Fe-H-Fe]$  and/or  $[Mo-H-Fe]$  fragments.

<sup>95</sup>Mo ENDOR measurements subsequently established that both hydrides bridge two Fe ions, forming two  $[Fe-H-Fe]$  fragments (Figure 4), as follows.<sup>189</sup> Equations for the

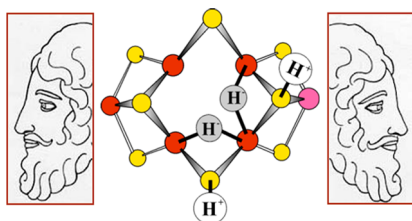
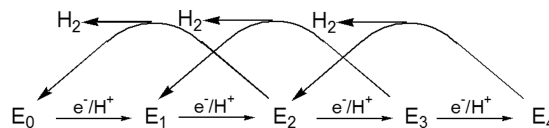

**Figure 4.** Depiction of  $E_4$  as containing two  $[Fe-H-Fe]$  moieties, emphasizing the essential role of this key “Janus intermediate”, which comes at the halfway point in the LT scheme, having accumulated four  $[e^-/H^+]$ , and whose properties have implications for the first and second halves of the scheme. Janus image adapted from [http://www.plotinus.com/janus\\_copy2.htm](http://www.plotinus.com/janus_copy2.htm). Figure adapted with permission from ref 156. Copyright 2013 American Chemical Society.

anisotropic hyperfine interaction matrix,  $T$ , of a nucleus that undergoes through-space dipolar interactions to two spin-coupled metal ions<sup>187</sup> were generalized to describe an arbitrary  $[M_1-H-M_2]$  fragment of a spin-coupled cluster. The components of  $T$  are a function of the  $[M_1-H-M_2]$  geometry and of the coefficients  $[K_1, K_2]$  that describe the projection of the total cluster spin on the two local  $M$ -ion spins. The <sup>95</sup>Mo ENDOR measurements of the intermediate showed a very small isotropic hyperfine coupling,  $a_{\text{iso}}(^{95}\text{Mo}) \sim 4$  MHz, which indicated that  $K_{\text{Mo}}$  is too small to yield the rhombic dipolar coupling,  $T_{\text{rh}}$ , observed in this intermediate.<sup>189</sup> The model for  $E_4$  displayed in Figure 4 is completed by placement on sulfurs of the two protons<sup>190,191</sup> that form part of the delivery of  $4[e^-/H^+]$  (Figure 3). The protons are so placed because they must be near to the negative charge density associated with the hydrides in order to obtain the electrostatic stabilization implicit in the required accumulation of one proton for each electron delivered to MoFe protein;<sup>17</sup> other arrangements are possible, such as putting both protons on doubly bridging sulfur, but see below.

Cryoannealing this “dihydride” intermediate in the frozen state at  $-20$  °C, which prevents further delivery of electrons from the Fe protein, showed that it relaxes to the resting FeMo-co state by the successive loss of two  $H_2$  molecules.<sup>183</sup> According to the LT scheme, only  $E_4$  would undergo this two-step relaxation process (Scheme 1), with the first relaxation step of  $E_4$  yielding  $H_2$  and the  $E_2$  state, the second step returning FeMo-co to the  $E_0$  stage with loss of a second  $H_2$ , and the production of  $H_2$  being revealed by solvent kinetic isotope effects in both stages. This relaxation protocol thus revealed that the trapped intermediate is the  $E_4$  state, which has accumulated  $n = 4$  electrons and protons.<sup>183</sup> As the relaxation

**Scheme 1**



measurements involved tracking the kinetically linked conversion of  $E_4$  into  $E_2$ , and the conversion of  $E_2$  into resting-state  $E_0$ , the measurements further allowed an unambiguous identification of the EPR signal associated with  $E_2$  (see above).

Examination of the simplified version of the LT scheme of Figure 3 reveals that  $E_4$  is a key stage in the process of  $N_2$  reduction.<sup>33,103</sup> Indeed, we have denoted it as the “Janus” intermediate, referring to the Roman God of transitions who is represented with two faces, one looking to the past and one looking to the future (Figure 4).<sup>156</sup> Looking “back” from  $E_4$  to the steps by which it is formed,  $E_4$  is the culmination of one-half of the electron/proton deliveries during  $N_2$  fixation: four of the eight reducing equivalents are accumulated in  $E_4$ , before  $N_2$  even becomes involved. Looking “forward”, toward  $NH_3$  formation,  $E_4$  is the state at which  $N_2$  hydrogenation begins, and it is involved in one of the biggest puzzles in  $N_2$  fixation: “why” and “how”  $H_2$  is lost upon  $N_2$  binding.

To date, we have visualized  $E_4$  by placing its two hydrides on the Fe2, 3, 6, 7 face of resting-state FeMo-co and sharing a common vertex at Fe6, Figure 4. Although the hydrides may well exhibit fluxionality at ambient temperature, their ability to adopt a configuration with a common vertex is required by the reductive elimination (re) mechanism of reversible  $H_2$  release upon  $N_2$  binding (section 7), and Fe6 is favored from earlier kinetic studies on MoFe protein variants.<sup>69,144,145,154,166,168</sup>

However, this model is only one of four possible configurations based on the resting structure that have two hydrides sharing an Fe6 vertex. To visualize these structures we have built the bound hydrides onto the crystal structure of resting-state FeMo-co using Fe–H distances from model complexes,<sup>188,192</sup> Figure 5.

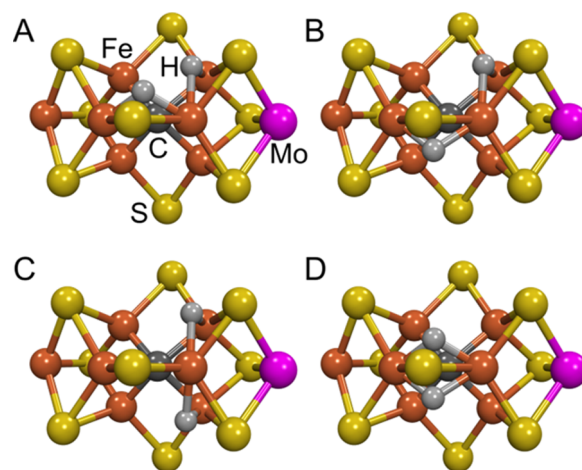

**Figure 5.** Mockups of the “Janus”  $E_4$  intermediate in which the two bridging hydrides  $[Fe-H-Fe]$  revealed by ENDOR spectroscopy are built onto the resting-state crystal structure. These models of FeMo-co have Fe6 as a “vertex” for the two bridging hydrides to facilitate reductive elimination. The figure was generated using the coordinate file PDB:2AFK. Iron is shown in rust, molybdenum in magenta, sulfur in yellow, carbon in dark gray, and hydrogen in light gray.

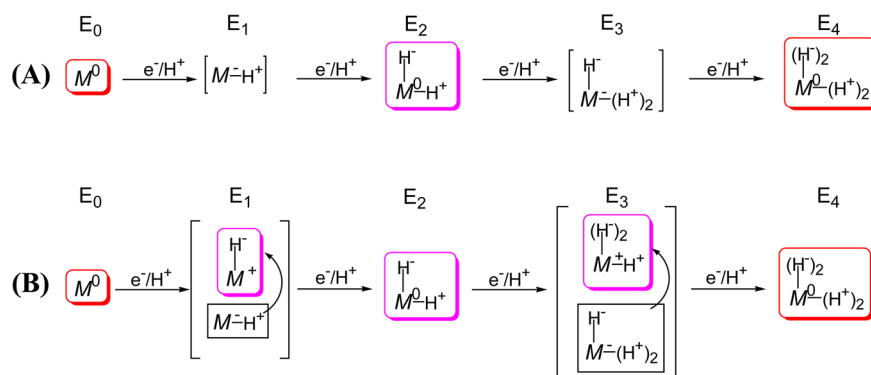

**Figure 6.** Formulations of E<sub>1</sub>–E<sub>4</sub> derived from consideration of E<sub>4</sub> as containing two bound hydrides and two protons. (A) Assuming reduction of the core in  $n = 1, 3$  states. (B) Alternative formulation of E<sub>1</sub>–E<sub>4</sub> under the assumption of hydride formation at every stage, in which case the core is formally oxidized for E<sub>*n*</sub>,  $n = 1, 3$ . Symbols: M represents FeMo-co core; superscripts are charge difference between core and that of resting-state (commonly denoted M<sup>N</sup>); the number of bound protons/hydrides are indicated. Adapted with permission from ref 156. Copyright 2013 American Chemical Society.

Quantum chemical computations will test these alternatives. However, the experimentally determined relative orientation of the hyperfine tensors of the two hydrides provides a significant constraint on their placement within E<sub>4</sub>. Given the stability of the FeMo-co structure that is likely imparted by the interstitial carbide, it seemed plausible to us that consideration of the constructed models of Figure 5 would allow us to test these alternative hydride distributions, even though it is beyond doubt that the structure of FeMo-co will distort upon substrate binding. This exercise (see Supporting Information) provides support for the *topology* of hydride binding pictured for the Janus E<sub>4</sub> intermediate in Figure 4, with hydrides bridging Fe2/Fe6 and Fe6/Fe7 (Figure 5A,B), as opposed to Figure 5C,D, but does not discriminate between the structures of Figure 5A,B. In discussions below, we retain the placement of the E<sub>4</sub> hydrides shown in Figure 4 (Figure 5A) as being more readily visualized in discussions of mechanism.

The characterization of the hyperfine interactions of the metal-ion core of E<sub>4</sub> that began with the <sup>95</sup>Mo ENDOR measurements<sup>189</sup> was completed by an ENDOR study of the <sup>57</sup>Fe atoms of the E<sub>4</sub> FeMo-co through use of a suite of advanced ENDOR methods.<sup>193</sup> The determination of hyperfine interactions for two ligand hydrides and all eight metal ions of FeMo-cofactor in this state will provide the experimental test that guides future computational studies that seek to characterize the geometric and electronic structure of E<sub>4</sub>.

Storage of the reducing equivalents accumulated in the E<sub>4</sub> state as bridging hydrides has major consequences. A bridging hydride is less susceptible to protonation than a terminal hydride, and thus bridging hydride(s) diminish the tendency to lose reducing equivalents through the formation of H<sub>2</sub> (Scheme 1), thereby facilitating the accumulation of reducing equivalents by FeMo-co. This mode also lowers the ability of the hydrides to undergo exchange with protons in the environment, a characteristic that is shown to be of central importance below. However, the bridging mode also lowers hydride reactivity toward substrate hydrogenation, relative to that of terminal hydrides.<sup>194,195</sup> As a result, substrate hydrogenation most probably incorporates the conversion of hydrides from bridging to terminal binding modes.<sup>196</sup> We next discuss how the structure found for E<sub>4</sub> guides assignment of structures for the E<sub>1</sub>–E<sub>3</sub> states. Subsequently, we show how the E<sub>4</sub> structure defined possible mechanisms for coupling H<sub>2</sub> loss to N<sub>2</sub> binding.

### 3.3. Redox Behavior and Hydride Chemistry of E<sub>1</sub>–E<sub>3</sub>: Why Such a Big Catalytic Cluster?

Given that the four accumulated electrons of E<sub>4</sub> reside not on the metal ions but, instead, are formally assigned to the hydrides of the two Fe-bridging hydrides, what then are the proper descriptions of E<sub>1</sub>–E<sub>3</sub>? The addition of one electron/proton to the MoFe protein results in the E<sub>1</sub> state, and a Mössbauer study of nitrogenase trapped during turnover under N<sub>2</sub><sup>180</sup> suggested that this state contains the reduced metal-ion core of FeMo-co, denoted M<sup>-</sup> in Figure 6A. The presence in E<sub>4</sub> of two bridging hydrides/two protons led us to propose that upon delivery of the second electron/proton to form E<sub>2</sub> the metal–sulfur core of the FeMo-cofactor “shuttles” both electrons onto one proton to form an [Fe–H–Fe] hydride, leaving the second proton bound to sulfur for electrostatic stabilization and the core formally at the resting-state, M<sup>0</sup>, redox level (also commonly referred to as, M<sup>N</sup>),<sup>197</sup> Figure 6A. A subsequent, analogous, two-stage process would then yield the E<sub>4</sub> state, with its two [Fe–H–Fe] hydrides, two sulfur-bound protons, and the core at the resting-state, M<sup>0</sup>, redox level.<sup>193</sup>

Such a process of acquiring the four reducing equivalents of E<sub>4</sub> involves only a single redox couple connecting two formal redox levels of the FeMo-co *core* of eight metal ions; M<sup>0</sup> the resting-state, and M<sup>-</sup> the one-electron reduced state of the core, Figure 6A.<sup>193</sup> Indeed, comparisons of the <sup>57</sup>Fe ENDOR results for the E<sub>4</sub> intermediate with earlier <sup>57</sup>Fe ENDOR studies and “electron inventory analyses”<sup>155,198</sup> of nitrogenase intermediates led us to the remarkable suggestion that, throughout the nitrogenase catalytic cycle, the FeMo-cofactor would cycle through only two formal redox levels of the metal-ion core. On reflection, it seems obvious that only by “storing” the equivalents as hydrides is it possible to accumulate so much reducing power at the constant potential of the Fe protein. We further proposed that such “simple” redox behavior of a complex metal center might apply to other FeS enzymes carrying out multielectron substrate reductions.<sup>193</sup>

Considering the critical role of hydrides in storing reducing equivalents, we also suggested that the E<sub>1</sub> and E<sub>3</sub> states, respectively, might well contain one and two bridging hydrides bound to a formally *oxidized* metal-ion core (Figure 6B),<sup>100</sup> in which case the single redox couple accessed would formally be that between M<sup>0</sup> and M<sup>+</sup>. In section 9, below we adopt this “oxidative” formulation of the E<sub>1</sub>–E<sub>3</sub> structures. We emphasize

that a third formulation of  $E_1(E_3)$ , with hydride(s) bound to  $M^0$  and the presence of oxidized P-cluster, is ruled out by the absence of EPR signals from  $P^+$  in samples trapped under turnover conditions.

If the FeMo-cofactor does not utilize more than one redox couple during catalysis, then why is it constructed from so many metal ions? As discussed above, the hydrides of  $E_4$  bind to at least two, and plausibly three Fe atoms of a 4-Fe face of FeMo-co, as shown in Figures 4 and 5. It is further possible that catalysis is modulated by the linkage of Fe ion(s) to the anionic atom C that is centrally located within the metal–sulfur core of the FeMo-cofactor.<sup>70,71</sup> Formation of such a 4Fe face and the incorporation of C is not likely with less than a trigonal prism of six Fe ions linked by sulfides to generate these structural features. In this view, the trigonal prismatic FeMo-cofactor core of six Fe ions plus C generates the catalytically active 4Fe face. This prism is capped, and its properties are likely “tuned”, by two “anchor” ions, one Fe plus a Mo, or a V or Fe in the alternative nitrogenases.

Finally, and far from least, as we have consistently noted (see section 7), there is good reason to imagine  $N_2$  and/or the  $N_2H_x$  reduction intermediates may interact with multiple Fe ions on a FeMo-co face.

### 3.4. Why Does Nitrogenase Not React with $H_2/D_2/T_2$ in the Absence of $N_2$ ?

The following question is commonly raised: If electrons accumulated in  $E_n$  intermediates,  $n = 2-4$ , can relax to  $E_{n-2}$  through formation and release of  $H_2$  during turnover, as captured in the partial LT scheme, Scheme 1, why does the enzyme not exhibit the reverse of this reaction, and react with  $H_2/D_2$  in what might appear to be the “microscopic reverse” of  $H_2$  release? We have proposed that  $H_2$  formation involves protonation of an  $[Fe-H-Fe]$ , and at a basic level, all three relaxation processes of Scheme 1 should have much the same characteristics. For simplicity in addressing this issue, we focus on the “first” of these, the  $E_2 \rightarrow E_0$  relaxation, and ask why  $E_0$  is not reduced by  $H_2$  to form  $E_2$ , eq 2



A logical answer to this question begins with the recognition that the LT kinetic scheme for  $N_2$  fixation, Figure 3 (also denoted the “MoFe protein cycle”), and the segment presented in Scheme 1, omit the reactions of the Fe protein for clarity; these are treated as a separate “Fe-protein cycle”.<sup>17,33,103,154</sup> A stoichiometrically correct scheme that merges the Fe protein and MoFe protein cycles is given in Figure 7. It reminds us that  $E_2$  is formed by two steps of  $Fe \rightarrow$  MoFe protein ET, with each step involving hydrolysis of two ATP molecules to drive a reaction that is highly “uphill” energetically.

Clearly the  $E_2 \rightarrow E_0$  relaxation with accompanying loss of  $H_2$  is *not* the “reverse” of the turnover formation of  $E_2$  from  $E_0$ ; neither Fe protein reduction nor ATP formation is involved. Instead, it is a side-reaction of  $E_2$ . Indeed, it is even quite unlikely that a direct reaction of  $H_2$  with  $E_0$  to form  $E_2$  (eq 2) would be the microscopic reverse of the  $E_2 \rightarrow E_0$  relaxation with accompanying loss of  $H_2$ . Moreover, the steric congestion caused by the sulfurs at the six tetrahedral  $[FeS_3C]$  sites of the FeMo-co “waist” requires that the core must relax for the Fe to bind any ligand; in particular it is probable that the structure of the  $[Fe_7S_3MoC]$  core of FeMo-cofactor of  $E_0$  (denoted  $M^N$ ) is altered during the reduction of  $E_0$  by two  $[e^-/H^+]$  to form  $E_2$  (also see section 9.2). In this case, as illustrated in Figure 7, the

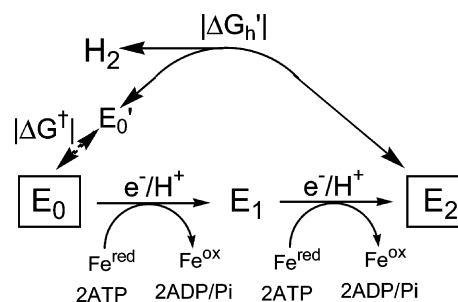

**Figure 7.** Formation and relaxation of  $E_2$ . In-line: The “on-path” two-step, ATP-dependent addition of two  $H^+/e^-$  to MoFe protein to form  $E_2$ . Off-line: Representation of the exergonic (free energy,  $+|\Delta G_h|$ ) “off-path” relaxation of  $E_2$ , liberating  $H_2$  and directly regenerating  $E_0$  without intervention of Fe protein, and of the energetically (free energy,  $+|\Delta G_h|$ ) and kinetically forbidden reverse of this process;  $E_0'$  is a putative intermediate state that causes the reaction of  $E_0$  not to be the microscopic reverse of the release of  $H_2$  from  $E_2$  (see text).

relaxation of  $E_2$  with loss of  $H_2$  to form the resting  $E_0$  state would be a 2-step process. The loss of  $H_2$  by  $E_2$  would be expected to form a state (denoted here  $E_0'$ ) that contains FeMo-cofactor in a conformation approximating that of  $E_2$ , corresponding to a metastable conformation of its resting redox level (denoted  $M^{N'}$ ); this conformer would in turn undergo a  $M^{N'} \rightarrow M^N$  structural relaxation associated with  $E_0' \rightarrow E_0$  relaxation. The reduction of  $E_0$  by  $H_2$  (eq 2) by the microscopic reverse of this two-step relaxation would correspondingly take place in two steps, Figure 7, with the initial  $E_0 \rightarrow E_0'$  thermal activation associated with the conformational change,  $M^N \rightarrow M^{N'}$ , adding an activation free energy (denoted  $|\Delta G^\ddagger|$ ) and kinetic barrier to the endergonic reduction of  $E_0' \rightarrow E_2$  by  $H_2$  (free energy denoted  $|\Delta G_h|$ ).

What would be the free energy for reduction of nitrogenase by  $H_2$ , as in eq 2? An upper bound for the free energy change for this reaction,  $\Delta G_{h2}$ , would be 4 times the negative of the free energy change for the hydrolysis of ATP to form ADP and  $P_i$  ( $-\Delta G_{Hyd} \sim +7$  kcal/mol; total, endergonic by  $\sim +28$  kcal/mol), that is required for the formation of  $E_2$  through the delivery of reducing equivalents by Fe protein; roughly compatible with that, oxidative addition of  $H_2$  to an Fe–S center (hydrogenase), corresponding to  $|\Delta G_h|$ , is uphill by at least  $+20$  kcal/mol,<sup>199,200</sup> to which must be added the conformational free energy  $|\Delta G^\ddagger|$ . Given the strongly endergonic nature of eq 2, coupled with the kinetic penalty associated with the activation of  $E_0$  to  $E_0'$ , it becomes clear why  $H_2$  is not observed to reduce FeMo-cofactor.

## 4. “DUELING” $N_2$ REDUCTION PATHWAYS

Researchers have long considered two competing proposals for the second half of the LT kinetic scheme, the reaction pathway for  $N_2$  reduction that begins with the Janus  $E_4$  state.<sup>17,139,155</sup> These invoke distinctly different intermediates, Figure 8, and computations suggest they likely involve different metal-ion sites on FeMo-co.<sup>139</sup> The “distal” (D) pathway is associated with the Chatt<sup>4,201</sup> or Chatt–Schrock cycle<sup>3</sup> because it is utilized by inorganic Mo complexes discovered by these investigators to cleave  $N_2$  (Chatt and co-workers<sup>202,203</sup>) and, most dramatically, to catalytically fix  $N_2$  (Schrock and co-workers<sup>24,204–206</sup>). In this cycle, which has been suggested to apply to nitrogen fixation by nitrogenase with Mo as the active site,<sup>139</sup> a single N of  $N_2$  is hydrogenated in three steps until the first  $NH_3$  is liberated, and then the remaining nitrido-N is

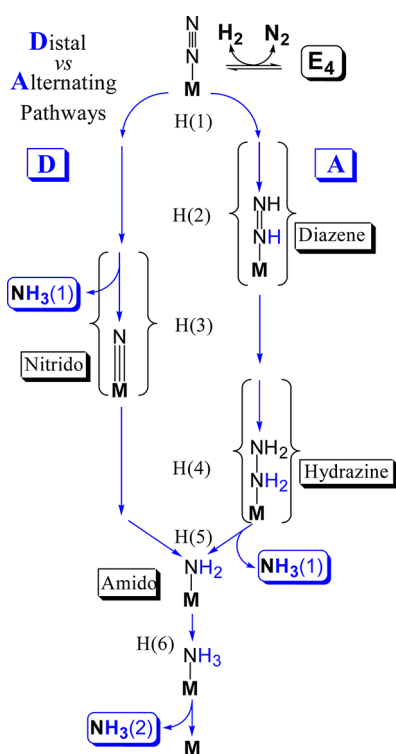

**Figure 8.** Comparison of distal (D) and alternating (A) pathways for  $N_2$  hydrogenation, highlighting the stages that best distinguish them, most especially noting the different stages at which  $NH_3(1)$  is released.

hydrogenated three more times to yield the second  $NH_3$ . In the “alternating” (A) pathway that has been suggested to apply to catalysis at Fe of FeMo-co,<sup>25,131</sup> the first two hydrogenations generate a diazene-level intermediate, the next two form hydrazine, and the first  $NH_3$  is liberated only by the fifth hydrogenation (Figure 8). As one can imagine alternative structures for the intermediates, the figure focuses on the defining difference between D and A pathways as being the release of the first  $NH_3$  in the D as occurring after three hydrogenations of substrate, the addition of three  $[e^-/H^+]$  to substrate, but only after five hydrogenations in A.

Simple arguments can be made for both pathways and for either Fe and Mo as the active site.<sup>17,154,155,207</sup> For example, the A route is suggested by the fact that hydrazine is both a substrate of nitrogenase and is released upon acid or base hydrolysis of the enzyme under turnover,<sup>17,208–211</sup> and is favored in computations with reaction at Fe,<sup>131</sup> while the D route was suggested by the fact that until recently the only inorganic complexes that catalytically fix  $N_2$  employ Mo and function via the D route,<sup>24</sup> which is computationally favored for reaction at Mo.<sup>139</sup> Interestingly, this argument is somewhat weakened by a recent study that reported small W clusters fix  $N_2$  by the A pathway.<sup>212</sup> More significantly, the argument based on  $N_2$  cleavage and catalytic  $N_2$  fixation by Mo model complexes has lost ground by the quite recent discovery of Fe model complexes that cleave  $N_2$  (Holland and co-workers<sup>22,213</sup>) and indeed that also catalytically fix  $N_2$  (Peters and co-workers<sup>214</sup>).

Further support for the A pathway is provided by considerations of the alternative nitrogenases. It is most economical to suggest that both the Mo-dependent nitrogenase studied here and the V-type nitrogenase reduce  $N_2$  by the same pathway. As V-nitrogenase produces traces of  $N_2H_4$  while

reducing  $N_2$  to  $NH_3$ ,<sup>215</sup> then according to Figure 8 this enzyme can be concluded to function via the A pathway, implying the same is true for Mo-nitrogenase.

## 5. INTERMEDIATES OF $N_2$ REDUCTION: $E_N$ , $N \geq 4$

As can be seen in Figure 8, characterization of catalytic intermediates formed during the reduction of  $N_2$  could distinguish between the D and A pathways. However, such intermediates had long eluded capture until four intermediates associated with  $N_2$  fixation were freeze-trapped and characterized by ENDOR spectroscopic studies.<sup>154,155</sup> These four states were generated under the hypothesis that intermediates associated with different reduction stages could be trapped using  $N_2$  or semireduced forms of  $N_2$  or their analogues:  $N_2$ ;  $NH=NH$ ;  $NH=N-CH_3$ ;  $H_2N-NH_2$ .<sup>17,153,154</sup> These included a proposed early (e) stage of the reduction of  $N_2$ ,  $e(N_2)$ , obtained from wild-type (WT) MoFe protein with  $N_2$  as substrate,<sup>166,170</sup> two putative “midstage” intermediates,  $m(NH=N-CH_3)$ , obtained from  $\alpha$ -19S<sup>Gln</sup> MoFe protein with  $CH_3-N=NH$  as substrate<sup>170,171</sup> and  $m(NH=NH)$ , obtained from the doubly substituted,  $\alpha$ -70<sup>Ala</sup>/ $\alpha$ -19S<sup>Gln</sup> MoFe protein during turnover with *in-situ*-generated  $NH=NH$ ;<sup>147</sup> and a “late” stage,  $l(N_2H_4)$ , from the  $\alpha$ -70<sup>Ala</sup>/ $\alpha$ -19S<sup>Gln</sup> MoFe protein during turnover with  $H_2N-NH_2$ .<sup>160,170</sup> Both hydrazine and diazene are substrates of wild-type nitrogenase that, like  $N_2$ , are reduced to ammonia.<sup>17,147,160,211,216</sup>

### 5.1. Intermediate I

A combination of X/Q-band EPR and  $^{15}N, ^2H$  ENDOR measurements on the intermediates formed with the three semireduced substrates during turnover of the  $\alpha$ -70<sup>Val</sup>/ $\alpha$ -19S<sup>His</sup>→<sup>Gln</sup> MoFe protein subsequently showed that in fact they all correspond to a common intermediate (here denoted I) in which FeMo-co binds a substrate-derived  $[N_xH_y]$  moiety (Figure 9).<sup>154–156,207</sup> Thus, both the diazenes and hydrazine enter and “flow through” the normal  $N_2$ -reduction pathway (Figure 8), and the diazene reduction must have “caught up” with the “later” hydrazine reaction.

$^2H$  and  $^{15}N$  35 GHz CW and pulsed ENDOR measurements next showed that I exists in two conformers, each with metal ion(s) in FeMo-co having bound a single nitrogen from a substrate-derived  $[N_xH_y]$  fragment.<sup>154,155</sup> Subsequent high-resolution 35 GHz pulsed ENDOR spectra and X-band HYSCORE measurements showed *no* response from a second nitrogen atom, and when I was trapped during turnover with the selectively labeled  $CH_3-^{15}N=NH$ ,  $^{13}CH_3-N=NH$ , or  $C^2H_3-N=NH$ , no signal was seen from the isotopic labels.<sup>207</sup> From these results we concluded the N–N bond had been cleaved in forming I, which thus represents a late stage of nitrogen fixation, after the first ammonia molecule already has been released and only a  $[NH_x]$  ( $x = 2$  or 3) fragment of substrate is bound to FeMo-co.<sup>207</sup>

### 5.2. Nitrogenase Reaction Pathway: D versus A

Given that states that could correspond to I are reached by both A and D pathways (Figure 8), the *identity* of this  $[NH_x]$  moiety need not in itself distinguish between pathways. However, the spectroscopic findings about I, in conjunction with a variety of additional considerations, led us to propose that nitrogenase functions via the A reaction pathway of Figure 8 for reduction of  $N_2$ .<sup>207</sup> As one example, to explain how nitrogenase could reduce each of the substrates,  $N_2$ ,  $N_2H_2$ , and  $N_2H_4$ , to two  $NH_3$  molecules via a common A reaction pathway, one need only postulate that each substrate “joins” the



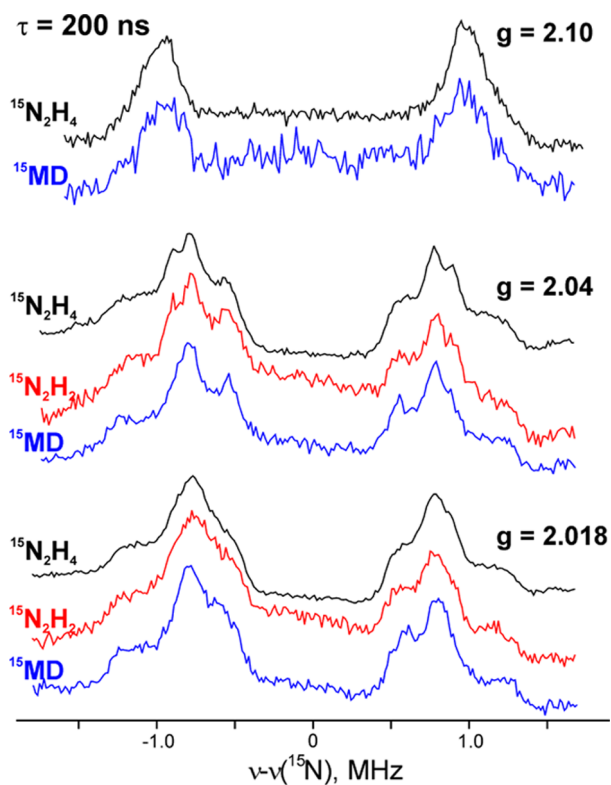

**Figure 9.** Comparison of 35 GHz ReMims pulsed  $^{15}\text{N}$  ENDOR spectra of intermediates trapped during turnover of the  $\alpha\text{-70}^{\text{Ala}}/\alpha\text{-195}^{\text{Gln}}$  MoFe protein with  $^{15}\text{N}_2\text{H}_4$ ,  $^{15}\text{N}_2\text{H}_2$ , and  $^{15}\text{NH}=\text{N}-\text{CH}_3$  (denoted  $^{15}\text{MD}$ ). Adapted with permission from ref 207. Copyright 2011 American Chemical Society.

pathway at the appropriate stage of reduction, binding to FeMo-co that has been “activated” by accumulation of a sufficient number of electrons (possibly with FeMo-co reorganization), and then proceeds along that pathway. Energetic considerations,<sup>139</sup> in combination with the strong influence of  $\alpha\text{-70}^{\text{Val}}$  substitutions of MoFe protein *without* modification of FeMo-co reactivity, then implicate Fe, rather than Mo, as the site of binding and reactivity.<sup>146,154,217</sup>

### 5.3. Intermediate H

When nitrogenase is freeze–quenched during turnover, the EPR signals from trapped intermediates in odd-electron FeMo-co states (Kramers states;  $S = 1/2, 3/2, \dots$ ;  $E_n$ ,  $n = \text{even}$ ),<sup>154,155</sup> plus the signals from residual resting-state FeMo-co, never quantitate to the total FeMo-co present, indicating that EPR-silent states of FeMo-co must also exist. These silent MoFe protein states must contain FeMo-co with an even number of electrons, and thus correspond to  $E_n$ ,  $n = \text{odd}$  ( $n = 2m + 1$ ,  $m = 0-3$ ) intermediates in the LT scheme. As noted above, such states may contain diamagnetic FeMo-co, or FeMo-co in integer-spin ( $S = 1, 2, \dots$ ), “non-Kramers (NK)” states,<sup>179,180,218</sup> but no EPR signal from an integer-spin form of FeMo-co had been detected until careful examination of samples that contain intermediate I<sup>154–156</sup> revealed an additional broad EPR signal at low field in Q-band spectra that arises from an integer-spin system with a ground-state non-Kramers doublet with spin  $S \geq 2$  (Figure 10).<sup>219</sup>

Earlier work showed how to characterize a non-Kramers doublet with ESEEM spectroscopy (NK-ESEEM),<sup>173,174</sup> so NK-ESEEM time-waves were collected for the NK intermediates trapped during turnover with:  $^{14}\text{N}$  and  $^{15}\text{N}$

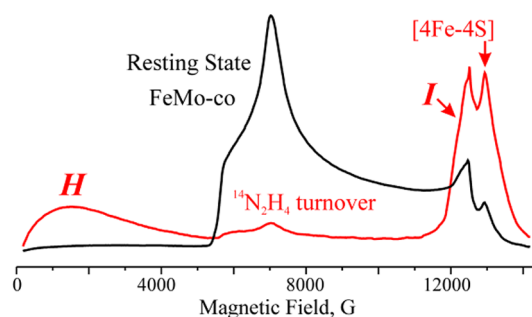

**Figure 10.** 2K Q-band CW EPR spectrum of  $\alpha\text{-70}^{\text{Val}\rightarrow\text{Ala}}$ ,  $\alpha\text{-195}^{\text{His}\rightarrow\text{Gln}}$  MoFe protein in resting-state ( $S = 3/2$ ) and trapped during turnover with  $^{14}\text{N}_2\text{H}_4$ . Kramers intermediate I and non-Kramers intermediate, H, are noted in the turnover spectrum. Adapted with permission from ref 219. Copyright 2012 National Academy of Sciences.

isotopologs of  $\text{N}_2\text{H}_2$  and  $\text{N}_2\text{H}_4$  substrates;  $^{95}\text{Mo}$ -enriched  $\alpha\text{-70}^{\text{Val}\rightarrow\text{Ala}}/\alpha\text{-195}^{\text{His}\rightarrow\text{Gln}}$  MoFe protein; H— $^{14}\text{N}=\text{N}-\text{CH}_3$ , H— $^{15}\text{N}=\text{N}-\text{CH}_3$ , and H— $^{14}\text{N}=\text{N}-\text{CD}_3$ . Figure 11

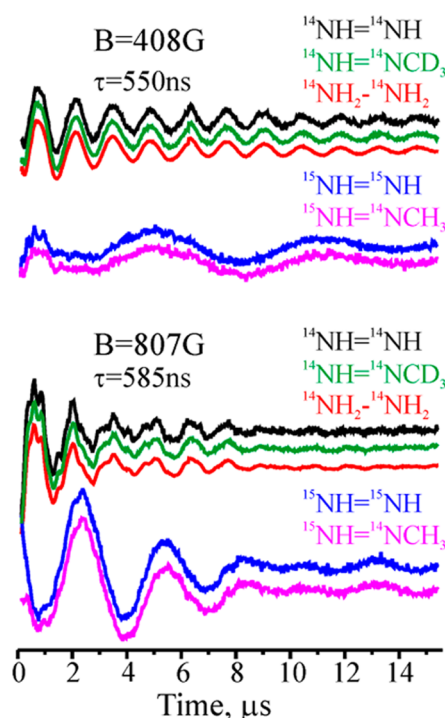

**Figure 11.** Three-pulse ESEEM traces after decay-baseline subtraction for NK intermediate H of  $\alpha\text{-70}^{\text{Val}\rightarrow\text{Ala}}$ ,  $\alpha\text{-195}^{\text{His}\rightarrow\text{Gln}}$  MoFe protein trapped during turnover with  $^{14}\text{NH}=\text{N}-\text{CH}_3$ ,  $^{14}\text{NH}=\text{N}-\text{CD}_3$ ,  $^{14}\text{NH}_2-\text{N}-\text{CH}_3$ ,  $^{15}\text{NH}=\text{N}-\text{CH}_3$ ,  $^{15}\text{NH}=\text{N}-\text{CH}_3$ . Adapted with permission from ref 219. Copyright 2012 National Academy of Sciences.

presents representative 35 GHz (2 K) three-pulse NK-ESEEM time-waves collected at several relatively low fields from the nitrogenase NK intermediates generated with isotopologs of the three substrates. The NK-ESEEM time-waves for the intermediates trapped during turnover with the corresponding  $^{14}\text{N}$  and  $^{15}\text{N}$  isotopologues of  $\text{N}_2\text{H}_2$ ,  $\text{N}_2\text{H}_4$ , and  $\text{HN}_2\text{CH}_3$  substrates are identical at all fields, indicating that they are associated with a common intermediate, denoted H, trapped during turnover with all three substrates.  $^{95}\text{Mo}$  enrichment of  $\alpha\text{-70}^{\text{Val}\rightarrow\text{Ala}}$ ,  $\alpha\text{-195}^{\text{His}\rightarrow\text{Gln}}$  MoFe protein produces a significant

change of the NK-ESEEM time-wave. This analysis established that the NK-EPR signal of **H** arises from the Mo-containing FeMo-co in an integer-spin-state with  $S \geq 2$ , and not the all-iron electron-transfer P cluster, also present in the MoFe protein, or even the  $[4\text{Fe}-4\text{S}]$  cluster of the Fe protein.<sup>219</sup>

Comparison of the  $^{14}\text{N}/^{15}\text{N}$  NK-ESEEM of **H** in Figure 11 indicates that a nitrogenous ligand derived from substrate is directly bound to FeMo-co of  $\alpha\text{-}70^{\text{Val}\rightarrow\text{Ala}}/\alpha\text{-}19\text{S}^{\text{His}\rightarrow\text{Gln}}$  MoFe protein. Modulation is absent from the second  $^{14}\text{N}$  that would be present if the N–N bond of substrate remained intact, as shown by comparison of the time-waves for the **H** prepared with  $\text{H}-^{15}\text{N}=\text{N}-^{15}\text{N}-\text{H}$  versus  $\text{H}-^{15}\text{N}=\text{N}-^{14}\text{N}-\text{CH}_3$ , as is modulation from  $^2\text{H}$  of  $\text{H}-^{14}\text{N}=\text{N}-^{14}\text{N}-\text{CD}_3$ . This indicates that **H** contains an  $\text{NH}_x$  fragment that remains bound to FeMo-co after cleavage of the N–N bond and loss of  $\text{NH}_3$ . Quadrupole coupling parameters for the  $\text{NH}_x$  fragment indicated it is not  $\text{NH}_3$ , and that **H** has bound  $[-\text{NH}_2]$ .<sup>219</sup>

## 6. UNIFICATION OF THE NITROGENASE REACTION PATHWAY WITH THE LT KINETIC SCHEME

The **H** and **I** intermediates provide “anchor-points” that allow assignment of the complete set of  $E_n$  intermediates that follow  $E_4$ ,  $5 \leq n \leq 8$ . As illustrated in Figure 12, the loss of two

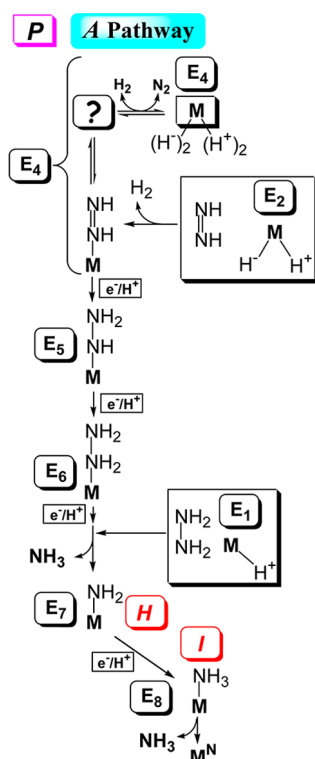

**Figure 12.** Integration of LT kinetic scheme with “prompt” (P) alternating (A) pathway for  $\text{N}_2$  reduction. The ? represents the product of  $\text{N}_2$  binding with  $\text{H}_2$  release, whose identity is discussed below. Also shown is how diazene and hydrazine join the  $\text{N}_2$  reduction pathway. Note: M denotes FeMo-co in its entirety, and substrate-derived species are drawn to indicate stoichiometry only, not mode of substrate binding.  $E_n$  states,  $n = \text{even}$ , are Kramers states;  $n = \text{odd}$  are non-Kramers.  $\text{M}^{\text{N}}$  denotes resting-state FeMo-co. Individual charges on M and a substrate fragment, not shown, sum to the charge on resting FeMo-co. Adapted with permission from ref 156 with corrections based on the re mechanism for  $\text{H}_2$  loss upon  $\text{N}_2$  binding discussed below. Copyright 2013 American Chemical Society.

reducing equivalents and two protons as  $\text{H}_2$  (eq 1) upon  $\text{N}_2$  binding to the FeMo-co of  $E_4$  leaves FeMo-co activated by two reducing equivalents and two protons. We argued that when  $\text{N}_2$  binds to FeMo-co it is “nailed down” by prompt hydrogenation, Figure 12, with  $\text{N}_2$  binding,  $\text{H}_2$  loss, and reduction to the diazene level, all occurring at the  $E_4$  kinetic stage of the LT scheme.<sup>219</sup> The identification of **H** with its  $E_n$  stage is achieved as follows. (i) As the same intermediate **H** is formed during turnover with the two diazenes and with hydrazine, the diazenes must have catalytically “caught up” to hydrazine, and **H** must occur at or after the appearance of a hydrazine-bound intermediate. (ii) As noted above, **H** contains FeMo-co in an integer-spin (NK) state, and thus corresponds to an  $E_n$  state with  $n = \text{odd}$ . As **H** is a common intermediate that contains a bound fragment of substrate, it must, therefore, correspond to  $E_5$  or  $E_7$ , and analysis of the pathway alternatives in the light of the EPR/ESEEM measurements indicated that **H** corresponds to the  $[\text{NH}_2]^-$ -bound intermediate formed subsequent to N–N bond cleavage and  $\text{NH}_3$  release at the  $E_7$  stage of the P–A pathway.

By parallel arguments, the only possible assignment for the  $S = 1/2$  state **I**, which we showed earlier to occur after N–N bond cleavage,<sup>207</sup> is as  $E_8$ : **I** must correspond to the final state in the catalytic process (Figure 12), in which the  $\text{NH}_3$  product is bound to FeMo-co at its resting redox state, prior to release and regeneration of the resting-state form of the cofactor. The trapping of a product-bound intermediate **I** is analogous to the trapping of a bio-organometallic intermediate during turnover of the  $\alpha\text{-}70^{\text{Val}\rightarrow\text{Ala}}$  MoFe protein with the alkyne, propargyl alcohol; this intermediate was shown to be the allyl alcohol alkene product of reduction.<sup>168</sup> With assignments of  $E_4$ ,  $E_7$ , and  $E_8$ , then filling in the LT “boxes” for  $E_5$ ,  $E_6$  of Figure 3 is straightforward, thus unifying the reaction pathway for  $\text{N}_2$  reduction with the LT scheme.

Figure 12 adopts a “prompt” (P)–alternating pathway for the stages following  $\text{N}_2$  binding and  $\text{H}_2$  loss, which offers explanations for how the hydrogenated reaction intermediates, diazene and hydrazine, join the  $\text{N}_2$  reduction pathway. Key to this issue was the finding that  $\text{H}_2$  inhibits the reduction of diazene,<sup>147</sup> but not hydrazine.<sup>211</sup> We took the simplest view, that under turnover, diazene and hydrazine each joins the  $\text{N}_2$  reduction pathway at its own characteristic entry point, and each then proceeds to generate both **H** and **I**. As shown in Figure 12, diazene binds to  $E_2$  with the release of  $\text{H}_2$ , thereby entering the  $\text{N}_2$  pathway as the “final” interconverting form of the  $E_4$  state.  $\text{N}_2\text{H}_4$  instead binds to  $E_1$  (as proposed for another two-electron substrate,  $\text{C}_2\text{H}_2$ <sup>17,33,103,220</sup>), joining the  $\text{N}_2$  pathway with the release of  $\text{NH}_3$  to form a stage corresponding to  $E_7$  in the  $\text{N}_2$  reduction scheme.<sup>156</sup>

## 7. OBLIGATORY EVOLUTION OF $\text{H}_2$ IN NITROGEN FIXATION: REDUCTIVE ELIMINATION OF $\text{H}_2$

The  $E_n$  assignments of Figure 6 plus those of Figure 12 give proposed structures to all  $E_n$  states of the LT kinetic scheme (Figure 3), but the assignments have been developed through independent analyses of the two four-electron halves of the eight-electron catalytic cycle (eq 1). In the first half (part I) of the pathway, accumulation of four electrons/protons activates FeMo-co, generating  $E_4$ ; in the second half (part II), bound  $\text{N}_2$  is hydrogenated by two of those electrons/protons plus an additional four electrons/protons. However, the assignments are silent about the mechanism by which the  $E_4$  Janus intermediate, Figure 4, connects these two halves: the

obligatory production of an  $H_2$  molecule upon  $N_2$  binding, as shown in Figure 12.<sup>33,156,158</sup> Why nitrogenase should “waste” fully 25% of the ATP required for nitrogen fixation through  $H_2$  generation (eq 1) has remained a mystery, and indeed is not even accepted uniformly.<sup>23,221</sup>

Consideration of the finding that  $E_4$  stores its four reducing equivalents as two bridging hydrides (Figure 4) within the context of the well-known organometallic chemistries of hydrides<sup>194,222</sup> and dihydrogen<sup>223</sup> led us to examine the two alternative mechanisms by which this state might bind and activate  $N_2$  with release of  $H_2$ , and proceed to the prompt formation of FeMo-co with a bound diazene-level species ( $N_2H_2$ ) without additional accumulation of  $[e^-/H^+]$ , as featured in the P–A reaction pathway, Figure 12. In one,  $H_2$  is formed by hydride protonation (hp mechanism), Figure 13, upper; the other forms  $H_2$  through reductive elimination (re),<sup>195</sup> Figure 13, lower. We first describe these two mechanisms, and then show that the re mechanism is operative.

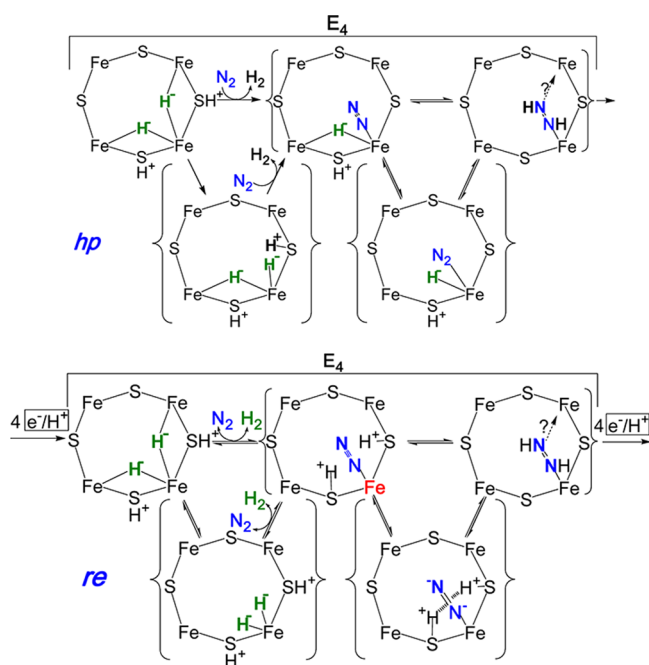

**Figure 13.** Visualization of hp and re mechanisms for  $H_2$  release upon  $N_2$  (blue) binding to  $E_4$ . The following is shown: the Fe-2,3,6,7 face of resting FeMo-co; the structure of FeMo-co must distort in different stages of catalysis. The Fe that binds  $N_2$  is presumed to be Fe6, as indicated by studies of  $\alpha$ -70<sup>Val</sup> variants; when bold, red, Fe6 is formally reduced by two equivalents (see text). The bridging hydrides of  $E_4$  (green) are positioned to share an Fe “vertex”, as suggested by re mechanism of  $H_2$  release upon  $N_2$  binding. Alternative binding modes for  $N_2$ -derived species can be envisaged.

### 7.1. Hydride Protonation (hp) Mechanism

In the hp scheme (Figure 13, upper),  $N_2$  binding is accompanied by the activation of *one* bridging hydride to the terminal form and protonation of this hydride by a sulfide-bound proton to form and release  $H_2$ . Such a mechanism for  $H_2$  formation is invoked in discussions of hydrogenases,<sup>223,224</sup> and there is strong precedence for replacement of a metal-bound  $H_2$  with  $N_2$ . In this context, by analogy to the mechanism for the (much less demanding) reduction of alkynes/alkenes one might propose that transient terminalization of the “second” hydride would then lead to hydrogenation

and protonation of the bound  $N_2$ , to form FeMo-co bound  $N_2H_2$  (see Figure 13, upper, below). For reasons that will become clear below, the hydrogenation of  $N_2$  to form metal bound- $N_2H_2$  must be reversible.

### 7.2. Reductive Elimination (re) Mechanism

The second mechanism for  $H_2$  loss upon  $N_2$  binding begins with transient terminalization of *both*  $E_4$  hydrides, Figure 13, lower. This is followed by reductive elimination of  $H_2$  as  $N_2$  binds, steps with considerable precedence.<sup>4,194,222,223,225</sup> Of key importance, the departing  $H_2$  carries away only two of the four reducing equivalents stored in  $E_4$ , while the Fe that binds  $N_2$  becomes highly activated through formal reduction by two equivalents; for example a formal redox state of Fe(II) would be reduced to Fe(0). This delivery of two reducing equivalents to the FeMo-co core which otherwise is reduced by at most one equivalent during electron/proton activation (Figures 6 and 7) would poise the cofactor to deliver the two activating electrons to  $N_2$ , whose  $\pi$  acidity could be further enhanced by electrostatic interactions with the two sulfur-bound protons: combined delivery of the two electrons and protons would directly yield cofactor-bound  $N_2H_2$ . This amounts to a “push–pull” mechanism for the hydrogenation of  $N_2$ , in which the “push” of electrons from the doubly reduced cofactor onto  $N_2$  is enhanced by the electrostatic “pull” of the protons bound to sulfur. As discussed in section 9, below, models of  $E_4(N_2)$  constructed by placing  $N_2$  and two protons on the doubly reduced FeMo-co core modeled with its resting-state structure provide a convincing illustration of this mechanism (and other insights, as well). The diminished electron donation to Fe by protonated sulfides would not only facilitate reductive elimination, but also would act to localize the added electrons on the Fe involved, limiting charge delocalization over the rest of the cofactor. This mechanism provides a compelling rationale for obligatory  $H_2$  formation during  $N_2$  reduction: the transient formation of a state in which an electrostatically activated  $N_2$  is bound to a highly activated, doubly reduced site, thereby generating a state optimally activated to carry out the initial hydrogenations of  $N_2$ , the most difficult process in  $N_2$  fixation.

### 7.3. Mechanistic Constraints Reveal That Nitrogenase Follows the re Mechanisms

A clear choice between hp and re mechanisms is achieved by testing them against the numerous constraints that are associated with the reaction of  $D_2$  with the diazene-level  $E_4(N_2/N_2H_2)$  state formed when  $N_2$  binds to the cofactor and is reduced. The three principal constraints are listed in Chart 1.

#### Chart 1

##### Chart 1: Key Constraints on HD Formation under $N_2/D_2$ :

- (i) *Stoichiometry*:  $M-N_2 + D_2 + 2H^+ + 2e \rightleftharpoons 2HD + M + N_2$
- (ii) *Scrambling*: “No”  $T^+$  released to solvent under  $T_2$
- (iii) *Reduction Stage*:  $D_2$  reacts at ‘ $N_2H_2$ ’ level

The first test that they provide for a mechanism is that it must accommodate the finding that when nitrogenase turns over in the presence of *both*  $N_2$  and  $D_2$ , then two HD are formed through  $D_2$  cleavage and solvent-proton reduction, with the stoichiometry summarized as constraint i of Chart 1.<sup>17,226–228</sup> Such HD formation *only* occurs in the presence of  $N_2$ , and not during reduction of  $H^+$  or *any* other substrate.<sup>226,229,230</sup>

The second key constraint and mechanistic test was revealed by Burgess and co-workers 30 years ago; the absence of exchange into solvent of  $D^+/T^+$  derived from  $D_2/T_2$  gas, Chart 1, constraint ii.<sup>226</sup> When nitrogenase turns over under a mixture of  $N_2$  and  $T_2$ , HT is formed with stoichiometry corresponding to Chart 1, constraint i, *but* during this process only a negligible amount of  $T^+$  is released to solvent ( $\sim 2\%$ ). The third constraint is provided by a later study of  $\alpha$ -19S<sup>His</sup>- and  $\alpha$ -191<sup>Gln</sup>-substituted MoFe proteins.<sup>161</sup> It provided persuasive evidence that HD formation under  $N_2/D_2$  requires that the enzyme be at least at the  $E_4$  redox level, with a FeMo-co-bound N–N species at the reduction level of  $N_2H_2$  or beyond, corresponding to the third constraint, Chart 1, iii.<sup>161</sup> Constraint iii, plus the stoichiometry of HD formation according to constraint i implies a process described as



Thus,  $N_2H_2$  formation is reversible, as shown in Figure 13.

Figure 14, upper, shows that the characteristics of HD formation during turnover under  $N_2/D_2$  *cannot* be reconciled

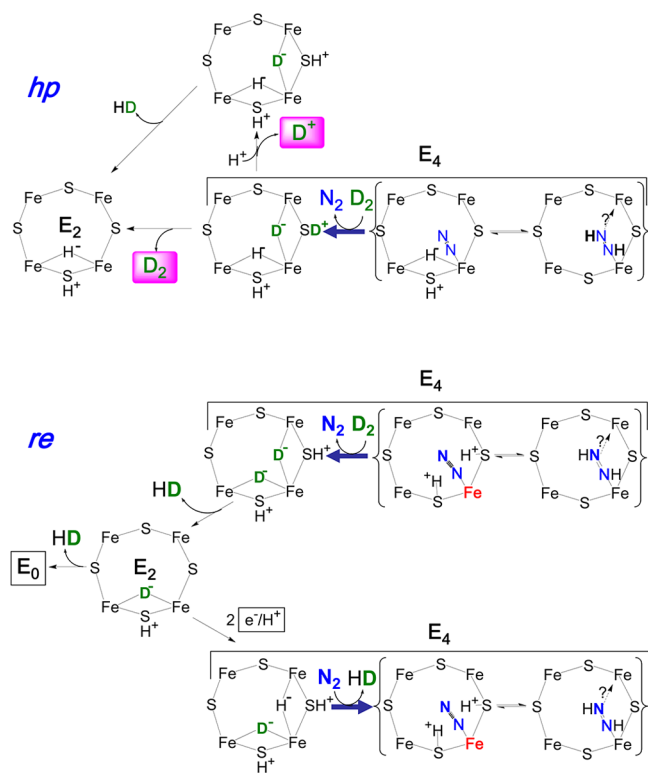

**Figure 14.** Reversal of hp and re mechanisms upon  $D_2$  binding. Details as in Figure 13. Bold arrows replace equilibrium arrows to emphasize the relaxation process.

with the hp mechanism. In the reverse of this mechanism,  $D_2$  binding and  $N_2$  release would generate an  $E_4$  state that has one deuteride bridge, which is deactivated for exchange with solvent. However, it carries the other deuteron in the form of  $D^+$  bound to sulfur (or a protein residue), which likely would be solvent exchangeable. Exchange of that  $D^+$  would violate the stoichiometric constraint, of eq 3 (line i, Chart 1), as relaxation of  $E_4$  to  $E_2$  within the reverse-hp mechanism would generate only one HD per  $D_2$ , not two as required. Correspondingly, replacement of  $D_2$  by  $T_2$  in Figure 14, upper, with exchange of  $T^+$  bound to sulfide would lose roughly one  $T^+$  per  $T_2$  to

solvent, contrary to the few percent loss observed by Burgess et al. (constraint ii).<sup>226</sup> The possibility that the proton-bearing site is “shielded” from exchange seems implausible for a catalytic cluster that depends on proton delivery for its catalytic function, and in any case solvent exchange need not be fast; the rate-limiting step in nitrogenase turnover is the off-rate for Fe protein after it has delivered its electron to MoFe,<sup>33,99</sup> and this process is quite slow, with a rate constant of  $\sim 6\text{ s}^{-1}$ .

If this proton were nonetheless shielded from exchange, relaxation to  $E_2$  would occur with regeneration of  $D_2$ , without the generation of HD, in disagreement with the stoichiometric constraint of Chart 1. This objection would be overcome if at ambient temperatures the hydrides/protons can “migrate” over the FeMo-co face, but this instead would require multiple sites to be “shielded” for slow exchange, while FeMo-co is accessible to rapid proton delivery. Overall, we conclude that the hp process fails to satisfy the constraints of Chart 1, as the reverse hp process satisfies *neither* the stoichiometry of eq 3 nor the constraint that  $T^+$  is not released to solvent (Chart 1).

In contrast, in the reverse of the re mechanism, shown in Figure 14, lower,  $D_2$  binding and  $N_2$  release would generate  $E_4(2D)$ , the  $E_4$  isotopomer in which *both* atoms of  $D_2$  exist as deuteride bridges. This state would relax with loss of HD to  $E_2(D)$ , and then to  $E_0$  with loss of the second HD, thus satisfying the stoichiometry of eq 3. If the reaction were carried out under  $T_2$ , essentially no  $T^+$  would be lost to solvent because the bridging deuterides are deactivated for exchange with the protein environment and solvent, thus satisfying the “ $T^+$  exchange” constraint, Chart 1.

One alternative fate of the  $E_4(2D)$  formed by  $D_2$  replacement of  $N_2$  would be to rebind an  $N_2$ , but this would merely release the  $D_2$  that had started the reverse process, creating a cycle invisible to detection. As a second alternative,  $E_2(D)$  could acquire two additional electrons/protons to achieve the monodeutero  $E_4$  state. However, as shown in Figure 14, lower, if this state then bound  $N_2$  it would release the second HD, again without solvent exchange, whereas if it ultimately relaxed to  $E_0$  it would release the second HD along with an  $H_2$ . Thus, the re mechanism for  $N_2$  binding and  $H_2$  release not only has the compelling chemical rationale discussed above, but also satisfies the three critical HD constraints for the various alternatives that arise when it is run in reverse, Chart 1.

In short, the re mechanism, Figure 13, lower, satisfies the constraints summarized in Chart 1, as visualized in Figure 14, lower; to the best of our knowledge, it likewise satisfies all other constraints on the mechanism provided by earlier studies, most of which are not directly tied to  $D_2$  binding.

## 8. TEST OF THE RE MECHANISM

Subsequent to formulation of the re mechanism for the activation of FeMo-cofactor to reduce  $N_2$  (Figure 13, lower),<sup>156</sup> we noted that addition of  $C_2H_2$  to a  $N_2/D_2$  reaction mixture should offer a rigorous test of the mechanism. The test is founded on a defining characteristic of nitrogenase catalysis, an exact distinction between hydrons ( $H/D/T$ ) associated with the gaseous diatomics,  $H_2/D_2/T_2$ , and those derived from solvent water. Thus, when nitrogenase in protic buffer is turned over under  $N_2/D_2$ , gaseous  $D_2$  can displace  $N_2$  from the  $E_4(N_2/N_2H_2)$  state (Figure 14, lower), stoichiometrically yielding two HD.<sup>226–228</sup> This and other observations clearly show that diatomic  $H_2/D_2$  is not used to reduce  $N_2$  during turnover under  $N_2/H_2/D_2$  (in particular,  $T$  incorporated into the ammonia product of  $N_2$  fixation would exchange with solvent).<sup>17</sup>

Likewise, as demonstrated below, when  $C_2H_2$  is reduced in the presence of  $D_2$ , no deuterated ethylenes are generated.

### 8.1. Predictions

With this foundation, we recognized that the re mechanism predicts that turnover under  $C_2H_2/D_2/N_2$  should not only incorporate H from solvent to generate  $C_2H_4$  by the normal reduction process, but through the agency of the added  $N_2$  also should breach the separation of gaseous  $D_2$  from solvent protons by generating *both*  $C_2H_3D$  and  $C_2H_2D_2$  (Figure 15).

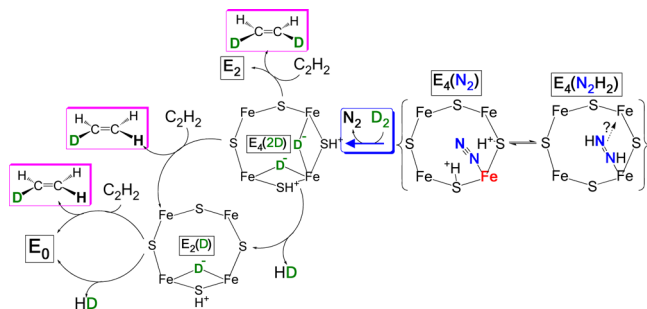

**Figure 15.** Formation of deuterated acetylenes during turnover under  $N_2/D_2/C_2H_2$  as predicted according to re mechanism. Cartoons again depict the Fe<sub>2,3,6,7</sub> face of resting-state FeMo-co, with no attempt to incorporate likely structural modifications. Figure shows that the “reverse” of re mechanism through displacement of  $N_2$  by  $D_2$  produces, successively,  $E_4(2D)$  and  $E_2(D)$ , further showing potential reaction channels for capture of  $E_4(2D)$  and  $E_2(D)$  intermediates with  $C_2H_2$ .

According to the re mechanism, when turnover is carried out under  $N_2/D_2$ ,  $D_2$  can react with  $E_4(N_2/N_2H_2)$ , replacing the  $N_2$  and undergoing oxidative addition to generate  $E_4(2D)$ . We recognized that this state in fact might be expected to react with  $C_2H_2$  to form  $C_2H_2D_2$  through the idealized mechanism (Figure 16A) involving terminalization of an [Fe–D–Fe] bridge of  $E_4$ , and migratory insertion of bound  $C_2H_2$  into the Fe–D bond to form an Fe-alkenyl intermediate, followed by reductive elimination of  $C_2H_2D_2$ .<sup>195,231</sup> Previous studies<sup>17,103</sup> could not distinguish reaction at the  $E_4$  state from reaction at the  $E_2$  state when  $C_2H_2$  is reduced in the absence of  $N_2$ , as  $N_2$  is required to enable gaseous  $D_2$  to enter the nitrogenase catalytic process. The possibility that acetylene can access different nitrogenase redox states, however, had been suggested on the basis of experiments using a nitrogenase variant that exhibits  $N_2$  reduction that is resistant to inhibition by acetylene.<sup>232,233</sup>

The  $E_4(2D)$  state also would relax through the loss of HD to form  $E_2(D)$ , an  $E_2$  state whose unique isotopic composition can be generated in no other way. Interception of the  $E_2(D)$  state by  $C_2H_2$  would then generate  $C_2H_3D$ , with Figure 16B presenting a plausible mechanism: deuteride terminalization and insertion, followed by alkenyl protonolysis.<sup>195,231</sup> This reaction also might occur through an alternative reaction channel of  $E_4(2D)$ , as noted in Figure 15.

### 8.2. Testing the Predictions

We tested the predictions based on the re mechanism of an unprecedented involvement of gaseous  $D_2$  in substrate reduction by use of  $C_2H_2$  reduction under  $N_2/D_2/C_2H_2$  gas mixtures to intercept the  $E_4(2D)$  and  $E_2(D)$  states. As expected, the control reaction of turnover under  $D_2/C_2H_2$  generates only  $C_2H_4$ , without incorporation of D from gaseous  $D_2$  to generate either  $C_2H_3D$  or  $C_2H_2D_2$  (Figure 17). In dramatic contrast,

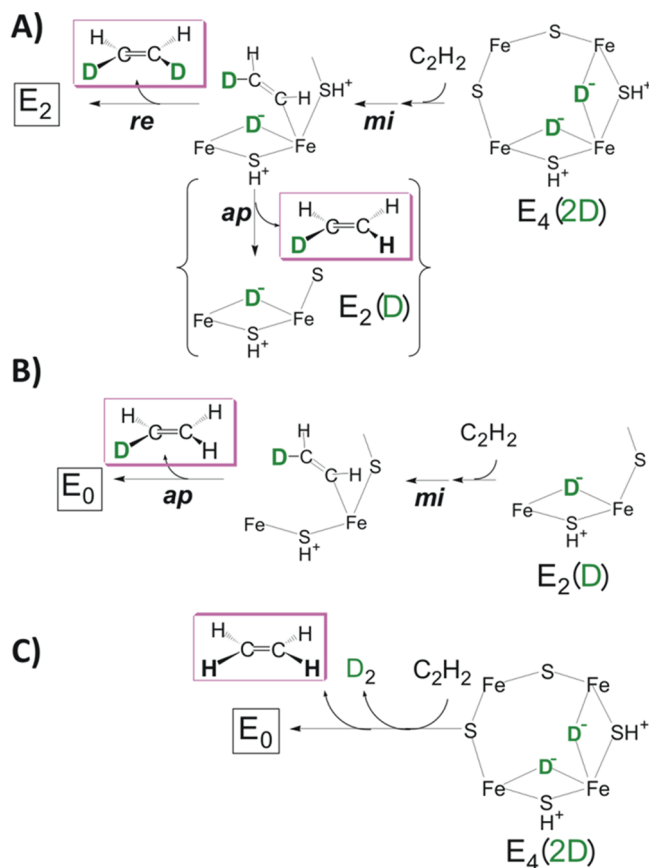
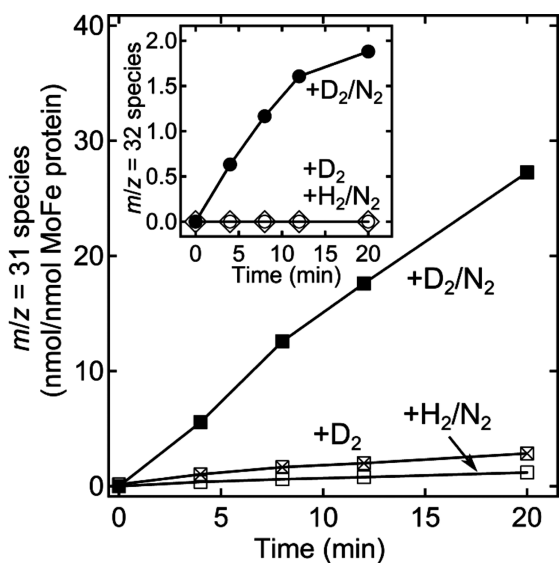

**Figure 16.** Schematic mechanism for reaction of  $C_2H_2$  with  $E_4(2D)$  and  $E_2(D)$ . (A) Formation of  $C_2H_2D_2$ , which follows Scheme 15.20 of Hartwig;<sup>231</sup> mi = migratory insertion; re = reductive elimination. In braces: Possible alternative reaction channel that leads to formation of  $C_2H_3D$ , ap = alkenyl protonolysis. (B) Schematic mechanism for formation of  $C_2H_3D$  from reaction of  $C_2H_2$  with  $E_2(D)$ . (C) Illustration of possibility that  $C_2H_2$  displaces  $D_2$  formed by reductive elimination of the  $E_4(2D)$  deuterides, leading to direct formation of  $C_2H_4$  without D incorporation.

$C_2H_2$  reduction by nitrogenase under a  $N_2/D_2/C_2H_2$  gas mixture in fact produces readily measured amounts of  $C_2H_2D_2$  and even greater amounts of  $C_2H_3D$  (Figure 17).<sup>157</sup>

On reflection, the success of this test for the formation of  $E_4(2D)$  is a consequence of the greater reactivity of  $C_2H_2$  compared to that of  $N_2$  and/or of the difference in the likely ways that these two substrates bind to FeMo-co: side-on for  $C_2H_2$ , end-on for  $N_2$ . Otherwise, in a process analogous to that for  $N_2H_2$  formation in the re mechanism (Figure 13, lower),  $C_2H_2$  might in principle displace  $D_2$  formed by reductive elimination of the  $E_4(2D)$  deuterides, leading to direct formation of  $C_2H_4$  without D incorporation, Figure 16C. The yield of  $C_2H_2D_2$  may be less than that of  $C_2H_3D$ , because the contribution from this reaction channel diminishes the yield of the former, but it is perhaps more likely that the binding and reduction of  $C_2H_2$  by  $E_4(2D)$  is substantially less likely than the relaxation of  $E_4(2D)$  to  $E_2(D)$  through loss of HD, and the reduction of  $C_2H_2$  by  $E_2(D)$  (Figure 15).

These observations are enriched by consideration of the dependences of the yields of  $C_2H_3D$  and  $C_2H_2D_2$  on the partial pressures of  $C_2H_2$ ,  $D_2$ ,  $N_2$ , and electron flux, all of which are understandable in terms of the production of the  $E_4(2D)$  and  $E_2(D)$  states under these turnover conditions, as predicted by



**Figure 17.** Time-dependent formation of  $^{13}\text{C}_2\text{H}_3\text{D}$  and  $^{13}\text{C}_2\text{H}_2\text{D}_2$  catalyzed by nitrogenase reduction of  $^{13}\text{C}_2\text{H}_2$ .  $^{13}\text{C}_2\text{H}_3\text{D}$  determined by GC/MS monitoring of  $m/z = 31$  for a reaction mixture containing  $^{13}\text{C}_2\text{H}_2$  and including  $\text{D}_2$  and  $\text{N}_2$  (■), just  $\text{D}_2$  (x inside □), or  $\text{H}_2$  and  $\text{N}_2$  (□). Inset:  $^{13}\text{C}_2\text{H}_2\text{D}_2$ ,  $m/z = 32$ , formation starting with  $^{13}\text{C}_2\text{H}_2/\text{D}_2/\text{N}_2$  (●), just  $\text{D}_2$  (◇), or  $\text{H}_2/\text{N}_2$  (○). Partial pressures of 0.02 atm  $^{13}\text{C}_2\text{H}_2$ , 0.25 atm  $\text{N}_2$ , and 0.7 atm  $\text{H}_2/\text{D}_2$ , where present. The molar ratio of Fe protein to MoFe protein was 2:1. All assays incubated at 30 °C. Adapted with permission from ref 157. Copyright 2013 National Academy of Sciences.

the re mechanism for FeMo-cofactor activation for  $\text{N}_2$  binding and reduction.<sup>157</sup> For example, reduction of acetylene and  $\text{N}_2$  are mutually exclusive, with complicated inhibition kinetics between these two substrates.<sup>217,234</sup> Therefore, it was of interest to determine the effect of varying the  $\text{N}_2$  partial pressure on the formation of  $\text{C}_2\text{H}_3\text{D}$  and  $\text{C}_2\text{H}_2\text{D}_2$  at fixed  $\text{C}_2\text{H}_2$  and  $\text{D}_2$  pressures. The yields of  $\text{C}_2\text{H}_3\text{D}$  and  $\text{C}_2\text{H}_2\text{D}_2$  increase in parallel with increasing partial pressure of  $\text{N}_2$  (Figure 18). This can be explained by enhanced formation of  $\text{E}_4[\text{N}_2/\text{N}_2\text{H}_2]$  by reaction of  $\text{N}_2$  with  $\text{E}_4$ . Increased formation of  $\text{E}_4[\text{N}_2/\text{N}_2\text{H}_2]$  in turn would enhance reaction with  $\text{D}_2$  to form  $\text{E}_4(2\text{D})$ , which can be intercepted by acetylene to form deuterated ethylenes (Figure 15).<sup>157</sup>

It is of interest to note that the reduction of  $\text{C}_2\text{H}_2$  to  $\text{C}_2\text{H}_3\text{D}$  by reaction with  $\text{E}_2(\text{D})$  formally corresponds to the reduction of  $\text{C}_2\text{H}_2$  by the HD that otherwise would form during relaxation of  $\text{E}_2(\text{D})$  to  $\text{E}_0$ , a perspective that highlights the contrast between this result, achieved in the presence of  $\text{N}_2$ , with the failure of nitrogenase to use  $\text{H}_2/\text{D}_2$  to reduce any substrate in the absence of  $\text{N}_2$ . As an elaboration on this perspective, the formation of HD during turnover under  $\text{N}_2/\text{D}_2$ , with stoichiometry (eq 3, above),<sup>17</sup> can be seen to correspond to the nitrogenase-catalyzed reduction of protons by  $\text{D}_2$  and electrons with  $\text{N}_2$  as cocatalyst, eq 3'

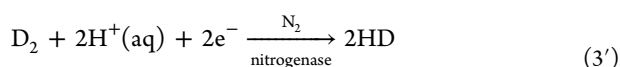

as the reaction neither proceeds without  $\text{N}_2$  nor consumes  $\text{N}_2$ . Likewise, although  $\text{C}_2\text{H}_2\text{D}_2$  is well-known to form during nitrogenase reduction of  $\text{C}_2\text{D}_2$  in  $\text{H}_2\text{O}$  buffer (or  $\text{C}_2\text{H}_2$  in  $\text{D}_2\text{O}$  buffer),<sup>148</sup> formation of this species during turnover under  $\text{C}_2\text{H}_2/\text{D}_2/\text{N}_2$  corresponds to the previously unobserved reduction of  $\text{C}_2\text{H}_2$  by gaseous  $\text{D}_2$  with  $\text{N}_2$  as cocatalyst (eq 4).

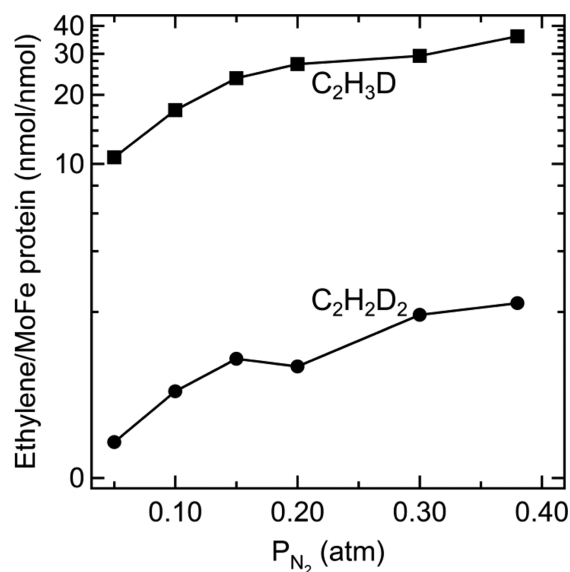

**Figure 18.** Deuterated ethylene formation as a function of  $\text{N}_2$  partial pressure. The partial pressure of  $\text{C}_2\text{H}_2$  was 0.02 atm and  $\text{D}_2$  was 0.6 atm. The molar ratio of Fe protein to MoFe protein was 4:1. Assay conditions as in Figure 17. Adapted with permission from ref 157. Copyright 2013 National Academy of Sciences.

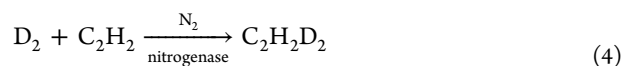

Correspondingly, the formation of  $\text{C}_2\text{H}_3\text{D}$  involves incorporation of  $\text{D}^-$  derived from  $\text{D}_2$  along with  $\text{H}^+$  from solvent with  $\text{N}_2$  as cocatalyst.

## 9. COMPLETING THE MECHANISM OF NITROGEN FIXATION

Figure 12, above, presents a formal integration of the reaction pathway for nitrogen fixation (intermediates  $\text{E}_4$ – $\text{E}_8$ ) with the LT kinetic scheme, the key to the resulting mechanism being  $\text{N}_2$  binding and  $\text{H}_2$  release through the re mechanism, Figure 13, lower. This mechanism is built on the structure of the  $\text{E}_4$  intermediate and its implication that hydride chemistry is central to nitrogen fixation by nitrogenase (section 3). As a corresponding implication, we further offered the two alternative sets of proposed structures for the “early”,  $\text{E}_1$ – $\text{E}_3$ , intermediates (Figure 6). We now discuss in greater depth the  $\text{E}_5$ – $\text{E}_8$  intermediates of nitrogen fixation, proposing in Figure 19, II not only more detailed structures for the stages following the formation of  $\text{N}_2\text{H}_2$ -bound FeMo-co, the  $\text{E}_4(\text{N}_2\text{H}_2)$  state, written as binding diazene itself, but also the nature of the chemical transformations that link these stages during the delivery of the ‘second half’ of the eight  $[\text{e}^-/\text{H}^+]$  that comprise the stoichiometry of nitrogen fixation, eq 1. The analysis further leads us to provisionally assign the early, “first half” intermediates to the alternative described in Figure 6B, now visualized in Figure 19, I. When combined with the reductive elimination (re) mechanism for the binding  $\text{N}_2$  and release of  $\text{H}_2$ , Figure 13, lower, the result, Figure 19, is a self-consistent proposal for the structures of all intermediates in the nitrogen fixation mechanism and a formal description of the transformations that convert each stage to the subsequent one: a complete, though of course still simplified, mechanism for nitrogen fixation by nitrogenase.

Figure 19, II, is constructed on two assumptions that (i) the formation and reactions of hydrides is key; (ii) beginning with

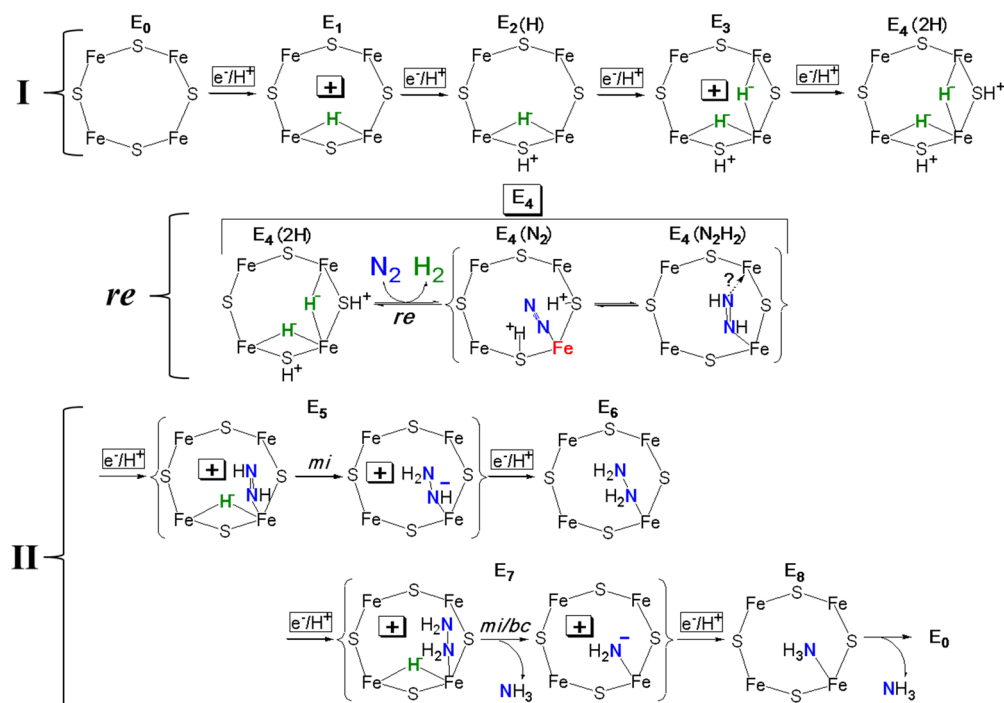

**Figure 19.** Proposed mechanism displaying structures of all intermediates in nitrogen fixation, inspired by the assumption of primacy of hydride chemistry associated with the Fe<sub>2</sub>,3,6,7 face of FeMo-co, and containing a formal description of the transformations that convert each stage to the subsequent one. In I the mechanism tentatively adopts and visualizes the view of E<sub>n</sub> states  $n = 1-4$  presented in Figure 6B; in II it visualizes bridging hydrides by analogy, without evidence for or against terminal hydrides for  $n = 5-7$ . Likewise, the structure of the N<sub>2</sub>H<sub>2</sub> species as end-on bound diazene is suggestive, not definitive, etc. I and II are connected by the re mechanism, Figure 13, lower. Formal charges are included as useful to help guide the reader.

N<sub>2</sub>H<sub>2</sub>, the hydrogenation of reduced forms of N<sub>2</sub> involves migratory insertion into Fe–H bonds. These assumptions lead to the conclusion that [e<sup>−</sup>/H<sup>+</sup>] transfer to FeMo-co of the E<sub>4</sub>(N<sub>2</sub>H<sub>2</sub>) and E<sub>6</sub> states creates E<sub>5</sub> and E<sub>7</sub> that each contain an [Fe–H–Fe] bridging hydride moiety bound to an oxidized FeMo-co, Figure 19, II, in correspondence with the analogous [e<sup>−</sup>/H<sup>+</sup>] transfer to E<sub>0</sub> and E<sub>2</sub>, shown in the cartoon of Figure 6B, and now visualized in Figure 19, I. In the case of E<sub>5</sub>, an accompanying migratory insertion of the N<sub>2</sub>H<sub>2</sub> into an Fe–H bond (presumably formed by terminalization of the bridge) forms the [N<sub>2</sub>H<sub>3</sub>]<sup>−</sup> moiety bound to the oxidized cluster; in the case of E<sub>7</sub>, migratory insertion leads to N–N bond cleavage and formation of [NH<sub>2</sub>]<sup>−</sup> bound to the formally oxidized cofactor (Figure 19, II). The follow-up [e<sup>−</sup>/H<sup>+</sup>] transfer to E<sub>5</sub>, E<sub>7</sub> generates the E<sub>6</sub> and E<sub>8</sub> states, respectively. This mechanistic picture is anchored by the final stages, E<sub>7</sub> and E<sub>8</sub>, whose structures match those proposed in the EPR/ENDOR/ESEEM studies of intermediates H, assigned to E<sub>7</sub>, and I, assigned to E<sub>8</sub>, Figure 12.

The proposal completes a mechanism in which the stoichiometrically required delivery of all 8 [e<sup>−</sup>/H<sup>+</sup>] to FeMo-co is controlled by the hydride chemistry of the cofactor. The clearly understandable differences between the first “half” of the catalytic cycle, visualized in Figure 19, I, and the “second half”, Figure 19, II, arise because the former involves accumulation of reducing equivalents while the latter involves delivery of reducing equivalents to substrate.

The two halves are similar in that addition of [e<sup>−</sup>/H<sup>+</sup>] to form an  $n = \text{odd}$  intermediate ( $n = 1, 3$ , first half;  $n = 5, 7$ , second half) generates an [Fe–H–Fe] bridging hydride attached to a formally oxidized FeMo-co core. They differ in that the hydride is “stored” in  $n = 1, 3$ , but is promptly

transferred to substrate in  $n = 5, 7$  to form a (formally) anionic reduced substrate. Upon addition of [e<sup>−</sup>/H<sup>+</sup>] to any one of these four  $n = \text{odd}$  intermediates, to form the subsequent  $n = \text{even}$  intermediate, the electron formally reduces the core to the resting-state redox level. In the first half ( $n = 2, 4$ ), the H<sup>+</sup> is delivered to a sulfur and its charge balances that on a hydride; in the second half ( $n = 6, 8$ ), the proton neutralizes the anionic nitrogenous ligand, to form the neutral, N<sub>2</sub>H<sub>4</sub> of E<sub>6</sub>, NH<sub>3</sub> of E<sub>8</sub>. The two halves of the nitrogen fixation mechanism are joined at the E<sub>4</sub> stage, as described above and displayed as Figure 19, re: the E<sub>4</sub>(2H) intermediate formed by accumulation of four [e<sup>−</sup>/H<sup>+</sup>] and containing two bridging hydrides undergoes reductive elimination as it binds N<sub>2</sub> and releases the two “sacrificial” reducing equivalents as H<sub>2</sub>. Figure 19 thus represents a complete mechanism for nitrogen fixation by nitrogenase that invokes the primacy of the hydride chemistry of FeMo-co.

### 9.1. Uniqueness of N<sub>2</sub> and Nitrogenase

The mechanistic proposal of Figure 19 invokes the primacy of hydride chemistry associated with a 4Fe face of FeMo-co, a structural feature made possible only with a cluster of at least six metal ions. The hydrogenations of reduced forms of N<sub>2</sub>, starting with N<sub>2</sub>H<sub>2</sub>, involve migratory insertion of substrate into Fe–H bonds, one at a time. This is the same mechanism visualized for the “normal” reduction of C<sub>2</sub>H<sub>2</sub> at the E<sub>2</sub> stage, and even for the rare trapping of E<sub>4</sub> by C<sub>2</sub>H<sub>2</sub>, Figure 16; we suggest migratory insertions are likely to be involved in the hydrogenation of all other substrates.

But N<sub>2</sub> is not reactive to hydride insertion. So nitrogenase adopts a different “strategy” for attacking its physiological substrate. It is forced to accumulate four reducing equivalents as

two Fe hydrides, which requires a 4-Fe face, and thus the large cluster is “held together” by the carbide at its core. We have concluded that this cluster can only become activated for N<sub>2</sub> hydrogenation through reductive elimination of two of those equivalents in the form of H<sub>2</sub>.<sup>156,157</sup> The “push” of the doubly reduced metal-ion core of the cluster, compounded by the electrostatic “pull” of sulfur-bound protons, is required to overcome the high barrier to the initial hydrogenation of N<sub>2</sub>, directly to N<sub>2</sub>H<sub>2</sub>, Figure 19.

### 9.2. Structure of the E<sub>4</sub>(N<sub>2</sub>) Intermediate: Some Implications

As an exercise to illustrate four points worth noting, we have modeled alternative structures of the E<sub>4</sub>(N<sub>2</sub>) intermediate by building the bound substrate onto the crystal structure of resting-state FeMo-co using structural information from model complexes.<sup>235–240</sup> It seems most likely, on the basis of the structures of model complexes, that N<sub>2</sub> binds end-on, rather than bridging. As illustrated in Figure 20, and emphasized over

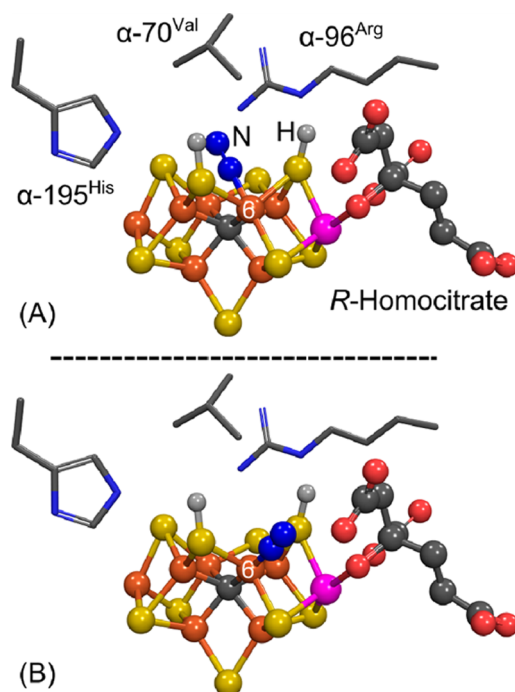

**Figure 20.** Models for the two alternative modes for N<sub>2</sub> binding at Fe6 of FeMo-cofactor in the E<sub>4</sub>(N<sub>2</sub>) state, with two protons bound to two adjacent sulfides as in Figure 4: (A) *endo* mode; (B) *exo* mode. The side chains of selected amino acid residues are shown as sticks. The figure was generated in Pymol by building N<sub>2</sub> onto the resting-state of FeMo-co using the coordinate file PDB:2AFK. Iron is shown in rust, molybdenum in magenta, sulfur in yellow, carbon in dark gray, hydrogen in light gray, nitrogen in blue, and oxygen in red.

the years,<sup>137,241,242</sup> end-on bound N<sub>2</sub> can bind to FeMo-co in two basic, alternative modes: *endo*, with the N<sub>2</sub> “nestled” in the pocket above the Fe<sub>2,3,6,7</sub> face; *exo*, with N<sub>2</sub> pointed away from that face. The first point is as follows. According to our mechanism, E<sub>4</sub>(N<sub>2</sub>) contains doubly reduced metal-ion core with two protons bound to sulfur. There are multiple potential dispositions of the H<sup>+</sup> on different sulfurs, but distance measurements with the mockups show that the atoms of N<sub>2</sub> and protons can indeed be in close enough proximity to support the electrostatic “pull” postulated above.

Second, this mockup demonstrates the commonly understood need for the FeMo-co core to “relax” upon substrate binding. In the resting-state the Fe ions are roughly tetrahedral, and without such relaxation, the N<sub>2</sub>–S distances would be far too short. The normal assumption would be that Fe6 roughly forms a plane with three S atoms, with a major contribution to the relaxation being an elongation of the bond *trans* to N<sub>2</sub>.

The third issue is the resulting structural/electronic-structure consequences of the *identity* of the *trans* ligand in *exo* versus *endo* N<sub>2</sub> binding, and it does not appear to have been widely discussed. The modulation of metal-ion reactivity by variations in the *trans* ligand (the “*trans* effect”) is well-known,<sup>231</sup> and recently, a series of trigonal Fe complexes that are biomimetic of nitrogenase have shown that the *trans* ligands to a terminal Fe–N<sub>2</sub> can regulate the ability of the complex to catalytically reduce N<sub>2</sub>.<sup>214</sup> In the *exo* binding mode, the interstitial carbide is *trans* to N<sub>2</sub>. This mode would favor the idea that carbide modulates the properties of Fe6 through the *trans* effect, and may well act as a hemilabile ligand. However, in the *endo* mode, which has been favored by some computations, the *trans* ligand is now a S that bridges to Mo. As C is (roughly) an “in-plane” ligand, not *trans*, its influence on reactivity would be different than for *endo* binding, in which case modulation of Fe6 reactivity by the *trans* effect would involve [S–Mo] being “axial” ligand.

There is a corollary to considerations of the *endo* binding mode. It is widely assumed that the catalytic centers of the alternative nitrogenases have the same structure as FeMo-co, with the heterometal atom Mo being replaced by V or Fe.<sup>18</sup> Thus, if N<sub>2</sub> does bind *endo* to Fe6 of a FeMo-co-like structure in all three systems, its reactivity would be modulated by differences in the axial –S–M “ligand” caused by differences in the properties of Mo, V, and Fe.

The fourth point is the possible importance of interactions of substrate with adjacent amino acid residues. In the *endo* binding mode the N<sub>2</sub> is nestled within a binding pocket capped by the side-chain of  $\alpha$ -70<sup>Val</sup>; in the *exo* mode, the N<sub>2</sub> is pointed to a pocket surrounded by  $\alpha$ -191<sup>Gln</sup> and the homocitrate ligand of Mo. The present mockups suggest that the protein environment in either binding mode could readily accommodate, and even stabilize, N<sub>2</sub> with no more than minor conformational rearrangements.

## 10. SUMMARY OF MECHANISTIC INSIGHTS

### 10.1. Catalytic Intermediates of N<sub>2</sub> Fixation

Two major points can be made regarding intermediates trapped: (1) Characterization of the E<sub>4</sub> “Janus” intermediate as bearing four reducing equivalents in the form of two [Fe–H–Fe] bridging hydrides has provided the foundation for proposals that the FeMo-co core is never oxidized or reduced by more than one equivalent relative to the resting-state, and that the oxidative couple in fact is operative, Figure 19, I. (2) The characterization of the common intermediates H and I, trapped during turnover with nitrogenous substrates, led to the proposed unification of kinetic scheme and A reaction pathway, Figure 12.

### 10.2. *re* Mechanism

Reductive elimination of two hydrides upon N<sub>2</sub> binding (*re* mechanism) provides an explanation for the nitrogenase stoichiometry (eq 1) and for the obligatory formation of H<sub>2</sub> upon N<sub>2</sub> binding. This mechanism for H<sub>2</sub> production upon N<sub>2</sub> binding to E<sub>4</sub>, Figure 13, lower, satisfies both the stoichiometric



constraint of HD formation (Chart 1, line i) and the “T<sup>+</sup>” constraint against exchange of gas-derived hydrons with solvent (Chart 1, line ii), whereas the hp mechanism (Figure 13, upper) satisfies neither. The re mechanism further involves D<sub>2</sub> binding to a state at the “diazene level” of reduction, as required by the constraint of eq 3 and Chart 1, line iii. Finally, to the best of our knowledge, all other constraints on the mechanism, most of which are not directly tied to D<sub>2</sub> binding, are satisfied, as well.

This mechanism answers the following long-standing and oft-repeated question: Why does nature “waste” four ATP/two reducing equivalents through an obligatory loss of H<sub>2</sub> when N<sub>2</sub> binds? The answer follows: reductive elimination of H<sub>2</sub> upon binding of N<sub>2</sub> to FeMo-co of the E<sub>4</sub> state generates a state in which highly reduced FeMo-co binds N<sub>2</sub>, which likely is activated for reduction through electrostatic interactions with the remaining two sulfur-bound protons. Transfer of the two reducing equivalents generated by the reductive elimination, combined with transfer of the two activating protons, then forms N<sub>2</sub>H<sub>2</sub>, Figure 13, lower, in keeping with the P–A scheme of Figure 12. It appears that only through this activation is the enzyme able to hydrogenate N<sub>2</sub>.

### 10.3. Turnover under N<sub>2</sub>/D<sub>2</sub>/C<sub>2</sub>H<sub>2</sub> as a Test of the re Mechanism

This mechanism has been supported by a rigorous test which provided experiments in which C<sub>2</sub>H<sub>2</sub> is added to an N<sub>2</sub>/D<sub>2</sub> reaction mixture. Although diatomic D<sub>2</sub> does not reduce nitrogenase C<sub>2</sub>H<sub>2</sub> in the absence of N<sub>2</sub>, the re mechanism successfully predicted that turnover under C<sub>2</sub>H<sub>2</sub>/D<sub>2</sub>/N<sub>2</sub> would breach the separation of gaseous D<sub>2</sub> from solvent protons by generating *both* C<sub>2</sub>H<sub>3</sub>D and C<sub>2</sub>H<sub>2</sub>D<sub>2</sub>.

The conclusions regarding H<sub>2</sub> formation upon N<sub>2</sub> binding reached from this study are as follows. (i) The unprecedented incorporation of D from D<sub>2</sub> into the nitrogenase reduction products C<sub>2</sub>H<sub>2</sub>D<sub>2</sub> and C<sub>2</sub>H<sub>3</sub>D during turnover under C<sub>2</sub>H<sub>2</sub>/D<sub>2</sub>/N<sub>2</sub> in H<sub>2</sub>O demonstrates the presence of the E<sub>4</sub>(2D) and E<sub>2</sub>(D) states under these conditions. In our view any model that fails to incorporate obligatory H<sub>2</sub> loss as a fundamental aspect of N<sub>2</sub> activation is unlikely to provide a robust description of the chemistry associated with the biological process.<sup>242</sup> (ii) This incorporation provides a very clear demonstration of the essential mechanistic role for obligatory, reversible loss of H<sub>2</sub> upon N<sub>2</sub> binding and thus of the eight-electron stoichiometry for nitrogen fixation by nitrogenase embodied in eq 1. Until now, the data indicating that some H<sub>2</sub> must be evolved during N<sub>2</sub> reduction has been viewed as being much more compelling than the data indicating an obligatory evolution of one H<sub>2</sub> for every N<sub>2</sub> reduced, leading to the stoichiometry of eq 1.<sup>17</sup> (iii) The formation of E<sub>4</sub>(2D) and E<sub>2</sub>(D) during turnover under D<sub>2</sub>/N<sub>2</sub> in H<sub>2</sub>O is predicted by the re mechanism for the activation of FeMo-cofactor for reduction of N<sub>2</sub>, and the interception of these intermediates by C<sub>2</sub>H<sub>2</sub> thus provides direct experimental evidence in support of this mechanism (Figure 17). (iv) The well-known reduction of protons by D<sub>2</sub> to form 2HD during turnover under D<sub>2</sub>/N<sub>2</sub> in H<sub>2</sub>O and the newly discovered reductions of C<sub>2</sub>H<sub>2</sub> by D<sub>2</sub>/N<sub>2</sub> should be viewed as being catalyzed by nitrogenase with N<sub>2</sub> as cocatalyst. (v) This review has proposed an explanation of the inability of H<sub>2</sub>/D<sub>2</sub> to reduce nitrogenase and/or catalyze substrate reduction in the absence of N<sub>2</sub>.

## 11. CONCLUSIONS

The trapping and characterization of five nitrogenase catalytic intermediates, which correspond to three of the five stages involved in binding and reduction of nitrogen (Figure 3), most especially the “Janus intermediate”, E<sub>4</sub>, and including the nitrogenous intermediate states H (E<sub>7</sub>) and I (E<sub>8</sub>), have identified the “prompt–alternating (P–A)” pathway of Figure 12, carried out on a four-Fe face of FeMo-co, as most likely operative for nitrogenase and led to the unification of the nitrogenase reaction pathway and the LT kinetic scheme.

The recognition of the central role played by conversion of accumulated [e<sup>-</sup>/H<sup>+</sup>] into metal hydrides has led to the proposal that this most complex of biological catalytic clusters, and by extension perhaps all biological clusters involved in multielectron substrate hydrogenation, function through a limited set of redox couples, and indeed most likely through a single couple, with multiple reducing equivalents being stored as hydrides rather than as reduced metal ions, Figures 6, 19. Only in this way can a cluster accumulate equivalents delivered at a constant potential set by its biological partners. These considerations provide part of the reason why such a large cluster is required for nitrogenase catalysis.

Simple energetic considerations have further illuminated the heretofore puzzling observation that states of nitrogenase activated by the accumulation of multiple [e<sup>-</sup>/H<sup>+</sup>] can relax through release of H<sub>2</sub> (Scheme 1), but H<sub>2</sub> cannot reduce nitrogenase in what appears to be the reverse process: the answer is that the processes are not microscopic reverses.

Perhaps the central question of nitrogen fixation by nitrogenase has been that of stoichiometry: “Why does (or even, does) nature ‘waste’ four ATP/two reducing equivalents through an obligatory loss of H<sub>2</sub> when N<sub>2</sub> binds?” An answer has been proposed on the basis of further consideration of hydride chemistry exhibited by E<sub>4</sub>: the enzyme exhibits the stoichiometry of eq 1 because reductive elimination (re) of two [e<sup>-</sup>/H<sup>+</sup>] in the form of H<sub>2</sub> activates FeMo-co for hydrogenation of N<sub>2</sub> to N<sub>2</sub>H<sub>2</sub> via a “push–pull” mechanism, Figure 13, lower. A test of the mechanism involving turnover under N<sub>2</sub>/D<sub>2</sub>/C<sub>2</sub>H<sub>2</sub>, as in Figure 15, validated the re mechanism, and in so doing confirmed the stoichiometry of nitrogen fixation, eq 1, as requiring eight [e<sup>-</sup>/H<sup>+</sup>].

The test reaction further highlighted the role of N<sub>2</sub> as cocatalyst in reductions catalyzed by nitrogenase that would not occur in the absence of N<sub>2</sub>. We have further noted some issues regarding the uniqueness of N<sub>2</sub> and nitrogenase as the catalyst for its hydrogenation, and of the implications of alternative structures of the N<sub>2</sub> complex.

The result of these efforts is the mechanism for nitrogen fixation presented in Figure 19 for further tests, both experimental and theoretical.

## ASSOCIATED CONTENT

### Supporting Information

Analysis of the relative orientations of bridging hydrides of E<sub>4</sub> intermediate. This material is available free of charge via the Internet at <http://pubs.acs.org>.

## AUTHOR INFORMATION

### Corresponding Authors

\*E-mail: [bmh@northwestern.edu](mailto:bmh@northwestern.edu).

\*E-mail: [deandr@vbi.vt.edu](mailto:deandr@vbi.vt.edu).

\*E-mail: [lance.seefeldt@usu.edu](mailto:lance.seefeldt@usu.edu).

## Notes

The authors declare no competing financial interest.

## Biographies

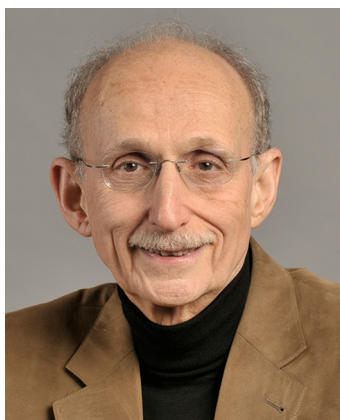

Brian M. Hoffman was an undergraduate at the University of Chicago, received his Ph.D. from Caltech, and spent a postdoctoral year at MIT. From there, he went to Northwestern University, where he is the Charles E. and Emma H. Morrison Professor in the Departments of Chemistry and of Molecular Biosciences. He is a member of the National Academy of Sciences.



Dmitriy Lukoyanov received a M.S. degree and a Ph.D. from Kazan State University. He is a postdoctoral fellow at Northwestern University.

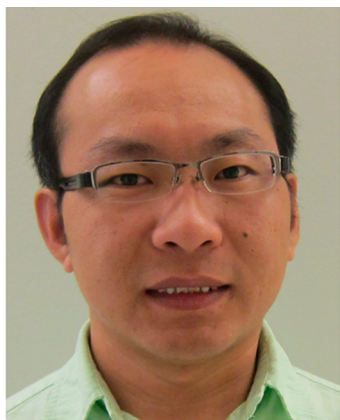

Zhi-Yong Yang received a B.S. degree in chemistry and a Ph.D. degree in organic chemistry from Nankai University in Tianjin, China. Following a position at Shanghai ChemPartner as an organic scientist, he joined the Ph.D. program in biochemistry at Utah State University, where he recently completed his degree. During the past 12 years, his

research has covered biomimetic chemistry of hydrogenases, and the mechanism of nitrogenase. His research interest is in the activation and formation of chemical bonds catalyzed by biological and synthetic transition-metal catalysts.



Dennis R. Dean received a B.A. from Wabash College and a Ph.D. from Purdue University. He is currently a University Distinguished Professor at Virginia Tech where he also serves as the Director of the Fralin Life Science Institute and the Virginia Bioinformatics Institute.



Lance C. Seefeldt received a B.S. degree in chemistry from the University of Redlands in California and a Ph.D. in biochemistry from the University of California at Riverside. He was a postdoctoral fellow at the Center for Metalloenzyme Studies at the University of Georgia before joining the faculty of the Chemistry and Biochemistry Department at Utah State University, where he is now Professor. He was recently awarded the D. Wynne Thorne Career Research Award and elected a Fellow of the American Association for the Advancement of Science. Over the past 25 years, his research has focused on elucidating the mechanism of nitrogenase.

## ACKNOWLEDGMENTS

This work was supported by the NIH (HL 13531, B.M.H.; GM59087, L.C.S. and D.R.D.), NSF (MCB 0723330, B.M.H.), and DOE (DE-SC0010687 to L.C.S. and D.R.D.). We gratefully acknowledge many illuminating discussions with friends and colleagues, most especially noting Professors Richard H. Holm, Pat Holland, and Jonas Peters. Thanks to Dr. K. Danylak for assistance with Figure 1.

## REFERENCES

- (1) Ferguson, S. J. *Curr. Opin. Chem. Biol.* **1998**, *2*, 182.
- (2) Smil, V. *Enriching the Earth: Fritz Haber, Carl Bosch, and the Transformation of World Food Production*; MIT Press: Cambridge, MA, 2004.

- (3) Jia, H.-P.; Quadrelli, E. A. *Chem. Soc. Rev.* **2014**, *43*, 547.
- (4) MacKay, B. A.; Fryzuk, M. D. *Chem. Rev.* **2004**, *104*, 385.
- (5) Canfield, D. E.; Glazer, A. N.; Falkowski, P. G. *Science* **2010**, *330*, 192.
- (6) Cheng, Q. *J. Integr. Plant Biol.* **2008**, *50*, 786.
- (7) Thamdrup, B. *Annu. Rev. Ecol. Evol. Syst.* **2012**, *43*, 407.
- (8) Raymond, J.; Siefert, J. L.; Staples, C. R.; Blankenship, R. E. *Mol. Biol. Evol.* **2004**, *21*, 541.
- (9) Gruber, N.; Galloway, J. N. *Nature* **2008**, *451*, 293.
- (10) Burk, D. *Ergeb. Enzymforsch.* **1934**, *3*, 23.
- (11) Burk, D.; Lineweaver, H.; Horner, C. K. *J. Bacteriol.* **1934**, *27*, 325.
- (12) McGlynn, S. E.; Boyd, E. S.; Peters, J. W.; Orphan, V. J. *Front. Microbiol.* **2013**, *3*, 419.
- (13) Dos Santos, P. C.; Fang, Z.; Mason, S. W.; Setubal, J. C.; Dixon, R. *BMC Genomics* **2012**, *13*, 162.
- (14) Haber, F. *Naturwissenschaften* **1922**, *10*, 1041.
- (15) Haber, F. *Naturwissenschaften* **1923**, *11*, 339.
- (16) Boyd, E. S.; Anbar, A. D.; Miller, S.; Hamilton, T. L.; Lavin, M.; Peters, J. W. *Geobiology* **2011**, *9*, 221.
- (17) Burgess, B. K.; Lowe, D. J. *Chem. Rev.* **1996**, *96*, 2983.
- (18) Eady, R. R. *Chem. Rev.* **1996**, *96*, 3013.
- (19) Beatty, P. H.; Good, A. G. *Science* **2011**, *333*, 416.
- (20) Godfray, H. C. J.; Beddington, J. R.; Crute, I. R.; Haddad, L.; Lawrence, D.; Muir, J. F.; Pretty, J.; Robinson, S.; Thomas, S. M.; Toulmin, C. *Science* **2010**, *327*, 812.
- (21) Rubio, L. M.; Ludden, P. W. *Annu. Rev. Microbiol.* **2008**, *62*, 93.
- (22) Macleod, K. C.; Holland, P. L. *Nat. Chem.* **2013**, *5*, 559.
- (23) Peters, J. C.; Mehn, M. P. In *Activation of Small Molecules: Organometallic and Bioinorganic Perspectives*; Tolman, W. B., Ed.; Wiley-VCH Verlag GmbH & Co. KGaA: Weinheim, Germany, 2006; pp 81–119.
- (24) Schrock, R. R. *Acc. Chem. Res.* **2005**, *38*, 955.
- (25) Tanabe, Y.; Nishibayashi, Y. *Coord. Chem. Rev.* **2013**, *257*, 2551.
- (26) Jodin, C. C. R. *Acad. Paris* **1862**, *55*, 612.
- (27) Carnahan, J. E.; Mortenson, L. E.; Mower, H. F.; Castle, J. E. *Biochim. Biophys. Acta* **1960**, *44*, 520.
- (28) Bulen, W. A.; Burns, R. C.; LeComte, J. R. *Biochem. Biophys. Res. Commun.* **1964**, *17*, 265.
- (29) Schneider, K. C.; Bradbeer, C.; Singh, R. N.; Wang, L. C.; Wilson, P. W.; Burris, R. H. *Proc. Natl. Acad. Sci. U.S.A.* **1960**, *46*, 726.
- (30) Burgess, B. K. *Chem. Rev.* **1990**, *90*, 1377.
- (31) Hardy, R. W.; Burns, R. C.; Parshall, G. W. In *Bioinorganic Chemistry*; Dessy, R.; Dillard, J.; Taylor, L., Eds.; American Chemical Society: Washington, DC, 1971; Vol. 100, pp 219–247.
- (32) Howard, J. B.; Rees, D. C. *Chem. Rev.* **1996**, *96*, 2965.
- (33) Thorneley, R. N. F.; Lowe, D. J. In *Molybdenum Enzymes*; Spiro, T. G., Ed.; Wiley: New York, 1985; pp 221–284.
- (34) Winter, H. C.; Burris, R. H. *Annu. Rev. Biochem.* **1976**, *45*, 409.
- (35) Bulen, W. A.; LeComte, J. R. *Proc. Natl. Acad. Sci. U.S.A.* **1966**, *56*, 979.
- (36) Mortenson, L. E. *Fed. Proc.* **1965**, *24*, 233.
- (37) Mortenson, L. E. *Biochim. Biophys. Acta* **1966**, *127*, 18.
- (38) Hageman, R. V.; Burris, R. H. *Proc. Natl. Acad. Sci. U.S.A.* **1978**, *75*, 2699.
- (39) Dean, D. R.; Bolin, J. T.; Zheng, L. *J. Bacteriol.* **1993**, *175*, 6737.
- (40) Howard, J. B.; Rees, D. C. *Annu. Rev. Biochem.* **1994**, *63*, 235.
- (41) Kim, J.; Rees, D. C. *Biochemistry* **1994**, *33*, 389.
- (42) Bulen, W. A.; Burns, R. C.; LeComte, J. R. *Proc. Natl. Acad. Sci. U.S.A.* **1965**, *53*, 532.
- (43) Burns, R. C.; Bulen, W. A. *Biochim. Biophys. Acta* **1965**, *105*, 437.
- (44) Mortenson, L. E. *Biochim. Biophys. Acta* **1964**, *81*, 473.
- (45) Mortenson, L. E. *Proc. Natl. Acad. Sci. U.S.A.* **1964**, *52*, 272.
- (46) Shah, V. K.; Brill, W. J. *Proc. Natl. Acad. Sci. U.S.A.* **1977**, *74*, 3249.
- (47) Peters, J. W.; Fisher, K.; Newton, W. E.; Dean, D. R. *J. Biol. Chem.* **1995**, *270*, 27007.
- (48) Kim, J.; Rees, D. C. *Science* **1992**, *257*, 1677.
- (49) Ma, L.; Brosius, M. A.; Burgess, B. K. *J. Biol. Chem.* **1996**, *271*, 10528.
- (50) Lowe, D. J.; Fisher, K.; Thorneley, R. N. F. *Biochem. J.* **1993**, *292*, 93.
- (51) Georgiadis, M. M.; Komiya, H.; Chakrabarti, P.; Woo, D.; Kornuc, J. J.; Rees, D. C. *Science* **1992**, *257*, 1653.
- (52) Kim, J.; Rees, D. C. *Nature* **1992**, *360*, 553.
- (53) Chan, M. K.; Kim, J.; Rees, D. C. *Science* **1993**, *260*, 792.
- (54) Kim, J.; Woo, D.; Rees, D. C. *Biochemistry* **1993**, *32*, 7104.
- (55) Jang, S. B.; Seefeldt, L. C.; Peters, J. W. *Biochemistry* **2000**, *39*, 14745.
- (56) Jang, S. B.; Seefeldt, L. C.; Peters, J. W. *Biochemistry* **2000**, *39*, 641.
- (57) Jang, S. B.; Jeong, M. S.; Seefeldt, L. C.; Peters, J. W. *J. Biol. Inorg. Chem.* **2004**, *9*, 1028.
- (58) Jeong, M. S. *Mol. Cells* **2004**, *18*, 374.
- (59) Strop, P.; Takahara, P. M.; Chiu, H.-J.; Angove, H. C.; Burgess, B. K.; Rees, D. C. *Biochemistry* **2001**, *40*, 651.
- (60) Sen, S.; Igarashi, R.; Smith, A.; Johnson, M. K.; Seefeldt, L. C.; Peters, J. W. *Biochemistry* **2004**, *43*, 1787.
- (61) Sen, S.; Krishnakumar, A.; McClelland, J.; Johnson, M. K.; Seefeldt, L. C.; Szilagy, R. K.; Peters, J. W. *J. Inorg. Biochem.* **2006**, *100*, 1041.
- (62) Peters, J. W.; Stowell, M. H. B.; Soltis, S. M.; Finnegan, M. G.; Johnson, M. K.; Rees, D. C. *Biochemistry* **1997**, *36*, 1181.
- (63) Mayer, S. M.; Lawson, D. M.; Gormal, C. A.; Roe, S. M.; Smith, B. E. *J. Mol. Biol.* **1999**, *292*, 871.
- (64) Sørle, M.; Christiansen, J.; Lemon, B. J.; Peters, J. W.; Dean, D. R.; Hales, B. J. *Biochemistry* **2001**, *40*, 1540.
- (65) Einsle, O.; Tezcan, F. A.; Andrade, S. L. A.; Schmid, B.; Yoshida, M.; Howard, J. B.; Rees, D. C. *Science* **2002**, *297*, 1696.
- (66) Schmid, B.; Ribbe, M. W.; Einsle, O.; Yoshida, M.; Thomas, L. M.; Dean, D. R.; Rees, D. C.; Burgess, B. K. *Science* **2002**, *296*, 352.
- (67) Rees, D. C.; Tezcan, F. A.; Haynes, C. A.; Walton, M. Y.; Andrade, S.; Einsle, O.; Howard, J. B. *Phil. Trans. R. Soc., A* **2005**, *363*, 971.
- (68) Sarma, R.; Mulder, D. W.; Brecht, E.; Szilagy, R. K.; Seefeldt, L. C.; Tsuruta, H.; Peters, J. W. *Biochemistry* **2007**, *46*, 14058.
- (69) Sarma, R.; Barney, B. M.; Keable, S.; Dean, D. R.; Seefeldt, L. C.; Peters, J. W. *J. Inorg. Biochem.* **2010**, *104*, 385.
- (70) Spatzal, T.; Aksoyoglu, M.; Zhang, L.; Andrade, S. L. A.; Schleicher, E.; Weber, S.; Rees, D. C.; Einsle, O. *Science* **2011**, *334*, 940.
- (71) Lancaster, K. M.; Roemelt, M.; Ettenhuber, P.; Hu, Y.; Ribbe, M. W.; Neesse, F.; Bergmann, U.; DeBeer, S. *Science* **2011**, *334*, 974.
- (72) Lancaster, K. M.; Hu, Y.; Bergmann, U.; Ribbe, M. W.; DeBeer, S. *J. Am. Chem. Soc.* **2013**, *135*, 610.
- (73) Wiig, J. A.; Hu, Y.; Lee, C. C.; Ribbe, M. W. *Science* **2012**, *337*, 1672.
- (74) Wiig, J. A.; Lee, C. C.; Hu, Y.; Ribbe, M. W. *J. Am. Chem. Soc.* **2013**, *135*, 4982.
- (75) Lee, H.-I.; Benton, P. M. C.; Laryukhin, M.; Igarashi, R. Y.; Dean, D. R.; Seefeldt, L. C.; Hoffman, B. M. *J. Am. Chem. Soc.* **2003**, *125*, 5604.
- (76) Yang, T.-C.; Maeser, N. K.; Laryukhin, M.; Lee, H.-I.; Dean, D. R.; Seefeldt, L. C.; Hoffman, B. M. *J. Am. Chem. Soc.* **2005**, *127*, 12804.
- (77) Lukoyanov, D.; Pelmentschikov, V.; Maeser, N.; Laryukhin, M.; Yang, T. C.; Noodleman, L.; Dean, D. R.; Case, D. A.; Seefeldt, L. C.; Hoffman, B. M. *Inorg. Chem.* **2007**, *46*, 11437.
- (78) Chiu, H.-J.; Peters, J. W.; Lanzilotta, W. N.; Ryle, M. J.; Seefeldt, L. C.; Howard, J. B.; Rees, D. C. *Biochemistry* **2001**, *40*, 641.
- (79) Schmid, B.; Einsle, O.; Chiu, H.-J.; Willing, A.; Yoshida, M.; Howard, J. B.; Rees, D. C. *Biochemistry* **2002**, *41*, 15557.
- (80) Schindelin, H.; Kisker, C.; Schlessman, J. L.; Howard, J. B.; Rees, D. C. *Nature* **1997**, *387*, 370.
- (81) Tezcan, F. A.; Kaiser, J. T.; Mustafi, D.; Walton, M. Y.; Howard, J. B.; Rees, D. C. *Science* **2005**, *309*, 1377.
- (82) Soboh, B.; Boyd, E. S.; Zhao, D.; Peters, J. W.; Rubio, L. M. *FEBS Lett.* **2010**, *584*, 1487.

- (83) Dos Santos, P. C.; Dean, D. R.; Hu, Y.; Ribbe, M. W. *Chem. Rev.* **2004**, *104*, 1159.
- (84) Hu, Y.; Fay, A. W.; Lee, C. C.; Yoshizawa, J.; Ribbe, M. W. *Biochemistry* **2008**, *47*, 3973.
- (85) Hu, Y.; Ribbe, M. W. *Acc. Chem. Res.* **2010**, *43*, 475.
- (86) Hu, Y.; Ribbe, M. W. *Microbiol. Mol. Biol. Rev.* **2011**, *75*, 664.
- (87) Hu, Y.; Ribbe, M. W. *Coord. Chem. Rev.* **2011**, *255*, 1218.
- (88) Hu, Y.; Ribbe, M. W. *J. Biol. Chem.* **2013**, *288*, 13173.
- (89) Hu, Y.; Ribbe, M. W. *Biochim. Biophys. Acta* **2013**, *1827*, 1112.
- (90) Rehder, D. J. *Inorg. Biochem.* **2000**, *80*, 133.
- (91) Eady, R. R. *Coord. Chem. Rev.* **2003**, *237*, 23.
- (92) Crans, D. C.; Smee, J. J.; Gaidamauskas, E.; Yang, L. *Chem. Rev.* **2004**, *104*, 849.
- (93) Fisher, K.; Dilworth, M. J.; Newton, W. E. *Biochemistry* **2006**, *45*, 4190.
- (94) Lee, C. C.; Hu, Y.; Ribbe, M. W.; Holm, R. H. *Proc. Natl. Acad. Sci. U.S.A.* **2009**, *106*, 9209.
- (95) Lee, C. C.; Hu, Y.; Ribbe, M. W. *Science* **2010**, *329*, 642.
- (96) Lee, C. C.; Hu, Y.; Ribbe, M. W. *Angew. Chem., Int. Ed.* **2011**, *50*, 5545.
- (97) Dance, I. *Dalton Trans.* **2011**, *40*, 5516.
- (98) Hu, Y.; Lee, C. C.; Ribbe, M. W. *Dalton Trans.* **2012**, *41*, 1118.
- (99) Duval, S.; Danyal, K.; Shaw, S.; Lytle, A. K.; Dean, D. R.; Hoffman, B. M.; Antony, E.; Seefeldt, L. C. *Proc. Natl. Acad. Sci. U.S.A.* **2013**, *110*, 16414.
- (100) Seefeldt, L. C.; Hoffman, B. M.; Dean, D. R. *Curr. Opin. Chem. Biol.* **2012**, *16*, 19.
- (101) Howard, J. B.; Rees, D. C. *Proc. Natl. Acad. Sci. U.S.A.* **2006**, *103*, 17088.
- (102) Duyvis, M. G.; Wassink, H.; Haaker, H. *Biochemistry* **1998**, *37*, 17345.
- (103) Wilson, P. E.; Nyborg, A. C.; Watt, G. D. *Biophys. Chem.* **2001**, *91*, 281.
- (104) Peters, J. W.; Szilagy, R. K. *Curr. Opin. Chem. Biol.* **2006**, *10*, 101.
- (105) Danyal, K.; Mayweather, D.; Dean, D. R.; Seefeldt, L. C.; Hoffman, B. M. *J. Am. Chem. Soc.* **2010**, *132*, 6894.
- (106) Danyal, K.; Dean, D. R.; Hoffman, B. M.; Seefeldt, L. C. *Biochemistry* **2011**, *50*, 9255.
- (107) Mayweather, D.; Danyal, K.; Dean, D. R.; Seefeldt, L. C.; Hoffman, B. M. *Biochemistry* **2012**, *51*, 8391.
- (108) Chan, J. M.; Christiansen, J.; Dean, D. R.; Seefeldt, L. C. *Biochemistry* **1999**, *38*, 5779.
- (109) Nyborg, A. C.; Johnson, J. L.; Gunn, A.; Watt, G. D. *J. Biol. Chem.* **2000**, *275*, 39307.
- (110) Rupnik, K.; Hu, Y.; Lee, C. C.; Wiig, J. A.; Ribbe, M. W.; Hales, B. J. *J. Am. Chem. Soc.* **2012**, *134*, 13749.
- (111) Lanzilotta, W. N.; Christiansen, J.; Dean, D. R.; Seefeldt, L. C. *Biochemistry* **1998**, *37*, 11376.
- (112) Duyvis, M. G.; Wassink, H.; Haaker, H. *FEBS Lett.* **1996**, *380*, 233.
- (113) Angove, H. C.; Yoo, S. J.; Münck, E.; Burgess, B. K. *J. Biol. Chem.* **1998**, *273*, 26330.
- (114) Seefeldt, L. C.; Dean, D. R. *Acc. Chem. Res.* **1997**, *30*, 260.
- (115) Chan, J. M.; Ryle, M. J.; Seefeldt, L. C. *J. Biol. Chem.* **1999**, *274*, 17593.
- (116) Lanzilotta, W. N.; Parker, V. D.; Seefeldt, L. C. *Biochim. Biophys. Acta* **1999**, *1429*, 411.
- (117) Ryle, M. J.; Seefeldt, L. C. *J. Biol. Chem.* **2000**, *275*, 6214.
- (118) Danyal, K.; Ingle, B. S.; Vincent, K. A.; Barney, B. M.; Hoffman, B. M.; Armstrong, F. A.; Dean, D. R.; Seefeldt, L. C. *J. Am. Chem. Soc.* **2010**, *132*, 13197.
- (119) Roth, L. E.; Nguyen, J. C.; Tezcan, F. A. *J. Am. Chem. Soc.* **2010**, *132*, 13672.
- (120) Roth, L. E.; Tezcan, F. A. *ChemCatChem* **2011**, *3*, 1549.
- (121) Roth, L. E.; Tezcan, F. A. *J. Am. Chem. Soc.* **2012**, *134*, 8416.
- (122) Durrant, M. C. *Biochem. J.* **2001**, *355*, 569.
- (123) Durrant, M. C. *Biochemistry* **2002**, *41*, 13934.
- (124) Durrant, M. C. *Biochemistry* **2002**, *41*, 13946.
- (125) Cui, Z.; Dunford, A. J.; Durrant, M. C.; Henderson, R. A.; Smith, B. E. *Inorg. Chem.* **2003**, *42*, 6252.
- (126) Thorneley, R. N. F.; Angove, H. C.; Durrant, M. C.; Fairhurst, S. A.; George, S. J.; Sinclair, A.; Tolland, J. D.; Hallenbeck, P. C. *J. Inorg. Biochem.* **2003**, *96*, 18.
- (127) Durrant, M. C.; Francis, A.; Lowe, D. J.; Newton, W. E.; Fisher, K. *Biochem. J.* **2006**, *397*, 261.
- (128) Hinnemann, B.; Nørskov, J. K. *J. Am. Chem. Soc.* **2003**, *125*, 1466.
- (129) Hinnemann, B.; Nørskov, J. K. *J. Am. Chem. Soc.* **2004**, *126*, 3920.
- (130) Hinnemann, B.; Nørskov, J. K. *Phys. Chem. Chem. Phys.* **2004**, *6*, 843.
- (131) Hinnemann, B.; Nørskov, J. K. *Top. Catal.* **2006**, *37*, 55.
- (132) Varley, J. B.; Nørskov, J. K. *ChemCatChem* **2013**, *5*, 732.
- (133) Lovell, T.; Li, J.; Liu, T.; Case, D. A.; Noodleman, L. *J. Am. Chem. Soc.* **2001**, *123*, 12392.
- (134) Lovell, T.; Liu, T.; Case, D. A.; Noodleman, L. *J. Am. Chem. Soc.* **2003**, *125*, 8377.
- (135) Torres, R. A.; Lovell, T.; Noodleman, L.; Case, D. A. *J. Am. Chem. Soc.* **2003**, *125*, 1923.
- (136) Pelmenchikov, V.; Case, D. A.; Noodleman, L. *Inorg. Chem.* **2008**, *47*, 6162.
- (137) Dance, I. *J. Am. Chem. Soc.* **2007**, *129*, 1076.
- (138) Harris, T. V.; Szilagy, R. K. *Inorg. Chem.* **2011**, *50*, 4811.
- (139) Neese, F. *Angew. Chem., Int. Ed.* **2006**, *45*, 196.
- (140) Kästner, J.; Blöchl, P. E. *J. Am. Chem. Soc.* **2007**, *129*, 2998.
- (141) Seefeldt, L. C.; Rasche, M. E.; Ensign, S. A. *Biochemistry* **1995**, *34*, 5382.
- (142) Rasche, M. E.; Seefeldt, L. C. *Biochemistry* **1997**, *36*, 8574.
- (143) Mayer, S. M.; Niehaus, W. G.; Dean, D. R. *J. Chem. Soc., Dalton Trans.* **2002**, 802.
- (144) Dos Santos, P. C.; Mayer, S. M.; Barney, B. M.; Seefeldt, L. C.; Dean, D. R. *J. Inorg. Biochem.* **2007**, *101*, 1642.
- (145) Igarashi, R. Y.; Dos Santos, P. C.; Niehaus, W. G.; Dance, I. G.; Dean, D. R.; Seefeldt, L. C. *J. Biol. Chem.* **2004**, *279*, 34770.
- (146) Dos Santos, P. C.; Igarashi, R. Y.; Lee, H.-I.; Hoffman, B. M.; Seefeldt, L. C.; Dean, D. R. *Acc. Chem. Res.* **2005**, *38*, 208.
- (147) Barney, B. M.; McClead, J.; Lukoyanov, D.; Laryukhin, M.; Yang, T.-C.; Dean, D. R.; Hoffman, B. M.; Seefeldt, L. C. *Biochemistry* **2007**, *46*, 6784.
- (148) Seefeldt, L. C.; Yang, Z.-Y.; Duval, S.; Dean, D. R. *Biochim. Biophys. Acta* **2013**, *1827*, 1102.
- (149) Fisher, K.; Dilworth, M. J.; Kim, C.-H.; Newton, W. E. *Biochemistry* **2000**, *39*, 10855.
- (150) Yang, Z.-Y.; Dean, D. R.; Seefeldt, L. C. *J. Biol. Chem.* **2011**, *286*, 19417.
- (151) Hu, Y.; Lee, C. C.; Ribbe, M. W. *Science* **2011**, *333*, 753.
- (152) Yang, Z.-Y.; Moure, V. R.; Dean, D. R.; Seefeldt, L. C. *Proc. Natl. Acad. Sci. U.S.A.* **2012**, *109*, 19644.
- (153) Barney, B. M.; Lee, H.-I.; Dos Santos, P. C.; Hoffman, B. M.; Dean, D. R.; Seefeldt, L. C. *Dalton Trans.* **2006**, 2277.
- (154) Seefeldt, L. C.; Hoffman, B. M.; Dean, D. R. *Annu. Rev. Biochem.* **2009**, *78*, 701.
- (155) Hoffman, B. M.; Dean, D. R.; Seefeldt, L. C. *Acc. Chem. Res.* **2009**, *42*, 609.
- (156) Hoffman, B. M.; Lukoyanov, D.; Dean, D. R.; Seefeldt, L. C. *Acc. Chem. Res.* **2013**, *46*, 587.
- (157) Yang, Z.-Y.; Khadka, N.; Lukoyanov, D.; Hoffman, B. M.; Dean, D. R.; Seefeldt, L. C. *Proc. Natl. Acad. Sci. U.S.A.* **2013**, *110*, 16327.
- (158) Simpson, F. B.; Burris, R. H. *Science* **1984**, *224*, 1095.
- (159) Davis, L. C.; Henzl, M. T.; Burris, R. H.; Orme-Johnson, W. H. *Biochemistry* **1979**, *18*, 4860.
- (160) Barney, B. M.; Laryukhin, M.; Igarashi, R. Y.; Lee, H.-I.; Dos Santos, P. C.; Yang, T.-C.; Hoffman, B. M.; Dean, D. R.; Seefeldt, L. C. *Biochemistry* **2005**, *44*, 8030.
- (161) Fisher, K.; Dilworth, M. J.; Newton, W. E. *Biochemistry* **2000**, *39*, 15570.

- (162) Scott, D. J.; May, H. D.; Newton, W. E.; Brigle, K. E.; Dean, D. R. *Nature* **1990**, *343*, 188.
- (163) Thomann, H.; Bernardo, M.; Newton, W. E.; Dean, D. R. *Proc. Natl. Acad. Sci. U.S.A.* **1991**, *88*, 6620.
- (164) Kim, C.-H.; Newton, W. E.; Dean, D. R. *Biochemistry* **1995**, *34*, 2798.
- (165) Dilworth, M. J.; Fisher, K.; Kim, C.-H.; Newton, W. E. *Biochemistry* **1998**, *37*, 17495.
- (166) Barney, B. M.; Lukoyanov, D.; Igarashi, R. Y.; Laryukhin, M.; Yang, T.-C.; Dean, D. R.; Hoffman, B. M.; Seefeldt, L. C. *Biochemistry* **2009**, *48*, 9094.
- (167) Benton, P. M. C.; Laryukhin, M.; Mayer, S. M.; Hoffman, B. M.; Dean, D. R.; Seefeldt, L. C. *Biochemistry* **2003**, *42*, 9102.
- (168) Lee, H.-I.; Igarashi, R. Y.; Laryukhin, M.; Doan, P. E.; Dos Santos, P. C.; Dean, D. R.; Seefeldt, L. C.; Hoffman, B. M. *J. Am. Chem. Soc.* **2004**, *126*, 9563.
- (169) Igarashi, R. Y.; Laryukhin, M.; Dos Santos, P. C.; Lee, H.-I.; Dean, D. R.; Seefeldt, L. C.; Hoffman, B. M. *J. Am. Chem. Soc.* **2005**, *127*, 6231.
- (170) Barney, B. M.; Yang, T.-C.; Igarashi, R. Y.; Dos Santos, P. C.; Laryukhin, M.; Lee, H.-I.; Hoffman, B. M.; Dean, D. R.; Seefeldt, L. C. *J. Am. Chem. Soc.* **2005**, *127*, 14960.
- (171) Barney, B. M.; Lukoyanov, D.; Yang, T.-C.; Dean, D. R.; Hoffman, B. M.; Seefeldt, L. C. *Proc. Natl. Acad. Sci. U.S.A.* **2006**, *103*, 17113.
- (172) Orme-Johnson, W. H.; Hamilton, W. D.; Jones, T. L.; Tso, M. Y. W.; Burris, R. H.; Shah, V. K.; Brill, W. J. *Proc. Natl. Acad. Sci. U.S.A.* **1972**, *69*, 3142.
- (173) Hoffman, B. M. *J. Phys. Chem.* **1994**, *98*, 11657.
- (174) Hoffman, B. M.; Sturgeon, B. E.; Doan, P. E.; DeRose, V. J.; Liu, K. E.; Lippard, S. J. *J. Am. Chem. Soc.* **1994**, *116*, 6023.
- (175) Hoffman, B. M. *Proc. Natl. Acad. Sci. U.S.A.* **2003**, *100*, 3575.
- (176) Hoffman, B. M. *Acc. Chem. Res.* **2003**, *36*, 522.
- (177) Schweiger, A.; Jeschke, G. *Principles of Pulse Electron Paramagnetic Resonance*; Oxford University Press: Oxford, U.K., 2001.
- (178) George, S. J.; Barney, B. M.; Mitra, D.; Igarashi, R. Y.; Guo, Y.; Dean, D. R.; Cramer, S. P.; Seefeldt, L. C. *J. Inorg. Biochem.* **2012**, *112*, 85.
- (179) Huynh, B. H.; Henzl, M. T.; Christner, J. A.; Zimmermann, R.; Orme-Johnson, W. H.; Münck, E. *Biochim. Biophys. Acta* **1980**, *623*, 124.
- (180) Yoo, S. J.; Angove, H. C.; Papaefthymiou, V.; Burgess, B. K.; Münck, E. *J. Am. Chem. Soc.* **2000**, *122*, 4926.
- (181) Lowe, D. J.; Eady, R. R.; Thorneley, N. F. *Biochem. J.* **1978**, *173*, 277.
- (182) Fisher, K.; Newton, W. E.; Lowe, D. J. *Biochemistry* **2001**, *40*, 3333.
- (183) Lukoyanov, D.; Barney, B. M.; Dean, D. R.; Seefeldt, L. C.; Hoffman, B. M. *Proc. Natl. Acad. Sci. U.S.A.* **2007**, *104*, 1451.
- (184) Barney, B. M.; Igarashi, R. Y.; Dos Santos, P. C.; Dean, D. R.; Seefeldt, L. C. *J. Biol. Chem.* **2004**, *279*, 53621.
- (185) Yates, M. G.; Lowe, D. J. *FEBS Lett.* **1976**, *72*, 121.
- (186) Kinney, R. A.; Hettterscheid, D. G. H.; Hanna, B. S.; Schrock, R. R.; Hoffman, B. M. *Inorg. Chem.* **2010**, *49*, 704.
- (187) Willems, J.-P.; Lee, H.-I.; Burdi, D.; Doan, P. E.; Stubbe, J.; Hoffman, B. M. *J. Am. Chem. Soc.* **1997**, *119*, 9816.
- (188) Kinney, R. A.; Saouma, C. T.; Peters, J. C.; Hoffman, B. M. *J. Am. Chem. Soc.* **2012**, *134*, 12637.
- (189) Lukoyanov, D.; Yang, Z.-Y.; Dean, D. R.; Seefeldt, L. C.; Hoffman, B. M. *J. Am. Chem. Soc.* **2010**, *132*, 2526.
- (190) Henderson, R. A. *Chem. Rev.* **2005**, *105*, 2365.
- (191) Henderson, R. A. *Coord. Chem. Rev.* **2005**, *249*, 1841.
- (192) Chiang, K. P.; Scarborough, C. C.; Horitani, M.; Lees, N. S.; Ding, K.; Dugan, T. R.; Brennessel, W. W.; Bill, E.; Hoffman, B. M.; Holland, P. L. *Angew. Chem., Int. Ed.* **2012**, *51*, 3658.
- (193) Doan, P. E.; Telsler, J.; Barney, B. M.; Igarashi, R. Y.; Dean, D. R.; Seefeldt, L. C.; Hoffman, B. M. *J. Am. Chem. Soc.* **2011**, *133*, 17329.
- (194) Peruzzini, M.; Poli, R. *Recent Advances in Hydride Chemistry*; Elsevier Science B.V.: Amsterdam, The Netherlands, 2001.
- (195) Crabtree, R. H. *The Organometallic Chemistry of the Transition Metals*, 5th ed.; Wiley: Hoboken, NJ, 2009.
- (196) Oro, L. A.; Sola, E. In *Recent Advances in Hydride Chemistry*; Peruzzini, M., Poli, R., Eds.; Elsevier Science B.V.: Amsterdam, The Netherlands, 2001; pp 299–328.
- (197) Zimmermann, R.; Münck, E.; Brill, W. J.; Shah, V. K.; Henzl, M. T.; Rawlings, J.; Orme-Johnson, W. H. *Biochim. Biophys. Acta* **1978**, *537*, 185.
- (198) Lee, H.-I.; Sørli, M.; Christiansen, J.; Yang, T.-C.; Shao, J.; Dean, D. R.; Hales, B. J.; Hoffman, B. M. *J. Am. Chem. Soc.* **2005**, *127*, 15880.
- (199) Siegbahn, P. E. M.; Tye, J. W.; Hall, M. B. *Chem. Rev.* **2007**, *107*, 4414.
- (200) Surawatanawong, P.; Hall, M. B. *Inorg. Chem.* **2010**, *49*, 5737.
- (201) Pickett, C. J. *J. Biol. Inorg. Chem.* **1996**, *1*, 601.
- (202) Chatt, J.; Dilworth, J. R.; Richards, R. L. *Chem. Rev.* **1978**, *78*, 589.
- (203) Chatt, J.; Richards, R. L. *J. Organomet. Chem.* **1982**, *239*, 65.
- (204) Schrock, R. R. *Chem. Commun.* **2003**, 2389.
- (205) Yandulov, D. V.; Schrock, R. R. *Science* **2003**, *301*, 76.
- (206) Schrock, R. R. *Angew. Chem., Int. Ed.* **2008**, *47*, 5512.
- (207) Lukoyanov, D.; Dikanov, S. A.; Yang, Z.-Y.; Barney, B. M.; Samoilova, R. I.; Narasimhulu, K. V.; Dean, D. R.; Seefeldt, L. C.; Hoffman, B. M. *J. Am. Chem. Soc.* **2011**, *133*, 11655.
- (208) Thorneley, R. N.; Lowe, D. J. *Biochem. J.* **1984**, *224*, 887.
- (209) Burgess, B. K. In *Metal Ions in Biology: Molybdenum Enzymes*; Spiro, T. G., Ed.; John Wiley and Sons: New York, 1985; pp 161–220.
- (210) Thorneley, R. N. F.; Eady, R. R.; Lowe, D. J. *Nature* **1978**, *272*, 557.
- (211) Davis, L. C. *Arch. Biochem. Biophys.* **1980**, *204*, 270.
- (212) Murakami, J.; Yamaguchi, W. *Sci. Rep.* **2012**, *2*, 407.
- (213) Rodriguez, M. M.; Bill, E.; Brennessel, W. W.; Holland, P. L. *Science* **2011**, *334*, 780.
- (214) Anderson, J. S.; Rittle, J.; Peters, J. C. *Nature* **2013**, *501*, 84.
- (215) Dilworth, M. J.; Eady, R. R. *Biochem. J.* **1991**, *277*, 465.
- (216) McKenna, C. E.; Simeonov, A. M.; Eran, H.; Bravo-Leerabhandh, M. *Biochemistry* **1996**, *35*, 4502.
- (217) Seefeldt, L. C.; Dance, I. G.; Dean, D. R. *Biochemistry* **2004**, *43*, 1401.
- (218) Münck, E.; Ksurerus, K.; Hendrich, M. P. *Metallobiochemistry Part D: Physical and Spectroscopic Methods for Probing Metal Ion Environment in Metalloproteins*. In *Methods in Enzymology*; James, F., Riordan, B. L. V., Ed.; Academic Press: New York, 1993; Vol. 227, pp 463–479.
- (219) Lukoyanov, D.; Yang, Z.-Y.; Barney, B. M.; Dean, D. R.; Seefeldt, L. C.; Hoffman, B. M. *Proc. Natl. Acad. Sci. U.S.A.* **2012**, *109*, 5583.
- (220) Lowe, D. J.; Fisher, K.; Thorneley, R. N. *Biochem. J.* **1990**, *272*, 621.
- (221) As summarized by Peters and Mehn, many of the attempts to understand nitrogen fixation theoretically treat a six-electron stoichiometry, and thus implicitly reject this central mechanistic feature of the LT scheme.
- (222) Ballmann, J.; Munhá, R. F.; Fryzuk, M. D. *Chem. Commun.* **2010**, *46*, 1013.
- (223) Kubas, G. J. *Chem. Rev.* **2007**, *107*, 4152.
- (224) Tard, C.; Pickett, C. J. *Chem. Rev.* **2009**, *109*, 2245.
- (225) Crabtree, R. H. *Inorg. Chim. Acta* **1986**, *125*, L7.
- (226) Burgess, B. K.; Wherland, S.; Newton, W. E.; Stiefel, E. I. *Biochemistry* **1981**, *20*, 5140.
- (227) Li, J.-L.; Burris, R. H. *Biochemistry* **1983**, *22*, 4472.
- (228) Jensen, B. B.; Burris, R. H. *Biochemistry* **1985**, *24*, 1141.
- (229) Hoch, G. E.; Schneider, K. C.; Burris, R. H. *Biochim. Biophys. Acta* **1960**, *37*, 273.
- (230) Jackson, E. K.; Parshall, G. W.; Hardy, R. W. F. *J. Biol. Chem.* **1968**, *243*, 4952.
- (231) Hartwig, J. *Organotransition Metal Chemistry: From Bonding to Catalysis*; University Science Books: Sausalito, CA, 2010.

- (232) Christiansen, J.; Seefeldt, L. C.; Dean, D. R. *J. Biol. Chem.* **2000**, *275*, 36104.
- (233) Christiansen, J.; Cash, V. L.; Seefeldt, L. C.; Dean, D. R. *J. Biol. Chem.* **2000**, *275*, 11459.
- (234) Rivera-Ortiz, J. M.; Burris, R. H. *J. Bacteriol.* **1975**, *123*, 537.
- (235) Stieber, S. C. E.; Milsmann, C.; Hoyt, J. M.; Turner, Z. R.; Finkelstein, K. D.; Wieghardt, K.; DeBeer, S.; Chirik, P. J. *Inorg. Chem.* **2012**, *51*, 3770.
- (236) Moret, M.-E.; Peters, J. C. *J. Am. Chem. Soc.* **2011**, *133*, 18118.
- (237) Moret, M.-E.; Peters, J. C. *Angew. Chem., Int. Ed.* **2011**, *50*, 2063.
- (238) Saouma, C. T.; Moore, C. E.; Rheingold, A. L.; Peters, J. C. *Inorg. Chem.* **2011**, *50*, 11285.
- (239) Takaoka, A.; Mankad, N. P.; Peters, J. C. *J. Am. Chem. Soc.* **2011**, *133*, 8440.
- (240) Fong, H.; Moret, M.-E.; Lee, Y.; Peters, J. C. *Organometallics* **2013**, *32*, 3053.
- (241) Dance, I. *Chem.—Asian J.* **2007**, *2*, 936.
- (242) Dance, I. *Chem. Commun.* **2013**, *49*, 10893.