

Research Article

Lipid Extraction from *Spirulina* sp. and *Schizochytrium* sp. Using Supercritical CO₂ with Methanol

Shihong Liu ¹, Husam A. Abu Hajar,² Guy Riefler,³ and Ben J. Stuart⁴

¹Department of Chemical and Biomolecular Engineering, Ohio University, Athens, OH, USA

²Civil Engineering Department, School of Engineering, The University of Jordan, Amman, Jordan

³Department of Civil Engineering, Ohio University, Athens, OH, USA

⁴Department of Civil & Environmental Engineering, Old Dominion University, Norfolk, VA, USA

Correspondence should be addressed to Shihong Liu; sl871014@ohio.edu

Received 12 June 2018; Revised 10 November 2018; Accepted 22 November 2018; Published 9 December 2018

Academic Editor: Beom Soo Kim

Copyright © 2018 Shihong Liu et al. This is an open access article distributed under the Creative Commons Attribution License, which permits unrestricted use, distribution, and reproduction in any medium, provided the original work is properly cited.

Microalgae are one of the most promising feedstocks for biodiesel production due to their high lipid content and easy farming. However, the extraction of lipids from microalgae is energy intensive and costly and involves the use of toxic organic solvents. Compared with organic solvent extraction, supercritical CO₂ (SCCO₂) has demonstrated advantages through lower toxicity and no solvent-liquid separation. Due to the nonpolar nature of SCCO₂, polar organic solvents such as methanol may need to be added as a modifier in order to increase the extraction ability of SCCO₂. In this paper, pilot scale lipid extraction using SCCO₂ was studied on two microalgae species: *Spirulina* sp. and *Schizochytrium* sp. For each species, SCCO₂ extraction was conducted on 200 g of biomass for 6 h. Methanol was added as a cosolvent in the extraction process based on a volume ratio of 4%. The results showed that adding methanol in SCCO₂ increased the lipid extraction yield significantly for both species. Under an operating pressure of 4000 psi, the lipid extraction yields for *Spirulina* sp. and *Schizochytrium* sp. were increased by 80% and 72%, respectively. It was also found that a stepwise addition of methanol was more effective than a one-time addition. In comparison with Soxhlet extraction using methylene chloride/methanol (2:1, v/v), the methanol-SCCO₂ extraction demonstrated its high effectiveness for lipid extraction. In addition, the methanol-SCCO₂ system showed a high lipid extraction yield after increasing biomass loading fivefold, indicating good potential for scaling up this method. Finally, a kinetic study of the SCCO₂ extraction process was conducted, and the results showed that methanol concentration in SCCO₂ has the strongest influence on the lipid extraction yield.

1. Introduction

Fossil fuels, which include coal, petroleum, and natural gas, comprise 81% of the total energy consumed by mankind in 2014 [1]. Compared to other energy types, developing and producing fossil fuels is the most economical way of energy production. Also, the energy density of fossil fuels is above other alternative energy sources, which means fossil fuels are the most efficient energy sources. However, the use and consumption of fossil fuels has caused many problems. Because fossil fuels are considered to be a nonrenewable and nonsustainable form of energy, their production will decline and eventually be exhausted. Since the combustion of fossil fuels emits greenhouse gases (GHGs), the use of fossil fuels is a major contributor to global warming [2]. The extraction

of fossil fuels also causes other forms of environmental degradation [3]. Because of these disadvantages, developing sustainable and cleaner energy forms is a global necessity and has become an urgent pursuit in scientific research.

Biodiesel is a renewable energy form that can be used as a substitute for fossil fuels. It is considered to be one of the best candidates to replace fossil diesel, because it can be directly used in any compression ignition engine without major modifications [4]. Biodiesel can be used in its pure form, but due to its high production cost and poor cold flow properties, it is often used as a diesel additive. Commercially used biodiesel is primarily composed of fatty acid methyl esters (FAMES) that are produced via transesterification of triglycerides obtained from plants, animal fats, and microalgae [5].

Among all of the biodiesel production feedstocks, microalgae are considered to be the most promising feedstock due to their high rate and efficiency of photosynthesis. Microalgae can accumulate high lipid content in their biomass (up to 77% of total biomass), depending on the type of microalgae [6]. Compared to other available feedstocks for biodiesel production, microalgae have higher oil productivity and require less land area for cultivation. Most importantly, commercial-scale microalgae farms would not be in competition with food production [5].

Nevertheless, the main drawback of microalgae as a feedstock for biodiesel production is the energy intensive and costly production process, due mainly to the harvesting and the lipid extraction processes [7].

It is therefore necessary to develop effective methods to reduce the cost of these processes. For lipid extraction, two methods are often used: organic solvent extraction and supercritical CO₂ (SCCO₂) extraction. Organic solvent extraction requires a large volume of expensive and toxic organic solvents. It also requires an energy intensive lipid-solvent separation process after extraction, and not all of the solvent can be recycled. In addition, the lipid extraction rate is slow [8].

Compared to organic solvent extraction, SCCO₂ extraction has several advantages. SCCO₂ extraction is faster and has a higher selectivity toward biodiesel desirable lipid fractions, and the solvent-liquid separation process is not required, since SCCO₂ will become gas after pressure is reduced [8]. The main drawback of SCCO₂ extraction is its high equipment installation cost and its high energy requirement [9].

Previous researcher has demonstrated effective results for SCCO₂ lipid extraction from microalgae. Halim et al. [10] studied the effect of SCCO₂ on extracting lipid from the marine microalga *Chlorococcum* sp. They found that 80 min of SCCO₂ extraction at 4400 psi and 30°C resulted in a maximum lipid yield of 7.1 wt% of dry biomass, which was equivalent to 5.5 h of hexane extraction using a Soxhlet apparatus. Mendes et al. [11] studied the SCCO₂ lipid extraction of *Arthrospira maxima* with the addition of ethanol. They found that the addition of a polar modifier such as ethanol could greatly improve the results of SCCO₂ extraction. Under the optimal experiment conditions of 60°C and 5000 psi, the addition of ethanol could increase the γ -linolenic acid (GLA) extraction yield from 0.05 wt% of dry biomass to 0.44%. Other researchers also have reported high efficiency supercritical CO₂ extraction [12–14].

However, many of these experiments were conducted at the bench scale, and few of them used microalgae masses beyond 200 g. For a larger amount of microalgae sample, the effectiveness of SCCO₂ extraction is not well investigated. Moreover, most of the SCCO₂ extraction experiments were conducted at high pressures (at or above 5000 psi). Operating at such high pressures at commercial scale is more costly and could be potentially dangerous. Further, adding a polar modifier to the SCCO₂ extraction process has been demonstrated to improve extraction efficiency [11]. Lorenzen et al. [15] conducted an industrial scale lipid extraction on the microalga *Scenedesmus* sp. using SCCO₂ at low pressure

(1740 psi) without any modifier or cosolvent in the extraction process, resulting in a long extraction time requirement (9 h) for a high lipid extraction yield.

The goal of this study is to investigate the scaling up potential of SCCO₂ extraction for microalgae. Our study focused on SCCO₂ extraction at a larger scale (from 200 g to 1 kg) at moderate pressures (below 5000 psi) with a modifier (methanol) added. A comparison between SCCO₂ extraction and Soxhlet extraction was also conducted. The fatty acid profile in the extracted lipids was analyzed in order to predict the quality of biodiesel produced. Finally, a kinetic model was established to analyze the effects of pressure, methanol concentration, and CO₂ flow rate on the lipid extraction yield.

2. Methodology

2.1. Optimizing the Operating Pressure of SCCO₂ Extraction.

The SCCO₂ extraction unit used in this research is shown in Figure 1(a). Figure 1(b) is a schematic representation of the supercritical extraction process. 200 g of dry microalgae biomass is first placed in an extractor. An air-driven gas booster was used to pump CO₂ from a cylinder to the extractor and increased the pressure in the extractor. The operating pressure has a significant impact on the SCCO₂ extraction process, because the solubility of SCCO₂ is a function of the pressure.

A pressure regulator was installed at the exit of the extractor in order to reduce the pressure in the separators, where the pressure was kept at 350 psi. The CO₂ became a supercritical fluid and was able to extract lipids from the microalgae in the extractor, returned to a gas phase in the separators, and then was pumped back to the extractor by the air-driven gas booster. The extracted lipids were automatically collected in the separators. A valve was installed at the bottom of each separator to collect lipids after the operation. After the extraction process, the CO₂ in the system was pumped back to the CO₂ cylinder for recycling. Although two separators were used in the process, most of extracted lipids were collected in the first separator. The purpose of the second separator was to provide extra retention time to ensure pure CO₂ was pumped back to the CO₂ cylinder. The entire system was maintained at 50°C.

In order to investigate the effect of pressures, three different operating pressures were tested during the SCCO₂ extraction process: 2000 psi, 3000 psi, and 4000 psi. Since the CO₂ flow in the system was controlled by the air-driven gas booster, the pressure in the extractor also affected the CO₂ flow rate in the system. The corresponding CO₂ flow rates for the gas booster operated under 2000 psi, 3000 psi, and 4000 psi were 7.5, 7.1, and 6.8 standard cubic feet per minute (scfm), respectively, based on the performance curves of the gas booster. The residence time of CO₂ in the extractor can be roughly estimated using the ratio of CO₂ mass in the 5 L extractor to the CO₂ mass flow rate. Under 2000 psi, 3000 psi, and 4000 psi of pressure, the residence times of CO₂ were calculated as 0.13, 0.18, and 0.20 h, respectively.

Two different species of microalgae were tested in the SCCO₂ extraction. *Spirulina* sp., a blue green alga commonly

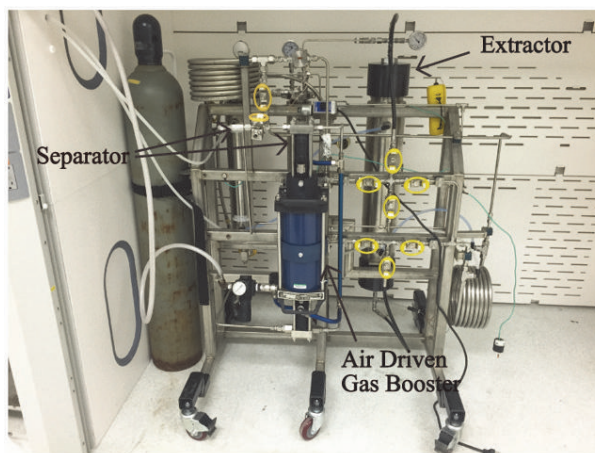

(a)

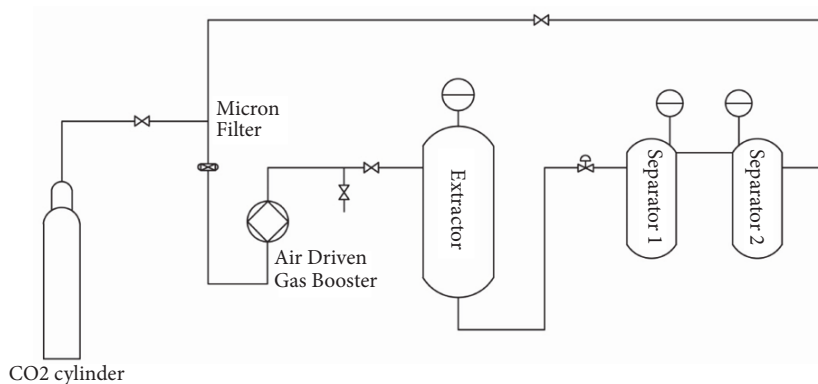

(b)

FIGURE 1: The supercritical CO₂ extraction unit (a) and the schematic extraction process (b).

used as a food supplement or animal nutrition [16] with a lipid content of less than 33.3% dry weight of biomass (as reported by the producer), was purchased from Ojio® (India). The other species was *Schizochytrium* sp., which is a marine microalga characterized by its high content of polyunsaturated fatty acids [14], had a lipid content of 25% dry weight of biomass (as reported by the producer), and was purchased from Xiamen Huison Biotech Co. (China). The lipid content of this microalga was determined after docosahexaenoic acid (DHA) extraction conducted by the company. Both microalgae were obtained as dry powders and were used directly in the extraction without pre-treatment.

CHNS analysis and TGA analysis were conducted for both species to determine the elemental composition in microalgae biomass. For *Spirulina* sp., the composition was 45.83 wt% C, 6.52 wt% H, 10.73 wt% N, 0.66 wt% S, 20.76 wt% O, 6.46 wt% moisture, and 9.04 wt% ash. For *Schizochytrium* sp., the composition was 62.57 wt% C, 9.55 wt% H, 0.82 wt% N, 0 wt% S, 22.89 wt% O, 0.48 wt% moisture, and 3.69 wt% ash. These results were generally consistent with published data [17, 18]. Lower nitrogen and sulfur contents in biomass are preferred, since the biodiesel produced by that biomass will have lower exhaust emissions (such as NO_x and SO₂) when used in a diesel engine [17]. Lower oxygen percentage

in biomass is also desirable, since it can affect the stability of the produced biodiesel [17].

The SCCO₂ extraction experiments were operated for 2, 4, and 6 h, and the extraction yield was measured after each time period during operation. The lipid extraction yield was calculated using the mass loss of the dried biomass before and after extraction, using the following equation:

$$\text{Lipid extraction yield} = \frac{W_i - W_f}{W_i} \quad (1)$$

where W_i is the initial weight of the dried biomass (g) and W_f is the final weight of the dried biomass (g). The equation could overestimate the lipid extraction yield, since nonlipid components such as chlorophyll could also be extracted; however the equation was considered to be appropriate to compare the effectiveness of the extraction method for the tested conditions. Due to the physical characteristics of the extraction system, extracted lipids remaining in the extractor could not be easily measured; therefore the total mass of lipids was not used in the evaluation.

For comparison, lipid extraction using the organic solvent method was also investigated. A Soxhlet apparatus was charged with 25 g dry biomass, and 150 mL of methylene chloride/methanol (2:1, v/v) was refluxed for 6 h [19]. The

extraction yield was calculated according to (1). An independent samples *t*-test was conducted to determine whether the difference was significant for the two extraction methods.

2.2. Investigating the Addition of Methanol and Its Effect on SCCO₂ Extraction. Because SCCO₂ can be treated as a nonpolar solvent, it will be difficult for SCCO₂ to extract lipid complexes that are linked to the proteins on the microalgae cell membrane. Therefore, mixing SCCO₂ with a polar solvent such as methanol might be a good way to increase the efficiency of SCCO₂ extraction [20]. Methanol was chosen instead of ethanol due to its relative inexpensiveness, lower boiling point, and good solvation potential for polar components.

To investigate the effect of adding methanol to the SCCO₂ extraction, 200 mL of methanol was added to the 5 L extractor before the extraction, so that the volume ratio of methanol/SCCO₂ was 1:25 v/v. Experiments were conducted on both species mentioned previously. A stepwise addition of methanol was also tested, where 200 mL of methanol was added at 0, 2, and 4 h, for a total addition of 600 mL. The operating pressure used was similar to the previous experiments. The lipid extraction yield was measured and compared with SCCO₂ extraction without the addition of methanol.

2.3. Investigating the Biomass Loading and Its Effect on SCCO₂ Extraction. As stated previously, many experiments in the literature focused on small quantities of microalgae biomass. To assess the potential of scaling up the extraction process, the mass of microalgae in the extractor was increased from 200 g to 1 kg, while maintaining the porosity and the surface area. SCCO₂ extraction was evaluated to see if similar lipid extraction yields could be achieved with larger biomass loading rates. The operating pressures and the amount of methanol added in the extractor were similar to those in the previous experiments. The residence time of CO₂ in the extractor was kept constant when the biomass increased (see Section 2.1). An independent samples *t*-test was conducted to determine whether the difference was significant for different biomass loadings.

2.4. Characterization of the Extracted Lipids. The fatty acid profile of lipids in microalgae can affect the quality of biodiesel produced from microalgae lipids. Normally, cis-unsaturated fatty acids are favored over saturated fatty acids because the FAMES derived from cis-unsaturated fatty acids often have advantageous cold flow properties [21]. The fatty acid profiles of the lipids from the two species were reported previously in published data [22, 23]. Therefore, matching the fatty acid profile in the extracted lipids and comparing to reported data in the literature can be a good indicator of the lipid extraction effectiveness of SCCO₂.

The extracted lipids from the two species were characterized using gas chromatography (GC). Before the characterization, a derivatization step was conducted to convert the different compounds in the lipids to FAMES. 1 mL of extracted lipid sample was collected in a test tube, and 1 mL

of toluene and 2 mL of 1% sulfuric acid in methanol were added into the test tube. This test tube was then sealed and stored in a 50°C oven for 8 h. After cooling, 5 mL of 5% sodium chloride in water was added to the test tube to encourage phase separation. After phase separation, 1 mL of the top organic phase was collected in a GC vial for analysis. An Agilent 7890B GC containing a DB-23 column (60 m length and 0.15 μm film) and a flame ionization detector was used with helium as the carrier gas. The FAME mixture (C8-C24) (Sigma Aldrich) was used as the calibration standard with methyl myristate as the internal standard. The operating conditions of the GC system were selected according to the literature [24].

2.5. Kinetic Study of the SCCO₂ Extraction. The lipid extraction from microalgae using SCCO₂ can be expressed using first-order kinetic as follows [10]:

$$M_e = M_i (1 - e^{-kt}) \quad (2)$$

where M_e is the amount of extracted lipids at time t (g/g biomass), M_i is the total lipid content in microalgae cell (g/g biomass), t is the extraction time (h), and k (h^{-1}) is a time constant correlated to the lipid mass transfer from the microalgae cells to SCCO₂.

For a typical mass transfer problem, the time constant k is a function of Reynolds number (Re) and Schmitt number (Sc), as shown in the following equation:

$$k = F(Re, Sc) \quad (3)$$

In SCCO₂ extraction, the values of the dimensionless numbers Re and Sc are dependent on pressure, temperature, concentration of methanol, and CO₂ flow rate. Therefore, the time constant k can be expressed as

$$k = F(Re, Sc) = f(P, T, [ME], Q) \quad (4)$$

where P is pressure (psi), T is temperature (°C), $[ME]$ is the concentration of methanol in SCCO₂ (v/v), and Q is the flow rate of CO₂ (scfm).

To simplify the model, the effect of temperature was eliminated in (4) due to the constant temperature used in this research. The extracted lipids were treated as a single substance instead of a compound. It was assumed that the all of the extractable lipids could be extracted eventually; therefore all of curves under different operating conditions will have the same asymptotes. M_i of the two microalgae species was assumed to be 0.25 g/g biomass. In addition, the methanol concentration in SCCO₂ was assumed to be constant (4%) during the extraction process. Also, the methanol concentration during the stepwise addition was also assumed to be constant (4%). To study the effects of P , $[ME]$, and Q on the time constant k and lipid extraction yield, we assumed a first-order equation to express the relation:

$$k = a * P + b * [ME] + c * Q + d \quad (5)$$

where a , b , c , d are unknown constants. These four constants can be estimated by fitting the kinetic model with

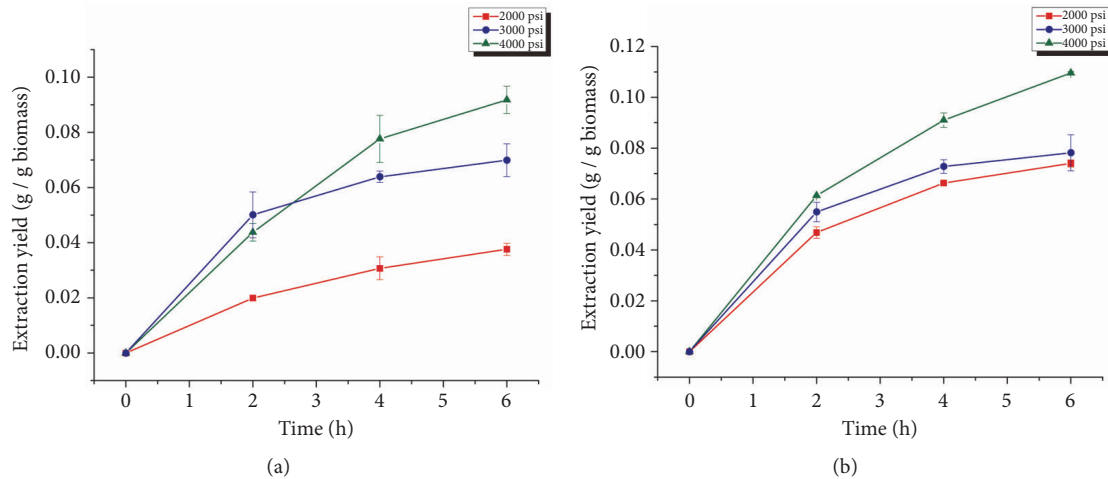

FIGURE 2: Lipid extraction yield from *Spirulina* sp. (a) and *Schizochytrium* sp. (b) using SCCO₂ under different operating pressures. Error bars represent one standard error from three replicates.

the experimental data obtained from the previous sections. MATLAB programming platform was used to perform the model fitting, and these constants were determined by minimizing the sum of squared errors between experimental and calculated values of lipid extraction yield. The minimization was performed using the MATLAB toolbox `fmincon`. Since the lipid mass transfer coefficients may be different for different microalgae species, the estimation of the constants was conducted separately for the two species.

To validate the kinetic model, SCCO₂ extraction data obtained by a previous research conducted by Nobre et al. [25] was also modeled. The authors of the research investigated the lipid extraction yield from microalga *Nannochloropsis* sp. under different pressures, flow rates, and ethanol concentrations in a laboratory scale SCCO₂ extraction system (5 cm³ extraction vessel). To perform the model fitting, the ethanol concentration was used in place of [ME] (methanol) in (5). The data used for parameter fitting included the lipid extraction yields at 40°C, pressures of 1800, 2900, or 4350 psi, CO₂ flow rates of 6.64×10⁻³ or 1.18 ×10⁻² scfm, and ethanol concentrations of 5, 10, or 20 wt%. M_i used for *Nannochloropsis* sp. was 0.45 g/g biomass, based on the reported results by the authors, and the biomass loading of *Nannochloropsis* sp. was 1.25 g.

After obtaining the constants, a sensitivity analysis was conducted to analyze the influence of P , [ME], and Q on the simulated results. Sensitivity analysis was carried out by calculating the lipid mass transfer coefficient (k) and lipid extraction yield at 4 h under the conditions where the value of one parameter was changed by 50% without changing other parameters. The experiment conditions used in the sensitivity analysis were 4000 psi of pressure, 200 mL of methanol with stepwise addition, and 6.8 scfm of CO₂ flow rate. For microalga *Nannochloropsis* sp., the experiment conditions used were 4350 psi of pressure, 1.18×10⁻² scfm of CO₂ flow rate, and 5 wt% of ethanol concentrations [25].

3. Results

3.1. Lipid Extraction Yields of SCCO₂ under Different Operating Pressures. Different operating pressures of SCCO₂ resulted in a significant difference in lipid extraction effectiveness from *Spirulina* sp. (Figure 2(a)). As operating pressures increased, the extraction yield increased, and 4000 psi SCCO₂ resulted in the highest lipid extraction yield. A similar trend was observed in SCCO₂ extraction from *Schizochytrium* sp. (Figure 2(b)). These results suggest that higher operating pressures should be selected when conducting SCCO₂ extraction; therefore 4000 psi was chosen as the operating pressure for subsequent experiments.

3.2. Lipid Extraction Yields of SCCO₂ with Addition of Methanol. As shown in Figure 3, adding 200 mL of methanol as a cosolvent increased the lipid extraction yield of SCCO₂ for both species in the first 2 h. However, after the initial 2 h, the effectiveness of extraction due to the added methanol decreased and eventually became insignificant after 4 h of extraction. These results indicated that the methanol added to the SCCO₂ extractor might be washed away with the SCCO₂ flow during the extraction process resulting in no increase in lipid extraction yield observed after 6 h of extraction. These results suggested that adding methanol once may not be a good method. To examine this possibility, a stepwise addition of methanol was applied in subsequent experiments.

SCCO₂ lipid extraction with a stepwise addition of methanol was also tested by adding 200 mL of methanol every 2 h into the extractor to keep the methanol concentration in SCCO₂ at 4% (v/v), as shown in Figure 4. The stepwise addition of methanol significantly increased the lipid extraction yield for both species compared with pure SCCO₂ extraction. An 80% increase in lipid extraction yield was found for *Spirulina* sp., while a 72% increase was found for *Schizochytrium* sp. These results suggest that the stepwise addition of methanol overcame the decreasing methanol concentration and was more effective than adding methanol

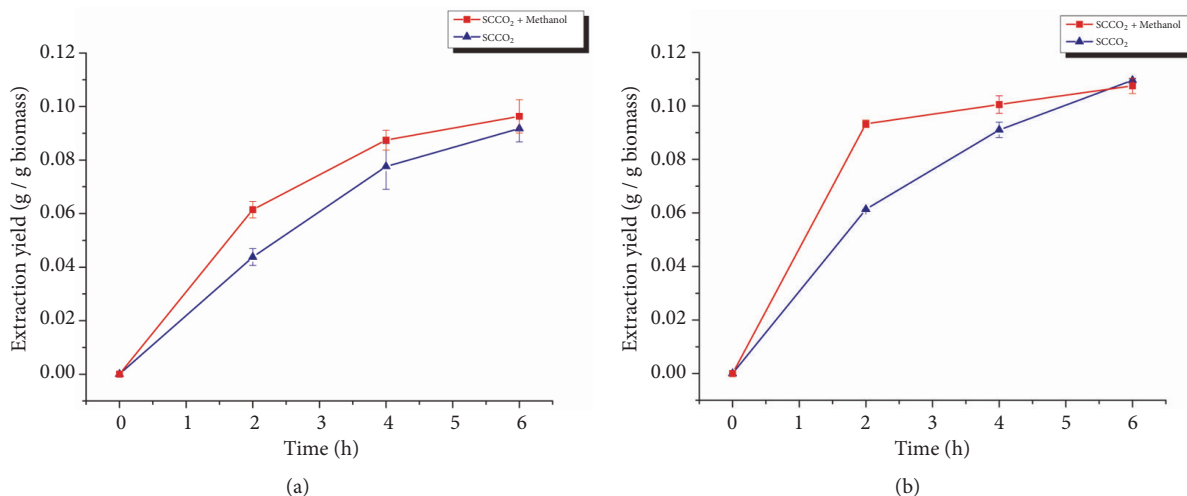

FIGURE 3: Lipid extraction yield from *Spirulina* sp. (a) and *Schizochytrium* sp. (b) using SCCO₂ with a single initial methanol addition. Error bars represent one standard error from three replicates.

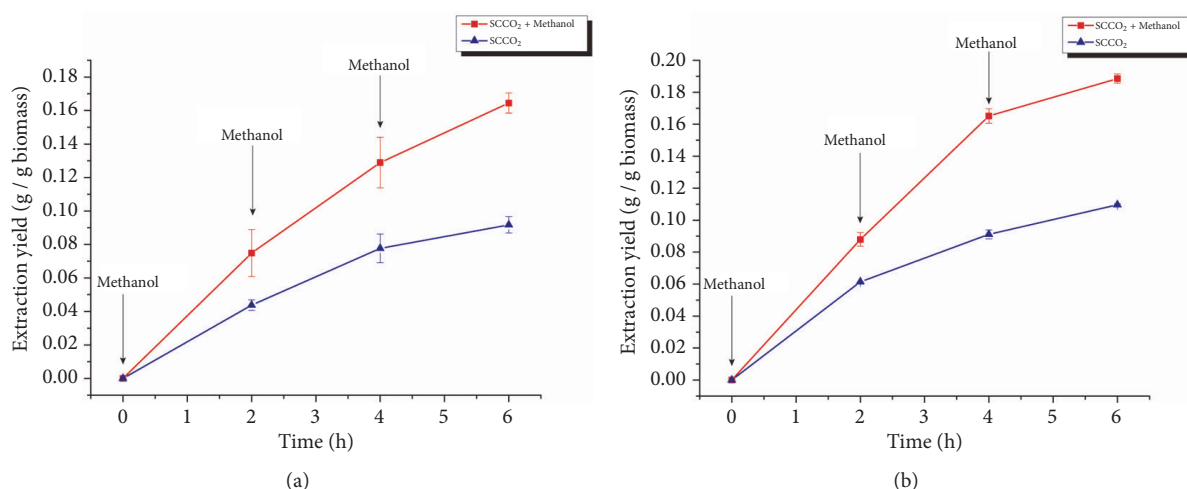

FIGURE 4: Lipid extraction yield from *Spirulina* sp. (a) and *Schizochytrium* sp. (b) using SCCO₂ with a stepwise addition of methanol. Error bars represent one standard error from three replicates.

once. Average yields of 0.164 ± 0.006 and 0.188 ± 0.003 were obtained after 6 h of SCCO₂ extraction with stepwise methanol addition for *Spirulina* sp. and *Schizochytrium* sp., respectively.

3.3. Soxhlet Lipid Extraction Using Organic Solvents. The Soxhlet extraction of lipids was conducted for both microorganisms and compared with the highest extraction yield obtained from the SCCO₂ extraction, which was achieved at 4000 psi of SCCO₂ with methanol added sequentially (Figure 5). The Soxhlet extraction resulted in higher lipid extraction yield for both species. For *Schizochytrium* sp., the methanol-SCCO₂ extraction produced 91.4% of the lipid extraction yield obtained from Soxhlet extraction after 6 h, but the difference was not statistically significant. For *Spirulina* sp., the methanol-SCCO₂ extraction produced 79.6% of the lipid extraction yield obtained from Soxhlet extraction,

which was statistically significant. While these results indicate that methanol-SCCO₂ extraction is not superior to Soxhlet extraction, the methanol-SCCO₂ method demonstrated comparable extraction yield while avoiding the use of a toxic solvent such as methylene chloride.

3.4. Investigating the Scale-Up Potential. To investigate the scale-up potential of methanol-SCCO₂ extraction, experiments were conducted with increased biomass loadings of up to 1 kg while maintaining other operating conditions (4000 psi, 200 mL methanol added sequentially every 2 h). As shown in Figure 6, increasing the biomass loading from 200 g to 1 kg resulted in a slight decrease in lipid extraction yields for both species. The lipid extraction yield for *Schizochytrium* sp. decreased by 7.4%, while lipid extraction yield for *Spirulina* sp. decreased by 7.8%, although neither difference was statistically different. These results demonstrated that the loading

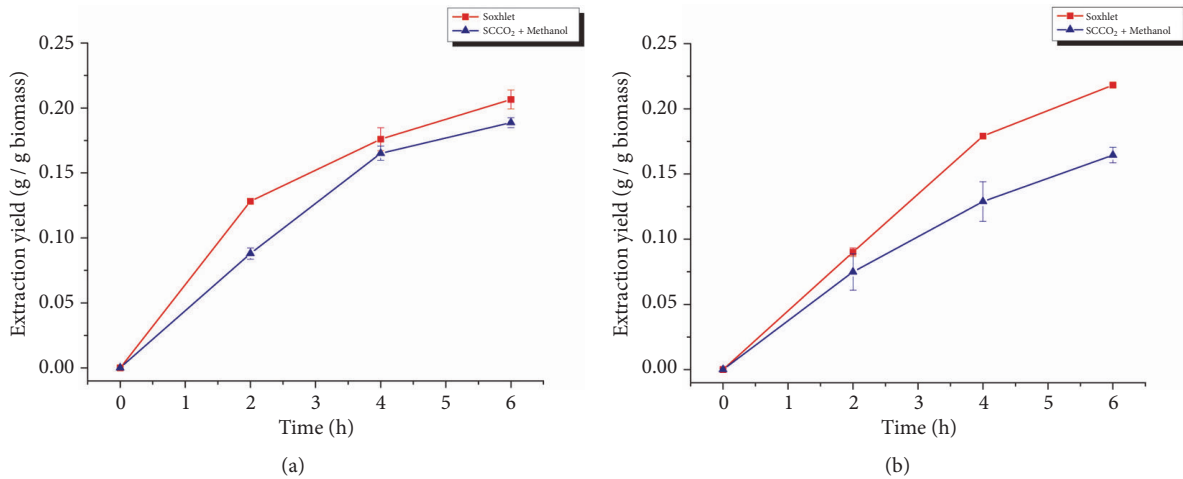

FIGURE 5: Comparison of lipid extraction yield from *Schizochytrium sp.* (a) and *Spirulina sp.* (b) using Soxhlet extraction and SCCO₂ extraction. Error bars represent one standard error from three replicates.

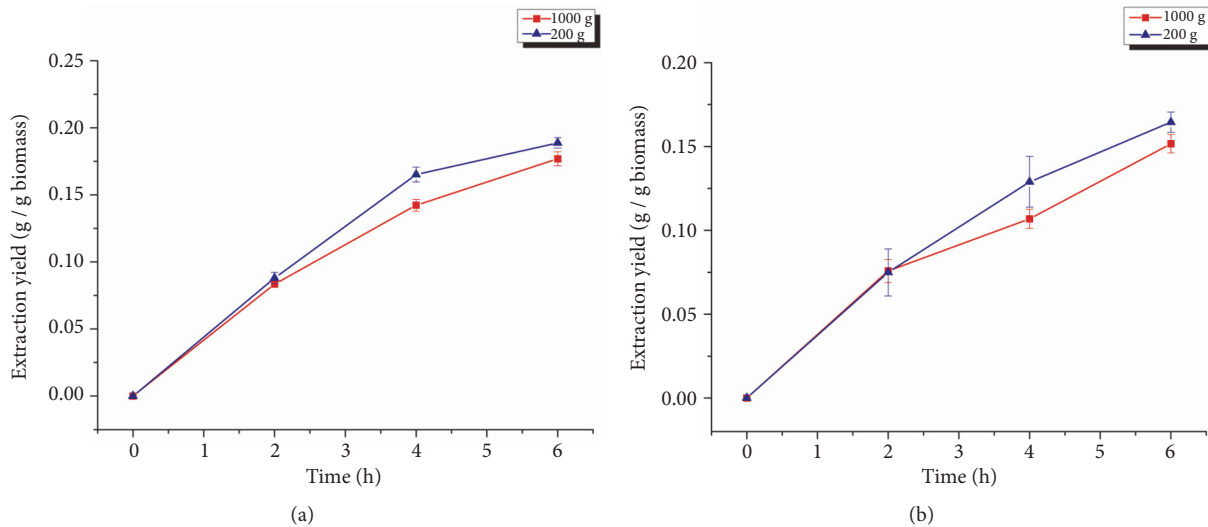

FIGURE 6: Lipid extraction yield from *Schizochytrium sp.* (a) and *Spirulina sp.* (b) using methanol-SCCO₂ with different biomass loadings. Error bars represent one standard error from three replicates.

amount of microalgae biomass could be increased in SCCO₂ extraction without a significant loss of extraction yield.

3.5. Characterizing the Fatty Acid Profile in Extracted Lipids. For *Spirulina sp.*, the fatty acids extracted by the Soxhlet method differed significantly from those extracted by SCCO₂, particularly in the composition of decanoic acid (C10), palmitic acid (C16), and total unsaturated fatty acids (Table 1). The total unsaturated fatty acids were the sum of myristoleic acid (C14:1), palmitoleic acid (C16:1), oleic acid (cis C18:1), linoleic acid (cis C18:2), and linolenic acid (C18:3). On the other hand, the methanol-SCCO₂ extraction resulted in a similar fatty acid composition to the Soxhlet method. The Soxhlet method was presumed to be most representative of complete lipid extraction. The fatty acid compounds were

mostly C16 and C18, while total of 47.25% of unsaturated fatty acids was found in the extracted lipids.

The SCCO₂ method extracted significantly lower amounts of unsaturated fatty acids compared to the Soxhlet method, while greatly increasing the content of C10 compounds. However, when combining SCCO₂ with methanol, the fatty acid profile of the extracted lipids was similar to that obtained by the Soxhlet method, with C16 and C18 as the main compounds and total unsaturated fatty acids of 45.11%. These results indicate the content of unsaturated fatty acids in extracted lipids was greatly affected by the polarity of the extraction fluid in that increasing the polarity of the extraction fluid increased the total unsaturated fatty acids extracted.

For *Schizochytrium sp.*, it can be observed that the three extraction methods used in this research resulted in

TABLE 1: Fatty acid profile of extracted lipids from *Spirulina* sp. using three extraction methods.

Fatty acid Compounds	wt%		
	Soxhlet	SCCO ₂	SCCO ₂ + methanol
C10	7.48 ± 0.06	47.21 ± 0.24	16.51 ± 0.10
C14:1	1.79 ± 0.01	-	-
C16	44.02 ± 0.23	22.41 ± 0.14	37.15 ± 0.31
C16:1	2.22 ± 0.01	1.97 ± 0.01	2.66 ± 0.01
C18	1.25 ± 0.01	1.57 ± 0.01	1.23 ± 0.01
Cis C18:1	2.65 ± 0.03	2.85 ± 0.01	3.38 ± 0.01
Cis C18:2	18.10 ± 0.34	12.27 ± 0.06	17.67 ± 0.28
C18:3 n6	18.26 ± 0.12	9.43 ± 0.03	18.44 ± 0.09
C18:3 n3	4.23 ± 0.10	2.29 ± 0.01	2.96 ± 0.24
Total unsaturated fatty acids	47.25	28.81	45.11

TABLE 2: Fatty acid profile of extracted lipids from *Schizochytrium* sp. using three extraction methods.

Fatty acid Compounds	wt%		
	Soxhlet	SCCO ₂	SCCO ₂ + methanol
C14	8.28 ± 0.01	8.30 ± 0.01	8.23 ± 0.02
C16	88.76 ± 0.01	87.05 ± 0.05	88.83 ± 0.04
C18	2.96 ± 0.01	4.65 ± 0.06	2.94 ± 0.05
Total unsaturated fatty acids	0	0	0

TABLE 3: The estimated values of a , b , c , and d after model fitting with MATLAB.

Parameters	<i>Schizochytrium</i>	<i>Spirulina</i>	<i>Nannochloropsis</i>
a (h ⁻¹ psi ⁻¹)	1.96×10^{-5}	2.02×10^{-5}	7.05×10^{-5}
b (h ⁻¹)	2.98	2.13	21.7
c (h ⁻¹ scfm ⁻¹)	3.47×10^{-3}	1.15×10^{-5}	1.25×10^{-4}
d (h ⁻¹)	8.01×10^{-4}	9.51×10^{-5}	4.59×10^{-7}

similar fatty acid compositions with no significant differences (Table 2). Unlike *Spirulina* sp., no unsaturated fatty acids were found in *Schizochytrium* sp.; therefore the difference induced by the polarity of extraction fluid became insignificant, which resulted in the similar fatty acid profiles.

3.6. Kinetic Study of the SCCO₂ Extraction. The estimated values of a , b , c , and d after model fitting with MATLAB are shown in Table 3. The parity plots of calculated lipid extraction yields versus experimental lipid extraction yields for all experiments in this research are presented in Figure 7. For *Schizochytrium* sp., an average error of 12.7% was found between the experimental data and calculated values while for *Spirulina* sp., the average error was 16.6%.

Figure 8 shows the comparison of simulated and experimental lipid extraction yields at 2000 and 4000 psi, as well as 4000 psi with the addition of methanol. Generally good agreement was observed for both species. However, for *Spirulina* sp., the simulated results were more accurate under high operating pressures; therefore 4000 psi was chosen as the operating pressure for sensitivity analysis.

Applying the kinetic model to the results from Nobre et al. [25], the estimated values of a , b , c , and d are shown in Table 3.

The parity plot of calculated lipid extraction yields versus experimental lipid extraction yields (Figure 9) showed an average error of 35.6%, indicating the model was less accurate for the SCCO₂ extraction of *Nannochloropsis* sp. However, model agreement improved between simulated values and experimental data when the extraction was conducted at high operating pressures (Figure 10).

Results of the sensitivity analysis suggest that the influences of pressure, methanol concentration, and CO₂ flow rate on lipid extraction yield were species dependent (Table 4). However, for all species the methanol concentration (or ethanol concentration) in SCCO₂ had the strongest influence on the lipid extraction yield, followed by the operating pressure. While the CO₂ flow rate showed some influence on the lipid extraction yield for *Schizochytrium* sp., it was insignificant for *Spirulina* sp. and *Nannochloropsis* sp.

4. Discussion

In our study, results showed that the effectiveness of SCCO₂ lipids extraction increased with an increasing pressure for both species. This is an expected result and matches the findings of the work published by other researchers [26]. It is generally believed that, at a constant temperature, increasing the pressure increases the density of SCCO₂, which increases the solubility of lipids [8]. Thus, a higher operating pressure of SCCO₂ would produce a stronger lipid extraction power. Therefore, the highest operating pressure that the equipment could sustain, which was 4000 psi, was chosen as the optimal operating pressure for subsequent experiments.

The effect of methanol as a cosolvent in SCCO₂ extraction was shown to increase the lipid extraction yield at least for

TABLE 4: Sensitivity analysis of P , $[ME]$, and Q on the simulated results.

	Parameter change	Deviation with parameter change (%)								
		<i>Schizochytrium</i>			<i>Spirulina</i>			<i>Nannochloropsis</i>		
		P	$[ME]$	Q	P	$[ME]$	Q	P	$[ME]$	Q
k	+50%	+17.69	+26.81	+5.32	+24.31	25.64	+0.02	+11.04	+38.96	+0
	-50%	-17.69	-26.81	-5.32	-24.31	-25.64	-0.02	-11.04	-38.96	+0
Lipid extraction yield	+50%	+10.16	+14.82	+3.22	+15.80	+16.60	+0.02	+0.18	+0.34	+0
	-50%	-11.89	-18.80	-3.38	-18.58	-19.69	-0.02	-0.33	-2.99	+0

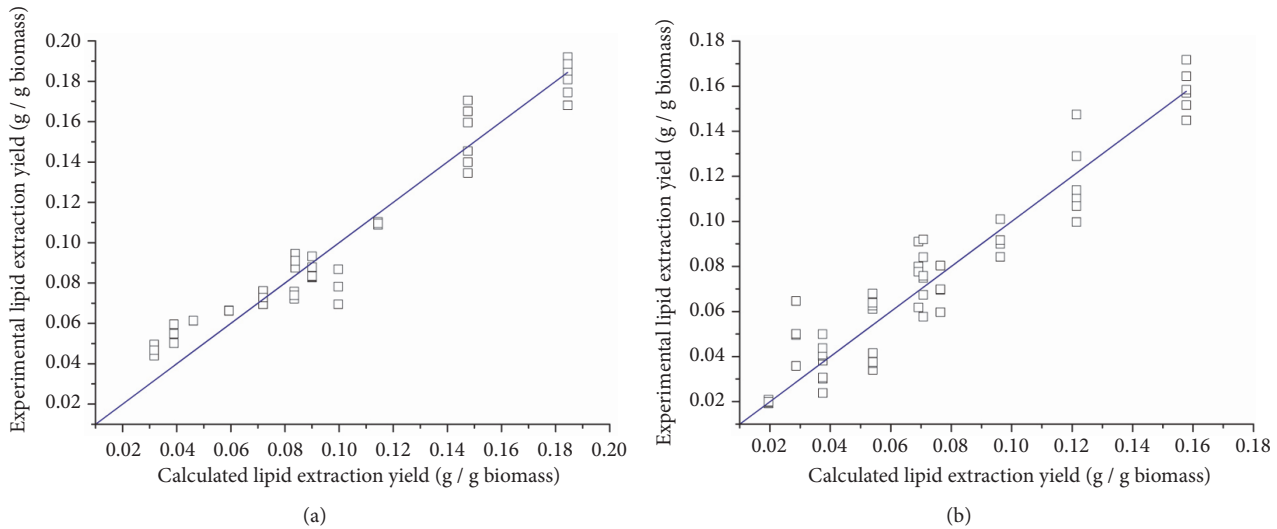

FIGURE 7: Parity plot of calculated lipid extraction yields versus experimental lipid extraction yields for all experiments. (a) *Schizochytrium* sp. (b) *Spirulina* sp.

the first 2 h. The reason for the improved extraction yield can be explained by the polarity of CO_2 and methanol. The CO_2 molecule is a nonpolar molecule and can attach to nonpolar acylglycerols in microalgae cytoplasm by Van der Waals forces during the extraction process [27]. However, some of the acylglycerols in microalgae were associated with proteins on cell membrane via hydrogen bonds. The Van der Waals forces were not strong enough to disrupt the hydrogen bonds. On the other hand, methanol molecules are polar and can easily form hydrogen bonds with the proteins on the cell membrane and replace those lipids, leaving the lipids to be extracted by $SCCO_2$ [27] thus increasing lipid extraction yield when methanol was added.

Nevertheless, the effectiveness of the methanol addition decreased over time. It was assumed that the methanol added to the $SCCO_2$ extractor was washed away with the $SCCO_2$ flow during the extraction process, since methanol was easily soluble in $SCCO_2$. Because the $SCCO_2$ would return to gas status in the separator, methanol would accumulate in the separator, which led to the reduction of methanol concentration in the extractor. In order to overcome this problem, a stepwise addition of methanol was applied for the $SCCO_2$ extraction, and the results indicated that adding methanol sequentially to the $SCCO_2$ extractor resulted in higher extraction efficiency compared to adding methanol at once.

Soxhlet extraction using methylene chloride/methanol (2:1 v/v) was reported to be a superior effective lipid extraction method and a good substitute for the Bligh and Dyer method for its lower toxicity. The lipid extraction yields after 6 h of Soxhlet extraction reached 0.21 g/g biomass and 0.22 g/g biomass for *Spirulina* sp. and *Schizochytrium* sp. These results were consistent with the reported lipid content on the label (below 33 wt% for *Spirulina* sp. and 25 wt% for *Schizochytrium* sp.). The methanol- $SCCO_2$ extraction method was not significantly different from, or only slightly less effective than, the Soxhlet extraction. Further, the methanol- $SCCO_2$ extraction excelled in its low toxicity and requirement of organic solvent, since only 600 mL of methanol was used for a 5 L extraction chamber, which can be loaded with 1 kg of biomass (0.6 mL/g). By comparison, the Soxhlet extraction required 100 mL of methylene chloride and 50 mL of methanol for every 25 g of biomass (6 mL/g). Methylene chloride usage, which is considered carcinogenic, was also avoided. Overall, the results indicated that the methanol- $SCCO_2$ extraction method can produce high lipid extraction yield and might be a good replacement for the organic solvent extraction. In addition, further improvements could be considered to increase the efficiency of the methanol- $SCCO_2$ extraction method, such as optimizing the methanol amount added at each stage of stepwise addition, or optimizing the temperature provided for the extraction system. Increasing pressure

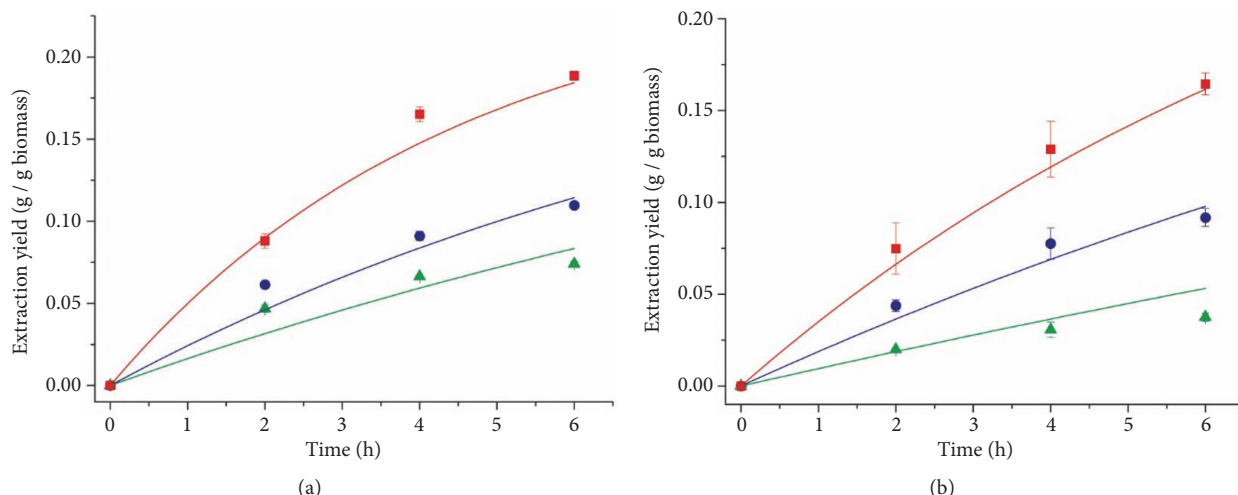

FIGURE 8: Comparison of simulated lipid extraction yields (lines) and experimental lipid extraction yields (symbols) under different operating pressures and the test when methanol was added. (a) *Schizochytrium* sp.: red square, 4000 psi with 200 ml of methanol, $r^2 = 0.985$; blue circle, 4000 psi, $r^2 = 0.957$; green triangle, 2000 psi, $r^2 = 0.885$. (b) *Spirulina* sp.: red square, 4000 psi with 200 ml of methanol, $r^2 = 0.992$; blue circle, 4000 psi, $r^2 = 0.974$; green triangle, 2000 psi, $r^2 = 0.608$. Error bars represent one standard error from three replicates.

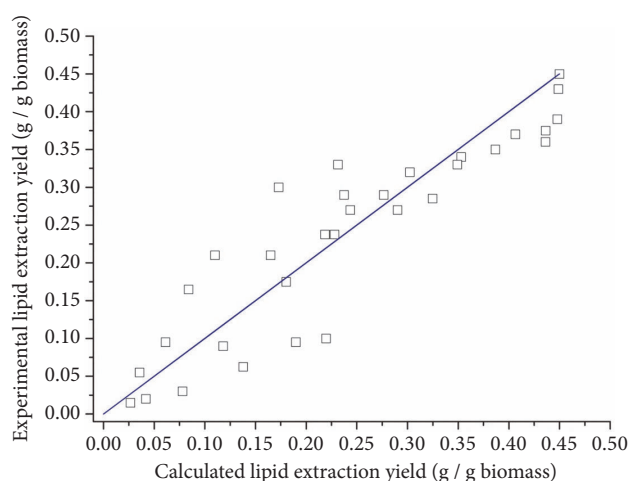

FIGURE 9: Parity plot of calculated lipid extraction yields versus experimental lipid extraction yields using the data of SCCO₂ extraction from microalga *Nannochloropsis* sp. [25].

could also be an option, although it may also increase the capital and operating expenses.

The effect of biomass loading rate was also investigated, and it was found that a statistically insignificant decrease in lipid extraction yield occurred when the biomass loading rate was increased from 200 g to 1 kg. The decrease in yield may be explained by the fact that increasing the biomass loading increases the packing density of the microalgae. This might hinder overall extraction as the lipids may reabsorb on the microalgae surface or cause nonhomogeneous extraction via fluid channeling effects [28]. However, the decrease in yield was less than 8% for both species implying that scale-up can be successful and that the methanol-SCCO₂

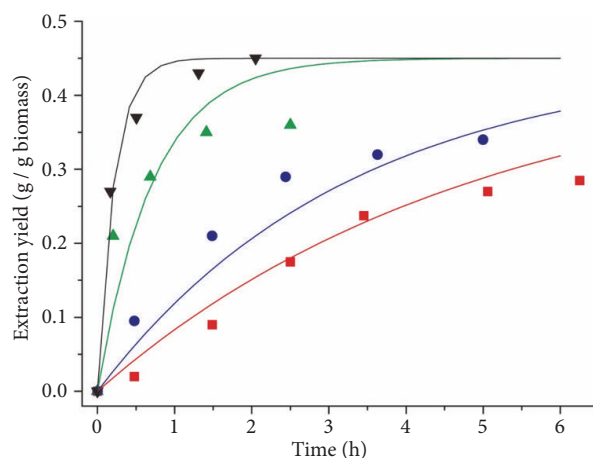

FIGURE 10: Comparison of simulated lipid extraction yields (lines) and experimental lipid extraction yields (symbols) from microalga *Nannochloropsis* sp. [25] under different conditions. Red square, 2900 psi of pressure, 6.64×10^{-3} scfm of CO₂ flow rate, $r^2 = 0.960$; blue circle, 4350 psi of pressure, 6.64×10^{-3} scfm of CO₂ flow rate, $r^2 = 0.931$; green triangle, 4350 psi of pressure, 1.18×10^{-2} scfm of CO₂ flow rate, 5 wt% of ethanol concentration, $r^2 = 0.802$; black inverted triangle, 4350 psi of pressure, 1.18×10^{-2} scfm of CO₂ flow rate, 20 wt% of ethanol concentration, $r^2 = 0.982$.

extraction method is feasible for 1 kg biomass loadings with our apparatus.

For *Spirulina* sp., the fatty acid compositions obtained from the Soxhlet and methanol-SCCO₂ method supported published data [22, 29], while the SCCO₂ extraction without methanol showed a significant decrease in the extraction of palmitic acid and total unsaturated fatty acids. These results indicate that using SCCO₂ alone was insufficient in obtaining the ideal fatty acid composition from *Spirulina* sp. due to its ineffectiveness in targeting the lipids associated

with cell membrane proteins. Adding methanol to SCCO₂ increased the extracting power of SCCO₂ by extracting all types of fatty acids in the cells. For the *Schizochytrium* sp., the three extraction methods did not show significant differences. These results also supported published data except for the composition of DHA [23, 30]. Since the microalgae used in these experiments were obtained after a DHA extraction process, the absence of DHA was expected. In general, methanol-SCCO₂ extraction could recover lipids with fatty acid composition similar to that extracted by the Soxhlet extraction, proving the effectiveness of this method.

In the kinetic study of the SCCO₂ extraction, the estimated values of *a*, *b*, *c*, and *d* varied greatly as a function of species and operating parameters. However, the sensitivity analysis of the kinetic modeling showed similar results for all species, indicating that both the operating pressure and concentration of methanol (or ethanol) in SCCO₂ greatly affected the lipid extraction yield. Therefore, to increase lipid extraction yield, the addition of a polar modifier (such as methanol) in the SCCO₂ process might be preferred to increasing pressure, since the increase in pressure would also increase the operating cost. On the other hand, it is not recommended to increase the CO₂ flow rate since it had little or no influence on the lipid extraction yield and the mass transfer coefficient. Similar results were also found by Nobre et al. [25] where the authors noted that the flow rate of CO₂ had no influence on lipid extraction yield.

5. Conclusions

SCCO₂ combined with methanol demonstrated a high efficiency in lipid extraction from microalgae, as well as a high potential for process scale-up. The high lipid extraction yield and the fatty acid composition in the extracted lipids indicated that the methanol-SCCO₂ extraction method can be used as a good substitute for the Soxhlet extraction method, while the requirement of organic solvents was significantly reduced. At same time, the lack of usage of toxic organic solvents such as methyl chloride showed that the methanol-SCCO₂ extraction was safer than organic solvent extraction, suggesting it might be a preferable method in commercial-scale extraction. It should be noted that dry biomass was used in this research. Since the drying process is typically energy intensive, it would be preferable if wet biomass was used in the extraction process. Future research involving the extraction of wet biomass is needed. In addition, further studies regarding the optimization of the rate of methanol addition during the extraction process, as well as temperature effects, should be investigated in order to optimize both the extraction efficiency and economic feasibility of supercritical CO₂ lipid extraction from microalgae.

Data Availability

The figures and tables used to support the findings of this study are included within the article.

Conflicts of Interest

The authors declare that they have no conflicts of interest.

Acknowledgments

This work was funded entirely by the National Science Foundation (NSF) through the Sustainable Energy Pathways (SEP) program (Award # 1230961/1631953).

References

- [1] The International Development Association (IDA), "Fossil fuel energy consumption (% of total)," 2017, <http://data.worldbank.org/indicator/EG.USE.COMM.FO.ZS>.
- [2] M. Höök and X. Tang, "Depletion of fossil fuels and anthropogenic climate change—a review," *Energy Policy*, vol. 52, pp. 797–809, 2013.
- [3] M. A. Palmer, E. S. Bernhardt, W. H. Schlesinger et al., "Mountaintop mining consequences," *Science*, vol. 327, no. 5962, pp. 148–149, 2010.
- [4] A. Datta and B. K. Mandal, "A comprehensive review of biodiesel as an alternative fuel for compression ignition engine," *Renewable and Sustainable Energy Reviews*, vol. 57, pp. 799–821, 2016.
- [5] L. Brennan and P. Owende, "Biofuels from microalgae—a review of technologies for production, processing, and extractions of biofuels and co-products," *Renewable & Sustainable Energy Reviews*, vol. 14, no. 2, pp. 557–577, 2010.
- [6] Y. Chisti, "Biodiesel from microalgae," *Biotechnology Advances*, vol. 25, no. 3, pp. 294–306, 2007.
- [7] H. C. Greenwell, L. M. L. Laurens, R. J. Shields, R. W. Lovitt, and K. J. Flynn, "Placing microalgae on the biofuels priority list: a review of the technological challenges," *Journal of the Royal Society Interface*, vol. 7, no. 46, pp. 703–726, 2010.
- [8] R. Halim, M. K. Danquah, and P. A. Webley, "Extraction of oil from microalgae for biodiesel production: a review," *Biotechnology Advances*, vol. 30, no. 3, pp. 709–732, 2012.
- [9] L. Martin, C. Skinner, and R. J. Marriott, "Supercritical extraction of oil seed rape: Energetic evaluation of process scale," *The Journal of Supercritical Fluids*, vol. 105, 2017.
- [10] R. Halim, B. Gladman, M. K. Danquah, and P. A. Webley, "Oil extraction from microalgae for biodiesel production," *Bioresource Technology*, vol. 102, no. 1, pp. 178–185, 2011.
- [11] R. L. Mendes, A. D. Reis, and A. F. Palavra, "Supercritical CO₂ extraction of γ -linolenic acid and other lipids from *Arthrospira (Spirulina) maxima*: comparison with organic solvent extraction," *Food Chemistry*, vol. 99, no. 1, pp. 57–63, 2006.
- [12] G. Andrich, U. Nesti, F. Venturi, A. Zinnai, and R. Fiorentini, "Supercritical fluid extraction of bioactive lipids from the microalga *Nannochloropsis* sp.," *European Journal of Lipid Science and Technology*, vol. 107, no. 6, pp. 381–386, 2005.
- [13] M. G. Sajilata, R. S. Singhal, and M. Y. Kamat, "Supercritical CO₂ extraction of γ -linolenic acid (GLA) from *Spirulina platensis* ARM 740 using response surface methodology," *Journal of Food Engineering*, vol. 84, no. 2, pp. 321–326, 2008.
- [14] A. Zinnai, C. Sanmartin, I. Taglieri, G. Andrich, and F. Venturi, "Supercritical fluid extraction from microalgae with high content of LC-PUFAs. A case of study: Sc-CO₂ oil extraction from *Schizochytrium* sp.," *The Journal of Supercritical Fluids*, vol. 116, pp. 126–131, 2016.

- [15] J. Lorenzen, N. Igl, M. Tippelt et al., "Extraction of microalgae derived lipids with supercritical carbon dioxide in an industrial relevant pilot plant," *Bioprocess and Biosystems Engineering*, vol. 40, no. 6, pp. 911–918, 2017.
- [16] C. Crampon, C. Nikitine, M. Zaier et al., "Oil extraction from enriched *Spirulina platensis* microalgae using supercritical carbon dioxide," *The Journal of Supercritical Fluids*, vol. 119, pp. 289–296, 2017.
- [17] P. Nautiyal, K. A. Subramanian, and M. G. Dastidar, "Production and characterization of biodiesel from algae," *Fuel Processing Technology*, vol. 120, pp. 79–88, 2014.
- [18] R. Gautam, A. K. Varma, and R. Vinu, "Apparent Kinetics of Fast Pyrolysis of Four Different Microalgae and Product Analyses Using Pyrolysis-FTIR and Pyrolysis-GC/MS," *ENERGY & FUELS*, vol. 31, no. 11, pp. 12339–12349, 2017.
- [19] J. B. Guckert, K. E. Cooksey, and L. L. Jackson, "Lipid solvent systems are not equivalent for analysis of lipid classes in the microeukaryotic green alga, *Chlorella*," *Journal of Microbiological Methods*, vol. 8, no. 3, pp. 139–149, 1988.
- [20] F. Venturi, C. Sanmartin, I. Taglieri, G. Andrich, and A. Zinnai, "A simplified method to estimate Sc-CO₂ extraction of bioactive compounds from different matrices: Chili pepper vs. tomato by-products," *Applied Sciences (Switzerland)*, vol. 7, no. 4, 2017.
- [21] R. O. Dunn, "Improving the cold flow properties of biodiesel by fractionation," 2017, <https://www.intechopen.com/books/soybean-applications-and-technology/improving-the-cold-flow-properties-of-biodiesel-by-fractionation>.
- [22] S. Ötleş and R. Pire, "Fatty acid composition of *Chlorella* and *Spirulina* microalgae species," *Journal of AOAC International*, vol. 84, no. 6, pp. 1708–1714, 2001.
- [23] K. H. V. Arafiles, J. C. O. Alcantara, P. R. F. Cordero et al., "Cultural optimization of thraustochytrids for biomass and fatty acid production," *Mycosphere*, vol. 2, pp. 521–531, 2011.
- [24] F. David, P. Sandra, and A. K. Vickers, *Column Selection for The Analysis of Fatty Acid Methyl Esters*, Research Institute for Chromatography, Agilent Technology, USA, 2005.
- [25] B. P. Nobre, F. Villalobos, B. E. Barragán et al., "A biorefinery from *Nannochloropsis* sp. microalga—extraction of oils and pigments. Production of biohydrogen from the leftover biomass," *Bioresource Technology*, vol. 135, pp. 128–136, 2013.
- [26] P. C. K. Cheung, "Temperature and pressure effects on supercritical carbon dioxide extraction of n-3 fatty acids from red seaweed," *Food Chemistry*, vol. 65, no. 3, pp. 399–403, 1999.
- [27] A. Robles Medina, E. Molina Grima, A. Giménez Giménez, and M. J. Ibáñez González, "Downstream processing of algal polyunsaturated fatty acids," *Biotechnology Advances*, vol. 16, no. 3, pp. 517–580, 1998.
- [28] S. M. Pourmortazavi and S. S. Hajimirsadeghi, "Supercritical fluid extraction in plant essential and volatile oil analysis," *Journal of Chromatography A*, vol. 1163, no. 1-2, pp. 2–24, 2007.
- [29] L. M. Colla, T. E. Bertolin, and J. A. Costa, "Fatty Acids Profile of *Spirulina platensis* Grown Under Different Temperatures and Nitrogen Concentrations," *Zeitschrift für Naturforschung C*, vol. 59, no. 1-2, pp. 55–59, 2004.
- [30] Y. Jiang, K.-W. Fan, R. T.-Y. Wong, and F. Chen, "Fatty Acid Composition and Squalene Content of the Marine Microalga *Schizochytrium mangrovei*," *Journal of Agricultural and Food Chemistry*, vol. 52, no. 5, pp. 1196–1200, 2004.