



Since January 2020 Elsevier has created a COVID-19 resource centre with free information in English and Mandarin on the novel coronavirus COVID-19. The COVID-19 resource centre is hosted on Elsevier Connect, the company's public news and information website.

Elsevier hereby grants permission to make all its COVID-19-related research that is available on the COVID-19 resource centre - including this research content - immediately available in PubMed Central and other publicly funded repositories, such as the WHO COVID database with rights for unrestricted research re-use and analyses in any form or by any means with acknowledgement of the original source. These permissions are granted for free by Elsevier for as long as the COVID-19 resource centre remains active.

Molecular characterization of a novel coronavirus associated with epizootic catarrhal enteritis (ECE) in ferrets

Annabel G. Wise^{a,b,*}, Matti Kiupel^{a,b,c}, Roger K. Maes^{a,b,d}

^a Diagnostic Center for Population and Animal Health, Rm. 136E, 4125 Beaumont Road, Lansing, MI 48909, USA

^b Michigan State University, East Lansing, MI 48824, USA

^c Department of Pathobiology and Diagnostic Investigation, Michigan State University, East Lansing, MI 48824, USA

^d Department of Microbiology and Molecular Genetics, Michigan State University, East Lansing, MI 48824, USA

Received 18 October 2005; returned to author for revision 19 November 2005; accepted 17 January 2006

Available online 24 February 2006

Abstract

A novel coronavirus, designated as ferret enteric coronavirus (FECV), was identified in feces of domestic ferrets clinically diagnosed with epizootic catarrhal enteritis (ECE). Initially, partial sequences of the polymerase, spike, membrane protein, and nucleocapsid genes were generated using coronavirus consensus PCR assays. Subsequently, the complete sequences of the nucleocapsid gene and the last two open reading frames at the 3' terminus of the FECV genome were obtained. Phylogenetic analyses based on predicted partial amino acid sequences of the polymerase, spike, and membrane proteins, and full sequence of the nucleocapsid protein showed that FECV is genetically most closely related to group 1 coronaviruses. FECV is more similar to feline coronavirus, porcine transmissible gastroenteritis virus, and canine coronavirus than to porcine epidemic diarrhea virus and human coronavirus 229E. Molecular data presented in this study provide the first genetic evidence for a new coronavirus associated with clinical cases of ECE.

© 2006 Elsevier Inc. All rights reserved.

Keywords: Coronavirus; Epizootic catarrhal enteritis; Ferret; *Mustelo putorius furo*; Consensus PCR for coronaviruses

Introduction

Epizootic catarrhal enteritis (ECE), a relatively new enteric disease of domestic ferrets (*Mustelo putorius furo*), was first described in the spring of 1993 on the East Coast of the United States (Williams et al., 2000). Since then, the disease has spread throughout the U.S. and other countries. Clinically, ECE is characterized by a foul-smelling bright green diarrhea with high mucus content and is commonly associated with lethargy, anorexia, and vomiting. The morbidity for ECE approaches 100%, but the overall mortality rate is low (<5%), with juvenile ferrets often developing only mild and even subclinical disease. Clinical signs are more severe in older ferrets and the mortality rate is often higher.

Earlier investigations into the etiology of ECE implicated a coronavirus (Williams et al., 2000). The microscopic lesions observed in affected ferrets were consistent with those described for intestinal coronavirus infections in other species. Transmission electron microscopy revealed coronavirus-like particles in the feces and in affected jejunal enterocytes of ferrets with ECE. Moreover, positive immunohistochemical staining, using a feline coronavirus-specific monoclonal antibody, confirmed the presence of coronaviral antigen in sections of affected intestines. There have been no reports confirming these previous findings at the genetic level.

Coronaviruses are enveloped, positive-strand RNA viruses classified under the genus *Coronavirus* within the family Coronaviridae, order Nidovirales (Enjuanes et al., 2000; Holmes, 1999; Murphy et al., 1999). Virions are pleomorphic, with a diameter of 60–220 nm. The coronavirus genome consists of a nonsegmented, positive-sense, single-stranded RNA that is approximately 27–31 kb in length. The capsid has a helical confirmation and is made up of monomers of the nucleocapsid (N) protein. Inserted in the envelope is the spike

* Corresponding author. Diagnostic Center for Population and Animal Health, Rm. 136E, 4125 Beaumont Road, Lansing, MI 48909, USA. Fax: +1 517 353 5096.

E-mail addresses: wise@dcpah.msu.edu (A.G. Wise), kiupel@dcpah.msu.edu (M. Kiupel), maes@dcpah.msu.edu (R.K. Maes).

(S) protein the membrane (M) protein and the small envelope (E) protein. Coronaviruses are subdivided into three groups, based originally upon serologic properties and more recently upon sequence homology (Chouljenko et al., 2001; Enjuanes et al., 2000; Gonzalez et al., 2003; Hegyi et al., 2002; Holmes, 1999; Murphy et al., 1999; Siddell, 1995; Stephensen et al., 1999; Wege et al., 1982). Group 1 includes human coronavirus strain 229E, porcine transmissible gastroenteritis virus, canine coronavirus, feline coronavirus, and porcine epidemic diarrhea virus. Group 2 includes human coronavirus strain OC43, murine hepatitis virus, rat coronavirus, bovine coronavirus, porcine hemagglutinating encephalomyelitis virus, and equine coronavirus. The avian viruses, infectious bronchitis virus of chickens, turkey coronavirus, and pheasant coronavirus, belong to Group 3. Based upon sequencing, the recently identified SARS virus appears to be the prototype of a fourth group (Marra et al., 2003; Rota et al., 2003; Snijder et al., 2003).

Using consensus PCR assays for the genus *Coronavirus*, followed by additional genomic sequencing and phylogenetic analyses, we provide the first molecular evidence that the virus associated with ECE in ferrets is a new coronavirus, tentatively designated as “ferret enteric coronavirus” (FECV).

Results

Consensus RT-PCR for coronaviruses and sequencing

Amplicons of the expected sizes were derived for each consensus coronavirus RT-PCR assay performed on RNA extracted from the diarrheic feces of ferrets clinically diagnosed with ECE. The respective product sizes obtained were 628 bp, 735 bp, and 251 bp, for the S, M-N and polymerase gene regions. After cloning and sequencing the products, similarity searches with BLAST (Altschul et al., 1990) showed the sequences to be authentic coronavirus sequences, with the most significant matches to porcine transmissible gastroenteritis virus, feline, and canine coronaviruses. Percentage nucleotide sequence identities of the ferret coronavirus sequences (excluding primer sequences) with the corresponding sequences of porcine transmissible gastroenteritis virus (GenBank accession nos. AY35549, for the S and the M genes, and AJ011482, for the polymerase gene) were as follows: 60.8% for the 586-bp partial S gene sequence, 66.7% for the 334-bp partial M gene sequence, and 76.4% for the 208-bp partial polymerase sequence. These initial findings provided the first nucleotide sequence-based evidence that an enteric coronavirus is shed in the feces of ferrets clinically affected with ECE.

Sequencing of the entire N gene, sequence and phylogenetic analyses

The entire N gene of the ferret enteric coronavirus (FECV), hereafter referred to as strain FECV-MSU1, was derived by the 3' RACE method. The N gene of FECV-MSU1 is 1125 nucleotides in length and translates into a 374-amino-acid protein (Fig. 1). It is flanked upstream by a 16-base intergenic sequence, followed by the open reading frame corresponding to

the sequenced 3'-end portion of the M protein gene. The recognized transcription-regulating sequence (TRS), 5'-CTAAAC-3', of coronaviruses (Budzilowicz et al., 1985; Horsburgh et al., 1992; Kapke and Brian, 1986; Snijder et al., 2003; Spaan et al., 1988) is conserved in FECV-MSU1, and found within the intergenic sequence preceding the N gene.

BLAST analysis of the entire FECV-MSU1 N gene sequence consistently demonstrated significant similarities to reported coronavirus N gene sequences in the GenBank database. As was previously observed with the partial S, M and polymerase nucleotide sequences analyzed, group 1 coronavirus sequences produced the most significant alignments with the ferret sequence. The FECV-MSU1 N gene shared nucleotide identities of 51.6, 48.7, and 48.2% with canine coronavirus (GenBank accession no. AY342160), porcine transmissible gastroenteritis virus (GenBank accession no. AF104420), feline coronavirus (GenBank accession no. AB086902), respectively.

The deduced amino acid sequence of the FECV-MSU1 N protein was aligned with corresponding coronavirus sequences from GenBank, representing each of the coronavirus antigenic groupings. Table 1 shows the sequence identities between the N protein of FECV-MSU1 and those of porcine transmissible gastroenteritis virus (TGEV), canine coronavirus (CCV), feline coronavirus (FCoV), porcine epidemic diarrhea virus (PEDV), human coronavirus (HCoV) 229E, bovine coronavirus (BCV), mouse hepatitis virus (MHV), HCoV OC43, SARS virus, avian infectious bronchitis virus (IBV), and turkey coronavirus (TCoV). The GenBank accession numbers for these coronavirus strains are given in Fig. 2. Group 1 coronaviruses, CCV, FCoV, TGEV, PEDV, and HCoV 229E, shared the highest sequence identities with FECV-MSU1 at 57.1, 56, 57.3, 31.2, and 35.7%, respectively. Group 2 (BCV, MHV, HCoV OC43), SARS virus, and group 3 (IBV, TCoV) coronaviruses, showed much lower identities with FECV-MSU1 at 22.9 to 26.9%. The N protein sequence alignment data was used to generate a phylogenetic tree (Fig. 2) which clearly shows that the ferret coronavirus, FECV-MSU1, is a novel coronavirus that groups within the group 1 coronaviruses. Within this group, FECV-MSU1 is more closely related to FCoV, CCV, and TGEV than to PEDV and HCoV 229E.

Fig. 3 shows the alignment of the deduced N protein sequences of FECV-MSU1, TGEV, CCV, FCoV, and PEDV. The amino acid substitutions that occurred in the FECV sequence in relation to the consensus (majority) sequence appear randomly throughout, with stretches of up to 6 substitutions. Insertions and deletions appear to be random as well, with the largest deletion of 6 residues, with respect to the consensus, observed to have occurred between amino acid positions 178 and 179. A highly conserved region between the N proteins of FECV-MSU1, TGEV, CCV, and FCoV was noted at amino acid positions 88–109 (22 total residues), with only 3 substitutions occurring within the FECV-MSU1 sequence. PEDV stands out as the most distantly related among this group of animal coronaviruses, possessing extra sequence strings, not found in the consensus, of up to 35 amino acid residues at a stretch.

Table 1
Percent amino acid sequence identities between coronavirus nucleocapsid proteins

1	2	3	4	5	6	7	8	9	10	11	12		
	57.3	57.1	56	35.7	31.2	24.5	26.9	24	25.9	22.9	23.2	1	FECV-MSU1
		89.5	75.9	34.8	32.5	25.4	28	25.4	27.5	23.6	23.3	2	TGEV
			74.9	36.1	33	24.9	27.7	24.9	26.7	22.8	22.5	3	CCV
				34.5	30.2	24.1	26.5	23.9	25.7	22.5	22.3	4	FCoV
					38	22.9	25.4	22.9	22.4	19.3	19.3	5	HCoV 229E
						19	19	18.8	20.4	17.5	17.5	6	PEDV
							71.7	97.3	31	22.5	22.5	7	BCV
								70.7	32.2	24.2	23.8	8	MHV
									30.8	22.5	22.5	9	HCoV OC43
										25.1	25.1	10	SARS Virus
											95.8	11	IBV
												12	TCoV

Phylogenetic analyses based upon partial sequences of the polymerase, S and M proteins

The predicted partial amino acid sequences of the FECV-MSU1 polymerase, S and M proteins were also aligned with corresponding sequences of other known coronaviruses and phylogenetic trees were derived. As was evident from the N protein sequence analysis, the data presented in Figs. 4–6 show that FECV-MSU1 is most similar to group 1 coronaviruses and more specifically to FCoV, CCV, and TGEV.

Identification and analysis of 2 open reading frames (ORFs) downstream of the FECV N gene

Amplification of the 3'-end of FECV-MSU1 by the 3' RACE method enabled determination of the entire N gene sequence and a 994 nucleotide sequence downstream from the N gene (Fig. 1). Analysis of this sequence revealed the presence of two ORFs. The first ORF is 225 nucleotides in length with its start codon located 9 nucleotides downstream of the N gene. The second ORF is 615 nucleotides in length and overlaps the first ORF by 62 bases. The deduced amino acid sequences of the two ORFs were subjected to BLAST analyses. The first ORF codes for a putative 74-amino-acid protein (8.5

K polypeptide) which is 23.9% similar to the hypothetical 3x protein of the Insavc strain of CCV strain from the U.K. (GenBank accession no. BAA02410) (Horsburgh et al., 1992). The second ORF codes for a putative 204-amino-acid protein which is most similar to the nonstructural protein 7b of enteric canine coronaviruses and feline coronaviruses. This putative 7b protein sequence shares 37.3% homology with the corresponding protein of the CCV Insavc-1 strain, and 35.8% similarity to the 7b protein of feline coronavirus (GenBank accession no. CAA62193). The conserved TRS, 5'-CTAAAC-3', was found upstream of the 3x-like ORF, but not of the 7b-like ORF (Fig. 1). The 10-base sequence highly conserved in the 3' noncoding region of all coronaviruses, 5'-GGGAA-GAGCT-3' (Horsburgh et al., 1992; Kapke and Brian, 1986), was observed 169 bases downstream of the 7b-like ORF (Fig. 1), with 2 base mismatches, a T instead of a G in the first base, and a G instead of an A at the seventh base.

Virus isolation

Cytopathic changes were not observed in any of the inoculated cultures. FECV-specific RT-PCR on inoculated CRFK RNA extracts yielded negative results.

Detection of FECV in clinical samples by RT-PCR, ISH, and IHC

An FECV N gene-specific RT-PCR assay was used to analyze fecal, saliva, and serum samples from 13 ferrets naturally affected with ECE. FECV was detected in feces and saliva, but not in serum, of all ferrets examined on days 0, 7, 12, and 26 (Fig. 7, panels a and b). The PCR products derived from 2 fecal samples on day 0 were sequenced and confirmed as FECV. Amplification products were not observed using TGEV, CCV, FCoV, and BCV RNA as templates.

FECV RNA and antigen were detected in the cytoplasm of enterocytes at the villi tips in the jejunum of affected ferrets on day 17 (n = 10) and 26 (n = 3). The ISH signal (Fig. 8, panel a) co-localized with viral protein detected by IHC (Fig. 9, panel a). FECV RNA or antigen was not found in the large intestine, lymph nodes, spleen, esophagus, stomach, and parotid salivary glands.

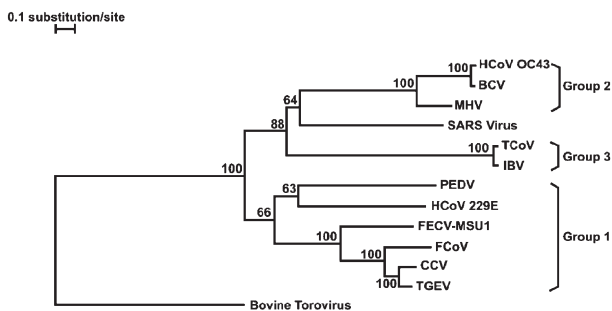

Fig. 2. Phylogenetic tree, based on deduced amino acid sequences of the nucleocapsid proteins of FECV-MSU1 (this study), CCV (AY342160), TGEV (AF104420), FCoV (AB086902), PEDV (AF353511), HCoV 229E (NC_002645), SARS virus (NC_004718), MHV (AY700211), HCoV OC43 (NC_005147), BCV (U00735), TCoV (AF111997), and IBV (AY363968). Bovine torovirus (AJ575389) was included as the outgroup sequence. Bootstrap values are indicated at the nodes. GenBank accession numbers are in parentheses.

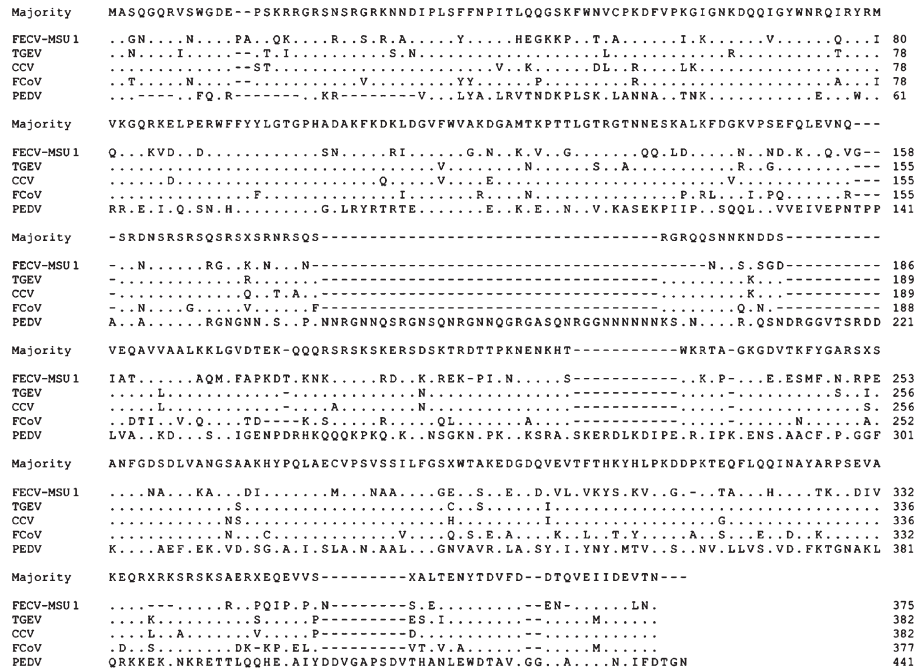

Fig. 3. Alignment of the deduced amino acid sequences of the nucleocapsid proteins of FECV-MSU1 (this study), TGEV (AF104420), CCV (AY342160), FCoV (AB086902), and PEDV (AF353511). Residues that match the majority (consensus) sequence are shown in dots. Deletions are indicated by minus signs. GenBank accession numbers are in parentheses.

Nucleotide sequence GenBank accession numbers

FECV-MSU-1 sequences have been assigned GenBank accession numbers DQ340560, for the partial polymerase sequence; DQ340561, for the partial S sequence; and DQ340562, for the partial M and downstream ORF sequences (N, 3x and 7b) up to the partial 3' UTR.

Discussion

Epizootic catarrhal enteritis (ECE), an enteric disease of ferrets, was first described in 1993. Previous work (Williams et

al., 2000) utilizing electron microscopy and immunohistochemistry implicated a coronavirus as the causative agent of ECE. Based upon these previous data, consensus PCR protocols using primers that target conserved areas within the genomes of coronaviruses were utilized in this study to confirm the association of a coronavirus with ECE. Sequencing of the PCR products and BLAST analyses confirmed the coronavirus origin of the amplification products and provided the first genetic evidence for the detection of a novel coronavirus in ferrets, tentatively designated ferret enteric coronavirus (FECV). Subsequently, the sequences of the entire N gene and downstream ORFs were derived. Sequence alignment and phylogenetic analysis based upon the predicted N protein

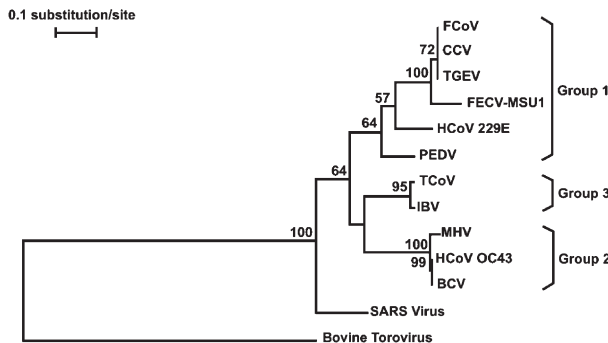

Fig. 4. Phylogenetic tree, based on deduced partial amino acid sequences of the polymerase proteins of FECV-MSU1 (this study), CCV (AF124986), TGEV (AJ011482), FCoV (AF124987), PEDV (AF353511), HCoV 229E (NC_002645), SARS virus (NC_004718), MHV (AY700211), HCoV OC43 (NC_005147), BCV (U00735), TCoV (AF124991), and IBV (M95169). Bovine torovirus (NC_007447) was included as the outgroup sequence. Bootstrap values are indicated at the nodes. GenBank accession numbers are in parentheses.

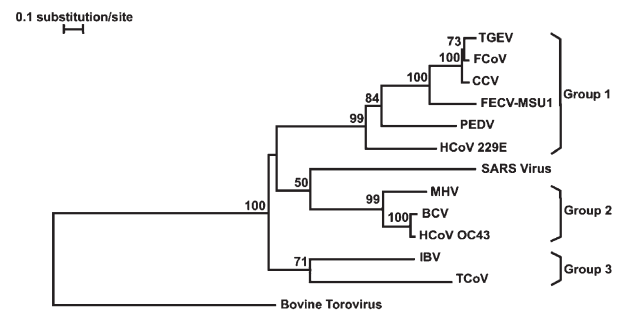

Fig. 5. Phylogenetic tree, based on deduced partial amino acid sequences of the spike proteins of FECV-MSU1 (this study), CCV (AY342160), TGEV (AF104420), FCoV (X80799), PEDV (AF353511), HCoV 229E (NC_002645), SARS virus (NC_004718), MHV (AY700211), HCoV OC43 (NC_005147), BCV (U00735), TCoV (AY342357), and IBV (DQ001339). Bovine torovirus (NC_007447) was included as the outgroup sequence. Bootstrap values are indicated at the nodes. GenBank accession numbers are in parentheses.

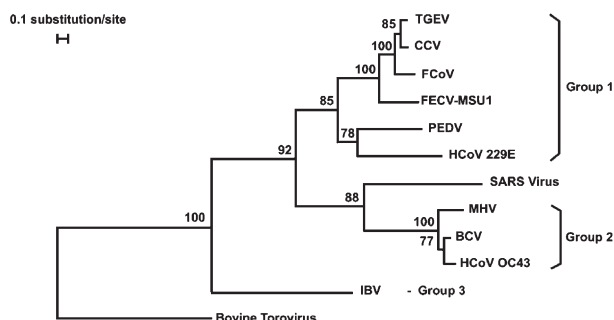

Fig. 6. Phylogenetic tree, based on deduced partial amino acid sequences of the membrane proteins of FECV-MSU1 (this study), CCV (AY342160), TGEV (AF104420), FCoV (AB086902), PEDV (AF353511), HCoV 229E (NC_002645), SARS virus (NC_004718), MHV (AY700211), HCoV OC43 (NC_005147), BCV (U00735), and IBV (DQ001339). Bovine torovirus (NC_007447) was included as the outgroup sequence. Bootstrap values are indicated at the nodes. GenBank accession numbers are in parentheses.

sequences of FECV and other coronaviruses clearly indicated that FECV clusters with group 1 coronaviruses. FECV appears to be more closely related to the group 1 coronaviruses FCoV, CCV, and TGEV, than to PEDV and HCoV 229E. Yet, FCoV, CCV, and TGEV together form a tighter cluster with pairwise amino acid sequence identities from 74.9 to 89.5%, compared to only 56.8% average identity shared by FECV with these three viruses. The close serologic relationship between CCV, FCoV, TGEV, and the related PRCV is well established (Sanchez et al., 1990; Siddell et al., 1983; Spaan et al., 1988). Likewise, the close genetic relationship between these viruses, based upon sequence analysis, has been well documented (Enjuanes et al., 2000; Gonzalez et al., 2003; Horsburgh et al., 1992). PEDV, although a group 1 coronavirus of animal origin, has been shown to be most closely related to HCoV 229E (Bridgen et al., 1993; Kocherhans et al., 2001). These two viruses were observed to clearly form their own cluster separate from the other group 1 coronavirus members in the phylogenetic trees shown in Figs. 2 and 6.

The predicted partial polymerase, S and M protein sequences of FECV were also compared to corresponding sequences of other known coronaviruses. As with the analysis of the N protein sequence, phylogenetic analyses based upon these three other regions of the genome gave similar results, further supporting the classification of FECV as a member of group 1

coronaviruses with highest similarities to CCV, FCoV, and TGEV and more distantly related to PEDV and HCoV 229E. The extent of genetic relatedness of FECV to other coronaviruses appears to be consistent, at least for the four regions analyzed so far.

Group 1 feline and canine coronaviruses are known to contain two additional ORFs, namely ORFs 7a and 7b, downstream from the N gene at the 3'-end of their genomes (Herrewegh et al., 1995; Vennema et al., 1992a). TGEV was found to have an ORF 7a but not an ORF 7b in its genome (Herrewegh et al., 1995; Vennema et al., 1992a). These ORFs code for accessory nonstructural proteins, the functions of which have not yet been defined. ORF 7a codes for a small hydrophobic protein that is membrane-associated (Tung et al., 1992), while ORF 7b appears to be a secretory glycoprotein not stably associated with viral particles (Vennema et al., 1992b). Analyses of the 3'-end of FECV-MSU1 downstream from the N gene showed the presence of 2 ORFs. The gene corresponding to ORF 7a of other group 1 animal coronaviruses was not found in the FECV genome. Instead, an ORF with 23.9% homology to the 3x pseudogene of CCV strain Insavc-1 (Horsburgh et al., 1992) was found in the genomic location of ORF 7a. Within the CCV genome, ORF 3x is located between the S and M genes. TGEV has a counterpart to the CCV pseudogene in a similar location but with a deletion of 92 nucleotides (Horsburgh et al., 1992). Fig. 10 shows the gene arrangements of the 3' termini of the genomes of FECV, FCoV, CCV, and TGEV. Interestingly, the 3x gene is clearly in a different genomic location in the strain of FECV being analyzed, but this could be a strain-specific feature. It is possible that the 3x pseudogene homologue in FECV-MSU1 is the result of an insertional event. It is well known that recombination, insertions, and deletions are typical features of coronavirus biology (Lai, 1992, 1996; Sawicki and Sawicki, 1998; Spaan et al., 1984; Zhang et al., 2005). Even though the 3x gene of CCV Insavc-1 could conceivably encode a 71-amino-acid 10 K polypeptide, this was considered unlikely, based upon codon usage and base preference programs (Horsburgh et al., 1992; Staden, 1982). It was suggested that ORF 3x is an evolutionary redundant sequence which is no longer required. Of note, the significant similarity of the FECV 3x-like gene to that of CCV was only apparent after BLAST analysis without the default filtering of low complexity

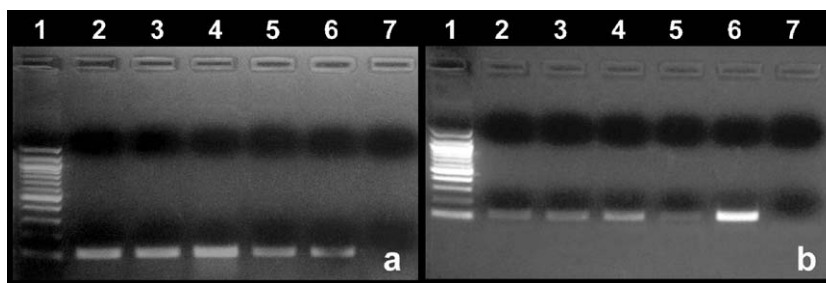

Fig. 7. FECV-specific RT-PCR on clinical samples from ferrets with ECE. (a) Lane 1, 100-bp DNA ladder. Lanes 2–5, amplicons from fecal specimens collected from one of the ferrets on days 0, 7, 12, and 26, respectively. Lane 6, FECV positive control (113-bp product). Lane 7, negative reagent control (RNase-free water as the template). (b) Lane 1, 100-bp DNA ladder. Lanes 2–5, amplicons from saliva specimens collected from one of the ferrets on days 0, 7, 12, and 26, respectively. Lane 6, FECV positive control (113-bp product). Lane 7, negative reagent control (RNase-free water as the template).

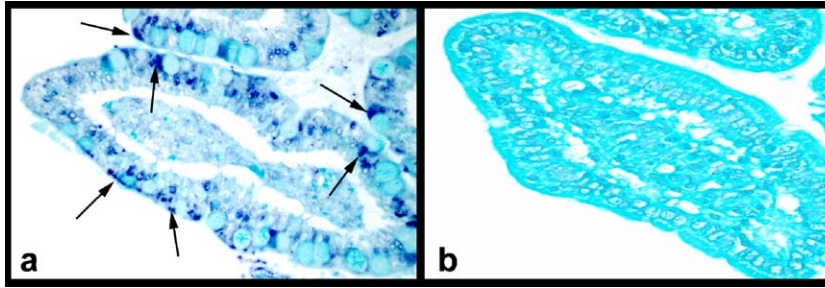

Fig. 8. Detection of FECV RNA by in situ hybridization. (a) Positive dark-blue staining (arrows) showing the presence of FECV RNA in the cytoplasm of villar epithelial cells. (b) Negative reagent control slide, hybridized in buffer without the probe and counterstained with the dye “light green”. (For interpretation of the references to colour in this figure legend, the reader is referred to the web version of this article.)

sequences. Examination of the deduced amino acid sequence of the FECV 3x-like gene showed multiple regions of biased composition including homopolymeric runs and overrepresentation of some residues characteristic of low complexity sequences (data not shown) (Wootton and Federhen, 1996). Therefore, the 3x-like ORF in FECV-MSU1, as in Insavc-1, does not appear to encode a functional viral protein.

FECV-MSU1 is missing a counterpart to ORF 7a of feline and canine group 1 coronaviruses. It is known that the accessory nonstructural protein genes of coronaviruses can be acquired or lost easily in their evolution (Snijder et al., 2003). The ORF 7a in TGEV was found to have a deletion of 69 nucleotides (de Groot et al., 1988). The genomic region downstream of the N gene is known to be a “deletion hot spot” in coronaviruses (Collison et al., 1990; de Groot et al., 1988; Horsburgh et al., 1992). Hence, it is not unusual for FECV to have a missing ORF 7a homologue, most likely due to a deletion event. There is a need to sequence and analyze more strains to ascertain whether this is a common feature among FECV isolates.

The putative ORF 7b protein of FECV appears to be intact and has identities of 37.3% and 35.8% to CCV and FCoV, respectively. This ORF was observed to be the least conserved between feline and canine coronaviruses, with only 57% identity between the two (Horsburgh et al., 1992). A number of feline enteric coronavirus strains with deletions in ORF 7b have been identified (Herrewegh et al., 1995). In feline coronaviruses, the ORF 7b glycoprotein was found dispensable for viral replication in tissue culture (Vennema et al., 1992b) and for infection of the natural host (Pedersen et al., 1984). It has been presumed that the 7b glycoprotein functions as a virus-

encoded mediator of the host immune response (Herrewegh et al., 1995).

The minimal conserved transcription regulatory sequence (TRS), CTAAAC, found in group 1 animal coronaviruses, is essential in the synthesis of subgenomic mRNAs during viral replication (Budzilowicz et al., 1985; Snijder et al., 2003; Spaan et al., 1988). In the genus *Coronavirus*, the nonreplicase ORFs are expressed from a nested set of subgenomic mRNAs that are both 5' and 3' coterminal with the viral genome (Lai and Cavanagh, 1997). It has been postulated that TRSs guide the discontinuous synthesis of negative-stranded subgenomic mRNAs that serve as templates for subgenomic mRNA synthesis (Pasternak et al., 2000; Sawicki and Sawicki, 1995). The TRS, CTAAAC, was found to be conserved in FECV-MSU1 upstream of the N gene and the 3x-like ORF, but not upstream of ORF 7b. In the CCV strain Insavc-1, the conserved TRS was present upstream of ORF 7a but was absent upstream of ORF 7b (Horsburgh et al., 1992). It is presumed that ORFs 7a and 7b are likely to be expressed from a single mRNA species, since polycistronic coronavirus mRNAs have been previously identified (Liu and Inglis, 1992; Liu et al., 1991). Hence, the FECV 7b protein may very well be expressed from a bicistronic mRNA, containing the nonfunctional 3x-like ORF at its 5'-end.

The 10-base sequence, 5'-GGGAAGAGCT-3', highly conserved in the 3' noncoding region of all coronaviruses (Horsburgh et al., 1992; Kapke and Brian, 1986), was also observed 169 bases downstream of ORF 7b of FECV. It was conserved, except for 2 base mismatches. This sequence is believed to be a recognition site for the attachment of the

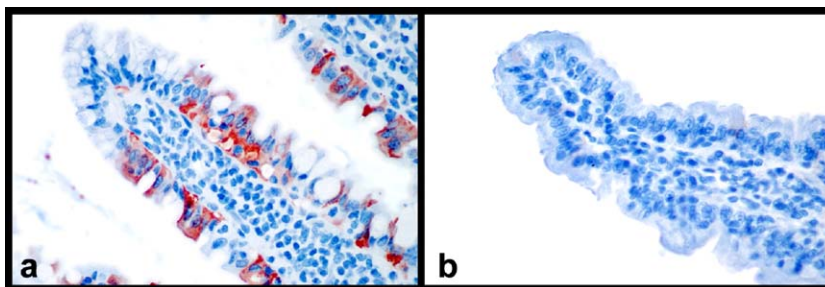

Fig. 9. Detection of FECV antigen by immunohistochemistry. (a) Positive red staining demonstrating the presence of coronavirus antigen in the cytoplasm of villar epithelial cells. (b) Negative reagent control tissue section stained with a murine monoclonal antibody of different specificity but with matching immunoglobulin concentration.

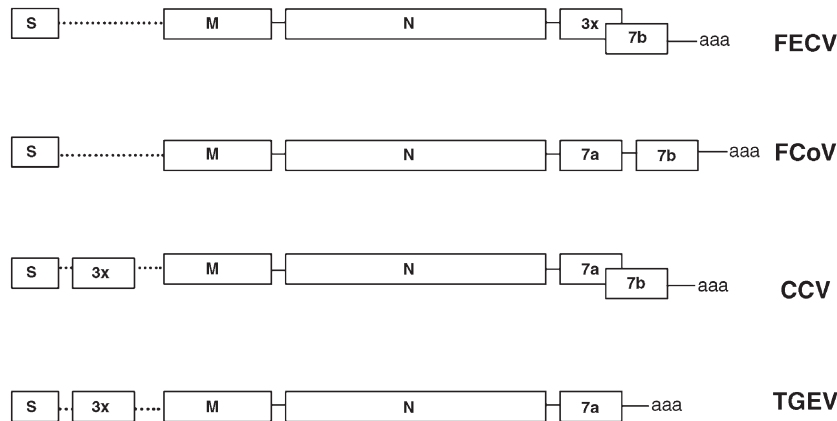

Fig. 10. Schematic of the gene arrangements of the 3' termini of the genomes of FECV-MSU1 (FECV), FCoV, CCV, and TGEV. The open reading frames are represented as boxes. The genes for the structural proteins S, M and N, and nonstructural proteins 3x, 7a, and 7b are shown. The dotted lines indicate other genomic regions not shown in the diagram or areas of FECV not yet sequenced.

polymerase, as synthesis of the negative strand RNA is initiated (Kapke and Brian, 1986).

Our attempt to isolate FECV in CRFK cells was negative. Virus isolation was previously attempted by Williams et al. (2000) in MV-1-LU, HRT-18, DK-5966, CRSK, and A72-163 cells but was unsuccessful. Other enteric coronaviruses, e.g., type 1 feline enteric coronavirus, have been shown to be difficult to propagate in cell culture.

ECE is a common clinical diagnosis, and the clinical signs associated with ECE are fairly distinct (green slimy diarrhea). However, some of the clinical signs such as vomiting and hypoproteinemia may be observed with other enteric diseases of ferrets including inflammatory bowel disease, gastric helicobacteriosis, and rotavirus infections in juveniles. The availability of FECV genomic sequence data will facilitate the development of molecular assays to confirm clinical diagnosis. In this study, FECV was detected in feces and saliva of naturally infected ferrets using an N gene-specific RT-PCR. This PCR assay has potential as a standard diagnostic assay, but further validation is required.

The tissue localization of FECV may be similar to that of FCoV. Both antigen and nucleic acid were detected in the cytoplasm of enterocytes at the tip of villi in the jejunum of affected ferrets by IHC and ISH, respectively. Viral antigen or nucleic acid was not present in the large intestine, lymph nodes, spleen, esophagus, stomach, or parotid salivary glands. In a recent field case of ECE, we detected viral proteins both in the small and large intestines (data not shown). Herrewegh et al. (1997), using nested RT-PCR, detected FCoV-specific RNA in kidney, lung, brain, tonsils, salivary gland, and bone marrow. Viral RNA was most abundant in duodenum, jejunum, ileum, colon, and rectum. Interestingly, when evidence of replicating virus was evaluated with an RT-PCR targeting N gene-specific mRNA, evidence of viral replication could be obtained only in homogenates of ileum, colon, and rectum. Immunohistochemistry confirmed that FCoV-specific antigens were present only in the ileum, colon, and rectum.

In conclusion, this study provides the first molecular evidence indicating that a novel coronavirus, herein designated

as ferret enteric coronavirus, is associated with enteric catarrhal enteritis in ferrets. Further definition of the pathogenesis of FECV will be dependent upon the development of an in vitro culture system.

Materials and methods

Consensus RT-PCR for detecting coronaviruses

Samples

Fecal specimens from a ferret clinically diagnosed with ECE were obtained from a veterinary clinic. Total RNA was extracted from fecal specimens using the QIAGEN RNeasy Mini Kit (Valencia, CA).

Amplification of S and M-N regions

Degenerate consensus primers were used to amplify portions of the S (spike), M (membrane) glycoprotein, and N (nucleocapsid) genes of any coronavirus (Tobler and Ackermann, 1996). Primer 55: 5'-GGAKAAGGTKAATGARTGYGT-3' and primer 56: 5'-CCAKACVTACCAWGGCCAYTT-3' delineate an approximately 700-bp region of the coronavirus S gene. Primer 25: 5'-GACTAGTTGGTGGAGWTTTAA YCCWGA-3' and primer 24: 5'-CTCGAGCGACCCAGAMGACW-CCKTC-3', bracket an approximately 700-bp region of the coronavirus genome, beginning from the 3' terminus of the M gene to the 5' terminus of the N gene. RT-PCR was performed using the QIAGEN OneStep RT-PCR Kit with 0.6 μ M of each primer. Cycling conditions for both S and M-N regions amplifications were as follows: cDNA synthesis at 45 °C for 45 min; predenaturation at 95 °C for 15 min; 50 cycles, each consisting of denaturation at 94 °C for 30 s, annealing at 45 °C for 1 min, and extension at 72 °C for 2 min and 30 s. A final extension at 72 °C for 7 min was added after the last PCR cycle.

Amplification of the polymerase (pol) region

A pair of degenerate primers, 2BP: 5'-ACTCARWTRAA-TYTNAATAYGC-3' and 4Bm: 5'-TCACAYTTWGGA-TARTCCCA3', was used to amplify a 251-bp region of the

coronavirus polymerase gene within ORF 1b (Stephensen et al., 1999). RT-PCR was carried out with the QIAGEN OneStep RT-PCR Kit with 0.6 μ M of each primer. Cycling conditions were as follows: cDNA synthesis at 40 °C for 45 min and pre-denaturation at 95 °C for 15 min; 5 cycles of PCR at 94 °C for 1 min, 40 °C for 2 min, and 72 °C for 1 min; then 40 cycles of PCR at 94 °C for 1 min, 50 °C for 1.5 min, and 72 °C for 1 min; with a final extension of 72 °C for 10 min. PCR products were analyzed by agarose gel electrophoresis and visualized by UV transillumination of ethidium bromide-stained gels.

Cloning and sequencing of PCR products

The PCR products were extracted from the gel using the QIAquick Gel Extraction Kit (QIAGEN). The purified products were TA-cloned into a plasmid vector using the QIAGEN PCR Cloning Kit. The inserts were amplified with M13 forward and reverse primers, which prime the cloning vector at positions just outside the multiple cloning site. PCR products were sent to the Genomic Technology Support Facility of Michigan State University for automated bi-directional sequencing.

Sequencing of the entire N gene

A 683-nucleotide sequence (excluding primer sequences) of the ferret coronavirus, which spans the last 334 nucleotides of the M gene, 16 nucleotides of intergenic sequence, and the first 333 nucleotides of the N gene, was obtained by sequencing of amplicons generated with consensus primers. Based upon this sequence, the entire N gene sequence was derived by the 3' RACE method, using a commercial kit (GIBCO BRL, Life Technologies, Rockville, MD). Complementary DNA was synthesized from 5 μ l of fecal RNA template with an oligo-(dT)-containing adapter primer according to the kit manufacturer's protocol. The gene-specific primer (5'-ACCCATGAAGGTAAGAAGCCC-3') used for PCR amplification of the target cDNA was based on the initially derived 5' sequence of the N gene. The abridged universal primer (AUAP) provided in the kit was used as reverse primer. PCR was carried out with the QIAGEN HotStar Taq DNA Polymerase Kit, using 2 μ l of cDNA template, 0.5 μ M of the gene-specific primer, 2 μ l of AUAP and the following cycling conditions: pre-denaturation at 95 °C for 15 min, followed by 50 cycles of denaturation at 94 °C for 1 min, annealing at 55 °C for 1 min, and extension at 72 °C for 2 min and 30 s, and a final extension at 72 °C for 7 min. PCR products of the expected size were purified for direct sequencing. Sequence data for the approximately 2 kb product were obtained by initially using the gene-specific primer described above and a poly-T sequencing primer, followed by primer-walking with newly designed 5' and 3' primers derived with the OLIGO 6 primer analysis software (Molecular Biology Insights, Cascade, CO).

Sequence and phylogenetic analyses

BLAST (Altschul et al., 1990) searches against the GenBank database were performed to confirm that the sequence data

obtained were authentic coronavirus sequences. Sequence assembly and analyses, including multiple alignments of nucleotide and predicted amino acid sequences using the Clustal W method (Thompson et al., 1994), were done with the Lasergene biocomputing software (DNASTAR, Inc., Madison, WI). Phylogenetic trees were constructed with the Treecon software package (Van de Peer and De Wachter, 1994), using the neighbor-joining method (Saitou and Nei, 1987) and 100 bootstrap analyses (Efron and Gong, 1983; Felsenstein, 1985). Sequence alignment data generated with Lasergene were converted to the Treecon format using the ForCon software (Raes and Van de Peer, 1999).

Virus isolation

Virus isolation was attempted in the Crandell Reese feline kidney (CRFK) cell line, obtained from the American Type Culture Collection (CCL 94). The CRFK cells were grown in Eagle's minimum essential medium (EMEM), supplemented with 10% heat-inactivated fetal bovine serum, 100 U/ml of penicillin, and 100 μ g/ml of streptomycin (BRL-Life Sciences, Gaithersburg, MD). Confluent monolayers were inoculated with 0.45 μ m filtrates of fecal homogenates. The inoculated cells were observed during a 7-day period for the appearance of cytopathic changes. RNA was extracted from inoculated and mock-inoculated cell homogenates and tested by RT-PCR, using the FECV N gene-specific primers described above.

Detection of FECV in clinical samples

Animals and sample collection

A group of 13 ferrets, naturally affected with ECE, was housed at the MSU Laboratory Animal Resources (ULAR) Facility. Ferrets were kept in individual cages and fed a commercial ferret diet. Ferrets were monitored clinically on a daily basis. Fecal samples, rectal and oral swabs were collected daily from each ferret. Ferrets were bled on a weekly basis to obtain serum samples.

Necropsy

The 13 ferrets were exsanguinated and euthanized on days 17 ($n = 10$) or 26 ($n = 3$). Necropsies were performed immediately thereafter, and samples of small and large intestine, lymph nodes, spleen, esophagus, stomach, and salivary glands were collected. Sections of tissues were fixed in 10% neutral buffered formalin and routinely processed for histopathology, in situ hybridization, and immunohistochemistry.

FECV-specific RT-PCR

A pair of primers was designed from the nucleocapsid gene sequence of FECV-MSU1 using the OLIGO 6 software. The selected primer pair, 5'-ACA GGT GGT TCT TTT ACT ACC-3' (forward primer) and 5'-TGT AGG CAC AGT TTT AGC AC-3' (reverse primer) targets a 113-bp region of the N gene. Total RNA from fecal, oral and serum samples were extracted using the QIAGEN RNeasy Mini Kit (Valencia, CA). The

QIAGEN OneStep RT-PCR kit was used with an optimal primer concentration of 0.6 μ M for each primer in a final reaction volume of 50 μ l. Five microliters of the extracted RNA was used as the template. The optimized cycling conditions were as follows: cDNA synthesis at 50 °C for 30 min; predenaturation at 95 °C for 15 min; 40 PCR cycles of 94 °C for 30 s, 53 °C for 30 s, and 72 °C for 30 s; and a final extension step of 72 °C for 7 min. PCR products were run on a 2% agarose gel stained with ethidium bromide and were visualized with a UV transilluminator. Amplicons of the expected size from two fecal samples, collected on day 0, were purified using the QIAquick PCR Purification kit (QIAGEN, Inc., Valencia, CA) and were directly sequenced at the Genomics Technology Support Facility at Michigan State University. FECV-positive control RNA used was the fecal RNA extract previously amplified with consensus coronavirus PCR primers. Specificity of the assay was evaluated with RNA extracted from TGEV, CCV, FCoV, and BCV.

In situ hybridization (ISH)

A 25-mer FECV-specific probe (5'-TCGGTAACGT-TGCTGTCTATTCCA-3') was designed based upon the FECV nucleocapsid gene sequence using the Oligo 6 software. The probe was synthesized commercially, 3'-end labeled with digoxigenin and HPLC-purified (IDT DNA, Coralville, IA). Tissue sections were deparaffinized then subjected to proteolytic digestion with 0.2N HCl for 20 min and with proteinase K at 37 °C for 15 min. Subsequently, the slides were post-fixed in 4% paraformaldehyde for 5 min. Prehybridization and hybridization were performed according to a previously described protocol (Kiupel et al., 2001). Briefly, prehybridization was performed at 50 °C for 1 h in 100% formamide. This was followed by hybridization at 105 °C for 5 min and at 37 °C for 1 h, using Fischer's microprobe workstation (Fischer Scientific, Hampton, NH). High stringency washes were performed in saline sodium citrate buffers to ensure specific binding of the probe to the target. The detection system consisted of anti-digoxigenin antibody (Boehringer Mannheim Biochemica, Indianapolis, IN) conjugated with alkaline phosphatase (1:500) applied at 37 °C for 45 min, and the substrate, NBT/X Phos (Nitro-blue tetrazolium/5 Bromo-4-chloro-3-indoylphosphate, Boehringer Mannheim Biochemica, Indianapolis, IN). Dye reduction to insoluble blue formazan was allowed for 120 min. Slides were counterstained with light green manually to best highlight the signal. Negative reagent control slides were incubated with hybridization buffer from which the FECV probe was omitted.

Immunohistochemistry (IHC)

Immunohistochemical staining of tissues with monoclonal antibody FCV3-70 (Custom Monoclonals International, West Sacramento, CA), known to react with feline, canine, and porcine coronaviruses (Kipar et al., 1998a, 1998b), and ECE-associated coronavirus in ferrets (Williams et al., 2000), was performed as described previously by Williams et al. (2000).

Acknowledgments

We thank Dr. Cheryl Isenhour (College of Veterinary Medicine Class of 2005) for the excellent technical assistance. The authors would like to thank Marshall Farms Group, Ltd. for their generous sponsorship of this research project. This study was also supported by grants from the Office of Intellectual Property of Michigan State University and from the Companion Animal Fund of the College of Veterinary Medicine, Michigan State University.

References

- Altschul, S.F., Gish, W., Miller, W., Myers, E.W., Lipman, D.J., 1990. Basic local alignment search tool. *J. Mol. Biol.* 215, 403–410.
- Bridgen, A., Duarte, M., Tobler, K., Laude, H., Ackermann, M., 1993. Sequence determination of the nucleocapsid protein gene of the porcine epidemic diarrhea virus confirms that this is a coronavirus related to human coronavirus 229E and porcine transmissible gastroenteritis virus. *J. Gen. Virol.* 74, 1795–1804.
- Budzilowicz, C.J., Wilczynski, S.P., Weiss, S.R., 1985. Three intergenic regions of coronavirus mouse hepatitis virus strain A59 genome RNA contain a common nucleotide sequence that is homologous to the 3' end of the viral mRNA leader sequence. *J. Virol.* 53, 834–840.
- Chouljenko, V.N., Lin, X.Q., Kousoulas, K.G., Gorbalenya, A.E., 2001. Comparison of genomic and predicted amino acid sequences of respiratory and enteric bovine coronaviruses isolated from the same animal with fatal shipping pneumonia. *J. Gen. Virol.* 82, 2927–2933.
- Collison, E.W., Williams, A.K., Haar, R.V., Li, W., Sneed, L.W., 1990. Sequence comparisons of the 3' end of the genomes of five strains of avian infectious bronchitis virus. *Adv. Exp. Med. Biol.* 276, 373–377.
- De Groot, R.J., Andeweg, A.C., Horzinek, M.C., Spaan, W.J.M., 1988. Sequence analysis of the 3' end of the feline coronavirus FIPV 79–1146 genome: comparison with the genome of porcine coronavirus TGEV reveals large insertions. *Virology* 167, 370–376.
- Efron, B., Gong, G., 1983. A leisurely look at the bootstrap, the jackknife, and cross-validation. *Am. Stat.* 37, 36–48.
- Enjuanes, L., Brian, D., Cavanagh, D., Holmes, K., Lai, M.M.C., Laude, H., Masters, P., Rottier, P., Siddell, S.G., Spaan, W.J.M., Taguchi, F., Talbot, P., 2000. Coronaviridae. In: van Regenmortel, M.H.V., Fauquet, C.M., Bishop, D.H.L., Carsten, E.B., Estes, M.K., Lemon, S.M., McGeoch, D.J., Maniloff, J., Mayo, M.A., Pringle, C.R., Wickner, R.B. (Eds.), *Virus Taxonomy. Classification and Nomenclature of Viruses*. Academic Press, San Diego, pp. 835–849.
- Felsenstein, J., 1985. Confidence limits on phylogenies: an approach using the bootstrap. *Evolution* 39, 783–791.
- Gonzalez, J.M., Gomez-Puertas, P., Cavanagh, D., Gorbalenya, A.E., Enjuanes, L., 2003. A comparative sequence analysis to revise the current taxonomy of the family Coronaviridae. *Arch. Virol.* 148, 2207–2235.
- Hegy, A., Friebe, A., Gorbalenya, A.E., 2002. Mutational analysis of the active centre of coronavirus 3C-like proteases. *J. Gen. Virol.* 83, 581–593.
- Herrewegh, A.A.P.M., Vennema, H., Horzinek, M.C., Rottier, P.J.M., de Groot, R.J., 1995. The molecular genetics of feline coronaviruses: comparative sequence analysis of the ORF7a/7b transcription unit of different biotypes. *Virology* 212, 622–631.
- Herrewegh, A.A.P.M., Mahler, M., Hedrich, H.J., Haagmans, B.L., Egberink, H.F., Horzinek, M.C., Rottier, P.J.M., de Groot, R.J., 1997. Persistence and evolution of feline coronavirus in a closed cat-breeding colony. *Virology* 234, 349–363.
- Holmes, K.V., 1999. Coronaviruses. In: Granoff, A., Webster, R.G. (Eds.), *Encyclopedia of Virology*. Academic Press, San Diego, pp. 291–298.
- Horsburgh, B.C., Brierley, I., Brown, T.D.K., 1992. Analysis of a 9.6 kb sequence from the 3' end of canine coronavirus genomic RNA. *J. Gen. Virol.* 73, 2849–2862.

- Kapke, P.A., Brian, D.A., 1986. Sequence analysis of the porcine transmissible gastroenteritis coronavirus nucleocapsid protein gene. *Virology* 151, 41–49.
- Kipar, A., Bellman, S., Kremendahl, J., Kohler, K., Reinacher, M., 1998a. Cellular composition, coronavirus antigen expression and production of specific antibodies in lesions in feline infectious peritonitis. *Vet. Immunol. Immunopathol.* 65, 243–257.
- Kipar, A., Kremendahl, J., Addie, D.D., Leukert, W., Grant, C.K., Reinacher, M., 1998b. Fatal enteritis associated with coronavirus infection in cats. *J. Comp. Pathol.* 119, 1–14.
- Kiupel, M., Stevenson, G.W., Choi, J., Latimer, K.S., Kanitz, C.L., Mittal, S.K., 2001. Viral replication and lesions in BALB/c mice experimentally inoculated with porcine circovirus (PCV) isolated from a pig with postweaning multisystemic wasting disease (PMWS). *Vet. Pathol.* 38, 74–82.
- Kocherhans, R., Bridgen, A., Ackermann, M., Tobler, K., 2001. Completion of the porcine epidemic diarrhoea coronavirus (PEDV) genome sequence. *Virus Genes* 23, 137–144.
- Lai, M.M.C., 1992. Genetic recombination in RNA viruses. *Curr. Top. Microbiol. Immunol.* 176, 21–32.
- Lai, M.M.C., 1996. Recombination in large RNA viruses: coronaviruses. *Semin. Virol.* 7, 381–388.
- Lai, M.M.C., Cavanagh, D., 1997. The molecular biology of coronaviruses. *Adv. Virus Res.* 48, 1–100.
- Liu, D.X., Inglis, S.C., 1992. Identification of two new polypeptides encoded by mRNA5 of the coronavirus infectious bronchitis virus. *Virology* 186, 342–347.
- Liu, D.X., Cavanagh, D., Green, I.J., Inglis, S.C., 1991. A polycistronic mRNA specified by the coronavirus infectious bronchitis virus. *Virology* 184, 531–544.
- Marra, M.A., Jones, S.J., Astell, C.R., Holt, R.A., Brooks-Wilson, A., Butterfield, Y.S.N., Khattri, J., Asano, J.K., Barber, S.A., Chan, S.Y., Cloutier, A., Coughlin, S.M., Freeman, D., Girm, N., Griffith, O.L., Leach, S.R., Mayo, M., McDonald, H., Montgomery, S.B., Pandoh, P.K., Petrescu, A.S., Robertson, A.G., Schein, J.E., Siddiqui, A., Smailus, D.E., Stott, J.M., Yang, G.S., Plummer, F., Andonov, A., Artsob, H., Bastien, N., Bernard, K., Booth, T.F., Bowness, D., Czub, M., Drebot, M., Fernando, L., Flick, R., Garbutt, M., Gray, M., Grolla, A., Jones, S., Feldmann, H., Meyers, A., Kabani, A., Li, Y., Normand, S., Stroher, U., Tipples, G.A., Tyler, S., Vogrig, R., Ward, D., Watson, B., Brunham, R.C., Kraiden, M., Petric, M., Skowronski, D.M., Upton, C., Roper, R.L., 2003. The genome sequence of the SARS-associated coronavirus. *Science* 300, 1399–1404.
- Murphy, F.A., Gibbs, E.P.J., Horzinek, M.C., Studdert, M.J., 1999. *Veterinary Virology*. Academic Press, San Diego.
- Pasternak, A.O., van den Born, E., Spaan, W.J.M., Snijder, E.J., 2000. Sequence requirements for RNA strand transfer during nidovirus discontinuous subgenomic RNA synthesis. *EMBO J.* 20, 7220–7228.
- Pedersen, N.C., Evermann, J.F., Alison, J., McKeirnan, A.J., Ott, R.L., 1984. Pathogenicity studies of feline coronavirus isolates 79–1146 and 79–1683. *Am. J. Vet. Res.* 45, 2580–2585.
- Raes, J., Van de Peer, Y., 1999. ForCon: a software tool for the conversion of sequence alignments. *EMBnet News* 6 (1), 10–12 (Available at: http://www.embnet.org/download/embnetnews/embnet_news_6_1.pdf).
- Rota, P.A., Oberste, M.S., Monroe, S.S., Nix, W.A., Campagnoli, R., Icenogle, J. P., Penaranda, S., Bankamp, B., Maher, K., Chen, M., Tong, S., Tamin, A., Lowe, L., Frace, M., DeRisi, J.L., Chen, Q., Wang, D., Erdman, D.D., Peret, T.C.T., Burns, C., Ksiazek, T.G., Rollin, P.E., Sanchez, A., Liffick, S., Holloway, B., Limor, J., McCaustland, K., Olsen-Rasmussen, M., Fouchier, R., Gunther, S., Osterhaus, A.D.M.E., Drost, C., Pallansch, M.A., Anderson, L.J., Bellini, W.J., 2003. Characterization of a novel coronavirus associated with severe acute respiratory syndrome. *Science* 300, 1394–1399.
- Saitou, N., Nei, M., 1987. The neighbor-joining method: a new method for reconstructing phylogenetic trees. *Mol. Biol. Evol.* 4, 406–425.
- Sanchez, C.M., Jimenez, G., Laviada, M.D., Correa, I., Sune, C., Bullido, M.J., Gebauer, F., Smerdou, C., Callebaut, P., Escribano, J.M., Enjuanes, L., 1990. Antigenic homology among coronaviruses related to transmissible gastroenteritis virus. *Virology* 174, 410–417.
- Sawicki, S.G., Sawicki, D.L., 1995. Coronaviruses use discontinuous extension for synthesis of subgenome-length negative strands. *Adv. Exp. Med. Biol.* 380, 499–506.
- Sawicki, S.G., Sawicki, D.L., 1998. A new model for coronavirus transcription. *Adv. Exp. Med. Biol.* 440, 215–219.
- Siddell, S.G., 1995. The Coronaviridae: an introduction. In: Siddell, S.G. (Ed.), *The Coronaviridae*. Plenum Press, New York, pp. 1–10.
- Siddell, S., Wege, H., Ter Meulen, V., 1983. The biology of coronaviruses. *J. Gen. Virol.* 64, 761–776.
- Snijder, E.J., Bredendiek, P.J., Dobbe, J.C., Thiel, V., Ziebuhr, J., Poon, L.L.M., Guan, Y., Rozanov, M., Spaan, W.J.M., Gorbalenya, A.E., 2003. Unique and conserved features of genome and proteome of SARS-coronavirus, an early split-off from the coronavirus group 2 lineage. *J. Mol. Biol.* 331, 991–1004.
- Spaan, W., Delius, H., Skinner, M.A., Armstrong, J., Rottier, P., Smeekens, S., Siddell, S.G., van der Zeijst, B., 1984. Transcription strategy of coronaviruses: fusion of non-contiguous sequences during mRNA synthesis. *Adv. Exp. Med. Biol.* 173, 173–186.
- Spaan, W., Cavanagh, D., Horzinek, M.C., 1988. Coronaviruses: structure and genome expression. *J. Gen. Virol.* 69, 2939–2952.
- Staden, R., 1982. Automation of the computer handling of the gel reading data produced by the shotgun method of DNA sequencing. *Nucleic Acids Res.* 10, 4731–4751.
- Stephens, C.B., Casebolt, D.B., Gangopadhyay, N.N., 1999. Phylogenetic analysis of a highly conserved region of the polymerase gene from 11 coronaviruses and development of a consensus polymerase chain reaction assay. *Virus Res.* 60, 181–189.
- Thompson, J.D., Higgins, D.G., Gibson, T.J., 1994. CLUSTAL W: improving the sensitivity of progressive multiple sequence alignment through sequence weighting, position-specific gap penalties and weight matrix choice. *Nucleic Acids Res.* 22, 4673–4680.
- Tobler, K., Ackermann, M., 1996. Identifikation und charakterisierung von neuen und unbekanntem coronaviren mit hilfe von RT-PCR und degenerierten primern. *Schweiz. Arch. Tierheilk.* 138, 80–86.
- Tung, F.Y.T., Abraham, S., Sethna, M., Hung, S.-L., Sethna, P., Hogue, B.G., Brian, D.A., 1992. The 9-kDa hydrophobic protein encoded at the 3' end of the porcine transmissible gastroenteritis coronavirus genome is membrane-associated. *Virology* 186, 676–683.
- Van de Peer, Y., De Wachter, R., 1994. TREECON for Windows: a software package for the construction and drawing of evolutionary trees for the Microsoft Windows environment. *Comput. Appl. Biosci.* 10, 569–570.
- Vennema, H., Rossen, J.W.A., Wesseling, J., Horzinek, M.C., Rottier, P.J.M., 1992a. Genomic organization and expression of the 3' end of the canine and feline enteric coronaviruses. *Virology* 191, 134–140.
- Vennema, H., Heunen, L., Rottier, P.J.M., Horzinek, M.C., Spaan, W.J.M., 1992b. A novel glycoprotein of feline infectious peritonitis coronavirus contains a KDEL-like endoplasmic reticulum retention signal. *J. Virol.* 66, 4951–4956.
- Wege, H., Siddell, S., ter Meulen, V., 1982. The biology and pathogenesis of coronaviruses. *Curr. Top. Microbiol. Immunol.* 99, 165–200.
- Williams, B.H., Kiupel, M., West, K.H., Raymond, J.T., Grant, C.K., Glickman, L.T., 2000. Coronavirus-associated epizootic catarrhal enteritis in ferrets. *J. Am. Vet. Med. Assoc.* 217 (4), 526–530.
- Wootton, J.C., Federhen, S., 1996. Analysis of compositionally biased regions in sequence databases. *Methods Enzymol.* 266, 554–571.
- Zhang, X.W., Yap, Y.L., Danchin, A., 2005. Testing the hypothesis of a recombinant origin of the SARS-associated coronavirus. *Arch. Virol.* 150, 1–20.