



Since January 2020 Elsevier has created a COVID-19 resource centre with free information in English and Mandarin on the novel coronavirus COVID-19. The COVID-19 resource centre is hosted on Elsevier Connect, the company's public news and information website.

Elsevier hereby grants permission to make all its COVID-19-related research that is available on the COVID-19 resource centre - including this research content - immediately available in PubMed Central and other publicly funded repositories, such as the WHO COVID database with rights for unrestricted research re-use and analyses in any form or by any means with acknowledgement of the original source. These permissions are granted for free by Elsevier for as long as the COVID-19 resource centre remains active.

[5] Characterization of Coronavirus RNA Polymerase Gene Products

By JENS HEROLD, STUART SIDDELL, and JOHN ZIEBUHR

Introduction

The coronavirus RNA polymerase gene encompasses about 20,000 nucleotides and comprises two large open reading frames (ORFs), ORF 1a and ORF 1b, that overlap in the (-1) reading frame by approximately 40–80 nucleotides. Together, these two ORFs have the potential to encode polypeptides with a total molecular mass of 750,000–800,000. *In vitro* studies suggest that the downstream ORF 1b is expressed by a mechanism involving (-1) ribosomal frameshifting, mediated by a “slippery” sequence and a tertiary structure, the RNA pseudoknot. These elements are positioned in the RNA polymerase mRNA (which is equivalent to the viral genomic RNA) in the region of the ORF 1a/ORF 1b overlap.^{1–6}

Genetic analysis of coronavirus temperature-sensitive (ts) mutants, defective in RNA synthesis at the restrictive temperature, has identified a number of distinct viral functions required for the replication and transcription of genomic and subgenomic RNAs. Characterization of these mutants by recombination and sequence analysis has allowed these functions to be located and ordered within the RNA polymerase gene. Moreover, because the complementation frequencies of these mutants are indicative of intergenic rather than intragenic complementation, they provide clear evidence for the activity of proteinases that process the primary translation product(s) of the polymerase gene into smaller, functional polypeptides.^{7–10}

¹ M. E. G. Bournsnel, T. D. K. Brown, I. J. Foulds, P. F. Green, F. M. Tomley, and M. M. Binns, *J. Gen. Virol.* **68**, 57 (1987).

² P. J. Bredenbeek, C. J. Pachuk, A. F. H. Noten, J. Charité, W. Luytjes, S. R. Weiss, and W. J. M. Spaan, *Nucleic Acids Res.* **18**, 1825 (1990).

³ H.-J. Lee, C.-K. Shieh, A. E. Gorbalenya, E. V. Koonin, N. La Monica, J. Tuler, A. Bagdzhadzhyan, and M. M. C. Lai, *Virology* **180**, 567 (1991).

⁴ J. Herold, T. Raabe, B. Schelle-Prinz, and S. G. Siddell, *Virology* **195**, 680 (1993).

⁵ P. J. Bonilla, A. E. Gorbalenya, and S. R. Weiss, *Virology* **198**, 736 (1994).

⁶ J.-F. Eleouet, D. Rasschaert, P. Lambert, L. Levy, P. Vende, and H. Laude, *Virology* **206**, 817 (1995).

⁷ M. C. Schaad, S. A. Stohlman, J. Egbert, K. Lum, K. Fu, T. Wei, Jr., and R. S. Baric, *Virology* **177**, 634 (1990).

⁸ R. S. Baric, K. Fu, M. C. Schaad, and S. A. Stohlman, *Virology* **177**, 646 (1990).

⁹ K. Fu and R. S. Baric, *J. Virol.* **68**, 7458 (1994).

¹⁰ M. C. Schaad and R. S. Baric, *J. Virol.* **68**, 8169 (1994).

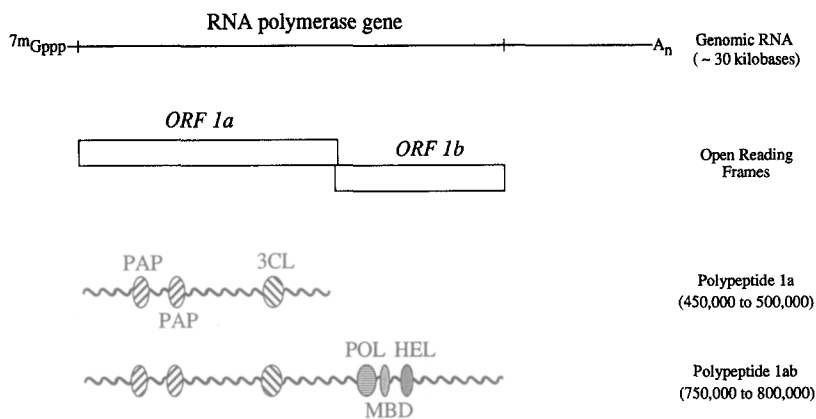

FIG. 1. Organization and expression of the coronavirus RNA polymerase gene. The genomic RNA is indicated as a solid line and the positions of ORFs 1a and 1b are shown. The location of putative functional domains in the primary products of the RNA polymerase gene is indicated. PAP, papain-like proteinase; 3CL, 3C-like proteinase; POL, polymerase module; MBD, metal-binding domain; HEL, helicase (NTP-binding) domain.

Computer-assisted analyses of coronavirus ORF 1a sequences have identified motifs characteristic of both papain-like cysteine proteinases and proteinases with homology to the 3C proteinase of picornaviruses.

Biochemical analysis of the expression and function of coronavirus RNA polymerase gene products has been obtained both *in vitro* and *in vivo*. These studies have focused on the characterization of proteinase activities rather than the enzymatic functions involved in RNA synthesis. The characterization of the coronavirus 3C-like proteinase has been facilitated by the bacterial expression of a biologically active molecule.¹¹

Structural Analysis

The RNA polymerase genes of four coronaviruses have been sequenced to date: avian infectious bronchitis virus (IBV),¹ murine hepatitis virus (MHV),^{2,3,5} human coronavirus 229E (HCV 229E),⁴ and porcine transmissible gastroenteritis virus (TGEV).⁶ The sequences of the predicted gene products have been compared to those of other viral and cellular proteins, and a number of putative functional domains have been recognized. These domains and their approximate positions are illustrated schematically in Fig. 1. Essentially, the same pattern is seen for all coronaviruses, although only a single papain-like proteinase domain has been identified in the IBV

¹¹ J. Ziebuhr, J. Herold, and S. G. Siddell, *J. Virol.* **69**, 4331 (1995).

RNA polymerase gene product(s). A number of conserved domains that are restricted to the RNA polymerase gene product(s) of coronaviruses or toroviruses (the second genus of the *Coronaviridae*) or cannot, as yet, be associated with specific enzymatic functions are not illustrated in Fig. 1.

Papain-like Proteinases. The papain-like proteinases belong to a group of cysteine proteinases that have a catalytic diad composed of Cys and His residues.¹² The coronavirus papain-like proteinase motifs, encoded in ORF 1a, also feature a typical aromatic residue (Tyr or Trp) adjacent to the putative catalytic cysteine.

3C-like Proteinases. The 3C-like proteinases are a class of viral proteinases structurally related to the chymotrypsin-like serine proteinases. However, the catalytic triad is composed of His, Asp, and Cys.¹² The coronavirus 3C-like proteinase motifs, encoded in ORF 1a, also display a number of further characteristics. First, the position of the putative catalytic Asp residue (if present at all) is apparently not conserved. Second, a conserved Gly residue in the putative substrate-binding domain is replaced by Tyr. The predicted cleavage sites of the coronavirus 3C-like proteinases (based mainly on the known cleavage sites of picornavirus 3C proteinases) are predominantly found in the carboxy-terminal halves of the ORF 1a and ORF 1ab translation products.

Polymerase Module. The coronavirus polymerase module, encoded in ORF 1b, is composed of eight distinct regions, as has been recognized for a wide variety of putative RNA polymerases.¹³ The alteration of the RNA polymerase "core" sequence from Gly-Asp-Asp to Ser-Asp-Asp is characteristic of the coronavirus motif.

Metal-Binding Domain. The second motif encoded in the coronavirus ORF 1b region is related to the "finger" domain characteristic of numerous DNA- and RNA-binding proteins.¹⁴

Helicase. The third motif encoded in ORF 1b is the purine NTP-binding sequence pattern that is thought to be a feature of duplex unwinding, i.e., helicase, activities.¹⁵

Genetic Analysis

A collection of MHV RNA(-) ts mutants has been characterized by complementation, recombination, and sequence analysis.⁷⁻¹⁰ These studies have revealed five complementation groups, two of which are positioned

¹² W. G. Dougherty and B. L. Semler, *Microbiol. Rev.* **57**, 781 (1993).

¹³ E. V. Koonin, *J. Gen. Virol.* **72**, 2197 (1991).

¹⁴ A. E. Gorbalenya, E. V. Koonin, A. P. Donchenko, and V. M. Blinov, *Nucleic Acids Res.* **17**, 4847 (1989).

¹⁵ A. E. Gorbalenya and E. V. Koonin, *Nucleic Acids Res.* **17**, 8413 (1989).

in the region of ORF 1a (A and B), two of which are positioned in the region of ORF 1b (D and E), and one which spans the ORF 1a/1b junction (C). Two phenotypically distinct subgroups (C1 and C2) can be distinguished within the group C mutants, which may suggest that the complementation group C gene product is multifunctional. Sequence analysis of group C and group E mutants, and their revertants, has identified mutations that are tightly linked to the ts phenotype. A much larger number of mutants has to be sequenced before the size and location of the functional domains represented by these complementation groups can be accurately determined. Eventually, it should be possible to compare the location of cistrons on the complementation map with the posttranslational processing map of the coronavirus RNA polymerase gene product(s).

Biochemical Analysis

The biochemical analysis of coronavirus RNA polymerase gene expression and function has been hampered by a number of difficulties. These include the large size of the RNA polymerase gene and the relatively low level of RNA polymerase gene products in the virus-infected cell. For these reasons, the use of *in vitro* systems and the analysis of bacterial-expressed gene products have, to date, predominated.

Ribosomal Frameshifting. The region of coronavirus RNA that encompasses the overlap of ORFs 1a and 1b has been shown to mediate a high frequency (20–30%) of (–1) ribosomal frameshifting *in vitro* and, in the case of IBV and MHV, *in vivo*.^{2–4,6} This region contains two elements that are involved in this process: the so-called “slippery” sequence (UUU-AAAC) and an H-type RNA pseudoknot. The H-type pseudoknot is a tertiary structure that involves a stem–loop region where bases within the loop are able to pair with bases outside the hairpin. Two models have been proposed for the coronavirus pseudoknot, involving two (IBV and MHV^{2,3,16–19}) or three (HCV 229E and TGEV^{4,6,20}) stem structures. In either case, the models propose that these stem regions form a quasi-continuous double helix.

Co- or Posttranslational Processing. The first biochemical evidence for the co- or posttranslational processing of the coronavirus RNA polymerase gene product(s) came from the *in vitro* translation of MHV genomic RNA.²¹

¹⁶ I. Brierley, M. E. G. Bournsnel, M. M. Binns, B. Bilimoria, V. C. Blok, T. D. K. Brown, and S. C. Inglis, *EMBO J.* **6**, 3779 (1987).

¹⁷ I. Brierley, P. Digard, and S. C. Inglis, *Cell (Cambridge, Mass.)* **57**, 537 (1989).

¹⁸ I. Brierley, N. J. Rolley, A. J. Jenner, and S. C. Inglis, *J. Mol. Biol.* **220**, 889 (1991).

¹⁹ I. Brierley, A. J. Jenner, and S. C. Inglis, *J. Mol. Biol.* **227**, 463 (1992).

²⁰ J. Herold and S. G. Siddell, *Nucleic Acids Res.* **21**, 5838 (1993).

²¹ M. R. Denison and S. Perlman, *J. Virol.* **60**, 12 (1986).

Subsequently, these data were confirmed by the *in vitro* translation of synthetic mRNA.^{22,23} Using the same approach, the position of a proteinase activity, responsible for the cleavage of an amino-terminal polypeptide (p28) from the MHV ORF 1a translation product, has been mapped to the first papain-like proteinase domain of the ORF 1a polyprotein. Site-specific mutation of putative catalytic residues in this domain confirmed that two amino acids, Cys-1137 and His-1288, are essential for this activity.²⁴ The p28 cleavage site has been positioned at the dipeptide Gly-247/Val-248 in the MHV ORF 1a gene product, and the role of the amino acids flanking the cleavage site has been investigated by mutational analysis.²⁵

The 3C-like proteinase domain of HCV 229E has been expressed in bacteria and has proteolytic activity *in trans*, using *in vitro*-translated polypeptides encoded within ORFs 1a and 1b of the RNA polymerase gene as substrates. Furthermore, the HCV 229E 3C-like proteinase domain can be expressed as part of a β -galactosidase fusion protein with autoproteolytic activity. Sequence analysis of the cleavage reaction products has identified the sequence Leu, Gln/Ala, Gly, Leu (which corresponds to the predicted aminoterminal of the 3C-like proteinase domain) as an authentic cleavage site. This cleavage site is consistent with the features regarded as typical for the substrates of 3C-like proteinases.¹¹

Bacterial-expressed fusion proteins have, by and large, also been the basis for generating specific antisera which identify coronavirus RNA polymerase gene products synthesized in the virus-infected cell or in cell-free translation reactions programmed with genomic RNA. In this respect, the reader is referred to a review on coronavirus polyprotein processing.²⁶

RNA Polymerase Gene Function. There have been occasional reports of RNA-dependent RNA polymerase activity in subcellular fractions of coronavirus-infected cells or in coronavirus-infected cells permeabilized with lysolecithin.²⁷⁻³¹ However, at the present time, there is no evidence

²² L. H. Soe, C.-K. Shieh, S. C. Baker, M.-F. Chang, and M. M. C. Lai, *J. Virol.* **61**, 3968 (1987).

²³ S. C. Baker, C.-K. Shieh, L. H. Soe, M.-F. Chang, D. M. Vannier, and M. M. C. Lai, *J. Virol.* **63**, 3693 (1989).

²⁴ S. C. Baker, K. Yokomori, S. Dong, R. Carlisle, A. E. Gorbalenya, E. V. Koonin, and M. M. C. Lai, *J. Virol.* **67**, 6056 (1993).

²⁵ S. Dong and S. C. Baker, *Virology* **204**, 541 (1994).

²⁶ S. R. Weiss, S. A. Hughes, P. J. Bonilla, J. D. Turner, J. L. Leibowitz, and M. R. Denison, *Arch. Virol., Suppl.* **9**, 349 (1994).

²⁷ P. R. Brayton, M. M. C. Lai, C. D. Patton, and S. A. Stohlman, *J. Virol.* **42**, 847 (1982).

²⁸ D. E. Dennis and D. A. Brian, *J. Virol.* **42**, 153 (1982).

²⁹ B. W. J. Mahy, S. Siddell, H. Wege, and V. ter Meulen, *J. Gen. Virol.* **64**, 103 (1983).

³⁰ S. R. Compton, D. B. Rogers, K. V. Holmes, D. Fertsch, J. Remenick, and J. J. McGowan, *J. Virol.* **61**, 1814 (1987).

³¹ J. L. Leibowitz and J. R. de Vries, *Virology* **166**, 66 (1988).

that any of these systems are capable of initiating the synthesis of new strands of RNA. Their application to the study of coronavirus RNA polymerase gene function, therefore, seems limited.

Ribosomal Frameshifting and Coronavirus RNA Polymerase Gene Expression

Background

In vitro transcription–translation experiments with reporter genes, into which viral frameshifting-mediating elements have been cloned, have been successfully used to describe both the sequence and the structural elements necessary for programmed (–1) ribosomal frameshifting in coronavirus-infected cells.^{18,19} Additionally, site-directed mutagenesis provides a means to investigate the functional roles of predicted base-paired regions in the frameshifting element. Predicted stem structures can be destabilized and, as a control, restabilized with an altered primary sequence. A method that combines polymerase chain reaction (PCR) mutagenesis and *in vivo* recombination is particularly useful.³² Briefly, two PCR products are synthesized carrying compatible ends of approximately 15–20 nucleotides and the mutation of interest incorporated within one or both of the PCR primers. The reaction products are combined and transformed into competent *Escherichia coli* cells. After recombination *in vivo*, plasmid DNA is isolated and analyzed by restriction enzymes and sequencing. This section describes methods that can be applied to examine the *cis*-acting elements mediating programmed (–1) ribosomal frameshifting during translation of the RNA polymerase gene of HCV 229E.²⁰

Materials

Oligonucleotides:

- I. 5' TAGTCGAGCGGCACTACT**CG**CCCCGGACTCGTTT-AAATAACT 3'
- II.a 5' GCCGCTCGACTAGAGCCCTGTAATGGTACAGAC-ATAGA 3'
- IIIb. 5' GCCGCTCGACTACT**CG**CCTGTAATGGTACAGAC-ATAGA 3'
- III. 5' TCTTCAGCATCTTTTACTTTT 3'
- IV. 5' GAAAGTAAAAGATGCTGAAGA 3'

Nucleotides differing from the HCV 229E genomic sequence are shown in bold letters.

³² D. H. Jones, *PCR Methods Appl* 3, 141 (1994).

Plasmid DNA: pFS 1 (1 $\mu\text{g}/\mu\text{l}$)²⁰

Restriction enzymes (New England Biolabs, Schwalbach/Ts., Germany)

PCR reagents: *Taq* DNA polymerase (5 U/ μl ; Cetus, Norwalk, CT), 10 \times PCR buffer (500 mM KCl; 100 mM Tris-Cl, pH 8.3; 20 mM MgCl₂; 2 mM of dATP, dCTP, dGTP, and TTP)

Competent *E. coli* cells: e.g., strain JM109 or TG1, prepared as described by Hanahan³³ or commercially available cells (e.g., strain DH5 α , Life Technologies, Eggenstein, Germany; Gaithersburg, MD)

Growth medium: LB medium (10 g bacto-tryptone, 2 g casamino acids, 5 g bacto yeast extract, 10 g NaCl, 1.5 ml 1 M sodium hydroxide in 1 liter of H₂O)

Small-scale plasmid DNA purification system: e.g., Wizard minipreps DNA purification systems (Promega Corp., Madison, WI)

DNA sequencing system: e.g., T7 sequencing kit (Pharmacia Biotech, Uppsala, Sweden); [³⁵S]dATP α S (Amersham Buchler, Braunschweig, Germany)

In vitro transcription reagents: *SP6* RNA polymerase (50 U/ μl ; Pharmacia Biotech, Uppsala, Sweden), 10 \times transcription buffer (400 mM Tris-Cl, pH 7.9; 60 mM MgCl₂; 20 mM spermidine; 100 mM dithiothreitol (DTT); 5 mM of ATP, CTP, and UTP; 500 μM GTP), RNasin (50 U/ μl ; Pharmacia Biotech), ^{m7}G(5')ppp(5')GTP (New England Biolabs), RQ1 RNase-free DNase (Promega Corp.)

In vitro translation reagents: rabbit reticulocyte lysate, nuclease-treated (Promega Corp.), L-[³⁵S]methionine (Amersham Buchler), reagents for agarose gel and polyacrylamide gel electrophoresis,^{34,35} and a ¹⁴C molecular weight marker (Amersham Buchler)

The Construct pFS1

Procedure. The plasmid pSP65-GUS, which has been used to characterize the frameshifting mediating elements of potato leafroll virus, a luteovirus, contains the β -glucuronidase gene (GUS-gene) of *E. coli* under control of the *SP6* RNA polymerase promoter.³⁶ The small *EcoRV* fragment

³³ D. Hanahan, in "DNA Cloning: A Practical Approach" (D. M. Glover, ed.), Vol. 1, p. 109. IRL Press, Oxford, 1985.

³⁴ J. Sambrook, E. F. Fritsch, and T. Maniatis, "Molecular Cloning: A Laboratory Manual," 2nd Ed. Cold Spring Harbor Lab. Press, Cold Spring Harbor, NY, 1989.

³⁵ U. K. Laemmli, *Nature (London)* **227**, 680 (1970).

³⁶ D. Prüfer, E. Tacke, J. Schmitz, B. Kull, A. Kaufmann, and W. Rhode, *EMBO J.* **11**, 1111 (1992).

(230 bp) of pSP65-GUS was exchanged for a 1264-bp, *E. coli*-DNA polymerase (Klenow fragment)-treated, *Nde*I-*Hpa*I cDNA fragment derived from the cDNA clone T16D8,⁴ resulting in pFS 1. The cDNA fragment, representing the nucleotides 12,293–13,557 of the genomic RNA of HCV 229E, contains the ORF 1a/ORF 1b overlapping region and encompasses the components that are predicted to be necessary for a high level of ribosomal frameshifting. These include the “slippery” sequence UUUAAAC at position 12,514–12,520 of the viral genomic RNA, as well as a downstream, tripartite pseudoknot structure (Fig. 2). The cloning procedure results in the formation of two open reading frames: NGUS-ORF 1a and ORF 1b-GUSC. After linearization with *Bst*EII and *in vitro* transcription, synthetic mRNA is translated in a rabbit reticulocyte lysate in the presence of L-[³⁵S]methionine and is analyzed by SDS-polyacrylamide gel electrophoresis. In the case of translation termination at the NGUS-ORF 1a stop codon, a translation product with a relative molecular mass of 30,000 is expected to be synthesized. If (–1) ribosomal frameshifting takes place at the predicted slippery sequence during translation, a 66,000 molecular mass, NGUS-ORF 1a/ORF 1b-GUSC fusion protein should be synthesized.²⁰

In Vivo Recombination PCR for Site-Directed Mutagenesis

Procedure. pFS 1 is digested with *Eco*RI or *Hind*III. After linearization, the DNA concentration is adjusted to 1 ng/ μ l. Overlapping DNA fragments are then amplified by PCR from 1 ng of pFS 1/*Hind*III or pFS 1/*Eco*RI in a volume of 100 μ l in 1 \times PCR buffer containing 2.5 *Utaq* DNA polymerase and either 100 ng each of oligonucleotides I and IV or of oligonucleo-

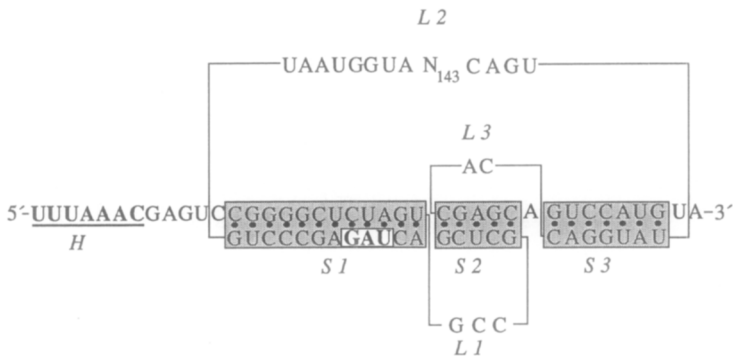

FIG. 2. The frameshifting elements in the RNA polymerase mRNA of HCV 229E. *H*, slippery sequence; *S1*, *S2*, *S3*, stems 1, 2, and 3; *L1*, *L2*, *L3*, loops 1, 2, and 3. The ORF 1a termination codon is boxed. These elements are located at the junction of the ORFs 1a and 1b in the RNA polymerase mRNA.

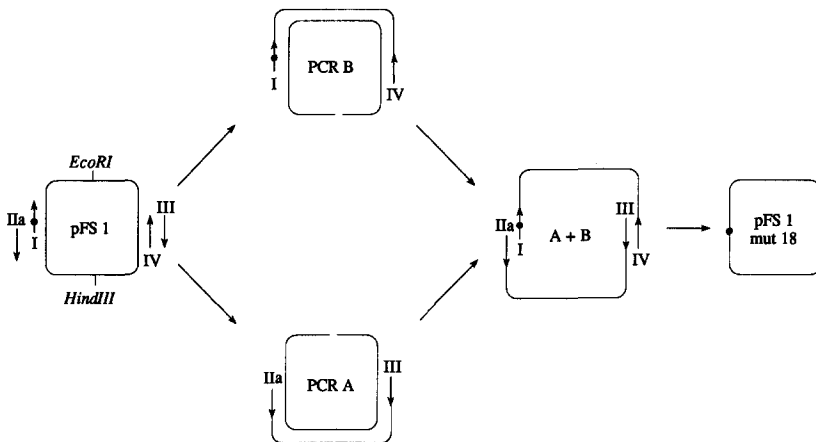

FIG. 3. *In vivo* recombination PCR for site-directed mutagenesis. The cleavage sites of the restriction enzymes *EcoRI* and *HindIII*, as well as the binding sites of the oligonucleotides used as PCR primers (I, IIa, III, and IV), are shown schematically. After restriction enzyme digestion, the DNA serves as a template for the amplification of the plasmid halves (PCR A and PCR B). Aliquots of the PCR reaction products are combined without further purification and are transformed into competent bacteria. *In vivo* recombination leads to a molecule which carries the desired mutation (pFS 1 mut 18).

tides IIa and III, respectively (Fig. 3). The amplification is performed after 4 min of denaturation at 94° in 30 cycles of denaturation at 94° (30 sec), annealing at 50° (30 sec), and extension at 72° (2 min). After a final extension step of 10 min at 72°, the reaction products are analyzed by agarose gel electrophoresis. Aliquots (5 μ l) of each reaction are combined and used to transform competent *E. coli* cells. The resulting colonies are isolated and grown in 2 ml LB medium containing ampicillin (100 μ g/ml). Plasmid DNA is isolated, digested with *EcoRI*/*HindIII*, and analyzed by agarose gel electrophoresis. Plasmid DNAs with the same restriction enzyme pattern as pFS 1 are analyzed by DNA sequencing, and the desired plasmid pFS 1 mut 18 is identified. The complementary nucleotide substitutions, which restabilize the stem structure, are introduced into pFS 1 by replacing oligonucleotide IIa with oligonucleotide IIb, resulting in the plasmid pFS 1 mut 17.

In Vitro Transcription/Translation

Procedure. Five micrograms of plasmid DNA is linearized with *BstEII* and is purified by phenol/chloroform extraction.³⁴ The DNA is transcribed according to the method of Melton *et al.*³⁷ Briefly, the DNA is incubated

³⁷ D. A. Melton, P. A. Krieg, M. R. Rebagliati, T. Maniatis, K. Zinn, and M. R. Green, *Nucleic Acids Res.* **12**, 7035 (1984).

with SP6 RNA polymerase (50 U) in 1× transcription buffer in the presence of 500 μM $^{\text{m}}\text{G}(5')\text{ppp}(5')\text{GTP}$ and RNasin (50 U). After a 20-min incubation at 40°, 500 μM GTP is added and the reaction is incubated at 40° for a further 30 min. DNA is then hydrolyzed by RQ1 RNase-free DNase for 20 min at 37° and the RNA is purified by phenol/chloroform extraction and ethanol precipitation. The RNA is dissolved in RNase-free H₂O and is adjusted to 1 $\mu\text{g}/\mu\text{l}$.

One microgram of synthetic RNA is translated in 20 μl rabbit reticulocyte lysate containing an additional 50 μM of each amino acid, except methionine, and 20 μCi L-[³⁵S]methionine for 60 min at 30°. Aliquots (2 μl) of the translation reaction are combined with 13 μl of protein-loading buffer heated at 100° for 5 min and are analyzed by electrophoresis in a 15% SDS–polyacrylamide gel. After electrophoresis, the gel is fixed and dried, and the translation products are quantified with PhosphorImager system (Molecular Dynamics, Sunnyvale, CA). A typical experiment is shown in Fig. 4A. The percentage of ribosomes that shift into the (−1) reading frame during translation can be easily calculated on the basis of the radioactivity incorporated into the “transframe” and “terminated” proteins, and the number of methionines is encoded in the NGUS-ORF 1a and ORF 1b-GUSC ORFs. In the experiment shown, the “wild-type” level of frameshifting was approximately 30%. The values for the mutated RNAs are given relative to this value (Fig. 4B).

Summary. The combination of a PCR-based, site-directed mutagenesis system, which allows the introduction of nucleotide substitutions into the plasmid DNA without any ligation steps, and the *in vitro* transcription and translation system allows for the rapid investigation of the sequence and structural elements that are needed to direct programmed ribosomal frameshifting *in vitro*.

Expression, Purification, and Characterization of Proteinases Encoded in the Coronavirus RNA Polymerase Gene

The Papain-like Proteinase(s)

Background

In vitro transcription/translation experiments, in combination with site-specific mutagenesis, have been the main experimental approach in studying coronavirus papain-like proteinases.

Materials. The materials needed for *in vitro* transcription and translation have been described previously. SP6 RNA polymerase has been replaced by T7 RNA polymerase (Pharmacia Biotech, Uppsala, Sweden) and 1 mg/

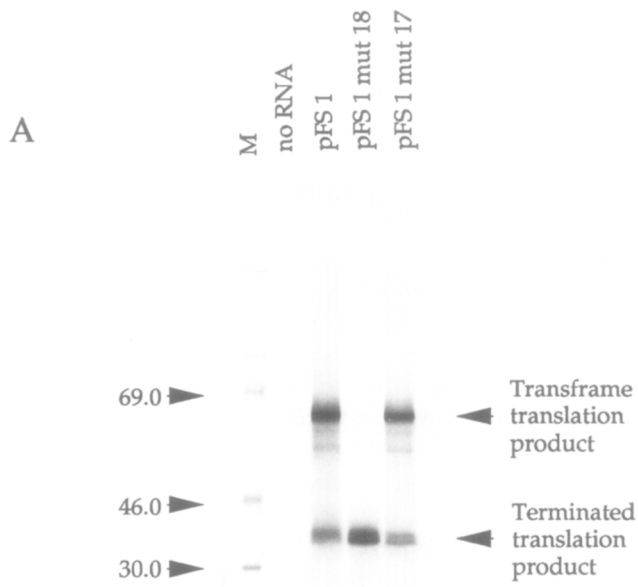

B

Construct	stem 1	FS
pFS 1	CGGGGCUCUAGU GUCCCGAGAUCA	1
pFS 1 mut 18	CGGGCGAGUAGU GUCC <u>CG</u> AGAUCA	<0.05
pFS 1 mut 17	CGGG <u>CG</u> AGUAGU GUCC <u>CG</u> CAUCA	1

FIG. 4. Programmed (-1) ribosomal frameshifting *in vitro*. (A) *In vitro* translation of pFS 1 mRNA and pFS 1-derived mRNAs. The L-[³⁵S]methionine-labeled proteins were analyzed on a 10% SDS-polyacrylamide gel. The terminated translation product (NGUS-ORF 1a) and the transframe translation product (NGUS-ORF1a/ORF 1b-GUSC) are marked by arrows. M, molecular weight marker. (B) Sequence and relative frameshifting frequency of pFS 1 mRNA and pFS 1-derived mRNAs. Mutated nucleotides are boxed. The ribosomal frameshifting activity of mutated mRNAs is given relative to pFS 1 mRNA.

ml BSA and 50 mM NaCl were added to the 10× transcription buffer. The isolation of poly(A) RNA from HCV 229E-infected cells and a reverse transcription (RT)-PCR method are described below.

Oligonucleotides:

V. 5' GATTACCAGAAGGTATAGC 3'

VI. 5' CCTACTCGAGGTTCCGTCTC 3'

Plasmid DNA; pBluescript II SK+ (Stratagene, Heidelberg, Germany)

Restriction enzymes (New England Biolabs)

Leupeptin (Sigma, Deisenhofen, Germany)

The Construct pPap

Procedure. Using the oligonucleotides V and VI as primers, a cDNA representing nucleotides 224–4793 of the HCV 229E genomic RNA has been amplified by RT-PCR from poly(A) RNA isolated from HCV 229E-infected cells. The amplification product is digested with the restriction enzymes *XhoI* and *XbaI* and is ligated with *XhoI/XbaI* pBluescript II SK+ DNA. After transformation of the ligation reaction into competent *E. coli* cells, DNA is prepared and analyzed by restriction enzymes. The nucleotide sequence of the cloned cDNA is determined and several PCR-derived nucleotide misincorporations are identified. In this context, the change of a lysine codon AAA (Lys-1318) to a termination codon TAA is relevant.

Autoproteolytic Activity in Vitro

Procedure. Using T7 RNA polymerase, a synthetic mRNA was transcribed from *XbaI*-linearized pPap DNA *in vitro* as described earlier. The 25 nucleotides at the 5' end of this RNA are vector derived, the rest represent the viral genomic RNA from position 224 to 4793. Because of the termination codon introduced by PCR, this mRNA has the potential to encode a protein with a relative molecular mass of 146,000. The synthetic mRNA is translated *in vitro* in a rabbit reticulocyte lysate in the presence of L-[³⁵S]methionine and the proteinase inhibitors leupeptin (2 mM) or ZnCl₂ (2 mM) (added after 20 min of translation). After 20, 40, and 80 min, 2 μl of the translation reaction is removed and the reaction is stopped by adding 13 μl of protein sample buffer and heating at 100° for 5 min. The proteins are analyzed by electrophoresis in a 7.5% SDS–polyacrylamide gel (Fig. 5). The addition of leupeptin to the translation reaction has no effect on the conversion of the 146,000 precursor protein to a 136,000 form. However, adding ZnCl₂, a potent inhibitor of cysteine proteinases,³⁸ completely blocks the processing.

³⁸ E. Z. Baum, G. A. Bebernitz, O. Palant, T. Mueller, and S. J. Plotch, *Virology* **185**, 140 (1991).

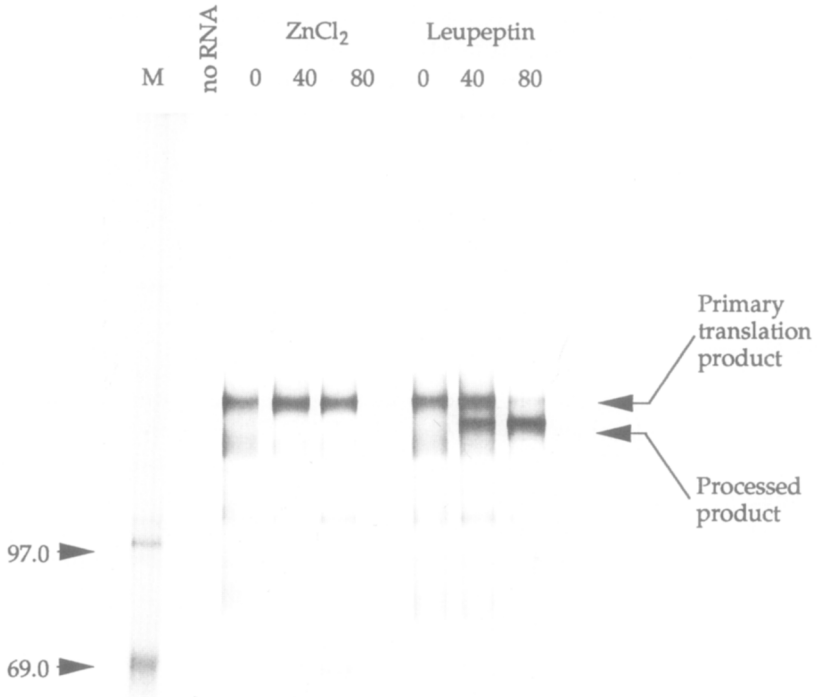

FIG. 5. Effect of proteinase inhibitors on the processing of the primary translation product of pPap-derived mRNA. RNA ($2 \mu\text{g}$) was translated in a rabbit reticulocyte lysate in the presence of L- $[^{35}\text{S}]$ methionine and either 2 mM leupeptin or 2 mM ZnCl_2 (added after 20 min of translation). Aliquots ($2 \mu\text{l}$) of the reaction mixture were removed after 20, 40, and 80 min and were analyzed on a 7.5% SDS-polyacrylamide gel. The primary translation product (146,000) and the processed product (136,000) are marked with arrows. M, molecular weight marker.

The 3C-like Proteinase

Background

The 3C-like proteinase domain of HCV 229E is predicted to be located between amino acids Ala-2966 and Gln-3267 of the RNA polymerase gene product(s).⁴ To characterize this proteolytic activity, the coding sequence of the proteinase can be amplified by RT-PCR from poly(A)-selected RNA of HCV 229E-infected MRC-5 cells and cloned into the bacterial expression plasmid pMal-c2. Subsequently, the HCV 229E 3C-like proteinase is ex-

pressed and purified from bacteria carrying the expression plasmid pMalc2-3CL. Finally, the biological activity of the bacterial-expressed protein can be assayed by the *trans* cleavage of an *in vitro*-synthesized polypeptide substrate.

Materials. HCV 229E is propagated in monolayers of MRC-5 cells (European Collection of Animal Cell Cultures, Salisbury, UK) grown in minimal essential medium with Earle's salts, 25 mM HEPES, Glutamax-I (Life Technologies, Eggenstein, Germany), and 10% fetal bovine serum at 33°. Virus stocks were concentrated by NaCl/polyethylene glycol (PEG) precipitation.³⁹

Oligonucleotides:

VII. 5' GCTGGTTTGC GCAA AATGGCA 3'

VIII. 5' TTATTGCAGGTTAACACCAAACAT 3'

IX. 5' TAATACGACTCACTATAGGGCCTTGGTTTTGAGCGTAACTCGTCA 3'

X. 5' TCACATTGCATAAGCATCACTAACAT 3'

Enzymes and buffers: Superscript reverse transcriptase (Life Technologies, Eggenstein, Germany), 5× RT buffer (250 mM Tris-Cl, pH 8.3; 375 mM KCl; 15 mM MgCl₂; 50 mM DTT; 2.5 mM of dATP, dCTP, dGTP, and TTP), L buffer (10 mM Tris-Cl, pH 7.5; 140 mM NaCl; 5 mM KCl; 1% NP40), 2× binding buffer (20 mM Tris-Cl, pH 7.5; 1 M LiCl; 2 mM EDTA; 0.5% SDS), washing buffer (10 mM Tris-Cl, pH 7.5; 150 mM LiCl; 1 mM EDTA), buffer C (20 mM Tris-Cl, pH 7.5; 200 mM NaCl; 1 mM EDTA; 1 mM DTT), buffer CM (20 mM Tris-Cl, pH 7.5; 200 mM NaCl; 1 mM EDTA; 1 mM DTT; 10 mM maltose), Dulbecco's phosphate-buffered saline, PBS (Life Technologies)

Plasmid DNA: pMal-c2 DNA (New England Biolabs)

Restriction enzymes (New England Biolabs)

Competent *E. coli* cells, strain TB-1, prepared as described by Hanahan³³

Growth medium: S medium (25 g bacto tryptone; 15 g bacto yeast extract; 5 g NaCl; 0.1 g ampicillin in 1 liter of H₂O)

Alkaline phosphatase from calf intestine (Boehringer Mannheim, Mannheim, Germany)

Taq DNA polymerase (Cetus, Norwalk, CT)

T4 DNA polymerase (Pharmacia Biotech)

T4 DNA ligase (Life Technologies)

Polynucleotide kinase (Pharmacia Biotech)

³⁹ H. Wege, H. Wege, K. Nagashima, and V. ter Meulen, *J. Gen. Virol.* **42**, 37 (1979).

IPTG (Life Technologies)
Amylose resin (New England Biolabs)
Factor Xa (New England Biolabs)
Cycloheximide (Sigma)
RNase A (Boehringer Mannheim)

Poly(A) RNA Isolation and RT-PCR

Procedure. Poly(A) RNA from HCV 229E-infected MRC-5 cells was prepared with DYNABEADS oligo(dT)₂₅ (Dynal, Hamburg, Germany). Briefly, MRC-5 cells (3×10^5) are infected at an multiplicity of infection (MOI) of 10 plaque-forming units (pfu)/cell with HCV 229E. After 1 hr of virus adsorption at 33°, the medium is removed and replaced by fresh medium. At 14 hr pi, the medium is removed, and the cells are washed with ice-cold PBS and lysed with 100 μ l of L buffer for 1 min at 4°. Subsequently, the cell lysate is pelleted, and the supernatant fraction is mixed with 0.25 mg of washed DYNABEADS oligo(dT)₂₅ in 100 μ l 2 \times binding buffer. After 5 min of incubation, the reaction tube is placed in a magnetic particle concentrator (MPC-E-1, Dynal) for 30 sec. The supernatant is removed and the bound poly(A) RNA is washed three times with 200 μ l washing buffer before the RNA is eluted from the magnetic oligo(dT) beads with 2 mM EDTA at 65° for 2 min. The tube is again placed in the magnetic particle concentrator, and the supernatant is collected.

An aliquot (approximately 0.5 μ g of RNA) of the purified poly(A) RNA is reverse transcribed in 1 \times RT buffer using 100 ng of the lower PCR primer of the subsequent PCR reaction (primer VIII) and 200 U Superscript reverse transcriptase. After 30 min of incubation at 42°, the cDNA is amplified by a standard PCR using oligonucleotides VII and VIII (100 ng each) and 2 μ l of the reverse transcription mixture as described previously.

The Construct pMalc2-3CL

Procedure. Approximately 1 μ g of purified PCR product is treated with T4 DNA polymerase to create blunt DNA ends.³⁴ The DNA is purified and subsequently 5'-phosphorylated using 1 mM ATP and polynucleotide kinase.³⁴ In parallel, the pMal-c2 plasmid DNA is digested with *Xmn*I and 5'-dephosphorylated with alkaline phosphatase from calf intestine.³⁴ The two DNA fragments are ligated using T4-DNA ligase and are used to transform competent *E. coli* TB1 cells. The sequence of the resultant plasmid, pMalc2-3CL, is determined using standard procedures.³⁴

Expression and Purification

Procedure. Plasmid pMalc2-3CL encodes a fusion protein containing the maltose-binding protein of *E. coli* and the 3C-like proteinase domain of HCV 229E.^{4,11} For expression of the recombinant protein, a single colony of *E. coli* TB1 [pMalc2-3CL] cells is used to inoculate 5 ml of S medium. The bacterial culture is grown overnight at 37°. The next day, 1 ml of the overnight culture is used to inoculate 1 liter of S medium. The bacterial culture is shaken vigorously until an OD₆₀₀ of 0.8 is reached. At this optical density the incubation temperature is set to 25°. The expression of the fusion protein is induced with 0.5 mM isopropyl β -D-thiogalactopyranoside (IPTG). After 4 hr of induction at 25°, the bacteria are harvested by centrifugation at 4000 g for 20 min. For resuspension of the pellet, 10 ml of buffer C/g cells is used. The suspension is frozen in dry ice/ethanol and thawed in cold water. Subsequently, the material is sonified at microtip setting 6, output 50%, for 2 min at 4° (Sonifier Model 450, Branson, Soest, The Netherlands). After an additional centrifugation step at 9000 g for 30 min at 4°, the supernatant is diluted 1:5 in buffer C and loaded onto a 2.5 \times 10-cm column packed with 6 ml of amylose resin and equilibrated with 60 ml of buffer C. After washing the column with 80 ml of buffer C, the recombinant protein is eluted with buffer CM. Fractions of 1 ml each are collected, and aliquots of 10 μ l are analyzed on 12.5% SDS–polyacrylamide gels. The fusion protein elutes within the fractions 4–8. Fractions containing high concentrations of recombinant protein are pooled and subjected to Factor Xa cleavage. For this purpose, the protein concentration of the sample is determined and Factor Xa is mixed at a molar ratio of 1:200 with the recombinant protein and incubated for 16 hr at 4°. The cleavage reaction and the purity of the fusion protein preparation are assessed by analysis of reaction aliquots on SDS–polyacrylamide gels.

Preparation of Proteinase Substrate and trans Cleavage Assay

Procedure. Poly(A) RNA from HCV 229E-infected cells is isolated, and reverse transcription using primer X is carried out as described previously. Subsequently, a cDNA fragment containing nucleotides 14,599–16,069 of the HCV 229E polymerase gene was amplified by a PCR reaction using primers IX and X (100 ng each) as described earlier. Primer IX contains the bacteriophage T7 promoter, which allows the subsequent *in vitro* transcription of the purified PCR product using T7 RNA polymerase without subcloning. The capped RNA is synthesized and used to program an *in vitro* translation reaction. The translation reaction is done for 40 min at 30° and is terminated by the addition of cycloheximide, RNase, and L-

[32 S]methionine at final concentrations of 1 $\mu\text{g}/\mu\text{l}$, 10 $\text{ng}/\mu\text{l}$, and 0.5 mM , respectively.

For the *trans* cleavage assay, 1 μl of the translation mixture is incubated with (i) 10 μl of buffer CM containing 2.5 $\text{ng}/\mu\text{l}$ Factor Xa, (ii) 10 μl of buffer CM containing 0.5 $\mu\text{g}/\mu\text{l}$ uncleaved MBP/3C-like proteinase fusion protein, or (iii) 10 μl of buffer CM containing 0.5 $\mu\text{g}/\mu\text{l}$ Factor Xa-cleaved MBP/3C-like proteinase fusion protein and 2.5 $\text{ng}/\mu\text{l}$ Factor Xa. The incubation is for 60 min at 30°. Subsequently, the translation and cleavage products are analyzed on 15% SDS–polyacrylamide gels (Fig. 6).

Summary

In the procedures just described, a putative 3C-like proteinase substrate, representing amino acids 4818 to 5259 of the HCV 229E ORF 1b gene product and containing one predicted cleavage site (dipeptide Gln-4995/

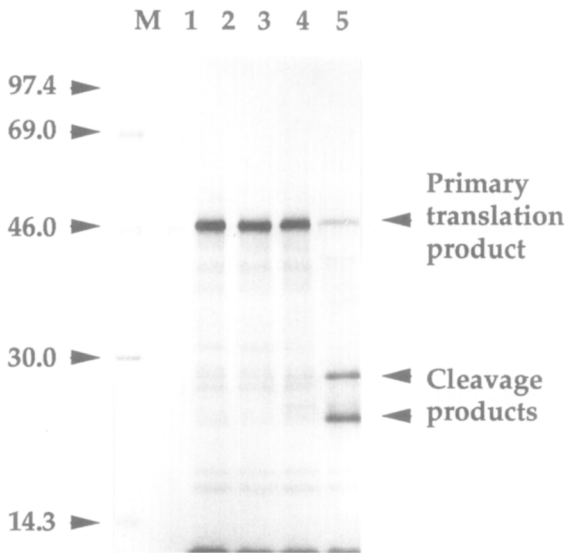

FIG. 6. The *trans* cleavage activity of a bacterial-expressed HCV 229E 3C-like proteinase. A polypeptide encoded in the HCV 229E ORF 1b (amino acids 4818 to 5259), containing the predicted cleavage site Gln-4995/Ala-4996, was translated *in vitro* from a synthetic mRNA and incubated with the bacterial-expressed 3C-like proteinase. Lane 1, no RNA; lane 2, translation reaction with mRNA; lane 3, translation reaction with mRNA, incubation with CM buffer containing Factor Xa; lane 4, translation reaction with mRNA, incubation with CM buffer containing the noncleaved MBP/3C-like proteinase fusion protein; lane 5, translation reaction with mRNA, incubation with CM buffer containing the Factor Xa-cleaved MBP/3C-like proteinase fusion protein. Protein molecular weight markers are shown in lane M and the primary translation product and cleavage products are indicated with arrows.

Ala-4996^{3,4,40}), was used to demonstrate the proteolytic activity of a bacterial-expressed HCV 229E 3C-like proteinase. However, when using this method, the importance of the overall conformation for accessibility of potential cleavage sites within the substrate should be recognized. To minimize these structural influences on cleavage, sets of overlapping peptide sequences, each of them containing identical potential cleavage sites, should be used as proteinase substrates. Furthermore, as is shown in Fig. 6, the uncleaved fusion protein does not mediate proteolytic activity. This demonstrates that the release of the proteinase from the fusion protein is required for enzymatic activity.

Determination of an HCV 229E 3C-like Proteinase Cleavage Site

Background

The *trans* cleavage assay described earlier can be used to provide important information on the location of potential proteinase cleavage sites in the coronavirus RNA polymerase gene products. However, only when specific radioactive amino acids are incorporated at the amino termini of the cleavage products can the exact position of the cleavage site be determined by sequence analysis. Sometimes there are theoretical limitations inherent in this approach and, in almost all cases, the procedure is relatively expensive. An alternative method is to use bacterial-expressed polypeptides as substrates for cleavage. In this case, the cleavage products can usually be produced in sufficient amounts to allow for chemical (i.e., nonradioactive) sequence analysis. The following section describes a procedure for determining an HCV 229E 3C-like proteinase cleavage site in an autoproteolytic β -galactosidase/HCV 229E 3C-like proteinase fusion protein.

Materials

Plasmid DNA: pROS⁴¹

Restriction enzymes (New England Biolabs)

Buffers: R buffer (50 mM sodium phosphate, pH 7.8; 300 mM NaCl),

E buffer (6 M urea in 100 mM NaH₂PO₄; 10 mM Tris-Cl, pH 8.0)

Immunological reagents: monoclonal antibody Mab 6D2H4, polyclonal rabbit antiserum, K17¹¹

Membrane: Glassybond GB 10 membrane (Biometra; Göttingen, Germany)

⁴⁰ D. X. Liu, I. Brierley, K. W. Tibbles, and T. D. K. Brown, *J. Virol.* **68**, 5772 (1994).

⁴¹ S. Ellinger, R. Glockshuber, G. Jahn, and A. Plückthun, *J. Clin. Microbiol.* **27**, 971 (1989).

Stain and destain: stain [40% (v/v) methanol; 10% acetic acid containing 0.1% Coomassie brilliant blue R-250], destain [30% (v/v) methanol; 10% acetic acid]

The Construct pROS-3CL

Procedure. DNA of plasmid pBS-J28C3⁴ is digested with *Bam*HI and *Hind*III. The 1122-nucleotide restriction fragment is isolated, treated with T4 DNA polymerase,³⁴ ligated to *Eco*RV-digested pROS, and used to transform competent *E. coli* TG1 cells. The plasmid pROS-3CL encodes a β -galactosidase/HCV 229E 3C-like proteinase fusion protein with auto-proteolytic activity. The carboxy-terminal cleavage product of this activity is recognized by the HCV 229E 3C-like proteinase-specific polyclonal anti-serum, K17.¹¹

Partial Purification of the C-Terminal Cleavage Product and N-Terminal Sequence Analysis

Procedure. *E. coli* BMH 71-18[pROS-3CL] cells are grown at 37° in 5 ml of S medium containing 100 μ g/ml ampicillin. At an OD₆₀₀ of 0.5, IPTG is added to 1 mM. After a 3-hr induction, the bacteria are harvested by centrifugation at 3500 g for 15 min. The pellet is resuspended in 3 ml of R buffer. The suspension is frozen in dry ice/ethanol and subsequently thawed in cold water. Thereafter, the material is sonified at microtip setting 6, 50% output, for 2 min at 4°. After centrifugation at 9000 g for 30 min at 4°, the supernatant is discarded and the pellet is subjected to extraction with E buffer for 1 hr. The suspension is centrifuged at 9000 g for 15 min and the insoluble fraction is resuspended in 100 μ l protein sample buffer. Thereafter, aliquots are separated on a 15% SDS-polyacrylamide gel and (i) visualized directly with Coomassie brilliant blue R-250, (ii) transferred to a nitrocellulose membrane and immunostained with the polyclonal anti-serum K17, or (iii) transferred by semidry blotting onto a Glassybond GB 10 membrane. Transfer to the Glassybond membrane is done at 200 mA using 50 mM boric acid, pH 9.0, at 4°. The methanol concentrations in the transfer buffer are 20% (anode) and 5% (cathode). Thereafter, the membrane is rinsed with water for 2 min, stained and destained, dried, and, finally, the area of membrane containing the C-terminal cleavage product of the fusion protein is isolated. The N-terminal sequence of the bound protein is done by Edman degradation with a pulsed-liquid protein sequencer (Model 476A; Applied Biosystems, Weiterstadt, Germany)

equipped with an on-board microgradient PTH analyzer using standard procedures.⁴²

Detection of RNA Polymerase Gene Products in Virus-Infected Cells

Background

To detect coronavirus RNA polymerase gene product in virus-infected cells, sensitive immunological assays are required. The method most commonly used is radioimmunoprecipitation using polyclonal antisera.^{11,40,43–45} Moreover, since the coronavirus RNA polymerase gene product(s) is post-translationally processed, peptide-specific antisera are particularly useful for the identification of specific cleavage products. In contrast, fusion protein-specific antisera often recognize more than one cleavage product. The following protocol describes the detection of an ORF 1 gene product (the 3C-like proteinase) in HCV 229E-infected MRC-5 cells using an antipeptide antiserum.

Materials

Buffers: lysis buffer (20 mM Tris-Cl, pH 7.5; 150 mM NaCl; 0.5% sodium desoxycholate; 1% NP40, 0.1% SDS; 1 mM PMSF; 1 mM benzamidine; 2 μ g/ml leupeptin; 100 μ g/ml aprotinin), detergent mix (50 mM Tris-Cl, pH 8.0; 62.5 mM EDTA; 0.4% sodium desoxycholate; 1% NP-40), RIPA buffer (10 mM Tris-Cl, pH 7.5; 150 mM NaCl; 1% NP-40; 0.1% SDS; 1% sodium desoxycholate), wash buffer B (20 mM Tris-Cl, pH 7.5; 0.1% NP40)

Reagents for peptide synthesis (Milligen, Eschborn, Germany)

Freund's complete adjuvant (Sigma)

Keyhole limpet hemocyanin (KLH; Sigma)

Fetal bovine serum, dialyzed (Life Technologies)

Promix labeling mix (Amersham Buchler)

Pansorbin (Calbiochem-Novabiochem, Bad Soden/Ts., Germany)

Peptide-Specific Antiserum K889

Procedure. An oligopeptide, NH₂-GLRKMAQPSGFVEKC-COOH, corresponding to amino acids 2967–2981 in the HCV 229E ORF 1 gene

⁴² P. Matsudeira, *J. Biol. Chem.* **262**, 10035 (1987).

⁴³ M. Denison and S. Perlman, *Virology* **157**, 565 (1987).

⁴⁴ M. R. Denison, P. W. Zoltick, S. A. Hughes, B. Giangreco, A. L. Olson, S. Perlman, J. L. Leibowitz, and S. R. Weiss, *Virology* **189**, 274 (1992).

⁴⁵ M. R. Denison, S. A. Hughes, and S. R. Weiss, *Virology* **207**, 316 (1995).

product is synthesized by solid-phase, Fmoc chemistry on a Model 9050 peptide synthesizer (Milligen) and coupled to KLH via the heterobifunctional reagent, MBS, using standard procedures.^{46,47} The peptide-specific antiserum, K889, is obtained after subcutaneous immunization of a 2-kg, male New Zealand White rabbit. The rabbit is given 10 injections at 2-week intervals with 100 μg (100 μl) of a KLH-peptide antigen emulsified with an equal volume of Freund's complete adjuvant.

Metabolic Labeling, Cell Lysis, and Immunoprecipitation

Procedure. MRC-5 cells (7×10^5) are mock-infected or infected at an MOI of 10 pfu/cell with HCV 229E. After 1 hr of virus adsorption at 33°, the medium is removed and replaced by 3 ml of fresh medium. Radioactive labeling of intracellular proteins is carried out for 3 hr between 4.5 and 7.5 hr postinfection. Prior to labeling, the cells are washed twice with methionine- and cysteine-free medium containing 2% dialyzed fetal bovine serum, and proteins are labeled with 200 μCi of L-[³⁵S]methionine and 84 μCi of L-[³⁵S]cysteine per ml of methionine- and cysteine-free medium at 33°.

Radiolabeled cells (7×10^5) are washed twice in ice-cold PBS and lysed for 15 min on ice with 330 μl of lysis buffer containing proteinase inhibitors. After centrifugation at 14,000 g for 2 min at 4°, EDTA is added to the supernatant to a final concentration of 5 mM. Then, 200 μl of cell lysate is mixed with 1000 μl of detergent mix and 20 μl 20% SDS. Subsequently, 5 μl of preimmune serum or 5 μl of K889 antiserum is added to 600 μl of the mixture and is incubated overnight at 4°. The next day, 25 μl of washed Pansorbin is added to each reaction for 30 min at 4°. Finally, the reactions are centrifuged, the supernatant is discarded, and the pellet fractions are resuspended twice in 500 μl of RIPA buffer and once in 500 μl of wash buffer B. After rinsing, the pellets are resuspended in 25 μl protein sample buffer, heated at 100° for 5 min, and centrifuged, and the supernatant is analyzed by electrophoresis on 12.5% SDS-polyacrylamide gels. The results of a typical experiment are shown in Fig. 7.

Perspectives

As may have been expected, the structural analysis of coronavirus RNA polymerase genes has been the focal point of research for the last few years, and a relatively clear and uniform picture of the organization of putative functional domains in the coronavirus RNA polymerase gene

⁴⁶ E. Harlow and D. Lane, "Antibodies: A Laboratory Manual." Cold Spring Harbor Lab. Press, Cold Spring Harbor, NY, 1988.

⁴⁷ R. H. Burdon and P. H. van Knippenberg, eds., "Laboratory Techniques in Biochemistry and Molecular Biology," Vol. 19. Elsevier, Amsterdam, 1988.

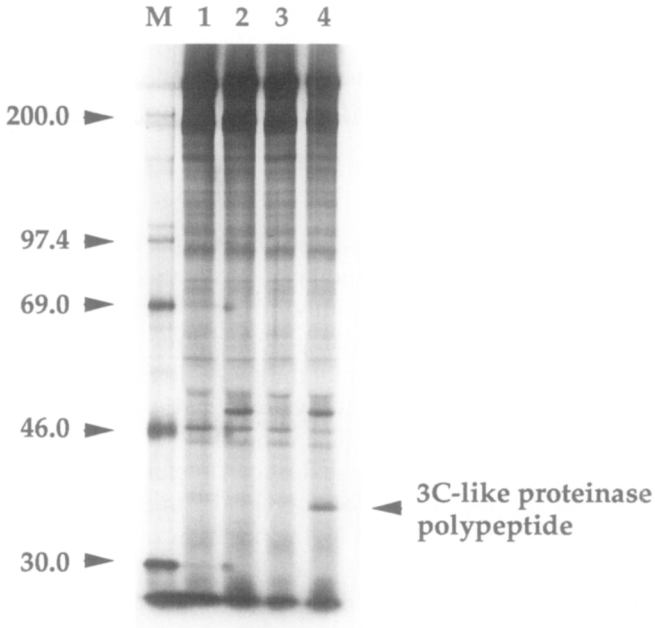

FIG. 7. Detection of a 3C-like proteinase polypeptide in HCV 229E-infected cells. Radiolabeled cell lysates from mock-infected (lanes 1 and 3) and HCV 229E-infected MRC-5 cells (lanes 2 and 4) were analyzed on a 12.5% SDS-polyacrylamide gel after immunoprecipitation with preimmune serum (lanes 1 and 2) or the peptide antiserum K889 (lanes 3 and 4). ^{14}C -labeled protein molecular weight markers are shown in lane M and the 3C-like proteinase polypeptide is indicated with an arrow.

product(s) has emerged. In contrast, the analysis of coronavirus RNA polymerase gene expression is incomplete and has, to date, relied heavily upon methods such as *in vitro* transcription and translation or the expression of gene products in bacterial systems. In the context of virus infection, the analysis of the coronavirus RNA polymerase gene expression will require the development of a large panel of sensitive and specific immunological reagents and, ultimately, the construction of an infectious coronavirus cDNA clone. Similarly, the analysis of coronavirus RNA polymerase gene function is rudimentary. The analysis of polymerase activity in subcellular fractions of coronavirus-infected cells or in permeabilized cells has proven unsatisfactory. A more promising approach may be the development of a coronavirus RNA polymerase expression system, e.g., using recombinant vaccinia viruses, combined with a “replicon” assay based on defective RNA constructs such as those described by Makino and co-workers for MHV.⁴⁸

⁴⁸ M. Joo and S. Makino, *J. Virol.* **69**, 272 (1995).