

Review

# Do Post-Translational Modifications Influence Protein Aggregation in Neurodegenerative Diseases: A Systematic Review

Larissa-Nele Schaffert  and Wayne G. Carter \* 

School of Medicine, University of Nottingham, Royal Derby Hospital Centre, Uttoxeter Road, Derby DE22 3DT, UK; larissaschaffert@yahoo.de

\* Correspondence: Wayne.Carter@nottingham.ac.uk; Tel.: +44-(0)1332-724738

Received: 18 March 2020; Accepted: 7 April 2020; Published: 11 April 2020



**Abstract:** The accumulation of abnormal protein aggregates represents a universal hallmark of neurodegenerative diseases (NDDs). Post-translational modifications (PTMs) regulate protein structure and function. Dysregulated PTMs may influence the propensity for protein aggregation in NDD-proteinopathies. To investigate this, we systematically reviewed the literature to evaluate effects of PTMs on aggregation propensity for major proteins linked to the pathogenesis and/or progression of NDDs. A search of PubMed, MEDLINE, EMBASE, and Web of Science Core Collection was conducted to retrieve studies that investigated an association between PTMs and protein aggregation in seven NDDs: Alzheimer's disease (AD), Parkinson's disease (PD), Huntington's disease (HD), amyotrophic lateral sclerosis (ALS), spinocerebellar ataxias, transmissible spongiform encephalopathy, and multiple sclerosis. Together, 1222 studies were identified, of which 69 met eligibility criteria. We identified that the following PTMs, in isolation or combination, potentially act as modulators of proteinopathy in NDDs: isoaspartate formation in A $\beta$ , phosphorylation of A $\beta$  or tau in AD; acetylation, 4-hydroxy-2-neonal modification, O-GlcNAcylation or phosphorylation of  $\alpha$ -synuclein in PD; acetylation or phosphorylation of TAR DNA-binding protein-43 in ALS, and SUMOylation of superoxide dismutase-1 in ALS; and phosphorylation of huntingtin in HD. The potential pharmacological manipulation of these aggregation-modulating PTMs represents an as-yet untapped source of therapy to treat NDDs.

**Keywords:** neurodegenerative diseases; neurotoxicity; post-translational modifications; protein aggregates

## 1. Introduction

Neurodegenerative diseases (NDDs) are a major cause of global morbidity and mortality in the elderly, and, with an ever-rising prevalence, represent one of the greatest health challenges of the 21st century. NDDs encompass heterogeneous cerebral proteinopathies, characterised by a progressive loss of vulnerable neurons such that patients present with broad clinical sequelae that includes motor, behavioural, and cognitive deficits [1–3]. At autopsy, NDDs can be characterised histopathologically via hallmark intra- or extracellular accumulations of degradation-resistant protein aggregates concentrated to certain brain regions (Table 1). These protein aggregates interfere with neuronal function, and presumably induce toxicity that ultimately drives cell death [2].

**Table 1.** Overview of neuropathology, approximate global prevalence rates, and frequency of genetic and sporadic forms of major neurodegenerative diseases [3–29].

NDD	Commonly Mutated Proteins	Primary Region of Damage	Compartment of Aggregate Deposition	Aggregate-Forming Proteins	Global Prevalence	Sporadic Cases	Familial Cases
AD	APP, presenilins	Cortex, hippocampus	Extracellular, intracytoplasmic	A $\beta$ (plaques), tau (tangles)	593:100,000	>98%	<2%
PD	$\alpha$ -synuclein, LRRK2	Substantia nigra, cortex	Intracytoplasmic	$\alpha$ -synuclein (Lewy bodies)	1–2:1000	>90%	<10%
HD	Htt	Striatum, basal ganglia	Intranuclear, intracytoplasmic	Htt	1:10,000	3%	97%
ALS	TDP-43, SOD1, c9orf72	Spinal motor neurons, motor cortex	Intracytoplasmic	SOD1, TDP-43	5:100,000	90–95%	5–10%
MS	-	Basal ganglia, brainstem	Intracytoplasmic, extracellular	A $\beta$ , tau, APP, bassoon protein	30.1:100,000	80–90%	10–20%
SCAs	ATX1, ATX2, ATX3, CACNA1A, ATX7, TBP, ATN1	Cerebellum, brainstem	Intranuclear	Atrophin-1, ataxins	3:100,000	No data	No data
TSEs	PrP	Cortex, brainstem, thalamus, cerebellum	Extracellular	PrP	1–2:1,000,000	85–90%	10–15%

Abbreviations: APP, Amyloid precursor protein; LRRK2, Leucine-rich repeat kinase-2; Htt, Huntingtin; TDP-43, TAR DNA-binding protein 43; c9orf72, Chromosome 9 open reading frame 72; SOD1, Superoxide dismutase 1; ATX, ataxins; CACNA1A, Voltage-gated calcium channel subunit  $\alpha$ 1A; TBP, TATA-binding protein; ATN1, atrophin 1; PrP, Prion protein.

Although the pathogenesis of Huntington’s disease (HD) and spinocerebellar ataxias (SCAs), as well as rare familial forms of other NDDs are influenced by gene mutations that affect protein structure and function, the majority of NDDs arise from a multifactorial idiopathic aetiology.

Numerous drug therapies to treat NDDs have entered clinical trials over the last two decades, but their low success rates underscore substantial gaps in understanding of the molecular mechanisms that drive neurodegeneration in sporadic diseases [1–3]. Consequently, there are no specific curative treatments available to reverse or even halt the progression of brain pathology in NDDs, and all therapeutics licensed for treatment merely work at a symptomatic level. Furthermore, the number of patients with these age-related diseases is rising due to increased longevity, and this carries an enormous social and economic global burden. It is therefore crucial to elucidate the molecular mechanisms that trigger protein aggregation and subsequent neurotoxicity in order to identify potential targets for drug development, to resist or possibly reverse disease progression.

### 1.1. Alzheimer’s Disease

Alzheimer’s disease (AD) is the most common NDD and accounts for 60–80% of all cases of dementia [27,30]. More than 30 million people are currently suffering from AD, and this number is estimated to increase to 115 million by 2050 [31]. Clinically, patients predominantly present with a decline in cognitive function that initially manifests as episodic short-term memory loss, but as the disease progresses, visuospatial, behavioural, and psychiatric disturbances follow and eventually lead to the inability to perform activities of daily living [32]. Diagnosing AD relies heavily on patient history and cognitive function tests such as the Mini Mental State Examination or the

Montreal Cognitive Assessment, but screening for plasma and CSF biomarkers and brain imaging have proven helpful ancillary methods [1,33]. Nevertheless, macroscopic confirmation of AD is provided from post-mortem examination, and typified by widespread cortical atrophy primarily within the frontotemporal lobes (including the hippocampus) that leads to an enlargement of the lateral ventricles [1,2,34]. Microscopically, AD pathology is characterised by extracellular plaque deposits of aggregated amyloid-beta peptide ( $A\beta$ ) as well as intracellular neurofibrillary tangles (NFTs) primarily composed of hyperphosphorylated fibrils of microtubule-associated protein tau [2,34].

$A\beta$  peptide is primarily composed of 42–43 amino acids formed from proteolytic cleavage of the transmembranous amyloid precursor protein (APP) [34,35]. Two proteases that act on APP, a  $\beta$ -secretase and  $\gamma$ -secretase, yield the  $A\beta_{40}$  and  $A\beta_{42}$  isoforms, respectively. Alternatively, APP may be processed by  $\alpha$ -secretase via the non-amyloidogenic pathway [35–37]. While  $A\beta$  is believed to play a number of physiological roles, including regulation of synaptic activity [36,37], in AD, it acquires a toxic gain-of-function, undergoes oligomerisation and aggregation, eventually forming insoluble, fibrillar, senile plaques that are central to neurotoxicity and neurodegeneration [2,38,39].

Human tau protein exists in six isoforms of between 352 and 441 amino acids encoded by the *MAPT* gene on chromosome 17q21.31. It is localised predominantly to neuronal axons, where its primary function is the stabilisation of microtubules and regulation of neuronal transport [40–42]. In AD, abnormally phosphorylated tau adopts an altered conformation that hinders its binding to microtubules and promotes its self-assembly (aggregation) into paired helical filaments (PHFs), the primary component of NFTs [40–42]. It is these tau aggregates and  $A\beta$  aggregates that have been the subject of targeted therapies [42].

### 1.2. Parkinson's Disease

Approximately 1% of individuals over the age of 60 years and close to 5% of the population aged 80 or older suffer from Parkinson's disease (PD), the second most common NDD and most common movement disorder [43]. PD is characterised by a progressive loss of dopaminergic neurons in the subcortical basal ganglia; specifically, within the substantia nigra pars compacta (SNpc) [1,2,43–45]. Since this midbrain region plays a crucial role in fine-tuning motor circuits and facilitating movement, PD manifests clinically with a pathognomonic triad of bradykinesia, rigidity, and resting tremor [1,45]. In addition to nigral degeneration, the primary pathological feature of PD is the presence of intraneuronal proteinaceous inclusions termed Lewy bodies (LBs), primarily composed of  $\alpha$ -synuclein [2,46,47].

$\alpha$ -synuclein is a cytosolic 140 amino acid protein encoded by the *SNCA* gene on chromosome 4q21. Although widely expressed within neurons, it is abundant at presynaptic terminals, indicative of a role in synaptic signalling. A number of rare *SNCA* point mutations trigger dominant familial (early-onset) forms of PD. Fibrillar forms of  $\alpha$ -synuclein have been identified within LBs that accumulate in hereditary and sporadic forms of PD [46–49]. Oligomeric and/or fibrillar aggregates of  $\alpha$ -synuclein may be cytotoxic and trigger neuronal degeneration.

### 1.3. Amyotrophic Lateral Sclerosis

Amyotrophic lateral sclerosis (ALS) is a fatal, incurable NDD characterised by the loss of upper and lower motor neurons. ALS typically presents with symptoms of bulbar and spinal dysfunction including muscle weakness, wasting and spasticity, and ultimately, patients may become paralysed and die from respiratory failure [2,50,51]. Pathologically, both sporadic and familial ALS are characterised by marked cytoplasmic protein aggregates in degenerating neurons that harbour ubiquitinated forms of Trans-activation response DNA-binding protein 43 (TDP-43) and the antioxidant enzyme, superoxide dismutase 1 (SOD1) [10,50,51].

TDP-43 is a 414 amino acid protein encoded by the *TARDBP* gene on chromosome 1 and is normally nuclear resident and involved in the regulation of RNA metabolism. In ALS, cytoplasmic, ubiquitinated, hyperphosphorylated, and truncated forms of TDP-43 accumulate as protein aggregates [52–54]. These

cytoplasmic aggregates are neurotoxic, produce ALS-like phenotypes, and contribute to a loss of nuclear (functional) TDP-43 [52–55].

Superoxide dismutase 1 (SOD1) is a 153-amino acid copper- and zinc-dependent metalloenzyme encoded by the *SOD1* gene on chromosome 21q22.11. SOD1 functions to scavenge highly reactive superoxide radicals by catalysing their conversion to hydrogen peroxide and molecular oxygen [56]. SOD1 is predominantly cytoplasmic, although nuclear, lysosomal, and mitochondrial residences have also been reported [57]. In SOD1-mediated familial ALS, mutations in the *SOD1* gene sequence are thought to affect post-translational processing, rendering the protein prone to misfolding, aggregation, and formation of neuronal inclusion bodies. Misfolded SOD1 is also found in cytoplasmic inclusions in patients with sporadic ALS, as well as other proteins including TDP-43 [58]; suggesting a common pathophysiological mechanism for hereditary and idiopathic ALS.

#### 1.4. Huntington's Disease

Huntington's disease (HD) is a rare, autosomal dominant NDD with an average age of onset of 40 years [59]. HD is caused by an expansion of the CAG repeat ( $\geq 36$ ) in the Huntingtin (*Htt*) gene on chromosome 4p16.3, that when translated produces an elongated polyglutamine (polyQ) stretch in the Htt protein [59]. The formation of aggregated Htt within neuronal intranuclear inclusion bodies is a histopathological hallmark of HD [60]. Additionally, the degeneration of GABAergic medium spiny neurons in the striatum that project to other regions of the basal ganglia and thereby modulate central motor circuitries, is central to HD pathology [61]. This is reflected in the clinical picture of HD such that patients present with severe motoric abnormalities including prominent 'dance-like' involuntary movements termed chorea [62]. With disease progression, other brain regions undergo degeneration, with an associated array of additional psychiatric, behavioural, and cognitive symptoms.

Htt is a large, 3144-amino acid, monomeric protein required for embryonic neurogenesis that controls a number of nuclear and cytoplasmic homeostatic functions including regulation of synaptic activity [63,64]. In HD, the expanded polyQ stretch of the protein induces production of N-terminal Htt fragments that are prone to misfold and form amyloid-like structures [65–68]. Furthermore, polyQ tracts have a tendency to form  $\beta$ -pleated sheets and this conformational change directly increases the aggregation propensity of Htt [66–68]. These changes result in the assembly of oligomeric structures and eventually the formation of Htt-positive intracellular inclusion bodies that disrupt cellular homeostasis and cause neuronal degeneration [69].

#### 1.5. Spinocerebellar Ataxias

Spinocerebellar ataxias (SCAs) are a heterogeneous group of >27 different autosomal dominant NDDs that share the phenotypical core feature of ataxia and are characterized by degenerative and atrophic changes in the central nervous system, primarily affecting the cerebellum [70]. The most common SCAs belong to the polyQ repeat diseases and are caused by CAG expansion mutations in a number of different genes [71].

#### 1.6. Transmissible Spongiform Encephalopathy

Transmissible spongiform encephalopathies (TSEs), also known as prion diseases, are progressive NDDs that typically present with variable symptomology including dementia and ataxia [72]. They can be classified according to their genetic, acquired, and sporadic aetiology, with the most common TSE being sporadic Creutzfeldt-Jakob disease [23]. TSEs typically present with a pathology that involves neuronal vacuolation (spongiform change), widespread neuronal death, and subsequent gliotic scarring in cerebral grey matter secondary to the accumulation of aberrant, self-propagating prion protein scrapie (PrP<sup>Sc</sup>) [73]. Diagnostic criteria as well as ancillary tests such as electroencephalography or genetic testing facilitate diagnosis, but only at autopsy can a definitive diagnosis be confirmed [74]. Due to the propagating nature of TSEs and lack of disease-modifying or curative treatments, after clinical onset, the disease course is usually short with a median survival of 5 months [75].

The prion gene *PRNP* on chromosome 20 encodes a human prion glycoprotein, PrP<sup>C</sup>, of 253 amino acids localised to pre- and postsynaptic terminals in the CNS [76–78]. Its precise physiological function has been debated and is considered non-essential [79]: indicative that a toxic gain-of-function rather than loss-of-function of PrP<sup>C</sup> underlies neurotoxicity in prion diseases [80]. In TSEs, PrP<sup>C</sup> misfolds and is partially converted from an  $\alpha$ -helical to  $\beta$ -sheet structure that is resistant to proteolytic clearance, PrP<sup>Sc</sup> [78,81]. Misfolded PrP<sup>Sc</sup> accumulates in synaptic and axonal processes and forms fibrillar aggregates that are capable of inducing neuronal apoptosis in vitro and in vivo [80,82]. Pathology is thought to be propagated when abnormal PrP<sup>Sc</sup> converts normal PrP<sup>C</sup> into PrP<sup>Sc</sup> via an autocatalytic mechanism [83].

### 1.7. Multiple Sclerosis

Multiple Sclerosis (MS) is traditionally classed as a neuroinflammatory disease caused by autoimmune-mediated axonal demyelination within the CNS [84,85]. Clinical presentation is variable since focal inflammatory lesions may affect any CNS structure, and the diagnostic process is therefore based on a combination of clinical history and examination, brain imaging, and blood screening [84]. There are four MS subtypes: relapsing remitting (RRMS), progressive relapsing (PRMS), primary progressive (PPMS) and secondary progressive (SPMS), and each has a unique therapeutic approach and prognosis [84,85].

While most subjects ( $\approx 85\%$ ) are diagnosed with RRMS at symptomatic onset, the majority of patients will progress to development of highly debilitating SPMS [85]. Post-mortem analyses of MS patients have demonstrated degenerative lesions and significant cerebral atrophy indicative of a NDD. Furthermore, the identification of proteinaceous, oligomeric aggregates, that include A $\beta$ , tau, and APP, as well as deposits in neuronal somata composed of aggregated bassoon (Bsn) protein, may represent a link between neuroinflammation and neurodegeneration in MS [8,12,13].

Bsn is a large, 3926 amino acid, scaffold protein that is part of the presynaptic cytoskeletal matrix, and has multiple roles in mediating synaptic function [12,86]. In MS, Bsn is mis-localised and accumulates in neuronal cells, to induce neurotoxicity and neurodegeneration [12].

### 1.8. Protein Aggregation in Neurodegeneration

Protein misfolding and accumulation of toxic aggregates has emerged as a central theme of paradigmatic NDDs [87]. Protein turnover is an orchestrated process controlled via a balance of protein synthesis and degradation. Cells are equipped with efficient protein quality control mechanisms such as the ubiquitin-proteasome system and chaperone-mediated autophagy that are able to eliminate aberrant or misfolded proteins [87,88]. However, the capacity or indeed fidelity of these degradative pathways may be compromised with a corresponding accumulation of damaged, misfolded, or aggregated proteins, and associated pathology. Hence the formation of protein aggregates may serve as an initiating step in cellular dysfunction in NDDs, and it is therefore critical to understand the molecular mechanisms that alter the protein aggregation of these NDD-associated proteins.

### 1.9. Post-Translational Modifications and NDDs

The chemical modifications of proteins during or after their biosynthesis via the covalent attachment of functional groups or proteolytic cleavage at specific amino acids are collectively termed protein post-translational modifications (PTMs). PTMs can be mediated by enzymatic or non-enzymatic means and may be reversible or irreversible. Over 600 different PTMs have been demonstrated experimentally [89]. This plethora of PTMs diversifies the proteome by modulating the structural and functional properties of proteins. Due to their pivotal role in regulating cellular processes and roles in ageing, protein PTMs may need to be strictly controlled, such that dysregulation of PTMs could contribute to disease pathogenesis or progression [90,91].

The major risk factor for developing NDD is age, and this may also correlate with disturbed PTM homeostasis. One could hypothesise that as an individual ages the likelihood of dysregulation

of PTMs increases, and if this leads to aberrant modification of susceptible proteins then protein misfolding and aggregation, neurotoxicity, and ultimately neurodegeneration may ensue. Against this backdrop, the identification of the PTMs that drive dysregulated protein function proffer a therapeutic window if the formation of toxic protein aggregates could be obviated. Indeed, recent animal studies have demonstrated that therapies that influence protein PTMs provide a viable means to modulate proteinopathy and associated neurodegeneration [91,92].

The aim of this systematic research was to provide a comprehensive, unbiased analysis of the PTMs that have been reported to affect the aggregation propensity of proteins implicated in the pathology of AD, PD, ALS, HD, SCAs, TSEs, and MS. Mapping of the patterns and number of studies demonstrating aggregation-modulating PTMs will improve our understanding of the extent and site-specificity of aggregation-inducing PTMs, and thereby provide an insight into novel therapeutic targets that may limit pathogenesis and/or disease progression.

## 2. Methods

A systematic review of the literature was carried out according to the Preferred Reporting Items for Systematic Reviews and Meta-Analyses (PRISMA).

### 2.1. Search Strategy

From the 7th to 17th September 2019, a systematic electronic database search was conducted on MEDLINE (OvidSP), EMBASE (OvidSP), Web of Science Core Collection, and PubMed to retrieve all experimental studies investigating the effect of PTMs on protein aggregation in the pre-specified NDDs. A combination of controlled vocabulary (MeSH) and free-text keywords were used for each of the four concepts and search terms included: (a) neurodegenerative diseases, nerve degeneration, neurodegenerat \*, Alzheimer's disease, Parkinson's disease, amyotrophic lateral sclerosis, Huntington's disease, spinocerebellar ataxia, transmissible spongiform encephalopathy, and multiple sclerosis; (b) protein aggregation, aggreg \*; (c) beta-amyloid, tau, alpha-synuclein, TDP-43, superoxide dismutase 1, huntingtin, prions, protein aggregate, inclusion bodies; (d) post-translational modifications, protein processing. The full search strategy for MEDLINE is provided as Supplementary Data S1. Additional studies were identified through bibliography screening of relevant review articles and hand-searching of relevant articles.

### 2.2. Eligibility Criteria

All search results (n = 1222) were exported into Endnote (Clarivate Analytics) and Excel (Microsoft) for duplicate removal (automatic deduplication and manual checking) and title/abstract screening to identify studies deemed appropriate to the pre-specified inclusion criteria. Included articles were original studies directly investigating the effect of PTMs at residues of human proteins central to pathology in AD, PD, ALS, HD, SCAs, TSEs, or MS for which the PTM had an effect on aggregation behaviour. Studies were excluded if they focused on proteins or NDDs other than those pre-defined, or were published in a language other than English, or performed with non-human proteins or tissue, or were review articles, editorials, or conference abstracts.

### 2.3. Data Acquisition and Analysis

Eligible publications were read in full and information for the following variables collated as a data extraction spreadsheet: NDD; protein investigated; type of PTM; site of PTM; peptide or protein source; in vitro or in vivo study; assay method for aggregation; overall study findings and conclusion; authors and year of publication.

### 3. Results

A total of 1196 articles were identified from the database search and an additional 26 potentially relevant papers yielded from hand-searching key papers. Duplicate articles were removed, and then 166 papers excluded based upon title screening, yielding 804 papers for abstract review. Further screening led to the exclusion of 662 articles and left a final 142 papers for full-text assessment. Of these, 73 studies did not meet the pre-defined eligibility criteria and were rejected based on the following grounds: off-topic ( $n = 37$ ), full-text not accessible ( $n = 3$ ), conference abstract ( $n = 2$ ), review article ( $n = 6$ ), focus on condition/protein not pre-specified in the inclusion criteria ( $n = 5$ ), animal model ( $n = 5$ ), lack of specificity ( $n = 15$ ). The remaining 69 articles fulfilled the inclusion criteria and were included in the final analysis (Figure 1).

Of the 69 included studies, the majority were focused upon PTMs and protein aggregation in AD ( $n = 28$ ) and then PD ( $n = 20$ ), 10 studies considered ALS, 7 HD, and 2 studies each examined SCAs and TSEs, respectively. No studies investigating the effect of PTMs on protein aggregation in the context of MS were identified from this search. The most commonly employed method to assess aggregation behaviour was Thioflavin T (ThT) fluorescence for quantitation of *in vitro* formation of amyloid-like fibrils [93]. Other studies that examined aggregation included the use of Western blotting, immunohistochemistry, sedimentation assays, atomic force microscopy, and transmission electron microscopy. The results for each NDD-related protein are presented and stratified according to effects on: (1) aggregation in general; (2) formation of oligomeric species; (3) formation of fibrillar aggregates; and (4) formation of amorphous aggregates.

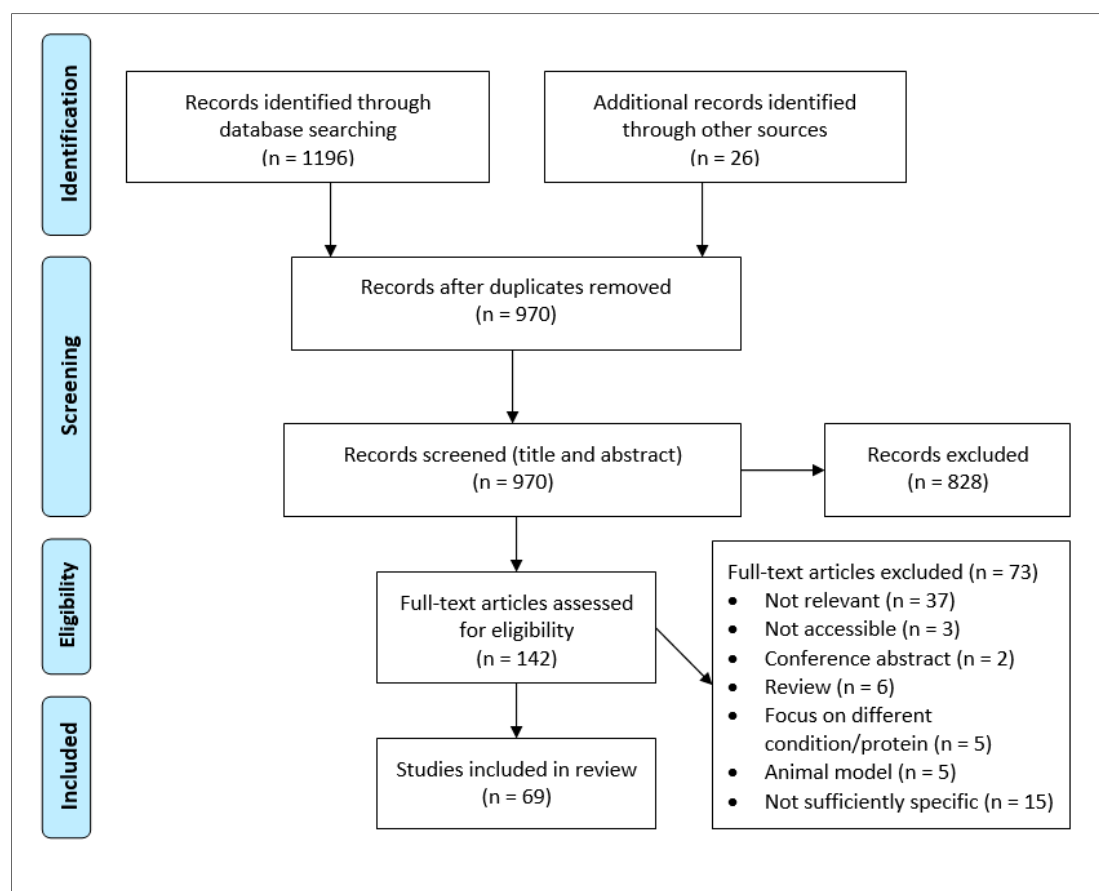

**Figure 1.** Preferred reporting items for systematic reviews and meta-analyses (PRISMA) flow chart detailing the stages of study retrieval and selection [94].

### 3.1. Alzheimer's Disease

#### 3.1.1. A $\beta$ PTMs and Propensity for Aggregation

Eleven studies focused upon aggregation behaviour of A $\beta$ . Two studies investigated isoaspartate modification (collectively covering residues D1, D7, and D23) and both reported that it had a pro-aggregation effect, with enhanced formation of A $\beta$  oligomers as well as fibrillar aggregates [95,96]. A similar pro-aggregation effect was observed after N-terminal pyroglutamylation at E3 of A $\beta$  [97]. The effect of phosphorylation on aggregation propensity of A $\beta$  varied for different residues: specifically, S8 phosphorylation increased the formation of oligomeric and high molecular weight species [98,99], while phosphorylation at S26 had an overall inhibitory effect on the formation of large aggregates through stabilising intermediate oligomers [100]. Reduced transition from oligomer to fibril was also observed for N-homocysteinylation at K16 and K28 [101]. The results relating to nitration at Y10 were inconclusive: two studies reported a decrease of A $\beta$  aggregation propensity [102,103], whereas one study reported a pro-aggregation effect [104]. Lastly, glycation at R5 and K16 reduced the formation of fibrillar aggregates [105]. A detailed overview of the effect of each PTM on the aggregation behaviour of A $\beta$  is presented in Table 2.

**Table 2.** Summary of  $\beta$ -amyloid PTMs and propensity for protein aggregation.

Post-Translational Modification	Residues Modified	Author & Year	Aggregation	Formation of Oligomers	Formation of Fibrillar Aggregates	Formation of Amorphous Aggregates
Glycation	R5, K16	Emendato et al., 2018 [105]	Decrease	-	Decrease	-
Isoaspartate formation	D23	Shimizu et al., 2002 [96]	Increase	-	Increase	-
	D1, D7, D23	Fossati et al., 2013 [95]	Increase	Increase	Increase	-
N-Homocysteinylation	K16, K28	Khodadadi et al., 2012 [101]	Decrease	Increase	Decrease	-
N-terminal pyroglutamylation	N-terminal E3	Schilling et al., 2006 [97]	Increase	Increase	Increase	-
Nitration	Y10	Kummer et al., 2011 [104]	Increase	Increase	Increase	-
	Y10	Zhao et al., 2015 [102]	Decrease	Decrease	Decrease	-
	Y10	Guivernau et al., 2016 [103]	Decrease	Increase	Decrease	-
Phosphorylation	S8	Jamasbi et al., 2017 [98]	Increase	-	Increase	-
	S8	Kumar et al., 2011 [99]	Increase	Increase	Increase	-
	S26	Kumar et al., 2016 [100]	Decrease	Increase	Decrease	-

Interestingly, all PTMs that affected A $\beta$  aggregation were within the first 28 residues of the peptide (Figure 2), leaving the 29–40 C-terminal section less prone to structural alterations.



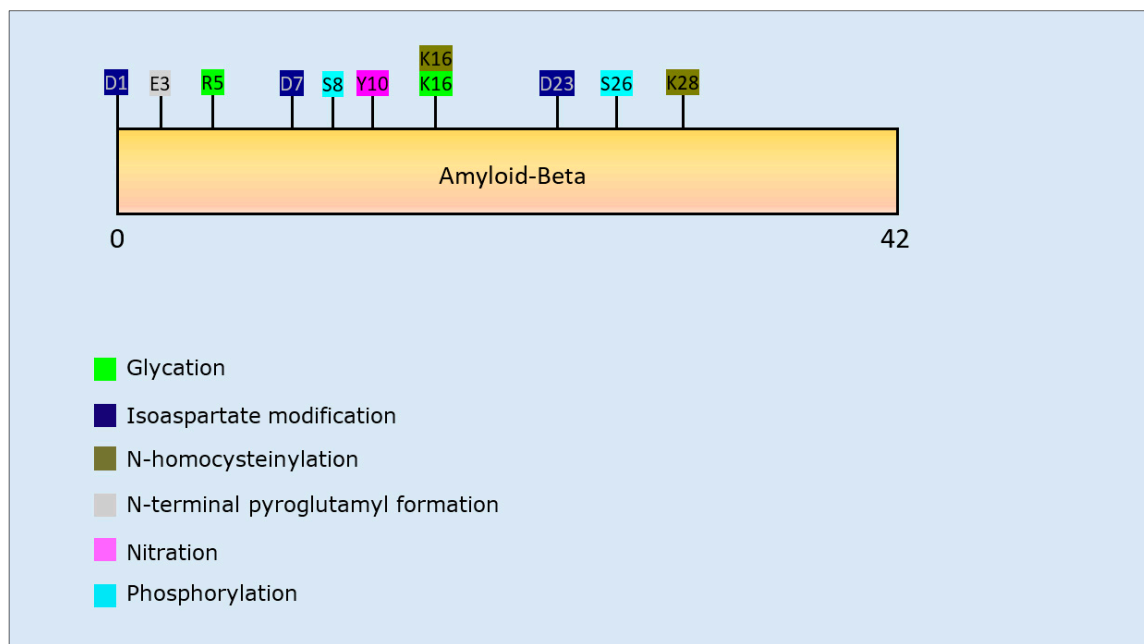

**Figure 2.** Schematic representation of beta-amyloid-42 peptide illustrating PTMs and respective amino acid residues.

### 3.1.2. Tau PTMs and Propensity for Aggregation

The majority of studies that have investigated PTMs of tau and protein aggregation have focused upon acetylation. Collectively, the results of acetylation analyses have been equivocal; with a demonstration of increased aggregation after acetylation at K280/K281 [106–108], but with acetylation at multiple lysine residues, including K280/281, also reported to decrease aggregation and the fibrillation rate of tau [109,110]. Furthermore, K321 acetylation alone or in combination with acetylation at other lysine residues decreased the level of tau aggregates [110,111].

Carbamylation, C-terminal truncation, glycation, proteolytic cleavage, pseudo-phosphorylation (replacement of a phospho-acceptor amino acid with a negatively charged amino acid to mimic phosphorylation), and SUMOylation all primarily increased tau assembly into aggregates [112–118], with the exception of pseudo-phosphorylation at S235 that significantly reduced tau aggregation [116]. O-GlcNAcylation, S-guanylation, and methylation decreased aggregation [119–121]. Likewise, site-specific tau nitration at Y18 and Y394 resulted in the formation of fewer and/or shorter tau filaments compared to the unmodified protein [122]. The effect of phosphorylation of tau and aggregation varied for different isoforms: phosphorylation of 4R2N and 3R1N at specific residues increased tau aggregation, while phosphorylation of 4R0N and 3R2N tau isoforms decreased their aggregation [114]. Additionally, one study identified an ‘acetylation-phosphorylation switch’, whereby acetylation of K321 was able to prevent phosphorylation at S324, a common PTM observed in tau inclusions in patients with AD [111]. A summary of the PTMs of tau that influence aggregation propensity are included as Table 3, and Figure 3.

**Table 3.** Summary of Tau PTMs and propensity for protein aggregation.

Post-Translational Modification	Isoform and Residues Modified	Author & Year	Aggregation	Formation of Oligomers	Formation of Fibrillar Aggregates	Formation of Amorphous Aggregates
Acetylation	4R2N: K280/K281	Trzeciakiewicz et al., 2017 [106]	Increase	-	Increase	-
	4R2N: K163/K174/K190/K224/K234/K240/K254/K280/K281/K290/K311/K375/K385/K395	Ferreon et al., 2018 [109]	Decrease	-	Decrease	-
	4R0N: K321, K259/K290/K321/K353, K290/K321, K274	Carlomagno et al., 2017 [111]	Decrease	-	Decrease	-
	4R2N: K163, K174, K224, K225, K234, K240, K259, K274, K280, K290/K321, K294, K298, K317, K353, K369	Kamah et al., 2014 [110]	Decrease	-	Decrease	-
	4R2N: K280	Haj-Yahya and Lashuel, 2018 [107]	Increase	Increase	Decrease	-
	4R, Tau-K18: K163/K280/K281/K369	Cohen et al., 2011 [108]	Increase	-	Increase	-
Carbamylation	4R2N: K311, K280, K311/K280	KrishnaKumar et al., 2018 [112]	Increase	-	Increase	-
C-terminal Truncation	4R2N: D421, E391	Yin and Kuret, 2006 [113]	Increase	-	Increase	-
Glycation	4R2N: K67, K148, K163, K180, K190, K259, K267, K274, K281, K290, K298, K311, K317, K321, K331, K340, K343, K353, K369, K370, K375, K383, K385, K395	Liu et al., 2016 [114]	Increase	-	Increase	-
	3R2N: K24, K163, K174, K180, K190, K254, K259, K267, K311, K343, K353, K369, K385	Liu et al., 2016 [114]	Increase	-	Increase	-
Methylation	4R2N: Multiple residues*	Funk et al., 2014 [121]	Decrease	-	Decrease	-
Nitration	4R2N: Y18, Y394	Reynolds et al., 2005 [122]	Decrease	-	Decrease	-
O-GlcNAcylation	4R2N: S400	Yuzwa et al., 2014 [119]	Decrease	-	Decrease	-
Phosphorylation	4R2N: S68, T169, S214, S262, S285, S319, S356, T403	Liu et al., 2016 [114]	Increase	-	Increase	-
	3R1N: T71	Liu et al., 2016 [114]	Increase	-	Increase	-
	4R0N: T111, S198, S214, S237, S238, S241, S258, S324, S352, S356, S400, S404	Liu et al., 2016 [114]	Decrease	-	Decrease	-
	3R2N: S235, S237, S324	Liu et al., 2016 [114]	Decrease	-	Decrease	-
Proteolytic cleavage	4R2N: D421	Mead et al., 2016 [115]	Increase	-	-	Increase

Table 3. Cont.

Post-Translational Modification	Isoform and Residues Modified	Author & Year	Aggregation	Formation of Oligomers	Formation of Fibrillar Aggregates	Formation of Amorphous Aggregates
Pseudo-phosphorylation	4R2N: S199, S199/S202/T205, T212, S214, T212/S214, S396/S404,	Necula and Kuret, 2004 [116]	Increase	-	Increase	-
	4R2N: S235	Necula and Kuret, 2004 [116]	Decrease	-	Decrease	-
	4R2N: T212	Chang et al., 2011 [117]	Increase	-	Increase	-
S-Guanylation	3R2N: C291	Yoshitake et al., 2016 [120]	Decrease	Decrease	Decrease	-
	4R2N: C291, C322	Yoshitake et al., 2016 [120]	Decrease	Decrease	Decrease	-
SUMOylation	4R2N: K340	Luo et al., 2014 [118]	Increase	-	-	-

\* Tau methylation at multiple residues across the protein.

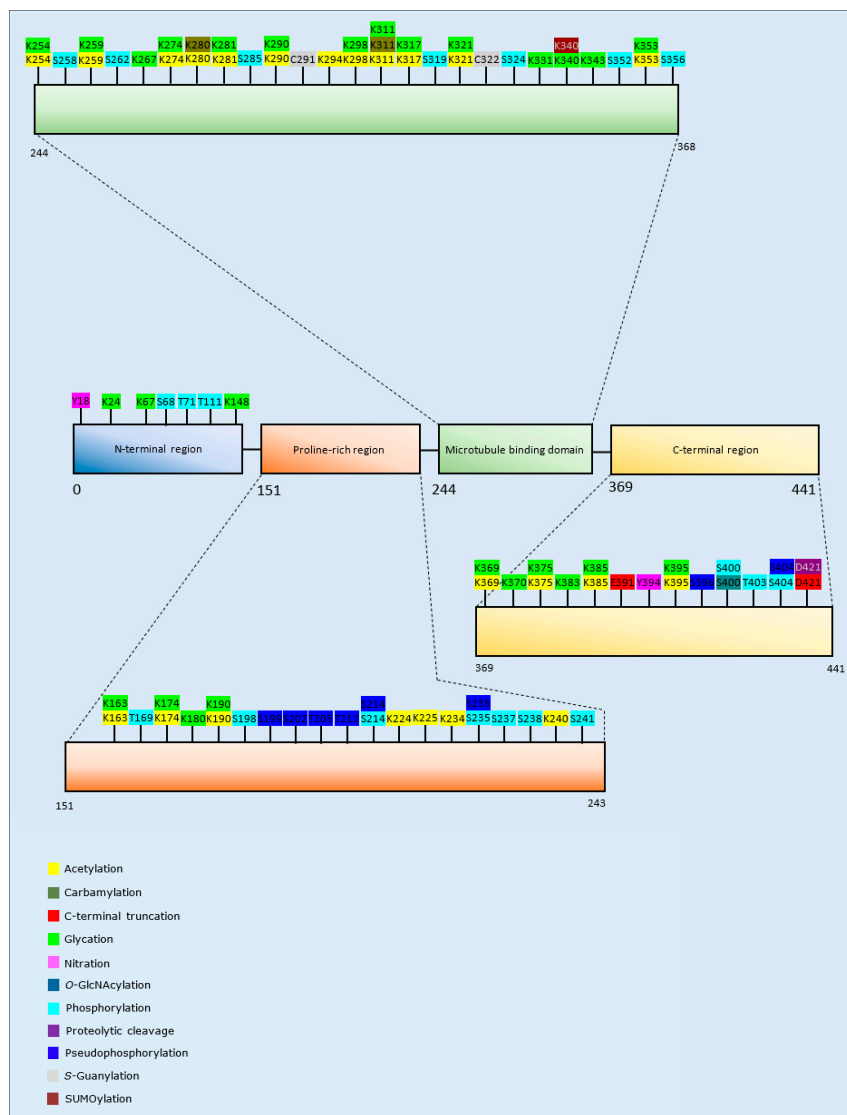

Figure 3. Schematic representation of tau protein illustrating PTMs and respective amino acid residues.

## 3.2. Parkinson's Disease

 $\alpha$ -Synuclein PTMs and Propensity for Aggregation

Twenty studies investigated the effects of PTMs on the PD-related protein,  $\alpha$ -synuclein. Collectively, acetylation of the N-terminal region of  $\alpha$ -synuclein reduced aggregation in four out of five studies [123–126], and with one study that reported that this PTM increased the propensity of  $\alpha$ -synuclein to aggregate [127]. Adenylation at T33, T54, and T75 reduced  $\alpha$ -synuclein aggregation [128]. Glycation at multiple lysine residues increased  $\alpha$ -synuclein aggregation and formation of stable oligomers [129]. Increased oligomerization but reduced aggregation was triggered after SUMOylation at K96 and K102 [130]. 4-hydroxy-2-neonal (HNE) modification at H50 resulted in enhanced formation of oligomers, which in two studies reduced the formation of fibrillar aggregates [131–133]. O-GlcNAcylation decreased formation of aggregates, and favoured the formation of oligomers after modification at T81 and S87, or when O-GlcNAcylation was performed across the whole protein [134,135]. By contrast,  $\alpha$ -synuclein O-GlcNAcylated at T72 formed markedly fewer oligomers compared to the non-modified protein [136]. O-GlcNAcylation at T72 also inhibited S129 phosphorylation [136]; a PTM that increased the formation of  $\alpha$ -synuclein aggregates [137,138]. Lastly, nitration of  $\alpha$ -synuclein displayed conflicting results regarding effects upon  $\alpha$ -synuclein aggregation [131,139–142]. Although all of these studies demonstrated that nitration increased oligomerisation, this was associated with a reduction or inability to form fibrils [131,139,141]. A summary of the PTMs that influence aggregation propensity of  $\alpha$ -synuclein are shown in Table 4.

**Table 4.** Summary of  $\alpha$ -synuclein PTMs and propensity for protein aggregation.

Post-Translational Modification	Residues Modified	Author & Year	Aggregation	Formation of Oligomers	Formation of Fibrillar Aggregates	Formation of Amorphous Aggregates
Acetylation	N-terminus	Bartels et al., 2014 [123]	Decrease	-	Decrease	-
	N-terminus	Kang et al., 2012 [124]	Decrease	-	Decrease	-
	N-terminus	Bu et al., 2017 [125]	Decrease	Decrease	Decrease	-
	N-terminus	Birol et al., 2019 [127]	Increase	-	Increase	-
	N-terminus, K6, K10	Oliveira et al., 2017 [126]	Decrease	Decrease	Decrease	-
Adenylation	T33, T54, T75	Sanyal et al., 2019 [128]	Decrease	-	Decrease	-
Glycation	K6, K10, K12, K21, K23, K32, K34, K43, K45	Vicente et al., 2017 [129]	Increase	Increase	Decrease	Increase
4-Hydroxy-2-neonalModification	H50, and other Lys residues	Qin et al., 2006 [133]	Decrease	Increase	Decrease	-
	H50, and other Lys residues	Xiang et al., 2013 [131]	Decrease	Increase	Decrease	-
	H50	Xiang et al., 2015 [132]	-	Increase	-	-
Nitration	Y39, Y125, Y133/Y136	Burai et al., 2015 [139]	Decrease	Increase	Decrease	Increase
	Y39, Y125, Y133, Y136	Liu et al., 2011 [140]	-	Increase	-	Increase
	Y39, Y125, Y133, Y136	Hodara et al., 2004 [141]	Increase	-	-	-
	Y39, Y125, Y133, Y136	Souza et al., 2000 [142]	Increase	Increase	-	-
	Y39/Y125/Y133/136	Xiang et al., 2013 [131]	Decrease	Increase	Decrease	-

Table 4. Cont.

Post-Translational Modification	Residues Modified	Author & Year	Aggregation	Formation of Oligomers	Formation of Fibrillar Aggregates	Formation of Amorphous Aggregates
O-GlcNAcylation	T72	Levine et al., 2019 [134]	Decrease	-	Decrease	-
	T75	Levine et al., 2019 [134]	Decrease	-	Decrease	-
	T81	Levine et al., 2019 [134]	Decrease	Increase	Decrease	-
	S87	Levine et al., 2019 [134]	Decrease	Increase	Decrease	-
	T72/T75/T81	Levine et al., 2019 [134]	Decrease	-	Decrease	-
	Multiple sites *	Zhang et al., 2017 [135]	Decrease	Increase	Decrease	-
	T72	Marotta et al., 2015 [136]	Decrease	Decrease	Decrease	-
Phosphorylation	S129	Fujiwara et al., 2002 [137]	Increase	Increase	Increase	-
	S129	Samuel et al., 2016 [138]	Increase	-	Increase	-
SUMOylation	K96, K102	Krumova et al., 2011 [130]	Decrease	Increase	Decrease	-

\*  $\alpha$ -synuclein O-GlcNAcylation at multiple residues across the entire protein was investigated.

Aggregation-related modifications of  $\alpha$ -synuclein cluster to discrete regions of the protein, dependent upon the type of PTM (Figure 4). More specifically, acetylation, glycation, and HNE modifications were confined to the N-terminal region, O-GlcNAcylation targeted the NAC region, and SUMOylation, phosphorylation, and nitration were predominantly at the C-terminal region.

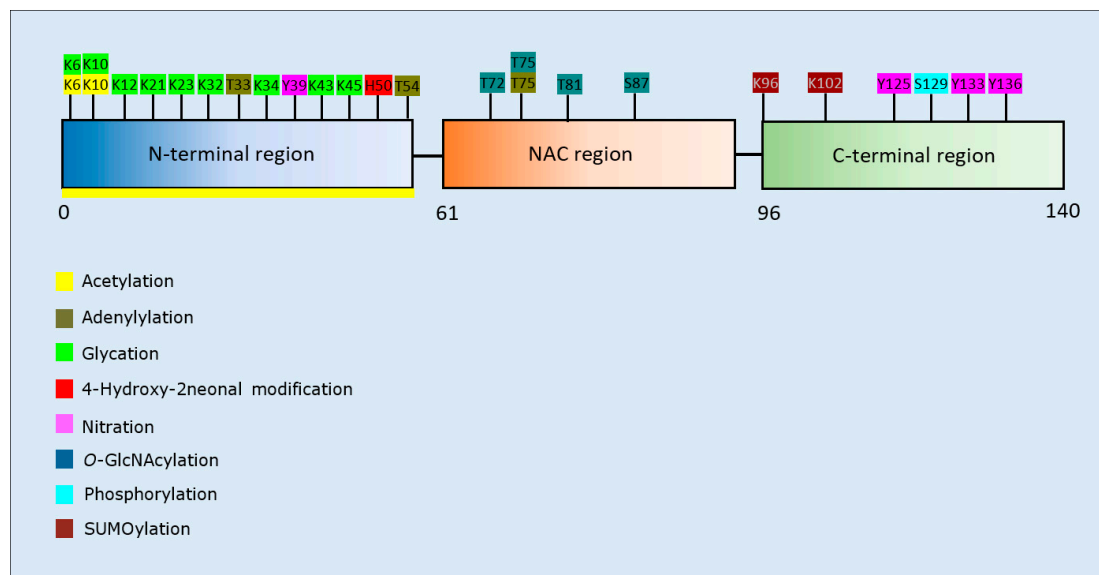

Figure 4. Schematic representation of  $\alpha$ -synuclein illustrating PTMs and respective amino acid residues.

### 3.3. Amyotrophic Lateral Sclerosis

#### 3.3.1. TAR DNA-Binding Protein 43 PTMs and Propensity for Aggregation

Acetylation of K145 and K192 increased aggregation of TDP-43 [143,144]. C-terminal fragmentation at D89 and D219 produced aggregation-prone TDP-43 fragments (residues 90–414 or residues

220–414, respectively) [145]. Phosphorylation of TDP-43 was detected at multiple sites, including S409/S410, and increased TDP-43 aggregation in two studies [146,147], but decreased the aggregation of C-terminal fragments of TDP-43 [148]. Phosphorylation at multiple serine residues (including S409 and S410) also induced a protective (reduction of aggregation) rather than pathogenic (pro-aggregation) effect [149]. C-terminal fragmentation at D219 produced a protein more prone to phosphorylation at S409/S410 [145], and similarly, acetylation at K145 promoted the accumulation of TDP-43 aggregates hyperphosphorylated at S409/S410 [144] (Table 5). TDP-43 phosphorylation arose primarily at residues clustered within the glycine-rich C-terminus (Figure 5); a protein region susceptible to formation of amyloid-like fibrils [150,151].

**Table 5.** Summary of TDP-43 PTMs and propensity for protein aggregation.

Post-Translational Modification	Residues Modified	Author & Year	Aggregation	Formation of Oligomers	Formation of Fibrillar Aggregates	Formation of Amorphous Aggregates
Acetylation	K145	Wang et al., 2017 [143]	Increase	-	-	-
	K145, K192	Cohen et al., 2015 [144]	Increase	-	-	-
C-terminal fragmentation	D89, D219	Zhang et al., 2009 [145]	Increase	-	-	-
Phosphorylation	S379, S403, S404, S409, S410, S403/S404, S409/S410, S379/S403/S404, S379/S409/S410, S403/S404/S409/S410	Li et al., 2011 [149]	Decrease	-	-	-
	S409/S410	Carlomagno et al., 2014 [146]	Increase	-	Increase	-
	S379, S403/404, S409, S410, S409/S410	Hasegawa et al., 2008 [147]	Increase	Increase	Increase	-
	S409/S410	Brady et al., 2011 [148]	Decrease	-	-	-

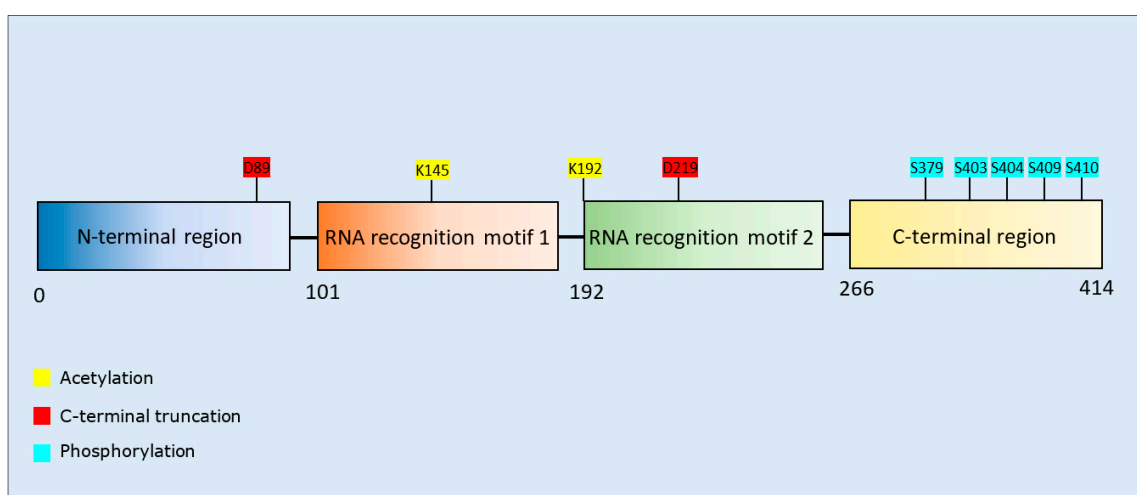

**Figure 5.** Schematic representation of TDP-43 illustrating PTMs and respective amino acid residues.

### 3.3.2. SOD1 PTMs and Propensity for Aggregation

The agent employed for acetylation of SOD1 *in vitro* as well as the site(s) of acetylation influenced the type of aggregates formed [152]. SUMOylation at K75 increased aggregation of mutant (and wild-type) SOD1 [153,154] (Table 6 and Figure 6).

**Table 6.** Summary of SOD1 PTMs and propensity for protein aggregation.

Post-Translational Modification	Residues Modified	Author & Year	Aggregation	Formation of Oligomers	Formation of Fibrillar Aggregates	Formation of Amorphous Aggregates
Acetylation	K23/K30/K36/H46/K91/K122/K128/K136 (BP *)	Rasouli et al., 2017 [152]	-	-	Decrease	-
	K36/K128 (BT *)	Rasouli et al., 2017 [152]	-	-	Decrease	Increase
	K23/S25/K30/K36/K91/K122/K128/K136 (PM *)	Rasouli et al., 2017 [152]	-	-	Decrease	Increase
	K9 (CA*)	Rasouli et al., 2017 [152]	-	-	Increase	-
	K9/K23/K30/K36/K91/K122/K136/T54/S68 (GA *)	Rasouli et al., 2017 [152]	-	-	Decrease	Increase
	K23/S25/K30/K36/K122/K128/K136 (SA *)	Rasouli et al., 2017 [152]	-	-	Increase	-
SUMOylation	K75 (SUMO3) †	Niikura et al., 2014 [153]	Increase	-	-	-
	K75 (SUMO1) ‡	Fei et al., 2006 [154]	Increase	-	-	-

\* Abbreviations: BP, 3,3',4,4'-biphenyltetracarboxylic dianhydride; BT, benzophenone-3,3',4,4'-tetracarboxylic dianhydride; PM, pyromellitic dianhydride; CA, citraconic anhydride; GA, glutaric anhydride; SA, succinic anhydride. † Mutant SOD-1 was used in this study. ‡ Wild-type and mutant SOD-1 were used in this study.

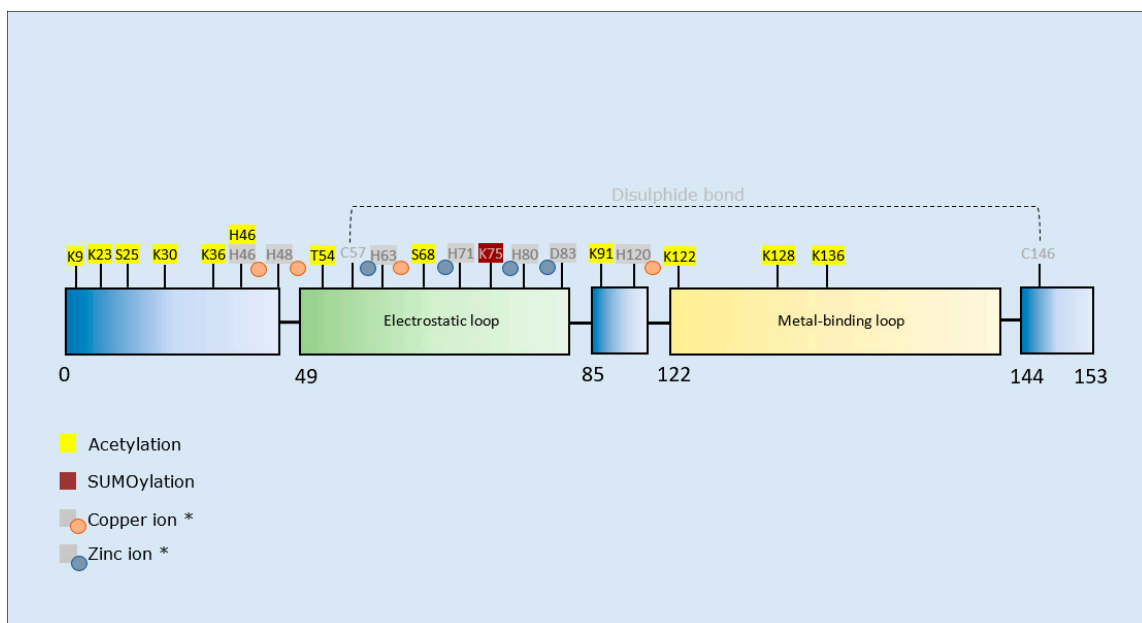

**Figure 6.** Schematic representation of SOD1 illustrating PTMs and respective amino acid residues. \* Due to their importance for SOD1 structural stability, metal-binding sites, and residues involved in disulphide bond formation are also marked.

### 3.4. Huntington's Disease

#### Htt PTMs and Propensity for Aggregation

Acetylation of Htt decreased the formation aggregated fibrils [155]. Htt phosphorylation at T3 decreased Htt aggregation [156–158], as did phosphorylation at S13 and/or S16 [159,160]. Proteolytic cleavage of mutant Htt generated fragments with an increased tendency to aggregate into nuclear and cytoplasmic inclusion bodies [161] (Table 7). Residues targeted by acetylation, phosphorylation,

or proteolytic cleavage were confined to the N-terminal region and polyQ stretch of Htt (Figure 7); regions that play a critical role in Htt aggregation behaviour [161,162].

**Table 7.** Summary of huntingtin PTMs and propensity for protein aggregation.

Post-Translational Modification	Residues Modified	Author & Year	Aggregation	Formation of Oligomers	Formation of Fibrillar Aggregates	Formation of Amorphous Aggregates
Acetylation	K6, K9, K15 ‡	Chaibva et al., 2016 [155]	Decrease		Decrease	-
Phosphorylation	T3 *	Chiki et al., 2017 [156]	Decrease	-	Decrease	-
	T3	Ansaloni et al., 2014 [157]	Decrease	Decrease	Decrease	-
	T3 *	Cariulo et al., 2017 [158]	Decrease	-	-	-
Pseudo-phosphorylation	S13, S16, S13/S16 †	DeGuire et al., 2018 [159]	Decrease	Increase	Decrease	-
	S13, S16 †	DeGuire et al., 2018 [159]	Decrease	Increase	Decrease	-
Pseudo-phosphorylation	S13/S16 *	Gu et al., 2009 [160]	Decrease	-	Decrease	-
	Cleavage site between residue 104 and 114 *	Lunkes et al., 2002 [161]	Increase	-	-	-

\* Mutant huntingtin protein was used in this study. † Wild-type and mutant huntingtin protein were used in this study. ‡ Wild-type and truncated huntingtin protein were used in this study.

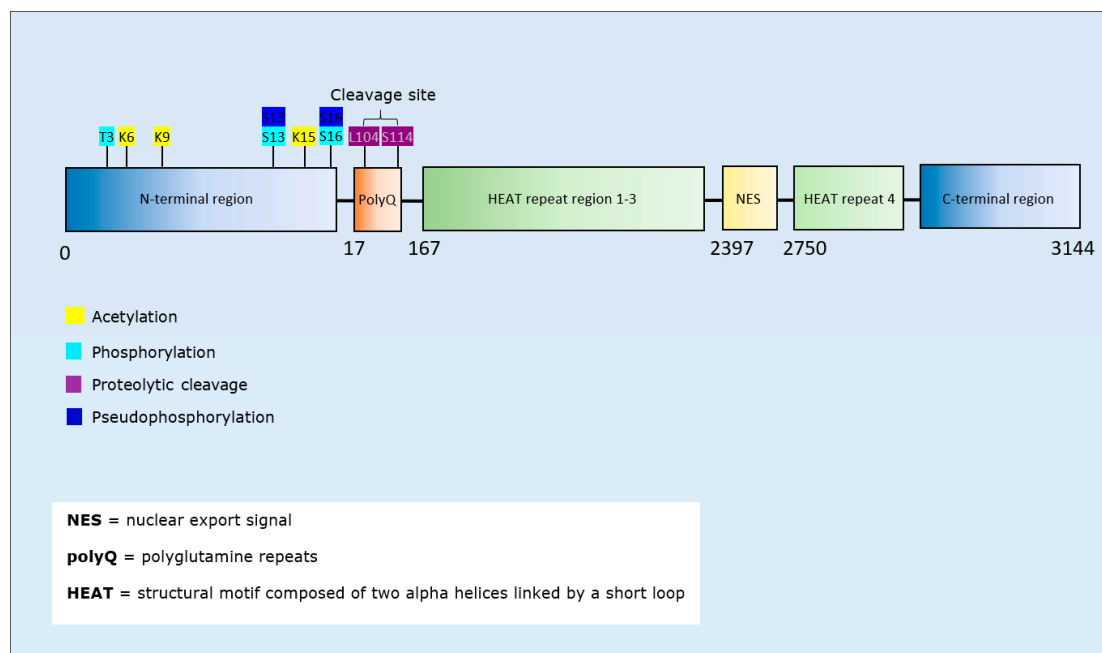

**Figure 7.** Schematic representation of huntingtin illustrating PTMs and respective amino acid residues.

### 3.5. Spinocerebellar Ataxias

#### Ataxins PTMs and Propensity for Aggregation

SUMOylation of ataxin-1 (across the whole protein) enhanced aggregation [163], as did proteolytic cleavage of ataxin-3 [164] (Table 8). Since SUMOylation of ataxin-1 was not confined to a specific amino acid residue, a schematic representation was only produced for ataxin-3. The proteolytic cleavage site was mapped to the second ubiquitin-interacting motif domain of the protein (Figure 8).



**Table 8.** Summary of ataxins PTMs and propensity for protein aggregation.

Post-Translational Modification	Residues Modified	Author & Year	Aggregation	Formation of Oligomers	Formation of Fibrillar Aggregates	Formation of Amorphous Aggregates
SUMOylation (ataxin-1)	Multiple residues	Ryu et al., 2010 [163]	Increase	-	-	-
Proteolytic Cleavage (ataxin-3)	N-terminal region cleavage near residue 250	Haacke et al., 2006 [164]	Increase	-	-	-

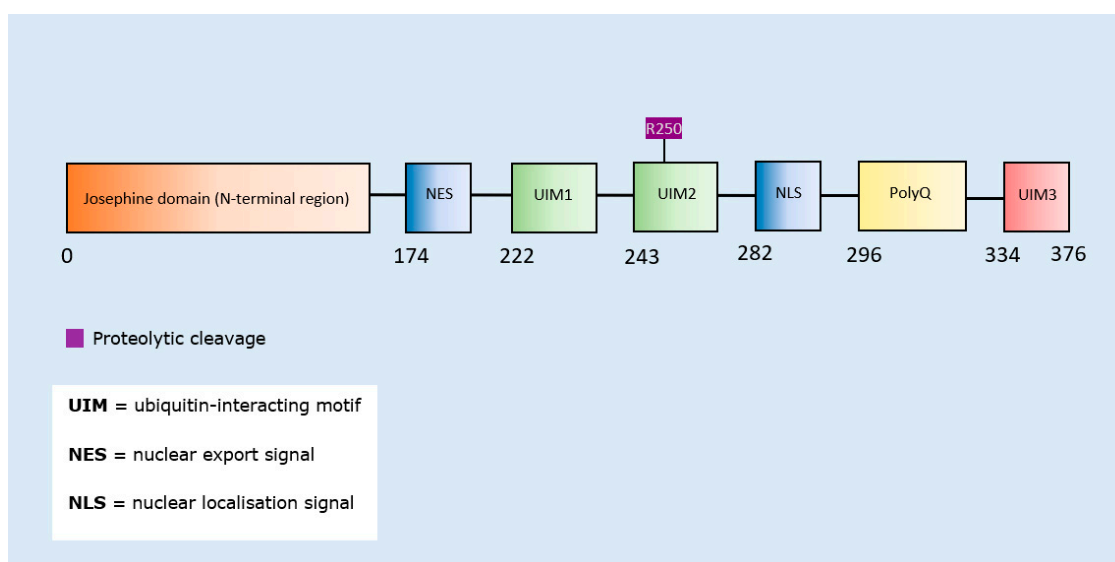
**Figure 8.** Schematic representation of ataxin-3 illustrating PTMs and respective amino acid residues.

### 3.6. Transmissible Spongiform Encephalopathies

#### Prion Protein PTMs and Propensity for Aggregation

Oxidation and nitration at multiple residues of PrP<sup>c</sup> increased aggregation propensity with enhanced formation of fibrillar as well as amorphous aggregates [165]. Phosphorylation at S43 of PrP<sup>c</sup> enhanced its aggregation, with a tendency of the phosphorylated form to produce large fibrillar and fewer amorphous aggregates than unmodified PrP<sup>c</sup> [166] (Table 9). PrP<sup>c</sup> residues susceptible to nitrative and oxidative modifications were primarily clustered within the folded C-terminal domain of the protein (Figure 9).

**Table 9.** Summary of PrP<sup>c</sup> PTMs and propensity for protein aggregation.

Post-Translational Modification	Residues Modified	Author & Year	Aggregation	Formation of Oligomers	Formation of Fibrillar Aggregates	Formation of Amorphous Aggregates
Oxidative modification and Nitration	Oxidation: W34, W60, M157, M209, M216, C217, M132/M137	Dear et al., 2007 [165]	Increase	-	Increase	Increase
	Nitration: Y41, Y41/Y52, Y131, Y148, Y152, Y153, Y158, Y221, Y227/Y228		Increase	-	Increase	Increase
Phosphorylation	S43	Giannopoulos et al., 2009 [166]	Increase	-	Increase	Decrease

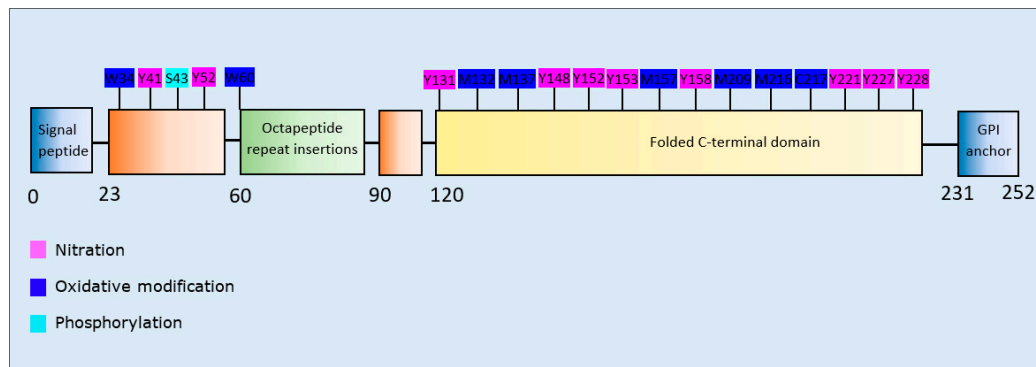

**Figure 9.** Schematic representation of PrP<sup>c</sup> illustrating PTMs and respective amino acid residues.

### 3.7. Multiple Sclerosis

**Bsn:** Bsn protein was identified only recently as a protein aggregate that may contribute to neurotoxicity in MS [12], and an examination of the influence of PTMs upon Bsn aggregation has yet to be undertaken.

**A $\beta$  and tau:** The detection of oligomeric aggregates of A $\beta$  and tau, and APP within brain tissue from MS patients [8,13] suggests that for some NDDs, a common subset of potentially toxic protein accumulations exist. The PTMs that influence protein aggregation of A $\beta$  and tau, are detailed in Tables 2 and 3, respectively, and Figures 2 and 3, respectively. Whether similar PTMs are relevant to the A $\beta$  and tau deposited in brain tissue of MS patients has yet to be determined.

## 4. Discussion

This review considered PTMs that may influence pathogenic protein aggregation in NDDs. Evidence indicating a role for PTMs in a NDD tended to reflect the prevalence of the disease: with most studies focused upon AD or PD, with relatively sparse literature coverage of PTMs in SCAs or TSEs, and no studies identified that investigated the PTM of Bsn protein in MS. Furthermore, for many of the studies of the PTMs, only a single report of the effect of the PTM has been published. However, for some of the PTMs, at least two independent studies have considered aggregation behaviour in response to a PTM at the same amino acid, and these have been discussed further:

**A $\beta$  isoaspartate:** Results from Table 2 indicate that isoaspartate formation has a pro-aggregation effect on A $\beta$ . Consistent with a role for this PTM in AD, the levels of isoaspartate in A $\beta$  was significantly higher in brain tissue from patients with AD compared with age-matched controls [167]. Isoaspartate is a non-enzymatic PTM that forms in peptides or proteins from asparagine deamination or aspartic acid isomerisation [168,169]. Isoaspartate formation influences protein structure and function since it results in a kink in the peptide backbone and the addition of a methylene group. Protein levels of isoaspartate are normally restricted in vivo via the action of the enzyme, protein L-isoaspartyl methyltransferase (PIMT) [168,169]. However, for peptides or proteins that become extracellular, including A $\beta$ , inaccessibility to cytosolic or nuclear PIMT activity renders them susceptible to ongoing isoaspartate formation. A therapeutic intervention that prevents the formation of isoaspartate within A $\beta$  and thereby limits its pro-aggregation effect may be of benefit in AD, perhaps through targeted repair of A $\beta$  or increased activity of PIMT.

**A $\beta$  phosphorylation:** The results of Table 2 suggest that there are divergent effects of phosphorylation on A $\beta$  aggregation; such that phosphorylation of S8 stimulated A $\beta$  aggregation, whereas phosphorylation at S26 decreased aggregation. Hence, total phosphorylation of A $\beta$  is unlikely to be an informative marker of aggregation propensity and toxicity. Moreover, site-specific phosphorylation may need to be considered for therapeutic interventions: agents that, for example, enhance phosphatase activity or inhibit kinase activity at S8, or conversely inhibit phosphatase activity and promote kinase activity at S26 may be useful for limiting pathogenic aggregation.

**Tau phosphorylation:** Although hyperphosphorylation of tau as a trigger for the formation of NFTs and progression of AD has been reported [170], evidence collated in this review suggests that tau phosphorylation and aggregation is only specific to certain tau isoforms (Table 3). Indeed, phosphorylation of the tau isoforms 4R0N and 3R2N resulted in decreased tau aggregation [114]. By contrast, phosphorylation or pseudo-phosphorylation of the longest tau isoform, 4R2N, increased tau aggregation [114,116,117]. Clinical treatments for AD that have utilised kinase inhibitors to prevent tau hyperphosphorylation and aggregation have had limited success [171], and future studies will need to consider those tau isoforms that exhibit increased propensity to aggregate after phosphorylation, as well as the influence of site-specific phosphorylations.

**$\alpha$ -synuclein acetylation:** Four of five studies reported reduced aggregation of  $\alpha$ -synuclein after acetylation within the N-terminal region (Table 4). Acetylation of  $\alpha$ -synuclein interferes with internal hydrogen-bonding and induces an  $\alpha$ -helical rather than  $\beta$ -pleated sheet structure, and this may be the mechanism for decreased aggregation [124,125]. In contrast, a single study reported increased  $\alpha$ -synuclein aggregation after acetylation [127]. Hence, collectively, there may be a beneficial therapeutic anti-aggregation effect upon  $\alpha$ -synuclein through targeted N-terminal acetylation.

**$\alpha$ -synuclein 4-hydroxy-2-neonal (HNE) modification:** NDDs are associated with cellular redox stress that can lead to increased lipid peroxidation and formation of the  $\alpha,\beta$ -unsaturated hydroxyalkenal, HNE, capable of covalently adducting  $\alpha$ -synuclein [133]. Adduction of  $\alpha$ -synuclein by HNE reduced the tendency of  $\alpha$ -synuclein to undergo fibrillar aggregation (Table 4) [131,133]. However, whether this could be exploited as a protective modification is equivocal, since HNE modification decreased aggregation by stabilising oligomeric intermediates, and  $\alpha$ -synuclein oligomers may also be toxic to neurons [172,173].

**$\alpha$ -synuclein O-GlcNAcylation:** Protein glycosylation as O-GlcNAcylation arises from enzymatic O-linked addition of  $\beta$ -N-acetyl-glucosamine at serine or threonine residues and is involved in a number of homeostatic mechanisms. All three studies undertaken to date reported decreased  $\alpha$ -synuclein aggregation after O-GlcNAcylation [134–136]. Furthermore, interplay between PTMs was reported, with an inhibitory effect of  $\alpha$ -synuclein T72 O-GlcNAcylation upon  $\alpha$ -synuclein S129 phosphorylation [136]; a PTM that normally enhances  $\alpha$ -synuclein aggregation and promotes neuropathology [137,138]. Collectively, these studies suggest a benefit of O-GlcNAcylation that could be manipulated by therapeutic intervention. However, total levels of O-GlcNAcylation were increased in post-mortem tissue from three PD patients compared to control subjects, although specific levels of O-GlcNAcylation of  $\alpha$ -synuclein were not determined [174].

**$\alpha$ -synuclein phosphorylation:** Phosphorylation at S129 of  $\alpha$ -synuclein has a pro-aggregation effect, is detected in LBs, and is associated with proteinopathy in PD [137,138,174]. Hence, there may be therapeutic value in manipulating the levels of this phosphorylation. To that end, a transgenic mouse model of  $\alpha$ -synucleinopathy with enhanced dephosphorylation at S129 displayed reduced aggregation and symptomatic improvement [91].

**TDP-43 acetylation:** Acetylated TDP-43 has been recovered within spinal cord of patients with ALS [144], indicative of its pathological relevance. In support of this supposition, two studies demonstrated enhanced aggregation of TDP-43 following its acetylation (Table 5). Since the acetylated residues (K145 and K192) are within the nucleic acid binding regions (Figure 5), this PTM may reduce RNA-binding of TDP-43 and promote the accumulation of dysfunctional TDP-43 aggregates [144]. Thus, preventing TDP-43 acetylation may provide a new approach for treatment of ALS.

**Superoxide Dismutase 1 SUMOylation:** SUMOylation of mutant or wild-type SOD1 by SUMO1 and SUMO3 at K75 enhanced its aggregation [153,154]. Thus, preventing SUMOylation of SOD1 may be beneficial to limit progression of fALS. Certainly, inhibition of mutant SOD1 SUMOylation at K75 has proven a successful approach to prevent SOD1 aggregation in neuronal cells [175], and therefore underpins a rationale for translation to animal models.

**Huntingtin phosphorylation:** Preclinical models of HD and HD patient brain samples display lower phosphorylation levels at T3 of huntingtin compared with controls [158]. Htt phosphorylation

at T3 as well as at S13/S16 inhibits the formation of aggregates, potentially serving as a protective mechanism against proteinopathic changes (Table 7). Consistent with this proposal, restored N-terminal Htt phosphorylation reversed neurotoxicity in a model of HD [176]. Therefore, modification of the levels of Htt phosphorylation represent a promising target for therapeutic development. Additionally, Htt phosphorylation at T3 prevents phosphorylation at S13/S16 [177]. Nevertheless, since both phosphorylation at T3 and S13/S16 decrease Htt aggregation, it will be of interest to delineate their potential cumulative effects upon Htt aggregation.

A summary of the PTMs whose manipulations may be of therapeutic benefit are included in Table 10.

**Table 10.** Summary of PTMs with therapeutic potential and suggested pharmacological interventions.

Protein	PTM	Residues	Schematic Representation of Modification	Suggested Pharmacological Intervention
A $\beta$	Isoaspartate modification	D1, D7, D23		Inhibition
A $\beta$	Phosphorylation	S8		Inhibition
A $\beta$	Phosphorylation	S26		Enhancement
$\alpha$ S	Acetylation	K6, K10, N-terminal region		Enhancement
$\alpha$ S	HNE modification	H50		Inhibition
$\alpha$ S	O-GlcNacylation	T72, T75, T81, S87		Enhancement
$\alpha$ S	Phosphorylation	S129		Inhibition
TDP-43	Acetylation	K145, K192		Inhibition

Table 10. Cont.

Protein	PTM	Residues	Schematic Representation of Modification	Suggested Pharmacological Intervention
SOD1	SUMOylation	K75		Inhibition
HTT	Phosphorylation	T3, S13, S16		Enhancement

Abbreviations:  $\alpha$ S,  $\alpha$ -synuclein.

#### 4.1. Study Limitations

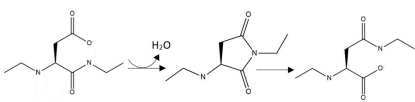
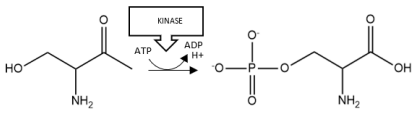
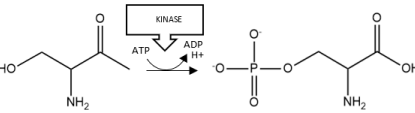
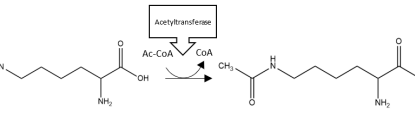
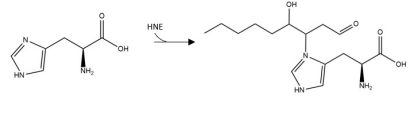
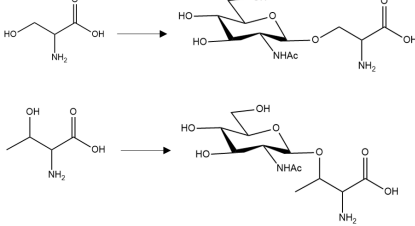
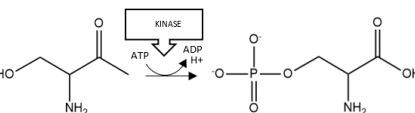
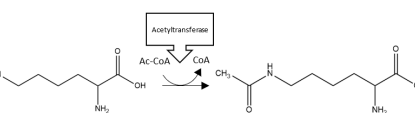
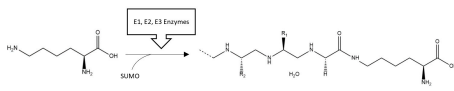
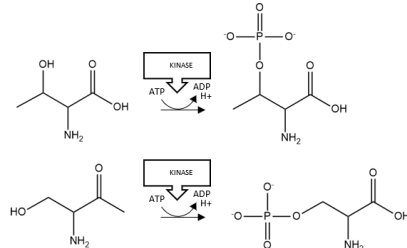
The majority of studies investigating the roles of PTMs for proteins that contribute to NDDs have been undertaken *in vitro*, and it is therefore difficult to make direct inferences to *in vivo* effects. Furthermore, while we have compiled and summarised the primary literature that has examined the effects of PTMs upon protein aggregation, these studies invariably only consider individual PTMs, and therefore will not reflect the multiple PTMs experienced within a dynamic *in vivo* system. Hence, analysis of site-specific PTMs by, for example, mass spectrometric means, only provides a snapshot of site occupancy at that juncture. Indeed, PTMs co-exist *in vivo* and may act in a permissive, reciprocal, antagonising, potentiating, or even synergistic manner to influence overall protein structure and function. Additionally, to consider functional relevance of each PTM to support therapeutic targeting, it is also important to consider the stoichiometry associated with each PTM, and this has not yet been addressed in most of the *in vitro* or *in vivo* studies.

Our study has also only focussed upon the influence of the PTM upon protein aggregation, and for which measurements of aggregation were conducted by different means. The majority of studies have utilised ThT fluorescent assays, but other protein separation and imaging systems were also used—refer to Supplementary Data, S2. Furthermore, differences between biological models, protein sources (for example, synthetic or recombinant peptides or proteins), and assay techniques, could account for some of the conflicting studies that describe the effects of PTMs on aggregation behaviour. Furthermore, we have tried to consider different aggregation elements: oligomers, fibrillary, and amorphous aggregates, but some studies have demonstrated reduced aggregate formation via increased stability of oligomeric species. Hence, one must interpret results with caution due to the unresolved debate as to whether oligomers and/or mature aggregates are the primary toxic species [178]. While both oligomers and larger aggregates are known to adopt  $\beta$ -sheet conformations, A $\beta$  and  $\alpha$ -synuclein oligomers can be arranged in antiparallel  $\beta$ -pleated sheets, whereas fibrillar aggregates display a parallel  $\beta$ -sheet structure [179,180]. Hence, differences in secondary structures, certainly for A $\beta$ , may ultimately influence neurotoxicity [181]. Lastly, the formation of toxic oligomers or aggregates may not only be a consequence of increased protein aggregation propensity, but also arise from dysfunctional protein degradation pathways.

#### 4.2. Summary and Conclusions

A more comprehensive understanding of the molecular mechanisms that trigger pathogenesis or progression of NDDs is a prerequisite to developing new treatment options. The results of this review highlight that multiple PTMs can alter aggregation potential and thereby contribute to proteinopathies.

The future development of therapies to modify PTM profiles for key NDD-related proteins may provide an as yet untapped source of novel drug treatments for NDDs.

**Supplementary Materials:** The following are available online at <http://www.mdpi.com/2076-3425/10/4/232/s1>.

**Author Contributions:** Conceptualization, L.-N.S. and W.G.C.; methodology, L.-N.S.; validation, L.-N.S. and W.G.C.; formal analysis, L.-N.S. and W.G.C.; investigation, L.-N.S. and W.G.C.; data curation, L.-N.S. and W.G.C.; writing—original draft preparation, L.-N.S. and W.G.C.; writing—review and editing, L.-N.S. and W.G.C.; supervision, W.G.C. All authors have read and agreed to the published version of the manuscript.

**Funding:** This research received no external funding.

**Conflicts of Interest:** The authors declare no conflict of interest.

## References

- Erkkinen, M.G.; Kim, M.O.; Geschwind, M.D. Clinical Neurology and epidemiology of the major neurodegenerative diseases. *Cold Spring Harb. Perspect. Biol.* **2018**, *10*, a033118. [[CrossRef](#)] [[PubMed](#)]
- Dugger, B.N.; Dickson, D.W. Pathology of neurodegenerative diseases. *Cold Spring Harb. Perspect. Biol.* **2017**, *9*, a028035. [[CrossRef](#)] [[PubMed](#)]
- Wolfe, M.S. (Ed.) Solving the puzzle of neurodegeneration. In *The Molecular and Cellular Basis of Neurodegenerative Diseases: Underlying Mechanisms*; Elsevier: London, UK, 2018.
- Sullivan, R.; Yau, W.Y.; O'Connor, E.; Houlden, H. Spinocerebellar ataxia: An update. *J. Neurol.* **2019**, *266*, 533–544. [[CrossRef](#)] [[PubMed](#)]
- Hussain, R.; Zubair, H.; Pursell, S.; Shahab, M. Neurodegenerative diseases: Regenerative mechanisms and novel therapeutic approaches. *Brain Sci.* **2018**, *8*, 177. [[CrossRef](#)]
- Ross, C.A.; Poirier, M.A. Protein aggregation and neurodegenerative disease. *Nat. Med.* **2004**, *10*, S10–S17. [[CrossRef](#)]
- Wan, L.; Xu, K.; Chen, Z.; Tang, B.; Jiang, H. Roles of post-translational modifications in spinocerebellar ataxias. *Front. Cell. Neurosci.* **2018**, *12*, 290. [[CrossRef](#)]
- David, M.A.; Tayebi, M. Detection of protein aggregates in brain and cerebrospinal fluid derived from multiple sclerosis patients. *Front. Neurol.* **2014**, *5*, 251. [[CrossRef](#)]
- Lane, C.A.; Hardy, J.; Schott, J.M. Alzheimer's disease. *Eur. J. Neurol.* **2018**, *25*, 59–70. [[CrossRef](#)]
- Blokhuis, A.M.; Groen, E.J.N.; Koppers, M.; van den Berg, L.H.; Pasterkamp, R.J. Protein aggregation in amyotrophic lateral sclerosis. *Acta Neuropathol.* **2013**, *125*, 777–794. [[CrossRef](#)]
- Ugalde, C.L.; Finkelstein, D.I.; Lawson, V.A.; Hill, A.F. Pathogenic mechanisms of prion protein, amyloid- $\beta$  and  $\alpha$ -synuclein misfolding: The prion concept and neurotoxicity of protein oligomers. *J. Neurochem.* **2016**, *139*, 162–180. [[CrossRef](#)]
- Schattling, B.; Engler, J.B.; Volkmann, C.; Rothhammer, N.; Woo, M.S.; Petersen, M.; Winkler, I.; Kaufmann, M.; Rosenkranz, S.C.; Fejtova, A.; et al. Bassoon proteinopathy drives neurodegeneration in multiple sclerosis. *Nat. Neurosci.* **2019**, *22*, 887–896. [[CrossRef](#)] [[PubMed](#)]
- Gehrmann, J.; Banati, R.B.; Cuzner, M.L.; Kreutzberg, G.W.; Newcombe, J. Amyloid precursor protein (APP) expression in multiple sclerosis lesions. *Glia* **1995**, *15*, 141–151. [[CrossRef](#)] [[PubMed](#)]
- Coarelli, G.; Brice, A.; Durr, A. Recent advances in understanding dominant spinocerebellar ataxias from clinical and genetic points of view. *F1000Res* **2018**, *7*, Rev-1781. [[CrossRef](#)] [[PubMed](#)]
- Miyasaka, T.; Watanabe, A.; Saito, Y.; Murayama, S.; Mann, D.M.A.; Yamazaki, M.; Ravid, R.; Morishima-Kawashima, M.; Nagashima, K.; Ihara, Y. Visualization of newly deposited tau in neurofibrillary tangles and neuropil threads. *J. Neuropathol. Exp. Neurol.* **2005**, *64*, 665–674. [[CrossRef](#)] [[PubMed](#)]
- Hasegawa, T.; Yoshida, S.; Sugeno, N.; Kobayashi, J.; Aoki, M. DnaJ/Hsp40 family and parkinson's disease. *Front. Neurosci.* **2018**, *11*, 743. [[CrossRef](#)] [[PubMed](#)]
- Pihlström, L.; Wiethoff, S.; Houlden, H.; Kovacs, G.G.; Alafuzoff, I. Genetics of neurodegenerative diseases: An overview. *Handb. Clin. Neurol.* **2017**, *145*, 309–323.
- Wirhth, O.; Bayer, T.A. Neuron Loss in Transgenic Mouse Models of Alzheimer's Disease. *Int. J. Alzheimers Dis.* **2010**, *12*, 723782. [[CrossRef](#)]
- Sánchez, A.; Milà, M.; Castellví-Bel, S.; Rosich, M.; Jiménez, D.; Badenas, C.; Estivill, X. Maternal transmission in sporadic Huntington's disease. *J. Neurol. Neurosurg. Psychiatry* **1997**, *62*, 535–537. [[CrossRef](#)]

20. Sim, V. Prion disease. In *BMJ Best Practice*; BMJ Publishing Group: London, UK, 2018; Available online: <https://bestpractice.bmj.com/topics/en-gb/484/pdf/484.pdf> (accessed on 20 September 2019).
21. Steenhof, M.; Stenager, E.; Nielsen, N.M.; Kyvik, K.; Möller, S.; Hertz, J.M. Familial multiple sclerosis patients have a shorter delay in diagnosis than sporadic cases. *Mult. Scler. Relat. Discord.* **2019**, *32*, 97–102. [[CrossRef](#)]
22. Kraft, S.; Furtado, S.; Ranaway, R.; Parboosingh, J.; Bleoo, S.; McElligott, K.; Bridge, P.; Spacey, S.; Das, S.; Suchowersky, O. Adult onset spinocerebellar ataxia in a Canadian movement disorders clinic. *Can. J. Neurol. Sci.* **2005**, *32*, 450–458. [[CrossRef](#)]
23. Chen, C.; Dong, X.P. Epidemiological characteristics of human prion diseases. *Infect. Dis. Poverty* **2016**, *5*, 47. [[CrossRef](#)] [[PubMed](#)]
24. Niclis, J.C.; Pinar, A.; Haynes, J.M.; Alsanie, W.; Jenny, R.; Dottori, M.; Cram, D.S. Characterization of forebrain neurons derived from late-onset Huntington’s disease human embryonic stem cell lines. *Front. Cell. Neurosci.* **2013**, *7*, 37. [[CrossRef](#)] [[PubMed](#)]
25. GBD 2016 Motor Neuron Disease Collaborators. Global, regional, and national burden of motor neuron diseases 1990–2016: A systematic analysis for the Global Burden of Disease Study 2016. *Lancet Neurol.* **2018**, *17*, 1083–1097. [[CrossRef](#)]
26. GBD 2016 Multiple Sclerosis Collaborators. Global, regional, and national burden of multiple sclerosis 1990–2016: A systematic analysis for the Global Burden of Disease Study 2016. *Lancet Neurol.* **2019**, *18*, 269–285. [[CrossRef](#)]
27. GBD 2016 Dementia Collaborators. Global, regional, and national burden of Alzheimer’s disease and other dementias, 1990–2016: A systematic analysis for the Global Burden of Disease Study 2016. *Lancet Neurol.* **2019**, *18*, 88–106. [[CrossRef](#)]
28. Tysnes, O.B.; Storstein, A. Epidemiology of Parkinson’s disease. *J. Neural. Transm.* **2017**, *124*, 901–905. [[CrossRef](#)]
29. Burré, J. The synaptic function of  $\alpha$ -Synuclein. *J. Park. Dis.* **2015**, *5*, 699–713. [[CrossRef](#)]
30. Alzheimer’s Association. 2016 Alzheimer’s disease facts and figures. *Alzheimer’s Dement. J. Alzheimers Dis.* **2016**, *12*, 459–509. [[CrossRef](#)]
31. Wortmann, M. Dementia: A global health priority - highlights from an ADI and World Health Organization report. *Alzheimers Res. Ther.* **2012**, *4*, 40. [[CrossRef](#)]
32. Burns, A.; Iliffe, S. Alzheimer’s disease. *BMJ* **2009**, *338*, b158. [[CrossRef](#)]
33. Hane, F.T.; Robinson, M.; Lee, B.Y.; Bai, O.; Leonenko, Z.; Albert, M.S. Recent progress in Alzheimer’s disease research, Part 3: Diagnosis and treatment. *J. Alzheimers Dis.* **2017**, *57*, 645–665. [[CrossRef](#)] [[PubMed](#)]
34. Perl, D.P. Neuropathology of Alzheimer’s disease. *Mt. Sinai. J. Med.* **2010**, *77*, 32–42. [[CrossRef](#)] [[PubMed](#)]
35. Gouras, G.K.; Olsson, T.T.; Hansson, O.  $\beta$ -Amyloid peptides and amyloid plaques in Alzheimer’s disease. *Neurotherapeutics* **2015**, *12*, 3–11. [[CrossRef](#)] [[PubMed](#)]
36. Brothers, H.M.; Gosztyla, M.L.; Robinson, S.R. The physiological roles of amyloid- $\beta$  peptide hint at new ways to treat Alzheimer’s disease. *Front. Ageing Neurosci.* **2018**, *10*, 118. [[CrossRef](#)]
37. Pearson, H.A.; Peers, C. Physiological roles for amyloid beta peptides. *J. Physiol.* **2006**, *575*, 5–10. [[CrossRef](#)]
38. Lührs, T.; Ritter, C.; Adrian, M.; Riek-Loher, D.; Bohrmann, B.; Döbeli, H.; Schubert, D.; Riek, R. 3D structure of Alzheimer’s amyloid-beta (1–42) fibrils. *Proc. Natl. Acad. Sci. USA* **2005**, *102*, 17342–17347. [[CrossRef](#)]
39. Braak, H.; Braak, E. Neuropathological staging of Alzheimer-related changes. *Acta Neuropathol.* **1991**, *82*, 239–259. [[CrossRef](#)]
40. Guo, T.; Noble, W.; Hanger, D.P. Roles of tau protein in health and disease. *Acta Neuropathol.* **2017**, *133*, 665–704. [[CrossRef](#)]
41. Medina, M.; Hernández, F.; Avila, J. New features about tau function and dysfunction. *Biomolecules* **2016**, *6*, 21. [[CrossRef](#)]
42. Jouanne, M.; Rault, S.; Voisin-Chiret, A.S. Tau protein aggregation in Alzheimer’s disease: An attractive target for the development of novel therapeutic agents. *Eur. J. Med. Chem.* **2017**, *139*, 153–167. [[CrossRef](#)]
43. Reeve, A.; Simcox, E.; Turnbull, D. Ageing and Parkinson’s disease: Why is advancing age the biggest risk factor? *Ageing Res. Rev.* **2014**, *14*, 19–30. [[CrossRef](#)] [[PubMed](#)]
44. Pakkenberg, H.; Brody, H. The number of nerve cells in the substantia nigra in paralysis agitans. *Acta Neuropathol.* **1965**, *5*, 320–324. [[CrossRef](#)] [[PubMed](#)]
45. DeMaagd, G.; Philip, A. Parkinson’s disease and its management: Part 1: Disease entity, risk factors, pathophysiology, clinical presentation, and diagnosis. *P T* **2015**, *40*, 504–532. [[PubMed](#)]

46. Spillantini, M.G.; Schmidt, M.L.; Lee, V.M.; Trojanowski, J.Q.; Jakes, R.; Goedert, M.  $\alpha$ -Synuclein in Lewy bodies. *Nature* **1997**, *388*, 839–840. [[CrossRef](#)]
47. Venda, L.L.; Cragg, S.J.; Buchman, V.L.; Wade-Martins, R.  $\alpha$ -Synuclein and dopamine at the crossroads of Parkinson's disease. *Trends Neurosci.* **2010**, *33*, 559–568. [[CrossRef](#)]
48. Cookson, M.R.  $\alpha$ -Synuclein and neuronal cell death. *Mol. Neurodegener.* **2009**, *4*, 9. [[CrossRef](#)]
49. Baba, M.; Nakajo, S.; Tu, P.H.; Tomita, T.; Nakaya, K.; Lee, V.M.; Trojanowski, J.Q.; Iwatsubo, T. Aggregation of  $\alpha$ -synuclein in Lewy bodies of sporadic Parkinson's disease and dementia with Lewy bodies. *Am. J. Pathol.* **1998**, *152*, 879–884.
50. Oskarsson, B.; Gendron, T.F.; Staff, N.P. Amyotrophic lateral sclerosis: An update for 2018. *Mayo Clin. Proc.* **2018**, *93*, 1617–1628. [[CrossRef](#)]
51. Zarei, S.; Carr, K.; Reiley, L.; Diaz, K.; Guerra, O.; Altamirano, P.F.; Pagani, W.; Lodin, D.; Orozco, G.; Chinaea, A. A comprehensive review of amyotrophic lateral sclerosis. *Surg. Neurol. Int.* **2015**, *6*, 171. [[CrossRef](#)]
52. Hergesheimer, R.C.; Chami, A.A.; de Assis, D.R.; Vourc'h, P.; Andres, C.R.; Corcia, P.; Lanznaster, D.; Blasco, H. The debated toxic role of aggregated TDP-43 in amyotrophic lateral sclerosis: A resolution in sight? *Brain* **2019**, *142*, 1176–1194. [[CrossRef](#)]
53. Prasad, A.; Bharathi, V.; Sivalingam, V.; Girdhar, A.; Patel, B.K. Molecular mechanisms of TDP-43 misfolding and pathology in amyotrophic lateral sclerosis. *Front. Mol. Neurosci.* **2019**, *12*, 25. [[CrossRef](#)] [[PubMed](#)]
54. Arai, T.; Hasegawa, M.; Akiyama, H.; Ikeda, K.; Nonaka, T.; Mori, H.; Mann, D.M.A.; Tsuchiya, K.; Yoshida, M.; Hashizume, Y.; et al. TDP-43 is a component of ubiquitin-positive tau-negative inclusions in frontotemporal lobar degeneration and amyotrophic lateral sclerosis. *Biochem. Biophys. Res. Commun.* **2006**, *351*, 602–611. [[CrossRef](#)] [[PubMed](#)]
55. Highley, J.R.; Kirby, J.; Jansweijer, J.A.; Webb, P.S.; Hewamadduma, C.A.; Heath, P.R.; Higginbottom, A.; Raman, R.; Ferraiuolo, L.; Cooper-Knock, J.; et al. Loss of nuclear TDP-43 in amyotrophic lateral sclerosis (ALS) causes altered expression of splicing machinery and widespread dysregulation of RNA splicing in motor neurones. *Neuropathol. Appl. Neurobiol.* **2014**, *40*, 670–685. [[CrossRef](#)] [[PubMed](#)]
56. Rakhit, R.; Chakrabarty, A. Structure, folding, and misfolding of Cu,Zn superoxide dismutase in amyotrophic lateral sclerosis. *Biochim. Biophys. Acta* **2006**, *1762*, 1025–1037. [[CrossRef](#)]
57. Pansarasa, O.; Bordoni, M.; Diamanti, L.; Sproviero, D.; Gagliardi, S.; Cereda, C. SOD1 in Amyotrophic Lateral Sclerosis: "Ambivalent" Behavior Connected to the Disease. *Int. J. Mol. Sci.* **2018**, *19*, 1345. [[CrossRef](#)]
58. Medinas, D.B.; Rozas, P.; Martínez Traub, F.; Woehlbier, U.; Brown, R.H.; Bosco, D.A.; Hetz, C. Endoplasmic reticulum stress leads to accumulation of wild-type SOD1 aggregates associated with sporadic amyotrophic lateral sclerosis. *Proc. Natl. Acad. Sci. USA* **2018**, *115*, 8209. [[CrossRef](#)]
59. Myers, R.H. Huntington's disease genetics. *NeuroRx* **2004**, *1*, 255–262. [[CrossRef](#)]
60. DiFiglia, M.; Sapp, E.; Chase, K.O.; Davies, S.W.; Bates, G.P.; Vonsattel, J.P.; Aronin, N. Aggregation of huntingtin in neuronal intranuclear inclusions and dystrophic neurites in brain. *Science* **1997**, *277*, 1990–1993. [[CrossRef](#)]
61. Huang, W.J.; Chen, W.W.; Zhang, X. Huntington's disease: Molecular basis of pathology and status of current therapeutic approaches. *Exp. Ther. Med.* **2016**, *12*, 1951–1956. [[CrossRef](#)]
62. Roos, R.A. Huntington's disease: A clinical review. *Orphanet J Rare Dis* **2010**, *5*, 40. [[CrossRef](#)]
63. Nasir, J.; Floresco, S.B.; O'Kusky, J.R.; Diewert, V.M.; Richman, J.M.; Zeisler, J.; Borowski, A.; Marth, J.D.; Phillips, A.G.; Hayden, M.R. Targeted disruption of the Huntington's disease gene results in embryonic lethality and behavioral and morphological changes in heterozygotes. *Cell* **1995**, *81*, 811–823. [[CrossRef](#)]
64. McKinstry, S.U.; Karadeniz, Y.B.; Worthington, A.K.; Hayrapetyan, V.Y.; Ozlu, M.I.; Serafin-Molina, K.; Risher, W.C.; Ustunkaya, T.; Dragatsis, I.; Zeitlin, S.; et al. Huntingtin is required for normal excitatory synapse development in cortical and striatal circuits. *J. Neurosci.* **2014**, *34*, 9455–9472. [[CrossRef](#)] [[PubMed](#)]
65. Finkbeiner, S. Huntington's disease. *Cold Spring Harb Perspect Biol.* **2011**, *3*, a007476. [[CrossRef](#)] [[PubMed](#)]
66. Kim, M. Beta conformation of polyglutamine track revealed by a crystal structure of Huntingtin N-terminal region with insertion of three histidine residues. *Prion* **2013**, *7*, 221–228. [[CrossRef](#)] [[PubMed](#)]
67. Arrasate, M.; Finkbeiner, S. Protein aggregates in Huntington's disease. *Exp. Neurol.* **2012**, *238*, 1–11. [[CrossRef](#)] [[PubMed](#)]
68. Sánchez, I.; Mahlke, C.; Yuan, J. Pivotal role of oligomerization in expanded polyglutamine neurodegenerative disorders. *Nature* **2003**, *421*, 373–379. [[CrossRef](#)]



69. Davies, S.W.; Turmaine, M.; Cozens, B.A.; DiFiglia, M.; Sharp, A.H.; Ross, C.A.; Scherzinger, E.; Wanker, E.E.; Mangiarini, L.; Bates, G.P. Formation of neuronal intranuclear inclusions underlies the neurological dysfunction in mice transgenic for the HD mutation. *Cell* **1997**, *90*, 537–548. [CrossRef]
70. Ramachandra, N.B.; Kusuma, L. An understanding of spinocerebellar ataxia. *Indian J. Med. Res.* **2015**, *141*, 148–150. [CrossRef]
71. Paulson, H.L. The spinocerebellar ataxias. *J. Neuroophthalmol.* **2009**, *29*, 227–237. [CrossRef]
72. Rabinovici, G.D.; Wang, P.N.; Levin, J.; Cook, L.; Pravdin, M.; Davis, J.; DeArmond, S.J.; Barbaro, N.M.; Martindale, J.; Miller, B.L.; et al. First symptom in sporadic Creutzfeldt–Jakob disease. *Neurology* **2006**, *66*, 286. [CrossRef]
73. Jeffrey, M.; Scott, J.; Williams, A.; Fraser, H. Ultrastructural features of spongiform encephalopathy transmitted to mice from three species of bovidae. *Acta Neuropathol.* **1992**, *84*, 559–569. [CrossRef] [PubMed]
74. Gupta, A.; Hirsch, N. Prion diseases. *Anaesth. Inten. Care Med.* **2013**, *14*, 407–409. [CrossRef]
75. Collins, S.J.; Sanchez-Juan, P.; Masters, C.L.; Klug, G.M.; van Duijn, C.; Pologgi, A.; Pocchiari, M.; Almonti, S.; Cuadrado-Corrales, N.; de Pedro-Cuesta, J.; et al. Determinants of diagnostic investigation sensitivities across the clinical spectrum of sporadic Creutzfeldt–Jakob disease. *Brain* **2006**, *129*, 2278–2287. [CrossRef]
76. Moya, K.L.; Salès, N.; Hässig, R.; Créminon, C.; Grassi, J.; Di Giamberardino, L. Immunolocalization of the cellular prion protein in normal brain. *Microsc. Res. Tech.* **2000**, *50*, 58–65. [CrossRef]
77. Um, J.W.; Nygaard, H.B.; Heiss, J.K.; Kostylev, M.A.; Stagi, M.; Vortmeyer, A.; Wisniewski, T.; Gunther, E.C.; Strittmatter, S.M. Alzheimer amyloid- $\beta$  oligomer bound to postsynaptic prion protein activates Fyn to impair neurons. *Nat. Neurosci.* **2012**, *15*, 1227–1235. [CrossRef] [PubMed]
78. Acevedo-Morantes, C.Y.; Wille, H. The structure of human prions: From biology to structural models-considerations and pitfalls. *Viruses* **2014**, *6*, 3875–3892. [CrossRef] [PubMed]
79. Bueler, H.; Fischer, M.; Lang, Y.; Bluethmann, H.; Lipp, H.P.; DeArmond, S.J.; Prusiner, S.B.; Aguet, M.; Weissmann, C. Normal development and behaviour of mice lacking the neuronal cell-surface PrP protein. *Nature* **1992**, *356*, 577–582. [CrossRef]
80. Ambadi Thody, S.; Mathew, M.K.; Udgaonkar, J.B. Mechanism of aggregation and membrane interactions of mammalian prion protein. *Biochim. Biophys. Acta Biomembr.* **2018**, *1860*, 1927–1935. [CrossRef]
81. Pan, K.M.; Baldwin, M.; Nguyen, J.; Gasset, M.; Serban, A.; Groth, D.; Mehlhorn, I.; Huang, Z.; Fletterick, R.J.; Cohen, F.E. Conversion of alpha-helices into beta-sheets features in the formation of the scrapie prion proteins. *Proc. Natl. Acad. Sci. USA* **1993**, *90*, 10962–10966. [CrossRef]
82. Kovacs, G.G.; Budka, H. Molecular pathology of human prion diseases. *Int. J. Mol. Sci.* **2009**, *10*, 976–999. [CrossRef]
83. Laurent, M. Autocatalytic processes in cooperative mechanisms of prion diseases. *FEBS Lett.* **1997**, *407*, 1–6. [CrossRef]
84. Ghasemi, N.; Razavi, S.; Nikzad, E. Multiple sclerosis: Pathogenesis, symptoms, diagnoses and cell-based therapy. *Cell J.* **2017**, *19*, 1–10. [PubMed]
85. Dutta, R.; Trapp, B.D. Relapsing and progressive forms of multiple sclerosis: Insights from pathology. *Curr. Opin. Neurol.* **2014**, *27*, 271–278. [CrossRef] [PubMed]
86. Altrock, W.D.; tom Dieck, S.; Sokolov, M.; Meyer, A.C.; Sigler, A.; Brakebusch, C.; Fässler, R.; Richter, K.; Boeckers, T.M.; Potschka, H. Functional inactivation of a fraction of excitatory synapses in mice deficient for the active zone protein bassoon. *Neuron* **2003**, *37*, 787–800. [CrossRef]
87. Takalo, M.; Salminen, A.; Soininen, H.; Hiltunen, M.; Haapasalo, A. Protein aggregation and degradation mechanisms in neurodegenerative diseases. *Am. J. Neurodegener. Dis.* **2013**, *2*, 1–14.
88. Lim, J.; Yue, Z. Neuronal aggregates: Formation, clearance, and spreading. *Dev. Cell* **2015**, *32*, 491–501. [CrossRef]
89. Uniprot Modified Residues in Proteins. Available online: <http://www.uniprot.org/docs/ptmlist.txt> (accessed on 15 March 2020).
90. Xu, H.; Wang, Y.; Lin, S.; Deng, W.; Peng, D.; Cui, Q.; Xue, Y. PTMD: A database of human disease-associated Post-translational Modifications. *Genom. Proteom. Bioinform.* **2018**, *16*, 244–251. [CrossRef]
91. Lee, K.W.; Chen, W.; Junn, E.; Im, J.Y.; Grosso, H.; Sonsalla, P.K.; Feng, X.; Ray, N.; Fernandez, J.R.; Chao, Y.; et al. Enhanced phosphatase activity attenuates  $\alpha$ -synucleinopathy in a mouse model. *J. Neurosci.* **2011**, *31*, 6963–6971. [CrossRef]

92. Lindstedt, P.R.; Aprile, F.A.; Matos, M.J.; Perni, M.; Bertoldo, J.B.; Bernardim, B.; Peter, Q.; Jiménez-Osés, G.; Knowles, T.P.J.; Dobson, C.M.; et al. Enhancement of the anti-aggregation activity of a molecular chaperone using a rationally designed post-translational modification. *ACS Cent. Sci.* **2019**, *5*, 1417–1424. [[CrossRef](#)]
93. Xue, C.; Lin, T.Y.; Chang, D.; Guo, Z. Thioflavin T as an amyloid dye: Fibril quantification, optimal concentration and effect on aggregation. *R. Soc. Open Sci.* **2017**, *4*, 160696. [[CrossRef](#)]
94. Moher, D.; Liberati, A.; Tetzlaff, J.; Altman, D.G. Preferred reporting items for systematic reviews and meta-analyses: The PRISMA statement. *BMJ* **2009**, *339*, b2535. [[CrossRef](#)]
95. Fossati, S.; Todd, K.; Sotolongo, K.; Ghiso, J.; Rostagno, A. Differential contribution of isoaspartate post-translational modifications to the fibrillization and toxic properties of amyloid  $\beta$  and the Asn23 Iowa mutation. *Biochem. J.* **2013**, *456*, 347–360. [[CrossRef](#)]
96. Shimizu, T.; Fukuda, H.; Murayama, S.; Izumiyama, N.; Shirasawa, T. Isoaspartate formation at position 23 of amyloid beta peptide enhanced fibril formation and deposited onto senile plaques and vascular amyloids in Alzheimer's disease. *J. Neurosci. Res.* **2002**, *70*, 451–461. [[CrossRef](#)] [[PubMed](#)]
97. Schilling, S.; Lauber, T.; Schaupp, M.; Manhart, S.; Scheel, E.; Böhm, G.; Demuth, H.U. On the Seeding and Oligomerization of pGlu-Amyloid Peptides (in vitro). *Biochemistry* **2006**, *45*, 12393–12399. [[CrossRef](#)]
98. Jamasbi, E.; Separovic, F.; Hossain, M.A.; Ciccotosto, G.D. Phosphorylation of a full length amyloid- $\beta$  peptide modulates its amyloid aggregation, cell binding and neurotoxic properties. *Mol. Biosyst.* **2017**, *13*, 1545–1551. [[CrossRef](#)] [[PubMed](#)]
99. Kumar, S.; Rezaei-Ghaleh, N.; Terwel, D.; Thal, D.R.; Richard, M.; Hoch, M.; Mc Donald, J.M.; Wüllner, U.; Glebov, K.; Heneka, M.T.; et al. Extracellular phosphorylation of the amyloid  $\beta$ -peptide promotes formation of toxic aggregates during the pathogenesis of Alzheimer's disease. *EMBO J.* **2011**, *30*, 2255–2265. [[CrossRef](#)] [[PubMed](#)]
100. Kumar, S.; Wirths, O.; Stüber, K.; Wunderlich, P.; Koch, P.; Theil, S.; Rezaei-Ghaleh, N.; Zweckstetter, M.; Bayer, T.A.; Brüstle, O.; et al. Phosphorylation of the amyloid  $\beta$ -peptide at Ser26 stabilizes oligomeric assembly and increases neurotoxicity. *Acta Neuropathol.* **2016**, *131*, 525–537. [[CrossRef](#)]
101. Khodadadi, S.; Riazi, G.H.; Ahmadian, S.; Hoveizi, E.; Karima, O.; Aryapour, H. Effect of N-homocysteinylation on physicochemical and cytotoxic properties of amyloid  $\beta$ -peptide. *FEBS Lett.* **2012**, *586*, 127–131. [[CrossRef](#)]
102. Zhao, J.; Wang, P.; Li, H.; Gao, Z. Nitration of Y10 in A $\beta$ 1–40: Is it a compensatory reaction against oxidative/nitrative stress and A $\beta$  aggregation? *Chem. Res. Toxicol.* **2015**, *28*, 401–407. [[CrossRef](#)]
103. Guivernau, B.; Bonet, J.; Valls-Comamala, V.; Bosch-Morató, M.; Godoy, J.A.; Inestrosa, N.C.; Perálvarez-Marín, A.; Fernández-Busquets, X.; Andreu, D.; Oliva, B.; et al. Amyloid- $\beta$  peptide nitrotyrosination stabilizes oligomers and enhances NMDAR-Mediated Toxicity. *J. Neurosci.* **2016**, *36*, 11693–11703. [[CrossRef](#)]
104. Kummer Markus, P.; Hermes, M.; Delekarte, A.; Hammerschmidt, T.; Kumar, S.; Terwel, D.; Walter, J.; Pape, H.C.; König, S.; Roeber, S.; et al. Nitration of tyrosine 10 critically enhances amyloid  $\beta$  aggregation and plaque formation. *Neuron* **2011**, *71*, 833–844. [[CrossRef](#)]
105. Emendato, A.; Milordini, G.; Zacco, E.; Sicorello, A.; Dal Piaz, F.; Guerrini, R.; Thorogate, R.; Picone, D.; Pastore, A. Glycation affects fibril formation of A $\beta$  peptides. *J. Biol. Chem.* **2018**, *293*, 13100–13111. [[CrossRef](#)]
106. Trzeciakiewicz, H.; Tseng, J.H.; Wander, C.M.; Madden, V.; Tripathy, A.; Yuan, C.X.; Cohen, T.J. A dual pathogenic mechanism links tau acetylation to sporadic tauopathy. *Sci. Rep.* **2017**, *7*, 44102. [[CrossRef](#)]
107. Haj-Yahya, M.; Lashuel, H.A. Protein semisynthesis provides access to tau disease-associated post-translational modifications (PTMs) and paves the way to deciphering the tau ptm code in health and diseased states. *J. Am. Chem. Soc.* **2018**, *140*, 6611–6621. [[CrossRef](#)] [[PubMed](#)]
108. Cohen, T.J.; Guo, J.L.; Hurtado, D.E.; Kwong, L.K.; Mills, I.P.; Trojanowski, J.Q.; Lee, V.M. The acetylation of tau inhibits its function and promotes pathological tau aggregation. *Nat. Commun.* **2011**, *2*, 252. [[CrossRef](#)]
109. Ferreón, J.C.; Jain, A.; Choi, K.J.; Tsoi, P.S.; MacKenzie, K.R.; Jung, S.Y.; Ferreón, A.C. Acetylation disfavors tau phase separation. *Int. J. Mol. Sci.* **2018**, *19*, 1360. [[CrossRef](#)] [[PubMed](#)]
110. Kamah, A.; Huvent, I.; Cantrelle, F.X.; Qi, H.; Lippens, G.; Landrieu, I.; Smet-Nocca, C. Nuclear magnetic resonance analysis of the acetylation pattern of the neuronal tau protein. *Biochemistry* **2014**, *53*, 3020. [[CrossRef](#)] [[PubMed](#)]

111. Carlomagno, Y.; Chung, D.E.C.; Yue, M.; Castanedes-Casey, M.; Madden, B.J.; Dunmore, J.; Tong, J.; DeTure, M.; Dickson, D.W.; Petrucelli, L.; et al. An acetylation-phosphorylation switch that regulates tau aggregation propensity and function. *J. Biol. Chem.* **2017**, *292*, 15277–15286. [[CrossRef](#)] [[PubMed](#)]
112. Guru KrishnaKumar, V.; Baweja, L.; Ralhan, K.; Gupta, S. Carbamylation promotes amyloidogenesis and induces structural changes in Tau-core hexapeptide fibrils. *Biochim. Biophys. Acta Gen. Subj.* **2018**, *1862*, 2590–2604. [[CrossRef](#)]
113. Yin, H.; Kuret, J. C-terminal truncation modulates both nucleation and extension phases of  $\tau$  fibrillization. *FEBS Lett.* **2006**, *580*, 211–215. [[CrossRef](#)]
114. Liu, K.; Liu, Y.; Li, L.; Qin, P.; Iqbal, J.; Deng, Y.; Qing, H. Glycation alter the process of Tau phosphorylation to change Tau isoforms aggregation property. *Biochim. Biophys. Acta* **2016**, *1862*, 192–201. [[CrossRef](#)] [[PubMed](#)]
115. Mead, E.; Kestoras, D.; Gibson, Y.; Hamilton, L.; Goodson, R.; Jones, S.; Eversden, S.; Davies, P.; O'Neill, M.; Hutton, M.; et al. Halting of caspase activity protects tau from MC1-Conformational change and aggregation. *J. Alzheimers Dis.* **2016**, *54*, 1521–1538. [[CrossRef](#)] [[PubMed](#)]
116. Necula, M.; Kuret, J. Pseudophosphorylation and glycation of tau protein enhance but do not trigger fibrillization in vitro. *J. Biol. Chem.* **2004**, *279*, 49694–49703. [[CrossRef](#)] [[PubMed](#)]
117. Chang, E.; Kim, S.; Schafer, K.N.; Kuret, J. Pseudophosphorylation of tau protein directly modulates its aggregation kinetics. *Biochim. Biophys. Acta* **2011**, *1814*, 388–395. [[CrossRef](#)]
118. Luo, H.B.; Xia, Y.Y.; Shu, X.J.; Liu, Z.C.; Feng, Y.; Liu, X.H.; Yu, G.; Yin, G.; Xiong, Y.S.; Zeng, K.; et al. SUMOylation at K340 inhibits tau degradation through deregulating its phosphorylation and ubiquitination. *Proc. Natl. Acad. Sci. USA* **2014**, *111*, 16586–16591. [[CrossRef](#)] [[PubMed](#)]
119. Yuzwa, S.A.; Cheung, A.H.; Okon, M.; McIntosh, L.P.; Vocadlo, D.J. O-GlcNAc modification of tau directly inhibits its aggregation without perturbing the conformational properties of tau monomers. *J. Mol. Biol.* **2014**, *426*, 1736–1752. [[CrossRef](#)]
120. Yoshitake, J.; Soeda, Y.; Ida, T.; Sumioka, A.; Yoshikawa, M.; Matsushita, K.; Akaike, T.; Takashima, A. Modification of Tau by 8-Nitroguanosine 3',5'-Cyclic Monophosphate (8-Nitro-cGMP): Effects of nitric oxide-linked chemical modification on tau aggregation. *J. Biol. Chem.* **2016**, *291*, 22714–22720. [[CrossRef](#)]
121. Funk, K.E.; Thomas, S.N.; Schafer, K.N.; Cooper, G.L.; Liao, Z.; Clark, D.J.; Yang, A.J.; Kuret, J. Lysine methylation is an endogenous post-translational modification of tau protein in human brain and a modulator of aggregation propensity. *Biochem. J.* **2014**, *462*, 77–88. [[CrossRef](#)]
122. Reynolds, M.R.; Berry, R.W.; Binder, L.I. Site-Specific nitration differentially influences  $\tau$  assembly in vitro. *Biochemistry* **2005**, *44*, 13997–14009. [[CrossRef](#)]
123. Bartels, T.; Kim, N.C.; Luth, E.S.; Selkoe, D.J. N-alpha-acetylation of  $\alpha$ -synuclein increases its helical folding propensity, GM1 binding specificity and resistance to aggregation. *PLoS ONE* **2014**, *9*, e103727. [[CrossRef](#)]
124. Kang, L.; Moriarty, G.M.; Woods, L.A.; Ashcroft, A.E.; Radford, S.E.; Baum, J. N-terminal acetylation of  $\alpha$ -synuclein induces increased transient helical propensity and decreased aggregation rates in the intrinsically disordered monomer. *Protein Sci.* **2012**, *21*, 911–917. [[CrossRef](#)] [[PubMed](#)]
125. Bu, B.; Tong, X.; Li, D.; Hu, Y.; He, W.; Zhao, C.; Hu, R.; Li, X.; Shao, Y.; Liu, C.; et al. N-Terminal Acetylation Preserves  $\alpha$ -Synuclein from Oligomerization by Blocking Intermolecular Hydrogen Bonds. *ACS Chem. Neurosci.* **2017**, *8*, 2145–2151. [[CrossRef](#)]
126. de Oliveira, R.M.; Vicente, M.H.; Francelle, L.; Pinho, R.; Szegö, É.M.; Martinho, R.; Munari, F.; Lázaro, D.F.; Moniot, S.; Guerreiro, P.; et al. The mechanism of sirtuin 2-mediated exacerbation of alpha-synuclein toxicity in models of Parkinson disease. *PLoS Biol.* **2017**, *15*, e2000374. [[CrossRef](#)] [[PubMed](#)]
127. Birol, M.; Wojcik, S.P.; Miranker, A.D.; Rhoades, E. Identification of N-linked glycans as specific mediators of neuronal uptake of acetylated  $\alpha$ -Synuclein. *PLoS Biol.* **2019**, *17*, e3000318. [[CrossRef](#)] [[PubMed](#)]
128. Sanyal, A.; Dutta, S.; Camara, A.; Chandran, A.; Koller, A.; Watson, B.G.; Sengupta, R.; Ysselstein, D.; Montenegro, P.; Cannon, J.; et al. Alpha-Synuclein is a target of fic-mediated adenylylation/ampylation: Possible implications for parkinson's disease. *J. Mol. Biol.* **2019**, *431*, 2266–2282. [[CrossRef](#)] [[PubMed](#)]
129. Vicente, M.H.; Szego, E.M.; Oliveira, L.M.A.; Breda, C.; Darendelioglu, E.; de Oliveira, R.M.; Ferreira, D.G.; Gomes, M.A.; Rott, R.; Oliveira, M.; et al. Glycation potentiates alpha-synuclein-associated neurodegeneration in synucleinopathies. *Brain* **2017**, *140*, 1399–1419. [[CrossRef](#)]
130. Krumova, P.; Meulmeester, E.; Garrido, M.; Tirard, M.; Hsiao, H.H.; Bossis, G.; Urlaub, H.; Zweckstetter, M.; Kügler, S.; Melchior, F.; et al. Sumoylation inhibits alpha-synuclein aggregation and toxicity. *J. Cell Biol.* **2011**, *194*, 49–60. [[CrossRef](#)]

131. Xiang, W.; Schlachetzki, J.C.M.; Helling, S.; Bussmann, J.C.; Berlinghof, M.; Schäffer, T.E.; Marcus, K.; Winkler, J.; Klucken, J.; Becker, C.M. Oxidative stress-induced posttranslational modifications of alpha-synuclein: Specific modification of alpha-synuclein by 4-hydroxy-2-nonenal increases dopaminergic toxicity. *Mol. Cell. Neurosci.* **2013**, *54*, 71–83. [[CrossRef](#)]
132. Xiang, W.; Menges, S.; Schlachetzki, J.C.; Meixner, H.; Hoffmann, A.C.; Schlötzer-Schrehardt, U.; Becker, C.M.; Winkler, J.; Klucken, J. Posttranslational modification and mutation of histidine 50 trigger alpha synuclein aggregation and toxicity. *Mol. Neurodegener.* **2015**, *10*, 8. [[CrossRef](#)]
133. Qin, Z.; Hu, D.; Han, S.; Reaney, S.; Di Monte, D.; Fink, A. Effect of 4-hydroxy-2-nonenal modification on alpha-synuclein aggregation. *J. Biol. Chem.* **2007**, *282*, 5862–5870. [[CrossRef](#)]
134. Levine, P.M.; Galesic, A.; Balana, A.T.; Mahul-Mellier, A.L.; Navarro, M.X.; De Leon, C.A.; Lashuel, H.A.; Pratt, M.R.  $\alpha$ -Synuclein O-GlcNAcylation alters aggregation and toxicity, revealing certain residues as potential inhibitors of Parkinson's disease. *PNAS USA* **2019**, *116*, 1511–1519. [[CrossRef](#)] [[PubMed](#)]
135. Zhang, J.; Lei, H.; Chen, Y.; Ma, Y.T.; Jiang, F.; Tan, J.; Zhang, Y.; Li, J.D. Enzymatic O-GlcNAcylation of alpha-synuclein reduces aggregation and increases SDS-resistant soluble oligomers. *Neurosci. Lett.* **2017**, *655*, 90–94. [[CrossRef](#)] [[PubMed](#)]
136. Marotta, N.P.; Lin, Y.H.; Lewis, Y.E.; Ambroso, M.R.; Zaro, B.W.; Roth, M.T.; Arnold, D.B.; Langen, R.; Pratt, M.R. O-GlcNAc modification blocks the aggregation and toxicity of the protein  $\alpha$ -synuclein associated with Parkinson's disease. *Nat. Chem.* **2015**, *7*, 913–920. [[CrossRef](#)] [[PubMed](#)]
137. Fujiwara, H.; Hasegawa, M.; Dohmae, N.; Kawashima, A.; Masliah, E.; Goldberg, M.S.; Shen, J.; Takio, K.; Iwatsubo, T.  $\alpha$ -Synuclein is phosphorylated in synucleinopathy lesions. *Nat. Cell Biol.* **2002**, *4*, 160–164. [[CrossRef](#)]
138. Samuel, F.; Flavin, W.P.; Iqbal, S.; Pacelli, C.; Sri Renganathan, S.D.; Trudeau, L.E.; Campbell, E.M.; Fraser, P.E.; Tandon, A. Effects of Serine 129 Phosphorylation on  $\alpha$ -Synuclein Aggregation, Membrane Association, and Internalization. *J. Biol. Chem.* **2016**, *291*, 4374–4385. [[CrossRef](#)]
139. Burai, R.; Ait-Bouziad, N.; Chiki, A.; Lashuel, H.A. Elucidating the role of site-specific nitration of  $\alpha$ -synuclein in the pathogenesis of parkinson's disease via protein semisynthesis and mutagenesis. *J. Am. Chem. Soc.* **2015**, *137*, 5041–5052. [[CrossRef](#)]
140. Liu, Y.; Qiang, M.; Wei, Y.; He, R. A novel molecular mechanism for nitrated {alpha}-synuclein-induced cell death. *J. Mol. Cell. Biol.* **2011**, *3*, 239–249. [[CrossRef](#)]
141. Hodara, R.; Norris, E.H.; Giasson, B.I.; Mishizen-Eberz, A.J.; Lynch, D.R.; Lee, V.M.; Ischiropoulos, H. Functional consequences of alpha-synuclein tyrosine nitration: Diminished binding to lipid vesicles and increased fibril formation. *J. Biol. Chem.* **2004**, *279*, 47746–47753. [[CrossRef](#)]
142. Souza, J.M.; Giasson, B.I.; Chen, Q.; Lee, V.M.; Ischiropoulos, H. Dityrosine cross-linking promotes formation of stable alpha -synuclein polymers. Implication of nitrate and oxidative stress in the pathogenesis of neurodegenerative synucleinopathies. *J. Biol. Chem.* **2000**, *275*, 18344–18349. [[CrossRef](#)]
143. Wang, P.; Wander, C.M.; Yuan, C.X.; Bereman, M.S.; Cohen, T.J. Acetylation-induced TDP-43 pathology is suppressed by an HSF1-dependent chaperone program. *Nat. Commun.* **2017**, *8*, 82. [[CrossRef](#)]
144. Cohen, T.J.; Hwang, A.W.; Restrepo, C.R.; Yuan, C.X.; Trojanowski, J.Q.; Lee, V.M.Y. An acetylation switch controls TDP-43 function and aggregation propensity. *Nat. Commun.* **2015**, *6*, 5845. [[CrossRef](#)] [[PubMed](#)]
145. Zhang, Y.J.; Xu, Y.F.; Cook, C.; Gendron, T.F.; Roettges, P.; Link, C.D.; Lin, W.L.; Tong, J.; Castanedes-Casey, M.; Ash, P.; et al. Aberrant cleavage of TDP-43 enhances aggregation and cellular toxicity. *Proc. Natl. Acad. Sci. USA* **2009**, *106*, 7607–7612. [[CrossRef](#)] [[PubMed](#)]
146. Carlomagno, Y.; Zhang, Y.; Davis, M.; Lin, W.L.; Cook, C.; Dunmore, J.; Tay, W.; Menkosky, K.; Cao, X.; Petrucelli, L.; et al. Casein kinase II induced polymerization of soluble TDP-43 into filaments is inhibited by heat shock proteins. *PLoS ONE* **2014**, *9*, e90452. [[CrossRef](#)] [[PubMed](#)]
147. Hasegawa, M.; Arai, T.; Nonaka, T.; Kametani, F.; Yoshida, M.; Hashizume, Y.; Beach, T.G.; Buratti, E.; Baralle, F.; Morita, M.; et al. Phosphorylated TDP-43 in frontotemporal lobar degeneration and amyotrophic lateral sclerosis. *Ann. Neurol.* **2008**, *64*, 60–70. [[CrossRef](#)] [[PubMed](#)]
148. Brady, O.A.; Meng, P.; Zheng, Y.; Mao, Y.; Hu, F. Regulation of TDP-43 aggregation by phosphorylation and p62/SQSTM1. *J. Neurochem.* **2011**, *116*, 248–259. [[CrossRef](#)]
149. Li, H.Y.; Yeh, P.A.; Chiu, H.C.; Tang, C.Y.; Tu, B.P. Hyperphosphorylation as a defense mechanism to reduce TDP-43 aggregation. *PLoS ONE* **2011**, *6*, e23075. [[CrossRef](#)] [[PubMed](#)]

150. Prasad, A.; Sivalingam, V.; Bharathi, V.; Girdhar, A.; Patel, B.K. The amyloidogenicity of a C-terminal region of TDP-43 implicated in Amyotrophic Lateral Sclerosis can be affected by anions, acetylation and homodimerization. *Biochimie* **2018**, *150*, 76–87. [[CrossRef](#)]
151. Yang, C.; Tan, W.; Whittle, C.; Qui, L.; Cao, L.; Akbarian, S.; Xu, Z. The C-terminal TDP-43 fragments have a high aggregation propensity and harm neurons by a dominant-negative mechanism. *PLoS ONE* **2011**, *5*, e15878. [[CrossRef](#)]
152. Rasouli, S.; Abdolvahabi, A.; Croom, C.M.; Plewman, D.L.; Shi, Y.; Ayers, J.I.; Shaw, B.F. Lysine acylation in superoxide dismutase-1 electrostatically inhibits formation of fibrils with prion-like seeding. *J. Biol. Chem.* **2017**, *292*, 19366–19380. [[CrossRef](#)]
153. Niikura, T.; Kita, Y.; Abe, Y. SUMO3 modification accelerates the aggregation of ALS-linked SOD1 mutants. *PLoS ONE* **2014**, *9*, e101080. [[CrossRef](#)]
154. Fei, E.; Jia, N.; Yan, M.; Ying, Z.; Sun, Q.; Wang, H.; Zhang, T.; Ma, X.; Ding, H.; Yao, X.; et al. SUMO-1 modification increases human SOD1 stability and aggregation. *Biochem. Biophys. Res. Commun.* **2006**, *347*, 406–412. [[CrossRef](#)] [[PubMed](#)]
155. Chaibva, M.; Jawahery, S.; Pilkington Albert, W.; Arndt James, R.; Sarver, O.; Valentine, S.; Matysiak, S.; Legleiter, J. Acetylation within the first 17 residues of huntingtin exon 1 alters aggregation and lipid binding. *Biophys. J.* **2016**, *111*, 349–362. [[CrossRef](#)] [[PubMed](#)]
156. Chiki, A.; DeGuire, S.M.; Ruggeri, F.S.; Sanfelice, D.; Ansaloni, A.; Wang, Z.M.; Cendrowska, U.; Burai, R.; Vieweg, S.; Pastore, A.; et al. Mutant exon1 huntingtin aggregation is regulated by T3 phosphorylation-induced structural changes and crosstalk between T3 phosphorylation and acetylation at K6. *Angew. Chem. Int. Ed. Engl.* **2017**, *56*, 5202–5207. [[CrossRef](#)] [[PubMed](#)]
157. Ansaloni, A.; Wang, Z.M.; Jeong, J.S.; Ruggeri, F.S.; Dietler, G.; Lashuel, H.A. One-Pot semisynthesis of Exon 1 of the huntingtin protein: New tools for elucidating the role of posttranslational modifications in the pathogenesis of huntington's disease. *Angew. Chem. Int. Ed. Engl.* **2014**, *53*, 1928–1933. [[CrossRef](#)]
158. Cariulo, C.; Azzollini, L.; Verani, M.; Martufi, P.; Boggio, R.; Chiki, A.; Deguire, S.M.; Cherubini, M.; Gines, S.; Marsh, J.L.; et al. Phosphorylation of huntingtin at residue T3 is decreased in Huntington's disease and modulates mutant huntingtin protein conformation. *Proc. Natl. Acad. Sci. USA* **2017**, *114*, E10809. [[CrossRef](#)]
159. DeGuire, S.M.; Ruggeri, F.S.; Fares, M.B.; Chiki, A.; Cendrowska, U.; Dietler, G.; Lashuel, H.A. N-terminal Huntingtin (Htt) phosphorylation is a molecular switch regulating Htt aggregation, helical conformation, internalization, and nuclear targeting. *J. Biol. Chem.* **2018**, *293*, 18540–18558. [[CrossRef](#)]
160. Gu, X.; Greiner, E.R.; Mishra, R.; Kodali, R.; Osmand, A.; Finkbeiner, S.; Steffan, J.S.; Thompson, L.M.; Wetzel, R.; Yang, X.W. Serines 13 and 16 are critical determinants of full-length human mutant huntingtin induced disease pathogenesis in HD mice. *Neuron* **2009**, *64*, 828–840. [[CrossRef](#)]
161. Lunkes, A.; Lindenbergh, K.S.; Ben-Haïem, L.; Weber, C.; Devys, D.; Landwehrmeyer, G.B.; Mandel, J.L.; Trotter, Y. Proteases acting on mutant huntingtin generate cleaved products that differentially build up cytoplasmic and nuclear inclusions. *Mol. Cell* **2002**, *10*, 259–269. [[CrossRef](#)]
162. Raspe, M.; Gillis, J.; Krol, H.; Krom, S.; Bosch, K.; van Veen, H.; Reits, E. Mimicking proteasomal release of polyglutamine peptides initiates aggregation and toxicity. *J. Cell Sci.* **2009**, *122*, 3262–3271. [[CrossRef](#)]
163. Ryu, J.; Cho, S.; Park, B.C.; Lee, D.H. Oxidative stress-enhanced SUMOylation and aggregation of ataxin-1: Implication of JNK pathway. *Biochem. Biophys. Res. Commun.* **2010**, *393*, 280–285. [[CrossRef](#)]
164. Haacke, A.; Broadley, S.A.; Boteva, R.; Tzvetkov, N.; Hartl, F.U.; Breuer, P. Proteolytic cleavage of polyglutamine-expanded ataxin-3 is critical for aggregation and sequestration of non-expanded ataxin-3. *Hum. Mol. Genet.* **2006**, *15*, 555–568. [[CrossRef](#)] [[PubMed](#)]
165. Dear, D.V.; Young, D.S.; Kazlauskaite, J.; Meersman, F.; Oxley, D.; Webster, J.; Pinheiro, T.J.; Gill, A.C.; Bronstein, I.; Lowe, C.R. Effects of post-translational modifications on prion protein aggregation and the propagation of scrapie-like characteristics in vitro. *Biochim. Biophys. Acta* **2007**, *1774*, 792–802. [[CrossRef](#)] [[PubMed](#)]
166. Giannopoulos, P.N.; Robertson, C.; Jodoin, J.; Paudel, H.; Booth, S.A.; LeBlanc, A.C. Phosphorylation of prion protein at serine 43 induces prion protein conformational change. *J. Neurosci.* **2009**, *29*, 8743–8751. [[CrossRef](#)] [[PubMed](#)]
167. Moro, M.L.; Phillips, A.S.; Gaimster, K.; Paul, C.; Mudher, A.; Nicoll, J.A.R.; Boche, D. Pyroglutamate and Isoaspartate modified Amyloid-Beta in ageing and Alzheimer's disease. *Acta Neuropathol. Commun.* **2018**, *6*, 3. [[CrossRef](#)] [[PubMed](#)]

168. Vigneswara, V.; Cass, S.; Wayne, D.; Bolt, E.L.; Ray, D.E.; Carter, W.G. Molecular ageing of alpha- and Beta-synucleins: Protein damage and repair mechanisms. *PLoS ONE* **2013**, *8*, E61442. [[CrossRef](#)] [[PubMed](#)]
169. Vigneswara, V.; Lowenson, J.D.; Powell, C.D.; Thakur, M.; Bailey, K.; Clarke, S.; Ray, D.E.; Carter, W.G. Proteomic identification of novel substrates of a protein isoaspartyl methyltransferase repair enzyme. *J. Biol. Chem.* **2006**, *281*, 32619–32629. [[CrossRef](#)]
170. Neddens, J.; Temmel, M.; Flunkert, S.; Kerschbaumer, B.; Hoeller, C.; Loeffler, T.; Niederkofler, V.; Daum, G.; Attems, J.; Hutter-Paier, B. Phosphorylation of different tau sites during progression of Alzheimer's disease. *Acta Neuropathol. Commun.* **2018**, *6*, 52. [[CrossRef](#)]
171. Congdon, E.E.; Sigurdsson, E.M. Tau-targeting therapies for Alzheimer disease. *Nat. Rev. Neurol.* **2018**, *14*, 399–415. [[CrossRef](#)]
172. Helwig, M.; Klinkenberg, M.; Rusconi, R.; Musgrove, R.E.; Majbour, N.K.; El-Agnaf, O.M.; Ulusoy, A.; Di Monte, D.A. Brain propagation of transduced alpha-synuclein involves non-fibrillar protein species and is enhanced in alpha-synuclein null mice. *Brain* **2016**, *139*, 856–870. [[CrossRef](#)]
173. Winner, B.; Jappelli, R.; Maji, S.K.; Desplats, P.A.; Boyer, L.; Aigner, S.; Hetzer, C.; Loher, T.; Vilar, M.; Campioni, S.; et al. In vivo demonstration that alpha-synuclein oligomers are toxic. *Proc. Natl. Acad. Sci. USA* **2011**, *108*, 4194–4199. [[CrossRef](#)]
174. Saito, Y.; Kawashima, A.; Ruberu, N.N.; Fujiwara, H.; Koyama, S.; Sawabe, M.; Arai, T.; Nagura, H.; Yamanouchi, H.; Hasegawa, M.; et al. Accumulation of phosphorylated  $\alpha$ -synuclein in aging human brain. *J. Neuropathol. Exp. Neurol.* **2003**, *62*, 644–654. [[CrossRef](#)] [[PubMed](#)]
175. Dangoumau, A.; Marouillat, S.; Burlaud Gaillard, J.; Uzbekov, R.; Veyrat-Durebex, C.; Blasco, H.; Arnoult, C.; Corcia, P.; Andres, C.R.; Vourc'h, P. Inhibition of Pathogenic mutant SOD1 aggregation in cultured motor neuronal cells by prevention of its sumoylation on lysine 75. *Neurodegener. Dis.* **2016**, *16*, 161–171. [[CrossRef](#)] [[PubMed](#)]
176. Bowie, L.E.; Maiuri, T.; Alpaugh, M.; Gabriel, M.; Arbez, N.; Galleguillos, D.; Hung, C.L.K.; Patel, S.; Xia, J.; Hertz, N.T.; et al. N6-Furfuryladenine is protective in Huntington's disease models by signaling huntingtin phosphorylation. *Proc. Natl. Acad. Sci. USA* **2018**, *115*, E7081–E7090. [[CrossRef](#)] [[PubMed](#)]
177. Herrera, F.; Branco-Santos, J.; Outeiro, T. Threonine 3 regulates Serine 13/16 phosphorylation in the huntingtin exon 1. *Matters Sel.* **2019**. [[CrossRef](#)]
178. Verma, M.; Vats, A.; Taneja, V. Toxic species in amyloid disorders: Oligomers or mature fibrils. *Ann. Indian Acad. Neurol.* **2015**, *18*, 138–145. [[PubMed](#)]
179. Celej María, S.; Sarroukh, R.; Goormaghtigh, E.; Fidelio Gerardo, D.; Ruysschaert, J.M.; Raussens, V. Toxic prefibrillar  $\alpha$ -synuclein amyloid oligomers adopt a distinctive antiparallel  $\beta$ -sheet structure. *Biochem. J.* **2012**, *443*, 719–726. [[CrossRef](#)]
180. Cerf, E.; Sarroukh, R.; Tamamizu-Kato, S.; Breydo, L.; Derclaye, S.; Dufrene, Y.F.; Narayanaswami, V.; Goormaghtigh, E.; Ruysschaert, J.M.; Raussens, V. Antiparallel beta-sheet: A signature structure of the oligomeric amyloid beta-peptide. *Biochem. J.* **2009**, *421*, 415–423. [[CrossRef](#)]
181. Simmons, L.K.; May, P.C.; Tomaselli, K.J.; Rydel, R.E.; Fuson, K.S.; Brigham, E.F.; Wright, S.; Lieberburg, I.; Becker, G.W.; Brems, D.N.; et al. Secondary structure of amyloid beta peptide correlates with neurotoxic activity in vitro. *Mol. Pharmacol.* **1994**, *45*, 373–379.

