

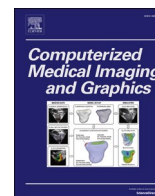

Since January 2020 Elsevier has created a COVID-19 resource centre with free information in English and Mandarin on the novel coronavirus COVID-19. The COVID-19 resource centre is hosted on Elsevier Connect, the company's public news and information website.

Elsevier hereby grants permission to make all its COVID-19-related research that is available on the COVID-19 resource centre - including this research content - immediately available in PubMed Central and other publicly funded repositories, such as the WHO COVID database with rights for unrestricted research re-use and analyses in any form or by any means with acknowledgement of the original source. These permissions are granted for free by Elsevier for as long as the COVID-19 resource centre remains active.



# Evaluation of deep learning approaches for identification of different corona-virus species and time series prediction

Mohammed Chachan Younis\*

University of Mosul, College of Computer Sciences and Mathematics, Computer Sciences Department, Mosul, Iraq

## ARTICLE INFO

### Keywords:

NCOV  
Convolutional Neural Networks  
LSTM  
VGG-16

## ABSTRACT

Novel corona-virus (nCOV) has been declared as a pandemic that started from the city Wuhan of China. This deadly virus is infecting people rapidly and has targeted 4.93 million people across the world, with 227 K people being infected only in Italy. Cases of nCOV are quickly increasing whereas the number of nCOV test kits available in hospitals are limited. Under these conditions, an automated system for the classification of patients into nCOV positive and negative cases, is a much needed tool against the pandemic, helping in a selective use of the limited number of test kits. In this research, Convolutional Neural Network-based models (one block VGG, two block VGG, three block VGG, four block VGG, LetNet-5, AlexNet, and Resnet-50) have been employed for the detection of Corona-virus and SARS\_MERS infected patients, distinguishing them from the healthy subjects, using lung X-ray scans, which has proven to be a challenging task, due to overlapping characteristics of different corona virus types. Furthermore, LSTM model has been used for time series forecasting of nCOV cases, in the following 10 days, in Italy. The evaluation results obtained, proved that the VGG1 model distinguishes the three classes at an accuracy of almost 91%, as compared to other models, whereas the approach based on the LSTM predicts the number of nCOV cases with 99% accuracy.

## 1. Introduction

Novel corona-virus (nCOV) disease originated in Wuhan, China, has widely spread all across the globe, since January 2020 (Coronavirus, 2019). The pandemic of nCOV was announced as “Public Health Emergency of International Concern” by the World Health Organization (WHO) on 30 January 2020 (W.H. Organization et al., 2020). This deadly virus was termed as Novel corona-virus by WHO in February 2020 (W.H. Organization et al., 2020). nCOV has infected 3,513,292 people worldwide, including 245,494 deaths and 1,132,677 recoveries, (according to data dated 3rd May 2020) (Singh et al., 2020). USA is the most affected country, having 1,188,385 confirmed cases, while in other countries the numbers are as follows: Spain (247,122), Italy (210,717), UK (186,599), France (168,693) and Germany (165,664) (Singh et al., 2020). India being the second most populated country in the world has recorded 42,533 COVID-19 confirmed cases, including 1391 reported deaths, until the 4th of May 2020. Dry cough and fever are a few characteristic signs and symptoms of nCOV, while fatigue, headache and dyspnea are other usual symptoms (Surveillances, 2020; Xie, 2020; Wang et al., 2020a).

SARS-CoV-2 virus, also known as severe acute respiratory syndrome Corona-virus 2, is responsible for the COVID-19 global pandemic (Stoecklin et al., 2020). Diseases like Middle East Respiratory Syndrome (MERS-CoV) and Severe Acute Respiratory Syndrome (SARS-CoV) are induced by the wide family of Corona-viruses. COVID-19 is a new class of Corona-viruses family, initially observed in humans in December 2019 (Narin et al., 2020). According to research, humans caught the MERS-CoV virus from dromedary and the SARS-CoV virus from musk cats (Narin et al., 2020; Huang et al., 2020).

No particular medication is available for COVID-19 until now, the only effective action is to identify the disease at an initial stage and immediately isolate the infected patients. As reported by the Chinese Government, Real-Time Polymerase Chain Reaction (RT-PCR) is a verified method of COVID-19 diagnosis (Ai et al., 2020). Still, RT-PCR demonstrates prolonged and high false-negative rates (Ai et al., 2020; Butt et al., 2020; Wang et al., 2020b; Sethy and Behera, 2020; Narin et al., 2020). In a pandemic situation, a low responsiveness of RT-PCR is not acceptable. In some circumstances, the Corona positive patient may not be identified and treated in time. Due to the infectious nature of nCOV, the Corona positive patient may act as a carrier and infect other

\* Corresponding author.

E-mail address: [mohammed.c.y@uomosul.edu.iq](mailto:mohammed.c.y@uomosul.edu.iq).

<https://doi.org/10.1016/j.compmedimag.2021.101921>

Received 27 May 2020; Received in revised form 28 January 2021; Accepted 5 April 2021

Available online 23 April 2021

0895-6111/© 2021 Elsevier Ltd. All rights reserved.

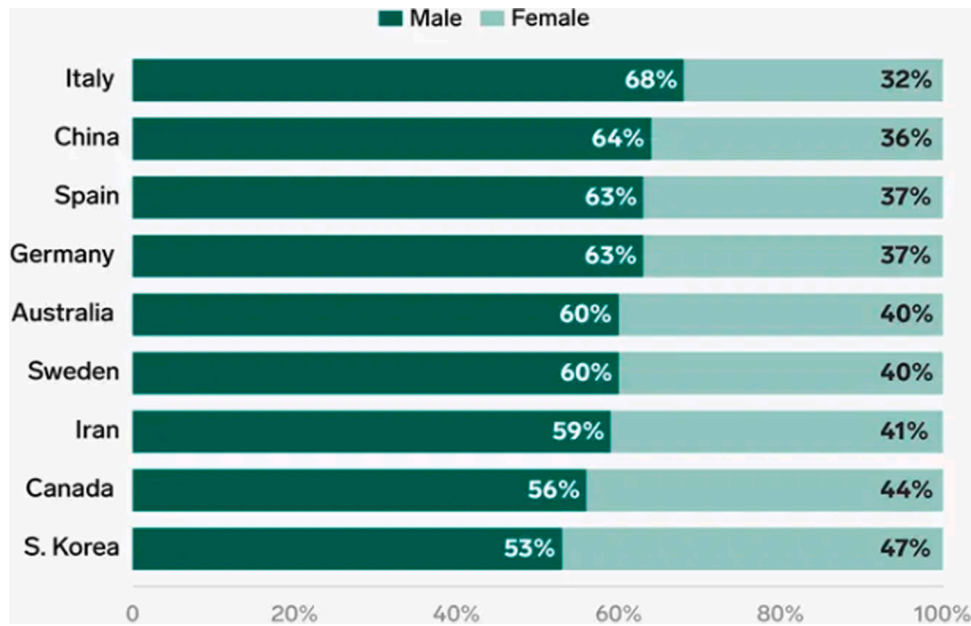

Fig. 1. Male vs. Female COVID-19 deaths (W. Health Organization, 2020).

### A breakdown of deaths by age

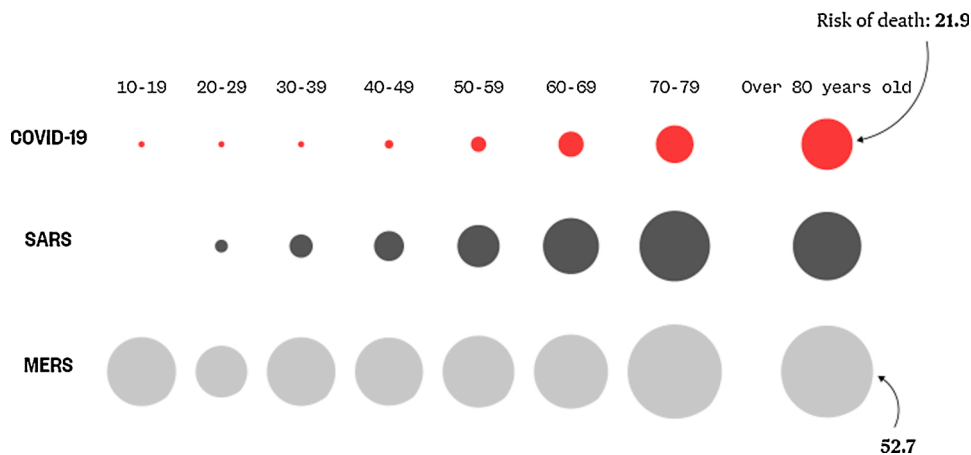

Fig. 2. Comparison study of COVID-19, SARS and MERS mortality rate (nbcnews, 2020).

people too.

According to a study (Narin et al., 2020), the number of infected males is higher than that of infected females and no death is reported among children between the age of 0 and 9 years old. People with pre-existing respiratory diseases are more likely to be infected with COVID-19 pneumonia, rather than healthy people (Wang et al., 2020). Male vs. female COVID-19 deaths, recorded across the world, are shown in Fig. 1 (WHO, 2020).

National health systems of even advanced countries failed, due to the rapidly increasing need for Intensive Care Units (ICUs). ICUs are packed with nCOV patients in critical conditions. A comparison study of COVID-19, SARS and MERS mortality rate is shown in Fig. 2 (nbcnews, 2020).

In recent publications, the Chinese government stated that blood samples or gene sequencing of respiratory system should be used as a key indicator to establish the examination of nCOV for hospitalization or reverse transcription-polymerase chain reaction (RT-PCR) (Littrup et al., 2005).

COVID-19 chest scan showing obvious pneumonia pattern, is now a

part of the diagnosis phase, rather than waiting for the patient to get a positive virus test result. By using this model, nCOV infected patients can be immediately isolated and treated accordingly. After surviving the COVID-19 infection, a patient may get permanent lung damage. WHO stated that, as in the case of SARS, nCOV also opens honeycomb-like holes in the lungs (Narin et al., 2020; Zhang, 2020).

Computed Tomography (CT) scan of the chest can also be used to examine pneumonia. Automated CT image analysis tools, based on Artificial Intelligence (AI), have been developed for recognition, evaluation and observation of nCOV, in order to differentiate between a healthy and a Corona infected person in (Gozes et al., 2020b). A deep learning-based system is developed by Fei et al., where the chest CT is used to automate the segmentation of lung and infection sites (Shan et al., 2020). Xiaowei et al. proposed to build an initial scanning model, using deep learning techniques and pulmonary CT images, to differentiate Influenza-A viral pneumonia and COVID-19 pneumonia from a healthy state (Butt et al., 2020).

In a study (Narin et al., 2020; Mahase, 2020) about the use of chest

CT images in determining whether a person is COVID-19 positive or not, Multi-Objective Differential Evolution (MODE) and Convolutional Neural Networks (CNN) are used to design a novel deep learning model for classifying COVID-19 infected people. By examining the specificity and responsiveness, a multi objective fitness function is designed to analyse COVID-19-positive patients.

Shuai et al. developed a deep learning method to derive radiographic changes in CT images, in order to provide faster clinical diagnosis compared to the pathogenic testing and save crucial time on COVID-19 testing (Wang et al., 2020b). Ahmet Hamimi (Hamimi, 2016) investigated the features of CT and X-ray, for MERS, that are similar to the signs of pneumonia. Xuanyang et al. used data mining techniques in their research to differentiate pneumonia and SARS with the help of X-ray images (Xie et al., 2006).

Bodies affected by tumours, pneumonia, bone dislocations, lung infections and fractures are scanned by using X-ray machines, while the clear images of the organs and of the inner soft tissue of active body parts are monitored by using CT scanning, which is an advanced version of the X-ray scanning (Bio, 2020). The use of CT is slower, difficult, expensive and more harmful than X-ray. Slow diagnosis and treatment of nCOV can lead to higher death rates.

The contribution of the proposed work can be described as:

- To segregate different Corona-virus infected patients i.e., Covid-19 patients against SARS\_MERS patients and also from the healthy subjects, using lung X-ray images (a challenging task, due to similar characteristics of different Corona virus types), which is not yet applicable due to lack of training data availability in the past.
- To evaluate the performance of Convolutional Neural Network-based models, such as one block VGG, two block VGG, three block VGG, four block VGG, LetNet-5, AlexNet and Resnet-50 on multi class X-ray image data sets.
- To employ LSTM model for time series forecasting of nCOV cases, during the time span of 10 days, in Italy.

The paper is organized as follows: Section 2 summarizes previous work on COVID detection and forecasting. Section 3 includes CNN's architecture, CNN's layers, different CNN variants and a description of Long Short-Term Memory. Experiments on X-ray image data set and the derived results are analyzed in Sections 4 and 5. The study conclusions are presented in Section 6.

## 2. Related work

Maghdid et al. (2020) proposed a novel framework by utilizing on-board smartphone sensors for the detection of nCOV. Their proposed method is more cost effective because nearly all radiologists own and use smartphones for various daily tasks. Their approach enables doctors to use their smartphones to detect nCOV. This AI-based method provides the prediction and severity rate of pneumonia, by reading the signal frequencies of the smart phones sensors. The adopted technique can also be used by other researchers, to observe the degree of lung inflammation. Their stated framework is much faster in detecting nCOV, compared to a radiologist and it also helps in monitoring the severity of disease and in later prescribing treatment accordingly.

Another study (Ghoshal and Tucker, 2020) analyses the use of Monte-Carlo Dropweights (MC Dropweights) Bayesian Convolutional Neural Networks in the determination of the unpredictability in deep learning. The available dataset of nCOV chest X-rays has been used and proved that the ambiguous estimations have obvious correspondence with the classification accuracy, hence inaccurate predictions can be identified. It has also been stated that these flaws will empower the broader implementation of AI in the practice of medicines.

Novel deep learning framework i.e., COVIDX-Net has been proposed by authors in Hemdan et al. (2020), to aid radiologists, by automating the diagnosis of nCOV in X-ray images. The framework has been tested

on a dataset consisting of 50 images of chest X-ray where half of them refer to positive nCOV patients. The proposed framework is comprised of seven distinct structures of deep CNN models, like the second variant of Google Mobile-net and the revised version of deep CNN models. All of the proposed models are capable of testing the concentrations of X-ray images, in order to determine the patient as a negative or a positive case of nCOV. The evaluation of the framework was carried out by using 80% of X-ray images for training the model and the remaining 20% for testing.

Venkatakrishnan et al. in Venkatakrishnan et al. (2020) illustrate that a comprehensive platform of data science can support the availability of unique number of unstructured and structured openly accessible data, to speed up the production of effective biological suggestions and penetrations. A cloud-based software, called nferX, is used, allowing the user to inquire from the bulk of potential theoretical relations, comprising of more than 100 million documents of biomedicine, including Open Research Dataset of nCOV published by White House.

Hofmarcher et al. (2020) have presented the testing of novel molecules with greater potency. A comprehensive ligand-based virtual screening was conducted, which ended with 30,000 inherent inhibitors of SARS-CoV-2 having positive properties. They have used a DNN called ChemAI, which was trained based on three overboard databases of drug-discovery, consisting of over 220 million data points beyond 3.6 million molecules. They have decreased the count to maximum 30,000 compounds, that are promptly available and can be purchased through ZINC database.

Novel deep learning algorithm has been proposed by authors in Gozes et al. (2020a), to assist radiologists in the time of the pandemic. Their algorithm can identify, measure and restrict the intensity of nCOV indication, through CT scans of the chest. Their proposed algorithm includes a pipeline of image processing methods, including fine-grain localization, 2D slice classification and lung segmentation. For additional indications of nCOV, unsupervised clustering of irregular slices was performed. They tested their results on a dataset containing 110 nCOV positive patients from the Zhejiang province of China.

Another study (Rajinikanth et al., 2020) proposes a novel image-based system that can utilize the CT scans of lungs to derive the infected segments. Their main purpose was to help the pulmonologist in recognizing and treating COVID-19 patients. Their system aims to improve the testing facilities and to reduce the difficulties of the diagnosis process. Their research was tested using MATLAB software, based on gathered CTSI of nCOV from the database of Radiopedia.

Another study (Ozkaya et al., 2020) has been carried out, where the characteristics of deep learning are used for early detection of nCOV. They have generated sub-datasets, i.e., first subset of  $16 \times 16$  patches and second subset of  $32 \times 32$  patches, using 150 CT images. According to the proposed technique, they have marked 3000 images as nCOV. For maximizing the performance of their algorithm, they have used ranking and feature blending methods. They have also used Support Vector Machine (SVM) to classify the processed data. Their research method has presented 97.60% specificity, 98.93% sensitivity, 97.63% precision, 96.54% Matthews Correlation Coefficient (MCC) metrics and 98.27% accuracy on the second subset.

Alom et al. in Zahangir Alom et al. (2020) proposed a technique to detect nCOV patients more efficiently, by using multi-tasking methods of deep learning. They used CT scan and X-ray images to assess their technique. They detected nCOV by manipulating Inception Residual Recurrent Convolutional Neural Network with Transfer Learning (TL) method and performed segmentation of infected parts by using NABLA-N network model. In case of X-ray images, their detection method exhibited 84.67% accurate results, while for CT-images they produced 98.78% accurate results.

Another study (Basu and Mitra, 2020) aimed to design an innovative transfer learning based algorithm, named Domain Extension Transfer Learning (DETL), to provide another method for detection of nCOV, using X-ray images of chest. They manipulated DETL, with DCNN on a

large relevant dataset of chest X-ray images, to classify the disease into the following four categories, i.e., COVID-19, pneumonia, other disease and normal. They utilized the Gradient Class Activation Map (Grad-CAM) method, to extract the particular traits from X-ray images.

The authors carried out a study (Kassani et al., 2020) to compare some famous feature extraction frameworks of deep learning for the automation of the classification process of nCOV. They chose some of the DCNNs i.e., NASNet, InceptionRes-NetV2, VGGNet, Mobile-net, InceptionV3, Xception, ResNet and Dense-net, to get the particular characteristics of learning. Next, the derived characteristics were assigned to multiple classifiers of machine learning, in order to group the cases as COVID-19 positive or negative. They verified the performance of their method on overboard nCOV datasets of CT and X-ray images. Bagging tree classifier and DenseNet121 feature extractor exhibited the highest accuracy rates i.e., 99% while ResNet50's hybrid version was second-most accurate feature extractor with 98% accuracy.

The authors introduced a new method in Singh Punn and Agarwal (2020), using different famous deep learning methods, such as DenseNet169, Inception-v3, baseline ResNet, NASNetLarge and Inception ResNet-v2. They presented random oversampling to perform binary and multi-class classification of posteroanterior CXR images. In binary classification, images are classified into nCOV positive and normal cases, while in multi-class classification there are three target classes i.e., normal, pneumonia and COVID-19. For assessing the performance of their models, they have used precision, loss, area under the curve (AUC), recall and the accuracy of these models. According to the results, NASNet-Large shows superior performance, compared to other models.

Novel Virus Host Prediction (VHP) method, using a deep learning model, is proposed by the authors in Zhu et al. (2020), to forecast the nCOV infected patients. Their model predicted that COVID-19 is similar to the other viruses of Corona-viruses family, such as Bat SARS-like Corona-virus, Middle East Respiratory Syndrome Corona-Virus (MERS-CoV) and Severe Acute Respiratory Syndrome Corona Virus (SARS-CoV). Based on the comparison made between different viruses, they concluded that COVID-19 resembles, to a high degree, the bat Corona-virus. Moreover, after comparison of different viruses, they evaluated that the mink virus infects the host in a similar way as COVID-19 does.

Xu and Meng (2021) carried out a study, based on the theory that AI-based deep learning techniques are possibly capable of deriving graphical characteristics of COVID-19. The proposed technique can perform clinical testing better than pathogenic testing and can prevent waste of crucial disease control time. For the testing phase, they gathered 453 CT scan images of confirmed nCOV patients and for the training phase, they utilized 217 images. In order to train the algorithm, they used inception migration-learning technique. Their algorithm achieved 84% sensitivity, 80.5% specificity and 82.9% accuracy.

Another study (Song et al., 2020) has produced an automated method for helping radiologists in the identification of nCOV infected patients, by using CT images. For comparison purposes, 88 CT scan images of Corona positive patients, 86 CT images of healthy people and 101 images of pneumonia infected people were obtained. A deep learning-based diagnosis system, named DeepPneumonia, was developed, by using the collected data set, to detect nCOV positive patients. The outcomes proved that their proposed method can precisely detect nCOV patients within 30 s, at 0.99 AUC and 0.93 sensitivity.

Researchers introduced a novel deep learning-based method in Chen et al. (2020), for identifying nCOV patients, using CT scan images, in order to relieve radiologists work pressure in this time of global pandemic. For evaluation and testing of their model, they collected 46,096 unsigned images of 106 patients, among which 51 patients were confirmed as nCOV positive patients, while 55 patients were infected with some other diseases, admitted in Renim Hospital of Wuhan University. Their model achieved 95.24% accuracy, 84.62% PPV, 93.55% specificity and 100% NPV.

Novel CNN approach, as proposed by the authors in Lopez-Rincon

et al. (2020), automates the creation of features, based on the virus genetic sequence. The outcome of the trials proved that, the suggested method can successfully perform classification on SARS-CoV-2 and can differentiate it from other viruses, like HCoV-HKU1, HCoV-229E, HCoV-OC43, SARS-CoV, MERS-CoV and HCoV-NL63 of the Corona-virus family, even if there exists noise in the dataset information. Their method classified different Corona-viruses with an accuracy of 98.75%, in a data set containing unique genome sequences, by using 10-fold cross-validation. Their method can classify SARS-CoV-2 with 98% AUC, 1.00 sensitivity and 0.9939 specificity, using binary classification.

Razzak et al. (2020) proposed an effective method for detection of nCOV, by distinguishing it from bacterial pneumonia, healthy cases and viral pneumonia, based on deep learning processes. They utilized the pre-trained data set to enhance the performance of their algorithm and compared it to some other CNN methods. Their assessment showed that their novel method gave 98.75% accurate results, utilizing X-ray and CT scan images.

Another study (Mei et al., 2020), based on algorithms of AI, combines verdicts of CT scan with scientific indications, vulnerability records and results of laboratory tests, to identify positive patients of SARS-CoV-2 immediately and more precisely. For testing phase, they gathered records of 905 patients confirmed by RT-PCR, out of which 419 cases of laboratory tests were positive and 486 patients were reported negative by two further tests of RT-PCR. Their algorithm scored 0.92 AUC and also showed high performance, in terms of sensitivity on a data set of 279 patients.

In Crossman (2020), a study on the training of deep learning-based neural networks, to generate the replicated sequences of spike protein, was presented. These results will assist in the creation of vaccines, by designing potential substitute spike sequences. They trained deep learning-based RNN, to automate the creation of spike protein sequences of Corona-virus, in a similar manner of prior known sequences. For the training phase, they utilized delta, alpha, gamma and beta spike sequences of Corona-virus, while the testing was carried out on a dataset of 100 sequences.

A novel deep learning-based method, proposed by authors in Beck et al. (2020) and named Molecule Transformer-Drug Target Interaction (MT-DTI), was used to recognize industrially available medicines for the treatment of SARS-CoV-2. They proved that existing antiretroviral medicine, used for the prevention of Human Immunodeficiency Virus (HIV), can help treat SARS-CoV-2, coupled with ritonavir (204.05 nM), efavirenz (199.17 nM), dolutegravir (336.91 nM) and remdesivir (113.13 nM). They stated that ritonavir, darunavir and lopinavir are meant to treat viral infections. They also discovered that Kaletra (lopinavir/ritonavir) can also be used for treating SARS-CoV-2.

Nguyen et al. (2020) performed a survey on the use of AI and block chain for battling nCOV pandemic, based on current research. They introduced a novel method that combines AI and blockchain for combating nCOV. Specifically, they underlined the fundamental solutions in the fight against COVID-19, using techniques of AI and block chain combined. They studied the latest projects designed, by using these techniques and methods to assist in this time of global pandemic. As a result, they highlighted the difficulties and trends which can motivate people to handle such pandemics in the future.

Another study (Hasan et al., 2020) demonstrates a features level mixture of deep learning and Q-deformed entropy hand-crafted features, for classifying pneumonia, healthy cases and nCOV cases, based on CT scan images of lungs. First, there was pre-processing of the dataset, to minimize the noise. Next, they used histogram thresholding to detach the history of lungs CT scan. Following, Q-deformed entropy algorithm and deep learning methods were performed on every CT scan for features extraction. The extracted features were classified by using a classifier named Long Short-Term Memory (LSTM) neural network. Their proposed method achieved an accuracy of 99.68% on a dataset of 321 patients.

**Table 1**  
Detailed description of Related work on different nCOV applications.

Sr.	Ref	Year	Proposed technique	Dataset	Result
1	Maghdid et al. (2020)	2020	AI enabled smartphone framework	CT images	Gained above 90% accuracy
2	Ghoshal and Tucker (2020)	2020	MC Dropweights Bayesian Convolutional Neural Networks	chest X-ray	Obtained high accuracy rates
3	Hemdan et al. (2020)	2020	Deep CNN models	chest X-ray	Achieved 80% accurate results.
4	Venkatakrishnan et al. (2020)	2020	Cloud-based software called nferX	Biomedical documents	Gained highly accurate results
5	Hofmarcher et al. (2020)	2020	DNN called ChemAI	Databases of drug-discovery	Obtained high accuracy rates
6	Gozes et al. (2020a)	2020	Deep learning algorithm	CT scans of the chest	Achieved maximum accuracy rates
7	Rajinikanth et al. (2020)	2020	Image-based system	CT scans of lungs	Gained better accuracy than earlier method
8	Ozkaya et al. (2020)	2020	SVM	CT images	Obtained 98.27% accuracy
9	Zahangir Alom et al. (2020)	2020	RNN with Transfer Learning (TL)	CT scan and X-ray images	Came up with 98.78% accurate results
10	Basu and Mitra (2020)	2020	Domain Extension Transfer Learning (DETL)	X-ray images of chest	Achieved 95.3% accuracy rate
11	Kassani et al. (2020)	2020	DCNNs	CT and X-ray images	Obtained 99% accurate results
12	Singh Punn and Agarwal (2020)	2020	Deep learning methods	CXR images	Showed best scores as compared to other models
13	Zhu et al. (2020)	2020	VHP (Virus Host Prediction)	DNA sequence	Achieved maximum accuracy rates
14	Xu and Meng (2021)	2020	AI-based deep learning techniques	CT scan images	Showed up 82.9% accuracy.
15	Song et al. (2020)	2020	CT diagnosis system (DeepPneumonia)	CT images	Obtained highly accurate results
16	Chen et al. (2020)	2020	Deep learning-based method	Unsigned images	Gained 95.24% accuracy
17	Lopez-Rincon et al. (2020)	2020	CNN	Genome sequences	Came up with accuracy of 98.75%
18	Razzak et al. (2020)	2020	CNN	X-ray and CT scan images	Showed up high accuracy.
19	Mei et al. (2020)	2020	Algorithms of AI	CT scan images	Gained above 90% accurate results
20	Crossman (2020)	2020	Deep learning-based RNN	Delta, alpha, gamma and beta spike sequences	Gained highly effective and accurate results
21	Beck et al. (2020)	2020	Molecule Transformer-Drug Target Interaction (MT-DTI)	Antiviral drugs	Achieved maximum accuracy rates
22	Nguyen et al. (2020)	2020	AI and blockchain	Surveys	Obtained effective results
23	Hasan et al. (2020)	2020	Q-deformed entropy	CT scan images of lungs	Gained an accuracy of 99.68%
24	Zhavoronkov et al. (2020)	2020	Deep learning techniques	ACE2 RNA	Came up with best accuracy rates
25	Zhang et al. (2020)	2020	DFCNN	Sequences of RNA virus	Showed up highly effective results
26	Sethy and Behera (2020)	2020	Deep learning-based CNN	X-ray images	Obtained effective and accurate results
27	Zhou et al. (2020)	2020	Pharmacology-based network	HCoV whole genomes	Gained better accuracy

The authors carried out a study (Zhavoronkov et al., 2020), where they stated that COVID-19 is also a type of bat Coronavirus, which is quite different from human SARS virus. They concluded that COVID-19 is on the seventeenth number in the family of Corona-viruses. They recommended to use SARS-COV, COVID-19 and endosomal pathway to enter into the targeted cell and to also use similar cell entry receptor i.e., Angiotensin-Converting Enzyme II (ACE2). They carried out single-cell RNA expression for profiling ACE2.

Novel deep learning-based algorithm, named DFCNN, was proposed by authors in Zhang et al. (2020). They gathered the sequences of RNA virus from the database of GISAID and interpreted these into sequences of protein. Following, the homology modelling was used to build a protein 3D model. The main protease of nCOV was acknowledged as a primary therapeutic target and they concentrated on screening drug, based on this model. Their proposed method can accurately detect and list the interactions of protein-ligand. It can also recognize inherent medicines for COVID-19 protease, by screening drug into databases of four chemical compounds. Ultimately, they presented a list of potential peptide medications and chemical ligands to use in empirical verifications.

Sethy and Behera (2020) proposed deep learning-based CNN for detection of nCOV. The two developed datasets, one comprising 25 X-ray images of nCOV positive patients, gathered from GitHub repository, while the other one of 25 X-ray images of nCOV negative patients from Kaggle repository. They stated that the positive nCOV cases omit ARDS, SARS and MERS. The second test set comprised 133 positive nCOV X-ray images, together with ARDS, SARS and MERS. They also collected 133 images of chest X-ray of negative nCOV cases, from Open-i repository. They evaluated both data sets independently and used these for deep extraction of features, through deep learning models like InceptionV3, ResNet101, ResNet50, ResNet18, VGG16, AlexNet, GoogleNet, XceptionNet and DenseNet201. Next, they used SVM classifier to classify the extracted features.

Another study (Zhou et al., 2020) demonstrates the behaviour of an existing antiviral drug, through a network medicine program based on pharmacology, which measures the communication between virus and host and the drug effects on the host. They discovered that the proteins, which are used as drugs against a particular disease, can also be used for the treatment of inherent viral diseases with common PPIs and the functional pathways, as illustrated by human interactions.

### 3. Material and methods

#### 3.1. CNN's architecture

Deep learning marked its first significant impression on the world of science in 2002. Convolutional Neural Network (CNN) which was considered as the fundamental deep learning architecture, won the biggest competition of object classification, i.e., Visual Recognition Competition held in 2012 in the area of object classification (Krizhevsky et al., 2012). This was the unbelievable emergence of deep learning as the Top-5, where error rate was decreased from 26.1% to 15.3%.

According to CNN, some initial layers include pooling and convolution layers, while the final layers are a classification and a fully connected layer. CNN also includes a series of numerous trainable layers and a classifier. The layer starts functioning once the input is received in CNN and then the training process begins. Last, a prediction is derived and compared to the actual results. Deviation between the produced results and aspired results is directly proportional to the number of errors occurred. Errors are transferred to all training weights, using back propagation method. At the end of each iteration, weights are updated and errors are decreased. Video, audio, images and signals can be used as input to CNNs. CNNs' major application field was initially about classification of images, but recently there are various other fields considered. During the classification of images in CNNs, patterns containing a blend of edges are combined to produce pieces and parts of

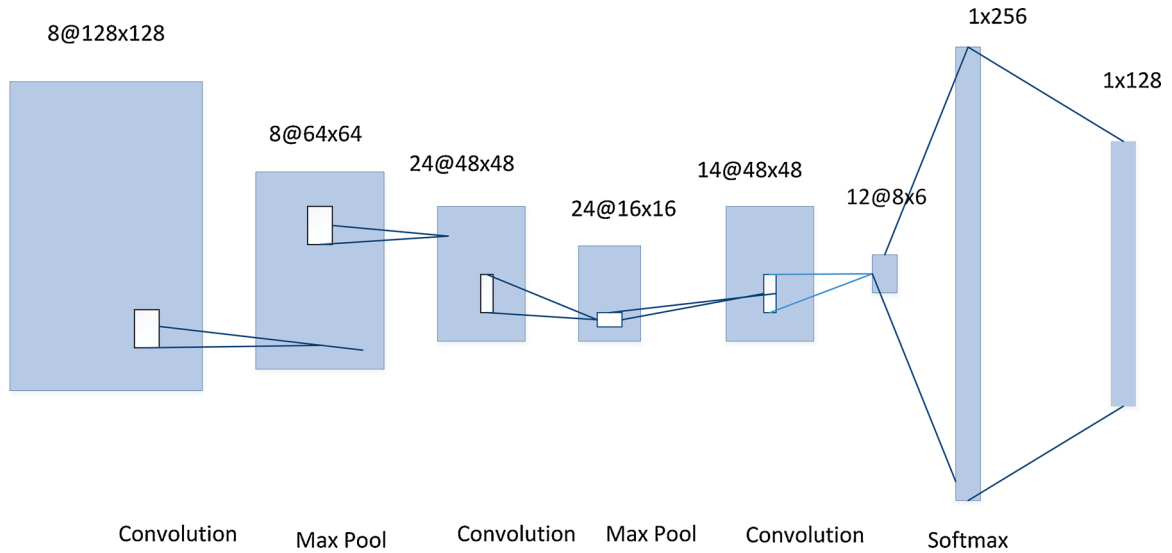

Fig. 3. Architecture of LeNet-5 containing maximum 256 vector length.

objects (LeCun et al., 2015).

A brief description of related work about nCOV is given in Table 1.

### 3.2. CNN's layers

#### 3.2.1. Input layer

The initial layer of a CNN is called input layer. Raw data is broadcasted over the network to this layer. Data size has a major impact on the performance of the used model. High-quality images require more memory and longer training and testing time, for each image, potentially increasing the success rate of the network. Whereas low-quality images require shorter training time and less memory, but it may exhibit lower performance. An appropriate compromise regarding the image size should be sought, in order to achieve optimal computing cost and higher network success.

#### 3.2.2. Convolution layer

Convolution layer is known as the base of CNN. In this process, a distinct filter is applied over the whole image. Filters of various sizes i.e.,  $5 \times 5$ ,  $3 \times 3$  and  $2 \times 2$  can be used. An output data is generated by filters, when convolution method is applied to images of prior layer. The outcome of the convolution layer includes an activation map. The area, where every filter-based feature is located, is called convolution layer. In the training phase, filter coefficients vary among each iteration. Consequently, important areas, where features may be discovered, are determined by the network.

#### 3.2.3. Rectified linear units layer (ReLU)

After convolution layer, there comes Rectified linear units layer (ReLU), which is considered as the most frequently used rectifier, when CNN neurons output is concerned. Eq. (1) represents this notion mathematically. Another name for this layer is activation layer. Each negative state is changed to zero by ReLU function. Several mathematical operations are carried out on convolution layer, due to the linear nature of the network. Deep network is specified for non-linear architecture, using this layer, making the network learn quickly.

$$y_{ijk} = \max\{0, x_{ijk}\} \quad (1)$$

#### 3.2.4. Pooling layer

The main objective of this layer is to reduce the size of input for subsequent convolution layer. A pooling layer can be regularly attached among convolution layers, as expressed in terms of Eq. (2).

$$y_{ijk} = \max\{y_{i'jk'} : i \leq i' < i + p, j \leq j' < j + p\} \quad (2)$$

#### 3.2.5. Output layer

The last layer considers the sigmoid function and contains number of neurons equal to the number of target classes required for the classification.

### 3.3. LeNet

LeNet method, appearing in 18,261 citations, is acknowledged as a pioneer CNN method used for recognizing digits. On the basis of MNIST database, LeNet is the architecture which triggered the growth of CNN. A comprehensive structure of this network involves  $5 \times 5$  convolution on input, implemented by  $2 \times 2$  pooling and terminates at two fully connected layers. An ultimate input of  $12 \times 1 \times 1$  is contributed to FCN, where nearly 60,000 parameters are considered. Architecture of LeNet-5 with maximum 256 vector length is presented in Fig. 3.

### 3.4. AlexNet

AlexNet is one of the leading CNN and won the competition of 2012 ILSVRC. A data set of  $3 \times 224 \times 224$  sized 15 million RGB images was provided as input to almost 22,000 classes. There are 60 million parameters and 7 layers in a structure that resembles LeNet, apart from its deep nature. There are operations including  $3 \times 3$ ,  $5 \times 5$  and  $11 \times 11$  convolutions.  $3 \times 3$  pooling concludes with two fully connected layers, where each layer consists of 409 layers. For better optimization, ReLU activation and Layer Normalisation were used, rather than tanh activation, for achieving higher speed. Dropout layers are used for bypassing over-fitting dropout layers, even though it leads to more training time. The design was split into two parts, since the structure was trained for 6 days, using two GTX 580 CPUs.

### 3.5. VGG-16 net

Visual Geometric Group (VGG) was launched in ILSVRC 2014 challenge, where it came in second but it is still highly trusted and acknowledged. Since its structure resembles AlexNet, it also has numerous features. Specifically, it has got 138 million parameters. 16 convolutional layers of VGG-16 are divided into two  $3 \times 3$  convolutional layers, accompanied by  $2 \times 2$  max pooling and two blocks, including three layers of  $3 \times 3$  convolutions succeeded by  $2 \times 2$  max pooling. The

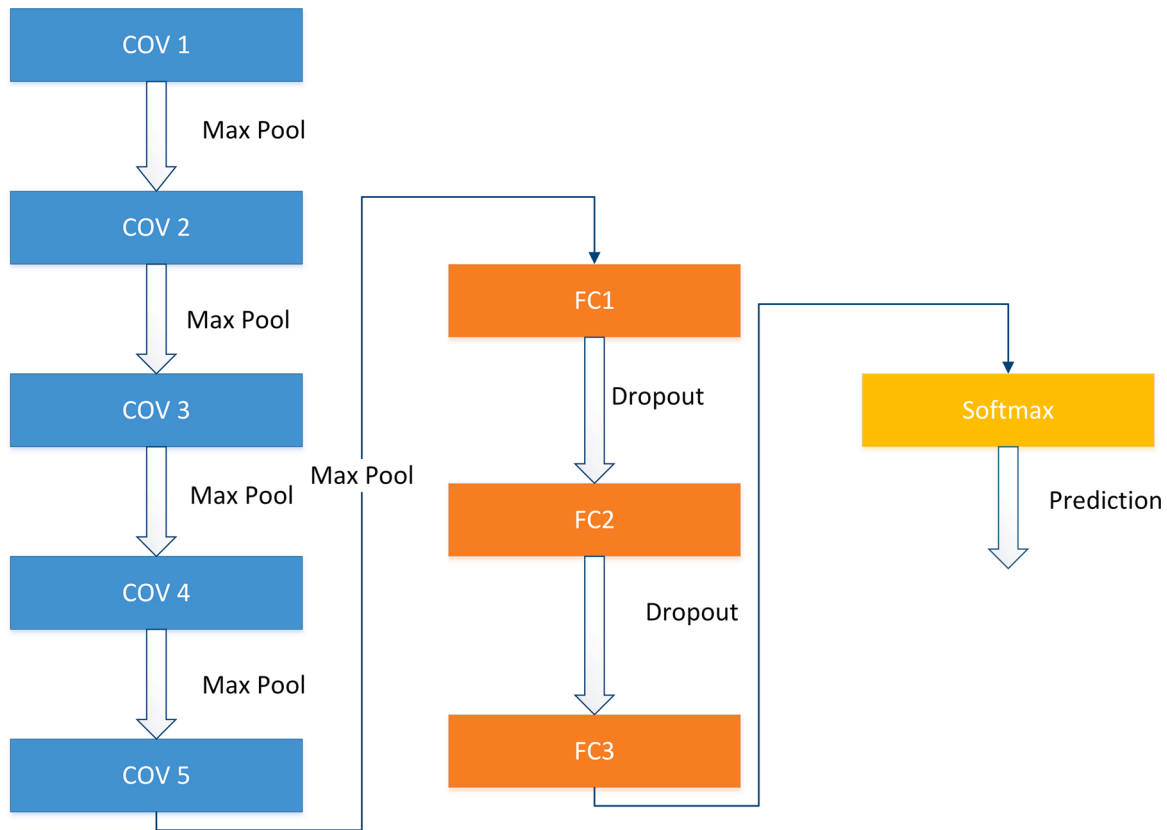

Fig. 4. VGG-16 network architecture with 5 convolutional layers.

model concludes with two fully connected layers, each one containing 4096 hidden layers. Fig. 4 illustrates the VGG-16 network architecture. Some prominent benefits of VGG are due to its non-linear nature within blocks, which allows it to provide higher discrimination. Furthermore, the lower number of parameters, required to be computed, decreases the respective computational power. Another benefit of blocks is that, ReLu activation can occur twice per block, in every convolution. Following, the inception model is added into the VGG-16, in order to make it more comprehensible. Inception model that can be combined with the VGG-16 is shown in Fig. 5.

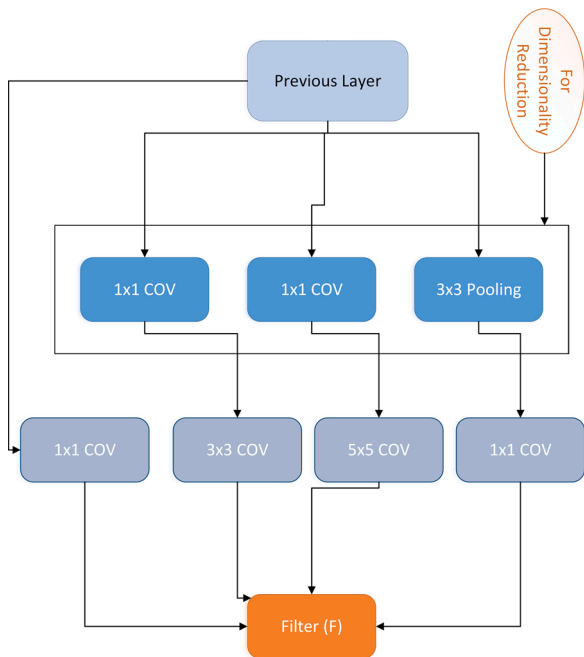

Fig. 5. Inception model network architecture that can be combined with the VGG-16.

### 3.6. ResNet-50

ResNet won the challenge of ImageNet in 2015 for striking the errors in human accuracy, for the first time in history, at a 3.6% error rate. ResNet is a real deep network that was exhibited in the challenge with 152 layers. According to the observations, the network depth is directly proportional to the saturation of accuracy, while after that point, it starts to get corrupted rapidly and the Vanishing Gradient Problem is needed to be resolved by network team. To overcome these issues, skip connection feature was presented by ResNet. ResNet was introduced to train the deep networks as if they were shallow networks, through a skipping connection after every two layers. For computation purposes, both output and input are copied to the succeeding layer for making the leftover of the previous calculation known. Sixty five million parameters are computed. Only a few layers have a congested start and end with a  $1 \times 1$  convolution. ResNet 5 convolutional layer architecture is presented in Fig. 6.

### 3.7. Long Short-Term Memory (LSTM)

In response to the solution of the short term memory, LSTMs (Jiasen et al., 2020) were carried out to overcome the RNN shortcomings.



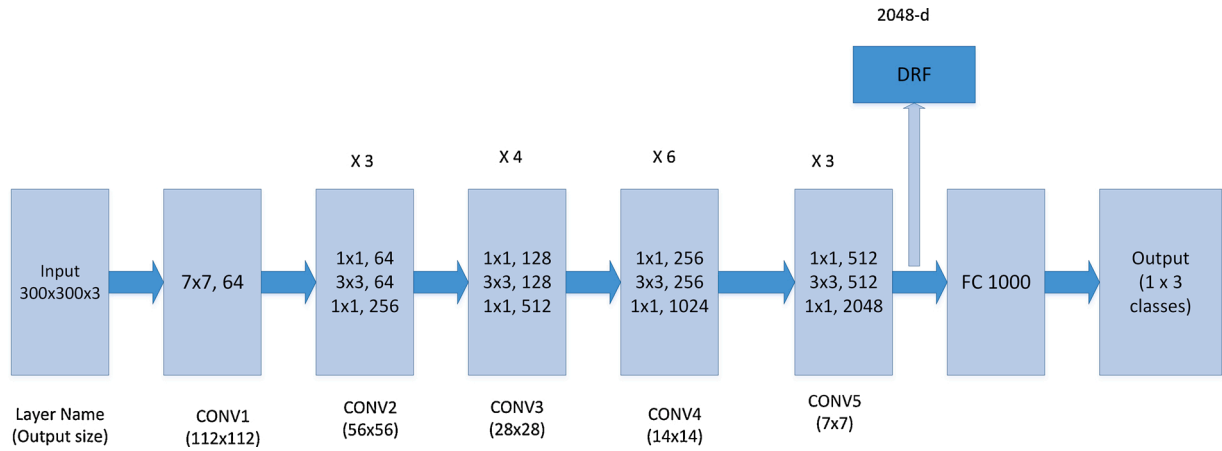

Fig. 6. Resnet architecture with 5 convolutional layers.

Table 2

Detailed description of X-ray images data set used for experimentation.

Classes	Number of images
nCov	45
SARS_MERS	49
Normal	51
<b>Total</b>	<b>145</b>

Considered gates have been implemented in an inward manner, controlling the progression of data. These entryways in the LSTM can receive the learning memory, where information in a succession is critical to conserve or discard. Due to this mechanism, it can transfer important data and can retain long series of arrangements to make predictions. Cell state on each layer of the network is a central idea of LSTM and it represents several gates. At each backward or forward network layer, the cell state acts as a medium throw-away, which moves relative data right down the pattern series. The data in this cell state are called the memory of the network. The cell state, in principle, can convey pertinent data all through the process of the succession. The prior time period can advance towards later time periods, diminishing the impacts of transient memory. The gates are diverse neural systems, selecting which data to be permitted to the cell state.

## 4. Experiments

### 4.1. X-ray Image dataset

In this study, a data set, containing 3 classes with a total of 145 images, has been compiled. All acquired images are X-ray images. The resolution of the original data set varies according to the type of image, that is whether the lung contains nCOV or SARS\_MERS or the image indicates healthy lungs. The description of the data set, used for the experimentation, is listed in Table 2. Samples of X-ray images dataset, regarding 3 underlying classes, are presented in Fig. 7.

### 4.2. Time series dataset

For time series analysis, Italy is considered, being one of the highly affected countries, to run a prediction process of nCOV counts, during the period of 10 days. The data set contains three main features i.e., Lat; which indicates the global latitude of Italy, Long; reflecting the global longitude of Italy and last, the date. The everyday pervasiveness information of nCOV, from January 22, 2020 to May 20, 2020, were recovered from the official website of the World Health Organization (W. Health Organization, 2020). The dataset consists of everyday case

records and day by day time arrangement summary tables. In the current investigation, significant time-series data have been acquired and arranged in tables in CSV format. There are three tables listing: confirmed cases, recovered cases and deaths instances of nCOV with six properties, including: area/state, nation/district, last update, declared, death and recovered cases. The update frequency of the dataset is once per day. The data clearly shows the exponential development of the spread, which should be controlled in time.

### 4.3. Evaluation metrics

In the case of the X-ray image classification problem, precision metrics were used to show the output of each network applied. The precision metrics used for the examination are F1-Score, Recall, Precision and Accuracy. Accuracy alludes to the proportion of an effectively anticipated class example (True Positive) to the entire number of occurrences, anticipated by the particular class (False Positive + True Positive). In addition, Recall is the proportion of an accurately anticipated class example (True Positive) to the absolute number of occurrences related to all classes (True Positive + False Negative), which, in the case of our classification model, is equal to 3. At the point where both Recall and Precision have appeared at the midpoint, as indicated by their weight, it fits F1-Score. Accuracy relates the whole of effectively and inaccurately anticipated class example (True Positive + True Negative) to all-out occasions (True Positive + False Positive + False Negative + True Negative). The following Eqs. (3)–(5) refer to the definition of each of the above-stated metrics (Hossin and Sulaiman, 2015).

$$\text{Precision} = \frac{\text{True Positive}}{\text{True Positive} + \text{False Positive}} \quad (3)$$

$$\text{Recall} = \frac{\text{True Positive}}{\text{True Positive} + \text{False Negative}} \quad (4)$$

$$\text{F1 - Score} = 2 \times \frac{\text{Precision} \times \text{Recall}}{\text{Precision} + \text{Recall}} \quad (5)$$

$$\text{Accuracy} = \frac{\text{TruePositive} + \text{TrueNegative}}{\text{TruePositive} + \text{FalsePositive} + \text{TrueNegative} + \text{FalseNegative}} \quad (6)$$

## 5. Results

### 5.1. nCov X-Ray image classification

State of the art deep learning Convolutional Neural Networks have been employed to classify the X-ray image target instances i.e., nCov vs. Normal vs. SARS\_MERS. For training and testing purposes, the data set is divided into 20% testing and 80% training data, with an input shape for

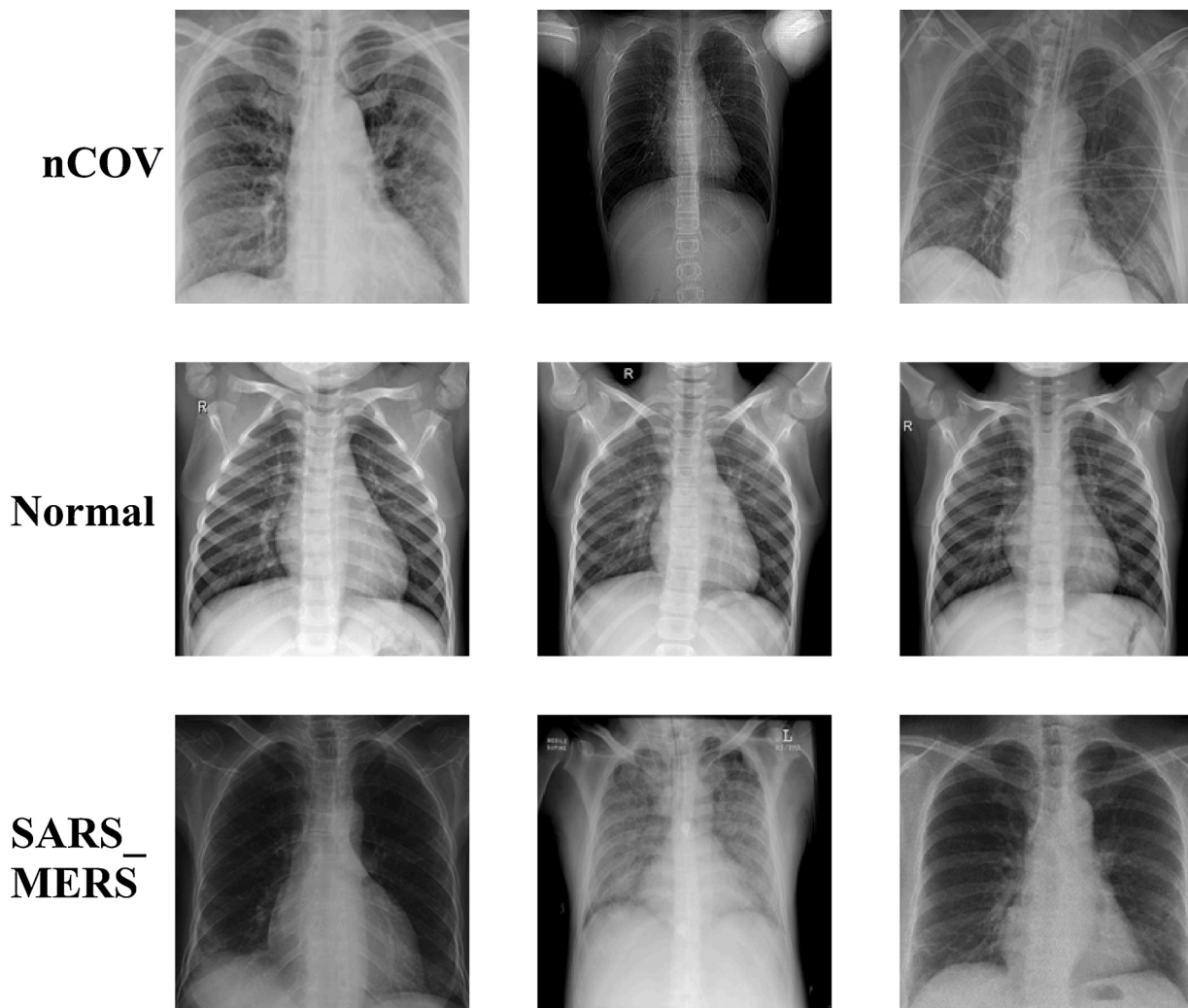

Fig. 7. Samples of X-ray images dataset regarding 3 underlying classes.

**Table 3**  
Numerical results obtained using one block VGG, two-block VGG, three-block VGG and LeNet-5.

	VGG1			VGG2			LeNet-5			VGG3		
	Precision	Recall	F1	Precision	Recall	F1	Precision	Recall	F1	Precision	Recall	F1
nCOV	83	100	91	90	90	90	100	70	82	80	80	80
NORMAL	83	83	83	75	100	86	86	100	92	100	100	100
SARS-MERS	100	86	92	92	79	85	81	93	87	87	87	87
Weighted Mean Accuracy	91	90	90	88	87	87	88	87	86	87	87	87

**Table 4**  
Numerical results obtained using four-block VGG, AlexNet and ResNet-50.

	VGG4			AlexNet			ResNet-50		
	Precision	Recall	F1	Precision	Recall	F1	Precision	Recall	F1
nCOV	67	100	80	75	60	67	71	50	59
NORMAL	75	100	86	100	83	91	100	100	100
SARS-MERS	100	50	67	71	86	77	71	86	77
Weighted Mean Accuracy	84	77	75	78	77	77	77	77	76

the first convolutional layer as (200, 200, 3), representing width = 200, height = 200 and 3 indicating the number of input neurons in a network. Four variants of VGG-16, including one block VGG, two-block VGG, three-block VGG and four block VGG, have been examined to test and train the acquired data set. Furthermore, three other recent networks i.

e., LeNet-5, AlexNet and ResNet-50, have been used in the testing for comparison purposes. Numerical results, obtained using one block VGG, two-block VGG, three-block VGG, four-block VGG, LeNet-5, AlexNet and ResNet-50, are presented in [Tables 3 and 4](#).

Moreover, the learning curves, accuracy graphs, loss curves and

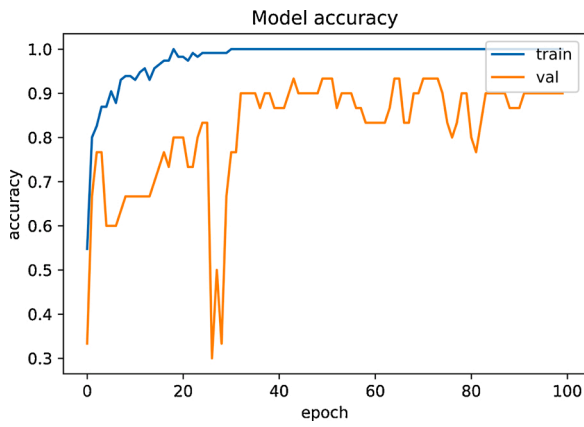

Fig. 8. Accuracy curves for VGG1 model.

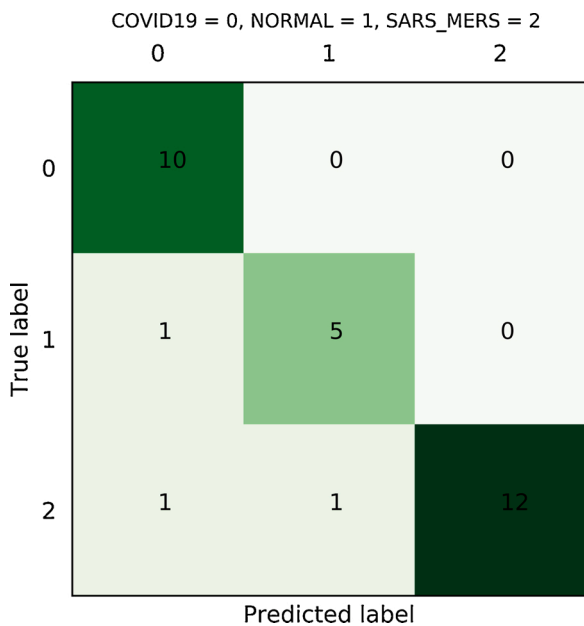

Fig. 9. Obtained confusion matrix for VGG1 model.

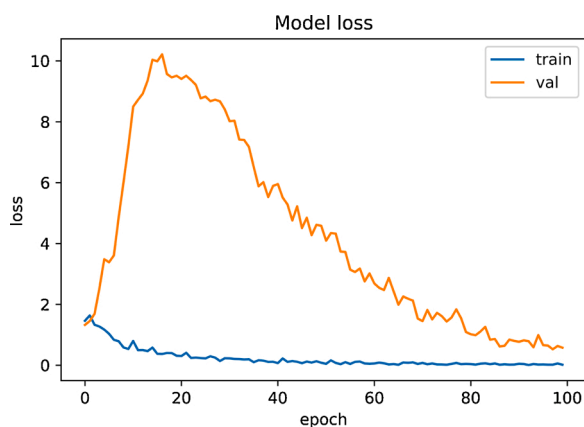

Fig. 10. AlexNet model – loss curve for 100 epochs.

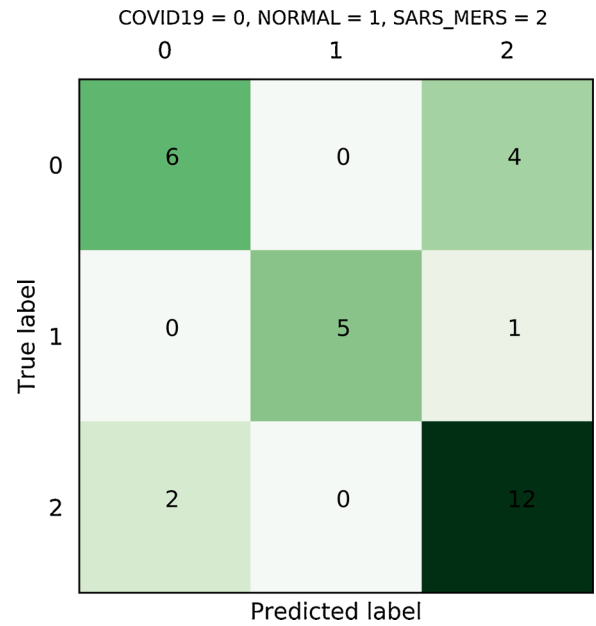

Fig. 11. Obtained confusion matrix for AlexNet model.

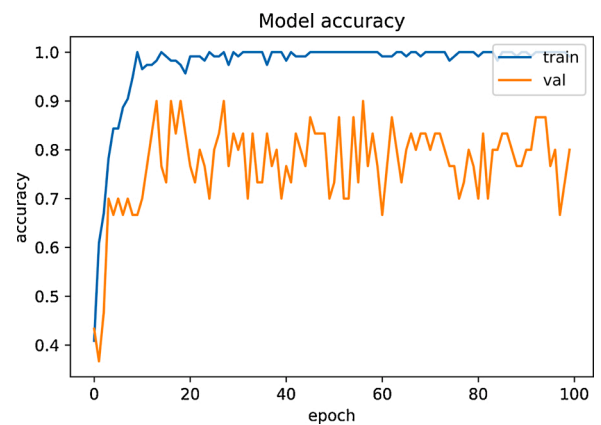

Fig. 12. Accuracy curves for ResNet-50 model.

confusion matrix for few networks are shown in Figs. 8–13.

5.2. Time series analysis

The nCOV poses a serious threat to human lives, so it is of extreme importance to break down the transmission development at the earliest possible point, as well as acquire a conjecture about the approaching prospects of the transmission. To this end, LSTM has been applied to predict the total number of cases that can appear within the next 10 days, in Italy. Transfer learning based deep learning approaches have been implemented using the python library “Keras” and “Sklearn” separately, to foresee the total outnumber of declared, regained and death cases around the world. The forecast will allow for important choices to be made, depending on the transmission development. For example, expanding the lock-down time frame, initiating the disinfection procedure, supplying ordinary assets and so forth. The predicted results can be found in Table 5, listing date, actual cases on the particular date and the predicted cases, as provided by the LSTM model.

The summary of nCOV confirmed, recovered and death cases, in Italy, from January 22, 2020 to May 20, 2020 is presented in Fig. 14. Furthermore, the line curves for predicted nCov cases and actual nCov cases are illustrated in Fig. 15.

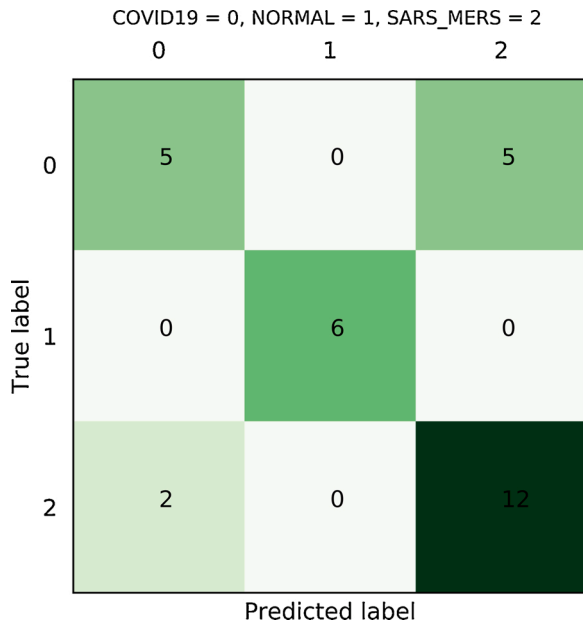

Fig. 13. Obtained confusion matrix for ResNet-50 model.

**Table 5**  
nCOV forecasting results for Italy up to 2020-05-29.

Date	Actual	Predicted	Min	Max
2020-05-10	219,070	220,051.4	210,990.8	229,111.9
2020-05-11	219,814	221,350.3	212,289.7	230,410.8
2020-05-12	221,216	222,603.1	213,542.5	231,663.6
2020-05-13	222,104	223,809.2	214,748.6	232,869.7
2020-05-14	223,096	224,998.6	215,938	234,059.1
2020-05-15	223,885	226,179.2	217,118.7	235,239.8
2020-05-16	224,760	227,358.8	218,298.3	236,419.3
2020-05-17	225,435	228,517.2	219,456.7	237,577.8
2020-05-18	225,886	229,654.5	220,594	238,715.1
2020-05-19	226,699	230,775.1	221,714.6	239,835.7
2020-05-20	-	231,890.8	222,830.3	240,951.4
2020-05-21	-	232,961.4	223,900.8	242,021.9
2020-05-22	-	234,012.7	224,952.1	243,073.2
2020-05-23	-	235,046.3	225,985.8	244,106.9
2020-05-24	-	236,064.6	227,004.1	245,125.2
2020-05-25	-	237,067.5	228,006.9	246,128
2020-05-26	-	238,054.5	228,994	247,115.1
2020-05-27	-	239,025.1	229,964.6	248,085.7
2020-05-28	-	239,979.6	230,919.1	249,040.2
2020-05-29	-	240,918.4	231,857.8	249,978.9

5.3. Analysis

Referring to Table 3, we can observe that one block VGG (VGG1) outperformed others exhibiting 91% weighted average accuracy, as compared to the two block VGG (VGG2) of 88%, LetNet-5 with 88% and three block VGG (VGG3) with 87%. In addition, VGG1 classified SARS\_MARS with 100% true prediction. On the other hand, images, in the Normal target class, are 100% accurately segregated by VGG2, LeNet-5 and VGG3. It is also perceived that, images with nCOV are not 100% classified by any of the networks listed in Table 3.

Furthermore, in Table 4, four VGG (VGG4) prevailed over state of the art networks, showing 84 % weighted average accuracy, as opposed to the Alexnet with 77% and ResNet-50 with 77%. Moreover, VGG4 classified images, of Normal and nCOV class, with 100% reliable prediction. Nonetheless, images of Normal target class are 100% explicitly segregated, using also ResNet-50. The validation curve in Fig. 8, regarding VGG1, shows that VGG1 performed well from 1 to 35 epochs, while after that point, the validation curve abruptly decreases. The interpretation of this phenomenon may be about a limitation of early stoppage criteria of CNN. However, the curve for VGG1, after epoch 35, raises up to overcome the under-fitting of the model. In contrast to VGG1, the pattern for the AlexNet model (Fig. 12) is different. The loss curve of AlexNet appears higher from 1 to 15 epochs, while following, the loss curve persistently decreases up to 100 epochs. This phenomenon may occur due to the limitation of early stoppage criteria of CNN. The investigation of this curve shape may lead to a prevention mechanism of late stoppage criteria of CNN. However, the loss curve for Alexnet, after epoch 15, decreased to overcome the over-fitting of the model.

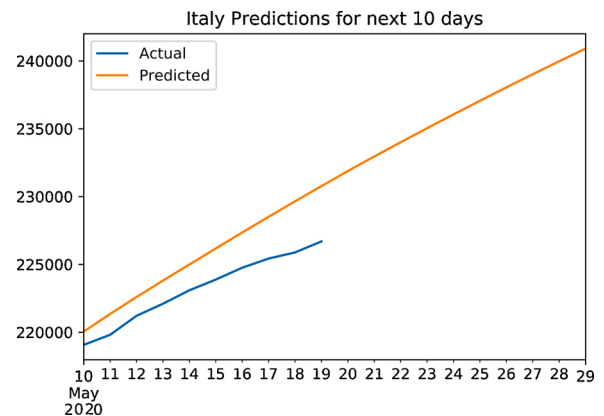

Fig. 15. Line curves for predicted vs. actual cases obtained by employing LSTM.

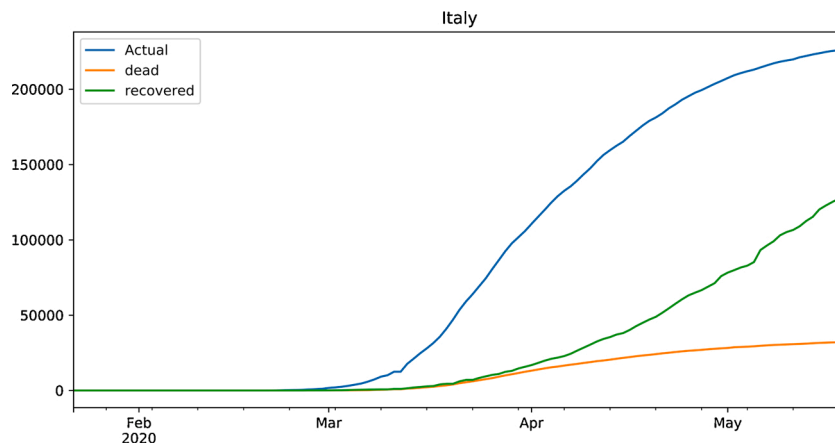

Fig. 14. Summary of nCOV confirmed, recovered and death cases from January 22, 2020 to May 20, 2020, in Italy.

In case of time series analysis of nCOV cases, in Italy, one can see that LSTM achieved 99% accuracy on the forecasted data from January 22, 2020 to May 20, 2020. The prediction curve, as illustrated in Fig. 15, shows significant difference and more positive case trends towards the next 10 days. This means that there is higher demand by the Italian government to take urgent steps to control the probable nCOV cases. Moreover, the predicted and actual nCOV cases difference increases almost 1500 to 1900 on each following day (Table 5).

## 6. Conclusion

Patients of nCOV should be detected at early stages, to limit the further spread of the virus. It is also important to differentiate among the various Corona virus types, for deriving the correct diagnosis and providing treatment accordingly. In an effort to automate the detection of nCOV patients, several deep learning approaches were used on lung X-ray images of nCOV patients, SARS-MERS patients and healthy persons. It is a challenging task, due to similarities among the different Corona virus types and was not attempted in the past, due to unavailability of patient scans with different types of Corona virus. According to the observed performance of the Networks, VGG1 showed the maximum rate of accuracy i.e., 91%, compared to five other models. It is concluded that the high performance of the proposed model will assist radiologists in detecting positive nCOV patients, among other types of Corona patients and healthy population. In addition, time series forecast analysis was applied in Italy, to predict the number of nCOV patients in the following 10 days. This time series analysis will allow the government to proceed with higher certainty, regarding decisions like expanding the lock-down time frame, initiating the disinfection process, supplying the every day assets and so forth.

## Declaration of Competing Interest

The authors report no declarations of interest.

## Acknowledgment

I would like to thank University of Mosul for providing the opportunity to conduct this research study.

**Conflict of interest:** The authors declare no conflict of interest.

## References

- Ai, T., Yang, Z., Hou, H., et al., 2020. Correlation of chest ct and rt-pcr testing in coronavirus disease 2019 (COVID-19) in China: a report of 1014 cases. *Radiology*. <https://doi.org/10.1148/radiol.2020200642>.
- Basu, S., Mitra, S., 2020. Deep Learning for Screening Covid-19 Using Chest X-ray Images (arXiv preprint). arXiv:2004.10507.
- Beck, B.R., Shin, B., Choi, Y., Park, S., Kang, K., 2020. Predicting commercially available antiviral drugs that may act on the novel coronavirus (sars-cov-2) through a drug-target interaction deep learning model. *Comput. Struct. Biotechnol. J.*
- Bio, <https://bioidifferences.com/difference-between-x-ray-and-ct-scan.html> (May 2020).
- Butt, C., Gill, J., Chun, D., Babu, B.A., 2020. Deep learning system to screen coronavirus disease 2019 pneumonia. *Appl. Intell.* 1.
- Chen, J., Wu, L., Zhang, J., Zhang, L., Gong, D., Zhao, Y., Hu, S., Wang, Y., Hu, X., Zheng, B., et al., 2020. Deep learning-based model for detecting 2019 novel coronavirus pneumonia on high-resolution computed tomography: a prospective study. *medRxiv*.
- Coronavirus, W.N., 2019. Situation Report-22. World Health Organization. <https://www.who.int/docs/default-source/coronaviruse/situation-reports/20200211-sitrep-22-ncov.pdf>.
- Crossman, L.C., 2020. Leverging deep learning to simulate coronavirus spike proteins has the potential to predict future zoonotic sequences. *bioRxiv*.
- Ghoshal, B., Tucker, A., 2020. Estimating Uncertainty and Interpretability in Deep Learning for Coronavirus (Covid-19) Detection (arXiv preprint). arXiv:2003.10769.
- Gozes, O., Frid-Adar, M., Sagie, N., Zhang, H., Ji, W., Greenspan, H., 2020a. Coronavirus Detection and Analysis on Chest ct With Deep Learning (arXiv preprint). arXiv:2004.02640.
- Gozes, O., Frid-Adar, M., Greenspan, H., Browning, P.D., Zhang, H., Ji, W., Bernheim, A., Siegel, E., 2020b. Rapid Ai Development Cycle for the Coronavirus (Covid-19) Pandemic: Initial Results for Automated Detection & Patient Monitoring Using Deep Learning CT Image Analysis (arXiv preprint). arXiv:2003.05037.
- Hamimi, A., 2016. Mers-cov: Middle east respiratory syndrome corona virus: can radiology be of help? Initial single center experience. *Egypt. J. Radiol. Nucl. Med.* 47 (1), 95–106.
- Hasan, A.M., AL-Jawad, M.M., Jalab, H.A., Shaiba, H., Ibrahim, R.W., AL-Shamasneh, A.R., 2020. Classification of covid-19 coronavirus, pneumonia and healthy lungs in ct scans using q-deformed entropy and deep learning features. *Entropy* 22 (5), 517.
- Hemdan, E.E.-D., Shouman, M.A., Karar, M.E., 2020. Covidx-net: A Framework of Deep Learning Classifiers to Diagnose Covid-19 in X-ray Images (arXiv preprint). arXiv:2003.11055.
- Hofmarcher, M., Mayr, A., Rumetshofer, E., Ruch, P., Renz, P., Schimunek, J., Seidl, P., Vall, A., Widrich, M., Hochreiter, S., et al., 2020. Large-scale Ligand-Based Virtual Screening for sars-cov-2 Inhibitors Using Deep Neural Networks. Available at SSRN 3561442.
- Hossin, M., Sulaiman, M., 2015. A review on evaluation metrics for data classification evaluations. *Int. J. Data Min. Knowl. Manag. Process* 5 (2), 1.
- Huang, C., Wang, Y., Li, X., Ren, L., Zhao, J., Hu, Y., Zhang, L., Fan, G., Xu, J., Gu, X., et al., 2020. Clinical features of patients infected with 2019 novel coronavirus in Wuhan, China. *Lancet* 395 (10223), 497–506.
- L. Jiasen, C. Xiong, R. Socher, Sentinel gate for modulating auxiliary information in a long short-term memory (lstm) neural network, US Patent 10,565,306 (Feb. 18 2020).
- Kassani, S.H., Kassani, P.H., Wesolowski, M.J., Schneider, K.A., Deters, R., 2020. Automatic Detection of Coronavirus Disease (Covid-19) in X-ray and ct Images: A Machine Learning-based Approach (arXiv preprint). arXiv:2004.10507.
- Krizhevsky, A., Sutskever, I., Hinton, G.E., 2012. Imagenet classification with deep convolutional neural networks. *Advances in Neural Information Processing Systems*, pp. 1097–1105.
- LeCun, Y., Bengio, Y., Hinton, G., 2015. Deep learning. *Nature* 521 (7553), 436–444.
- Littrup, P.J., Freeman-Gibb, L., Andea, A., White, M., Amerikia, K.C., Bouwman, D., Harb, T., Sakr, W., 2005. Cryotherapy for breast fibroadenomas. *Radiology* 234 (1), 63–72.
- Lopez-Rincon, A., Tonda, A., Mendoza-Maldonado, L., Claassen, E., Garssen, J., Kraneveld, A.D., 2020. Accurate identification of sars-cov-2 from viral genome sequences using deep learning. *bioRxiv*.
- Maghdid, H.S., Ghafoor, K.Z., Sadiq, A.S., Curran, K., Rabie, K., 2020. A Novel Ai-Enabled Framework to Diagnose Coronavirus Covid 19 Using Smartphone Embedded Sensors: Design Study (arXiv preprint). arXiv:2003.07434.
- Mahase, E., 2020. Coronavirus: Covid-19 Has Killed More People Than sars and mers Combined, Despite Lower Case Fatality Rate.
- Mei, X., Lee, H.-C., Diao, K., Huang, M., Lin, B., Liu, C., Xie, Z., Ma, Y., Robson, P.M., Chung, M., et al., 2020. Artificial intelligence for rapid identification of the coronavirus disease 2019 (covid-19). *medRxiv*.
- Narin, A., Kaya, C., Pamuk, Z., 2020. Automatic Detection of Coronavirus Disease (Covid-19) Using X-ray Images and Deep Convolutional Neural Networks (arXiv preprint). arXiv:2003.10849.
- nbcnews, <https://www.nbcnews.com/health/health-news/coronavirus-diseases-comparing-covid-19-sars-mers-numbers-n1150321> (May 2020).
- Nguyen, D., Ding, M., Pathirana, P.N., Seneviratne, A., 2020. Blockchain and Ai-based Solutions to Combat Coronavirus (Covid-19)-like Epidemics: A Survey.
- Ozkaya, U., Ozturk, S., Barstugan, M., 2020. Coronavirus (covid-19) Classification Using Deep Features Fusion and Ranking Technique (arXiv preprint). arXiv:2004.03698.
- Rajinikanth, V., Dey, N., Raj, A.N.J., Hassanien, A.E., Santosh, K., Raja, N., 2020. Harmony-search and otsu Based System for Coronavirus Disease (covid-19) Detection Using Lung ct Scan Images (arXiv preprint). arXiv:2004.03431.
- Razzak, I., Naz, S., Rehman, A., Khan, A., Zaib, A., 2020. Improving coronavirus (covid-19) diagnosis using deep transfer learning. *medRxiv*.
- Sethy, P.K., Behera, S.K., 2020. Detection of Coronavirus Disease (covid-19) Based on Deep Features, p. 2020. Preprints 2020030300.
- Shan+, F., Gao+, Y., Wang, J., Shi, W., Shi, N., Han, M., Xue, Z., Shen, D., Shi, Y., 2020. Lung Infection Quantification of Covid-19 in CT Images With Deep Learning (arXiv preprint). arXiv:2003.04655.
- Singh, D., Kumar, V., Kaur, M., 2020. Classification of covid-19 patients from chest ct images using multi-objective differential evolution-based convolutional neural networks. *Eur. J. Clin. Microbiol. Infect. Dis.* 1–11.
- Singh Punn, N., Agarwal, S., 2020. Automated Diagnosis of Covid-19 With Limited Posteroanterior Chest X-ray Images Using Fine-tuned Deep Neural Networks arXiv (2020) arXiv:2004.
- Song, Y., Zheng, S., Li, L., Zhang, X., Zhang, X., Huang, Z., Chen, J., Zhao, H., Jie, Y., Wang, R., et al., 2020. Deep learning enables accurate diagnosis of novel coronavirus (covid-19) with ct images. *medRxiv*.
- Stoecklin, S.B., Rolland, P., Silue, Y., Mailles, A., Campese, C., Simonon, A., Mechain, M., Meurice, L., Nguyen, M., Bassi, C., et al., 2020. First cases of coronavirus disease 2019 (covid-19) in France: surveillance, investigations and control measures, January 2020. *Eurosurveillance* 25 (6), 2000094.
- Surveillances, V., 2020. The epidemiological characteristics of an outbreak of 2019 novel coronavirus diseases (covid-19)-China, 2020. *China CDC Wkly.* 2 (8), 113–122.
- Venkatakrishnan, A., Puranik, A., Anand, A., Zemmour, D., Yao, X., Wu, X., Chilaka, R., Murakowski, D.K., Standish, K., Raghunathan, B., et al., 2020. Knowledge Synthesis From 100 Million Biomedical Documents Augments the Deep Expression Profiling of Coronavirus Receptors (arXiv preprint). arXiv:2003.12773.
- W. Health Organization, <https://www.who.int/emergencies/diseases/novel-coronavirus-2019/global-research-on-novel-coronavirus-2019-ncov> (May 2020).
- W.H. Organization, et al., 2020. Novel Coronavirus: Situation Report, p. 3.
- Wang, Y., Hu, M., Li, Q., Zhang, X.-P., Zhai, G., Yao, N., 2020. Abnormal Respiratory Patterns Classifier May Contribute to Large-Scale Screening of People Infected With

- Covid-19 in an Accurate and Unobtrusive Manner (arXiv preprint). arXiv: 2002.05534.
- Wang, D., Hu, B., Hu, C., Zhu, F., Liu, X., Zhang, J., Wang, B., Xiang, H., Cheng, Z., Xiong, Y., et al., 2020a. Clinical characteristics of 138 hospitalized patients with 2019 novel coronavirus-infected pneumonia in Wuhan, China. *JAMA* 323 (11), 1061–1069.
- Wang, S., Kang, B., Ma, J., Zeng, X., Xiao, M., Guo, J., Cai, M., Yang, J., Li, Y., Meng, X., et al., 2020b. A deep learning algorithm using ct images to screen for corona virus disease (covid-19). MedRxiv.
- WHO, <https://www.who.int/emergencies/diseases/novel-coronavirus-2019> (May 2020).
- Xie, Z., 2020. Pay attention to sars-cov-2 infection in children. *Pediatr. Investig.* 4 (1), 1–4.
- Xie, X., Li, X., Wan, S., Gong, Y., 2006. Mining X-ray images of sars patients. *Data Mining*. Springer, pp. 282–294.
- B. Xu, X. Meng, A deep learning algorithm using ct images to screen for corona virus disease (covid-19).
- Zahangir Alom, M., Shaifur Rahman, M., Shamima Nasrin, M., Taha, T.M., Asari, V.K., 2020. Covid\_mtnet: Covid-19 Detection With Multi-Task Deep Learning Approaches arXiv (2020) arXiv-2004.
- Zhang, W., 2020. Imaging changes of severe covid-19 pneumonia in advanced stage. *Intensive Care Med.* 1–3.
- H. Zhang, K.M. Saravanan, Y. Yang, M.T. Hossain, J. Li, X. Ren, Y. Wei, Deep learning based drug screening for novel coronavirus 2019-ncov.
- Zhavoronkov, A., Aladinskiy, V., Zhebrak, A., Zagribelnyy, B., Terentiev, V., Bezrukov, D. S., Polykovskiy, D., Shayakhmetov, R., Filimonov, A., Orekhov, P., et al., 2020. Potential covid-2019 3c-like protease inhibitors designed using generative deep learning approaches. *Insilico Med. Hong Kong Ltd A* 307, E1.
- Zhou, Y., Hou, Y., Shen, J., Huang, Y., Martin, W., Cheng, F., 2020. Network-based drug repurposing for novel coronavirus 2019-ncov/sars-cov-2. *Cell Discov.* 6 (1), 1–18.
- Zhu, H., Guo, Q., Li, M., Wang, C., Fang, Z., Wang, P., Tan, J., Wu, S., Xiao, Y., 2020. Host and infectivity prediction of Wuhan 2019 novel coronavirus using deep learning algorithm. BioRxiv.