

Importance of the conserved nucleotides around the tRNA-like structure of *Escherichia coli* transfer-messenger RNA for protein tagging

Kyoko Hanawa-Suetsugu^{1,2}, Valérie Bordeau³, Hyouta Himeno^{1,2,4,*}, Akira Muto^{1,2,4} and Brice Felden³

¹Department of Biology, Faculty of Science, Hirosaki University, Hirosaki 036-8561, Japan, ²The United Graduate School of Agricultural Sciences, Iwate University, Morioka 020-8550, Japan, ³Laboratoire de Biochimie Pharmaceutique, Faculté de Pharmacie, Université de Rennes I, UPRES Jeune Equipe 2311, IFR 97, 2 avenue du Pr Léon Bernard, 35043 Rennes cedex, France and ⁴Department of Biochemistry and Biotechnology, Faculty of Agriculture and Life Science, Hirosaki University, Hirosaki 036-8561, Japan

Received July 17, 2001; Revised and Accepted October 2, 2001

ABSTRACT

A bacterial RNA functioning as both tRNA and mRNA, transfer-messenger RNA (tmRNA) rescues stalled ribosomes and clears the cell of incomplete polypeptides. For function, *Escherichia coli* tmRNA requires an elaborate interplay between a tRNA-like structure and an internal mRNA domain that are connected by a 295 nt long compact secondary structure. The tRNA-like structure is surrounded by 16 unpaired nt, including 10 residues that are >95% conserved among the known 140 tmRNA sequences. All these residues were mutated to define their putative role(s) in *trans*-translation. Both the extent of aminoacylation and the alanine incorporation into the tag sequence, reflecting the two functions of tmRNA, were measured *in vitro* for all variants. As anticipated from the low sequence conservation, mutating positions 8–12 and position 15 affects neither aminoacylation nor protein tagging. Mutating a set of two conserved positions 13 and 14 abolishes both functions. Probing the solution conformation indicates that this defective mutant adopts an alternate conformation of its acceptor stem that is no more aminoacylatable, and thus inactive in protein tagging. Selected point mutations at the conserved nucleotide stretches 16–20 and 333–335 seriously impair protein tagging with only minor changes in their solution conformations and aminoacylation. Point mutations at conserved positions 19 and 334 abolish *trans*-translation and 70S ribosome binding, although retaining nearly normal aminoacylation capacities. Two proteins that are known to interact with tmRNA were purified, and their interactions with the defective RNA variants were examined *in vitro*. Based

on phylogenetic and functional data, an additional structural motif consisting of a quartet composed of non-Watson–Crick base pairs 5'-YGAC-3':5'-GGAC-3' involving some of the conserved nucleotides next to the tRNA-like portion is proposed. Overall, the highly conserved nucleotides around the tRNA-like portion are maintained for both structural and functional requirements during evolution.

INTRODUCTION

In all bacteria, some chloroplasts and possibly one mitochondrion, tmRNA (transfer-messenger RNA), known alternatively as SsrA RNA or 10Sa RNA, rescues stalled ribosomes and contributes to the degradation of incompletely synthesized peptides, providing some advantages for cell survival (1,2). This molecule is quite remarkable, acting both as a transfer RNA (tRNA) and as a messenger RNA (mRNA) to orchestrate an unusual reaction referred to as *trans*-translation. The current model is that aminoacylated tmRNA is first recruited to the ribosomal A site. Subsequently, the nascent polypeptide chain is transferred to the tRNA-like portion of aminoacylated tmRNA. The ribosome translocates and the incomplete mRNA is replaced with the internal open reading frame (ORF) of tmRNA possessing a termination codon. Thus, tmRNA acts first as a tRNA, and then as an mRNA with an internal ORF that begins, for the vast majority of known tmRNA sequences, with an alanine (resume) codon. *Escherichia coli* tmRNA secondary structure (3) is shown in Figure 1. Circularly permuted versions of several tmRNA genes (alpha-proteobacteria, a lineage of cyanobacteria and mitochondria) were reported (4).

The only known endogenous target for *trans*-translation is the mRNA encoding the Lac repressor, involved in the cellular adaptation to lactose availability (5). Recent evidence suggests that tmRNA is associated with a large ribonucleoprotein complex that contains SmpB (small protein B) (6), ribosomal protein S1 (7), phosphoribosyl pyrophosphate synthase, RNase

*To whom correspondence should be addressed at: Department of Biochemistry and Biotechnology, Faculty of Agriculture and Life Science, Hirosaki University, Hirosaki 036-8561, Japan. Tel: +81 172 39 3592; Fax: +81 172 39 3593; Email: himeno@cc.hirosaki-u.ac.jp

R and YfbG (8), and may also contain elongation factor (EF)-Tu (9,10) and the tRNA that decodes the resume codon (11).

The tRNA-like domain of tmRNA involves pairing between its 5'- and 3'-termini, forming an acceptor stem with a 3'-terminal CCA preceded by a TΨC stem-loop (12–14). *Escherichia coli* tmRNA is specifically aminoacylated by alanyl-tRNA synthetase *in vitro* (12,13). The structural mimicry of tmRNA with canonical tRNA is apparently restricted to the acceptor stem as well as to the TΨC stem-loop. As for canonical tRNA alanine (15,16), a G–U wobble base pair at the third position of the acceptor stem and an adenosine at the discriminator position (the position adjacent to the 3'-terminal CCA) are both responsible for aminoacylation. As for canonical tRNAs, *E.coli* tmRNA interacts with EF-Tu (9,10), at least *in vitro*. The internal ORF of *E.coli* tmRNA encodes 10 residues (ANDENYALAA) and is flanked by two pseudoknots PK1 and PK2 (Fig. 1).

The molecular interplay between the tRNA and the mRNA domains is predicted to be essential for ribosome recycling. tmRNA has first to be aminoacylated (tRNA function), subsequently acting as an mRNA, at least *in vitro* (17,18). Both the functional and structural links between the tRNA and the mRNA portions of *E.coli* tmRNA are, however, poorly understood. In this report, 32 tmRNA variants targeting nucleotides that are phylogenetically conserved (Fig. 1, inset) in the vicinity of the tRNA part of *E.coli* tmRNA were designed, produced *in vivo* and purified. We reasoned that mutating these conserved nucleotides might affect some crucial steps during directed degradation of truncated proteins. To determine which steps might be affected during *trans*-translation, both the aminoacylation plateaus with purified alanyl-tRNA synthetase and the efficiency of poly(U)-dependent tag-peptide synthesis were measured *in vitro*. The solution structures of the defective variants in one or both functions were monitored with chemical and enzymatic probes in solution. We show here that some phylogenetically conserved positions around the tRNA-like domain of tmRNA are essential for tmRNA to bind 70S ribosomes, and that two of the known tmRNA-associated protein factors, EF-Tu and ribosomal protein S1, are not involved.

MATERIALS AND METHODS

Overproduction and preparation of the tmRNA mutant

Mutations were introduced by primer-directed polymerase chain reaction (PCR), and the amplified DNA fragment was ligated under the T7 RNA polymerase promoter sequence of the plasmid pGEMEX-2. The DNA sequence was confirmed by dideoxy sequencing using a fluorescence DNA sequencer (Hitachi SQ-5500). This plasmid was co-transformed with pACYC184 encoding the T7 RNA polymerase gene under the *lac*-promoter sequence into *E.coli* strain W3110 Δ *ssrA*, which lacks the tmRNA gene (13). tmRNA induced by the addition of 1.0 mM isopropyl-1-thio- β -D-galactopyranoside was purified as described (12). The nucleic acid fraction was extracted with phenol from mid-log phase cells followed by ethanol precipitation. After two-times phenol extraction and ethanol precipitation, the resulting fraction was subjected to differential isopropyl-alcohol precipitations to roughly remove DNA, followed by incubation with RNase-free DNase I (Pharmacia). tmRNA was

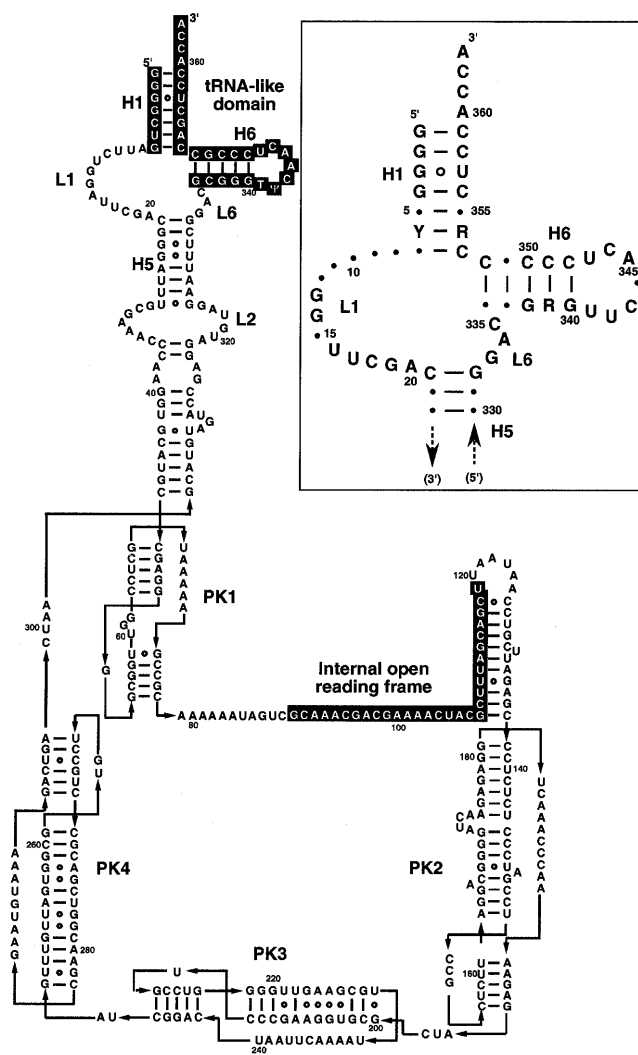

Figure 1. *Escherichia coli* tmRNA secondary structure. Both the internal ORF as well as the tRNA-like domain (H1 and H6) are highlighted by black boxes. Open circles are the non-Watson–Crick pairs. Two modified nucleotides, 5-methyl U and pseudouridine, both in the tRNA-like domain, are indicated as T and Ψ, respectively. The inset emphasizes the 5'- and 3'-ends of the molecule, encompassing the tRNA portion (H1 and H6). The indicated nucleotides (R corresponds to either G or A and Y corresponds to either C or U) are >95% conserved among all the known tmRNA sequences (26). Positions G₁₃, A₂₀ and A₃₄ are strictly conserved, there is one exception at position G₁₉, two exceptions at position G₃₃₃, three exceptions at position G₁₄ (all present in the two-piece tmRNAs) and four exceptions at position C₃₃₅. Post-transcriptional modifications have been omitted on purpose, as they have only been identified in *E.coli*.

purified by electrophoresis on a 5% polyacrylamide gel containing 7 M urea. Spectrophotometric measurements were made to determine the concentration of RNA.

Aminoacylation with alanine

The alanyl-tRNA synthetase overproducing strain (13) is a generous gift of Dr Inokuchi (Kyoto University, Japan). Alanyl-tRNA synthetase was purified with DEAE-Toyopearl 650 (Tosoh) and subsequent hydroxyapatite column chromatography (Gigapite, Seikagaku Corp.) (19). The aminoacylation reaction proceeded at 37°C, in a 50 μl reaction mixture

containing 80 mM Tris-HCl pH 7.5, 150 mM ammonium chloride, 2.5 mM dithiothreitol (DTT), 2.5 mM ATP, 20 μ M L-[U-¹⁴C]alanine (6.5 GBq/mmol, NEN Life Science Products), 1.0 μ M tmRNA mutants and 9.1×10^{-2} U alanyl-tRNA synthetase. At the times specified, an 11.5 μ l aliquot was withdrawn and spotted on Whatman 3MM filter paper, and radioactivity in the trichloroacetic (TCA) acid-insoluble fraction was measured by a liquid scintillation counter.

Poly(U)-dependent amino acid incorporations *in vitro*

The pre-incubated S30 fraction was prepared from mid-log phase cells of *E. coli* W3110 (Δ *ssrA*) strain, as described (20). The reaction mixture (100 μ l) contained 80 mM Tris-HCl pH 7.8, 7 mM magnesium acetate, 150 mM ammonium chloride, 2.5 mM DTT, 1 mM ATP, 0.2 mM GTP, 5 mM phosphoenol pyruvate, 20 μ M L-[U-¹⁴C]alanine, L-[U-¹⁴C]serine (6.3 GBq/mmol), L-[U-¹⁴C]threonine (8.5 GBq/mmol) or L-[U-¹⁴C]arginine (11.2 GBq/mmol) and 0.05 mM each of the remaining unlabelled 19 amino acids, 0.1 μ M tmRNA (when 1 A_{260} unit corresponds to 325 pmol) and 20 μ l of the S30 fraction, in the presence of 250 μ g poly(U) (50–100mer, Sigma). Each tmRNA variant was used in the reaction without any refolding procedure after the purification from the gel. The reaction mixture was incubated at 37°C. At each time point, a 23.5 μ l aliquot was withdrawn from a 100 μ l reaction mixture and spotted on Whatman 3MM filter paper, and radioactivity in the hot TCA acid-insoluble fraction was measured by a liquid scintillation counter. The final value of poly(U)-dependent amino acid incorporation was obtained by subtracting the value in the absence of poly(U) from that in the presence of poly(U).

Interaction with ribosome

After the 10 min incubation at 37°C, 100 μ l of reaction mixture containing 80 mM Tris-HCl pH 7.8, 7 mM magnesium acetate, 150 mM ammonium chloride, 300 mM potassium chloride, 2.5 mM DTT, 1 mM ATP, 0.2 mM GTP, 5 mM phosphoenol pyruvate, 0.05 mM each of 20 amino acids, 25 pmol tmRNA, 250 μ g poly(U) and 90 μ l of the S30 fraction was immediately loaded on a 5–20% linear sucrose density gradient containing 10 mM Tris-HCl pH 7.8, 10 mM magnesium chloride and 300 mM potassium chloride, and was centrifuged at 25 000 r.p.m. (82 200 g) using a Hitachi P28S rotor for 5 h at 4°C. Nucleic acids prepared from each fraction by phenol extraction and ethanol precipitation were separated by electrophoresis on a 1.5% agarose gel containing 6.3% formaldehyde, and were then blotted onto a nylon membrane. tmRNA was detected by northern hybridization using a 3'-digoxigenin-labeled oligodeoxyribonucleotide (12) complementary to a portion of the tmRNA sequence (nt 251–280).

Protection from hydrolysis of alanyl-tmRNA by EF-Tu

Thermus thermophilus EF-Tu-GDP and EF-Ts were purified from overproducing strains as described (21,22). Aminoacylation reaction of tmRNA with L-[3-³H]alanine was stopped by phenol extraction in the presence of sodium acetate at pH 4.5. The RNAs were ethanol precipitated, washed and dried. Prior to that treatment, an aliquot of each sample was spotted on a Whatman 3MM filter paper and the 5% TCA acid insoluble fraction was measured to estimate the amount of alanylated tmRNA. *Thermus thermophilus* EF-Tu-GDP was activated

to EF-Tu-GTP by incubation at 37°C for 20 min in 50 mM Tris-HCl pH 7.5, 50 mM potassium chloride, 50 mM ammonium chloride, 1 mM GTP, 2 mM phosphoenol pyruvate, 5 U pyruvate kinase, 50 μ M EF-Tu-GDP and 5 μ M EF-Ts, and the solution was kept on ice until use. The hydrolysis protection assay was as described previously (9). For each of the experiments, ~1 pmol of the alanyl-tmRNA was dissolved in 50 mM Tris-HCl pH 7.5, 50 mM potassium chloride and 10 mM magnesium chloride and incubated with 0–10 μ M range of EF-Tu-GTP in a final volume of 100 μ l. After formation of the ternary complex (10 min incubation on ice), samples were further incubated at 37°C to allow hydrolysis of the chemically unstable ester bond to proceed. Aliquots (18 μ l) were pulled out at 0, 20, 40, 60 and 90 min and spotted onto Whatman 3MM filter paper. After TCA acid precipitation, the residual radioactivity was measured by liquid scintillation counter. Each set of experiments was repeated twice.

Gel-mobility shift assay

S1 protein was a gift from Dr SungGa Lee (Hirosaki University, Japan) which was isolated from the *E. coli* ribosome fraction by chromatography on poly(U)-Sepharose (Amersham Pharmacia Biotech) (23). The concentration of S1 protein was measured by the Bradford method. tmRNA was dephosphorylated by T4 alkaline phosphatase (Takara) and then it was phosphorylated with [γ -³²P]ATP by T4 polynucleotide kinase (Takara). Reaction mixtures (20 μ l) contained 50 000 c.p.m. of [³²P]tmRNA and varying amount of S1 in 10 mM Tris-HCl pH 7.6, 100 mM ammonium chloride, 100 mM magnesium acetate, 1 mM DTT, 0.02% NP-40 and 100 mg/ml bovine serum albumin. After incubation at 0°C for 30 min, mixtures were loaded onto a 5% polyacrylamide gel in a TGE buffer (25 mM Tris-HCl pH 7.6, 190 mM glycine, 1 mM EDTA and 2.5% glycerol). Radioactivity on a gel was monitored by Bio-Image Analyzer BAS3000 (Fuji Film).

Structural analysis of the variants

The melting temperature was measured in 10 mM cacodylate buffer pH 6.8, 100 μ M EDTA, 50 μ M sodium chloride and 10 mM magnesium chloride using a Pharmacia Biotech 'Ultrospec' 3000 spectrophotometer equipped with a temperature regulator. Labeling at the 5'-end of tmRNA was performed with [γ -³²P]ATP and phage T4 polynucleotide kinase on RNA dephosphorylated previously with alkaline phosphatase. Labeling at the 3'-end was carried out by ligation of [γ -³²P]pCp using T4 RNA ligase. After labeling, tmRNA was gel purified (5% PAGE), eluted, and ethanol precipitated. Before either enzymatic digestions, the labeled tmRNA was heated to 80°C for 2 min. Cleavage or modification sites were detected by gel electrophoresis by direct identification with the statistical cleavage patterns of the RNA itself. Digestions with various ribonucleases (V_1 , S_1 , T_1 and U_2) were performed as described on both 3'- and 5'-labeled tmRNA (20 000 c.p.m./reaction), supplemented with 1 μ g of total rRNA. The following amounts of nucleases were added: 0.15 U RNase T_1 , 0.2 U RNase U_2 , 20 U nuclease S_1 and 5×10^{-5} U nuclease V_1 (Kemotex, Estonia). Incubation times were 5.5 min at 37°C for V_1 and S_1 , and 10 min at 50°C for T_1 and U_2 . Probing with lead acetate was performed as described (24). Reactions carried out in a 20 μ l reaction volume at 37°C for 5.5 min by adding 1.3 mM of lead (II) acetate. RNAs were ethanol precipitated,

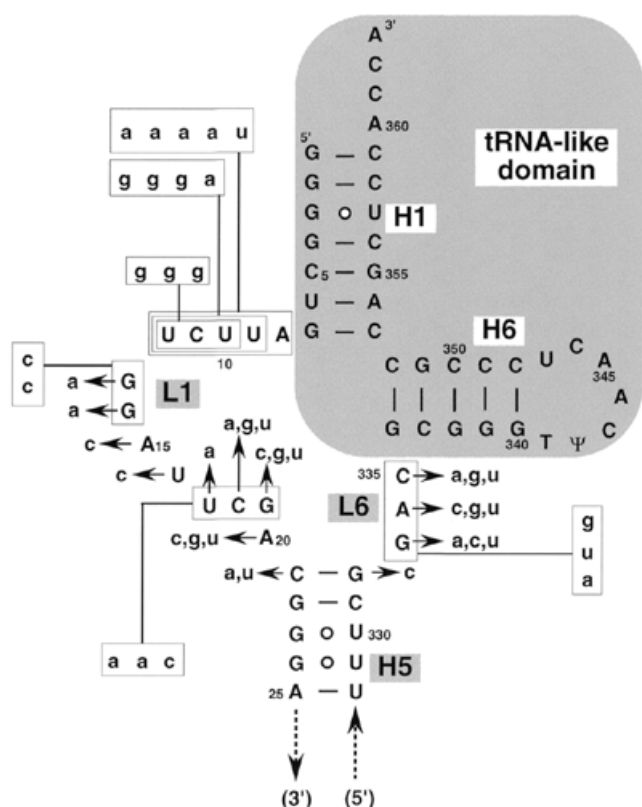

Figure 2. Location of the mutations, and description of the 32 mutants that were engineered, produced *in vivo* and tested functionally in this report. The focus was on all the conserved nucleotides surrounding the tRNA-like structure (black box) of *E. coli* tmRNA. The arrows indicate the base substitutions, and the multiple mutations are boxed.

dried and counted, and the RNA fragments were submitted to an electrophoresis.

RESULTS

Engineering the vicinity of the tRNA-like domain of *E. coli* tmRNA

The overproduction of the *E. coli* tmRNA variants was in *E. coli* strain Δ *ssrA*, with the endogenous gene of tmRNA being deleted, as described (25). This allows evaluation of the specific effects of each mutation on tmRNA functions *in vitro*. The RNA variants are named according to the location of the mutations within the sequence of tmRNA. Figure 2 summarizes the 32 tmRNA variants produced *in vivo* and purified. The tmRNA variants were mutated either at one (26 variants), two (one variant), three (three variants), four (one variant) or five positions (one variant). At first, mutations were engineered so that they target several nucleotides at once. Then, only a smaller subset of nucleotides from the initial pool was mutated, and all 3 nt combinations were performed on the conserved nucleotides that were shown as critical for tmRNA function.

Aminoacylation and tmRNA-dependent tag-peptide synthesis of the variants

Replacing the third G₃-U₃₅₇ pair in the acceptor stem of tmRNA by A-U pair abolishes aminoacylation and *trans*-translation (17). This mutant was used as an internal negative

control in our experiments. Abutting to the 5'-strand of tmRNA acceptor stem, positions 8–12 and position 15 are not phylogenetically conserved (Fig. 1, inset). Mutants 8UAAAA, 9AGGG and 10GGG are aminoacylated *in vitro* with alanine by purified *E. coli* alanyl-tRNA synthetase and are active in poly(U)-dependent alanine incorporation to levels comparable with wild-type (Fig. 3). For most sequences, position 15 is an A or a U (A in *E. coli*). Out of the known 140 sequences of tmRNA (tmRNA website; 26), only 10 have a C at position 15. Mutating A₁₅ into C₁₅ decreases aminoacylation only marginally without affecting protein tagging (Fig. 3). Several conserved nucleotides are in the vicinity of the tmRNA acceptor stem, at positions 13–14, 16–21 and 332–335 (Fig. 1, inset). Mutating these conserved positions has either positive effects (9AGGG and 18G or U), no effect (8UAAAA, 10GGG, 333AUG, 19A or U, 20C or G and three mutations at positions 334 and 335), slightly impaired effects (17AAC, 15C, 16C, 17A, 18A, 19C, 20U, 21A or U, 332C and three mutations at positions 333) or significantly impaired effects (13CC, 13A and 14A) on aminoacylation *in vitro* (Fig. 3A). Aminoacylation was not significantly damaged by any mutation within loop L6. When mutating the conserved nucleotides around the tRNA-like domain (Fig. 1, inset), e.g. at positions 13–14, 16–20 and 334–335, *in vitro* poly(U)-dependent alanine incorporation is largely reduced compared with wild-type tmRNA (Fig. 3B). Poly(U)-dependent alanine incorporation was affected by mutations within loop L6 (Figs 2 and 3). When all 3 nt at positions 333, 334 and 335 are mutated (variant 333AUG), there is no protein tagging. Then, each of these 3 nt was mutated separately. Position 333 (in L6) is a G in >95% of the known tmRNA sequences, whereas any of the 4 nt combinations works equally well in *trans*-translation. This suggests that nucleotide conservation at that position is not essential for function. At position 334, there is an A that can be mutated into a C without affecting function. Mutating A₃₃₄ into either G or U severely impairs or suppresses protein tagging *in vitro* (Fig. 3B). At position 335, the three base substitutions cause variable effects on alanine incorporation. Variant 333AUG is inactive, probably because it has the deleterious 334U point mutation.

Out of all the 32 mutants, only three constructs, 13A, 14A and 13CC, have severe defects in both aminoacylation and protein tagging, compared with wild-type (Fig. 3B). These results demonstrate that nucleotide conservation around the tRNA-like domain of tmRNA is essential for efficient protein tagging, at least *in vitro*. At positions 19, 20, 334 and 335, nucleotide identity is essential for efficient protein tagging (Fig. 3B). Mutating the conserved position 19, 20, 334 or 335 severely impairs *in vitro* alanine incorporation without perturbing aminoacylation (19C, 20G or U, 334G or U and 335G or U). This result was quite unexpected as positions 19 and 334 are adjacent to the tRNA-like domain, but largely away from the internal ORF.

The usual frame of tmRNA internal ORF is maintained

The putative poly(U)-dependent incorporation of either arginine, serine or threonine was also measured. These amino acids could be incorporated into the nascent polypeptide chain if an alternative coding frame was used during re-registration (27). Neither arginine, serine nor threonine incorporation was detected in any of the mutants reported here (data not shown);

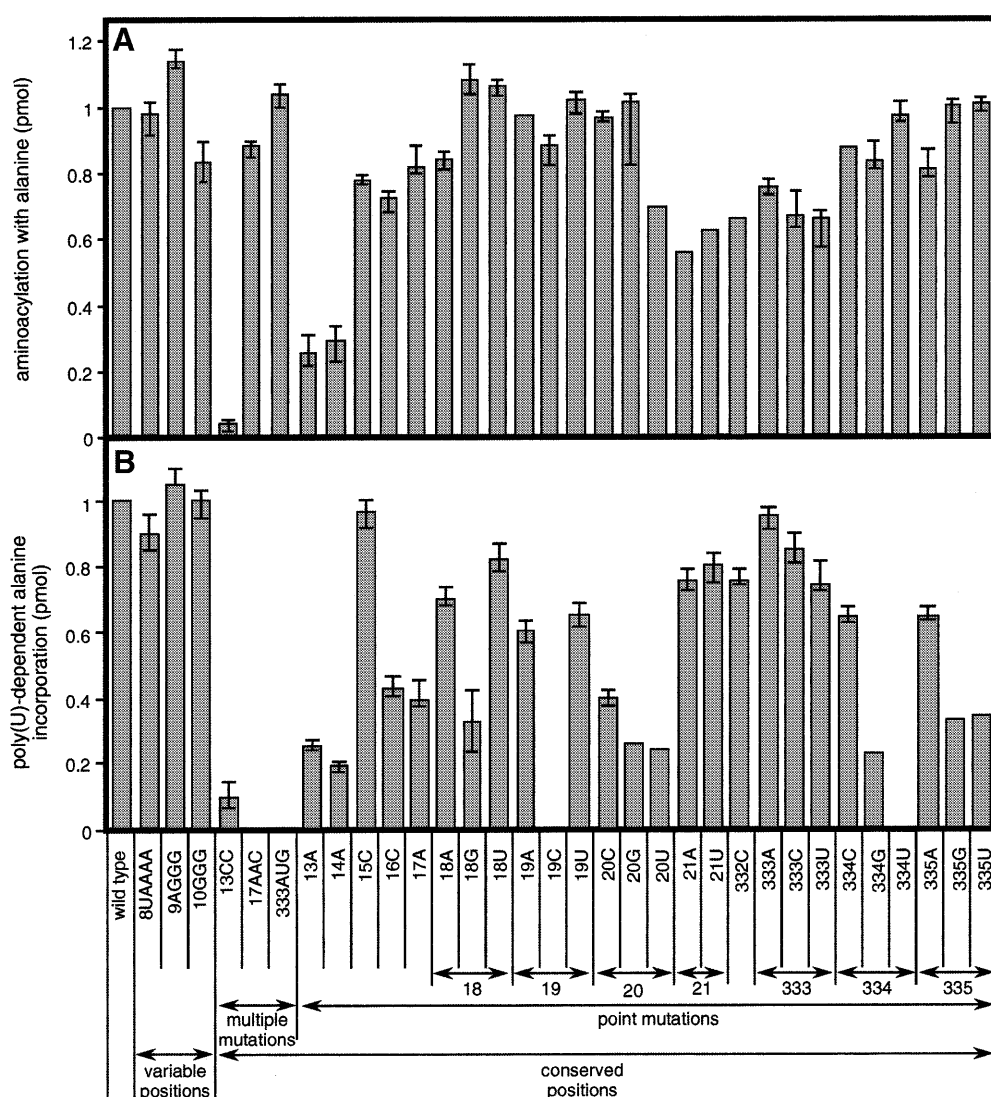

Figure 3. Functional analysis of the tmRNA variants. *In vitro* aminoacylation with alanine (**A**) and *in vitro* poly(U)-dependent alanine incorporations (**B**). The length of the bar indicates the amount (mole) of alanine incorporated at 12 min after incubation. The mean value obtained from at least two experiments was plotted. Error bar indicates the standard deviation. Note that the variable positions in all the known tmRNA sequences can be mutated without affecting function, whereas most of the conserved positions cannot without severely impairing either or both functions.

demonstrating that the usual frame encoding the tag peptide in *E.coli* cells was predominant in our *in vitro* system.

Some phylogenetically conserved residues are essential to bind the 70S ribosome

The ability of the mutants that are aminoacylatable but defective in protein tagging to bind the 70S ribosome was examined. A poly(U)-dependent *trans*-translation reaction mixture conducted by each tmRNA mutant was fractionated by sucrose density gradient centrifugation. Then, the localization of tmRNA was examined by northern hybridization. As shown previously (17,28), wild-type tmRNA is detected in the 70S ribosomal fraction as well as in the soluble fraction. Interestingly, mutants 13CC, 19C and 334U are exclusively located in the soluble fraction (Fig. 4). To account for this unexpected observation, several hypotheses are proposed: (i) their solution conformations might be altered, impairing the structural link

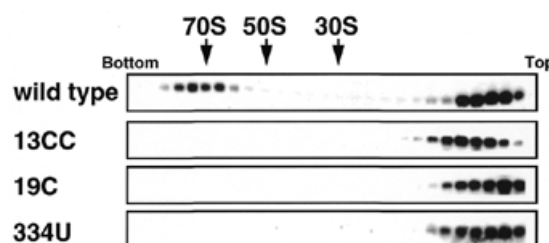

Figure 4. Northern blotting of three defective tmRNA variants onto a sucrose density gradient. This experiment demonstrates that mutants 13CC, 19C and 334U do not bind 70S ribosomes, whereas wild-type tmRNA does. The positions of 70S, 50S and 30S ribosomal fractions were monitored by UV absorption at 260 nm, and are indicated by the arrows.

between both the tRNA and the mRNA portions of tmRNA (seems unlikely for point mutants); (ii) these three mutants are

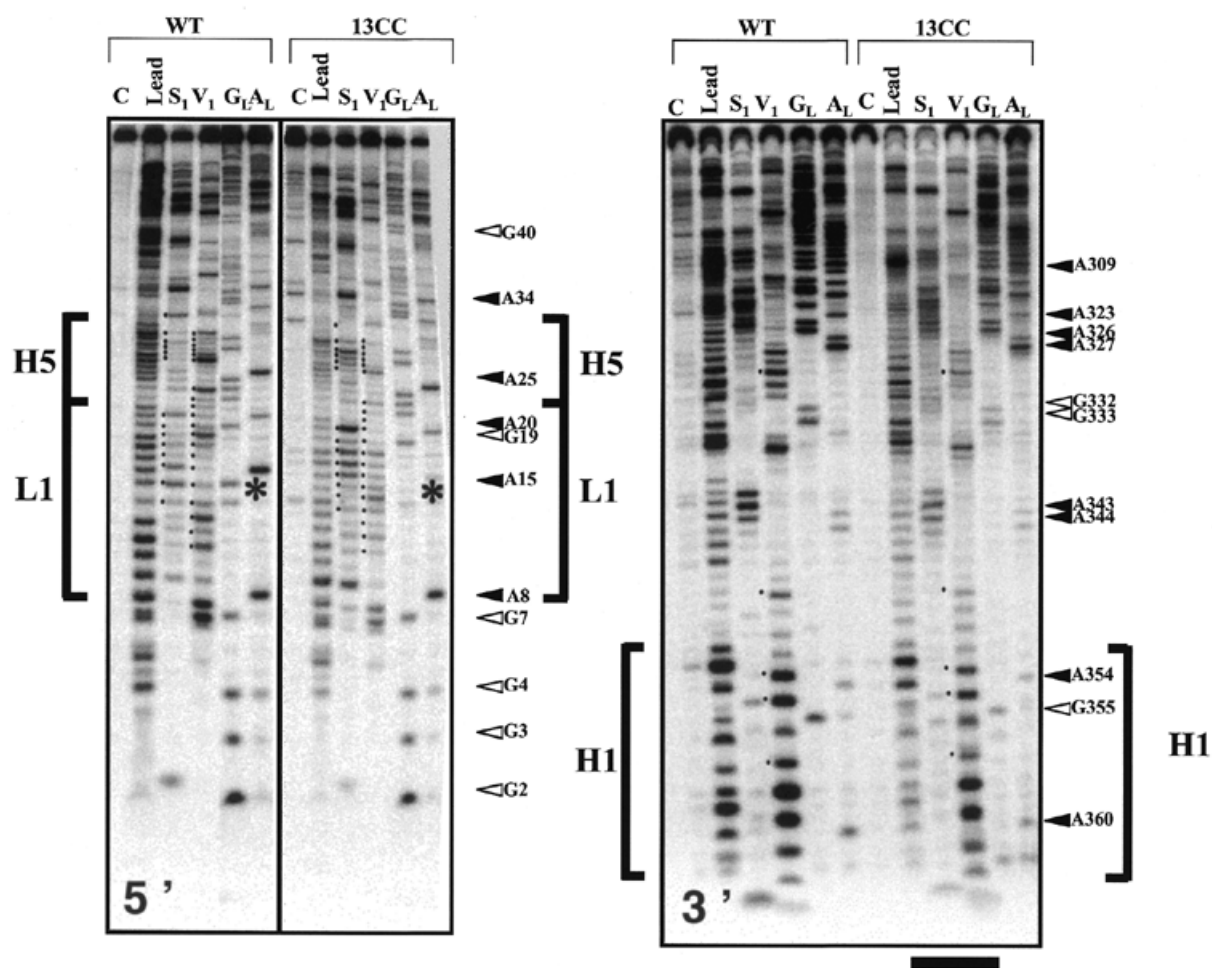

Figure 5. Nuclease mapping and lead cleavages of *E. coli* tmRNA variant 13CC, compared with wild-type. Autoradiogram of 15% PAGE of cleavage products of 5'- (left) and 3'- (right) labeled RNAs. Lanes C, incubation controls; lanes G_L, RNase T₁ hydrolysis ladder; lanes A_L, RNase U₂ hydrolysis ladder. Sequencing tracks are numbered every 5–15 residues at A's or G's. The stars show the location of the mutations, and the bracket points to the area where the reactivity towards structural probes is affected. The black dots at the left edges of the lanes indicate the major changes of reactivity of nucleotides from variant 13CC, compared with wild type. The horizontal black bars emphasize the higher susceptibility of mutant 13CC towards the structural probes, an indirect argument suggesting that the conformation of that mutant is destabilized compared with wild-type.

unable to interact with a specific protein that is required for tmRNA to bind the ribosome; and (iii) these three conserved positions interact directly with specific components of the ribosome. The aminoacylation capacity of mutant 13CC is strongly impaired, whereas point mutants 19C and 334U are efficiently aminoacylated (Fig. 3A).

Structural analysis of the variants

Multiple or even point mutations targeting specific sequences within *E. coli* tmRNA might affect its conformation in solution. For all the variants, the temperature dependence of their UV absorbency was measured in the presence of 10 mM magnesium ions. As for wild-type tmRNA, all the variants have a melting temperature (T_m) $\sim 69.5 \pm 1^\circ\text{C}$ (data not shown). The data suggest that all the mutations, even the multiple ones, do not cause large structural rearrangements of tmRNA structure. Local structural effects, however, might still be induced by some mutations, especially those affecting either or both functions, without affecting the T_m value. To test this hypothesis, the solution conformations of nine defective mutants (13A, 13CC,

14A, 19C, 21A, 21U, 332C, 333U and 334U) were monitored using chemical and enzymatic probes. Lead acetate cleaves RNA single strands and its specific requirements for cleavage depend on very subtle conformational changes in RNAs. Thus, it might help deciphering discrete conformational changes in the structure of the inactive variants. Ribonuclease V₁, from cobra venom, cleaves RNA double-strands or stacked nucleotides, and was used to monitor whether all the RNA helices in the tmRNA structure were maintained in the structure of the defective variants. Conversely, nuclease S₁ cleaves RNA single strands. For each mutant, both 5'- and 3'-labeled RNAs were probed to discriminate between primary cuts, reflecting the RNA conformation, from secondary cuts induced by primary cleavage sites that are useless during the structural analysis.

With ribonucleases V₁, S₁ and lead acetate, there are no significant differences in the probing pattern of 5'- and 3'-labeled RNA variants 13A, 14A, 21A, 21U, 332C and 333U, compared with wild type (data not shown). This demonstrates that all these mutants are defective in aminoacylation

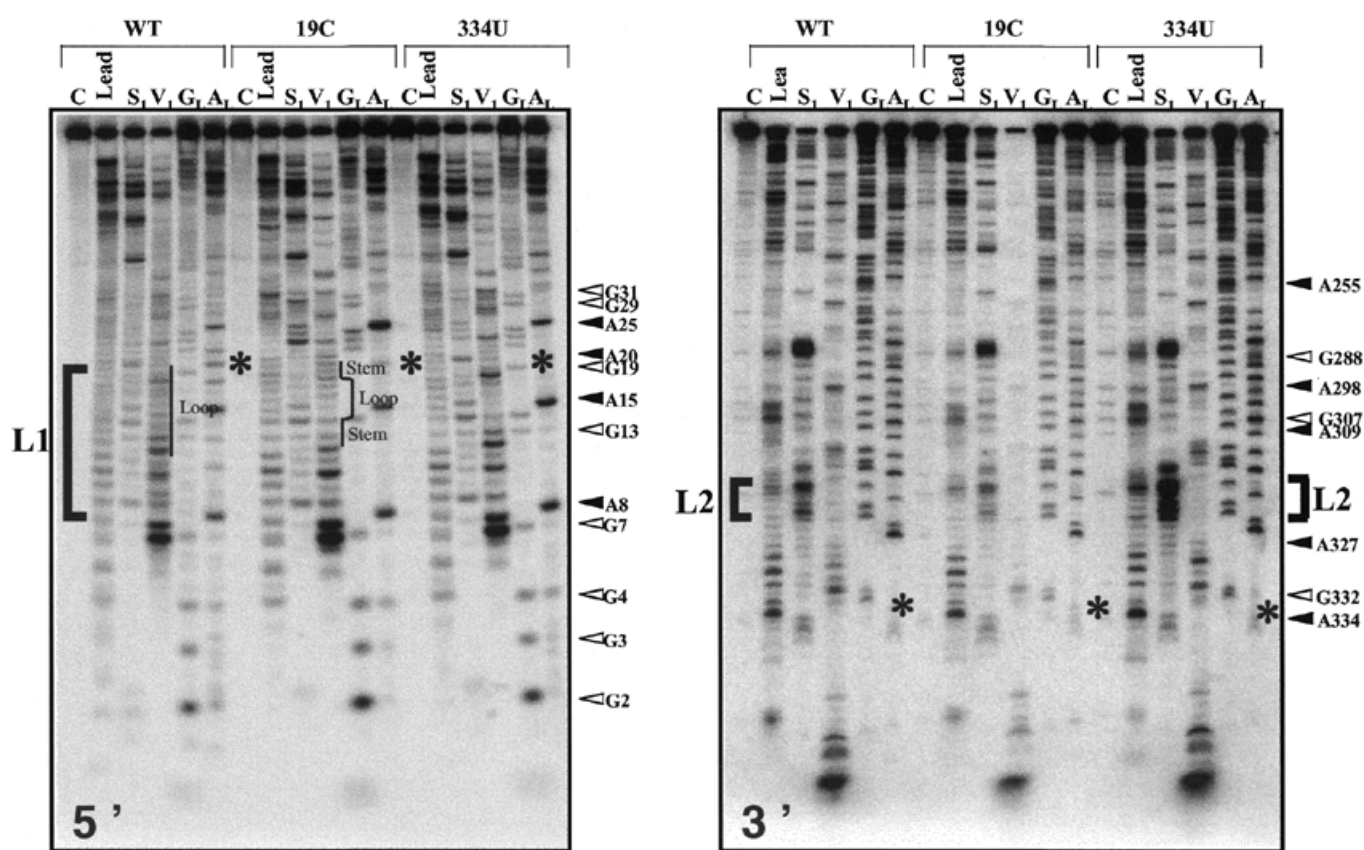

Figure 6. Nuclease mapping and lead cleavages of *E. coli* tmRNA variants 19C and 334U, compared with wild type. Autoradiogram of 20% (left) and 8% (right) PAGE of cleavage products of 5'- (left) and 3'- (right) labeled RNAs. For variant 19C, the suggested base pairing within L1 is indicated. Other indications provided are identical to those described in the legend to Figure 5.

and/or in protein tagging, despite their conformations being identical to wild-type tmRNA. Only three defective variants, 13CC (Fig. 5), 19C and 334U (Fig. 6) have detectable alterations of their conformations, compared with wild-type. Compared with wild type, the probing pattern of mutant 13CC deviates within and around the tRNA-like domain, especially at loop L1 (where the mutations are) and at helices H1 and H5 (Fig. 5, brackets in both panels). Helix H1 contains the G-U pair that is required for aminoacylation with alanine (12,13). Mutant 13CC is not aminoacylatable with alanine *in vitro* (Fig. 3A), probably because of the structural alteration of its acceptor stem, as illustrated in Figure 5. The probing patterns of all the other structural domains of variant 13CC, however, are essentially similar to the wild-type (Fig. 5). This suggests that the conserved nucleotides at positions 13 and 14 are not involved in long-range interactions involving domains other than the tRNA-like structure itself.

The probing pattern of mutant 19C is similar to wild-type tmRNA, except for loop L1 (Fig. 6, left panel). In variant 19C, several double-stranded specific cleavages appear in L1, concomitantly with the disappearance of single-stranded cuts, compared with wild-type tmRNA. It suggests that in mutant 19C, L1 is partially double stranded. One possibility is that residues $U_{12}G_{13}G_{14}$ are paired with $A_{20}C_{19}C_{18}$, but not in wild type, as there is a G at position 19. For mutant 334U, the probing pattern is similar to wild-type tmRNA, except in Loop

2 (L2, Figs 1 and 6). Compared with wild-type tmRNA, part of L2 ($G_{321}-G_{325}$) is now very accessible towards S1 cleavages in variant 334U. It suggests that L2 and L6 are somehow structurally dependent each other, despite helix H5 being in between. Possible structural alteration of 334U with respect to L2 might explain some of the functional defects of this mutant. According to these structural probes, no significant differences in reactivity were observed between variants 13A, 14A and wild-type (not shown).

EF-Tu recognizes efficiently the defective mutants

Escherichia coli tmRNA interacts with either *T. thermophilus* or *E. coli* EF-Tu *in vitro* (9,10), and probably also *in vivo*. The aminoacyl-bond of alanyl-tmRNA was shown to be efficiently protected by EF-Tu from spontaneous hydrolysis (9). Using *T. thermophilus* EF-Tu in complex with GTP, hydrolysis protection assays were performed on the alanylated tmRNA mutants that are defective in protein tagging *in vitro*, compared with wild-type tmRNA (Fig. 7). Variants 19C and 334U are aminoacylated with alanine to levels comparable with wild-type tmRNA, whereas there is a significantly smaller alanylated fraction of mutants 13A and 14A. In 0, 0.4, 2 and 10 μ M of EF-Tu-GTP, alanylated tmRNA mutants 13A, 14A, 19C and 334U have a first-order hydrolysis profile similar to wild type, although only a slightly faster hydrolysis was observed for 19C even in the absence of EF-Tu-GTP (Fig. 7). As a whole,

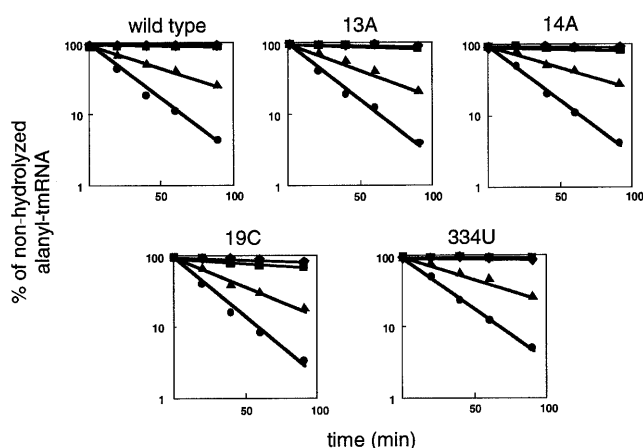

Figure 7. Hydrolysis protection assays of the aminoacyl-ester bond of tmRNA variants. Rates of hydrolysis of the 3'-terminal alanine residue of the L-[³H]alanyl-tmRNA variants 13A, 14A, 19C and 334U, compared with wild type in 0 (circles), 0.4 (triangles), 2 (squares) and 10 μM (diamonds) of EF-Tu-GTP from *T.thermophilus* are shown.

all the mutants were efficiently protected from EF-Tu-GTP as wild type. Thus, the interaction with EF-Tu is not the rationale for the functional defects of these RNA variants.

Ribosomal protein S1 recognizes efficiently the defective mutants

Ribosomal protein S1 facilitates the binding of tmRNA to ribosomes (7). Ribosomal protein was purified from the ribosomal fraction and its interaction with 13CC, 19C or 334U compared with wild-type tmRNA was monitored by gel-mobility shift assays (Fig. 8). Wild-type tmRNA efficiently binds S1 with an apparent dissociation constant of 2.5 ± 1 nM (result reproduced three times). The affinity of purified S1 with *in vivo* produced tmRNA is about four times higher than that reported for a His-tagged version of S1 with a synthetic tmRNA transcript (7). Variants 13CC, 19C and 334U bind protein S1 as wild-type tmRNA does, indicating that the interaction with S1 is not the rationale for the functional defects of these RNA variants.

DISCUSSION

We report the characterization of point mutations targeting phylogenetically conserved residues adjacent to the tRNA domain of tmRNA. Some of these mutations are deprived of detectable effects on the tRNA function of tmRNA (aminoacylation), but are essential for its mRNA function (protein tagging). These functionally important positions are located within the apparently single-stranded regions L1 (G₁₃-A₂₀) and L6 (G₃₃₃-C₃₃₅). The most severe effects on function are at positions 13, 14, 19, 20, 334 and 335.

In canonical tRNAs, the D-loop interacts with the T-loop via two long-range interactions, G₁₈-Ψ₅₅ and G₁₉-C₅₆. Within the tRNA-like portion of tmRNA structure, long-range interactions between G₁₃-Ψ₃₄₂ and G₁₄-C₃₄₃ might also be the rationale for the nucleotide conservation (two guanines) at positions 13 and 14. If these two long-range interactions are present in tmRNA, they are no more feasible in mutant 13CC.

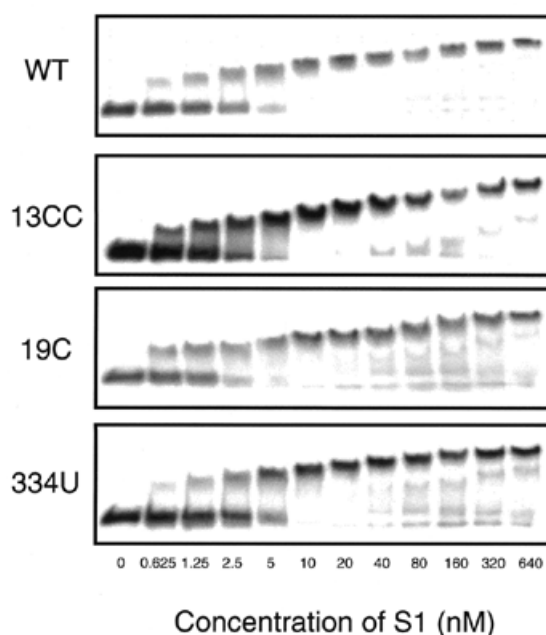

Figure 8. Native gel-retardation assays between purified ribosomal protein S1 and tmRNA variants 13CC, 19C and 334U, compared with wild-type tmRNA.

In all known tRNA^{Ala} sequences from prokaryotes, archaea, eukaryote cytoplasm and chloroplasts, the G₃-U₇₀ pair, as well as base pairs 1:72 and 2:71 and the N₇₃ discriminator base, are conserved. Based on a set of full-length deoxynucleotide substituted tRNAs, backbone interactions with alanyl-tRNA synthetase in both the acceptor stem and the T-loop (29). Aminoacylation is severely affected in variants 13CC, 13A and 14A. As positions 13 and 14 are proposed to interact with the T-loop in tmRNA, as positions 18 and 19 in canonical tRNAs, this may result in an inability of variants 13A and 14A to properly position themselves on the enzyme, so that they can simultaneously satisfy interactions with both the T-loop and the acceptor stem. It remains to be established, however, whether or not alanyl-tRNA synthetase interacts with tmRNA as with canonical tRNAs. As tmRNA is ~5-fold larger than tRNA^{Ala}, it is reasonable to assume that additional contacts might occur between tmRNA and the enzyme.

Mutating the universally conserved Gs at positions 13 and 14 (at least for all the one-piece tmRNA sequences) affect both functions of tmRNA. Probing its solution conformation indicates that its acceptor stem is destabilized, a rationale for the functional defects of the RNA variants at these two positions. Maintaining the conformation of the tRNA-like domain of tmRNA for efficient aminoacylation might explain the phylogenetic conservation of two guanines at positions 13 and 14, in addition to their possible involvement in the two tertiary interactions described above. Exceptions have been reported in a functional two-piece tmRNA (*Caulobacter crescentus*, alpha-proteobacteria, C₁₄ instead of G₁₄) as well as in a related sequence from the mitochondrial genome of *Reclinomonas americana* (U₁₄ instead of G₁₄), a species that has only maintained the sequence corresponding to the tRNA-like portion of tmRNA (4). In the primary sequence of permuted two-pieces tmRNA genes, the 5'-strand of the acceptor stem is next to the 3'-strand, especially

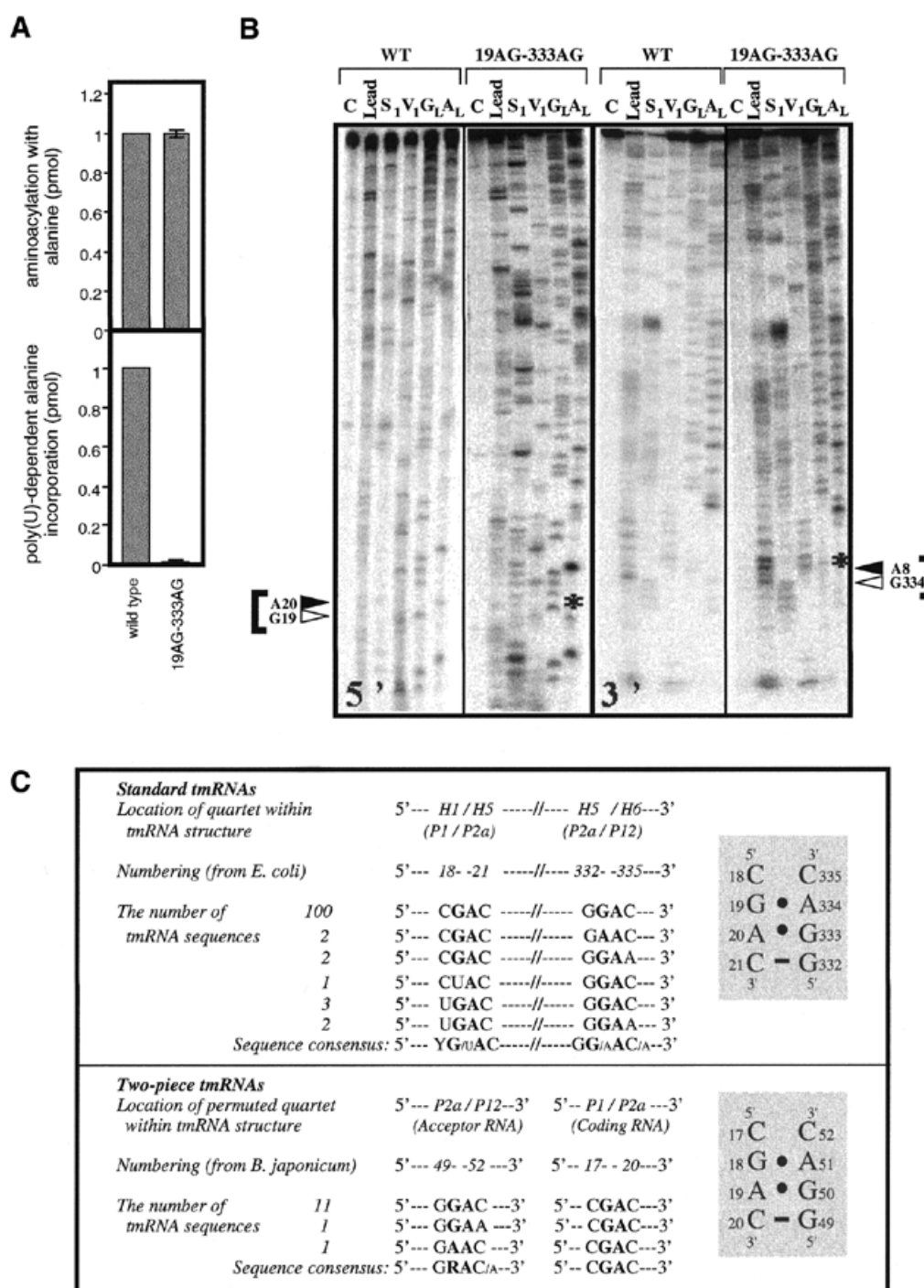

Figure 9. A putative additional RNA structural motif at the vicinity of the tRNA-like structure of *E. coli* tmRNA. (A) When the predicted 5'-₁₉GA₂₀-3'/5'-₃₃₃GA₃₃₄-3' interaction is flipped over to 5'-₁₉AG₂₀-3'/5'-₃₃₃AG₃₃₄-3' (variant 19AG-333AG), protein tagging (lower) is abolished *in vitro*, whereas aminoacylation (upper) remains as efficient as wild-type tmRNA. Other indications provided are identical to those described in the legend to Figure 3. (B) Nuclease mapping and lead cleavages of variant 19AG-333AG, compared with wild-type. Other indications provided are identical to those described in the legend to Figure 5. (C) The proposed interaction is feasible in the sequence context of both standard and permuted tmRNA sequences.

when the intervening sequence is rather short in length. However, in one-piece tmRNAs, both the 5'- and the 3'-strands are ~300 nt apart. Thus, during gene transcription, alternate pairings are favored in one-piece tmRNAs that might lead to the inactivation of RNAs (on native PAGE, several conforma-

tions are observable for one-piece tmRNAs). Consequently, nucleotide conservation at position 14 might be weaker in two-piece tmRNA sequences. Judging from both the melting profile and the probing pattern of variants 13A or 14A, which are essentially as wild-type tmRNA, these two point mutants

adopt basically the same conformation as wild-type tmRNA. Nevertheless, aminoacylation and tag-peptide synthesis are considerably impaired, suggesting that positions 13 and 14 have some other unidentified roles in *trans*-translation, apart from preventing from inactive alternate folds of tmRNA acceptor stem. Positions 19 and 334 are next to the tRNA-like portion of tmRNA, but away from the internal ORF. However, we report that variants 19C and 334U abolish the mRNA function of tmRNA by preventing binding with 70S ribosomes, without affecting aminoacylation. Thus, these two point mutations affect *trans*-translation after the aminoacylation of tmRNA but before its interaction with the ribosome. One possibility is that these two residues in the tRNA-like domain might be located in the proximity of the internal ORF in tmRNA tertiary structure. A specific intramolecular interaction is a priori excluded, as mapping their solution structures with chemical and enzymatic probes could not detect any changes on the reactivity of nucleotides from or around the internal ORF. Alternatively, positions 19 and/or 334 may bridge between the tRNA and the mRNA parts of tmRNA via a specific protein other than EF-Tu or S1. Also, a direct interaction between positions 19 and/or 334 and a specific component of the ribosome cannot be ruled out.

Escherichia coli tmRNA associates *in vivo* and/or *in vitro* with several proteins (4,7–9) and also with tRNA^{Ala} (11). We tested the ability of some of our defective variants to interact with two purified protein factors *in vitro* that interact with tmRNA prior and during its recruitment to the ribosome, EF-Tu and S1. Only one side of the T-stem helix, the CCA-end and the 5' phosphate of the tRNA are in direct contact with EF-Tu, whereas the anticodon branch is pointing away (30). As for canonical aminoacyl-tRNAs, EF-Tu protects the aminoacyl bond of alanyl-tRNAs from spontaneous deacylation (9). If one assumes that EF-Tu recognizes alanylated-tmRNA as it does for aminoacylated-tRNAs, point mutations at positions 19 and 334 that surround the tRNA-like domain are reasonable candidates to interfere with binding with EF-Tu-GTP. Purified EF-Tu efficiently protects the aminoacyl-ester bond of several variants deficient in protein tagging *in vitro*, including those at positions 19 and 334, with an affinity comparable with wild-type tmRNA, suggesting that EF-Tu does not account for their functional defects.

Ribosomal protein S1 is also required for tmRNA binding to isolated and poly(U)-programmed ribosomes (7). Nucleotides that cross-linked between tmRNA and S1 are located before the resume codon, within the coding sequence, as well as within three of the four pseudoknots in *E. coli* tmRNA, PK2, PK3 and PK4. We show here that point mutations around the tRNA-like domain impair ribosome binding. Purified protein S1 binds the defective variants with an affinity comparable with wild-type tmRNA, again suggesting that this protein does not account for their functional defects. Interestingly, even destabilizing the conformation of the tRNA-like domain by mutating positions 13 and 14 does not impair the binding of tmRNA with S1 (Fig. 8). Our preliminary data suggest that some defective tmRNA variants have an impaired association with SmpB, although whether this reflects a direct or an indirect effect has yet to be identified. This is in agreement with earlier reports showing that SmpB is required for tmRNA to bind 70S ribosomes (6).

Based on functional, structural and phylogenetic data, a novel structure encompassing eight highly conserved nucleotides at positions 18–21 and 332–335 (numbering of *E. coli* tmRNA) is proposed (Fig. 9). It consists of a quartet composed of a G–A tandem capping helix H5 and abutting onto the tRNA-like structure. If present, this motif would be conserved throughout the bacterial phylogeny, and is feasible in the sequence context of both standard and permuted tmRNA sequences (Fig. 9C). The proposed quartet would involve the two G–A pairs G₁₉–A₃₃₄ and A₂₀–G₃₃₃, surrounded by a C₂₁–G₃₃₂ pair with an unusual probing pattern (24), suggesting a non-Watson–Crick pairing as well as a C₁₈–C₃₃₅ mismatch. G–A tandems are quite extensively documented. They are found in many functional RNAs including ribosomal RNAs, and are implicated in both the structure and function of many different RNAs (e.g. ribosomal RNAs; 31). To give further experimental support to this interaction, the quadruple mutant 5'–₁₉AG₂₀–3'/5'–₃₃₃AG₃₃₄–3' (19AG–333AG), which is predicted to flip over the proposed interaction, was produced *in vivo* and purified. Interestingly, this mutant is unable to direct protein tagging *in vitro*, whereas being aminoacylated with alanine as well as wild type (Fig. 9A). As shown in Figure 9B, this mutant possesses a probing pattern similar to wild-type tmRNA, suggesting that its solution conformation cannot account its functional defect in protein tagging. Alternatively, direct base recognition at positions 19, 20, 333 and 334 of the tRNA-like domain of tmRNA by a tmRNA ligand required to bind stalled 70S ribosomes could also rationalize the functional results described above, in the absence of any conserved structural motif. Hence, further experiments, e.g. by UV cross-links and by additional mutational analysis, will be required to confirm (or invalidate) the proposed base pairs.

None of the mutations around the tRNA-like domain of *E. coli* tmRNA cause a shift of the tag-resuming point, in opposition to some of those targeting the upstream portion of the resume codon (27). This suggests that the precise determination of the initiation point of the tag-translation is an event not directly involving the tRNA domain. Earlier studies have reported that the sequence upstream of the tag-encoding region (27,32), pseudoknot PK1 (25), but not the other three (33), is critical for tmRNA-directed protein tagging. The present study reveals that several nucleotides around the tRNA domain that are phylogenetically conserved are critical for function. It rationalizes the high phylogenetic conservation at some apparently neutral positions located next to the tRNA-like portion of tmRNA.

ACKNOWLEDGEMENTS

We thank Drs Hachiro Inokuchi, Nobukazu Nameki, Gota Kawai, Kimitsuna Watanabe, Takashi Yokogawa, Joëlle Rudinger-Thirion and Chie Takemoto for helpful advice on this study, and Dr Reynald Gillet for critical reading of the manuscript. We also thank Prof. Mathias Sprinzl of Universität Bayreuth for providing *T. thermophilus* EF-Tu and EF-Ts over-producing plasmids, and Dr SungGa Lee for providing *E. coli* S1. Gratitude is extended to Gene Research Center of Hirosaki University for the use of the facility. This work was supported by a grant-in-aid for Scientific Research from the Ministry of Education, Science, Sports and Culture, Japan to A.M. and H.H., grants ('Research for the Future' Program,

JSPS-RFTF96100305 and JSPS-RFTF97L00593) from the Japan Society for the Promotion of Science to A.M. and H.H., Research Fellowships of Japan Society for the Promotion of Science for young Scientists to K.H. This work was also funded by a Human Frontier Science Program Research Grant (RG0291/2000-M 100) to H.H. and B.F., by a Research Grant entitled 'Recherche Fondamentale en Microbiologie et maladies infectieuses' (Institut Pasteur) and by an 'Action Concertée Incitative Jeunes Chercheurs 2000' from the French Ministry of Research, to B.F.

REFERENCES

- Huang, C., Wolfgang, M.C., Withey, J., Koomey, M. and Friedman, D.I. (2000) Charged tmRNA but not tmRNA-mediated proteolysis is essential for *Neisseria gonorrhoeae* viability. *EMBO J.*, **19**, 1098–1107.
- Muto, A., Fujihara, A., Ito, K., Matsuno, J., Ushida, C. and Himeno, H. (2000) Requirement of transfer-messenger RNA (tmRNA) for the growth of *Bacillus subtilis* under stresses. *Genes Cells*, **5**, 627–636.
- Hickerson, R., Watkins-Sims, C.D., Burrows, C.J., Atkins, J.F., Gesteland, R.F. and Felden, B. (1998) A nickel complex cleaves uridines in folded RNA structures: Application to *E. coli* tmRNA and related engineered molecules. *J. Mol. Biol.*, **279**, 577–587.
- Keiler, K.C., Shapiro, L. and Williams, K.P. (2000) tmRNAs that encode proteolysis-inducing tags are found in all known bacterial genomes: a two-piece tmRNA functions in *Caulobacter*. *Proc. Natl Acad. Sci. USA*, **97**, 7778–7783.
- Abo, T., Inada, T., Ogawa, K. and Aiba, H. (2000) SsrA-mediated tagging and proteolysis of LacI and its role in the regulation of *lac* operon. *EMBO J.*, **19**, 3762–3769.
- Karzai, A.W., Susskind, M.M. and Sauer, R.T. (1999) SmpB, a unique RNA-binding protein essential for the peptide-tagging activity of SsrA (tmRNA). *EMBO J.*, **18**, 3793–3799.
- Wower, J., Zwieb, C., Guven, S.A. and Wower, I. (2000) Binding and cross-linking of tmRNA to ribosomal protein S1, on and off the *Escherichia coli* ribosome. *EMBO J.*, **19**, 6612–6621.
- Karzai, A.W. and Sauer, R.T. (2001) Protein factors associated with the SsrA-SmpB tagging and ribosome rescue complex. *Proc. Natl Acad. Sci. USA*, **98**, 3040–3044.
- Rudinger-Thirion, J., Giegé, R. and Felden, B. (1999) Aminoacylated tmRNA from *Escherichia coli* interacts with prokaryotic elongation factor Tu. *RNA*, **5**, 989–992.
- Barends, S., Wower, J. and Kraal, B. (2000) Kinetic parameters for tmRNA binding to alanyl-tRNA synthetase and elongation factor Tu from *Escherichia coli*. *Biochemistry*, **39**, 2652–2658.
- Gillet, R. and Felden, B. (2001) Transfer RNA^{Ala} recognizes transfer-messenger RNA with specificity; a functional complex prior to entering the ribosome? *EMBO J.*, **20**, 2966–2976.
- Ushida, C., Himeno, H., Watanabe, T. and Muto, A. (1994) tRNA-like structures in 10Sa RNAs of *Mycoplasma capricolum* and *Bacillus subtilis*. *Nucleic Acids Res.*, **22**, 3392–3396.
- Komine, Y., Kitabatake, M., Yokogawa, T., Nishikawa, K. and Inokuchi, H. (1994) A tRNA-like structure is present in 10Sa RNA, a small stable RNA from *Escherichia coli*. *Proc. Natl Acad. Sci. USA*, **91**, 9223–9227.
- Felden, B., Hanawa, K., Atkins, J.F., Himeno, H., Muto, A., Gesteland, R.F., McCloskey, J.A. and Crain, P.F. (1998) Presence and location of modified nucleotides in *Escherichia coli* tmRNA: Structural mimicry with tRNA acceptor branches. *EMBO J.*, **17**, 3188–3196.
- McClain, W.H. and Foss, K. (1988) Changing the identity of a tRNA by introducing a G-U wobble pair near the 3' acceptor end. *Science*, **240**, 793–796.
- Hou, Y.-M. and Schimmel, P. (1988) A simple structural feature is a major determinant of the identity of a transfer RNA. *Nature*, **333**, 140–145.
- Himeno, H., Sato, M., Tadaki, T., Fukushima, M., Ushida, C. and Muto, A. (1997) *In vitro* trans-translation mediated by alanine-charged 10Sa RNA. *J. Mol. Biol.*, **268**, 803–808.
- Nameki, N., Tadaki, T., Muto, A. and Himeno, H. (1999) Amino acid acceptor identity switch of *Escherichia coli* tmRNA from alanine to histidine *in vitro*. *J. Mol. Biol.*, **289**, 1–7.
- Tamura, K., Asahara, H., Himeno, H., Hasegawa, T. and Shimizu, M. (1991) Identity determinants of *Escherichia coli* tRNA^{Ala}. *J. Mol. Recognit.*, **4**, 129–132.
- Oba, T., Andachi, Y., Muto, A. and Osawa, S. (1991) CGG, an unassigned or nonsense codon in *Mycoplasma capricolum*. *Proc. Natl Acad. Sci. USA*, **88**, 921–925.
- Ahmadian, M.R., Kreutzer, R. and Sprinzl, M. (1991) Overproduction of the *Thermus thermophilus* elongation factor Tu in *Escherichia coli*. *Biochimie*, **73**, 1037–1043.
- Blank, J., Grillenbeck, N.W., Kreutzer, R. and Sprinzl, M. (1995) Overexpression and purification of *Thermus thermophilus* elongation factors G, Tu and Ts from *Escherichia coli*. *Protein Expr. Purif.*, **6**, 637–645.
- Subramanian, A.R. (1983) Structure and function of ribosomal protein S1. *Prog. Nucleic Acid Res. Mol. Biol.*, **28**, 101–142.
- Felden, B., Himeno, H., Muto, A., McCutcheon, J.P., Atkins, J.F. and Gesteland, R.F. (1997) Probing the structure of the *Escherichia coli* 10Sa RNA (tmRNA). *RNA*, **3**, 89–104.
- Nameki, N., Felden, B., Atkins, J.F., Gesteland, R.F., Himeno, H. and Muto, A. (1999) Functional and structural analysis of a pseudoknot upstream of the tag-encoded sequence in *E. coli* tmRNA. *J. Mol. Biol.*, **286**, 733–744.
- Williams, K.P. (2000) The tmRNA website. *Nucleic Acids Res.*, **28**, 168.
- Lee, S., Ishii, M., Tadaki, T., Muto, A. and Himeno, H. (2001) Determinants on tmRNA for initiating efficient and precise trans-translation: Some mutations upstream of the tag-encoding sequence of *Escherichia coli* tmRNA shift the initiation point of trans-translation *in vitro*. *RNA*, **7**, 999–1012.
- Tadaki, T., Fukushima, M., Ushida, C., Himeno, H. and Muto, A. (1996) Interaction of 10Sa RNA with ribosomes in *Escherichia coli*. *FEBS Lett.*, **399**, 223–226.
- Pleiss, J.A., Wolfson, A.D. and Uhlenbeck, O.C. (2000) Mapping contacts between *Escherichia coli* alanyl-tRNA synthetase and 2' hydroxyls using a complete tRNA molecule. *Biochemistry*, **39**, 8250–8258.
- Nissen, P., Kjeldgaard, M., Thirup, S., Polekhina, G., Reshetnikova, L., Clark, B.F.C. and Nyborg, J. (1995) Crystal structure of the ternary complex of Phe-tRNA^{Phe}, EF-Tu and a GTP analog. *Science*, **270**, 1464–1472.
- Gutell, R.R., Cannone, J.J., Shang, Z., Du, Y. and Serra, M.J. (2000) *J. Mol. Biol.*, **304**, 335–354.
- Williams, K.P., Martindale, K.A. and Bartel, D.P. (1999) Resuming translation on tmRNA: a unique mode of determining a reading frame. *EMBO J.*, **18**, 5423–5433.
- Nameki, N., Tadaki, T., Himeno, H. and Muto, A. (2000) Three of four pseudoknots in tmRNA are interchangeable and are substitutable with single-stranded RNAs. *FEBS Lett.*, **470**, 345–349.