

Time-domain terahertz spectroscopy in high magnetic fields

Andrey BAYDIN (✉)¹, Takuma MAKIHARA², Nicolas Marquez PERACA², Junichiro KONO (✉)^{1,2,3}

¹ Department of Electrical and Computer Engineering, Rice University, Houston, TX 70005, USA

² Department of Physics and Astronomy, Rice University, Houston, Texas 77005, USA

³ Department of Materials Science and NanoEngineering, Rice University, Houston, Texas 77005, USA

© Higher Education Press 2020

Abstract There are a variety of elementary and collective terahertz-frequency excitations in condensed matter whose magnetic field dependence contains significant insight into the states and dynamics of the electrons involved. Often, determining the frequency, temperature, and magnetic field dependence of the optical conductivity tensor, especially in high magnetic fields, can clarify the microscopic physics behind complex many-body behaviors of solids. While there are advanced terahertz spectroscopy techniques as well as high magnetic field generation techniques available, a combination of the two has only been realized relatively recently. Here, we review the current state of terahertz time-domain spectroscopy (THz-TDS) experiments in high magnetic fields. We start with an overview of time-domain terahertz detection schemes with a special focus on how they have been incorporated into optically accessible high-field magnets. Advantages and disadvantages of different types of magnets in performing THz-TDS experiments are also discussed. Finally, we highlight some of the new fascinating physical phenomena that have been revealed by THz-TDS in high magnetic fields.

Keywords high magnetic field, terahertz time-domain spectroscopy (THz-TDS)

1 Introduction

Terahertz time-domain spectroscopy (THz-TDS) has proven itself to be an invaluable tool for studying materials. Particularly, it is an excellent probe for various low-energy excitations in condensed matter systems, such as intraband transitions, superconducting gap excitations, phonons, magnons, and plasmons. One of the advantages of THz-TDS over traditional far-infrared spectroscopy

based on Fourier-transform infrared spectrometers is its ability to measure the amplitude and phase of the transmitted or reflected THz electric field simultaneously, which allows one to determine the complex optical conductivity and refractive index of materials. There exist a number of good review articles about the basics of THz-TDS [1–6], and thus, we will focus on THz-TDS combined with high magnetic fields.

Matter placed in a magnetic field provides a fascinating laboratory in which to study exotic quantum phenomena in a highly controllable manner. A magnetic field can control the states of electrons through spin and orbital quantization while inducing nonintuitive topological modifications and quantum interference of electron waves, especially at low temperatures. These magnetic field-induced changes can drastically alter absorption, reflection, and emission spectra in the THz spectral range, which can be compared with many-body calculations to elucidate the origins of complex behaviors of materials.

The application of a high magnetic field allows one to enter a system-dependent *high-field regime* where new states or phenomena are expected to arise. For example, in an electron-hole system in a magnetic field, one enters the high-field regime when the cyclotron energy, E_c , becomes larger than the exciton binding energy, E_X . When $\gamma = E_c/E_X \ll 1$, the magnetic field is a small perturbation, and the main visible effects are Zeeman splittings and diamagnetic shifts [7]. Exciting things begin to happen when one achieves the high-field regime ($\gamma > 1$), where Landau quantization becomes important and quantum Hall physics kicks in. Most importantly, when $\gamma \gg 1$, one enters the *high-field limit*, where “hidden symmetry” protects excitons against dissociation even at ultrahigh electron-hole pair densities [8–11].

Another example is unconventional superconductors, such as high- T_c cuprates, for which a high magnetic field is required to suppress superconductivity [12,13] and study its normal state at low temperatures. Moreover, a high magnetic field can stabilize a magnetic field-induced

superconductivity phase; for instance, UTe_2 has the highest magnetic field range identified for a re-entrant superconductor (> 65 T) [14]. In strongly correlated systems, a quantum critical point is usually hidden inside a superconducting phase, and thus, it is important to be able to destroy superconducting order to reveal the physics of quantum criticality. In two-dimensional (2D) materials, typically large effective masses require one to use high magnetic fields to study integer and fractional quantum Hall effects [15] and to enter the quantum limit state [16]. Another important topic is Fermi surface topology studies through quantum oscillations in high magnetic fields, which occur only when Landau level spacings become larger than disorder or scattering rates.

To date, THz-TDS combined with high magnetic fields has enabled investigations of many-body physics of different types of modern materials, including quantum Hall systems, graphene and related 2D materials, topological insulators, and rare-earth orthoferrites, as detailed in Section 4. Below, after briefly describing the basics of THz-TDS (Section 2), we review the state-of-the-art experimental setups combining THz-TDS and magnetic fields (Section 3) and their ensuing results that show new exciting physics (Section 4).

2 Terahertz time-domain spectroscopy

2.1 Basics of THz-TDS

A burst of electromagnetic radiation containing frequency components in the THz (10^{12} s^{-1}) range can be generated by exciting a crystal with femtosecond (fs) laser pulses. The most common generation process employed is optical rectification, which is a second-order nonlinear optical process, while inducing a short real current pulse in a photoconductive antenna (PCA) is also often used. The choice of the generation process, and thus the THz emitter crystal, will define the bandwidth of the emitted THz radiation, which can range from ~ 0.2 to ~ 120 THz [6]. Commonly employed emitters include ZnTe, LiNbO_3 , and PCAs. Once a THz wave is generated, it needs to be guided through the magnet bore and eventually detected. The detection scheme used also determines the choice of the generation mechanism as the strength of the THz pulse needs to be taken into account for the best suited detection scheme, including single-shot detection approaches needed for THz-TDS with pulsed magnets.

One of the most widely used methods for detecting THz radiation is based on free-space electro-optic (EO) sampling [17]. Based on a second-order nonlinear optical effect referred to as the Pockels effect, this method employs the modulations of the detection crystal's

birefringence induced by the applied THz electric field. In free-space EO detection schemes, the THz electric field pulse is overlapped with an ultrashort probe pulse in the nonlinear optical detection crystal. By measuring the polarization rotation of the probe pulse induced by the THz electric field, one can determine the applied THz electric field strength. Some of the commonly used EO crystals are ZnTe [18,19], GaP [20], and GaSe [21,22], and they have different bandwidths.

Another popular method for detecting THz radiation uses a PCA. This method has been used since the 1980s [23]. PCA-based THz radiation detectors use an ultrashort probe pulse to generate transient charge carriers in a semiconductor (i.e., a time-dependent photocurrent), which are then driven by the instantaneous THz electric field at a time determined by the position of the delay stage. Therefore, measuring the photocurrent as a function of time delay enables sampling of the THz electric field waveform in the time domain.

A more recently developed methodology for THz radiation detection, referred to as the THz-air breakdown coherent detection (THz-ABCD) method, exploits the dependence of the efficiency of an optical probe pulse's second-harmonic generation in air in the presence of an applied THz electric field to measure ultrabroadband THz pulses [24]. This method is advantageous as it circumvents the appearance of phonon modes that are present in solid state THz detectors.

2.2 Temporally sampling THz electric fields

As mentioned in the previous section, detection of THz electric fields requires ultrashort laser pulses. These probe pulses are typically orders of magnitude shorter in duration than THz pulses. Here, we briefly review a few techniques for sampling the entire THz waveform in the time domain using such ultrashort laser pulses. As discussed in the subsequent sections, different techniques for temporally sampling the THz electric field are amenable to different types of magnets.

The most common method for temporally sampling a THz electric field uses a step-scan delay stage to adjust the time delay between the THz electric field and the probe pulse. In this technique, identical measurements must be repeated while systematically adjusting the delay between the probe pulse and the THz electric field until the entire THz waveform has been sampled. A particular advantage of using a delay stage is that measurements can be arranged with two mirrors or a retroreflector and a mechanical delay stage in a straightforward manner. Given the requirement for repeating identical measurements, using a delay stage is appropriate for measurements in a constant applied magnetic field.

2.2.1 Rapid-scan approaches

1) Asynchronous optical sampling (ASOPS)

When THz-TDS is combined with a pulsed magnet, the entire THz waveform must be sampled rapidly. This precludes the use of a step-scan, mechanical delay stage. One of the methods to rapidly acquire the entire THz waveform in the time domain is asynchronous optical sampling (ASOPS) [25]. ASOPS requires two lasers, one used for THz generation and the other used for detection. There is a finite offset in pulse repetition frequency (Δf). As a result, the time delay between a generation pulse and a detection pulse is systematically delayed until the detection pulse has sampled the entire temporal region between two generation pulses in a time duration $1/\Delta f$. ASOPS was first applied to THz-TDS in 2005 [26,27] and has subsequently been improved to enable time delays of up to 1 ns to be scanned in 100 μ s [28]. Not only does ASOPS enable rapid THz detection, it also eliminates certain challenges associated with using mechanical delay stages, such as probe beam misalignment as a result of mechanical motion. ASOPS has been demonstrated in THz-TDS measurements in pulsed magnetic fields up to 31 T [29].

2) Electronically controlled optical sampling (ECOPS)

A method closely related to ASOPS for rapidly recording the entire THz waveform is electronically controlled optical sampling (ECOPS) [30]. ECOPS also exploits two frequency-offset lasers, but with a time-varying frequency offset. ECOPS can be more desirable than ASOPS in many cases because it samples only a small time window following the generation pulse, enabling much faster acquisition. This is particularly relevant for THz-TDS, where the relevant physics being studied subsists for short times following the pump. For example, ASOPS using a 100 MHz repetition rate laser would sample the full 10-nanosecond time window between pulses [30], whereas THz-TDS is often concerned with picosecond timescales following the pump. In ECOPS, the frequency offset between the two lasers is modulated by modulating the cavity length of one laser. ECOPS has been demonstrated in THz-TDS measurements [31,32] and for THz-TDS in pulsed magnetic fields up to 30 T [33].

3) Rotating delay line

Another type of technique for rapidly sampling the entire THz waveform to enable THz-TDS in pulsed magnetic fields uses a rotating delay line [34]. Here, the time-delay between the THz electric field and the detection probe pulse is rapidly modulated by reflecting the detection probe pulse off of an angled mirror mounted on a rotating element. Using this technique enabled 140 ps time-delays

to be sampled at a repetition rate of 250 Hz in a 40 T pulsed magnetic field [34].

2.2.2 Single-shot approaches

1) Echelons

The best approach to the high-speed sampling of the entire THz waveform is single-shot detection, wherein a single ultrashort probe pulse samples the entire THz waveform. Teo et al. thoroughly reviewed the state-of-the-art single-shot THz detection techniques [35]. They concluded that using transmissive echelons is robust and easily implementable, enabling single-shot detection with greater signal-to-noise ratios and faster acquisition times than a conventional delay stage. They also suggest that using reflective echelons [36], as opposed to transmissive ones, would provide better frequency resolution and longer time windows.

The use of echelons for time-resolved ultrafast spectroscopies was pioneered in the 1970s [37,38]. In these measurements, a wide range of time delays between the pump and detection pulses was achieved by separating the probe pulse into time-delayed components using an echelon to alter the optical path length traveled by different portions. The first demonstration of single-shot THz-TDS using echelons employed two transmissive echelons, where the use of dual echelons enabled a longer time window to be observed [39]. In echelon-based THz-TDS, EO sampling is typically used to map the THz electric field onto the polarization of the time-delayed components of the optical detection pulse. The time-resolved polarization of the probe can be quantitatively analyzed by imaging the echelon onto a camera. More recently, reflective echelons have been used to demonstrate single-shot THz-TDS [36,40]. Reflective echelons can be advantageous compared to transmissive ones because they eliminate complications arising from having an ultrashort probe pulse propagating through a delicate optical component, such as chirp or defects in the material. As a result, reflective echelons have been used to demonstrate single-shot THz-TDS in pulsed magnetic fields up to 30 T [41,42].

2) Spectral encoding

Another technique for enabling single-shot THz-TDS is spectral encoding. In this technique, the different frequency components of a chirped optical probe pulse are used to sample the entire THz waveform [43,44]. However, there exists a trade-off between time-resolution and the time window sampled by the chirped pulse, as longer time windows require mapping the THz electric field onto a narrower frequency spectrum, which becomes increasingly more challenging to resolve on a

spectrometer. These limitations can be overcome using spectral interferometry [45], yet the sensitivity of this method to optical alignment [35] should make implementing this single-shot detection technique challenging in large magnets.

In summary, rapid-scan and single-shot approaches both provide viable techniques for combining THz-TDS with time-dependent (pulsed) magnetic fields. Notably, there exist commercially available ASOPS and ECOPS platforms specifically designed for ultrafast THz-TDS [46], whereas echelons suffer from requiring precisely machined components and difficulties associated with aligning non-traditional optics. Further, when combined with pulsed magnetic fields, rapid scanning techniques have demonstrated the acquisition of up to 100 THz waveforms for a single magnetic field pulse [29], providing extremely fine magnetic field-dependent data. Nonetheless, single-shot techniques represent the ultimate limit of ultrafast THz sampling and overcome challenges arising from making repeated measurements, such as measurement-induced damage to the sample. Further, in the authors' experience, reflective echelon-based single-shot THz-TDS provides the best signal-to-noise ratios and thus merits our recommendation.

3 Combining THz-TDS and high magnetic fields

The magnets that have been used for high-field THz-TDS can be classified into three categories: (i) DC superconducting magnets, (ii) DC resistive magnets, and (iii) pulsed magnets. Here, we briefly review the benefits and shortcomings of each magnet when used for THz time-domain magnetospectroscopy. We also discuss a few representative magnets for each category.

3.1 DC superconducting magnets

For individuals seeking to build a high-field THz time-domain magnetospectrometer, superconducting magnets should be considered first. These magnets are advantageous compared to resistive magnets, particularly in university settings, because they demand significantly less electrical power to operate. As suggested by their name, superconducting magnets only require a bath of liquid helium to maintain a coil in its superconducting state. For THz-TDS, these magnets are also advantageous as they provide easy optical access to samples in static magnetic fields. THz radiation is challenging to manipulate over large distances, so magnets with easy optical accessibility are crucial. Further, as mentioned in the previous section, static magnetic fields also allow for the simplest implementation of THz detection, namely, using a step-scan, mechanical delay stage. Static magnetic fields also

allow for arbitrarily large numbers of THz waveforms to be averaged at little cost. However, the magnetic field produced by a typical laboratory superconducting magnet with good optical access is limited to roughly 10 T. Nonetheless, their ease of implementation and operation has made the use of superconducting magnets and delay stage-based THz electric field sampling the most popular form of THz-TDS in high magnetic fields [47–58].

One of the earliest demonstrations of THz-TDS in strong magnetic fields combined a superconducting magnet with delay stage-based THz electric field sampling. This was achieved at the National High Magnetic Field Laboratory in Los Alamos, USA, where a fiber-coupled photoconductive THz emitter and receiver were placed directly in the cryogenic bore of an 18-T superconducting magnet [59]. The THz emitter and receiver were coupled by optical fibers to a Ti:Sapphire laser. Given the sensitivity of the emitted THz amplitude and spectrum on the inputted ultrafast optical pulse's temporal width, extreme attention was paid to dispersion of the optical gate pulse in the fiber. Specifically, to account for positive group velocity dispersion within the pulse, the inputted optical pulse was negatively chirped prior to entering the optical fiber. Further, generating optimum THz electric fields required precise positioning of the optical fiber on the THz emitter to within 1 μm . Thus, optical fiber-coupled THz emitters and receivers that were robust against thermal cycling were developed to enable temperature-dependent experiments down to 1.5 K.

Given that fiber-coupled, photoconductive THz emitters and detectors can be challenging due to their sensitivity to dispersion of ultrashort laser pulses, thermal cycling, and applied magnetic fields, free-space THz-TDS poses an attractive alternative. An early demonstration of free-space THz time-domain magnetospectroscopy at Rice University, USA [52] combined a 10-T superconducting magnet with delay stage-based free-space THz-TDS using ZnTe crystals. The robustness of this system has enabled a wealth of studies of condensed matter phenomena occurring in the THz frequency range in magnetic fields up to 10 T [60–66]. A schematic of this system is illustrated in Fig. 1. The output from an amplified Ti:Sapphire laser is divided into: (1) a generation beam that pumps a ZnTe crystal to generate THz radiation, and (2) a detection beam that samples the THz electric field at different time delays using a delay stage. The THz radiation is guided through the superconducting magnet using parabolic mirrors and is overlapped with the time-delayed detection pulse using a pellicle beamsplitter (PBS). Free-space EO sampling using ZnTe is implemented to sample the THz electric field. The detection crystal is followed by a quarter-wave plate (QWP) and a Wollaston prism (WP) to implement balanced detection of the detection pulse's polarization [18].

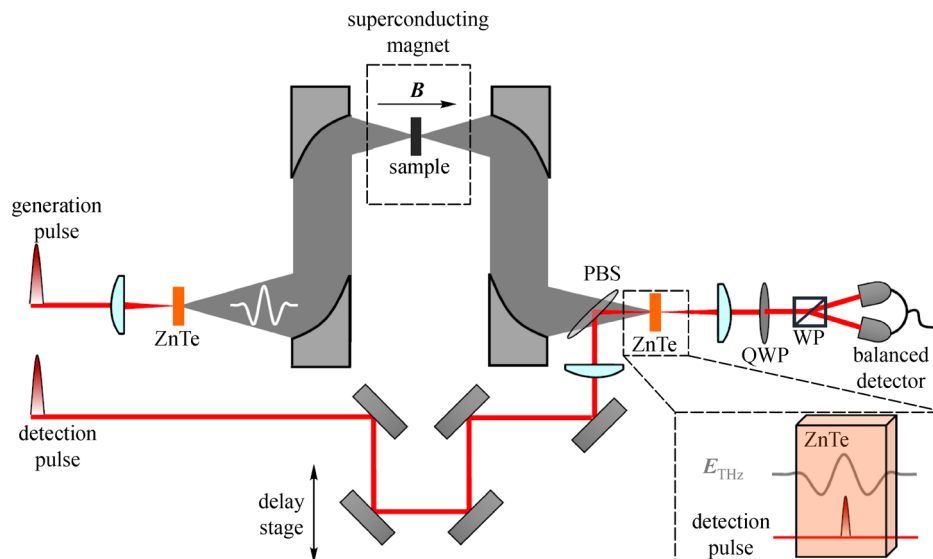

Fig. 1 Free-space THz time-domain spectroscopy (THz-TDS) system combined with a superconducting magnet. The generation and detection of THz radiation is achieved via optical rectification and the electro-optic effect, respectively, using ZnTe crystals. A pellicle beamsplitter (PBS) is used to combine the THz and near-infrared probe beams. A quarter-wave plate (QWP) and a Wollaston prism (WP) are commonly used to detect the polarization rotation of the probe beam

3.2 DC resistive magnets

Stronger static magnetic fields than those available in superconducting magnets can be achieved in resistive magnets [67]. As suggested by its name, resistive magnets exploit a coil made of a resistive material. This not only demands large amounts of electrical power, but also requires advanced cooling mechanisms to force large amounts of water through the coil. As a result, high-field resistive magnets are often found at national laboratories.

THz-TDS in a resistive magnet has been demonstrated in static magnetic fields up to 25 T in the recently developed Split-Florida Helix Magnet [68] at the National High Magnetic Field Laboratory in Tallahassee, USA. This magnet was specifically designed to allow easy optical access to samples through four large, elliptic, interchangeable windows, making it ideal for THz time-domain magnetospectroscopy [68,69]. The minimum experimentally accessible temperature is 5 K. The magnetic field is generated perpendicular to the optical access, making it well-designed for experiments in the Voigt geometry. To access the Faraday geometry, custom sample holders can be used to steer the beam inside the magnet to be parallel to the field [70]. Recently, this magnet has been used to perform optical-pump THz-probe studies of GaAs quantum wells in magnetic fields up to 25 T [68]. A schematic of the Split-Florida Helix system is illustrated in Fig. 2. THz radiation is generated using air-plasma generation [71,72], guided through the magnet using parabolic mirrors, and detected using THz-ABCD and a delay stage to obtain temporal resolution.

3.3 Pulsed magnets

Individuals seeking the strongest magnetic fields must forgo static magnetic fields for time-dependent, pulsed magnetic fields. Although stronger magnetic fields can be attractive for elucidating novel physics, the combination of pulsed magnetic fields and THz-TDS is challenging. Namely, as discussed in Section 2.2, one cannot easily sample THz waveforms using a delay stage in time-dependent magnetic fields. Thus, more sophisticated forms of sampling, also discussed in Section 2.2, must be implemented. Nonetheless, the allure of marrying magnetic fields exceeding 30 T with THz-TDS has motivated the development of several pulsed THz time-domain magnetospectroscopy facilities [29,33,34,41,42,73–75].

One facility that combines pulsed magnetic fields up to 30 T with THz-TDS was developed at Rice University, USA [74]. This magnet, known as the Rice Advanced Magnet with Broadband Optics (RAMBO), is a unique, table-top magnet that allows easy optical access to samples subjected to pulsed magnetic fields up to 30 T. The magnet measures only 17 cm in width with a bore diameter of 12 mm. This remarkable optical addressability makes RAMBO ideal for THz spectroscopy, yet the challenge of temporally sampling a THz electric in a time-dependent magnetic field remains. This challenge has been circumvented using ECOPS [33,75] and single-shot detection using reflective echelons [41]. A similar magnet combined with ASOPS has been developed at University of Manchester, UK [29]. A schematic of the RAMBO system is illustrated in Fig. 3 when combined with echelon-based

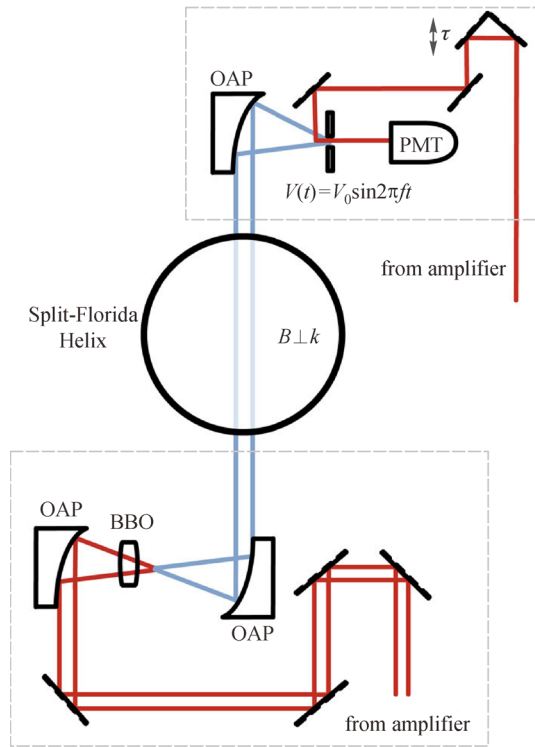

Fig. 2 Free-space THz time-domain spectroscopy system combined with the Split-Florida Helix Magnet [68]. The broadband THz pulses are generated by mixing the fundamental and its second-harmonic laser field (generated from a frequency-doubling BBO crystal) in a nitrogen-purged atmosphere. Laser pulses are focused and collimated using off-axis parabolic (OAP) mirrors. The THz wavevector is perpendicular to the applied magnetic field (Voigt geometry). For detection, THz pulses are focused onto a THz-air breakdown coherent detector (THz-ABCD). A portion of the fundamental beam is used to gate the THz-ABCD to recover the full electric field waveform

single-shot detection. The output from an amplified Ti:Sapphire laser is divided into: (1) a generation pulse that generates THz radiation using the tilted-pulse-front excitation method in LiNbO_3 [76], and (2) a detection pulse that samples the entire THz waveform by implementing single-shot detection. Specifically, the detection pulse is reflected off of a reflective echelon [36] that stretches the detection pulse front, allowing it to overlap with the entire THz waveform in the ZnTe detection crystal. The THz radiation is guided through the pulsed magnet using parabolic mirrors and is overlapped with the stretched detection pulse front using a PBS. Free-space EO sampling using ZnTe is implemented to sample the THz electric field. The THz electric field in the time domain can be extracted by imaging the reflective echelon surface through the ZnTe crystal, a QWP, and a WP [41,42]. The magnetic field profile (black line), output from the Ti:Sapphire laser (red line), and sampled magnetic field strengths (blue dots) are shown in the inset, where the

output from the Ti:Sapphire laser is measured by a photodiode.

Another facility that combines pulsed magnetic fields up to 40 T with THz-TDS was developed at Laboratoire National des Champs Magnétiques Intenses in Toulouse, France [34]. In this facility, THz time-domain magnetospectroscopy measurements are taken in the reflection geometry in a magnet with a bore diameter of 30 mm. To rapidly sample the THz waveform, the authors use a rotating delay line, described in Section 2.2.

Table 1 shows a summary of different types of magnets combined with THz-TDS. For static magnetic fields up to 25 T produced by superconducting and resistive magnets, THz waveform sampling utilizing a standard delay stage can be easily employed. For higher magnetic fields, pulsed magnets have to be used, which necessitates one to implement ASOPS, ECOPS, rotating delay line, or single-shot (echelon) methods for THz sampling. To acquire a complete THz waveform (tens of ps), all aforementioned sampling techniques, except the single-shot method, require a data acquisition time of about 150 μs , which is short enough for magnetic field pulses on the order of a few ms. However, if one tries to increase the magnetic field strength by reducing the magnetic field pulse width to a μs scale, then the only possible option is the single-shot (echelon) THz sampling scheme.

4 Physical phenomena in high magnetic fields probed by THz-TDS

A number of electronic, magnetic, and vibronic transitions in condensed matter systems occur in the THz frequency or meV photon energy range [1–3,5,77–80]. An applied magnetic field can change these transitions in terms of frequency, width, and strength, and a systematic study of such changes can provide significant insight into the nature of the transitions. Furthermore, a high magnetic field can induce new phenomena, including field-induced phase transitions, and THz spectroscopy can serve as a sensitive probe of the quantum states, interactions, and dynamics of the system exhibiting such phenomena. Specifically, the THz optical conductivity (or dielectric) tensor of a material as a function of frequency, temperature, and magnetic field often contains critical information on the microscopic physics behind complex many-body behaviors of solids.

While Fourier-transform infrared spectroscopy in the THz range has been extensively used in conjunction with high magnetic fields to study low-energy phenomena in condensed matter systems, such as spin excitations [81–88], magnetoplasmons [89], quantum spin liquids [90,91], topological insulators [92,93], and superconductors [94], the focus of this section is on THz-TDS experiments performed in high magnetic fields. For the purposes of this review, we consider high magnetic fields to be those higher than 5 T.

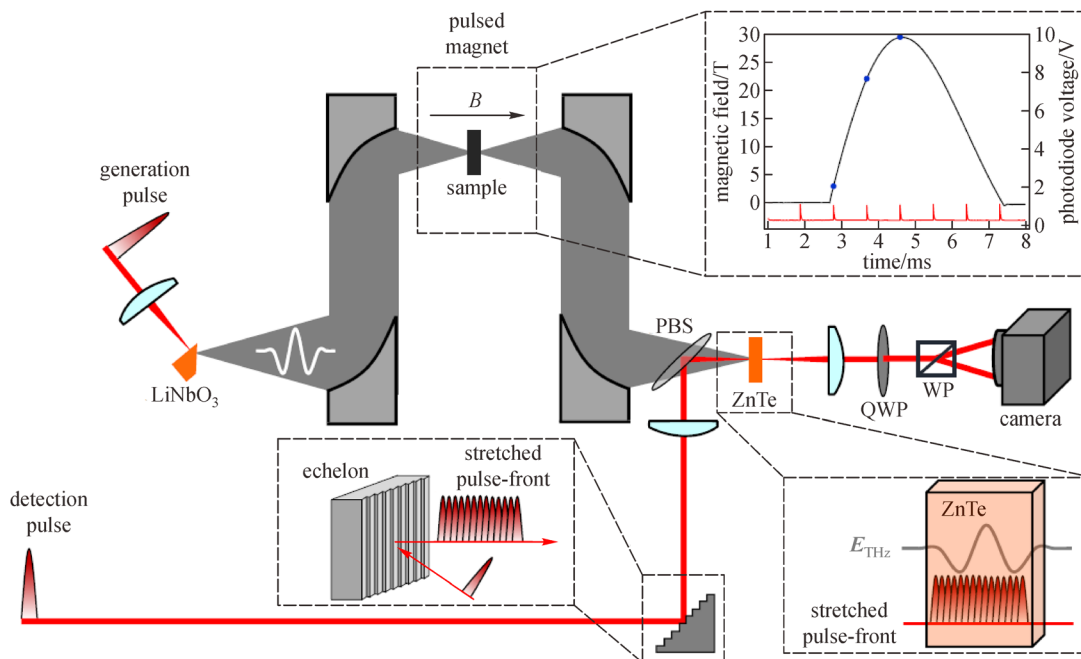

Fig. 3 Free-space single-shot THz time-domain spectroscopy system combined with a pulsed magnet [41,42]. THz pulses strong enough for single-shot detection are generated using LiNbO₃. Detection is performed in a single-shot manner using a reflective echelon, which stretches the probe pulse in the time domain. The inset at the top shows that for a 1-kHz repetition-rate laser, three measurements can be done on the rising edge of the magnetic field pulse. A pellicle beamsplitter (PBS) is used to combine the THz and near-infrared probe beams. A quarter-wave plate (QWP) and a Wollaston prism (WP) are commonly used to detect the polarization rotation of the probe beam

Table 1 Summary of magnets for high-field THz time-domain magnetospectroscopy

	superconducting	resistive	pulsed
magnetic field	≤ 10 T	≤ 25 T	≤ 30 T
THz sampling mechanism	delay stage [47–58]	delay stage [68]	ECOPS [33,75], ASOPS [29], reflective echelons [41,42], rotating delay line [34]
additional notes	Superconducting magnets are easiest to implement and benefit from having static fields, albeit the weakest fields.	Resistive magnets provide the strongest static fields but are only available at national laboratories due to their demand for resources.	Pulsed magnets provide the strongest magnetic fields but require sophisticated protocols for THz sampling.

4.1 Cyclotron resonance

A free electron of mass m^* in a magnetic field, B , undergoes a spiral motion with angular frequency $\omega_c = eB/m^*$, the cyclotron frequency. When electromagnetic radiation with angular frequency ω interacts with the spiraling electron, resonant absorption, i.e., cyclotron resonance (CR), occurs if $\omega = \omega_c$. CR spectroscopy has long been used for characterizing the band structure of semiconductor materials [77,95–100]. Since B and ω can be known with high precision, ω_c and hence m^* can be determined precisely. In addition, the resonance linewidth of CR contains information on scattering properties of carriers. Within the Drude model, the quality (Q) factor of a CR line is given by $\omega_c\tau$, where τ is the scattering time,

which can be precisely determined once ω_c is determined. Furthermore, the mobility $\mu = e\tau/m^*$ can be deduced from the knowledge of m^* and τ .

A unique ability of THz-TDS is to obtain dynamical information directly from time-domain data, as well as to perform quantum control experiments. The CR coherence time can be accurately determined through the decay of the CR amplitude as a function of time [101], and multiple THz pulses can be used to manipulate the coherent dynamics of a Landau-quantized 2D electron gas (2DEG) [61]. Furthermore, Zhang et al. [63] demonstrated that in an ultrahigh-mobility 2DEG the CR coherence time is determined by a superradiant decay, i.e., cooperatively accelerated radiative decay [102]. The authors performed systematic studies on the CR decoherence of 2DEGs using

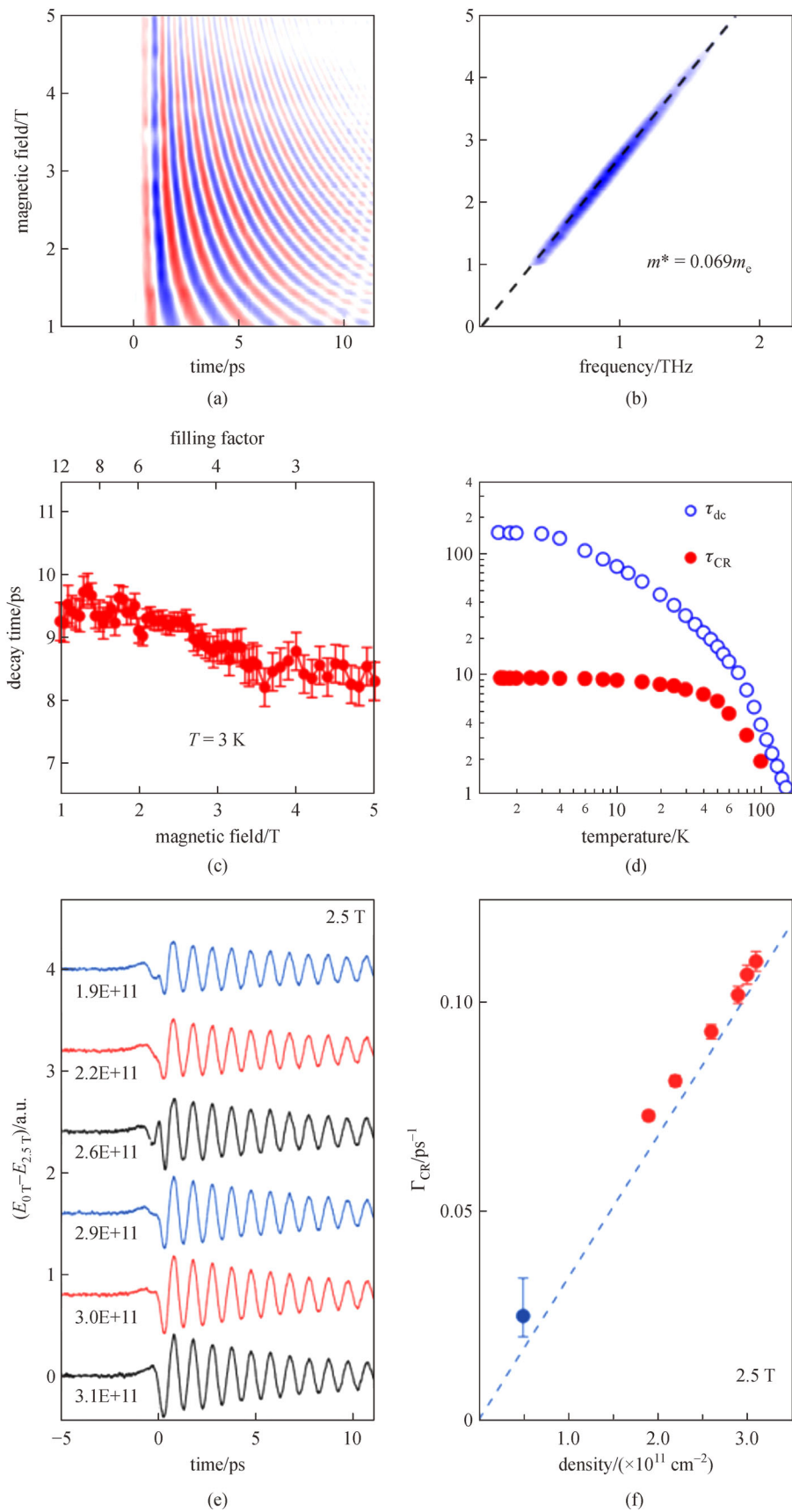

Fig. 4 Superradiant decay of cyclotron resonance in ultrahigh-mobility two-dimensional electron gases [63]. (a) Magnetic field dependence of CR oscillations in the time domain, showing peaks (blue) and valleys (red). (b) Frequency-domain version of (a). Black dashed line: a linear fit with a cyclotron mass of $0.069m_0$. (c) Magnetic field dependence of the CR decay time, τ_{CR} at 3 K. (d) Temperature dependence of τ_{CR} at 2.5 T and the DC scattering time, τ_{DC} , determined from the DC mobility, $\mu = e\tau_{DC}/m^*$. (e) CR oscillations in the time domain for samples with different densities by controlling the illumination time. (f) CR decay rate as a function of electron density. Blue solid circle: sample 2 (low density). Red solid circles: sample 1 (high density). The blue dashed line represents a theoretical relation expected from the phenomenon of superradiance [102] without any adjustable parameter (with $n_{GaAs} = 3.6$ and $m^* = 0.069m_0$)

THz-TDS in magnetic fields as a function of temperature, magnetic field, electron density, and mobility. Most importantly, it was demonstrated that the CR decay time is inversely proportional to the density; see Fig. 4. Experimental results were explained by a fully quantum mechanical theory, identifying superradiant damping as the dominant decay mechanism of CR at low temperatures [63].

The main advantage of using high magnetic fields in CR experiments is that CR becomes observable in large-mass, low-mobility materials [99]. CR can be observed only when the Q -factor $\omega_c \tau = B_r \mu$ is larger than 1, where B_r is the resonance magnetic field. This condition is not easy to fulfill when m^* is large or τ is small. Unfortunately, many strongly correlated materials have heavy masses, and newly discovered materials typically have short scattering times, requiring high magnetic fields to observe CR [29,75,103–108].

Recently, in a topological crystalline insulator, $\text{Pb}_{0.5}\text{Sn}_{0.5}\text{Te}$, THz conductivity measurements identified two types of CR [109]. The authors found different magnetic field dependencies of the cyclotron frequency and scattering rate for the two types of carriers, which they attributed to different nontrivial topological properties of their band structures. This work demonstrates that magnetoterahertz response can be used to isolate signatures of bulk states in Dirac and Weyl semimetals and study their nontrivial band geometry and Berry curvature that can be extracted from direct non-contact CR and field-dependent scattering rate measurements [109].

4.2 Magnetoexcitons

Excitons are bound states of an electron and a hole. Due to the long-range electron-electron, hole-hole, and electron-hole (e-h) Coulomb interactions, systems of e-h pairs can exhibit a variety of possible phases depending on the pair density, temperature, and magnetic field [110]. If an applied perpendicular magnetic field is sufficiently strong, exciton-exciton interactions can vanish in an ideal 2D system due to an e-h charge symmetry (hidden symmetry). This results in cancellation of Coulomb interactions between excitons and, therefore, formation of ultrastable 2D magnetoexcitons [8–11].

Zhang et al. have investigated the stability of an insulating exciton gas against a Mott transition [111]. The Mott transition is driven by density-dependent Coulomb interactions from an insulating excitonic gas into a metallic e-h plasma. However, the presence of the magnetic field protects the excitons from forming a plasma through ionization. The stability of excitons was revealed by performing optical-pump/THz-probe measurements to observe intraexciton transitions in a 10-T direct superconducting magnet with 150 fs optical pulses and a THz bandwidth of 2.5 THz. As the pump intensity increased, the excitons exhibited a clear Mott transition at 0 T, while

the $1s-2p_-$ intraexciton resonance persisted at the highest pump intensity at 9 T. Interestingly, however, 2D magnetoexcitons did dissociate under thermal excitation (a large magnetic field but higher temperatures), even if they are stable against a Mott transition [111].

More recently, Li et al. [112] reported an observation of THz gain in 2D magnetoexcitons in GaAs quantum wells in magnetic fields up to 8 T. The gain had a strict selection rule: it was observable only for hole-CR-active circular polarized THz radiation. The gain feature, represented by a negative optical conductivity, was a narrowband sharp peak with a linewidth of < 0.45 meV, and its frequency shifted with the applied magnetic field. As the origin of this surprising phenomenon, the authors proposed the scattering of two free excitons into one biexciton in the presence of a magnetic field [112].

4.3 Faraday and Kerr rotations

Faraday and magneto-optical Kerr spectroscopies are powerful techniques for investigating materials in which time-reversal symmetry is lifted, either by an internal or external magnetic field. The absence of time-reversal symmetry makes the off-diagonal elements of the optical conductivity (or dielectric) tensor finite, which leads to Faraday/Kerr rotations. With the advent of polarization-dependent THz-TDS, it has become possible to study Faraday and Kerr effects in the THz range [113].

A 2DEG in a strong perpendicular magnetic field naturally exhibits THz Faraday/Kerr rotations due to the finite Hall resistivity. At high enough magnetic fields and low enough temperatures, the quantum Hall effect (QHE) appears [114], with zero longitudinal resistivity and quantized Hall resistivity. Recently, Ikebe et al. [115] observed an *optical* Hall effect in a 2DEG at THz frequencies, showing that the Faraday rotation angle is of the order of the fine-structure constant in a quantum Hall plateau region [115]. A plateau behavior, a hallmark of the QHE, in the Faraday angle/optical conductivity versus magnetic field was seen at the filling factor $\nu = 2$, for magnetic fields between $4.3 \text{ T} < B < 5.4 \text{ T}$ at 3 K. As the temperature increased to 20 K, the classical limit was achieved.

Shimano et al. [116] have measured THz Faraday and Kerr rotations in monolayer graphene in the QHE regime, where both rotations exhibit values defined by the fine-structure constant. Figure 5(a) shows schematic of the propagation of a THz pulse through the sample, which results in the appearance of two pulses in the time domain (see Fig. 5(b)). The polarization state of the first pulse determines the Faraday angle, while the second pulse contains information on both Faraday and Kerr rotations. Therefore, the Kerr angle can be obtained in a transmission geometry along with the Faraday angle. The magnetic field dependence of the Kerr angle at 1 THz is shown in Fig. 5(c), where the $\nu = 2$ state is reached above 5.5 T. Both

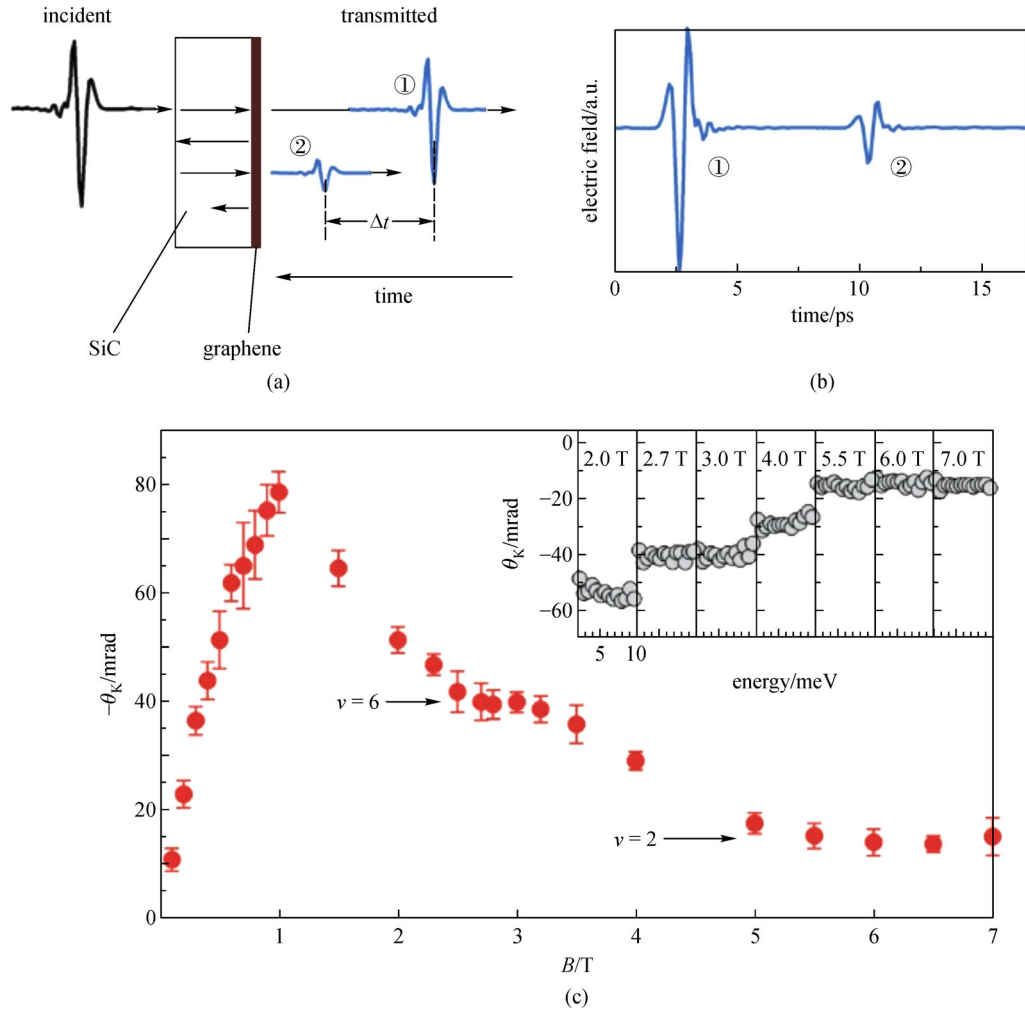

Fig. 5 Magneto-optical Kerr rotation in monolayer graphene. (a) Schematic of the experimental configuration depicting the transmission of a THz pulse through the sample. (b) Time-domain waveform of the THz pulse transmitted through the sample. (c) Magnetic field dependence of the Kerr rotation at 1 THz for the sample with a Fermi energy of 70 meV. The inset shows Kerr rotation spectra at the indicated magnetic fields. Adapted from Ref. [116]

Faraday (not shown) and Kerr rotations defined by the fine-structure constant appear precisely at the quantum Hall steps expected for the Dirac electrons in graphene [116].

In general, any coupling between magnetic and electric properties of a material is called the magnetoelectric effect (ME) [117]. Recent combination of high magnetic fields and THz-TDS applied to the ferrimagnetic pyroelectric $\text{CaBaCo}_4\text{O}_7$ provided deeper insights into the microscopic exchange striction and its magnetoelectricity [118]. The topological magnetoelectric effect (TME) refers to 3D topological insulators that can be characterized by bulk magnetoelectrics rather than surface conductors [119–127]. When a magnetic field is applied to a TI, it breaks time-reversal symmetry, which results in a gap in the surface Dirac state(s). Macroscopically, both the Hall conductivity of the sample surface and the bulk magnetoelectric response become quantized. In addition, this magnetoelectric coupling leads to the modified Maxwell's

equations inside the topological insulator, analogous to the theory of axion electrodynamics in particle physics [128].

The TME effect can be measured via Faraday and Kerr rotations at low photon energies, such as the microwave and far-infrared spectral ranges [121,124,125]. Several THz magneto-optical spectroscopy experiments to probe the TME have been performed at small [129] and moderate [58,92,130–133] magnetic fields. Wu et al. have used THz-TDS and observed quantization of Faraday and Kerr rotations at fields > 5 T in Bi_2Se_3 [58]. Figure 6(a) shows a schematic diagram of the Faraday rotation experimental setup. The real and imaginary parts of the Faraday rotation are shown in Figs. 6(c) and 6(d), indicating that for the 10-QL sample (QL: quintuple layer, 1 QL ≈ 1 nm) of Bi_2Se_3 above 5 T the low-frequency tail becomes flat and overlaps with higher field data at plateau values predicted by the theory. Similarly, the 6-, 8-, 12- and 16-QL samples enter the quantized regime as the low-frequency tails of real part

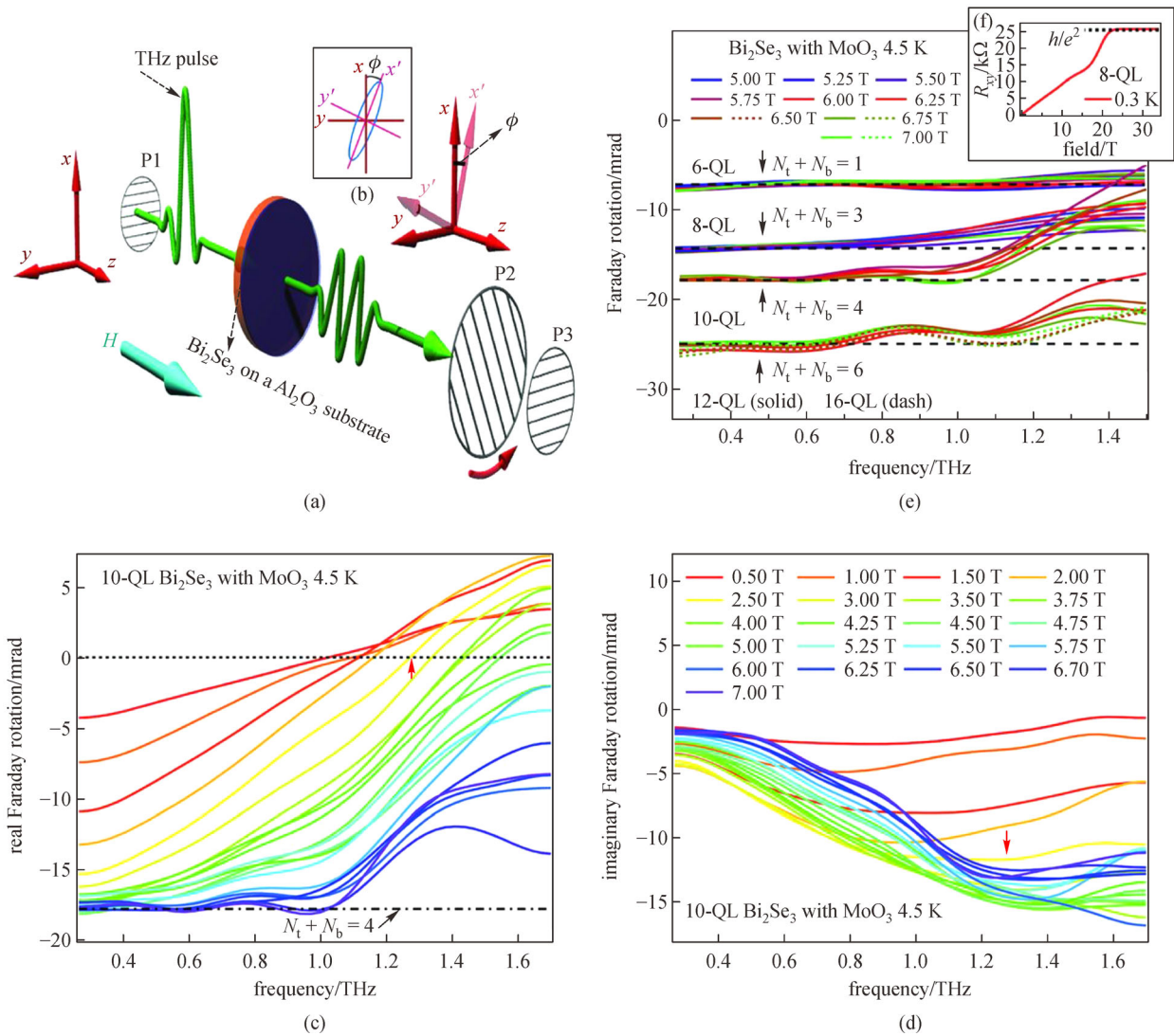

Fig. 6 Quantized Faraday rotation of topological surface states in Bi_2Se_3 . (a) Schematic diagram of the Faraday rotation experimental setup. P1, P2, and P3 are polarizers. The polarization acquires an ellipticity simultaneously, as shown in (b). (c) Real part of the Faraday rotation of 10-QL Bi_2Se_3 films with MoO_3 at 4.5 K at various magnetic fields [color-coded as in (d)]. The dash-dotted line is the theoretical expectation. (d) Imaginary part of the Faraday rotation. A representative cyclotron frequency is marked by a red arrow for data at 2.5 T. (e) Quantized Faraday rotation for different samples. Dashed black lines are theoretical expectation values assuming certain values for the filling factor of the surface states. (f) DC Hall resistance of a representative 8-QL sample. Adapted from Ref. [58]

of the Faraday rotation falls on their expected values (see Fig. 6(e)). Figure 6(f) further shows that this effect is not the conventional DC QHE as the quantum Hall resistivity exhibits a plateaus in these films only above ~ 24 T.

More recently, Li et al. reported THz Faraday and Kerr rotations in thin films of $\text{Bi}_{1-x}\text{Sb}_x$ in B up to 30 T [134]. Several samples with different compositions x were studied. As x increases, the $\text{Bi}_{1-x}\text{Sb}_x$ alloy shows a semimetal-to-topological-insulator transition. The Faraday and Kerr rotation measurements were conducted using a single-shot time-domain THz spectroscopy setup combined with a table-top pulsed minicoil magnet with B up to 30 T, as described in Section 3.3. Faraday and Kerr rotation

spectra for the semimetallic films ($x < 0.07$) showed a pronounced dip that blue shifted with B , whereas spectra for the topological insulator films ($x > 0.07$) were positive and featureless. Ellipticity spectra for the semimetallic films showed resonances, whereas the topological insulator films showed no detectable ellipticity. The evolution of Faraday and Kerr angles with B for a fixed THz frequency of 0.7 THz showed a saturation behavior. It might be tempting to explain it as the quantized optical Hall effect observed in several recent studies [58,133,135]. However, it turns out that this saturation behavior observed within < 30 T can be explained as a summation of the broadened CR signals contributed by the two electron

pockets. Theoretical calculations predicted a major quantum Hall plateau in the $60 \text{ T} < B < 110 \text{ T}$ range. Overall, the combination of the THz-TDS polarimetry experiments performed in high B and the detailed theoretical analysis can be applied to other topological materials to investigate surface and bulk carrier contributions to the optical conductivity.

4.4 Spin excitations

Recent years have seen the development of an exciting area of research, within the general area of spintronics, which focuses on antiferromagnets (AFMs) instead of ferromagnets/ferrimagnets. In AFMs, magnonic excitations typically occur in the THz frequency range and can couple with another degree of freedom coming from the same magnetic system rather than excitations supplied by an external source. These THz magnons are promising for high-speed, low-power computing applications. THz-TDS is well suited for exciting and probing such THz magnons in AFMs materials. Applying a strong magnetic field makes the excitation frequencies even higher and can lead to an observation of novel phenomena.

Morris et al. [136] investigated kink bound states in 1D ferromagnetic Ising chain compound CoNb_2O_6 . In addition to recently observed kink excitations by neutron scattering, high signal-to-noise ratio and high energy-resolution THz-TDS led to the appearance of new kink bound states. Magnetic field dependent measurements in the Faraday geometry were performed in order to understand the origin of these kink excitations, which were assigned to two- and four-kink excitations. An additional new feature observed at an energy somewhat less than twice the lowest bound state was interpreted as a novel bound state [136].

Magnons in quantum spin liquid (QSL) candidate materials have also been studied using THz-TDS [137–139]. $\alpha\text{-RuCl}_3$ is a promising Kitaev QSL candidate, but it orders magnetically at low temperatures despite the Kitaev exchange interactions present in the effective spin Hamiltonian. However, the magnetic order can be suppressed by an in-plane magnetic field of about 7.5 T, where several THz-TDS experiments demonstrated signatures of a field-induced QSL state, but complete understanding of the observed excitations is still lacking [90,137,140]. Wu et al. have investigated the field evolution of magnons in $\alpha\text{-RuCl}_3$. The susceptibility associated with the AFM state was measured as a function of applied DC field H and THz probe field B_{THz} . Two sharp resonances and other broader features appearing only above approximately 4 T were attributed to zero-wave-vector magnons and a continuum of two-magnon excitations, respectively [138]. Subsequently, Ozel et al. showed that the magnon behavior in an applied magnetic field can be understood only by including an off-diagonal

exchange term to the minimal Heisenberg-Kitaev model [139].

Another interesting example is the optical diode effect that appears in the paramagnetic phase of polar $\text{FeZnMo}_3\text{O}_8$ [141]. The authors demonstrated 100-fold difference for light traveling in different opposite directions. Notably, this effect exists at high temperatures (up to 110 K) where $\text{FeZnMo}_3\text{O}_8$ is in the paramagnetic state and no long range magnetic order exists. The optical diode is explained to be happening at the electron spin resonance frequency, which the authors assigned to the single-ion anisotropy gap excitation [141].

4.5 Ultrastrong light-matter coupling

Cavity quantum electrodynamics (QED) in the ultra-strong coupling (USC) regime has been recently studied using condensed matter systems [142,143]. In this unusual regime, realized due to the colossal dipole moments available in solids, as opposed to atoms, the normalized coupling strength $\eta = g/\omega_0$ becomes comparable to unity. Here, g is the light-matter coupling rate (or constant) and ω_0 is the resonance frequency. Particularly, THz-TDS in magnetic fields is useful for studying phenomena in the USC regime because of the typical frequencies of CR. The continuous tunability of the matter frequency (i.e., the cyclotron frequency, ω_c) with respect to a cavity photon mode frequency makes this system distinctly advantageous compared to other intraband transitions such as quantum-well intersubband transitions.

Scalari et al. [55] studied the USC between the CR of a high-mobility 2DEG and an array of metallic split-ring resonators (SRRs). Transmission measurements were carried out using a broadband THz-TDS system coupled to a cryostat equipped with a split-coil superconducting magnet. As observed in Fig. 7(a), an anticrossing behavior between the first SRR mode and the CR of the 2DEG was observed. Since some regions of the 2DEG were not covered by the resonators, the uncoupled CR signal (CYC) is visible in the spectra together with the upper and lower polaritons (UP and LP, respectively) (see Fig. 7(b)). By using a modified geometry and shifting the SRR frequency down to 500 GHz, the authors achieved $\eta = 0.58$, putting the system in the USC regime. Figure 7(c) shows the transmission minima (open circles) plotted as a function of magnetic field and the two polariton branches (solid lines) were fit by a theoretical model by Hagenmüller et al. [144].

Li et al. reported the observation of a vacuum Bloch-Siegert shift (VBSS) in CR of a 2DEG in a THz cavity QED setting [65]. The authors used a circularly polarized THz probe pulse to isolate the contributions coming from the counter-rotating terms in the Hamiltonian, therefore providing an unambiguous and direct demonstration of the VBSS. THz-TDS measurements were performed in the Faraday geometry using an achromatic THz quarter-wave

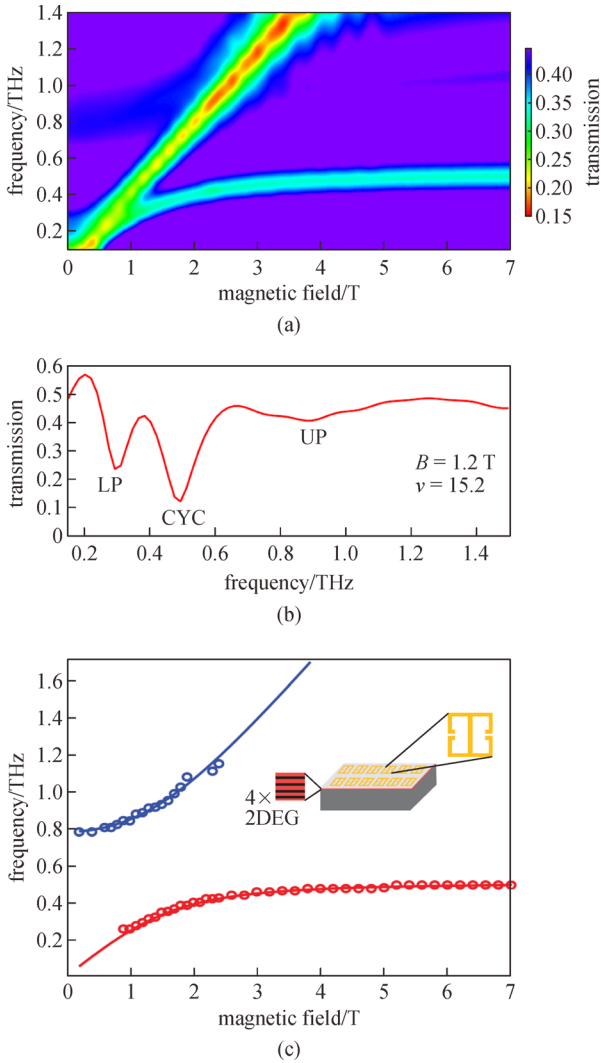

Fig. 7 Ultrastrong coupling between THz split-ring resonators and the CR of a high-mobility 2DEG. (a) Transmission as a function of B at 10 K. (b) A vertical cut from panel (a) in the anticrossing region at $B = 1.2$ T. Both the upper-polariton and lower-polariton modes are observed together with the free-space CR (CYC) arising from the uncovered regions of the 2DEG. (c) Polariton branches plotted as a function of magnetic field. Solid lines are theoretical calculations. Inset: schematic of the 500 GHz resonator deposited on the sample surface. Adapted from Ref. [55]

plate. As shown in Fig. 8, three branches were resolved in the transmission spectra. Two of them, labeled CR-active (CRA) upper polariton and lower polariton (CRA-UP and CRA-LP, respectively), arise in the $B > 0$ region from the co-rotating interaction between the CR of electrons and the right-hand circularly polarized (RCP) probe beam. In the $B < 0$ region, the polarization of the probe is preserved but the negative B value reverses the electronic CR trajectory, resulting in the observation of the CR-inactive (CRI) mode. Since the VBSS arises from the USC between matter and the counter-rotating vacuum field in the cavity, the authors found that by isolating and individually

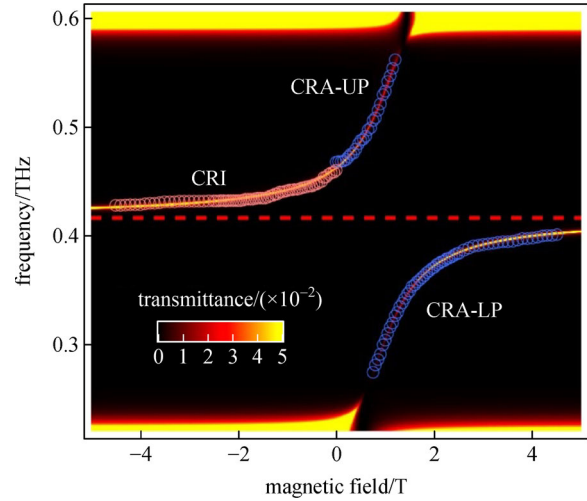

Fig. 8 Vacuum Bloch–Siegert shift in Landau polaritons with ultrahigh cooperativity [65]. Transmission spectra in the vicinity of the anticrossing region between CR and the first cavity mode (red dashed line) for simulations using the full Hamiltonian (solid lines) is shown. The counter-rotating and A^2 terms have to be included in the full Hamiltonian. Experimental data points are shown as open circles

measuring the CRI mode it was possible to distinguish between the diamagnetic (or A^2) shift and the VBSS.

USC has also been observed in an unusual spin-magnon-coupled system [66]. Li et al. observed USC between the electron paramagnetic resonance (EPR) of Er^{3+} spins and the quasi-ferromagnetic (qFM) mode of the Fe^{3+} magnons in the rare-earth orthoferrite, $\text{Er}_x\text{Y}_{1-x}\text{FeO}_3$. An applied external DC magnetic field tuned the EPR frequency with respect to the fixed qFM magnon mode frequency, and a clear anticrossing behavior was resolved in the THz range. Moreover, a $g \propto \sqrt{N}$ behavior (so-called Dicke cooperativity [102]), where N is the net density of EPR-contributing Er^{3+} spins, was obtained. The authors estimated a maximum $\eta = 0.18$ in one of the configurations, achieving USC for this matter-matter coupled system.

Most recently, an observation has been made of USC between the qAFM and qFM magnon modes in YFeO_3 [42]. The authors demonstrated that this novel matter-matter USC simulates a unique cavity QED Hamiltonian with tunable coupling strengths and dominant counter-rotating interactions. Figure 9(a) shows a schematic of the experiment. The YFeO_3 crystals were cut such that the external magnetic field \mathbf{H}_{DC} could be applied in the b – c plane at different angles θ with respect to the c -axis. An example of a transmitted THz waveform for $\theta = 20^\circ$ at $\mu_0|\mathbf{H}_{\text{DC}}| = 12.60$ T is shown in Fig. 9(b) demonstrating beating in the time domain and, consequently, two peaks in the frequency domain. Figure 9(c) demonstrates the magnetic field dependence of these two magnon peaks for $\theta = 20^\circ$ and $\theta = 40^\circ$, where frequency splitting is clearly

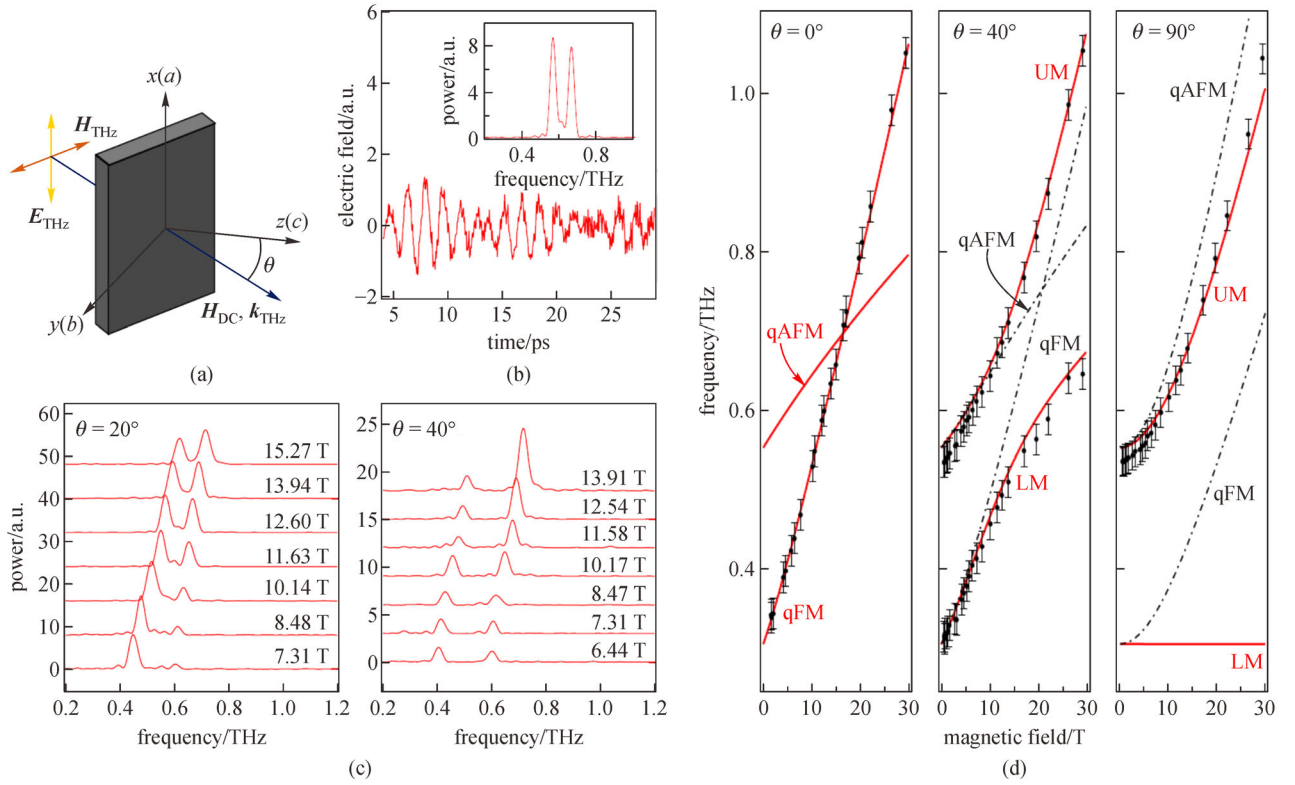

Fig. 9 THz-TDS of magnon-magnon ultrastrong coupling in $YFeO_3$ evidencing dominant vacuum Bloch–Siegert shifts [42]. (a) Schematic of THz magnetospectroscopy studies of $YFeO_3$ in a tilted magnetic field. H_{DC} was applied in the b – c plane at an angle of θ with respect to the c -axis, with $k_{THz} \parallel H_{DC}$ and H_{THz} polarized in the b – c plane. (b) Transmitted THz waveform for $\theta = 20^\circ$ at $\mu_0 |H_{DC}| = 12.60$ T displaying beating in the time domain and two peaks in the frequency domain. (c) Magnon power spectra for $\theta = 20^\circ$ and $\theta = 40^\circ$ at different H_{DC} , displaying larger frequency splitting for larger θ . (d) Experimentally measured magnon frequencies for $\theta = 0^\circ, 40^\circ, 90^\circ$ versus $\mu_0 |H_{DC}|$ (black dots) with calculated resonance magnon frequencies (solid red lines) and decoupled qFM and qAFM magnon frequencies (black dashed-dotted lines). The upper mode frequency becomes lower than the qAFM frequency at $\theta = 90^\circ$, indicating a dominant vacuum Bloch–Siegert shift compared to the vacuum Rabi splitting-induced shift

larger for $\theta = 40^\circ$. Figure 9(d) plots experimentally measured magnon frequencies (black dots) for $\theta = 0^\circ, 40^\circ, 90^\circ$ as a function of applied magnetic field, $\mu_0 |H_{DC}|$. Theoretically calculated resonance magnon frequencies are plotted as red solid lines, demonstrating excellent agreement. Therefore, the authors found that the applied magnetic field could be used to tune the vacuum Rabi splitting and the VBSS. Further, in certain geometries, the frequency shifts of the coupled modes were dominated by the VBSSs and not the vacuum Rabi splitting-induced shifts. This is particularly clear when $\theta = 90^\circ$, where the red shift from the VBSS dominates the blue shift from the vacuum Rabi splitting-induced shift, leading to the upper mode being lower in frequency than the decoupled qAFM mode. A well-established microscopic spin model of this material system [145] accurately reproduced their observed resonances without any adjustable parameters. Moreover, it was shown that this lightless spin model can be precisely mapped to a polariton model described by an *anisotropic* Hopfield Hamiltonian in which the magnon-magnon coupling strengths are easily tunable and the counter-rotating terms dominate the co-rotating terms,

consistent with their observation of giant VBSSs. Finally, they theoretically showed that the ground state is intrinsically squeezed, consisting of a two-mode squeezed vacuum as expected in the USC regime [146–148], with quantum fluctuation suppression as large as 5.9 dB.

5 Summary and outlook

In conclusion, we reviewed the current state-of-the-art of the rapidly advancing techniques for combining strong magnetic fields with THz time-domain spectroscopy. We described different types of high-field magnets, including superconducting, resistive, and pulsed magnets, and various THz radiation detection schemes. Table 1 gives a summary of maximum field strengths for each magnet type and provides a short guide to a reader looking to build a similar experimental setup. These experimental developments have already led to observations of new exciting physical phenomena, some of which were also reviewed in this article, including superradiant decay of cyclotron resonance, stability of 2D magnetoexcitons against a Mott

transition, quantized Faraday and Kerr rotations, coherent THz magnon excitations, and ultrastrong light-matter and matter-matter coupling in the THz range. Clearly, the combination of time-domain THz spectroscopy with high magnetic fields is a fertile field of research in condensed matter physics, many exciting new discoveries are expected to be made, and combining even higher magnetic fields with THz spectroscopy will allow researchers to investigate a broader range of materials.

Acknowledgements J. K. acknowledges support from the U.S. Army Research Office (W911NF-17-1-0259), the U.S. National Science Foundation (NSF MRSEC DMR-1720595), the U.S. Department of Energy (DEFG02-06ER46308), and the Robert A. Welch Foundation (C-1509).

References

- Nuss M C, Orenstein J. Terahertz time-domain spectroscopy. In: Grüner G, ed. *Millimeter and Sub-millimeter Wave Spectroscopy of Solids*. Berlin: Springer-Verlag, 1998, Chap. 2, 7–50
- Schmittenmaier C A. Exploring dynamics in the far-infrared with terahertz spectroscopy. *Chemical Reviews*, 2004, 104(4): 1759–1780
- Lee Y S. *Principles of Terahertz Science and Technology*, vol. 170. Berlin: Springer, 2009
- Jepsen P U, Cooke D G, Koch M. Terahertz spectroscopy and imaging—modern techniques and applications. *Laser & Photonics Reviews*, 2011, 5(1): 124–166
- Ulbricht R, Hendry E, Shan J, Heinz T F, Bonn M. Carrier dynamics in semiconductors studied with time-resolved terahertz spectroscopy. *Reviews of Modern Physics*, 2011, 83(2): 543–586
- Neu J, Schmittenmaier C A. Tutorial: an introduction to terahertz time domain spectroscopy (THz-TDS). *Journal of Applied Physics*, 2018, 124(23): 231101
- Cong K, Noe G T II, Kono J. *Excitons in Magnetic Fields*. Oxford: Elsevier, 2018, 63–81
- MacDonald A H, Rezayi E H. Fractional quantum Hall effect in a two-dimensional electron-hole fluid. *Physical Review B: Condensed Matter and Materials Physics*, 1990, 42(5): 3224–3227
- Dzyubenko A B, Lozovik Y E. Symmetry of Hamiltonians of quantum two-component systems: condensate of composite particles as an exact eigenstate. *Journal of Physics A, Mathematical and General*, 1991, 24(2): 415–424
- Apal'kov V M, Rashba E I. Magnetospectroscopy of 2D electron-gas: cusps in emission-spectra and Coulomb gaps. *JETP Letters*, 1991, 53: 442–448
- Rashba E I, Sturge M D, Yoon H W, Pfeiffer L N. Hidden symmetry and the magnetically induced “Mott transition” in quantum wells containing an electron gas. *Solid State Communications*, 2000, 114(11): 593–596
- Proust C, Taillefer L. The remarkable underlying ground states of cuprate superconductors. *Annual Review of Condensed Matter Physics*, 2019, 10(1): 409–429
- Shi Z, Baity P G, Sasagawa T, Popović D. Vortex phase diagram and the normal state of cuprates with charge and spin orders. *Science Advances*, 2020, 6(7): eaay8946
- Ran S, Liu I L, Eo Y S, Campbell D J, Neves P M, Fuhrman W T, Saha S R, Eckberg C, Kim H, Graf D, Balakirev F, Singleton J, Paglione J, Butch N P. Extreme magnetic field-boosted superconductivity. *Nature Physics*, 2019, 15(12): 1250–1254
- Dean C R, Young A F, Cadden-Zimansky P, Wang L, Ren H, Watanabe K, Taniguchi T, Kim P, Hone J, Shepard K L. Multicomponent fractional quantum Hall effect in graphene. *Nature Physics*, 2011, 7(9): 693–696
- Moll P J, Potter A C, Nair N L, Ramshaw B J, Modic K A, Riggs S, Zeng B, Ghimire N J, Bauer E D, Kealhofer R, Ronning F, Analytis J G. Magnetic torque anomaly in the quantum limit of Weyl semimetals. *Nature Communications*, 2016, 7(1): 12492
- Wu Q, Zhang X C. Free-space electro-optic sampling of terahertz beams. *Applied Physics Letters*, 1995, 67(24): 3523–3525
- Wu Q, Zhang X C. Ultrafast electro-optic field sensors. *Applied Physics Letters*, 1996, 68(12): 1604–1606
- Nahata A, Welting A S, Heinz T F. A wide-band coherent terahertz spectroscopy system using optical rectification and electro-optic sampling. *Applied Physics Letters*, 1996, 69(16): 2321–2323
- Wu Q, Zhang X C. 7 terahertz broadband GaP electro-optic sensor. *Applied Physics Letters*, 1997, 70(14): 1784–1786
- Huber R, Brodschelm A, Tauser F, Leitenstorfer A. Generation and field-resolved detection of femtosecond electromagnetic pulses tunable up to 41 THz. *Applied Physics Letters*, 2000, 76(22): 3191–3193
- Liu K, Xu J, Zhang X C. GaSe crystals for broadband terahertz wave detection. *Applied Physics Letters*, 2004, 85(6): 863–865
- Smith P R, Auston D H, Nuss M C. Subpicosecond photoconducting dipole antennas. *IEEE Journal of Quantum Electronics*, 1988, 24(2): 255–260
- Lu X, Karpowicz N, Zhang X C. Broadband terahertz detection with selected gases. *Journal of the Optical Society of America B, Optical Physics*, 2009, 26(9): A66–A73
- Elzinga P A, Kneisler R J, Lytle F E, Jiang Y, King G B, Laurendeau N M. Pump/probe method for fast analysis of visible spectral signatures utilizing asynchronous optical sampling. *Applied Optics*, 1987, 26(19): 4303–4309
- Janke C, Först M, Nagel M, Kurz H, Bartels A. Asynchronous optical sampling for high-speed characterization of integrated resonant terahertz sensors. *Optics Letters*, 2005, 30(11): 1405–1407
- Yasui T, Saneyoshi E, Araki T. Asynchronous optical sampling terahertz time-domain spectroscopy for ultrahigh spectral resolution and rapid data acquisition. *Applied Physics Letters*, 2005, 87(6): 061101
- Bartels A, Cerna R, Kistner C, Thoma A, Hudert F, Janke C, Dekorsy T. Ultrafast time-domain spectroscopy based on high-speed asynchronous optical sampling. *Review of Scientific Instruments*, 2007, 78(3): 035107
- Spencer B, Smith W F, Hibberd M T, Dawson P, Beck M, Bartels A, Guiney I, Humphreys C J, Graham D M. Terahertz cyclotron resonance spectroscopy of an AlGaIn/GaN heterostructure using a high-field pulsed magnet and an asynchronous optical sampling technique. *Applied Physics Letters*, 2016, 108(21): 212101
- Tauser F, Rausch C, Posthumus J H, Lison F. Electronically

- controlled optical sampling using 100 MHz repetition rate fiber lasers. In: *Proceedings of Commercial and Biomedical Applications of Ultrafast Lasers VIII*. San Jose: SPIE, 2008, 688100
31. Kim Y, Yee D S. High-speed terahertz time-domain spectroscopy based on electronically controlled optical sampling. *Optics Letters*, 2010, 35(22): 3715–3717
 32. Liu J, Mbonye M K, Mendis R, Mittleman D M. Measurement of terahertz pulses using electronically controlled optical sampling (ECOPS). In: *Proceedings of CLEO/QELS: 2010 Laser Science to Photonic Applications*. San Jose: IEEE, 2010, 1–2
 33. Noe G T II, Zhang Q, Lee J, Kato E, Woods G L, Nojiri H, Kono J. Rapid scanning terahertz time-domain magnetospectroscopy with a table-top repetitive pulsed magnet. *Applied Optics*, 2014, 53(26): 5850–5855
 34. Molter D, Ellrich F, Weinland T, George S, Goiran M, Keilmann F, Beigang R, Léotin J. High-speed terahertz time-domain spectroscopy of cyclotron resonance in pulsed magnetic field. *Optics Express*, 2010, 18(25): 26163–26168
 35. Teo S M, Ofori-Okai B K, Werley C A, Nelson K A. Single-shot THz detection techniques optimized for multidimensional THz spectroscopy. *Review of Scientific Instruments*, 2015, 86(5): 051301
 36. Minami Y, Hayashi Y, Takeda J, Katayama I. Single-shot measurement of a terahertz electric-field waveform using a reflective echelon mirror. *Applied Physics Letters*, 2013, 103(5): 051103
 37. Topp M, Rentzepis P, Jones R. Time-resolved absorption spectroscopy in the 10–12-sec range. *Journal of Applied Physics*, 1971, 42(9): 3415–3419
 38. Topp M, Rentzepis P, Jones R. Time resolved picosecond emission spectroscopy of organic dye lasers. *Chemical Physics Letters*, 1971, 9(1): 1–5
 39. Kim K Y, Yellampalle B, Taylor A J, Rodriguez G, Glowonia J H. Single-shot terahertz pulse characterization via two-dimensional electro-optic imaging with dual echelons. *Optics Letters*, 2007, 32(14): 1968–1970
 40. Katayama I, Sakaibara H, Takeda J. Real-time time-frequency imaging of ultrashort laser pulses using an echelon mirror. *Japanese Journal of Applied Physics*, 2011, 50(10): 102701
 41. Noe G T II, Katayama I, Katsutani F, Allred J J, Horowitz J A, Sullivan D M, Zhang Q, Sekiguchi F, Woods G L, Hoffmann M C, Nojiri H, Takeda J, Kono J. Single-shot terahertz time-domain spectroscopy in pulsed high magnetic fields. *Optics Express*, 2016, 24(26): 30328–30337
 42. Makihara T, Hayashida K, Noe G T II, Li X, Kono J. Magnonic quantum simulator of antiresonant ultrastrong light-matter coupling. 2020, arXiv:2008:10721
 43. Jiang Z, Zhang X C. Electro-optic measurement of THz field pulses with a chirped optical beam. *Applied Physics Letters*, 1998, 72(16): 1945–1947
 44. Jiang Z, Zhang X C. Single-shot spatiotemporal terahertz field imaging. *Optics Letters*, 1998, 23(14): 1114–1116
 45. Matlis N, Plateau G, van Tilborg J, Leemans W. Single-shot spatiotemporal measurements of ultrashort THz waveforms using temporal electric-field cross correlation. *Journal of the Optical Society of America B, Optical Physics*, 2011, 28(1): 23–27
 46. Noe G T II, Zhang Q, Lee J, Kato E, Woods G L, Nojiri H, Kono J. Rapid scanning terahertz time-domain magnetospectroscopy with a table-top repetitive pulsed magnet. *Applied Optics*, 2014, 53(26): 5850–5855
 47. Walecki W, Some D, Kozlov V, Nurmikko A. Terahertz electromagnetic transients as probes of a two-dimensional electron gas. *Applied Physics Letters*, 1993, 63(13): 1809–1811
 48. Some D, Nurmikko A V. Real-time electron cyclotron oscillations observed by terahertz techniques in semiconductor heterostructures. *Applied Physics Letters*, 1994, 65(26): 3377–3379
 49. Some D, Nurmikko A V. Coherent transient cyclotron emission from photoexcited GaAs. *Physical Review B: Condensed Matter and Materials Physics*, 1994, 50(8): 5783–5786
 50. Some D, Nurmikko A V. Ultrafast photoexcited cyclotron emission: contributions from real and virtual excitations. *Physical Review B: Condensed Matter and Materials Physics*, 1996, 53(20): R13295–R13298
 51. Crooker S A. Fiber-coupled antennas for ultrafast coherent terahertz spectroscopy in low temperatures and high magnetic fields. *Review of Scientific Instruments*, 2002, 73(9): 3258–3264
 52. Wang X, Hilton D J, Ren L, Mittleman D M, Kono J, Reno J L. Terahertz time-domain magnetospectroscopy of a high-mobility two-dimensional electron gas. *Optics Letters*, 2007, 32(13): 1845–1847
 53. Sumikura H, Nagashima T, Kitahara H, Hangyo M. Development of a cryogen-free terahertz time-domain magneto-optical measurement system. *Japanese Journal of Applied Physics*, 2007, 46(4A): 1739–1744
 54. Ikebe Y, Shimano R. Characterization of doped silicon in low carrier density region by terahertz frequency Faraday effect. *Applied Physics Letters*, 2008, 92(1): 012111
 55. Scalari G, Maissen C, Turcinková D, Hagenmüller D, De Liberato S, Ciuti C, Reichl C, Schuh D, Wegscheider W, Beck M, Faist J. Ultrastrong coupling of the cyclotron transition of a 2D electron gas to a THz metamaterial. *Science*, 2012, 335(6074): 1323–1326
 56. George D K, Stier A V, Ellis C T, McCombe B D, Černe J, Markelz A G. Terahertz magneto-optical polarization modulation spectroscopy. *Journal of the Optical Society of America. B, Optical Physics*, 2012, 29(6): 1406–1412
 57. Wood C D, Mistry D, Li L H, Cunningham J E, Linfield E H, Davies A G. On-chip terahertz spectroscopic techniques for measuring mesoscopic quantum systems. *Review of Scientific Instruments*, 2013, 84(8): 085101
 58. Wu L, Salehi M, Koirala N, Moon J, Oh S, Armitage N P. Quantized Faraday and Kerr rotation and axion electrodynamics of a 3D topological insulator. *Science*, 2016, 354(6316): 1124–1127
 59. Crooker S. Fiber-coupled antennas for ultrafast coherent terahertz spectroscopy in low temperatures and high magnetic fields. *Review of Scientific Instruments*, 2002, 73(9): 3258–3264
 60. Wang X, Belyanin A A, Crooker S A, Mittleman D M, Kono J. Interference-induced terahertz transparency in a semiconductor magneto-plasma. *Nature Physics*, 2010, 6(2): 126–130
 61. Arikawa T, Wang X, Hilton D J, Reno J L, Pan W, Kono J. Quantum control of a Landau-quantized two-dimensional electron

- gas in a GaAs quantum well using coherent terahertz pulses. *Physical Review B: Condensed Matter and Materials Physics*, 2011, 84(24): 241307
62. Arikawa T, Wang X, Belyanin A A, Kono J. Giant tunable Faraday effect in a semiconductor magneto-plasma for broadband terahertz polarization optics. *Optics Express*, 2012, 20(17): 19484–19492
 63. Zhang Q, Arikawa T, Kato E, Reno J L, Pan W, Watson J D, Manfra M J, Zudov M A, Tokman M, Erukhimova M, Belyanin A, Kono J. Superradiant decay of cyclotron resonance of two-dimensional electron gases. *Physical Review Letters*, 2014, 113(4): 047601
 64. Zhang Q, Lou M, Li X, Reno J L, Pan W, Watson J D, Manfra M J, Kono J. Collective non-perturbative coupling of 2D electrons with high-quality-factor terahertz cavity photons. *Nature Physics*, 2016, 12(11): 1005–1011
 65. Li X, Bamba M, Zhang Q, Fallahi S, Gardner G C, Gao W, Lou M, Yoshioka K, Manfra M J, Kono J. Vacuum Bloch–Siegert shift in Landau polaritons with ultra-high cooperativity. *Nature Photonics*, 2018, 12(6): 324–329
 66. Li X, Bamba M, Yuan N, Zhang Q, Zhao Y, Xiang M, Xu K, Jin Z, Ren W, Ma G, Cao S, Turchinovich D, Kono J. Observation of Dicke cooperativity in magnetic interactions. *Science*, 2018, 361(6404): 794–797
 67. Toth J, Bird M D, Bole S, O'Reilly J W. Fabrication and assembly of the NHMFL 25 T resistive split magnet. *IEEE Transactions on Applied Superconductivity*, 2012, 22(3): 4301604
 68. Curtis J A, Burch A D, Barman B, Linn A G, McClintock L M, O'Beirne A L, Stiles M J, Reno J L, McGill S A, Karaiskaj D, Hilton D J. Broadband ultrafast terahertz spectroscopy in the 25 T Split Florida-Helix. *Review of Scientific Instruments*, 2018, 89(7): 073901
 69. Curtis J A, Tokumoto T, Nolan N K, McClintock L M, Cherian J G, McGill S A, Hilton D J. Ultrafast pump-probe spectroscopy in gallium arsenide at 25 T. *Optics Letters*, 2014, 39(19): 5772–5775
 70. Paul J, Stevens C E, Smith R P, Dey P, Mapara V, Semenov D, McGill S A, Kaindl R A, Hilton D J, Karaiskaj D. Coherent two-dimensional Fourier transform spectroscopy using a 25 Tesla resistive magnet. *Review of Scientific Instruments*, 2019, 90(6): 063901
 71. Kim K Y, Taylor A J, Glowina J H, Rodriguez G. Coherent control of terahertz supercontinuum generation in ultrafast laser-gas interactions. *Nature Photonics*, 2008, 2(10): 605–609
 72. Kress M, Löffler T, Eden S, Thomson M, Roskos H G. Terahertz-pulse generation by photoionization of air with laser pulses composed of both fundamental and second-harmonic waves. *Optics Letters*, 2004, 29(10): 1120–1122
 73. Molter D, Torosyan G, Ballon G, Drigo L, Beigang R, Léotin J. Step-scan time-domain terahertz magneto-spectroscopy. *Optics Express*, 2012, 20(6): 5993–6002
 74. Noe G T II, Nojiri H, Lee J, Woods G L, Léotin J, Kono J. A tabletop, repetitive pulsed magnet for nonlinear and ultrafast spectroscopy in high magnetic fields up to 30 T. *Review of Scientific Instruments*, 2013, 84(12): 123906
 75. Post K W, Legros A, Rickel D G, Singleton J, McDonald R D, He X, Bozovic I, Xu X, Shi X, Armitage N P, Crooker S A. Observation of cyclotron resonance and measurement of the hole mass in optimally-doped $\text{La}_{2-x}\text{Sr}_x\text{CuO}_4$. 2020, arXiv:2006.09131
 76. Hebling J, Yeh K L, Hoffmann M C, Bartal B, Nelson K A. Generation of high-power terahertz pulses by tilted-pulse-front excitation and their application possibilities. *Journal of the Optical Society of America B, Optical Physics*, 2008, 25(7): B6–B19
 77. McCombe B D, Wagner R J. Intraband magneto-optical studies of semiconductors in the far-infrared. I. In: Marton L, ed. *Advances in Electronics and Electron Physics*, vol. 37. New York: Academic Press, 1975, 1–78
 78. Mittleman D M. *Sensing with Terahertz Radiation*. Berlin: Springer, 2003
 79. Basov D N, Averitt R D, VanDerMarel D, Dressel M, Haule K. Electrodynamics of correlated electron materials. *Reviews of Modern Physics*, 2011, 83(2): 471–541
 80. Dexheimer S L. *Terahertz Spectroscopy: Principles and Applications*. Boca Raton, Florida: CRC press, 2017
 81. Kézsmárki I, Szaller D, Bordács S, Kocsis V, Tokunaga Y, Taguchi Y, Murakawa H, Tokura Y, Engelkamp H, Rößm T, Nagel U. One-way transparency of four-coloured spin-wave excitations in multiferroic materials. *Nature Communications*, 2014, 5(1): 3203
 82. Bordács S, Kézsmárki I, Szaller D, Demkó L, Kida N, Murakawa H, Onose Y, Shimano R, Rößm T, Nagel U, Miyahara S, Furukawa N, Tokura Y. Chirality of matter shows up via spin excitations. *Nature Physics*, 2012, 8(10): 734–738
 83. Penc K, Romhányi J, Rößm T, Nagel U, Antal A, Fehér T, Jánossy A, Engelkamp H, Murakawa H, Tokura Y, Szaller D, Bordács S, Kézsmárki I. Spin-stretching modes in anisotropic magnets: spin-wave excitations in the multiferroic $\text{Ba}_2\text{CoGe}_2\text{O}_7$. *Physical Review Letters*, 2012, 108(25): 257203
 84. Peedu L, Kocsis V, Szaller D, Viirik J, Nagel U, Rößm T, Farkas D G, Bordács S, Kamenskyi D L, Zeitler U, Tokunaga Y, Taguchi Y, Tokura Y, Kézsmárki I. Spin excitations of magnetoelectric LiNiPO_4 in multiple magnetic phases. *Physical Review B: Condensed Matter and Materials Physics*, 2019, 100(2): 024406
 85. Talbayev D, LaForge A D, Trugman S A, Hur N, Taylor A J, Averitt R D, Basov D N. Magnetic exchange interaction between rare-earth and Mn ions in multiferroic hexagonal manganites. *Physical Review Letters*, 2008, 101(24): 247601
 86. Mihály L, Talbayev D, Kiss L F, Zhou J, Fehér T, Jánossy A. Field-frequency mapping of the electron spin resonance in the paramagnetic and antiferromagnetic states of LaMnO_3 . *Physical Review B: Condensed Matter and Materials Physics*, 2004, 69(2): 024414
 87. Mihály L, Fehér T, Dóra B, Náfrádi B, Berger H, Forró L. Spin resonance in the ordered magnetic state of $\text{Ni}_5(\text{TeO}_3)_4\text{Cl}_2$. *Physical Review B: Condensed Matter and Materials Physics*, 2006, 74(17): 174403
 88. Kézsmárki I, Nagel U, Bordács S, Fishman R S, Lee J H, Yi H T, Cheong S W, Rößm T. Optical diode effect at spin-wave excitations of the room-temperature multiferroic BiFeO_3 . *Physical Review Letters*, 2015, 115(12): 127203
 89. Autore M, Engelkamp H, D'Apuzzo F, Gaspare A D, Pietro P D, Vecchio I L, Brahlek M, Koirala N, Oh S, Lupi S. Observation of magnetoplasmons in Bi_2Se_3 topological insulator. *ACS Photonics*,

- 2015, 2(9): 1231–1235
90. Wang Z, Reschke S, Huvonen D, Do S H, Choi K Y, Gensch M, Nagel U, Rödöm T, Loidl A. Magnetic excitations and continuum of a possibly field-induced quantum spin liquid in α -RuCl₃. *Physical Review Letters*, 2017, 119(22): 227202
 91. Sahasrabudhe A, Kaib D A S, Reschke S, German R, Koethe T C, Buhot J, Kamenskyi D, Hickey C, Becker P, Tsurkan V, Loidl A, Do S H, Choi K Y, Grüninger M, Winter S M, Wang Z, Valentí R, van Loosdrecht P H M. High-field quantum disordered state in α -RuCl₃: spin flips, bound states, and multi-particle continuum. *Physical Review B: Condensed Matter and Materials Physics*, 2020, 101(14): 140410
 92. LaForge A D, Frenzel A, Pursley B C, Lin T, Liu X, Shi J, Basov D N. Optical characterization of Bi₂Se₃ in a magnetic field: Infrared evidence for magnetoelectric coupling in a topological insulator material. *Physical Review B: Condensed Matter and Materials Physics*, 2010, 81(12): 125120
 93. Schafgans A, Post K W, Taskin A A, Ando Y, Qi X L, Chapler B C, Basov D N. Landau level spectroscopy of surface states in the topological insulator Bi_{0.91}Sb_{0.09} via magneto-optics. *Physical Review B: Condensed Matter and Materials Physics*, 2012, 85(19): 195440
 94. Schafgans A A, LaForge A D, Dordevic S V, Qazilbash M M, Padilla W J, Burch K S, Li Z Q, Komiyama S, Ando Y, Basov D N. Towards a two-dimensional superconducting state of La_{2-x}Sr_xCuO₄ in a moderate external magnetic field. *Physical Review Letters*, 2010, 104(15): 157002
 95. Dresselhaus G, Kip A F, Kittel C. Cyclotron resonance of electrons and holes in silicon and germanium crystals. *Physical Review*, 1955, 98(2): 368–384
 96. Lax B, Mavroides J G. Cyclotron resonance. In: Seitz F, Turnbull D, eds. *Solid State Physics*, vol. 11. New York: Academic Press, 1960, 261–400
 97. McCombe B D, Wagner R J. Intraband magneto-optical studies of semiconductors in the far-infrared. II. In: Marton L, ed. *Advances in Electronics and Electron Physics*, vol. 38. New York: Academic Press, 1975, 1–53
 98. Kono J. Cyclotron resonance. In: Kaufmann E N, et al. (eds.) *Methods in Materials Research*. New York: John Wiley & Sons, 2001, Chap. 9b.2
 99. Kono J, Miura N. Cyclotron resonance in high magnetic fields. In: Miura N, Herlach F, eds. *High Magnetic Fields: Science and Technology*, Volume III. Singapore: World Scientific, 2006, 61–90
 100. Hilton D J, Arikawa T, Kono J. Cyclotron resonance. In: Kaufmann E N, ed. *Characterization of Materials*, 2nd edition. New York: John Wiley & Sons, Inc., 2012, 1–15
 101. Wang X, Hilton D J, Reno J L, Mittleman D M, Kono J. Direct measurement of cyclotron coherence times of high-mobility two-dimensional electron gases. *Optics Express*, 2010, 18(12): 12354–12361
 102. Dicke R H. Coherence in spontaneous radiation processes. *Physical Review*, 1954, 93(1): 99–110
 103. Miura N, Yokoi H, Kono J, Sasaki S. High field cyclotron resonance and the electron effective masses in AlAs. *Solid State Communications*, 1991, 79(12): 1039–1042
 104. Kono J, Miura N, Takeyama S, Yokoi H, Fujimori N, Nishibayashi Y, Nakajima T, Tsuji K, Yamanaka M. Observation of cyclotron resonance in low-mobility semiconductors using pulsed ultra-high magnetic fields. *Physica B, Condensed Matter*, 1993, 184(1–4): 178–183
 105. Kono J, Takeyama S, Takamasu T, Miura N, Fujimori N, Nishibayashi Y, Nakajima T, Tsuji K. High-field cyclotron resonance and valence-band structure in semiconducting diamond. *Physical Review B: Condensed Matter and Materials Physics*, 1993, 48(15): 10917–10925
 106. Kono J, Takeyama S, Yokoi H, Miura N, Yamanaka M, Shinohara M, Ikoma K. High-field cyclotron resonance and impurity transition in *n*-type and *p*-type 3C-SiC at magnetic fields up to 175 T. *Physical Review B: Condensed Matter and Materials Physics*, 1993, 48(15): 10909–10916
 107. Knap W, Contreras S, Alause H, Skierbiszewski C, Camassel J, Dyakonov M, Robert J L, Yang J, Chen Q, Asif Khan M, Sadowski M L, Huan S, Yang F H, Goiran M, Leotin J, Shur M S. Cyclotron resonance and quantum hall effect studies of the two-dimensional electron gas confined at the GaN/AlGa_N interface. *Applied Physics Letters*, 1997, 70(16): 2123–2125
 108. Wang Y, Kaplan R, Ng H K, Doverspike K, Gaskill D K, Ikedo T, Akasaki I, Amano H. Magneto-optical studies of GaN and GaN/Al_xGa_{1-x}N: Donor Zeeman spectroscopy and two dimensional electron gas cyclotron resonance. *Journal of Applied Physics*, 1996, 79(10): 8007–8010
 109. Cheng B, Taylor P, Folkes P, Rong C, Armitage N P. Magnetoterahertz response and Faraday rotation from massive dirac fermions in the topological crystalline insulator Pb_{0.5}Sn_{0.5}Te. *Physical Review Letters*, 2019, 122(9): 097401
 110. Jeffries C D. Electron-hole condensation in semiconductors: electrons and holes condense into freely moving liquid metallic droplets, a plasma phase with novel properties. *Science*, 1975, 189(4207): 955–964
 111. Zhang Q, Wang Y, Gao W, Long Z, Watson J D, Manfra M J, Belyanin A, Kono J. Stability of high-density two-dimensional excitons against a Mott transition in high magnetic fields probed by coherent terahertz spectroscopy. *Physical Review Letters*, 2016, 117(20): 207402
 112. Li X, Yoshioka K, Zhang Q, Marquez Peraca N, Katsutani F, Gao W, Noe G T II, Watson J D, Manfra M J, Katayama I, Takeda J, Kono J. Observation of terahertz gain in two-dimensional magnetoexcitons. 2020, arXiv:2004.11459
 113. Hangyo M, Tani M, Nagashima T. Terahertz time-domain spectroscopy of solids: a review. *International Journal of Infrared and Millimeter Waves*, 2005, 26(12): 1661–1690
 114. von Klitzing K, Dorda G, Pepper M. New method for high-accuracy determination of the fine-structure constant based on quantized Hall resistance. *Physical Review Letters*, 1980, 45(6): 494–497
 115. Ikebe Y, Morimoto T, Masutomi R, Okamoto T, Aoki H, Shimano R. Optical Hall effect in the integer quantum Hall regime. *Physical Review Letters*, 2010, 104(25): 256802
 116. Shimano R, Yumoto G, Yoo J Y, Matsunaga R, Tanabe S, Hibino H, Morimoto T, Aoki H. Quantum Faraday and Kerr rotations in graphene. *Nature Communications*, 2013, 4(1): 1841
 117. Fiebig M. Revival of the magnetoelectric effect. *Journal of Physics*

- D, *Applied Physics*, 2005, 38(8): R123–R152
118. Yu S, Dhanasekhar C, Adyam V, Deckoff-Jones S, Man M K L, Madéo J, Wong E L, Harada T, Murali Krishna M B, Dani K M, Talbayev D. Terahertz-frequency magnetoelectric effect in Ni-doped $\text{CaBaCo}_4\text{O}_7$. *Physical Review B*, 2017, 96(9): 094421
 119. Armitage N P, Wu L. On the matter of topological insulators as magnetoelectrics. *SciPost Physics*, 2019, 6: 046
 120. Essin A M, Moore J E, Vanderbilt D. Magnetoelectric polarizability and axion electrodynamics in crystalline insulators. *Physical Review Letters*, 2009, 102(14): 146805
 121. Maciejko J, Qi X L, Drew H D, Zhang S C. Topological quantization in units of the fine structure constant. *Physical Review Letters*, 2010, 105(16): 166803
 122. Morimoto T, Furusaki A, Nagaosa N. Topological magnetoelectric effects in thin films of topological insulators. *Physical Review B: Condensed Matter and Materials Physics*, 2015, 92(8): 085113
 123. Qi X L, Hughes T L, Zhang S C. Topological field theory of time-reversal invariant insulators. *Physical Review B: Condensed Matter and Materials Physics*, 2008, 78(19): 195424
 124. Tse W K, MacDonald A H. Giant magneto-optical Kerr effect and universal Faraday effect in thin-film topological insulators. *Physical Review Letters*, 2010, 105(5): 057401
 125. Tse W K, MacDonald A H. Magneto-optical Faraday and Kerr effects in topological insulator films and in other layered quantized Hall systems. *Physical Review B: Condensed Matter and Materials Physics*, 2011, 84(20): 205327
 126. Wang J, Lian B, Qi X L, Zhang S C. Quantized topological magnetoelectric effect of the zero-plateau quantum anomalous Hall state. *Physical Review B: Condensed Matter and Materials Physics*, 2015, 92(8): 081107
 127. Zhang D, Shi M, Zhu T, Xing D, Zhang H, Wang J. Topological axion states in the magnetic insulator MnBi_2Te_4 with the quantized magnetoelectric effect. *Physical Review Letters*, 2019, 122(20): 206401
 128. Wilczek F. Two applications of axion electrodynamics. *Physical Review Letters*, 1987, 58(18): 1799–1802
 129. Hancock J N, van Mechelen J L, Kuzmenko A B, van der Marel D, Brüne C, Novik E G, Astakhov G V, Buhmann H, Molenkamp L W. Surface state charge dynamics of a high-mobility three-dimensional topological insulator. *Physical Review Letters*, 2011, 107(13): 136803
 130. Jenkins G S, Sushkov A B, Schmadel D C, Butch N P, Syers P, Paglione J, Drew H D. Terahertz Kerr and reflectivity measurements on the topological insulator Bi_2Se_3 . *Physical Review B: Condensed Matter and Materials Physics*, 2010, 82(12): 125120
 131. Valdés Aguilar R, Stier A V, Liu W, Bilbro L S, George D K, Bansal N, Wu L, Cerne J, Markelz A G, Oh S, Armitage N P. Terahertz response and colossal Kerr rotation from the surface states of the topological insulator Bi_2Se_3 . *Physical Review Letters*, 2012, 108(8): 087403
 132. Wu L, Tse W K, Brahlek M, Morris C M, Aguilar R V, Koirala N, Oh S, Armitage N P. High-resolution Faraday rotation and electron-phonon coupling in surface states of the bulk-insulating topological insulator $\text{Cu}_{0.02}\text{Bi}_2\text{Se}_3$. *Physical Review Letters*, 2015, 115(21): 217602
 133. Dziom V, Shuvaev A, Pimenov A, Astakhov G V, Ames C, Bendias K, Böttcher J, Tkachov G, Hankiewicz E M, Brüne C, Buhmann H, Molenkamp L W. Observation of the universal magnetoelectric effect in a 3D topological insulator. *Nature Communications*, 2017, 8(1): 15197
 134. Li X, Yoshioka K, Xie M, Noe G T, Lee W, Marquez Peraca N, Gao W, Hagiwara T, Handegård Ø S, Nien L W, Nagao T, Kitajima M, Nojiri H, Shih C K, MacDonald A H, Katayama I, Takeda J, Fiete G A, Kono J. Terahertz Faraday and Kerr rotation spectroscopy of $\text{Bi}_{1-x}\text{Sb}_x$ films in high magnetic fields up to 30 Tesla. *Physical Review B: Condensed Matter and Materials Physics*, 2019, 100(11): 115145
 135. Okada K N, Takahashi Y, Mogi M, Yoshimi R, Tsukazaki A, Takahashi K S, Ogawa N, Kawasaki M, Tokura Y. Terahertz spectroscopy on Faraday and Kerr rotations in a quantum anomalous Hall state. *Nature Communications*, 2016, 7(1): 12245
 136. Morris C M, Valdés Aguilar R, Ghosh A, Koochpayeh S M, Krizan J, Cava R J, Tchernyshyov O, McQueen T M, Armitage N P. Hierarchy of bound states in the one-dimensional ferromagnetic Ising chain CoNb_2O_6 investigated by high-resolution time-domain terahertz spectroscopy. *Physical Review Letters*, 2014, 112(13): 137403
 137. Little A, Wu L, Lampen-Kelley P, Banerjee A, Patankar S, Rees D, Bridges C A, Yan J Q, Mandrus D, Nagler S E, Orenstein J. Antiferromagnetic resonance and terahertz continuum in $\alpha\text{-RuCl}_3$. *Physical Review Letters*, 2017, 119(22): 227201
 138. Wu L, Little A, Aldape E E, Rees D, Thewalt E, Lampen-Kelley P, Banerjee A, Bridges C A, Yan J Q, Boone D, Patankar S, Goldhaber-Gordon D, Mandrus D, Nagler S E, Altman E, Orenstein J. Field evolution of magnons in $\alpha\text{-RuCl}_3$ by high-resolution polarized terahertz spectroscopy. *Physical Review B*, 2018, 98(9): 094425
 139. Ozel I O, Belvin C A, Baldini E, Kimchi I, Do S, Choi K Y, Gedik N. Magnetic field-dependent low-energy magnon dynamics in $\alpha\text{-RuCl}_3$. *Physical Review B*, 2019, 100(8): 085108
 140. Shi L, Liu Y Q, Lin T, Zhang M Y, Zhang S J, Wang L, Shi Y G, Dong T, Wang N L. Field-induced magnon excitation and in-gap absorption in the Kitaev candidate RuCl_3 . *Physical Review B: Condensed Matter and Materials Physics*, 2018, 98(9): 094414
 141. Yu S, Gao B, Kim J W, Cheong S W, Man M K L, Madéo J, Dani K M, Talbayev D. High-temperature terahertz optical diode effect without magnetic order in polar $\text{FeZnMo}_3\text{O}_8$. *Physical Review Letters*, 2018, 120(3): 037601
 142. Forn-Díaz P, Lamata L, Rico E, Kono J, Solano E. Ultrastrong coupling regimes of light-matter interaction. *Reviews of Modern Physics*, 2019, 91(2): 025005
 143. Kockum A F, Miranowicz A, De Liberato S, Savasta S, Nori F. Ultrastrong coupling between light and matter. *Nature Reviews Physics*, 2019, 1(1): 19–40
 144. Hagenmüller D, De Liberato S, Ciuti C. Ultra-strong coupling between a cavity resonator and the cyclotron transition of a two-dimensional electron gas in the case of an integer filling factor. *Physical Review B: Condensed Matter and Materials Physics*, 2010, 81(23): 235303
 145. Herrmann G. Resonance and high frequency susceptibility in

canted antiferromagnetic substances. *Journal of Physics and Chemistry of Solids*, 1963, 24(5): 597–606

146. Artoni M, Birman J L. Polaritonsqueezing: theory and proposed experiment. *Quantum Optics: Journal of the European Optical Society Part B*, 1989, 1(2): 91–97
147. Schwendimann P, Quattropani A. Nonclassical properties of polariton states. *Europhysics Letters*, 1992, 17(4): 355–358
148. Ciuti C, Bastard G, Carusotto I. Quantumvacuum properties of the intersubband cavity polariton field. *Physical Review B: Condensed Matter and Materials Physics*, 2005, 72(11): 115303



Andrey Baydin is a postdoctoral scholar in Department of Electrical and Computer Engineering at Rice University, USA. He obtained his Ph.D. degree in Physics from Vanderbilt University, USA in May 2018. His current research interests include ultrafast spectroscopy of quantum materials and light-matter interaction in the ultrastrong coupling regime.



Takuma Makihara joined Prof. Kono's laboratory in the spring of 2019, where he focused on terahertz time-domain magnetospectroscopy of orthoferrites using the Rice Advanced Magnet with Broadband Optics. He received his B.S. degree in Physics from Rice University, USA in 2020, and is currently pursuing his Ph.D. at Stanford University, USA with a focus on quantum hardware.



Nicolas Marquez Peraca received his B.S. degree in Physics from University of the Republic in Montevideo, Uruguay in 2016. Before joining Prof. Kono's laboratory in the fall of 2018, he was a Guest Researcher for two years at National Institute of Standards and Technology in Gaithersburg, MD, USA, where he worked in the electric and opto-electronic characterization of multijunction solar cells. His research interests include ultrafast phenomena in condensed matter physics, terahertz magnetospectroscopy of quantum materials, and quantum technology.

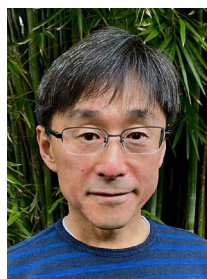

Junichiro Kono is Karl F. Hasselmann Chair in Engineering, Professor in Departments of Electrical & Computer Engineering, Physics & Astronomy, and Materials Science & Nanoengineering, and Chair of Applied Physics at Rice University, USA. He received his B.S. and M.S. degrees in Applied Physics from University of Tokyo, Japan in 1990 and 1992, respectively, and completed his Ph.D. in Physics from State University of New York at Buffalo, USA in 1995. He was a postdoctoral research associate at University of California Santa Barbara, USA from 1995 to 1997, and the W. W. Hansen Experimental Physics Laboratory Fellow in Department of Physics at Stanford University, USA from 1997 to 2000. His current research interests include quantum optics in condensed matter, ultrastrong light-matter coupling, and terahertz science and technology.