

- High-salinity sample
- Intermediate-salinity sample
- Low-salinity sample

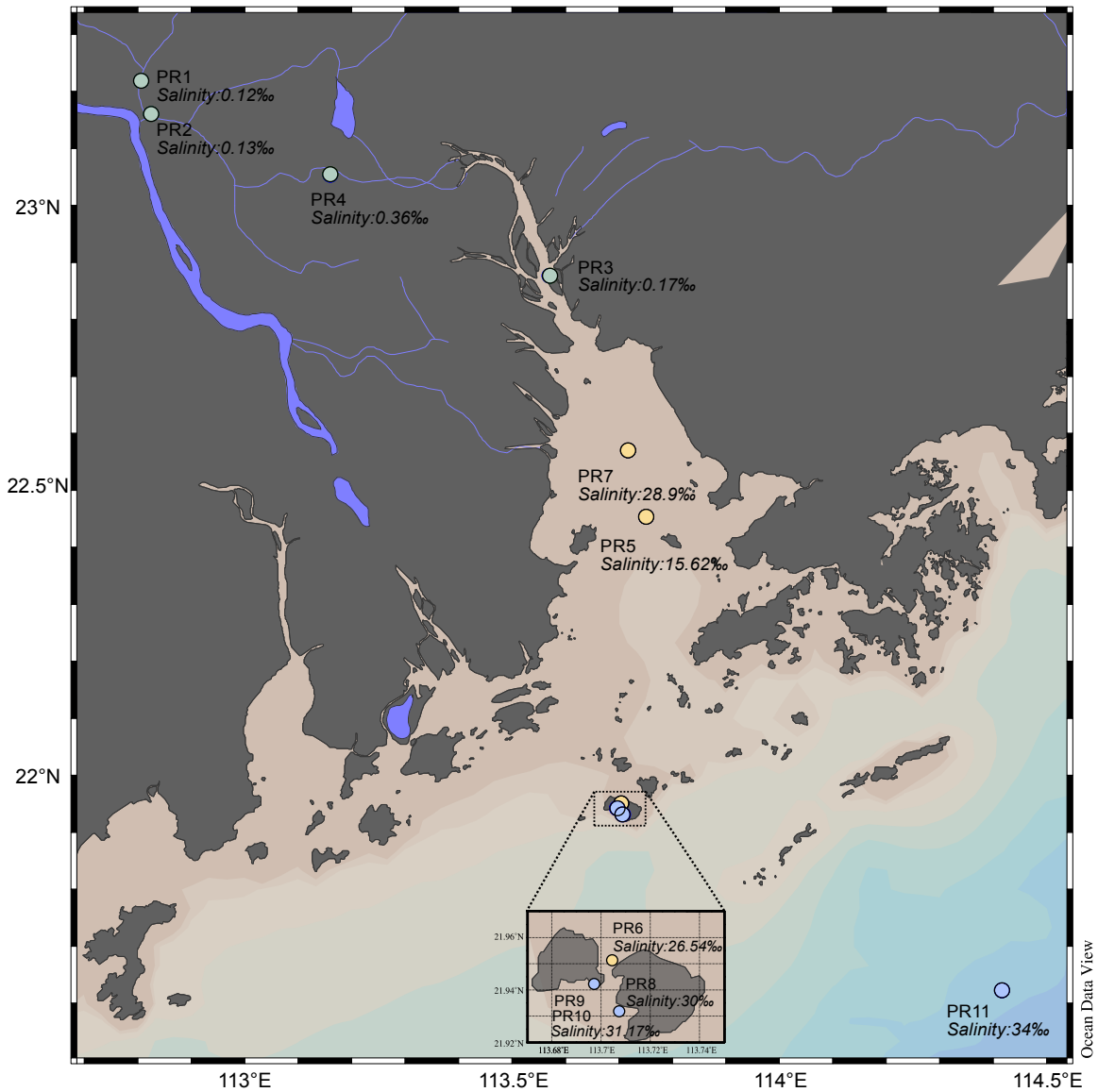

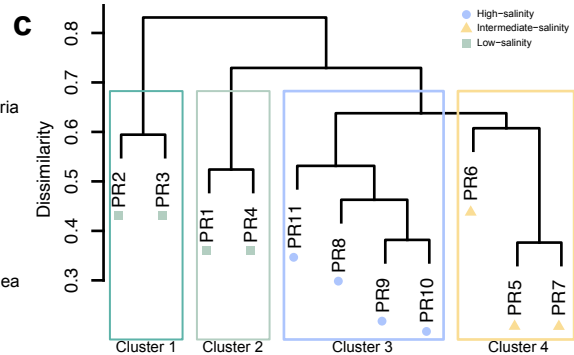

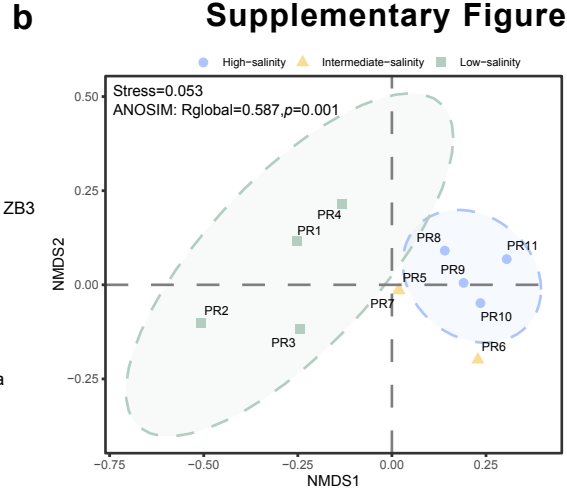
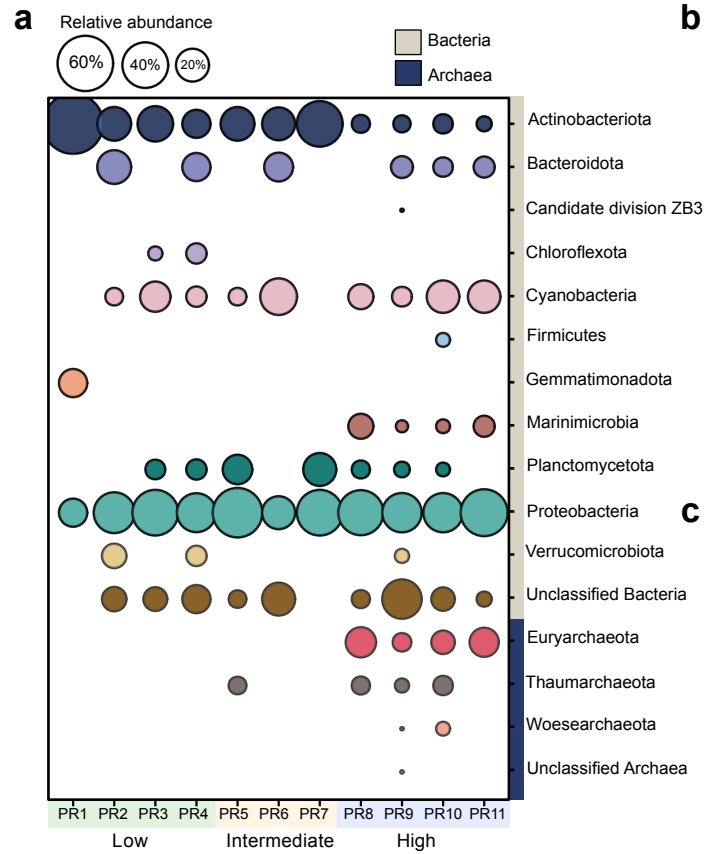
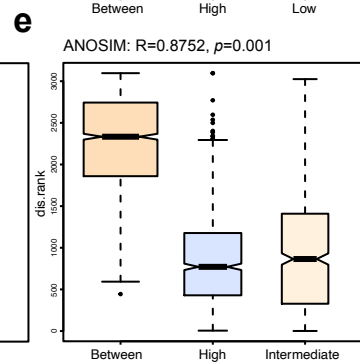
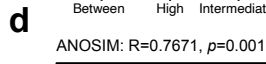
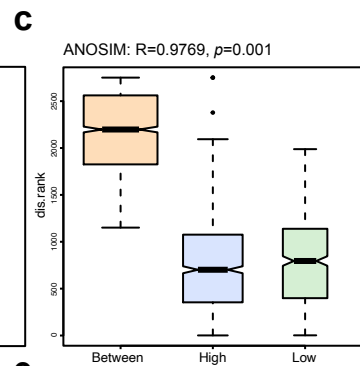
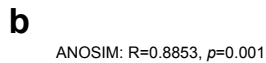
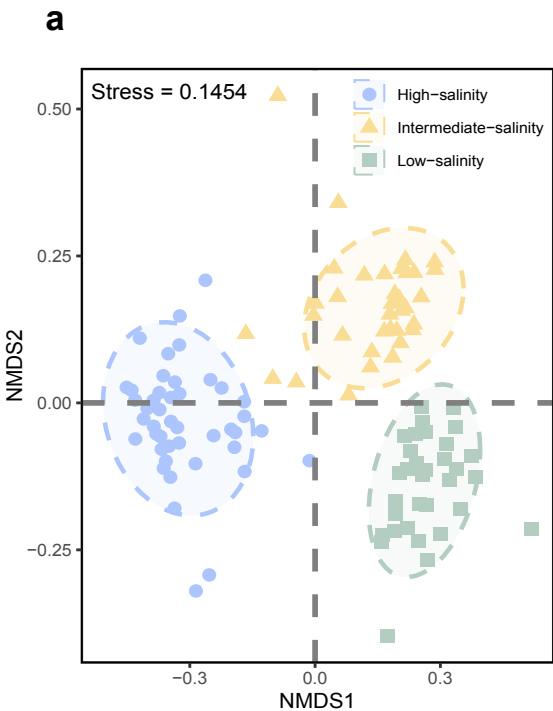

# Supplementary Figure S4

