

## IMPROVEMENT IN HUMAN VISION UNDER BRIGHT LIGHT: GRAIN OR GAIN?

BY BING CHEN, DONALD I. A. MACLEOD\* AND ANDREW STOCKMAN

*From the Department of Psychology, University of California at San Diego,  
La Jolla, CA 92093, U.S.A.*

(Received 7 May 1987)

### SUMMARY

1. The factor by which increment threshold changes with changing background intensity is less if the test flash is small than if it is large. This is commonly attributed to a reduction of the area over which visual signals are integrated as light adaptation increases.

2. We propose and test an alternative hypothesis that the change in slope is the result of purely local processes: if it is assumed that increasing the background intensity increases the exponent of the local response function, but does not alter the extent of spatial integration, then the threshold of the small test flash will rise more slowly than the threshold of the large test flash simply because the small test flash is of a higher intensity than the large and therefore evokes a correspondingly greater local response.

3. We measured small and large test field increment thresholds and dichoptic brightness matches as a function of background intensity.

4. The log–log slopes of the small and large field increment threshold functions differed by not more than about 20%, suggesting that even under the conventional interpretation of such data, the change of spatial integration is less than is usually supposed.

5. The intensity of a large (2.3 deg) suprathreshold test field matched to a standard in the other eye varies with increasing background intensity with the same shallow slope as the small test (2.6 min) threshold *versus* intensity function; this is in agreement with the predictions of the local non-linearity hypothesis and suggests that there is no substantial change in spatial integration during light adaptation.

### INTRODUCTION

When a scene is viewed under bright or moderate illumination, texture and detail emerge that go undetected at lower photopic light levels. In the words of a commercial slogan: 'More light means better sight'. But why should this be so? An obvious answer, that more light means bigger visual signals, seems incomplete because the improvement in resolution is not accompanied by a correspondingly dramatic increase in apparent brightness or contrast. The visual system, therefore,

\* Addressee for correspondence.

must be adjusting its gain in response to increasing illumination. To the extent that the visual system adapts to high illumination with a reciprocal adjustment of its gain, the resulting signals should be independent of illumination. More light, then, by this interpretation, will not mean bigger signals.

Since resolution is related to the spacing and receptive field size of the cells that represent the image, improvements in resolution could be effected if either the spacing or the field size depended strongly on intensity. In the first model to gain wide acceptance the effective spacing and not the field size was assumed to be intensity dependent. Hecht (1928) postulated that the thresholds for exciting individual cells differ from cell to cell and cover the entire intensity range across which visual resolving power varies. Thus, the number of cells that can contribute to the resolution of an image increases with increasing illumination. Recordings from single cells have shown Hecht's postulate to be unrealistic, but they have given some plausibility to an alternative suggestion, traceable to Broca (1901), that the region over which local stimuli are synergistic in their net effects on the cell's activity is reduced in bright light. This could happen either because lateral inhibitory influences, which may cancel or outweigh the direct, excitatory effect of stimuli falling in the periphery of a cell's receptive field, require light adaptation to make them prominent (Barlow, Fitzhugh & Kuffler, 1957), or else because at high light levels more cells with smaller receptive field centres come into play (Pirenne, 1967; Enroth-Cugell & Shapley, 1973). In either case the region over which the relevant cells respond similarly to incident light would be reduced. The effect would be roughly like reducing the grain size in a photographic film (Barlow, 1972), allowing unwanted sensitivity to be exchanged for a useful improvement in resolution. The regulation of sensitivity implicit in Weber's law (according to which sensitivity is inversely proportional to illuminance) would be accomplished in part through adjustments of spatial integration.

This attractive idea has received what seems at first sight to be strong support from psychophysical experiments of two kinds.

First, it has been demonstrated that threshold *versus* intensity (t.v.i.) curves are shallower if measured using a small, brief flash than if measured using a large, long flash. (A t.v.i. curve is a function, plotted on double-logarithmic co-ordinates, defining how the threshold intensity required to detect an incremental test stimulus varies as the background intensity increases.) For example, Barlow (1958*b*) indicated that with brief (7 ms duration), small (5.2 min diameter) test fields, t.v.i. curves conform to the DeVries-Rose square-root law, whereas with long (1 s duration), large (55 min diameter) fields they conform to Weber's law; that is, the slopes are close to 0.5 and 1.0, respectively. Comparable results have been provided for rod-mediated vision by Blakemore & Rushton (1965). Idealized t.v.i. curves conforming to this description are illustrated in Fig. 2. The change in the vertical difference between these curves is usually regarded as a measure of the change in spatial integration.

The second line of evidence is that contrast sensitivity functions change from having low-pass filter characteristics at low background intensities to bandpass characteristics at higher intensities (see for example Daitch & Green, 1969; Van Nes & Bouman, 1967; Van Meeteren & Vos, 1968; Kelly, 1977). This change in character has been related to the differences between the slopes of t.v.i. curves, since the loss

of contrast sensitivity at low spatial frequencies follows Weber's law, whereas the sensitivity loss at middle spatial frequencies follows the square-root law (Barlow, 1972).

The relative improvement in sensitivity to small, brief test flashes, and to higher spatial frequencies, found as the adaptation level increases, has been taken as evidence that adaptation reduces the area over which signals are integrated. In this paper we question this interpretation on both physiological and psychophysical grounds.

Although the square-root law is consistent with the behaviour of an ideal detector limited only by quantum fluctuations, recent physiological reports show that receptors conform more closely to Weber's law than to the square-root law (Boynton & Whitten, 1970; Baylor & Hodgkin, 1974; Kleinschmidt & Dowling, 1975; Fain, 1976). Thus the idea that compliance with the square-root law reflects the behaviour of the receptors without significant changes in spatial integration is questionable. Recordings from post-receptoral cells using small test spots show that the change in sensitivity on increasing the adaptation level is slightly or appreciably more than the square-root law would imply; recordings using large spots conform to Weber's law only asymptotically at best (Enroth-Cugell & Shapley, 1973; Barlow & Levick, 1976). Thus these physiological t.v.i. curves differ less from one another than do the traditional idealizations based on psychophysics. Further, in recordings from mammalian retinal ganglion cells or lateral geniculate cells the change in receptive field profile with light adaptation (Barlow *et al.* 1957; Enroth-Cugell & Robson, 1966; Cleland & Enroth-Cugell, 1968; Jacobs & Yolton, 1970) is much smaller than would be predicted from psychophysical observations. The changes in receptive field size found in these studies are mainly attributed to changes in the effectiveness of the antagonistic surround. Such changes are not always consistently observed (Jacobs & Yolton, 1970; Enroth-Cugell, Hertz & Lennie, 1977*a*), and calculations (see Appendix) suggest that their maximum effect on integration area is in any case quite small.

Thus the evidence for a substantial change in spatial integration with adaptation is mainly psychophysical. Surprisingly, even this evidence turns out on close consideration to be equivocal. Three confounding factors can be identified, two affecting sine-wave contrast sensitivity experiments, and a third affecting both these and the t.v.i. curve evidence.

First, the effects of *eye movements* must be considered: gratings, like anything else, are seen only by virtue of the time-varying signals created by fixational eye movements. Eye movements will force a temporal factor to become involved when a spatial modulation transfer function is measured. At high luminance levels, light adaptation greatly speeds the impulse response and improves the temporal resolution of the visual response of visual cells (Baylor & Hodgkin, 1974). In the important range of frequencies where the direction of gaze tends to drift or jump over large fractions of a cycle, the higher frequency gratings will be represented by a higher frequency modulation of the membrane potential or of the firing rate. Improvements in temporal resolution with light adaptation will therefore differentially improve spatial contrast sensitivity at higher frequencies. Second, *retinal inhomogeneity* must be reckoned with: the parafovea begins to lose sensitivity at lower adaptation

levels than the central fovea (see for instance the data of Kishto & Saunders, 1970; Drum, 1980) even when only cone vision is involved. The contribution of the poorly resolving parafovea to visual performance will thus vary as a function of light adaptation.

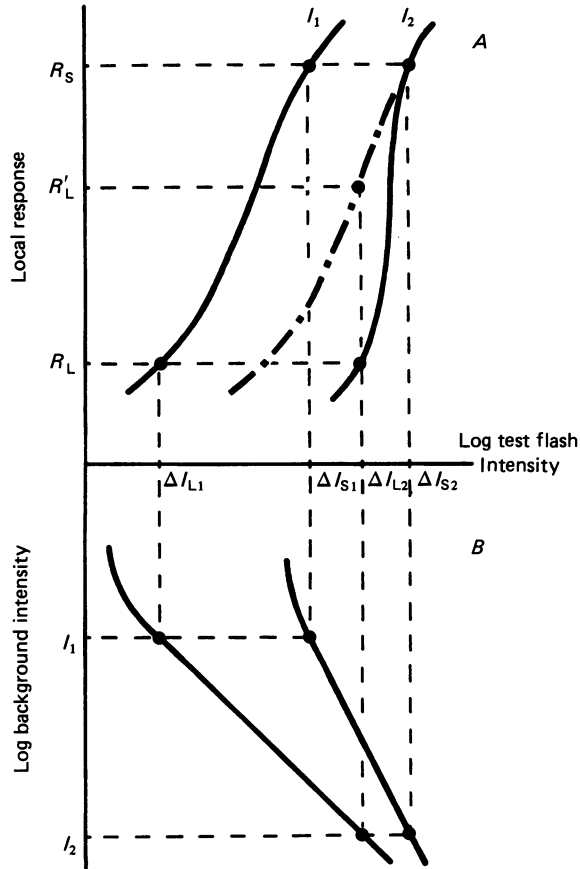

Fig. 1. Diagram illustrating the two competing models for converging t.v.i. curves: *A*, based on a change of spatial integration and *B*, on a change in the response-intensity function. See text for details.

Incremental thresholds for brief, spatially restricted flashes (t.v.i. curves) are unlikely to be influenced by eye movements or retinal inhomogeneity. But they may be influenced by another confounding factor, common to both increment threshold and contrast sensitivity experiments, that has up to now gone unrecognized but forms the main subject of this paper. At the visual threshold, small stimuli are of higher intensity than large stimuli. This makes it possible to account for their greater visibility at high light levels without invoking any change at all in spatial integration, by invoking what we call an *adaptation-dependent non-linearity* in the function relating local response to test intensity as the cause of the change in the slopes of t.v.i. curves. We assume that increasing the background intensity increases the exponent of the function relating the local response to test flash intensity, but

does not alter the extent of spatial integration. Thus the threshold of the small test flash will rise more slowly than the threshold of the large test flash, simply because the small test flash is of a higher intensity than the large and therefore evokes a correspondingly greater local response.

This hypothesis is illustrated in Fig. 1. We propose that the gradient of the function relating the local test flash response to the logarithm of the test flash intensity increases with increasing background intensity. This is shown for two background intensities ( $I_1$  and  $I_2$ ) in Fig. 1A. Figure 1B shows two t.v.i. curves: the lower curve represents a large test field t.v.i. curve, and the upper one a small test field t.v.i. curve. (The t.v.i. curves have been rotated through 90 deg to allow comparison with the upper response-intensity curves.) The detection of the small test field requires a larger local incremental response ( $R_s$ ) than does the detection of the large test field ( $R_L$ ). At the low background intensity ( $I_1$ ) test field intensities of  $\Delta I_{L1}$  and  $\Delta I_{S1}$  are required to elicit threshold responses  $R_L$  and  $R_s$  respectively, whereas at the higher background intensity ( $I_2$ ) test flash intensities of  $\Delta I_{L2}$  and  $\Delta I_{S2}$  are required. Because of the steepening of the function relating the test flash response to the log of the flash intensity, the difference between  $\log \Delta I_{L1}$  and  $\log \Delta I_{L2}$  is larger than the difference between  $\log \Delta I_{S1}$  and  $\Delta I_{S2}$ . Thus the large and small test field t.v.i. curves converge as the background intensity increases. There is no change of spatial integration in this model: for a particular test stimulus the local signal at threshold is constant across light levels.

In the alternative hypothesis of a change in spatial integration at threshold, it is assumed that the gradient of the response *versus* log intensity function remains constant with increasing background intensity, with a lateral shift reflecting the loss of sensitivity observed with small test flashes. This is illustrated by the dashed response *versus* log intensity function shown in Fig. 1. Since there is less spatial integration of the local signals in the high intensity condition ( $I_2$ ), a greater local signal ( $R'_L$ ) is required for an extended test stimulus to reach threshold than in the low intensity condition ( $R_L, I_1$ ). It is assumed that the detectability of the small field is not affected by changes in spatial integration. Thus the threshold response ( $R_s$ ) is unaffected by changes in adaptation level. On this model the small and large test field t.v.i. curves converge because  $R'_L$  is closer to  $R_s$  than is  $R_L$ .

The decision between these alternative explanations for the convergence of the t.v.i. curves must be based upon independent evidence for a change in either spatial integration or the gradient of the response *versus* log intensity function with changing illumination. The evidence for a change of spatial integration is not compelling, as pointed out above. The alternative explanation of a change in response-intensity non-linearity is strongly supported by the dichoptic brightness matching data of Whittle & Challands (1969). They determined the test flash intensities required to match a suprathreshold standard flash, when the standard was presented to one eye under fixed adaptation conditions and the variable test flash was presented against a range of background intensities in the other eye. The resulting 'constant brightness curve' representing the test flash intensity required to match the standard as a function of the background intensity, looks (for sufficiently high test intensities) very much like the t.v.i. curve for a small test flash, even though Whittle & Challands (1969) used large test stimuli. Evidently the factor by which

adaptation alters the intensity required for a constant visual effect (threshold or brightness) does vary with the intensity of the test stimuli involved. The change in the response *versus* intensity function suggested by the findings of Whittle & Challands (1969) is sufficient to account for the converging small and large field t.v.i. curves without invoking any change in spatial integration. The increase of the

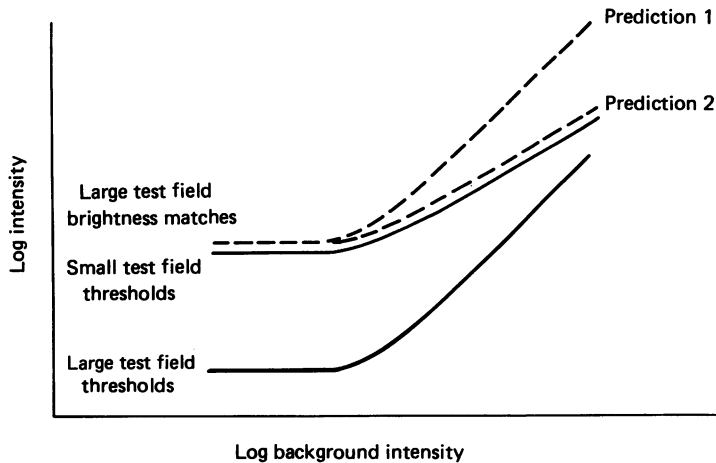

Fig. 2. Brightness matches predicted by the spatial integration hypothesis (prediction 1) and the adaptation-dependent non-linearity (prediction 2). See text for details.

brightness exponent under light adaptation (Stevens & Stevens, 1963) points in the same direction. Adaptation-dependent deviations from area-intensity reciprocity at rod threshold (Scholtes & Bouman, 1977), and several phenomena of colour appearance (Nayatani, Takahama & Sobagaki, 1981), are most naturally explained by a steepening of the response *versus* log intensity function with light adaptation. Yet another piece of psychophysical evidence for an adaptation-dependent non-linearity comes from observations of distortion products generated by unresolvable interference fringes: the inferred cone response-intensity function is less negatively accelerated at high levels than at low ones (Makous, MacLeod & Williams, 1986). The physiological picture with respect to non-linearity is more ambiguous, perhaps partly due to species differences and rod-cone differences. The required adaptation dependence is clear in turtle horizontal cells, but not in turtle cones (Normann & Perlman, 1979). It appears to be absent in some recordings of the rod-dominated responses of cat ganglion cells (Sakmann & Creutzfeldt, 1969), but present in others (Barlow & Levick, 1960*a*). Most relevantly, it does appear in extracellular recordings from primate cones (Boynton & Whitten, 1970).

Our test of the response-intensity non-linearity hypothesis is to compare small and large test field t.v.i. measurements and large test field suprathreshold brightness matching measurements. The intensity of the standard brightness matching field is chosen so that at low background intensities the intensity of the large field required to match it is the same as the threshold intensity of the small field. Thus at low background intensities the local response elicited by the two fields should be the same. The response-intensity non-linearity hypothesis predicts that on increasing

the background intensity the small field threshold intensities and the brightness matching intensities should both increase but remain the same as each other. However, if there is a reduction in spatial integration with increasing background intensity, the large field brightness matching intensities should rise more steeply than the small field threshold intensities. In fact, a pure spatial integration hypothesis predicts that the brightness matching function and the large test field t.v.i. function should be similar in shape, since the test fields used in the two types of measurements are of the same size. These predictions are illustrated in Fig. 2.

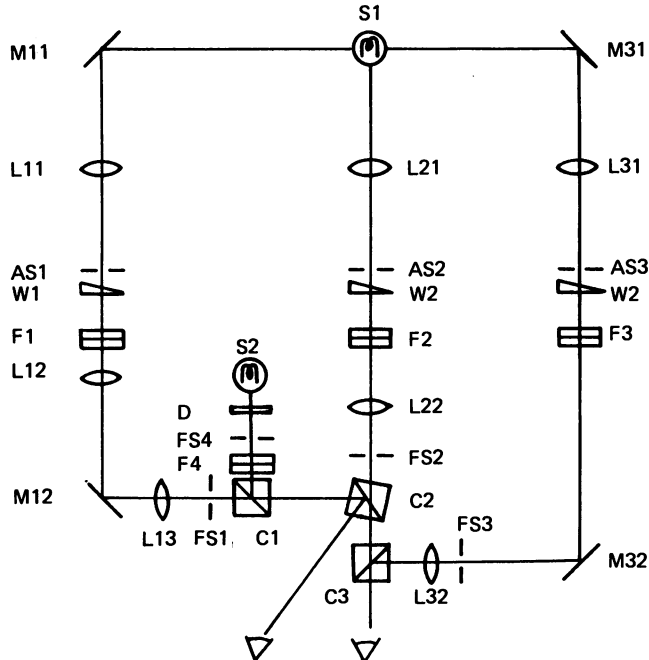

Fig. 3. Schematic diagram of optical apparatus. See text for abbreviations and details.

## METHODS

### *Apparatus*

Measurements were made using a binocular 4-channel optical system, schematically shown in Fig. 3. Three channels seen in Maxwellian view, originated from a common light source (S1; 24 V, 250 W Bellaphot tungsten-halogen lamp). Two of these channels were presented to the right eye; the other was presented to the left eye. Channels 1 and 2 provided test fields for the left and the right eye respectively. Channels 3 and 4 provided background fields for the right and left eyes respectively. Channel 4, not seen in Maxwellian view, originated from a separate light source (S2; 20 V, 5 W, G.E. 1458 lamp). Its primary purpose was to back-illuminate a fixation square provided to aid binocular fusion. A diffuser (D) was placed in front of the source S2 in order to make the back-illumination appear uniform.

Channels 1, 2 and 3 were similar in design. In each channel the filament was imaged on an aperture stop (AS1, AS2 or AS3). These stops restricted the size of the final filament image so that it was in all cases smaller than 2.5 mm in diameter, and smaller than the pupil size. Field stops FS1 and FS2 were placed in front of the Maxwellian lens and were directly viewed by the subject. These field stops and field stop FS3 (placed before the Maxwellian lens), were positioned so that all three fields appeared in good focus at the eye. Channels 2 and 3 were combined at cube C3; channels 1

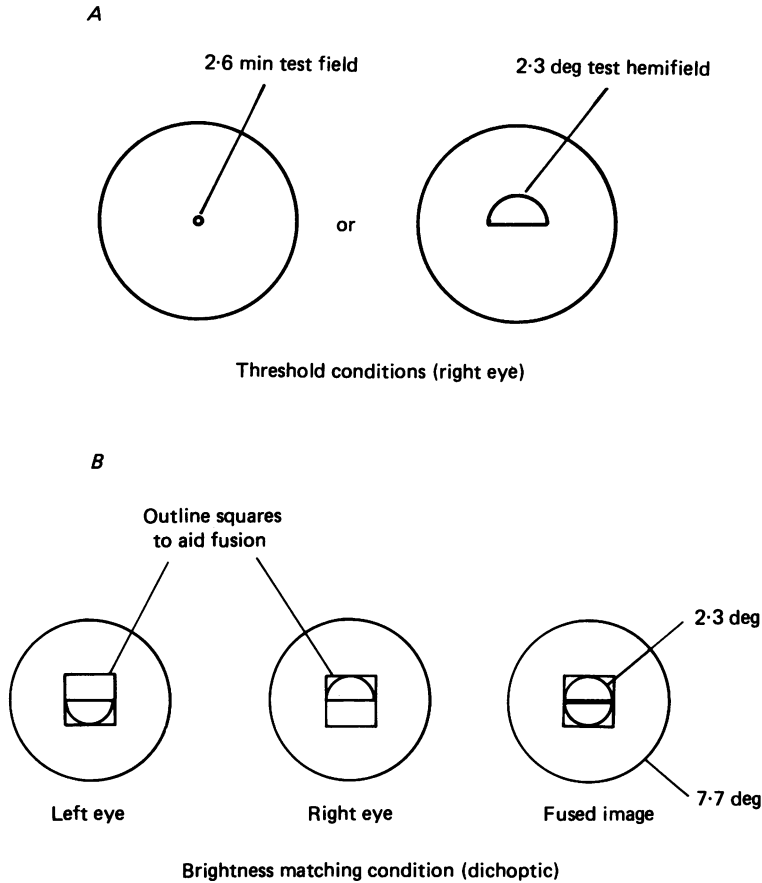

Fig. 4. *A*, subject's fields of view in the incremental threshold experiments. *B*, subject's fields of view in the brightness matching experiments.

and 4 were combined at cube C1. Cube C2 was positioned so that light from channel 2 passed through it to be seen by the observer's right eye, but so that light from channel 1 was reflected by it to be seen by the observer's left eye. Lenses L13, L22 and L32 focused the filament images in the plane of the observer's pupils. Fixed neutral density filters and colour filters were placed at F1, F2, F3 and F4. The radiance in each channel was controlled by Inconel circular neutral density wedges (W1, W2 and W3) and by Inconel fixed neutral density filters. Experimental control was achieved by a Z-80 microcomputer interfaced to a PDP-11 minicomputer. The two computers operated shutter ST1, positioned wedge W2, and monitored the observer's responses.

#### *Stimuli*

Two alternative field stops were used at FS2: one defined a circular 2.6 min test field, the other the upper half of a circular 2.3 deg test field. The size of the small field was large enough so that optical imperfections of the eye would not severely reduce the intensity at its centre; the results of Gubisch (1967, Fig. 9) suggest a reduction of 0.2 log units, and focusing errors of plausible magnitude (say, 0.25 D) would not alter this much. A field stop placed at FS1 defined the lower half of a circular 2.3 deg standard test field. In the increment threshold measurements the subject monocularly viewed either the circular 2.6 min test flash, or the upper semicircular 2.3 deg test field, superimposed on a circular 7.7 deg steady background (Fig. 4A). In the suprathreshold



dichoptic brightness matching, the subject's left eye viewed the lower semicircular 2.3 deg standard field. This field was superimposed on a dim background (the primary purpose of which was to back-illuminate the fixation square surrounding the standard field); both the standard and the background fields were of fixed intensity. The subject's right eye viewed the upper semicircular 2.3 deg test field. This field was presented on a variable intensity background. The two outline squares aided binocular fusion. When fused, the two semicircular fields combined to form a single circular field within the outline of a single square (Fig. 4B).

### Calibrations

Regular calibrations were carried out with an EG&G Radiometer/Photometer, with a photopic filter in place to eliminate infra-red. Neutral filters, fixed and variable, were calibrated *in situ*. As a precaution, fixed neutral density filters were added so that the same region of the variable neutral density wedge was used for all measurements.

### Subjects

Three subjects were tested in these experiments, A.S., B.C. and K.P. All three had normal colour vision. A.S. was emmetropic and required no optical correction. K.P. and B.C. were myopic and were optically corrected with  $-1.5$  D and  $-4.0$  D spherical lenses respectively.

### Procedure and experimental conditions

In the experiments described below increment thresholds and brightness matches were measured as a function of background intensity. Two combinations of test and background colours were used. In one a white test field was presented on a white background. This combination was used to restrict detection to achromatic post-receptoral channels. By selecting a single post-receptoral channel, we hope to avoid any problems (e.g. slope changes) that might be associated with an adaptation-dependent transition from one type of receptoral channel to another. In the other a red test field (Wratten gelatin filter No. 25) was presented on a green background field (541 nm interference filter). This combination was chosen to favour detection by the long-wavelength cone mechanism (Stiles, 1978). Other combinations of test and field wavelengths could result in more than one cone mechanism determining the shape of the t.v.i. curves. This would considerably complicate our analysis.

To estimate increment thresholds we used either a two-interval forced-choice procedure or a yes-no staircase procedure. To make suprathreshold brightness matches we used a yes-no staircase procedure.

For two-interval forced-choiced increment threshold measurements the following procedure was used. After pre-adapting to the background field for 2 min, the subject pressed a button to start the experiment. In each trial a 20 ms test flash could occur in one of two intervals. The two intervals, separated by 1 s, were defined by 20 ms bursts of white noise heard through earphones. The subject's task was to correctly identify within which interval the test flash occurred. Shutter  $ST_2$  exposed the test field. A second shutter  $ST_0$  was added that did not interrupt the test beam. This shutter was opened for 20 ms during the interval in which the test flash was not presented. The audible clicks heard when  $ST_0$  and  $ST_2$  operated were similar, but not identical. We found that when the shutter openings were additionally masked by bursts of white noise, the occurrence of the test flash could not be distinguished on the basis of any auditory cues. If the subject was wrong on any trial the intensity of the test flash was increased on the next trial. If the subject was correct on two successive trials the intensity was decreased. The threshold estimate was based on the subject's responses on the last forty to sixty trials. This procedure provides an estimate of the threshold intensity at which the flash is detected 71% of the time.

Thresholds were also measured using a yes-no procedure, in which two staircases were randomly interleaved. The test flash was presented for 20 ms (or in one condition 150 ms). The subject's task was to press one of two buttons to indicate whether he or she did see the test flash (a yes response) or did not see it (a no response). Following a yes response the intensity of the test flash was decreased; following a no response the intensity was increased. For the dichoptic brightness matches, a similar procedure was used, except that the subject's task was to press one of two buttons to indicate whether the test field appeared brighter or dimmer than the standard field. The threshold or brightness match was based on the subject's response on the last forty to sixty trials. These measures yield an estimate of the threshold that is equivalent to the level at which the test

field would be detected 50% of the time, or an estimate of brightness that is equivalent to the level at which the test field would be judged brighter than the standard 50% of the time.

In general, a perfect match between the dichoptic brightness matching fields could not be achieved. When matched for brightness, small differences in apparent size, apparent duration and apparent colour were noticeable. Nevertheless, acceptable brightness matches spanned only a limited range of stimulus intensities.

In all cases, the reported results are averaged from three or four separate estimates (from different sessions) of the threshold or brightness match. In the experiments in which a white test was presented on a white background, cone plateau thresholds were determined to ensure that there was no rod intrusion at the lower background intensities.

## RESULTS

In Figs 5*A–D* and 6*A* and *B* the incremental thresholds and equal brightness matches are plotted as a function of background intensity. The large open circles are 2.3 deg test field incremental thresholds, the filled small circles are 2.6 min test field incremental thresholds and the open and filled triangles are 2.3 deg brightness matches. For the brightness matches, the standard test field presented to the observer's left eye had an intensity approximately equal to that of the test field corresponding to the left-most data point of the brightness matching curve. Each data point is the mean of three or four experimental sessions representing a total of 150–200 judgements. The error bars indicate  $\pm 1$  standard deviation between sessions. Figure 5*A* and *B* shows results for subjects B.C. and K.P. obtained for the heterochromatic condition (a red test field superimposed on a green background). The thresholds were measured using a yes–no procedure. Figure 5*C* and *D* is the data obtained for subjects A.S. and C.B. under the same conditions, except that a forced-choice procedure was used to estimate thresholds. For B.C., in Fig. 5*D*, two standard test field intensities were used to estimate brightness matches. These were chosen so that the resulting curves were slightly above and below the small field threshold curve. Figure 6*A* and *B* is the results for the white flash on white background condition, using a forced-choice procedure. All these measurements were obtained for a 20 ms test flash duration.

Although not illustrated here, one subject (K.P.) also ran the white on white condition using a longer (150 ms) duration test flash. The results are similar to those found for K.P. and C.B. under other conditions: the brightness matching curve was similar in shape to the small test field t.v.i. curve, but both were shallower than the large test field t.v.i. curve. Curve fitting parameters for each condition are shown in Fig. 8.

Casual inspection reveals that for all three subjects and for all conditions the large test field constant brightness curves are similar in shape to the small test field t.v.i. curves. With the exception of subject A.S., the small test field t.v.i. curves and the large test constant brightness curves are noticeably shallower than the large test field t.v.i. curves. The results for B.C. and K.P., therefore, support the adaptation-dependent non-linearity hypothesis. The results for A.S. do not distinguish well between the competing hypotheses.

*Shift or slope change?*

The t.v.i. curves and constant brightness curves can be characterized quantitatively by fitting the data with the following descriptive equation:

$$\Delta I = W(I + I_0)^n. \quad (1)$$

Here  $n$  is the high intensity asymptotic slope of the curve (so that Weber's law is given by  $n = 1$ ),  $I_0$  is the background intensity at which sensitivity begins to be reduced, and  $W$  is a sensitivity scaling factor (which, for  $n = 1$ , is the Weber fraction). Considering first our threshold data: when these three parameters are chosen independently for a least-squares fit to each large and small field t.v.i. curve, the threshold data points can be fitted with a root-mean-square (r.m.s.) error of about 0.073 log units per degree of freedom for both the large and small field conditions. Although this error includes a systematic component (arising because the observed transition between the low-intensity asymptote with zero slope, and the high-intensity asymptote with a slope of  $n$  tends to be more gradual than given by eqn (1)), it is small enough to make eqn (1) useful for characterizing the curves and their differences in terms of the best fitting parameter values.

When both  $n$  and  $I_0$ , as well as  $W$ , were allowed to vary independently for each curve, the differences between the small and large field t.v.i. curves were mainly reflected in differences in  $I_0$  (a shift of the small field curve to the right) and  $W$  (a shift of the small field curve up), rather than in differences in  $n$ . Values of  $n$  averaged over observers and conditions were therefore very similar: 0.89 for the large test field and 0.84 for the small field, with no obvious systematic variation between conditions.

The suggestion that deviations of the small and large field t.v.i. curves from parallelism can be better described by a horizontal shift rather than by a change of slope was examined in the following way. We constrained one of the parameters, either  $I_0$  or  $n$  (at an optimized value), to be the same for all three curves under a given condition and for a given observer, so that the convergence of the curves is accounted for entirely by changes in the other parameter. The two panels on the right of Fig. 7 illustrate, for the white on white data of K.P., the fits obtained by shifting a common template (i.e. by varying only the critical background parameter,  $I_0$ ) with the slope parameter  $n$  chosen for a fit to all three curves (in this case  $n = 0.95$ ). Across subjects and conditions the average error (r.m.s.) in the prediction of the threshold data was 0.069 log units per degree of freedom with vertical and horizontal shifts alone (these fits are illustrated by the curves drawn in Fig. 7), and 0.089 log units with vertical shift and slope change. This difference is statistically reliable at  $P < 0.01$ , based on a  $t$  test applied to the differences in mean squared error for each condition and each subject, a conservative test which assumes independence of errors only between different sessions. Likewise, contrary to the conclusions of Barlow (1958*b*), D. E. Cope, K. L. Pilsworth & P. Whittle (unpublished observations) report that t.v.i. curves for small (6.8 min diameter), brief (10 ms duration) test flashes can be described by an upward and rightward displacement of the curve for large (1.14 deg), long (20 ms) flashes. Thus the small and large field t.v.i. curves should be considered as differing in position rather than in slope.

The constant brightness curves are also well fitted by the large field threshold

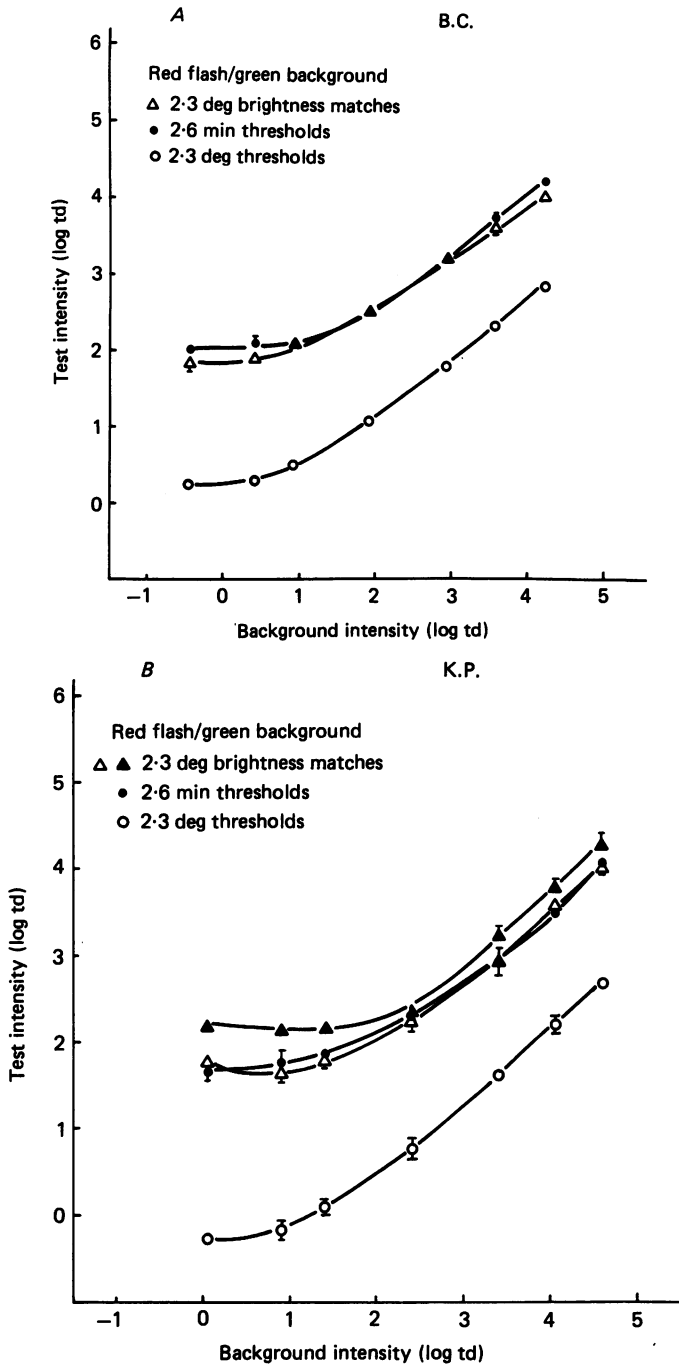
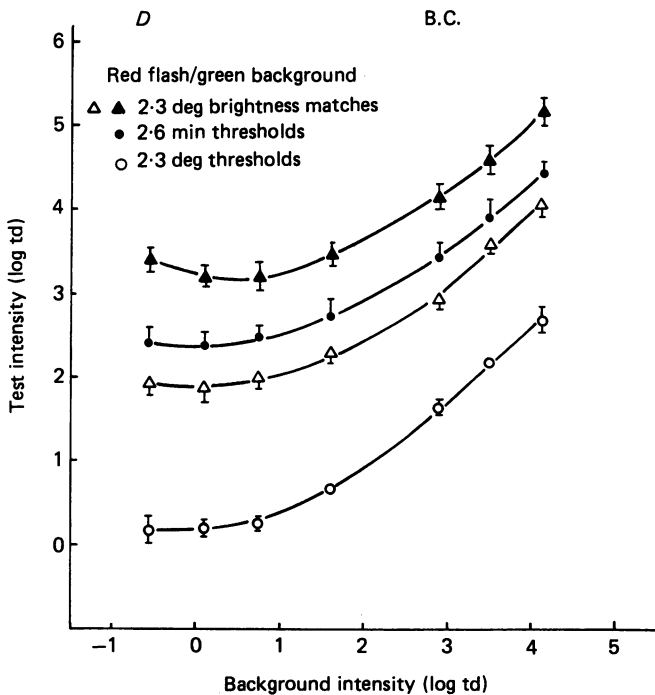
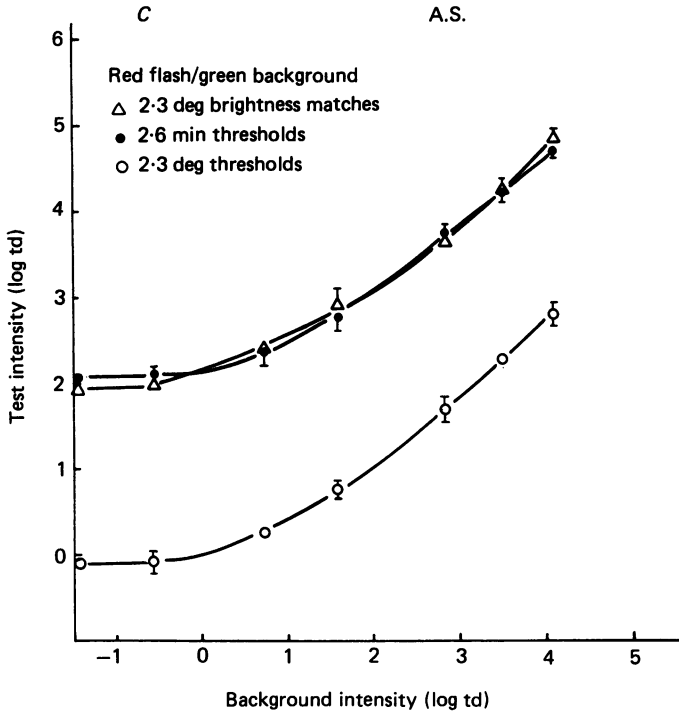

Fig. 5. *A*, incremental thresholds and brightness matches plotted as a function of background intensity. The intensities are plotted in log trolands (log td). The test stimulus was a red flash (Wratten No. 25), which was superimposed on a green background (541 nm interference filter). Subject B.C. In this and other Figures, error bars are  $\pm$  one s.e.m. based on intersession variation, from at least three sessions, and when not shown they are smaller than the heights of the symbols. The yes-no procedure was used to estimate thresholds. *B*, incremental thresholds and equal brightness matches for subject



K. P. Same conditions as in *A*. *C*, incremental thresholds and equal brightness matches for subject A.S. Same conditions as in *A*, except that the forced-choice procedure was used to estimate thresholds. *D*, incremental thresholds and equal brightness matches for subject B.C. The conditions were the same as in *A*, except that the forced-choice procedure was used to estimate thresholds.

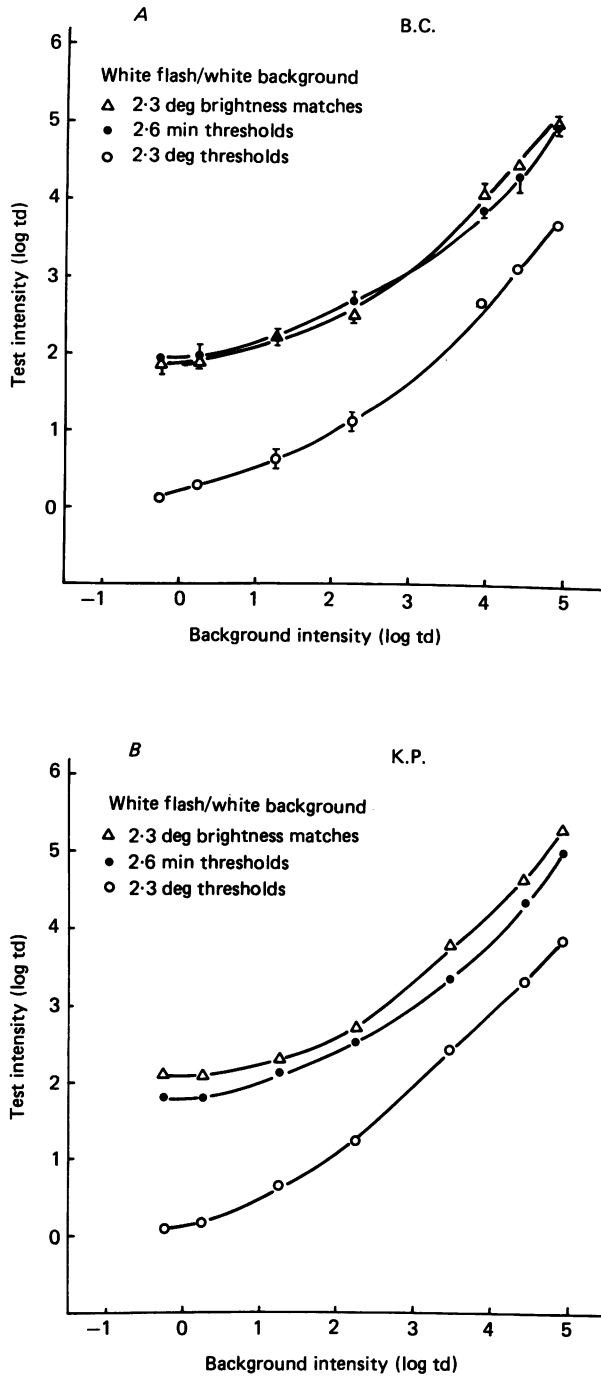

Fig. 6. *A*, incremental thresholds and equal brightness matches plotted as a function of background intensity. The test stimulus was a white flash, which was superimposed on a white background. The yes-no procedure was used to estimate thresholds. *B*, incremental thresholds and equal brightness matches for subject K.P. Same conditions as in *A*.

curves shifted up and to the right, as noted by Whittle & Challands (1969); the r.m.s. error was 0.072 log units.

*Comparison of t.v.i. curves for large and small flashes*

Although the curves are better described as differing in position rather than in slope, we will compare them first in terms of slope because that is more customary.

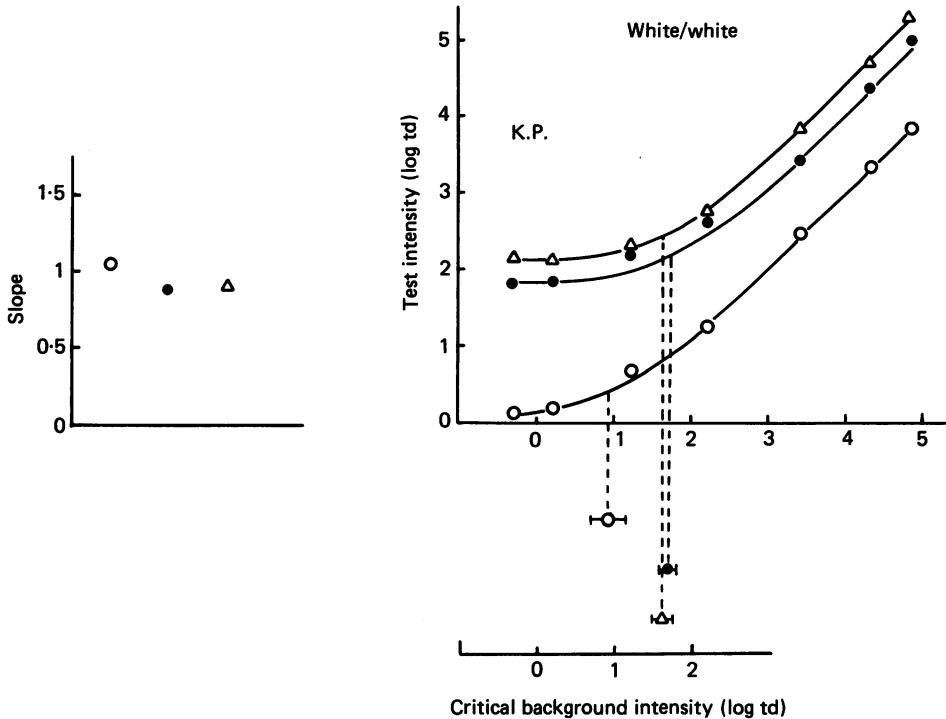

Fig. 7. Diagram illustrating how the parameters for the slope and critical background intensity are estimated. The estimates were determined from eqn (1) (see text for details). The curves through the points are shifted versions of a common template, with  $n = 0.95$  in eqn (1) and with the critical background parameter varying as shown in the lower panel. The left panel shows values of  $n$  required in an alternate fit with the critical background parameter fixed. Data shown are for subject K.P. for the white test flash/white background condition (from Fig. 6B).

With  $I_0$  constrained to the same value for small and large test t.v.i. curves, the asymptotic slope parameter  $n$ , averaged over conditions and observers, was 0.97 for the large test flash and 0.80 for the small test flash. Figure 8 shows values of  $n$  obtained in this way for each condition. These differences in slope are much smaller than is traditionally assumed. Nevertheless the difference in log threshold between small and large test flashes is substantially reduced by light adaptation. This can be conveniently quantified using the alternative fitting procedure where the describing curves are chosen to be similar in slope (by constraining  $n$ ), differing only in position. The relevant values of the position parameter  $I_0$  are shown in Fig. 8. The difference in log threshold between the functions reaches a high-intensity asymptotic value of

$\Delta \log W + n \Delta \log I_0$ , where  $\Delta \log W$  and  $\Delta \log I_0$  are the upward and rightward displacements, respectively, of the small flash curve relative to the large one. The low-intensity asymptotic difference is simply  $\Delta \log W$ , and the difference,  $n \Delta \log I_0$ , is the change attributable to either a change in spatial integration or a change in the gradient of the response-intensity function. The average of  $n \Delta \log I_0$ , across

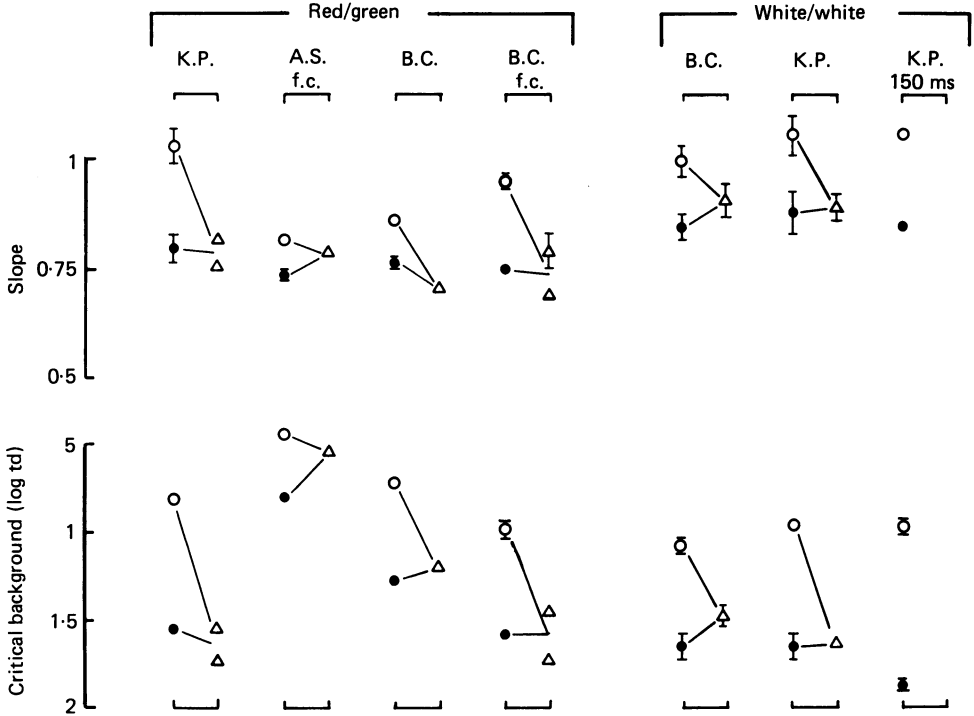

Fig. 8. Summary of our results for each subject and condition, in terms of either slope (upper panel) or critical background (lower panel). For each condition, filled circles show parameters for small field t.v.i. curves, open circles for large field t.v.i. curves and triangles for large field constant brightness curves. In each case the parameter not indicated was constrained to be the same for all three curves in a given condition. The letters f.c. denote that thresholds were determined by the forced-choice procedure.

conditions and observers (seven cases), is 0.56, with a standard error of 0.07 based on variation among the seven cases. If this change is attributed to a change in spatial organization, light adaptation must reduce the integration area by a factor  $10^{0.56} = 3.6$ .

#### *Comparison of small flash threshold versus intensity curves with large flash constant brightness curves*

As explained in the Introduction, this comparison is critical for separating the effects of adaptation-dependent non-linearity from the effects of changes in spatial integration. If only the former is important, these curves should coincide (Fig. 2), provided that the experimental conditions have been chosen so that the two curves have some point in common. A deviation from coincidence is evidence of a change in



spatial integration. Such deviations are obviously not large. Computing  $n \Delta \log I_0$  as before and averaging across conditions yield a value of 0.08 for the asymptotic reduction in log integration area when the effects of adaptation-dependent non-linearity are controlled for. The 95% confidence interval, based on variation among conditions, is 0.02–0.14. Thus there is evidence for a reduction in integration area but the effect is small, too small to be a major influence on the shapes of the t.v.i. curves.

#### *Observations with rod vision*

The foregoing experiments all pertain to cone vision. For rod vision our results are similar in that small and large t.v.i. curves were not very different in slope: with a 20 ms, 500 nm test and 681 nm background at an eccentricity of 10 deg, the slopes differed by 15%. Cone intrusion prevented us from completing the experiment with constant brightness curves.

#### DISCUSSION

The slopes of small and large test field t.v.i. curves measured in these experiments do not agree with predictions based on the DeVries–Rose law and Weber’s law. Instead, we find that the asymptotic slopes of the small field curves are consistently more than one-half, and the slopes of the large field curves are generally a little less than one. Thus, if these differences in slope do reflect a change in spatial integration, that change must be significantly smaller than is traditionally presumed.

Furthermore, our results show that the small test field t.v.i. functions are similar in shape to the large field suprathreshold brightness matching functions. For reasons discussed above, this similarity is consistent with the predictions of the local response–intensity non-linearity hypothesis, and indicates that most of what little difference exists between the small and large field t.v.i. curves is due to adaptation-dependent non-linearity rather than to a change in spatial integration. We therefore conclude that there is little or no change in spatial integration with light adaptation. At the upper limit of our 95% confidence interval the reduction is 0.14 log units (28%) in area or 15% in diameter.

#### *How much do adjustments in integration contribute to sensitivity regulation?*

Since in these experiments spatial integration stays nearly constant despite large adaptive changes in sensitivity, the contribution of changes in integration area to sensitivity regulation appears to be small at best. Actually, the results do not strictly force that conclusion, for the following reason. Many successive stages of lateral spreading jointly determine the spatial integration characteristic of the visual system, yet adaptation presumably reduces the lateral spreading at only some (if any) of these stages. No matter how restricted the spreading at the adapting stages may become, the psychophysically monitored integration area must stay above a lower limit of size, fixed by the spreading at the stages that are unaffected by light adaptation. Suppose now that the spreading at the adaptively modifiable stage(s) is less than the spreading at the other, unmodifiable stages. Then the contribution of the modifiable stage to the psychophysically monitored integration area will always

be small. By the same token the psychophysical integration area will then be only slightly reduced even if the spreading at the adaptively modifiable stage itself were reduced by a very large factor, for instance a factor sufficient to account for the entire loss of sensitivity observed with large test stimuli. However, the conclusion that adjustments of the integration area make only a small contribution to sensitivity regulation is supported quite independently by the phenomenon of 'high-frequency linearity' in flicker detection (Kelly, 1961). In cone vision, sensitivity to rapid flicker in uniform fields is not reduced by light adaptation. This suggests that sensitivity is regulated entirely by adjustments of integration time (MacLeod, 1978), leaving nothing left over to be accomplished by adjustments of integration area.

#### *Characteristics of the non-linearity*

Only a moderate steepening of the local response-log intensity function in light adaptation is required in order to make non-linearity rather than spatial reorganization account for our converging t.v.i. curves. In the following equation we denote the local incremental responses associated with two different visual criteria (detection thresholds for differently sized flashes, or different brightness levels) by  $R_1$  and  $R_2$ . The flash intensities needed to achieve responses  $R_1$  and  $R_2$  we denote by  $\Delta I_1$  and  $\Delta I_2$  respectively. If the function relating response to flash intensity can be approximated over the relevant range by a power function with exponent  $k$ , it follows that

$$\log \Delta I_1 - \log \Delta I_2 = (\log R_1 - \log R_2)/k. \quad (2)$$

Here the exponent and the flash intensities can be regarded as functions of the adapting background intensity, satisfying the relationships  $R_1 = \text{constant}$  and  $R_2 = \text{constant}$ . The left-hand side then represents the vertical separation between two t.v.i. curves (or constant brightness curves), and this is seen to be inversely proportional to  $k$ , the adaptation-dependent exponent. The factor by which  $k$  increases with light adaptation, estimated from our curves, is less than 1.40. This estimate of the change in  $k$  neglects the effects of ocular aberrations, focus errors and diffraction in reducing the intensity of the retinal image of the small flash. This reduction is unlikely to have exceeded 0.3 log units (see Methods, and Gubisch, 1967). If the intensity of the small flash at threshold is assumed to be 0.3 log units less than its nominal value, the exponent must increase by a factor of about 1.5. These requirements of the model are quite consistent with other physiological and psychophysical indications (Boynton & Whitten, 1970; Stevens & Stevens, 1963).

The power function formulation has been adopted here only as a convenient description of behaviour over a limited range. The data are equally consistent with other possibilities, including non-linearities that behave approximately linearly for weak responses under all states of adaptation.

It is essential to our hypothesis that the non-linearity in question be local: it must precede most, if not all, of the spatial integration at the psychophysical threshold. Clear evidence of an adaptation-dependent non-linearity of this kind comes from observations of difference frequency gratings generated by non-linear interactions in cone vision between pairs of mutually incoherent, unresolvable interference fringes (MacLeod, Williams & Makous, 1985; Makous *et al.* 1986). The implied non-linearity is compressive, especially so when the level of adaptation is low. In rod vision, too,

such a non-linearity provides the simplest explanation of Scholtes & Bouman's observation (1977) that threshold energy may be much greater for a small flash than for a larger one, but only at low adaptation levels.

An adaptation-dependent non-linearity of the sort required might originate in the action of the brief test flash itself on the sensitivity-regulating mechanism. It is, indeed, tempting to assume that the effect of the background illumination on sensitivity will inevitably be less when the test flash is intense, simply because the intense flash already reduces sensitivity when no background is present, and that our constant brightness and t.v.i. curves converge for this straightforward reason. Contrary to intuition, however, one simple model of this kind fails to predict convergence. If the flash (of intensity  $\Delta I$ ) and the background (of intensity  $I$  with a critical background level  $I_0$ ) combine linearly in setting sensitivity in accordance with Weber's law, a constant visual effect requires

$$\Delta I = W(I + I_0 + c\Delta I), \quad (3)$$

where  $W$  is the Weber fraction (which will be different for different curves) and  $c$  is a coefficient representing the effectiveness of the test stimulus in adaptation. Since this can be rewritten

$$\Delta I = \frac{W}{1 - Wc}(I + I_0), \quad (4)$$

the effect of adaptation to the test light is merely to change the Weber fraction, yielding a vertical shift in a plot of  $\log \Delta I$  versus  $\log I$ , without any lateral shift or change in slope. Thus it seems likely that the steepening of the response-log intensity function is set up during adaptation to the background, although a role for the test stimulus cannot be excluded.

#### *Earlier psychophysical evidence*

In view of the relatively small differences that we find between the small and large test field t.v.i. functions we decided to look more closely at the results of previous researchers, in particular those of Crawford (1947), Barlow (1958 *a, b*) and Geisler (1979).

Crawford's (1947) t.v.i. curves, which show a distinct difference between small and large test field functions, reflect mixed rod and cone detection. Relative to detection mediated solely by the cones, rod detection would be expected to increase the observer's sensitivity to large test fields at lower background intensities. Thus, the added rod contribution would tend to increase the differences between the small and large field t.v.i. functions.

The data of Barlow (1958*b*) do not separate the effects of test flash size from those of test flash duration. In a more extensive study, Barlow (1958*a*) measured increment thresholds for various test field sizes at five different background intensities. For two of the test field sizes used by Barlow (1958*a*), we found, for each t.v.i. curve, the critical background and slope of the best fitting function of the form  $\Delta I = W(I + I_0)^n$ . For test flashes of 8.5 ms duration, the slope and critical background for the small test flash (0.01 deg<sup>2</sup>) are 0.56 and 3.54 log quanta s<sup>-1</sup> deg<sup>-2</sup> respectively, and for the large test flash (23 deg<sup>2</sup>) they are 0.67 and 2.99 log quanta s<sup>-1</sup> deg<sup>-2</sup> respectively. At a longer test field duration (0.93 s), the slope and critical background

are 0.64 and 3.28 quanta  $s^{-1} \text{deg}^{-2}$ , respectively, for the small flash and are 0.75 and 3.18 quanta  $s^{-1} \text{deg}^{-2}$  for the large one. Such small differences in slope are comparable with our findings.

Geisler's results (1979) are also consistent with our results. He found that the slopes of t.v.i. curves for 3.5, 10 and 50 min diameter test flashes were very similar. At intermediate and high background intensities the three curves are almost parallel.

In summary, previous t.v.i. measurements are roughly consistent with the relatively small differences that we find between small and large field t.v.i. functions, provided that the confounding effects of temporal summation and rod intrusion are eliminated.

Nevertheless, the difference found is still enough to indicate (on the usual interpretation of such data) a substantial reduction in integration area with light adaptation, in the case of our results a reduction by a factor of about four. We have concluded on the basis of the brightness matching data, however, that most of the difference is due to adaptation-dependent local non-linearity and not to a change in spatial integration. No previous work has been explicitly aimed at separating the effects of these two factors, but one study (Bouman & van den Brink, 1954) is unique in providing an estimate of change in integration that is essentially unaffected by local response-intensity non-linearity, because the spatially different test stimuli that were compared in each condition of adaptation were always of the same intensity. Bouman & van den Brink (1954) measured the probability of detecting double-dot target flashes, of fixed intensity for each condition of adaptation, as a function of the separation between the dots. From their results for parafoveal presentation they concluded that the diameter of the integration region changed by a factor that never exceeded 1.7:1. Most of this slight change occurred near the absolute rod threshold or at the rod-cone transition; the remaining change is small enough to be consistent with our own observations. Indeed, in the central fovea they found no measurable change in integration area.

### *Physiological considerations*

There is good physiological evidence that centre-surround antagonism increases with increasing light adaptation. It is reasonable to assume that the dropping out or the reduced effectiveness of the antagonistic surround during dark adaptation has the effect of significantly increasing the optimal stimulus size for the cell. However, analysis reveals that if we define an integration area for the cell by the ratio of its sensitivity for a stimulus of optimal size to its sensitivity for a centred punctate stimulus, the change in this area resulting from the loss of the antagonistic surround would be much too small to account for the observed differences between small and large test field t.v.i. functions. Assuming: (i) that the ratio of centre and surround diameters is 1:3 (Hayhoe, 1979; Spillman, Ransom-Hogg & Oehler, 1987), (ii) that the sensitivity profiles of the centre and surround are Gaussian functions, and (iii) that the sensitivity of the surround for a uniform stimulus is negligible in the dark adapted eye, but becomes as great as that of the centre under light adaptation, so that the integrated sensitivities are equal, we calculate that the change in integration area, in this sense, is no more than 19% (for further details see the Appendix).

Therefore, in order for the observed differences to be consistent with changes in spatial integration, there would have to be a further reduction of the summation area of the receptive field by about a factor of three, in addition to that resulting from the loss of the antagonistic surround.

Such a change would be difficult to implement in a neural system, and physiological evidence for it is not compelling. Measurements made using different methods on different species, perhaps not surprisingly, give different results. For example, in the cat, Enroth-Cugell & Robson (1966) report a 50% reduction in the spread function of the centre mechanism of on-centre X cells. Comparable results have been obtained by Derrington & Lennie (1982) who report a 32% reduction in spread function of the centre mechanism. On the other hand, Cleland & Enroth-Cugell (1968) found no change in the centre mechanism spread function of cat ganglion cells with increasing illumination, a finding which has been shown to apply from mid-scotopic to photopic levels (Enroth-Cugell, Hertz & Lennie, 1977*b*).

Another relevant consideration is that if adaptive changes are applied strictly independently within individual cones or to signals from individual cones, there will be no opportunity for spatial reorganization because uniform adaptation will simply act like a neutral filter. The observations of MacLeod *et al.* (1985) suggest that most, if not all, adaptation in cone vision is strictly local in this sense. They found that with adaptation to interference fringes of frequencies comparable to the cone spacing, sensitivity can be manipulated independently for test lights that impinge on adjacent cones.

Clearly, physiological data on changes of spatial integration with light adaptation within the receptive field centre show no clear consensus, but are broadly consistent with our present conclusions, especially if the possibility of species differences and rod-cone differences is acknowledged.

#### *Dark adaptation and equivalent background*

Dark adaptation curves plotting the recovery of log threshold for small and large flashes after exposure to a light of bleaching intensity converge at short recovery times, just as t.v.i. curves do at high background levels. Crawford (1947) put this correspondence on a quantitative basis with the principle of 'equivalent background of bleaching'. If, as we suggest, the convergence of the t.v.i. curves is due to an adaptation-dependent non-linearity instead of a change in spatial organization, then the physiological requirements for equivalence between bleaches and backgrounds become far less stringent: bleaches and backgrounds need be similar only in their local action on the local non-linear process, and there is no requirement that bleaching gives rise to a laterally propagated signal such as would be implied if bleaching causes changes in spatial organization.

#### *Brightness matching and thresholds*

The interpretation of our experiments relies on the assumption that the mechanisms that determine thresholds and brightness matches are the same. This assumption is supported by the results of several workers. For example, Whittle & Challands (1969), who measured dichoptic brightness matches and increment thresholds, show that increment thresholds can be considered to be a special case of

brightness matching. That is, they found that the shapes of brightness matching *versus* intensity functions tend towards the shapes of increment threshold *versus* intensity functions as the intensity of the brightness matching standard is reduced. This finding suggests that the underlying mechanisms are the same. Similarly, Kulikowski's (1976) brightness matching data obtained using gratings suggest that, for a given pattern, subjective contrast is directly proportional to the physical contrast of the pattern minus the contrast threshold.

On the other hand, a recent study by Shevell (1986) suggests that the apparent brightness of a test patch may be influenced by signals from both eyes. However, in the relevant experiments the test field was a combination of fused left eye *and* right eye components. This situation allows scope for stimulus-dependent changes in eye dominance, which may be avoided in displays like ours where the test and comparison stimuli are monocular (Levelt, 1965). Shevell's (1985) conclusion that brightness matches do not represent equalities between monocularly derived signals may therefore not apply in our case. We are reassured by the observations of others, made under comparable conditions to ours, that any binocular interactions are small (e.g. Hering, 1920; Whittle & Challands, 1969).

Even if it is granted that a brightness match is a match in magnitude of a central neural signal that also determines threshold, the correspondence between brightness curves and the small test field forced-choice thresholds is surprising, since for the latter it is the ratio of signal to noise that is constant. Evidently the noise or variability in the final signal on which brightness and threshold depend is almost independent of adaptation, as Barlow & Levick (1969*b*) found at the ganglion cell level. It is as if the noise originates after the sensitivity-regulating mechanism (or else originates before it with an amplitude inversely proportional to sensitivity). If its site of origin is also after the local non-linearity, it is easy to justify the implicit assumption of our threshold model, that threshold corresponds to a fixed value of the spatial integral of the non-linearly transformed signal. The relative location of non-linearity and noise sources is not, however, critical in this regard. The non-linearity appears to be important only for intense test stimuli (Whittle & Challands, 1969; Barlow & Levick, 1969*b*), such as would be required at threshold only in the case of a small test stimulus. In that case, most of the relevant noise will be derived by spatial integration from regions not polarized by the test stimulus. Thus even noise of physical or receptor origin will be mostly unaffected by the non-linearity.

#### *From flashes to objects*

We have assumed that in our brightness matching experiments it is the incremental signals evoked by the flashes that are compared, without any substantial contribution from the steady and uniform background. Some justification for this can be found in the well-known fading of retinally stable images (recently discussed by Arend & Timberlake, 1986); the same phenomenon also suggests that results with flashes may be relevant to the natural situation. Static objects are seen only by virtue of the (contrast-dependent) temporal transients generated at their borders by small involuntary eye movements, which convert otherwise invisible spatial contrast into a temporal modulation capable of acting on a strictly local non-linearity. The expected correspondence between brightness matches with flashed and with steady

viewing has been convincingly demonstrated by Whittle & Challands (1969). In particular the 'shift to the right' which is essential to our argument is observed equally in the two cases.

*Why do we see better in bright light?*

Our results and analysis lead to a conception of the adaptation process in which the enhanced visibility of fine detail in bright light is attributable to strictly local changes. Across a wide range of light levels, local sensitivity is set to be approximately inversely proportional to the prevailing level, as Weber's law would require, but this holds only if the test stimulus by which sensitivity is assessed is sufficiently low in contrast, or in intensity relative to the background. So long as this constraint on intensity or contrast is satisfied, we see no reason to believe that the applicability of Weber's law depends importantly on the stimulus size. Now, to the extent that Weber's law holds, better vision in bright light is not to be expected: the signals will be independent of illumination. But with any stimulus whose contrast is not very low (for instance, with any very small or finely detailed, but potentially visible feature), the change in sensitivity is less than would be given by Weber's law and so is not enough to compensate for a change in light level. In this way more light allows enhanced visibility, even without the benefit of any spatial reorganization. In short, we see better in bright light not because the grain of the neural representation is finer, but simply because the signals are bigger.

APPENDIX

We compare the effective integration areas of difference-of-Gaussian (DOG) receptive fields under two conditions: with and without the antagonistic surround. The assumption is that the sensitivity profile of the receptive field centre and surround are Gaussian functions, and that the integrated sensitivities of the centre and surround mechanisms (when a surround is present) are equal. We define the *integration area* as the ratio of the volume under the receptive field sensitivity profile enclosed within its zero crossings to the maximal sensitivity at the receptive field centre position. This is the ratio of sensitivity for an optimally sized uniform stimulus to sensitivity for an optimally placed point stimulus.

First we calculate the radius ( $r$  value) at the zero crossing point: it must satisfy

$$\frac{1}{2\pi\sigma^2} \exp\left(-\frac{r^2}{2\sigma^2}\right) - \frac{1}{2\pi k^2\sigma^2} \exp\left(-\frac{r^2}{2k^2\sigma^2}\right) = 0,$$

where  $\sigma$  is the centre standard deviation and  $k$  is the ratio of surround standard deviation to the centre standard deviation. Hence,

$$2 \ln k = \frac{r^2}{2\sigma^2} - \frac{r^2}{2k^2\sigma^2}, \quad \frac{r}{\sigma} = \sqrt{\left(\frac{4k^2 \ln k}{k^2 - 1}\right)}.$$

If we assume  $k$  is 3, then

$$\frac{r}{\sigma} = 2.22.$$

The volume of the Gaussian function enclosed within a radius  $r$  is calculated as follows:

$$\int_0^{2\pi} \int_0^r \frac{u}{2\pi\sigma^2} \exp -\frac{u^2}{2\sigma^2} du d\theta = 1 - \exp(-r^2/2\sigma^2).$$

Here  $\exp(-r^2/2\sigma^2)$  is the fraction of volume outside  $r$ ; also it is the relative height of the Gaussian function at radius  $r$ . It is equal to 0.09 at  $r/\sigma = 2.22$ . So the centre mechanism's sensitivity integrated within the zero crossing contour is equal to the total centre volume  $\times (1 - 0.09)$  or 0.91.

The surround mechanism's integrated sensitivity within the zero crossing contour is calculated in the same way as the centre mechanism, except that

$$\frac{r}{\sigma} = \frac{2.22}{k} = 0.74.$$

This yields an integrated sensitivity equal to 0.2 times the total surround volume. We assume that the centre and surround mechanisms are balanced in the light adapted condition, that is that the surround volume is equal to centre volume, so that the cell is completely unresponsive to uniform stimulation. The net sensitivity of the cell is simply the difference between the centre and surround mechanism's sensitivity. For a stimulus that exactly fills the zero crossing contour this is equal to  $(0.91 - 0.2) \times$  total centre mechanism volume, or  $0.71 \times$  total centre volume. We use the volume/height ratio as an estimate of the integration area. The height (at receptive field centre) with the surround is reduced below the height with the centre mechanism only by the factor

$$1 - \frac{1}{k^2} = 0.89.$$

So the change in integration area is by the factor:  $0.71/0.89 = 0.81$ . This implies a 19% (0.09 log unit) reduction of the cell's integration area, as defined above, by surround inhibition. The decrease in radius is directly calculated from the change in area and is only 10% (0.05 log units). If  $k$  exceeds 3, as much evidence suggests (Hayhoe, 1979; Spillmann *et al.* 1987), the change in spatial integration due to the entry of the antagonistic surround must be even smaller.

This work was supported by NIH Grant EY01711 and by a NATO Post-doctoral Fellowship awarded to A. Stockman. J. B. Mulligan gave invaluable help with apparatus and programming. We thank Dr L. T. Sharpe for help in preparing an early draft of this manuscript, and Drs H. B. Barlow, C. Enroth-Cugell and P. Whittle for later advice and comments.

#### REFERENCES

- AREND, L. E. & TIMBERLAKE, G. T. (1986). What is psychophysically perfect image stabilization? Do perfectly stabilized images always disappear? *Journal of the Optical Society of America* **A3**, 235-241.
- BARLOW, H. B. (1958*a*). Temporal and spatial summation in human vision at different background intensities. *Journal of Physiology* **141**, 337-350.
- BARLOW, H. B. (1958*b*). Intrinsic noise of cones. In *Vision Problems of Colour*, vol. 2, pp. 617-630. London: Her Majesty's Stationery Office.



- BARLOW, H. B. (1972). Dark and light adaptation: Psychophysics. In *Handbook of Sensory Physiology*, vol. VII, part 4, pp. 1–28. Berlin: Springer-Verlag.
- BARLOW, H. B., FITZHUGH, R. & KUFFLER, S. W. (1957). Change of organization in the receptive fields of the cat's retina during dark adaptation. *Journal of Physiology* **137**, 338–354.
- BARLOW, H. B. & LEVICK, W. R. (1969a). Coding of light intensity by the cat retina. In *Processing of the Optical Data by Organisms and by Machines*, ed. REICHARDT, W., pp. 385–396. New York: Academic.
- BARLOW, H. B. & LEVICK, W. R. (1969b). Three factors limiting the reliable detection of light by retinal ganglion cells of the cat. *Journal of Physiology* **200**, 1–24.
- BARLOW, H. B. & LEVICK, W. R. (1976). Threshold setting by the surround of cat retinal ganglion cells. *Journal of Physiology* **259**, 737–757.
- BAYLOR, D. A. & HODGKIN, A. L. (1974). Changes in time scale and sensitivity in turtle photoreceptors. *Journal of Physiology* **242**, 729–758.
- BLAKEMORE, C. B. & RUSHTON, W. A. H. (1965). Dark adaptation and increment threshold in a rod monochromat. *Journal of Physiology* **181**, 612–628.
- BOUMAN, M. A. & VAN DEN BRINK, G. (1954). Variation of integrative action in the retinal system: an adaptational phenomenon. *Journal of the Optical Society of America* **44**, 616–620.
- BOYNTON, R. M. & WHITTEN D. N. (1970). Visual adaptation in monkey cones: recordings of late receptor potentials. *Science* **170**, 1423–1426.
- BROCA, A. (1901). Causes retiniennes de variation de l'acuité visuelle en lumière blanche. *Journal de physiologie et pathologie generale* **3**, 384–392.
- CLELAND, B. D. & ENROTH-CUGELL, C. (1968). Quantitative aspects of sensitivity and summation in the cat retina. *Journal of Physiology* **198**, 17–38.
- CRAWFORD, B. H. (1947). Visual adaptation in relation to brief conditioning stimuli. *Proceedings of the Royal Society B* **134**, 283–302.
- DAITCH, J. M. & GREEN, D. G. (1969). Contrast sensitivity of the human peripheral retina. *Vision Research* **9**, 947–952.
- DERRINGTON, A. M. & LENNIE, P. (1982). The influence of temporal frequency and adaptation level on receptive field organization of retinal ganglion cells in cat. *Journal of Physiology* **333**, 343–366.
- DODGE, F. A., KNIGHT, B. W. & TOYODA, J. (1968). Voltage noise in *Limulus* visual cells. *Science* **160**, 88.
- DRUM, B. (1980). Cone threshold vs. retinal eccentricity: changes with dark adaptation. *Investigative Ophthalmology and Visual Science* **19**, 432–435.
- ENROTH-CUGELL, C., HERTZ, B. G. & LENNIE, P. (1977a). Cone signals in the cat's retina. *Journal of Physiology* **269**, 273–296.
- ENROTH-CUGELL, C., HERTZ, B. G. & LENNIE, P. (1977b). Convergence of rod and cone signals in the cat's retina. *Journal of Physiology* **269**, 297–318.
- ENROTH-CUGELL, C. & ROBSON, J. G. (1966). The contrast sensitivity of retinal ganglion cells of the cat. *Journal of Physiology* **187**, 517–552.
- ENROTH-CUGELL, C. & SHAPLEY, R. M. (1973). Adaptation and dynamics of cat retinal ganglion cells. *Journal of Physiology* **233**, 271–309.
- FAIN, G. H. (1976). Sensitivity of toad rods: dependence on wavelength and background illumination. *Journal of Physiology* **233**, 271–309.
- FAIN, G. L. & DOWLING, J. E. (1973). Intracellular recordings from single rods and cones in the mudpuppy retina. *Science* **180**, 1178–1181.
- GEISLER, W. S. (1979). Evidence for the equivalent-background hypothesis in cones. *Vision Research* **19**, 799–805.
- GUBISCH, R. W. (1967). Optical performance of the human eye. *Journal of the Optical Society of America* **57**, 407–415.
- HAYHOE, M. M. (1979). After-effects of small adapting fields. *Journal of Physiology* **296**, 141–158.
- HECHT, S. (1928). The relation between visual acuity and illumination. *Journal of General Physiology* **11**, 255–281.
- HERING, E. (1920). Grundzuge de Lehre vom Lichtsinn. English translation by HURVICH, L. M. & JAMESON, D. (1964). Cambridge, MA, U.S.A.: Harvard University Press.
- JACOBS, G. H. & YOLTON, R. L. (1970). Center-surround balance in receptive fields of cells in the lateral geniculate nucleus. *Vision Research* **10**, 1127–1144.

- KELLY, D. H. (1961). Visual responses to time-dependent stimuli: 1. Amplitude sensitivity measurements. *Journal of the Optical Society of America* **51**, 422-429.
- KELLY, D. H. (1977). Visual contrast sensitivity. *Optica acta* **24**, 107-129.
- KISHITO, B. N. & SAUNDERS, R. (1970). Variation of the visual threshold with retinal location. *Vision Research* **10**, 762-768.
- KLEINSCHMIDT, J. & DOWLING, J. E. (1975). Intracellular recordings from gecko photoreceptors during light and dark adaptation. *Journal of General Physiology* **66**, 617-648.
- KULIKOWSKI, J. J. (1976). Effective contrast constancy and linearity of contrast sensation. *Vision Research* **16**, 1419-1432.
- LEVELT, W. J. M. (1965). *On Binocular Rivalry*. Soesterberg: Institute for Perception RVO-TNO.
- MAKOUS, W., MACLEOD, D. I. A. & WILLIAMS, D. R. (1985). Nonlinear transformation in human vision. *Journal of the Optical Society of America* **A2**, P80.
- MACLEOD, D. I. A. (1978). Visual sensitivity. *Annual Review of Psychology* **29**, 613-645.
- MACLEOD, D. I. A., WILLIAMS, D. R. & MAKOUS, W. (1985). Difference frequency gratings above the resolution limit. *Investigative Ophthalmology and Visual Science* **26**, suppl., 11.
- MAKOUS, W., MACLEOD, D. I. A. & WILLIAMS, D. R. (1985). Nonlinear transformation in human vision. *Journal of the Optical Society of America* **A2**, 1366.
- NAYATANI, Y., TAKAHAMA, K., & SOBAGAKI, H. (1981). Formulation of a nonlinear model of chromatic adaptation. *Color Research and Application* **6**, 161-171.
- NORMANN, S. & PERLMAN, I. (1979). Signal transmission from red cones to horizontal cells in the turtle retina. *Journal of Physiology* **6**, 509-524.
- PIRENNE, M. H. (1967). *Vision and the Eye* (2nd edn.), chap. 12. London: Chapman and Hall.
- SAKMANN, B. & CREUTZFELDT, W. (1969). Scotopic and mesopic light adaptation in the cat's retina. *Archiv für die gesamte Physiologie* **313**, 168-185.
- SCHOLTES, A. M. W. & BOUMAN, M. A. (1977). Psychophysical experiments on spatial summation at threshold levels of the human peripheral retina. *Vision Research* **17**, 867-873.
- SHEVELL, S. (1986). On neural signals that mediate brightness. *Vision Research* (in the Press).
- SPILLMANN, L., RANSOM-HOGG, A. & OEHLER, R. (1987). A comparison of perceptive and receptive fields in man and monkey. *Human Neurobiology* **6**, 51-62.
- STEVENS, J. C. & STEVENS, S. S. (1963). Brightness function: effects of addition. *Journal of the Optical Society of America* **53**, 375-385.
- STILES, W. S. (1978). *Mechanisms of Color Vision*. London: Academic.
- VAN NES, F. L. & BOUMAN, M. A. (1967). Spatial modulation transfer in the human eye. *Journal of the Optical Society of America* **57**, 401-406.
- VAN MEETEREN, A. & VOS, J. J. (1968). *Applicability of Fourier Transformation upon Contrast Sensitivity Functions*. Report No. IZF 1968-20. Soesterberg: Institute for Perception RVO-TNO.
- WHITTLE, D. & CHALLANDS, P. D. C. (1969). The effect of background luminance on the brightness of flashes. *Vision Research* **9**, 1095-1110.