

cDNA cloning, gene organization and expression analysis of human peptidylarginine deiminase type I

Marina GUERRIN^{*1}, Akihito ISHIGAMI^{†1}, Marie-Claire MÉCHIN^{*}, Rachida NACHAT^{*}, Séverine VALMARY^{*}, Mireille SEBBAG^{*}, Michel SIMON^{*2}, Tatsuo SENSU^{†3} and Guy SERRE^{*}

^{*}Department of Epidermal Differentiation and Rheumatoid Autoimmunity, Toulouse-Purpan Pathophysiology Center, INSERM U563 - P. Sabatier University (IFR30, INSERM-CNRS-P. Sabatier Université-Centre Hospitalier Universitaire), 37 allées J. Guesde, 31073 Toulouse, France, and [†]Department of Bioactivity Regulation, Tokyo Metropolitan Institute of Gerontology, 35-2 Sakae-cho, 173-0015 Itabashi-ku, Tokyo, Japan

Peptidylarginine deiminases (PADs) catalyse a post-translational modification of proteins through the conversion of arginine residues into citrullines. The existence of four isoforms of PAD (types I, II, III and IV) encoded by four different genes, which are distinct in their substrate specificities and tissue-specific expression, was reported in rodents. In the present study, starting from epidermis polyadenylated RNA, we cloned by reverse transcriptase-PCR a full-length cDNA encoding human PAD type I. The cDNA was 2711 bp in length and encoded a 663-amino-acid sequence. The predicted protein shares 75% identity with the rat PAD type I sequence, but displays only 50–57% identity with the three other known human isoforms. We have described the organization of the human PAD type I gene on chromosome 1p36. A recombinant PAD type I was produced in

Escherichia coli and shown to be enzymically active. Human PAD type I mRNAs were detected by reverse transcriptase-PCR not only in the epidermis, but also in various organs, including prostate, testis, placenta, spleen and thymus. In human epidermis extracts analysed by Western blotting, PAD type I was detected as a 70 kDa polypeptide, in agreement with its predicted molecular mass. As shown by immunohistochemistry, the enzyme was expressed in all the living layers of human epidermis, with the labelling being increased in the granular layer. This is the first description of the human PAD type I gene and the first demonstration of its expression in epidermis.

Key words: citrulline, deimination, enzyme, epidermis, post-translational modification.

INTRODUCTION

Post-translational modifications of proteins are involved in many cellular events, including signal transduction, gene expression and differentiation. One of these modifications is protein deimination, which corresponds to the conversion of their arginine residues into citrullines (for review, see [1]). This results in a decrease in the net charge of the proteins and probably in modifications of their function. For example, *in vitro* deimination of specific arginine residues has been shown to modify the functional properties of trypsin inhibitor [2], intermediate filament proteins [3], glycogen phosphorylase [4], and calcineurin [5], but the physiological role of these modifications remains to be explored. Citrullines were first demonstrated in hair follicles and subsequently in epidermis and the nerve myelin sheath [1]. In the cornified layer of epidermis, deiminated forms of cytokeratins, K1 and K10, and filaggrin, an intermediate filament-associated protein, were detected by amino acid analysis [6] and, more recently, by immunodetection with a rabbit antibody specific for chemically modified citrulline residues [7–9]. It is proposed that deimination of filaggrin disorganizes the cytokeratin–filaggrin complexes and facilitates the subsequent degradation of filaggrin into a pool of free amino acids, which play a key role in maintaining hydration of the cornified layer [6,10,11]. Deiminated forms of trichohyalin, another intermediate filament-associated protein, were detected in hair follicles [1]. Deimination of the protein induces its unfolding. This was suggested to

increase trichohyalin solubility, facilitating its association with cytokeratins and making it available for cross-linking by transglutaminase 3 [10,12]. In the brain, myelin basic protein exists as different isoforms and charged isomers generated by differential splicing of exons and by several post-translational modifications, including various degrees of deimination [13]. Deimination of the protein is thought to decrease its interaction with anionic lipid layers, leading to instability of the myelin sheath. Moreover, an abnormally high degree of deimination of the myelin basic protein was observed in multiple sclerosis patients and was proposed to be involved in the myelin degeneration characteristic of this debilitating disease [14–16]. Interestingly, we showed recently [17,18] that deiminated proteins, in particular a deiminated form of fibrin extracted from synovial membranes of rheumatoid arthritis patients, are specifically recognized by IgG autoantibodies closely associated with the disease. How the autoantibodies are involved in the pathophysiology of the autoimmune disease remains, however, to be elucidated.

Protein deimination is catalysed by a family of Ca²⁺-dependent enzymes called peptidylarginine deiminases (PADs; EC 3.5.3.15). PAD activity has been detected in numerous vertebrate tissues [19–23]. Purification and characterization of PADs from mammalian epidermis, hair follicles, brain and skeletal muscles has enabled three isoforms to be identified on the basis of their biochemical properties [20–26]. More recent cDNA cloning analyses revealed the existence of four isoforms of PADs in rodents. They display largely related amino acid sequences

Abbreviations used: BAEE, benzoyl-L-arginine ethyl ester; Bz-L-Arg, benzoyl-L-arginine; GST, glutathione S-transferase; IPTG, isopropyl β -D-thiogalactoside; PAD, peptidylarginine deiminase; RACE, rapid amplification of cDNA ends; RT, reverse transcriptase.

¹ These authors contributed equally to this work.

² To whom correspondence should be addressed (e-mail msimon@cict.fr).

³ Present address: Department of System Functions, Faculty of Science, Yokohama City University, Yokohama, Japan.

The nucleotide sequence data reported will appear in DDBJ, EMBL, GenBank® and GSDB Nucleotide Sequence Databases under the accession numbers AB033768 and NM-013358.

[27–32], but appear to have different tissue-specific expression as shown by reverse transcriptase (RT)-PCR and/or Northern-blot analysis: PAD type I mRNA is detected in mouse epidermis and uterus [32] and in rat epidermis and stomach [33], whereas PAD type III is mainly detected in epidermis and hair follicles [29]; PAD types II and IV were found to be expressed more widely, for example, in epidermis, stomach, skeletal muscle, brain, ovary, uterus and salivary glands [27,31,33]. Although transcripts of all four types of PAD were detected in newborn rodent epidermis, to date only PAD type I and III proteins have been identified in epidermal extracts [26,29]. In sheep, PAD type III mRNA was detected in hair follicles, but not in epidermis, suggesting that regulation of PAD expression varies between species [24]. Concerning human tissues, three types of PAD have been cloned to date, i.e. PAD type II (GenBank® accession number AB030176), PAD type III [34] and PAD type V [35], which is closely related to the rodent type IV. The tissue specificity of the human PADs is poorly known. PAD type II was immunodetected in sweat glands [36]. PAD type III was strongly immunodetected in both the inner and outer root sheaths of hair follicles and only weakly in all the cellular layers of the interfollicular epidermis, with the exception of the cornified layer [34]. PAD type V was found in blood eosinophil and neutrophil polymorphonuclear cells [37]. Virtually no data are available regarding the sequence and tissue expression of human PAD type I, although the data obtained in rodents suggest it is present in the epidermis.

In the present study, the full-length cDNA of human PAD type I was cloned from epidermis, its gene organization determined and its tissue expression analysed. Moreover, an active recombinant enzyme was produced in bacteria. Generation of peptide-specific antibodies against PAD type I allowed its expression in human epidermis to be demonstrated.

EXPERIMENTAL

Cloning of human PAD type I cDNA

A plastic surgery specimen of normal human skin (kindly provided by Professor J.-P. Chavoin, Service de Chirurgie Plastique, Centre Hospitalier Universitaire Rangueil, Toulouse, France) was cut into thin fragments and incubated promptly for 2 h at 37 °C in a 0.25% trypsin solution (Life Technologies). Epidermis was dissected with forceps and gently rinsed in PBS. Purification of mRNA was performed using oligo(dT)₂₅-tagged magnetic beads according to the manufacturer's instructions (Dynal). cDNA was synthesized by random priming with the SuperScript kit (Life Technologies) starting with approx. 80 ng of mRNA. PCR amplification of the central region of human PAD type I cDNA was performed with primers derived from the PAD type I rat sequence (nt 1007–1025 and 1911–1932; GenBank® accession number AB010998). The PCR product was cloned into the pCR2.1-TOPO vector (Invitrogen), sequenced and internal gene-specific primers were designed for rapid amplification of cDNA ends (RACE) cloning. The SMART™ RACE cDNA amplification kit (Clontech) was used, according to the manufacturer's instructions, to clone both 5'- and 3'-ends of the cDNA, starting from total RNA extracted from human epidermis (obtained as described above) using a standard guanidine method. RT reactions were performed by oligo(dT) priming of 1 µg of total RNA. PCR amplifications were carried out with one fortieth of the RT reactions, and the reaction products were cloned into pCR2.1-TOPO vector and sequenced. Sequencing was performed by the dideoxynucleotide chain termination method using a Thermo Sequenase fluorescent-labelled primer cycle sequencing kit (Amersham Biosciences) and an automated DNA sequencing system (model 1000L; Shimadzu). The entire

sequence of human PAD type I cDNA was constructed from the first cloned central region of human PAD type I cDNA and the 5'- and 3'-ends of the cDNA by overhang extension by PCR as described previously [28].

Expression of recombinant human PAD type I

The entire coding sequence of human PAD type I (nt 84–2111; GenBank® accession number AB033768) was amplified by PCR, and subcloned in the *SalI* site of pGEX-6P-1 vector (Amersham Biosciences). The resulting pGEX-hPADI plasmid encoding glutathione S-transferase (GST) fused to complete human PAD type I was used to transform the BL21 *Escherichia coli* strain. The transformants were grown overnight and treated for 4 h with 0.1 mM isopropyl β-D-thiogalactoside (IPTG) at 25 °C. The bacteria were resuspended in ice-cold PBS containing 5 mM dithiothreitol and disrupted by sonication. The cell lysate was centrifuged at 10000 g for 30 min. The supernatant was loaded on to a glutathione-Sepharose 4B column (Amersham Biosciences), and the column was thoroughly washed with PBS. The recombinant fusion protein was eluted with 10 mM GSH in 50 mM Tris/HCl buffer (pH 8.0).

PCR analysis of multiple tissue cDNA panels

Two human multiple tissue cDNA (MTC™; Clontech) panels (panels I and II) were used as templates for PCR analysis according to the manufacturer's instructions. PAD type I primers (nt 2089–2113 and 2635–2659) were designed in the 3' region of the cDNA after checking using Blast analysis [38] for the absence of similarity to any of the PAD sequences reported previously. PCR reactions were performed in a volume of 25 µl using 0.75 unit of *Taq* DNA polymerase (GoldStar, Eurogentec, Belgium) in the supplied buffer, 1.5 mM MgCl₂, 0.25 mM of each dNTP, 7.5 pmol of each primer and 2.5 µl of each cDNA sample of MTC™ panel I and II. A control reaction with epidermis cDNA was carried out in parallel using one fortieth of an RT reaction performed with 1 µg of total RNA and random primers. The PCR conditions were as follows: 94 °C for 10 s, followed by 28 or 34 cycles at 94 °C for 25 s, 60 °C for 20 s, and 72 °C for 40 s and a terminal extension period (72 °C for 5 min). The PCR products were separated on 2% agarose/TBE [where TBE is Tris/borate/EDTA (45 mM Tris/borate, 1 mM EDTA)] gels. Glyceraldehyde-3-phosphate dehydrogenase primers were used in PCR control reactions to confirm the normalization of the cDNAs provided by Clontech.

Antibodies

The anti-GST monoclonal antibody was purchased from Pierce. The ascites fluid of MOPC-21 (Sigma) was used as a negative control. Anti-peptide antibodies directed against human PAD type I were produced in rabbits by injecting synthetic peptides conjugated via an added N-terminal cysteine residue to keyhole-limpet (*Diodora aspera*) haemocyanin. The peptides used were synthesized according to the predicted amino acid sequence of human PAD type I as follows: peptide A, CMAP-KRVVQLSLKM (amino acids 1–13); peptide B, CNHRSA-EPDLTHSWLM (amino acids 158–172); and peptide C, CARGGNSLSYKQ (amino acids 215–227) (where single-letter amino-acid notation has been used). Anti-peptide antibody titres were determined by ELISA (CovalAb, Lyon, France). The antisera were affinity-purified on a mixture of the three peptides coupled to an agarose-activated affinity column (Sulfolink™ kit), essentially as described by the manufacturer (Pierce).

Protein electrophoresis and immunoblotting

Rabbit muscle PAD type II was purchased from Sigma, and recombinant human PAD types III and V were generously provided by Professor H. Takahara (Department of Applied Biological Resource Science, School of Agriculture, Ibaraki University, Ibaraki, Japan) and Professor M. Yamada (Graduate School of Integrate Science, Yokohama City University, Yokohama, Japan) respectively. Dermo-epidermal cleavage of normal human skin was performed by heat treatment, and epidermal proteins were extracted in TENP-40 buffer [40 mM Tris/HCl buffer (pH 7.5) and 10 mM EDTA containing 0.5% Nonidet P40 and protease inhibitors]. Proteins were separated by SDS/PAGE and either stained with Coomassie Blue or electrotransferred on to reinforced nitrocellulose membranes and probed with antibodies. The anti-GST monoclonal antibody and MOPC-21 were diluted to 0.1 µg/ml. Affinity-purified anti-peptide antibodies directed against human PAD type I were diluted to 0.46 or 0.11 µg/ml. For adsorption experiments, the antibodies were preincubated for either 30 min at 37 °C with peptides diluted to 20 µg/ml or overnight at 4 °C with recombinant human PAD type I transferred on to a nitrocellulose membrane. For the detection of deiminated proteins, citrulline residues of proteins transferred on to the membrane were chemically modified by overnight incubation at 37 °C in modification medium (0.0125% FeCl₃, 2.3 M H₂SO₄, 1.5 M H₃PO₄, 0.25% diacetyl monoxime, 0.125% antipyrine and 0.25 M acetic acid). The membrane was then incubated with antibodies specific to modified citrulline diluted to 0.125 µg/ml as reported previously [7,8]. Immunoreactivities were revealed using the ECLTM Western blotting kit as described by the manufacturer (Amersham Biosciences).

Immunohistochemistry

Immunohistochemistry was performed on Bouin's fixed samples of breast skin embedded in paraffin using the peroxidase-labelled streptavidin-biotin amplification method and on cryosections of breast skin using indirect immunofluorescence. The anti-peptide antibodies directed against human PAD type I and purified by affinity chromatography, as described above, were diluted to 20 µg/ml (immunofluorescence) or 4.6 µg/ml (streptavidin-biotin amplification method).

RESULTS AND DISCUSSION

Cloning of the human PAD type I cDNA

To amplify cDNA from human epidermis, we used two rat PAD type I-specific primers that had a high sequence identity with the mouse orthologue, but low identity with the other rodent PAD types. After cloning the PCR products, sequencing revealed two different inserts. One corresponded to human PAD type II, which we have deposited in the DNA databases during the course of this study (GenBank[®] accession number AB030176). The other insert was 81% identical with the rat and mouse PAD type I sequences, but only 68, 70 and 72% identical with the human PAD types II, III, and V respectively, as shown using Blast [38]. RACE-PCR was used to complete the human PAD type I cDNA. The full-length cDNA was 2711 bp in length and contained an open reading frame encoding a polypeptide of 663 amino acids with a calculated molecular mass of 74.6 kDa. The cDNA also consisted of a 5'-untranslated region of 83 bp and a 3'-untranslated region of 639 bp. During the course of the present study, a cDNA sequence encoding the human PAD type I was deposited in GenBank[®] (accession number AK026652). It essentially differs from the cDNA we obtained in the 3'-

untranslated region, which is 1156 nt longer, corresponding to the use of an alternative polyadenylation site. Sequence comparison of the predicted protein revealed 76% and 75% identity with the mouse and rat PAD type I respectively (Figure 1A). A lower degree of identity (52–57%) was observed with the other human PADs. More conserved regions were noted in the C-terminal region of all the murine and human PADs, supporting the hypothesis that this region is involved in the catalytic sites of the enzymes. In particular, His⁴⁷² and Cys⁶⁴⁵, two residues suggested previously as catalytic residues of the murine PAD type II [30], are conserved in the other cloned PAD sequences, including human PAD type I. Using the SignalP v1.1 program [39], no signal peptides or transmembrane regions were predicted, suggesting an intracellular location for the human PAD type I. A phylogenetic analysis suggested that the four human, rat and mouse PAD paralogues arose through a series of gene duplication events prior to divergence of these species, and confirmed that the human PAD type V is closely related to the murine PAD type IV (Figure 1B).

Determination of human PAD type I gene organization

A BLAT search at the Golden Path University of California at Santa Cruz web site (<http://genome.cse.ucsc.edu>) revealed that the four human PAD genes are located within a 300 kb region on chromosome 1p36.13. In agreement with our phylogenetic analysis, the genes of PAD types I, III and V are very close to each other and are included within a 160 kb region. Also, they are transcribed in the same orientation. Moreover, the transcribed regions of PAD types I and III are only 4 kb apart. In contrast, the PAD type II gene, transcribed in the opposite direction, is in a centromeric position 86 kb away (Figure 1C). Alignment of the human PAD type I cDNA and genomic sequences revealed that the entire cDNA sequence is covered over a range of 39.7 kb (GenBank[®] accession number NT_004401). The human PAD type I gene consists of 16 relatively short exons (ranging from 63–851 bp) interrupted by 15 intronic sequences from 104 bp to more than 16.9 kb (Table 1). Only scarce differences were found between the nt sequences of the exons and the corresponding PAD cDNA. Interestingly, the human PAD type II, III and V genes (M. Guerrin, unpublished work) and the rat PAD type II gene [42] also consist of 16 exons; moreover, the length of the exons, but not that of the introns, is conserved between the human and rat orthologous PAD genes.

Production of a recombinant human PAD type I

To express the cloned human PAD type I cDNA as a GST-fusion protein in *E. coli*, the entire coding sequence of the human PAD type I cDNA was cloned into the pGEX-6P vector. When IPTG-induced bacterial lysates were analysed by Western blotting with an anti-GST monoclonal antibody, a protein of 100 kDa was specifically immunodetected (results not shown). To demonstrate PAD activity, IPTG-induced bacterial lysates were incubated in the presence of 10 mM CaCl₂ in order to promote deimination of proteins by the recombinant fusion protein. Deiminated proteins in the incubated lysates were then immunodetected with the antibodies specific to modified citrulline after chemical modification of citrulline residues, as described in the Experimental section. As shown in Figure 2 (lane 3), numerous deiminated bacterial proteins over a broad range of molecular masses were detected, demonstrating the presence of PAD activity in the induced lysates. In both non-induced and IPTG-induced bacterial lysates incubated without CaCl₂, no deiminated proteins were detected (Figure 2, lanes 1 and 2). In addition, *E. coli* transformed with pGEX-hPADIr, containing the human PAD

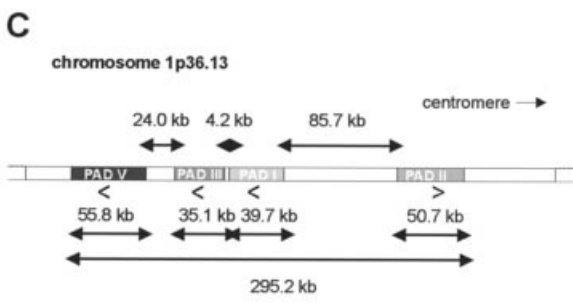
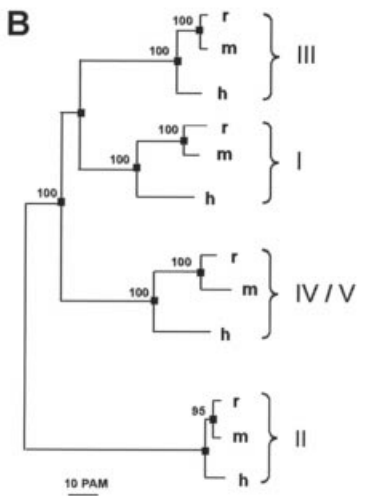
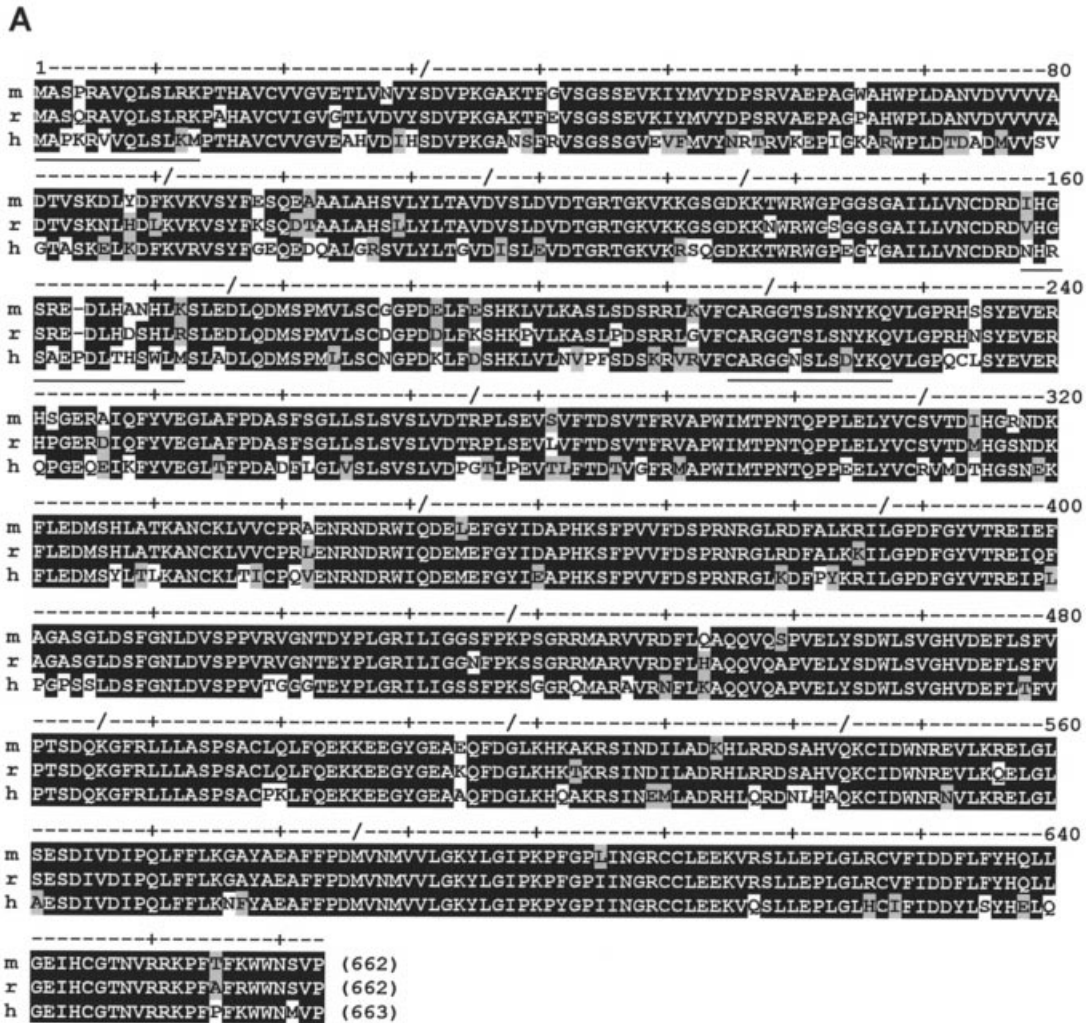

Figure 1 Alignment of human and rodent PAD type I (A), phylogenetic analysis of human and rodent PADs of different types (B), and representation of the human PAD gene locus (C)

(A) Comparison of the predicted amino acid sequences of mouse (m), rat (r) and human (h) PAD type I. Solid and shaded backgrounds indicate identical or similar (R/K/H, A/S/T, I/L/V/M/C/F/Y/W, G/P and E/D/Q/N; where single-letter amino-acid notation has been used) amino acids respectively. For each PAD, the total number of amino acid residues is indicated in brackets. Solidi (/) indicate the positions corresponding to exon–intron boundaries. The underlined sequences of human PAD type I correspond to the regions used to generate antibodies specific for the enzyme. (B) A phylogenetic tree was generated from a multiple sequence alignment of the entire amino acid sequences using the Multalin program [40]. Distances were calculated according to Dayhoff's

Table 1 Exon–intron organization of the human PAD type I gene

The numbers in the 3' boundary and 5' boundary columns indicate the location of the amino acid residues and nucleotides. Single-letter amino-acid notation is used.

Exon no.	Exon size (bp)	Intron size (bp)	Sequence of exon–intron junctions								
			3' boundary		Intron		5' boundary				
1	175	16978	I	H	S ₃₁				D ₃₂	V	
			ATT	CAC	AG ₁₇₅	GTAAGAGCTG ... TCTCTGCCAG	T	GAT	GTG		
2	181	1150	D	F	K ₉₁			V ₉₂	R	V	
			GAC	TTC	AAG ₃₅₆	GTAAGAGGCC ... TGTCTGCAG	GTG	AGG	G		
3	73	673	G	V	D ₁₁₆			I ₁₁₇	S		
			GGC	GTC	G ₄₂₉	GTAAGTAGCA ... CTCTTGCAG	AT	ATT	T		
4	62	1382	G	D	K ₁₃₆			K ₁₃₇	T	W	
			GGG	GAC	AAG ₄₉₁	GTGAGACCCT ... TTTGCCACAG	AAA	ACC	T		
5	118	104	L	A	D ₁₇₆			L ₁₇₇	Q		
			CTG	GCT	G ₆₀₉	GTGAGTGACA ... CTCTCCAG	AC	CTG	C		
6	126	2466	A	R	G ₂₁₈			G ₂₁₉	N		
			GCC	AGG	G ₇₃₅	GTGAGTGGCC ... TTCTCCTAG	GT	GGG	AA		
7	173	150	D	P	G ₂₇₅			T ₂₇₆	L		
			GAC	CCG	GGG ₉₀₈	GTGTGTACAG ... TTCCTCAG	ACC	CTG			
8	104	1033	V	C	R ₃₁₀			V ₃₁₁	M		
			GTG	TGC	AG ₁₀₁₂	GTGAGGCTCC ... CTTTACCAG	A	GTG	ATG		
9	124	363	W	I	Q ₃₅₁			D ₃₅₂	E	M	
			TGG	ATC	CAG ₁₁₃₆	GTGGGAGCTG ... CCCCTCCCAG	GAC	GAG	A		
10	108	2139	R	I	L ₃₈₇			G ₃₈₈	P	D	
			AGG	ATC	CTG ₁₂₄₄	GTACGTAGCG ... TCTCCATAG	GGT	CCT	G		
11	152	4343	F	P	K ₄₃₈			S ₄₃₉	G		
			TTC	CCC	AA ₁₃₉₆	GTGAGGGGCT ... TCCTGGCCAG	G	TCC	GGT		
12	145	1157	D	Q	K ₄₈₆			G ₄₈₇	F	R	
			GAC	CAG	AAG ₁₅₄₁	GTGCGTCCCC ... TCCGTGCCAG	GGC	TTC	C		
13	94	994	F	D	G ₅₁₈			L ₅₁₉	K		
			TTT	GAT	G ₁₆₃₅	GTGAGTGCCA ... CTTCTGCAG	GG	TTA	AAA		
14	80	851	H	A	Q ₅₄₄			K ₅₄₅	C	I	
			CAT	GCA	CAG ₁₇₁₅	GTGAGAGGCA ... CCTCCCCAG	AAA	TGC	AT		
15	126	3249	P	D	M ₅₈₆			V ₅₈₇	N	M	
			CCA	GAC	ATG ₁₈₄₁	GTGAGAGCCC ... TCTTTGCAG	GTT	AAC	AT		
16	851		TAGAAAAAAA								

type I cDNA in the reverse direction, had no PAD activity (results not shown). We next measured the activity of the IPTG-induced bacterial lysate towards two synthetic substrates, benzoyl-L-arginine ethyl ester (BAEE) and benzoyl-L-arginine (Bz-L-Arg). Activities against both substrates were rather low (0.123 and 0.118 unit/ml respectively) when compared with similar lysates of bacteria expressing GST–rat PAD type I (0.811 and 0.920 unit/ml respectively) or GST–human PAD type II (1.750 and 0.400 unit/ml respectively). However, the substrate specificity of the recombinant human PAD type I was similar to that of the recombinant rat PAD type I and clearly differentiated these enzymes from PADs of other types, recombinant or native (Table 2). Attempts to purify the recombinant human enzyme in an active form were unsuccessful, because it unexpectedly lost its activity for unknown reasons. It might be either denatured or unfolded during the purification steps.

Analysis of PAD type I mRNA expression in human tissues

cDNAs of human MTCTM panels were used as PCR templates to study the expression of PAD type I in adult tissues. A rep-

resentative amplification after 34 cycles is shown in Figure 3. Besides expression in epidermis, high levels of PAD type I mRNA were detected in prostate, testis, placenta, spleen and thymus. Colon, lung, liver and pancreas expressed intermediate levels of PAD type I mRNA. Very low levels or no signals were obtained in ovary, brain, peripheral blood leucocytes, small intestine, heart, skeletal muscle and kidney.

A Blast search of the GeneBank expressed sequence tag entries with the human PAD type I cDNA sequence revealed several expressed sequence tags from human (three from uterus, two from pancreas and two from colon), rat (three from eye) and mouse (including thymus, uterus, skin and vaginal epithelium) tissues, confirming that PAD type I is not skin-specific, but is expressed more widely.

Characterization and localization of human PAD type I in epidermis

Anti-peptide antibodies to human PAD type I were developed against three peptides corresponding to regions that differ

PAM250 matrix. The bar indicates 10 substitutions per site. PAM, percentage of accepted point mutation. An identical tree was obtained with ClustalW program [41] using the neighbour-joining method (results not shown). Bootstrap values were calculated after 100 replicate trials using Consense program of the Phylip package (version 3.6a3; distributed by the author, J. Felsenstein, Department of Genetics, University of Washington, Seattle, WA, U.S.A.) and are indicated. Values below 70 have been deleted. GenBank® accession numbers of the sequences used in all alignments are as follows: human (h) PAD types II, III and V, AB030176, AB026831 and AB017919 respectively; rat (r) PAD types I, II, III and IV, AB010998, NM-017226, D88034 and AB010999 respectively; mouse (m) PAD types I, II, III and IV, NM-011059, NM-008812, NM-011060 and NM-011061 respectively. (C) Schematic representation of the human PAD genes on chromosome 1p36.13. The transcribed region of the four genes is represented by grey boxes. Their transcription orientations are shown by arrowheads.

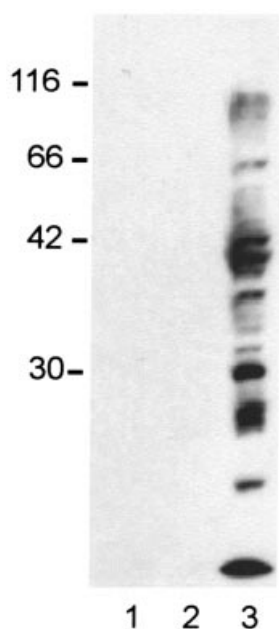

Figure 2 Activity of a recombinant human PAD type I

E. coli cells transformed with pGEX-hPAD1 were induced in the absence or presence of IPTG. IPTG-induced and non-induced bacterial lysates were incubated in the presence or absence of 10 mM CaCl_2 for 1 h at 37 °C. The incubated lysates (10 μg of proteins per lane) were then analysed for the presence of deiminated proteins by immunoblotting with antibodies specific to modified citrulline. Lane 1, non-induced bacterial lysate incubated with 10 mM CaCl_2 ; lane 2, IPTG-induced bacterial lysate incubated without CaCl_2 ; and lane 3, IPTG-induced bacterial lysate incubated with 10 mM CaCl_2 . The position of molecular-mass markers (in kDa) is indicated on the left.

Table 2 Comparison of substrate specificity of recombinant human PAD type I with other PADs

PADs (purified proteins or bacterial extracts) were incubated with 10 mM BAEE or Bz-L-Arg. The amount of citrulline derivatives formed was determined colorimetrically as described previously [22]. One unit of the enzyme was defined as the amount that deiminated 1 μmol of the substrate in 1 h at 50 °C. Relative activity was calculated on the basis of specific activity towards BAEE.

PADs	Relative activity (%)	
	BAEE	Bz-L-Arg
Recombinant human PAD type I (bacterial extract)	100.0	95.9
Recombinant rat PAD type I*	100.0	114.3
Rat muscle PAD type II†	100.0	18.5
Recombinant human PAD type II‡ (bacterial extract)	100.0	22.9
Recombinant human PAD type III§	100.0	19.7
Recombinant rat PAD type IV*	100.0	17.5
Recombinant human PAD type V‡,¶	100.0	152.6

Data from Ishigami et al. [31]*; Watanabe et al. [22]†; A. Ishigami (unpublished work)‡; Kanno et al. [34]§; and Nakashima et al. [35]¶.

between PAD type I and the other types of PAD, as described in the Experimental section. The reactivity of the sera was tested by ELISA against each of the three peptides. The sera reacted predominantly with the peptide corresponding to residues 158–172, but not with the peptide corresponding to residues 1–13

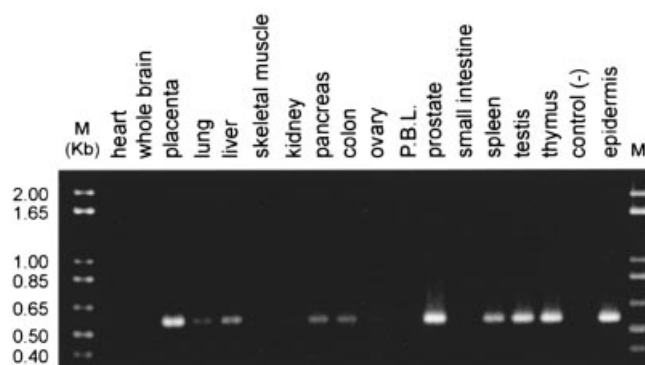

Figure 3 Expression of the PAD type I transcripts in human adult tissues

cDNAs in MTC™ panels were derived from polyadenylated RNA isolated from the several different human tissues (as indicated at the top of the Figure) and have been normalized using different housekeeping genes [according to the manufacturer's instructions (Clontech)]. Therefore the PCR results give an accurate assessment of tissue specificity. Epidermal cDNAs were produced by random priming of 1 μg of total RNAs extracted from human epidermis. In most tissues, PAD transcripts were detected on a 2% agarose/TBE gel as a PCR fragment of 570 bp after 34 PCR cycles. M, 1 kb Plus DNA Ladder (Life Technologies); control (-), PCR reaction proceeded in the absence of cDNA; P.B.L., peripheral blood leucocytes.

(Figure 4A). The antisera were affinity-purified on a mixture of the three peptides and the specificity of the affinity-purified anti-peptide antibodies was demonstrated by immunoblotting human PAD type I recombinant protein produced in *E. coli* and by adsorption experiments (Figure 4B, lanes 1–6). The antibodies immunodetected neither rabbit PAD type II nor recombinant human PAD types III and V (results not shown).

The antibody reactivity was then investigated by immunoblotting proteins extracted from human breast epidermis. The affinity-purified antibodies detected a 70 kDa protein. The reactivity was specific, as it was blocked after absorption of the antibodies by recombinant human PAD type I (Figure 4B, lanes 7–9). Moreover, the protein was not detected when non-immune serum or unrelated rabbit antibodies were used (results not shown).

To localize human PAD type I precisely in epidermis, unfixed cryosections of human skin fragments as well as sections of Bouin's-fixed skin were immunohistochemically analysed using the affinity-purified antibodies. On both unfixed (Figures 5A and B) and fixed skin (Figure 5C), the antibodies showed cytoplasmic keratinocyte labelling in all the epidermis living layers, the labelling intensity being higher in the upper spinous and granular layers. On parallel control sections incubated in the absence of primary antibody, no significant immunoreactivity was observed. Moreover, the reactivity decreased sharply or even disappeared after adsorption of the purified serum on recombinant human PAD type I (results not shown).

In human epidermis, PAD type III was also shown to be expressed in all the nucleated cell layers [34]. This distribution of PADs from basal to the cornified layer in the epidermis is in striking contrast with the distribution of deiminated proteins. Indeed, using antibodies specific for modified citrullines, virtually all deiminated proteins were found to be located in the cornified layer [7,8,43]. The lack of detection of PAD types I and III in the cornified layer is most probably due to masking of epitopes, as often observed with epidermal proteins, although deimination by other PAD types cannot be fully excluded. The presence of PADs in the lower epidermis could also indicate that PAD types

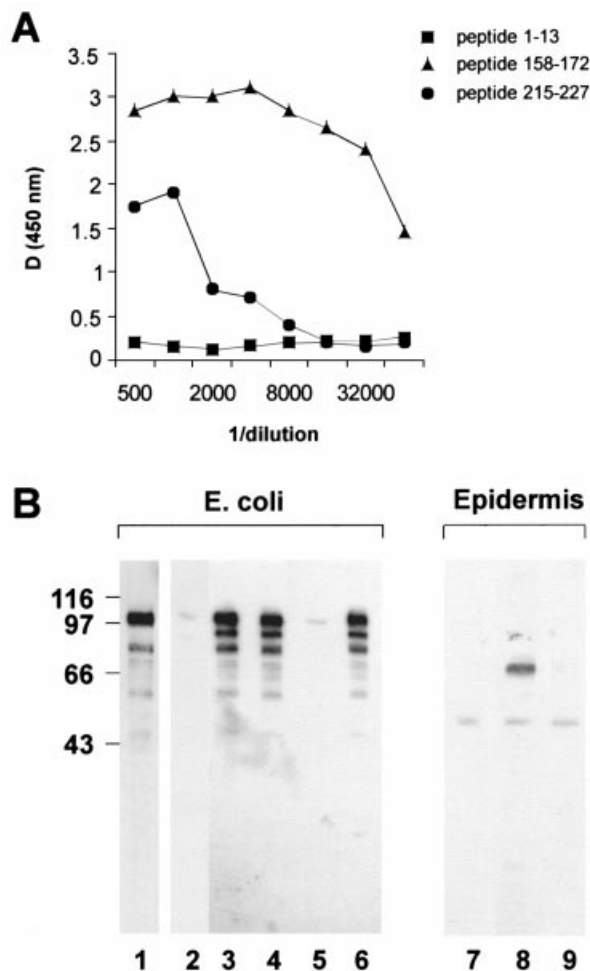

Figure 4 Immunodetection of PAD type I in human epidermis as a 70 kDa protein

(A) Anti-peptide serum directed against human PAD type I was tested by ELISA against each of the peptides used for its production (amino acids 1–13, 158–172 and 215–227) as indicated. (B) *E. coli* cells transformed with pGEX-hPAD1 were induced in the absence (lane 2) or presence of IPTG (lanes 1, 3–6). Bacterial extracts were then immunodetected with an anti-GST monoclonal antibody (lane 1), affinity-purified anti-peptide antibodies directed against human PAD type I diluted to 0.11 $\mu\text{g/ml}$ (lane 2 and 3), and the antibodies preadsorbed with peptides 1–13, 158–172 or 215–227 respectively (lanes 4–6). A TENP-40 extract of human epidermis was immunodetected in the absence of rabbit antiserum (lane 7), in the presence of the affinity-purified anti-peptide antibodies directed against human PAD type I diluted to 0.46 $\mu\text{g/ml}$ (lane 8), and the antibodies preadsorbed with the recombinant human PAD type I (lane 9). The position of molecular-mass markers (in kDa) is indicated on the left.

I and III are kept inactive in the lower epidermis and activated later during differentiation. They could be activated by the calcium gradient that exists between the lower and the upper epidermis [44], as has been described for several other epidermal proteins [45]. Alternatively, substrate conformation or accessibility may be involved.

The expression of both PAD types I and III in human epidermis raises other questions, including why are several PAD isoforms expressed in the same tissue and even in the same cells, and do they act on the same targets? Since this process has already been shown to be disturbed in psoriatic epidermis [46], what about epidermis protein deimination in various other

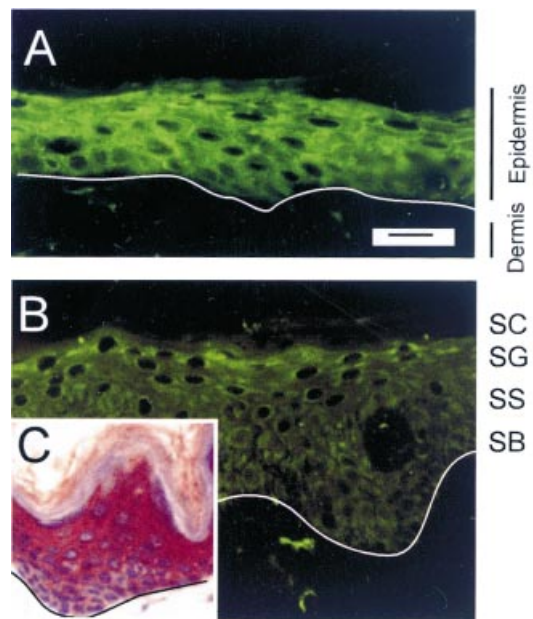

Figure 5 Immunohistochemical localization of PAD type I in human epidermis

Cryosections of human skin were analysed by indirect immunofluorescence (A and B), and sections of Bouin's-fixed samples were analysed by immunoperoxidase (C) with the affinity-purified anti-peptide antibodies directed against human PAD type I. The antibodies were diluted to 20 $\mu\text{g/ml}$ when analysed by indirect immunofluorescence and to 4.6 $\mu\text{g/ml}$ when analysed by immunoperoxidase. Note the labelling of all the living layers of the epidermis. A higher intensity in the upper spinous and granular layers is usually observed (B and C). Layers of the epidermis are indicated (SB, stratum basale; SS, stratum spinosum; SG, stratum granulosum; and SC, stratum corneum). The continuous lines indicate the dermo-epidermal junction. The scale bar represents 50 μm (A and B) and 35 μm (C) respectively.

cutaneous diseases? The availability of the recombinant enzyme and specific antibodies described in the present study, in combination with the antibodies specific to modified citrullines, will be useful in answering these questions, permitting the biological role of human PAD type I to be studied first in normal and then in diseased epidermis.

We thank Professor H. Takahara and Professor M. Yamada for generously providing recombinant PAD types III and V respectively. We also thank Professor J.-P. Chavoin for providing us with normal human skin, and J. Henry for her valuable advice on using the Phylip Package. This study was supported in part by grants from the Université Paul Sabatier-Toulouse III, from INSERM (CJF 96-02), and from the Association pour la Recherche sur la Polyarthrite.

REFERENCES

- 1 Rothnagel, J. A. and Rogers, G. E. (1984) Citrulline in proteins from the enzymatic deimination of arginine residues. *Methods Enzymol.* **107**, 624–631
- 2 Takahara, H., Okamoto, H. and Sugawara, K. (1985) Specific modification of the functional arginine residue in soybean trypsin inhibitor (Kunitz) by peptidylarginine deiminase. *J. Biol. Chem.* **260**, 8378–8383
- 3 Inagaki, M., Takahara, H., Nishi, Y., Sugawara, K. and Sato, C. (1989) Ca^{2+} -dependent deimination-induced disassembly of intermediate filaments involves specific modification of the amino-terminal head domain. *J. Biol. Chem.* **264**, 18119–18127
- 4 Luo, S., Martin, B. L., Senshu, T. and Graves, D. J. (1995) Enzymatic deimination of glycogen phosphorylase and a peptide of the phosphorylation site: identification of modification and roles in phosphorylation and activity. *Arch. Biochem. Biophys.* **318**, 362–369
- 5 Imparl, J. M., Senshu, T. and Graves, D. J. (1995) Studies of calcineurin–calmodulin interaction: probing the role of arginine residues using peptidylarginine deiminase. *Arch. Biochem. Biophys.* **318**, 370–377

- 6 Harding, C. R. and Scott, I. R. (1983) Histidine-rich protein (filaggrins): structural and functional heterogeneity during epidermal differentiation. *J. Mol. Biol.* **170**, 651–673
- 7 Senshu, T., Akiyama, K., Kan, S., Asaga, H., Ishigami, A. and Manabe, M. (1995) Detection of deaminated proteins in rat skin: probing with a monospecific antibody after modification of citrulline residues. *J. Invest. Dermatol.* **105**, 163–169
- 8 Senshu, T., Kan, S., Ogawa, H., Manabe, M. and Asaga, H. (1996) Preferential deimination of keratin K1 and filaggrin during the terminal differentiation of human epidermis. *Biochem. Biophys. Res. Commun.* **225**, 712–719
- 9 Senshu, T., Akiyama, K. and Nomura, K. (1999) Identification of citrulline residues in the V subdomains of keratin K1 derived from the cornified layer of newborn mouse epidermis. *Exp. Dermatol.* **8**, 392–401
- 10 Tarcsa, E., Marekov, L. N., Mei, G., Melino, G., Lee, S.-C. and Steinert, P. M. (1996) Protein unfolding by peptidylarginine deiminase. Substrate specificity and structural relationships of the natural substrates trichohyalin and filaggrin. *J. Biol. Chem.* **271**, 30709–30716
- 11 Harding, C. R., Bartolone, J. and Rawlings, A. V. (2000) Effects of natural moisturizing factor and lactic acid isomers on skin function. In *Dry Skin and Moisturizers: Chemistry and Function* (Loden, M. and Maibach, H. I., eds.), pp. 229–241. CRC Press, London
- 12 Tarcsa, E., Marekov, L. N., Andreoli, J., Idler, W. W., Candi, E., Chung, S. and Steinert, P. (1997) The fate of trichohyalin. Sequential post-translational modifications by peptidyl-arginine deiminase and transglutaminases. *J. Biol. Chem.* **272**, 27893–27901
- 13 Wood, D. D. and Moscarello, M. A. (1989) The isolation, characterization, and lipid-aggregating properties of a citrulline containing myelin basic protein. *J. Biol. Chem.* **264**, 5121–5127
- 14 Mastronardi, F. G., Mak, B., Ackerley, C. A., Roots, B. I. and Moscarello, M. A. (1996) Modifications of myelin basic protein in DM20 transgenic mice are similar to those of myelin basic protein from multiple sclerosis. *J. Clin. Invest.* **97**, 349–358
- 15 Beniac, D. R., Wood, D. D., Palaniyar, N., Ottensmeyer, F. P., Moscarello, M. A. and Harauz, G. (2000) Cryoelectron microscopy of protein–lipid complexes of human myelin basic protein charge isomers differing in degree of citrullination. *J. Struct. Biol.* **129**, 80–95
- 16 Tranquill, L. R., Cao, L., Ling, N. C., Kalbacher, H., Martin, R. M. and Whitaker, J. N. (2000) Enhanced T cell responsiveness to citrulline-containing myelin basic protein in multiple sclerosis patients. *Mult. Scler.* **6**, 220–225
- 17 Girbal-Neuhausser, E., Durieux, J.-J., Arnaud, M., Dalbon, P., Sebbag, M., Vincent, C., Simon, M., Senshu, T., Masson-Bessière, C., Jolivet-Raynaud, C. et al. (1999) The epitopes targeted by the rheumatoid arthritis-associated antifilaggrin autoantibodies are post-translationally generated on various sites of (pro)filaggrin by deimination of arginine residues. *J. Immunol.* **162**, 585–594
- 18 Masson-Bessière, C., Sebbag, M., Girbal-Neuhausser, E., Nogueira, L., Vincent, C., Senshu, T. and Serre, G. (2001) The major synovial targets of the rheumatoid arthritis-specific antifilaggrin autoantibodies are deaminated forms of the α - and β -chains of fibrin. *J. Immunol.* **166**, 4177–4184
- 19 Fujisaki, M. and Sugawara, K. (1981) Properties of peptidylarginine deiminase from the epidermis of new born rats. *J. Biochem. (Tokyo)* **89**, 257–263
- 20 Kubilus, J. and Baden, H. P. (1983) Purification and properties of a brain enzyme which deaminates proteins. *Biochim. Biophys. Acta* **745**, 285–291
- 21 Sugawara, K., Oikawa, Y. and Uchi, T. (1982) Identification and properties of peptidylarginine deiminase from rabbit skeletal muscle. *J. Biochem. (Tokyo)* **91**, 1065–1071
- 22 Watanabe, K., Akiyama, K., Hikichi, K., Ohtsuka, R., Okuyama, A. and Senshu, T. (1988) Combined biochemical and immunohistochemical comparison of peptidylarginine deiminases present in various tissues. *Biochim. Biophys. Acta* **966**, 375–383
- 23 Takahara, H., Tsuchida, M., Kusubata, M., Akutsu, K., Tagami, S. and Sugawara, K. (1989) Peptidylarginine deiminase of the mouse. Distribution, properties, and immunocytochemical localization. *J. Biol. Chem.* **264**, 13361–13368
- 24 Rogers, G., Winter, B., McLaughlan, C., Powell, B. and Nesci, T. (1997) Peptidylarginine deiminase of the hair follicle: characterization, localization, and function in keratinizing tissues. *J. Invest. Dermatol.* **108**, 700–707
- 25 Lamensa, J. W. E. and Moscarello, M. A. (1993) Deimination of human myelin basic protein by a peptidylarginine deiminase from bovine brain. *J. Neurochem.* **61**, 987–996
- 26 Terakawa, H., Takahara, H. and Sugawara, K. (1991) Three types of mouse peptidylarginine deiminase: characterization and tissue distribution. *J. Biochem. (Tokyo)* **110**, 661–666
- 27 Watanabe, K. and Senshu, T. (1989) Isolation and characterization of cDNA clones encoding rat skeletal muscle peptidylarginine deiminase. *J. Biol. Chem.* **264**, 15255–15260
- 28 Tsuchida, M., Takahara, H., Minami, N., Arai, T., Kobayashi, Y., Tsujimoto, H., Fukazawa, C. and Sugawara, K. (1993) cDNA nucleotide sequence and primary structure of mouse uterine peptidylarginine deiminase. Detection of a 3'-untranslated nucleotide sequence common to the mRNA of transiently expressed genes and rapid turnover of this enzyme's mRNA in the estrous cycle. *Eur. J. Biochem.* **215**, 677–685
- 29 Nishijyo, T., Kawada, A., Kanno, T., Shiraiwa, M. and Takahara, H. (1997) Isolation and molecular cloning of epidermal- and hair follicle-specific peptidylarginine deiminase (type III) from rat. *J. Biochem. (Tokyo)* **121**, 868–875
- 30 Yamakoshi, A., Ono, H., Nishijyo, T., Shiraiwa, M. and Takahara, H. (1998) Cloning of cDNA encoding a novel isoform (type IV) of peptidylarginine deiminase from rat epidermis. *Biochim. Biophys. Acta* **1386**, 227–232
- 31 Ishigami, A., Kuramoto, M., Yamada, M., Watanabe, K. and Senshu, T. (1998) Molecular cloning of two novel types of peptidylarginine deiminase cDNAs from retinoic acid-treated culture of a newborn rat keratinocyte cell line. *FEBS Lett.* **433**, 113–118
- 32 Rus'd, A. A., Ikejiri, Y., Ono, H., Yonekawa, T., Shiraiwa, M., Kawada, A. and Takahara, H. (1999) Molecular cloning of cDNAs of mouse peptidylarginine deiminase type I, type III and type IV, and the expression pattern of type I in mouse. *Eur. J. Biochem.* **259**, 660–669
- 33 Ishigami, A., Asaga, H., Ohsawa, T., Akiyama, K. and Maruyama, N. (2001) Peptidylarginine deiminase type I, type II, type III and type IV are expressed in rat epidermis. *Biomed. Res.* **22**, 63–65
- 34 Kanno, T., Kawada, A., Yamanouchi, J., Yosida-Noro, C., Yoshiki, A., Shiraiwa, M., Kusakabe, M., Manabe, M., Tezuka, T. and Takahara, H. (2000) Human peptidylarginine deiminase type III: molecular cloning and nucleotide sequence of the cDNA, properties of the recombinant enzyme, and immunohistochemical localization in human skin. *J. Invest. Dermatol.* **115**, 813–823
- 35 Nakashima, K., Hagiwara, T., Ishigami, A., Nagata, S., Asaga, H., Kuramoto, M., Senshu, T. and Yamada, M. (1999) Molecular characterization of peptidylarginine deiminase in HL-60 cells induced by retinoic acid and $1\alpha,25$ -dihydroxyvitamin D₃. *J. Biol. Chem.* **274**, 27786–27792
- 36 Urano, Y., Watanabe, K., Sakaki, A., Arase, S., Watanabe, Y., Shigemitsu, F., Takeda, K., Akiyama, K. and Senshu, T. (1990) Immunohistochemical demonstration of peptidylarginine deiminase in human sweat glands. *Am. J. Dermatopathol.* **12**, 249–255
- 37 Asaga, H., Nakashima, K., Senshu, T., Ishigami, A. and Yamada, M. (2001) Immunocytochemical localization of peptidylarginine deiminase in human eosinophils and neutrophils. *J. Leukocyte Biol.* **70**, 46–51
- 38 Altschul, S. F., Gish, W., Miller, W., Myers, E. W. and Lipman, D. J. (1990) Basic local alignment search tool. *J. Mol. Biol.* **215**, 403–410
- 39 Nielsen, H., Engelbrecht, J., Brunak, S. and von Heijne, G. (1997) Identification of prokaryotic and eukaryotic signal peptides and prediction of their cleavage sites. *Protein Eng.* **10**, 1–6
- 40 Corpet, F. (1988) Multiple sequence alignment with hierarchical clustering. *Nucleic Acids Res.* **16**, 10881–10890
- 41 Higgins, D. G., Thompson, J. D. and Gibson, T. J. (1996) Using CLUSTAL for multiple sequence alignments. *Methods Enzymol.* **266**, 383–402
- 42 Watanabe, K., Nomoto, M., Nagata, S., Itoh, Y., Hikichi, K., Maruyama, N., Mita, T. and Senshu, T. (1992) The rat peptidylarginine deiminase-encoding gene: structural analysis and the 5'-flanking sequence. *Gene* **114**, 261–265
- 43 Ishida-Yamamoto, A., Senshu, T., Eady, R. A., Takahashi, H., Shimizu, H., Akiyama, K. and Iizuka, H. (2002) Sequential reorganization of cornified cell keratin filaments involving filaggrin-mediated compaction and keratin 1 deimination. *J. Invest. Dermatol.* **118**, 282–287
- 44 Menon, G. H., Grayson, S. and Elias, P. M. (1985) Ionic calcium reservoirs in mammalian epidermis: ultrastructural localization by ion-capture cytochemistry. *J. Invest. Dermatol.* **84**, 508–512
- 45 Fairley, J. (1991) Calcium: a second messenger. In *Physiology, Biochemistry, and Molecular Biology of the Skin* (Goldsmith, L. A., ed.), pp. 314–328. Oxford University Press, New York
- 46 Ishida-Yamamoto, A., Senshu, T., Takahashi, H., Akiyama, K., Nomura, K. and Iizuka, H. (2000) Decreased deaminated keratin K1 in psoriatic hyperproliferative epidermis. *J. Invest. Dermatol.* **114**, 701–705

Received 5 June 2002/18 October 2002; accepted 5 November 2002

Published as BJ Immediate Publication 5 November 2002, DOI 10.1042/BJ20020870