

Strain Sensitivity and Turnover Rate of Low Force Cross-bridges in Contracting Skeletal Muscle Fibers in the Presence of Phosphate

H. Iwamoto

Department of Physiology, School of Medicine, Teikyo University, Tokyo 173 Japan

ABSTRACT Inorganic phosphate (P_i) decreases the isometric tension of skinned skeletal muscle fibers, presumably by increasing the relative fraction of a low force quaternary complex of actin, myosin, ADP, and P_i ($A \cdot M \cdot ADP \cdot P_i$). At the same time, P_i gives rise to a fast relaxing mechanical component as detected by oscillations at 500 Hz. To characterize the dynamic properties of this $A \cdot M \cdot ADP \cdot P_i$ complex, the effect of P_i on the tension response to stretch was investigated with rabbit psoas fibers. A ramp stretch applied in the presence of 20 mM P_i increased tension more than in the control solution (0 mM P_i) but reduced the fast relaxing component to the control level. Thus, a stretch seems to convert the low force, fast relaxing $A \cdot M \cdot ADP \cdot P_i$ complex to a high force, slow relaxing form. However, the P_i -induced enhancement of the tension response was not observed until the fibers were stretched more than 0.4% of their length, suggesting that a critical cross-bridge extension of ~ 4 nm is required for this conversion. The rate constant of the attachment/detachment of this low force complex was estimated from the velocity dependence of the enhancement. It was ~ 10 s $^{-1}$, in marked contrast to the $A \cdot M \cdot ADP \cdot P_i$ complex under low salt, relaxed conditions ($\sim 10,000$ s $^{-1}$). The enhancement of the tension response was not observed when isometric tension was reduced by lowering free calcium, implying that calcium and P_i affect different steps in the actomyosin ATPase cycle during contraction.

INTRODUCTION

Muscle contraction is initiated by the attachment of myosin heads (cross-bridges) to actin, which is followed by the generation of a sliding force. Stiffness and x-ray diffraction measurements (Cecchi et al., 1982; Ford et al., 1986; Hatta et al., 1988; Huxley, 1975; Matsubara and Yagi, 1978; Wakabayashi et al., 1985) suggest that cross-bridges initially attach to actin in a low force form and then are converted within a short period (~ 10 ms) to a force-generating form. This conversion seems to limit the rate of rise of isometric tension. It usually takes time of the order of 100 ms until isometric tension reaches a plateau in fast skeletal muscle fibers. However, this conversion seems to be accelerated greatly when the muscle is stretched. When living frog skeletal muscles are stretched at the beginning of a twitch, the tension is abruptly enhanced to a value comparable to a tetanic level (Hill, 1949). As this enhancement is accompanied by accelerated increases of stiffness (Haugen and Sten-Knudsen, 1987) and of the changes of equatorial reflection intensities (Iwamoto et al., 1993), it has been postulated that the low force cross-bridges are strain sensitive and are readily converted to a high force, high stiffness form upon stretch (Iwamoto et al., 1993).

Although the chemical species of the low force, strain-sensitive cross-bridges has not been determined, it should represent one of the states preceding the power stroke. Evidence has been presented that the force generation is coupled to the step of inorganic phosphate (P_i) release from a quaternary complex of actin, myosin, ADP and P_i

($A \cdot M \cdot ADP \cdot P_i$) (Hibberd et al., 1985), which is accompanied by a major free energy change (Kodama, 1985). A possibility has also been raised that it is the isomerization of an $A \cdot M \cdot ADP \cdot P_i$ complex that is coupled to force generation (Dantzig et al., 1992). These results make an $A \cdot M \cdot ADP \cdot P_i$ complex a most likely candidate for the low force, strain-sensitive cross-bridges that appear at the beginning of contraction.

Another form of $A \cdot M \cdot ADP \cdot P_i$ complex (along with $A \cdot M \cdot ATP$) has been reported under low salt, relaxed conditions (Stein et al., 1979). Under these conditions the actomyosin complex is weakly bound, and its associated and dissociated forms are in rapid equilibrium. This rapid actomyosin interaction gives rise to fiber stiffness that is highly velocity dependent (Brenner et al., 1982), and the rate constant of the attachment/detachment is estimated to be 5,000–10,000 s $^{-1}$ (Schoenberg, 1988). As the interaction was observed in the absence of calcium, it was proposed that the point of calcium regulation in the actomyosin ATPase cycle is the step of P_i release, which occurs after attachment (Chalovich et al., 1981). This is contrasted with the steric hindrance model of calcium regulation in which the step of attachment itself is regulated (Huxley, 1973; Parry and Squire, 1973).

The present study has two purposes. The first is to artificially increase the fraction of the $A \cdot M \cdot ADP \cdot P_i$ cross-bridge population in contracting skinned skeletal muscle fibers and to test whether those cross-bridges have strain sensitivity as expected from the experiments with living muscles. The second is to test whether the $A \cdot M \cdot ADP \cdot P_i$ cross-bridges during contraction and those under low salt, relaxed conditions have dynamic characteristics in common.

For the first purpose, P_i was added to the bathing solution to populate the $A \cdot M \cdot ADP \cdot P_i$ species. Addition of P_i reduces the tension whereas it reduces the stiffness to a lesser extent

Received for publication 25 July 1994 and in final form 18 October 1994.

Address reprint requests to Dr. Hiroyuki Iwamoto, Department of Physiology, Teikyo University School of Medicine, 2-11-1 Kaga, Itabashi-ku, Tokyo 173, Japan.

© 1995 by the Biophysical Society

0006-3495/95/01/243/08 \$2.00

(Hibberd et al., 1985; Kawai et al., 1987; Brozovich et al., 1988; Martyn and Gordon, 1992), corroborating that P_i favors an attached cross-bridge state with low force. If a common low force $A \cdot M \cdot ADP \cdot P_i$ state is to be involved in the presence of P_i and at the beginning of contraction, similar strain dependence of cross-bridges should be demonstrated in both cases. By determining the dependence of the tension response to stretch velocity, one may test whether the low force attached cross-bridges are also in rapid equilibrium with detached cross-bridges. One may obtain additional information about the step of calcium regulation by reducing the isometric tension to an extent comparable to that in the presence of P_i and comparing the mechanical sensitivity of the cross-bridges. Preliminary accounts have been presented elsewhere (Iwamoto and Sugi, 1994a, b).

MATERIALS AND METHODS

Preparation

Bundles (diameter ~ 1 – 2 mm) of muscle fibers were dissected from rabbit psoas, skinned in a relaxing solution containing 1% Triton X-100 for 15 min on ice, washed in a relaxing solution, and stored in a 50% mixture of the relaxing solution and glycerol for up to 2 months in a freezer. Small bundles consisting of two to four fibers (length, ~ 5 mm) were isolated, clamped with aluminum T-clips at both ends, and mounted in an experimental apparatus. Sarcomere length was adjusted to $2.5 \mu\text{m}$ by He-Ne laser beam diffraction.

Solution

The relaxing solution had the following composition: 80 mM potassium propionate, 10 mM EGTA, 5 mM MgCl_2 , 4 mM Na_2ATP , 20 mM phosphocreatine (Sigma, Chemical Co., St. Louis, Mo), 20 units/ml creatine phosphokinase (Sigma), and 20 mM imidazole (pH 7.2). In the preactivating solution, EGTA was reduced to 0.1 mM. For the full activating solution, ~ 10 – 10.2 mM CaCl_2 was added to the relaxing solution. For partial activation, the concentration of CaCl_2 was reduced so that the peak isometric tension was about one-third of the fully activated level. Solutions containing phosphate were prepared by replacing potassium propionate by phosphate with a molar ratio of 2:1 to maintain ionic strength. The temperature of the experimental solutions were kept at 3 – 5°C .

Experimental apparatus

The force transducer was of semiconductor type (AE801, SensoNor; Horten, Norway), which had a resonant frequency of 3.5 kHz in solution and an elastic modulus of 2 N/mm. The servomotor was General Scanning G100PD or G120D with a JCCX-101 or CX-660 controller (General Scanning, Watertown, MA). The fibers were stationary while solution cells were exchanged by stepping motors. Those solution cells (volume, 150 or 300 μl) were made of anodized aluminum blocks and had glass walls on both sides. The temperature was controlled by circulating cooled glycol water. The sarcomere length was monitored by recording the position of the first order peak of the laser diffraction pattern with a position-sensitive diode (S3931; Hamamatsu Photonics, Hamamatsu, Japan).

The signals of tension, displacement of the servomotor, and the sarcomere length were monitored with a storage oscilloscope (5113; Tektronics, Beaverton, OR), stored in a digital memory (12-bit resolution), and sent to a personal computer (5530W; IBM Japan, Tokyo, Japan) for further analysis. This computer was also used for controlling the stepping motors for solution exchange.

The command signals for stretch were generated by a digital ramp-and-hold signal generator. The sinusoidal oscillation signal for stiffness measurement (500 Hz, $\sim 0.2\%$ L_0 -p-p, where L_0 is the fiber length at which sar-

comere length = $2.5 \mu\text{m}$) was generated by a function synthesizer (1930; NF, Yokohama, Japan). All timings were controlled by the computer and a three-channel electronic stimulator (SEN-7203; Nihon Kohden, Tokyo, Japan).

Experimental protocol

A rapid activation procedure (Moiescu, 1976) was used. Briefly, 2 min before activation, the bundle was transferred from the relaxing solution to the preactivating solution containing a low level of EGTA (0.1 mM). In the case of full activation ($p\text{Ca} = \sim 4.3$ – 4.9), the plateau of isometric tension was reached within 5 s. After the contraction period of 9 s, the bundle was relaxed by transferring it to the relaxing solution. In the case of submaximal activation ($p\text{Ca} = \sim 6.1$ – 6.7), the rate of rise of tension was slow and the period of activation was prolonged accordingly (up to 27 s). Each fiber bundle was activated every 4–5 min and contraction-relaxation cycles were repeated up to ~ 30 times. The level of isometric tension stayed fairly constant as long as the bundles were fully activated. In the case of submaximal activation, the level of isometric tension tended to decrease as contractions were repeated. After the tension had reached a plateau (in the case of full activation, 7 s after the transfer to the activating solution), a ramp stretch (duration, 1 to 1280 ms; amplitude, 0.3 to 1.2% L_0) was applied. For the measurement of fiber stiffness, oscillations (500 Hz, amplitude, 0.2% L_0 -p-p) were superposed. After the experiment was finished, the cross-sectional area of the fiber bundle was measured optically by the procedure of Blinks (1965).

RESULTS

Effect of P_i on the level of isometric tension

In accord with the previous studies with various types of muscles (Brozovich et al., 1988; Martyn and Gordon, 1992, and references therein), the addition of P_i in the solutions reduced the level of isometric tension. Fig. 1 shows the time course of tension during a single activation-relaxation cycle in the absence of added P_i (control, Fig. 1a) and in the presence of 20 mM P_i (Fig. 1b). In the control solution, because no procedure was taken to reduce the level of natural P_i (e.g., by adding sucrose and sucrose phosphorylase), a basal level of a few hundred μM P_i should be present within the fiber (Pate and Cooke, 1989). The average isometric tension was $1.24 \pm 0.23 \times 10^5 \text{ N/m}^2$ (mean \pm SD; $n = 5$). The presence of 20 mM P_i reduced the isometric tension level to $\sim 30\%$ of the control value, but the rate of rise of tension upon activation was not visibly affected. A comparable extent of tension depression was also achieved by reducing free calcium (Fig. 1c). The rate of rise of tension was appreciably reduced. This may be due to the reduced rate of tension development (k_{redev} ; Brenner, 1988) or slower diffusion of calcium into the fibers. The apparently greater depression of tension than reported earlier (for references see above) is due to the low temperature (3 – 5°C); at room temperature ($\sim 20^\circ\text{C}$) the extent of depression is comparable to the values reported earlier (data not shown).

Effect of P_i on fiber stiffness

In some fibers, fiber stiffness was measured by applying sinusoidal oscillations (frequency, 500 Hz; amplitude, 0.2% L_0 -p-p). The stiffness was decreased by the addition of 20 mM

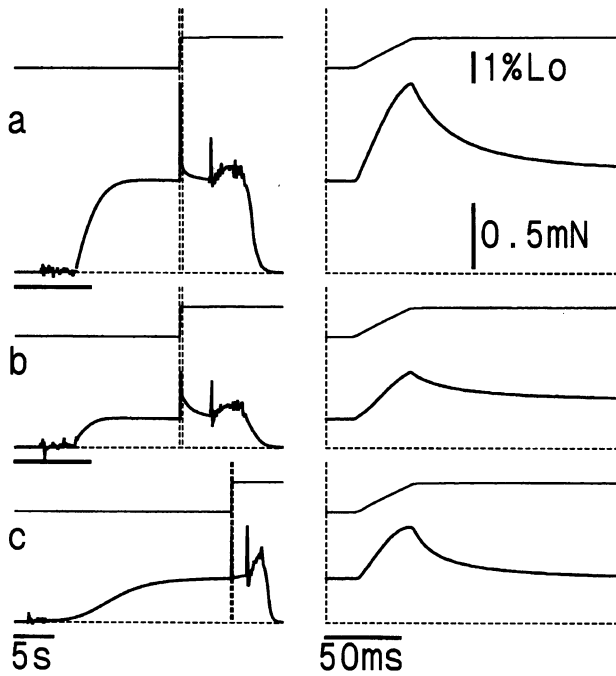

FIGURE 1 Time course of tension during a contraction-relaxation cycle in various solutions. Left column, slow time base. (a) Control (0 mM added P_i , full calcium activation; $pCa = 4.8$). (b) 20 mM added P_i , full calcium activation. (c) Submaximal calcium activation; $pCa = 6.1$. Upper trace, length (position output of the servomotor); lower trace, tension. The bar at the bottom left indicates 5 s. Note the difference in the time scale in c. A ramp stretch (amplitude, 1.2% L_o , where L_o is the fiber length at which sarcomere length = 2.5 μm ; duration, 40 ms) was applied between two vertical broken lines. In the right column, the part of the record between the two broken lines in the left column is expanded to show the time course of the tension response to stretch in detail. Records were obtained from a bundle consisting of two fibers.

P_i , but to a lesser extent than isometric tension ($\sim 40\%$). As a result, the stiffness-to-tension ratio was 1.40 ± 0.03 times higher in the presence of 20 mM P_i than in the control solution (mean \pm SD; $n = 12$). The stiffness-to-tension ratio at submaximal calcium activation was not different from the control value (1.03 ± 0.03 ; $n = 12$).

During oscillation, the phase of tension response usually leads that of length. The phase lead can be taken as an index of a mechanical component that decays rapidly with time (the value of stiffness multiplied by the sine of the phase lead is quadrature stiffness; see Goldman et al., 1984). Such a fast mechanical component can be produced by rapid attachment/detachment cycles or configurational fluctuations of proteins. In the control solution, the phase lead was $5.3 \pm 0.5^\circ$ ($n = 16$). The phase lead in the presence of 20 mM P_i was almost twice as large as in the control solution ($11.1 \pm 0.6^\circ$; $n = 12$), indicating that the proportion of the fast relaxing component had increased. The phase lead at submaximal calcium activation was again not very different from the control value ($6.0 \pm 0.8^\circ$; $n = 12$).

The higher stiffness-to-tension ratio is consistent with the idea that the myosin cross-bridges in a low force state are more populated in the presence of P_i . The higher phase lead

also seems to be consistent with the idea that the low force cross-bridges are in rapid equilibrium with their detached form, as the low salt, relaxed cross-bridges. As will be described later, however, there is evidence that those low force cross-bridges are turning over rather slowly.

Effect of P_i on the responses of tension and stiffness to stretch

In Fig. 1, a ramp stretch (amplitude, 1.2% L_o ; duration, 40 ms) was applied at the plateau of contraction. The tension response to the stretch is shown in the right column of Fig. 1 on an expanded time scale. The absolute magnitude of the tension response to stretch was reduced by adding P_i , but to a lesser extent than isometric tension (Fig. 1b). As a result, the magnitude of the tension response relative to preexisting isometric tension increased with increasing P_i concentrations (Fig. 2). The relatively large tension response with respect to the isometric tension level is consistent with the expectation from the response to stretch applied at the beginning of contraction (see Introduction). At submaximal calcium activation, the fractional tension response was slightly larger than in the control solution but much less than in the case of 20 mM P_i .

The change of stiffness upon stretch was measured by applying sinusoidal oscillations (frequency, 500 Hz; amplitude, 0.2% L_o p-p). Fig. 3 shows the time course of the stiffness and the phase lead as well as the tension. In the control solution (Fig. 3a), stiffness increased upon stretch but approached its original level after the stretch was completed. The phase lead, which had been small in the first place ($\sim 5^\circ$), reduced further upon stretch. In the presence of 20 mM P_i (Fig. 3b), the stiffness was enhanced by a stretch much more prominently and stayed high after the stretch was completed. The phase lead showed a marked decrease upon stretch, and

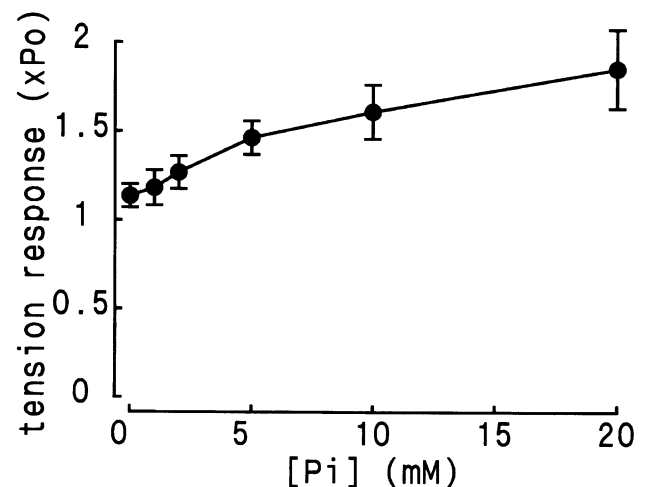

FIGURE 2 Dependence of the magnitude of tension response to stretch on the concentration of added P_i . The peak amplitude of the tension response to stretch (amplitude, 1.2% L_o ; duration, 40 ms) is divided by the isometric tension ($n = 5$; mean \pm SD).

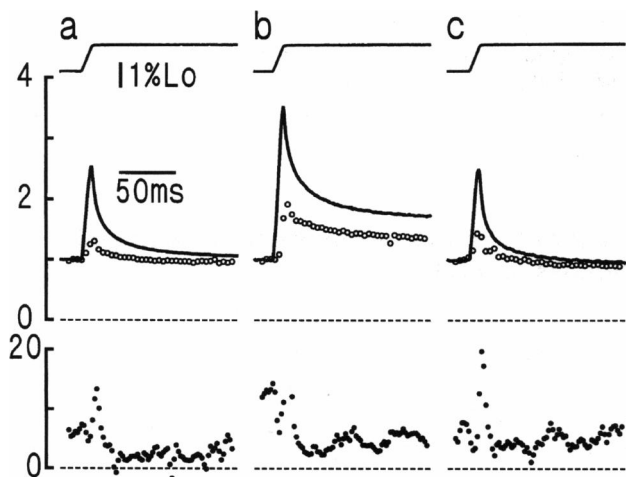

FIGURE 3 Changes of tension, stiffness, and phase lead induced by a stretch (amplitude, 1.2% L_0 ; duration, 10 ms). The stiffness and the phase lead of tension over length were measured by applying 500 Hz oscillations. Top trace, length (position output of the servomotor); middle traces, tension (—) and stiffness (O); bottom trace, phase lead. Tension and stiffness are normalized so that the values before application of stretch are 1. The phase lead is expressed in degrees. (a) Control; (b) 20 mM added P_i ; (c) submaximal calcium activation. Note that the phase lead is initially high in *b*.

it reached a level comparable to the control value. At submaximal calcium activation (Fig. 3c), the behavior of the stiffness and the phase lead was similar to that in the control solution.

Dependence of the tension response on the amplitude of stretch

To test whether the P_i -induced enhancement of the tension response is observed for smaller amplitudes of stretch, we examined the dependence of the magnitude of the tension response on the amplitude of stretch. The amplitude of the stretch (duration, 10 ms) was changed from 0.3 to 1.2% of L_0 with a 0.3% step (Fig. 4). In the control solution (Fig. 4a)

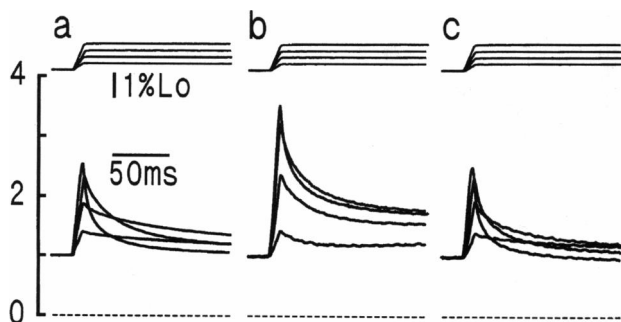

FIGURE 4 Tension responses to stretches (duration, 10 ms) of different amplitudes. Tension responses to 0.3, 0.6, 0.9, and 1.2% L_0 are superposed. Top traces, length (position output of the servomotor); bottom traces, tension. Tension is normalized to the values before stretch. (a) Control; (b) 20 mM added P_i ; (c) submaximal calcium activation. Note that the tension responses to stretches in *b* are larger than the corresponding responses in *a* or *c*, except for the response to 0.3% stretch.

and at submaximal calcium activation (Fig. 4c), the magnitude of the tension response was roughly proportional to the amplitude of stretch. In the presence of 20 mM P_i (Fig. 4b), the response to a 0.3% stretch was not very different from that in the control solution. At larger amplitudes, however, the tension response became disproportionately greater.

In the control solution and at submaximal calcium activation, the tension decay after the completion of a 1.2% L_0 stretch was faster than for smaller amplitudes. This tendency was less prominent in the presence of P_i . If the amount of stress in a cross-bridge affects its rate of detachment, it may mean that the average stress in a cross-bridge after the stretch in the presence of P_i is still smaller than under the other conditions.

The magnitude of the tension response is plotted against the amplitude of stretch in Fig. 5. The curves for the control solution and matching submaximal calcium activation are linear and overlapping. On the other hand, the curve for 20 mM P_i started to deviate from the others at >0.3% of stretch amplitude. This amount of stretch corresponds to a filament displacement of ~ 4 nm/half sarcomere.

It is possible that the nonlinear tension response observed in the presence of P_i is caused because the stretch applied at one end of the fibers is not transmitted correctly when its amplitude is small. To test this possibility, the sarcomere length was monitored by laser diffraction during stretch. At full activation, the laser diffraction line usually broadened and measurement of its position was sometimes impossible. In the case of 20 mM P_i or submaximal calcium, the diffraction lines were clearer, possibly due to smaller tension. Fig. 6 shows an example of the sarcomere length recording in the presence of 20 mM P_i . The sarcomere length change

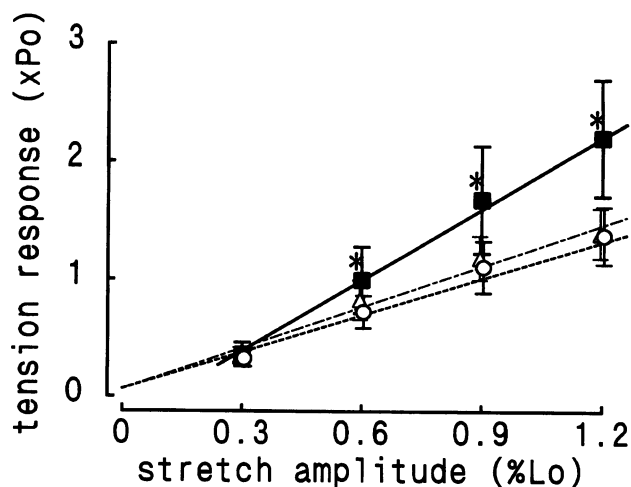

FIGURE 5 Dependence of tension response to stretch on the amplitude of stretch (duration, 10 ms). The peak tension response to stretch is divided by isometric tension as in Fig. 2. (O) Control; (■) 20 mM added P_i ; (Δ) submaximal calcium activation. Mean \pm SD ($n = 7$). The asterisk (*) by the square indicates that the difference between the values for 20 mM P_i and control is significant (paired *t*-test, $p < 0.005$ at 0.6%, $p < 0.001$ at 0.9 and 1.2% stretch). The lines are drawn by least-squares regression (---, control; —, 20 mM P_i ; - - -, submaximal calcium activation). Note that the line for 20 mM P_i starts to deviate from other lines at 0.3% stretch.

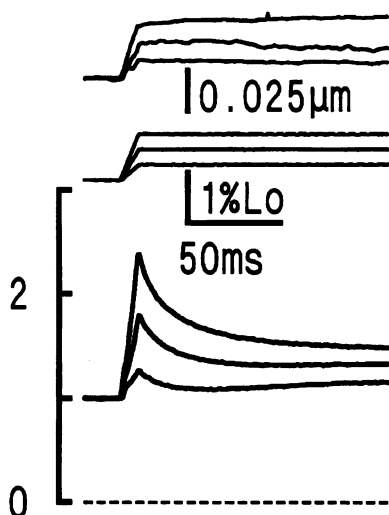

FIGURE 6 Sarcomere length change during stretch in the presence of 20 mM added P_i . Top traces, sarcomere signal; middle traces, overall fiber length (position output of the servomotor); bottom traces, tension. Sarcomere signal was recorded as the position of the first-order reflection with a position-sensitive diode. Tension is normalized to the value before stretch. Traces for 0.3, 0.6, and 0.9% stretches are superposed. The He-Ne laser beam irradiated the central region of the fibers.

was found roughly proportional to the amplitude of applied length changes whereas the nonlinearity in the tension response was clear. Therefore, the nonlinear tension response in the presence of P_i can be regarded as a genuine property of the fibers.

Dependence of the tension response on the duration of stretch

The above experiments suggest that the P_i -induced enhancement of the tension response to stretch is caused by the displacement of the low force cross-bridges beyond the critical distance of ~ 4 nm. If those low force cross-bridges are repeating rapid attachment/detachment, the effect of enhanced tension response should disappear as the velocity of stretch is reduced, as the cross-bridges would detach before they are displaced beyond the critical distance. To test this, we examined the velocity dependence of the tension response to stretch.

Fig. 7 shows the tension responses to stretches the durations of which are 1, 10, 40, and 160 ms. The enhancement of the tension response in the presence of 20 mM P_i (Fig. 7b) is recognized for all durations.

One of the methods to demonstrate the enhanced tension response is to take the ratio of the tension responses at two different amplitudes. For example, should the effect of enhancement exist, the amplitude of the tension response at 1.2% stretch would be more than three times that at 0.4% stretch. Fig. 8 shows the results of such an experiment with stretch durations ranging from 1 to 1280 ms. The ratios of the tension responses (1.2:0.4%) for the control solution and submaximal level of calcium are close to 3 for most of the stretch durations. The cause of the rise of the ratio in the

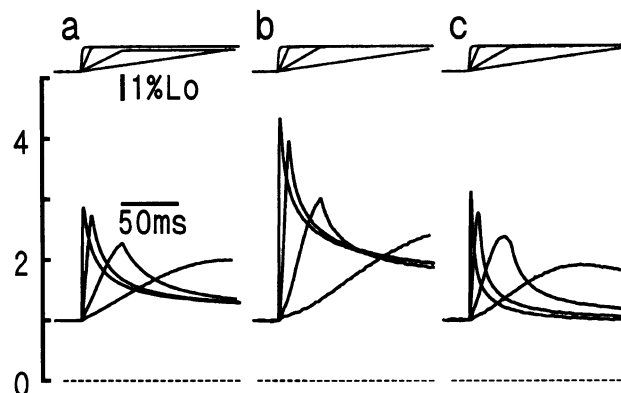

FIGURE 7 Tension responses to stretches (amplitude, 1.2% L_0) of different durations. Tension responses to 1-, 10-, 40-, and 160-ms stretches are superposed. Top traces, length (position output of the servomotor); bottom traces, tension. Tension is normalized to the values before stretch. (a) Control; (b) 20 mM added P_i ; (c) submaximal calcium activation. Note that the tension responses to stretch in b are still larger than others at the duration of 160 ms.

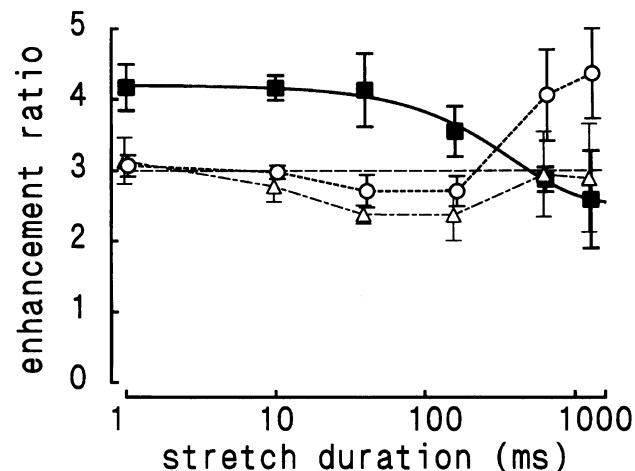

FIGURE 8 Linearity of tension response as a function of the duration of stretch. For each stretch duration, the magnitude of the tension response at 1.2% stretch is divided by that at 0.4% and plotted against the stretch duration in a logarithmic scale. This enhancement ratio should give a value of 3 (horizontal broken line) if the tension response is linear. (○) Control; (■) 20 mM added P_i ; (△) submaximal calcium activation. Mean \pm SD ($n = 5$ or 6). The solid line represents $y = 1.68e^{-0.398t} + 2.52$, where t is the duration of stretch in seconds.

control solution at very long durations is not clear, but this could be caused by the tendency of isometric tension to slowly decrease during a contraction. This could have led to a spuriously small value of response to a 0.4% stretch and therefore a high ratio. Such a tendency was not observed in the presence of P_i and therefore the data should be free of such an artifact.

In the presence of 20 mM P_i , the ratio is substantially higher than 3 for faster stretches. The ratio gradually decreases as the duration is prolonged and finally crosses the 3 line at ~ 500 ms duration. The ratio can be reasonably fitted to the sum of a single exponential and an offset, though the

offset is slightly less than 3. The solid curve in Fig. 8 represents $y = 1.68e^{-t/0.398} + 2.52$, where t is the duration of stretch in seconds. This suggests that the rate constant for the attachment/detachment of the low force, presumably $A \cdot M \cdot ADP \cdot P_i$ cross-bridges, is as small as $\sim 2.5 \text{ s}^{-1}$, in marked contrast to the rate constant for the low salt, relaxed cross-bridges ($\sim 5,000\text{--}10,000 \text{ s}^{-1}$; Schoenberg, 1988).

DISCUSSION

Implications for the calcium activation mechanism of muscle contraction

As mentioned earlier, there has been a debate regarding the step of calcium regulation in the cycle of the actomyosin ATPase reaction. The point is whether calcium regulates the attachment of myosin heads to actin (Huxley, 1973; Parry and Squire, 1973) or the step of P_i release (Chalovich et al., 1981). Comparison of the effect of P_i with the effect of reducing free calcium is expected to provide clues to this question.

In the present study, the calcium concentration was reduced so that the isometric tension level was comparable to that in the presence of 20 mM P_i ($\sim 30\%$ of isometric tension in the control solution). The dynamic properties of the fibers at low calcium concentration were remarkably similar to those in the control solution, in that (1), the magnitude of the tension response to stretch was almost proportional to the amplitude of stretch and (2), the phase lead of the tension response to 500 Hz oscillations and the stiffness-to-tension ratio are comparable with those in the control solution. These results would be best explained if reducing free calcium decreases the number of attached cross-bridges while their dynamic properties are unchanged (similar conclusions were reached by sinusoidal analysis; Kawai et al., 1981). Therefore, at least in high ionic strengths, calcium seems to control mainly the step before the step of force generation. This view is consistent with the results by Millar and Homsher (1990) that the rate of mechanical transients elicited by the photorelease of P_i (k_p), which reflects the force-generating isomerization, is not affected by calcium. Walker et al. (1992) found a small dependence of k_p on calcium, but its magnitude excluded the possibility of P_i release as the major regulation point by calcium. The reaction scheme presented by Potma et al. (1994) is also consistent with the present findings.

It is possible that calcium regulates more than one of the steps of actomyosin ATPase cycle. The result of Martyn and Gordon (1992) that fiber stiffness is more calcium sensitive than tension was not reproduced in the present study with 500 Hz oscillation. However, the larger tendency of the high force cross-bridges to yield at low calcium concentrations suggests that calcium also affects the mechanical properties of the cross-bridges that are already attached. The ionic strength of the bathing solution may also affect the step of calcium regulation. Recent results by Ma and Taylor (1994) have shown evidence that the calcium regulation at low ionic strength includes the step of product release. To settle this

problem, it will be necessary to perform various types of experiments on mechanics including those at low ionic strength.

Dynamic characteristics of the low force cross-bridges in the presence of P_i

The present results showed that the presence of P_i depresses isometric force more than stiffness, in accord with the previous studies with skinned rabbit muscle fibers (Hibberd et al., 1985; Kawai et al., 1987; Brozovich et al., 1988; Martyn and Gordon, 1992). In intact frog muscle fibers, in which intracellular P_i is known to increase in fatigue (Dawson et al., 1980), stiffness is also less affected than tension (Edman and Lou, 1990). A similar situation can be created by the presence of phosphate analogues, such as vanadate, aluminofluoride, and beryllium fluoride (Chase et al., 1993). In the presence of these analogues, fibers support little tension but still show stiffness. These analogues are considered to stabilize the actomyosin in a state analogous to $A \cdot M \cdot ADP \cdot P_i$. All of these studies support the view that addition of P_i reverses the steps of P_i release and increases the fraction of population of an $A \cdot M \cdot ADP \cdot P_i$ complex, which supports low tension but contributes to fiber stiffness.

When the fiber is oscillated at 500 Hz, the phase lead of tension over imposed oscillation is larger in the presence of P_i than in its absence. As the phase lead at matching submaximal calcium activation was not different from the control value, it is unlikely that the greater phase lead in the presence of P_i is an artifact due to the reduced resonant frequency of the fibers. Thus, the greater phase lead suggests that the $A \cdot M \cdot ADP \cdot P_i$ cross-bridges have a kinetic component that shows stress-relaxation occurring with a rate comparable to the frequency (500 Hz). Similar observations have been made in the presence of 10 mM P_i at a higher temperature (Dantzig et al., 1990).

The present results were obtained at 3–5°C, a temperature lower than usually used. Reducing the temperature will alter the distribution of the cross-bridge population among intermediates due to the differences in the temperature sensitivity of the rate constants. Dantzig et al. (1992) have shown that the forward rate constant of the force-producing isomerization of an $A \cdot M \cdot ADP \cdot P_i$ intermediate is highly temperature sensitive whereas the backward rate constant is not. Lowering temperature would then reverse this step and lead to reduced isometric tension and increased population of low force cross-bridges. This mechanism also seems to amplify the effect of P_i to increase the population of low force cross-bridges. At higher temperatures, the effect of P_i to reduce isometric tension is smaller. At 13–14°C, the nonlinearity in the tension response in the presence of 20 mM P_i (see Fig. 5) is less prominent than at 3–5°C but is still clearly observed (data not shown).

Mechanical sensitivity of the low force cross-bridges in the presence of P_i

The tension response to ramp stretch was enhanced by P_i when the stretch amplitude exceeded 0.3% of L_0 . Provided

the stiffness of each force-generating cross-bridge is unaffected by the presence of P_i , it implies that the low force cross-bridges start to support force upon stretch. As a result, the resistance of the fibers to stretch is retained even after isometric tension has been reduced by P_i . This has been experimentally verified by the reduced rate of fiber lengthening when the load of skinned rabbit fibers (Stienen et al., 1992) or intact frog muscle fibers during fatigue (Curtin and Edman, 1994) is clamped at values higher than their isometric tension.

As the low force cross-bridges start to support tension, the phase lead during 500 Hz oscillation was reduced. A 1.2% stretch reduced the phase lead to a level no different from the control value. This observation is best explained if a stretch converts the low force cross-bridges to a form of high force cross-bridges with a low rate of stress-relaxation.

There is evidence that the mechanically sensitive conversion of low force cross-bridges to high force ones takes place also in intact frog muscle fibers. During an isometric twitch of frog single fibers, the phase lead of tension over length at 1 kHz oscillation decreases as the tension rises after a stimulus (Iwamoto and Sugi, 1989). This decrease of the phase lead is accelerated by a stretch applied shortly after the stimulus as the tension is enhanced (Iwamoto et al., 1993), much as observed in the present study. X-ray evidence shows that, when the stretch is applied at the beginning of a twitch, the tension enhancement is accompanied by an accelerated mass movement from the myosin backbone to actin (Iwamoto et al., 1993). This behavior would be explained if the stretch shifts the equilibrium between detached and attached cross-bridges toward the latter, i.e., the low force cross-bridges are not merely subjected to physical extension, but their biochemical state is also altered.

Turnover kinetics of the $A \cdot M \cdot ADP \cdot P_i$ cross-bridges during contraction

Previous and present studies suggested that the low force cross-bridges in the presence of P_i contribute to fiber stiffness. These experiments were mostly carried out under high ionic strength conditions (~ 200 mM), in which little contribution of the weak binding, rapid equilibrium cross-bridges to stiffness is expected. Therefore, the cross-bridges in $A \cdot M \cdot ADP \cdot P_i$ or its analogous states are considered to represent a strong binding state (e.g., Brozovich et al., 1988).

Still a question remains as to whether these low force cross-bridges are still repeating rapid attachment/detachment as at low ionic strength. As mentioned earlier, the large phase lead observed in the presence of P_i could be explained by either (1), fast kinetics of attachment/detachment or (2), fast configurational fluctuations of cross-bridges with slow kinetics of attachment/detachment. The second possibility would equally explain the large phase lead because a strained cross-bridge will quickly relax to another configuration with less stress. An example is the rocking of a cross-bridge during the early tension recovery after a quick release (Huxley and Simmons, 1971). If the first possibility is correct, stretch-induced deceleration of cross-bridge detachment can also be

a mechanism for the enhanced tension response, besides the extension of attached cross-bridges. If the second possibility is correct, the mechanism for the enhancement would be the stretch-induced conversion of the cross-bridges from a low force to a high force state.

If the stretch-induced deceleration of detachment is the mechanism for the enhancement, the rate of attachment/detachment should be very fast, as the effect of enhanced tension response was already evident with a stretch as short as 1 ms. The result in Fig. 8 showed, however, that the decay of the P_i -induced enhancement has a rate constant of ~ 2.5 s^{-1} . Even after taking into consideration that the critical extension required to lock the cross-bridges in a high force state (~ 4 nm) corresponds to about one-fourth of the applied stretch in Fig. 8, the rate of attachment/detachment of low force cross-bridges would be still ~ 10 s^{-1} . Therefore, the large phase lead observed during 500 Hz oscillation would represent some configurational fluctuations of cross-bridges, i.e., a strained cross-bridge quickly relaxes into another configuration with lower stress while it stays attached to actin.

An interesting feature of the low force cross-bridges in the presence of P_i is that, in spite of their apparently slow turnover rate, they do not seem to inhibit shortening velocity (Cooke and Pate, 1985; Pate and Cooke, 1989; Warshaw et al., 1991). The low force cross-bridges may act like ratchets, i.e., they remain attached during stretch but easily detach during shortening. This mechanism would ensure enough velocity during shortening while providing enough resistance when the muscle is stretched externally.

The author expresses his hearty thanks to Prof. H. Sugi for his support of this work and to Dr. E. Homsher for his valuable comments on the manuscript.

REFERENCES

- Blinks, J. R. 1965. Influence of osmotic strength on cross-section and volume of isolated single muscle fibres. *J. Physiol.* 177:42–57.
- Brenner, B. 1988. Effect of Ca^{2+} on cross-bridge turnover kinetics in skinned single rabbit psoas fibers: implications for regulation of muscle contraction. *Proc. Natl. Acad. Sci. USA.* 85:3265–3269.
- Brenner, B., M. Schoenberg, J. M. Chalovich, L. E. Greene, and E. Eisenberg. 1982. Evidence for cross-bridge attachment in relaxed muscle at low ionic strength. *Proc. Natl. Acad. Sci. USA.* 79:7288–7291.
- Brozovich, F. V., L. D. Yates, and A. M. Gordon. 1988. Muscle force and stiffness during activation and relaxation: implications for the actomyosin ATPase. *J. Gen. Physiol.* 91:399–420.
- Cecchi, G., P. J. Griffiths, and S. Taylor. 1982. Muscular contraction: kinetics of cross-bridge attachment studied by high-frequency stiffness measurements. *Science.* 217:70–72.
- Chalovich, J. M., P. B. Chock, and E. Eisenberg. 1981. Mechanism of action of troponin tropomyosin: inhibition of actomyosin ATPase activity without inhibition of myosin binding to actin. *J. Biol. Chem.* 256:575–578.
- Chase, P. B., D. A. Martyn, M. J. Kushmerick, and A. M. Gordon. 1993. Effects of inorganic phosphate analogues on stiffness and unloaded shortening of skinned muscle fibres from rabbit. *J. Physiol.* 460:231–246.
- Cooke, R., and E. Pate. 1985. The effects of ADP and phosphate on the contraction of muscle fibers. *Biophys. J.* 48:789–798.
- Curtin, N. A., and K. A. P. Edman. 1994. Force-velocity relation for frog muscle fibres: effects of moderate fatigue and of intracellular acidification. *J. Physiol.* 475:483–494.
- Dantzig, J. A., Y. E. Goldman, and V. Lombardi. 1990. Cross-bridge vis-

- coelasticity in single rabbit skinned muscle fibres during steady lengthening and shortening in the presence and absence of phosphate. *J. Physiol.* 426:39P.
- Dantzig, J. A., Y. E. Goldman, N. C. Millar, J. Laktis, and E. Homsher. 1992. Reversal of the cross-bridge force-generating transition by photogeneration of phosphate in rabbit psoas muscle fibres. *J. Physiol.* 451:247-278.
- Dawson, M. J., D. G. Gadian, and D. R. Wilkie. 1980. Mechanical relaxation rate and metabolism studied in fatiguing muscle by phosphorus nuclear magnetic resonance. *J. Physiol.* 299:465-484.
- Edman, K. A. P., and F. Lou. 1990. Changes in force and stiffness induced by fatigue and intracellular acidification in frog muscle fibres. *J. Physiol.* 424:133-149.
- Ford, L. E., A. F. Huxley, and R. M. Simmons. 1986. Tension transients during the rise of tetanic tension in frog muscle fibres. *J. Physiol.* 372:595-609.
- Goldman, Y. E., M. G. Hibberd, and D. R. Trentham. 1984. Relaxation of rabbit psoas muscle fibres from rigor by photochemical generation of adenosine-5'-triphosphate. *J. Physiol.* 354:577-604.
- Hatta, I., H. Sugi, and Y. Tamura. 1988. Stiffness changes in frog skeletal muscle during contraction recorded using ultrasonic waves. *J. Physiol.* 403:193-209.
- Haugen, P., and O. Sten-Knudsen. 1987. The time course of the contractile force measured during a twitch under fixed sarcomere length. *J. Muscle Res. Cell Motil.* 8:173-187.
- Hibberd, M. G., D. R. Trentham, and Y. E. Goldman. 1985. Phosphate release and force generation in skeletal muscle fibers. *Science.* 228:1317-1319.
- Hill, A. V. 1949. The abrupt transition from rest to activity in muscle. *Proc. R. Soc. B.* 136:399-420.
- Huxley, H. E. 1973. Structural changes in the actin- and myosin-containing filaments during contraction. *Cold Spring Harbor Symp. Quant. Biol.* 37:361-376.
- Huxley, H. E. 1975. The structural basis of contraction and regulation in skeletal muscle. *Acta Anat. Nippon.* 50:310-328.
- Huxley, A. F., and R. M. Simmons. 1971. Proposed mechanism of force generation in striated muscle. *Nature.* 233:533-538.
- Iwamoto, H., and H. Sugi. 1989. Involvement of high-frequency actomyosin intermediates during normal contraction of frog skeletal muscle fibers. *Proc. Int. Union Physiol. Sci.* 17:86.
- Iwamoto, H., and H. Sugi. 1994a. Effect of inorganic phosphate on the stretch-induced tension enhancement in skinned rabbit skeletal muscle fibers. *Biophys. J.* 66:A303.
- Iwamoto, H., and H. Sugi. 1994b. Evidence that the myosin cross-bridge in an A·M·ADP·Pi state is converted to a force-producing form in a strain-dependent manner. *J. Muscle Res. Cell Motil.* 15:352.
- Iwamoto, H., K. Wakabayashi, Y. Amemiya, and H. Sugi. 1993. Mechanism of tension enhancement elicited by a ramp stretch applied at the onset of a twitch of frog skeletal muscle fibres. *J. Muscle Res. Cell Motil.* 14:359.
- Kawai, M., R. N. Cox, and P. W. Brandt. 1981. Effect of Ca ion concentration on cross-bridge kinetics in rabbit psoas fibers. *Biophys. J.* 35:375-384.
- Kawai, M., K. Guth, K. Winnikes, C. Haist, and J. C. Ruegg. 1987. The effect of inorganic phosphate on the ATP hydrolysis rate and the tension transients in chemically skinned rabbit psoas fibers. *Pflügers Arch.* 408:1-9.
- Kodama, T. 1985. Thermodynamic analysis of muscle ATPase mechanisms. *Physiol. Rev.* 65:467-551.
- Ma, Y.-Z., and E. W. Taylor. 1994. Kinetic mechanism of myofibril ATPase. *Biophys. J.* 66:1542-1553.
- Martyn, D. A., and A. M. Gordon. 1992. Force and stiffness in glycerinated rabbit psoas fibers: effects of calcium and elevated phosphate. *J. Gen. Physiol.* 99:795-816.
- Matsubara, I., and N. Yagi. 1978. A time-resolved x-ray diffraction study of muscle during twitch. *J. Physiol.* 278:297-307.
- Millar, N. C., and E. Homsher. 1990. The effect of phosphate and calcium on force generation in glycerinated rabbit skeletal muscle fibers: a steady-state and transient kinetic study. *J. Biol. Chem.* 265:20234-20240.
- Moisescu, D. G. 1976. Kinetics of reaction in calcium-activated skinned muscle fibres. *Nature.* 262:610-613.
- Parry, D. A. D., and J. M. Squire. 1973. Structural role of tropomyosin in muscle regulation: analysis of the x-ray diffraction patterns from relaxed and contracting muscles. *J. Mol. Biol.* 75:33-55.
- Pate, E., and R. Cooke. 1989. Addition of phosphate to active muscle fibers probes actomyosin states within the power stroke. *Pflügers Arch.* 414:73-81.
- Potma, E. J., G. J. M. Stienen, J. P. F. Barends, and G. Elzinga. 1994. Myofibrillar ATPase activity and mechanical performance of skinned fibres from rabbit psoas muscle. *J. Physiol.* 474:303-317.
- Schoenberg, M. 1988. Characterization of the myosin adenosine triphosphate (M·ATP) cross-bridge in rabbit and frog skeletal muscle fibers. *Biophys. J.* 54:135-148.
- Stein, L. A., R. P. Schwarz, Jr., P. B. Chock, and E. Eisenberg. 1979. Mechanism of actomyosin adenosine triphosphatase: evidence that adenosine 5'-triphosphate hydrolysis can occur without dissociation of the actomyosin complex. *Biochemistry.* 18:3895-3909.
- Stienen, G. J. M., P. G. A. Versteeg, and G. Elzinga. 1992. Mechanical properties of skinned rabbit psoas and soleus muscle fibres during lengthening: effects of phosphate and Ca²⁺. *J. Physiol.* 451:503-523.
- Wakabayashi, K., H. Tanaka, Y. Amemiya, A. Fujishima, T. Kobayashi, T. Hamanaka, H. Sugi, and T. Mitsui. 1985. Time-resolved x-ray diffraction studies on the intensity changes of the 5.9 and 5.1 nm actin layer lines from frog skeletal muscle during an isometric tetanus using synchrotron radiation. *Biophys. J.* 47:847-850.
- Walker, J. W., Z. Lu, and R. L. Moss. 1992. Effects of Ca²⁺ on the kinetics of phosphate release in skeletal muscle. *J. Biol. Chem.* 267:2459-2466.
- Warshaw, D. M., J. M. Desrosiers, S. S. Work, and K. M. Trybus. 1991. Effects of MgATP, MgADP, and Pi on actin movement by smooth muscle myosin. *J. Biol. Chem.* 266:24339-24343.