

Limb Mammary Syndrome: A New Genetic Disorder with Mammary Hypoplasia, Ectrodactyly, and Other Hand/Foot Anomalies Maps to Human Chromosome 3q27

Hans van Bokhoven,¹ Martin Jung,² Arie P. T. Smits,¹ Sylvia van Beersum,¹ Franz Rüschemdorf,² Maurice van Steensel,¹ Monique Veenstra,¹ Joep H. A. M. Tuerlings,¹ Edwin C. M. Mariman,¹ Han G. Brunner,¹ Thomas F. Wienker,² Andre Reis,^{2,3} Hans-Hilger Ropers,^{1,4} and Ben C. J. Hamel¹

¹Department of Human Genetics, University Hospital Nijmegen, Nijmegen; and ²Mikrosatellitenzentrum, Max-Delbrück-Centrum für Molekulare Medizin, ³Institute of Human Genetics, Charité, Humboldt University, and ⁴Max Planck Institut für Molekulare Genetik, Berlin

Summary

We report on a large Dutch family with a syndrome characterized by severe hand and/or foot anomalies, and hypoplasia/aplasia of the mammary gland and nipple. Less frequent findings include lacrimal-duct atresia, nail dysplasia, hypohydrosis, hypodontia, and cleft palate with or without bifid uvula. This combination of symptoms has not been reported previously, although there is overlap with the ulnar mammary syndrome (UMS) and with ectrodactyly, ectodermal dysplasia, and clefting syndrome. Allelism with UMS and other related syndromes was excluded by linkage studies with markers from the relevant chromosomal regions. A genomewide screening with polymorphic markers allowed the localization of the genetic defect to the subtelomeric region of chromosome 3q. Haplotype analysis reduced the critical region to a 3-cM interval of chromosome 3q27. This chromosomal segment has not been implicated previously in disorders with defective development of limbs and/or mammary tissue. Therefore, we propose to call this apparently new disorder “limb mammary syndrome” (LMS). The *SOX2* gene at 3q27 might be considered an excellent candidate gene for LMS because the corresponding protein stimulates expression of *FGF4*, an important signaling molecule during limb outgrowth and development. However, no mutations were found in the *SOX2* open reading frame, thus excluding its involvement in LMS.

Introduction

Limb defects are frequently encountered in humans, and their clinical presentation shows wide variation. In general, three categories can be distinguished (Stoll et al. 1998): (1) absence or severe hypoplasia leading to deficiencies of one or more limb elements; (2) duplication defects resulting in supernumerary limb elements (digits); and (3) fusion/separation defects, including syndactyly and symphalangia. Limb defects can be caused by genetic factors, chromosomal abnormalities, teratogens, mechanical constriction of limbs during fetal growth, or combinations of these factors.

Much of what is known about the normal development of limbs comes from experimental analysis of chick embryos (Tickle 1995; Cohn and Tickle 1996) and from spontaneous and induced mutations in mammals (Niswander 1997). The final specification of the limb morphology is determined by the action of signaling molecules along the three coordinates of the limb bud (proximal-distal, anterior-posterior, and dorsal-ventral). Signaling by fibroblast growth factors (FGFs) from the apical ectodermal ridge to the underlying mesenchyme promotes outgrowth of the bud and proximal-distal patterning (Niswander et al. 1993; Crossley et al. 1996). Expression of *Wnt-7a* in the dorsal ectoderm and *engrailed* in the ventral ectoderm provide the signals for dorsoventral pattern formation, as has been elegantly demonstrated by targeted inactivation of the respective genes in mice (Parr and McMahon 1995; Loomis et al. 1996). Expression of *Sonic hedgehog* (*Shh*) in the zone of polarizing activity, a group of cells in the posterior mesenchyme, is the key signal for anterior-posterior patterning of the limb (Riddle et al. 1993). Besides these signaling molecules, many others are involved in normal limb development. Signaling also occurs among the three axes, as demonstrated by the reciprocal interactions between *Shh*, *Fgf-4*, and *Wnt-7a* (Laufer et al. 1994; Nis-

Received August 6, 1998; accepted for publication December 15, 1998; electronically published February 4, 1999.

Address for correspondence and reprints: Dr. B. C. J. Hamel, Department of Human Genetics 417, University Hospital Nijmegen, P.O. Box 9101, 6500 HB Nijmegen, The Netherlands. E-mail: B.hamel@antrg.azn.nl

© 1999 by The American Society of Human Genetics. All rights reserved. 0002-9297/99/6402-0024\$02.00

wander et al. 1994; Parr and McMahon 1995; Yang and Niswander 1995).

During the past few years, there has been a steady increase in the number of limb disorders for which the genetic cause has been resolved. Some of the relevant proteins play a role as either signaling molecules (e.g., CDMP1 [Thomas et al. 1996, 1997; Polinkovsky et al. 1997]) or transcription factors (e.g., HOXA13, HOXD13, GLI3, LMX1B, and SOX9 [Vortkamp et al. 1991; Foster et al. 1994; Wagner et al. 1994; Muragaki et al. 1996b; Kang et al. 1997; Mortlock and Innis 1997; Radhakrishna et al. 1997; Chen et al. 1998]) or function as structural proteins (e.g., COL9A2 [Muragaki et al. 1996a]). Two putative transcription factors belonging to the Brachyury (T) family have recently been implicated in human limb-malformation syndromes: TBX5 in Holt-Oram syndrome (Basson et al. 1997; Li et al. 1997) and TBX3 in the ulnar-mammary syndrome (UMS) (Bamshad et al. 1997). UMS is characterized by posterior-limb deficiencies or duplications in conjunction with mammary-gland hypoplasia and apocrine and genital defects (Bamshad et al. 1996).

Here we present a large family with clinical manifestations resembling those seen in ectrodactyly, ectodermal dysplasia, clefting (EEC) syndrome and UMS. We propose the name "limb mammary syndrome" (LMS) for this apparently new syndrome. A genomewide screening with polymorphic markers allowed the localization of the genetic defect to the subtelomeric region of chromosome 3q.

Patients and Methods

Patients

The family (fig. 1, *branch B*) was ascertained when VII:11 was referred for genetic counseling because of his split hand/foot and similar and other hand/foot anomalies in close relatives. After having collected all the clinical data, we realized that there was another family with a similar constellation of anomalies who were living in the same city (fig. 1, *branch A*). Through genealogical studies, we were able to connect these as two branches of one family. Branch A of the family contains 11 patients who are still alive (9 males and 2 females) and branch B contains 18 (9 males and 9 females). In total, 21 patients (16 males and 5 females) were examined clinically. Preliminary data on this family have been presented previously at the annual meeting of the European Society of Human Genetics (Hamel et al. 1996).

Genotyping

After informed consent was obtained, genomic DNA was extracted, by a salt extraction procedure, from peripheral blood lymphocytes of 77 members of the family

(Miller et al. 1988). The DNA concentration was measured by optical density (OD_{260}), and the purity was checked by determination of the $OD_{260}:OD_{280}$ ratio. Manual genotyping of microsatellite markers in the proximity of the *TBX3* gene on chromosome 12q23–q24 was performed as described elsewhere (Kremer et al. 1994). Semiautomated genotyping was performed as described by Saar et al. (1997), with an ABI 373A sequencer and GENESCAN 2.0 and GENOTYPER 1.2 software. Genotypes were checked for Mendelian segregation by LINKRUN. Microsatellite markers were chosen from the MDC-microsatellite panel, on the basis of the final Généthon (Fondation Jean Dausset/CEPH) linkage map (Dib et al. 1996).

Linkage Analysis

A restricted set of 36 family members was chosen for genomewide linkage analysis after extensive simulations to determine the most informative situation. Approximately 300 markers were typed in these individuals, which excluded most of the genome. Chromosomes 13 and 14 were not tested, because convincing evidence for linkage was obtained with two markers, D3S1580 and D3S1265, both from distal chromosome 3q. Subsequently, we employed a total of 10 markers from this region, in a 20-cM interval, to narrow the region of the genetic defect. Two-point LOD scores were calculated by the LINKAGE package (Lathrop and Lalouel 1984). Penetrance was arbitrarily determined at 95%, and marker-allele frequencies were estimated by the ILINK option. Disease-gene frequency was defined as .00001. The affection status of individuals V:13 and VI:5 was unknown at the time of the calculations and was therefore fixed at 0.

Mutation Analysis

The initial mutation screening of the *SOX2* gene was performed by SSCP analysis. Five pairs of primers corresponding to sequences of the open reading frame (ORF) of the intronless *SOX2* gene were used to amplify 200–300-bp fragments of the gene in patients and healthy individuals from the family and in an unrelated control individual. Primer sequences were as follows: 1F, 5'-ACAGCGCCCGCATGTACAACA-3'; 1R, 5'-C-GCTTGCTGATCTCCGAGTTG-3'; 2F, 5'-GGC-AACCAGAAAAACAGCCCG-3'; 2R, 5'-GTACCTAT-CCTTCTTCATGAGCG-3'; 3F, 5'-AGCGCTGCACAT-GAAGGAGCA-3'; 3R, 5'-GCGGTGCATGGGCTGCA-TCT-3'; 4F, 5'-TGATGCAGGACCAGCTGGGC3'; 4R, 5'-TGCTGATCATGTCCCGGAGGT-3'; 5F, 5'-ATGTCCTACTCGCAGCAGGGC-3'; and 5R, 5'-AT-TTCTCCCCCTCCAGTTCG-3'. PCR reactions were performed either with [32 P] end-labeled primers or in the presence of [32 P]-dCTP. The SSCP was performed ac-

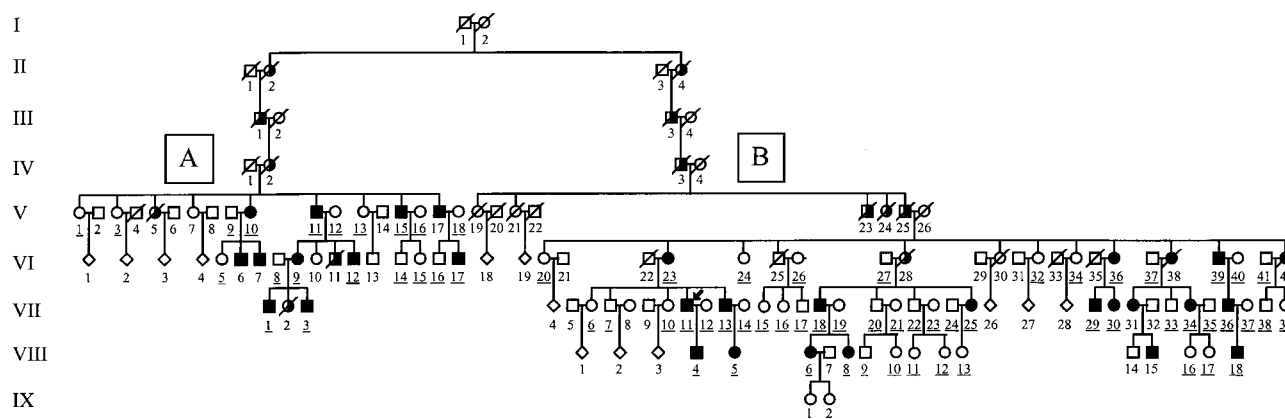

Figure 1 Pedigree of family with LMS. The proband, VII:11 in branch B, is indicated by the arrow. Genealogical study allowed us to connect branch B with branch A, which was already known to us. Blackened symbols denote affected individuals who had been clinically investigated by us; half-blackened symbols denote either obligate carriers of the disease or that the affected status was obtained anamnestically. Underlined numbers denote individuals on whom linkage analysis was performed.

according to the method of Orita et al. (1989), with slight modifications. Amplification products were denatured and applied to 6% nondenaturing polyacrylamide gels with or without 10% glycerol.

The entire ORF of the *SOX2* gene of patient VI:17 was also screened for mutations, by sequencing. For this, the *SOX2* sequences were amplified by primers 1F and 5R, and the resulting 1-kb product was cloned in the *Sma*I site of plasmid Bluescript SK⁺ (Stratagene). Both strands of seven individual clones were sequenced by the T3 and T7 primers, as well as primers 1F through 5R. Sequence reactions were performed by the Thermo Se-

quenase dye terminator cycle sequencing pre-mix kit (Amersham Life Science), according to the manufacturer's recommendations. Products were analyzed by an ABI 373A DNA Sequencing System (Applied Biosystems).

Results

Clinical Description of the Family

There were 29 living affected family members—18 men and 11 women. Medical records and clinical photographs were available for one deceased woman and for five other women who refused to be examined. Twenty-one individuals (16 males and 5 females) were clinically examined, and their medical histories were recorded. Clinical expression was extremely variable. The least affected person in the family is V:11, who has athelia only, although his grandchild VII:1 has severe hand and foot anomalies with athelia, lacrimal-duct atresia, hypodontia, and earpits. The clinical variability of the hand and foot anomalies is shown in figures 2–7. The three major categories of limb defects (i.e., deficiencies, duplications, and fusion/separation defects), as well as several combinations thereof, were all observed. Variation in the severity of the limb defects was observed not only between individuals but, occasionally, also between the left and right hand/foot of one individual. In general, patients from branch B (figs. 2–5 and 7) had more-pronounced limb defects than were seen in those from branch A (fig. 6). All clinical features are summarized in table 1. The most consistent defect was nipple hypoplasia/aplasia, which was seen in all affected individuals examined. Hand and/or foot anomalies and hypoplasia/aplasia of the mammary gland were also common features.

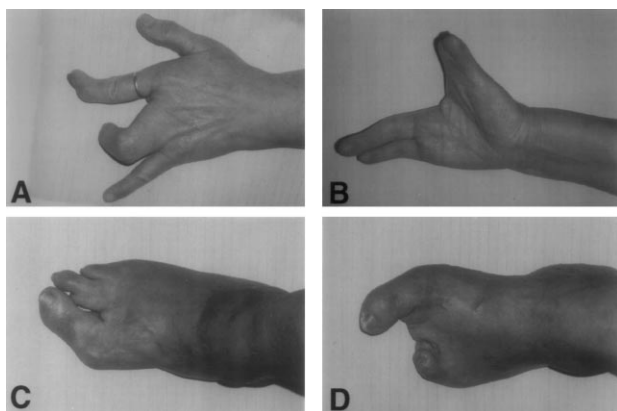

Figure 2 Hand and foot malformations of female VI:23. A, Right hand, showing syndactyly of 3d and 4th fingers and flexion or deformity of 2d–4th fingers. B, Left hand. Preaxial polydactyly with absence of the 2d and 3d fingers is most likely; alternatively, the defect is syndactyly of the 1st and 2d fingers, in combination with absence of the 3d finger. C, Right foot, showing hallux valgus, absence of the 2d toe, hypoplasia of the 3d toe, and syndactyly of the 3d and 4th toes. D, Left foot after surgical removal of the 2d and 3d toes, showing hypoplasia of the 4th and 5th toes and hallux valgus.

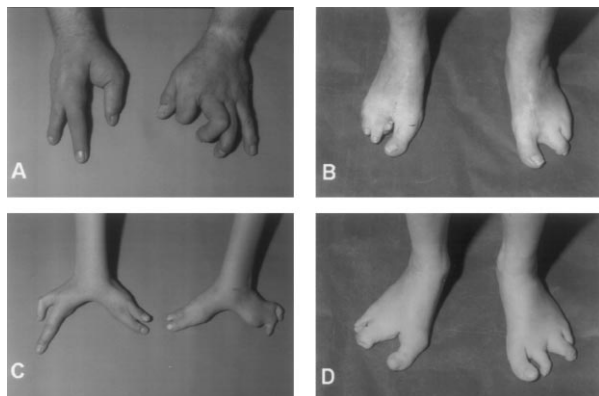

Figure 3 Hand and foot malformations of an affected son, VII:11, and grandson, VIII:4, of VI:23 (shown in fig. 2). *A*, Hands of VII:11. The right hand is cleft, with absence of the 2d and 3d fingers and hypoplasia of the 4th and 5th fingers; the left hand shows surgically corrected syndactyly of the 1st and 2d fingers and of the 3d and 4th fingers, hypoplasia of the 2d finger, and camptodactyly of the 3d and 4th fingers. *B*, Feet of VII:11, after undetermined surgical intervention. The right foot is split, with hallux valgus, absence of the 2d toe, syndactyly of the 3d–5th toes, and hypoplasia of the 3d toe; the left foot is split, with hallux valgus, absence of the 2d toe, and syndactyly of the 3d and 4th toes. *C*, Hands of VIII:4. The right hand is split, with absence of the 3d finger, syndactyly of the hypoplastic 1st and 2d fingers, and camptodactyly of the 5th finger; the left hand is split, with absence of the 3d finger and syndactyly of the 1st and 2d fingers and of the 4th and 5th fingers and with radial deviation of the tips of the 4th and 5th fingers. *D*, Feet of VIII:4. The right foot is split, with absence of the 2d toe, syndactyly of the 3d and 4th toes, and hallux valgus; the left foot is split, with syndactyly of the 3d and 4th toes and hallux valgus.

The differential diagnosis includes UMS (MIM 181450), EEC (MIM 129900), ectrodactyly with cleft palate (ECP [MIM 129830]), and acro-dermato-ungual-lacrimal-tooth (ADULT) syndrome (MIM 103285). Each of these entities, however, has one or more distinguishing features. The limb defects seen in this family were distinct from those in UMS (Bamshad et al. 1996). In the EEC and ECP syndromes, the hair/skin abnormalities are key features, which were not seen in this family. Cleft lip, a recurrent feature of EEC syndrome, was not observed in this family either. Furthermore, breast/nipple hypo/aplasia is only occasionally seen in EEC/ECP syndrome (Opitz et al. 1980; Rodini and Richieri-Costa 1990; Maas et al. 1996), whereas in this family it was a consistent feature. Additional characteristics of ADULT syndrome are hair and skin abnormalities and pigmentary problems, whereas cleft palate/bifid uvula, as well as breast and nipple anomalies, are lacking (Propping and Zerres 1993).

Linkage Analysis

Given the phenotypic overlap between this family and individuals with UMS, markers from the proximity of

the *TBX3* gene (i.e., D12S78, D12S84, D12S79, D12S369, and PLA-2) were tested for possible linkage. However, many recombination events between these markers and the disease locus were detected, excluding the involvement of the *TBX3* gene or any other gene in 12q23–q24. Other chromosomal regions to which syndromes with similar features have provisionally been localized were also excluded: 6q21 (split hand/foot syndrome), 7q11.21 and 19q (EEC syndrome), 7q21–q22 (split hand/foot), and 10q24–q25 (split hand/foot). Therefore, we decided to screen the entire genome to localize the genetic defect in this family. Almost 300

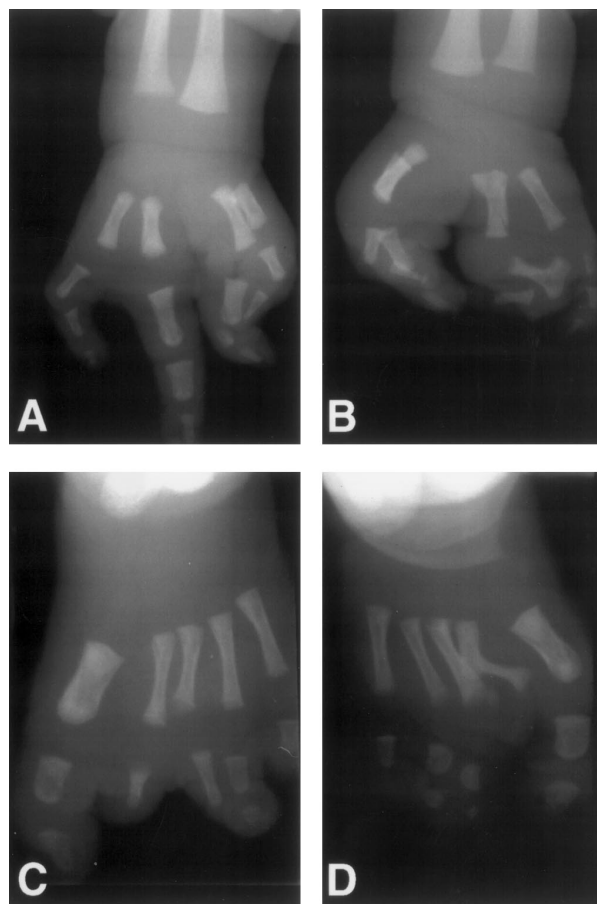

Figure 4 Radiographs of hand and feet of VIII:4, taken shortly after birth. For comparison with this individual's present condition, see fig. 3C and D. *A*, Right hand, showing normal 4th ray, absent 3d ray, and hypoplasia of the other three rays, with soft-tissue syndactyly of the 1st and 2d fingers. *B*, Left hand, showing absent 3d ray, superimposed 1st and 2d metacarpalia with incomplete phalanges, broad and possibly synostotic 4th metacarpus with bizarre synostotic phalanx, and soft-tissue syndactyly of the 1st and 2d fingers and of the 4th and 5th fingers. *C*, Left foot, showing normal metatarsalia except for the short 3d metatarsus, abnormally shaped and missing phalanges, and cutaneous syndactyly of the 3d and 4th toes. *D*, Right foot, showing hooked and possibly synostotic 2d metatarsus, abnormally shaped and missing phalanges, absence of the 2d toe, and cutaneous syndactyly of the 3d and 4th toes.

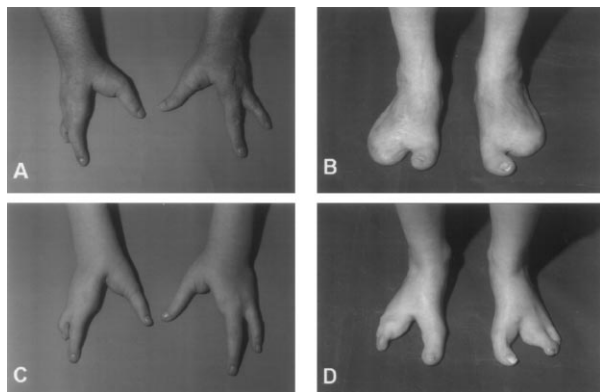

Figure 5 Hand and foot malformations of an affected son, VII:13, and granddaughter, VIII:5, of VI:23 (shown in fig. 2). *A*, Hands of VII:13. The right hand is split, with absence of the 2d and 3d fingers, syndactyly of the 4th and 5th fingers, and hypoplasia of the 5th finger. *B*, Feet of VII:13 after surgical removal of syndactylous toes, showing hallux valgus. *C*, Hands of VIII:5. The right hand is split, with absence of the 2d and 3d fingers, syndactyly of the 4th and 5th fingers, and both hypoplasia and camptodactyly of the 5th finger; the left hand is split, with absence of the 2d and 3d fingers. *D*, Feet of VIII:5. The right foot is split, with absence of the 2d toe, syndactyly of the 3d-5th toes, and hypoplasia of the 3d toe; the left foot is split, with absence of the 2d toe, syndactyly of the 3d and 4th toes, and hallux valgus.

markers were analyzed in a restricted set of 36 individuals, who were selected after extensive simulations to determine the most informative part of the family. Most of the genome could be excluded in this way, except for chromosomes 13 and 14, which were not tested. Evidence for linkage was obtained on distal chromosome 3q, near D3S1580 and D3S1265. To narrow this region,

a more detailed investigation was then performed in the entire family (72 persons), by use of a total of 10 markers covering a 20-cM interval within this region (table 2). Significant LOD scores (i.e., >3) were obtained with almost all markers from the 3q27 region. The highest LOD score was 12.014 at a recombination fraction (θ) of 0, for marker D3S3530. In addition, haplotype analysis was performed with the 10 markers from the critical region of chromosome 3. Reconstruction of the most probable haplotypes was accomplished manually and allowed us to trace the recombination events. An overview of the critical recombinations is presented in figure 8. Marker D3S2398 is not included in this figure because its position relative to the other markers could not be determined. A recombination event between D3S1314 and D3S3530 was seen in unaffected female V:1. The proximal boundary was determined by a recombination event between D3S1580 and D3S3530 in affected male VII:3. Additional crossovers were seen between D3S3686 and D3S1580, as well as between D3S1314 and D3S1601, showing that the most likely location of the genetic defect in this family is between D3S1580 and D3S1314.

Mutation Analysis in the SOX2 Gene

Of the few genes that have been mapped to the critical region on chromosome 3q, *SOX2*, a member of the *SRY*

Table 1

Summary of Clinical Features

Defect	Frequency
Hand anomalies ^a	18/27
Foot anomalies ^a	21/27
Mammary gland hypo/aplasia ^b	10/11
Nipple hypo/aplasia	27/27
Lacrimal-duct atresia ^c	7/15
Nail dysplasia	7/21
Hypohydrosis	7/21
Cleft palate/bifid uvula ^d	6/22
Hypodontia	3/21
Furunculosis/hydradenitis	3/21
Earpits	2/21
Skin and/or hair anomalies	0/21

^a Includes camptodactyly, brachydactyly, syndactyly, preaxial polydactyly, split hand/foot, incomplete phalanges, and hypoplasia.

^b One female was prepubertal.

^c In the absence of records, this defect could not always be verified.

^d One of the five women not examined had a cleft palate.

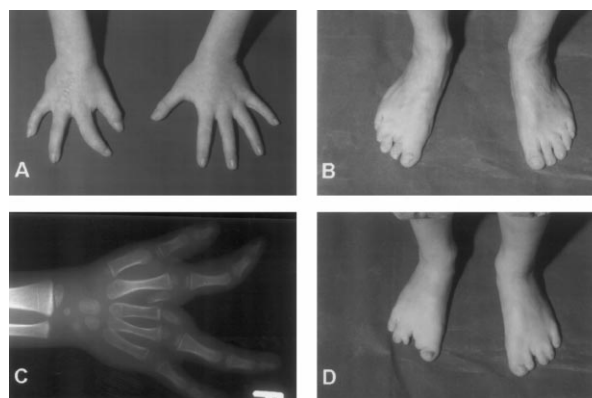

Figure 6 Limb defects observed in VI:9 and her son VII:3. *A*, Hands of VII:3. The right hand, shown after surgical removal of the 3d-ray bones, shows radial deviation of the 2d finger; the left hand is normal. *B*, Feet of VI:9. The right foot shows syndactyly of the 1st and 2d toes and of the 3d and 4th toes; the left foot is normal. *C*, Radiograph of right hand of VII:3 before surgery, showing normal metacarpalia, except for outgrowth of the 2d finger; radial deviation in the proximal interphalangeal joint of the 2d finger; absence of the 3d finger; and bony structures both between the 2d and 3d metacarpalia and on top of the 3d metacarpus. *D*, Feet of VII:3. The right foot is split, with syndactyly of the 1st and 2d toes and of the 3d and 4th toes and with hypoplasia of the 2d and 3d toes; the left foot is split, with syndactyly of the 1st and 2d toes and of the 3d and 4th toes and with hypoplasia of the 2d toe.

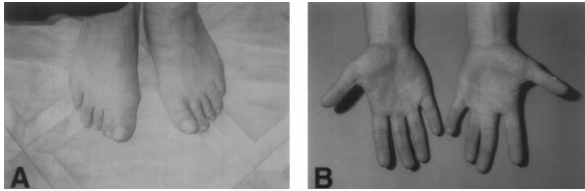

Figure 7 Limb defects observed in VI:39 and his son, VII:36. *A*, Feet of VI:39. The right foot shows syndactyly of the 1st and 2d toes; the left foot is normal. *B*, Hands of VII:36. The right hand is normal; the left hand shows syndactyly of the 3d and 4th fingers.

family, was considered a promising candidate because of its reported involvement in regulation of transcription of the *FGF4* gene (Yuan et al. 1995). Its entire 1-kb ORF, which is not interrupted by introns, was PCR-amplified by primers 1F and 5R. After verification of the sequence, this PCR product was used to hybridize a Southern blot containing *EcoRI*-digested DNA from several affected and unaffected individuals in this family. A 5-kb fragment was detected, which was of comparable intensity in all lanes, excluding a large deletion as the cause of the disorder (data not shown). Next, mutation screening of the *SOX2* gene was performed by SSCP analysis. For this, five pairs of primers were designed that amplified the gene in overlapping fragments of 200–300 bp. Electrophoretic separation of the [³²P]-labeled products on gels with or without glycerol did not reveal any aberrantly migrating band. Finally, to exclude the possibility that a possible mutation had been missed by the SSCP screening, we sequenced the ORF of the *SOX2* gene from patient VI:17. No deviations from the published sequence were detected after sequencing of both DNA strands.

Discussion

We have presented a new syndrome with defects of the limbs, nipples, and mammary glands, which we have

denoted “LMS.” The locus for LMS could be assigned to a restricted region on chromosome 3q27. The major differential diagnosis for LMS is probably the EEC syndrome. However, mammary gland and nipple defects, which are the most consistent features in this LMS family, have been reported only occasionally for patients with classic EEC (Freire-Maia and Pinheiro 1984; Gorlin et al. 1990; Roelfsema and Cobben 1996). Furthermore, skin and hair anomalies have a very high incidence among patients with EEC but were not observed in any patient in this LMS family (Freire-Maia and Pinheiro 1984; Gorlin et al. 1990; Rodini and Richieri-Costa 1990; Buss et al. 1995). Previous studies have identified loci for the EEC syndrome that are on chromosomes 7 and 19 (Scherer et al. 1994; O’Quinn et al. 1998), both of which were excluded for this LMS family. Nevertheless, since there is evidence that additional loci for the EEC syndrome do exist (O’Quinn et al. 1998), the final conclusion that LMS and some of the EEC cases are allelic may be obtained after families with EEC have been found to have linkage to the 3q27 locus.

Linkage analysis revealed a maximum two-point LOD score of 12.01 at $\theta = 0$, for D3S3530. Haplotype analysis indicated that the most likely critical region for LMS spans a 3-cM interval between D3S1580 and D3S1314 in 3q27. The distal boundary was determined by a recombination event between D3S1314 and D3S3530 in unaffected female V:1. This localization was obtained under the assumption of full penetrance of the disorder. If only the recombination events in affected individuals are taken into account, the critical region is a 6-cM interval between D3S1580 and D3S1601.

So far, no single gene is known to map to the critical 3q27 interval between D3S1580 and D3S1314, and only a few genes have been localized to the wider, 3q26.3–3q27 region, by FISH. Of these, *SOX2*, which encodes a member of the SRY-related HMG-box (*SOX*) family of DNA-binding proteins, has been considered to be a strong positional candidate gene for the disorder

Table 2
Cumulative Two-Point LOD Scores, between 3q27 Markers and LMS Locus

MARKER	LOD SCORE AT $\theta =$								MAXIMUM θ
	.00	.01	.05	.10	.15	.20	.30	.40	
D3S1262	-9.96	4.91	7.01	7.21	6.81	6.13	4.26	1.91	7.21
D3S3686	-8.58	5.83	7.14	7.02	6.48	5.75	3.91	1.71	7.14
D3S1580	6.87	9.74	9.79	9.16	8.30	7.31	5.02	2.38	9.79
D3S3530	12.01	11.80	10.90	9.75	8.55	7.31	4.68	1.92	12.01
D3S2398	10.77	10.59	9.83	8.86	7.85	6.80	4.55	2.09	10.77
D3S1314	8.01	7.92	7.49	6.82	6.07	5.26	3.50	1.56	8.01
D3S1601	-5.66	1.42	2.90	3.30	3.28	3.04	2.21	1.05	3.30
D3S2748	-16.02	-1.82	.92	1.84	2.12	2.12	1.61	.74	2.12
D3S1265	-4.17	3.66	4.85	4.97	4.70	4.25	3.03	1.49	4.97
D3S1311	-19.21	-2.61	1.03	2.32	2.76	2.81	2.23	1.10	2.81

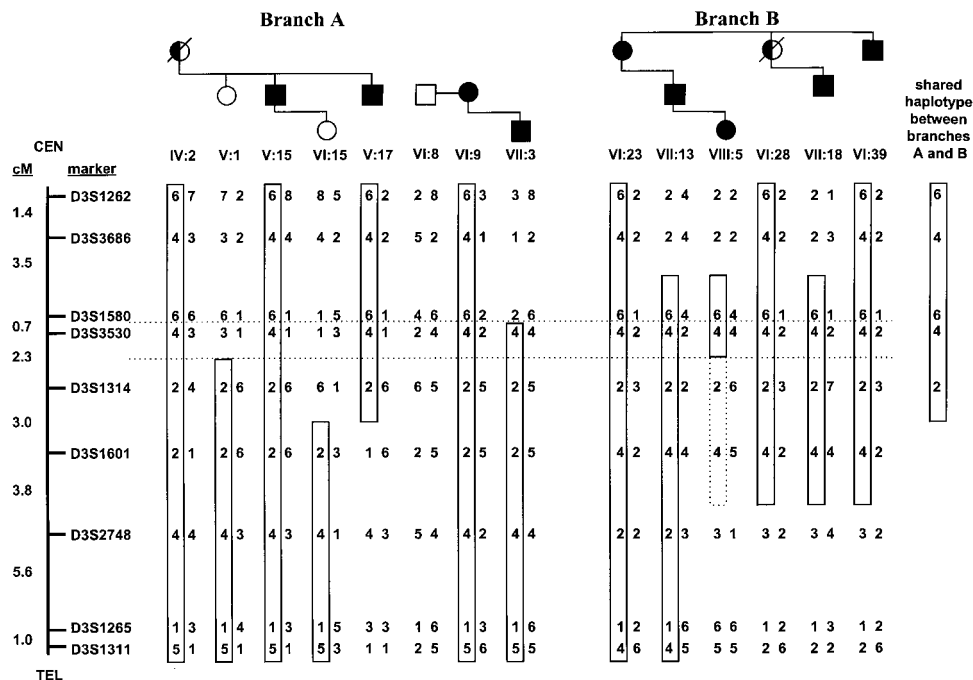

Figure 8 Schematic representation of critical recombination events. The order of markers in the relevant region of chromosome 3q27 is shown on the left. The various alleles of a marker that were encountered in the individuals shown are identified by number. Boxes denote haplotypes that cosegregate with the disorder. Note that affected individuals from branches A and B have different alleles for markers D3S1601, D3S2748, D3S1265, and D3S1311, which reflects an ancient recombination event in the family. The box on the far right denotes the haplotype common to all affected individuals. Markers D3S1314 and D3S1601 are not informative for patient VIII:5, who is represented by the dotted line.

described here (Stevanovic et al. 1994). Studies with embryonic stem cells have shown that the mouse Sox2 protein can form a ternary complex with either the ubiquitous Oct-1 or the embryonic Oct-3 protein, on enhancer sequences of the *Fgf-4* gene (Yuan et al. 1995). However, only the Sox2-Oct3 complex is able to promote transcriptional activation of the gene. It is well established that FGF-4 is an essential signaling molecule for growth and pattern formation of the developing limb (Niswander et al. 1993; Parr and McMahon 1995; Yang and Niswander 1995) and, probably, of the mammary gland (Coleman-Krnacik and Rosen 1994). It was therefore anticipated that mutation of a protein involved in regulation of embryonic *FGF4* transcription could result in a phenotype including limb defects. Mutation analysis in the *SOX2* gene of patients, determined by Southern blotting, SSCP, and sequencing, did not reveal any deviation of the published *SOX2* sequence. Thus, it is highly unlikely that LMS is caused by mutation of *SOX2*, although we cannot exclude disruption of promoter regulatory sequences. Another strong positional candidate gene is *DVL3*, a human homologue of the *Drosophila dishevelled* gene (Pizzuti et al. 1996). The segment polarity gene *dishevelled* is required for response to the "wingless," or "Wg," signal, the *Dro-*

sophila equivalent of WNT (i.e., the wingless-type MMTV integration-site family) (Klingensmith et al. 1994). Southern hybridization of *EcoRI*-digested DNA with a probe from the human *DVL3* gene was unable to detect any gross alteration of this gene (data not shown). Fine mapping of *DVL3* should soon reveal whether it is located in the critical interval, and, if it is, then exhaustive mutation screening will be performed in patients with LMS.

The region between D3S1580 and D3S1314 measures 2-3 Mb and has been fully covered by YAC clones (Gemmill et al. 1995). According to the Human Gene Map and the UniGene map, ~10 expressed sequence tags (ESTs) have been assigned to this segment, and, for three of these (WI-6145, WI-8844, and WI-6489), the location on one or more YAC clones from the critical interval has been demonstrated. Accurate mapping of the other ESTs should indicate which of these can be considered part of a positional candidate gene.

Finding the causative gene for LMS is of particular interest, given the unique combination of symptoms, the extreme clinical variation, and the suggestion that other genes influence the severity of the limb defects. Pleiotropic genetic features are also seen in UMS. It has been proposed that the causative gene in UMS, *TBX3*, is in-

involved in promotion of the regional induction of specific mesodermal cell populations during limb development. Furthermore, a role for *TBX3* in ectoderm-mesoderm inductive interactions is suggested by both its expression in ectoderm-derived epithelial structures of the mammary buds and its lack of expression in the underlying mesenchyme. Given the clinical overlap between UMS and LMS, it seems plausible that the causative genes in these syndromes have similar functions. Several other members of the same *Brachyury* (*T*) family have been identified, but so far none of these has been localized to chromosome 3. Alternatively, the causative gene in the LMS family in the present study encodes a protein that functions in the same signaling pathway as does *TBX3*. So far, molecules interacting with members of the *Brachyury* family have not been identified in mammals. Therefore, elucidation of the genetic defect in the family in the present study may have important implications for the field of developmental biology. Finding the causative gene for LMS will also provide the tools to definitively test the possibility of allelism between LMS and some cases of EEC.

Acknowledgments

We are grateful to the family for its participation in this research. We thank S. van der Velde-Visser and L. Boender-van Rossum for handling the blood samples. Drs. G. Van Buggenhout, H. Hoekstra, and J. Cobben are acknowledged for their aid in the clinical examination of some of the patients. The technical assistance of Barbara Beyer is gratefully acknowledged. The MDC Mikrosatellitenzentrum is supported by a grant in aid from the German Genome project to A.R. and T.F.W.

Electronic-Database Information

Accession numbers and URLs for data in this article are as follows:

- Fondation Jean Dausset/CEPH, <http://www.cephb.fr> (for markers used in the genome screen, and genetic map and distances between markers from chromosome 3q27)
 Human Gene Map, <http://www.ncbi.nlm.nih.gov/SCIENCE96> (for mapping of ESTs between D3S1580 and D3S1314)
 Online Mendelian Inheritance in Man (OMIM), <http://www.ncbi.nlm.nih.gov/Omim> (for ADULT [MIM 103285], ECP [MIM 129830], EEC [MIM 129900], and UMS [MIM 181450])
 UniGene, <http://www.ncbi.nlm.nih.gov/UniGene> (for mapping of ESTs to the region between D3S1580 and D3S1314)

References

- Bamshad M, Lin RC, Law DJ, Watkins WC, Krakowiak PA, Moore ME, Franceschini P, et al (1997) Mutations in human *TBX3* alter limb, apocrine and genital development in ulnar-mammary syndrome. *Nat Genet* 16:311–315
- Bamshad M, Root S, Carey JC (1996) Clinical analysis of a large kindred with the Pallister ulnar-mammary syndrome. *Am J Med Genet* 65:325–331
- Basson CT, Bachinsky DR, Lin RC, Levi T, Elkins JA, Soultis J, Grayzel D, et al (1997) Mutations in human cause limb and cardiac malformation in Holt-Oram syndrome. *Nat Genet* 15:30–35
- Buss PW, Hughes HE, Clarke A (1995) Twenty-four cases of the EEC syndrome: clinical presentation and management. *J Med Genet* 32:716–723
- Chen H, Lun Y, Ovchinnikov D, Kokubo H, Oberg KC, Picicelli CV, Gan L, et al (1998) Limb and kidney defects in *Lmx1b* mutant mice suggest an involvement of *LMX1B* in human nail patella syndrome. *Nat Genet* 19:51–55
- Cohn MJ, Tickle C (1996) Limbs: a model for pattern formation within the vertebrate body plan. *Trends Genet* 12:253–257
- Coleman-Krnacik S, Rosen JM (1994) Differential temporal and spatial gene expression of fibroblast growth factor family members during mouse mammary gland development. *Mol Endocrinol* 8:218–229
- Crossley PH, Minowada G, MacArthur CA, Martin GR (1996) Roles for *FGF8* in the induction, initiation, and maintenance of chick limb development. *Cell* 84:127–136
- Dib C, Faure S, Fizames C, Samson D, Drouot N, Vignal A, Millasseau P, et al (1996) A comprehensive genetic map of the human genome based on 5,264 microsatellites. *Nature* 380:152–154
- Foster JW, Dominguez-Steglich MA, Guioli S, Kwok C, Weller PA, Stevanovic M, Weissenbach J, et al (1994) Campomelic dysplasia and autosomal sex reversal caused by mutations in an *SRY*-related gene. *Nature* 372:525–530
- Freire-Maia N, Pinheiro M (1984) Ectodermal dysplasias: a clinical and genetic study, 1st ed. Alan R Liss, New York
- Gemmill RM, Chumakov I, Scott P, Waggoner B, Rigault P, Cypser J, Chen Q, et al (1995) A second generation YAC contig map of human chromosome 3. *Nature Suppl* 377:299–319
- Gorlin RJ, Cohen MM Jr, Levin LS (1990) Syndromes of the head and neck, 3d ed. Oxford University Press, New York and Oxford
- Hamel B, Smits A, van Beersum S, Hoekstra H, Mariman E, Tuerlings J, van Buggenhout G, et al (1996) A large family with limb-mammary syndrome: clinical and molecular findings. *Eur J Hum Genet Suppl* 4:148
- Kang S, Graham JM Jr, Olney AH, Biesecker LG (1997) *GLI3* frameshift mutations cause autosomal dominant Pallister-Hall syndrome. *Nat Genet* 15:266–268
- Klingensmith J, Nusse R, Perrimon N (1994) The *Drosophila* segment polarity gene *dishevelled* encodes a novel protein required for response to the wingless signal. *Genes Dev* 8:118–130
- Kremer H, Pinckers A, van den Helm B, Deutman AF, Ropers HH, Mariman ECM (1994) Localization of the gene for dominant cystoid macular dystrophy on chromosome 7p. *Hum Mol Genet* 3:299–302
- Lathrop GM, Lalouel JM (1984) Easy calculations of LOD scores and genetic risks on small computers. *Am J Hum Genet* 36:460–465
- Laufer E, Nelson CE, Johnson RL, Morgan BA, Tabin C (1994) Sonic hedgehog and *FGF-4* act through a signalling cascade

- and feedback loop to integrate growth and patterning of the developing limb bud. *Cell* 79:993-1003
- Li QY, Newbury-Ecob RA, Terrett JA, Wilson DI, Curtis AR, Yi CH, Gebuhr T, et al (1997) Holt-Oram syndrome is caused by mutations in *TBX5*, a member of the Brachyury (T) gene family. *Nat Genet* 15:21-29
- Loomis CA, Harris E, Michaud J, Wurst W, Hanks M, Joyner AL (1996) The mouse *Engrailed-1* gene and ventral limb patterning. *Nature* 382:360-363
- Maas SM, de Jong TPVM, Buss P, Hennekam RCM (1996) EEC syndrome and genitourinary anomalies: an update. *Am J Med Genet* 63:472-478
- Miller SA, Dykes DD, Polesky HF (1988) A simple salting out procedure for extracting DNA from human nucleated cells. *Nucleic Acids Res* 16:1215
- Mortlock DP, Innis JW (1997) Mutation of *HOXA13* in hand-foot-genital syndrome. *Nat Genet* 15:179-180
- Muragaki Y, Mariman ECM, van Beersum SEC, Perala M, van Mourik JBA, Warman ML, Olsen BR, et al (1996a) A mutation in the gene encoding the alpha-2 chain of the fibril-associated collagen IX, *COL9A2*, causes multiple epiphyseal dysplasia (EDM2). *Nat Genet* 12:103-105
- Muragaki Y, Mundlos S, Upton J, Olsen BR (1996b) Altered growth and branching patterns in synpolydactyly caused by mutations in *HOXD13*. *Science* 272:548-551
- Niswander L (1997) Limb mutants: what can they tell us about normal limb development? *Curr Opin Genet Dev* 7:530-536
- Niswander L, Jeffrey S, Martin GR, Tickle C (1994) A positive feedback loop coordinates growth and patterning in the vertebrate limb. *Nature* 371:609-612
- Niswander L, Tickle C, Vogel A, Booth I, Martin GR (1993) *FGF-4* replaces the apical ectodermal ridge and directs outgrowth and patterning of the limb. *Cell* 75:579-587
- Opitz JM, Frias JL, Cohen MM Jr (1980) The ECP syndrome, another autosomal dominant cause of monodactylous ectrodactyly. *Eur J Pediatr* 133:217-220
- O'Quinn JR, Hennekam RCM, Jorde LB, Bamshad M (1998) Syndromic ectrodactyly with severe limb, ectodermal, urogenital, and palatal defects maps to chromosome 19. *Am J Hum Genet* 62:130-135
- Orita M, Iwahana H, Kanazawa H, Hayashi K, Sekiya T (1989) Detection of polymorphisms of human DNA by gel electrophoresis as single-strand conformation polymorphisms. *Proc Natl Acad Sci USA* 86:2766-2770
- Parr BA, McMahon AP (1995) Dorsalizing signal *Wnt-7a* required for normal polarity of D-V and A-P axes of mouse limb. *Nature* 374:350-353
- Pizzuti A, Amati F, Calabrese G, Mari A, Colosimo A, Silani V, Giardino L, et al (1996) cDNA characterization and chromosomal mapping of two human homologues of the *Drosophila dishevelled* polarity gene. *Hum Mol Genet* 5:953-958
- Polinkovsky A, Robin NH, Thomas JT, Irons M, Lynn A, Goodman FR, Reardon W, et al (1997) Mutations in *CDMP1* cause autosomal dominant brachydactyly type C. *Nat Genet* 17:18-19
- Propping P, Zerres K (1993) ADULT-syndrome: an autosomal-dominant disorder with pigment anomalies, ectrodactyly, nail dysplasia, and hypodontia. *Am J Med Genet* 45:642-648
- Radhakrishna U, Wild A, Grzeschik KH, Antonarakis SE (1997) Mutation in *GLI3* in postaxial polydactyly type A. *Nat Genet* 17:269-271
- Riddle RD, Johnson RL, Laufer E, Tabin C (1993) Sonic hedgehog mediates the polarizing activity of the ZPA. *Cell* 75:1401-1416
- Rodini ESO, Richieri-Costa (1990) EEC syndrome: report on 20 new patients, clinical and genetic considerations. *Am J Med Genet* 37:42-53
- Roelfsema NM, Cobben JM (1996) The EEC syndrome: a literature study. *Clin Dysmorphol* 5:115-127
- Saar K, Chrzanowska KH, Stumm M, Jung M, Nürnberg G, Wienker TE, Seemanová E, et al (1997) The gene for the ataxia-telangiectasia variant, Nijmegen breakage syndrome, maps to a 1-cM interval on chromosome 8q21. *Am J Hum Genet* 60:605-610
- Scherer SW, Poorkaj P, Massa H, Soder S, Allen T, Nunes M, Geshuri D, et al (1994) Physical mapping of the split hand/split foot locus on chromosome 7 and implication in syndromic ectrodactyly. *Hum Mol Genet* 3:1345-1354
- Stevanovic M, Zuffardi O, Collignon J, Lovell-Badge R, Goodfellow P (1994) The cDNA sequence and chromosomal location of the human *SOX2* gene. *Mamm Genome* 5:640-642
- Stoll C, Duboule D, Holmes LB, Spranger J (1998) Classification of limb defects. *Am J Med Genet* 77:439-441
- Thomas JT, Kilpatrick MW, Lin K, Erlacher L, Lembessis P, Costa T, Tsipouras P, et al (1997) Disruption of human limb morphogenesis by a dominant negative mutation in *CDMP1*. *Nat Genet* 17:58-64
- Thomas JT, Lin K, Nandedkar M, Camargo M, Cervenka J, Luyten FP (1996) A human chondrodysplasia due to a mutation in a TGF-beta superfamily member. *Nat Genet* 12:315-317
- Tickle C (1995) Vertebrate limb development. *Curr Opin Genet Dev* 5:478-484
- Vortkamp A, Gessler M, Grzeschik KH (1991) *GLI3* zinc-finger gene interrupted by translocations in Greig syndrome families. *Nature* 352:539-540
- Wagner T, Wirth J, Meyer J, Zabel B, Held M, Zimmer J, Pasantes J, et al (1994) Autosomal sex reversal and campomelic dysplasia are caused by mutations in and around the SRY-related gene *SOX9*. *Cell* 79:1111-1120
- Yang Y, Niswander L (1995) Interaction between the signaling molecules *WNT7a* and *SHH* during vertebrate limb development: dorsal signals regulate anteroposterior patterning. *Cell* 80:939-947
- Yuan H, Corbi N, Basilico C, Dailey L (1995) Developmental-specific activity of the *FGF-4* enhancer requires the synergistic action of *Sox2* and *Oct-3*. *Genes Dev* 9:2635-2645