

# LIGHT DIFFRACTION STUDIES OF SARCOMERE DYNAMICS IN SINGLE SKELETAL MUSCLE FIBERS

PAUL J. PAOLINI, *Department of Biology, San Diego State University,  
San Diego, California 92182,*

KENNETH P. ROOS AND RONALD J. BASKIN, *Department of Zoology,  
University of California, Davis, California 95616 U.S.A.*

**ABSTRACT** A position-sensitive optical diffractometer has been used to examine the diffraction spectra produced by single skeletal muscle fibers during twitch and tetanic contraction. First-order diffraction lines were computer-analyzed for mean sarcomere length, line intensity, and percent dispersion in sarcomere length. Line intensity was observed to decrease rapidly by about 60% during a twitch, with an exponential recovery to resting intensity persisting well beyond cessation of sarcomere shortening; recovery was particularly prolonged at zero myofilament overlap. A number of single fibers at initial lengths from 2.5 to 3.5  $\mu\text{m}$  exhibited a splitting of the first-order line into two or more components during relaxation, with components merging back into a single peak by 200 ms after stimulation. This splitting reflects the asynchronous nature of myofibrillar relaxation within a single fiber. During tetanus, the dispersion decreased by more than 10% from onset to plateau, implying a gradual stabilization of sarcomeres.

## INTRODUCTION

When studying the contractile properties of whole skeletal muscles or even of isolated single fibers, it is necessary to assume that the myofibrillar sarcomeres within the muscle at any instant display identical lengths and uniform kinetics. This assumption is hardly justified, since the cells within most muscles are known to possess variable fiber types, thresholds, degrees of activation, and contraction kinetics; studies indicate that even in single fibers individual myofibrils may not be fully activated (Rüdel and Taylor, 1969). Consequently, it is important to assess variations in sarcomere length within the skeletal muscle fiber not only under steady-state (resting and tetanic plateau) but also under transient conditions (e.g., during the rise and fall of isometric tension or sarcomere shortening), as during a single twitch.

Because striated muscle cells possess a relative regularity in spacing of light and dark transverse bands along their length, they act like simple one-dimensional transmission diffraction gratings when illuminated by monochromatic light (Buchthal and Knappeis, 1940). The separation between zero and first-order optical diffraction

---

This work has appeared in abstract form (Paolini et al., 1977).

maxima provides an accurate measure of the transverse striation repeat distance, i.e., the sarcomere length (Cleworth and Edman, 1969) of the muscle fiber. The change in first-order diffraction line position has been used to follow sarcomere shortening during twitch contraction of cardiac muscle (Nassar et al., 1974; Krueger and Pollack, 1975) and during tetanic plateau of skeletal muscle (Goldspink et al., 1970; Paolini and Roos, 1975).

It has been shown that the distribution of sarcomere lengths increases during tetanus in bundles of two to nine fibers (Kawai and Kuntz, 1973), while no substantial increase was usually observed in single fibers (Paolini et al., 1976b). Resting sarcomere dispersion, calculated from the diffraction line width and confirmed by photomicrography of the same muscles, was observed to vary from about 2% in single fibers to 8–10% in large bundles or whole muscles.

As a consequence of the time lag associated with a 55 ms time constant of image persistence on the photocathode screen, the vidicon diffractometer used in these recent studies could not resolve dynamic changes in diffraction line profile or intensity during twitch contraction or onset of tetanus. Potentially lag-free diffractometers have now been developed (Paolini et al., 1976a; Pollack and Krueger, 1976; Halpern, 1977) that allow characterization of rapidly changing diffraction patterns. We have now examined the variations in average sarcomere length, the percent length dispersion, and the first-order line intensity that accompany twitch and tetanic contraction of single skeletal muscle cells.

## MATERIALS AND METHODS

### *Muscle Fiber Preparation*

Semitendinosus muscles from small, double-pithed grass frogs (*Rana pipiens*) were exposed and tied at each tendon with suturing thread. *In situ* lengths were measured to the nearest 0.5 mm; the ventral head of the muscle was removed and its entire dorsal segment was placed within the muscle chamber and covered with saline. With the aid of a low-power stereomicroscope, a microforceps and microscalpel were then used carefully to dissect fascia and adjacent fibers away from a single fiber within the center of the bundle. After dissection, single cells were allowed to equilibrate 30 min in saline at 0°C before experimentation. The composition of the frog Ringer's solution (in grams per liter) was NaCl, 6.50; KCl, 0.14; NaHCO<sub>3</sub>, 0.20; NaH<sub>2</sub>PO<sub>4</sub>, 0.011; CaCl<sub>2</sub>, 0.12; saline pH was adjusted to 7.4.

18 single fiber preparations were used in the experiments reported here. Of these 18, 11 fibers continued to exhibit twitch or tetanic responses for the duration of each experiment. Data from the other 7 fibers were discarded. In addition, 5 multifibered preparations, numbering from 2 to 20 fibers, were examined; data from a representative fiber bundle are presented for comparison with single-fiber preparations.

### *Muscle Chamber*

Fibers were mounted horizontally on a glass microscope slide enclosed by a rectangular plastic chamber, and fastened between a moveable clamp and the pin of a low-compliance (16  $\mu\text{m/g}$ ) strain gauge force transducer. Care was taken during mounting to insure that the fiber was not twisted. Fiber length was adjusted by a micrometer screw attached to the clamp. The fiber was stimulated by current pulses passed between two parallel platinum wires spaced 5 mm apart and

positioned on either side of the muscle. Twitch responses were elicited by supramaximal stimuli of 2 ms duration; upon tetanic stimulation these pulses were applied at a rate of 60 s<sup>-1</sup>. Tetanus:twitch tension ratios of approximately 2.5:1 were taken as evidence of good fiber quality.

*Optical System*

The muscle chamber was mounted 10 cm above a 632.8 nm helium-neon continuous wave laser. Laser output intensity was regulated within 1% at 3 mW. The intensity of laser beam passing through the bottom of the chamber was adjusted by crossed polarizer elements. Light diffracted by the fiber was collected by two cylindrical lenses positioned back to back so that diffraction bands produced by the fiber striations were focused to spots on the meridional plane. The image then passed through a field and relay lens assembly of variable focal length so that

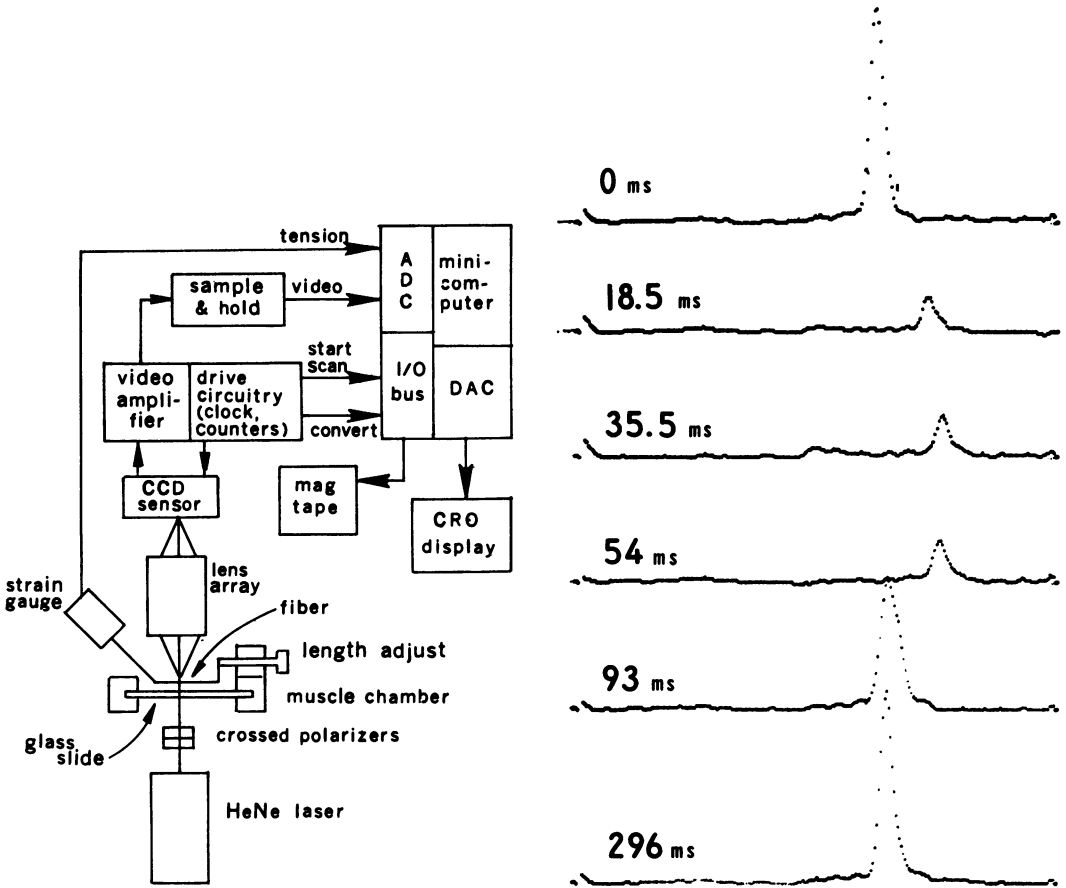

FIGURE 1

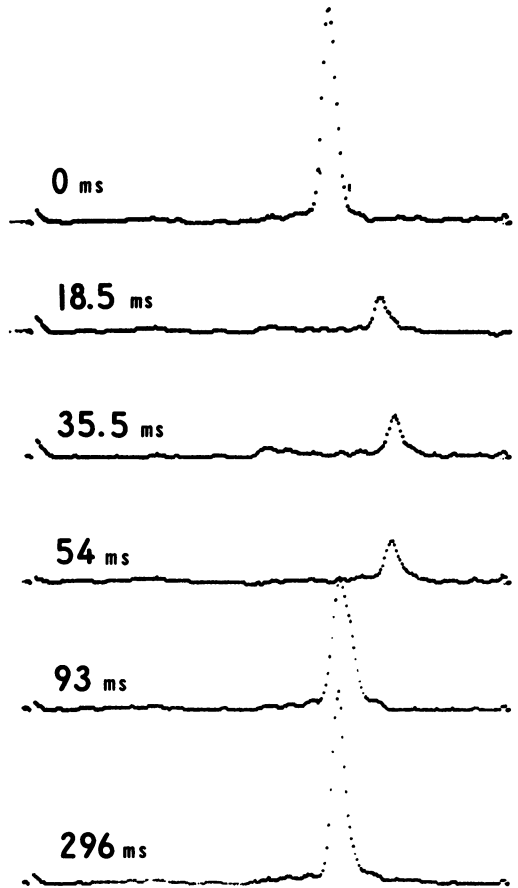

FIGURE 2

FIGURE 1 Optical diffractometer and data acquisition system.

FIGURE 2 First-order diffraction line spectra obtained from a single semitendinosus fiber (muscle 86) during an isometric twitch at 20°C. Time after stimulus is shown for each scan. Horizontal axis: sarcomere length in micrometers.

the zero and first-order maxima of the diffraction pattern were reduced to a spacing of 1 or 2 mm (Paolini et al., 1976a).

### *Diffractionmeter*

The image was focused upon the optical window of an integrated circuit chip, a Fairchild Corp. type CCD-110 256 element linear photosensor array (Fairchild Industrial Products Div., Fairchild Industries, Winston-Salem, N.C.). This "charge-coupled device" served as the detector of a position-sensitive diffractometer (Paolini et al., 1976a). The video signal from the sample-and-hold output circuit in the diffractometer consisted of stepwise changes in analogue voltage corresponding to the light level sensed by consecutive photosensor elements. The diffractometer also produced an output pulse train synchronized with successive photoelement output levels, and a pulse indicating the start of each spectral scan. Although the instrument could operate at a scan duration of less than 50  $\mu$ s, the scan period in these experiments was preset to 9.25 ms. Scanning frequency was limited by the speed with which the computer hardware available for data acquisition from the diffractometer could digitize the sequential photoelement output levels.

### *Data Acquisition System*

Experiments were controlled by a digital minicomputer equipped with magnetic tape transports, a multiplexed analog-to-digital converter, and a cathode ray tube (CRT) controller; see Fig. 1. Operating programs and digitized data produced in each experiment were stored on magnetic tape. Computer input consisted of the diffractometer's image scan, refreshed every 9.25 ms, and the output from the tension transducer. Diffraction patterns were displayed in real time on the CRT refreshed every 18.5 ms, but could be stored on tape for later analysis. Teletypewriter keyboard commands to the computer initiated various responses from the system, including the application of a stimulus to the muscle fiber and storage of a sequence of 20 diffraction spectra at 18.5-ms intervals.

### *Data Reduction and Analysis*

Stored spectra were subsequently subjected to subtraction of the diffractometer's dark current signal and then to a simple three-point smoothing function. Sarcomere lengths were determined by computer evaluation of the first-order line peak position relative to the calculated position of the zero-order line (which was usually displaced from the CCD's optical window). These calculations utilized calibration data obtained from first-order peak position determinations produced by precision diffraction gratings of 1.89, 2.50, 2.77, and 3.33  $\mu$ m ruling spacings. First-order diffraction line intensity and line width were calculated, and the percent length dispersion among sarcomeres was estimated with equations described previously (Paolini and Roos, 1975).

## RESULTS

### *Twitch Contraction*

First-order line data from the light diffraction patterns produced during a total of 90 isometric twitch contractions of 9 single semitendinosus fiber preparations were analyzed. Data from each twitch contraction consisted of 20 diffraction spectra obtained at 18.5-ms intervals after stimulation. Of these data sets, 42 responses from 6 fibers were quite similar and appeared to constitute a faithful representation of fiber dynamics. Remaining data sets often suggested that the fiber sustained a net lateral

displacement in the beam during contraction so that line width and intensity data (but not peak positions indicative of sarcomere length) were invalid: such a displacement plagues measurements made at sarcomere lengths below  $2.5 \mu\text{m}$ .

Figure 2 presents typical diffraction line spectra obtained from a single semi-tendinosus fiber during an isometric twitch. A plot of sarcomere shortening, tension development, line intensity, and sarcomere distribution during a similar twitch is illustrated in Fig. 3. Sarcomere shortening and tension development appeared to occur in synchrony, at least within the accuracy of the time resolution provided by the spectrometer. The dispersion of sarcomeres was greatest during relaxation, increasing to approximately 3.5% from an initial value of 2.9%. The average sarcomere shortening in the range of initial lengths from  $2.31$  to  $3.70 \mu\text{m}$  was  $0.13 \mu\text{m}$ . Line intensity decreased to approximately 0.4 of resting value.

In all of the 42 twitch responses analyzed, the return of first-order line intensity to its initial value was prolonged noticeably after the end of sarcomere shortening and twitch tension. The slow return to resting intensity appeared to be exponential. A least squares fit of intensity data from approximately 140 to 285 ms after stimulus yielded an average time constant of 0.33 s for twitches at initial lengths ranging from 2.21 to  $3.35 \mu\text{m}$ .

Intensity decreases were also obtained in five experiments at zero myofilament over-

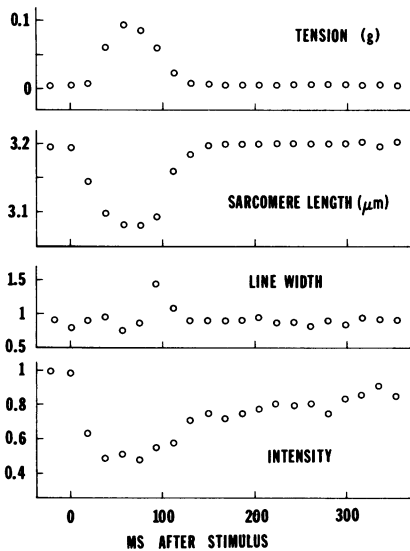

FIGURE 3

FIGURE 3 First-order diffraction line parameters vs. time during an isometric twitch of a single muscle fiber (muscle 59) including sarcomere length, tension, line intensity (relative to initial value), and percent dispersion among sarcomeres.

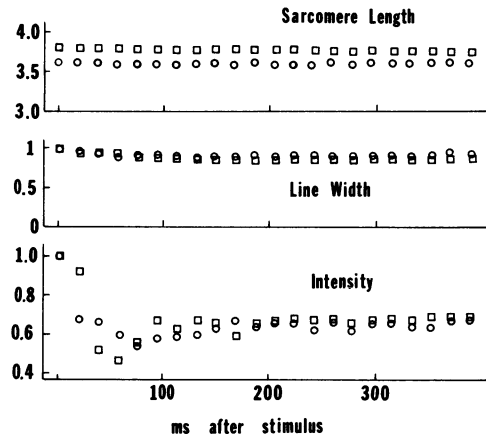

FIGURE 4

FIGURE 4 Change in first-order parameters after twitch stimulation of single fibers. ( $\square$ ) at  $3.80 \mu\text{m}$ ; muscle 82. ( $\circ$ ) at  $3.65 \mu\text{m}$ ; muscle 86.

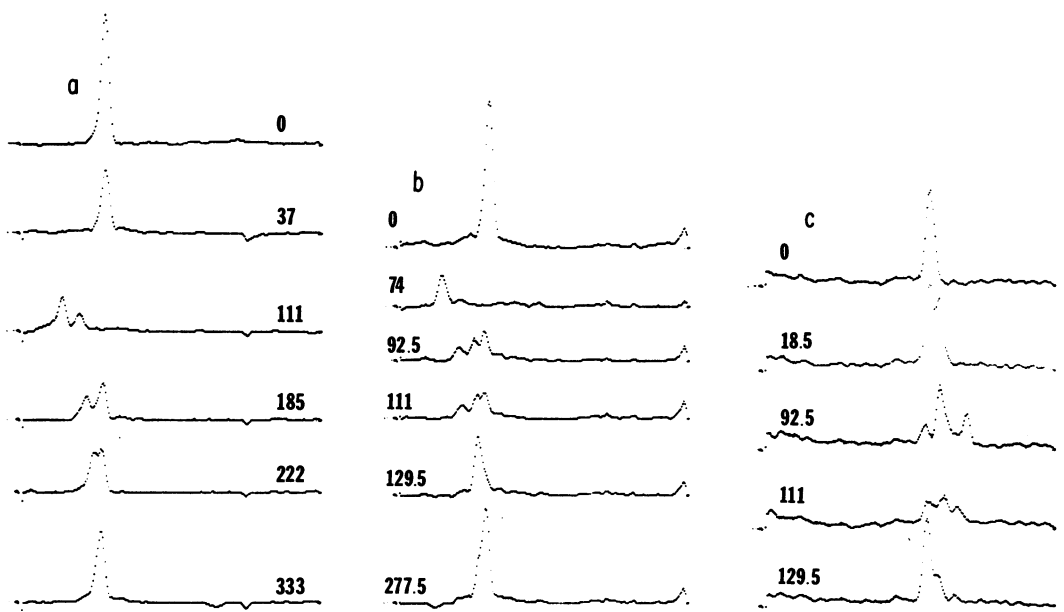

FIGURE 5 First-order diffraction line spectra from muscle preparations exhibiting evidence of distinct sarcomere populations during isometric twitches at 20°C. (a) two peaks: muscle 86, a single fiber; (b) three peaks: muscle 82, a single fiber; (c) a 13-fiber bundle, illustrating independent fiber kinetics.

lap, from 3.65 to 3.80  $\mu\text{m}$ . Recovery to initial intensity appeared to be even more prolonged under these conditions, with an average time constant of 1.47 s: see Fig. 4.

Some sequences of spectra obtained during single-fiber twitch contraction exhibited a splitting of the first-order line into two or more components: in these cases, discrete peaks would momentarily appear during relaxation, and would fuse back into a single peak within approximately 200 ms. Two representative responses are shown in Fig. 5a and b. These distinct diffraction peaks suggest the presence of independently shortening sarcomeric populations within the muscle cell. Independent movements of discrete sarcomere populations are also observed in multicellular muscle preparations, as exemplified by the response of a 13-fiber bundle during twitch contraction, shown in Fig. 5c.

#### *Tetanic Contraction*

First-order diffraction line data sets obtained during 29 isometric tetani of 6 single semitendinosus fibers were also analyzed. As before, each data set consisted of 20 spectra recorded during 9.25-ms sampling periods taken at 18.5-ms intervals.

We compared spectra recorded during the rise of tetanus (taken between 100 and 350 ms after the onset of tetanic stimulation at 60  $\text{s}^{-1}$ ) to spectra recorded during tetanic plateau (2 s after application of the stimulus). In 18 measurements made on 4 isolated fibers contracting from an initial length of 2.97  $\mu\text{m}$  sarcomere shortening

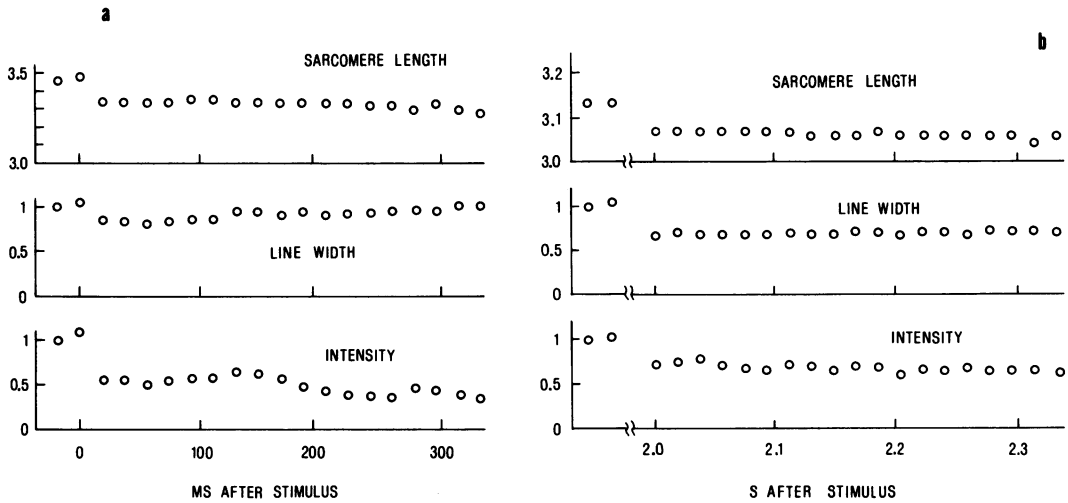

FIGURE 6 Change in first-order parameters during tetanus in a single fiber. (a) onset: 0–350 ms. (b) plateau; data from a 350-ms interval 2 s after stimulation; muscle 84.

has proceeded by an average of  $0.03 \mu\text{m}$  during the rise of tetanus, and by  $0.13 \mu\text{m}$  at plateau. Sarcomere dispersion increased from a resting mean value of 2.5% to 3.5% during onset, and then decreased during plateau to 3.1%. Line intensity changed insignificantly from onset to plateau, from 0.70 during onset to 0.68 at plateau. A graph of representative onset and plateau data appears in Fig. 6. Dispersion of sarcomeres

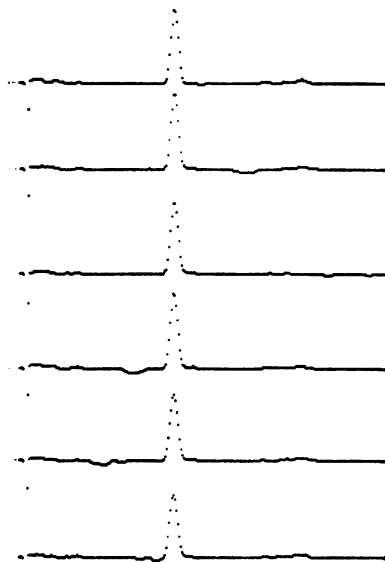

FIGURE 7 First-order spectra obtained from a single semitendinosus fiber during plateau of tetanus at  $20^{\circ}\text{C}$ . Muscle 80.

decreased from onset to plateau, indicating a gradual stabilization of sarcomeres. Sarcomere length usually remained stable during the plateau of tetanus (Fig. 7).

Like whole muscles (Paolini and Roos, 1975), single cells exhibit a strong sarcomere length dependence of diffraction line parameters during contraction. The greatest decrease in intensity during tetanus in a single fiber occurs at a sarcomere length of approximately  $2.9 \mu\text{m}$ , the length at which resting intensity is maximum (Paolini et al., 1976b). Dispersion appeared to increase with length.

## DISCUSSION

### *Sarcomere Distribution during a Twitch*

The absence of a significant increase in optical diffraction line width suggests that the sarcomeres within a single muscle cell operate quite synchronously at the onset and during the rising phase of twitch contraction. There is probably a delay of a few milliseconds associated with activation of myofibrils within the center of a fiber as excitation is propagated from the surface to inner regions of the cell via the transverse tubular system (Gonzalez-Serratos, 1966). While we were unable to detect differences in onset time of shortening between inner and surface sarcomere populations, our present instrument does allow resolution of apparent differences in the relaxation time of separate sarcomere populations. During relaxation, the variation among sarcomere lengths increased approximately 20% in six of the single fibers examined, while the sarcomere population remained homogeneous.

In five fibers, the first-order diffraction line split into two or more discrete lines, but recombined to form a single peak within 100–150 ms after stimulation. This repeatedly observed phenomenon suggests a transient presence of multiple sarcomere length populations within the cell during twitch relaxation. It is not clear what mechanism could cause discrete populations rather than a continuum of sarcomere lengths to appear during relaxation. We cannot discount the possibility that one or more of these preparations consisted of two fibers, while appearing to be a single fiber under the dissecting microscope. A few preparations were examined under the electron microscope: these preparations provided to be single fibers both when splitting was and was not observed. There was no evidence of damage sustained by the fibers in the latter measurements.

The cells of a multifibered preparation (Fig. 5c) exhibit independent contraction as well as relaxation dynamics, indicating an additional lack of uniformity in excitation of the individual fibers. The relaxation time constants of multiple sarcomere populations in a single fiber (that is, the time required for split first-order diffraction line peaks to return to their initial position) were observed to be virtually identical: thus, separate myofibrillar populations show approximately the same relaxation kinetics but with different onset times.

Huxley and Gordon (1962) have utilized cinemicrography to demonstrate heterogeneity in myofibrillar shortening within contracting isolated semitendinosus fibers from the frog. They observed "wavy fibrils," i.e., inactive myofibrils kinked by actively



contracting myofibrils during tetanus. Rüdell and Taylor (1969) have also observed this phenomenon by cinemicrography, both in slightly damaged and in presumably undamaged fibers capable of producing large ( $5 \text{ kg/cm}^2$ ) tetanic tensions. Rüdell and Taylor demonstrated that a prolonged stimulus (e.g. 10 ms at  $5^\circ\text{C}$ ) could suppress the appearance of the often observed "shoulder" on the isometric twitch tension vs. time curve; they attributed this effect to an inhibition of the spread of activation through the fiber. Prior investigations have therefore produced direct structural evidence of variable behavior among the sarcomeres within a single cell.

Borredjo and Mason (1976) have recently studied sarcomere length changes in 5–10 fiber bundles prepared from frog semitendinosus muscle. Their detection system used a rotating light chopper so that the laser beam diffracted by the muscle fell upon two photodiodes at an electronically measured time interval corresponding to sarcomere length. They routinely observed "severe dispersion, amounting to a complete splitting of the diffracted beam . . . at several points in each specimen." This observation is not surprising, considering the responses we have obtained (Fig. 5c) from multifibered preparations; what is more surprising, perhaps, is the splitting we have recorded from single cells. Huxley and Simmons (1970) have suggested that the shoulder in the isometric twitch tension vs. time curve of isolated single fibers arises from the "give" of some rapidly deactivating sarcomeres when these sarcomeres are unable to sustain high external tension during relaxation. The sarcomeres that yield and are stretched beyond initial length during relaxation were generally found grouped towards the tendinous ends of the preparations. However, the splitting we observe during tension decay within the central portion of single fibers appears to involve a simple variability of relaxation time onset among groups of myofibrils.

#### *Sarcomere Distribution during a Tetanus*

Tetanic contraction of a single semitendinosus fiber produces a sustained decrease of 30% in first-order line intensity at a  $3\text{-}\mu\text{m}$  sarcomere length, and is accompanied by a slight increase in dispersion among sarcomeres. Similar responses were reported by Kawai and Kuntz (1973) working with semitendinosus fiber bundles. We did not detect slow oscillations in sarcomere length during tetanic plateau in most of the fibers examined. Perhaps the apparent oscillations reported by Goldspink et al. (1970) in chick whole latissimus dorsi muscle arose as a consequence of the rise and fall of activation in groups of fibers having different mean sarcomere lengths during sustained contraction. The photographic recording technique used by Goldspink and co-workers and by Cleworth and Edman (1972) and also the more recently developed light chopper apparatus of Borredjo and Mason (1976) or the beam splitter system of Haugen and Sten-Knudsen (1976), respond only to the peak position of the diffraction line, so that changes in the line profile caused by variable activation of fibers within a whole muscle or of myofibrillar populations within a single fiber would be interpreted as shortening-lengthening cycles of the same sarcomeres. This fact may also explain why Borredjo and Mason (1976) observed an apparent lack of synchrony between tension and sarcomere shortening rate during development of tetanus (see their Fig. 4): in

a multifibered preparation, a redistribution of tension from fiber to fiber during the approach to plateau may not be reflected by the "mean" sarcomere length record.

It is surprising to find that the distribution of sarcomere lengths becomes somewhat narrower and more homogeneous during a sustained tetanus. As A. V. Hill (1953) and Deleze (1961) have pointed out, the negative slope of the isometric length-tension diagram beyond reference length describes an unstable system in which "the parts that started strong would shorten and become stronger, while the parts that started weak would be lengthened and would become weaker." The marked internal readjustments of sarcomere length demonstrated by Huxley and Peachey (1961) during isometric tetanus within isolated semitendinosus fibers were associated with shortening at the ends rather than an increased sarcomere length variability within central regions of the fiber. Thus, sustained isometric contraction appears to be accompanied by an increase in short-range sarcomere order, despite a decrease in long-range order.

#### *Origin of the Intensity Decrease*

The possible causes of the observed decrease in first-order diffraction line intensity during contraction have been discussed at length by Kawai and Kuntz (1973). The magnitude of the change may imply the occurrence of large (in the 0.1  $\mu\text{m}$  range) structural rearrangements, but there is no evidence for a substantial increase in sarcomere disordering (Paolini et al., 1976b). Other potential sources include increases in multiple diffraction (D. K. Hill, 1953) or a decrease in index of refraction gradients (Huxley, 1957). Muscle transparency is known to increase very slightly upon activation, as a consequence of a small decrease in diffracted light (D. K. Hill, 1953); transparency subsequently decreases by several percent during tension development (D. K. Hill, 1949).

Barry and Carnay (1969) detected changes in scattered light accompanying excitation-contraction coupling. Bezanilla and Horowicz (1975) have described extrinsic fluorescence intensity changes in stained frog semitendinosus muscles during activation. They suggest that these changes parallel alterations in the transmembrane potential of the sarcoplasmic reticulum before  $\text{Ca}^{++}$  release. In addition, numerous studies have demonstrated optical changes accompanying nerve membrane depolarization (see, for example, Tasaki et al., 1968). Thus, it is possible that membrane-related conformational changes that must accompany excitation-contraction coupling may alter the diffraction pattern.

The intensity decreases seen under conditions of zero myofilament overlap suggest either this membrane origin, or a myofilament origin other than actomyosin force development, such as thick filament cross-bridge dithering (Huxley, 1972) or  $\text{Ca}^{++}$  binding to troponin on thin filaments (Ebashi and Endo, 1968). Fujime (1975) electrophoretically injected calcium through a micropipette into a mechanically skinned sartorius fiber attached to a glass slide to prevent changes in sarcomere length during tetanus. He attributed the observed diffraction line intensity decreases upon  $\text{Ca}^{++}$  injection to small random fluctuations in thick filament axial position during force development.

It is unlikely that the observed decreases were due to contraction of shorter sarcomeres at the fiber ends, since there were no detectable changes in line width, sarcomere length, sarcomere dispersion, or fiber tension accompanying these responses. It is possible that slight lateral shifts in fiber position at shorter sarcomere lengths could contribute to apparent intensity decreases prolonged beyond sarcomere shortening.

H. E. Huxley (1975) has recently used a position-sensitive X-ray detector with 10-ms resolution to examine rapid changes in the myosin layer lines of the X-ray diffraction pattern produced during the onset of contraction in frog skeletal muscle. He reported that the off-meridional reflections dropped by  $\frac{2}{3}$  during stimulation at zero overlap, indicating a loss of resting periodicity and implying that actin is not required for cross-bridge activation. These  $I_{11}$  changes associated with cross-bridge orientation during contraction also persist beyond completion of sarcomere shortening (Huxley, 1972). Perhaps the decrease in diffracted light intensity reflects this same actin-independent randomization of cross-bridge position after activation. The slower recovery of intensity at zero overlap may parallel the longer lifetime of the myosin-ADP-phosphate complex (20 s time constant vs. 0.1 s) in the absence of actin (Taylor, 1972).

We are grateful to Mr. Ralph Dakin, Analytical Systems Division, Bausch and Lomb, Inc., Rochester, N.Y., for kindly providing the calibration gratings.

This investigation was supported in part by a research grant (NIH AM 16716-03) from the U.S. Public Health Service to one of us (R.J.B.).

Received for publication 5 April 1977.

## REFERENCES

- BARRY, W. H., and L. D. CARNAY. 1969. Changes in light scattered by striated muscle during excitation-contraction coupling. *Am. J. Physiol.* **217**:1425.
- BEZANILLA, F., and P. HOROWICZ. 1975. Fluorescence intensity changes associated with contractile activation in frog muscle stained with Nile Blue A. *J. Physiol. (Lond.)* **246**:709.
- BORREJDO, J., and P. MASON. 1976. Sarcomere length changes during stimulation of frog semitendinosus muscle. *J. Mechanochem. Cell Motility*. **3**:155
- BUCHTHAL, F., and G. G. KNAPPEIS. 1940. Diffraction spectra and minute structure of the cross-striated muscle fibre. *Skand. Arch. Physiol.* **83**:281.
- CLEWORTH, D. R., and K. A. P. EDMAN. 1969. Laser diffraction studies on single skeletal muscle fibers. *Science (Wash. D.C.)*. **163**:296.
- CLEWORTH, D. R., and K. A. P. EDMAN. 1972. Changes in sarcomere length during isometric tension development in frog skeletal muscle. *J. Physiol. (Lond.)*. **277**:1.
- DELEZE, J. B. 1961. The mechanical properties of the semitendinosus muscle at lengths greater than its length in the body. *J. Physiol. (Lond.)*. **158**:154.
- EBASHI, S., and M. ENDO. 1968. Calcium ion and muscle contraction. *Prog. Biophys. Mol. Biol.* **18**:123.
- FUJIME, S. 1975. Optical diffraction study of muscle fibers. *Biochim. Biophys. Acta.* **379**:227.
- GOLDSPINK, G., R. E. LARSON, and R. E. DAVIES. 1970. Fluctuations in sarcomere length in the chick anterior and posterior latissimus dorsi muscle during contraction. *Experientia (Basel)*. **26**:16.
- GONZALEZ-SERRATOS, H. 1966. Inward spread of contraction during a twitch. *J. Physiol. (London.)*. **185**:209.
- HALPERN, W. 1977. A rapid on-line high resolution analyzer of striated muscle diffraction patterns. *Proc. S.D. Acad. Sci.* In press.
- HAUGEN, P., and O. STEN-KNUDSEN. 1976. Sarcomere lengthening and tension drop in the latent period of isolated frog skeletal muscle fibers. *J. Gen. Physiol.* **68**:247.

- HILL, A. V. 1953. The mechanics of active muscle. *Proc. R. Soc. Lond. Biol. Sci.* **141**:104.
- HILL, D. K. 1949. Changes in transparency of muscle during a twitch. *J. Physiol. (Lond.)* **108**:292.
- HILL, D. K. 1953. The effect of stimulation on the diffraction of light by striated muscle. *J. Physiol. (Lond.)* **119**:501.
- HUXLEY, A. F. 1957. Muscle structure and theories of contraction. *Prog. Biophys.* **7**:255.
- HUXLEY, A. F., and A. M. GORDON. 1962. Striation patterns in active and passive shortening of muscle. *Nature (Lond.)* **193**:280.
- HUXLEY, A. F., and L. D. PEACHEY. 1961. The maximum length for contraction in vertebrate striated muscle. *J. Physiol. (Lond.)* **156**:150.
- HUXLEY, A. F., and R. M. SIMMONS. 1970. Rapid 'give' and the tension 'shoulder' in the relaxation of frog muscle fibres. *J. Physiol. (Lond.)* **210**:32P. (Abstr.)
- HUXLEY, H. E. 1972. Structural changes in the actin- and myosin-containing filaments during contraction. *Cold Spring Harbor Symp. Quant. Biol.* **37**:361.
- HUXLEY, H. E. 1975. Time-resolved X-Ray studies on muscle. Symposium presentation at 5th International Biophysics Congress, Copenhagen.
- KAWAI, M., and I. E. KUNTZ. 1973. Optical diffraction studies of muscle fibers. *Biophys. J.* **13**:857.
- KRUEGER, J. W., and G. H. POLLACK. 1975. Myocardial sarcomere dynamics during isometric contraction. *J. Physiol. (Lond.)* **251**:627.
- NASSAR, R., A. MANRING, and E. A. JOHNSON. 1974. Light diffraction of cardiac muscle: sarcomere motion during contraction. In *The Physiological Basis of Starling's Law of the Heart*. Elsevier North-Holland, Inc., New York, 57.
- PAOLINI, P. J., and K. P. ROOS. 1975. Length-dependent optical diffraction pattern changes in frog sartorius muscle. *Physiol. Chem. Phys.* **7**:235.
- PAOLINI, P. J., K. P. ROOS, and R. J. BASKIN. 1977. Light diffraction studies of sarcomere dynamics in single skeletal muscle fibers. *Biophys. J.* **17**:200a. (Abstr.)
- PAOLINI, P. J., R. J. BASKIN, K. P. ROOS, and J. W. CLINE. 1976a. Dual channel diffractometer utilizing linear image sensor change-coupled devices. *Rev. Sci. Instrum.* **47**:698.
- PAOLINI, P. J., R. SABBADINI, K. P. ROOS, and R. J. BASKIN. 1976b. Sarcomere length dispersion in single skeletal muscle fibers and fiber bundles. *Biophys. J.* **16**:919.
- POLLACK, G. H., and J. W. KREUGER. 1976. Sarcomere dynamics in intact cardiac muscle. *Eur. J. Cardiol.* **4**(Suppl.):53.
- RÜDEL, R., and S. R. TAYLOR. 1969. The influence of stimulus parameters on contractions of isolated frog muscle fibres. *J. Physiol. (Lond.)* **205**:499.
- TASAKI, I., A. WATANABE, R. SANDLIN, and L. CARNAY. 1968. Changes in fluorescence, turbidity and birefringence associated with nerve excitation. *Proc. Natl. Acad. Sci. U.S.A.* **61**:883.
- TAYLOR, E. W. 1972. Chemistry of muscle contraction. *Annu. Rev. Biochem.* **41**:577.