

# Effects of diltiazem on calcium concentrations in the cytosol and on force of contractions in porcine coronary arterial strips

Katsuya Hirano, <sup>1</sup>Hideo Kanaide, Shimako Abe & Motoomi Nakamura

Research Institute of Angiocardiology, Division of Molecular Cardiology and Cardiovascular Clinic, Faculty of Medicine, Kyushu University, 3-1-1 Maidashi, Higashi-ku, Fukuoka 812, Japan

- 1 Using front-surface fluorometry with fura-2-loaded porcine coronary arterial strips, we simultaneously measured effects of a  $\text{Ca}^{2+}$  antagonist, diltiazem, on cytosolic  $\text{Ca}^{2+}$  concentrations ( $[\text{Ca}^{2+}]_i$ ) and on tension development.
- 2 In the presence of extracellular  $\text{Ca}^{2+}$  (1.25 mM), histamine concentration-dependently induced abrupt (the first component) and then sustained (the second component) elevations of  $[\text{Ca}^{2+}]_i$ . In the absence of extracellular  $\text{Ca}^{2+}$ , histamine induced transient elevations of  $[\text{Ca}^{2+}]_i$ , and the time course was similar to that of the first component observed in the presence of extracellular  $\text{Ca}^{2+}$ . Histamine caused a greater contraction for a given change in  $[\text{Ca}^{2+}]_i$  than did potassium, at  $[\text{Ca}^{2+}]_i$  over 300 nM.
- 3 Diltiazem,  $10^{-8}$  M to  $10^{-5}$  M, concentration-dependently inhibited the second component of  $[\text{Ca}^{2+}]_i$  elevation and tension development induced by histamine ( $10^{-5}$  M). Only at higher concentrations (over  $10^{-5}$  M) did diltiazem inhibit the first component of increases in  $[\text{Ca}^{2+}]_i$  and tension development induced by histamine, both in the presence and absence of extracellular  $\text{Ca}^{2+}$ .
- 4 Diltiazem ( $10^{-6}$  M) inhibited increases in  $[\text{Ca}^{2+}]_i$  and tension development induced by cumulative applications of extracellular  $\text{Ca}^{2+}$  during  $\text{K}^+$ -depolarization. The curve of  $[\text{Ca}^{2+}]_i$  against tension of these  $\text{Ca}^{2+}$ -induced contractions obtained in diltiazem-treated strips overlapped with that obtained in untreated strips. This suggests that diltiazem has no direct effects on contractile elements.
- 5 In contrast, the histamine-induced  $\text{Ca}^{2+}$ -tension curve (second component) was shifted in parallel to the left by diltiazem.
- 6 We conclude that diltiazem, at therapeutic concentrations, specifically inhibits extracellular  $\text{Ca}^{2+}$ -dependent increases in  $[\text{Ca}^{2+}]_i$ , with no effects on the release of  $\text{Ca}^{2+}$  from intracellular store sites or on  $\text{Ca}^{2+}$ -sensitivity of the contractile elements involved in the contractions induced by elevations of  $[\text{Ca}^{2+}]_i$ .

## Introduction

Changes in cytosolic  $\text{Ca}^{2+}$  concentrations ( $[\text{Ca}^{2+}]_i$ ) play a central role in determining the force of contraction of vascular smooth muscles (Kamm & Stull, 1985; Sommerville & Hartshorne, 1986). However, the precise relationship between  $[\text{Ca}^{2+}]_i$  and tension development in intact smooth muscles has not been clarified, because of the difficulty in making direct and simultaneous determinations of  $[\text{Ca}^{2+}]_i$  and contractile force in intact cells. To assess the relationship between  $\text{Ca}^{2+}$  concentrations and tension development, mechanically or chemically skinned muscle strips have been used. In such cases, sarcolemmal signal transduction systems might be seriously damaged (Saida & Nonomura, 1978; Kuriyama *et al.*, 1982).

Recent developments in optical techniques in biology and in fluorescent-indicator dyes have made the direct determination of metabolic and ionic changes in intact cells feasible (Tsien *et al.*, 1982; Grynkiewicz *et al.*, 1985; Kobayashi *et al.*, 1985; Kanaide *et al.*, 1988). We developed front-surface NADH-fluorometry, of the whole heart, using optic fibres, the objective being to minimize optical artifacts which can arise from contractile movements (Kanaide *et al.*, 1982). Using the  $\text{Ca}^{2+}$ -indicator dye fura-2 and front-surface fluorometry, we measured simultaneously  $[\text{Ca}^{2+}]_i$  and force during contractions of porcine coronary arteries induced by endothelin (Kodama *et al.*, 1989) or by okadaic acid (Hirano *et al.*, 1989).

$\text{Ca}^{2+}$ -antagonists are potent vasodilators and inhibit coronary artery spasm and reduce high blood pressure (Fleckenstein 1977; Cauvin *et al.*, 1983). It was demonstrated in our laboratory that pretreatment with the  $\text{Ca}^{2+}$ -antagonist, diltiazem, inhibited the spasm of coronary artery induced by histamine in experimentally produced atherosclerotic lesions of miniature swine (Shimokawa *et al.*, 1983). In aortic smooth

muscle cells in primary culture, we found that diltiazem not only specifically inhibited the histamine-induced influx of  $\text{Ca}^{2+}$  through the sarcolemma at low concentrations ( $\text{IC}_{50}$  0.18  $\mu\text{M}$ ), but also inhibited the release of  $\text{Ca}^{2+}$  from intracellular store sites at high concentrations ( $\text{IC}_{50}$  97.5  $\mu\text{M}$ ), resulting in a reduction in  $[\text{Ca}^{2+}]_i$  (Kanaide *et al.*, 1988; Matsumoto *et al.*, 1989). In the present study, we simultaneously determined the effects of diltiazem on  $[\text{Ca}^{2+}]_i$  and on tension development and examined the effects on the relationship between  $[\text{Ca}^{2+}]_i$  and tension in fura-2-loaded, intact muscle strips of the porcine coronary artery.

## Methods

### Tissue preparation

Hearts from adult pigs of either sex were obtained from a local slaughterhouse immediately after the animals had been killed. These hearts were placed in ice-cold saline solution and brought to the laboratory. Left circumflex arteries were isolated and cut longitudinally, and then segments 2–3 cm from the origin were excised. To remove the endothelium, the luminal surface was rubbed off with a cotton swab. Following removal of the adventitia, medial preparations were cut into approximately  $1 \times 5$  mm circular strips 0.1 mm thick.

### Fura-2 loading

Vascular strips thus prepared were loaded with the  $\text{Ca}^{2+}$  indicator dye, fura-2 by incubating in medium containing 25  $\mu\text{M}$  fura-2/AM (an acetoxymethyl ester form of fura-2) and 5% foetal bovine serum for 3–4 h at 37°C. The fura-2-loaded strips were washed with normal physiological salt solution (normal PSS) to remove dye in the extracellular space, and further incubated in normal PSS for 1 h before the initiation of mea-

<sup>1</sup> Author for correspondence.

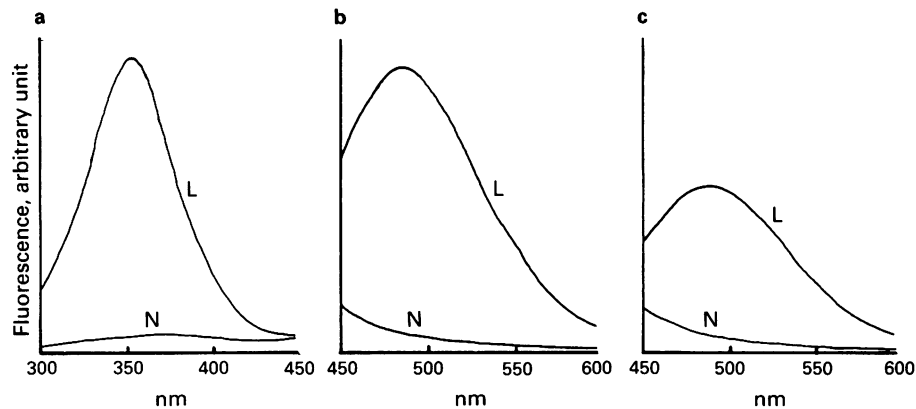

**Figure 1** Fluorescence spectra of fura-2-loaded vascular strips. Excitation and emission spectra were recorded in the same strip, before and after fura-2-loading. Fluorescence spectra were recorded in normal PSS (1.25 mM  $\text{Ca}^{2+}$ ) with a Hitachi fluorescence spectrophotometer (model 650-40). Excitation spectrum (a) was recorded at 500 nm emission. Emission spectra were recorded either at 340 nm (b) or 380 nm (c) excitation. L, loaded strip; N, non-loaded strip.

surements. To examine whether strips were effectively loaded with fura-2, fluorescence excitation and emission spectra were determined in the same strips before and after fura-2-loading. A fluorescence spectrophotometer (model 650-40, Hitachi, Tokyo, Japan) was used.

Non-loaded strips showed no significant peak in the excitation spectrum when the fluorescence emission was monitored at 500 nm (Figure 1a). Fluorescence emission spectra also showed no peak at 340 nm or at 380 nm excitation (Figure 1b,c). In the fura-2-loaded strips, the intensity of the fluorescence markedly increased; 20 times at 340 nm excitation and 10 times at 380 nm excitation. The fura-2-loaded strip showed a fluorescence excitation spectrum with a peak at 340–350 nm (Figure 1a) and fluorescence emission spectra with a peak at 500 nm, both at 340 nm and at 380 nm excitation (Figure 1b,c). These characteristics indicated that fluorescence spectra obtained with fura-2 loaded strips were specific for this dye (Gryniewicz *et al.*, 1985).

#### Measurement of tension development

Strips were mounted vertically in a quartz organ bath and a force-transducer (TB-612T, Nihon Kodan, Japan) was used. During a one hour fura-2 equilibration period, the strips were stimulated with 60 mM  $\text{K}^{+}$ -depolarization every 15 min, and the resting tension was increased stepwise. After equilibration, the resting tension was adjusted to 250 mg. The responsiveness of each strip to 118 mM  $\text{K}^{+}$ -depolarization was recorded before the experimental protocol was started. The developed tension was expressed as %; the values in normal PSS (5.9 mM  $\text{K}^{+}$ ) and 118 mM  $\text{K}^{+}$  PSS were assumed to be 0% and 100%, respectively.

#### Front-surface fluorometry

Changes in the fluorescence intensity of fura-2- $\text{Ca}^{2+}$  complex were monitored with a specifically designed front-surface fura-2 fluorometer (model CAM-OF-1) in collaboration with Japan Spectroscopic Co., (Tokyo, Japan). A block diagram of the front-surface fluorometer is shown in Figure 2. In brief, excitation light (340 nm and 380 nm) was obtained spectroscopically from a Xenon light source. Strips were illuminated by guiding the alternating (400 Hz) excitation light through quartz optic fibres arranged in a concentric inner circle (diameter = 3 mm). Surface fluorescence of strips was collected by glass optic fibres arranged in an outer circle (diameter = 7 mm) and introduced through a 500 nm band-pass filter into a photomultiplier. Special care was taken to keep the distance between a strip and the end of the optical fibres constant during measurement.

Ratio of the fluorescence intensities at 340 nm excitation to that at 380 nm excitation was monitored and expressed as %; the values in normal PSS (5.9 mM  $\text{K}^{+}$ ) and 118 mM  $\text{K}^{+}$  PSS were assumed to be 0% and 100%, respectively. The absolute value of  $[\text{Ca}^{2+}]_i$  was calculated from the % ratio (R), from the following equation;

$$[\text{Ca}^{2+}]_i = K_d(R - R_{\min})/(R_{\max} - R)$$

where  $K_d$  is a dissociation constant and assumed to be 224 nM (Gryniewicz *et al.*, 1985).  $R_{\max}$  was determined by the addition of 25  $\mu\text{M}$  ionomycin in normal PSS (1.25 mM  $\text{Ca}^{2+}$ ) and  $R_{\min}$  was determined in  $\text{Ca}^{2+}$ -free PSS (0 mM  $\text{Ca}^{2+}$ ; 2 mM EGTA). Mean values ( $n = 10$ ) of  $R_{\max}$  and  $R_{\min}$  were  $156.3 \pm 11.8\%$  and  $-76.1 \pm 22.9\%$ , respectively. The mean values of ten different measurements of  $[\text{Ca}^{2+}]_i$  at rest (0%) and during 118 mM  $\text{K}^{+}$ -depolarization (100%) were  $108 \pm 27$  nM and  $715 \pm 103$  nM, respectively.

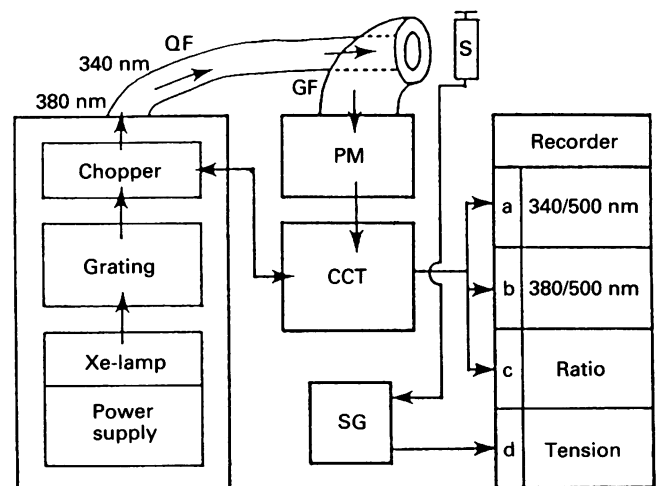

**Figure 2** Block diagram of a front-surface fluorometer. Excitation light was obtained from a spectroscope (grating) from a Xenon light source. Strips ( $1 \times 5 \times 0.1$  mm) were illuminated by guiding the alternating (400 Hz) 340 nm and 380 nm excitation light through quartz optic fibres arranged in a concentric inner circle (diameter = 3 mm). Surface fluorescence of strips was collected by glass optic fibres arranged in an outer circle (diameter = 7 mm) and introduced through a 500 nm band-pass filter into a photomultiplier. CCT, control circuit; GF, glass optic fibres; PM, photomultiplier; QF, quartz optic fibres; S, vascular strip; SG, strain gauge.

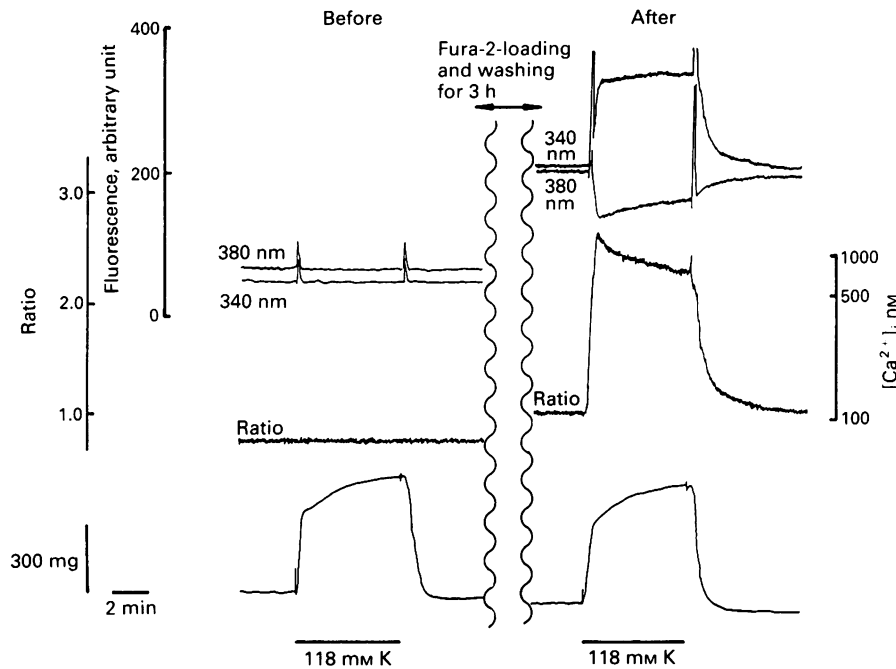

**Figure 3** Effects of fura-2-loading on the contractility of porcine coronary arterial strips. The response to 118 mM  $\text{K}^+$ -depolarization was recorded in the same strip, before and after fura-2-loading. The first and the second traces from the top show traces in 500 nm fluorescence intensities obtained at 340 nm and 380 nm excitations. The third trace shows changes in ratio of fluorescence at 340 nm excitation to that at 380 nm excitation and the lowest trace shows tension development.

#### Effects of fura-2-loading on contractility of porcine coronary arterial strips

$\text{Ca}^{2+}$  indicator dyes have a  $\text{Ca}^{2+}$ -buffering action and hence, may decrease the contractility (Tsien *et al.*, 1982; Grynkiewicz *et al.*, 1985; Rink & Pozzan, 1985). To examine the effects of dye-loading on contractility of porcine coronary arterial strips, the responsiveness to 118 mM  $\text{K}^+$ -depolarization of the same strip was determined before and after loading with fura-2 (Figure 3). Before the strips were loaded with fura-2, 118 mM  $\text{K}^+$ -depolarization caused a rapid increase in tension and a maximum steady level was reached at 3 min. During this response there were no changes in fluorescence intensities at either 340 nm and or 380 nm excitations, or in the ratio of these fluorescence intensities. After the strips were loaded with fura-2, resting fluorescence intensities at 340 nm and at 380 nm excitations increased from 63 to 230 arbitrary units and from 77 to 222 arbitrary units, respectively, and the fluorescence ratio accordingly increased from 0.84 to 1.05. Loading with fura-2 did not affect the resting tension. After fura-2-loading, 118 mM  $\text{K}^+$ -depolarization caused the same extent of tension development with the same time course as that observed before loading. If the maximum developed tension during 118 mM  $\text{K}^+$ -depolarization before fura-2-loading is assumed to be 100%, that obtained after fura-2-loading was  $96.0 \pm 10.7\%$  ( $n = 3$ ). There were abrupt increases and decreases in 500 nm fluorescence intensities at 340 nm and at 380 nm excitations, respectively, and an increase in fluorescence ratio. When the bathing solutions were exchanged, optic artifacts in fluorescence intensities resulted both at 340 nm and at 380 nm excitations. However, these artifacts offset each other and disappeared. These results indicate that fura-2 loading produces no change in the contractility of vascular strips.

#### Drugs and solutions

Normal PSS was of the following composition (in mM): NaCl 123, KCl 4.7,  $\text{NaHCO}_3$  15.5,  $\text{KH}_2\text{PO}_4$  1.2,  $\text{MgCl}_2$  1.2,  $\text{CaCl}_2$  1.25 and D-glucose 11.5.  $\text{Ca}^{2+}$ -free version of PSS ( $\text{Ca}^{2+}$ -free PSS) contained 2 mM ethyleneglycol-bis( $\beta$ -aminoethylether)-

N,N,N',N'-tetraacetic acid (EGTA) instead of 1.25 mM  $\text{CaCl}_2$ . High potassium PSS was identical to normal PSS, except for an equimolar substitution of KCl for NaCl. PSS was gassed with a mixture of 5%  $\text{CO}_2$  and 95%  $\text{O}_2$  (pH 7.4; 37°C). Diltiazem hydrochloride was kindly donated by Tanabe Seiyaku Co. (Osaka, Japan). Histamine dihydrochloride and fura-2/AM were purchased from Wako (Osaka, Japan) and Molecular Probes Inc., (Eugene, OR, U.S.A.), respectively.

#### Statistical analysis

Values are expressed as mean  $\pm$  s.e.mean. Student's *t* test was used to determine the statistical significance. A *P* value less than 0.05 was considered to be significant. The  $[\text{Ca}^{2+}]_i$ -tension curve of contractions induced by cumulative applications of  $\text{Ca}^{2+}$  during  $\text{K}^+$ -depolarization was fitted to Hill's equation (Segel, 1976);

$$\log(T/(T_{\max} - T)) = n(\log[\text{Ca}^{2+}]_i - \log K_d)$$

where *T* represents measured value of developed tension, expressed as %, and  $[\text{Ca}^{2+}]_i$  represents value of cytosolic  $\text{Ca}^{2+}$  concentration calculated as described in the case of front-surface fluorometry. *n* and  $K_d$  are constant values.  $T_{\max}$  represents estimated maximum tension development and was calculated by use of the following equation (Scatchard plot (Scatchard, 1949)) and least squares method.

$$T/[\text{Ca}^{2+}]_0 = (T_{\max} - T)/K'$$

where  $[\text{Ca}^{2+}]_0$  represents the extracellular  $\text{Ca}^{2+}$  concentration applied and  $K'$  is a constant.

## Results

#### Effects of diltiazem on histamine-induced contractions

Figure 4 shows representative recordings of changes in fluorescence ratio and force induced by  $10^{-5}$  M histamine in normal PSS (a) and  $\text{Ca}^{2+}$ -free PSS (b). When histamine ( $10^{-5}$  M) was applied in normal PSS, the fluorescence ratio abruptly elevated and reached the first peak (the first

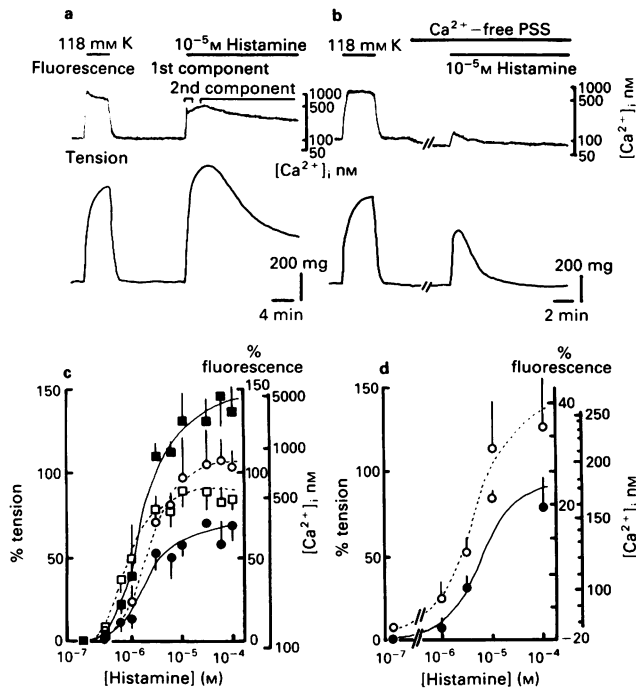

**Figure 4** Changes in fluorescence ratio (340/380 nm excitation) and tension induced by histamine. (a and b) Representative time courses of fluorescence ratio and tension induced by  $10^{-5}$  M histamine in normal PSS (a) and  $\text{Ca}^{2+}$ -free PSS (b). Histamine was applied after 15 min incubation in  $\text{Ca}^{2+}$ -free PSS. Note that the time scales differ between (a) and (b). (c and d) Dose-related responses of the first component and the second component induced by histamine in normal PSS (c) and  $\text{Ca}^{2+}$ -free PSS (d). In (c), (●, ■) indicate developed tension of the first (●) and the second (■) component and (○, □) indicate fluorescence ratio of the first (○) and the second (□) component. In (d), (○) and (●) indicate fluorescence ratio and developed tension, respectively. Data are mean of 6 different measurements; vertical lines show s.e.mean.

component) at  $12 \pm 3$  s ( $n = 6$ ). After a slight dip at 30 s, the fluorescence ratio reached the second peak at  $2.4 \pm 0.6$  min ( $n = 6$ ) and then began to decline gradually, but remained at levels higher than those seen before stimulation (the second component) (Figure 4a). The levels of  $[\text{Ca}^{2+}]_i$  before stimulation, at the first peak (the first component) and 15 min after the application of histamine (the second component) were  $108 \pm 27$  nM ( $n = 10$ ),  $413 \pm 131$  nM and  $283 \pm 47$  nM ( $n = 6$ ), respectively. Tension also developed rapidly and reached a maximum at  $3.8 \pm 0.7$  min ( $n = 6$ ), then declined gradually. The extent of tension developed at the maximum and after 15 min was  $121 \pm 3\%$  and  $62 \pm 12\%$  of that observed during 118 mM  $\text{K}^+$ -depolarization, respectively. In  $\text{Ca}^{2+}$ -free PSS, histamine induced a rapid and transient elevation of both fluorescence and tension. When vascular strips were exposed to  $\text{Ca}^{2+}$ -free PSS containing 2 mM EGTA, the fluorescence ratio gradually declined to reach a steady state ( $82 \pm 4$  nM) while the tension remained unchanged (Figure 4b). Application of  $10^{-5}$  M histamine after 15 min incubation in  $\text{Ca}^{2+}$ -free PSS caused abrupt elevations in the fluorescence ratio and tension, which then rapidly declined to the pre-stimulation level within 10 min. The extent of the elevations of the first and second components of the fluorescence ratio and developed tension in normal and  $\text{Ca}^{2+}$ -free PSS were concentration-dependent (Figure 4c,d). Because of similarities between the time courses of the first components observed both in normal and  $\text{Ca}^{2+}$ -free PSS and of the lack of the second component in  $\text{Ca}^{2+}$ -free PSS, we propose that the first component is due to a release of  $\text{Ca}^{2+}$  from intracellular store sites (Somlyo, 1985) and that the second component depends on extracellular  $\text{Ca}^{2+}$ .

Figure 5 shows the effects of various concentrations of diltiazem on time courses of changes in fluorescence and tension development induced by histamine ( $10^{-5}$  M; the concentration

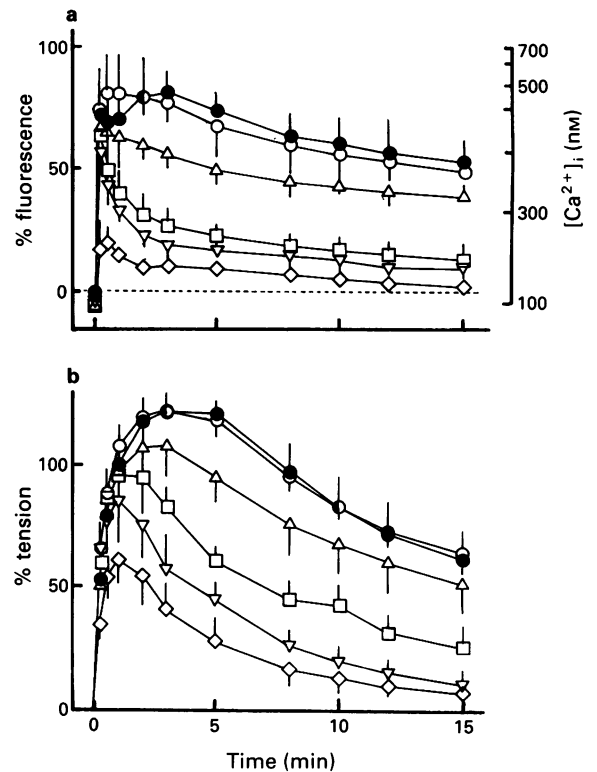

**Figure 5** Effects of diltiazem on changes in fluorescence (a) and tension development (b) induced by  $10^{-5}$  M histamine in normal PSS. Time courses of changes in fluorescence ratio (a) and tension development (b) induced by  $10^{-5}$  M histamine in strips treated with 0 (●; control),  $10^{-8}$  (○),  $10^{-7}$  (△),  $10^{-6}$  (□),  $10^{-5}$  (▽) and  $10^{-4}$  (◇) M diltiazem. Diltiazem was applied 15 min before the application of histamine. The abscissa scales indicate the time (in min) after the application of histamine. Both fluorescence and tension developed in PSS (5.9 mM  $\text{K}^+$ ) and 118 mM  $\text{K}^+$ -PSS are assumed to be 0% and 100%, respectively. Dotted line in (a) indicates the fluorescence zero level. Data are mean of 6 different measurements; vertical lines show s.e.mean.

which gave maximum responses of fluorescence,  $89.0 \pm 10.2\%$  of that observed during 118 mM  $\text{K}^+$ -depolarization) in normal PSS. Diltiazem was applied 15 min before and during the applications of histamine, because it has been shown that 15 min were required for equilibration at its binding sites (Green *et al.*, 1985). Diltiazem (over  $10^{-6}$  M) significantly ( $P < 0.05$ ) decreased the fluorescence level at rest (before histamine-stimulation), but did not affect the resting tension. In the range  $10^{-8}$  M to  $10^{-5}$  M, diltiazem concentration-dependently decreased fluorescence levels in the second component with no effects on the first component. The inhibitory effect of diltiazem on fluorescence levels gradually became apparent after the initiation of contractions. Diltiazem also inhibited the histamine-induced tension development in the second component and shortened the time to reach the maximum development of tension. The inhibitory effects of diltiazem on tension development gradually became apparent after the application of histamine (as in the case of fluorescence). Only very high concentrations of diltiazem ( $> 10^{-5}$  M) inhibited both the first and second components of the fluorescence ratio and caused further decreases in tension development. Although we incubated the tissues with diltiazem for 15 min before applying histamine, there was practically no difference in changes in fluorescence ratio and tension development between the groups of 15 min, 10 min and 0 min of pre-incubation with diltiazem.

In  $\text{Ca}^{2+}$ -free PSS, elevations in fluorescence ratio and tension induced by  $10^{-5}$  M histamine were little inhibited by diltiazem  $10^{-6}$  to  $10^{-5}$  M. Only very high concentrations of diltiazem ( $10^{-4}$  M) inhibited the fluorescence ratio and tension elevations ( $P < 0.05$ , Figure 6).

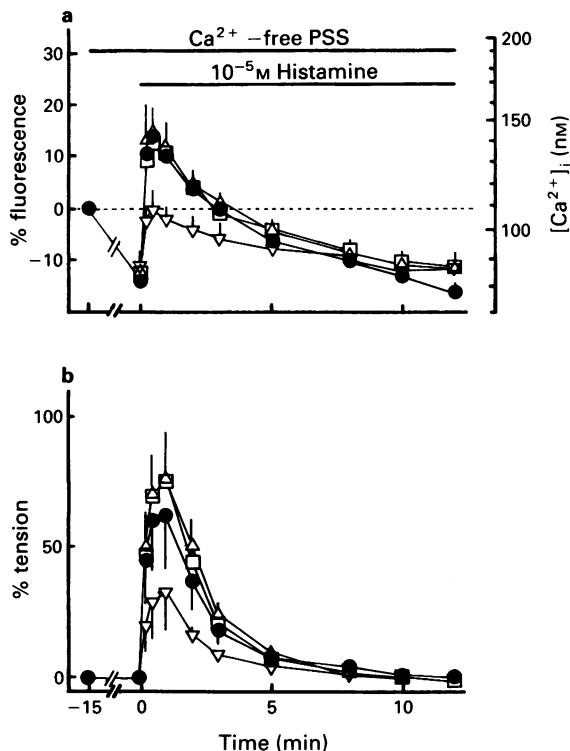

**Figure 6** Effects of diltiazem on histamine-induced  $\text{Ca}^{2+}$ -release in  $\text{Ca}^{2+}$ -free PSS. Time courses of changes in fluorescence ratio (a) and tension development (b) induced by  $10^{-5}$  M histamine in strips treated with 0 (●; control),  $10^{-6}$  (Δ),  $10^{-5}$  (□) and  $10^{-4}$  (▽) M diltiazem. Diltiazem was applied at the time of exposure to  $\text{Ca}^{2+}$ -free PSS, i.e. 15 min before the application of histamine. Both fluorescence and tension developed in PSS (5.9 mM  $\text{K}^+$ ) and 118 mM  $\text{K}^+$ -PSS were assumed to be 0% and 100%, respectively. Dotted line in (a) indicates the fluorescence zero level. Data are mean of 3 different measurements; vertical lines show s.e.mean.

#### Effects of diltiazem on $\text{Ca}^{2+}$ -induced contractions

After 10 min incubation of tissues in  $\text{Ca}^{2+}$ -free PSS containing 2 mM EGTA, and then 5 min incubation in  $\text{Ca}^{2+}$ -free PSS without EGTA, the re-addition of extracellular  $\text{Ca}^{2+}$  in a cumulative manner (from 0 mM to 10 mM) during 118 mM  $\text{K}^+$ -depolarization led to increases in fluorescence and tension development (Figure 7b,c). With no exposure to diltiazem, the fluorescence increased from  $-19.8 \pm 4.7\%$  at 0 mM extracellular  $\text{Ca}^{2+}$  to  $131.8 \pm 8.9\%$  at 10 mM extracellular  $\text{Ca}^{2+}$  ( $n = 6$ ). The tension increased from  $2.6 \pm 1.6\%$  to  $120.9 \pm 3.7\%$  ( $n = 6$ ). Treatment with  $10^{-6}$  M diltiazem 15 min before and during cumulative applications of extracellular  $\text{Ca}^{2+}$  significantly inhibited increases in fluorescence and tension development. In the diltiazem-treated strips, the fluorescence increased from  $-18.2 \pm 3.8\%$  to  $93.1 \pm 8.5\%$  and tension increased from  $1.6 \pm 1.7\%$  to  $99.1 \pm 5.7\%$  ( $n = 6$ ) with cumulative applications of extracellular  $\text{Ca}^{2+}$  from 0 mM to 10 mM during 118 mM  $\text{K}^+$ -depolarization.

#### Effects of diltiazem on $[\text{Ca}^{2+}]_i$ -tension relationship

Effects of diltiazem on the  $[\text{Ca}^{2+}]_i$ -tension relationship were evaluated from data in Figures 5 and 7. Absolute values of  $[\text{Ca}^{2+}]_i$  were calculated, as described. The  $[\text{Ca}^{2+}]_i$ -tension relationship of the  $\text{Ca}^{2+}$ -induced contractions during  $\text{K}^+$ -depolarization was fitted to a Hill equation with a least squares method. In strips not exposed to diltiazem, tension developed concentration-dependently within the range 100 nM and 3000 nM  $[\text{Ca}^{2+}]_i$ . The  $K_d$  value and Hill coefficient of the  $[\text{Ca}^{2+}]_i$ -tension relationship obtained in untreated strips was  $356 \pm 52$  nM and  $2.6 \pm 0.4$ , respectively ( $n = 6$ ). The

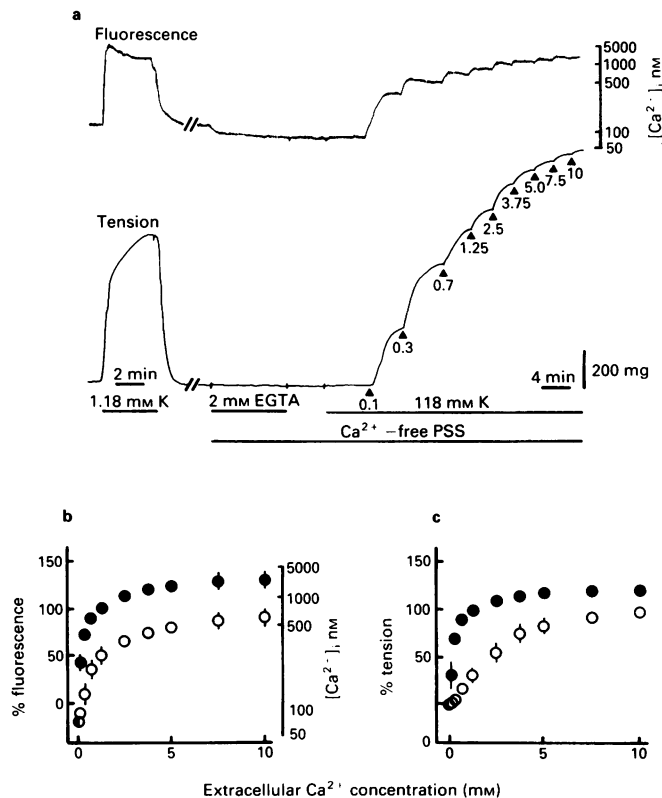

**Figure 7** Effects of  $10^{-6}$  M diltiazem on contractions induced by cumulative applications of extracellular  $\text{Ca}^{2+}$  during 118 mM  $\text{K}^+$ -depolarization. (a) Representative recording of the changes in fluorescence (upper panel) and tension (lower panel) induced by cumulative applications of extracellular  $\text{Ca}^{2+}$  during 118 mM  $\text{K}^+$ -depolarization. Numbers at each triangle (▲) indicate concentrations of extracellular  $\text{Ca}^{2+}$  (in mM). (b and c) Fluorescence ratio (b) and tension development (c) obtained from 6 different measurements, with (○) or without (●) treatment with  $10^{-6}$  M diltiazem. Both fluorescence and tension developed in PSS (5.9 mM  $\text{K}^+$ ) and 118 mM  $\text{K}^+$ -PSS are assumed to be 0% and 100%, respectively. Data are mean and vertical lines show s.e.mean.

$[\text{Ca}^{2+}]_i$ -tension curve obtained in diltiazem-treated strips practically overlapped that obtained in untreated strips. In other words, treatment with diltiazem moved each point downwards along with the  $[\text{Ca}^{2+}]_i$ -tension curve of control contractions. The  $K_d$  value and Hill coefficient in treated strips were  $307 \pm 35$  nM and  $3.5 \pm 0.8$ , respectively ( $n = 6$ ) (not significantly different from  $K_d$  in the absence of diltiazem).

The  $[\text{Ca}^{2+}]_i$ -tension relationship of contractions induced by cumulative applications of histamine (from  $10^{-7}$  to  $10^{-4}$  M) is shown in Figure 8. The extent of tension development for a given change in  $[\text{Ca}^{2+}]_i$  in  $\text{K}^+$ -depolarization-induced contractions was smaller than that for histamine-induced contractions, at  $[\text{Ca}^{2+}]_i$  over 300 nM. Effects of diltiazem on the  $[\text{Ca}^{2+}]_i$ -tension relationship of  $10^{-5}$  M histamine-induced contractions were examined at 8 min after the initiation of contractions (the second component). In the range  $10^{-8}$  to  $10^{-4}$  M, diltiazem caused a parallel displacement of the  $[\text{Ca}^{2+}]_i$ -tension relationship to the left of the curve produced by histamine alone.

#### Discussion

After incubation in fura-2/AM-containing media, strips of porcine coronary artery showed marked increases in fluorescence intensity. During 118 mM  $\text{K}^+$ -depolarization, there were no changes in 500 nm fluorescence intensities and ratio of fluorescence intensities at 340 nm and at 380 nm excitations, without fura-2-loading. However, after fura-2-loading, there was an increase in fluorescence intensity at 340 nm excitation,

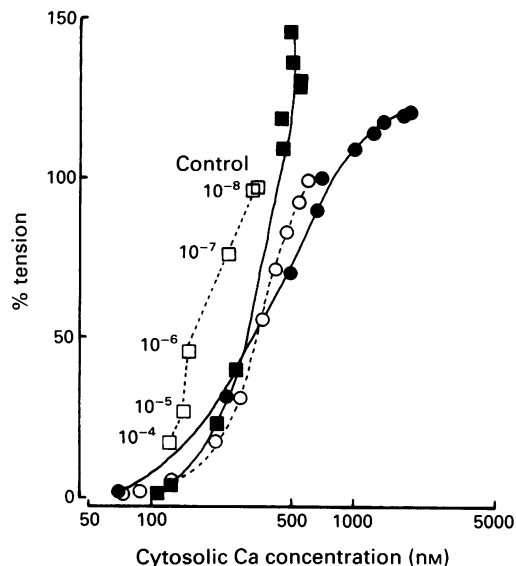

**Figure 8** Effects of diltiazem of the  $[Ca^{2+}]_i$ -tension relationship. The  $[Ca^{2+}]_i$ -tension relationship was obtained from data in Figures 5 and 7. Absolute values of  $Ca^{2+}$  concentrations were calculated as described in the Methods section. (○, ●) Indicate values obtained with contractions induced by cumulative applications of extracellular  $Ca^{2+}$  during  $K^+$ -depolarization, with (○) or without (●) treatment with  $10^{-6}$  M diltiazem, respectively ( $n = 6$ ). (□) Indicate values obtained with  $10^{-5}$  M histamine-induced contractions 8 min after application of histamine, in the strips treated with various concentrations of diltiazem ( $n = 6$ ). (■) Indicate values obtained with contractions induced by cumulative applications of histamine. Numbers beside each open square indicate the concentration of diltiazem applied (in M).

a decrease in 380 nm excitation and an increase in fluorescence ratio. These results suggest that fura-2/AM was effectively incorporated into cells and converted intracellularly to fura-2 free acid. The changes in fluorescence reflect changes in  $Ca^{2+}$  concentration, mainly in the cytosol (Grynkiewicz *et al.*, 1985). Loading the strips with fura-2 did not alter the time courses and the maximum levels of tension development during 118 mM  $K^+$ -depolarization, thereby suggesting that tissue damage by possible acidification of the cells due to formaldehyde released on acetoxymethyl-ester hydrolysis did not occur (Tsien *et al.*, 1982; Rink & Pozzan, 1985). Thus, one can measure tension development and fura-2-fluorescence simultaneously, and carry out quantitative evaluations of the  $[Ca^{2+}]_i$ -tension relationship in intact tissues.

Histamine, a receptor stimulating compound, caused greater tension development for a given change in  $[Ca^{2+}]_i$  than depolarization at  $[Ca^{2+}]_i$  over 300 nM (Figure 8). This suggests that receptor-mediated stimulation increased  $Ca^{2+}$ -sensitivity of the contractile apparatus (Morgan & Morgan, 1984; Bruschi *et al.*, 1988; Himpens & Somlyo, 1988; Rembold & Murphy, 1988; Sato *et al.*, 1988). In addition, the  $[Ca^{2+}]_i$ -tension relationship of the  $Ca^{2+}$ -induced contraction during depolarization was similar to the pCa-tension relationship noted with skinned fibres of the porcine coronary artery (Itoh *et al.*, 1982) and of others (Saida & Nonomura, 1978; Kuriyama *et al.*, 1982).

In the present study, diltiazem concentration-dependently inhibited histamine-induced, extracellular  $Ca^{2+}$ -dependent increases in  $[Ca^{2+}]_i$  (the second component) within the range  $10^{-8}$  M to  $10^{-5}$  M and only at higher concentrations (over  $10^{-5}$  M) inhibited the histamine-induced  $Ca^{2+}$ -release from the intracellular store sites (the first component). As in the case of  $[Ca^{2+}]_i$ , diltiazem also inhibited the extracellular  $Ca^{2+}$ -dependent development of tension at lower concentrations ( $\leq 10^{-5}$  M), and only at high concentrations ( $> 10^{-5}$  M) inhibited the first component of contractions in normal PSS and in  $Ca^{2+}$ -free PSS. These results are consistent with our previous findings in rat aortic smooth muscle cells in primary

culture. In rat cultured aortic smooth muscle cells, diltiazem inhibits histamine-mediated, extracellular  $Ca^{2+}$ -dependent increases in  $[Ca^{2+}]_i$  with low  $IC_{50}$  values (for  $10^{-5}$  M histamine,  $IC_{50} = 0.18 \mu M$ ); and only at high concentrations ( $IC_{50} = 95.7 \mu M$ ) did it inhibit the histamine-induced  $Ca^{2+}$ -release from intracellular store sites (Matsumoto *et al.*, 1989). We have also shown that diltiazem blocks  $[^3H]$ -mepyramine binding to membrane preparations from the porcine aorta at high concentrations ( $K_i = 114 \mu M$ ) (Matsumoto *et al.*, 1989).  $Ca^{2+}$ -antagonists inhibit the binding of several agonists to specific binding sites (Fairhurst *et al.*, 1980; Glossman & Hornung, 1980; Barnathan *et al.*, 1982; Karliner *et al.*, 1982; Nayler *et al.*, 1982; Motulsky *et al.*, 1983). Thus, inhibition of the receptor-mediated  $Ca^{2+}$ -release from intracellular store sites seen with very high concentrations of diltiazem (around  $10^{-4}$  M) may be due to competitive binding to receptor-sites.

It has been found that histamine, through the  $H_1$ -receptor, depolarizes the membrane potential of the rabbit ear artery (Casteels & Suzuki, 1980) and guinea-pig main pulmonary artery (Suzuki & Kou, 1983). Nelson *et al.* (1988), with patch clamp study, showed that an agonist, even when administered outside of a pipette, enhanced the  $Ca^{2+}$  current through voltage-operated  $Ca^{2+}$  channels (VOCs). They suggested that an agonist could modulate the  $Ca^{2+}$  current in the case of depolarization by acting through second messengers. From evidence obtained in these electrophysiological studies, it seems likely that histamine can increase the  $Ca^{2+}$  current through VOCs by depolarizing the membrane potential or by activating other receptor-mediated pathways. In the present study, such events may explain why diltiazem decreased the histamine-induced and extracellular  $Ca^{2+}$ -dependent increases in  $[Ca^{2+}]_i$  and contractions in the late phase. We did not obtain direct evidence that the late sustained phase of  $[Ca^{2+}]_i$  increase is primarily due to a  $Ca^{2+}$  influx through VOCs or receptor-operated channels. As it has been found that therapeutic peak blood levels of diltiazem range from  $10^{-7}$  M to  $10^{-6}$  M (Koiwaya *et al.*, 1981), our results suggest that the clinical efficacy of diltiazem appears to be due to the inhibitory effects on  $Ca^{2+}$  influx through  $Ca^{2+}$  channels. In certain peripheral vasculatures,  $Ca^{2+}$ -antagonists are concentrated and reach a relatively high level (Kates *et al.*, 1981). The inhibition of receptor-mediated  $Ca^{2+}$ -release from intracellular store sites may be able to inhibit the contraction.

The present study showed that the  $Ca^{2+}$ -tension relationship during depolarization in diltiazem-treated strips overlaps with that seen in the untreated strips. This would suggest that diltiazem has no direct effects on the contractile elements. However, in the case of histamine-induced contractions, the  $Ca^{2+}$ -tension relationship of the second component obtained with diltiazem paralleled that of the  $Ca^{2+}$ -induced contractions obtained in the absence of diltiazem, the result being a leftward shift of the  $Ca^{2+}$ -tension curve. These observations suggest that the mechanisms by which histamine produces a greater extent of tension development for a given change in  $[Ca^{2+}]_i$  than depolarization might be independent of  $[Ca^{2+}]_i$  and not be affected by treatment with diltiazem. These findings also indicate that relaxation of the histamine-induced contractions by diltiazem is caused by a decrease in  $[Ca^{2+}]_i$ , with no direct effects on the contractile elements. The leftward shift of the  $Ca^{2+}$ -tension relationship does not indicate that diltiazem potentiates the  $Ca^{2+}$ -sensitivity of contractile elements. These observations are consistent with findings that diltiazem had no effect on myosin light chain kinase or on protein kinase C (Shächtele *et al.*, 1989) and that diltiazem did not affect the pCa-tension relationship in skinned muscles (Suzuki *et al.*, 1982). However, other workers have shown that diltiazem, at high concentrations, has direct effects on contractile elements (Boström *et al.*, 1981; Johnson *et al.*, 1982) and decreases the effectiveness of  $Ca^{2+}$ -tension relationship (Saida & van Breemen, 1983).

Diltiazem ( $\geq 10^{-6}$  M) decreased the resting levels of  $[Ca^{2+}]_i$  without causing relaxation in the normal PSS. This also occurs on exposure to  $Ca^{2+}$ -free PSS. Therefore, diltiazem-

sensitive  $\text{Ca}^{2+}$  channels are apparently active under resting conditions and play a role in maintaining the resting level of  $[\text{Ca}^{2+}]_i$ . These events may be caused by dissociation of the  $[\text{Ca}^{2+}]_i$ -tension relationship, or it may be due to difficulties in detecting decreases in the resting tension.

We simultaneously measured fura-2 fluorescence and contractions in the porcine coronary artery and examined the vasodilator mechanisms of diltiazem. It was observed that diltiazem ( $\leq 10^{-5}$  M) specifically inhibited extracellular  $\text{Ca}^{2+}$ -dependent increases in  $[\text{Ca}^{2+}]_i$ , possibly  $\text{Ca}^{2+}$  influx through  $\text{Ca}^{2+}$  channels, and secondarily caused proportional decreases in tension development, with no effect on  $\text{Ca}^{2+}$ -sensitivity of the contractile elements. At high concentrations ( $> 10^{-5}$  M),

diltiazem inhibited  $\text{Ca}^{2+}$ -release from intracellular store sites, possibly by inhibiting binding of the agonist at receptor sites.

We thank M. Ohara for helpful comments. The present study was supported in part by Grant-in-Aids for Scientific Research on Priority Areas (No. 63624510 and No. 01641532) and for General Scientific Research (No. 01480250) from the Ministry of Education, Science and Culture, Japan and grants from the "Research Program on Cell Calcium Signals in the Cardiovascular System", from Suzuken Memorial Foundation, from Tokyo Biochemical Research Foundation, from Kanehara Ichiro Memorial Foundation, from Casio Science Promotion Foundation, Uehara Memorial Foundation, and from Ciba-Geigy Foundation (Japan) for the Promotion of Science.

## References

- BARNATHAN, E.S., ADDONIZO, P. & SHATTIL, S.J. (1982). Interaction of verapamil with human platelet  $\alpha$ -adrenergic receptors. *Am. J. Physiol.*, **242** (Heart Circ. Physiol., 11), H19-H23.
- BOSTRÖM, S.L., LJUNG, B., MARDH, S., FORSEN, S. & THULIN, E. (1981). Interaction of the antihypertensive drug felodipine with calmodulin. *Nature*, **292**, 777-778.
- BRUSCHI, G., BRUSCHI, M.E., REGOLISTI, G. & BORGHETTI, A. (1988). Myoplasmic  $\text{Ca}^{2+}$ -force relationship studied with fura-2 during stimulation of rat aortic smooth muscle. *Am. J. Physiol.*, **254**, (Heart Circ. Physiol., 23), H840-H854.
- CASTEELS, R. & SUZUKI, H. (1980). The effects of histamine on the smooth muscle cells of the ear artery of the rabbit. *Pflügers Archiv.*, **387**, 17-25.
- CAUVIN, C., LOUZENZHISER, R. & VAN BREEMEN, C. (1983). Mechanisms of calcium antagonist-induced vasodilation. *Ann. Rev. Pharmacol. Toxicol.*, **23**, 373-396.
- FAIRHURST, A.S., WHITTAKER, M.L. & ELERT, F.J. (1980). Interaction of D600 (methoxy-verapamil) and local anesthetics with rat brain  $\alpha$ -adrenergic and muscarinic receptors. *Biochem. Pharmacol.*, **29**, 155-162.
- FLECKENSTEIN, A. (1977). Specific pharmacology of calcium in myocardium, cardiac pacemakers, and vascular smooth muscle. *Ann. Rev. Pharmacol. Toxicol.*, **17**, 149-166.
- GLOSSMAN, H. & HORNING, R. (1980). Calcium- and potassium-channel blockers interact with  $\alpha$ -adrenoceptors. *Mol. Cell Endocrinol.*, **19**, 243-251.
- GREEN, F.J., FARMER, B.B., WISEMAN, G.L., JOSE, M.J.L. & WATANABE, A.M. (1985). Effect of membrane depolarization on binding of  $[^3\text{H}]$  nitrendipine to rat cardiac myocytes. *Circ. Res.*, **56**, 576-585.
- GRYNKIEWICZ, G., POENIE, M. & TSIEN, R.Y. (1985). A new generation of  $\text{Ca}^{2+}$  indicators with greatly improved fluorescence properties. *J. Biol. Chem.*, **260**, 3440-3450.
- HIMPENS, B. & SOMLYO, A.P. (1988). Free-calcium and force transients during depolarization and pharmacomechanical coupling in guinea-pig smooth muscle. *J. Physiol.*, **395**, 507-530.
- HIRANO, K., KANAIDE, H. & NAKAMURA, M. (1989). Effects of okadaic acid on cytosolic calcium concentrations and on contractions of the porcine coronary artery. *Br. J. Pharmacol.*, **98**, 1261-1266.
- ITOH, T., KAJIWARA, M., KITAMURA, K. & KURIYAMA, H. (1982). Roles of stored calcium on the mechanical response evoked in smooth muscle cells of the porcine coronary artery. *J. Physiol.*, **322**, 107-125.
- JOHNSON, J.D., VAGHY, P.L., CROUCH, T.H., POTTER, J.D. & SCHWARTZ, A. (1982). An hypothesis for the mechanism of action of some of the  $\text{Ca}^{2+}$  antagonist. Drug: calmodulin as a receptor. *Adv. Pharmacol. Ther.*, **3**, 121-138.
- KAMM, K.E. & STULL, J.T. (1985). The function of myosin and myosin light chain phosphorylation in smooth muscle. *Ann. Rev. Pharmacol. Toxicol.*, **25**, 593-620.
- KANAIDE, H., YOSHIMURA, R., MAKINO, R. & NAKAMURA, M. (1982). Regional myocardial function and metabolism during acute coronary artery occlusion. *Am. J. Physiol.*, **242** (Heart Circ. Physiol., 11), H980-H989.
- KANAIDE, H., KOBAYASHI, S., NISHIMURA, J., HASEGAWA, M., SHOGAKIUCHI, Y., MATSUMOTO, Y. & NAKAMURA, M. (1988). Quin2 microfluorometry and effects of verapamil and diltiazem in calcium release from rat aorta smooth muscle cells in primary culture. *Circ. Res.*, **63**, 16-26.
- KARLINER, J.S., MOTULSKY, H.J., DUNLAP, J., BROWN, J.H. & INSEL, P.A. (1982). Verapamil competitively inhibits  $\alpha_1$ -adrenergic and muscarinic, but not  $\beta$ -adrenergic receptors in rat myocardium. *J. Cardiovascular Pharmacol.*, **4**, 515-520.
- KATES, R.E., KEEFE, D., SCHWARTZ, J., HARAPAT, S., HARRISON, D., KIRSTEN, E. & JOHNSON, S.M. (1981). Deposition kinetics of verapamil and norverapamil (abstract). *Clin. Pharmacol. Ther.*, **29**, 257.
- KOBAYASHI, S., KANAIDE, H. & NAKAMURA, M. (1985). Cytosolic-free calcium transients in cultured vascular smooth muscle cells: microfluorometric measures. *Science*, **229**, 553-556.
- KODAMA, M., KANAIDE, H., ABE, S., HIRANO, K., KAI, H. & NAKAMURA, M. (1989). Endothelin-induced  $\text{Ca}^{2+}$ -independent contraction of the porcine coronary artery. *Biochem. Biophys. Res. Commun.*, **160**, 1302-1308.
- KOIWAYA, Y., ASHIHARA, T., NAKAMURA, M. & ETOH, A. (1981). Plasma concentration of diltiazem after oral administration in normal volunteers. *Clin. Ther.*, **3**, 436-440.
- KURIYAMA, H., ITOH, Y., SUZUKI, H., KITAMURA, K. & ITOH, T. (1982). Factors modifying contraction-relaxation cycle in vascular smooth muscles. *Am. J. Physiol.*, **243** (Heart Circ. Physiol., 12), H641-H662.
- MATSUMOTO, T., KANAIDE, H., NISHIMURA, J., KUGA, T., KOBAYASHI, S. & NAKAMURA, M. (1989). Histamine-induced calcium transients in vascular smooth muscle cells: effects of verapamil and diltiazem. *Am. J. Physiol.*, **257** (Heart Circ. Physiol., 26), H563-H570.
- MORGAN, J.P. & MORGAN, K.G. (1984). Stimulation-specific patterns of intracellular calcium levels in smooth muscle of ferret portal vein. *J. Physiol.*, **351**, 155-167.
- MOTULSKY, H.J., SNAVELY, M.D., HUGHES, R.J. & INSEL, P.A. (1983). Interaction of verapamil and other calcium channel blockers with  $\alpha_1$ - and  $\alpha_2$ -adrenergic receptors. *Circ. Res.*, **52**, 226-231.
- NELSON, M.T., STANDEN, N.B., BRAYDEN, J.E. & WORLEY III, J.F. (1988). Noradrenaline contracts arteries by activating voltage-dependent calcium channels. *Nature*, **336**, 382-385.
- NAYLER, W.G., THOMPSON, J.E. & JARROTT, B. (1982). The interaction of calcium antagonists (slow channel blockers) with myocardial  $\alpha$  adrenoceptors. *J. Mol. Cell Cardiol.*, **14**, 185-188.
- REMBOLD, C.M. & MURPHY, R.A. (1988). Myoplasmic  $[\text{Ca}^{2+}]_i$  determines myosin phosphorylation in agonist-stimulated swine arterial smooth muscle. *Circ. Res.*, **63**, 593-603.
- RINK, T.J. & POZZAN, T. (1985). Using quin2 in cell suspensions. *Cell Calcium*, **6**, 133-144.
- SAIDA, K. & NONOMURA, Y. (1978). Characteristics of  $\text{Ca}^{2+}$ - and  $\text{Mg}^{2+}$ -induced tension development in chemically skinned smooth muscle fibers. *J. Gen. Physiol.*, **72**, 1-14.
- SAIDA, K. & VAN BREEMEN, C. (1983). Mechanism of  $\text{Ca}^{2+}$  antagonist-induced vasodilation-intracellular actions. *Circ. Res.*, **52**, 137-142.
- SATO, K., OZAKI, H. & KARAKI, H. (1988). Changes in cytosolic calcium level in vascular smooth muscle strip measured simultaneously with contraction using fluorescent calcium indicator fura2. *J. Pharmacol. Exp. Ther.*, **246**, 294-300.
- SCATCHARD, G. (1949). The attractions of protein for small molecules and ion. *Ann. New York Acad. Sci.*, **51**, 660-672.
- SCHÄCHTELE, C., WAGNER, B. & RUDOLPH, C. (1989). Effect of  $\text{Ca}^{2+}$  entry blockers on myosin light-chain kinase and protein kinase C. *Eur. J. Pharmacol.*, **163**, 151-155.
- SEGEL, I.H. (1976). *Biochemical Calculation*, 2nd ed. New York: John Wiley & Sons, Inc.
- SHIMOKAWA, H., TOMOIKE, H., NABEYAMA, S., YAMAMOTO, H., ARAKI, H., NAKAMURA, M., ISHII, Y. & TANAKA, K. (1983). Coronary artery spasm induced in atherosclerotic miniature swine. *Science*, **221**, 560-562.
- SOMLYO, A.P. (1985). Excitation-contraction coupling and the ultrastructure of smooth muscle. *Circ. Res.*, **57**, 497-507.
- SOMMERVILLE, L.E. & HARTSHORNE, D.J. (1986). Intracellular calcium and smooth muscle contraction. *Cell Calcium*, **7**, 353-364.

- SUZUKI, H., ITOH, T. & KURIYAMA, H. (1982). Effects of diltiazem on smooth muscles and neuromuscular junction in the mesenteric artery. *Am. J. Physiol.*, **242** (Heart Circ. Physiol., 11), H325–H336.
- SUZUKI, H. & KOU, K. (1983). Direct and indirect effects of histamine on the smooth muscle cells of the guinea-pig main pulmonary artery. *Pflügers Archiv.*, **339**, 46–53.

- TSIEN, R.Y., POZZAN, T. & RINK, T.J. (1982). Calcium homeostasis in intact lymphocytes: cytoplasmic free calcium monitored with a new, intracellularly trapped fluorescence indicator. *J. Cell Biol.*, **94**, 325–334.

(Received January 16, 1990  
Revised June 17, 1990  
Accepted June 19, 1990)