

Isometric Contraction by Fibroblasts and Endothelial Cells in Tissue Culture: A Quantitative Study

Michael S. Kolodney and Robert B. Wysolmerski*

Department of Biochemistry and Molecular Biophysics, Washington University School of Medicine, St. Louis, Missouri 63110; and
*Department of Pathology, St. Louis University School of Medicine, St. Louis, Missouri 63104

Abstract. We have used an isometric force transducer to study contraction of two types of nonmuscle cells in tissue culture. This method permits the quantitative measurement of contractile force generated by cells of defined type under the influence of external agents while allowing detailed morphological observation. Chick embryo fibroblasts (CEF), which form a contractile network inside a collagen matrix, and human umbilical vein endothelial cells (HUVE), which are located in a monolayer on the surface of the collagen matrix, were studied. CEF and HUVE in 10% FCS produce a substantial tension of $4.5 \pm 0.2 \times 10^4$ dynes/cm² and 6.1×10^4 dynes/cm², respectively. Both

cell types contract when stimulated with thrombin, generating a force per cell cross-sectional area of $\sim 10^5$ dynes/cm², a value approximately an order of magnitude less than smooth muscle. The integrity of the actin cytoskeleton is essential for force generation, as disruption of actin microfilaments with cytochalasin D results in a rapid disappearance of force. Intact microtubules appear to reduce isometric force exerted by CEF, as microtubule-disrupting drugs result in increased tension. Contraction by HUVE precedes a dramatic rearrangement of actin microfilaments from a circumferential ring to stress fibers.

MOST of what is known about force generation in animal cells has come from studies of muscle. However, the generation of force is essential to such nonmuscle cell functions as wound contraction, gastrulation, and connective tissue morphogenesis. We have developed a simple quantitative technique to study isometric contraction of cells in tissue culture. This technique allows mechanical study of a variety of nonmuscle and smooth muscle cells undergoing biochemical and genetic manipulations.

Nonmuscle cells are believed to generate force through interaction between actin and myosin as in smooth and skeletal muscle (1, 20, 25, 26). Recently it has been demonstrated that nonmuscle cells express isoforms of nonsarcomeric myosin distinct from those expressed in smooth muscle (18, 19). The nature of these isoforms has been characterized; however, their function remains unclear. Thus, a quantitative study of isometric contraction in a tissue culture system may provide insight into the mechanical specialization of nonmuscle myosin isoforms.

Unlike skeletal muscle, in which the cytoskeleton is arranged in a well-defined, stable organization, nonmuscle cells rearrange their cytoskeletons in response to physiological stimuli such as growth factors and secretagogues. It is clear that studies correlating cell mechanics with cytoskeletal morphology and biochemistry are needed to understand mechanisms through which nonmuscle cells control their mechanical machinery. In this study, we present the results of initial efforts to assay quantitatively the force produced in

vitro by nonmuscle cells as they undergo stimulation and morphological change. We present measurements of the isometric force developed by a contractile network of chick embryo fibroblasts (CEF)¹ as well as a monolayer of human umbilical vein endothelial (HUVE) cells. We examine the contractile response of both cell types to thrombin, a potent growth factor for CEF (5), as well as an agonist for endothelial retraction (21, 24). In addition, we have determined the mechanical response to specific disruption of actin filaments and microtubules. In all studies, we examined correlations between changes in cytoskeletal morphology and contraction.

Materials and Methods

Cell Culture

CEF cells (a generous gift of Dr. Milton Schlesinger, Washington University, St. Louis, MO) isolated from 11-d-old chick embryos were maintained in DME supplemented with 10% FCS, 50 U/ml penicillin, and 50 μ g/ml streptomycin. CEF cells were used in the second passage. HUVE cells were harvested from human umbilical veins by the method of Jaffe et al. (16). Cells were seeded on fibronectin-coated T-25 cm² flasks in MCDB-107 medium supplemented with 20% FCS, 90 μ g/ml heparin, 50 μ g/ml endothelial cell growth supplement (Sigma Chemical Co., St. Louis, MO) (27), 5 μ g/ml transferrin, 5 μ g/ml penicillin, and 50 U/ml streptomycin. HUVE were used in the first passage.

1. *Abbreviations used in this paper:* CEF, chick embryo fibroblasts; HUVE, human umbilical vein endothelial cells.

Isometric Tension Apparatus

Figure 1 *A* is a diagrammatic representation of the isometric force monitoring apparatus. The chamber was constructed from a 100-mm polymethylpentene petri dish (Nalge Co., Nalgene Labware Div., Rochester, NY) filled to a depth of 5 mm with Sylgard 186 silicone elastomer (Dow Corning Corp., Midland, MI) and allowed to harden overnight. A 25-mm strip was cut out of the silicone elastomer (\sim vol 10 ml) to form a trough for casting of the collagen gel. Bars 7 cm \times 3 mm \times 0.25 in. of porous polyethylene (Bel-Art Products, Pequannock, NJ) were cut from a stock sheet with a dull band saw, producing a large burr on the polyethylene bar to which the collagen gel adhered. After cutting, the polyethylene bars were soaked for 3 d in concentrated sulfuric acid and then washed for 2 d in 10 changes of distilled water. Holders were then constructed by attaching 3.5-in., 25-gauge spinal needles to the midpoints of the bar. The holders and experimental chamber were steam sterilized by autoclaving for 15 min at 121 PSI. One of the pair of polyethylene holders was attached to an x,y,z-multiaxis stage manipulator, whereas the other was affixed to a research-grade isometric force transducer (model 52-9545; Harvard Apparatus Co., Inc., S. Natick, MA). The transducer detects force as a capacitance change due to minute deflection of a stiff beam. The beam deflects $<10^{-3}$ cm under a load of 1,000 dynes, giving a strain of $<0.1\%$ under maximal load for all experiments in this study. The transducer was calibrated with a series of weights ranging from 10 to 1,000 dynes. All measurements were performed at 37°C in a humidified 5% CO₂/95% air atmosphere.

Collagen Gel Preparation

For both CEF and HUVE experiments, collagen gels were cast from a collagen/DME solution (4) composed of 4.0 ml bovine skin collagen (3 mg/ml stock bovine calf skin collagen [Vitrogen, Collagen Corp., Palo Alto, CA]), 4.4 ml 2 \times DME, 1 ml FCS, 4 ml DME with 10% FCS, penicillin, streptomycin, and 0.4 ml 0.1 N NaOH. All solutions used to prepare collagen gels were maintained at 4°C to retard collagen polymerization.

For isometric force studies of CEF, 10⁷ cells were suspended in 13 ml chilled collagen/DME solution, gently mixed, and poured between polyethylene holders. The collagen/cell suspension gelled within 1 h at 37°C.

For studies on HUVE, a slight modification of this procedure was used. 5 ml of 1 mg/ml collagen/DME solution was poured between the polyethylene holders and allowed to gel for 24 h at 37°C in a humidified incubator. HUVE (4.5 \times 10⁶) were seeded onto precast gels, where they formed a confluent monolayer within 2 d. Monolayers used in this study were 5 d postconfluent.

24 h before measurement, CEF were refed with DME without serum and HUVE monolayers were fed with MCDB-107 supplemented only with 10% FCS and 5 μ g/ml transferrin.

Immunofluorescence

To investigate cytoskeletal morphology, cells were grown in or on collagen membranes prepared identically to those used for force measurements. To visualize microtubules, fibroblasts in the collagen membrane were permeabilized in a microtubule-stabilizing buffer (60 mM Pipes, 10 mM HEPES, 10 mM EGTA, 2 mM MgCl₂, pH 6.9) with 0.1% Triton for 40 s. The cells were then fixed in microtubule-stabilizing buffer plus 0.1% Triton with 0.5% glutaraldehyde, and then treated with sodium borohydride (1 mg/ml) for 3 min. The samples were incubated first with a mixture of monoclonal antibodies (1:1,000 dilution) to α - and β -tubulin (Amersham Corp., Arlington Heights, IL) for 1 h and then with rhodamine-conjugated goat anti-mouse antibody (Sigma Chemical Co.) for 30 min.

To visualize actin microfilaments, cells in or on collagen membranes were fixed with freshly made 3% formaldehyde in PBS and stained with rhodamine phalloidin (Molecular Probes, Inc., Eugene, OR) by the method of Barak et al. (2). Collagen membranes were coverslipped in 90% glycerol/10% PBS containing 0.1 M n-propyl gallate (10) and sealed with nail polish.

Determination of Cellular Cross-Sectional Area

For determination of cross-sectional area, collagen membranes with cells were washed once in Dulbecco's phosphate-buffered saline, pH 7.3, and immediately flooded with fixative consisting of 1% formaldehyde (Polysciences, Inc., Warrington, PA) and 2.5% glutaraldehyde (Polysciences, Inc.) warmed to 37°C. The collagen membranes were washed twice with fixative at 37°C and then fixed for an additional 24 h at 4°C. Fixed tissues were removed from the polyethylene holders, cut into 1-mm³ blocks, post-

fixed in 1% osmium tetroxide in 0.15 M phosphate buffer for 1 h, dehydrated in graded steps of ethanol, infiltrated with resin, and embedded in Poly Bed 812. 1- μ m sections were cut and stained with toluidine blue.

To enhance contrast of cells for computational determination of cell area, we exploited the apparent ability of toluidine blue to quench the autofluorescence of the Poly Bed 812 resin. Semithin sections were viewed with a confocal microscope (model MRC-600, Bio-Rad Laboratories, Richmond, CA) using neutral density filter 2 with the pinhole aperture fully opened. At 563-nm excitation, Poly Bed 812 is highly fluorescent, producing an intensely bright background, whereas the cells stained with toluidine blue appear as black areas. Frames were taken sequentially through the entire thickness of the collagen membrane (typically 800 μ m). The fractional area occupied by the cells in each frame was computed using the MRC-600 software package, which allowed us to select structures of a particular intensity range for quantitation. After averaging 20 scans using the Kalman filter, we used the statistical function to produce a histogram of pixel intensities. The band function allowed us to highlight the appropriate pixel intensity range in pseudocolor on the monitor screen and to verify visually that the highlighted region corresponded exactly to the cells. The band function was then used to compute the fractional area occupied by the cells. Force for each collagen membrane was normalized to its cellular cross-sectional area determined in this manner.

Results

For experiments using CEF, a collagen gel containing 1 \times 10⁷ cells was prepared by pouring a collagen-cell suspension between the two porous polyethylene holders of the isometric force apparatus. The collagen-cell suspension gelled within 1 h after casting. By 4 h after casting, the CEF contract the gel from an initial thickness of \sim 8 mm to an 800- μ m-thick membrane (Fig. 1 *B*). The hydrophobic nature of the Sylgard 18 elastomer filler and the polymethylpentene petri dish ensured that the collagen membrane adhered only to the porous polyethylene holders. At the cell density used in these experiments, no cell replication occurred within the collagen membrane (data not shown). HUVE were seeded onto a precast collagen gel, which the cells contracted into a thin membrane within 48 h of culture. Upon collagen polymerization, the gel filled the entire expanse between the silicone elastomer. Within 1 h, both the CEF and HUVE began to contract the collagen matrix away from the silicone elastomer. By 24 h, the collagen membrane only spanned the area between the porous polyethylene holders (Fig. 1 *B*).

Examination of semithin Epon sections revealed that CEF within the collagen membrane organized into three characteristic patterns. As demonstrated in Fig. 2, the cross-sectional distribution of CEF within the collagen membrane can be categorized as follows: (a) a random dispersal of cells (Fig. 2 *A*); (b) longitudinally oriented layers one cell thick (Fig. 2 *B*); and (c) layers three to five cells thick located at the base of the gel (Fig. 2 *C*). The HUVE seeded on the gel surface did not invade the gel but instead formed a monolayer on the top surface of the gel (Fig. 2 *D*).

Fig. 3 is a representative tracing of the time course of isometric force developed by CEF maintained in 10% FBS. A force of 20 dynes was produced by the cells within 3 h after casting the collagen-cell suspension. The initial slow rise in force corresponds to the period in which the cells retracted the collagen gel into a thin membrane spanning the porous polyethylene holders (Fig. 1 *B*). Typically, a steady increase in force occurred over the next 24 h and then plateaued at a steady state value of \sim 600 dynes by 36 h after casting. Cells maintained this steady state force for as long as 7 d in culture.

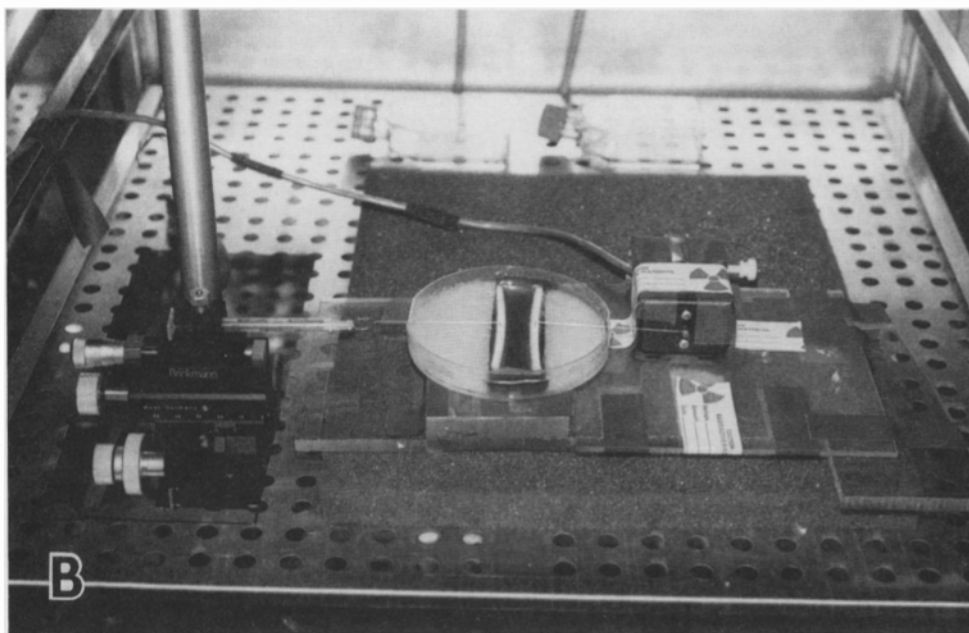
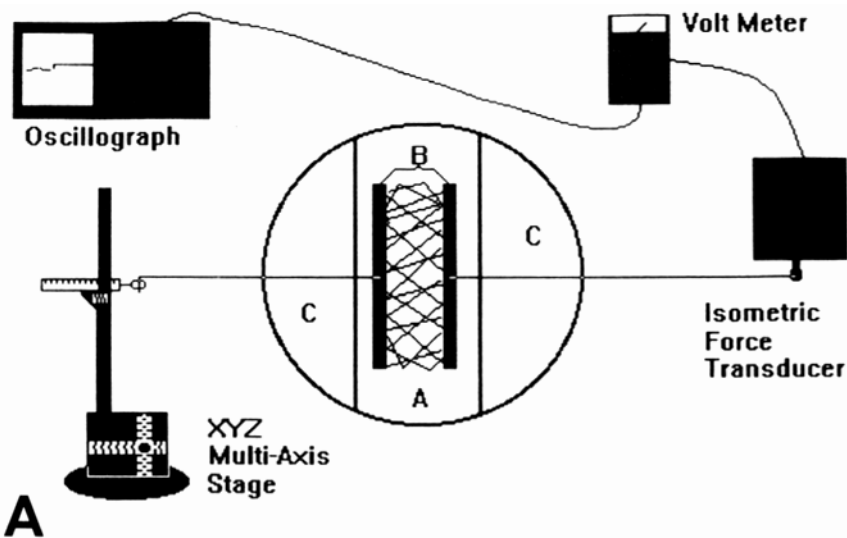

Figure 1. (A) A schematic representation of the isometric force monitoring apparatus. A polymethylpentene petri dish (100 mm) is filled with silicon elastomer (C). A 25-mm trough (A) is cut out from the elastomer for positioning of the porous polyethylene holders (B). One of the holders is attached to a multi-axis stage manipulator, and the other is attached to an isometric force transducer. Force is monitored with a volt meter and recorded with an oscillograph. (B) Experimental force monitoring apparatus. The cells have compressed the collagen gel into a thin membrane spanning the two porous polyethylene holders. The holders and collagen membrane float in media, creating a frictionless system required for accurate force measurements. All experiments are performed at 37°C in a humidified 5% CO₂/95% air atmosphere.

To compare isometric force values in our system with those produced by other preparations (Table I), we calculated cellular cross-sectional areas in the collagen membranes. Measurements were performed by computing the percentage of collagen membrane cross-sectional area occupied by the cells in semithin Epon sections as outlined in Materials and Methods. Using this measurement, we calculated that CEF maintained in 10% FCS produce a steady state isometric force per cross-sectional area of $4.5 \pm 0.2 \times 10^4$ dynes/cm².

To further evaluate the organization of cells populating the collagen membrane, CEF were stained with the actin filament-specific probe rhodamine phalloidin. Fig. 4 illustrates the F-actin distribution in CEF populating the collagen membrane. Cells were oriented longitudinally and exhibited well-defined F-actin bundles that coaligned at cell-cell contacts. The direction of this alignment was often along the iso-

metric axis, but in some areas of the collagen membrane other orientations at various angles to this axis were observed.

Contractile Effects of Thrombin

Fig. 5 depicts a typical tracing of isometric force developed by CEF exposed to increasing doses of thrombin. Fibroblast-populated collagen membranes were used in these experiments 48 h after casting and were maintained in serum-free DME for the final 12 h before addition of thrombin. As indicated in the dose-response curve, CEF responded to repeated challenges with thrombin. Doses of 0.2 U/ml and 1 U/ml yielded the largest incremental rises in active force. Force reached maximum at 10 U/ml of thrombin, after which additional thrombin did not increase force.

An unexpected finding was the stability of thrombin-

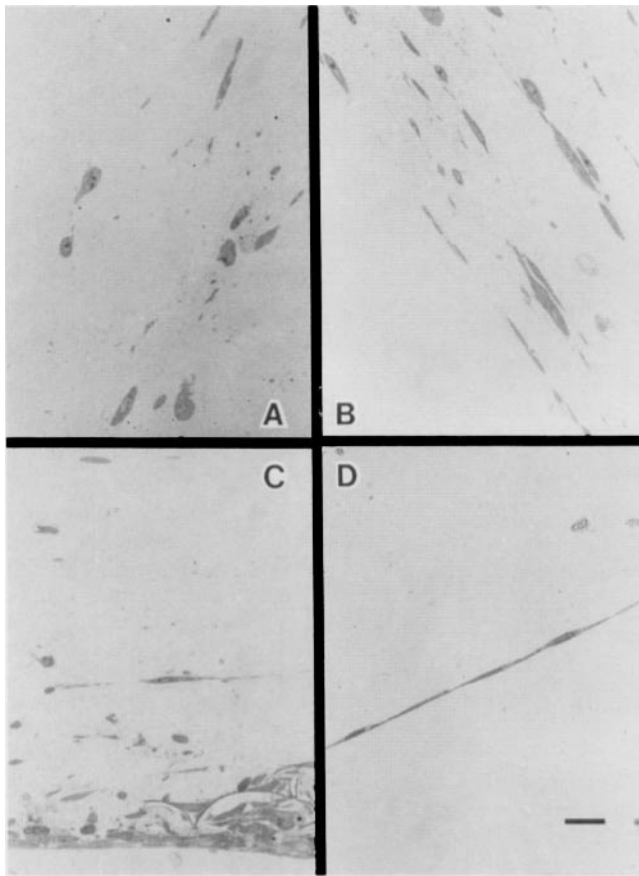

Figure 2. Semithin Epon sections of CEF within the collagen membrane and HUVE in a monolayer on the surface of the membrane. Collagen membranes are fixed, embedded, and stained as outlined in Materials and Methods. (A) Randomly dispersed CEF. (B) Longitudinally oriented layers of CEF. (C) Multiple layers of CEF at the base of the collagen membrane. (D) Coherent monolayer of HUVE on the top surface of the collagen membrane. Collagen membranes prepared in this manner are used to determine cellular cross-sectional area. Bar, 10 μm .

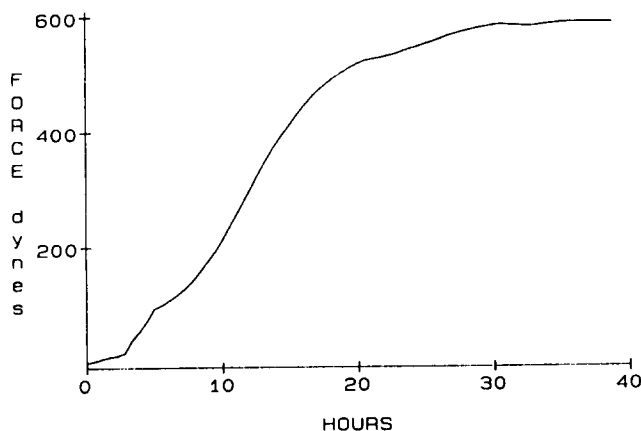

Figure 3. Representative tracing of force development by a CEF-populated collagen membrane. Collagen-cell suspension containing 1×10^7 CEF was cast, and the force is continuously monitored. The collagen gel is contracted into a thin membrane within the first 3 h (Fig. 1 B), after which a steady force increase occurs over the first 24 h. Force begins to plateau 24 h after casting and reaches a steady state force by 36 h.

Table I. Force Normalized to Cross-sectional Area in Selected Muscle and Non-muscle Cell Preparations

Preparations	Tension	Reference
	dynes/cm ²	
Contracting skin wound*	3.2×10^4	13
Rat skeletal muscle‡	2.3×10^6	3
Arterial smooth muscle‡	6.7×10^6	12
CEF§	1.0×10^5	
HUVE§	1.3×10^5	

* Nonstimulated.

‡ These preparations were stimulated electrically to give maximal force.

§ CEF and HUVE were prepared for isometric force studies as outlined in Materials and Methods. Both CEF and HUVE collagen membranes were treated with 1 U/ml thrombin for 15 min and then fixed and processed for cellular cross-sectional area determination.

stimulated contraction (Fig. 6). Isometric force increased to near maximal values within minutes after thrombin challenge. This rise in tension was then stable for days after thrombin administration. We investigated the possibility that this force maintenance was due to a structural alteration within the collagen membrane rather than continual force production by the CEF. Disruption of actin microfilaments with 2 μM cytochalasin D (Fig. 7) abolished most of the tension within 10 min (Fig. 6), indicating that the tension was maintained by the cells' actin cytoskeleton rather than the collagen matrix. However, we could not identify any obvious changes in the CEF actin cytoskeleton after treatment with thrombin.

Cytoskeletal Disruption

We studied the effects of drugs that disrupt specific cytoskeletal structures to determine the involvement of these components in the generation of contractile force (Fig. 8). Cytochalasin D, which disrupts actin filaments (Fig. 7), rapidly abolished the force. The microtubule-disrupting drug nocodazole typically caused a twofold increase in force, which returned to baseline after several hours. Microtubule disruption by nocodazole in the experiments was verified by immunofluorescence. The force increase resulting from nocodazole was typically >50% of the resting force. The microtubule-stabilizing drug taxol produced a sustained decrease in force and was able to block both the morphological (microtubule-disrupting) and mechanical effects of nocodazole. Colchicine, which disrupts microtubules in a manner similar to nocodazole, produced an identical morphological and mechanical effect (data not shown).

Endothelial Monolayers

Upon determining the nature of isometric force produced by CEF, we sought to characterize the isometric tension produced by a more highly specialized cell type. We used HUVE, because they are readily available at early passage, and, in contrast to CEF, form a characteristic contact-inhibited monolayer on the top surface of the collagen membrane. In addition, it has recently been shown that permeabilized endothelial monolayers use a myosin-based contractile system (28, 29), as do fibroblasts (15), in response to exogenous stimuli. Experiments were performed on first-passage monolayers.

Collagen gels were seeded with HUVE at a confluent den-

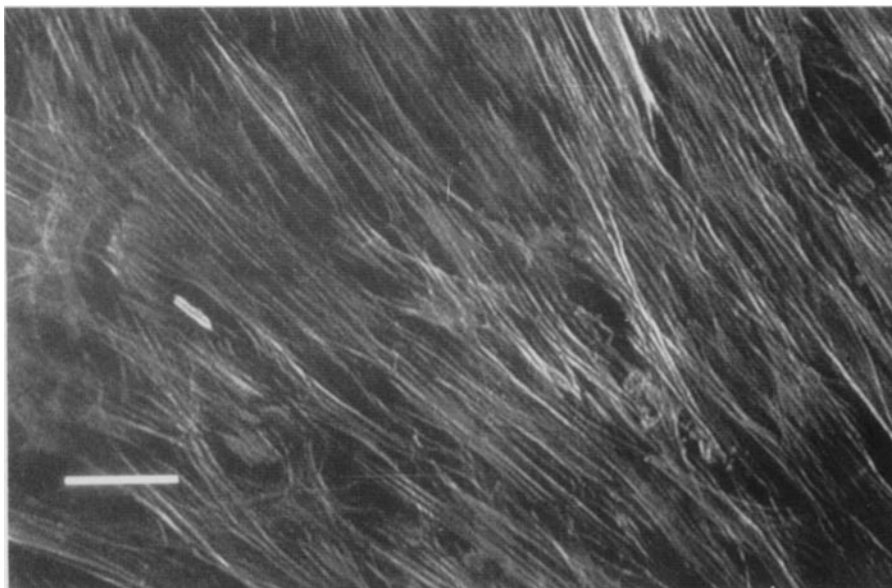

Figure 4. Fluorescence micrograph of F-actin distribution of CEF populating a collagen membrane prepared identically to those used for force measurements. A collagen membrane was fixed 48 h after casting and stained with rhodamine-conjugated phalloidin as outlined in Materials and Methods. Actin bundles appear oriented in the longitudinal direction of the cells and appear to align at cell-cell contacts. Bar, 25 μ M.

sity. The cells reorganized and contracted the collagen gel into a membrane within 2 d. After 4–5 d at confluence, monolayers developed a steady state isometric force of 65–70 dynes (9–10 dynes/cm). Monolayers were used within 24 h of reaching a steady state force. Before stimulation, monolayers were washed with MCDB-107 containing 0.1% BSA and the force was allowed to stabilize for 30 min. When HUVE monolayers were then exposed to 1 U/ml thrombin, contraction was evident within the first minute of stimulation (Fig. 9). The force began to plateau by 5 min, near a peak of 132 dynes (18.8 dynes/cm). Force declined slightly in the 30 min following maximal force development. Addition of 2 μ M cytochalasin D rapidly eliminated tension in the monolayer.

A maximum force of 1.3×10^5 dynes/cm² of cellular cross-sectional areas is typical for HUVE treated with thrombin (1 U/ml), a value comparable to that for CEF.

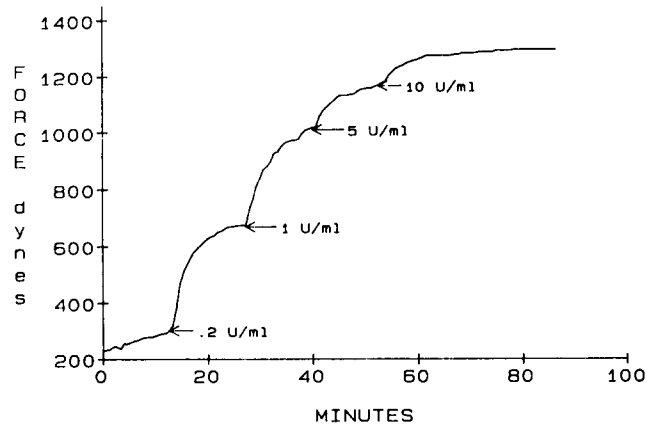

Figure 5. Effect of incremental doses of thrombin on CEF isometric tension. After establishment of a steady state force, collagen membranes were washed and maintained in serum-free media for 12 h before being challenged with thrombin.

Having demonstrated that an increase in isometric tension results upon exposure to thrombin, we sought to establish a temporal relationship between rearrangements in actin morphology and development of tension in the cytoplasm of HUVE. Monolayers prepared identically to those used for force measurements were treated with 1 U/ml thrombin for various times, fixed, permeabilized, and stained with rhodamine phalloidin. Fig. 10 A illustrates the F-actin distribution from a control monolayer grown on a collagen matrix. HUVE exhibited a cohesive sheet of polygonal cells that covered the collagen membrane. A thin rim of fluorescent staining was present at the cell margins that clearly delineate each individual cell. The central regions of the unstimulated cells were devoid of prominent stress fibers; however, a few randomly oriented microfilament bundles were present. Small droplets of fluorescent staining material were also evident throughout the cytoplasm.

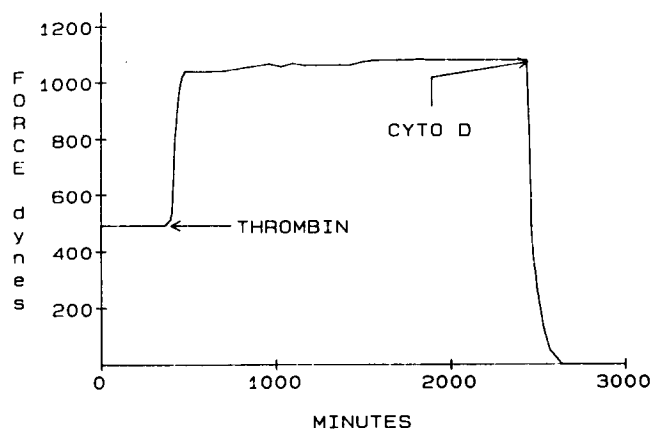

Figure 6. Stability of thrombin-stimulated contraction. After reaching steady state force, CEF were treated with 2 U/ml thrombin. Force reached new steady state value within 5–10 min of thrombin treatment and stayed at this level for up to several days. Treatment with 2 μ M cytochalasin D (CYTO D) abolished tension within 10 min.

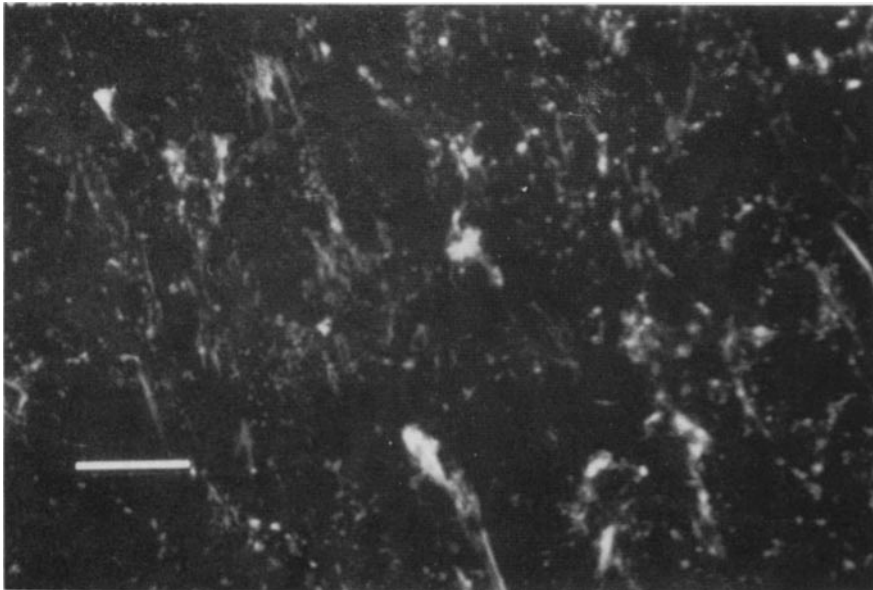

Figure 7. Fluorescent micrograph of F-actin distribution in CEF-populated collagen lattice treated with 2 μ M cytochalasin D for 15 min. Severe disruption of actin morphology occurred, with the loss of actin bundles. Aggregates of F-actin appear at sites of cell-cell attachment. Bar, 25 μ m.

After a 5-min exposure to thrombin (Fig. 10, B and C), a fine network of actin filaments became apparent throughout the cytoplasm. Force was near maximum at this point, although most stress fibers had not yet formed. The rim of fluorescent staining at the cell margin was less distinct, and it appeared as if circumferential bundles of actin filaments

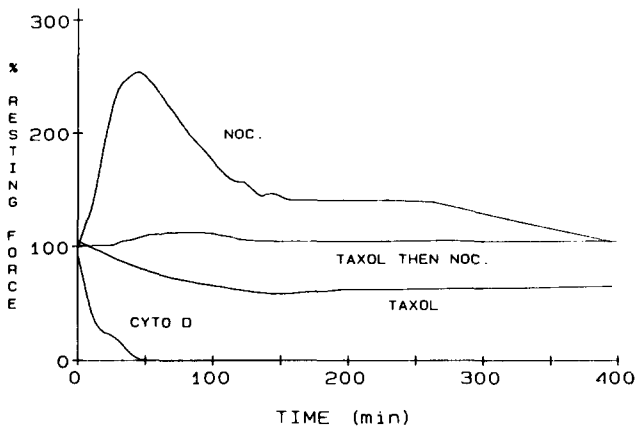

Figure 8. Modulation of CEF isometric tension by specific cytoskeletal-disrupting drugs. CEF collagen membranes were prepared as described in Materials and Methods and used within 12 h after reaching maximal resting force. Drugs were added at time 0, and membranes were incubated in the continuous presence of either 2 μ M nocodazole (*NOC.*), a 2-h pretreatment with taxol followed by 2 μ M nocodazole at time 0 (*TAXOL THEN NOC.*), 2 μ M taxol (*TAXOL*), or 2 μ M cytochalasin D (*CYTO D*). Force production was monitored for an additional 6 h. Nocodazole treatment increased force twofold over basal levels within 60 min. Force gradually returned to basal levels over the ensuing 5 h. The increase in force produced by nocodazole alone was dramatically diminished by a 2-h pretreatment with 10 μ M taxol. A reduction in basal force to 60% of control values occurred within 90 min of taxol treatment alone. Cytochalasin D caused a rapid reduction in force to undetectable levels within 40 min. Disruption of actin microfilaments and microtubules was verified by fluorescence microscopy.

were beginning to develop. HUVE retained their polygonal morphology but exhibited small gaps between cells within the monolayer. By 15 min after exposure to thrombin, the fine actin network reorganized into prominent stress fibers aligned parallel to each other and to the long axis of the cell (Fig. 10 D). A circumferential band of actin filaments formed at the cell margins. HUVE retracted from one another but remained attached by slender cell processes containing cores of actin filaments (Fig. 10 D).

No evidence of stress fiber arrangement parallel to the isometric axis could be detected in unstimulated monolayers. In contrast to CEF, which develop their polarity while retracting the collagen matrix around the polyethylene holders,

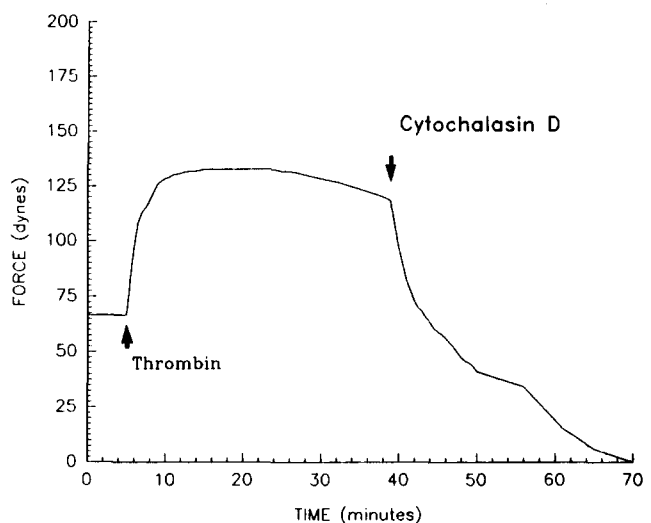

Figure 9. Representative tracing of isometric force production by HUVE exposed to 1 U/ml thrombin. Thrombin caused a rapid rise in active force, reaching a peak force of 132 dynes. Addition of 2 μ M cytochalasin D rapidly abolished the thrombin-stimulated increase in isometric force. Within 25 min, no detectable force could be measured in the monolayer.

stress fiber formation in thrombin-stimulated HUVE does not appear to show a preferential orientation along the isometric axis. These cells appear to exert an equal isometric load on all adjacent cells.

A number of manipulations have been performed to ascertain if the collagen lattice impedes isometric force measurements by bearing a compressive load. Varying the collagen concentration from 1 to 3 mg/ml had no effect on the force measurements (data not shown). In addition, inhibition of covalent collagen cross-linking with a 1-mM concentration of the lysyl oxidase inhibitor β -aminopropionitrile had no effect on measured force (data not shown). Since modification of the stiffness of the collagen gel had no effect on measured force and in view of the cytochalasin D data, we believe that the collagen membrane does not bear a significant load. To verify that active contraction of the collagen gel itself or drift in the transducer output did not affect our measurements, we performed experiments with cell-free collagen gels. No force (<2 dynes) was measured over 48 h.

Discussion

Most physiological studies of force generation have focused on either muscle preparations or purified proteins. Studies on purified myosin have established that myosin phosphorylation is a principal activation mechanism, both of myosin assembly into bipolar filaments and actin-activated ATPase activity, whereas studies of smooth muscle have shown a correlation of myosin phosphorylation with force generation. This phosphorylation is catalyzed by myosin light chain kinase, a Ca^{2+} /calmodulin-dependent enzyme that specifically phosphorylates the 20-kD myosin light chain, thereby initiating contraction (1, 20, 26). In contrast, a major gap exists in our understanding of the biochemical and physiological properties of nonmuscle cell contraction. In recent years, intact as well as permeabilized cell preparations have been used to characterize mechanisms that regulate nonmuscle cell contraction (14, 15, 28, 29). The assumption has been that an alteration in the spread form of the cell is indicative of cell contraction.

However, a relevant quantitative measure of nonmuscle cell contraction akin to that for smooth muscle has been lacking. In this study, we have demonstrated a simple quantitative technique for studying isometric force produced by cells maintained in tissue culture. A tissue culture-based system offers several advantages to the study of contractile physiology not found in whole tissue preparations. The investigator can precisely control experimental conditions, use a homogenous cell population, study cell populations that either invade or form monolayers on top of the collagen matrix, vary extracellular matrix components, and obtain high-quality images of cytoskeletal components. In addition, tissue culture allows biochemical and genetic manipulations to be performed in an attempt to dissect the molecular pathways involved in the control of mechanical functions.

Although the apparatus to measure isometric force is easy to construct and requires little maintenance, three steps need to be followed rigorously to obtain reliable force measurements: (a) porous polyethylene holders must be cut from stock with a band saw so that a large burr is formed, to which the collagen matrix can adhere; (b) sulfuric acid treatment

of the porous polyethylene bars is needed to decrease hydrophobicity; and (c) enough media must be loaded into the chamber so that the polyethylene holders float, thus providing a frictionless system.

Several investigations of contraction in cultured cells have used a flexible silicone membrane (11, 23, 24). This qualitative assessment of contraction relies on the ability of the cell to wrinkle the silicone membrane with the magnitude of cell force inferred from the degree of wrinkling (11). Although this technique has provided valuable insights into the regulatory mechanisms of nonmuscle cell contraction, its limitations must be recognized. The measurement of force is not truly isometric, since the cell often pulls excessive silicone membrane under its leading edge. In addition, the inability to produce a membrane of defined mechanical properties makes it difficult to compare parallel samples. In the present study, we used a collagen support of known concentration as a substratum. We closely followed the development of force and determined when a steady state had been established. Since the cells apparently pull against each other through cell-cell attachments rather than against a flexible substratum, the force we recorded on agonist-stimulated cultures closely approaches isometric measurements.

A previous effort to quantitatively examine isometric contraction by tissue culture cells has been reported by James and Taylor (17), who found that cells migrating from two chick embryo bone explants on a glass slide would meet between two explants, form a monolayer, and pull the two explants together. If the explants were held isometrically with glass needles, a force of 3.4×10^4 dynes/cm² could be measured by the degree of bending of the glass needles. Our force measurements for CEF give values slightly higher than that determined by James and Taylor (17). Although our methods of measuring force are conceptually similar, these investigators may have underestimated the true force because of cell adherence to the glass slide in their experiments.

A principal result of this study is determination of the magnitude of force (4.5×10^4 dynes/cm²) exerted by cells maintained simply in 10% FCS. This tension must be taken into account in mechanical models of cells. It is of interest to compare this force with that documented for other biological preparations (Table I). The force that seems to correlate best with that produced by CEF is skin wound contraction. If the margins of a rabbit skin wound are held isometrically, a force of 3.2×10^4 dynes/cm² can be measured (13). The cross-sectional area used to normalize force in this study was the entire granulation tissue rather than the fraction occupied by the cells. Thus, this measurement is likely to underestimate the true cellular tension.

Our observation that the force exerted by CEF is rapidly abolished by the addition of cytochalasin D indicates the critical importance of actin filaments in force development. The increase in force observed upon microtubule depolymerization confirms the studies of Danowski (6) using the silicone rubber wrinkling technique. The mechanical response to nocodazole and taxol are consistent with the tensegrity model (7). This model hypothesizes that a portion of a cell's contractile load is borne by rigid internal structure, whereas another portion is resisted by elements external to the cell. In our experimental apparatus, the force transducer senses the load exerted on the external structures. If microtubules

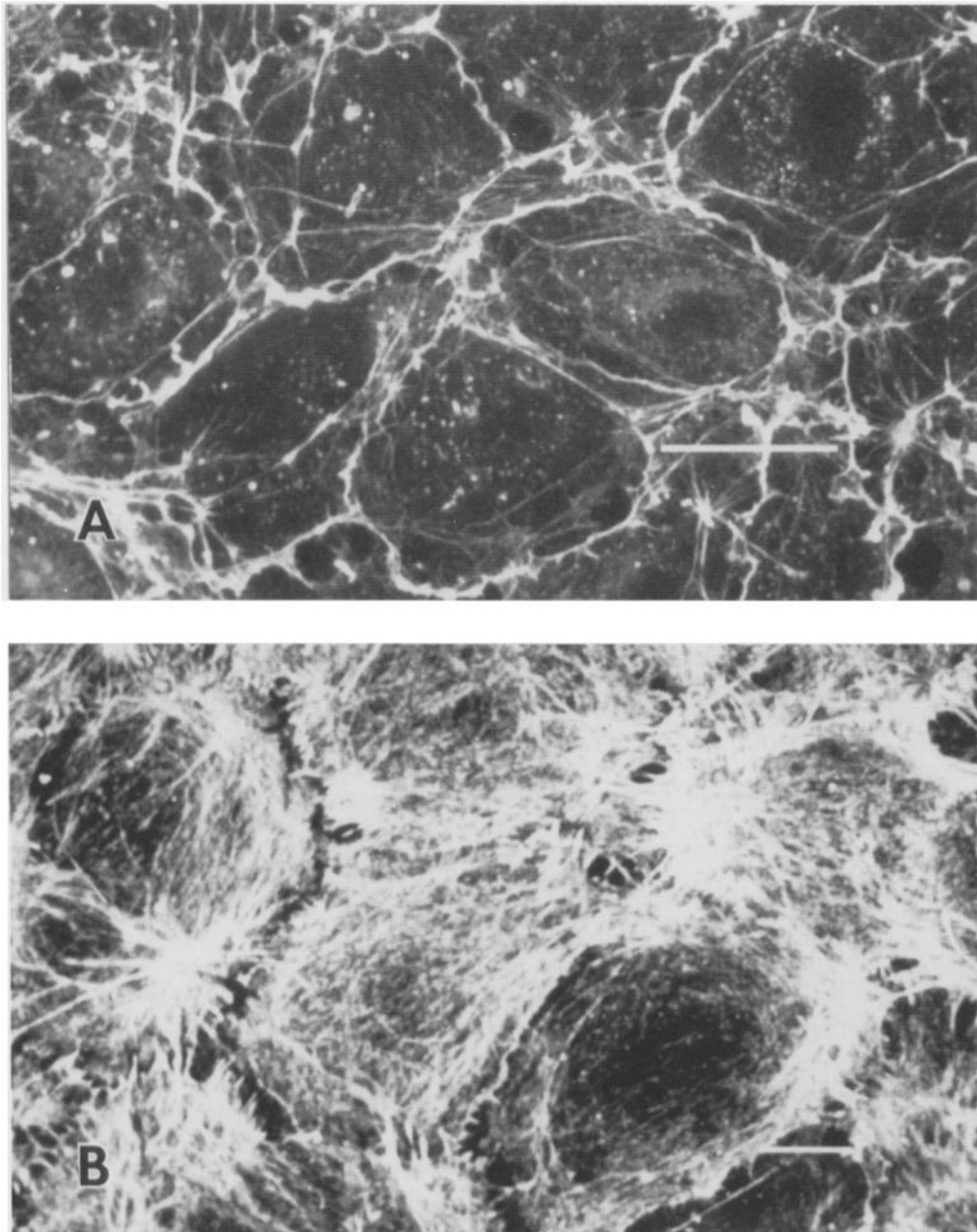

Figure 10. Fluorescence micrograph of F-actin filament distribution in control and thrombin-treated HUVE monolayers. Fluorescent images were obtained using a confocal microscope. Images were produced by combining a series of optical sections through the entire thickness of the cell. (A) Fluorescent actin filament distribution in control monolayer. A prominent rim of fluorescent staining delineates the cell margins. A few randomly oriented filaments are present within the cytoplasm. (B) HUVE monolayer treated with 1 U/ml thrombin for 5 min. A fine network of actin filaments has formed that appears to occupy the entire cytoplasm. Occasional small gaps are present within the monolayer. (C) A single optical section through the midpoint of the cell demonstrates the formation of a fine filamentous network. (D) 15 min after exposure to thrombin, the fine network of actin filaments has reorganized into a series of F-actin cables that run parallel to the long axis of the cell. Bar, 10 μm .

function as rigid internal struts, depolymerization of these structures by nocodazole would be expected to result in a greater measured force as the load shifts from internal to external structures. Taxol would be expected to induce hyperpolymerization of the free tubulin pool, producing additional microtubule struts and thus reducing measured force. The ability of taxol to block the effect of nocodazole demonstrates that nocodazole exerts its contractile effect through microtubule depolymerization. The mechanism by which the force returns to baseline several hours after microtubule inhibitors are added is unclear but may reflect a nonspecific toxicity imparted by the microtubule-disrupting agents.

The possibility of endothelial contractility as a mechanism for controlling vascular permeability has been a subject of speculation since Majno and Palade (22) demonstrated the formation of intercellular gaps in the endothelial barrier of

vessels exposed to histamine. Exposure of cultured endothelial monolayers to histamine or thrombin results in reversible intercellular gap formation accompanied by a rearrangement of actin morphology (21). A similar morphological change has been demonstrated in a permeabilized monolayer of endothelial cells to depend on phosphorylation of myosin 19-kD light chains by MLCK (28, 29).

The present study provides quantitative evidence for the development of isometric contractile force by HUVE monolayers upon stimulation with thrombin. The force is associated with a dramatic change in actin morphology. Actin filaments shift from a circumferential rim to stress fibers. Most stress fibers appear after maximal force has already developed, indicating that stress fibers may be a result of isometric tension generation in the cytoplasm rather than essential for generating the tension.

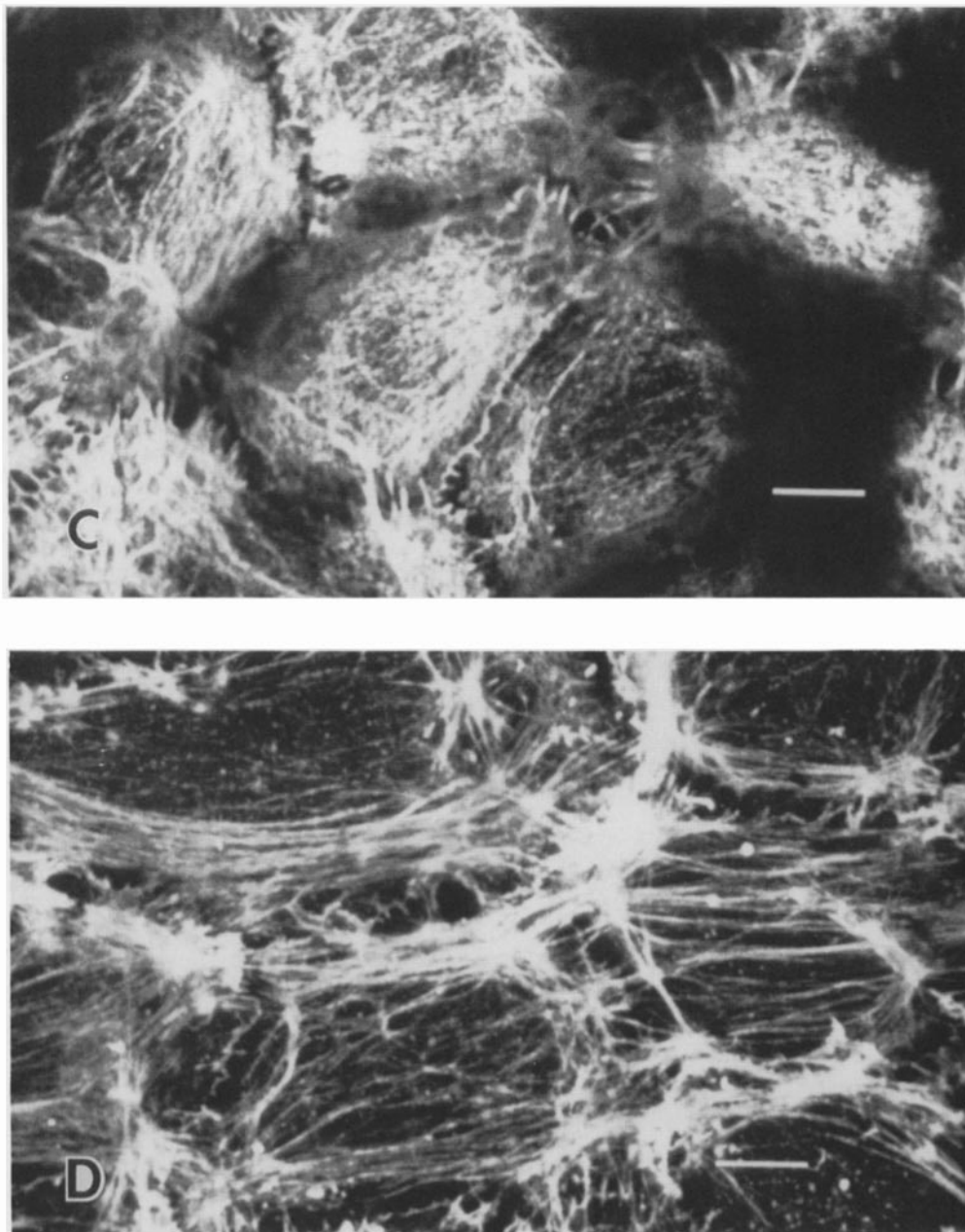

Figure 10.

Recently, Morel and coworkers (24) employed a silicone rubber assay to examine thrombin stimulated contraction of microvessel endothelial cells. In these studies, pre-confluent cells were seeded onto silicone membranes 72 hours prior to stimulation. Cells were observed to contract 3 minutes after stimulation with 2 U/ml thrombin peaking within 9 to 15 minutes. Our data was obtained on monolayers of large vessel endothelial cells which had established a steady baseline force and were 5 days post confluent. We were able to detect a contraction within 30 seconds of stimulation that peaked by 5 minutes. The apparent differences in the time course of the thrombin effect could be explained by: 1) large vessel vs. small vessel cells; 2) pre vs. post confluent cells; 3) adhesion to substratum; or 4) sensitivity of force measurement. However, our data is largely consistent with that of Morel et al.

(24) despite the difference in our method of force measurement.

It may be useful to speculate on the physiological function of the large force that endothelial cells can maintain. One function of endothelial contraction may be formation of gaps in the endothelial barrier, thus causing edema or allowing diapedesis of phagocytes through the endothelial barrier. Another possible role for this tension may be regulation of the diameter and distensibility of microvessels. The law of Laplace relates the wall tension in a vessel of radius (r) with blood pressure (P): $T = Pr$.

In a pulmonary capillary with a diameter of 5 μm , endothelial cells producing a tension of 10 dynes/cm would result in a pressure of 4×10^4 dynes/cm², a value that exceeds pulmonary capillary pressure (10 mm Hg or $1.3 \times$

10^4 dynes/cm²). Thus, it is likely that activation of pulmonary capillary endothelial cells results in a decrease in the diameter and/or deformability of capillaries. It must be noted that HUVE are from a large vessel and these studies must be extended to small vessel cells. However, the qualitative studies of Morel et al. (23) indicate that small vessel endothelial cells produce even stronger contractions than large vessel cells.

In summary, we have used a new method to quantitatively measure the contractile force generated by a population of cells in culture. The method is relatively easy to implement and is applicable to a wide variety of cells, including those that invade the collagen matrix and form a three-dimensional contractile network, as well as cells that form a monolayer on the surface of the collagen matrix. CEF maintained in 10% serum produce a force of $4.5 \pm 0.2 \times 10^4$ dynes/cm². When stimulated with thrombin, both CEF and HUVE produce a similar force (1×10^5 dynes/cm²), which is approximately an order of magnitude less than intact smooth and skeletal muscle preparations. The actin cytoskeleton is essential for force production in both cell types, whereas intact microtubules appear to reduce isometric force. Contraction in HUVE monolayers is associated with a dramatic reorganization of the actin cytoskeleton, which appears to be a result of tension generation rather than the cause of it.

We thank Dr. Elliot Elson for scientific advice and discussion in all phases of this work.

This work was supported by National Institutes of Health grants GM-38838 to E. Elson and HL-45788 and HL-30572 to R. Wysolmerski. M. Kolodney was supported by Medical Scientist Training Program grant T32 GM-07200. Shared Instrumentation grant RR-0566 was awarded to St. Louis University by the National Institutes of Health to establish a confocal imaging facility.

Received for publication 7 August 1991 and in revised form 2 January 1992.

References

- Adelstein, R. S., and M. A. Conti. 1975. Phosphorylation of platelet myosin increases actin-activated myosin ATPase activity. *Nature (Lond.)* 256:597-598.
- Barak, L. S., R. R. Yocum, E. A. Nothnagel, and W. W. Webb. 1980. Fluorescence staining of the actin cytoskeleton in living cells with 7-nitrobenz-2-nitrobenz-2-oxa-1, 3 diazole-phalloidin. *Proc. Natl. Acad. Sci. USA* 77:980-984.
- Barany, M., and R. I. Close. 1971. The transformation of myosin in cross-innervated rat muscles. *J. Physiol. (Lond.)* 213:455-474.
- Bell, E., B. Ivarson, and C. Merrill. 1979. Production of a tissue-like structure by contraction of collagen lattices by human fibroblasts of different proliferative potentials in vitro. *Proc. Natl. Acad. Sci. USA* 76:1274-1278.
- Chen, L. B., and J. M. Buchanan. 1975. Mitogenic activity of blood components. I. Thrombin and prothrombin. *Proc. Natl. Acad. Sci. USA* 72:131-135.
- Danowski, B. A. 1989. Fibroblast contractility and actin organization are stimulated by microtubule inhibitors. *J. Cell Sci.* 93:225-266.
- Dennerll, T. J., H. C. Joshi, V. L. Steel, R. E. Buxbaum, and S. R. Heidemann. 1988. Tension and compression in the cytoskeleton of PC-12 neurites. II. Quantitative measurements. *J. Cell Biol.* 107:665-674.
- Elson, E. L. 1988. Cellular mechanics as an indicator of cytoskeletal structure and function. *Annu. Rev. Biophys. Biophys. Chem.* 17:397-430.
- Fuki, Y., T. J. Lynch, H. Brezka, and E. D. Korn. 1989. Myosin I is located at the leading edge of locomoting *Dictyostelium amoebae*. *Nature (Lond.)* 341:328-331.
- Giloh, H., and J. W. Sedat. 1982. Fluorescence microscopy: reduced photobleaching of rhodamine and fluorescein protein conjugates by n-propyl gallate. *Science (Wash. DC)* 217:1252-1255.
- Harris, A. K., P. Wild, and D. Stopak. 1980. Silicone rubber substrate: a new wrinkle in the study of cell locomotion. *Science (Wash. DC)* 208:177-179.
- Herlihy, J. T., and R. A. Murphy. 1973. Length-tension relationship of smooth muscle of the hog carotid artery. *Circ. Res.* 33:275-283.
- Higton, D. I. R., and D. W. James. 1964. The force of contraction of full-thickness wounds of rabbit skin. *Br. J. Surg.* 51:462-466.
- Hoffman-Berling, H. 1954. Adenosintriphosphat als Betriebsstoff von Zellbewegungen. *Biochim. Biophys. Acta.* 14:182-194.
- Holzappel, G., J. Wehland, and K. Weber. 1983. Calcium control of actin-myosin based contraction in triton models of 3T3 fibroblasts is mediated by the myosin light chain kinase (MLCK)-calmodulin complex. *Exp. Cell Res.* 148:117-126.
- Jaffe, E. A., R. L. Nachman, C. G. Becker, and C. R. Minick. 1973. Culture of human endothelial cells derived from umbilical veins: identification by morphological and immunological criteria. *J. Clin. Invest.* 52:2745-2756.
- James, D. W., and J. F. Taylor. 1969. The stress developed by sheets of chick fibroblasts in vitro. *Exp. Cell Res.* 54:107-110.
- Katsuragawa, Y., M. Yanagisawa, A. Inoue, and T. Masaki. 1989. Two distinct non-muscle heavy chains are expressed in various chicken tissues: identification of a novel gene family of vertebrate non-sarcomeric myosin heavy chains. *Eur. J. Biochem.* 184:611-616.
- Kawamoto, S., and R. S. Adelstein. 1991. Chicken nonmuscle myosin heavy chains: differential expression of two mRNAs and evidence for two different polypeptides. *J. Cell Biol.* 112:915-924.
- Korn, E. D., and J. A. Hammer. 1988. Myosins of nonmuscle cells. *Annu. Rev. Biophys. Biophys. Chem.* 17:23-45.
- Laposata, M., D. K. Dohnarsky, and H. S. Shin. 1982. Thrombin-induced gap formation in confluent endothelial cell monolayers in vitro. *Blood* 62:549-556.
- Majno, G., and G. E. Palade. 1961. Studies on inflammation. I. The effect of histamine and serotonin on vascular permeability: an electron microscopic study. *J. Biophys. Biochem. Cytol.* 11:571-585.
- Morel, N. M. L., A. B. Dodge, W. F. Patton, I. M. Herman, H. B. Hechtman, and D. Shepro. 1989. Pulmonary microvascular endothelial cell contractility on silicone rubber substrate. *J. Cell. Physiol.* 141:653-659.
- Morel, N. M. L., P. P. Petruzzo, H. B. Hechtman, and D. Shepro. 1990. Inflammatory agonists that increase microvascular permeability in vivo stimulate cultured pulmonary microvessel endothelial cell contraction. *Inflammation.* 14:571-583.
- Pollard, T. D., S. K. Doberstein, and H. G. Zot. 1991. Myosin-I. *Annu. Rev. Physiol.* 53:653-681.
- Sellers, J. R., and R. S. Adelstein. 1987. Regulation of contractile activity. In *The Enzymes*. Vol. 18. P. D. Boyer and E. G. Krebs, editors. Academic Press Inc., Orlando, FL. 381-395.
- Thornton, S. C., S. N. Mueller, and E. M. Levine. 1983. Human endothelial cells: use of heparin in cloning and long term cultivation. *Science (Wash. DC)* 222:623-625.
- Wysolmerski, R. B., and D. Lagunoff. 1990. Involvement of myosin light chain kinase in endothelial cell retraction. *Proc. Natl. Acad. Sci. USA* 87:16-20.
- Wysolmerski, R. B., and D. Lagunoff. 1991. Regulation of permeabilized endothelial cell retraction by myosin phosphorylation. *Am. J. Physiol.* 30:C32-C40.