

ESCRT-0 complex

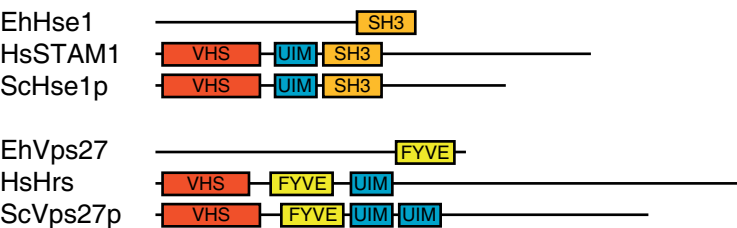

ESCRT-I complex

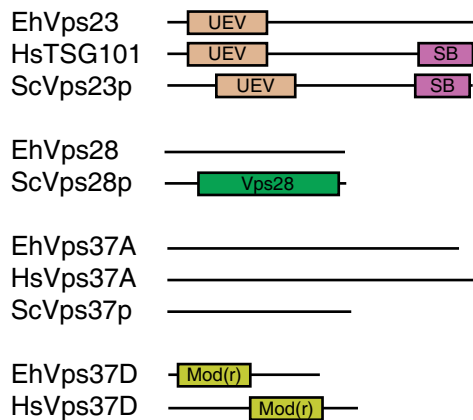

ESCRT-II complex

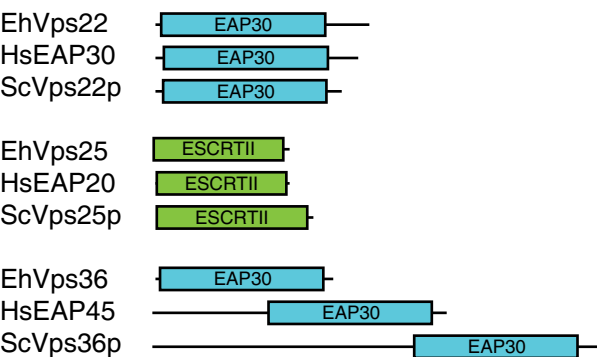

ESCRT-III complex

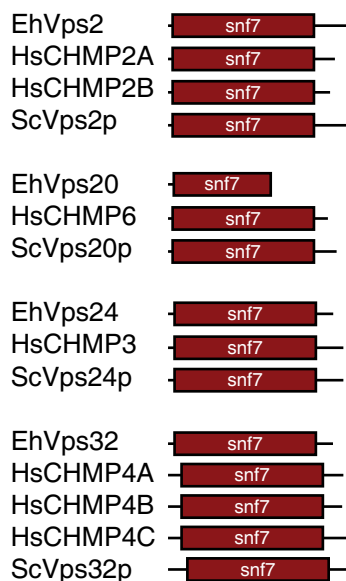

Vps4

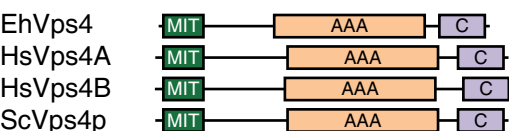

Other MVB proteins

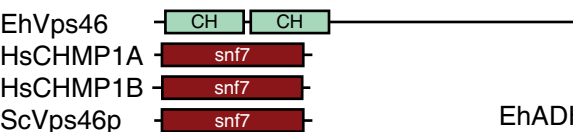
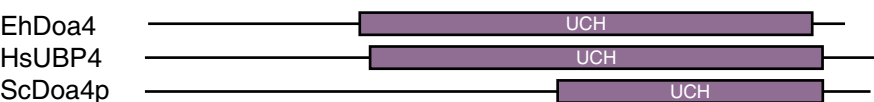
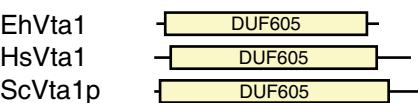

Ubiquitination components

