

Measurement of De Novo Hepatic Lipogenesis in Humans Using Stable Isotopes

M. K. Hellerstein,^{**} M. Christiansen,^{**} S. Kaempfer,^{*} C. Kletke,^{||} K. Wu,^{*} J. S. Reid,^{||}
K. Mulligan,[§] N. S. Hellerstein,[†] and C. H. L. Shackleton^{||}

^{*}Department of Nutritional Sciences, University of California, Berkeley, California 94720; [†]Division of Endocrinology and Metabolism, Department of Medicine, and [§]Koret Center for Human Nutrition, San Francisco General Hospital, University of California at San Francisco, California 94110; ^{||}Oakland Children's Hospital Research Center, Oakland, California 94609; and ^{||}Department of Mathematics, Lincoln University, San Francisco, California 94118

Abstract

Direct measurement of de novo lipogenesis has not previously been possible in humans. We measured de novo hepatic lipogenesis in normal men by means of stable isotopes and by combining the acetylated-xenobiotic probe technique with mass isotopomer analysis of secreted very low density lipoprotein-fatty acids (VLDL-FA). Sulfamethoxazole (SMX) was administered with [¹³C]acetate during an overnight fast followed by refeeding with intravenous glucose (7–10 mg/kg of weight per min), oral Ensure (7–10 mg of carbohydrate/kg of weight per min), or a high-carbohydrate mixed-meal breakfast (3.5 g of carbohydrate/kg of weight). Respiratory quotients remained < 1.0. High-performance liquid chromatography/mass spectrometry-determined enrichments in SMX-acetate attained stable plateau values, and hepatic acetyl-coenzyme A (CoA) dilution rate did not increase with refeeding (~ 0.024 mmol/kg per min). The fraction of VLDL-palmitate derived from de novo lipogenesis was only 0.91±0.27% (fasted) and 1.64–1.97% (fed). For stearate, this was 0.37±0.08% and 0.47–0.64%. Precursor enrichments predicted from isotopomer ratios were close to measured SMX-acetate enrichments, indicating that SMX-acetate samples the true lipogenic acetyl-CoA pool. Stearate synthesis was less than palmitate and the two did not move in parallel. Estimated total VLDL-FA synthesis is < 500 mg/day. Thus, de novo hepatic lipogenesis is a quantitatively minor pathway, consistent with gas exchange estimates; fatty acid futile cycling (oxidation/resynthesis) is not thermogenically significant; and synthesis rates of different nonessential fatty acids by human liver are not identical in nonoverfed normal men. The contribution and regulation of de novo lipogenesis in other settings can be studied using this technique. (*J. Clin. Invest.* 1991; 87:1841–1852.). Key words: carbohydrate disposal • high-performance liquid chromatography/mass spectrometry • isotopomers • nonessential fatty acids • precursor-product relationship • xenobiotic probes

Portions of this work have appeared in abstract form (1989). *FASEB [Fed. Am. Soc. Exp. Biol.] J.* 3:A243.

Address reprint requests to Dr. Hellerstein, Department of Nutritional Sciences, 119 Morgan Hall, University of California, Berkeley, CA 94720.

Received for publication 20 June 1990 and in revised form 31 October 1990.

J. Clin. Invest.

© The American Society for Clinical Investigation, Inc.

0021-9738/91/05/1841/12 \$2.00

Volume 87, May 1991, 1841–1852

Introduction

The capacity for de novo lipogenesis, the synthesis of long-chain fatty acids (FA)¹ from acetyl-coenzyme A (CoA), exists in procaryotes, plants, and animals. However, the extent of de novo lipogenesis in humans remains uncertain. Previous estimates based on inferential methods such as whole-body indirect calorimetry (1–4) have indicated that net conversion of dietary carbohydrate into fat is a minor pathway: i.e., only 1–2% of a 500-g carbohydrate meal was calculated by respiratory calorimetry (2, 3) to be converted to fat in normal (not overfed) humans. If true, this would suggest that neither hypertriglyceridemia nor obesity could result from carbohydrate overfeeding alone. However, indirect calorimetry can only provide information about net lipogenesis, so the existence of FA synthesis concurrent with FA oxidation (futile cycling) has not been addressed nor excluded as a thermogenic mechanism. Moreover, the lack of de novo lipogenesis would appear to be inconsistent with some clinical observations, for example, that high carbohydrate diets cause persistent hypertriglyceridemia in some human populations, including adult onset diabetics (5–7) and subjects with genetic dyslipidemias (8). On the other hand, carbohydrate-induced hypertriglyceridemia could be due to increased FA reesterification or to altered triglyceride clearance rather than increased de novo lipogenesis. A definitive answer regarding the importance of the de novo pathway requires its direct measurement.

Direct measurement of lipogenesis in humans has not been possible previously owing to a methodologic constraint. In order to measure the synthesis of FA (or any macromolecule) using tracers, one needs to know the labeling intensity (specific activity or enrichment) of the true biosynthetic precursor which, for lipogenesis, is cytosolic acetyl-CoA. In contrast to glycogen and protein synthesis, which occur in numerous tissues, the majority of lipogenesis probably occurs in liver in humans (9–11) and newly synthesized FA then enter the circulation in the form of very low density lipoprotein-triglyceride (VLDL-TG) and phospholipids. Accordingly, isotopic measurement of total lipogenesis in humans could in theory be achieved by sampling only blood if hepatic cytosolic acetyl-CoA were experimentally accessible.

We (12–20) and others (21–23) have previously sampled intrahepatic metabolites using the xenobiotic “probe” technique (Fig. 1). One such probe is secreted acetaminophen-glucuronide (GlcUA). This is derived from hepatic uridine di-

1. *Abbreviations used in this paper:* FA, fatty acid(s); GC, gas chromatography; MPE, molar percent excess; MS, mass spectrometry; SMX, sulfamethoxazole; TG, triglyceride.

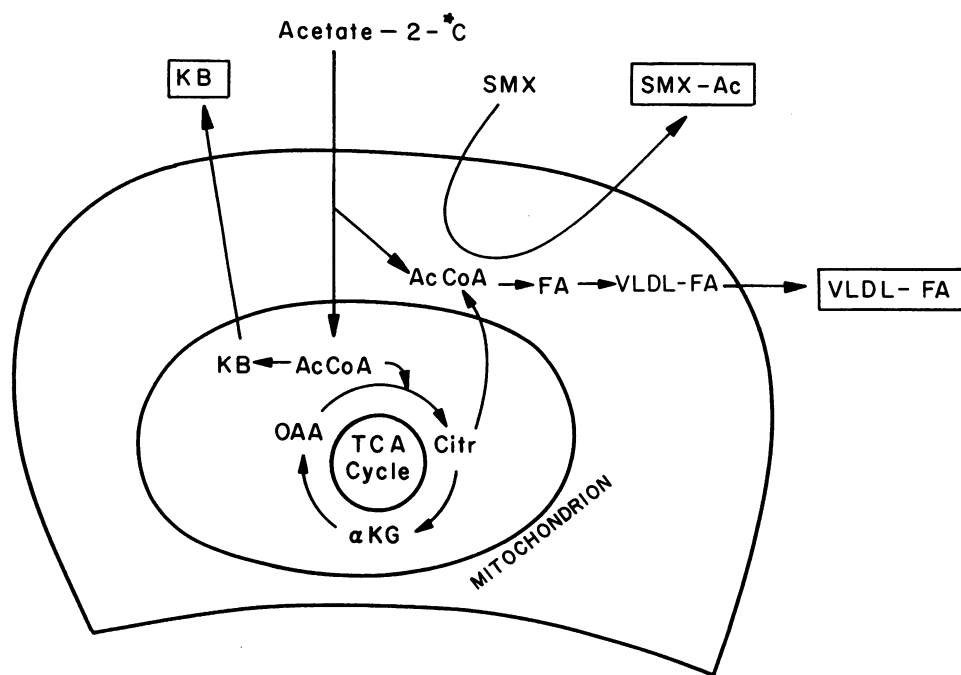

Figure 1. In vivo sampling of hepatic cytosolic acetyl-CoA pool using the xenobiotic probe technique. A schematic liver cell with mitochondrial and cytosolic metabolites is shown. In this example, [2-¹³C]acetate has been administered. Abbreviations: Ac, acetate; AcCoA, acetyl-CoA; KB, ketone bodies; OAA, oxaloacetate; Citr, citrate; α KG, α -ketoglutarate; TCA, tricarboxylic acid; * labeled atom. Extrahepatic metabolites enclosed by bold lines can be sampled experimentally and their enrichments determined by mass spectrometry.

phosphate (UDP)-GlcUA, which in turn derives exclusively from UDP-glucose. The labeling pattern in secreted GlcUA has been used for investigations of UDP-glucose biosynthesis in rats, humans, and dogs (12, 16, 20–22). More recently, we (17–20) have used acetylated xenobiotics as probes for hepatic cytosolic acetyl-CoA (Fig. 1). We (20) have confirmed earlier reports (24–26) that acetylation of sulfa drugs such as sulfamethoxazole (SMX) occurs in parenchymal hepatocytes in the rat, not in extraparenchymal liver cells (27). Here, we apply this acetylated xenobiotic technique to measure de novo hepatic lipogenesis in normal human subjects from the true precursor (cytosolic acetyl-CoA), using stable isotopes. A mathematical model is presented for quantifying lipogenesis based on the binomial distribution, taking into account the occurrence of isotopomers in lipid end products. We use this model to calculate contribution of the de novo pathway to circulating lipids in normal human subjects fasted and refed in different ways.

Methods

Human subjects.

Normal male volunteers were recruited by advertisement. All studies were performed after approval by the University of California, San Francisco (UCSF) Committee on Human Research. Informed consent was obtained for all procedures. Participants were excluded if screening history, physical exam, or laboratory testing revealed intercurrent medical conditions, alcohol abuse, obesity (body mass index > 120% predicted), elevated serum TG concentrations or family history of lipid disorder, recent weight loss or weight gain, or allergy to sulfa drugs. Human immunodeficiency virus (HIV) serologic status was determined (with informed consent) on all subjects because of the possibility that asymptomatic seropositivity is associated with altered lipid metabolism (28, 29; Hellerstein, M. K., K. Wu, C. Grunfeld, M. Christiansen, S. Kaempfer, C. Kletke, and C. H. L. Shackleton, unpublished observations). All subjects were HIV negative and normotriglyceridemic (< 100 mg/dl).

Infusion protocols

Subjects entered the General Clinical Research Center of the San Francisco General Hospital at 10 a.m. and ate ad lib. until 6:00 p.m., after

which they fasted (other than noncaloric beverages) until 9:00 a.m. Refeeding began at 9:00 a.m. with either a constant infusion of i.v. glucose at 7 or 10 mg/kg per min, an hourly liquid mixed meal (Ensure, containing 53.7% of calories as carbohydrate [85% glucose, 15% fructose], 31.5% as fat, and 14.8% as protein) to deliver carbohydrate at 7 or 10 mg/kg per min, or a single high-carbohydrate breakfast (3.5 g of carbohydrate/kg of body wt, 20–25 g of protein, 15–20 g of fat, to provide 75% of calories as carbohydrate, 15% as fat, 10% as protein). Intravenous and Ensure refeeding lasted from 9:00 a.m. until 5:00 p.m. (Fig. 2). We chose the 7–10-mg/kg per min feeding rates for carbohydrate because these are well above the maximal capacity for glucose oxidation in normal humans (~ 4 mg/kg per min), but are submaximal for storage under euglycemic conditions (10–12 mg/kg per min, reference 30), and over the course of a 9-h infusion result in sizable but not physiologically unreasonable carbohydrate loads (260–380 g in a 70-kg subject). These high but purportedly not lipogenic feeding rates therefore served as a direct test of previous indirect calorimetric estimates.

Intravenous lines were placed at 10:00 p.m. At 2:00 a.m. and at 7:00 a.m. 750 mg of SMX (as oral suspension) was administered followed by SMX 500 mg at 11:00 a.m. and at 3:00 p.m. From 2:00 a.m. until 5:00 p.m. Na [1-¹³C]acetate (0.85–1.83 μ mol/kg per min) or [2-¹³C]acetate (0.73–1.22 μ mol/kg per min) were infused. Urine aliquots were collected with each void and hourly venous blood samples drawn from 8:00 a.m. until 5:00 p.m. Indirect calorimetry was performed on certain subjects between 8–9:00 a.m. (fasted) and 3–5:00 p.m. (refed), in duplicate, using Douglas bags. Volume was measured by spirometry and nonprotein respiratory quotient (RQ) was calculated by the modified Weir method (31), with correction for urea nitrogen measured in urine collected during the infusion or by estimation of daily nitrogen excretion from diet records.

Plasma measurements

Insulin was measured by radioimmunoassay (RIA, Cambridge Medical Diagnostics, Billerica, MA). Glucose was determined by autoanalyzer and VLDL-triglyceride (TG) by an enzymatic technique (32).

Sample preparation

Urinary SMX-acetate was isolated by HPLC (12, 19). Briefly, SMX-acetate is isolated from urine using a reverse-phase C-18 column (Microbondapak, Waters Associates, Milford, MA). Elution buffer consists of 65% 0.067 M PO₄/35% methanol (vol/vol) at a 2–4 ml/min. SMX-

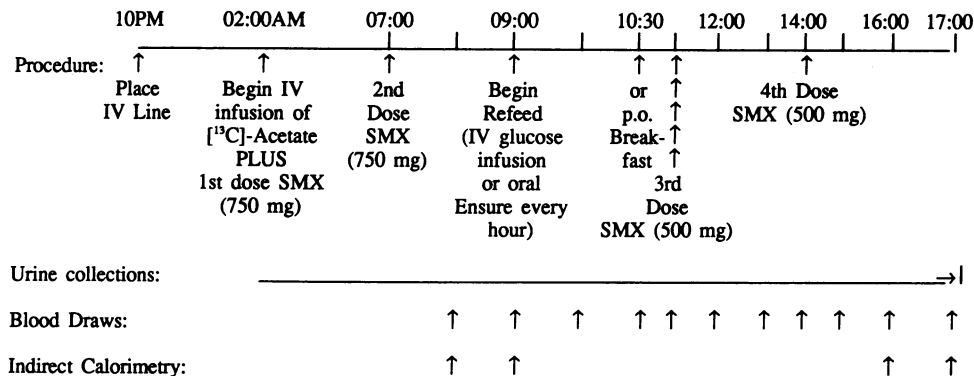

Figure 2. Experimental protocol. All subjects were fasted from 8:00 p.m. until the next morning. In some subjects, an infusion of i.v. glucose at 7 or 10 mg/kg per min was administered from 9:00 a.m. until 6:00 p.m. In others, a liquid mixed meal (Ensure) was given hourly to deliver 7 or 10 mg of carbohydrate/kg per min (3.5 or 5 ml/kg per h) from 9:00 a.m. until 6:00 p.m. In the third group, a high-carbohydrate breakfast was eaten at 10:30 a.m., consisting of 3.5 g of carbohydrate/kg, with no further calories provided until 6:00 p.m. Timing of isotope and xenobiotic administration and of urine, blood, and breath sampling is indicated. See text for further details.

acetate elutes between 2.0 and 2.3 min. The HPLC system consists of pumps (model 110B, Beckman Instruments, Inc., Palo Alto, CA), variable wavelength UV detector (model 166), integrator (model 427), and analogue interface module (model 406) with a PC-8300 Controller (NEC, Tokyo, Japan). Detection is at 225 nm. VLDL was isolated from plasma by ultracentrifugation after removal of chylomicrons in fed subjects. The VLDL fraction was transesterified in methanolic HCl (33, 34) and the fatty acid methyl esters were dried under N_2 before mass spectrometric (MS) analysis. Plasma VLDL-TG concentrations were measured on aliquots of VLDL (32).

Mass spectrometric analyses

Gas chromatography (GC)/MS. FA methyl esters were analyzed by means of GC/MS (model 5970, Hewlett-Packard Co., Palo Alto, CA) (35). Conditions are isothermal (200°C) with a 20-m fused silica column. Molecular anions m/z 299 and 298 are compared (for 18:0) and 271 and 270 (for 16:0) for determination of percent excess enrichment

of the FA methyl esters. With quadruplicate analyses, standard error of these measurements was < 0.03 molar percent excess (MPE).

HPLC/MS. SMX-acetate enrichments were determined by HPLC/MS as we have described elsewhere (36), using a quadrupole mass spectrometer (model VG30-250, VG Masslab, Altrincham, Cheshire, UK) linked to a Waters model 600 Multisolute Delivery System (Waters/Millipore, Millford, MA) via a thermospray interface (VG Masslab). Samples are chromatographed on a 4.6×150 -mm C_{18} 5- μ m Econosphere cartridge column (Alltech Associates, Inc., Deerfield, IL) with a solvent system of methanol/0.2 M ammonium acetate (9/1 by volume) at a flow rate of 1.0 ml min^{-1} . For quantification, the molecular anion, $[M - H]^-$, and an isotope, $[M + 1 - H]^-$, are monitored in selected ion recording (SIR) mode. Quantification involves comparison of peak heights of the enriched anion, $[M + 1 - H]^-$, to the molecular anion, $[M - H]^-$, to calculate the molar fraction, and subtraction of the subjects' baseline unenriched sample value to generate an MPE. No derivatization is necessary, and rapid sequential injection (up to 40/h) make sample analysis extremely rapid. Using quadruplicate analyses, stan-

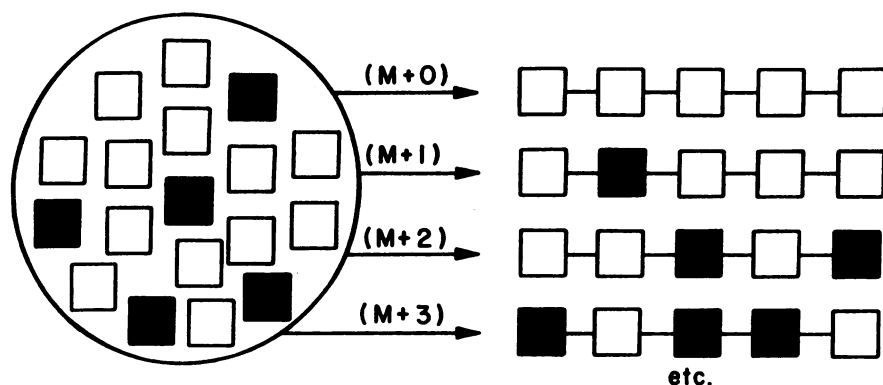

$$F(M+1) = \binom{n}{1} \cdot (p)^1 \cdot (1-p)^{(n-1)} = \frac{(n)!}{(n-1)!(1)!} \cdot (p)^1 \cdot (1-p)^{(n-1)}$$

$$F(M+2) = \binom{n}{2} \cdot (p)^2 \cdot (1-p)^{(n-2)} = \frac{(n)!}{(n-2)!(2)!} \cdot (p)^2 \cdot (1-p)^{(n-2)}$$

$$F(M+3) = \binom{n}{3} \cdot (p)^3 \cdot (1-p)^{(n-3)} = \frac{(n)!}{(n-3)!(3)!} \cdot (p)^3 \cdot (1-p)^{(n-3)}$$

etc.

Figure 3. Schematic model of the relationship between isotope abundance in precursor units (■) and abundance of isotopomers in a polymeric product. The frequency (F) of each isotopomer containing x labeled units (■) in a product containing n total units is a function of the probability (p) that each precursor unit is labeled, according to the binomial expansion: $F(M+x) = \binom{n}{x} (p)^x (1-p)^{n-x}$. In this example, the product would contain five precursor units ($n = 5$), the probability that each precursor unit is labeled would be $^{5}/_{18}$ ($p = 0.278$), and calculation of the abundance of each isotopomer species [$F(M+1)$, $F(M+2)$, and $F(M+3)$, where $x = 1$, $x = 2$, and $x = 3$, respectively] using the binomial expansion is shown. See text for details.

standard errors for HPLC/MS analysis of SMX-acetate are < 0.0004 (i.e., < 0.04 MPE), resulting in extremely low errors of the estimate (< 1%).

Enrichments were calculated as MPE (37):

$$\frac{M+1}{(M+1)+(M+0)} (\text{MPE}) = \left(\frac{[296/295]_E}{1+[296/295]_E} - \frac{[296/295]_B}{1+[296/295]_B} \right) \times 100,$$

where 295 and 296 are m/z 295 and m/z 296, E is enriched sample, and B is baseline sample.

Model for calculation of de novo lipogenesis

Traditionally, studies of biosynthesis have used radioactive isotopes or, when stable isotopes are used, the macromolecule has been hydrolyzed to its precursor units (i.e., enriched protein to [¹³C]leucine). Comparison of precursor to product labeling has been straightforward because the existence of isotopomers² has not been an issue. This is so for radioisotopes because the average value for all molecular species is measured, i.e., specific activity is measured as the total disintegrations per minute per total mass present, and the existence of different subpopulations of labeled molecules is not relevant. In contrast, when one analyzes intact lipid molecules (C-16, C-18) using MS, each isotopomer will appear as a separate species. If, for example, one FA molecule ends up with two labeled acetates and another with zero, this is not identical analytically to two molecules having one labeled acetate in stable isotope studies whereas they would be identical with radioisotopes. The effect of isotopomer distribution on biosynthetic calculations therefore had to be addressed.

The relationship between an enriched precursor and the distribution of label in a macromolecular product is shown (Fig. 3). The frequency of isotopomers in a product (e.g., VLDL-stearate, containing nine acetate units) synthesized from a precursor (e.g., enriched acetyl-CoA) can be predicted using the binomial expansion. This gives the likelihood of choosing x special (enriched) units out of n total units:

$$b(x; n, p) = \binom{n}{x} p^x (1-p)^{n-x}, \quad (1)$$

where n is the number of precursor units in product, x is the number of enriched precursor units in product, p is the probability of each precursor unit being enriched, and $\binom{n}{x} = \frac{n!}{(n-x)!(x)!}$.

In intuitive terms, this is the problem of how often you will get one black ball and eight white balls if you draw nine balls from a box and the probability of each ball being black is p . What makes the application slightly more complex here is that there is a natural background p as well as the experimentally induced p . Moreover, our goal is not just to calculate the theoretical frequency of an isotopomer but is to compare this frequency to a measured frequency in order to calculate a fractional replacement (synthesis) rate.

An example of the method for calculating de novo lipogenesis for VLDL-stearate follows. If infusion of [¹³C]acetate results in an acetyl-CoA enrichment of 7.0 MPE and natural abundance of acetate is assumed to be 2.22%, the ratio of $M+1/(M+0) + (M+1)$ isotopomers before and after administration of tracer will be:

$$\begin{aligned} \text{Background} \quad \frac{(M+1)}{(M+0)+(M+1)} &= \frac{b(1; 9, 0.022)}{b(0; 9, 0.022) + b(1; 9, 0.022)} \\ &= \frac{0.1657}{0.8186 + 0.1657} \\ &= 0.1683 \end{aligned} \quad (2)$$

2. Isotopomers are defined as molecules of identical formula and structure, differing only in molecular weight.

$$\begin{aligned} \text{Enriched} \quad \frac{(M+1)}{(M+0)+(M+1)} &= \frac{b(1; 9, 0.092)}{b(0; 9, 0.092) + b(1; 9, 0.092)} \\ &= \frac{0.3826}{0.4195 + 0.3826} \\ &= 0.4770 \end{aligned} \quad (3)$$

$$\text{Excess} \quad \frac{(M+1)}{(M+0)+(M+1)} = 0.4770 - 0.1683 = 0.3087 \quad (4)$$

This can be readily translated into kinetic terms. At time zero, the ratio of $M+1$ abundance relative to $(M+1) + (M+0)$ is 0.1683 in VLDL-stearate. If all VLDL-stearate were then replaced by newly synthesized molecules derived from acetyl-CoA during the experiment, $M+1/(M+0) + (M+1)$ would increase to 0.4770, or the excess, termed EF[$M+1/(M+0) + (M+1)$] would be 0.3087. If only 50% of VLDL-stearate were derived from acetyl-CoA and the remainder were from reesterification of preformed stearate, $M+1/(M+0) + (M+1)$ would be half-way between 0.1683 and 0.4770 (0.3227), or the excess would be half of EF[$M+1/(M+0) + (M+1)$] (0.1544). If only 10% of stearate came by way of acetyl-CoA, the observed excess would be one-tenth of EF[$M+1/(M+0) + (M+1)$]; and so on. The value for EF[$M+1/(M+0) + (M+1)$] thereby represents the asymptote or maximal value toward which the product enrichment may approach, and the relationship between observed excess $M+1/(M+0) + (M+1)$ and EF[$M+1/(M+0) + (M+1)$] is precisely analogous to the standard relationship between product and precursor specific activity or enrichment used in fractional synthesis calculations (38–40).

Accordingly, calculation of fractional VLDL-FA synthesis from acetyl-CoA during an experiment is straightforward. The measured enrichment in the FA [$M+1/(M+0) + (M+1)$] is divided by the calculated asymptotic (“precursor”) value, EF[$M+1/(M+0) + (M+1)$]. The latter is calculated from the equation relating p to EF[$M+1/(M+0) + (M+1)$] (Fig. 4 A). SMX-acetate enrichments are used to represent hepatic acetyl-CoA enrichments (p).

With regard to the theoretical basis of the calculations, three further points should be made. First, precursor–product models are simpler mathematically if a steady-state enrichment is present in the precursor pool (38, 39) but the product enrichment need not attain a plateau during the experimental period for valid biosynthetic calculations (38–40). Secondly, the excess $M+2/\text{excess } M+1$ ($EM+2/EM+1$) isotopomer ratio is uniquely determined by the enrichment of the precursor (Fig. 4 B). Conversely, the $EM+2/EM+1$ ratio uniquely predicts a true precursor enrichment. This relationship can be exploited experimentally as an internal check of the validity of the model, by comparing true precursor enrichments inferred from isotopomer frequencies to measured SMX-acetate enrichments. Finally, it is worth noting that lipid elongation will not be described by this model. However, this is unlikely to account for a significant amount of label in FAs because only one acetyl-CoA rather than a string of acetyl-CoA units is added, in addition to its probably minor input quantitatively.

Results

Enrichments of hepatic acetyl-CoA (SMX-acetate) over time during fasting and refeeding. A steady state in SMX-acetate enrichment was observed by 9:00 a.m., after 7 h of [¹⁻¹³C]- or [²⁻¹³C]acetate infusion in the overnight fasted state, but with neither i.v. glucose, Ensure, nor breakfast refeeding did we observe a fall in SMX-acetate enrichment (Fig. 5). Thus, the dilution of hepatic acetyl-CoA relative to infused [¹³C]acetate did not increase with carbohydrate feeding (Fig. 6 C). This was initially surprising, as we expected dilution from unlabeled acetyl-CoA units derived from administered carbohydrate. There was no difference between dilution rates for [¹⁻¹³C]- vs. [²⁻¹³C]-acetate (not shown). In both fasted and fed states, a strong

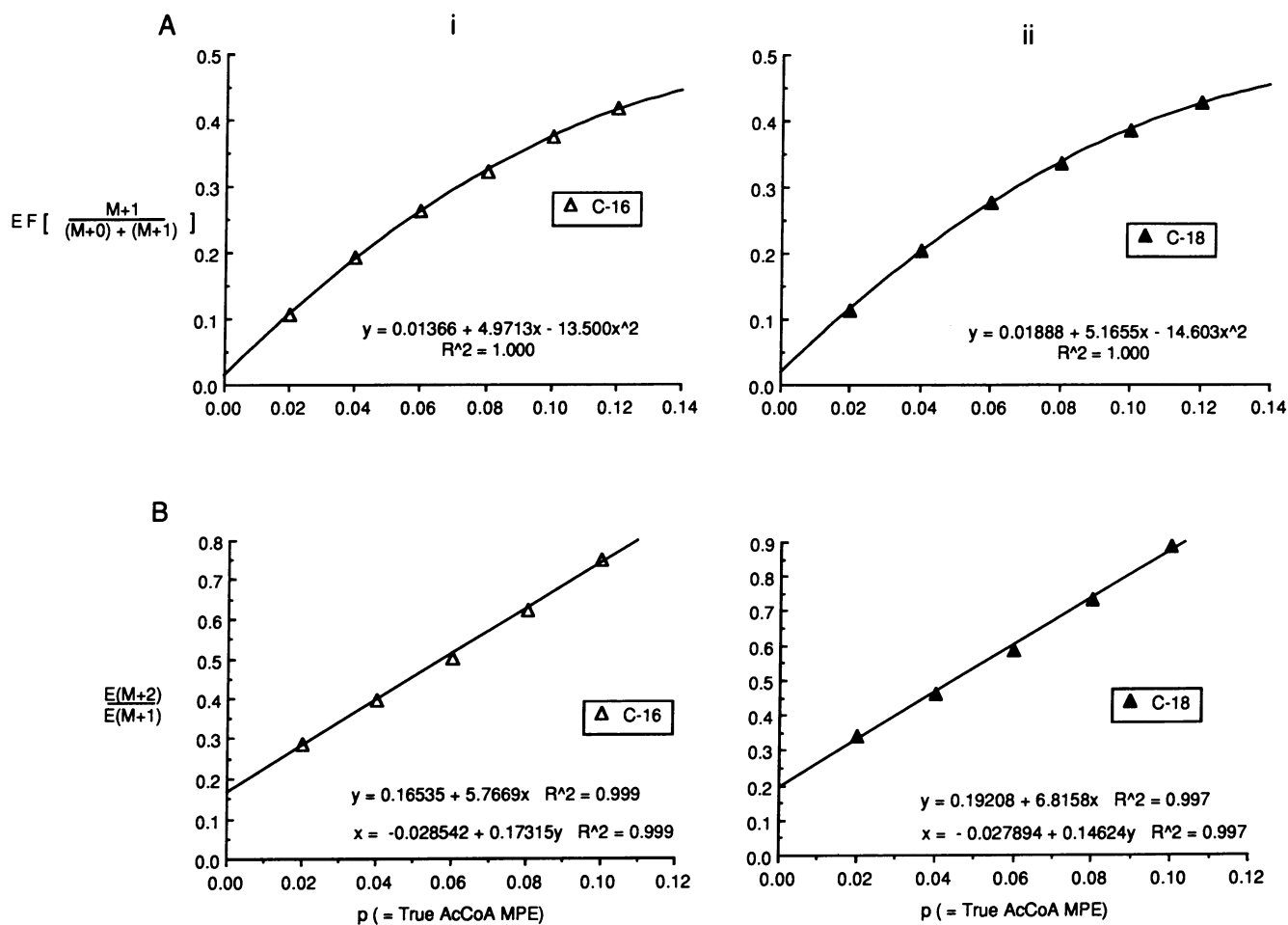

Figure 4. (A) The theoretical relationship between p (enrichment of acetyl-CoA) and $EF[M + 1/(M + 0) + (M + 1)]$, the excess ratio of $(M + 1)/(M + 0) + (M + 1)$ isotopomers in VLDL-FA if all VLDL-FA were derived from acetyl-CoA. Background $(M + 1)/(M + 0) + (M + 1)$ is subtracted assuming a natural ^{13}C abundance of 2.22% in acetate, according to Eq. 4 in the text. (B) The theoretical relationship between p and the ratio of excess $M + 2/\text{excess } M + 1$ ($EM + 2/EM + 1$) enrichments in VLDL-FA, calculated as excess $M + 2/(M + 0) + (M + 1) + (M + 2)$ divided by excess $M + 1/(M + 0) + (M + 1) + (M + 2)$. Curves in A and B are computer simulations. The relationship in A is used for calculating the percent of VLDL-FA synthesized by the de novo pathway (observed $M + 1/(M + 0) + (M + 1)$ divided by $EF[M + 1/(M + 0) + (M + 1)]$). The relationship in B permits inference of p from $EM + 2/EM + 1$ ratios in VLDL-FAs, which can be compared to SMX-acetate enrichments for internal validation of the model. See text for details of calculations.

correlation between $[^{13}\text{C}]$ acetate infusion rate and SMX-acetate enrichment (Fig. 6, A and B) was observed ($R^2 = 0.61$ fasted, $R^2 = 0.39$ refeed). In five subjects, urine collections were continued and SMX-acetate enrichments determined after discontinuation of $[^{13}\text{C}]$ acetate infusion. Within 1 h after stopping $[^{13}\text{C}]$ acetate infusions, enrichments of urinary SMX-acetate fell by $32 \pm 2\%$ (to 68%, 63%, 71%, 73%, and 66% of enrichments determined before discontinuing the tracer).

Enrichments of FA-methyl esters $[M + 1/(M + 0) + (M + 1)]$. During a constant infusion of $[^{13}\text{C}]$ acetate, enrichments in VLDL-palmitate ($M + 1$) were low after an overnight fast then rose steadily during refeeding by all three routes (Table I, Fig. 7 A). Interestingly, VLDL-stearate labeling did not always move in a parallel fashion (Table I, Fig. 7 B). The measurement error was $\pm < 0.03$ MPE.

De novo lipogenesis in fasted and fed states. SMX-acetate enrichments, theoretical $EF[M + 1/(M + 0) + (M + 1)]$ for palmitate and stearate based on these acetyl-CoA enrichments and actual measured excess $M + 1/(M + 0) + (M + 1)$ in VLDL-palmitate and VLDL-stearate are shown (Table I). The

contribution of the de novo lipogenic pathway was calculated from the precursor-product relationship as described above (Table I, Fig. 8). After an overnight fast, de novo lipogenesis accounted for only $0.91 \pm 0.27\%$ (mean \pm SE, $n = 11$) of VLDL-palmitate and $0.37 \pm 0.08\%$ ($n = 11$) of VLDL-stearate. Even after 8 h of refeeding with Ensure to deliver 7–10 mg/kg per min carbohydrate, the de novo pathway accounted for only $1.64 \pm 0.42\%$ ($n = 7$) of VLDL-palmitate and $0.64 \pm 0.23\%$ ($n = 7$) of VLDL-stearate (Fig. 8). Results from Ensure refeeding, i.v. glucose refeeding and mixed meal refeeding were similar. In individual subjects, VLDL-stearate and VLDL-palmitate de novo synthesis did not necessarily move in parallel (Table I). It is apparent that de novo lipogenesis contributes a very small fraction of circulating VLDL-palmitate and stearate under these dietary conditions. By inference, most circulating FA must either be derived from reesterification of preformed FFA or were “old” (not newly secreted during the 9-h isotope infusion period). Since the fractional catabolic rate of circulating VLDL-TG in humans is $\sim 0.30\text{--}0.50 \text{ h}^{-1}$ (i.e., half-life is $\sim 1.5\text{--}2.0 \text{ h}$) (41–44), the latter possibility is unlikely to be

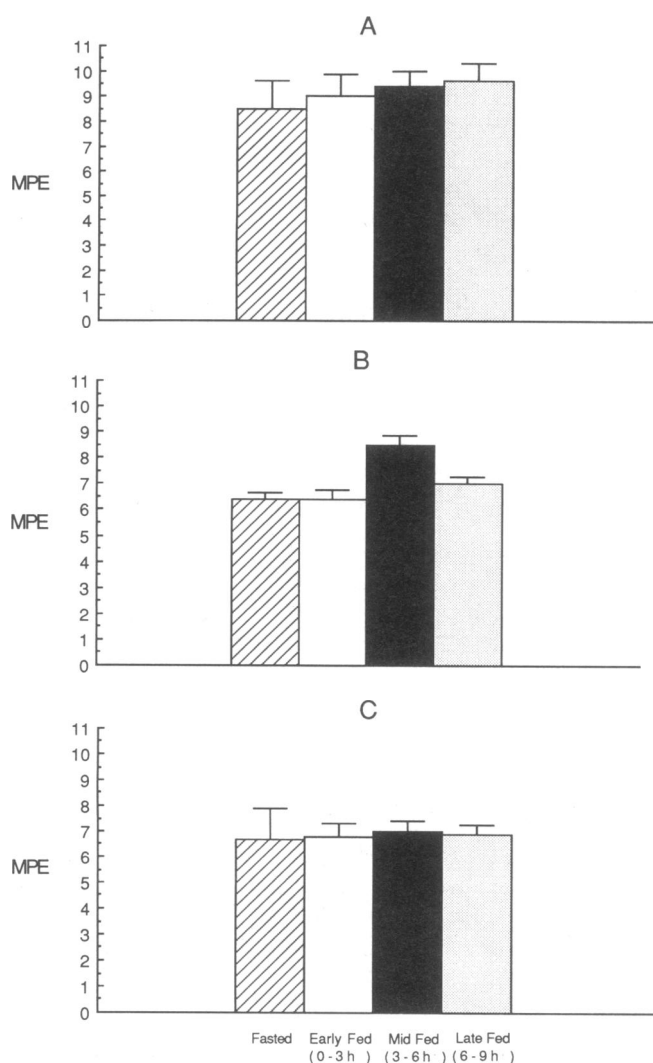

Figure 5. Measured enrichments $[M + 1/(M + 0) + (M + 1)]$ of urinary SMX-acetate in subjects during an overnight fast followed by refeeding. $[1-^{13}\text{C}]$ - or $[2-^{13}\text{C}]$ acetate was infused at a constant rate from 2:00 a.m. until 6:00 p.m. SMX-acetate time points during each period were measured separately and the time-weighted value over the interval was used. (A) Ensure refed ($n = 8$). (B) Intravenous glucose refed ($n = 4$). (C) Breakfast refed ($n = 7$).

important here. Plasma VLDL-TG concentrations were stable during the last 5 h of the refeeding period (not shown).

Other isotopomers ($EM + 2/EM + 1$ ratios). According to the model, the ratio of $EM + 2/EM + 1$ enrichments is uniquely determined by the enrichment of the true precursor (Fig. 4 B) thus can be used as a check on the accuracy of SMX-acetate in reflecting the true precursor enrichment. The $(M + 2)$ and $(M + 1)$ isotopomers of VLDL-palmitate and stearate were analyzed in several subjects, and the binomial distribution was used to predict SMX-acetate enrichments based upon $EM + 2/EM + 1$ ratios (Table II). Predicted hepatic acetyl-CoA enrichments based upon $EM + 2/EM + 1$ ratios were close to the measured SMX-acetate values (although this took several hours of refeeding in some subjects, presumably reflecting the turnover of circulating VLDL). Enrichments in $(M + 3)$ or higher isotopomers were not adequate to measure accurately (not shown).

Indirect calorimetry. Nonprotein (NP) RQ in subjects after an overnight fast ranged between 0.77 and 0.89 (0.83 ± 0.02 , mean \pm SE, $n = 9$). Nonprotein oxygen consumption ($\text{NP } \dot{V}\text{O}_2$) ranged between 0.187 and 0.374 liter/min (0.260 ± 0.024 , $n = 9$) and nonprotein carbon dioxide production ($\text{NP } \dot{V}\text{CO}_2$) was 0.167–0.312 liter/min (0.214 ± 0.017 , $n = 9$). Oxygen consumption and carbon dioxide production due to protein ($\text{P } \dot{V}\text{O}_2$ and $\text{P } \dot{V}\text{CO}_2$, respectively) were calculated from urinary urea excretion in subjects refed Ensure by the oral route. After 2 h of oral refeeding, NP RQ rose to 0.93 ± 0.03 ($n = 3$); after 4 h this value was 0.96 ± 0.01 and after 6–8 h was 0.96 ± 0.02 . NP $\dot{V}\text{O}_2$ rose 18.7% from baseline values whereas NP $\dot{V}\text{CO}_2$ rose 32.3% after 6–8 h of refeeding. We did not measure NP RQ simultaneously with $[^{13}\text{C}]$ acetate infusions in i.v. glucose refed subjects, owing to technical problems. However, in many of the same normal controls since infused with i.v. glucose at similar rates for other isotopic studies (45), NP RQ rose from baseline values of 0.81 ± 0.02 ($n = 6$) to 0.88 ± 0.03 at 2 h, 0.86 ± 0.03 at 4 h, and 0.89 ± 0.02 at 6 h. In all subjects, regardless of refeeding route, NP RQ remained < 1.00 throughout the refeeding period, except for one oral refed subject who had a single value of 1.02 (which fell back below 1.00 on subsequent measurements). These results are consistent with previous reports with refeeding at these rates or higher (30), wherein NP RQ remains < 1.00 . According to indirect calorimetric theory (46), there is no net lipogenesis while NP RQ is < 1.00 . Although this conclusion is not exactly correct (Table I, Figs. 7 and 8) with regard to unidirectional lipogenesis, which is not excluded by the indirect calorimetric results, it is not far off quantitatively.

Plasma insulin and glucose concentrations. Fasting insulin concentration was $11.0 \pm 1.3 \mu\text{U/ml}$ and rose to plateau values of $51.3 \pm 9.0 \mu\text{U/ml}$ in Ensure refed subjects. Plasma glucose concentrations were $< 8 \text{ mM}$ (range 4.2–7.9 mM).

Discussion

There is a conceptual difference between radioisotopic and stable-isotopic tracer studies of macromolecule synthesis. MS analyzes each isotopic species (isotopomer) or subpopulation of the macromolecule separately, whereas scintillation counting cannot distinguish between species and is not altered by the distribution of label within subpopulations of the macromolecule. This makes the stable isotopic approach more complex, since each isotopomer requires a separate measurement and a different calculation, but ultimately provides additional information about the system. The binomial expansion can be used to calculate the maximum possible enrichment for each isotopomer as a unique function of precursor enrichment (Figs. 3 and 4 A). Each isotopomer provides independent information and their comparison represents a check on the internal consistency of the model. Our observation that the ratio of $EM + 2/EM + 1$ isotopomers predicted from SMX-acetate was similar to observed $EM + 2/EM + 1$ ratios (Table II) supports the model in its broadest sense, i.e., not only for the appropriateness of the binomial distribution to represent this biosynthetic process but also for the accuracy of SMX-acetate (Fig. 1) in reflecting the true hepatic cytosolic acetyl-CoA enrichment during the experiment. If SMX-acetate had not accurately reflected the true precursor enrichment for de novo lipogenesis, then the relationship between excess $M + 2$ and $M + 1$ isotopomers would have been different than predicted by the SMX-

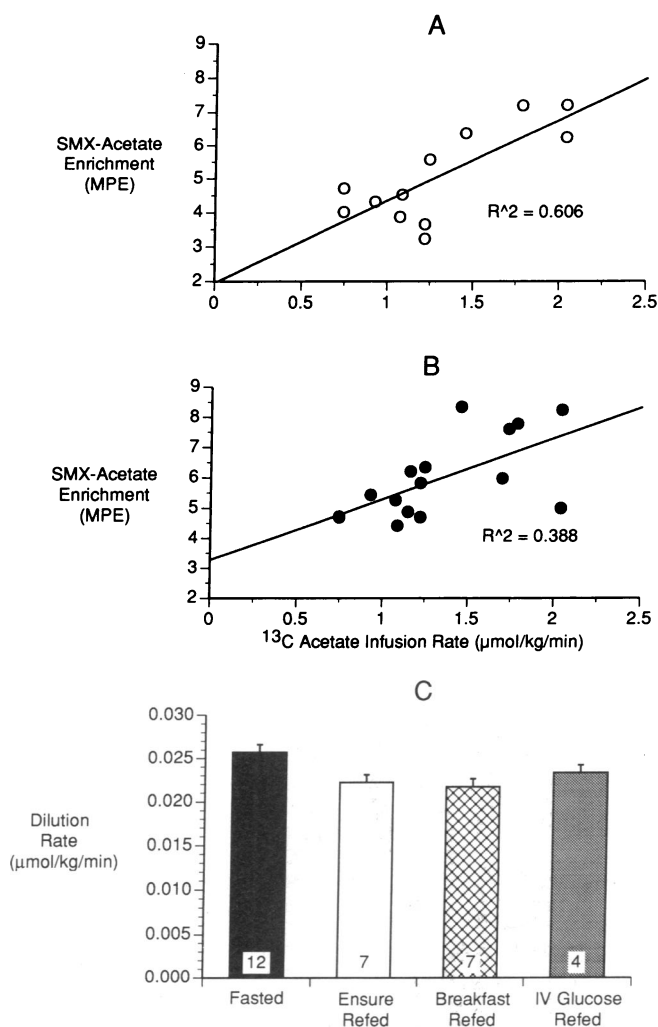

Figure 6. (A) Correlation between rate of ^{13}C acetate infusion and plateau enrichment in urinary SMX-acetate in fasted subjects. (B) Correlation in refeed subjects. Plateau isotopic enrichments were used. (C) Dilution rate of hepatic acetyl-CoA relative to administered $[1-^{13}\text{C}]$ or $[2-^{13}\text{C}]$ acetate (see text for details).

acetate enrichment (Fig. 4 B, Table II). Inability to measure cytosolic acetyl-CoA specific activity in rats has limited the utility of labeled acetate as a tracer for lipogenesis measurements (47, 48), since dilution occurs and mitochondrial acetyl-CoA (at least as represented by plasma ketone bodies) is not in isotopic equilibrium with the cytosolic pool.³ The xenobiotic acetyl-CoA probe technique resolves this problem and makes acetate a useful tracer for lipogenesis measurements in humans and experimental animals (17).

This is the first application of the xenobiotic acetylation technique for sampling acetyl-CoA in humans (Fig. 1). We have recently confirmed, using cell elutriation techniques, that parenchymal rat hepatocytes are responsible for acetylation of sulfa drugs (20). The data presented here in humans further strengthens the validity of the acetylated-xenobiotic technique

3. We have also observed much lower enrichments in circulating beta-hydroxybutyrate than SMX-acetate in rats and humans infused with ^{13}C acetate (unpublished observations).

for sampling the true hepatic acetyl-CoA pool noninvasively. The technique is analogous to the xenobiotic-glucuronidation technique for sampling hepatic UDP-glucose (12) which has now been used in rats (12–15, 17, 19, 20), dogs (23), and humans (16, 21, 22). The only risk associated with the method is the potential for allergic reactions to sulfa drugs. Urine concentrations of SMX-acetate were generally substantial enough for easy HPLC isolation within 3–4 h of the first oral dose and remained adequate throughout the infusions. Use of urinary rather than plasma SMX-acetate may tend to smooth out variations over time, but urinary enrichments are responsive enough to fall by $32 \pm 2\%$ within 1 h of discontinuing ^{13}C acetate infusion, consistent with rapid urinary excretion of plasma SMX-acetate. HPLC/MS analysis is rapid, requires no derivitization, and is extremely precise (SE of < 0.04 MPE, thus errors of the estimate $< 1\%$). By virtue of its simplicity, lack of radiation exposure, ease of analysis, and apparent accuracy in animals as well as humans, we believe that the xenobiotic-acetylation technique with HPLC/MS analysis holds promise for a number of metabolic questions.

Our results demonstrate clearly that de novo lipogenesis is in fact a quantitatively minor pathway under nonoverfed conditions in normal men (Table I, Fig. 8). This is the first direct measurement of de novo lipogenesis in humans of which we are aware. It should be noted that these subjects were receiving significant carbohydrate loads (7–10 mg/kg per min for 9 h or 3.5 g/kg as a meal). However, they were not chronically overfed or obese and they had fasted from 8:00 p.m. the prior evening. These are fairly lifelike fasting and feeding conditions. Under such conditions, it is likely that most circulating and adipocyte fat is ultimately derived from dietary sources other than glucose (i.e., fatty acids, perhaps ethanol). This conclusion is congruent with prior inferences based on adipocyte fatty acid analysis (49), in vitro biosynthetic studies (10, 11), and in vivo indirect calorimetry (1–4). In this context, it is important to note that the indirect calorimetric technique can even in theory only state whether net lipogenesis is occurring; i.e., concurrent lipogenesis/FA oxidation will not result in an RQ > 1.0 (31, 46). Thus, the existence of futile FA cycling had not previously been addressed using indirect calorimetry in humans nor excluded as an important thermogenic factor. In cold-adapted rats, futile FA cycling is not a thermogenic mechanism (50). Under physiologic conditions in normal humans, our results show that futile FA cycling does not make an important thermogenic contribution (est. < 500 mg/d [see below] $\cong 2$ kcal/d). Indirect calorimetry is based on a number of fairly complex assumptions (45), but for estimation of lipogenesis in normal subjects our results indicate that the gas exchange approach is essentially correct. As noted above, the absence of de novo lipogenesis need not preclude a contribution from excess carbohydrate intake to hypertriglyceridemia (by inhibition of FA oxidation and diversion of hepatic FA into reesterification) but does imply that carbohydrate is unlikely to contribute carbon directly to adipose TG at this level of intake in normal, nonoverfed humans. Calories in the form of carbohydrate could still play a role in obesity, either by sparing oxidation of ingested fats or if chronic carbohydrate overfeeding induces an adaptive increase in the de novo pathway. It will be important to test the latter possibility experimentally. At present, however, our results indicate that a fundamental question remains unanswered, namely where do excess carbohydrate calories go in humans?

Table I. De Novo VLDL-Palmitate and Stearate Synthesis

Refeeding protocol/subject no.	Measured <i>p</i> (SMX-Ac MPE)	Calculated EF[M + 1/(M + 0) + (M + 1)]		Measured VLDL-FA enrichment (MPE)		Percent de novo lipogenesis	
		C-16	C-18	C-16	C-18	C-16	C-18
I. Ensure refed							
1. Fasted	—	—	—	—	—	—	—
Early fed	6.64	0.2842	0.2974	0.57	0.08	2.01	0.27
Late fed	7.60	0.3135	0.3270	0.60	0.06	1.91	0.18
2. Fasted	—	—	—	—	—	—	—
Early fed	6.60	0.2830	0.2961	0.63	0.00	2.23	0.00
Late fed	6.21	0.2703	0.2833	1.08	0.00	3.99	0.00
3. Fasted	7.19	0.3013	0.3147	0.16	0.19	0.53	0.60
Early fed	7.83	0.3202	0.3337	0.24	0.41	0.75	1.23
Late fed	7.78	0.3187	0.3323	0.42	0.61	1.32	1.84
4. Fasted	6.36	0.2752	0.2883	0.50	0.17	1.82	0.59
Early fed (10)	7.97	0.3246	0.3377	0.38	0.17	1.17	0.50
Late fed (10)	8.34	0.3344	0.3480	0.38	0.32	1.14	0.92
5. Fasted	7.20	0.3016	0.3150	0.03	0.04	0.10	0.13
Early fed	7.89	0.3219	0.3355	0.20	0.29	0.62	0.86
Late fed	8.24	0.3316	0.3453	0.33	0.26	1.00	0.75
6. Fasted	3.66	0.1775	0.1883	0.14	0.02	0.79	0.11
Early fed	4.63	0.2149	0.2267	0.06	0.12	0.28	0.53
Late fed	4.70	0.2175	0.2293	0.15	0.11	0.69	0.48
7. Fasted	—	—	—	—	—	—	—
Early fed	6.35	—	—	—	—	—	—
Late fed	6.27	0.2720	0.2849	0.39	0.08	1.43	0.28
8. Fasted	5.57	0.2487	0.2613	0.17	0.08	0.68	0.31
II. Breakfast refed							
1. Fasted	3.23	0.1602	0.1704	0.16	0.15	1.00	0.88
Early fed	5.34	0.2406	0.2530	—	—	—	—
Late fed	5.82	0.2573	0.2700	—	—	—	—
2. Fasted	6.24	0.2713	0.2843	0.08	0.11	0.29	0.11
Early fed	5.72	0.2539	0.2665	0.09	0.00	0.35	0.00
Late fed	4.99	0.2281	0.2402	0.14	0.04	0.61	0.04
3. Fasted	4.02	0.1917	0.2029	0.14	0.06	0.73	0.30
Early fed	4.69	0.2171	0.2289	0.43	0.23	1.98	1.00
Late fed	4.72	0.2182	0.2301	0.37	0.22	1.70	0.96
4. Fasted	4.71	0.2179	0.2297	0.50	0.12	2.30	0.52
Early fed	4.72	0.2182	0.2301	0.92	0.25	4.22	1.09
Late fed	4.70	0.2175	0.2293	0.88	0.27	4.05	1.18
5. Fasted	—	—	—	—	—	—	—
Early fed	3.94	—	—	—	—	—	—
Late fed	4.87	0.2241	0.2361	0.56	0.16	2.50	0.07
6. Fasted	—	—	—	—	—	—	—
Early fed	5.37	0.2408	0.2533	0.05	0.00	0.21	0.00
Late fed	5.54	0.2476	0.2602	0.06	0.00	0.24	0.00
7. Fasted	3.66	0.1775	0.1883	0.17	0.09	0.96	0.48
Early fed	4.98	0.2281	0.2402	0.40	0.12	1.75	0.50
Late fed	4.87	0.2240	0.2359	0.61	0.14	2.72	0.59
III. Intravenous glucose refed							
1. Fasted	—	—	—	—	—	—	—
Early fed	4.30	0.2025	0.2139	0.23	0.19	1.14	0.89
Late fed	4.88	0.2241	0.2361	0.47	0.29	2.10	1.23
2. Fasted	—	—	—	—	—	—	—
Early fed	5.68	0.2525	0.2651	0.29	0.18	1.15	0.68
Late fed	5.98	0.2627	0.2755	0.34	0.19	1.29	0.69
3. Fasted	4.53	0.2112	0.2228	0.16	0.00	0.76	0.00
Early fed (10)	4.62	0.2145	0.2263	0.21	0.00	0.98	0.00
Late fed (10)	4.42	0.2070	0.2186	0.35	0.00	1.69	0.00

Normal human subjects were infused with [¹³C]acetate during fasting and refeeding (2:00 a.m. through 5:00 p.m.). Methods of refeeding are described in text. Measured *p* refers to the probability of the true lipogenic precursor (hepatic cytosolic acetyl-CoA) being enriched with ¹³C, and is represented by the SMX-acetate (SMX-Ac) enrichment over the time interval. EF[M + 1/(M + 0) + (M + 1)] is the maximum possible frequency of the M + 1 isotopomer relative to the sum of (M + 0) plus (M + 1) isotopomers, calculated from *p* using the relationships shown in Fig. 4 A. Measured VLDL-FA enrichments [M + 1/(M + 0) + (M + 1)] are also shown. Percentage of each VLDL-FA derived from the de novo pathway (percent de novo lipogenesis) is calculated using the precursor-product relationship (equal to measured VLDL-FA enrichment/EF[M + 1/(M + 0) + (M + 1)]). Early fed refers to hours 3–6 of refeeding, late fed refers to the final 3 h of the refeeding period. In I-4 and III-3 the (10) indicates that glucose or carbohydrate refeeding rate was 10 mg/kg per min; otherwise refeeding rate was 7 mg/kg per min.

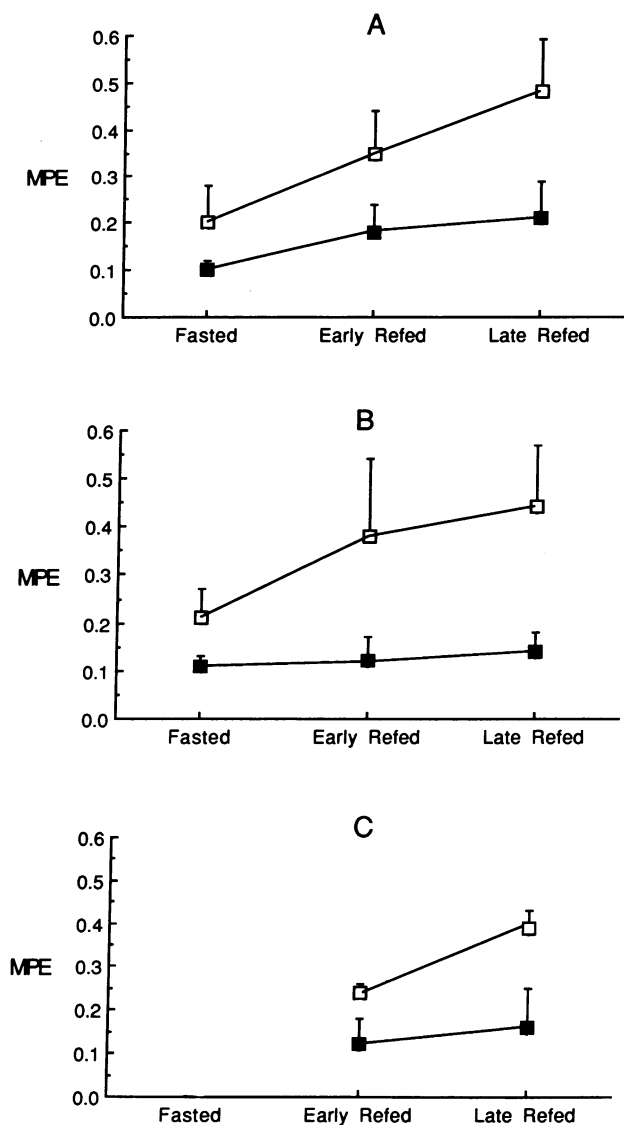

Figure 7. Time course of VLDL-FA $M + 1/(M + 0) + (M + 1)$ enrichment during infusion of $[^{13}\text{C}]$ acetate in fasted and re-fed subjects. See text for details. (□) VLDL-palmitate. (■) VLDL-stearate. (A) Ensure re-fed ($n = 7$). (B) Breakfast re-fed ($n = 6$). (C) Intravenous glucose re-fed ($n = 3$).

Some methodologic issues require comment. Assuming the half-life of circulating VLDL to be in the range of 1.5–2.0 h (41–44), essentially all circulating VLDL should represent newly secreted particles after a 7–9-h infusion (the duration of our tracer infusion during fasting and again during refeeding). A more complex question is whether all newly synthesized VLDL-FA in the liver will be secreted over this time period. The time lag between synthesis and secretion of VLDL from human hepatocytes is quite short, in the range of 20–30 min based on pulse-chase experiments (51–53). VLDL is assembled in the lumen of the smooth endoplasmic reticulum (52–55), is secreted constitutively via trans-cisternal secretory vesicles, and does not accumulate in the liver except in disease states such as abetalipoproteinemia or alcoholic liver disease (52, 53, 56). Moreover, during the course of our 16-h tracer experiments, > 20 g of VLDL-TG will be secreted (41–44), which

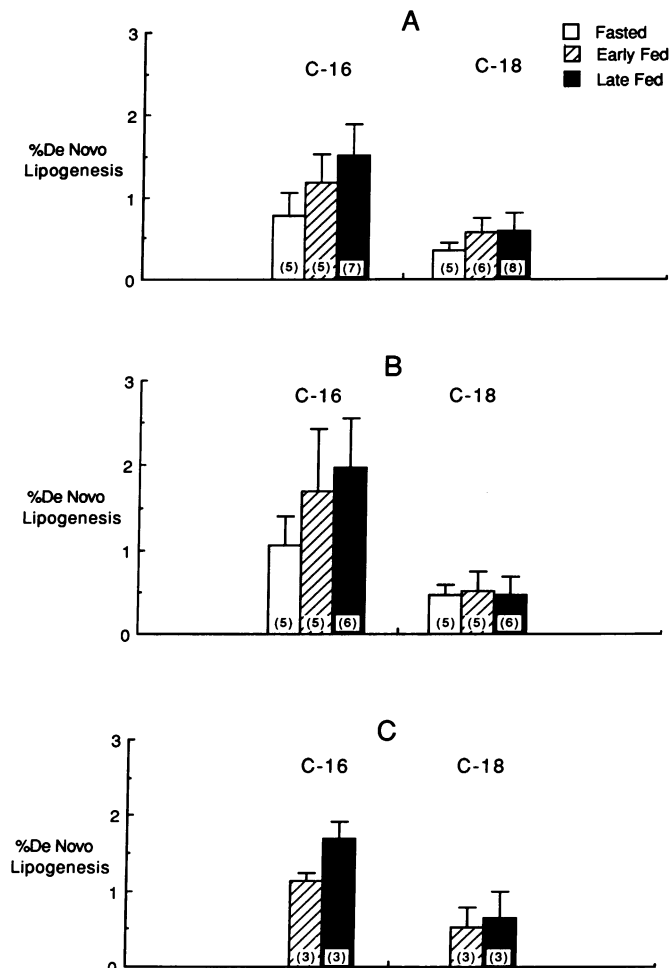

Figure 8. Percent de novo lipogenesis over time in fasted-refed subjects. De novo lipogenesis was calculated as described in the text, by dividing the observed $M + 1/(M + 0) + (M + 1)$ frequency ratio in C-16 and C-18 VLDL-FA by $F[M + 1/(M + 0) + (M + 1)]$. The latter is calculated from the relationship in Fig. 4 A, using measured SMX-acetate enrichments to represent p for C-16 and C-18, respectively. n for each measurement is indicated in parentheses. (A) Ensure re-fed. (B) Breakfast re-fed. (C) Intravenous glucose re-fed.

would represent ~ 2% by weight of a human liver; i.e., the flux is much greater than any preformed VLDL stores are likely to be. The possibility that dilution by preformed hepatic VLDL-FA is the reason for our low de novo lipogenesis estimates seems unlikely. Even if preformed VLDL in the liver diluted the secreted VLDL-FA by 50%, the contribution from de novo lipogenesis would still be < 5% (Table I). Another potential source of underestimation would be if significant amounts of newly synthesized FA entered the circulation in a form other than VLDL. There is no evidence for de novo hepatic synthesis and secretion of FFA. The subcellular locations for de novo lipogenesis and VLDL assembly are both in the smooth endoplasmic reticulum, so escape from liver in the form of FFA is unlikely a priori. If significant amounts of FA in TG or phospholipids enter the circulation in particles other than VLDL (IDL, LDL, or HDL) they could escape our detection. Although the liver probably does directly secrete these species to some extent (57, 58), they represent a small fraction of total TG secretion particularly in view of their small triglyceride con-

Table II. Observed vs. Predicted Acetyl-CoA Enrichments (P)

Time	EM + 2/EM + 1 ratio		Predicted P	Observed P
	C-16	C-18		
				<i>MPE</i>
4-h values	0.3841	0.4641	3.90	4.88
	0.5045	—	5.88	5.86
	0.3762	—	3.66	4.88
	0.4961	—	5.74	4.98
	0.4258	—	4.52	4.75
	0.5000	—	5.80	5.57
	0.4762	—	5.39	5.19
	0.3989	—	4.05	5.12
	0.4872	—	5.58	5.83
		0.5070	0.4546	<u>5.92</u>
Mean±SE			5.04±0.29	5.24±0.13
8-h values	0.4722	0.5323	5.16	5.64
	0.4421	0.4833	4.54	5.09
	0.5195	0.5530	5.72	6.05
	0.5949	—	7.45	8.34
	0.3871	—	4.60	4.03
	0.5088	0.5055	5.28	4.63
	0.5262	—	6.26	5.00
	0.4143	—	4.32	5.37
	0.3987	—	6.49	5.65
	0.4395	—	4.76	5.83
	0.4401	—	5.16	4.75
	0.4122	0.4783	4.25	5.54
	0.4333	—	8.88	7.51
	0.3710	—	7.91	6.64
		0.4535	—	<u>5.00</u>
Mean±SE			5.72±0.36	5.70±0.29

EM + 2/EM + 1 isotopomer ratios in VLDL-palmitate (C-16) and VLDL-stearate (C-18) were measured at 4 and 8 h of refeeding during infusion of [1-¹³C]- or [2-¹³C]acetate. The predicted P (precursor acetyl-CoA enrichment) was calculated using the mathematical relationship to EM + 2/EM + 1 ratio shown in Fig. 4 B. Where both C-16 and C-18 ratios were available, the mean predicted P is used. Observed P (SMX-acetate enrichments) are compared.

tent. The answer is not as simple for phospholipids, particularly phospholipids in HDL. However, most HDL-phospholipids are probably formed in the plasma compartment off the surface of TG-rich lipoproteins (reviewed in reference 59), so this is unlikely to be a significant bypass route for entry of FA into the circulation. Exchange of VLDL-FA with other particles (i.e., cholesterol esters in HDL) is very slow (e.g., plasma cholesterol ester pool size of ~ 10,000 μmol with exchange rate ~ 10 μmol/min, reference 60) relative to VLDL-TG clearance. Finally, total secretion of FA from liver in the form of cholesterol-esters could account for only ~ 200 mg/d, assuming 500 mg/d hepatic cholesterol ester secretion (61, 62) and FA representing 40% of cholesterol-ester mass, so any contribution by the de novo pathway would only be a fraction of this already small number and is unlikely to add significantly to our quantitative estimates. In summary, it is unlikely that ignoring any of these routes could lead to a quantitatively important underestimation of de novo hepatic lipogenesis, although they may in sum increase the actual value to some extent. Direct

experimental testing of their individual contributions is feasible, however, by their isolation and measurement of tracer incorporation.

We did not observe a consistent decrease in SMX-acetate enrichment going from fasted to fed states (Figs. 5 and 6), which initially surprised us as we expected activation of hepatic pyruvate dehydrogenase (PDH) to occur and to result in an influx of unlabeled acetate units. However, the rather minor increase in lipogenesis is consistent with the lack of dilution of hepatic cytosolic acetyl-CoA. This does not rigorously prove that hepatic PDH remained inactive, since other sources of unlabeled acetyl-CoA (e.g., fatty acid oxidation) are likely to have been suppressed by carbohydrate feeding, but only that any increase in PDH flux does not markedly exceed the decreased input from other sources into acetyl-CoA. Regulation of flux across hepatic pyruvate dehydrogenase by availability of acetyl-CoA from other sources would suggest operation of the Randle cycle in liver (fatty acid oxidation products inhibiting PDH) (63). The dilution rate of hepatic acetyl-CoA relative to infused acetate tracer calculated from our results (Fig. 6 C) was 0.022–0.026 mmol/kg per min. The same parameter calculated by us recently in rats (17) was ~ 0.158–0.200 mmol/kg per min, and by Block and Rittenberg (64) in rats using a comparable technique almost 40 years ago was 0.132–0.153 mmol/kg per min—consistent with the usual difference between rats and humans relating to metabolic body size (65). This dilution parameter does not represent a true hepatic acetyl-CoA appearance rate, however, since infused acetate does not all enter the liver (in fact, most is taken up by peripheral tissues, references 66–68). We cannot therefore address the question why de novo lipogenesis proceeds at such a low rate in human liver: i.e., is the restriction at the level of PDH flux, acetyl-CoA carboxylase activity, FA synthase activity, or other steps in the pathway? This question may prove amenable to study using this isotopic technique, for example, by studying the effect of bypassing PDH via ethanol administration.

An interesting observation was that hepatic VLDL-stearate and palmitate synthesis are not identical or even parallel in humans (Table I, Fig. 8). The de novo synthesis of stearate was always lower than palmitate. What this means is unclear. It might represent further metabolism of stearate to oleate (18:1), which we did not measure, for TG or cholesterol-ester synthesis. In rats, however, almost all fatty acid synthesis is into palmitate and stearate (69). It might represent synthesis of C-18:0 in a different subcellular location, regulated by different factors. Alternatively, tissue needs for the two FA may independently influence their synthesis. These experimental questions can be studied using this technique and other FA (e.g., C-18:1) can be added to future mass spectrometric analyses.

Absolute de novo synthetic rates can be calculated using literature values for VLDL-triglyceride production rate (41–44). Published rates range from 120 (41) to 350 mg/kg per d (44), making the total VLDL-TG secretion rate ~ 10–25 g/d. De novo lipogenesis is between 1 and 2% of this rate (Table I, Fig. 8), or only ~ 200–500 mg/d. The energy cost of converting carbohydrate to fat before oxidation is estimated to be 28% of the energy content of the carbohydrate (70). If we use a 500 mg/d estimate, equivalent to ~ 2 mmol palmitate/d, this would require 9.0 mmol glucose (70) or < 2 g glucose/d. The caloric cost (28% × 4.0 kcal/g) is in the range of 2 kcal/d. In whole-body quantitative terms, this is not an important pathway under these conditions.

In summary, we present a noninvasive stable-isotopic method for measuring de novo lipogenesis in humans and describe the mathematical underpinnings of the model. The results are internally consistent and support the validity of the technique. In normal, weight-stable nonobese male human subjects, de novo lipogenesis does occur to a minor extent during fasting and carbohydrate refeeding at moderate loads, but quantitatively only a small fraction of circulating lipids derive from de novo lipogenesis and a similarly small fraction of a carbohydrate load is disposed via de novo lipogenesis. Fatty acid oxidation/synthesis (futile cycling) is unlikely to contribute significantly to thermogenesis under normal conditions. Hepatic acetyl-CoA does not reflect a dilution by unlabeled acetate units under these feeding conditions, suggesting that any increase in PDH activity only balances or slightly outweighs decreased input from fat oxidation or other acetyl-CoA sources. Finally, synthesis rates of different nonessential fatty acids (16:0, 18:0) by human liver are not identical or even parallel. It will be of interest to examine de novo lipogenesis in women and in a variety of physiologic and pathologic conditions—including acute and chronic overfeeding, type II diabetes mellitus, chronic ethanol intake, genetic dyslipidemias, inflammatory conditions, hyperthyroidism, cytokine therapies, etc.—using this approach, to ask whether this seemingly vestigial pathway takes on metabolic significance in other settings or populations. Use of this precursor sampling technique to measure hepatic cholesterol synthesis with stable isotopes is also possible (Hellerstein, M. K., C. Kletke, K. Wu, S. Kaempfer, J. S. Reid, and C. H. L. Shackleton, unpublished observations).

Acknowledgments

We thank Cici Hyde and Joe Watson for preparation of the manuscript, Dr. Ronald Krauss and Laura Glines for measurement of triglyceride concentrations, Angie DeCarlo for insulin measurements, and the San Francisco General Hospital General Clinical Research Center nurses for their effort and patience.

This research was supported in part by grant DK-40995 from the National Institutes of Health, R87SF091 from the University of California Universitywide Task Force on AIDS, and 87-51 (BRSG) from the University of California at Berkeley (Dr. Hellerstein), and Shared Instrumentation Grant RR03300 and DK-34400 from the National Institutes of Health (Dr. Shackleton).

References

- Acheson, K. J., Y. Schutz, T. Bessard, E. Ravussin, E. Jequier, and J. P. Flatt. 1984. Nutritional influences on lipogenesis and thermogenesis after a carbohydrate meal. *Am. J. Physiol.* 246:E62-E70.
- Acheson, K. J., J.-P. Flatt, and E. Jequier. 1982. Glycogen synthesis versus lipogenesis after a 500-g carbohydrate meal. *Metab. Clin. Exp.* 31:1234-1240.
- Bjorntorp, P., and L. Sjostrom. 1978. Carbohydrate storage in man: speculations and some quantitative considerations. *Metab. Clin. Exp.* 27:1853-1865.
- Passmore, R., and Y. E. Swindells. 1963. Observations on the respiratory quotients and weight gain of man after eating large quantities of carbohydrate. *Br. J. Nutr.* 17:331-339.
- Danforth, E., Jr. 1985. Diet and obesity. *Am. J. Clin. Nutr.* 41:1132-1145.
- Coulston, A. M., C. B. Hollenbeck, A. L. M. Swislocki, and G. M. Reaven. 1989. Persistence of hypertriglyceridemic effect of low-fat high-carbohydrate diets in NIDDM patients. *Diabetes Care.* 12:94-101.
- Abbott, W. G. H., V. L. Boyce, S. M. Grundy, and B. V. Howard. 1989. Effects of replacing saturated fat with complex carbohydrate in diets of subjects with NIDDM. *Diabetes Care.* 12:102-107.
- Musliner, T. A., and R. M. Krauss. 1988. Lipoprotein subspecies and risk of coronary disease. *Clin. Chem.* 34:B78-B83.
- Shrago, E., J. A. Glennon, and E. S. Gordon. 1971. Comparative aspects of lipogenesis in mammalian tissues. *Metab. Clin. Exp.* 20:54-62.
- Shrago, E., T. Spennetta, and E. Gordon. 1969. Fatty acid synthesis in human adipose tissue. *J. Biol. Chem.* 244:2761-2766.
- Sjostrom, L. 1973. Fatty acid synthesis de novo in adipose tissue from obese subjects on a hypercaloric high-carbohydrate diet. *Scand. J. Clin. Lab. Invest.* 32:339-349.
- Hellerstein, M. K., D. J. Greenblatt, and H. N. Munro. 1986. Glycoconjugates as non-invasive probes of intrahepatic metabolism: pathways of glucose entry into compartmentalized hepatic UDP-glucose pools during glycogen accumulation. *Proc. Natl. Acad. Sci. USA.* 83:7044-48.
- Hellerstein, M. K., D. J. Greenblatt, and H. N. Munro. 1987. Glycoconjugates as non-invasive probes of intrahepatic metabolism. I. Kinetics of labelling of urinary acetaminophen-glucuronide from carbohydrate precursors and absence of compartmentalized hepatic UDP-glucose pools for secreted glucuronyl- and galactosyl-conjugates. *Metab. Clin. Exp.* 36:988-994.
- Hellerstein, M. K., and H. N. Munro. 1987. Glycoconjugates as non-invasive probes of intrahepatic metabolism. II. Application to measurement of plasma alpha 1-acid glycoprotein turnover during experimental inflammation. *Metab. Clin. Exp.* 36:995-1000.
- Hellerstein, M. K., and H. N. Munro. 1988. Glycoconjugates as non-invasive probes of intrahepatic metabolism. III. Application to galactose assimilation in the intact rat. *Metab. Clin. Exp.* 37:312-317.
- Hellerstein, M. K., K. Wu, S. Kaempfer, W. P. Lee, S. Reid, and C. H. L. Shackleton. 1989. Non-invasive studies of intrahepatic metabolism in human subjects using mass spectrometry (MS). I. Glucuronide probe. *FASEB (Fed. Am. Soc. Exp. Biol.) J.* 3:A244.
- Kaempfer, S., K. Wu, and M. K. Hellerstein. 1989. Non-invasive studies of intrahepatic metabolism in rats using the acetyl probe. *FASEB (Fed. Am. Soc. Exp. Biol.) J.* 3:A243.
- Wu, K., S. Kaempfer, S. Reid, C. H. L. Shackleton, and M. K. Hellerstein. 1989. Non-invasive studies of intrahepatic metabolism in humans. II. Acetyl Probe. *FASEB (Fed. Am. Soc. Exp. Biol.) J.* 3:A243.
- Blackham, M., S. Kaempfer, K. Wu, M. Christiansen, T. Vary, and M. Hellerstein. 1990. Regulation of hepatic carbohydrate metabolism by nutrients: correlation between pyruvate dehydrogenase (PDH) activity and non-invasive isotopic fluxes. *FASEB (Fed. Am. Soc. Exp. Biol.) J.* 4:A282.
- Kaempfer, S., M. Blackham, K. Wu, D. Cesar, T. Vary, and M. K. Hellerstein. 1991. In vivo measurement of the fraction of hepatic cytosolic acetyl-CoA derived from glucose and its relation to pyruvate dehydrogenase phosphorylation state. *Am. J. Physiol.* In press.
- Magnusson, I., V. Chandramouli, W. C. Schumann, K. Kumaran, J. Wahren, and B. R. Landau. 1987. Quantitation of the pathways of hepatic glycogen formation on ingesting a glucose load. *J. Clin. Invest.* 80:1748-1754.
- Magnusson, I., V. Chandramouli, W. C. Schumann, K. Kumaran, J. Wahren, and B. R. Landau. 1989. Pathways of hepatic glycogen formation in humans following ingestion of a glucose load in the fed state. *Metab. Clin. Exp.* 38:583-585.
- Schwenk, W. F. 1990. Acetaminophen glucuronidation accurately reflects gluconeogenesis in fasted dogs. *Clin. Res.* 38:309A. (Abstr.)
- Olsen, H. 1982. Interaction between drug acetylation and ethanol, acetate, pyruvate, citrate, and L(-)carnitine in isolated rat liver parenchymal cells. *Acta Pharmacol. Toxicol.* 50:67-74.
- Olsen, H., and J. Morland. 1978. Ethanol-induced increase in drug acetylation in man and isolated rat liver cells. *Br. Med. J.* 2:1260-1262.
- Olsen, H., and J. Morland. 1983. Ethanol interaction with drug acetylation in vivo and in vitro. *Pharmacol. Biochem. Behav.* 18:295-300.
- Govier, W. C. 1965. Reticuloendothelial cells as the site of sulfanilamide acetylation in the rabbit. *J. Pharmacol. Exp. Ther.* 150:305-308.
- Grunfeld, C., D. P. Kotler, R. Hamadeh, A. Tierney, J. Wong, and R. N. Pierson. 1989. Hypertriglyceridemia in the acquired immunodeficiency syndrome. *Am. J. Med.* 86:27-31.
- Grunfeld, C., D. Kotler, J. Shigenaga, W. Doerfler, A. Tierney, J. Wang, R. Pierson, and K. Feingold. 1991. Circulating interferon-alpha levels and hypertriglyceridemia in the acquired immunodeficiency syndrome. *Am. J. Med.* In press.
- Thiebaud, D., E. Jacot, R. A. DeFronzo, E. Maeder, E. Jequier, and J.-P. Felber. 1982. The effect of graded doses of insulin on total glucose uptake, glucose oxidation, and glucose storage in man. *Diabetes.* 31:957-963.
- Weir, J. B. de V. 1949. New methods for calculating metabolic rate with special reference to protein metabolism. *J. Physiol. (Lond.)* 109:1091-1099.
- Nägele, U., E. O. Hegele, G. Sauer, E. Wiedemann, P. Lehman, A. W. Wahlefeld, and W. Gruber. 1984. Reagent for the enzymatic determination of serum total triglycerides with improved lipolytic efficiency. *J. Clin. Chem. Clin. Biochem.* 22:165-174.
- Work, E., T. S. Work. 1972. *Laboratory Techniques in Biochemistry and Molecular Biology.* North Holland and American Elsevier Press, New York. 351-352.
- Christie, W. W. 1982. *Lipid Analysis.* 2nd edition. Pergamon Press, New York. 52-53.

35. Von Schacky, C., J. Fischer, and P. C. Weber. 1985. Long-term effects of dietary marine omega-3 fatty acids upon plasma and cellular lipids, platelet function and eicosanoid formation in humans. *J. Clin. Invest.* 76:1626-31.
36. Reid, J. S., K. Wu, S. Kaempfer, M. Hellerstein, and C. Shackleton. 1990. Liquid chromatography-mass spectrometry of plasma glucose and secreted glucuronate for metabolic studies in humans. *Biomed. Mass Spectrom.* 19:535-540.
37. Wolfe, R. R. 1984. Tracers in Metabolic Research. Radio-Isotope and Stable Isotope/Mass Spectrometric Methods. Alan R. Liss, Inc., New York.
38. Waterlow, J. C., P. J. Garlick, and D. J. Millward, editors. 1978. Protein Turnover in Mammalian Tissues and in the Whole Body. North Holland, Amsterdam.
39. Zilversmit, D. B., C. Entenman, and M. Fishler. 1943. The calculation of turnover rate and turnover time from experiments involving the use of labeling agents. *J. Gen. Physiol.* 26:325-331.
40. Hetenyi, G., Jr., G. Perez, and M. Vranic. 1983. Turnover and precursor-product relationships of nonlipid metabolites. *Physiol. Rev.* 63:606-667.
41. Kissebah, A. H., S. Alfarsi, D. J. Evans, and P. W. Adams. 1982. Integrated regulation of very low density lipoprotein triglyceride and apolipoprotein B kinetics in non-insulin dependent diabetes mellitus. *Diabetes.* 31:217-225.
42. Abrams, J. J., H. Ginsberg, and S. M. Grundy. 1982. Metabolism of cholesterol and plasma triglycerides in nonketotic diabetes mellitus. *Diabetes.* 31:903-910.
43. Streja, D. A., E. B. Marliss, and G. Steiner. 1977. The effects of prolonged fasting on plasma triglyceride kinetics in man. *Metab. Clin. Exp.* 26:505-516.
44. Taskinen, M. R., W. F. Beltz, I. Harper, R. M. Fields, G. Schonfeld, S. M. Grundy, and B. V. Howard. 1986. Effects of NIDDM on very low density lipoprotein triglyceride and apolipoprotein B metabolism: studies before and after sulfonyl urea therapy. *Diabetes.* 35:1268-1277.
45. O'Connor, M., K. Mulligan, M. K. Hellerstein, M. M. Hammami, and J. H. Karam. 1991. Sulfonylurea euglycemic clamp on insulin secretion and carbohydrate (CH²) metabolism in man. *Diabetes.* (Suppl.) in press.
46. Ferrannini, E. 1988. The theoretical basis of indirect calorimetry. *Metab. Clin. Exp.* 37:287-301.
47. Dietschy, J. M., and M. S. Brown. 1974. Effect of alterations of the specific activity of the intracellular acetyl-CoA pool on apparent rates of hepatic cholesterol synthesis. *J. Lipid Res.* 15:508-516.
48. Dietschy, J. M., and J. D. McGarry. 1974. Limitations of acetate as a substrate for measuring cholesterol synthesis in liver. *J. Biol. Chem.* 249:52-58.
49. Hirsch, J. 1965. Fatty acid patterns in human adipose tissue. In *Handbook of Physiology*. Section 5, Adipose Tissue. J. F. Cahill, and A. E. Renold, editors. Waverly Press Inc., Baltimore, MD. 181-189.
50. Patkin, J. K., and E. J. Masoro. 1964. Fatty acid synthesis in normal and cold acclimated rats. *Can. J. Physiol. Pharmacol.* 42:101-107.
51. Olotsson, S.-O., K. Bostrom, P. Carlsson, J. Boren, M. Wettesten, G. Bjursell, O. Wiklund, and G. P. Bondjiers. 1987. Structure and biosynthesis of apolipoprotein B. *Am. Heart J.* 113:446.
52. Glickman, R. M., and S. M. Sabesin. 1989. Lipoprotein metabolism. In *The Liver, Biology and Pathobiology*. I. M. Arias, W. B. Jakoby, H. Popper, D. Schacter, and D. A. Shafritz, editors. Raven Press, New York. 332-338.
53. Havel, R. J., and J. P. Kane. 1989. Disorders of the biogenesis and secretion of lipoproteins containing the B apolipoproteins. In *Metabolic Basis of Inherited Diseases*, 6th edition. C. R. Scriver, A. L. Beaudet, W. S. Sly, and D. Valle, editors. McGraw-Hill Book Co., Inc., New York. 1139-1145.
54. Hamilton, R. L. 1983. Hepatic secretion of plasma lipoproteins. In *Plasma Protein Secretion by the Liver*. H. Glaumann, T. Peters Jr., and C. Redman, editors. Academic Press, Inc., New York. 357.
55. Janero, D. R., P. Siuta-Mangano, K. W. Miller, and M. D. Lane. 1984. Synthesis, processing and secretion of hepatic very low density lipoprotein. *J. Cell Biochem.* 24:131.
56. Lackner, K. J., J. C. Monge, R. E. Gregg, J. M. Hoeg, T. T. Triche, S. W. Law, and H. B. Brewer Jr. 1986. Analysis of the apolipoprotein B gene and messenger ribonucleic acid in abetalipoproteinemia. *J. Clin. Invest.* 78:1707.
57. Kesaniemi, Y. A., W. F. Beltz, and S. M. Grundy. 1985. Comparison of metabolism of apolipoprotein B in normal subjects, obese patients and patients with coronary heart disease. *J. Clin. Invest.* 76:586-595.
58. Cohn, J. S., D. A. Wagner, S. D. Cohn, J. S. Millar, and E. J. Schaefer. 1990. Measurement of very low density and low density lipoprotein apolipoprotein (Apo) B-100 and high density lipoprotein Apo-A-I production in human subjects using deuterated leucine. *J. Clin. Invest.* 85:804-811.
59. Tall, A. 1990. Plasma high density lipoproteins. Metabolism and relationship to atherogenesis. *J. Clin. Invest.* 86:379-384.
60. Schwartz, C. C., L. A. Zech, J. M. Vandenbroek, and P. S. Cooper. 1989. Reverse cholesterol transport measured in vivo in man: the central roles of HDL. In *High Density Lipoproteins and Atherogenesis II*. N. E. Miller, editor. Elsevier Science Publishing Co., Inc., New York. 321-329.
61. Grundy, S., E. H. Ahrens, and J. Davignon. 1969. The interaction of cholesterol absorption and cholesterol synthesis in man. *J. Lipid Res.* 10:304-315.
62. Nestel, P. 1970. Cholesterol turnover in man. *Adv. Lipid Res.* 8:1-39.
63. Randle, P. J. 1986. Fuel selection in animals. *Biochem. Soc. Trans.* 14:799-806.
64. Bloch, K., and D. Rittenberg. 1945. An estimation of acetic acid formation in the rat. *J. Biol. Chem.* 159:45-58.
65. Munro, H. N. 1969. Evolution of protein metabolism in mammals. In *Mammalian Protein Metabolism*, Vol. 3. H. N. Munro, editor. Academic Press, Inc., New York. 133-182.
66. Ballard, F. J. 1972. Supply and utilization of acetate in mammals. *Am. J. Clin. Nutr.* 25:773-779.
67. Knowles, S. E., I. G. Jarret, O. H. Filsell, and F. J. Ballard. 1974. Production and utilization of acetate in mammals. *Biochem. J.* 142:401-411.
68. Lundquist, F., N. Tygstrup, K. Winkler, K. Mellemegaard, and S. Munck-Petersen. Ethanol metabolism and production of free acetate in the human liver. *J. Clin. Invest.* 41:955-961.
69. Foster, D. W., and B. Bloom. 1963. The synthesis of fatty acids by rat liver slices in tritiated water. *J. Biol. Chem.* 238:888-892.
70. Flatt, J. P. 1978. The biochemistry of energy expenditure. *Rec. Adv. Obesity Res.* 2:211-227.