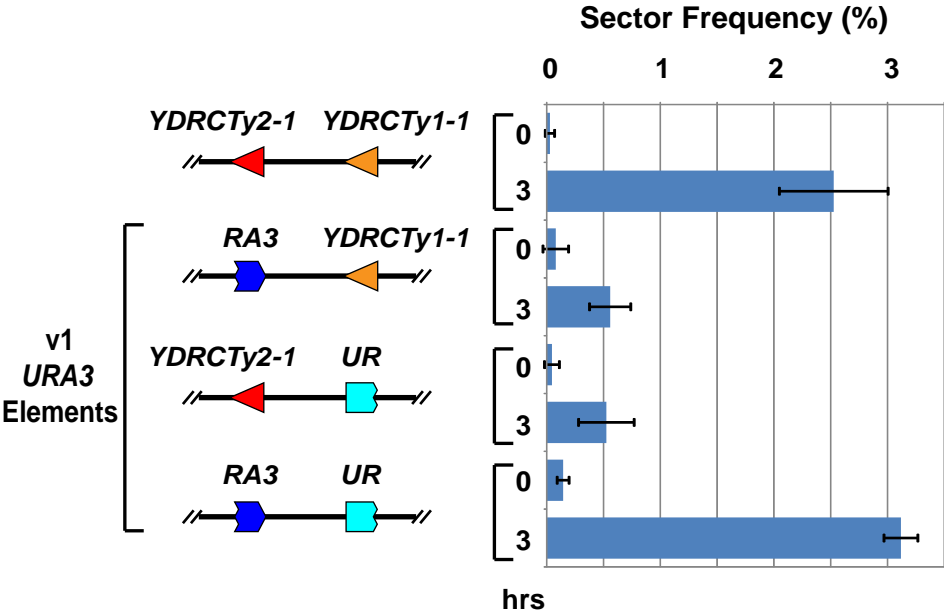

Figure S2

A



B

