

Genetic construction, expression, and melanoma-selective cytotoxicity of a diphtheria toxin-related α -melanocyte-stimulating hormone fusion protein

(synthetic gene/chimeric toxin)

JOHN R. MURPHY*, WILLIAM BISHAI*[†], MARIANNE BOROWSKI*, ATSUSHI MIYANOHARA*[‡], JESSICA BOYD*, AND STANLEY NAGLE[§]

*Biomolecular Medicine Section, Evans Department of Clinical Research and Department of Medicine, University Hospital, Boston University Medical Center, Boston, MA 02118; [†]Department of Microbiology and Molecular Genetics, Harvard Medical School, Boston, MA 02115; and [§]Frederick Cancer Research Facility, National Institute of Allergy and Infectious Diseases, Frederick, MD 21701

Communicated by A. M. Pappenheimer, Jr., July 1, 1986

ABSTRACT The structural gene for diphtheria toxin, *tox*, has been modified at its *Sph* I site by the introduction of an oligonucleotide linker encoding a unique *Pst* I restriction endonuclease site and a synthetic oligonucleotide encoding α -melanocyte-stimulating hormone (α -MSH). The resulting fusion gene directs the expression of a diphtheria toxin-related α -MSH hybrid protein in which the diphtheria toxin receptor-binding domain has been replaced with α -MSH sequences. The chimeric toxin has been partially purified from periplasmic extracts of recombinant *Escherichia coli* K-12 and has been found to be selectively toxic for α -MSH receptor-positive human malignant melanoma NEL-M1 cells *in vitro*.

Since polypeptide fragments of microbial or plant toxins that are devoid of their cell receptor-binding domains are not cytotoxic (1, 2), it has become attractive to use these polypeptides in the assembly of hybrid toxins. A variety of cell-surface-directed agents, monoclonal antibodies (reviewed in ref. 3), lectins (4, 5), and polypeptide hormones (6-8) have been chemically coupled to toxin fragments in order to direct the action of the toxin component toward specific eukaryotic cells. In general, either the A chain of the plant toxin ricin or the A fragment of diphtheria toxin has been conjugated through disulfide bond linkage to the above agents in attempts to assemble hybrid proteins that have targeted cytotoxicity. With rare exception (9, 10), those conjugates that were assembled with ricin A chain were found to be cytotoxic, whereas hybrids that were assembled with diphtheria toxin fragment A were nontoxic (11).

To develop chimeric toxins that have defined structure and may be readily modified by site-directed mutagenesis, we have used solid-phase DNA synthesis and recombinant DNA methodologies for the genetic assembly of a diphtheria toxin-related α -melanocyte-stimulating hormone (α -MSH) fusion gene. The toxin-hormone chimeric gene directs the expression of a fusion protein that retains the ADP-ribosyltransferase (NAD⁺ ADP-ribosyltransferase; EC 2.4.2.30) activity and lipid-associating domains of diphtheria toxin; however, the diphtheria toxin receptor-binding domain is replaced with α -MSH sequences. The chimeric toxin has been found to be toxic for α -MSH receptor-positive human malignant melanoma (NEL-M1) cells in culture, whereas the fusion protein is not toxic for either Chinese hamster ovary (CHO-K1) or African green monkey kidney (CV-1) cells, both of which lack the α -MSH receptor.

The publication costs of this article were defrayed in part by page charge payment. This article must therefore be hereby marked "advertisement" in accordance with 18 U.S.C. §1734 solely to indicate this fact.

Table 1. Bacterial strains and plasmids used in this study

Bacterial strain or plasmid	Genotype, phenotype, or toxin amino acids and modifications	Ref. or source
Strain		
<i>E. coli</i> SY327	F ⁻ <i>araD</i> (<i>lac-pro</i>) <i>argE</i> (Am) Rif ^r <i>malA</i> <i>recA56</i>	J. Mekalanos
<i>E. coli</i> HB101	F ⁻ <i>hsdS20</i> (<i>r_B</i> , <i>m_B</i>) <i>recA13</i> <i>ara14</i> <i>proA2</i> <i>lacY1</i> <i>galK2</i> <i>rspL20</i> (Str) <i>xyl5</i> <i>mtl1</i> <i>supE44</i>	12
Plasmid		
pUC8	Amp ^r <i>lacZ'</i>	13
pAB313	<i>tox</i> 1-313	This study
pDT301	<i>tox</i> 219-543	14
pABC313	<i>tox</i> 1-313-Ile-Asp-(Ala) ₄ -Cys(Am)	This study
pBC508	<i>tox</i> 219-508-His-(Ala) ₄ -Cys(Am)	This study
pBM508	<i>tox</i> 219-508-His-(Ala) ₄ - α -MSH(Am)	This study
pABM508	<i>tox</i> 1-508-His-(Ala) ₄ - α -MSH(Am)	This study
pABM1508	<i>cI857</i> P, <i>tox</i> fMet-Asp-Pro-2-508-His-(Ala) ₄ - α -MSH(Am)	14
pMSH53	α -MSH(Am)	This study

METHODS

Bacterial Strains and Plasmids. The *Escherichia coli* K-12 strains and plasmids used in this study are listed in Table 1.

Nucleic Acids. Plasmid DNAs were prepared by the alkaline lysis method and purified on cesium chloride/ethidium bromide gradients (15). DNA was digested with restriction endonucleases as recommended by the manufacturer (New England Biolabs). Restriction fragments were analyzed by electrophoresis on horizontal 1.0% agarose gels in TBE buffer (89 mM boric acid/89 mM Trizma base/2.5 mM Na₂EDTA, pH 7.0) or by electrophoresis on vertical 8% polyacrylamide gels in TBE buffer.

Oligonucleotides were synthesized on an Applied Biosystems (Foster City, CA) 380A DNA synthesizer and purified by electrophoresis on 8% denaturing polyacrylamide gels. After elution in TE buffer (10 mM Tris-HCl/1 mM EDTA, pH 8.0) the oligonucleotides were further purified on NENSorb 20 columns (New England Nuclear). Equivalent molar concentrations of appropriate oligonucleotides were then mixed,

Abbreviations: α -MSH, α -melanocyte-stimulating hormone; CRM, crossreacting material; bp, base pair(s); CHO, Chinese hamster ovary; EF-2, elongation factor 2; BL, biosafety level.

[‡]Present address: The Chemo-Sero-Therapeutic Research Institute, Kumamoto 860, Japan.

heated to 65°C for 15 min, and allowed to cool slowly to room temperature. Duplexes were cloned into plasmid vectors by standard methods (15).

Partial Purification of the Chimeric Toxin. *E. coli*(pABM508) or *E. coli*(pABM1508) were grown in Luria broth in 10-liter volumes. Cultures were sparged with air at 10 liter/min and agitated at 350 rpm. *E. coli*(pABM508) was grown at 37°C to an A_{590} of 1.5–2.0; *E. coli*(pABM1508) was grown at 30°C to A_{590} of 1.0, expression of the chimeric toxin gene was induced at 42°C for 15 min, and the culture was then grown at 40°C for 1 hr. Bacteria were harvested by centrifugation and washed, and periplasmic extracts were prepared as described (16). Crude periplasmic extracts were dialyzed against 10 mM phosphate buffer (pH 7.2) and fractionated on DE-52 (Whatman) using a linear 50–200 mM NaCl gradient. Protein samples were electrophoresed in 0.1% NaDodSO₄/12.5% polyacrylamide gels, essentially as described by Laemmli (17). The transfer of proteins to nitrocellulose paper was performed according to the method of Towbin *et al.* (18), and immunoblot analysis (19) was performed as described (20).

signal downstream from the *Pst* I site in the fragment B-determined translational reading frame.

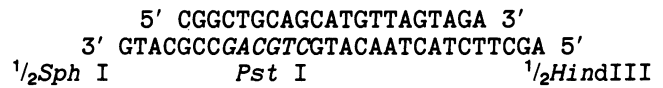

This design allows for the vectorial cloning of the oligonucleotide into *Sph* I- + *Hind*III-digested pDT301 vector as well as for *either* the genetic construction of a toxin-related peptide hormone fusion gene at the *Pst* I site or, alternatively, the construction of a modified diphtheria *tox* gene that encodes a C-terminal cysteine residue.

As shown below, the genetic information encoding α -MSH and an amber translational stop signal was synthesized *in vitro* on two 50-mer oligonucleotides. Following synthesis, purification, and hybridization, the synthetic α -MSH encoding gene was cloned in the *Pst* I site of plasmid pEMBL8 (31) and its sequence was verified by the dideoxy chain-termination method of Sanger *et al.* (32).

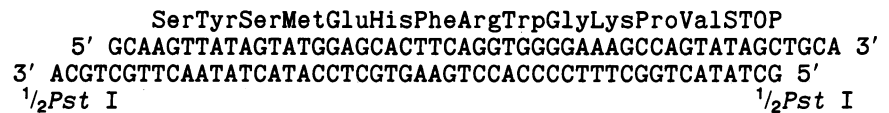

Cytotoxicity Assays. Cytotoxicity assays were performed as described by Bacha *et al.* (21). Human malignant melanoma NEL-M1 (22), CHO-K1 (23), and African green monkey kidney CV-1 [ref. 24; American Type Culture Collection (ATCC) CCL 70] cells were seeded in microtiter wells (10⁵ cells per well) and exposed to various concentrations of diphtheria toxin or the chimeric toxin for 24–36 hr prior to pulse labeling with 0.5 μ Ci of [¹⁴C]leucine (1 Ci = 37 GBq) for 1 hr. Cells were harvested, collected on Whatman GF/A paper, and assayed for radioactivity in Econofluor (New England Nuclear). Experiments were performed in triplicate.

ADP-Ribosyltransferase Assay. Transferase activity was measured in triplicate by using 50 μ l of a standard assay mixture containing 10 mM Tris-HCl (pH 8.0), 2 μ M [adenine-¹⁴C]NAD (2.5 μ Ci/mmol), and a wheat germ extract as the source of EF-2. The sample (50 μ l) was added and the mixture was incubated at 37°C. The reaction was stopped by the addition of 5% trichloroacetic acid, the precipitate was collected on glass fiber pads and washed, and radioactivity was determined. Background was \approx 200 cpm and maximal incorporation was \approx 12,000 cpm. Transferase activity is plotted as μ g of diphtheria toxin fragment A equivalents per ml.

RESULTS

Chimeric Toxin Gene Construction. The structural gene for diphtheria toxin, *tox*, is carried on a 3900-base-pair (bp) *Bam*HI fragment of the corynebacteriophage β genome (25, 26). This DNA fragment has three *Sau*3A1 restriction sites that divide the *tox* structural gene into two major segments: the *Sau*3A1-2 segment has been shown to encode the diphtheria *tox* promoter, signal sequence, and all of fragment A (27); the *Sau*3A1-1 segment encodes all of fragment B of toxin, except for the C-terminal 17 amino acids (28–30).

The strategy we used for the genetic construction of diphtheria toxin-related α -MSH chimeric gene involved the modification of the *Sau*3A1-1 segment of the *tox* structural gene at its *Sph* I site, followed by the assembly of a fragment B-related α -MSH fusion gene. The synthetic oligonucleotide linker (shown below) used to modify *Sau*3A1-1 at its *Sph* I site introduces a unique *Pst* I restriction site. In addition, the linker introduces a TGT cysteine codon and an amber stop

Fig. 1 outlines the strategy used for the genetic assembly of the recombinant plasmid pABM508 that carries the diphtheria toxin-related α -MSH gene fusion at the *tox* *Sph* I site.

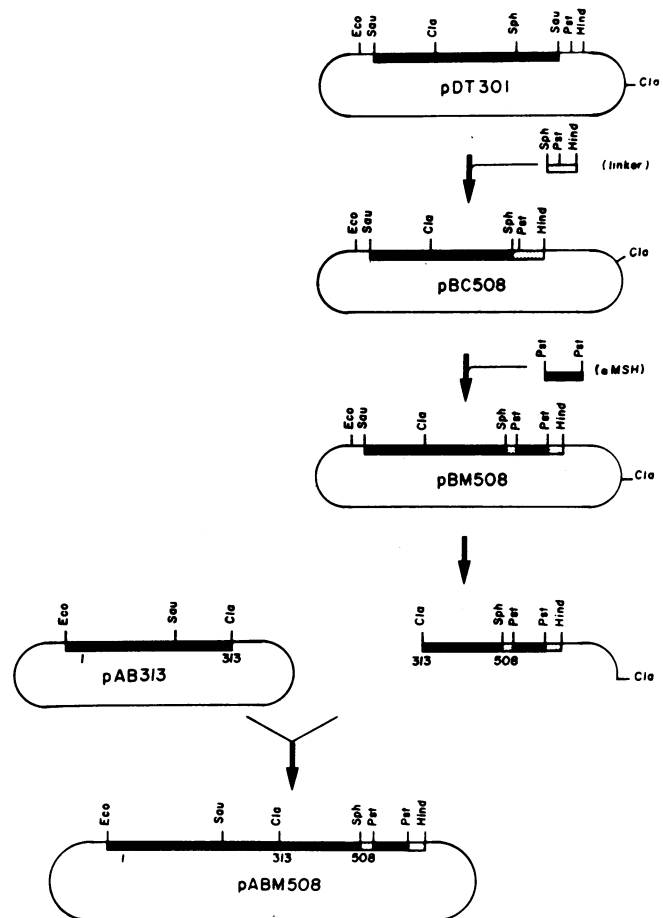

FIG. 1. Plasmid DNA construction used in the assembly of the chimeric diphtheria toxin-related α -MSH fusion gene of pABM508. The *Sph* I-*Hind*III linker and α -MSH-encoding oligonucleotides are indicated.

Plasmid pDT301, which contains the fragment B-encoding *Sau3A1*-1 sequences, was modified at its *Sph* I site with the *Sph* I-*Hind*III oligonucleotide linker to give pBC508 (the *Sph* I site occurs immediately after amino acid 508 of diphtheria toxin). Next, the α -MSH-encoding oligonucleotide was inserted into *Pst* I-digested pBC508 to give pBM508; the DNA sequence of the insert and a portion of fragment B-encoding region of the fusion gene was determined to verify that the correct translational reading frame with respect to *tox* sequences was maintained (Fig. 2).

The intact chimeric diphtheria toxin-related α -MSH gene was constructed by the ligation of the *Cla* I restriction fragment encoding the toxin fragment B-related α -MSH gene fusion into the *Cla* I site of the recombinant plasmid pAB313 under the biosafety level 4 (BL-4) level of containment (Fig. 1). Orientation of the *Cla* I fragment carrying the α -MSH sequences in recombinant plasmids was determined by restriction endonuclease patterns following *Eco*RI and *Hind*III digestion. Of several plasmids that revealed the digestion pattern expected for the intact diphtheria toxin-related α -MSH fusion gene, one was selected and designated pABM508.

Following the purification of plasmid DNA, pABM508 was digested with *Eco*RI + *Hind*III and the anticipated 1721-bp fragment encoding the diphtheria toxin-related α -MSH gene fusion was detected by agarose gel electrophoresis. This fragment is cleaved into the expected segments following digestion with *Sau3A1* (940 bp, 741 bp) and *Cla* I (1068 bp, 653 bp). In addition, digestion of pABM508 with *Pst* I and *Sph* I + *Hind*III yields the expected 54-bp and 69-bp fragments, respectively (data not shown).

Expression of the Chimeric Toxin Gene. Since it has been shown that diphtheria toxin-related polypeptides that were expressed from cloned sequences in *E. coli* K-12 were exported to the periplasmic compartment (33, 34), we anticipated that the toxin-related α -MSH fusion protein would also be localized in the periplasmic compartment. Recombinant strains of *E. coli* were grown in 10-liter volumes (see *Methods*). Periplasmic extracts were prepared, sterilized by membrane filtration, and, after confirmation of sterility, were removed from the BL-4 laboratory for further study.

Based upon ADP-ribosyltransferase activity of the crude periplasmic extract, we estimate that *E. coli*(pABM508) and *E. coli*(pABM1508) each produce ≈ 10 mg of diphtheria toxin-related material per liter of culture. Since the chimeric toxin should be cytotoxic only for eukaryotic cells with α -MSH surface receptors, we examined the cytotoxicity of periplasmic extracts as well as DE-52-purified preparations from *E. coli*(pUC8), *E. coli*(pABM508), and *E. coli*(pABM1508) on NEL-M1, CHO-K1, and CV-1 cells *in vitro*. As can be seen in Fig. 3, extracts of recombinant *E. coli* that carry the toxin-related α -MSH fusion gene were found to markedly inhibit growth of the α -MSH receptor-positive NEL-M1 cell

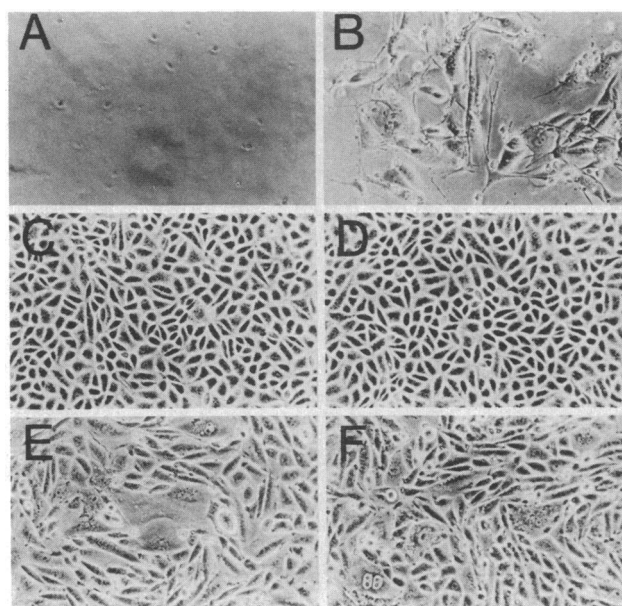

FIG. 3. Growth of α -MSH receptor-positive NEL-M1 melanoma cells (A and B) and α -MSH receptor-negative CV-1 (C and D) and CHO-K1 (E and F) cells in the presence of DE-52-purified extracts from *E. coli*(pABM1508) and *E. coli*(pUC8). A, C, and E contain extracts from *E. coli*(pABM1508); B, D, and F contain extracts from *E. coli*(pUC8).

line and to be nontoxic for the α -MSH receptor-negative CHO-K1 and CV-1 cell lines *in vitro*.

We have partially purified the toxin-related α -MSH fusion protein from periplasmic extracts of recombinant *E. coli* by ion-exchange chromatography. Fig. 4 shows the elution profile of crude periplasmic extracts of *E. coli*(pABM1508) from DE-52 cellulose. The ADP-ribosyltransferase activity associated with the N-terminal M_r 21,167 fragment A of the diphtheria toxin-related proteins expressed by *E. coli*(pABM1508) was found to elute over a broad range of ionic strength. In contrast, the NEL-M1 melanoma cell toxic material was found to elute in a single peak at ≈ 6.5 mmho in the NaCl gradient. We have analyzed the biologically active and inactive fractions by NaDodSO₄/polyacrylamide gel electrophoresis and immunoblot using polyclonal anti-diphtheria toxin serum. As can be seen in Fig. 5, the NEL-M1 cell active and inactive fractions contain several proteins that are immunologically related to diphtheria toxin. Comparison of the immunoblots of NEL-M1 cell toxic and nontoxic fractions indicate that the toxin-related hormone fusion protein is the highest molecular weight species (M_r 56,000). This value is in excellent agreement with the M_r of 54,543 deduced from the nucleic acid sequence of the chimeric toxin gene. Since only those fractions that contained the M_r 56,000 toxin-related protein were toxic for NEL-M1 melanoma cells, we conclude that the smaller molecular weight toxin-related proteins have little or no toxicity. Indeed, the M_r 56,000 fusion protein purified by immunoaffinity chromatography using CRM45-adsorbed antitoxin was found to account for all of the melanoma-specific cytotoxicity (M.B., K. Parker, and J.R.M., unpublished).

To demonstrate that the inhibition of [¹⁴C]leucine incorporation in NEL-M1 cells was due to action of diphtheria toxin-related proteins, we have performed a series of neutralization experiments with polyclonal antitoxin serum. Under the conditions described, preincubation of the chimeric toxin with 1 unit of antitoxin resulted in the neutralization of the melanoma cell cytotoxicity (Table 2). The action of diphtheria toxin on NEL-M1 cells also was found to be neutralized following incubation with proportionate levels

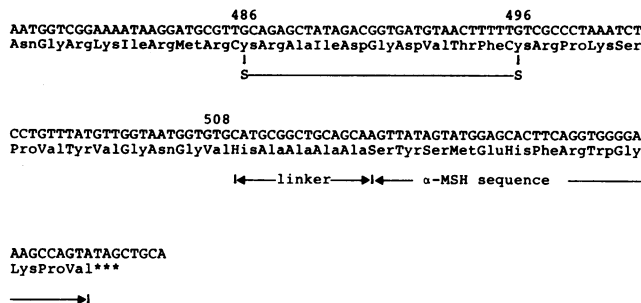

FIG. 2. Nucleotide sequence of the C-terminal region of the diphtheria toxin-related α -MSH fusion gene. Numbers indicate the amino acid in the precursor form of diphtheria toxin. The C-terminal 67 amino acids of toxin have been replaced with 18 amino acids encoded by an oligonucleotide linker and the synthetic gene for α -MSH.

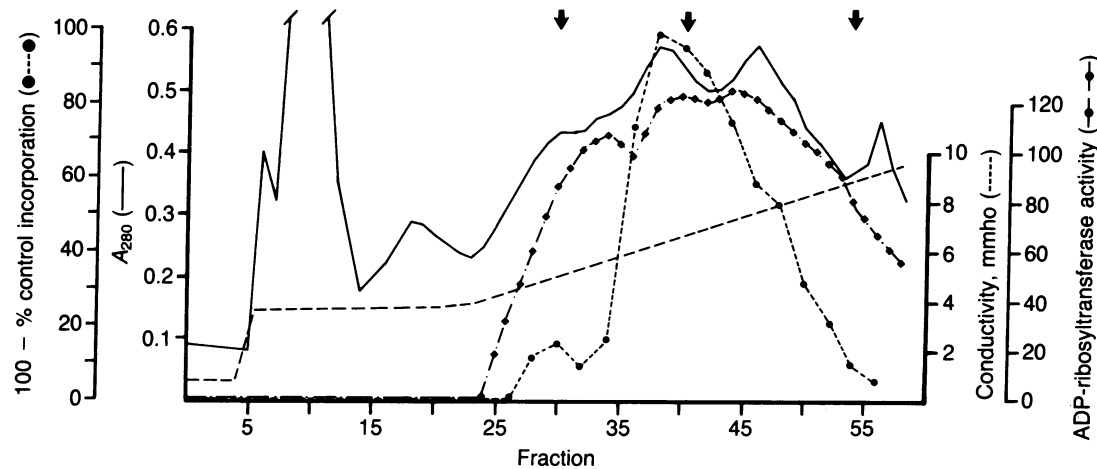

FIG. 4. Partial purification of the chimeric diphtheria toxin-related α -MSH fusion protein by DE-52 ion-exchange chromatography. —, A_{280} ; ---, conductivity (mmho); \bullet - \bullet -, ADP-ribosyltransferase activity (μ g of fragment A equivalents per ml); \bullet - \bullet -, inhibition of [14 C]leucine incorporation by NEL-M1 cells plotted as 100 - % control incorporation. Arrows indicate the fractions analyzed by immunoblot.

of antitoxin. In addition, we have measured the NEL-M1 cell EF-2 that was available for ADP-ribosylation (35) following exposure to either the chimeric toxin or 0.01 μ M diphtheria toxin. In both cases, <5% of the control level of EF-2 was found to be available (data not shown).

Finally, it is widely known that diphtheria toxin must pass through acidic vesicles in its entry into sensitive eukaryotic cells. The addition of NH_4Cl (36), chloroquine (37, 38), and other agents (39) that increase the pH of endocytic vesicles has been shown to protect eukaryotic cells against the action of diphtheria toxin. We have performed a series of NEL-M1 cytotoxicity assays with diphtheria toxin and DE-52-purified chimeric toxin in the presence of 10 mM NH_4Cl . In both instances, NH_4Cl was found to block the cytotoxic action of the respective toxins (Table 2). These results strongly suggest that the entry of the chimeric toxin, like diphtheria toxin, requires a low pH intermediate step for the translocation of fragment A into the target cell cytosol.

DISCUSSION

We have separately cloned DNA segments that encode fragments A and B of diphtheria toxin and have genetically constructed a *tox* fragment B-related α -MSH fusion gene at the BL-1 level of containment. The final genetic construction of the intact chimeric diphtheria toxin-related α -MSH gene was made by joining the fragment B-related α -MSH fusion with cloned

fragment A sequences in the correct orientation and translational reading frame under the BL-4 level of containment.

DNA sequence analysis demonstrated that correct translational reading frame was maintained through the linker and α -MSH-encoding portions of the chimeric gene. The synthetic hormone gene is positioned 36 bp downstream from the TGT codon for Cys-496 in the precursor form of diphtheria toxin. Thus, the chimeric toxin includes both disulfide loops that are present in diphtheria toxin.

The chimeric toxin differs from diphtheria toxin with respect to its trypsin sensitivity. Mild trypsin digestion of diphtheria toxin results in specific cleavage in the exposed 14 amino acid peptide loop between the A and B fragments. In the case of the toxin-related proteins expressed by *E. coli* strains carrying (pABM508) or (pABM1508), mild trypsin digestion results in the release of a series of peptides that chase into fragment A (M_r 24,000). Upon immunoblot analysis, the peptides smaller than fragment A are immunoreactive with anti-fragment B serum (M.B. and J.R.M., unpublished). The failure to resolve a "B fragment" following mild trypsin digestion suggests that the conformation of the toxin-related proteins partially purified from *E. coli* differs from either diphtheria toxin or CRM45 purified from lysogenic strains of *Corynebacterium diphtheriae*.

Eberle and Schwyzer (40) have shown that α -MSH interacts with its receptor on melanocytes through its C-terminal Glu-His-Phe-Arg-Trp and Gly-Lys-Pro-Val sequences. Thus, we reasoned that as long as the α -MSH sequences were exposed on the chimeric toxin, they would be capable of binding to the receptor on the surface of melanocytes. Since Varga and coworkers (41) had shown that fluorescein isothiocyanate-labeled MSH was internalized in cytoplasmic vesicles, we anticipated that if the chimeric toxin bound to

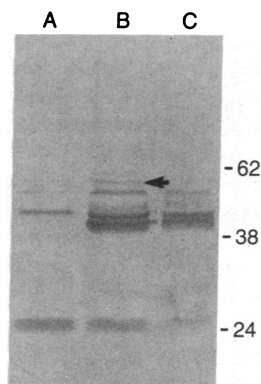

FIG. 5. Immunoblot analysis of fractions 30 (lane A), 40 (lane B), and 54 (lane C) from the DE-52 column shown in Fig. 4 using polyclonal anti-diphtheria toxin serum. Although the immunoblot revealed several degradation products, only the M_r 56,000 protein (arrow) was cytotoxic for NEL-M1 cells *in vitro*. Molecular weights are shown as $M_r \times 10^{-3}$.

Table 2. NEL-M1 cell incorporation of [14 C]leucine into trichloroacetic acid-insoluble material following exposure to ABM1508 or diphtheria toxin in the presence or absence of NH_4Cl or antitoxin

Treatment	% control incorporation
ABM1508	26
+ 10 mM NH_4Cl	98
+ 1 unit of antitoxin	100
Diphtheria toxin (0.06 μ M)	28
+ 10 mM NH_4Cl	93
Diphtheria toxin (0.075 μ M) + 10 units of antitoxin	100

MSH surface receptors, the NEL-M1 melanoma cells would become intoxicated by a mechanism parallel to that of diphtheria toxin.

We have shown that the partially purified toxin-related α -MSH fusion protein is cytotoxic for human NEL-M1 malignant melanoma cells *in vitro* and nontoxic for either CHO-K1 or CV-1 cells. Since cytotoxicity can be specifically neutralized with anti-diphtheria toxin serum, the melanoma-directed action is clearly due to the effect of a diphtheria toxin-related molecule. In addition, we have shown that the action of the chimeric toxin, as well as diphtheria toxin, on NEL-M1 cells can be blocked by NH_4Cl . These results suggest that, following binding to surface receptors and internalization, the chimeric toxin must pass through an acidic endosomal vesicle to deliver its fragment A to the NEL-M1 cell cytosol.

Since the assembly of the chimeric toxin reported here was accomplished at the level of the gene, the linkage between the toxin component and the ligand component is a peptide bond, and, as a result, the chimeric toxin should be a single molecular species. We have shown by immunoblot analysis that the chimeric toxin is cleaved into several distinct polypeptides in recombinant strains of *E. coli*. This heterogeneity is likely due to the action of *E. coli* proteases on the recombinant protein (42).

Though the DEAE-cellulose-purified toxin-related proteins have an IC_{50} of 3–6 nM (where IC_{50} = concentration of diphtheria toxin-related material required to inhibit protein synthesis to 50% of the control level), the M_r 56,000 toxin-related hormone fusion protein purified by immunoaffinity chromatography is >100 times as toxic for NEL-M1 human malignant melanoma cells. In addition, preliminary experiments suggest that the purified fusion protein is between 1000- and 10,000-fold more toxic for NEL-M1 cells than diphtheria toxin itself and that this difference is related to the number of α -MSH receptors vs. diphtheria toxin receptors on the cell surface. Even at the highest concentration tested, the toxin-hormone fusion protein had no effect on either CHO-K1 or CV-1 cells in culture, whereas 1/1000 of this amount was lethal for the NEL-M1 melanoma cell line (M.B., K. Parker, and J.R.M., unpublished).

The failure of the chimeric toxin to inhibit protein synthesis in either the CHO-K1 or CV-1 cell line suggests that the genetic removal of the C-terminal 67 amino acids of diphtheria toxin alters the toxin receptor-binding domain such that it is no longer functional or that the toxin receptor-binding domain lies within this region. In either case, the failure of the chimeric toxin to act on these two sensitive cell lines strongly suggests that the C-terminal 67 amino acids of diphtheria toxin are required for binding to its receptor.

In recent years there has been considerable interest in chemically coupling the A chain of ricin to a variety of monoclonal antibodies through disulfide linkage (reviewed in ref. 3). Many of the immunotoxins that have been formed have shown therapeutic promise in *in vivo* and *ex vivo* applications. We have shown that solid-phase DNA synthesis and recombinant DNA methodologies can be employed in the genetic construction of a diphtheria toxin-related polypeptide hormone fusion gene in which the linkage between the toxin-related component and the ligand is a peptide bond. Experiments reported here have demonstrated that the chimeric toxin expressed by *E. coli*(pABM508) or *E. coli*(pABM-1508) has selective cytotoxicity for α -MSH receptor-positive human malignant melanoma NEL-M1 cells *in vitro*. It is envisioned that these chimeric molecules might serve as prototypes in the development of targeted toxins for the treatment of human malignant melanoma.

We are grateful to Dr. Dennis DiSorbo (University Hospital) for

providing the NEL-M1 human malignant melanoma cells, and we thank John Brewer for technical assistance. Polyclonal horse anti-diphtheria toxin serum was kindly provided by Dr. Rino Rappuoli (Sclavo Research Center, Siena, Italy). We also thank Dr. Kenneth Coleman and Mary K. McCormick for helpful discussions during the early phases of this work. This work was supported by a grant from Seragen (Lexington, MA) and by Public Health Service Grants AI-21628 from the National Institute of Allergy and Infectious Diseases and CA-41746 from the National Cancer Institute (to J.R.M.). M.B. is supported by a Postdoctoral Fellowship from the Massachusetts Division of the American Cancer Society.

- Uchida, T., Gill, D. M. & Pappenheimer, A. M., Jr. (1971) *Nature (London) New Biol.* **233**, 8–11.
- Olsnes, S., Refsnes, K. & Piph, A. (1974) *Nature (London)* **249**, 627–631.
- Vitetta, E. S., Krolick, K. A., Miyama-Inaba, M., Cashley, W. & Uhr, J. W. (1983) *Science* **219**, 644–650.
- Gilliland, D. G., Collier, R. J., Moehring, J. M. & Moehring, T. J. (1973) *Proc. Natl. Acad. Sci. USA* **75**, 5319–5323.
- Yamazuchi, T., Kato, R., Berry, M., Terao, T., Inoue, Y., Ikawa, Y. & Osawa, T. (1979) *J. Natl. Cancer Inst.* **62**, 1387–1395.
- Chang, T., Dazord, A. & Neville, D. M., Jr. (1977) *J. Biol. Chem.* **252**, 1515–1522.
- Oeltman, T. N. & Heath, E. C. (1979) *J. Biol. Chem.* **254**, 1022–1027.
- Bacha, P., Murphy, J. R. & Reichlin, S. (1983) *J. Biol. Chem.* **258**, 1565–1570.
- Cawley, D. B., Simpson, D. L. & Herschman, H. R. (1981) *Proc. Natl. Acad. Sci. USA* **78**, 3383–3387.
- Oeltman, T. N. (1985) *Biochem. Biophys. Res. Commun.* **133**, 430–435.
- Cawley, D. B., Herschman, H. R., Gilliland, D. G. & Collier, R. J. (1980) *Cell* **22**, 563–570.
- Boyer, H. W. & Roulland-Dussoix, D. (1969) *J. Mol. Biol.* **41**, 459–472.
- Vieira, J. & Messing, J. (1982) *Gene* **19**, 259–268.
- Miyanojara, A., Bishai, W., Boyd, J., Nagle, S. & Murphy, J. R. (1986) *FEMS Symp.*, in press.
- Maniatis, T., Fritsch, E. F. & Sambrook, J. (1982) *Molecular Cloning: A Laboratory Manual* (Cold Spring Harbor Laboratory, Cold Spring Harbor, NY).
- Schnaitman, C. (1971) *J. Bacteriol.* **108**, 553–563.
- Laemmli, U. (1970) *Nature (London)* **227**, 680–685.
- Towbin, H., Staekelin, T. & Gordon, J. (1979) *Proc. Natl. Acad. Sci. USA* **76**, 4350–4354.
- Burnette, W. N. (1981) *Anal. Biochem.* **112**, 195–203.
- Robb, M., Nichols, J. C., Whoriskey, S. & Murphy, J. R. (1982) *Infect. Immun.* **38**, 267–272.
- Bacha, P., Murphy, J. R. & Moynihan, M. (1980) *J. Biol. Chem.* **255**, 10658–10662.
- DiSorbo, D. M., Harris, N. A. & Nathanson, L. (1985) *Cancer Res.* **45**, 1633–1637.
- Kao, F., Chasin, L. & Puck, T. (1969) *Proc. Natl. Acad. Sci. USA* **64**, 1284–1291.
- Jensen, F. C., Girardi, A. J., Gilden, R. V. & Koprowski, H. (1964) *Proc. Natl. Acad. Sci. USA* **52**, 53–59.
- Costa, J. J., Michel, J. L., Rappuoli, R. & Murphy, J. R. (1981) *J. Bacteriol.* **148**, 124–130.
- Buck, G. A. & Groman, N. B. (1981) *J. Bacteriol.* **148**, 153–162.
- Leong, D., Coleman, K. D. & Murphy, J. R. (1983) *J. Biol. Chem.* **258**, 15016–15020.
- Kaczorek, M., Delpyroux, F., Chenciner, N., Streeck, R. E., Murphy, J. R., Boquet, P. & Tiollais, P. (1983) *Science* **221**, 855–858.
- Ratti, G., Rappuoli, R. & Giannini, G. (1983) *Nucleic Acids Res.* **11**, 6589–6595.
- Greenfield, L., Bjorn, M. J., Horn, G., Fong, D., Buck, G. A., Collier, R. J. & Kaplan, D. A. (1983) *Proc. Natl. Acad. Sci. USA* **80**, 6853–6857.
- Dente, L., Cesareni, G. & Cortese, R. (1983) *Nucleic Acids Res.* **11**, 1645–1655.
- Sanger, F., Nicklen, S. & Coulson, A. R. (1977) *Proc. Natl. Acad. Sci. USA* **74**, 5463–5467.
- Leong, D., Coleman, K. D. & Murphy, J. R. (1983) *Science* **220**, 515–517.
- Tweten, R. K. & Collier, R. J. (1983) *J. Bacteriol.* **156**, 680–685.
- Moynihan, M. R. & Pappenheimer, A. M., Jr. (1981) *Infect. Immun.* **32**, 575–582.
- Kim, K. & Groman, N. B. (1965) *J. Bacteriol.* **90**, 1552–1556.
- Sandvig, K., Olsnes, S. & Phil, A. (1979) *Biochem. Biophys. Res. Commun.* **90**, 648–655.
- Leppla, S., Dorland, R. & Middlebrook, J. (1980) *J. Biol. Chem.* **255**, 2247–2250.
- Sandvig, K. & Olsnes, S. (1982) *J. Biol. Chem.* **257**, 7504–7513.
- Eberle, A. N. & Schwyzer, R. (1976) *Clin. Endocrinol. (NY)* **5**, 41s–48s.
- Varga, J. M., Moellmann, K. A., Fritsch, P., Godawska, E. & Lerner, A. B. (1976) *Proc. Natl. Acad. Sci. USA* **73**, 559–562.
- Goff, S. A. & Goldberg, A. L. (1985) *Cell* **41**, 587–595.