

Fibronectin

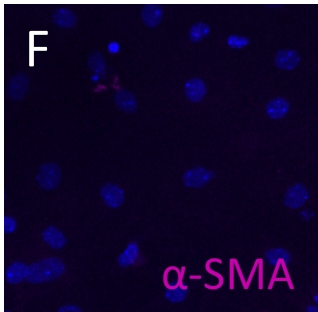

Fibronectin + TGF β 1

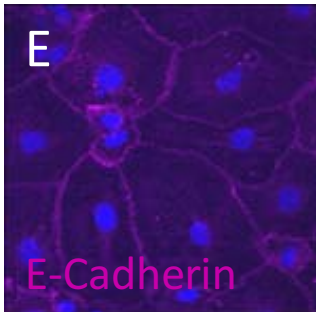
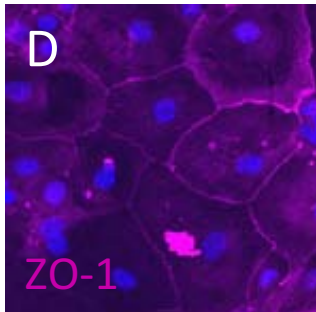
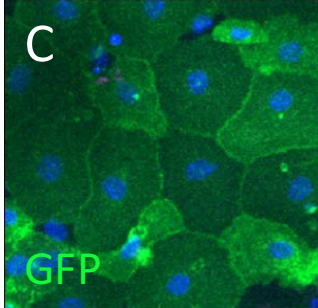
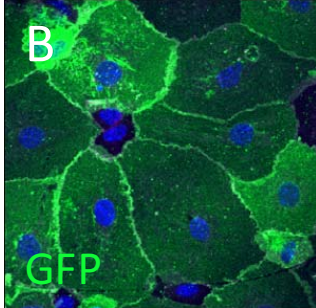
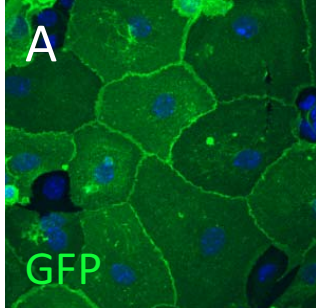
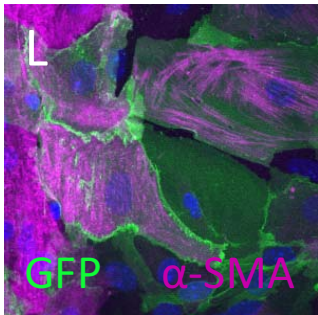
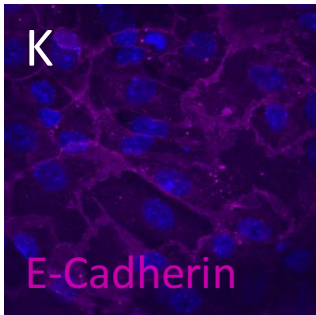
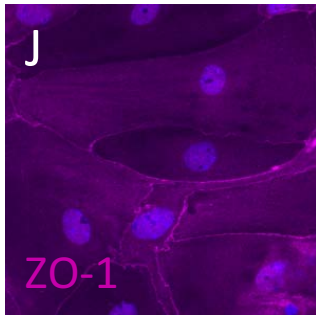
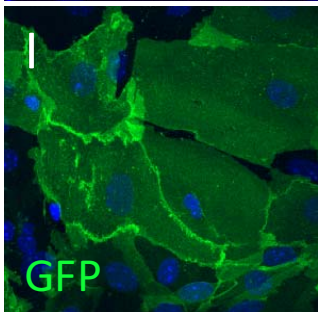
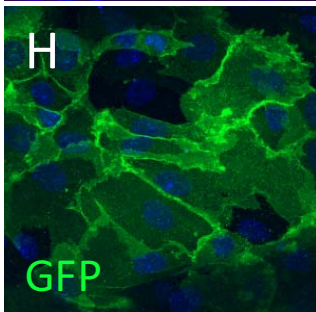
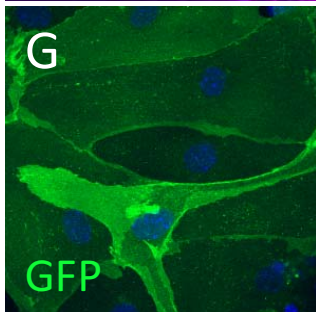

Laminin-5 + TGFβ1

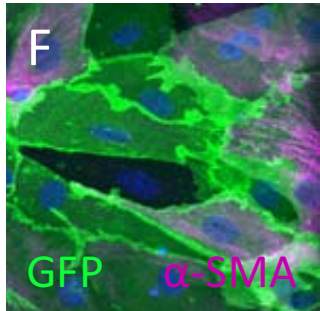
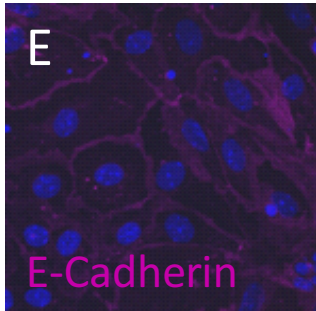
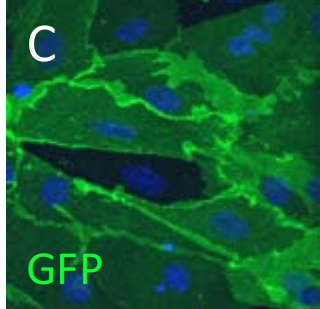
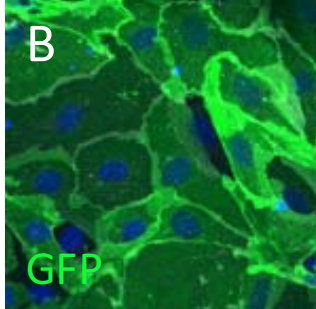
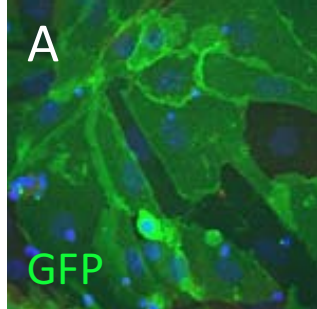

Collagen I + TGFβ1

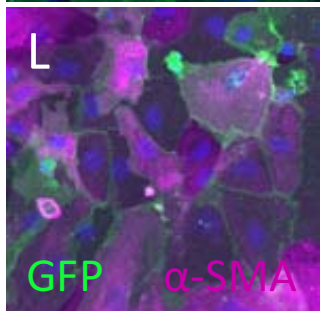
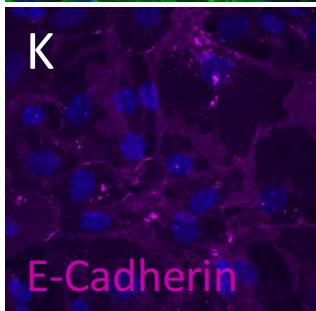
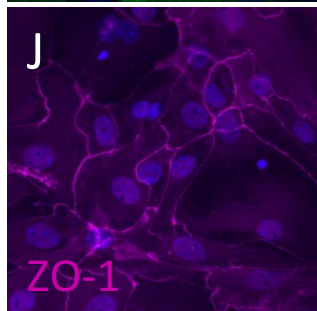
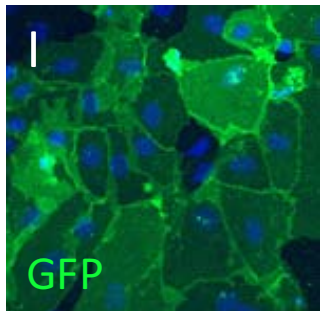
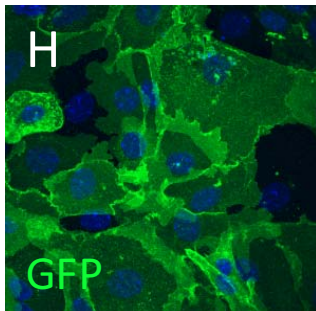
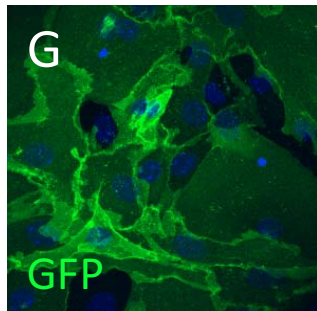

A

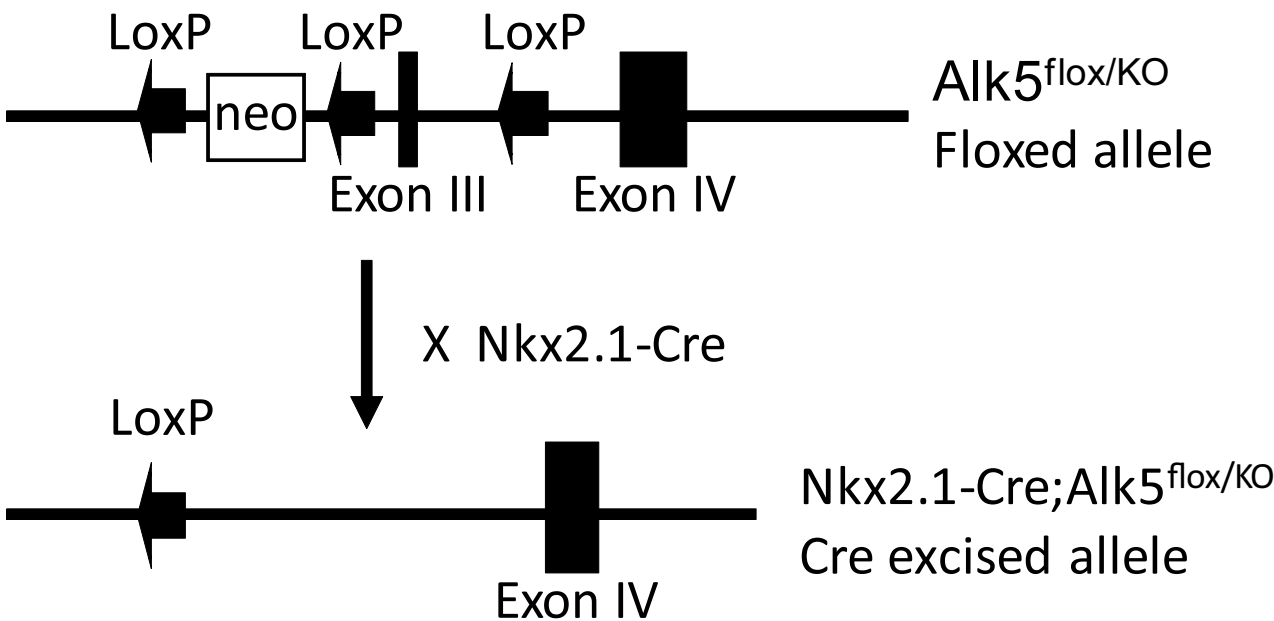

B

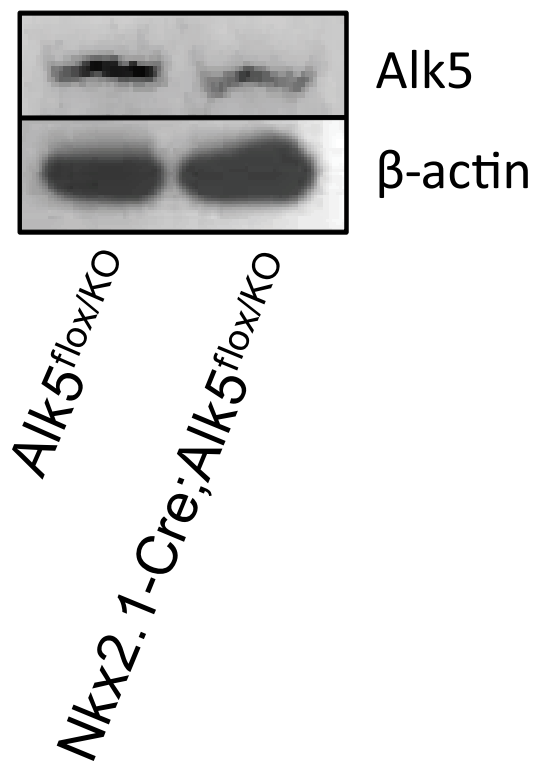

A

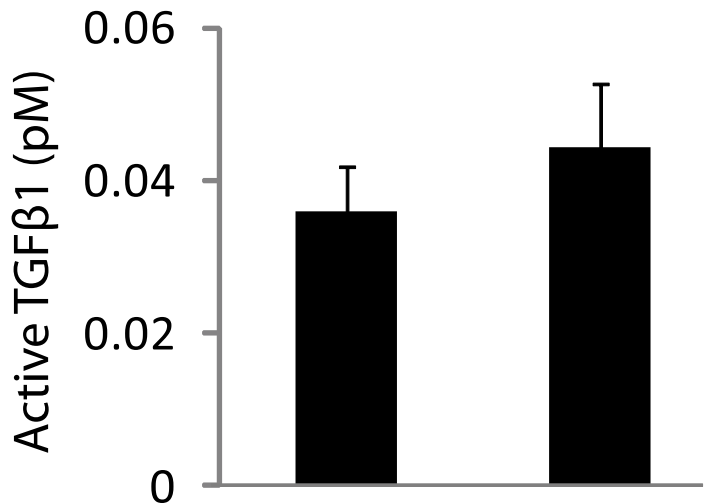

B

