

# RapV12 antagonizes Ras-dependent activation of ERK1 and ERK2 by LPA and EGF in Rat-1 fibroblasts

Simon J. Cook<sup>1</sup>, Bonnee Rubinfeld, Iris Albert and Frank McCormick

Onyx Pharmaceuticals Inc., 3031 Research Drive, Richmond, CA 94806, USA

<sup>1</sup>Corresponding author

Communicated by M. Fried

**Rap1 is a small Ras-related GTPase which when over-expressed is able to revert transformation by Ki-Ras. We have investigated the role of Rap1 in regulating 'normal' Ras function by studying the activation of the mitogen-activated protein (MAP) kinases ERK1 and ERK2 by two fundamentally different growth factors, epidermal growth factor (EGF) and 1-oleoyl-*lyso*-phosphatidic acid (LPA). Conditional expression of RasN17 (a dominant-negative mutant) in Rat-1 cells inhibited activation of MAP kinases by EGF and also LPA, the first time a defined G-protein-coupled receptor mitogen has been shown to require Ras to exert its effects. Conditional or constitutive expression of even low levels of RapV12 (a mutant insensitive to Rap-GAP) attenuated activation of MAP kinases by EGF and LPA, but did not interfere with growth factor-stimulated increases in Ras-GTP, indicating that signalling from receptors to Ras was not impaired. Inhibition of Ras-mediated signalling with either RasN17 or RapV12 attenuated DNA synthesis by EGF and LPA. We conclude that receptor tyrosine kinases and G-protein-coupled receptors use Ras as a common step in signalling to MAP kinases and that Rap-GTP (RapV12) at physiological levels interferes with downstream signalling from Ras to MAP kinases *in vivo*.**

**Key words:** epidermal growth factor/extracellular signal-regulated kinase/lysophosphatidic acid/Rap/Ras

## Introduction

The Ras proto-oncogene products are 21 kDa monomeric GTPases which serve as intracellular transducers of extracellular growth and differentiation signals (Barbacid, 1987; Bollag and McCormick, 1991b). Ras proteins cycle between inactive, GDP-bound and active, GTP-bound forms; the ratio of Ras-GTP/Ras-GDP is thought to be the key determinant of downstream signalling from Ras proteins and is regulated by nucleotide exchange and GTPase activity. Release of GDP is catalysed by specific exchange factors (Downward, 1992) and allows binding of GTP, thereby activating Ras. Since Ras proteins have low intrinsic GTPase activity, GTPase activating proteins (GAPs; p120-GAP and neurofibromin) are required to accelerate GTP hydrolysis, thereby terminating the signalling capacity of Ras (Trahey and McCormick, 1987; McCormick, 1989; Bollag and

McCormick, 1991b). Activating mutations of Ras encode proteins which are refractory to the catalytic activity of p120-GAP and neurofibromin but are still able to bind to both proteins (Bollag and McCormick, 1991a). Ras-GTP activates an as yet unidentified effector molecule; p120-GAP and neurofibromin, as proteins known to interact with Ras-GTP, are candidates for this effector (McCormick, 1989; Bollag and McCormick, 1991b).

Identification of a Ras effector pathway has been hampered by the lack of a suitable biochemical signal which shows a requirement for Ras. Recently, studies using the dominant-negative allele of Ras (RasN17) have shown that Ras is required for activation of the mitogen-activated protein kinases (MAP kinases) ERK1 and 2, by epidermal growth factor (EGF), platelet-derived growth factor (PDGF), nerve growth factor (NGF) and insulin (de Vries-Smits *et al.*, 1992; Thomas *et al.*, 1992; Wood *et al.*, 1992). Furthermore, scrapeloading of oncogenic Ras proteins into Swiss 3T3 cells is alone sufficient to activate ERK2 (Leevers and Marshall, 1992). Thus, Ras is required to mediate signals from receptor tyrosine kinases (Cai *et al.*, 1990), an observation consistent with previous reports that the Ras-neutralizing monoclonal antibody Y13-259 blocks EGF and PDGF-stimulated mitogenesis (Mulcahy *et al.*, 1985) and NGF-stimulated neurite outgrowth (Hagag *et al.*, 1986).

In the present study we have investigated the involvement of the Rap1/Krev-1 protein in Ras signalling. Rap1 was isolated from mammalian cells by its ability to morphologically revert Ki-Ras transformation and was found to encode a 21 kDa GTPase with high homology to Ras itself (Kitayama *et al.*, 1989). Most significantly, Ras and Rap1 are identical in a region (amino acids 32–44 in H-Ras) which contributes to the genetically defined effector region of Ras oncoproteins (Adari *et al.*, 1988). Rap-GTP is able to bind to p120-GAP with higher affinity than Ras-GTP but is resistant to the catalytic activity of p120-GAP; this has prompted speculation that Rap1 reverses Ras transformation by sequestering a Ras effector molecule in a non-productive complex (Frech *et al.*, 1990; Hata *et al.*, 1990). Hydrolysis of GTP on Rap1 is catalysed by a specific Rap-GAP, a version of which has been purified and cloned (Rubinfeld *et al.*, 1991). Rap-GAP is a substrate for PKA and CDC2 kinases and its expression drops markedly upon differentiation of some myeloid cells, suggesting a role for Rap1 and Rap-GAP in growth and differentiation programmes. However, other than its ability to revert Ras transformation when overexpressed, little is known about the normal function of Rap1. It is expressed at high levels in platelets and neutrophils where it is a substrate for PKA, but little is known about Ras function in these systems (Bokoch, 1993).

A role for Rap1 in antagonizing Ras in a defined signal transduction pathway has been demonstrated in *Drosophila*, where Ras is required for transduction of an inductive signal from the *Sevenless* gene product, a receptor tyrosine

kinase which determines photoreceptor development (Simon *et al.*, 1991). Recently, it was shown that the gene responsible for the *Roughened* phenotype in which eye development is disrupted at an early stage, encodes a *Drosophila* homologue of the human *Rap1* gene (Hariharan *et al.*, 1991). A mutation in this *Rap1* homologue responsible for the *Roughened* phenotype occurs at codon 157 and is thought to be a dominant gain-of-function mutation though the precise biochemical properties of this mutant have yet to be established.

In Rat-2 cells co-transfection of *Rap1*(*Krev-1*) with the polyomavirus middle T antigen (mTAg) resulted in a dose-dependent reduction in the number of mTAg-induced foci (Jelinek and Hassell, 1992); in addition transfection of *Rap1* cDNA into Rat-2 cells stably transformed with mTAg resulted in revertants which showed an inverse correlation between *Rap1* mRNA and protein expression and growth rates. These results are consistent with *Rap1* antagonizing Ras-mediated proliferative signals from mTAg and c-Src. In transient transfection assays it has recently been shown that *Rap1* is able to antagonize signals to the c-Fos promoter from c-K-Ras but not c-Raf-1 (Sakoda *et al.*, 1992). However, no study has addressed the effect of *Rap1* directly on normal Ras-mediated biochemical signals in non-transformed cells.

We have studied the interaction of Rap-GTP with the Ras signal transduction pathway by expressing the Val12 mutant of *Rap1* (*RapV12*) in Rat-1 fibroblasts. *RapV12* is refractory to the effects of Rap-GAP (Polakis and McCormick, 1992) and so remains predominantly in the GTP-bound state; this serves as a means of elevating Rap-GTP without greatly overexpressing the wild type protein. We find that *RapV12* inhibits activation of ERKs by both 1-oleoyl-*lyso*-phosphatidic acid (LPA) and EGF indicating that Rap-GTP is able to antagonize early Ras-mediated biochemical signals *in vivo* in a manner consistent with interference of Ras-effector interactions. In addition, we have looked at the role of Ras in the activation of MAP kinases by LPA which exemplifies a group of growth factors, including  $\alpha$ -thrombin, which bind to 'serpentine' receptors and activate trimeric GTPases (Pouyssegur, 1990; Pouyssegur and Seuwen, 1992). In Rat-1 cells re-initiation of DNA synthesis stimulated by LPA is inhibited by pertussis toxin suggesting a major role for a  $G_i$  or  $G_o$  protein in generating key mitogenic signals (van Corven *et al.*, 1989). Neither inositol lipid hydrolysis nor inhibition of adenylyl cyclase are sufficient to account for the potent mitogenic effects of LPA or  $\alpha$ -thrombin (van Corven *et al.*, 1989; Seuwen *et al.*, 1990a; Moolenaar, 1991; Vouret-Craviari *et al.*, 1992). Here we show that LPA requires Ras for complete activation of ERKs and S phase entry.

## Results

### Biphasic activation of ERK1 and ERK2 by LPA and EGF

Activation of ERKs was assayed by immune complex kinase assays using myelin basic protein as substrate or by Western blot analysis in which the hyperphosphorylated, activated forms exhibit retarded mobility on SDS-PAGE. Addition of LPA or EGF to confluent, serum-starved Rat-1 fibroblasts resulted in activation of both ERK1 and ERK2 kinases as determined by their activity in immune complex kinase assays (Figure 1) and their shift in mobility on SDS-PAGE

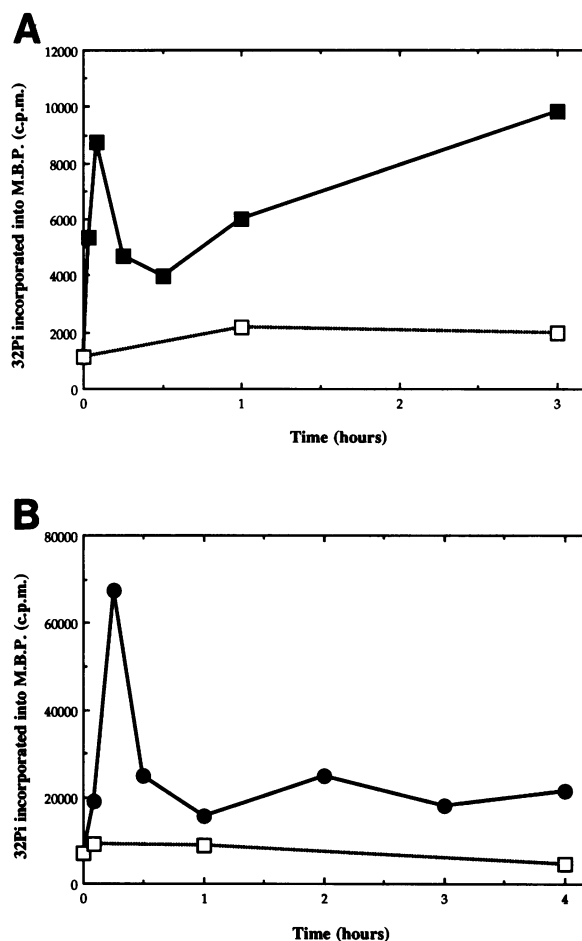

**Fig. 1.** Biphasic activation of ERK1 by LPA and EGF in Rat-1 cells. Immune complex kinase assays of ERK activation in Rat-1 cells stimulated with (A) LPA (■), (B) EGF (●) or mock-stimulated (□) Rat-1 cells. Quiescent, serum-starved Rat-1 cells were stimulated with the indicated growth factors up to 4 h. Cells were then lysed, ERK1 immune precipitated and MBP kinase activity assayed in the immune complex. Following resolution of the reaction products on 12% SDS-PAGE gels, staining and autoradiography, the MBP band was excised and counted. Data shown are from a single experiment representative of three giving similar results.

gels (see also Figure 4C and D). Both LPA and EGF stimulated a biphasic activation of ERK MBP kinase activity; the response was maximal within 5 min for LPA (Figure 1A) and 5–15 min for EGF (Figure 1B). In the case of LPA the second phase was sustained from 15 min for up to 3 h and generally amounted to 40% of the maximum response, but in some cases more (Figure 1A). This biphasic response is reminiscent of that recently described for  $\alpha$ -thrombin (Kahan *et al.*, 1992). For EGF the second phase of MBP kinase activity persisted from 30 min for at least 4 h (Figure 1B) in a manner similar to that for LPA.

From 30 min onwards hyperphosphorylated ERK1 and ERK2 were barely detectable by Western blotting (Figure 4C and D). However, the more sensitive immune complex kinase assay revealed detectable MBP kinase activity (~30–40% of the maximum response) continuing for up to 2–3 h for both growth factors (Figure 1A and B) suggesting that a discrete pool of MAP kinase remains active for a prolonged period after stimulation with either EGF or LPA. Sustained MAP kinase activation correlates well with mitogenicity in CCL39 cells stimulated with  $\alpha$ -thrombin or carbachol (Kahan *et al.*, 1992).

### Expression of RasN17 and RapV12 in Rat-1 cells

A number of studies have demonstrated that the dominant-negative mutant H-RasN17 inhibits the ability of insulin, PDGF, EGF and NGF to activate ERKs (de Vries-Smits *et al.*, 1992; Thomas *et al.*, 1992; Wood *et al.*, 1992). We sought to address the involvement of Ras and Rap in LPA and EGF signal transduction by constructing cell lines expressing RasN17 or the activating Val12 mutation of Rap1 (called RapV12). In the case of RasN17 a conditional expression system was used since constitutive expression of this dominant-negative allele inhibits proliferation (Feig and Cooper, 1988). Use of this mutant has been described previously and is thought to be based upon its ability to sequester Ras exchange factor thereby preventing activation of endogenous Ras proteins (Feig and Cooper, 1988). In the case of Rap1 we reasoned that a mutation which locked Rap1 in the GTP-bound state might serve as a more potent Ras antagonist than wild type and be able to inhibit Ras-mediated signalling events. For RapV12 both conditional and stable expression systems were employed.

Rat-1 cell lines were constructed in which either RasN17 or RapV12 were expressed under the control of a modified mouse metallothionein promoter (McNeill *et al.*, 1989) in the pM<sub>2</sub>N vector; the resulting cell lines were named R1ΔRasN17 and R1ΔRapV12. R1ΔRasN17 cells showed 'leaky' expression of the recombinant RasN17 protein in the presence of serum but barely detectable levels after 23 h of serum deprivation (Figure 2A). Treatment of serum-free R1ΔRasN17 cells with a combination of 2 μM CdCl<sub>2</sub> and 100 μM ZnCl<sub>2</sub> for up to 23 h resulted in high level induction of RasN17 protein (Figure 2A); induction in the presence of serum gave similar maximum levels of immune-reactive Ras but coupled with a higher background due to 'leakiness'. Since all experiments reported here were performed in serum-free conditions, we concluded that the use of the pM<sub>2</sub>N vector was suitable for our experimental purposes. In the case of R1ΔRasN17 cells, expression was assayed by Western blotting with a mouse monoclonal antibody, 6B7, which recognizes the effector domain of both Ras and Rap proteins (Wong *et al.*, 1986). It was not possible to estimate reliably the fold increase in expression of RasN17 due to the non-linear nature of ECL detection; however, Western blotting clearly revealed that RasN17 was induced to considerable excess over the endogenous Ras/Rap background signal (Figure 2A).

Two cell lines containing RapV12 cDNA were used and in both cases expression was monitored with a polyclonal antibody specific for Rap1a and Rap1b. The R1CVN RapV12 cell line was isolated as a clone stably expressing low levels of RapV12. Expression of RapV12, which was distinguished from endogenous Rap1 by its retarded mobility on SDS-PAGE, was modest and was estimated to be at the same level as wild type Rap1 (Figure 2B) In R1ΔRapV12 cells the RapV12 cDNA contained the first five codons of Ras in place of the normal sequence. The single amino acid difference in this region was sufficient to abolish the altered mobility of the RapV12 mutant but these cells exhibited a conditional 2- to 3-fold increase in RapV12 expression (Figure 2C) and sequencing confirmed the identity of the cDNA as RapV12(Ras1-5). Exchange of these sequences between Ras and Rap does not alter their biological activity (Zhang *et al.*, 1990) and in these experiments the R1ΔRapV12 cells behaved similarly to the stably expressing R1CVN RapV12 cells.

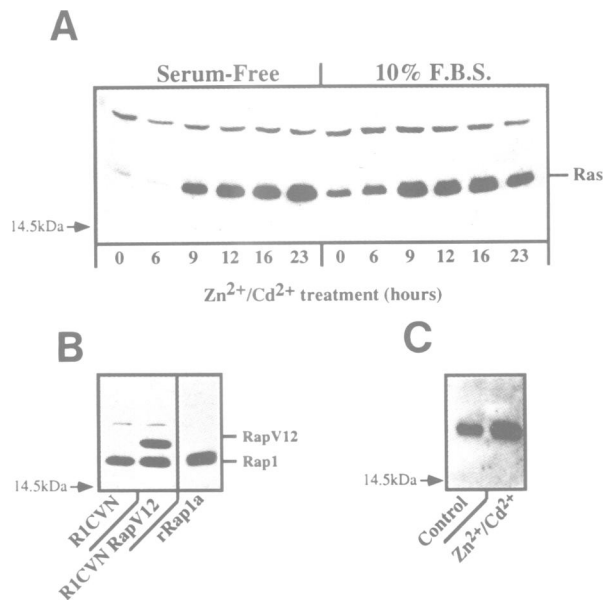

**Fig. 2.** Expression of RasN17 and RapV12 in Rat-1 cells. (A) Heavy metal-inducible expression of RasN17 in R1ΔRasN17 cells. R1ΔRasN17 cells were incubated for up to 23 h in serum-free medium alone or in the presence of 10% FBS with 100 μM ZnCl<sub>2</sub> and 2 μM CdCl<sub>2</sub> (Zn<sup>2+</sup>/Cd<sup>2+</sup>) for the times indicated. Following lysis, samples normalized for total cellular protein were resolved on SDS-PAGE gels, transferred to nitrocellulose and blotted with monoclonal antibody 6B7 which recognizes Ras and Rap. (B) Stable expression of RapV12 in the R1CVN RapV12 cell line. Rat-1 cell lines stably transfected with the CVN vector alone or with vector containing RapV12 cDNA were lysed and equal amounts of cell lysate were resolved by SDS-PAGE and analysed by Western blotting with the Rap polyclonal antibody, α-Rap1. Recombinant Rap1a was included as a standard for the antibody and for the mobility of the wild type protein. (C) Heavy metal-inducible expression of RapV12 in R1ΔRapV12 cells. R1ΔRapV12 cells were incubated for 23 h in serum-free medium alone (control) or in the presence of 100 μM ZnCl<sub>2</sub> and 2 μM CdCl<sub>2</sub> (Zn<sup>2+</sup>/Cd<sup>2+</sup>). Following lysis, samples normalized for total cellular protein were resolved on SDS-PAGE gels, transferred to nitrocellulose and blotted with the polyclonal antibody α-Rap1.

### Ras is required for complete activation of ERK1 and ERK2 by EGF and LPA

In R1ΔRasN17 cells treatment with heavy metal salts resulted in ~70–80% inhibition of peak ERK1 activation by LPA at 5 min and also complete loss of the smaller sustained phase (Figure 3A) indicating that LPA, a G-protein-coupled receptor mitogen, requires activation of Ras to maximally stimulate MAP kinase. Similar results were obtained with ERK2 where mobility shift due to LPA stimulation was inhibited in the presence of RasN17 (Figure 3D). Expression of RasN17 also inhibited EGF-stimulated MAP kinase activity (Figure 3B) as expected from previous reports (Thomas *et al.*, 1992; Wood *et al.*, 1992). In some experiments the early phase of the EGF response was delayed and the peak stimulation was only inhibited by 30–40% (data not shown); however, the smaller sustained phase was completely inhibited by expression of RasN17 in all experiments. In a control cell line constructed with the pM<sub>2</sub>N vector alone there was no effect of heavy metal salts upon ERK activation by growth factors (see Figure 4E). These results suggest that the first phase of the response to LPA and EGF may include Ras-dependent and Ras-independent pathways of ERK activation. However, LPA and EGF share in common a smaller sustained activation of MAP kinase which appears entirely Ras-dependent.

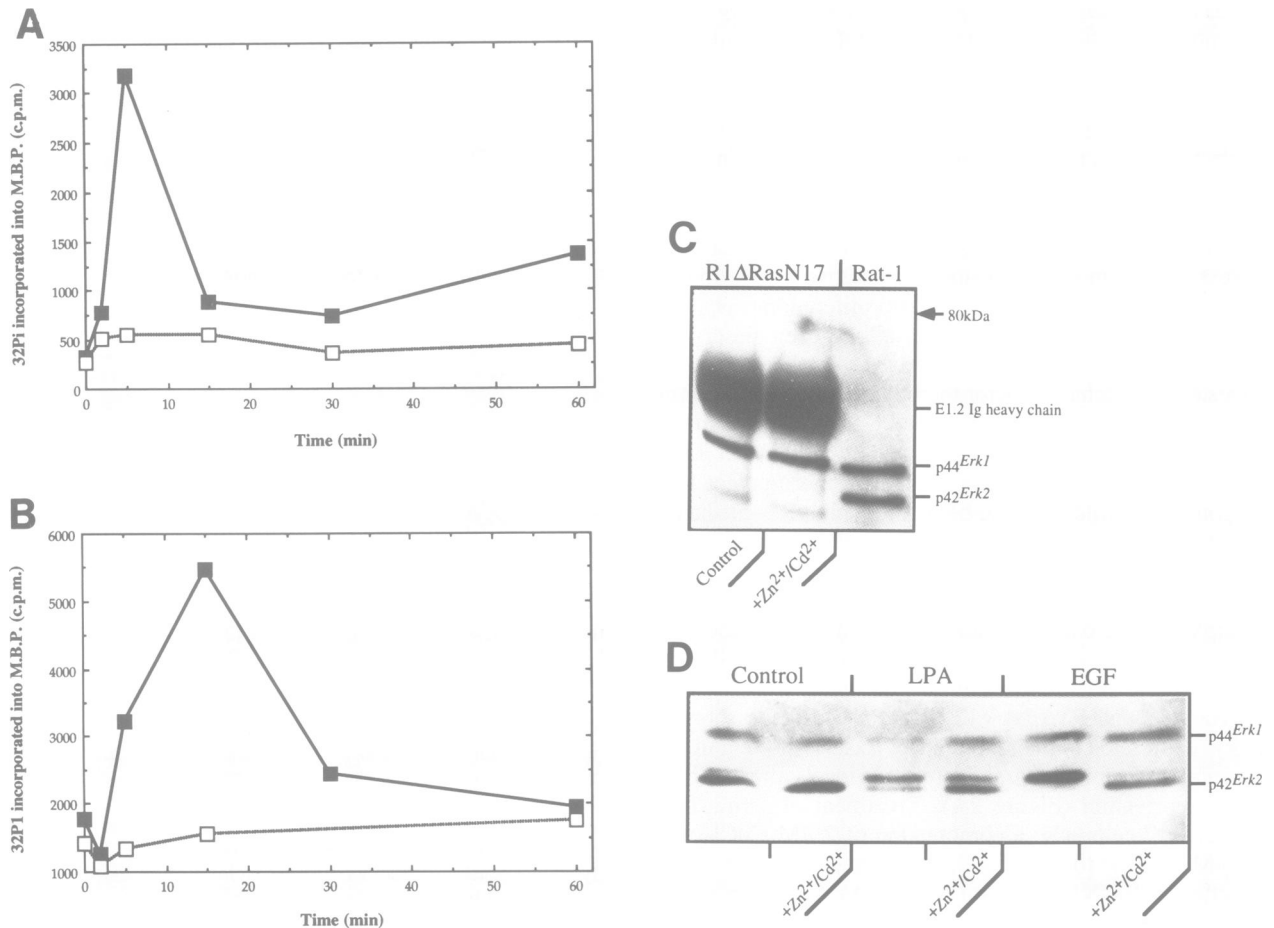

**Fig. 3.** RasN17 expression inhibits LPA- and EGF-stimulated ERK1 activation. (A and B) R1ΔRasN17 cells were incubated for 48 h in serum-free conditions; for the last 18 h cells remained untreated (■) or received 100 μM ZnCl<sub>2</sub> and 2 μM CdCl<sub>2</sub> (□). These cells were then stimulated with either 100 μM LPA (A) or 10 nM EGF (B) for the indicated times before assaying cell lysates for ERK1 MBP kinase activity in immune complexes. Data shown are from a single experiment representative of three. (C) Expression of RasN17 did not affect the amount of immunoprecipitable ERK1 since identical amounts were immune-precipitated with ERK1 antisera E1.2. R1ΔRasN17 cells were treated with ZnCl<sub>2</sub> and CdCl<sub>2</sub> as described above before immunoprecipitating with antiserum E1.2; following SDS-PAGE and transfer to nitrocellulose ERK1 and 2 were detected with the ERK1 and 2 monoclonal antibody MK12; a Rat-1 cell lysate is shown as a control for the presence of immune reactive ERK1 and 2. (D) Expression of RasN17 inhibited LPA- and EGF-stimulated ERK2 mobility shift. R1ΔRasN17 cells were treated with ZnCl<sub>2</sub> and CdCl<sub>2</sub> as indicated before stimulation with LPA or EGF for 5 min. Following SDS-PAGE and transfer to nitrocellulose activation of ERK2 was assayed by the appearance of a low mobility form by Western blotting with MK12.

### RapV12 antagonizes Ras-dependent activation of ERK1 and 2

When R1CVN and R1CVN RapV12 cells were compared for activation of ERK1 and ERK2, marked differences were found between the two cell lines. In the case of LPA the peak activation of ERK1 and ERK2, at 5 min, was inhibited in the R1CVN RapV12 cell line; this was apparent both in immune complex kinase assay of ERK2 (Figure 4A) where the peak activity in response to LPA was inhibited by 50–70% in the RapV12-expressing cells and in mobility shift on Western blots (Figure 4C). In addition to inhibiting the first phase, sustained activation of ERK1 and 2 by LPA was absent in R1CVN RapV12 cells; the response declined from 15 min onwards in R1CVN RapV12 cells (Figure 4A and C) and at 60 min had returned to basal levels whereas LPA still elicited a robust response at 60 min in the control R1CVN cells (Figure 4A).

Activation of ERKs in response to EGF was less affected by RapV12 expression than that for LPA. At early time points (5 min) the two cell lines appeared similar in immune complex kinase assays (Figure 4B; only 30–40% inhibition at most) and mobility shift assays (Figure 4D). However,

thorough kinetic analysis revealed that ERK activation was more sustained in the mock-transfected R1CVN cells, persisting for at least 2 h, whereas the response subsided at 30 min in the R1CVN RapV12 cells.

To confirm that the effect of RapV12 was not a clonal artefact due to stable expression we examined the effect of conditional expression of RapV12 on ERK1 MBP kinase activity in the R1ΔRapV12 cell line. Figure 4E shows that essentially the same results were obtained in this independently derived clone; conditional RapV12 expression inhibited activation of ERK1 by both LPA and EGF. In addition Figure 4E shows that ERK1 MBP kinase activity in R1Δ control cells was not affected by the Zn<sup>2+</sup>/Cd<sup>2+</sup> treatment; thus, inhibition of MAP kinase activity in both R1ΔRasN17 and R1ΔRapV12 cells is due to expression of the Ras or Rap mutants and not a non-specific effect of Zn<sup>2+</sup>/Cd<sup>2+</sup>.

### Expression of RapV12 does not impair activation of Ras

To delineate the site of action of RapV12 in antagonizing ERK activation, we looked at the ability of EGF and LPA to activate Ras in control and RapV12-expressing cells.

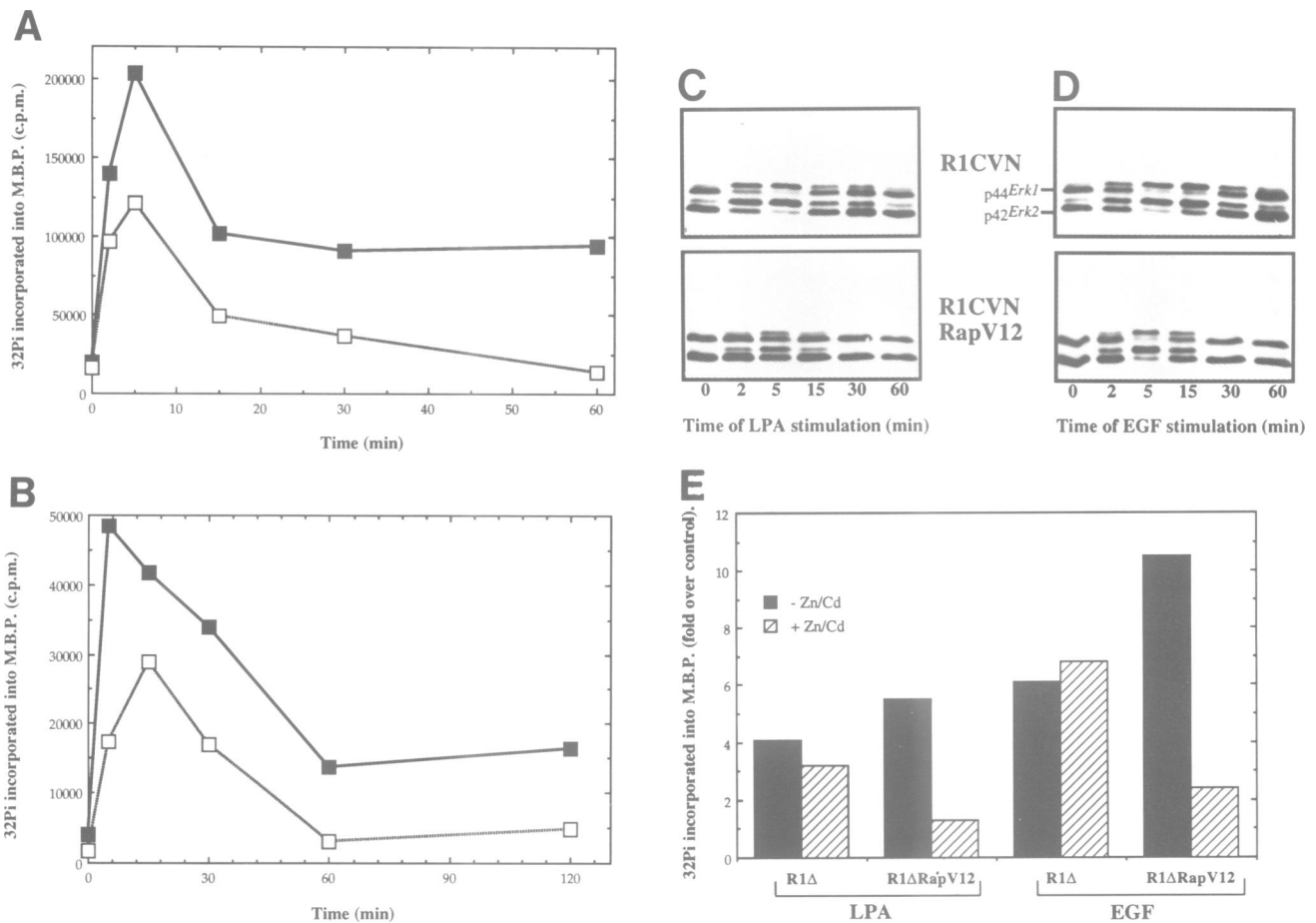

**Fig. 4.** RapV12 inhibits LPA- and EGF-stimulated ERK activation. (A and B) ERK2 immune complex kinase assay and (C and D) mobility shift assay for ERK1 and ERK2 activation in RICVN (■) and RICVN RapV12 cells (□) stimulated with LPA (A and C) or EGF (B and D). Cells were stimulated with 100 μM LPA or 10 nM EGF before lysis and equal amounts of cell protein were assayed for ERK2 MBP kinase activity in antiserum 121 immune complexes (A and B) or for hyperphosphorylation of ERK1 and ERK2 by mobility shift assay (C and D). (E) Immune complex kinase assay for ERK1 activation in the R1Δ and R1ΔRapV12 cell lines. Untreated R1Δ or R1ΔRapV12 cells (black bars) or cells treated with 100 μM ZnCl<sub>2</sub> and 2 μM CdCl<sub>2</sub> (hatched bars) were stimulated with 100 μM LPA or 100 nM EGF for 30 min, lysed and samples assayed for phosphorylation of MBP by ERK1 immune complexes. The results presented are from single experiments representative of three; the results are from independent experiments and have been normalized to fold increase over basal level to allow a comparison.

RICVN and RICVN RapV12 cells were grown to confluence and serum-starved for 48 h before labelling with [<sup>32</sup>P]orthophosphate. Following stimulation and immune precipitation of Ras, the proportion of labelled GTP and GDP was determined (Downward *et al.*, 1990). Wild type Rat-1 cells and RICVN cells (Table I) exhibited a basal Ras-GTP level of 13.6 ± 1.8% (mean ± SD from three separate determinations in duplicate). Stimulation of RICVN cells with EGF resulted in an increase in Ras-GTP up to 40.1 ± 5.4 (mean ± SD from three experiments in duplicate) which was clearly statistically significant (*P* < 0.01) (Figure 5). There was no significant difference in the ability of EGF to activate Ras in the RapV12-expressing cell line (*P* > 0.1) indicating that the site of action of RapV12 was not upstream of Ras and that signalling from the EGF receptor to Ras was intact in both cell lines.

Whilst there is much evidence that receptor and non-receptor tyrosine kinases require Ras to exert many of their effects, there is little evidence that ‘serpentine’ receptor mitogens are coupled to activation of Ras. The results in Figure 3 suggested that Ras was required for activation of ERK1 and ERK2 by LPA by virtue of the fact that these responses were antagonized by RasN17; we therefore determined directly whether LPA was able to activate Ras

**Table I.** RapV12 expression elevates basal Ras-GTP levels

Conditions	Cell line			
	WT Rat-1	RICVN	RICVN RapV12	R1ΔRapV12
Control	12.7 ± 2.5	12.3 ± 2.1	21.5 ± 2.7	14 ± 0.8
Zn <sup>2+</sup> /Cd <sup>2+</sup>	ND	ND	ND	21.4 ± 2.7

Wild type Rat-1, RICVN, RICVN RapV12 or R1ΔRapV12 cells were serum starved for 48 h before labelling with [<sup>32</sup>P]orthophosphate for 3 h and assaying Ras-GTP as described. For the R1ΔRapV12 cells 2 μM CdCl<sub>2</sub> and 100 μM ZnCl<sub>2</sub> were included for the final 18 h. Results are mean ± SD from a single experiment representative of three, performed in duplicate. ND, not determined.

in Rat-1 cells. In <sup>32</sup>P<sub>i</sub>-labelled Rat-1 cells LPA was able to stimulate a modest increase in the amount of GTP-bound Ras up to 20.5 ± 2.4 (*P* < 0.05, mean ± SD from three independent experiments in duplicate); this response is similar to, though smaller than, that recently described by van Corven *et al.* (1993). The response was clearly smaller than that for EGF which served as the positive control performed in the same series of experiments. Like EGF, this response was not inhibited by expression of RapV12

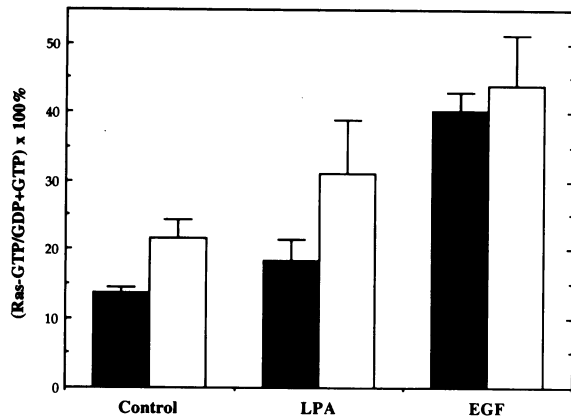

**Fig. 5.** RapV12 expression does not interfere with activation of Ras. Quiescent R1CVN (filled bars) or R1CVN RapV12 (open bars) cells were labelled with [ $^{32}$ P]orthophosphate for 3 h before stimulating with LPA (100  $\mu$ M) or EGF (10 nM) for 5 min. Following lysis, samples were immunoprecipitated with monoclonal antibody Y13-259 and bound GTP and GDP resolved on PEI-cellulose TLC plates. The proportion of radioactivity in GTP and GDP is expressed as  $(2/3 \times \text{GTP}/\text{GDP} + 2/3 \times \text{GTP}) \times 100\%$ . The results are from a single experiment representative of three performed in duplicate (mean  $\pm$  SD).

(Figure 5) but actually potentiated from 21 to 30% Ras-GTP ( $P < 0.01$  versus R1CVN basal). In the RapV12-expressing cells the LPA-stimulated increase in Ras-GTP was greater than in R1CVN cells ( $P < 0.01$  versus  $P < 0.05$ ; against R1CVN basal). Thus, RapV12-expressing cells exhibited enhanced Ras-GTP levels in response to LPA (21 to 30%) and yet peak and sustained activation of MAP kinases was inhibited. The response to LPA in RapV12-expressing cells was not always significantly elevated over the R1CVN RapV12 basal because of the increased basal counts in these cells (discussed below).

Interestingly, we found that the basal level of Ras-GTP was slightly elevated in unstimulated R1CVN RapV12 cells compared with R1CVN cells. Basal Ras-GTP levels were typically 12–14% in both wild type Rat-1 and R1CVN cells and rose to as much as 21% in cells stably expressing RapV12 (Table I) ( $P < 0.05$  based on mean  $\pm$  SD of duplicate determinations). To confirm that this was the case, we looked at Ras-GTP levels in the R1 $\Delta$ RapV12 cell line under control conditions or when induced to express RapV12 by treatment with heavy metal salts. In this cell line basal Ras-GTP levels increased from 14 to 21% ( $P < 0.05$ , based on mean  $\pm$  SD from duplicate determinations) in response to heavy metal-induced RapV12 expression; there was no effect of heavy metal salts on Ras-GTP levels in the R1 $\Delta$  control cell line (data not shown). Thus, under these conditions basal Ras-GTP was elevated, agonist-stimulated Ras-GTP was intact (or in the case of LPA potentiated) and yet activation of downstream pathways was inhibited.

#### **RasN17 and RapV12 antagonize S phase entry in Rat-1 cells**

Stimulation of quiescent Rat-1 cells with LPA or EGF results in traverse of  $G_1$  and reinitiation of S phase (van Corven *et al.*, 1989). The  $EC_{50}$  values for stimulation of [ $^3$ H]-thymidine incorporation into DNA in the R1 $\Delta$  control cell line were comparable with those for wild type Rat-1 cells; 3–10  $\mu$ M for LPA and 0.03–0.1 nM for EGF (Figure 6;

van Corven *et al.*, 1989). In the case of LPA there was ~20% inhibition of DNA synthesis in the uninduced R1 $\Delta$ RasN17 cells compared with the  $Zn^{2+}/Cd^{2+}$ -treated R1 $\Delta$  control cell line and a small shift to the right in the dose-response curve; this may be due to 'leaky' expression of RasN17 (Figure 6A). Induction of RasN17 expression by addition of  $CdCl_2$  and  $ZnCl_2$  resulted in severe inhibition of LPA-stimulated DNA synthesis; for example at 10  $\mu$ M LPA DNA synthesis was inhibited by ~70% compared with the R1 $\Delta$  (+  $Zn^{2+}/Cd^{2+}$ ) cell line (Figure 6A), whereas there was no effect in R1 $\Delta$  cells at the same concentration of LPA (Figure 6E). Under conditions of maximal RasN17 expression the dose-response curve to LPA became bell-shaped such that at maximal concentrations (100–300  $\mu$ M) DNA synthesis was completely abolished. The inhibition of DNA synthesis by RasN17 was not associated with significant toxicity except at 100–300  $\mu$ M LPA where some cells were detached from the plate. However, at 10–30  $\mu$ M LPA we observed significant inhibition of LPA-stimulated DNA synthesis without toxicity. This is consistent with Ras being required for optimal progression of Rat-1 cells through  $G_1$  and commitment to S phase when stimulated by the G-protein-coupled receptor agonist LPA. At submaximal concentrations of LPA RasN17 was less effective suggesting that LPA is able to utilize Ras-dependent and Ras-independent pathways for stimulation of DNA synthesis.

Ras is required for the growth promoting effects of EGF (Mulcahy *et al.*, 1985). We found that EGF-stimulated DNA synthesis was reproducibly less sensitive to RasN17 expression than the response to LPA (Figure 6B). In parallel experiments with LPA and on 'matched' plates of R1 $\Delta$ RasN17 cells the greatest inhibition of EGF-stimulated DNA synthesis observed was 50% suggesting that Ras-independent pathways contribute to EGF-stimulated S phase entry. Once again this was a specific effect of RasN17 since in the same experiments there was no inhibition of EGF-stimulated DNA synthesis by heavy metal treatment in the control R1 $\Delta$  cell line (Figure 6E). In some experiments RasN17 expression resulted in a small inhibition of basal [ $^3$ H]thymidine incorporation indicating that even the small percentage of cells not synchronized by serum starvation required Ras for  $G_1/S$  transition. Thus, conditional expression of RasN17 inhibits S phase entry in Rat-1 cells.

Since Rap1 was isolated by its ability to revert Ki-Ras transformation, we were surprised to find that stable expression of RapV12 had no profound effect upon growth of R1CVN RapV12 cells. However, at limiting serum concentrations we observed a 30–40% inhibition of growth rates but at 10% FBS we observed no effect (data not shown).

Induction of RapV12 expression in R1 $\Delta$ RapV12 cells also inhibited growth factor-stimulated DNA synthesis under identical conditions in which ERK activation was compromised (Figure 6C and D). Dose-response curves to both growth factors were shifted to the right and slightly inhibited in the uninduced R1 $\Delta$ RapV12 cells compared with the R1 $\Delta$  control cells perhaps due to 'leaky' expression of RapV12. Induction of RapV12 expression inhibited 80–90% of LPA-stimulated DNA synthesis but was less effective against EGF where the response was inhibited by only 50–60%. Thus under conditions where RapV12 antagonizes Ras-mediated signalling to MAP kinases it also inhibits reinitiation of DNA synthesis by either LPA or EGF.

Treatment of R1 $\Delta$  control cell lines with heavy metal

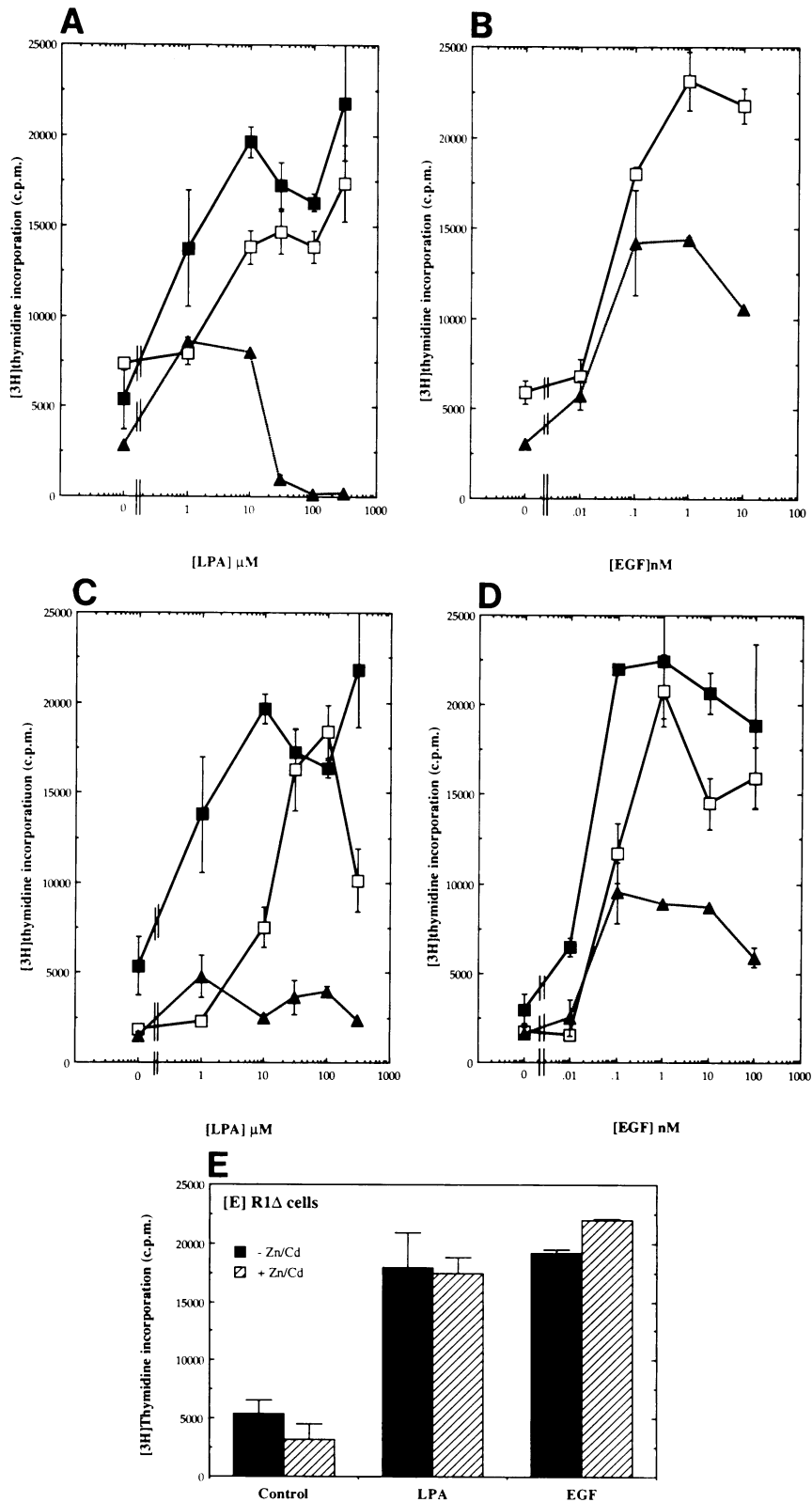

**Fig. 6.** RasN17 and RapV12 inhibit S phase entry in Rat-1 cells. (A and B) Serum-starved R1 $\Delta$  (■, ▲) and R1 $\Delta$ RasN17 cells (□, ▲) were incubated with (■, ▲) or without (□) 2  $\mu$ M CdCl<sub>2</sub> and 50  $\mu$ M ZnCl<sub>2</sub> for 10 h prior to addition of the indicated concentration of LPA (A) or EGF (B). DNA synthesis was assayed 24 h later after addition of a pulse of [<sup>3</sup>H]thymidine during the last 4 h of stimulation. Results are mean  $\pm$  SD of duplicate determinations from a single experiment representative of three giving similar results. (C and D) Serum-starved R1 $\Delta$  (■, ▲) and R1 $\Delta$ RapV12 cells (□, ▲) were incubated with (■, ▲) or without (□) 2  $\mu$ M CdCl<sub>2</sub> and 50  $\mu$ M ZnCl<sub>2</sub> for 10 h prior to addition of the indicated concentration of LPA (C) or EGF (D). DNA synthesis was assayed 24 h later after addition of a pulse of [<sup>3</sup>H]thymidine during the last 4 h of stimulation. Results are mean  $\pm$  SD of duplicate determinations from a single experiment representative of three giving similar results. (E) Serum-starved R1 $\Delta$  cells were untreated (black bars) or received ZnCl<sub>2</sub> and CdCl<sub>2</sub> as described above (hatched bars). They were then assayed for [<sup>3</sup>H]thymidine incorporation into DNA after 24 h exposure to 10  $\mu$ M LPA or 0.1 nM EGF. The data are from the same experiment as in Figure 6A–D and are representative of two others giving similar results.

salts ( $2 \mu\text{M CdCl}_2$  and  $50 \mu\text{M ZnCl}_2$ ) did not inhibit DNA synthesis by either LPA or EGF (Figure 6E); this confirmed that the inhibition of responses seen in the  $\text{R1}\Delta\text{RasN17}$  and  $\text{R1}\Delta\text{RapV12}$  cells was a specific effect of the  $\text{RasN17}$  or  $\text{RapV12}$  and not a non-specific effect of  $\text{Zn}^{2+}/\text{Cd}^{2+}$  treatment.

## Discussion

The results presented here have a number of implications for the role of Ras and Rap1 in mitogenic signal transduction. They show that LPA, a 'serpentine' receptor mitogen, is able to activate Ras and requires Ras for complete activation of the MAP kinase pathway and reinitiation of DNA synthesis. They also provide the first demonstration that increasing the concentration of active GTP-bound Rap1 in cells (by introducing  $\text{RapV12}$ ) antagonizes 'normal' Ras-mediated biochemical events in mitogenic signalling as well as reverting Ras transformation following overexpression (Kitayama *et al.*, 1989).

### LPA activates ERK1 and 2 by a Ras-mediated pathway

In quiescent Rat-1 cells LPA is a complete mitogen, stimulating reinitiation of DNA synthesis in serum-free medium with no other additions (van Corven *et al.*, 1989) (Figure 6). The protease  $\alpha$ -thrombin behaves similarly in hamster fibroblasts and these two factors are typical of a group of growth factors whose 'serpentine' receptors interact with trimeric GTPases (Pouyssegur, 1990; Moolenaar, 1991; Pouyssegur and Seuwen, 1992). The LPA receptor has not yet been cloned but cross-linking studies have identified a 38–40 kDa membrane protein which binds LPA with high affinity (van der Bend *et al.*, 1992). In addition, biochemical signals initiated by LPA exhibit all the hallmarks of being mediated by a 'serpentine receptor'; thus, DNA synthesis is pertussis toxin-sensitive (van Corven *et al.*, 1989) and inositol(1,4,5)triphosphate formation in permeabilized Rat-1 cells is modulated by  $\text{GTP}\gamma\text{S}$  and  $\text{GDP}\beta\text{S}$  in a manner consistent with receptor-stimulated nucleotide exchange being the rate limiting step (van Corven *et al.*, 1989; Plevin *et al.*, 1991). Both LPA and  $\alpha$ -thrombin are able to activate inositol lipid hydrolysis and inhibit adenylyl cyclase but biochemical, pharmacological and molecular genetic reconstitution of both pathways has shown that neither together is sufficient to account for the mitogenic effect of these growth factors (van Corven *et al.*, 1989; Seuwen *et al.*, 1990a,b; Vouret-Craviari *et al.*, 1992). At sub-maximal concentrations of LPA we did not observe complete inhibition of DNA synthesis with  $\text{RasN17}$  leading us to think that Ras is not the only pathway by which LPA stimulates DNA synthesis. Indeed, LPA is able to activate an array of second messenger pathways including phosphatidylinositol-phospholipase C (Figure 7), phosphatidylcholine-phospholipase D, phospholipase A2 and inhibition of adenylyl cyclase which may contribute to mitogenic signals (Moolenaar, 1991). However, our results suggest that the full mitogenic signalling potential of LPA is only realized when the Ras pathway is activated. LPA stimulated the sustained activation of ERK1 and ERK2; this response is highly sensitive to pertussis toxin (S.J.Cook and F.McCormick, in preparation). Sustained activation of ERK1 and ERK2 by LPA was abolished by  $\text{RasN17}$  suggesting a role for a Ras-mediated pathway, and LPA was able to stimulate an increase in

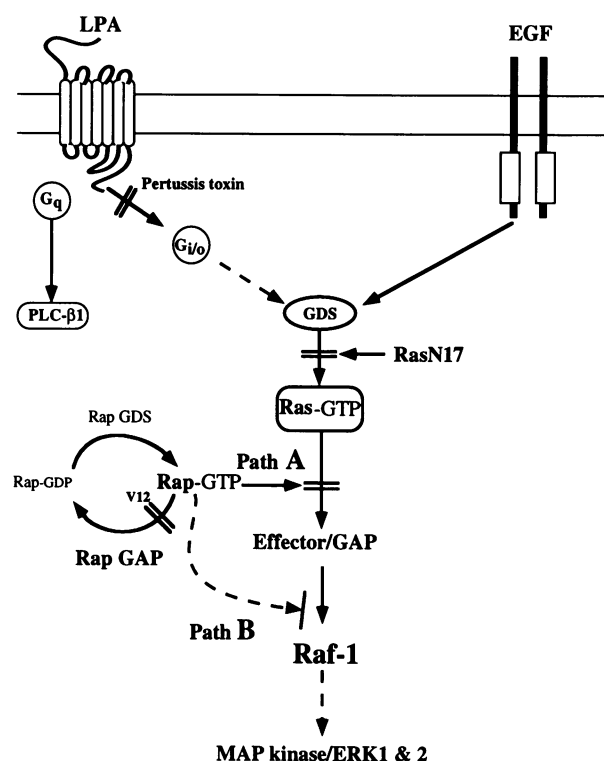

**Fig. 7.** Interaction of LPA and EGF signalling pathways with the Ras pathway and antagonism of downstream signalling by Rap1. Both LPA and EGF activate MAP kinases by a Ras-dependent pathway. Coupling from LPA to Ras involves a pertussis toxin-sensitive  $G_i$  or  $G_o$  protein distinct from the pertussis toxin-insensitive G-protein coupling to  $\text{PLC-}\beta$  (Moolenaar, 1991). Activation of the Ras pathway by either LPA or EGF is blocked by  $\text{RasN17}$  due to inhibition of endogenous exchange activity. Downstream signalling from Ras to the Raf/MEK/ERK pathway is blocked by  $\text{RapV12}$  which exerts its effect upstream of ERKs and probably Raf (Sakoda *et al.*, 1992) but downstream of Ras. This could be by direct competition for the Ras effector (Path A) or by an independent Rap1 signalling pathway acting between Ras and Raf (Path B).

Ras–GTP levels (this response is also pertussis toxin-sensitive; S.J.Cook and F.McCormick, unpublished). These results are in accord with the earlier observation that phosphatidic acid-stimulated DNA synthesis is blocked by Y13-259 injection in NIH3T3 cells (Yu *et al.*, 1988). The ability of LPA to increase Ras–GTP levels in a pertussis toxin-sensitive manner has recently been described (van Corven *et al.*, 1993); this observation is complemented by our novel demonstration that Ras is required for full signalling to MAP kinase and S phase entry.

Since Ras is required for the cellular effects of tyrosine kinases (Stacey *et al.*, 1991) do 'serpentine' receptor mitogens also activate tyrosine kinases which then feed into the Ras pathway? There are now a number of reports that 'serpentine' receptor agonists can activate tyrosine kinases including the Src substrate  $\text{p125}^{\text{FAK}}$  (Zachary *et al.*, 1992). We have recently found that herbimycin A inhibits the sustained activation of MAP kinase by LPA (S.J.Cook and F.McCormick, in preparation); thus, sustained activation of ERK1 and ERK2 is particularly sensitive to inhibition by pertussis toxin and tyrosine kinase inhibitors and is Ras-dependent. Taken together these observations are consistent with a model in which LPA, acting via a  $G_i$  or  $G_o$  protein, stimulates directly or indirectly a tyrosine



kinase which results in activation of Ras (Figure 7). Since the additional pathway required for S phase entry by  $\alpha$ -thrombin is thought to involve a tyrosine kinase (Vouret-Craviari *et al.*, 1992), we speculate that this pathway may also involve Ras. The ability of  $\alpha$ -thrombin to elevate Ras-GTP in hamster fibroblasts supports this hypothesis (van Corven *et al.*, 1993).

We were unable to demonstrate complete inhibition of MAP kinase activation in all experiments using conditional expression of RasN17 or particularly RapV12. In the case of EGF this may be due to the level of RasN17 expression being insufficient to inhibit the more robust EGF-stimulated increase in Ras-GTP. Alternatively, inhibition of GAP activity may play a role in signalling from the EGF receptor to Ras and this might be less sensitive to RasN17; certainly activation of EGF receptors leads to phosphorylation of p120-GAP in Rat fibroblasts (Ellis *et al.*, 199) but the functional consequences of this phosphorylation are not known. A more simple explanation is that both EGF and LPA utilize Ras-dependent and Ras-independent pathways to stimulate MAP kinases and subsequently DNA synthesis. RasN17 can strongly inhibit insulin- and PGDF-stimulated ERK activation (de Vries-Smits *et al.*, 1992): the relative contribution made by Ras to mitogenic signalling pathways may vary for different growth factors and at different times during the response (Cai *et al.*, 1990). Indeed, the most reproducible effects of RasN17 and RapV12 were to inhibit the smaller sustained activation of MAP kinases; full activation at early time-points probably requires Ras and additional signals such as PKC or calcium-dependent pathways. Thus it would appear that Ras mediates a partial but sustained activation of ERK1 and 2; this is likely to be an important signal for transit through G<sub>1</sub> since there is strong correlation between sustained MAP kinase activation and mitogenicity in CCL39 cells (Kahan *et al.*, 1992) and neuronal differentiation in PC12 cells (Qui and Green, 1992).

**RapV12 antagonizes Ras-mediated signal transduction**  
Rap1a/Krev-1 can revert Ki-ras transformation (Kitayama *et al.*, 1989) and antagonize transformation by Src and mTAg (Jelinek and Hassell, 1992) but its normal function in the Ras-mediated signalling pathways of non-transformed cells has not been addressed. Rap1 is present at high levels in platelets and neutrophils where it is a substrate for PKA (Siess *et al.*, 1990; Quilliam *et al.*, 1991) and is reported to associate with the cytochrome *b*<sub>558</sub> component of the NADPH oxidase system in human neutrophils (Bokoch, 1993); however, little is known about Ras function in either of these systems. Since dominant-negative Ras mutants are able to block activation of ERKs (de Vries-Smits *et al.*, 1992; Thomas *et al.*, 1992; Wood *et al.*, 1992) we reasoned that if Rap1 really is a Ras antagonist then RapV12 might have the same effect since it is refractory to Rap-GAP activity (Polakis and McCormick, 1992).

Stable expression of RapV12 at levels similar to the endogenous wild type protein greatly inhibited the ability of growth factors to activate ERK1 and ERK2; similar results were obtained in an additional clone in which RapV12 was under the control of the mouse metallothionein promoter ruling out the possibility that this was an artefact due to stable expression of RapV12. Sustained MAP kinase activation was particularly sensitive to RapV12, whereas at earlier times inhibition was only 40–60% again suggesting a Ras/Rap-

independent component in the response at these time points. This inhibition occurred at modest levels of expression suggesting that Rap-GTP, at physiological levels, functions as a potent antagonist of Ras function in the whole cell. This is the first demonstration that Rap1 is able to antagonize a 'normal' function of Ras proteins in untransformed cells.

Stable expression of RapV12 at levels similar to wild type protein (Figure 2B) had little effect on cell growth except at limiting serum concentrations and yet conditional expression inhibited DNA synthesis. We think this may reflect the selection of a clone stably expressing levels of RapV12 sufficiently low to allow some mitogenic signal but still high enough to observe inhibition of responses. Consistent with this is the observation that the transformation-reverting activity of Rap1 requires very high levels of expression, considerably in excess of physiological levels (Kitayama *et al.*, 1989; Jelinek and Hassell, 1992).

The site of action of RapV12 cannot as yet be fully defined (Figure 7); however, in cell lines stably expressing RapV12 the ability of EGF and LPA to increase Ras-GTP was not inhibited indicating that upstream signalling from receptors to Ras is intact and ruling out an effect on the nucleotide exchange factor responsible for activation of Ras. Rap1 clearly exerts its effects upstream of ERK1 and ERK2 and probably upstream of Raf since it can block signals to the Fos promoter from c-K-Ras but not c-Raf-1 in transient assays (Sakoda *et al.*, 1992). This appears to leave at least two distinct possibilities (Figure 7). One is that Rap-GTP(V12) antagonizes Ras function by competing directly for Ras effector molecules thereby preventing activation of the Ras pathway at source (Path A in Figure 7). The alternative possibility is that RapV12 sends, via its own specific effector (perhaps a Rap-GAP), a downstream signal to antagonize activation of the Raf/MEK/ERK pathway; this model envisages separate antagonistic Ras and Rap1 pathways (Path B).

The former model is consistent with the observation that Ras and Rap1 proteins share a cluster of identical amino acids (32–44 in H-ras) in the effector region of Ras oncoproteins (Adari *et al.*, 1988; Kitayama *et al.*, 1989). Rap-GTP is a very potent inhibitor of the interaction between Ras and p120-GAP, a candidate effector molecule for Ras (Frech *et al.*, 1990); indeed, *in vitro* studies estimate that the affinity of Rap-GTP for p120-GAP is at least 100 times greater than that for Ras-GTP. In guinea pig atrial patches Ras and p120-GAP cooperate to inhibit the opening of K<sup>+</sup> channels by carbachol; this represents the first cell-free assay for Ras function reported and Rap-GTP $\gamma$ S is able to competitively inhibit Ras in this system (Yatani *et al.*, 1991). Binding of Rap-GTP to a Ras-GAP (p120-GAP or neurofibromin) might be expected to result in increased [Ras-GTP] due to competitive inhibition of Ras-GAP interactions. We observed small increases in basal Ras-GTP levels but also LPA-stimulated Ras-GTP levels were potentiated in RapV12-expressing cells where ERK activation was inhibited. Since Ras and Rap1 interact with p120-GAP through common effector sites and Rap can block downstream signals from Ras this could suggest that a 'GAP' may also be the effector. The potential dual function of GAP(s) as signal transducers and terminators has been discussed before (McCormick, 1989). However, whilst it is known that Rap-GTP will bind and inhibit p120-GAP there is no information on the interaction of Rap1 with neurofibromin.

Given the high affinity of Ras-GTP for the catalytic domain of neurofibromin (Martin *et al.*, 1990; Bollag and McCormick, 1991a) one can envisage that neurofibromin might regulate Ras-GTP levels when p120-GAP is inhibited by Rap-GTP; these issues remain to be clarified by studying the interaction of Rap1 and neurofibromin. Our results suggest that RapV12 is able to block Ras-mediated signal transduction *in vivo* and also blocks the effects of GAP activity on Ras-GTP; whether the effector function of Ras resides in a GAP molecule remains to be defined.

Are Rap-GTP levels regulated by growth factors or during different stages of the cell cycle? When quiescent cells are stimulated with growth factors the increase in percentage of GTP/GDP + GTP levels on Ras is often relatively modest (Sato *et al.*, 1990). Perhaps the key determinant of Ras signal output is the ratio of Ras-GTP/Rap-GTP; increases in Ras-GTP would be far more meaningful if accompanied by decreases in Rap-GTP. To our knowledge no study has attempted to look at the nucleotide state of Rap1 in either growing versus quiescent cells or in growth factor-stimulated cells. The recently cloned Rap1-specific GAP (Rubinfeld *et al.*, 1991) possesses the hallmarks of an important regulatory protein in cell cycle progression; it contains consensus sites for phosphorylation by both PKA and CDC2 kinase and is readily phosphorylated by both kinases *in vitro* (Rubinfeld *et al.*, 1992); the effects of genetic manipulation of Rap-GAP on growth factor signalling to MAP kinases represent a future avenue of investigation. Finally, the ability of Rap-GTP to antagonize Ras signalling in both a 'normal' and 'transformed' cellular context suggests that inhibition of Rap-GAP or stimulation of Rap nucleotide exchange may represent avenues of pharmacological intervention for potential anti-Ras chemotherapeutics.

In conclusion, we have shown that Ras is required for activation of ERKs by both EGF and LPA indicating that G-protein-coupled receptors and receptor tyrosine kinases converge on Ras as a common, necessary step in mitogenic signalling pathways. Rap-GTP appears to be a potent antagonist of Ras *in vivo* and most likely exerts its effect by competing with Ras for its effector. Furthermore, Rap-GTP appears able to interact with a Ras-GAP in the whole cell thereby protecting Ras-GTP. Whether p120-GAP or neurofibromin represent the Ras effector remains to be clarified.

## Materials and methods

### Plasmid construction and cell culture

The pSV<sub>2</sub>M(2)6 vector, a kind gift of Dr Marilyn Sleight, contains a modified mouse metallothionein promoter into which additional metal-responsive elements have been engineered to provide maximum heavy metal inducibility (McNeill *et al.*, 1989). This vector was engineered to include the neomycin resistance gene at the *EcoRI* site of pSV<sub>2</sub>M(2)6 as follows: pCDNAI.Neo (Invitrogen) was digested with *KpnI*, blunted with T4 DNA polymerase and the fragment isolated by the Gene Clean protocol. This fragment was then partially digested with *HincII* and the resulting 3.0 kb fragment was isolated and ligated to the pSV<sub>2</sub>M(2)6 vector that had been digested with *EcoRI*, blunted with T4 and gel-purified. The resulting construct pSV<sub>2</sub>M(2)6-Neo (pM<sub>2</sub>N) was tested for its ability to generate neomycin-resistant colonies in Rat-1 cells. The vector pMMRasDN (Kremer *et al.*, 1991) (provided by Dr Joan Brugge) was digested with *BamHI*, blunted and finally cut with *XbaI*; the resulting H-RasN17 fragment was isolated by the Gene Clean protocol. pM<sub>2</sub>N was cut with *SacI*, blunted and then cut with *XbaI* to yield a cut vector with a blunt 3' end and *XbaI* site at the 5' end. The RasN17 fragment was then ligated into the pM<sub>2</sub>N vector and the resulting reaction used to transform competent DH5 $\alpha$  cells. The

vector pMM-RapV12 was constructed by inserting a *HindIII*-*BamHI* fragment of RapV12 into the *HindIII*-*BamHI* cut pMM-DNRas vector; as a result the RapV12 cDNA actually has the first five codons of H-Ras. However, this has no effect on the biological properties of Ras or Rap1 proteins (Zhang *et al.*, 1990). The RapV12 cDNA was then isolated from pMM-RapV12 and inserted into the pM<sub>2</sub>N vector by exactly the same strategy as described for RasN17. Following transformation, colonies were screened for incorporation of the insert and correct orientation by PCR using a sense oligo to the pM<sub>2</sub>N promoter and internal antisense oligos specific for Ras or Rap. One each of several positive clones was sequenced to confirm its integrity. CVN RapV12 was constructed by blunt end cloning full-length synthetic RapV12 DNA into the *EcoRV* site of CVN (Hudziak *et al.*, 1987). All constructs were confirmed by dideoxy nucleotide sequencing.

Rat-1 cells were routinely maintained in DMEM containing penicillin/streptomycin, glutamine and 10% fetal bovine serum. Cells were transfected with either the control vectors (pM<sub>2</sub>N or CVN) or the vectors containing the cDNA for H-RasN17 or RapV12 by a modified CaPO<sub>4</sub> precipitation method (Chen and Okayama, 1987). G418-resistant clones were selected after 14 days, isolated using cloning cylinders and screened for expression of recombinant proteins by Western blot analysis of whole cell lysates using the Ras/Rap effector domain monoclonal antibody, 6B7 (Wong *et al.*, 1986) or the Rap1 polyclonal antibody  $\alpha$ Rap1. The clones used in these experiments were maintained under G418 selection (400  $\mu$ g/ml) at all times until serum starvation. Control experiments confirmed that for the stable cell line (RICVN RapV12) 48 h incubation in serum- and G418-free DMEM did not affect expression of RapV12 (data not shown).

### Cell stimulations

Experiments were performed on 3 cm dishes of confluent, quiescent cells which had been serum starved for 36 h. Medium was replaced with 1 ml of serum-free DMEM containing the indicated growth factors and stimulations proceeded at 37°C for the time indicated. Incubations were terminated by aspiration and addition of ice-cold lysis buffer (20 mM Tris-HCl pH 8, 1% Triton X-100, 10% glycerol, 137 mM NaCl, 1.5 mM MgCl<sub>2</sub>, 1 mM EGTA, 50 mM NaF, 1 mM Na<sub>2</sub>VO<sub>4</sub>, 1 mM PMSF, 20  $\mu$ M leupeptin and 10  $\mu$ g/ml aprotinin). All manipulations of cell lysates were at 4°C. Lysates, prepared after 20 min on a rocking plate, were collected into Eppendorf tubes and cleared of nuclei and detergent insoluble material by centrifuging for 10 min at 14 000 r.p.m.

### Immune complex kinase assays for ERK1 and 2

Peptides corresponding to the C termini of ERK1 (LKELIFQETARFQ-PGAPEAP) or ERK2 (EETARFQPGYRS) were synthesized and conjugated to KLH by Multiple Peptide Systems, San Diego, CA. These peptides were used to immunize rabbits by the Berkeley Antibody Company (BABCo., Richmond, CA). The resulting sera, E1.2 for ERK1 and E2.1 for ERK2, were selected for their ability to immune precipitate a growth factor-stimulatable MBP kinase activity which could be blocked by inclusion of the competing peptide. These antisera behaved similarly to anti-ERK2 121 (Leevers and Marshall, 1992) in parallel assays and results obtained with these antisera were qualitatively identical to those in ERK1 and ERK2 mobility shift assays using the commercial monoclonal MK12.

Lysates were assayed for total cell protein (Bio-Rad) and equal amounts of cell lysate (typically 150  $\mu$ g) were immunoprecipitated with the indicated antiserum for 2 h; protein A-Sepharose beads were added for the last 30 min. Immune precipitates were collected by centrifuging for 10 s at 14 000 r.p.m. and were washed three times with 1 ml of lysis buffer.

Immune complexes were washed in kinase buffer (30 mM Tris pH 8, 10 mM MgCl<sub>2</sub> and 1 mM MnCl<sub>2</sub>) before being resuspended in 30  $\mu$ l of kinase assay cocktail containing kinase buffer, 7  $\mu$ g of myelin basic protein, 2  $\mu$ M cold ATP and 1–5  $\mu$ Ci of [ $\gamma$ -<sup>32</sup>P]ATP per sample. Incubations were for 30 min at 30°C and were terminated by the addition of hot 4  $\times$  SDS-PAGE sample buffer, followed by boiling for 5 min at 95°C. Samples were resolved on a 12% SDS-PAGE gel using Protean mini-gel apparatus. The gel was stained with Coomassie brilliant blue, dried and autoradiographed. The Coomassie blue-stainable MBP band was excised from the dried gel and the incorporated radioactivity determined by scintillation counting.

### Western blot analysis of ERK1 and ERK2

Quiescent, serum-starved Rat-1 monolayers in 6-well plates were stimulated with growth factors or hormones in serum-free DMEM at 37°C and lysis was as described above. After normalizing protein concentrations with lysis buffer samples were boiled at 95°C for 5 min in SDS-PAGE sample buffer. Samples, typically 10–20  $\mu$ g of total cell protein, were loaded onto 8% SDS-PAGE gels (35% acrylamide–0.6% bis) poured in 14  $\times$  14 cm Hoeffer apparatus and run at 5 mA overnight at 4°C. Separated proteins

were transferred to nitrocellulose in a Bio-Rad transblot apparatus at 300 mA for 55 min at 4°C and blots were blocked for 2 h in low detergent Blotto.

Blots were washed once in 0.05% Tween-20-PBS-1% BSA (TPBS-BSA) and incubated overnight (10 h) with a 1:2000 dilution of the mouse monoclonal anti-MAP kinase antibody MK12 (Glenntech, Kentucky) in TPBS-BSA at 4°C. Blots were washed three times with TPBS before incubating with goat anti-mouse HRP second antibody (1:15 000 in TPBS-BSA, Bio-Rad) for 1 h at room temperature. After washing three times with TPBS immunoreactive ERK1 and ERK2 were detected by the ECL protocol (Amersham).

#### Assay of Ras - GTP/Ras - GDP ratios

Confluent 6 cm dishes of Rat-1 cells were serum starved for 48 h to ensure quiescence. The cell monolayers were washed for 30 min in phosphate- and serum-free DMEM (ICN) before incubating for 3 h with 600  $\mu$ Ci of [<sup>32</sup>P]PO<sub>4</sub><sup>2-</sup> in 2 ml of phosphate-free DMEM. Cells were then stimulated with the indicated agonists in duplicate for 5 min before lysis and immune precipitation of Ras using Y13-259 as described by Downward *et al.* (1990). After elution in the presence of cold carrier, GDP and GTP were resolved by thin layer chromatography on PEI cellulose plates using 1 M LiCl. Radioactivity in GTP and GDP was determined by scanning the TLC plate on an AMBIS 4000 Radioisotopic Imaging System. Results are expressed as  $(\text{GTP} \times 2/3) / (\text{GDP} + \text{GTP} \times 2/3) \times 100\%$ .

#### Assay of DNA synthesis by [<sup>3</sup>H]thymidine incorporation

Matched confluent cultures of R1A, R1AΔRasN17 or R1AΔRapV12 cells were washed in serum-free medium for 24 h before stimulating with the appropriate growth factors for a further 24 h in the presence of 3  $\mu$ M cold thymidine. Reinitiation of DNA synthesis was assayed by incorporation of a pulse of [<sup>3</sup>H]thymidine (1  $\mu$ Ci/ml) during the last 4 h of stimulation. At the end of the stimulation time radioactivity incorporated into trichloroacetic acid-precipitable material was determined following solubilization in 0.1 M NaOH and liquid scintillation counting.

#### Reproducibility of results

Unless stated otherwise results are from single experiments representative of at least three giving similar results. ERK immune complex kinase assays were performed as single point assays; we and others (Kahan *et al.*, 1992) have found this a highly sensitive and reproducible assay. Ras-GTP loading and [<sup>3</sup>H]thymidine incorporation assays were performed in duplicate. Statistical significance was assessed with the Student's *t*-test; *P* values <0.05 were considered significant.

## Acknowledgements

We are grateful to Dr Paul Polakis and Dr Gideon Bollag at Onyx for discussions and critical reading of the manuscript. The RapV12 cDNA used in this study was originally prepared by Dr Heinz Haubruck. We thank Professor C.J. Marshall, Chester Beatty Labs, London, UK, for supplying ERK2 antisera 121 for immune complex kinase assays in the preliminary experiments of this study and Dr Susan Munemitsu, Onyx Pharmaceuticals, for help in the construction of pM<sub>2</sub>N from the vector pSV<sub>2</sub>M(2)6 which was supplied by Dr Marilyn Sleight, CSIRO, North Ryde, NSW, Australia. The pM<sub>2</sub>N constructs were kindly sequenced by Brian Souza, Onyx. S.J.C. and F.M. are supported by a grant from the National Cancer Institute (UO1 CA51992-03), NIH to F.M.

## References

- Adari, H., Lowy, D.R., Willumsen, B.M., Der, C.J. and McCormick, F. (1988) *Science*, **240**, 518–521.
- Barbacid, M. (1987) *Annu. Rev. Biochem.*, **56**, 779–827.
- Bokoch, G.M. (1993) *Biochem. J.*, **289**, 17–24.
- Bollag, G. and McCormick, F. (1991a) *Nature*, **351**, 576–579.
- Bollag, G. and McCormick, F. (1991b) *Annu. Rev. Cell Biol.*, **7**, 601–632.
- Cai, H., Szeberényi, J. and Cooper, G.M. (1990) *Mol. Cell. Biol.*, **10**, 5314–5323.
- Chen, C. and Okayama, H. (1987) *Mol. Cell. Biol.*, **7**, 2745–2752.
- de Vries-Smits, A.M.M., Burgering, B.M.T., Leever, S.J., Marshall, C.J. and Bos, J.L. (1992) *Nature*, **357**, 602–604.
- Downward, J. (1992) *Curr. Biol.*, **2**, 329–331.
- Downward, J., Graves, J.D., Warne, P.H., Rayter, S. and Cantrell, D.A. (1990) *Nature*, **346**, 719–723.
- Ellis, C., Moran, M., McCormick, F. and Pawson, T. (1990) *Nature*, **343**, 377–381.

- Feig, L.A. and Cooper, G.M. (1988) *Mol. Cell. Biol.*, **8**, 3235–3243.
- Frech, M., John, J., Pizon, V., Chardin, P., Tavittian, A., Clark, R., McCormick, F. and Wittinghofer, A. (1990) *Science*, **249**, 169–171.
- Hagag, N., Halegoua, S. and Viola, M. (1986) *Nature*, **319**, 680–682.
- Hariharan, I.K., Carthew, R.W. and Rubin, G.M. (1991) *Cell*, **67**, 717–722.
- Hata, Y., Kikuchi, A., Sasaki, T., Shaber, M.D., Gibbs, J.B. and Takai, Y. (1990) *J. Biol. Chem.*, **265**, 7104–7107.
- Hudziak, R.M., Schlessinger, J. and Ullrich, A. (1987) *Proc. Natl Acad. Sci. USA*, **84**, 7159–7163.
- Jelinek, M.A. and Hassell, J.A. (1992) *Oncogene*, **7**, 1687–1698.
- Kahan, C., Seuwen, K., Meloch, S. and Pouyssegur, J. (1992) *J. Biol. Chem.*, **267**, 13369–13375.
- Kitayama, H., Sugimoto, Y., Matsuzaki, T., Ikawa, Y. and Noda, M. (1989) *Cell*, **56**, 77–84.
- Kremer, N.E., D'Arcangelo, G., Thomas, S.M., DeMarco, M., Brugge, J.S. and Halegoua, S. (1991) *J. Cell Biol.*, **115**, 809–819.
- Leever, S.J. and Marshall, C.J. (1992) *EMBO J.*, **11**, 569–574.
- McCormick, F. (1989) *Cell*, **56**, 5–8.
- McNeill, J., Sanchez, A., Gray, P.P., Chesterman, C.N. and Sleight, M.J. (1989) *Gene*, **76**, 81–88.
- Martin, G.A. *et al.* (1990) *Cell*, **63**, 843–849.
- Moolenaar, W.H. (1991) *Cell Growth Differ.*, **2**, 359–364.
- Mulcahy, L.S., Smith, M.R. and Stacey, D.W. (1985) *Nature*, **313**, 241–243.
- Plevin, R., MacNulty, E.E., Palmer, S. and Wakelam, M.J.O. (1991) *Biochem. J.*, **280**, 609–615.
- Polakis, S. and McCormick, F. (1992) *Cancer Surveys*, **12**, 000–000.
- Pouyssegur, J. (1990) *G Proteins*. Academic Press, San Diego.
- Pouyssegur, J. and Seuwen, K. (1992) *Annu. Rev. Physiol.*, **54**, 195–210.
- Qiu, M.S. and Green, S.H. (1992) *Neuron*, **9**, 705–717.
- Quilliam, L.A., Mueller, H., Bohl, B.P., Prossnitz, V., Sklar, L.A., Der, C.J. and Bokoch, G.M. (1991) *J. Immunol.*, **147**, 1628–1635.
- Rubinfeld, B., Munemitsu, S., Clark, R., Conroy, L., Watt, K., Crosier, W.J., McCormick, F. and Polakis, P. (1991) *Cell*, **65**, 1033–1042.
- Rubinfeld, B., Crosier, W.J., Albert, I., Conroy, L., Clark, R., McCormick, F. and Polakis, P. (1992) *Mol. Cell. Biol.*, **12**, 4634–4642.
- Sakoda, T., Kaibuchi, K., Kishi, K., Kishida, S., Doi, K., Hoshino, M., Hattori, S. and Takai, Y. (1992) *Oncogene*, **7**, 1705–1711.
- Satoh, T., Endo, M., Nakafuku, M., Akiyama, T., Yamamoto, T. and Kaziro, Y. (1990) *Proc. Natl Acad. Sci. USA*, **87**, 7926–7929.
- Seuwen, K., Kahan, C., Hartmann, T. and Pouyssegur, J. (1990a) *J. Biol. Chem.*, **265**, 22292–22299.
- Seuwen, K., Magaldi, I., Kobilka, B.K., Caron, M.G., Regan, J.W., Lefkowitz, R.J. and Pouyssegur, J. (1990b) *Cell Regul.*, **1**, 445–451.
- Siess, W., Winegar, D.A. and Lapetina, E.G. (1990) *Biochem. Biophys. Res. Commun.*, **170**, 944–950.
- Simon, M.A., Bowtell, D.D.L., Dodson, G.S., Lavery, T.R. and Rubin, G.M. (1991) *Cell*, **67**, 701–716.
- Stacey, D.W., Roudebush, M., Day, R., Mosser, S.D., Gibbs, J.B. and Feig, L.A. (1991) *Oncogene*, **6**, 2297–2304.
- Thomas, S.M., DeMarco, M., D'Arcangelo, G., Halegoua, S. and Brugge, J.S. (1992) *Cell*, **68**, 1031–1040.
- Trahey, M. and McCormick, F. (1987) *Science*, **238**, 542–545.
- van Corven, E.J., Groenink, A., Jalink, K., Eichholtz, T. and Moolenaar, W.H. (1989) *Cell*, **59**, 45–54.
- van Corven, E.J., Hordijk, P.L., Medema, R.H., Bos, J.L. and Moolenaar, W.H. (1993) *Proc. Natl Acad. Sci. USA*, **90**, 1257–1261.
- van der Bend, R.L., Brunner, J., Jalink, K., van Corven, E.J., Moolenaar, W.H. and Van Blitterswijk, W.J. (1992) *EMBO J.*, **11**, 2495–2501.
- Vouret-Craviari, V., Van Obberghen-Schilling, E., Rasmussen, U.B., Pavirani, A., Lecoq, J.P. and Pouyssegur, J. (1992) *Mol. Biol. Cell*, **3**, 95–102.
- de Vries-Smits, A.M.M., Burgering, B.M.T., Leever, S.J., Marshall, C.J. and Bos, J.L. (1992) *Nature*, **357**, 602–604.
- Wong, G., Arnheim, N., Clark, R., McCabe, P., Innis, M., Aldwin, L., Nitecki, D. and McCormick, F. (1986) *Cancer Res.*, **46**, 6029–6035.
- Wood, K.W., Sarnecki, C., Roberts, T.M. and Blenis, J. (1992) *Cell*, **68**, 1041–1050.
- Yatani, A., Quilliam, L.A., Brown, A.M. and Bokoch, G.M. (1991) *J. Biol. Chem.*, **266**, 22222–22226.
- Yu, C.-L., Tsai, M.-H. and Stacey, D.W. (1988) *Cell*, **52**, 63–71.
- Zachary, I., Sinnett-Smith, J. and Rozengurt, E. (1992) *J. Biol. Chem.*, **267**, 19031–19034.
- Zhang, K., Noda, M., Vass, W.C., Papageorge, A.G. and Lowy, D.R. (1990) *Science*, **249**, 162–165.

Received on March 1, 1993; revised on May 3, 1993