

Table S1

Name	Species	Accession number	Domain Architecture
<u>Syntaxin1</u>			
	<i>Homo sapiens</i>	NP_004594.1	
	<i>Mus musculus</i>	NP_058081.2	
	<i>Strongylocentrotus purpuratus</i>	NP_999785.1	
	<i>Drosophila melanogaster</i>	NP_524475.1	
	<i>Caenorhabditis elegans</i>	NP_001022614.1	
	<i>Nematostella vectensis</i>	XP_001629417.1	
	<i>Trichoplax adhaerens</i>	XP_002115196.1	
	<i>Oscarella carmela</i>	g5158.t1 (Compagen)	
	<i>Amphimedon queenslandica</i>	XP_003388239.1	
	<i>Salpingoeca rosetta</i>	XP_004991322.1	
	<i>Monosiga brevicollis</i>	XP_001743911.1	
	<i>Capsaspora owczarzaki</i>	XP_004344243.1	
	<i>Rhizopus oryzae</i>	EIE84042.1	
	<i>Batrachochytrium dendrobatidis</i>	EGF79952.1	
	<i>Saccharomyces cerevisiae</i>	EGA56453.1	
<u>SNAP-25</u>			
	<i>Homo sapiens</i>	NP_570824.1	
	<i>Mus musculus</i>	NP_035558.1	
	<i>Strongylocentrotus purpuratus</i>	NP_999754.1	
	<i>Drosophila melanogaster</i>	NP_001036641.1	
	<i>Caenorhabditis elegans</i>	NP_505641.2	
	<i>Nematostella vectensis</i>	XP_001635030.1	
	<i>Trichoplax adhaerens</i>	XP_002107866.1	
	<i>Oscarella carmela</i>	g9602.t1 (Compagen)	
	<i>Amphimedon queenslandica</i>	XP_003388483.1	
	<i>Salpingoeca rosetta</i>	XP_004990098.1	
	<i>Monosiga brevicollis</i>	XP_001743132	
	<i>Capsaspora owczarzaki</i>	XP_004348618.1	
	<i>Rhizopus oryzae</i>	EIE91809.1	
	<i>Batrachochytrium dendrobatidis</i>	EGF82656.1	
	<i>Saccharomyces cerevisiae</i>	NP_011523.3	
<u>Synaptobrevin2</u>			
	<i>Homo sapiens</i>	NP_055047.2	
	<i>Mus musculus</i>	NP_033523.1	
	<i>Strongylocentrotus purpuratus</i>	NP_999795.1	
	<i>Drosophila melanogaster</i>	NP_001261269.1	
	<i>Caenorhabditis elegans</i>	NP_504688.1	
	<i>Nematostella vectensis</i>	XP_001634446.1	
	<i>Trichoplax adhaerens</i>	XP_002113403.1	
	<i>Oscarella carmela</i>	g10105.t1 (Compagen)	
	<i>Amphimedon queenslandica</i>	XP_003387152.1	
	<i>Salpingoeca rosetta</i>	XP_004998346.1	
	<i>Monosiga brevicollis</i>	XP_001744447.1	

Capsaspora owczarzaki
Rhizopus oryzae
Batrachochytrium dendrobatidis
Saccharomyces cerevisiae

XP_004345740.1
 EIE76199.1
 EGF81495.1
 NP_014972.3



Sec1/Munc18

Homo sapiens
Mus musculus
Strongylocentrotus purpuratus
Drosophila melanogaster
Caenorhabditis elegans
Nematostella vectensis
Trichoplax adhaerens
Oscarella carmela
Amphimedon queenslandica
Salpingoeca rosetta
Monosiga brevicollis
Capsaspora owczarzaki
Rhizopus oryzae
Batrachochytrium dendrobatidis
Saccharomyces cerevisiae

NP_003156.1
 NP_001107041.1
 NP_999834.1
 NP_523916.2
 NP_001024606.1
 XP_001635431.1
 XP_002109999.1
 g9363.t1 (Compagen)
 XP_003385042.1
 XP_004993080.1
 XP_001746141
 XP_004348283.1
 EIE78827.1
 EGF80549.1
 EDN60502.1

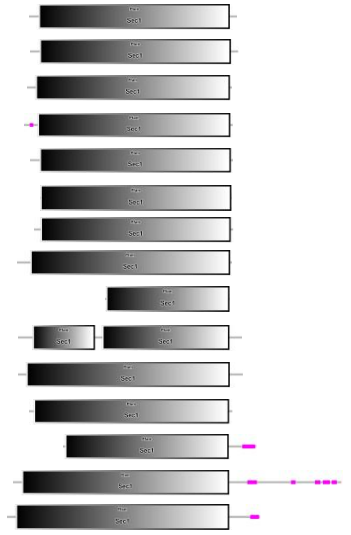

Tomosyn

Homo sapiens
Mus musculus
Strongylocentrotus purpuratus
Drosophila melanogaster
Caenorhabditis elegans
Nematostella vectensis
Trichoplax adhaerens
Oscarella carmela
Amphimedon queenslandica
Monosiga brevicollis
Capsaspora owczarzaki
Rhizopus oryzae
Saccharomyces cerevisiae

NP_640337.3
 NP_001074813
 XP_785653.3
 NP_001245644.1
 NP_491623.3
 XP_001640099.1
 XP_002112359.1
 g8759.t1 (Compagen)
 XP_003388719.1
 XP_001743265.1
 EFW43436.2
 EIE89460.1
 NP_015357.1

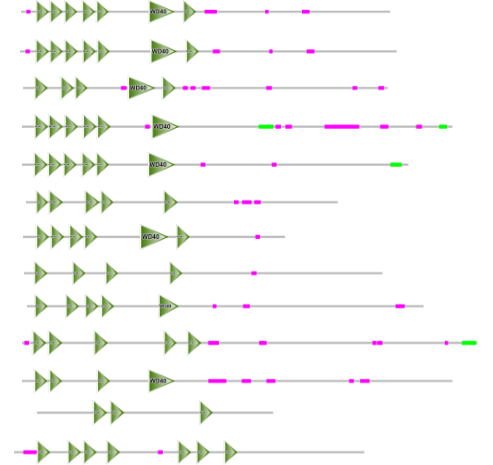

Synaptogyrin

Homo sapiens
Mus musculus
Strongylocentrotus purpuratus
Drosophila melanogaster
Caenorhabditis elegans
Trichoplax adhaerens
Oscarella carmela
Amphimedon queenslandica
Salpingoeca rosetta
Monosiga brevicollis
Capsaspora owczarzaki

NP_004702.2
 NP_997591.1
 XP_001177627.1
 NP_610908.1
 NP_509239.1
 XP_002113114.1
 g1016.t1 (Compagen)
 XP_003386894.1
 XP_004989169.1
 XP_001749438.1
 XP_004342699.1

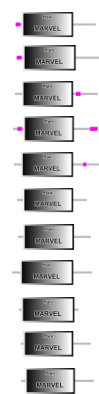

Complexin

Homo sapiens
Mus musculus

NP_006642.1
 NP_031782.3



Strongylocentrotus purpuratus XP_001199120.1
Drosophila melanogaster NP_525019.2
Caenorhabditis elegans NP_490868.1
Nematostella vectensis XP_001627218.1
Trichoplax adhaerens XP_002116780.1
Oscarella carmela g1637.t1 (Compagen)
Amphimedon queenslandica XP_003388526.1
Monosiga brevicollis XP_001747888.1
Capsaspora owczarzaki XP_004364368.1



SV2

Homo sapiens NP_055664.3
Mus musculus NP_071313.1
Strongylocentrotus purpuratus XP_787750.2
Drosophila melanogaster NP_572345.1
Caenorhabditis elegans NP_498960.2
Nematostella vectensis XP_001633415.1
Trichoplax adhaerens XP_002107649.1
Oscarella carmela g5198.t1 (Compagen)
Amphimedon queenslandica XP_003386333.1
Salpingoeca rosetta XP_004990136.1
Monosiga brevicollis XP_001750795.1

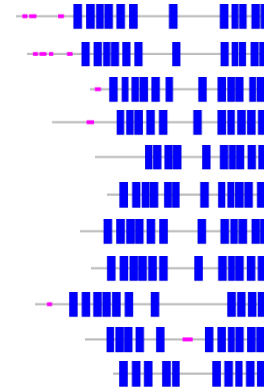

Munc13

Homo sapiens NP_006368.3
Mus musculus NP_001074882.1
Strongylocentrotus purpuratus XP_001178339.1
Drosophila melanogaster NP_651949.2
Caenorhabditis elegans NP_001021874.1
Trichoplax adhaerens XP_002110349.1
Oscarella carmela g1977.t1 (Compagen)
Amphimedon queenslandica XP_003389150.1

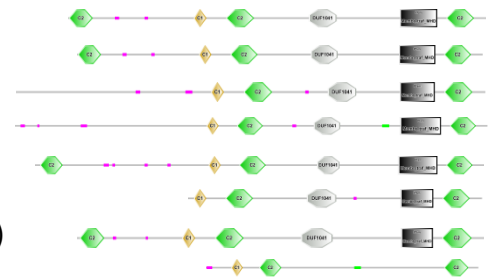

Synaptophysin

Homo sapiens NP_003170.1
Mus musculus NP_033331.2
Strongylocentrotus purpuratus XP_001175610.1
Caenorhabditis elegans NP_501360.2
Nematostella vectensis XP_001636455.1
Trichoplax adhaerens XP_002118614.1
Oscarella carmela g572.t1 (Compagen)
Amphimedon queenslandica XP_003384953.1
Capsaspora owczarzaki XP_004342419.1

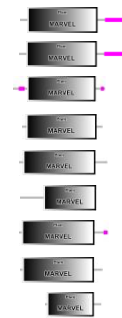

CAPS

Homo sapiens NP_003707.2
Mus musculus NP_001036082.1
Strongylocentrotus purpuratus XP_785306.2
Drosophila melanogaster NP_001027031.1
Caenorhabditis elegans NP_502437.3
Nematostella vectensis XP_001637484.1
Trichoplax adhaerens XP_002111376.1
Oscarella carmela g5696.t1 (Compagen)

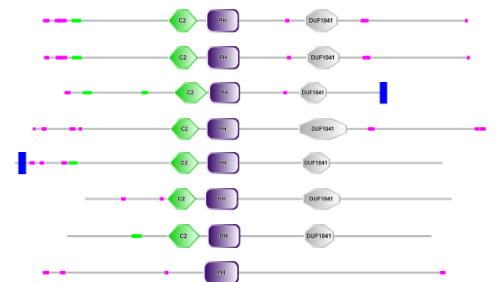

Amphimedon queenslandica

I1FTN5



Synaptotagmin1

Homo sapiens

NP_001129278.1

Mus musculus

NP_033332.1

Strongylocentrotus purpuratus

NP_001159462.1

Drosophila melanogaster

NP_523460.2

Caenorhabditis elegans

NP_001022129.1

Nematostella vectensis

XP_001623846.1

Trichoplax adhaerens

XP_002117742.1

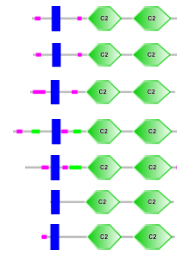

Rabphilin

Homo sapiens

NP_055769.2

Mus musculus

NP_035416.1

Drosophila melanogaster

NP_572651.1

Caenorhabditis elegans

NP_001022568.1

Nematostella vectensis

XP_001633996.1

Trichoplax adhaerens

XP_002115717.1



vGluT

Homo sapiens

NP_064705.1

Mus musculus

NP_892038.2

Strongylocentrotus purpuratus

XP_786480.2

Drosophila melanogaster

NP_608681.2

Caenorhabditis elegans

NP_499023.3

Nematostella vectensis

XP_001623804.1

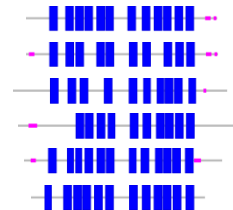

Synapsin

Homo sapiens

NP_008881.2

Mus musculus

NP_038708.3

Strongylocentrotus purpuratus

XP_001195845.1

Drosophila melanogaster

NP_731457.2

Caenorhabditis elegans

NP_741326.1

Nematostella vectensis

XP_001631589.1

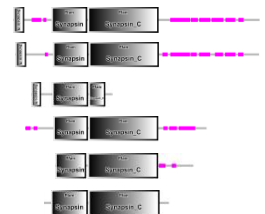

Doc2

Homo sapiens

NP_003577.2

Mus musculus

NP_034199.1

Strongylocentrotus purpuratus

XP_790269.1

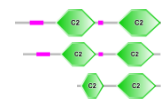

Spectrin

Homo sapiens

NP_001182461.1

Mus musculus

NP_001171139.1

Strongylocentrotus purpuratus

XP_785949.2

Drosophila melanogaster

NP_476739.1

Caenorhabditis elegans

NP_508537.1

Nematostella vectensis

XP_001618830.1

Trichoplax adhaerens

XP_002115915.1

Oscarella carmela

g5067.t1 (Compagen)

Amphimedon queenslandica

XP_003389115.1

Salpingoeca rosetta

XP_004989969.1

Monosiga brevicollis

XP_001743122.1

Capsaspora owczarzaki

XP_004365313.1

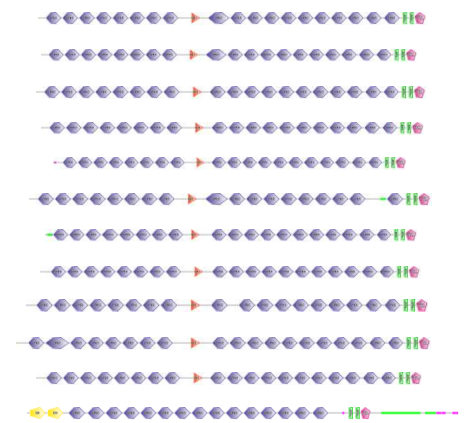

RimBP

Homo sapiens

Mus musculus

Strongylocentrotus purpuratus

Drosophila melanogaster

Caenorhabditis elegans

Nematostella vectensis

Trichoplax adhaerens

Oscarella carmela

Amphimedon queenslandica

Salpingoeca rosetta

Monosiga brevicollis

XP_005253619.1

NP_001074857.1

XP_001202010.1

NP_732029.3

NP_497459.2

Scaffold 97 (JGI)

XP_002115365.1

g8108.t1 (Compagen)

XP_003384147.1

XP_004991976.1

XP_001748571.1

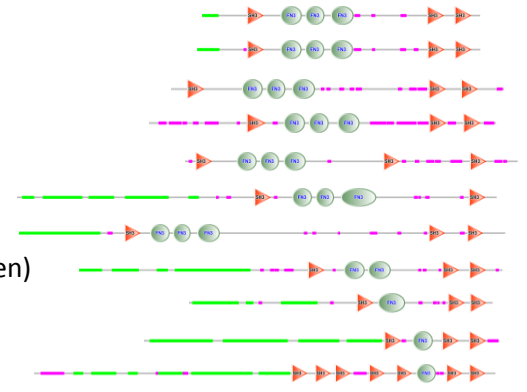

CASKin

Homo sapiens

Mus musculus

Strongylocentrotus purpuratus

Drosophila melanogaster

Caenorhabditis elegans

Nematostella vectensis

Trichoplax adhaerens

Oscarella carmela

Amphimedon queenslandica

Capsaspora owczarzaki

NP_065815.1

NP_082213.2

XP_795586.2

NP_651143.2

NP_509620.2

XP_001640093.1

XP_002109164.1

g6502.t1 (Compagen)

XP_003382820.1

XP_004346118.1

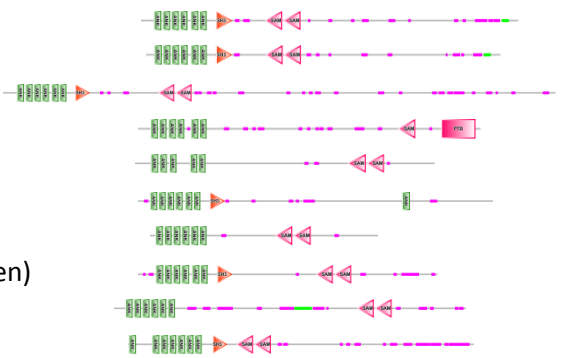

Mint

Homo sapiens

Mus musculus

Strongylocentrotus purpuratus

Drosophila melanogaster

Caenorhabditis elegans

Nematostella vectensis

Trichoplax adhaerens

Oscarella carmela

Amphimedon queenslandica

NP_001154.2

NP_796008.2

XP_001184612.1

NP_573224.2

NP_001020996.1

XP_001629713.1

XP_002110545.1

g916.t1 (Compagen)

XP_003388761.1

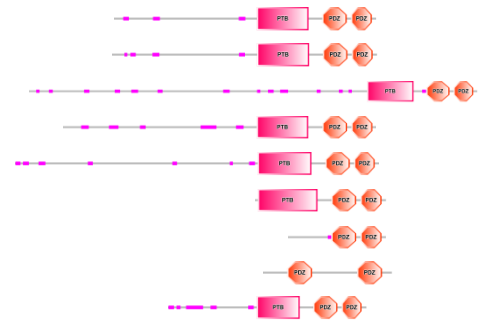

α -Liprin

Homo sapiens

Mus musculus

Strongylocentrotus purpuratus

Drosophila melanogaster

Caenorhabditis elegans

Nematostella vectensis

Trichoplax adhaerens

Oscarella carmela

Amphimedon queenslandica

NP_803172.1

NP_001028491.1

XP_797637.3

NP_609067.2

NP_509768.1

XP_001641246.1

XP_002108580

g2065.t1 (Compagen)

XP_003385618.1

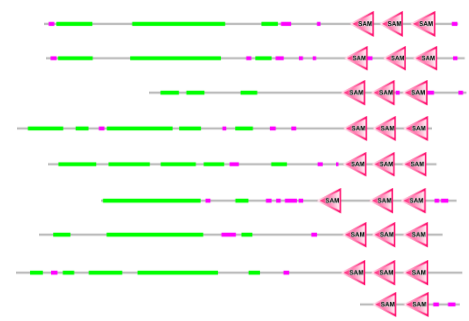

Erc/Cast

Homo sapiens

Mus musculus

Strongylocentrotus purpuratus

Drosophila melanogaster

Caenorhabditis elegans

BAC54107.1

Q6PH08.2

XP_003730089.1

NP_001097241.2

NP_500329.1

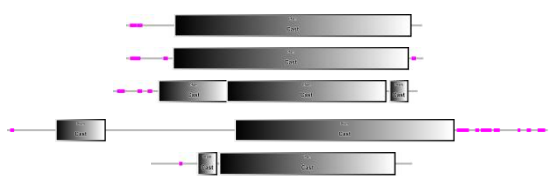

Nematostella vectensis
Trichoplax adhaerens
Oscarella carmela

Scaffold 116 (JGI)
 Scaffold 5 (JGI)
 g5213.t1 (Compagen)



CASK

Homo sapiens
Mus musculus
Strongylocentrotus purpuratus
Drosophila melanogaster
Caenorhabditis elegans
Nematostella vectensis
Trichoplax adhaerens

NP_001119527.1
 NP_033936.2
 XP_003726866.1
 NP_524441.2
 NP_001024587.1
 XP_001631427.1
 XP_002111823.1

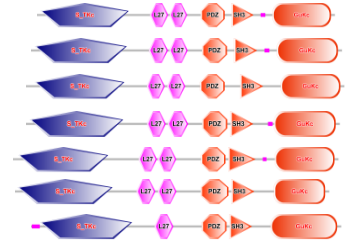

RIM

Homo sapiens
Mus musculus
Strongylocentrotus purpuratus
Drosophila melanogaster
Caenorhabditis elegans
Nematostella vectensis
Trichoplax adhaerens

XP_005248742.1
 NP_001012642.1
 XP_003724682.1
 NP_001014630.2
 NP_741831.1
 Scaffold 54 (JGI)
 XP_002114027.1

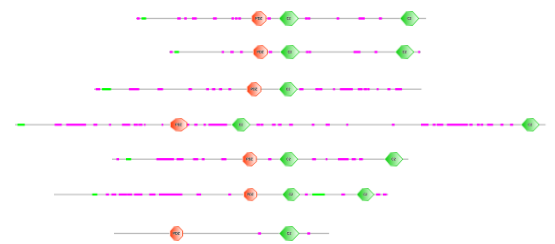

Bassoon

Homo sapiens
Mus musculus

NP_003449.2
 NP_031593.2



Piccolo

Homo sapiens
Mus musculus

NP_149015.2
 NP_036125.4



PICK

Homo sapiens
Mus musculus
Strongylocentrotus purpuratus
Drosophila melanogaster
Caenorhabditis elegans
Nematostella vectensis
Trichoplax adhaerens
Oscarella carmela
Amphimedon queenslandica
Salpingoeca rosetta
Monosiga brevicollis
Capsaspora owczarzaki

NP_001034672.1
 AAH48788.1
 XP_788322.1
 NP_609582.3
 NP_001041046.1
 XP_001630160.1
 XP_002109696.1
 g4666.t1 (Compagen)
 XP_003385466.1
 XP_004993209.1
 XP_001747250.1
 XP_004365363.1

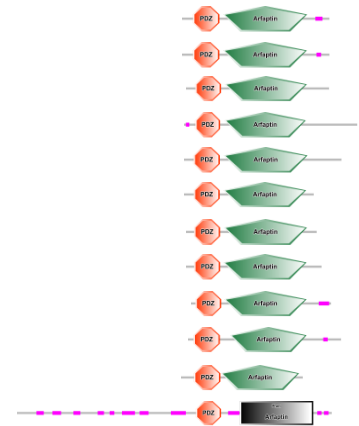

CaMKII

Homo sapiens
Mus musculus
Strongylocentrotus purpuratus
Drosophila melanogaster
Caenorhabditis elegans
Nematostella vectensis
Trichoplax adhaerens
Oscarella carmela

NP_741960.1
 NP_803126.1
 AAQ57276.1
 NP_726633.2
 NP_001023296.1
 XP_001622637.1
 XP_002115697.1
 g4055.t1 (Compagen)

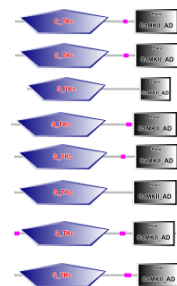

Amphimedon queenslandica
Salpingoeca rosetta
Monosiga brevicollis
Capsaspora owczarzaki

XP_003383392.1
 XP_004989001.1
 XP_001745863.1
 XP_004343000.1

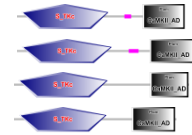

LAR

Homo sapiens
Mus musculus
Strongylocentrotus purpuratus
Drosophila melanogaster
Caenorhabditis elegans
Nematostella vectensis
Oscarella carmela
Amphimedon queenslandica
Salpingoeca rosetta
Capsaspora owczarzaki

NP_569707.2
 NP_035343.2
 XP_785900.3
 NP_523604.2
 NP_001021942.1
 XP_001635917.1
 g4996.t1 (Compagen)
 XP_003388438.1
 XP_004987827.1
 XP_004365141.1

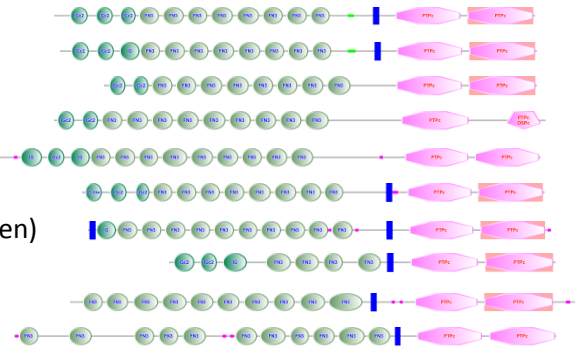

Citron

Homo sapiens
Mus musculus
Strongylocentrotus purpuratus
Drosophila melanogaster
Caenorhabditis elegans
Nematostella vectensis
Trichoplax adhaerens
Oscarella carmela
Amphimedon queenslandica
Salpingoeca rosetta
Monosiga brevicollis

NP_001193928.1
 NP_031734.3
 XP_001199576.1
 NP_648584.1
 NP_494921.1
 XP_001629741.1
 XP_002114488.1
 g185.t1 (Compagen)
 XP_003389466.1
 XP_004988028.1
 XP_001749073.1

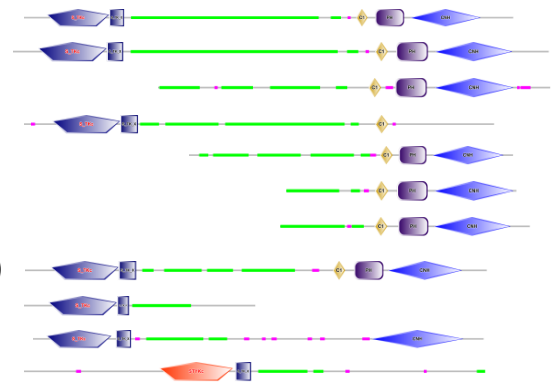

PKCαβγ

Homo sapiens
Mus musculus
Strongylocentrotus purpuratus
Drosophila melanogaster
Caenorhabditis elegans
Nematostella vectensis
Trichoplax adhaerens
Oscarella carmela
Amphimedon queenslandica
Salpingoeca rosetta
Monosiga brevicollis

NP_002730.1
 NP_035232.1
 XP_001183755.1
 NP_725626.1
 NP_001123122.1
 Scaffold 208 (JGI)
 XP_002110115.1
 g10350.t1 (Compagen)
 XP_003382766.1
 XP_004988458.1
 XP_001750627.1

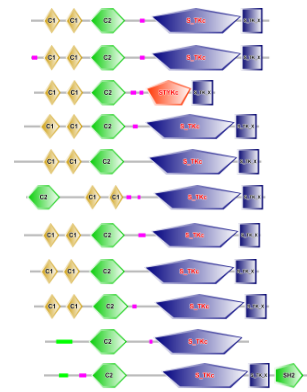

SPAR

Homo sapiens
Mus musculus
Strongylocentrotus purpuratus
Caenorhabditis elegans
Nematostella vectensis
Oscarella carmela
Amphimedon queenslandica
Salpingoeca rosetta
Monosiga brevicollis

NP_056371.1
 NP_766167.2
 XP_785253.2
 NP_505948.2
 XP_001635005.1
 g671.t1 (Compagen)
 XP_003387563.1
 XP_004988840.1
 XP_001743470.1

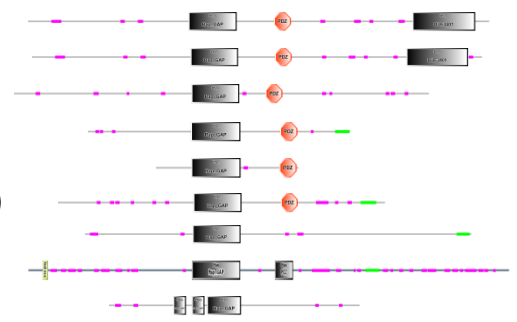

Ephrin R

Homo sapiens

Mus musculus

Strongylocentrotus purpuratus

Drosophila melanogaster

Caenorhabditis elegans

Nematostella vectensis

Trichoplax adhaerens

Oscarella carmela

Amphimedon queenslandica

NP_004432.1

NP_775623.3

XP_001199846.2

NP_726591.2

NP_494807.1

Scaffold 212 (JGI)

XP_002114653.1

g4793.t1 (Compagen)

XP_003383547.1

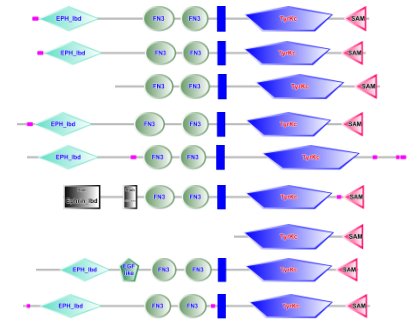

nNOS

Homo sapiens

Mus musculus

Strongylocentrotus purpuratus

Drosophila melanogaster

Nematostella vectensis

Trichoplax adhaerens

Oscarella carmela

Amphimedon queenslandica

NP_000611.1

NP_032738.1

XP_003729305.1

NP_523541.2

XP_001631503.1

XP_002116862.1

g2876.t1 (Compagen)

XP_003384187.1

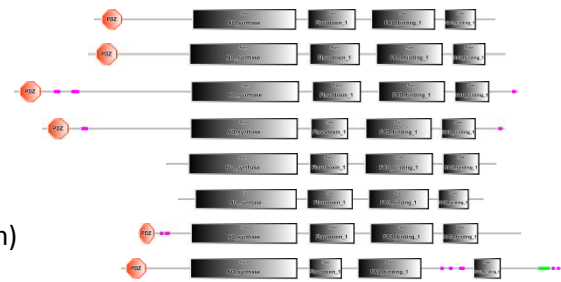

ErbB R

Homo sapiens

Mus musculus

Strongylocentrotus purpuratus

Drosophila melanogaster

Caenorhabditis elegans

Amphimedon queenslandica

NP_005219.2

NP_997538.1

XP_791361.2

NP_476759.1

NP_001129831.1

XP_003383353.1

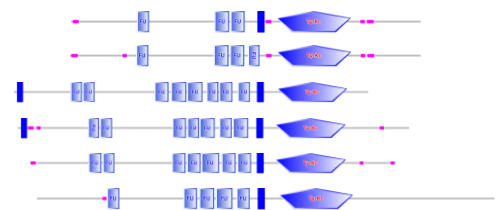

β-catenin

Homo sapiens

Mus musculus

Strongylocentrotus purpuratus

Drosophila melanogaster

Caenorhabditis elegans

Nematostella vectensis

Trichoplax adhaerens

Oscarella carmela

Amphimedon queenslandica

NP_001895.1

NP_031640.1

NP_001027543.1

NP_476666.1

NP_509206.1

XP_001647518.1

XP_002110303.1

g9376.t1 (Compagen)

NP_001266234.1

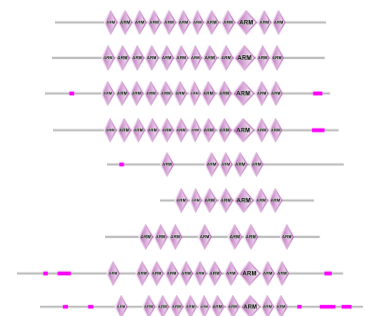

Neurexin

Homo sapiens

Mus musculus

Strongylocentrotus purpuratus

Drosophila melanogaster

Caenorhabditis elegans

Nematostella vectensis

Trichoplax adhaerens

Oscarella carmela

NP_001129131.1

NP_064648.3

XP_786974.1

NP_001163687.1

NP_502312.2

XP_001638936.1

XP_002116615.1

g10488.t1 (Compagen)

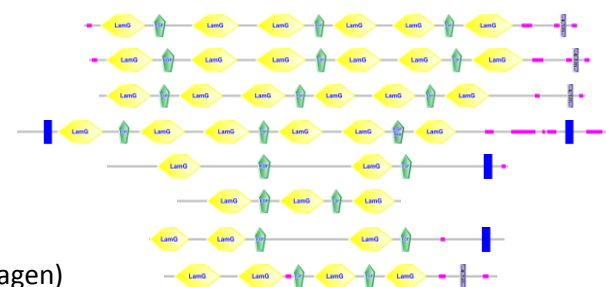

NCAM

Homo sapiens

Mus musculus

NP_851996.2

NP_001074914.1

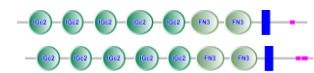

Strongylocentrotus purpuratus
Drosophila melanogaster
Caenorhabditis elegans
Nematostella vectensis
Trichoplax adhaerens

XP_001177682.1
 NP_525066.1
 NP_741707.3
 XP_001635577.1
 XP_002115623.1

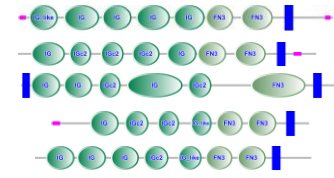

Neurologin

Homo sapiens
Mus musculus
Strongylocentrotus purpuratus
Drosophila melanogaster
Caenorhabditis elegans
Nematostella vectensis

NP_055747.1
 NP_001156859.1
 XP_001186317.1
 NP_523496.1
 NP_510283.1
 XP_001629673.1

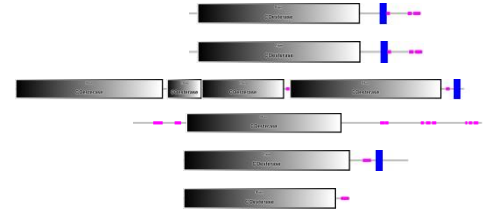

Ephrin-B

Homo sapiens
Mus musculus
Strongylocentrotus purpuratus
Drosophila melanogaster
Caenorhabditis elegans
Nematostella vectensis

NP_004420.1
 NP_034240.1
 XP_001200001.1
 NP_651927.1
 NP_501955.2
 XP_001628390.1

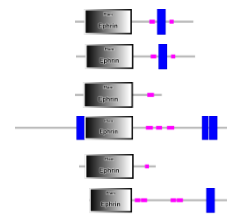

Narp (Pentraxin)

Homo sapiens
Mus musculus
Nematostella vectensis

NP_002513.2
 NP_032756.1
 XP_001639835.1

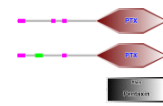

SynCam

Homo sapiens
Mus musculus

NP_055148.3
 NP_061240.3

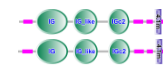

PMCA

Homo sapiens
Mus musculus
Strongylocentrotus purpuratus
Drosophila melanogaster
Caenorhabditis elegans
Nematostella vectensis
Trichoplax adhaerens
Oscarella carmela
Amphimedon queenslandica
Salpingoeca rosetta
Monosiga brevicollis
Capsaspora owczarzaki
Batrachochytrium dendrobatidis
Saccharomyces cerevisiae

XP_005268975.1
 NP_080758.1
 NP_001028822.1
 NP_001014688.3
 NP_741352.1
 XP_001633838.1
 XP_002112839.1
 8151.t1 (Compagen)
 XP_003383693.1
 XP_004995346.1
 XP_001746980.1
 XP_004345268.1
 EGF79342.1
 EDN61595.1

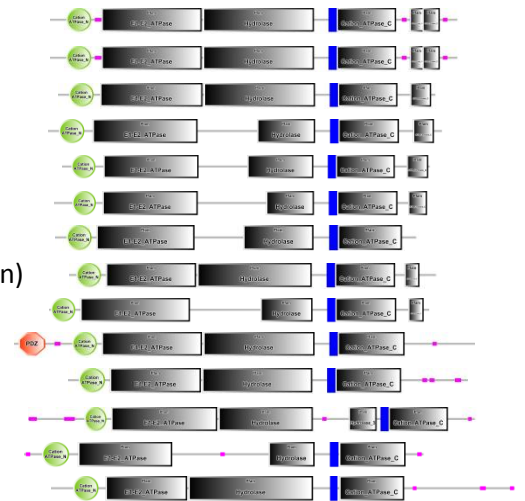

IP3R

Homo sapiens
Mus musculus
Strongylocentrotus purpuratus
Drosophila melanogaster
Caenorhabditis elegans

XP_005265165.1
 NP_034715.3
 XP_003724127.1
 NP_730941.1
 NP_001023170.1

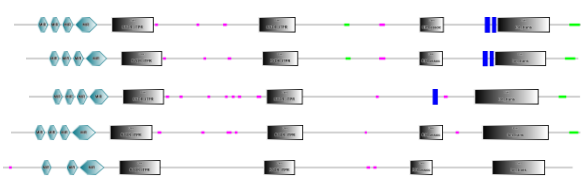

Nematostella vectensis
Trichoplax adhaerens
Oscarella carmela
Amphimedon queenslandica
Salpingoeca rosetta
Monosiga brevicollis
Capsaspora owczarzaki

XP_001629939.1
 XP_002112826.1
 g5722.t1 (Compagen)
 XP_003386591.1
 XP_004991454.1
 XP_001747685.1
 XP_004347577.1

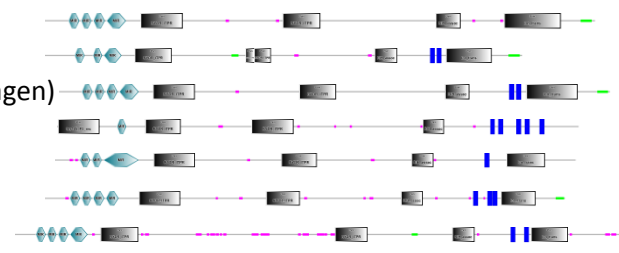

Nav-Channel

Homo sapiens
Mus musculus
Strongylocentrotus purpuratus
Drosophila melanogaster
Nematostella vectensis
Trichoplax adhaerens
Salpingoeca rosetta
Monosiga brevicollis

NP_006505.2
 NP_033160.2
 XP_001189610.1
 NP_001246510.1
 XP_001627761.1
 XP_002110559.1
 XP_004998888.1
 XP_001743090.1

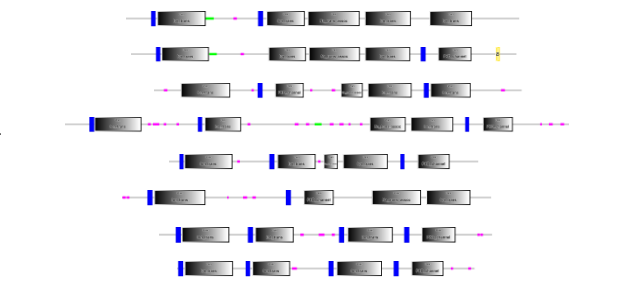

Cav-Channel

Homo sapiens
Mus musculus
Strongylocentrotus purpuratus
Drosophila melanogaster
Caenorhabditis elegans
Nematostella vectensis
Trichoplax adhaerens
Oscarella carmela
Amphimedon queenslandica
Salpingoeca rosetta
Monosiga brevicollis
Rhizopus oryzae
Saccharomyces cerevisiae

NP_001122311.1
 NP_083257.2
 NP_001118235.1
 NP_602305.1
 NP_741442.1
 XP_001639054.1
 XP_002108930.1
 g4118.t1 (Compagen)
 XP_003383036.1
 XP_004989719.1
 XP_001743090.1
 EIE92076.1
 NP_011733.3

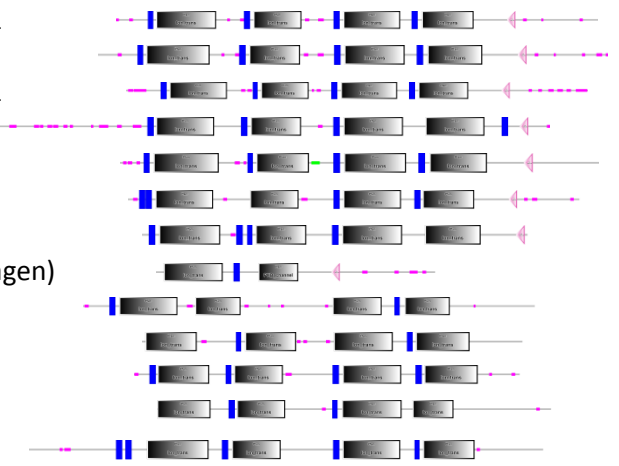

Kv-Channel

Homo sapiens
Mus musculus
Strongylocentrotus purpuratus
Drosophila melanogaster
Caenorhabditis elegans
Nematostella vectensis
Trichoplax adhaerens
Salpingoeca rosetta
Monosiga brevicollis
Capsaspora owczarzaki

NP_000208.2
 NP_034725.3
 XP_789180.2
 NP_728123.1
 NP_496104.2
 XP_001628953.1
 XP_002117304.1
 XP_004997201.1
 XP_001746676.1
 XP_004343602.1

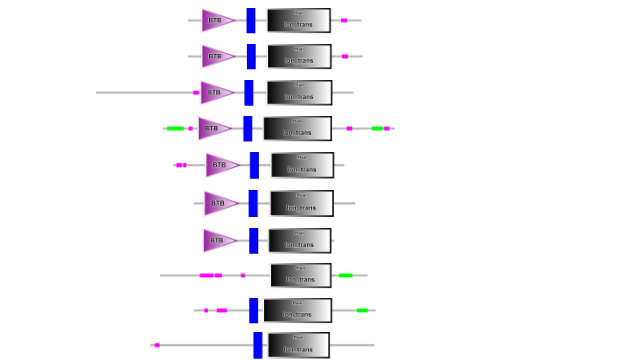

mGluR

Homo sapiens
Mus musculus
Strongylocentrotus purpuratus
Drosophila melanogaster
Caenorhabditis elegans
Nematostella vectensis
Trichoplax adhaerens

NP_001264993.1
 NP_058672.1
 XP_784936.2
 NP_524639.2
 NP_509674.1
 XP_001633378.1
 XP_002112453.1

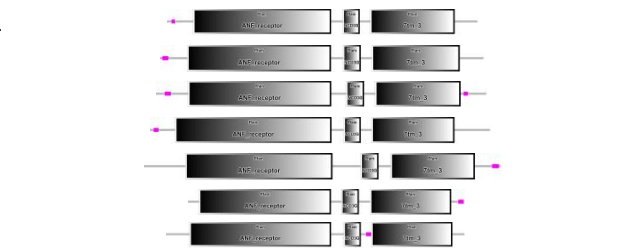

Oscarella carmela
Amphimedon queenslandica

g9680.t1 (Compagen)
 XP_003388055.1

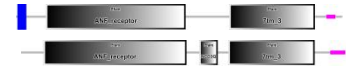

KainateGluR

Homo sapiens
Mus musculus
Strongylocentrotus purpuratus
Drosophila melanogaster
Caenorhabditis elegans
Nematostella vectensis
Trichoplax adhaerens
Oscarella carmela

NP_068775.1
 AAI31640.1
 XP_001178620.1
 AAM50963.1
 NP_741822.2
 XP_001622303.1
 XP_002111317.1
 g964.t1 (Compagen)

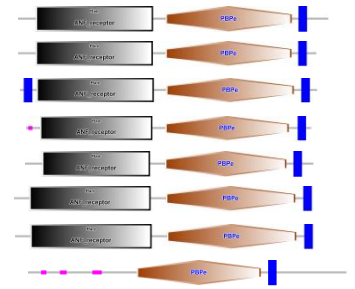

AMPAGluR

Homo sapiens
Mus musculus
Strongylocentrotus purpuratus
Drosophila melanogaster
Caenorhabditis elegans
Nematostella vectensis
Trichoplax adhaerens

CAA41491.1
 AAH56397.1
 XP_794826.2
 NP_476855.1
 NP_498887.2
 XP_001622303.1
 XP_002117383.1

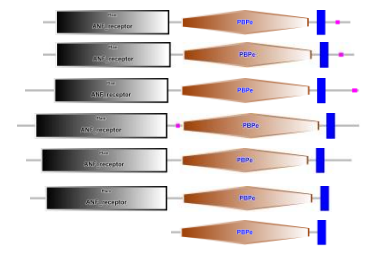

NMDAGluR

Homo sapiens
Mus musculus
Drosophila melanogaster
Caenorhabditis elegans
Nematostella vectensis

AAA21180.1
 AAH39157.1
 NP_730940.1
 NP_495033.2
 XP_001627645.1

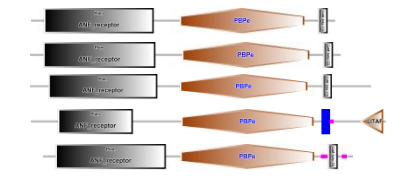

Stargazin

Homo sapiens
Mus musculus
Strongylocentrotus purpuratus
Drosophila melanogaster
Caenorhabditis elegans

NP_006069.1
 BC103564.1
 XM_003726378.1
 NM_001031910.1
 NP_001021976.1

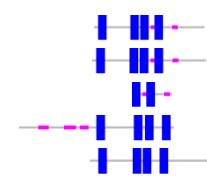

CRIP1

Homo sapiens
Mus musculus
Strongylocentrotus purpuratus
Drosophila melanogaster
Caenorhabditis elegans
Nematostella vectensis
Trichoplax adhaerens
Oscarella carmela
Amphimedon queenslandica
Salpingoeca rosetta
Monosiga brevicollis
Capsaspora owczarzaki
Rhizopus oryzae
Batrachochytrium dendrobatidis

NP_054890.1
 NP_064320.1
 XP_003730999.1
 NP_001097135.1
 NP_001032972.1
 XP_001625367.1
 Scaffold 12 (JGI)
 Scaffold7948 (Compagen)
 XP_003387592.1
 XP_004996986.1
 Scaffold 5 (JGI)
 XP_004363819.1
 EIE91262.1
 EGF84466.1



DLG/PSD-95

Homo sapiens

Mus musculus

Strongylocentrotus purpuratus

Drosophila melanogaster

Caenorhabditis elegans

Nematostella vectensis

Trichoplax adhaerens

Oscarella carmela

Amphimedon queenslandica

Salpingoeca rosetta

Monosiga brevicollis

Capsaspora owczarzaki

XP_005256549.1

NP_031890.1

XP_797198.2

NP_996404.1

NP_001024431.1

XP_001625677.1

XP_002108800.1

g10425.t1 (Compagen)

XP_003391362.1

XP_004997111.1

XP_001743865.1

XP_004349749.1

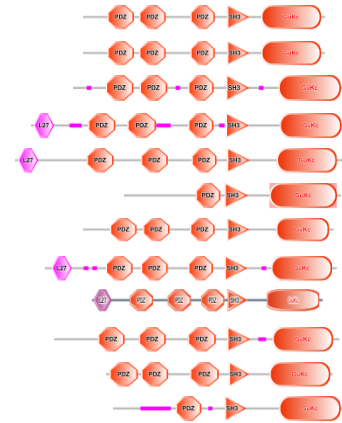

Homer

Homo sapiens

Mus musculus

Strongylocentrotus purpuratus

Drosophila melanogaster

Nematostella vectensis

Trichoplax adhaerens

Oscarella carmela

Amphimedon queenslandica

Salpingoeca rosetta

Monosiga brevicollis

Capsaspora owczarzaki

NP_004263.1

NP_671705.2

XP_788792.1

NP_477396.1

XP_001637685.1

XP_002111045.1

g2288.t1 (Compagen)

XP_003386457.1

XP_004998981.1

XP_001743073.1

XP_004349458.1

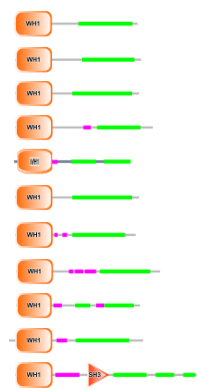

Shank

Homo sapiens

Mus musculus

Strongylocentrotus purpuratus

Drosophila melanogaster

Caenorhabditis elegans

Nematostella vectensis

Oscarella carmela

Salpingoeca rosetta

Monosiga brevicollis

Capsaspora owczarzaki

NP_036441.2

NP_001029287.1

XP_001203175.1

NP_610925.3

NP_001022007.1

XP_001634679.1

g1169.t1 (Compagen)

XP_004998206.1

XP_001748613.1

XP_004364328.1

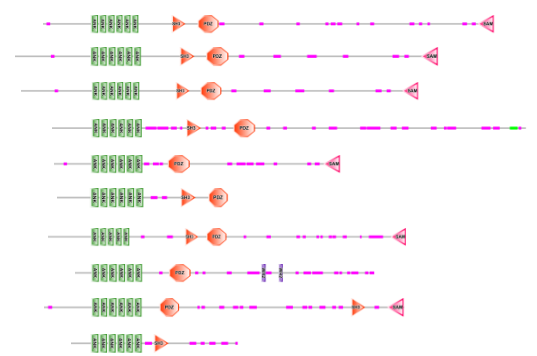

S-CAM/MAGI

Homo sapiens

Mus musculus

Strongylocentrotus purpuratus

Drosophila melanogaster

Caenorhabditis elegans

Nematostella vectensis

Trichoplax adhaerens

Oscarella carmela

Amphimedon queenslandica

Salpingoeca rosetta

Monosiga brevicollis

Capsaspora owczarzaki

NP_036433.2

NP_001164217.1

XP_001180066.2

NP_611551.1

NP_001255577.1

XP_001634602.1

XP_002111833.1

g7572.t1 (Compagen)

XP_003384006.1

XP_004998452.1

XP_001748311.1

XP_004348401.1

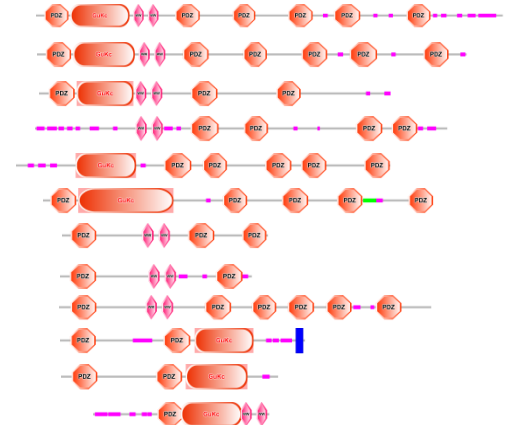

Velis/Lin-7

Homo sapiens

Mus musculus

Strongylocentrotus purpuratus

Drosophila melanogaster

Caenorhabditis elegans

Nematostella vectensis

Trichoplax adhaerens

Oscarella carmela

Amphimedon queenslandica

Capsaspora owczarzaki

NP_004655.1

NP_035828.1

XP_790016.1

NP_651330.1

NP_001122664.2

XP_001639785.1

XP_002117602.1

g7699.t1 (Compagen)

XP_003389314.1

XP_004343811.1

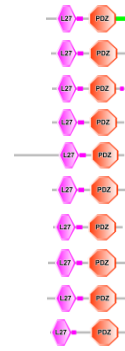

Preso/FRMPD4

Homo sapiens

Mus musculus

Drosophila melanogaster

Caenorhabditis elegans

Nematostella vectensis

Trichoplax adhaerens

Oscarella carmela

Salpingoeca rosetta

Monosiga brevicollis

NP_055543.2

NP_001028502.1

NP_731964.2

NP_497672.2

XP_001632502.1

XP_002118175.1

m.4788 (Compagen)

XP_004994899.1

XP_001747389.1

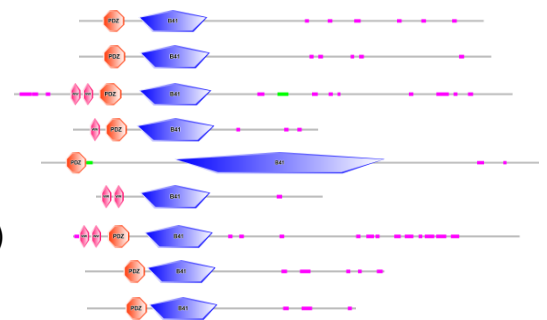

GKAP

Homo sapiens

Mus musculus

Strongylocentrotus purpuratus

Drosophila melanogaster

Caenorhabditis elegans

Nematostella vectensis

Trichoplax adhaerens

Oscarella carmela

Amphimedon queenslandica

Salpingoeca rosetta

Monosiga brevicollis

Capsaspora owczarzaki

NP_004737.2

NP_808307.2

XP_003724809.1

NP_524868.1

NP_498156.1

XP_001634969.1

XP_002116625.1

g1853.t1 (Compagen)

XP_003387885.1

XP_004992758.1

XP_001746231.1

XP_004342856.1

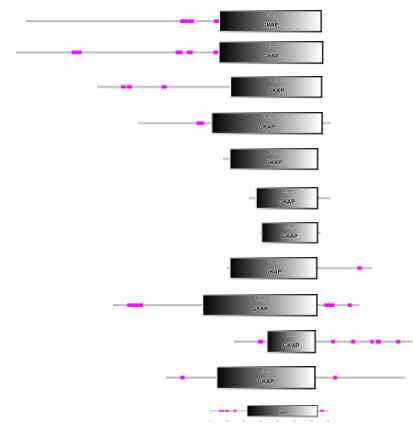

ras/Rap GTPase-activating protein SynGAP

Homo sapiens

Mus musculus

Strongylocentrotus purpuratus

Drosophila melanogaster

Caenorhabditis elegans

Nematostella vectensis

Oscarella carmela

Amphimedon queenslandica

Monosiga brevicollis

Salpingoeca rosetta

NP_006763.2

NP_001268420.1

XP_779967.3

NP_728095.2

NP_741873.1

XP_001627862.1

g1297.t1 (Compagen)

XP_003389599.1

XP_001746437.1

XP_004996548.1

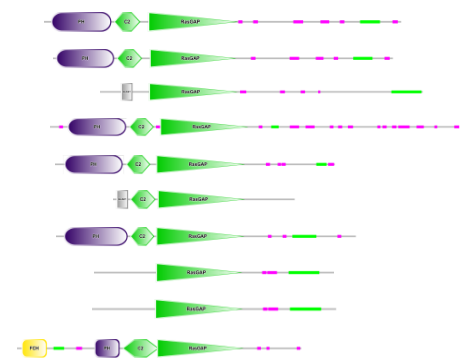

GRIP1

Homo sapiens

Mus musculus

Strongylocentrotus purpuratus

NP_066973.2

NP_083012.1

XP_003725220.1

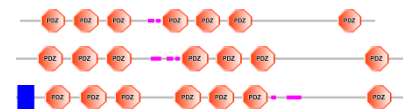

Drosophila melanogaster
O. carmela

NP_572285.2
g2718.t1 (Compagen)

