

X20B

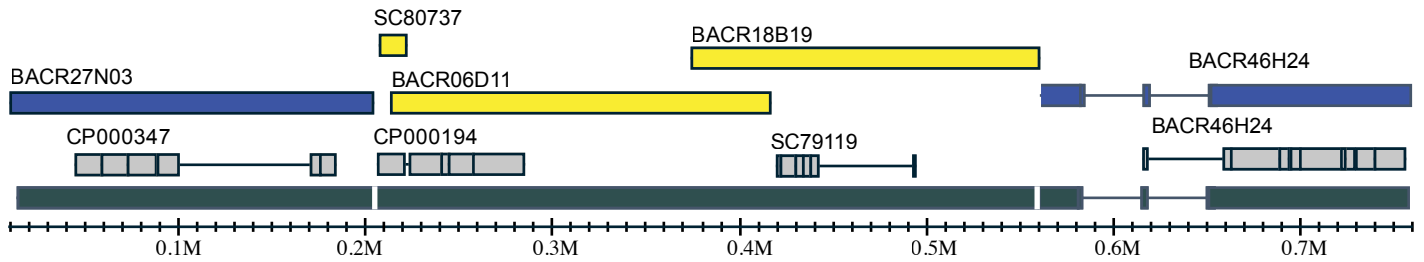

XHet.1

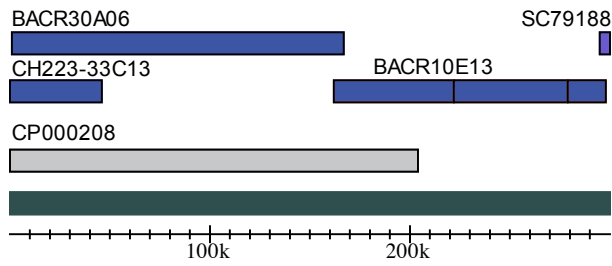

XHet.2

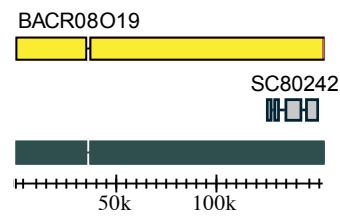

XHet.3

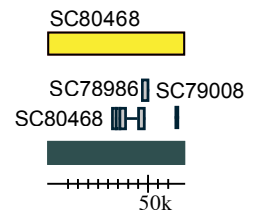

2LHet.1

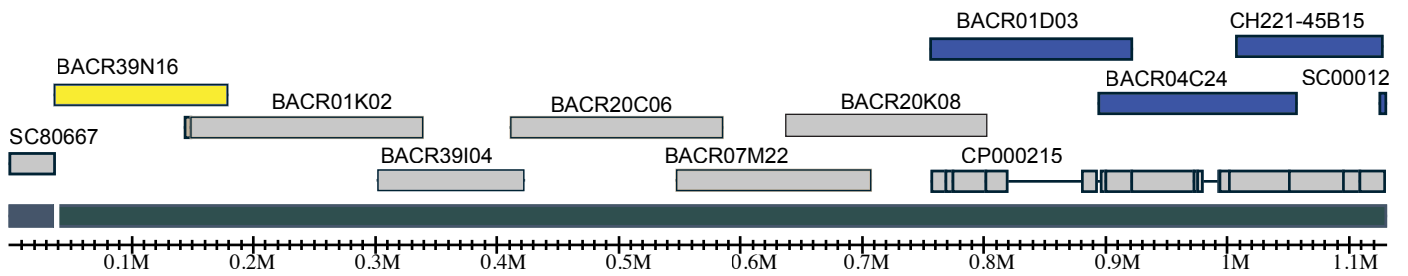

2RHet.1

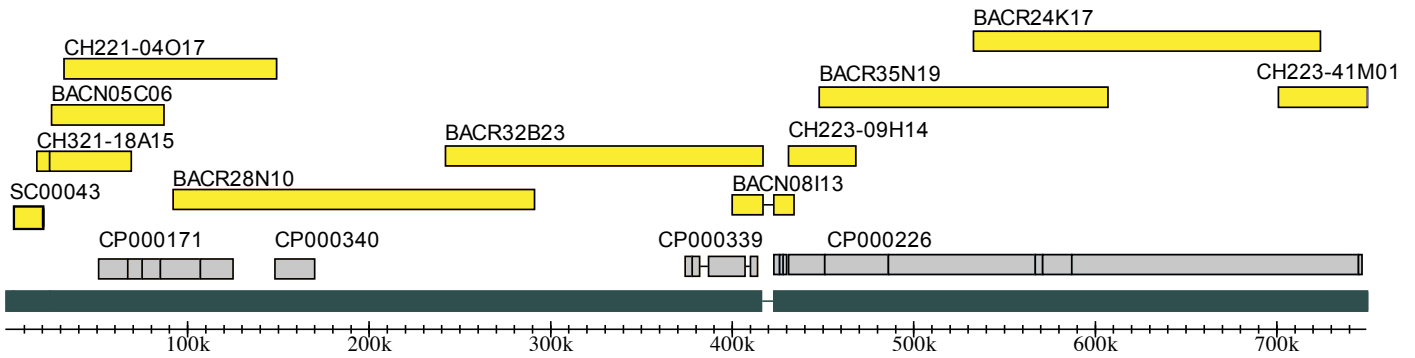

2RHet.2

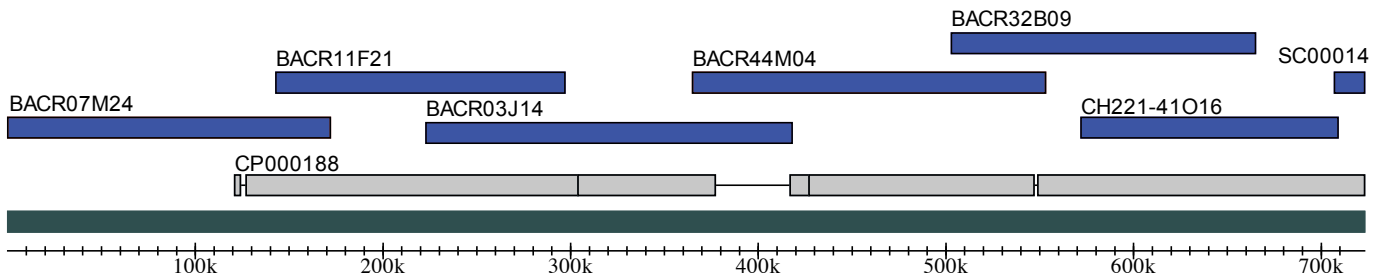

2RHet.3

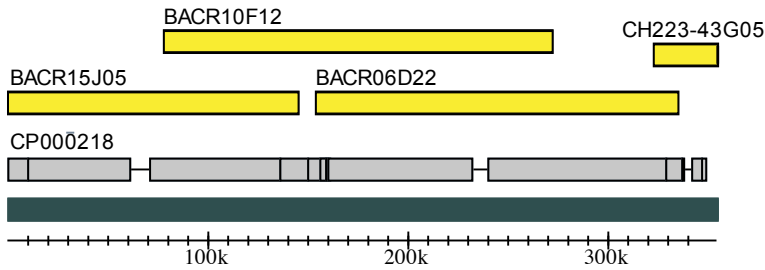

2RHet.4

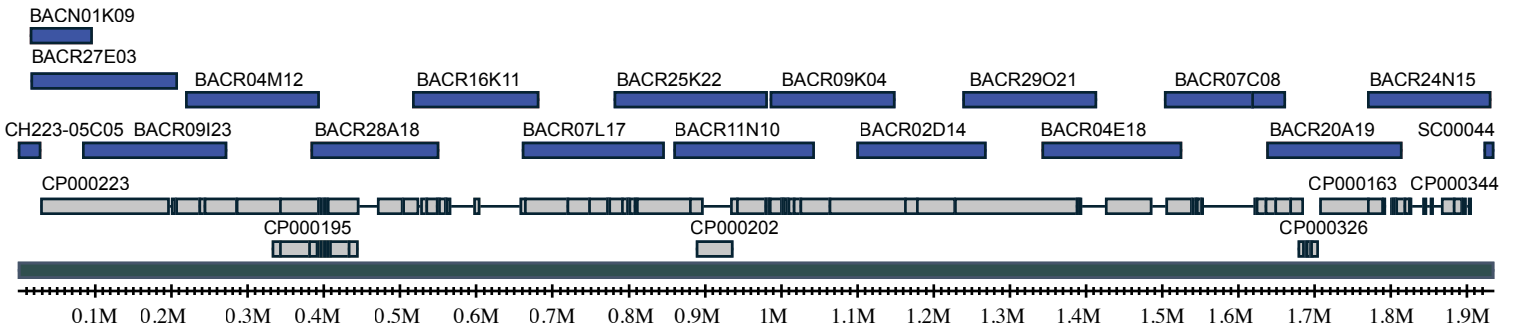

2RHet.5

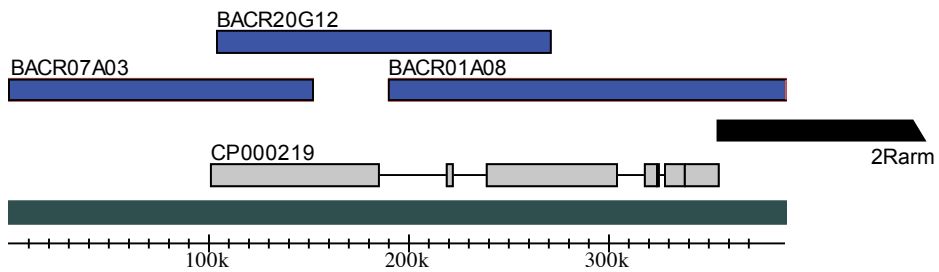

3LHet.1

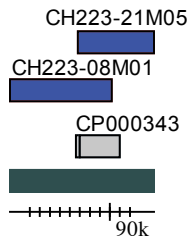

3LHet.2

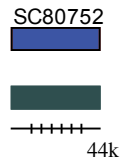

3LHet.3

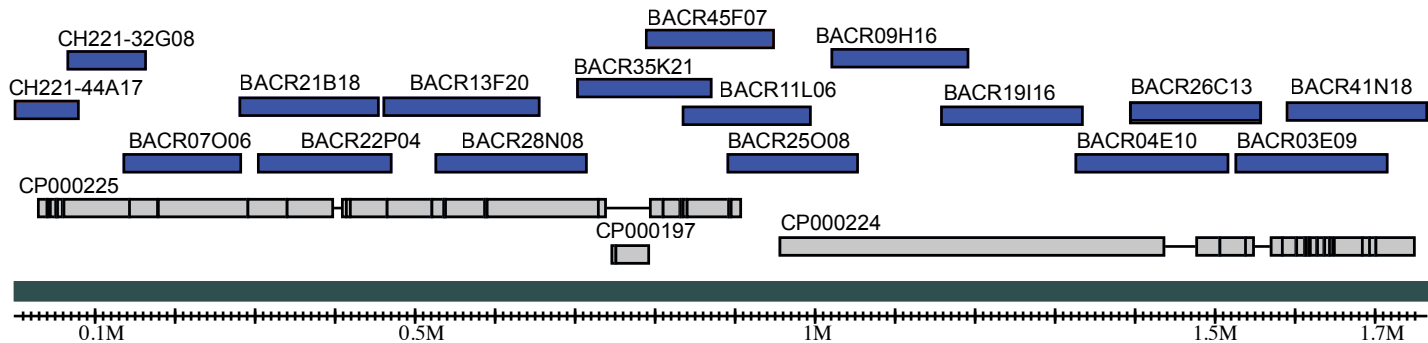

3LHet.4

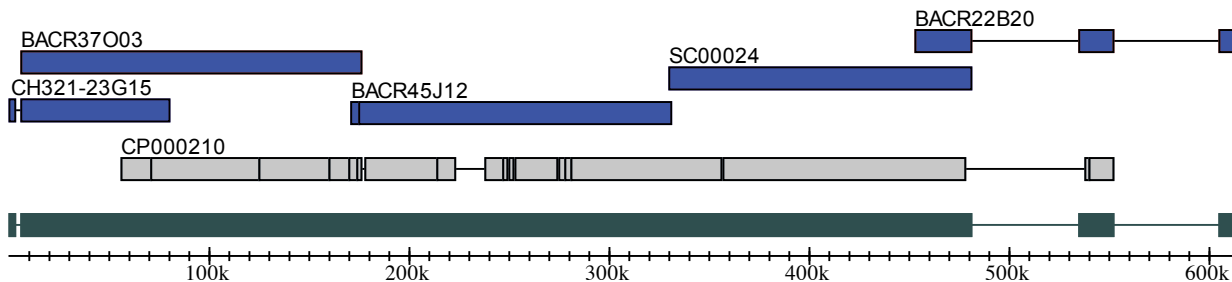

3LHet.5

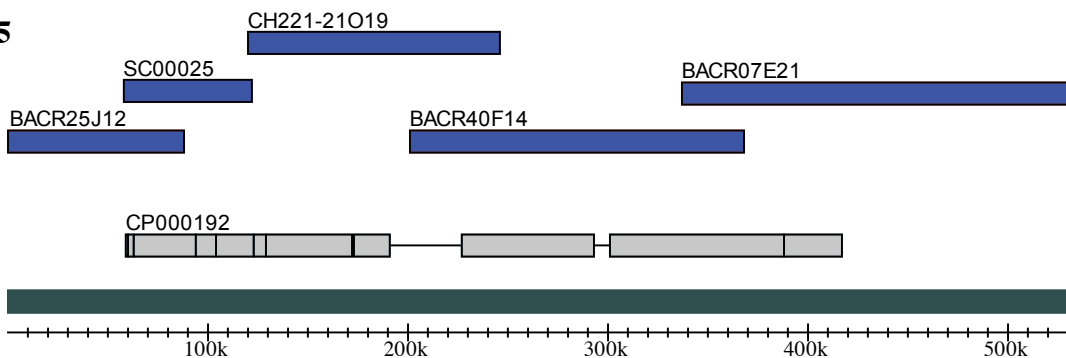

3LHet.6

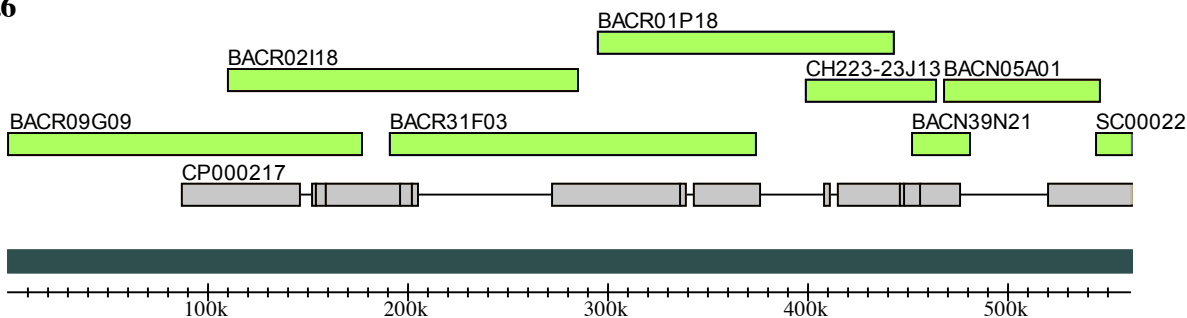

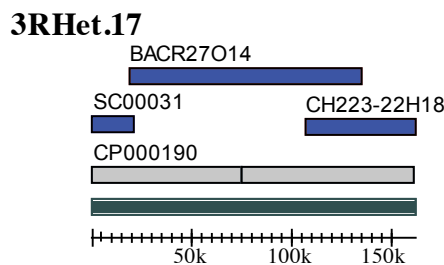
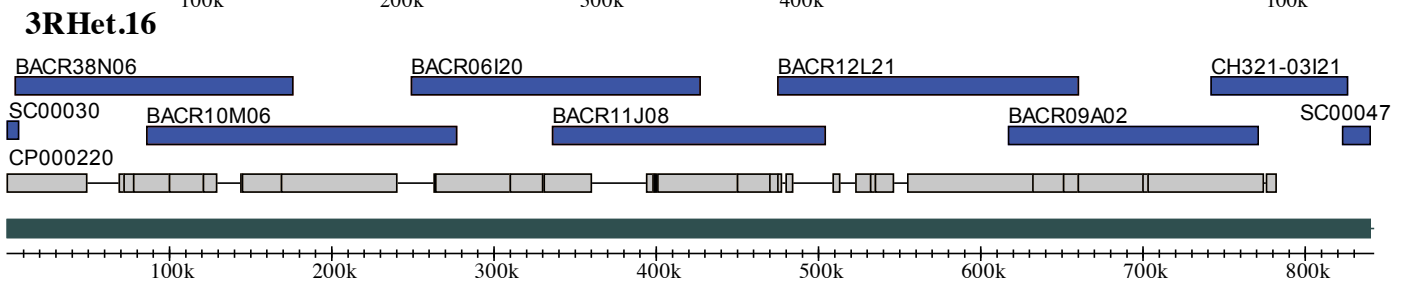
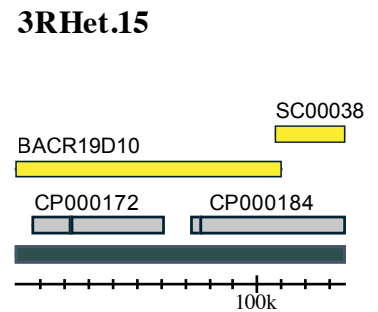
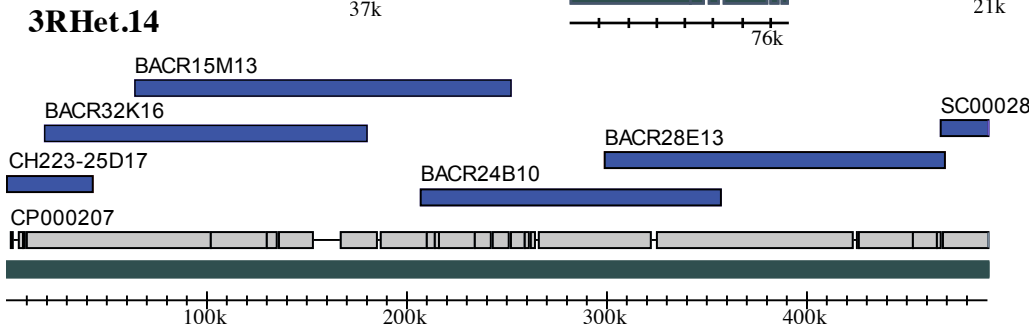
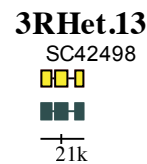
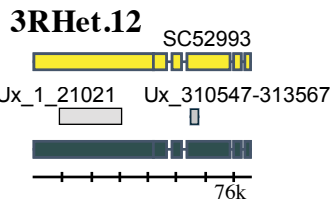
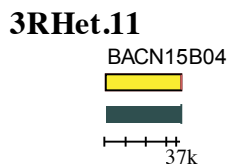
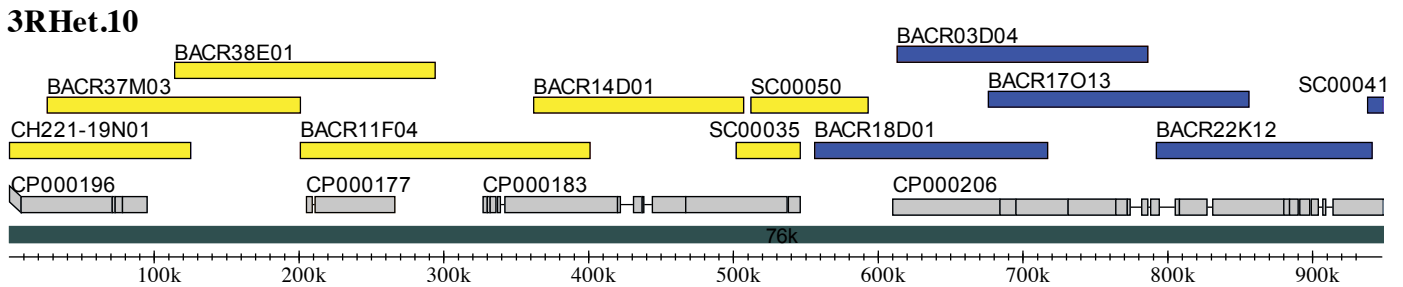
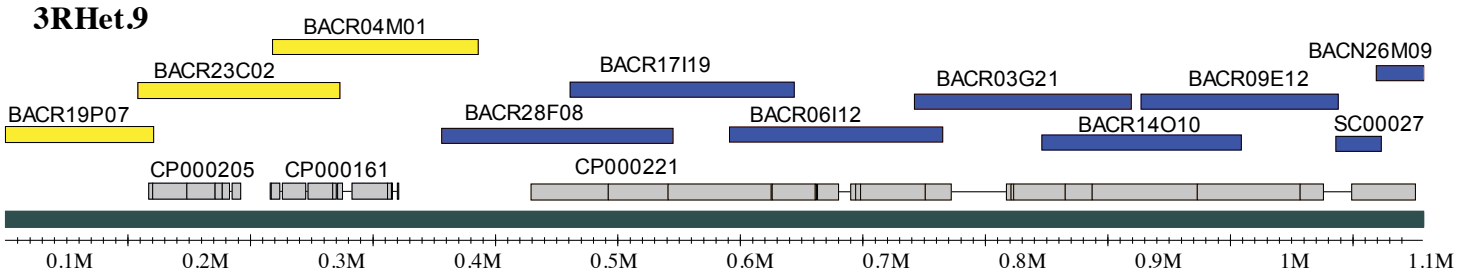
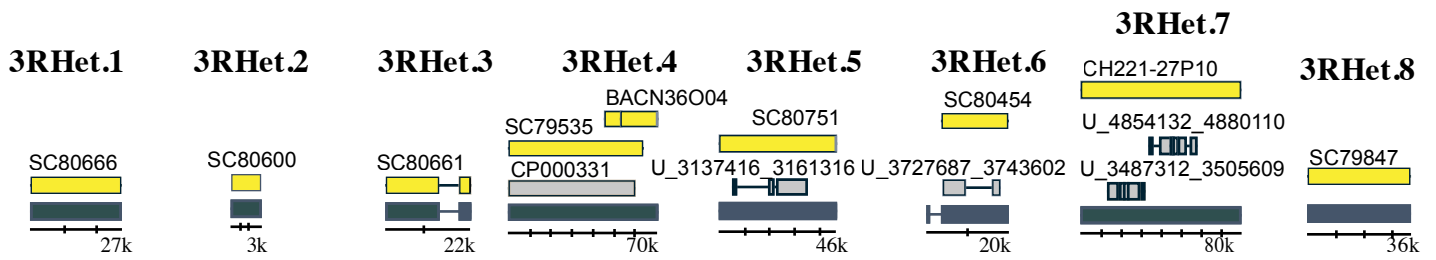

Pp1-Y1

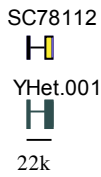

kl5

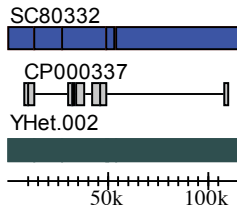

PRY

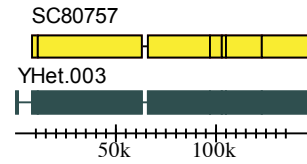

kl3

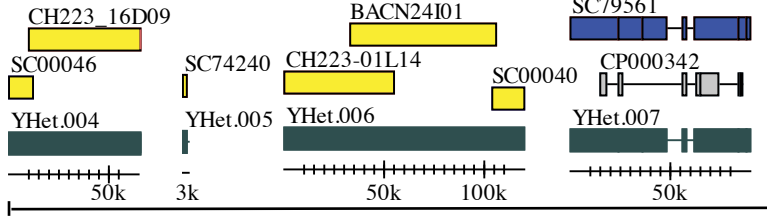

kl2

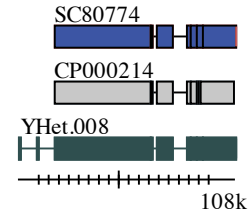

ARY

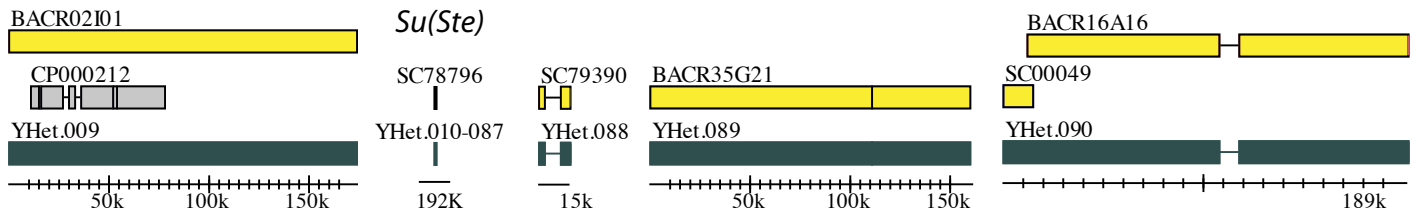

Ppr-Y

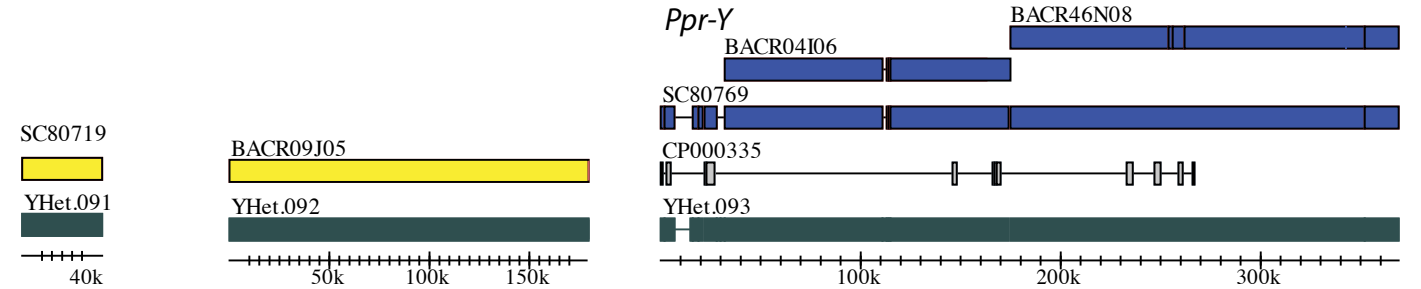

WDY

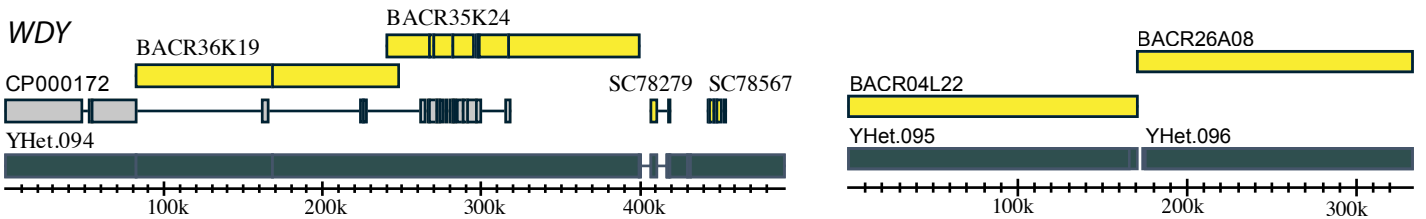

FDY

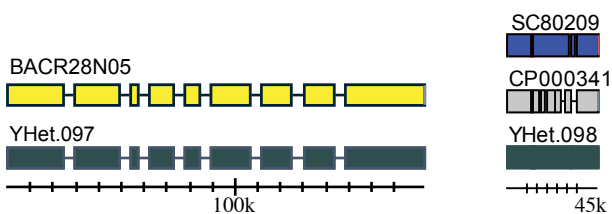

Mst35Y

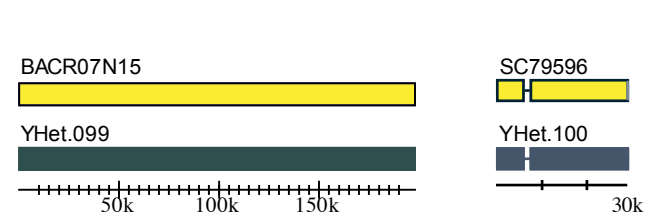

Mst77Y

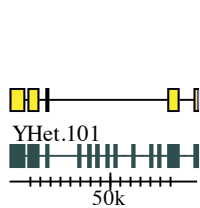

18HT

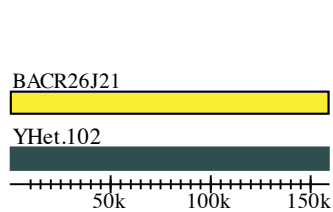

Pp1-Y2

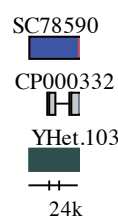

ORY

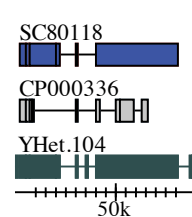

CCY

