

Figure 1

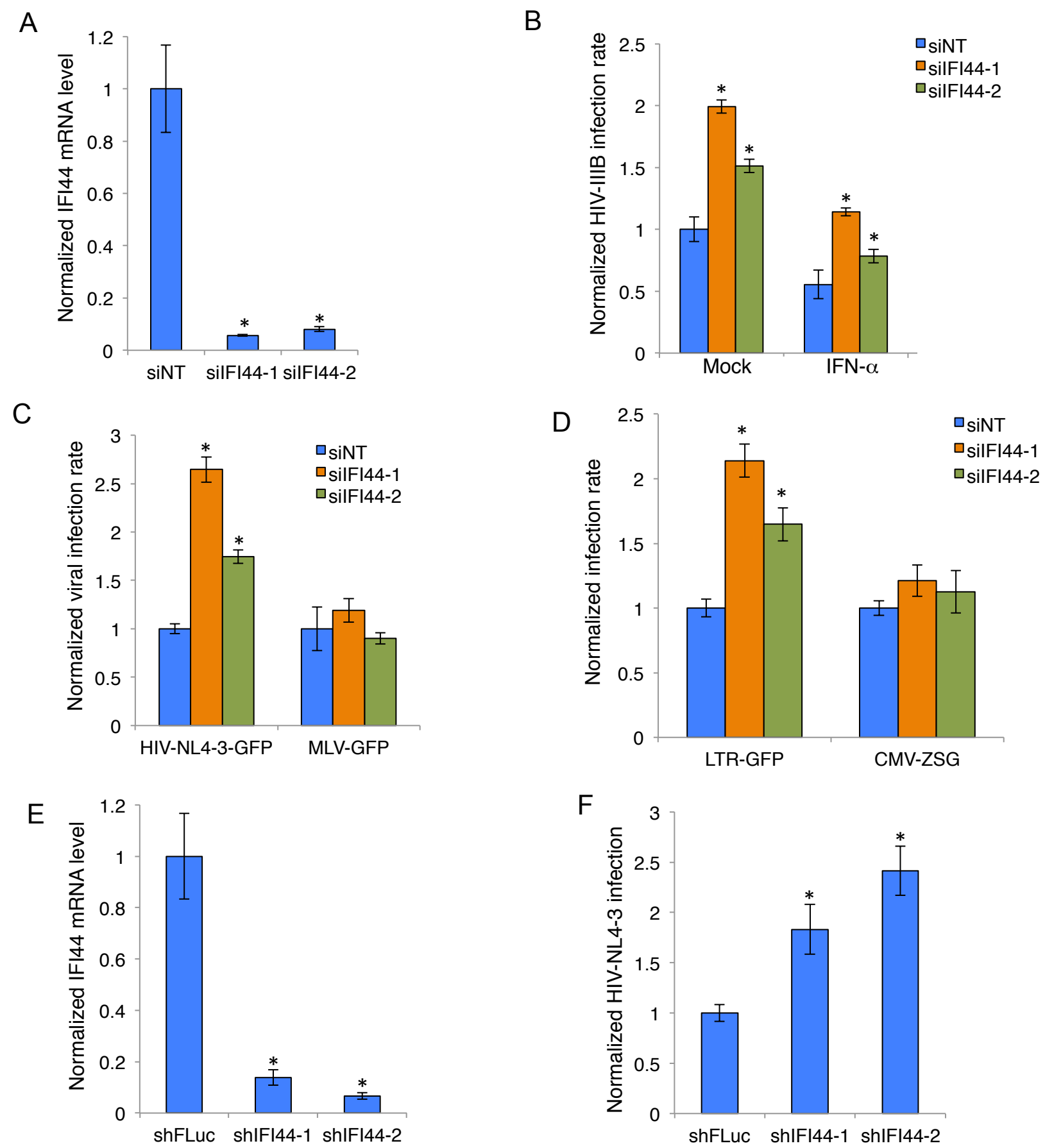

Figure 2

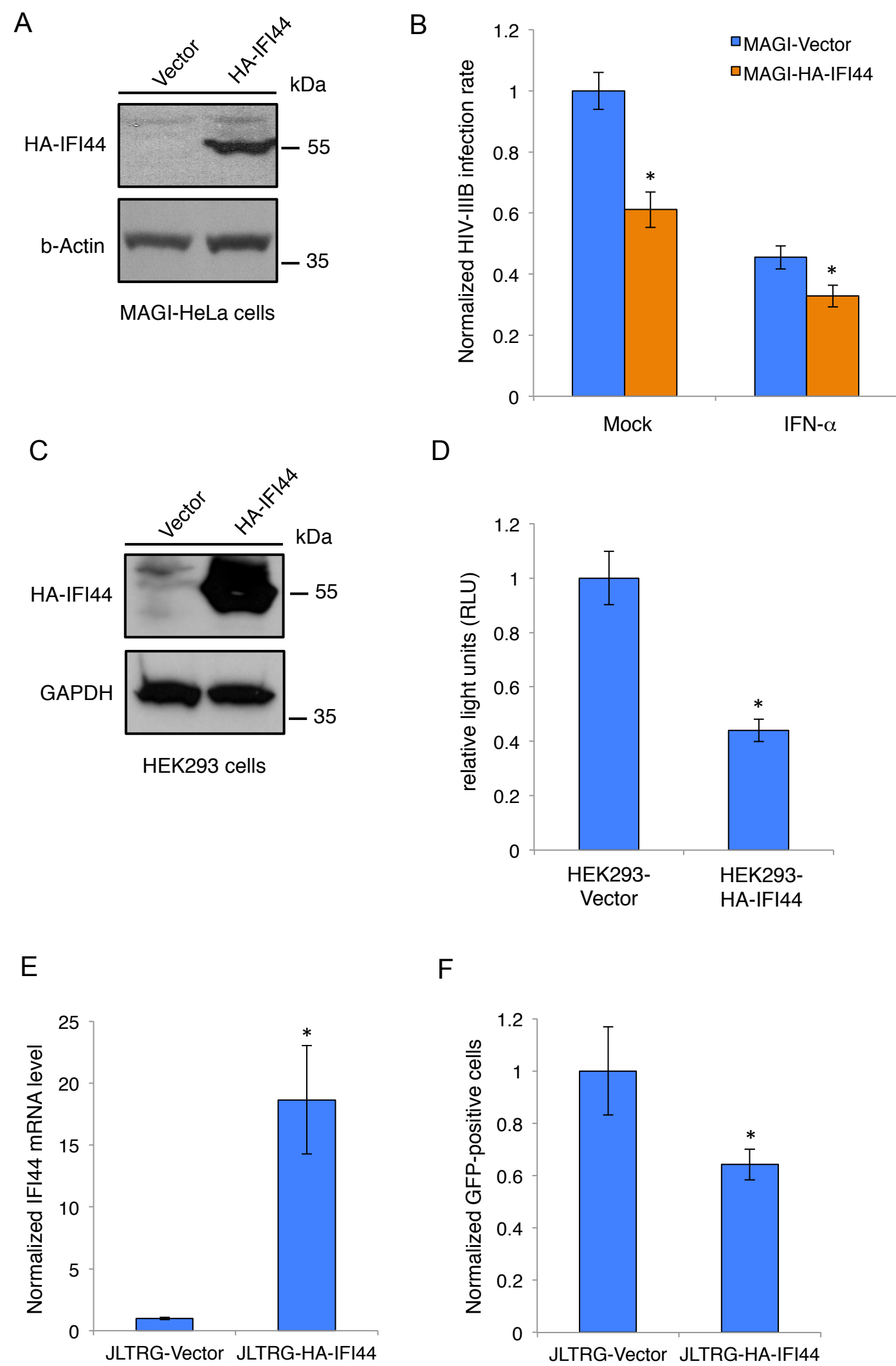
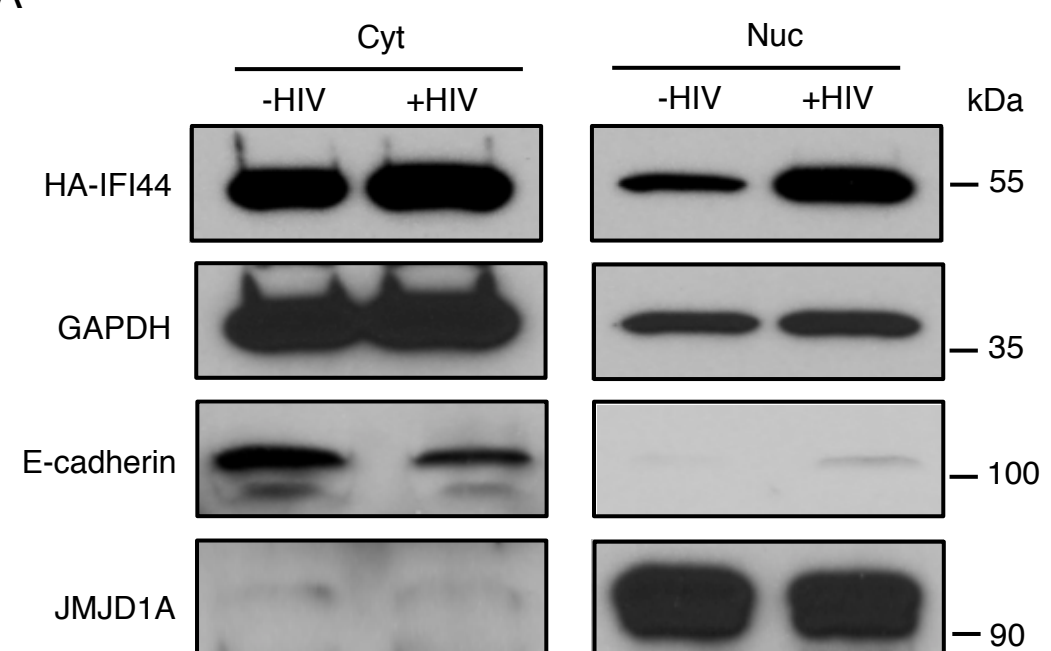

Figure 3

A



B

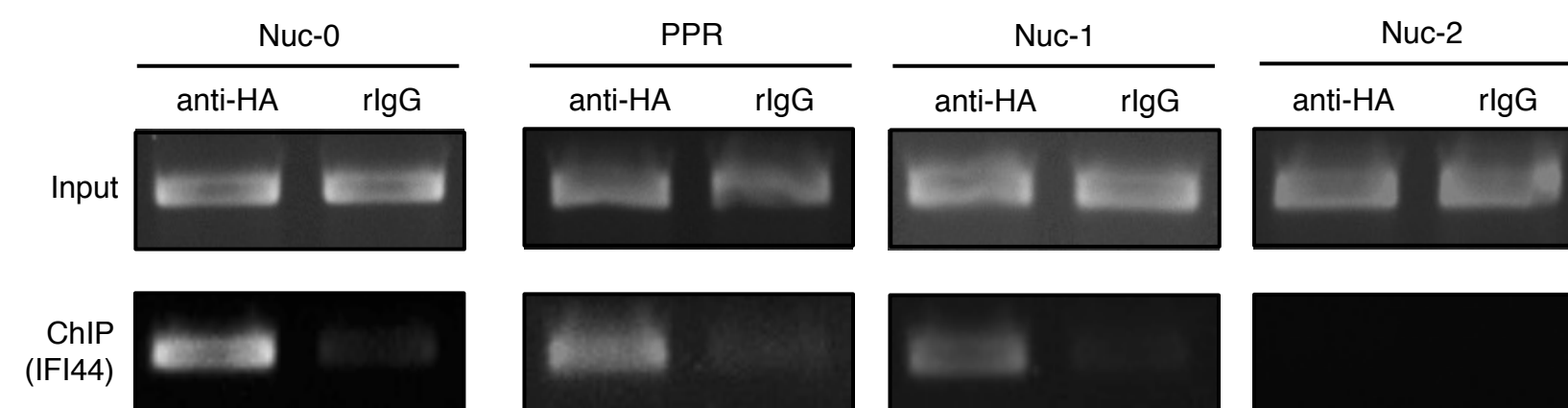
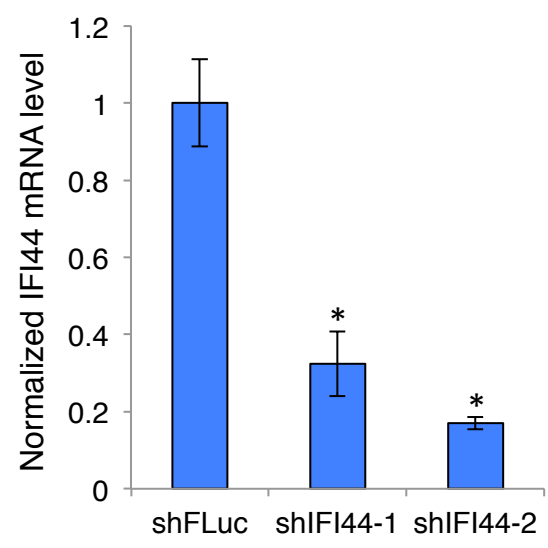
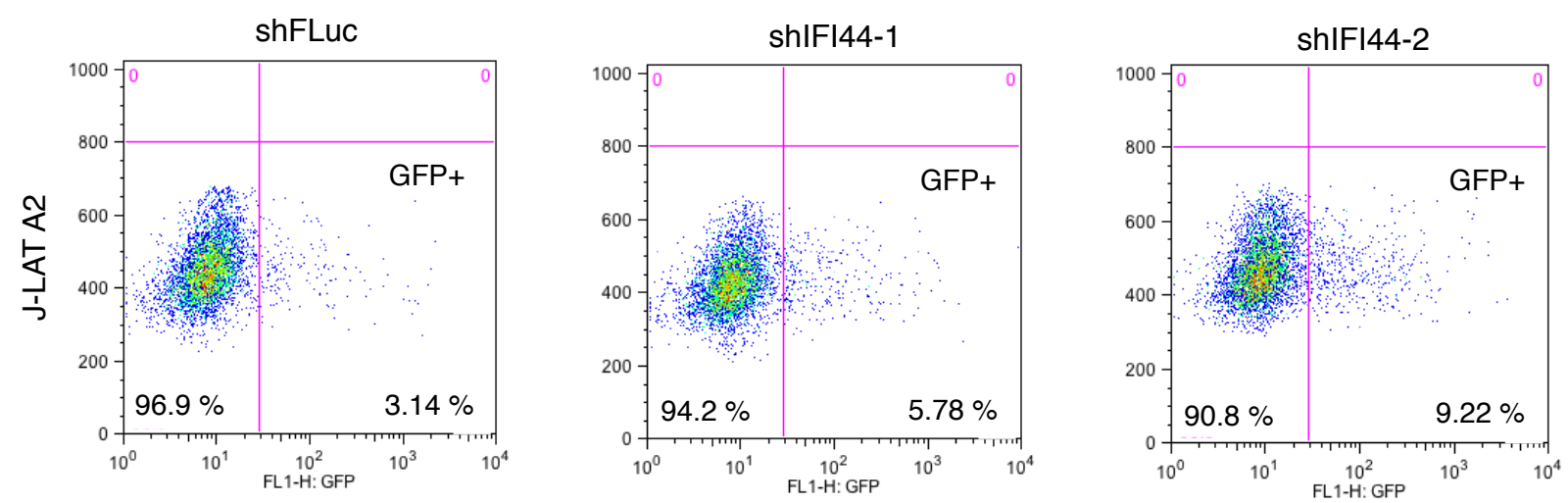

Figure 4

A



B



C

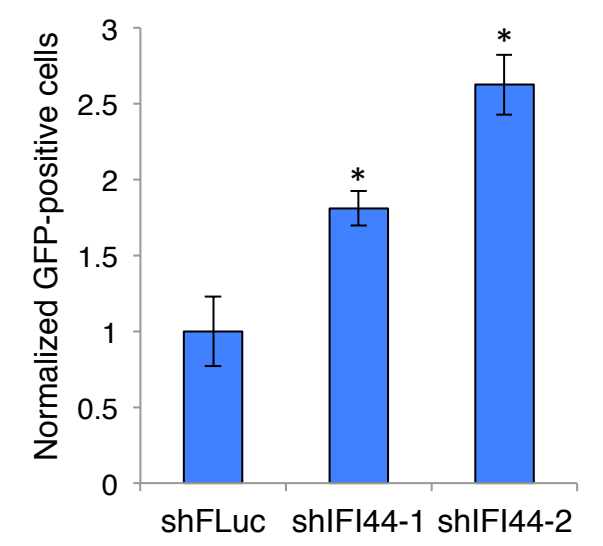

Figure S1

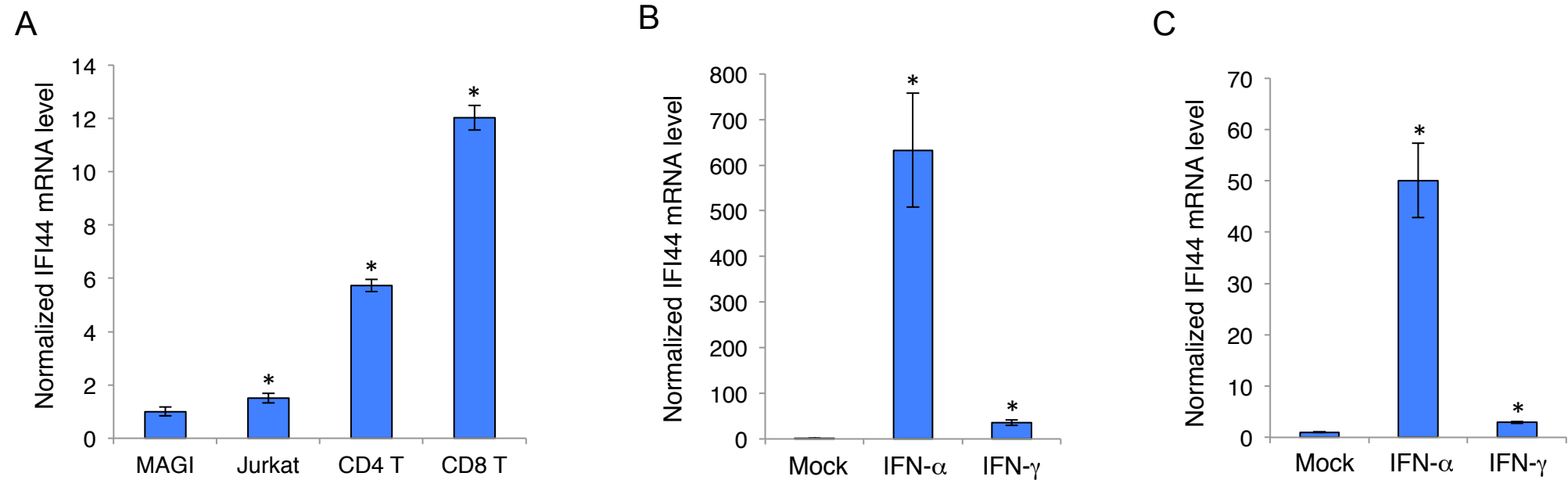
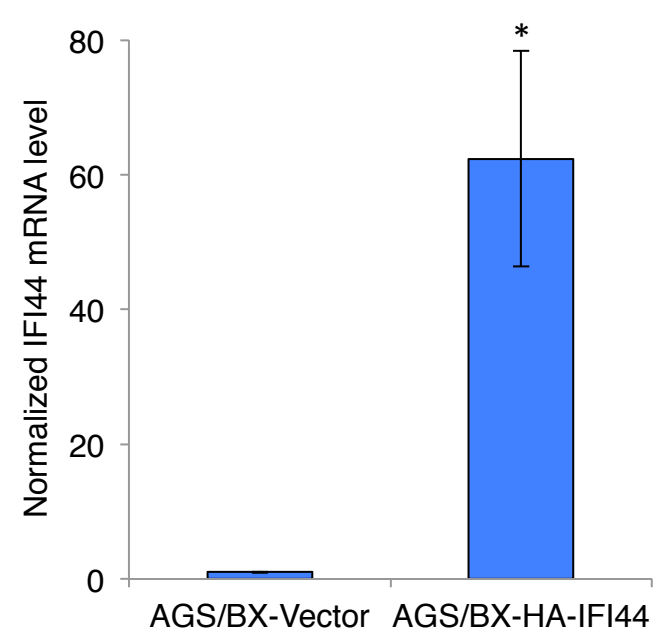

Figure S2

A



B

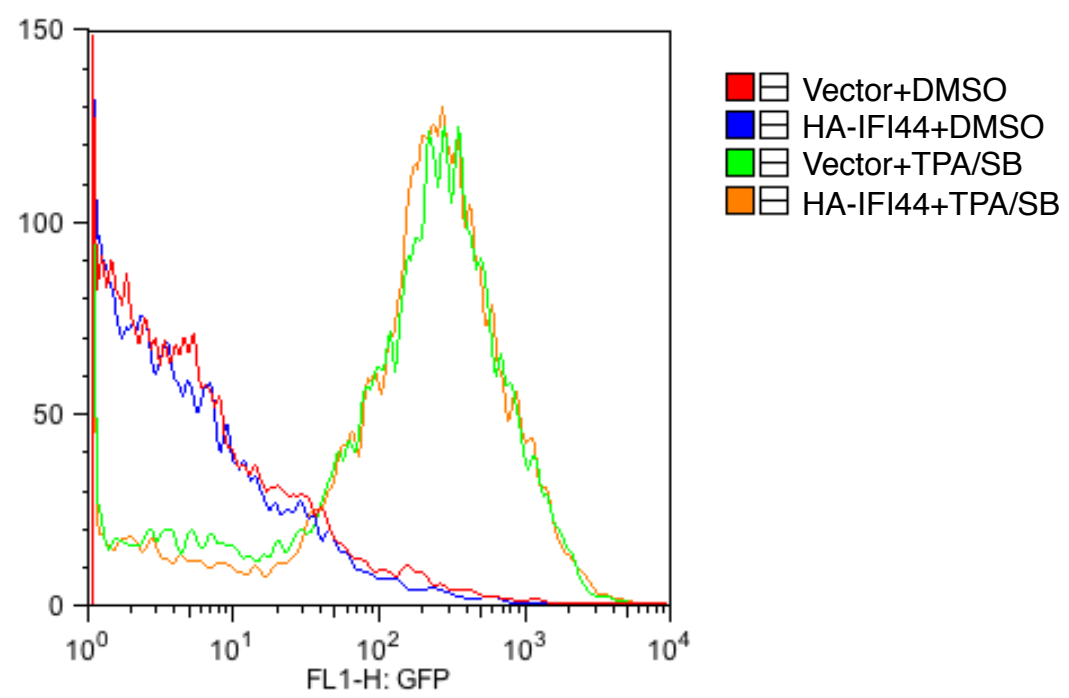

Figure S3

Figure S4

A



B

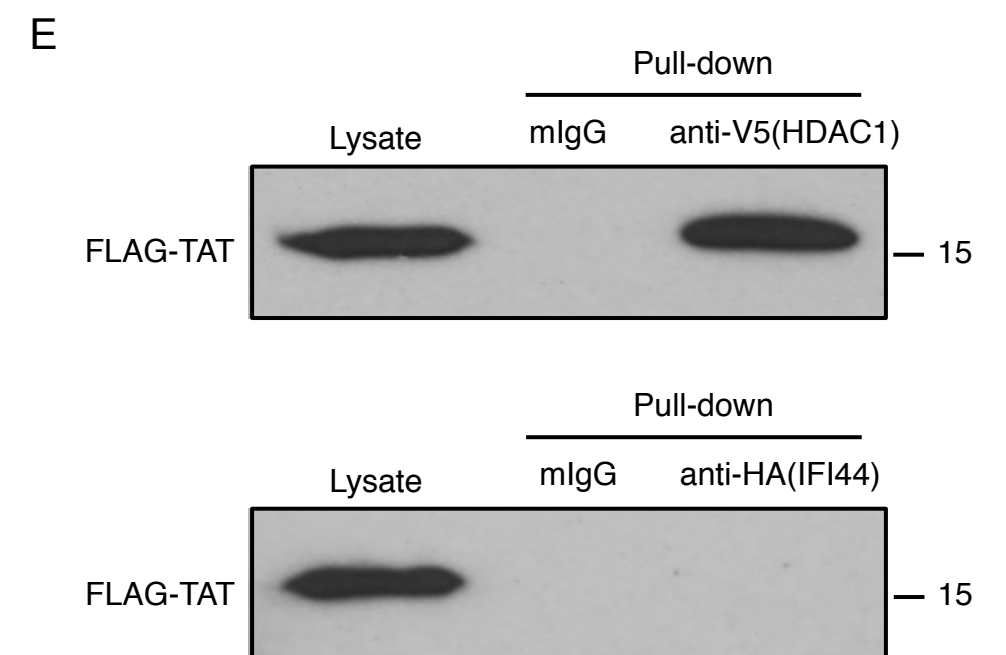
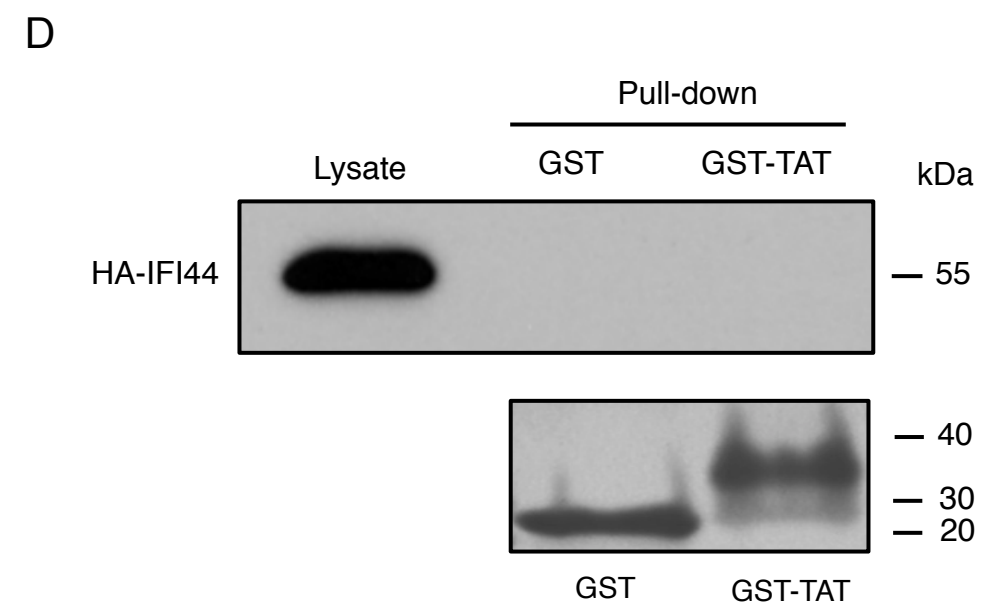
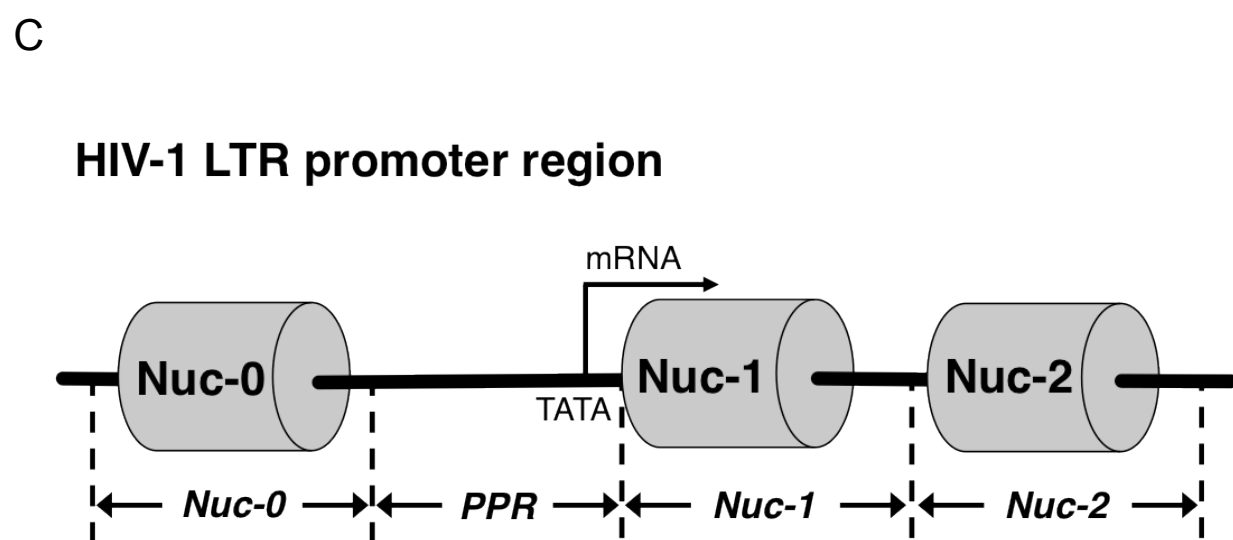
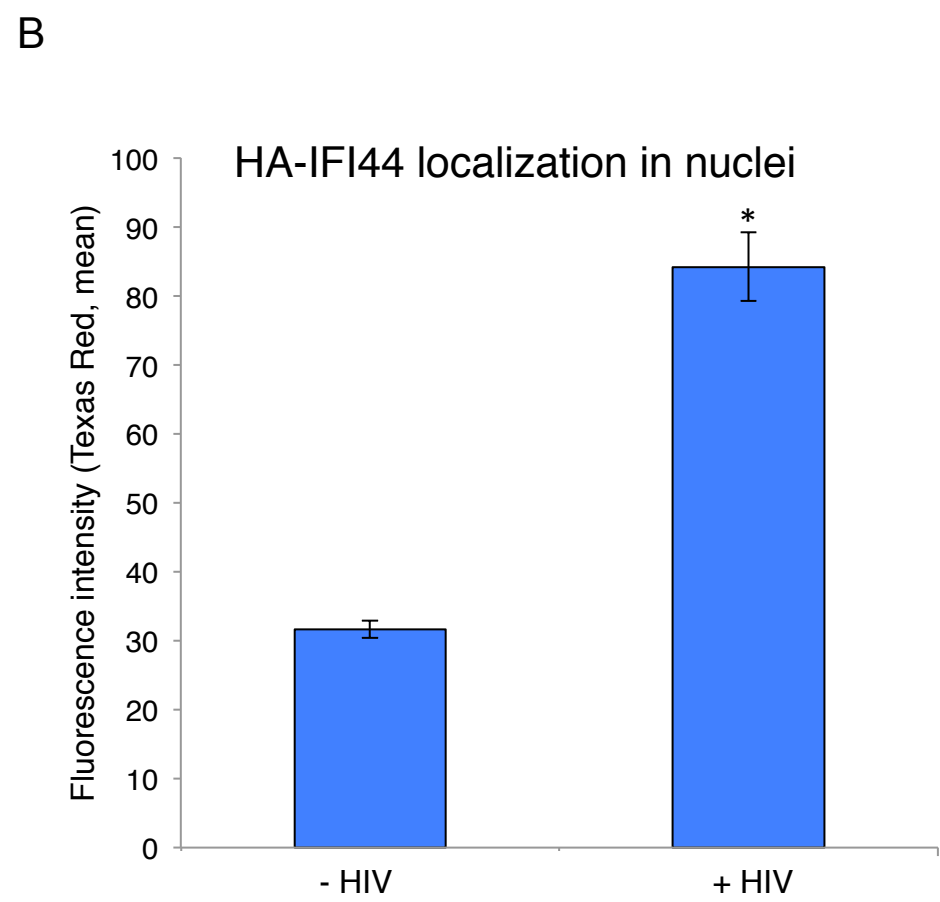
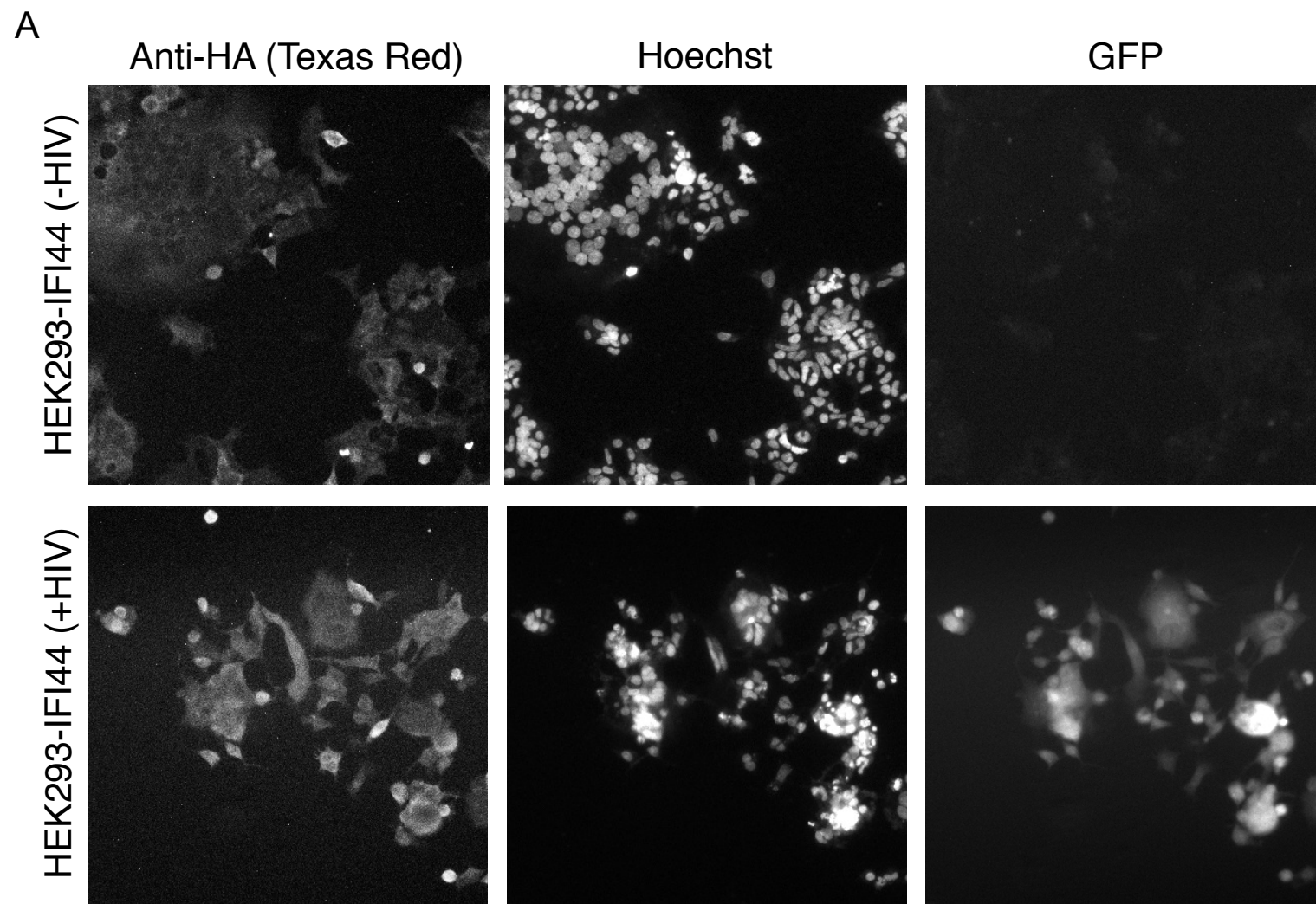
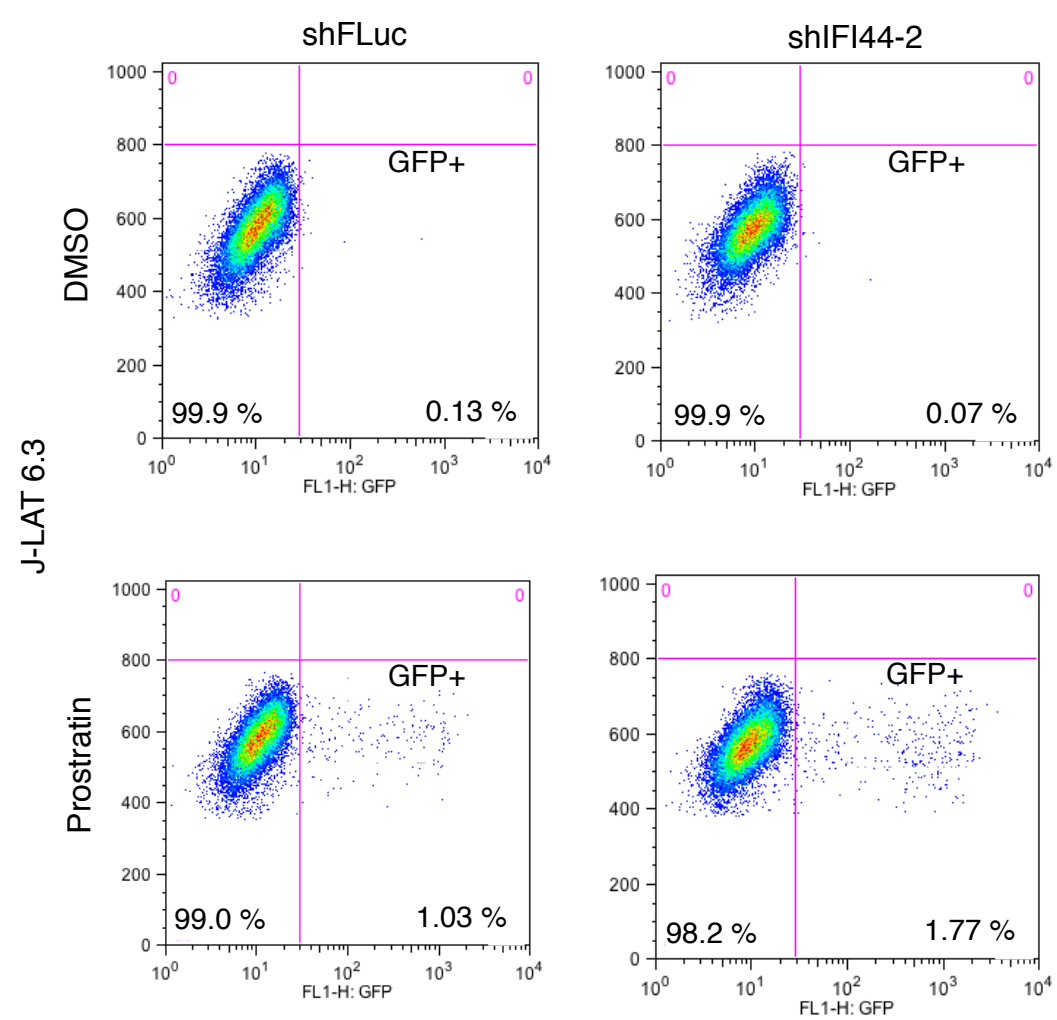