

The Resistance of Collateral Channels in Excised Human Lungs

JAMES C. HOGG, PETER T. MACKLEM, and WILLIAM M. THURLBECK

From the Department of Pathology, McGill University and the Cardiorespiratory Service, Royal Victoria Hospital, Montreal, Canada

ABSTRACT We measured the resistance of collateral channels, R_{co1} , in incomplete interlobar fissures in eight normal and eight emphysematous excised human lungs. Similar measurements were also made from the basal segments to the superior segment of the lower lobe in three normal and five emphysematous lungs. The lobe or segments were inflated through a bronchial cannula; air leaked through collateral channels and out of the other lobe or segment through a pneumotachograph which measured flow. Catheters inserted directly into the lung through the pleural surface on either side of the collateral channels measured the alveolar pressure difference producing collateral flow. R_{co1} is the ratio of this pressure difference to flow. By also measuring the inflating pressure and the airway pressure at the pneumotachograph, we calculated the lobar or segmental airway resistance, R_{aw} . In the normal lungs R_{co1} varied inversely with lung volume and was higher on inflation than on deflation. R_{aw} was very small compared to R_{co1} which ranged from 260 to 3300 cm H₂O/liter per sec when the distending pressure was 20 cm H₂O. In the emphysematous lungs on the other hand, R_{co1} was markedly decreased and ranged from 5 to 20 cm H₂O/liters per sec at the same distending pressure and was less than R_{aw} . We conclude that collateral channels are important ventilatory pathways in emphysema. When many units within a lung are ventilated by these pathways there may be disturbances of gas exchange and phase differences between normally and abnormally ventilated areas.

INTRODUCTION

In a recent study we found that airways less than 2 mm in diameter were responsible for the bulk of the in-

Dr. Hogg is a Harrison Watson Scholar of McGill University, supported by the Medical Research Council of Canada.

Received for publication 8 May 1968 and in revised form 23 September 1968.

creased airways resistance seen in emphysema (1). The fact that many of these small airways were occluded without evidence of atelectasis led to a consideration of the collateral pathways of ventilation in these lungs. Anatomic information concerning collateral pathways has been accumulating for over a century (2), but their physiologic significance was first studied much more recently (3, 4). To the best of our knowledge there has been no previous measurements of the resistance offered by collateral pathways either in normal or diseased human lungs.

Our experiments consisted of flowing air through three resistors in series (i.e., the lower lobe airways, the collateral channels in incomplete interlobar fissures, and the upper lobe airways). As the resistors are in series the flow through each of them at any point in time is equal, and thus resistance can be calculated if the pressure drop across them is known.

METHODS

The technique for measuring the resistance to collateral flow is shown in Fig. 1. The trachea was cannulated and the lung was suspended in a volume displacement plethysmograph. A Foley catheter was inserted through the side arm of the cannula and after its tip was placed in a desired position the balloon was inflated and tied in place to produce an airtight seal. To study the collateral channels in incomplete interlobar fissures the catheter was placed in the lower lobe bronchus so that air flowed from the lower lobe through the incomplete interlobar fissure and out of the upper lobe. To study the collateral channels within the lower lobe the catheter tip was placed in the lower lobe bronchus beyond the branch to the superior segment so that air flowed from the basal segments through collateral channels and out of the superior segment. In all of the experiments this flow was measured by a Sanborn 270 transducer attached to a pneumotachograph connected to the trachea.

We refer to the inflow bronchus as the airway through which air entered the system, i.e., the lower lobe bronchus or the bronchus to the basal segments, and the outflow bronchus as the airway through which air left the system i.e. the upper lobe bronchus or the apical segmental bronchus. Similarly, the inflow alveoli are the alveoli of the lower lobe

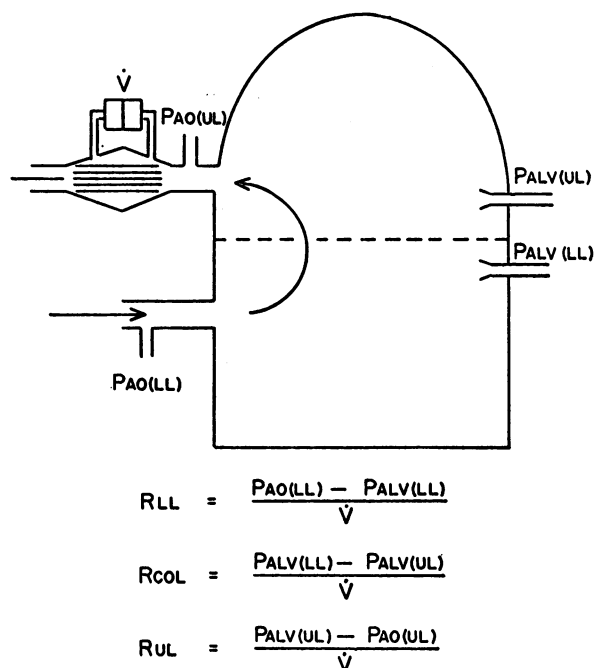

FIGURE 1 Diagrammatic illustration of method used to measure resistance to collateral flow. Air flowed through the lower lobe airways, across collateral channels in incomplete interlobar fissures, or between the basal and apical segment of the lower lobe, and through the airways leading from the upper lobe to atmosphere (indicated by arrow). The resistance offered by each of these structures was computed under steady-flow conditions. R_{LL} = lower lobe airway resistance; R_{COL} = the resistance of the collateral channels; and R_{UL} = the resistance of the upper lobe or apical segment airways; $P_{AO(LL)}$ = pressure measured at the opening of the lower lobe cannula; $P_{ALV(LL)}$ = alveolar pressure in the lower lobe; $P_{ALV(UL)}$ = alveolar pressure in the upper lobe; $P_{AO(UL)}$ = pressure at the airway opening of the upper lobe; \dot{V} = the flow.

or basal segments, and the outflow alveoli are the alveoli of the upper lobe or apical segment.

In the early experiments we only measured the pressure difference across the whole system, i.e., the pressure difference between the inflow and outflow bronchi. This was accomplished by passing a PE 190 polyethylene catheter through the Foley catheter and into the inflow bronchus and measuring the pressure in this catheter relative to the pressure at the upstream end of the pneumotachograph with a Sanborn 267B transducer. In subsequent studies the pressure differences across the three resistances were partitioned. This required the measurement of alveolar pressure on either side of the collateral channels, i.e., in both the inflow and outflow alveoli. This was accomplished by inserting polyethylene catheters, 1.2 mm internal diameter, with a bell-shaped end 3 mm in diameter, through the pleural surface in either side of the interlobar fissure or in a basal and apical segment of the lower lobe. Leaks were prevented around the catheter by taping them to the pleura with 3-0 silk thread and covering the junction of the catheter and pleura with Eastman 910 tissue adhesive. The pressure drop along the lower lobe or basal segments airways was mea-

sured by a Sanborn 267B transducer attached to the catheter at the cannula tip and the subpleural catheter in that lobe or segment. The pressure drop across the collateral channels was measured on another Sanborn 267B transducer attached to both subpleural catheters, and the pressure drop along the upper lobe or superior segment airways was measured by comparing the appropriate subpleural pressure to the tracheal pressure on another Sanborn 267B transducer. Pressure, volume, and flow signals were recorded on a Sanborn 4 channel recorder and a Tektronix storage oscilloscope (Tektronix, Inc., Beaverton, Ore.).

The protocol of the experiments was as follows. The cannulated lower lobe or basal segments of the lower lobe was inflated to a distending pressure of 30 cm of H_2O and deflated to 0 cm of H_2O several times to ensure a constant volume history. After the third or fourth inflation the maneuver was repeated quasi-statically requiring at least 1 min to complete. The volume change occurring in the lower lobe or basal segments was plotted simultaneously against both the distending pressure of these structures and against the flow which occurred through the collateral channels on the storage oscilloscope. These records were then copied on graph paper by an oscillogracer. After this, similar inflation and deflations were performed, and the flow was plotted against the pressure drop across the collateral channels and the pressure drop occurring along the outflow airways, and these records were traced. Finally, after a full inflation of the lower lobe or basal segments the distending pressure was held at 20 cm of H_2O . Flow under these conditions remained constant, and the pressure drop occurring along the inflow airways, across the collateral channels and along the outflow airways, was measured. At the beginning and end of each run the whole lung was inflated and held at a constant volume. The alveolar pressure as measured by the subpleural catheters was compared to the true alveolar pressure (the static distending pressure). If they were not equal the run was discarded.

The resistance of the lower lobe airways, the collateral channels, and the upper lobe airways could then be calculated as follows:

$$R_{aw(LL)} = \frac{P_{ao(LL)} - P_{alv(LL)}}{\dot{V}}$$

$$R_{col} = \frac{P_{alv(LL)} - P_{alv(UL)}}{\dot{V}}$$

$$R_{aw(UL)} = \frac{P_{alv(UL)} - P_{ao(UL)}}{\dot{V}}$$

where $R_{aw(LL)}$ = lower lobe airway resistance; R_{col} = collateral flow resistance; $R_{aw(UL)}$ = upper lobe airway resistance; $P_{ao(LL)}$ = pressure measured at the tip of the Foley catheter; $P_{alv(LL)}$ and $P_{alv(UL)}$ = pressures measured by catheters inserted in the pulmonary parenchyma of lower lobe and upper lobe, respectively; $P_{ao(UL)}$ = pressure at the trachea; and \dot{V} = steady-state flow.

The morphologic studies were carried out after the lungs had been fixed by intrabronchial liquid formalin at a constant pressure of 25 cm of formalin. Emphysema was assessed by measuring the percentage of parenchyma involved, the internal surface area, the mean linear intercept (average interalveolar distance), and by a subjective index of emphysema which scores severity on a scale of 0-30 units. The techniques used to make these measurements are fully described elsewhere (5). To assess the severity of emphysema

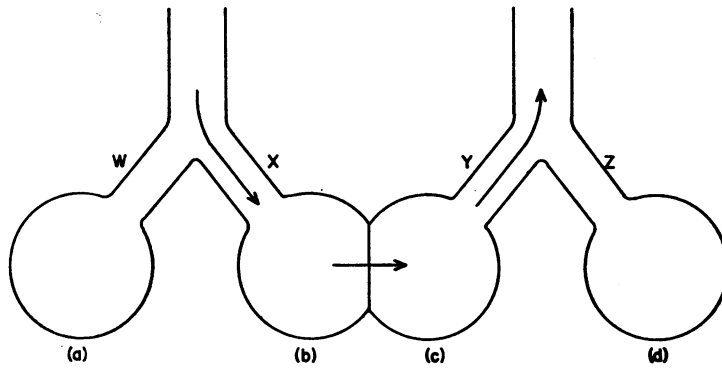

FIGURE 2 Sources of error in measuring alveolar pressure under dynamic conditions. This diagram illustrates the possible source of error in measuring the pressure difference across alveoli. If the pressure were measured in alveolus (a) rather than (b) we would tend to overestimate the pressure in alveolus (b) by an amount equal to the flow resistive pressure drop along airway X. Similarly, if pressure were measured in alveolus (d) rather than (c) we would underestimate the pressure by an amount equal to the flow resistive pressure drop along airway Y.

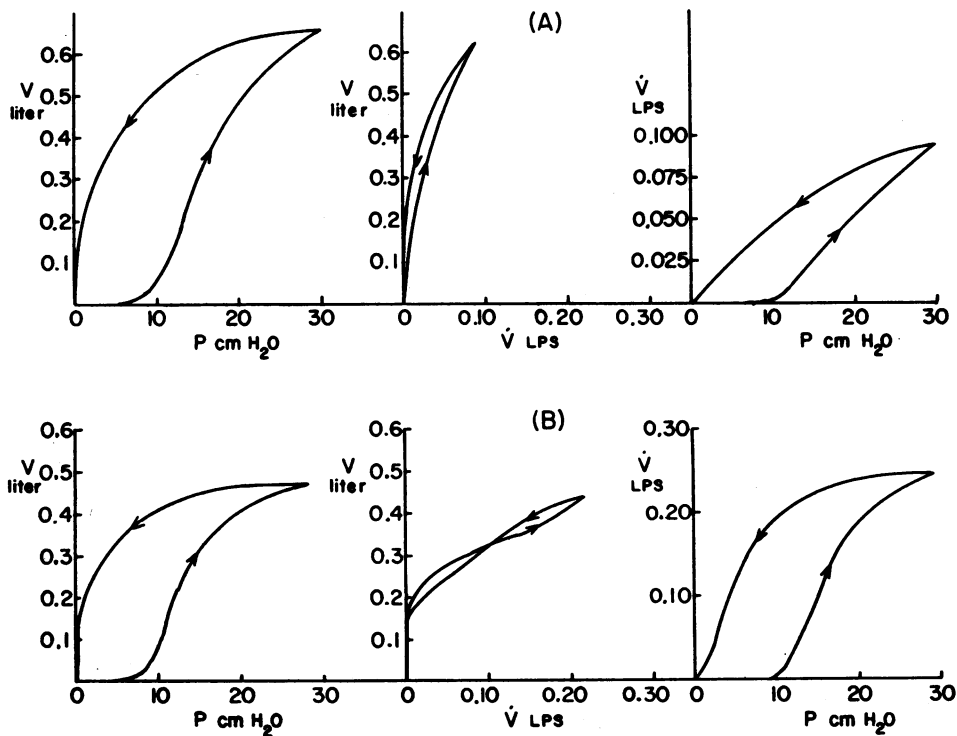

FIGURE 3 (A) (Case 11). The left and center panels represent data traced from the storage oscilloscope when lower lobe volume was simultaneously plotted against its distending pressure and flow leaving the lobe via collateral channels during a single inflation and deflation of the lobe. The panel on the right was constructed from the first two by plotting pressure against flow at the same volume. The data demonstrate that the flow leaving the lobe via collateral channels at a given volume is similar on both inflation and deflation, and that the channels conducting collateral flow undergo a volume hysteresis. (B) (Case 10). Similar data from a case of mild emphysema.

in the incomplete interlobar fissure and at the junction between the basal and superior segment of the lower lobe, paper-mounted sections of each lung were randomized and given to one observer (W. T.), who graded the emphysema in these areas as absent, mild, moderate, or severe.

Assumptions and possible sources of error. We are confident that the subpleural catheters were accurately measuring pressure in the air spaces in which they were situated. Under static conditions with the whole lung inflated, the subpleural catheters recorded pressures identical with the static distending pressure of the lobe. In these circumstances the catheters were certainly measuring alveolar pressure. That this was also the case when collateral flow was allowed to occur is shown by the following considerations. Under these conditions air from the parenchyma of the lung was freely removable through the catheter. The catheter was therefore in direct communication with the air in the parenchyma, and the pressure at its tip must have been equal to the pressure of the air within the parenchyma at that point.

Because the catheter was inserted into alveolar structures rather than airways this pressure must represent the alveolar pressure at the point of measurement.

Was this pressure identical with the pressure that would have been at this point if the catheter had not been placed there? In other words, what distortion did the catheter cause? Clearly there must have been considerable disruption of alveolar walls to accommodate the catheter. Under static conditions with no air flowing this is of no importance. In other words, as long as one group of air spaces (whether or not alveolar walls are intact) communicate with the rest of the lung, the pressures must everywhere be equal. We know that this was the case because the pressures were identical with the static distending pressures and because air was freely removable from the catheters.

Under dynamic conditions with the pressures in the alveoli changing continually the disruption of the alveolar walls and the presence of the catheter would be very likely to distort the pressure at the catheter tip. However, these

TABLE I
Collateral Flow from the Lower to the Upper Lobe

Case No.	Age	Sex	Side	Collateral flow	Involvement of the fissure	Emphysema				
						Involvement of the entire lung			Point count, parenchyma involved	Subjective index
	yr			cc/sec		Lm	ISA _s	%		
						% predicted	% predicted			
Normal										
1	19	M	L	76	0	87	109	<1	0	
2	31	F	R	Complete fissure	—	89	94	<1	0	
3	33	M	L	Complete fissure	—	100	103	<1	0	
4	45	M	L	25	0	102	103	<1	0	
5	52	M	R	25	0	89	111	<1	0	
6	63	F	L	Complete fissure	—	93	90	<1	0	
7	67	F	L	6	0	116	82	<1	0	
8	72	F	L	20	0	95	105	<1	0	
Emphysema										
9	52	M	R	260	0	89	86	5.8	2	
10	73	F	R	150	0	117	79	5.9	1	
11	58	M	L	50	Moderate	124	82	41.0	16	
12	80	M	R	500	Moderate	127	82	47.2	10	
13	53	F	R	Complete	—	125	84	51.4	14	
14	70	M	L	Large	Moderate	106	113	60.9	14	
15	73	M	L	Large	Severe	146	66	87.3	17	
16	59	M	R	400	Moderate	154	59	95.3	18	

Lm = mean linear intercept.

ISA_s = internal surface area corrected to a lung volume of 5 liters.

Point count = modification of Dunnill's method of quantitating emphysema.

Subjective index = an arbitrary index of emphysema which ranges from 0 to 30 units.

Involvement of the fissure = subjective assessment of emphysema in the region of the incomplete lobar fissure.

Collateral flow measured at a lower lobe distending pressure of 20 cm/H₂O after full inflation of the lung.

were not the conditions of our experiments. Each experiment was performed either statically or quasi-statically in the sense that volumes and flow were constant or nearly so. When flow is constant the pressure in each alveolus will also be constant. If each alveolus communicates freely with its immediate neighbors then the pressure differences between adjacent alveoli must be determined solely by any flow between one alveolus and its neighbor and the frictional resistance of the pathways between the alveoli. Within a secondary lobule it is reasonable to conclude that this would result in a very small pressure difference. Thus the pressures within the alveoli of a secondary lobule when there is constant collateral flow are also constant and are, to a close approximation, equal to one another. If so, the destruction of the alveolar walls and the insertion of the catheter should not influence the pressure in the lobule because there were no significant differences in pressure across the walls to begin with. Furthermore, distortions resulting from the change of the mechanical properties of the lobule which might result in phase shifts between the pressure changes in the lobule and the rest of the lung could not have occurred because the pressures were not changing. It is for these reasons that we state that the catheter was accurately measuring pressure in the air spaces in which it was situated. The pressure may not, however, be equal to the pressure producing collateral flow.

If the parenchymal catheters had been situated far from the collateral channels, they would overestimate the pressure difference across the channels as illustrated in Fig. 2.

If the catheter were in alveolus (*a*) through which no air was flowing, the pressure would be equal to that at the nearest branch upstream through which air was flowing. This would be greater than the pressure in alveolus (*b*) by an amount equal to the pressure required to overcome the frictional resistance of airway *X*. Similarly, if pressure was measured in alveolus (*c*) it would be equal to the pressure at the bifurcation between airways *Y* and *Z* and would be less than the pressure in alveolus (*d*) by an amount equal to the pressure required to overcome the frictional resistance of *Y*. Even with the catheters close to the collateral channels we may still have overestimated the pressure difference. However, in normal lungs this error is presumably small because the resistance of small airways is low (1). In lungs with emphysema this error might conceivably have been large because of the marked airway obstruction that is characteristic of this disease. This seems unlikely to be significant, however, because as will be seen, the resistance to collateral flow was very low in these lungs, whereas this error can only lead to an overestimate of collateral flow resistance.

RESULTS

Air flow across the major fissure was studied in 16 cases, eight with emphysema and eight without. The data concerning the age and sex of the subject, the side studied, the degree of collateral flow, and measurements of the

TABLE II
Collateral Flow from the Basal Segments to the Apical Segment of the Lower Lobe

Case No.	Age	Sex	Side	Collateral flow cc/sec	Lower lobe	Junction between base and apex of lower lobe	Emphysema				
							Entire lung			Point count, parenchymal involvement	Subjective index, 0-30
							Lm	ISA _s	%		
	yr						% predicted	% predicted	%		
Normal											
17	51	M	L	28	0	0	120	93	<1	1	
18	52	M	L	70	0	0	102	103	<1	0	
19	67	F	L	27	0	0	116	82	<1	0	
Emphysema											
20	66	M	L	106	Mild	Mild	116	96	2.5	2	
21	64	M	L	110	Mild	Mild	119	94	14.0	4	
22	80	M	R	80	Moderate	Moderate	127	82	47.2	8	
23	58	M	L	50	Moderate	Moderate	124	82	41.0	17	
24	70	M	R	115	Moderate	Moderate	106	113	60.9	14	

LM = mean linear intercept.

ISA_s = internal surface area corrected to a lung volume of 5 liters.

Point count = modification of Dunnill's method of quantitating emphysema.

Subjective index = an arbitrary index of emphysema which ranges from 0 to 30 units.

Emphysema in lower lobe and in junction between base and apex of lower lobe listed as mild, moderate, or severe.

Collateral flow measured under steady-flow conditions with a basal segment distending pressure of 20 cm/H₂O after full inflation of the basal segments.

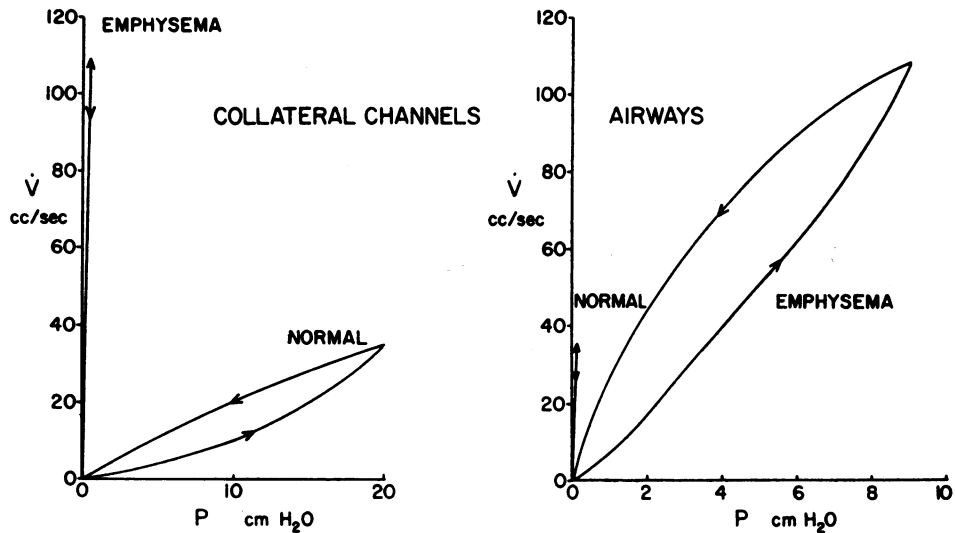

FIGURE 4 The flow through collateral channels is plotted on the ordinate of both graphs. The pressure shown on the abscissa on the left was that observed across the collateral channels, while the pressure on the abscissa of the right graph was the difference between the segmental alveolar and the atmosphere. The data were collected during a quasi-static inflation and deflation of one normal (case 17) and one emphysematous (case 21) lung.

emphysema present are shown in Table I. Flow from the base to the apical segment was studied in eight cases, and the data are presented in a similar fashion in Table II.

We confirmed the observation of Van Allen, Lindskog, and Richter (3), that when air enters a normal lobe or segment through collateral channels, it escapes from the parenchyma without the volume of the lobe undergoing any appreciable change. On the other hand, the behavior of severely emphysematous lungs was strikingly different. Emphysematous lobes receiving collateral flow rapidly inflated, in spite of the fact their airways were open to atmosphere. In two instances (cases 14 and 15), even though the lobe became fully inflated, there was no detectable air flow out of the lobe because the airways were completely obstructed.

Fig. 3(A) and 3(B) demonstrate data from one normal lung (case 1) and one lung with very mild emphysema (case 10), respectively, during a quasi-static inflation and deflation of the lower lobe. The left and center panels of (A) and (B) represent data collected from the face of the storage oscilloscope when lobar volume was simultaneously plotted against lobar distending pressure (left panels) and collateral flow measured at the trachea (center panels). Right panels were constructed by plotting the distending pressure in left panels against the collateral flow in center panels at equal volume points. The flow-volume curves (center panels) demonstrate that flow leaving the lobes is similar at a given lobar volume on both inflation and deflation, while

the pressure-volume and pressure-flow curves demonstrate that the pressure driving flow out of the lobe is much less on deflation, and therefore, the resistance is also much less.

The resistance of the collateral channels is compared to the airway resistance of the upper lobe airways in one normal and one emphysematous lung in Fig. 4. In the normal case (case 17) the bulk of the resistance was found in the collateral channels while the resistance of the segmental airways was barely measurable by this technique. In the emphysematous case (case 21), on the other hand, the reverse was true, so that the resistance of the segmental airways was actually greater than that of the collateral channels.

The resistance to flow from the lower lobe bronchus through the collateral channels to the upper lobe and out the trachea is shown in Table III. As the flow rates were extremely small in the normal lungs (6-76 cc/sec, Table I), the pressure drop along airways must have been small. We therefore assumed that in the normal lungs the total resistance was due almost entirely to the resistance of the collateral channels. We tested this assumption in two normal lungs (cases 7 and 8) by measuring the alveolar pressure with subpleural catheters and found in each case that it was very difficult to measure any pressure difference between the alveoli and the airway opening. Although the airway resistance must have a positive finite value it was difficult to measure in normal lungs under the conditions of this experiment, and we have therefore tabulated it as 0+.

In emphysematous cases the resistance of the entire circuit was generally lower and there were much higher flows (50–500 cc/sec). In view of the fact that an increase in airways resistance is characteristic of this disease, the collateral flow resistance *must* have been substantially reduced. The subpleural catheter experiments (cases 11 and 12) confirm this and illustrate that the resistance of the collateral channels has decreased by an order of magnitude. They also show that there is a substantial rise in airway resistance. Cases 14 and 15 also illustrate examples of severe emphysema where air passed easily through collateral channels to the upper lobe where it was trapped by completely obstructed upper lobe airways.

The data concerning the resistance to flow from the basal segments to the superior segments of lower lobes is shown in Table IV. In the normal lungs (cases 17–19) the total resistance varied from 285 to 740 cm H₂O/liters per sec, and again it can be seen from cases 17 and 19 that all of this is due to the resistance of the collateral channels. In emphysema, on the other hand, the total resistance was generally lower (172–400 cm H₂O/liters per sec), and it can be seen from cases 20, 21, and 22 that there has been a marked fall in the resistance of the collateral channels and a considerable rise in the resistance of the airways.

TABLE III
A Comparison of Total Resistance, Lobar Airway Resistance, and Collateral Flow Resistance*

Case No.	R _{LL} +R _{COL} +R _{UL}	R _{LL}	R _{COL}	R _{UL}
<i>cm H₂O/liters per sec</i>				
Normal				
1	260	—	—	—
2	∞	—	∞	—
3	∞	—	∞	—
4	800	—	—	—
5	800	—	—	—
6	∞	—	∞	—
7	3300	0+	3300	0+
8	1000	0+	1000	0+
Emphysema				
9	77	—	—	—
10	133	—	—	—
11	400	310	10	80
12	46	16	20	10
13	∞	—	∞	—
14	∞	—	—	∞
15	∞	—	—	∞
16	50	—	—	—

* All measurements were made under steady-flow conditions with a lower lobe distending pressure of 20 cm/H₂O after full inflation of the lung.

TABLE IV
Comparison of Total Resistance to That of the Segmental Airways and Collateral Channels in the Lower Lobe*

Case No.	R _{base} +R _{COL} +R _{apex}	R _{base}	R _{COL}	R _{apex}
<i>cm H₂O/liters per sec</i>				
Normal				
17	714	0+	714	0+
18	285	—	—	—
19	740	0+	740	0+
Emphysema				
20	188	118	10	60
21	182	97	5	80
22	400	304	16	80
23	250	—	—	—
24	172	—	—	—

* All measurements were made under steady-flow conditions with a basal segment distending pressure of 20 cm/H₂O after full inflation of the basal segments.

R base = the resistance of airways in the basal segments of the lower lobe.

R apex = resistance of airways in the superior segment of the lower lobe.

DISCUSSION

The fact that air can flow across the major fissure may at first seem surprising. However, Kent and Blades (6) have shown that the fissures are rarely complete in human lungs, and that major defects in the fissure were found in 30% of the lungs they dissected. In their original study, Van Allen, Lindskog, and Richter (3) found that air drift occurred easily within lobes but only crossed the fissure when the lobe was overdistended. However, our data demonstrate that air may flow through collateral channels between lobes throughout their whole volume range (Fig. 3). Furthermore, we show that air flows through collateral channels much more easily in an emphysematous than a normal lung. Although a systematic difference in the completeness of the interlobar fissure between normal and emphysematous lungs might conceivably explain the result obtained for collateral flow between lobes, it cannot explain the same observation when collateral flow was measured between segments within a lobe.

A comparison of the collateral channels at the same lung volume reached from deflation on one hand and from full inflation on the other indicates that the channels are wider and less resistant during deflation (Fig. 3). This means that the collateral channels undergo a greater hysteresis than the lung itself which is not surprising when we consider the forces acting on them. During both inflation and deflation the tissue forces will tend to widen the channels while the surface forces

will tend to narrow them. Although the tissue forces are similar on both inflation and deflation at the same lung volume, the surface forces are markedly less on deflation and the channels are consequently larger. In discussing the etiology of emphysema McLean (7) has stressed the importance of collateral channels in the ventilation of obstructed units. His hypothesis that these channels narrow during deflation and trap gas is difficult to accept in the light of our findings.

The fact that the resistance of the collateral channels was found to be less than the resistance of the outflow airways in our emphysematous cases was surprising. In Laennec's description of emphysema he refers to the sensation of handling an emphysematous lung as that perceived when handling a pillow of down (8). We suspect that this sensation is due to the ease with which air can be pushed from one area of an emphysematous lung to another and the difficulty one encounters when trying to push air out of the bronchi. These latter observations are easy to make at autopsy and provide further evidence that the resistance of collateral channels is less than that of the airways themselves.

From the data on Tables I and II it is apparent the collateral flow does not correlate with the age of the normal cases. Furthermore, in the emphysematous cases the collateral flow does not correlate either with the total amount of emphysema in the lung or the amount of emphysema present in the fissure. However, the presence of even minor grades of emphysema was associated with a marked fall in collateral flow resistance (Tables III and IV). As the earliest demonstrable lesion in emphysema is a destruction of the alveolar walls to form alveolar fenestrae (9), it seems probable that pathways through destroyed lung tissue offer less resistance to collateral flow between lung units than alveolar pores, Lamberts canals, or the connections between respiratory bronchioles demonstrated in dog lungs by Martin (10). Whether the interalveolar fenestrae are enlarged pores of Kohn or new holes that have arisen in the alveolar walls remains uncertain, but in advanced emphysema with marked tissue destruction this question is academic. However, it is reasonable to assume that the formation of fenestrae causes the resistance to collateral flow to fall in emphysema. In fact, considering the morphology of this disease, our results are exactly what one might predict.

The collateral channels whose resistance we measured are enclosed in a surface shared by both the inflow and outflow alveoli. In the normal lungs the size of the channels is determined by the inflow alveoli because the outflow alveoli do not inflate. In the emphysematous lung, on the other hand, the outflow alveoli do inflate and this may have enlarged the collateral channels and decreased their resistance. We did not test this possibility by artificially distending the outflow alveoli in the normal

lungs, but Macklem and Woolcock¹ have studied this effect on dog and pig lungs and found that the resistance of the collateral channels is determined by the alveoli with the largest volume. Since this was always the inflow alveoli in our experiments we have assumed that they determine the size of the collateral channels. Therefore, it seems unlikely that inflation of the outflow alveoli by itself can explain the difference in collateral flow resistance which we observed.

The electrical analogue of a two-compartment model suggested by Otis et al (11) is presented in Fig. 5(a). The distribution of charge and the phase differences between the capacitors C_1 and C_2 depend upon the time constants of each resistor-capacitor circuit in parallel. The common resistor, R_3 , has no influence. The pertinent time constant of each circuit is $R_1 C_1$ and $R_2 C_2$, respectively. If these are equal no phase differences will exist at any frequency. If they are unequal, phase differences will be present and these will increase with increases in cycling frequency. Our studies indicate that an additional resistor, R_4 , short circuiting R_1 and R_2 should be added as in Fig. 5(b) if the collateral channels are to be taken into account. Our data further suggest that in severe emphysema airway resistance is greater than collateral flow resistance because obliteration and plugging of small airways is common in emphysema (1). The appropriate electrical analogue of this situation is shown in Fig. 5(c). In this instance, both R_3 and R_2 are common to both capacitors and will not influence any phase shifts that exist between C_1 and C_2 . The time constant determining the phase and charge on C_1 will be $R_4 C_1$. The problem is to assign a value to the time constant for the unit represented by C_2 . Because it has no resistor it does not share with C_1 the appropriate resistance and therefore the time constant will be zero to a close approximation. Thus the time constants of the two circuits will be unequal by definition.

Although in this situation phase shifts will be present at any finite frequency, the magnitude of the phase difference will depend on the absolute value of $R_4 C_1$. If $R_4 C_1$ is small the phase differences will be smaller than if $R_4 C_1$ is large.

In the lungs, phase differences are present between different units if compliance falls with increasing frequency (11). Fig. 6 is the graphical solution to equation 13 in reference 11² and indicates the relationship between compliance and frequency in the two-compartment model shown in Fig. 5(c). In the model

¹ Unpublished observations.

²

$$C_e = \frac{\omega^2(T_2 C_1 + T_1 C_2)^2 + (C_1 + C_2)^2}{\omega^2(T_1^2 C_2 + T_2^2 C_1) + (C_1 + C_2)}$$

where C_e = effective compliance of the first and second compartment; ω = frequency; T_1 and T_2 are the time constants; and C_1 and C_2 = compliance of the two compartments.

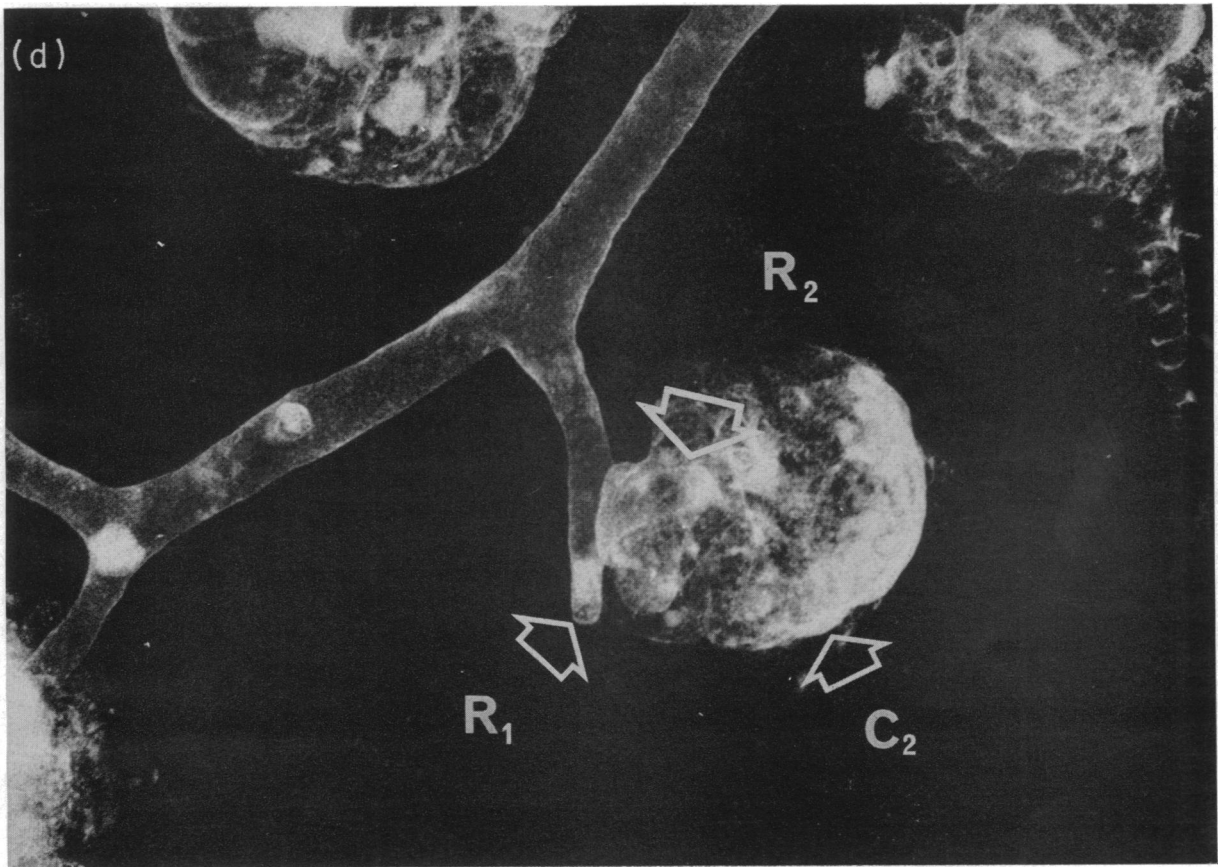
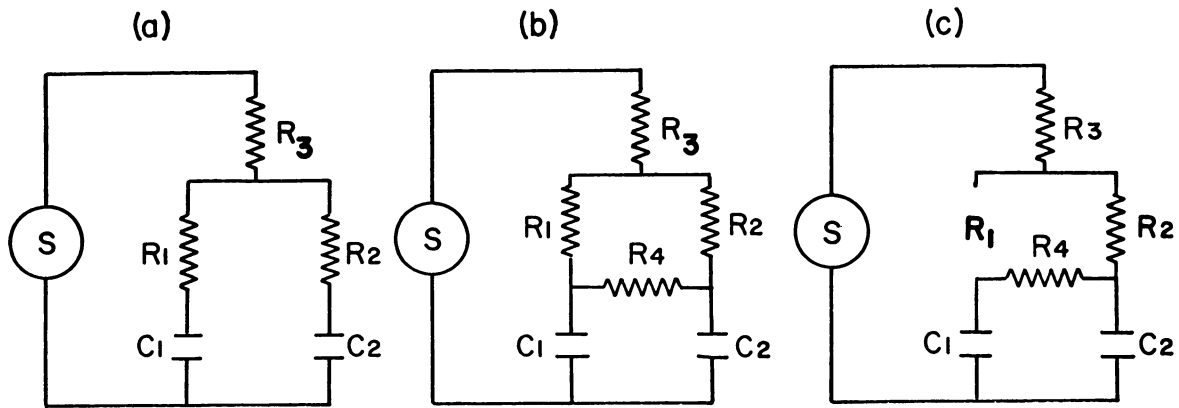

FIGURE 5 (a). Illustrates the electrical analogue of the lung introduced by Otis and his associates where the distribution of charge on the two capacitors C_1 and C_2 will be equal if the time constants of the pathways $R_1 C_1$ and $R_2 C_2$ are equal. The common resistor R_3 has no effect on either the phase angle or the distribution of charge on the capacitors. (b). Illustrates the electrical analogue if collateral pathways are taken into account. Their resistance is represented by R_4 , and it will have no effect on the distribution of charge on C_1 and C_2 as long as it is large in relation to R_1 and R_2 . (c). Illustrates a model of emphysema where R_1 has become occluded and C_1 is supplied entirely through the collateral channel R_4 . (d). Illustrates a highly magnified view of a bronchogram from a case of centrilobular emphysema. C_2 is represented by the centrilobular emphysematous space, and R_2 is its supplying airway. R_1 is the plugged bronchiole, and C_1 which is not shown would be the parenchyma supplied by R_1 if it were patent. $\times 9$

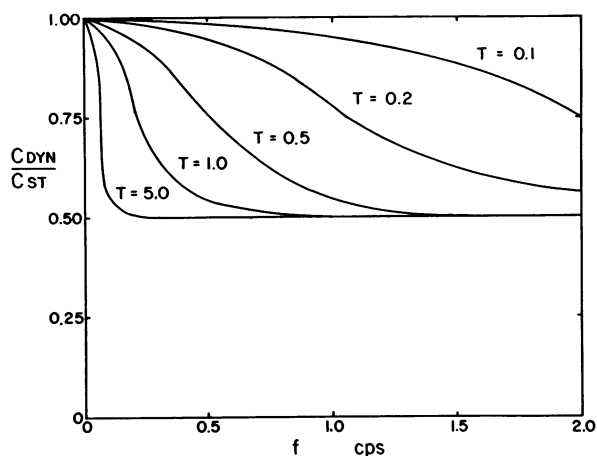

FIGURE 6 A graphical solution of equation 13 in reference 11 indicates the relationship between compliance and frequency in the two compartment model shown in Fig. 5(c). The time constant C_2 is 0 in this situation, and the curves shown are those obtained for the indicated values of the time constant T for the pathway R_1 . C_{dyn} = dynamic compliance, C_{st} = static compliance.

$C_1 = C_2$, the time constant of the pathway leading to C_2 is zero and curves are plotted for various values of the time constant $R_1 C_1$. When $T = 0.1$ sec, dynamic compliance only falls by 8% at a frequency of 1 cps and only 22% at 2 cps. When $T = 5$ sec, however, there is a marked fall in compliance as the frequency is increased. Assuming a resistance to collateral flow between the basal and apical segments of the lower lobe of 10 cm H₂O/liters per sec (Table IV) and a compliance of approximately 0.03 1/cm H₂O (this value is obtained by dividing the volume change between 2 and 5 cm H₂O on the pressure volume curve for the emphysematous lung shown in the left panel, Fig. 3(B)), the time constant for collateral ventilation between apical and basal segments in emphysema might be 0.3 sec. The curves in Fig. 6 demonstrate that this will result in frequency-dependent behavior. Therefore, ventilation of lung units via collateral channels in emphysema could be one of the causes of the marked fall in compliance which is observed in this condition when the breathing frequency is increased. The values for resistance and compliance in this argument were obtained from segments of lobes and must be interpreted with caution as it is likely that much smaller units are involved in collateral ventilation in the emphysematous lung. Therefore, it follows that measurements of the time constant of pathways between much smaller lung units are required before any firm conclusions can be drawn.

Although we have only made measurements on segments and lobes it is likely that similar situations exist in smaller units of the lung. In fact a magnified view of a bronchogram from a case of centrilobular emphysema

(FIG. 5(d)) demonstrates that the analysis presented above could fit the morphology which exists in this type of emphysema. In this case the plugged bronchiole would represent the resistor R_1 , while the centrilobular space could be the capacitor C_2 . R_2 would be the bronchiole leading to the centrilobular space, and R_3 would be the collateral channels leading from the centrilobular emphysematous space to the parenchyma normally supplied by the obstructed bronchiole R_1 . The centrilobular space would then be an antechamber which would fill and empty from the atmosphere and the surrounding parenchyma.

Although collateral ventilation may or may not result in frequency-dependent behavior, it will certainly lead to abnormal distribution of ventilation, and presumably impaired gas exchange. Air entering obstructed units via collateral channels will have already exchanged O₂ and CO₂. Provided blood flow is relatively undisturbed such units will have low alveolar ventilation-perfusion ratios (\dot{V}_A/\dot{Q}). The unobstructed units on the other hand will have high \dot{V}_A/\dot{Q} as additional air must pass through them to reach the obstructed units. Furthermore, marked stratification of gas concentration between units should be present, for it is most unlikely that pathway lengths and the geometry of the collateral channels would permit complete diffusion mixing in the time available. This additional abnormality of ventilation distribution is probably significant in emphysema.

If the unobstructed units are emphysematous spaces as is suggested by Fig. 5(d), and the emphysematous process reduces perfusion, the disordered gas exchange will be even more severe. The \dot{V}_A/\dot{Q} of the unobstructed units will be greater because the perfusion is decreased, and the blood which normally perfused such a space will be shunted to the obstructed areas, causing a further decrease in \dot{V}_A/\dot{Q} in these zones. Thus collateral ventilation will lead to a wide range of \dot{V}_A/\dot{Q} ratios within the lung, a situation which is characteristic of emphysema (12). On the other hand, if emphysematous spaces exist beyond obstructed airways (as might exist in panlobular emphysema), and the parenchyma beyond unobstructed airways remained intact, there might be relative preservation of \dot{V}_A/\dot{Q} ratios. In this instance gas exchange might not be grossly abnormal, in spite of marked partitioning of alveolar spaces. This situation is also known to occur in some patients with emphysema (13). Whether or not these speculations are valid awaits a detailed study of the relationship between destroyed alveolar spaces, their perfusion, and the nature of the airways leading to them.

ACKNOWLEDGMENTS

This work was supported by grants from the Medical Research Council and the John A. Hartford Foundation, and in part by the James Picker Foundation.

REFERENCES

1. Hogg, J. C., P. T. Macklem, and W. M. Thurlbeck. 1968. The site and nature of airway obstruction in chronic obstructive lung disease. *N. Engl. J. Med.* 278: 1355.
2. Loosli, C. G. 1947. Inter-alveolar communications in normal and in pathological mammalian lungs. *Arch. Pathol.* 24: 743.
3. Van Allen, C. M., G. E. Lindskog, and H. G. Richter. 1931. Collateral respiration transfer of air collaterally between pulmonary lobules. *J. Clin. Invest.* 10: 559.
4. Baarsma, P. R., M. N. J. Dirkin, and E. Huizinga. 1948. Collateral ventilation in man. *J. Thorac. Surg.* 17: 252.
5. Thurlbeck, W. M. 1967. Internal surface area and other measurements in emphysema. *Thorax.* 22: 483.
6. Kent, E. M., and B. Blades. 1942. Surgical anatomy of the pulmonary lobes. *J. Thorac. Surg.* 12: 18.
7. McLean, K. H. 1958. The pathogenesis of pulmonary emphysema. *Amer. J. Med.* 25: 62.
8. Laennec, R. T. H. 1962. *Disease of the Chest*. Published under the auspices of the Library of the New York Academy of Medicine by Hafner Publishing Company, New York. 86.
9. Boren, H. G. 1962. Alveolar fenestrae: relationship to the pathology and pathogenesis of pulmonary emphysema. *Amer. Rev. Resp. Dis.* 85: 328.
10. Martin, H. G. 1966. Respiratory bronchioles as the pathology for collateral ventilation. *J. Appl. Physiol.* 21: 1443.
11. Otis, A. B., C. B. McKerrow, R. A. Bartlett, J. Mead, M. B. McIlroy, N. J. Silverstone, and E. P. Radford, Jr. 1956. The mechanical factors in distribution of pulmonary ventilation. *J. Appl. Physiol.* 8: 427.
12. Bates, D. V., and R. V. Christie. 1964. *Respiratory function in disease*. W. B. Saunders Co., Philadelphia. 195.
13. Nash, E. S., W. A. Briscoe, and A. Cournand. 1965. A relationship between clinical and physiological findings in chronic obstructive diseases of the lung. *Med. Thorac.* 22: 305.