

Facile functionalization at the C4 position of pyrimidine nucleosides *via* amide group activation with (benzotriazol-1-yloxy)tris(dimethylamino)phosphonium hexafluorophosphate (BOP) and biological evaluations of the products

Hari K. Akula, Hariprasad Kokatla, Graciela Andrei, Robert Snoeck, Dominique Schols,
Jan Balzarini, Lijia Yang and Mahesh K. Lakshman*

TABLE OF CONTENTS

| Information | Page |
|---|-------------|
| 500 MHz ¹ H NMR spectrum of compound 4 in CDCl ₃ | S-5 |
| 125 MHz ¹³ C NMR spectrum of compound 4 in CDCl ₃ | S-6 |
| 500 MHz ¹ H NMR spectrum of compound 6 in acetone- <i>d</i> ₆ | S-7 |
| 125 MHz ¹³ C NMR spectrum of compound 6 in acetone- <i>d</i> ₆ | S-8 |
| 500 MHz ¹ H NMR spectrum of compound 11a in CDCl ₃ | S-9 |
| 125 MHz ¹³ C NMR spectrum of compound 11a in CDCl ₃ | S-10 |
| 500 MHz ¹ H NMR spectrum of compound 11b in acetone- <i>d</i> ₆ | S-11 |
| 125 MHz ¹³ C NMR spectrum of compound 11b in acetone- <i>d</i> ₆ | S-12 |
| gCOSY spectrum of compound 11b in acetone- <i>d</i> ₆ | S-13 |
| 500 MHz ¹ H NMR spectrum of compound 11c in CDCl ₃ | S-14 |
| 500 MHz ¹ H NMR spectrum of compound 11d in CDCl ₃ | S-15 |
| 125 MHz ¹³ C NMR spectrum of compound 11d in CDCl ₃ | S-16 |
| 500 MHz ¹ H NMR spectrum of compound 11e in CDCl ₃ | S-17 |
| 125 MHz ¹³ C NMR spectrum of compound 11e in acetone- <i>d</i> ₆ | S-18 |
| 500 MHz ¹ H NMR spectrum of compound 11f in CDCl ₃ | S-19 |
| 125 MHz ¹³ C NMR spectrum of compound 11f in CDCl ₃ | S-20 |
| gCOSY spectrum of compound 11f in CDCl ₃ | S-21 |
| 500 MHz ¹ H NMR spectrum of compound 11g in CDCl ₃ | S-22 |
| 125 MHz ¹³ C NMR spectrum of compound 11g in CDCl ₃ | S-23 |
| gCOSY spectrum of compound 11g in CDCl ₃ | S-24 |
| Expansion of gCOSY spectrum of compound 11g in CDCl ₃ | S-25 |
| 500 MHz ¹ H NMR spectrum of compound 11h in acetone- <i>d</i> ₆ | S-26 |
| 125 MHz ¹³ C NMR spectrum of compound 11h in acetone- <i>d</i> ₆ | S-27 |
| 500 MHz ¹ H NMR spectrum of compound 11i in acetone- <i>d</i> ₆ | S-28 |
| 125 MHz ¹³ C NMR spectrum of compound 11i in acetone- <i>d</i> ₆ | S-29 |
| 500 MHz ¹ H NMR spectrum of compound 11j in CDCl ₃ | S-30 |
| 125 MHz ¹³ C NMR spectrum of compound 11j in CDCl ₃ | S-31 |
| 500 MHz ¹ H NMR spectrum of compound 12a in acetone- <i>d</i> ₆ | S-32 |
| 125 MHz ¹³ C NMR spectrum of compound 12a in acetone- <i>d</i> ₆ | S-33 |
| 500 MHz ¹ H NMR spectrum of compound 12b in CDCl ₃ | S-34 |
| 125 MHz ¹³ C NMR spectrum of compound 12b in acetone- <i>d</i> ₆ | S-35 |
| 500 MHz ¹ H NMR spectrum of compound 12c in acetone- <i>d</i> ₆ | S-36 |

| | |
|---|------|
| 125 MHz ^{13}C NMR spectrum of compound 12c in acetone- d_6 | S-37 |
| gCOSY spectrum of compound 12c in acetone- d_6 | S-38 |
| gHMQC spectrum of compound 12c in acetone- d_6 | S-39 |
| 500 MHz ^1H NMR spectrum of compound 12d in acetone- d_6 | S-40 |
| 125 MHz ^{13}C NMR spectrum of compound 12d in acetone- d_6 | S-41 |
| 500 MHz ^1H NMR spectrum of compound 12e in CDCl_3 | S-42 |
| 125 MHz ^{13}C NMR spectrum of compound 12e in CDCl_3 | S-43 |
| gCOSY spectrum of compound 12e in CDCl_3 | S-44 |
| 500 MHz ^1H NMR spectrum of compound 13a in acetone- d_6 | S-45 |
| 125 MHz ^{13}C NMR spectrum of compound 13a in acetone- d_6 | S-46 |
| 500 MHz ^1H NMR spectrum of compound 13b in acetone- d_6 | S-47 |
| 125 MHz ^{13}C NMR spectrum of compound 13b in acetone- d_6 | S-48 |
| 500 MHz ^1H NMR spectrum of compound 13c in acetone- d_6 | S-49 |
| 125 MHz ^{13}C NMR spectrum of compound 13c in acetone- d_6 | S-50 |
| gCOSY spectrum of compound 13c in acetone- d_6 | S-51 |
| 500 MHz ^1H NMR spectrum of compound 13d in acetone- d_6 | S-52 |
| 125 MHz ^{13}C NMR spectrum of compound 13d in acetone- d_6 | S-53 |
| 500 MHz ^1H NMR spectrum of compound 14a in CDCl_3 | S-54 |
| 125 MHz ^{13}C NMR spectrum of compound 14a in CDCl_3 | S-55 |
| 500 MHz ^1H NMR spectrum of compound 14b in CDCl_3 | S-56 |
| 125 MHz ^{13}C NMR spectrum of compound 14b in CDCl_3 | S-57 |
| 500 MHz ^1H NMR spectrum of compound 15 in CDCl_3 | S-58 |
| 125 MHz ^{13}C NMR spectrum of compound 15 in CDCl_3 | S-59 |
| 500 MHz ^1H NMR spectrum of compound 16a in CDCl_3 | S-60 |
| 125 MHz ^{13}C NMR spectrum of compound 16a in CDCl_3 | S-61 |
| 500 MHz ^1H NMR spectrum of compound 16b in CDCl_3 | S-62 |
| 125 MHz ^{13}C NMR spectrum of compound 16b in CDCl_3 | S-63 |
| 500 MHz ^1H NMR spectrum of compound 17 in CDCl_3 | S-64 |
| 125 MHz ^{13}C NMR spectrum of compound 17 in CDCl_3 | S-65 |
| 500 MHz ^1H NMR spectrum of compound 18 in CDCl_3 | S-66 |
| 125 MHz ^{13}C NMR spectrum of compound of 18 in CDCl_3 | S-67 |
| 500 MHz ^1H NMR spectrum of compound 19 in CDCl_3 | S-68 |
| 125 MHz ^{13}C NMR spectrum of compound 19 in CDCl_3 | S-69 |
| 500 MHz ^1H NMR spectrum of compound 5 in CD_3OD | S-70 |
| 125 MHz ^{13}C NMR spectrum of compound 5 in CD_3OD | S-71 |
| 500 MHz ^1H NMR spectrum of compound 20a in CD_3OD | S-72 |
| 125 MHz ^{13}C NMR spectrum of compound 20a in CD_3OD | S-73 |
| 500 MHz ^1H NMR spectrum of compound 20b in CD_3OD | S-74 |
| 125 MHz ^{13}C NMR spectrum of compound 20b in CD_3OD | S-75 |
| 500 MHz ^1H NMR spectrum of compound 20c in CD_3OD | S-76 |
| 125 MHz ^{13}C NMR spectrum of compound 20c in CD_3OD | S-77 |
| 500 MHz ^1H NMR spectrum of compound 20d in CD_3OD | S-78 |
| 125 MHz ^{13}C NMR spectrum of compound 20d in CD_3OD | S-79 |
| 500 MHz ^1H NMR spectrum of compound 20e in CD_3OD | S-80 |

| | |
|---|-------|
| 125 MHz ¹³ C NMR spectrum of compound 20e in CD ₃ OD | S-81 |
| gCOSY spectrum of compound 20e in CD ₃ OD | S-82 |
| gHMQC spectrum of compound 20e in CD ₃ OD | S-83 |
| Expansion of gHMQC spectrum of compound 20e in CD ₃ OD | S-84 |
| 500 MHz ¹ H NMR spectrum of compound 20f in CD ₃ OD | S-85 |
| 125 MHz ¹³ C NMR spectrum of compound 20f in CD ₃ OD | S-86 |
| 500 MHz ¹ H NMR spectrum of compound 20g in CD ₃ OD | S-87 |
| 125 MHz ¹³ C NMR spectrum of compound 20g in CD ₃ OD | S-88 |
| 500 MHz ¹ H NMR spectrum of compound 20h in CD ₃ OD | S-89 |
| 125 MHz ¹³ C NMR spectrum of compound 20h in CD ₃ OD | S-90 |
| 500 MHz ¹ H NMR spectrum of compound 20i in CD ₃ OD | S-91 |
| 125 MHz ¹³ C NMR spectrum of compound 20i in CD ₃ OD | S-92 |
| 500 MHz ¹ H NMR spectrum of compound 20j in CD ₃ OD | S-93 |
| 125 MHz ¹³ C NMR spectrum of compound 20j in CD ₃ OD | S-94 |
| 500 MHz ¹ H NMR spectrum of compound 21a in CD ₃ OD | S-95 |
| 125 MHz ¹³ C NMR spectrum of compound 21a in CD ₃ OD | S-96 |
| 500 MHz ¹ H NMR spectrum of compound 21b in CD ₃ OD | S-97 |
| 125 MHz ¹³ C NMR spectrum of compound 21b in CD ₃ OD | S-98 |
| 500 MHz ¹ H NMR spectrum of compound 21c in CD ₃ OD | S-99 |
| 125 MHz ¹³ C NMR spectrum of compound 21c in CD ₃ OD | S-100 |
| 500 MHz ¹ H NMR spectrum of compound 21d in CD ₃ OD | S-101 |
| 125 MHz ¹³ C NMR spectrum of compound 21d in CD ₃ OD | S-102 |
| gCOSY spectrum of compound 21d in CD ₃ OD | S-103 |
| 500 MHz ¹ H NMR spectrum of compound 21e in CD ₃ OD | S-104 |
| 500 MHz ¹ H NMR spectrum of compound 21e in DMSO- <i>d</i> ₆ | S-105 |
| 500 MHz ¹ H NMR spectrum of compound 22a in CD ₃ OD | S-106 |
| 125 MHz ¹³ C NMR spectrum of compound 22a in CD ₃ OD | S-107 |
| 500 MHz ¹ H NMR spectrum of compound 22b in CD ₃ OD | S-108 |
| 125 MHz ¹³ C NMR spectrum of compound 22b in CD ₃ OD | S-109 |
| gCOSY spectrum of compound 22b in CD ₃ OD | S-110 |
| gHMQC spectrum of compound 22b in CD ₃ OD | S-111 |
| 500 MHz ¹ H NMR spectrum of compound 22c in CD ₃ OD | S-112 |
| 125 MHz ¹³ C NMR spectrum of compound 22c in CD ₃ OD | S-113 |
| 500 MHz ¹ H NMR spectrum of compound 22d in CD ₃ OD | S-114 |
| 125 MHz ¹³ C NMR spectrum of compound 22d in CD ₃ OD | S-115 |
| 500 MHz ¹ H NMR spectrum of compound 23a in CD ₃ OD | S-116 |
| 125 MHz ¹³ C NMR spectrum of compound 23a in CD ₃ OD | S-117 |
| 500 MHz ¹ H NMR spectrum of compound 23b in CD ₃ OD | S-118 |
| 125 MHz ¹³ C NMR spectrum of compound 23b in CD ₃ OD | S-119 |
| 500 MHz ¹ H NMR spectrum of compound 24 in CD ₃ OD | S-120 |
| 125 MHz ¹³ C NMR spectrum of compound 24 in CD ₃ OD | S-121 |
| 500 MHz ¹ H NMR spectrum of compound 25a in CDCl ₃ | S-122 |
| 125 MHz ¹³ C NMR spectrum of compound 25a in CDCl ₃ | S-123 |
| 500 MHz ¹ H NMR spectrum of compound 25b in CDCl ₃ | S-124 |

| | |
|---|-------|
| 125 MHz ^{13}C NMR spectrum of compound 25b in CDCl_3 | S-125 |
| 500 MHz ^1H NMR spectrum of compound 26a in CD_3OD | S-126 |
| 125 MHz ^{13}C NMR spectrum of compound 26a in CD_3OD | S-127 |
| 500 MHz ^1H NMR spectrum of compound 26b in CD_3OD | S-128 |
| 125 MHz ^{13}C NMR spectrum of compound 26b in CD_3OD | S-129 |
| 500 MHz ^1H NMR spectrum of compound 26c in CD_3OD | S-130 |
| 125 MHz ^{13}C NMR spectrum of compound 26c in CD_3OD | S-131 |
| gCOSY spectrum of compound 26c in CD_3OD | S-132 |
| 500 MHz ^1H NMR spectrum of compound 26d in CD_3OD | S-133 |
| 125 MHz ^{13}C NMR spectrum of compound 26d in CD_3OD | S-134 |

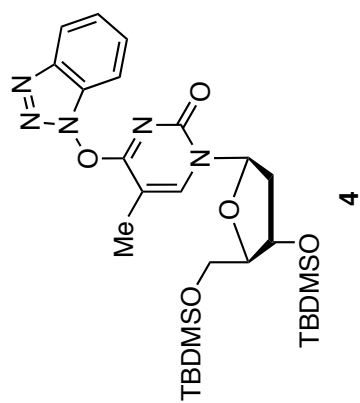

4

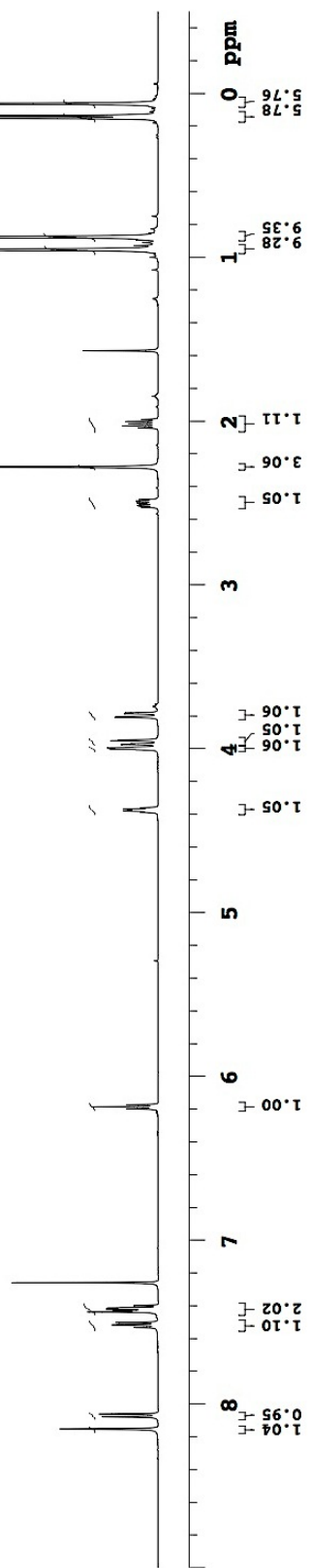

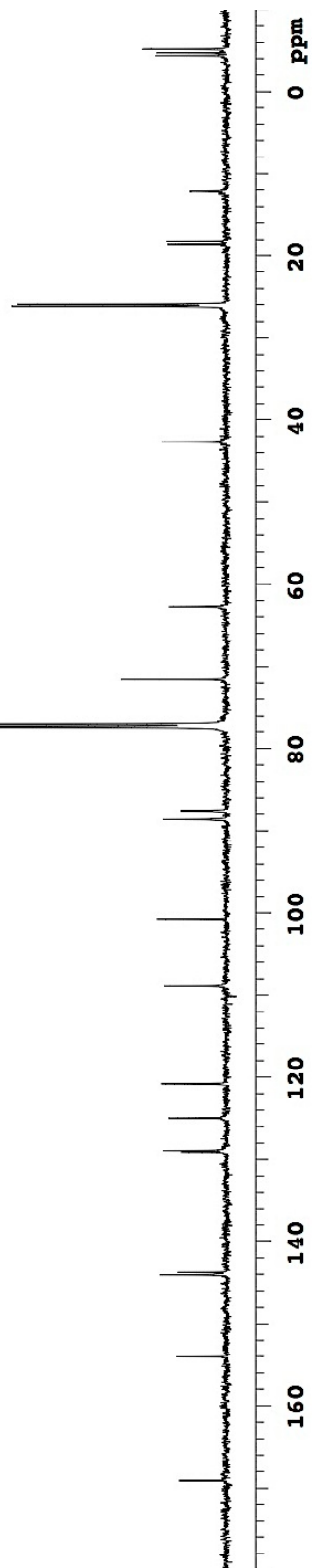
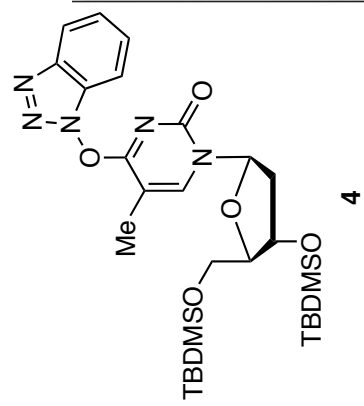

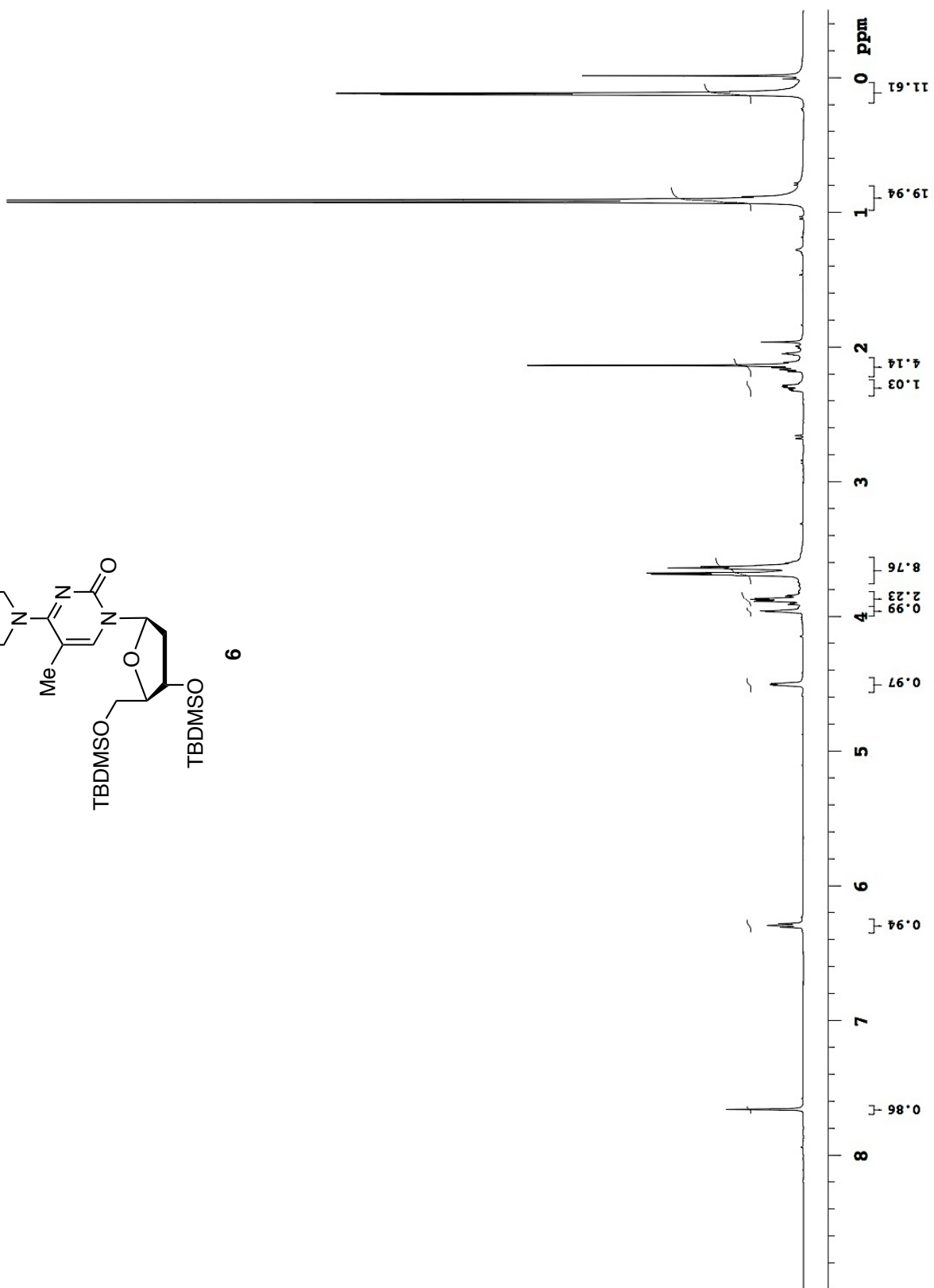
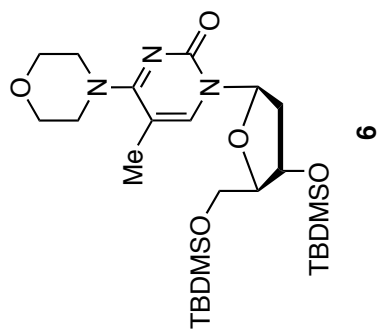

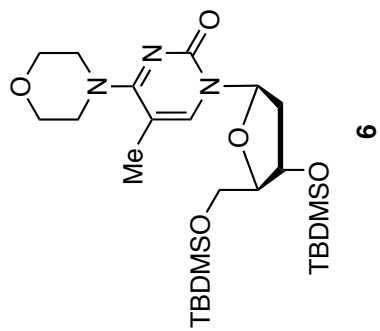

6

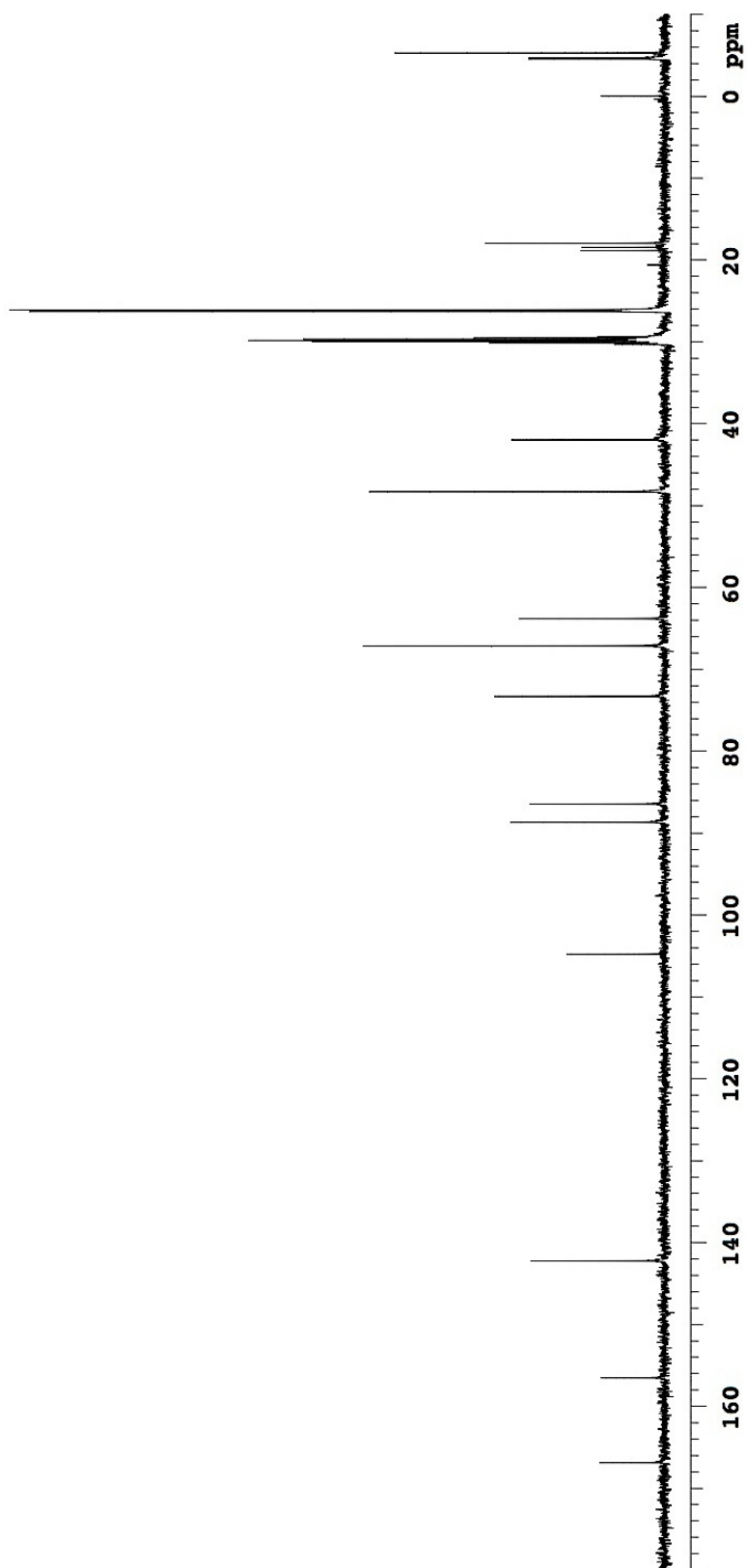

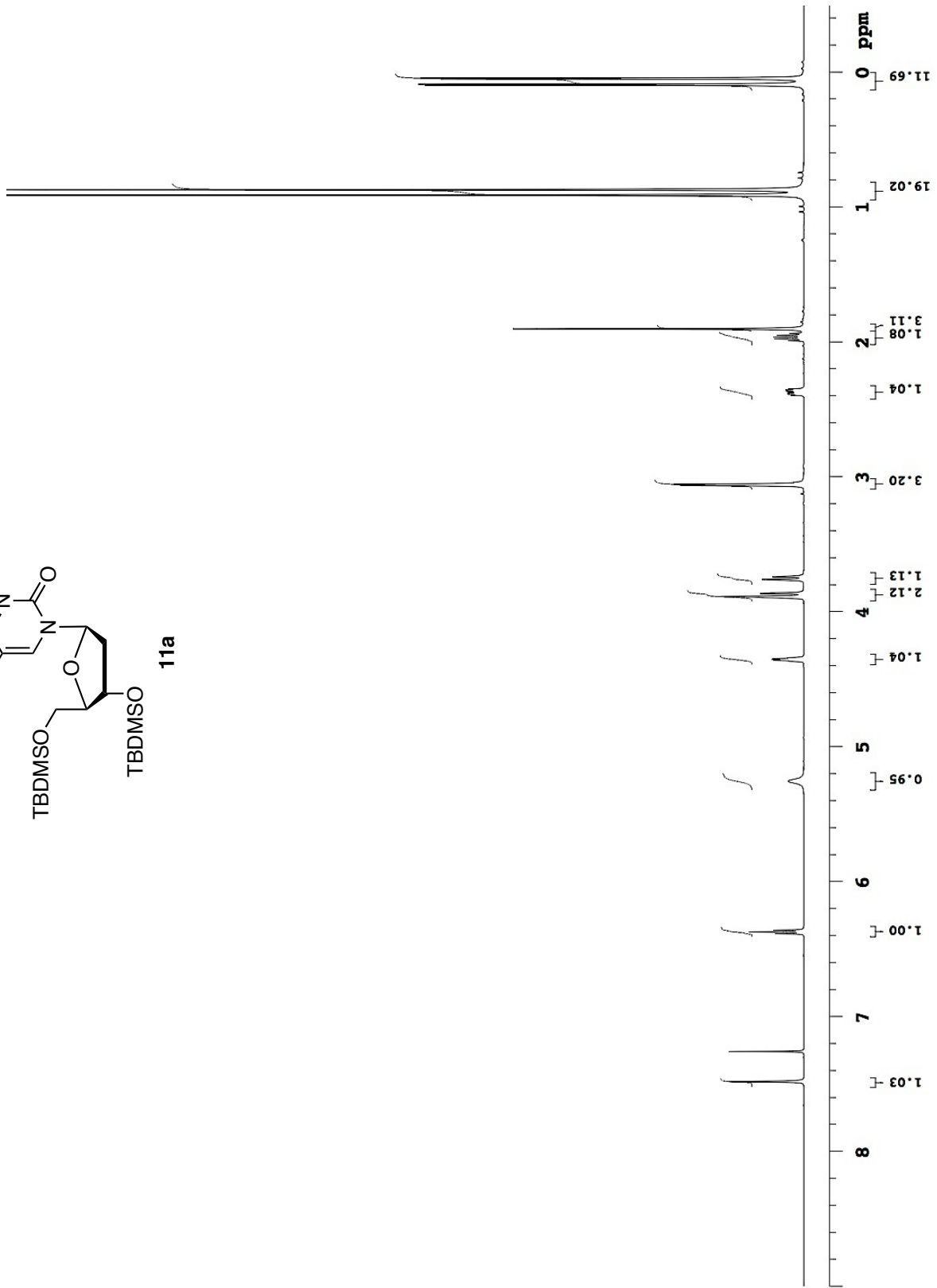
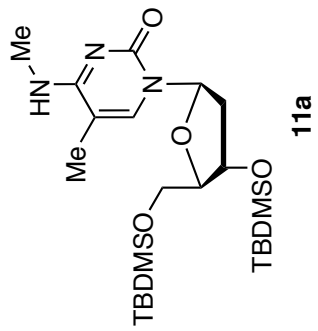

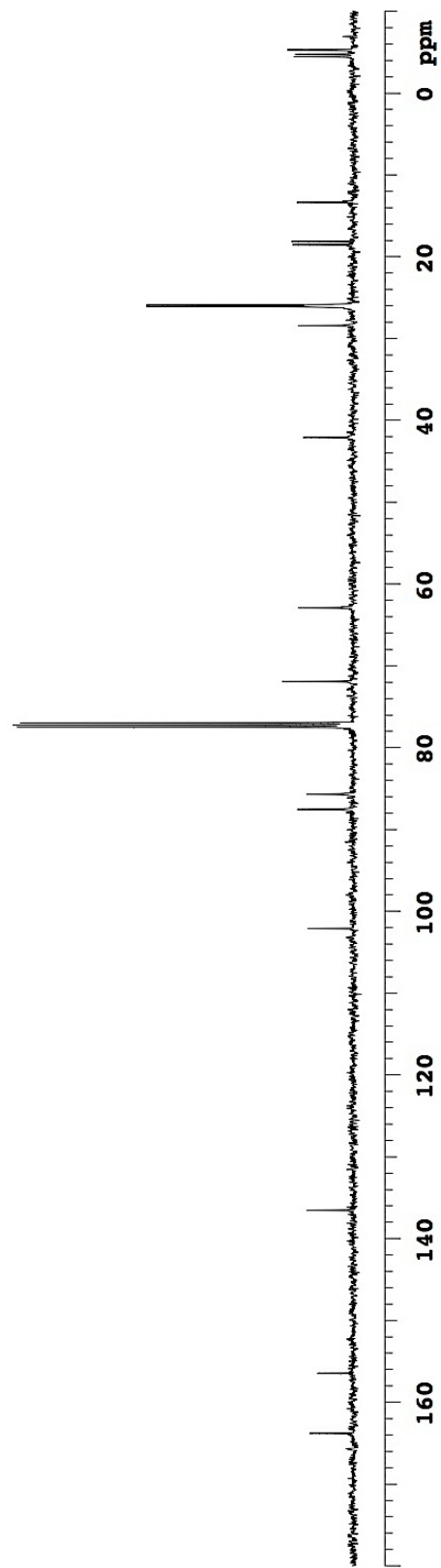
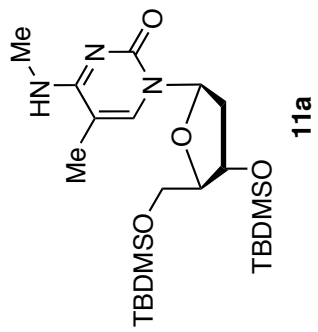

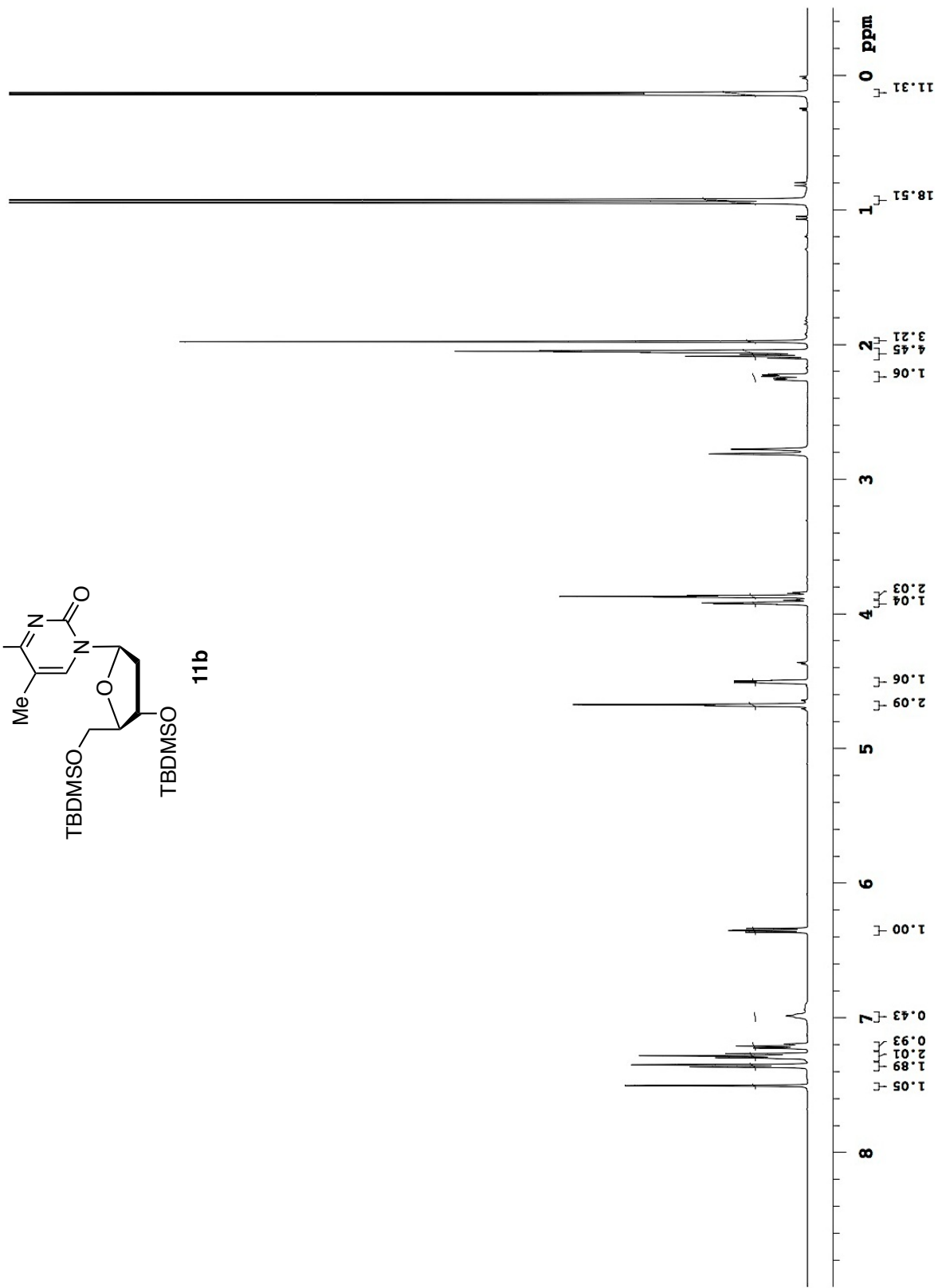
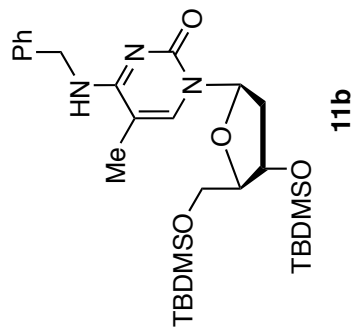

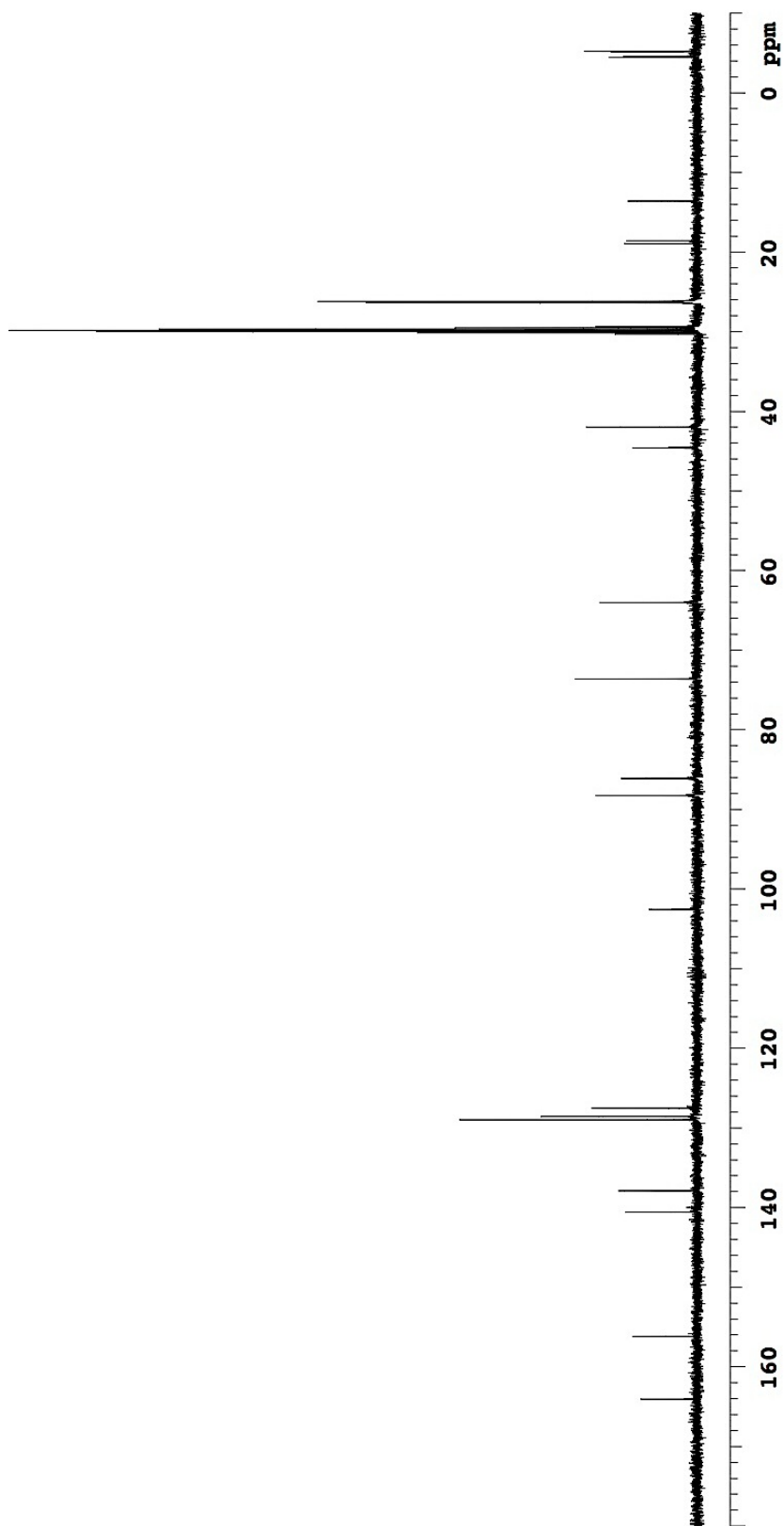
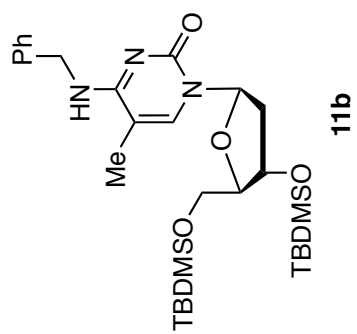

gCOSY spectrum of compound **11b** in acetone- d_6

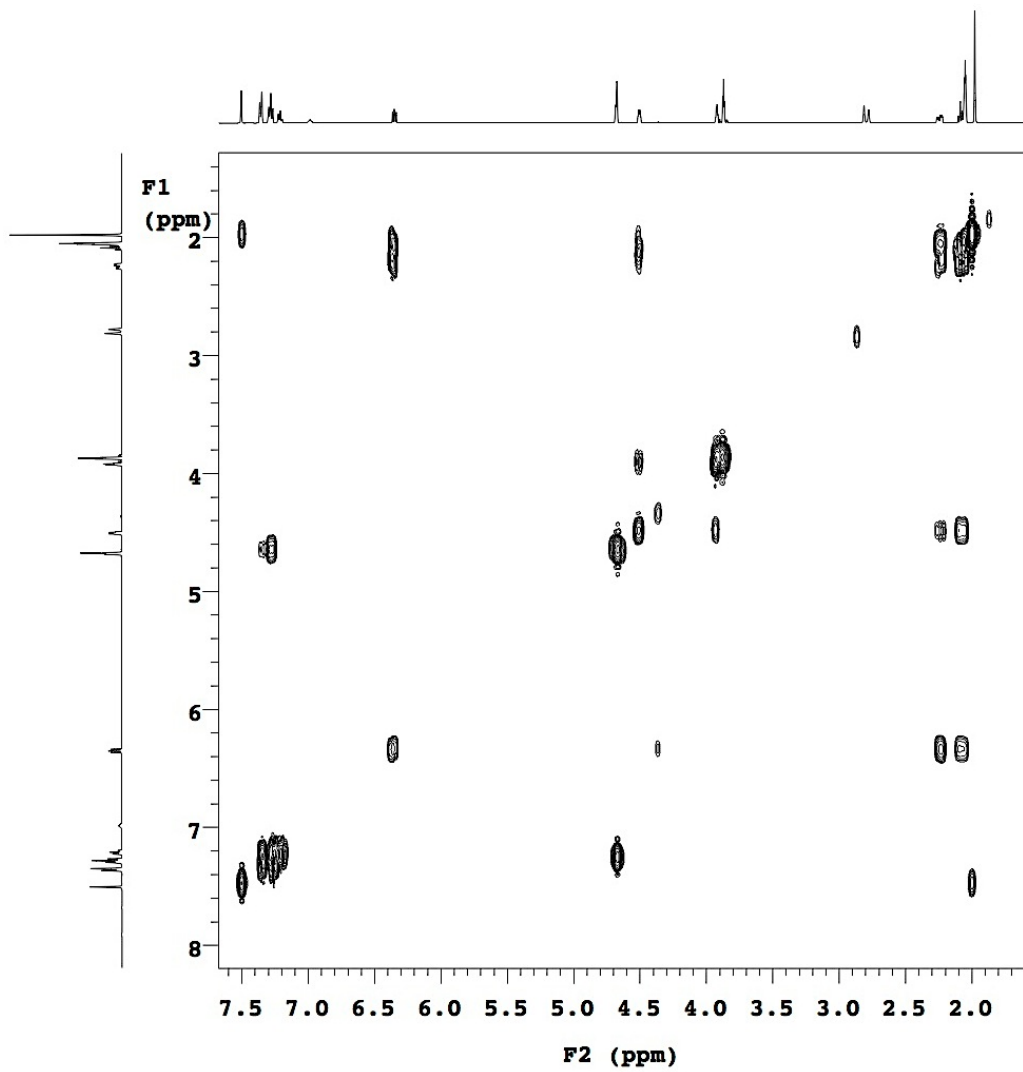
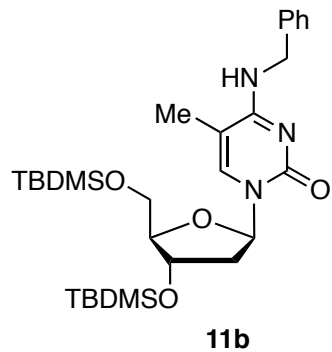

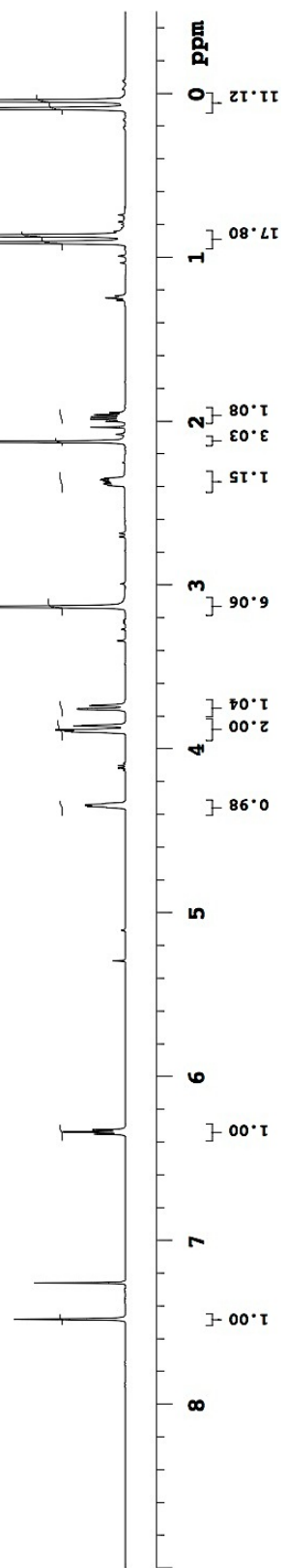
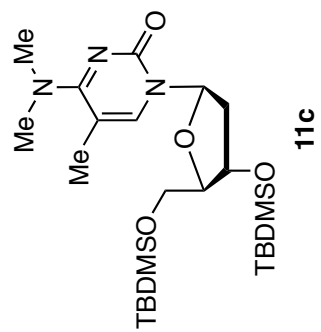

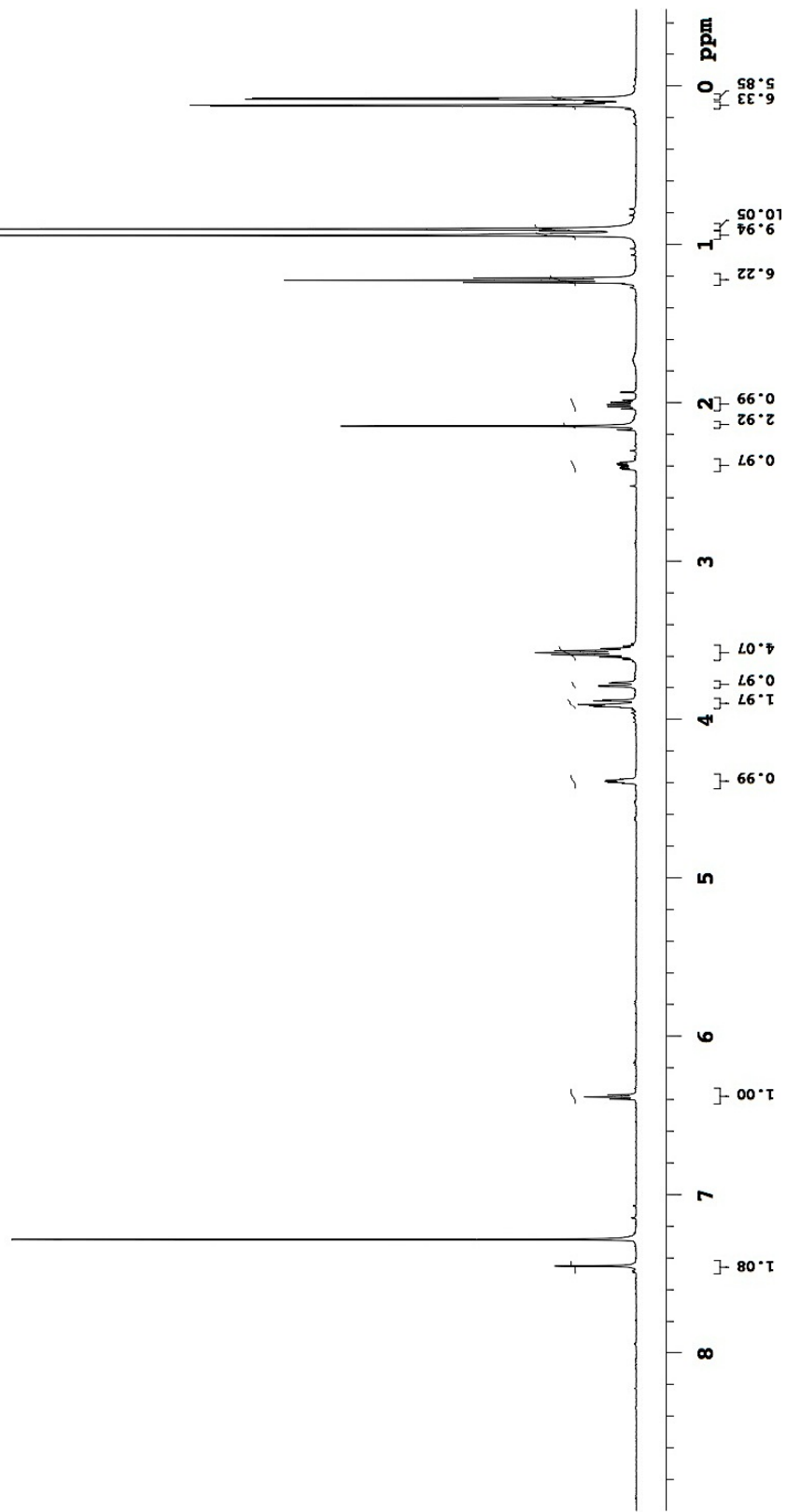
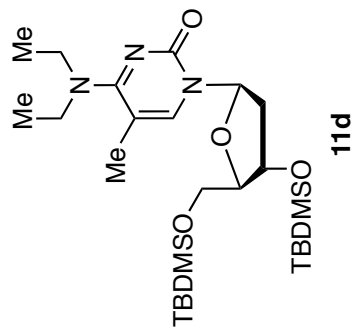

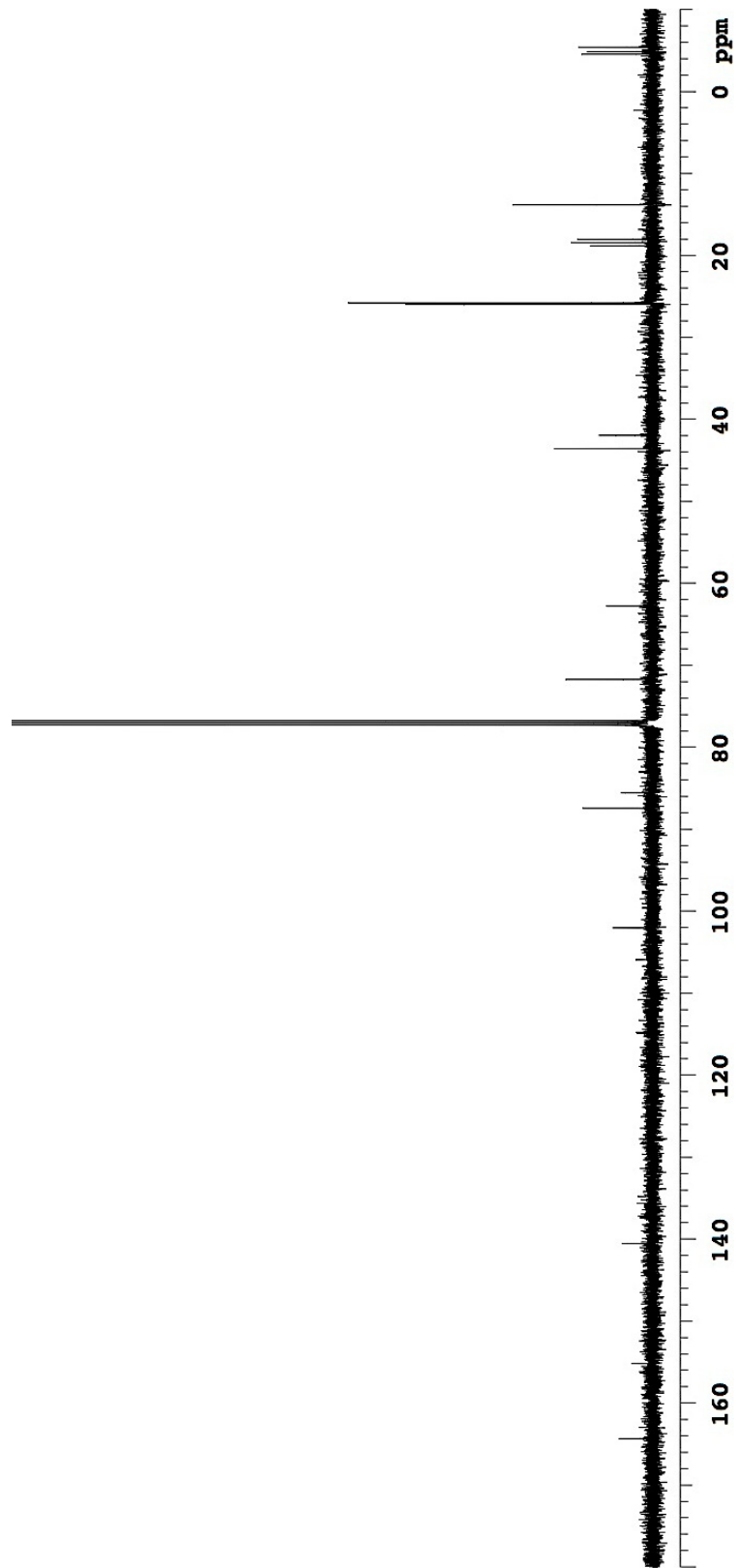
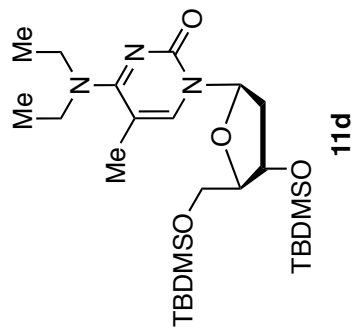

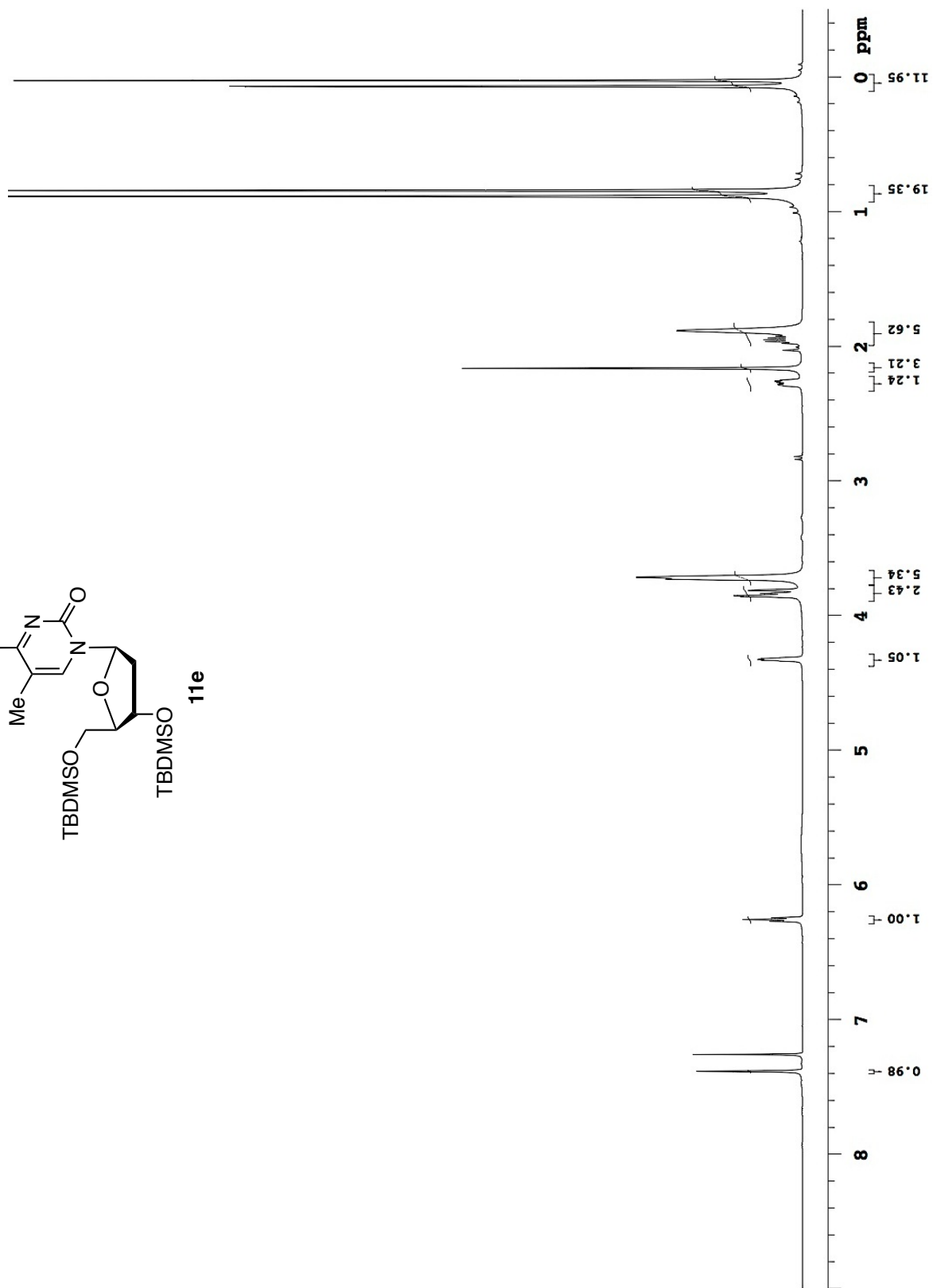
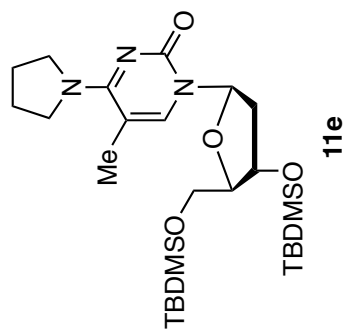

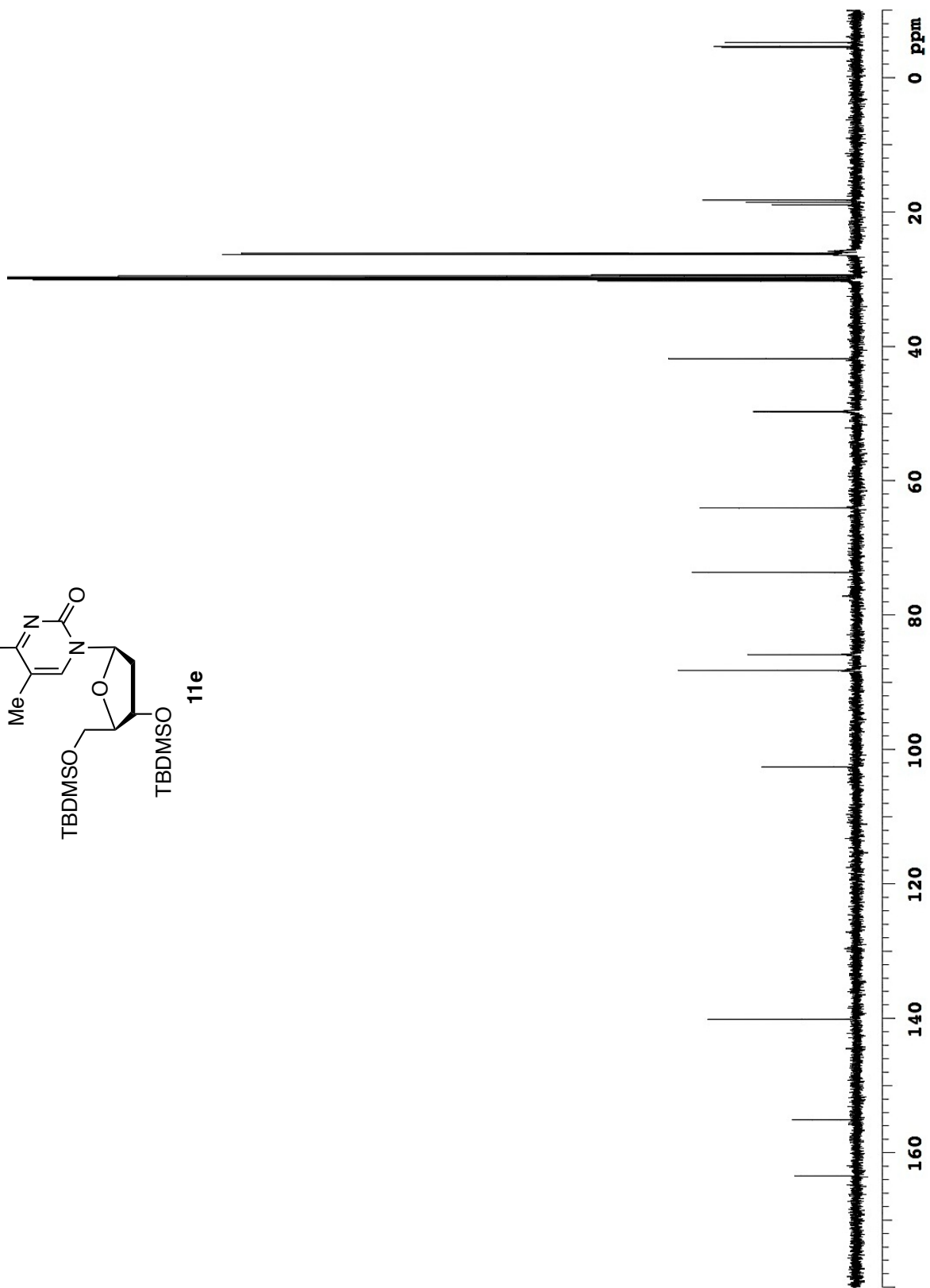
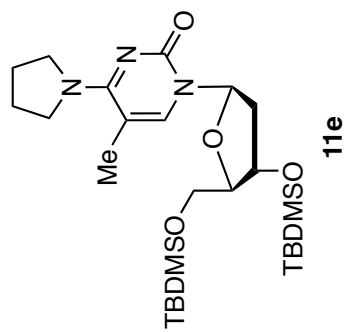

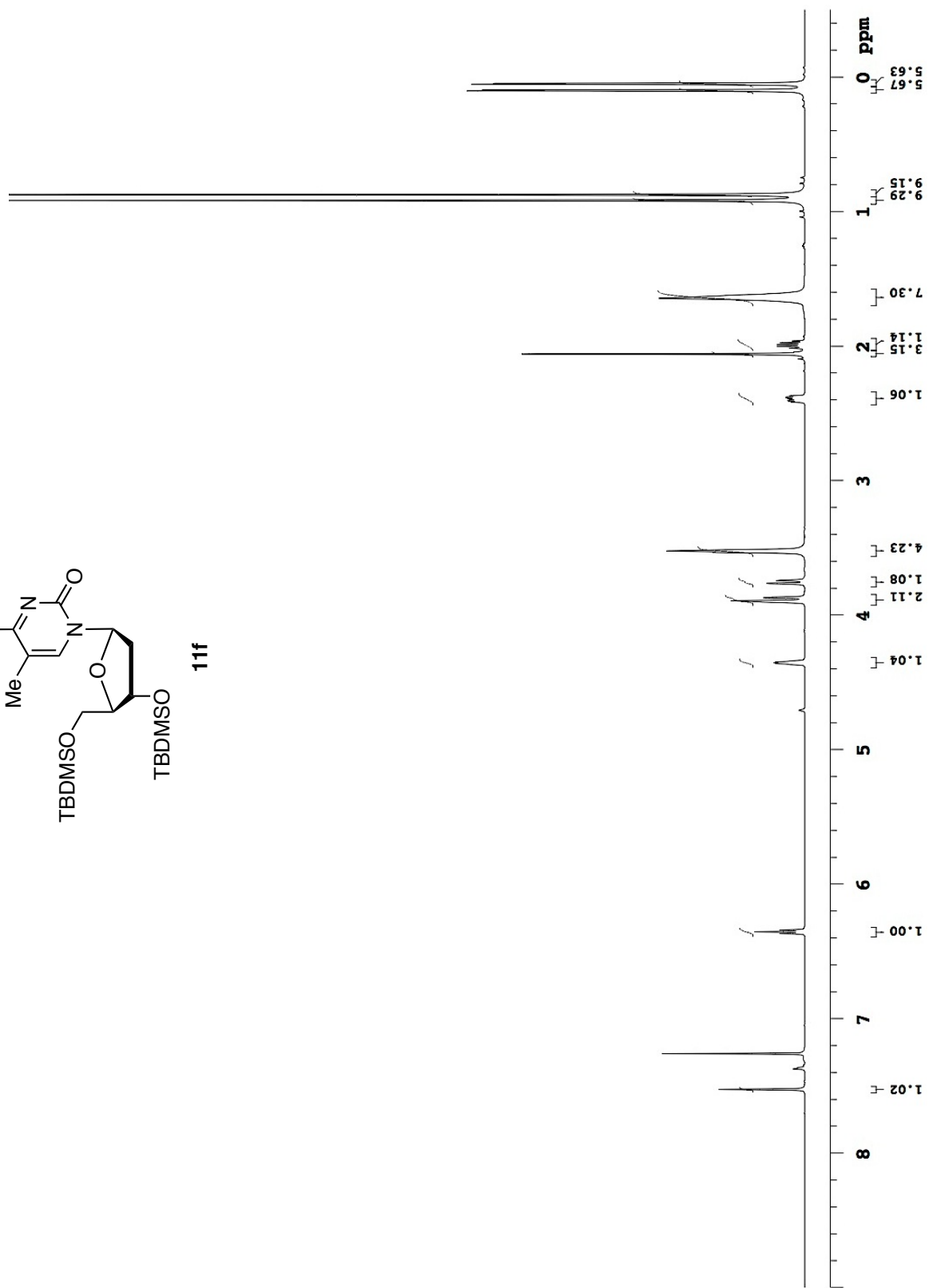
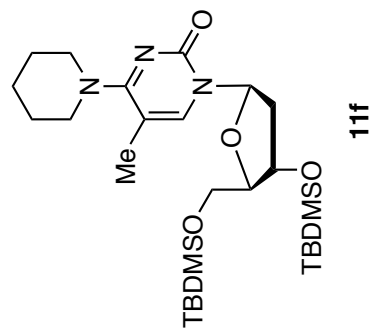

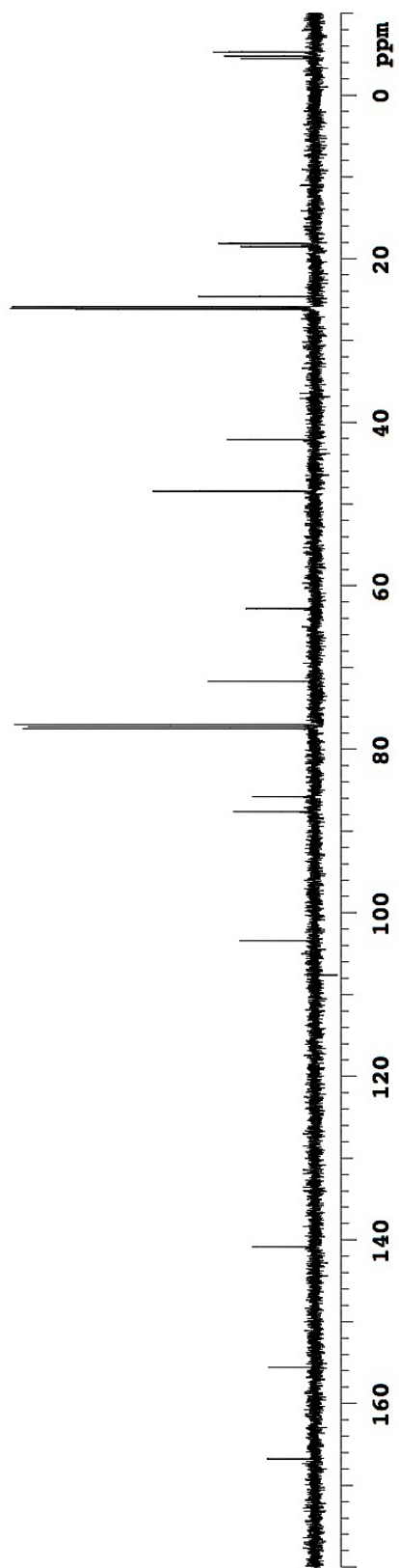
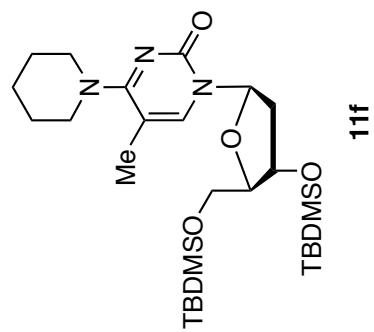

gCOSY spectrum of compound **11f** in CDCl₃

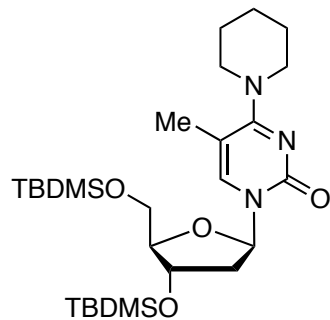

11f

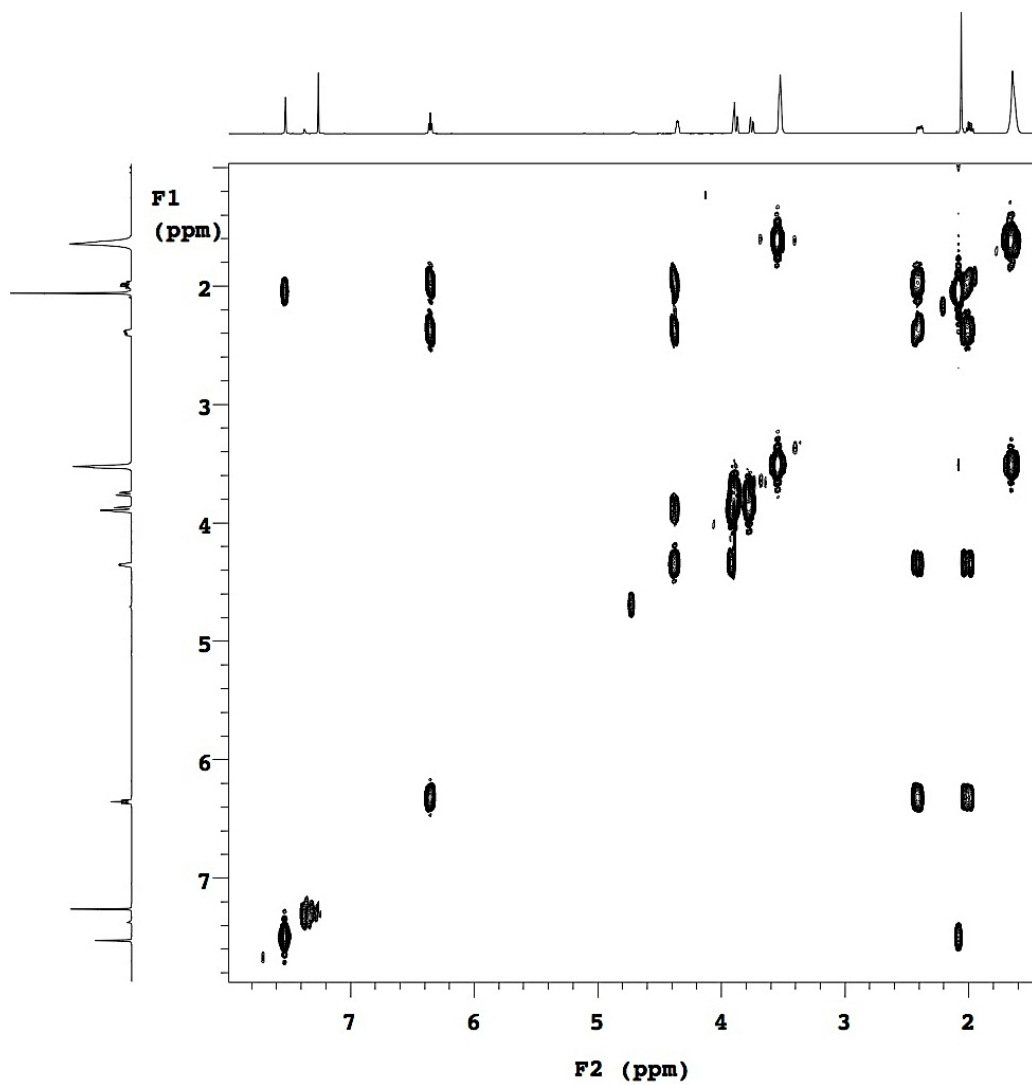

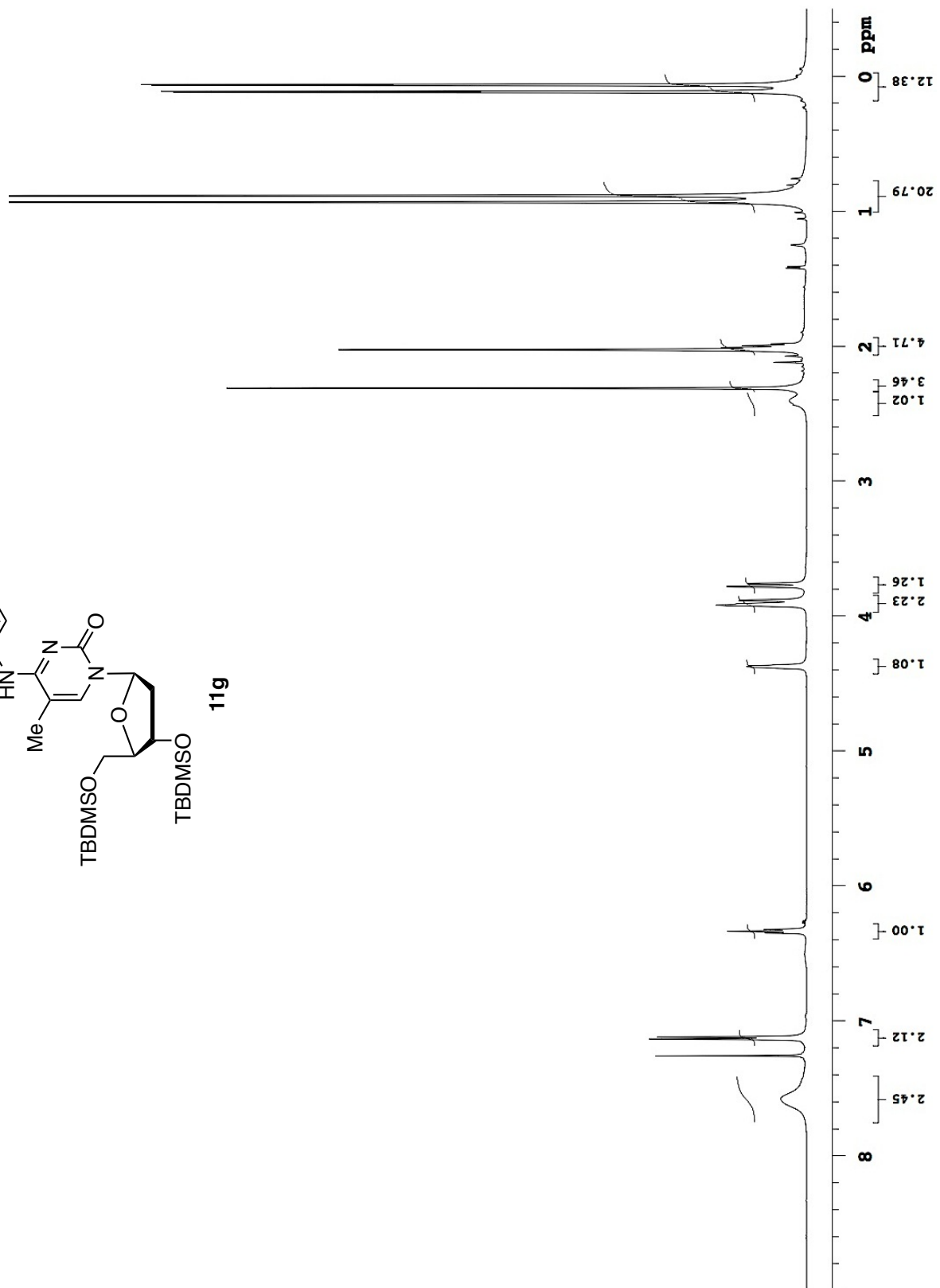
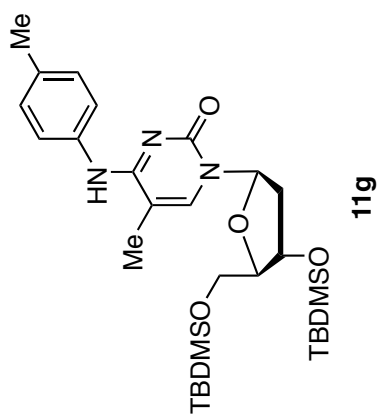

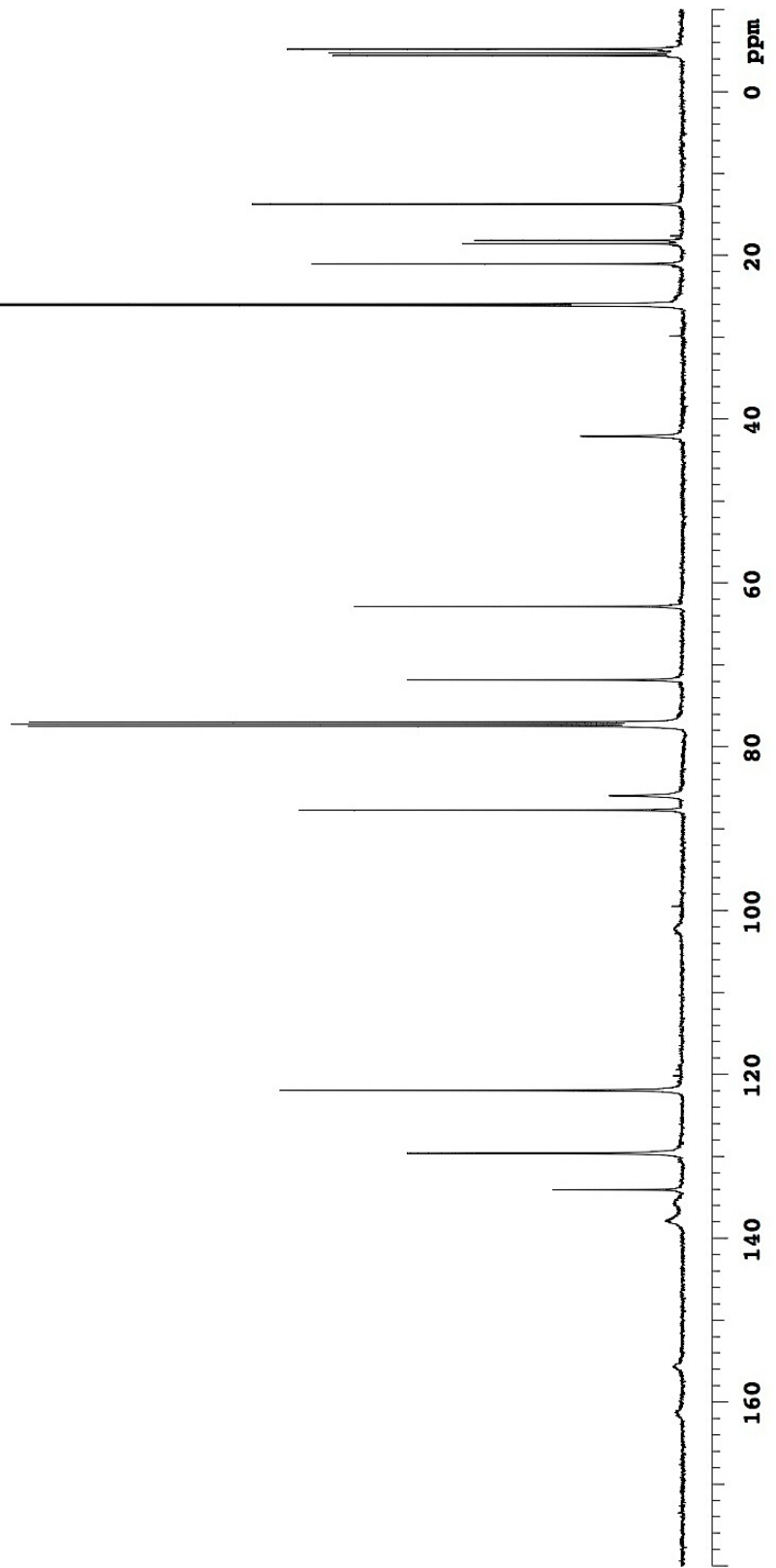
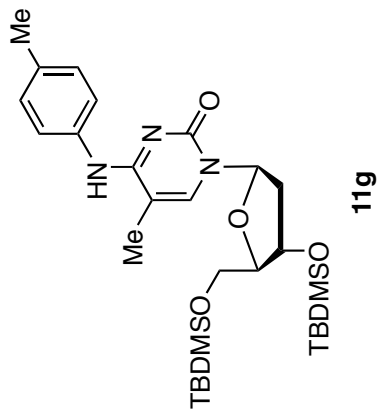

gCOSY spectrum of compound **11g** in CDCl₃

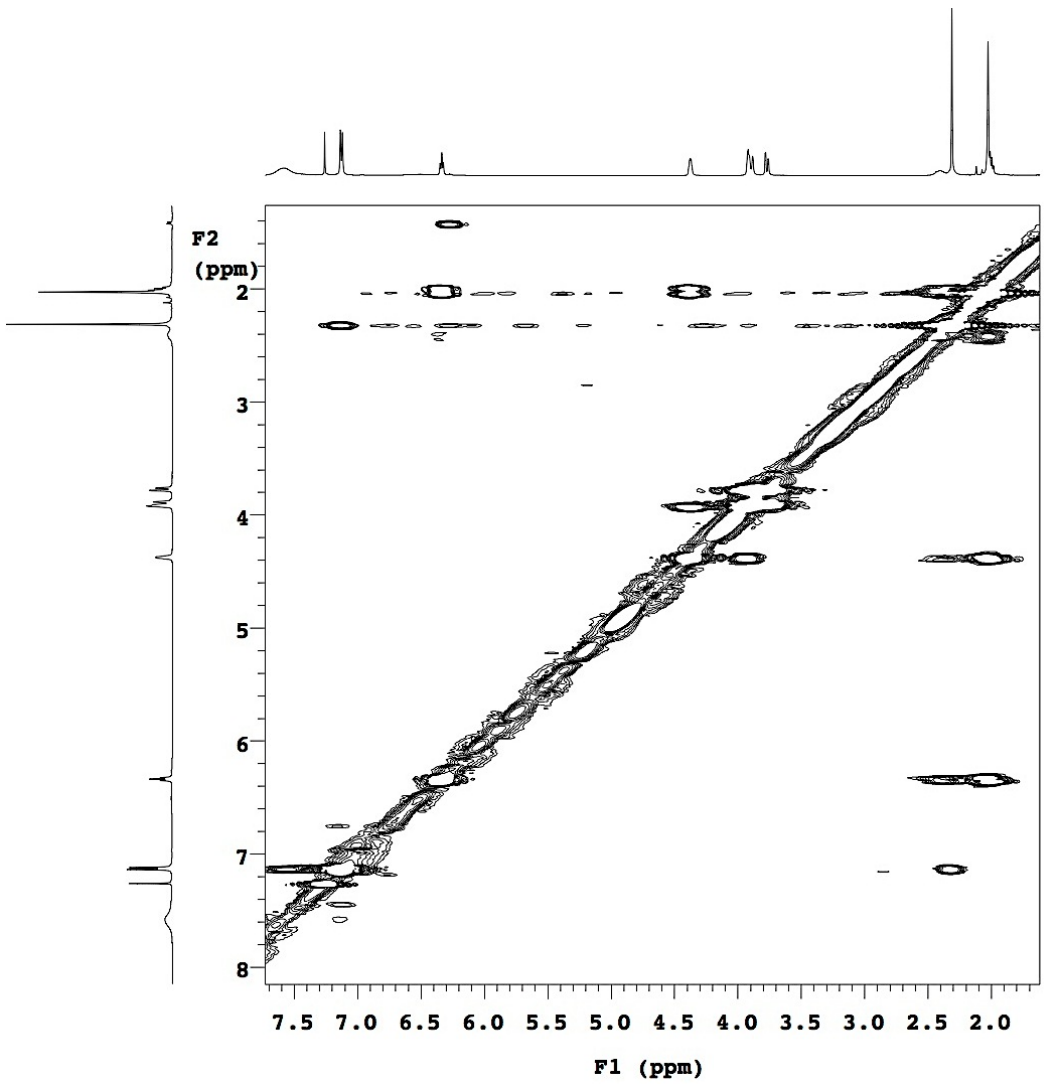
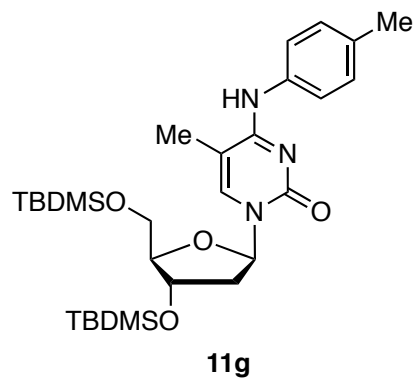

Expansion of gCOSY spectrum of compound **11g** in CDCl₃

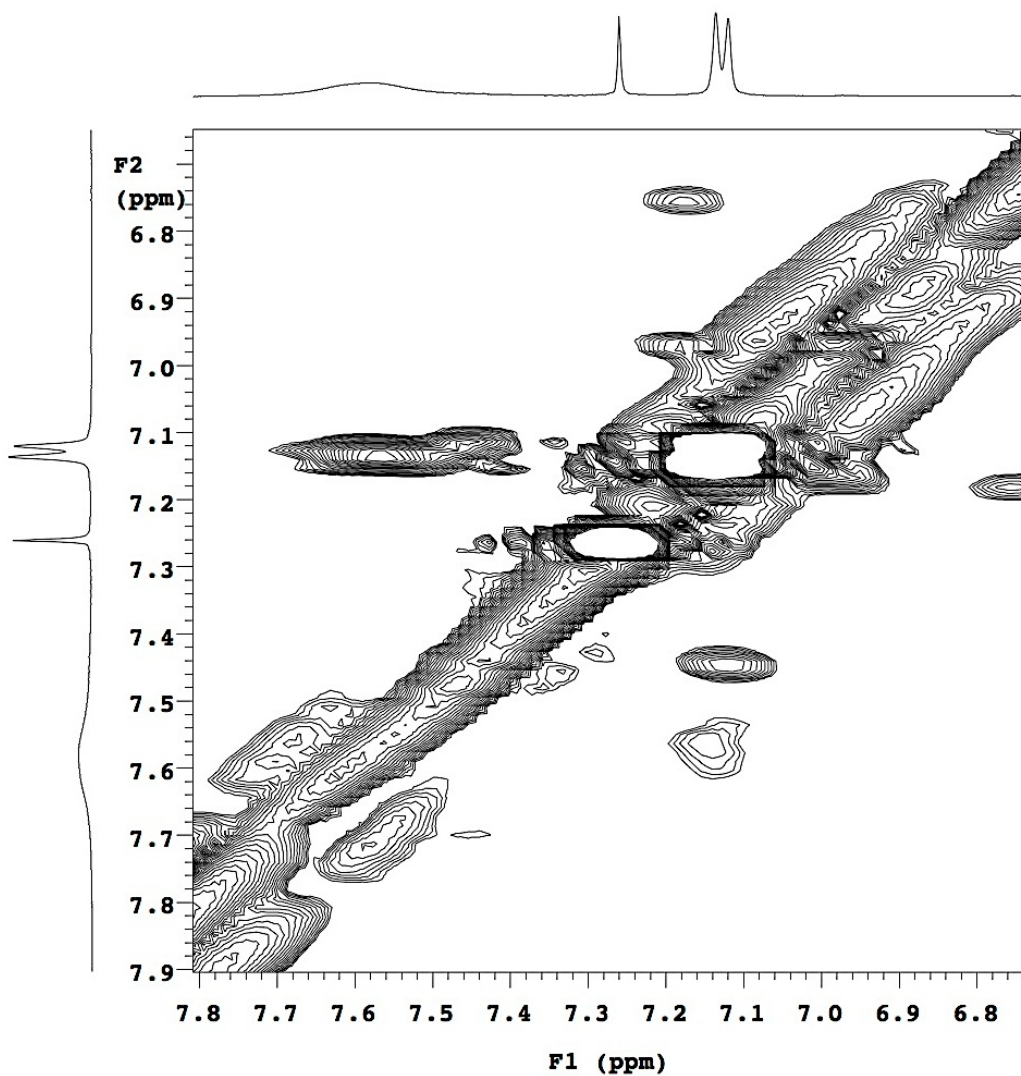
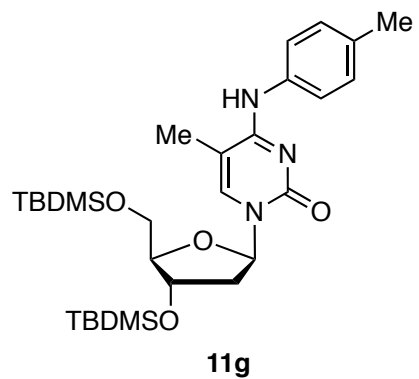

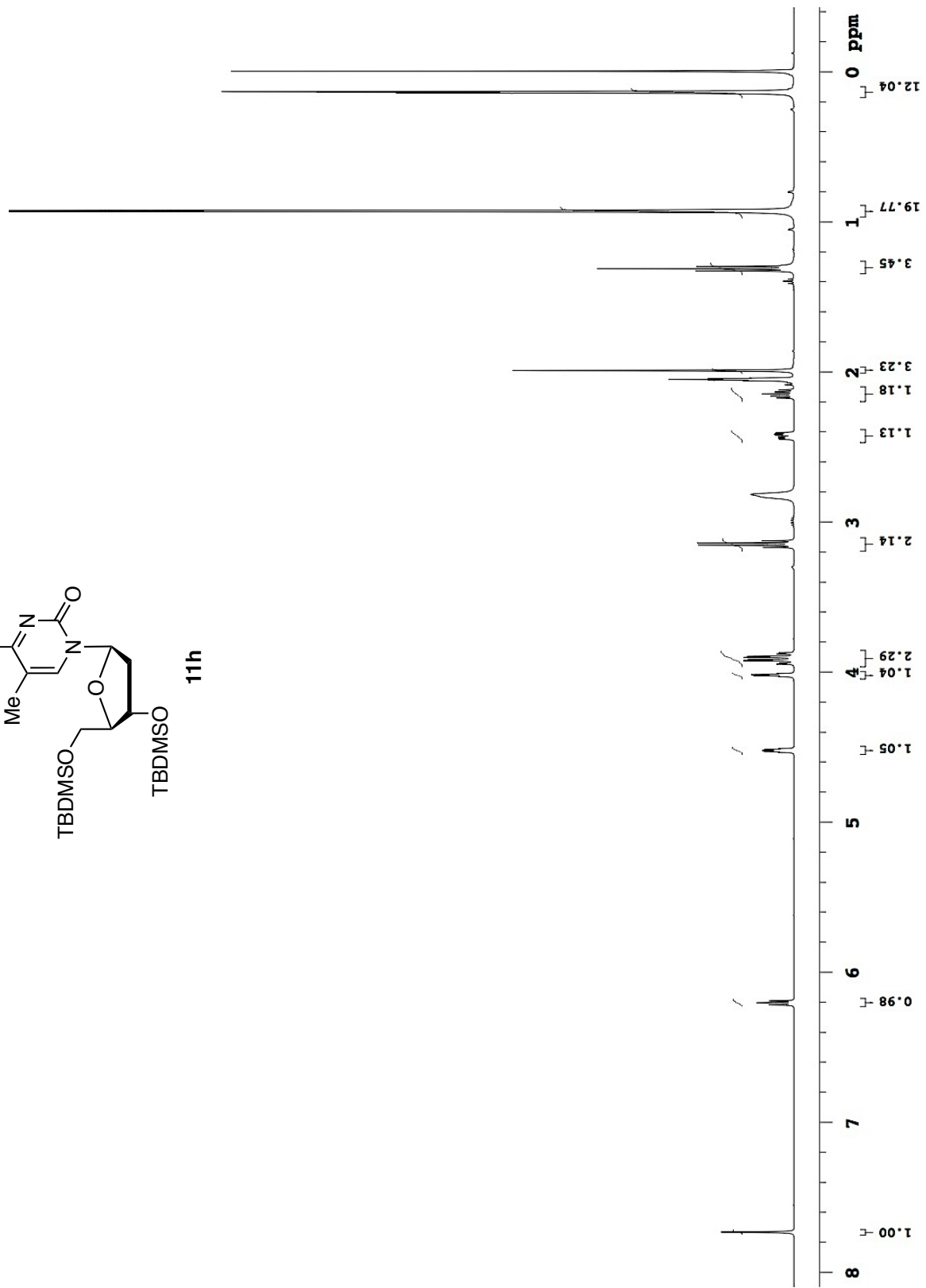
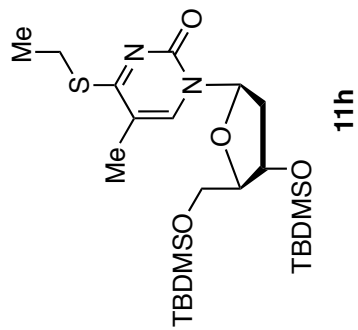

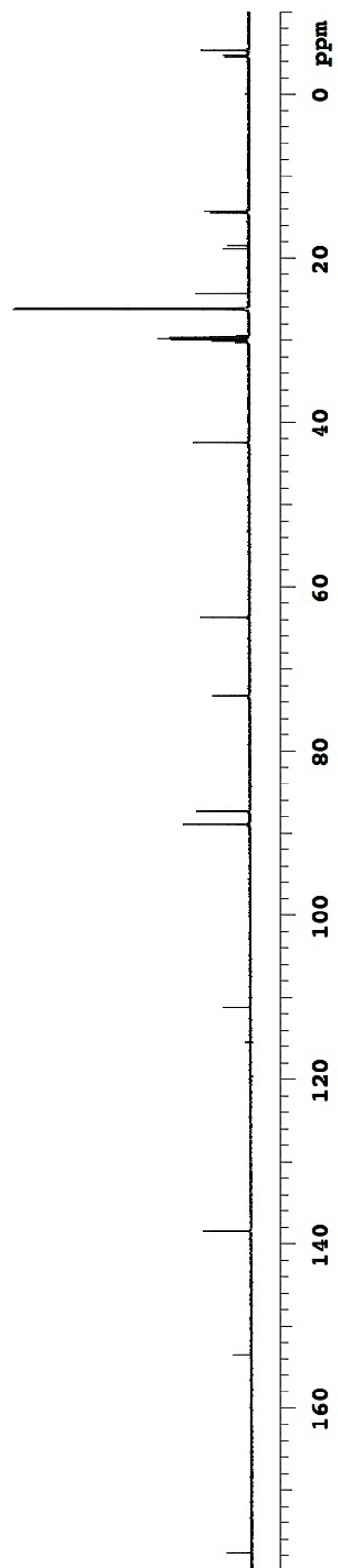
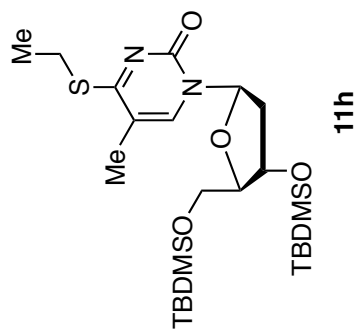

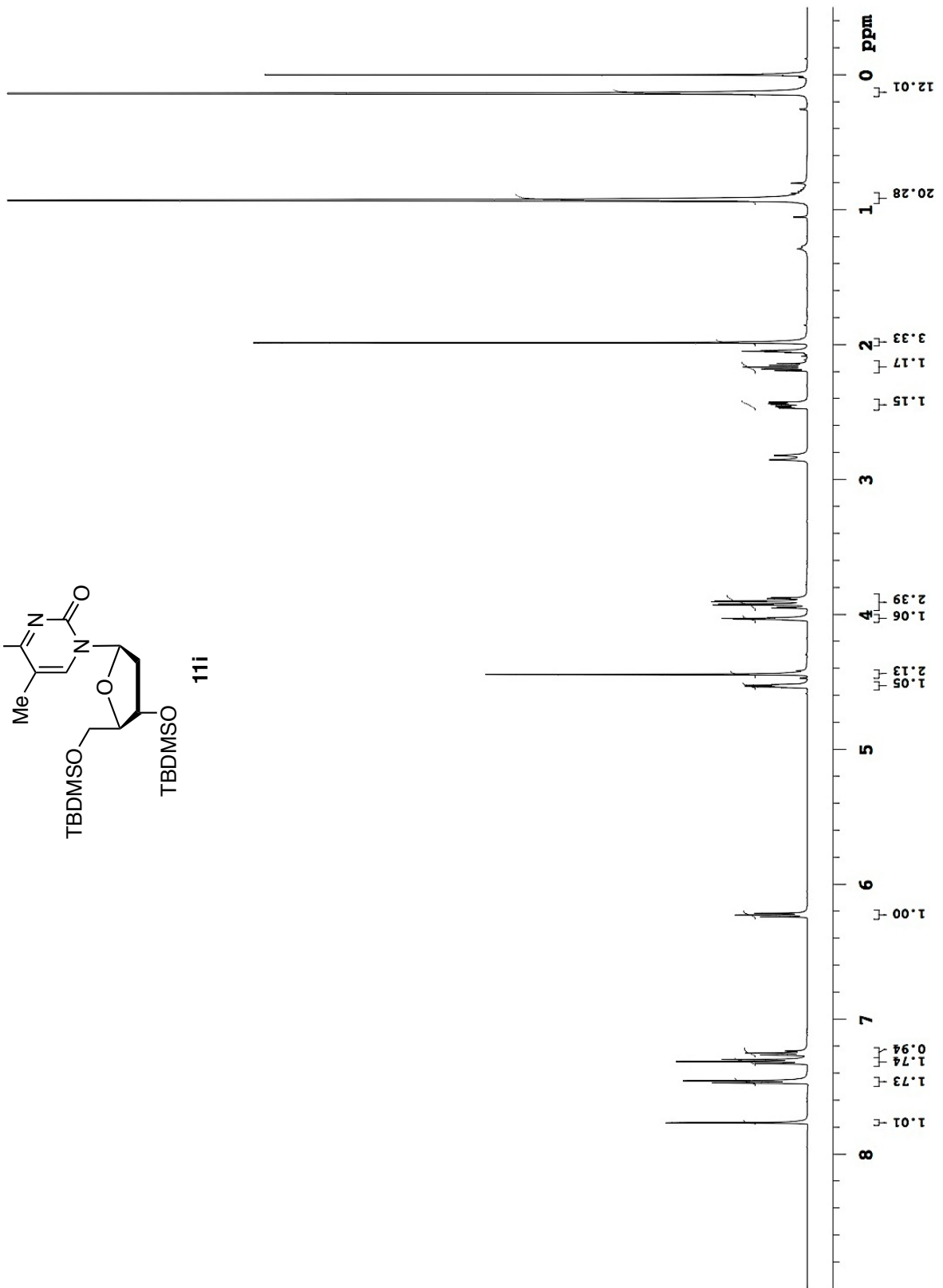
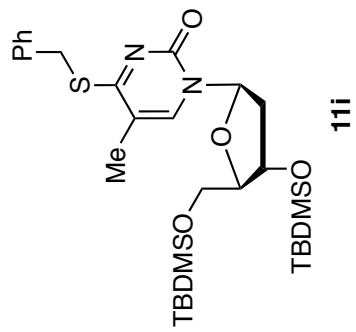

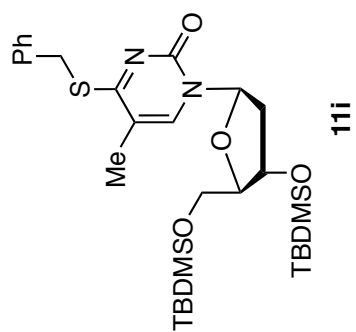

11i

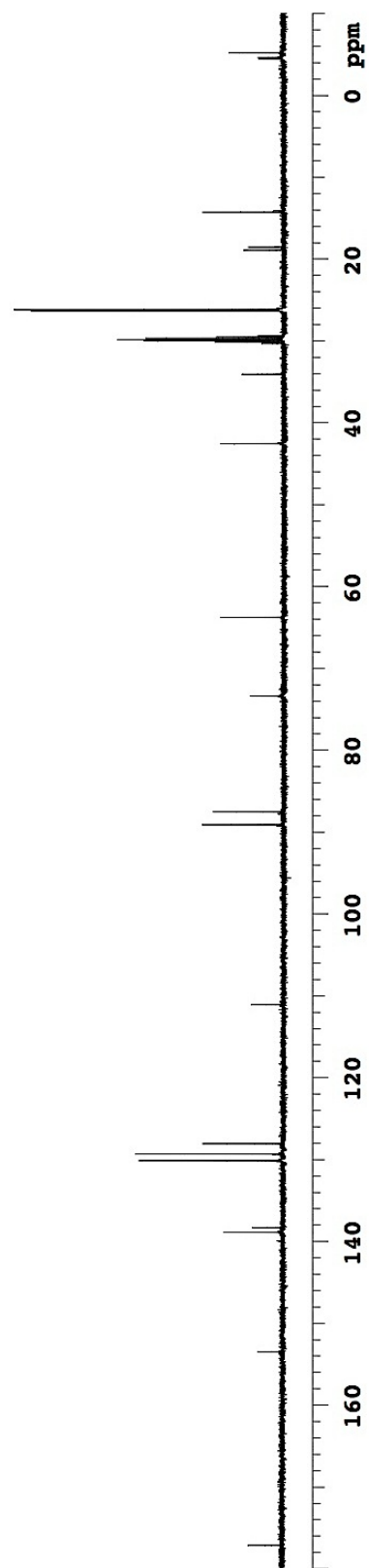

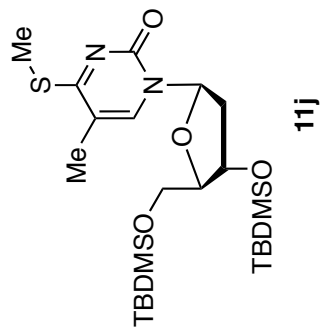

11j

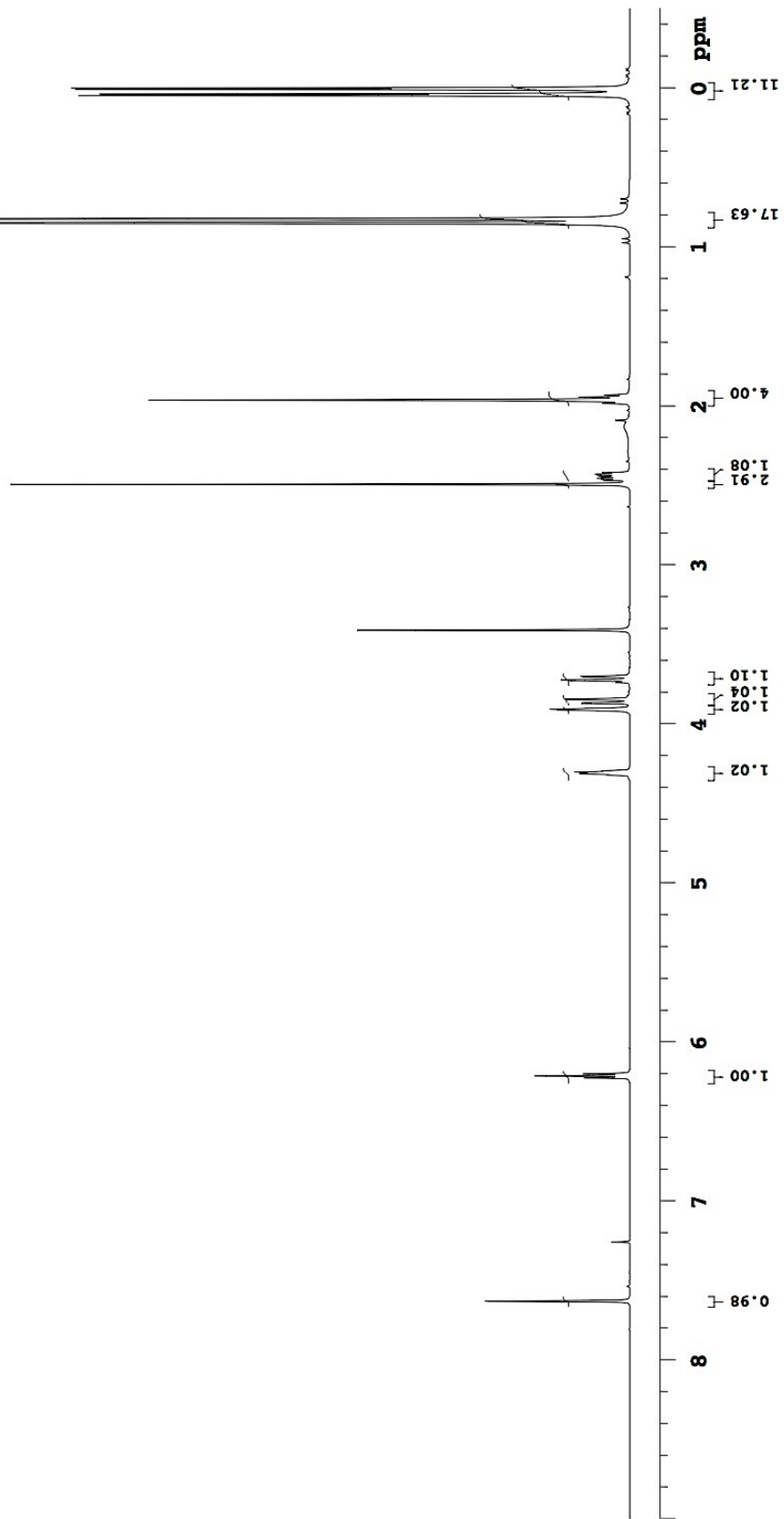

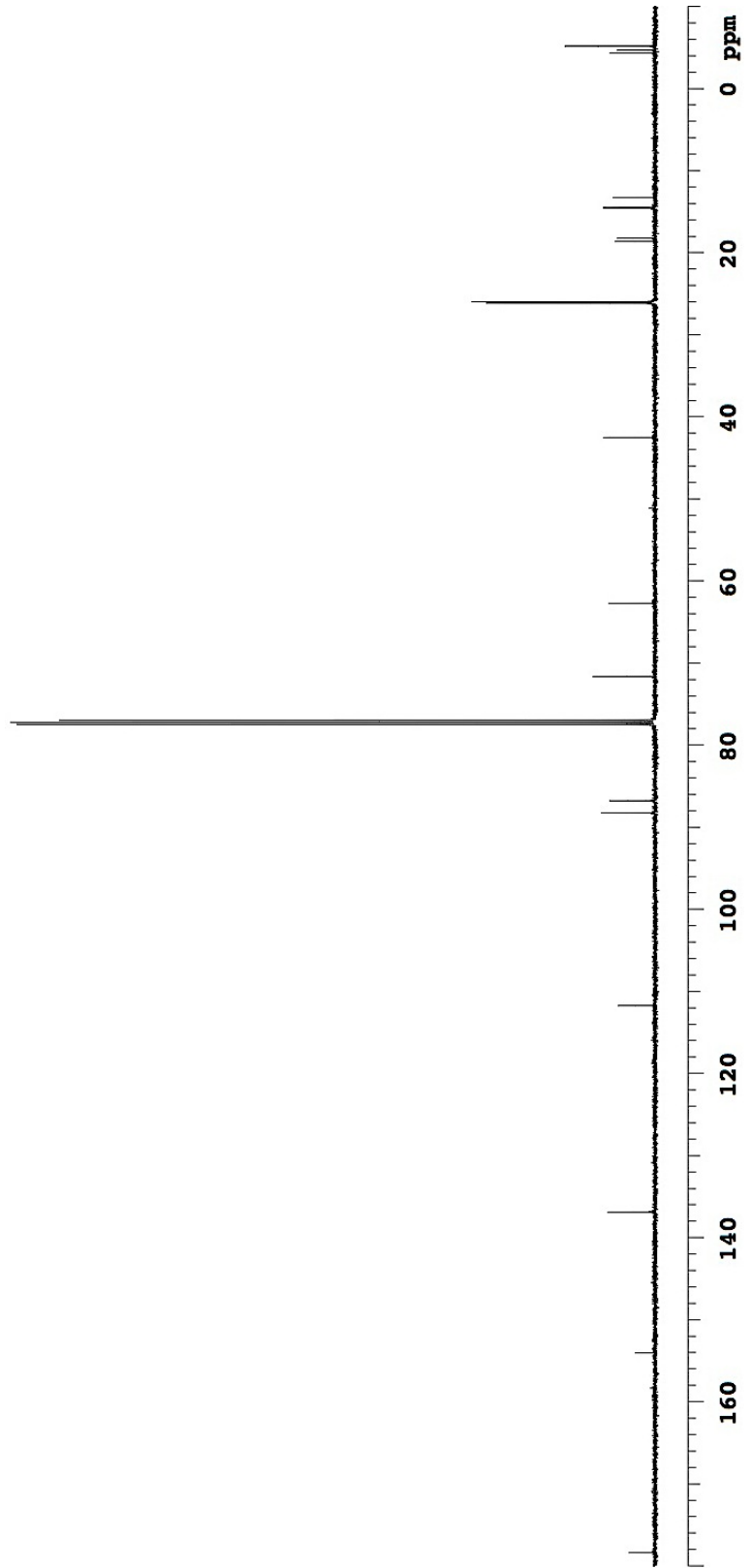
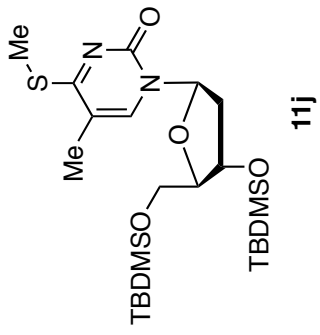

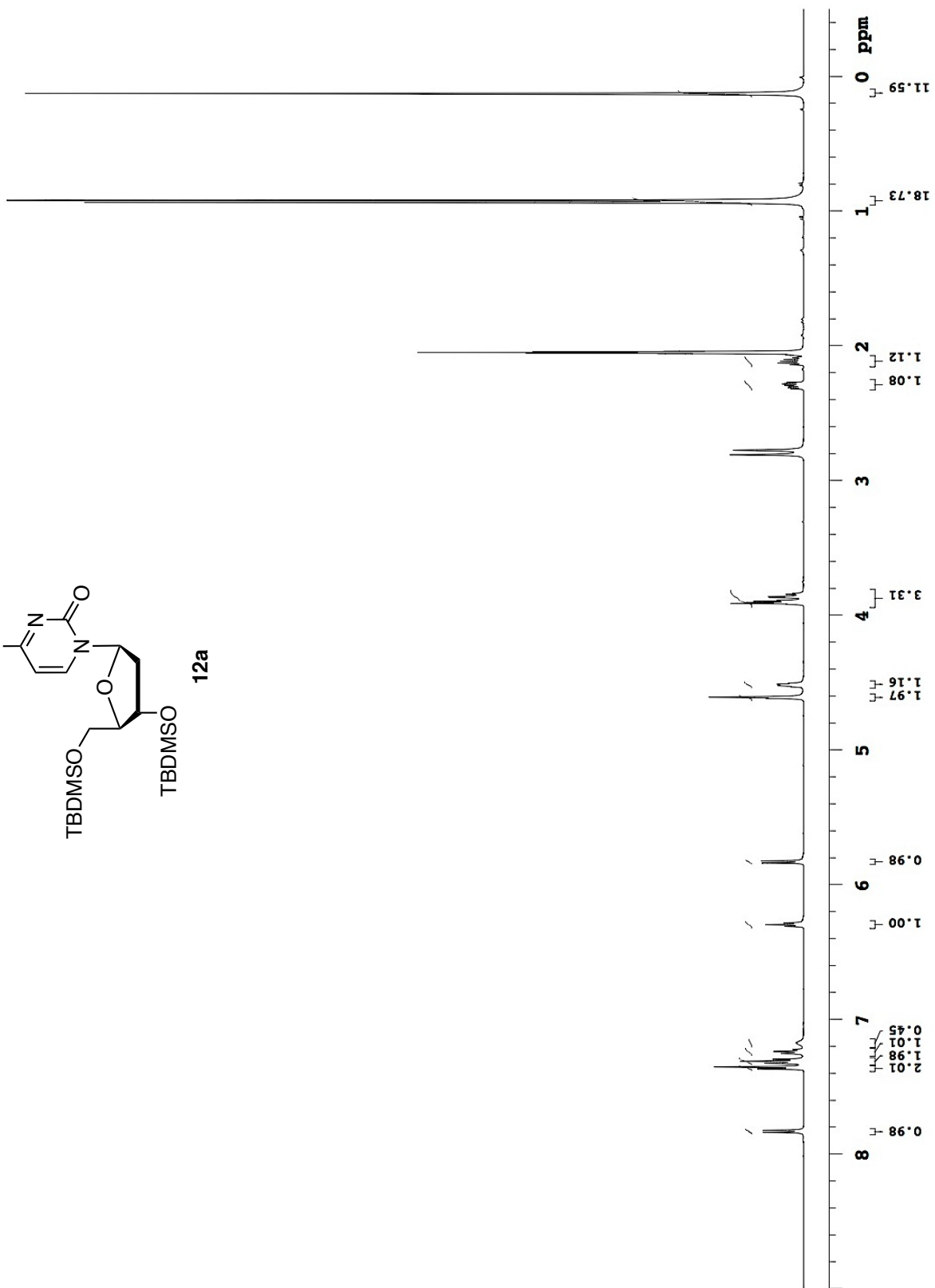
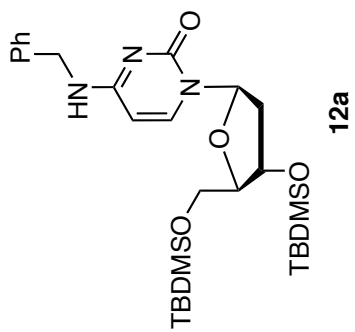

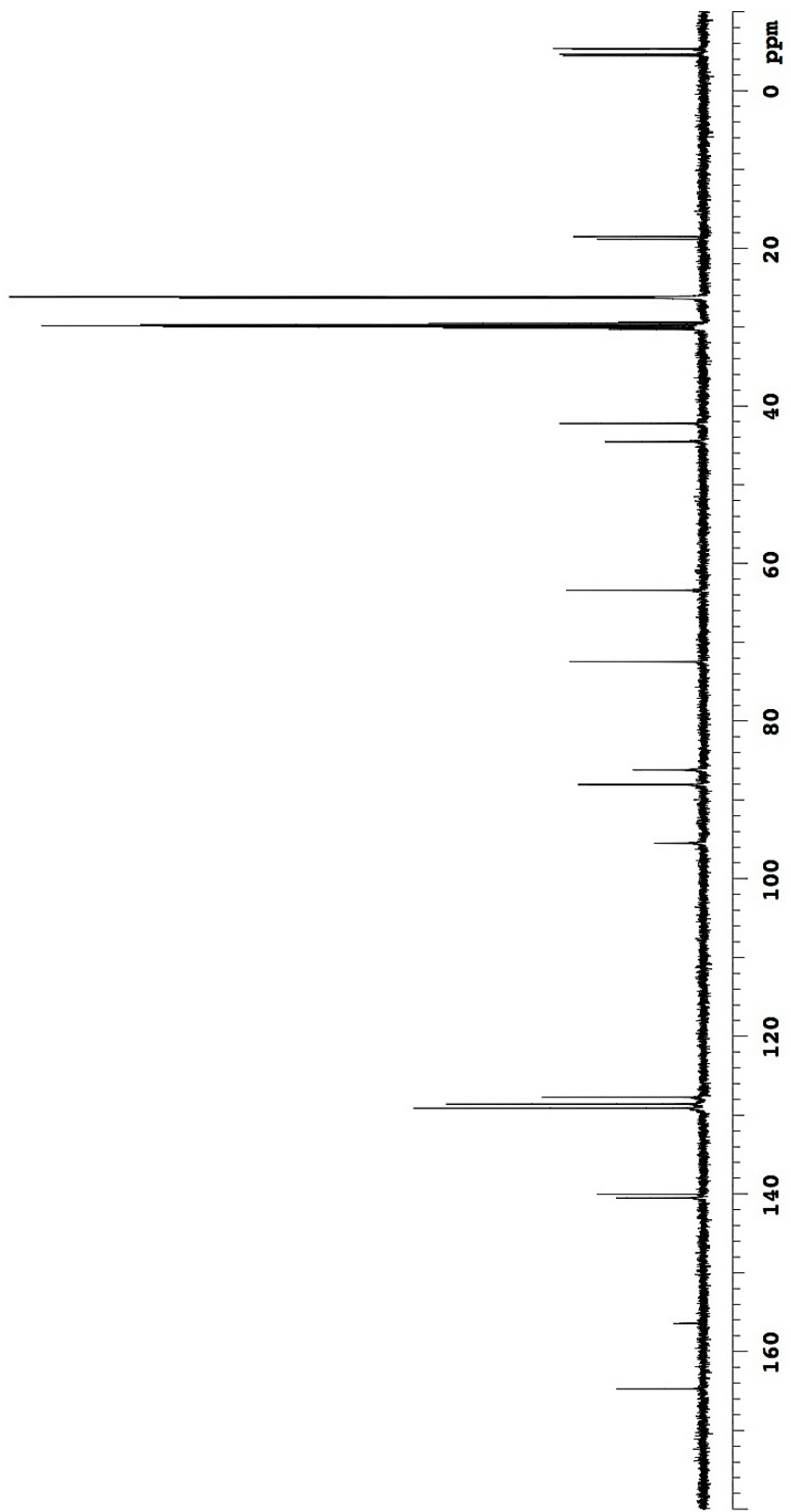
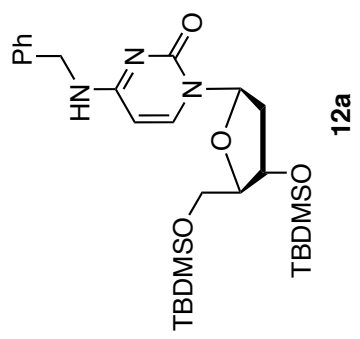

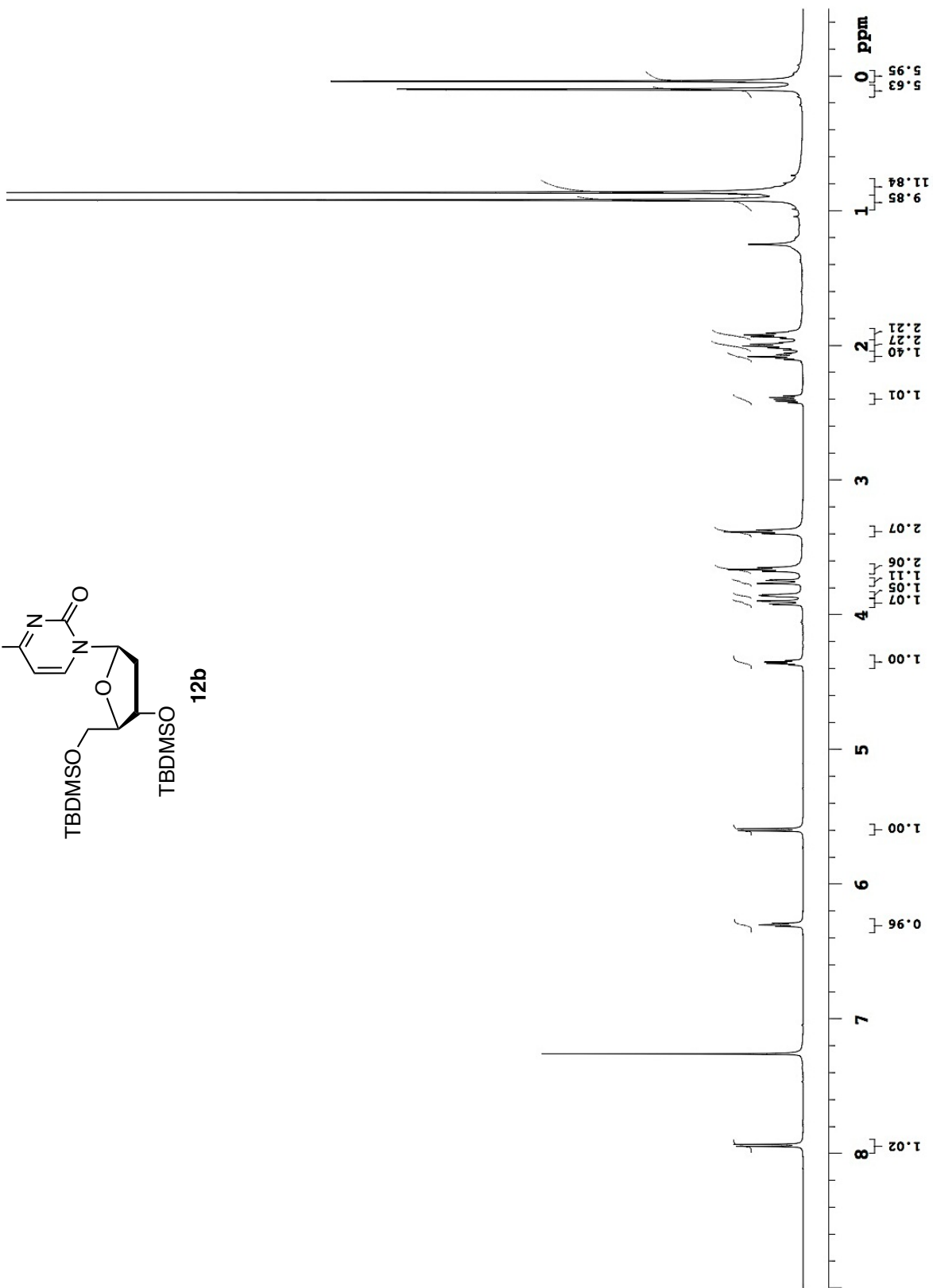
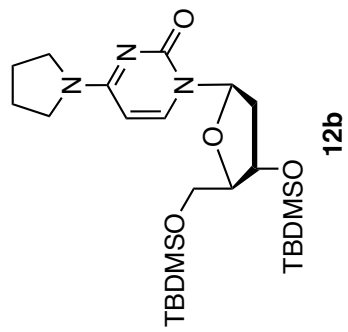

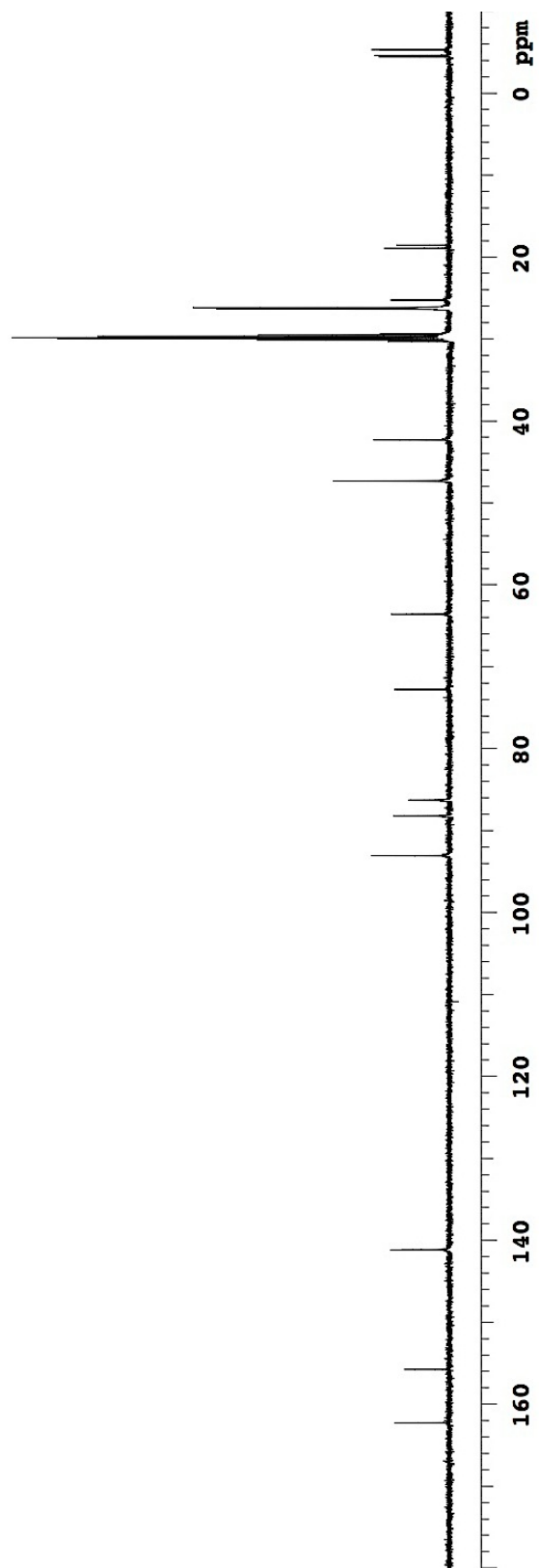
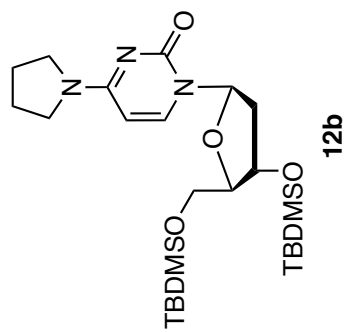

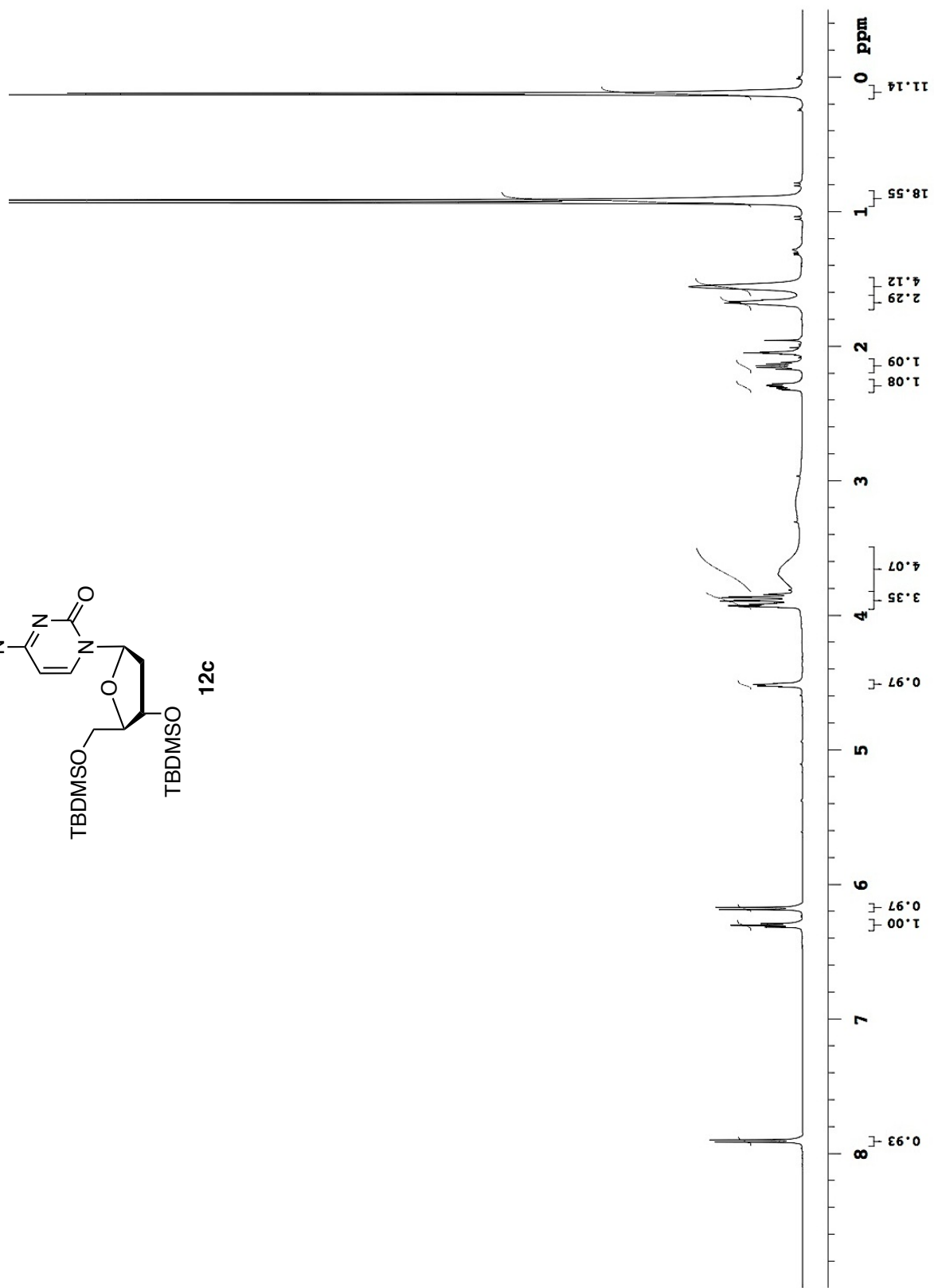
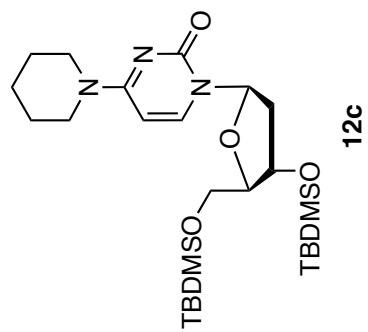

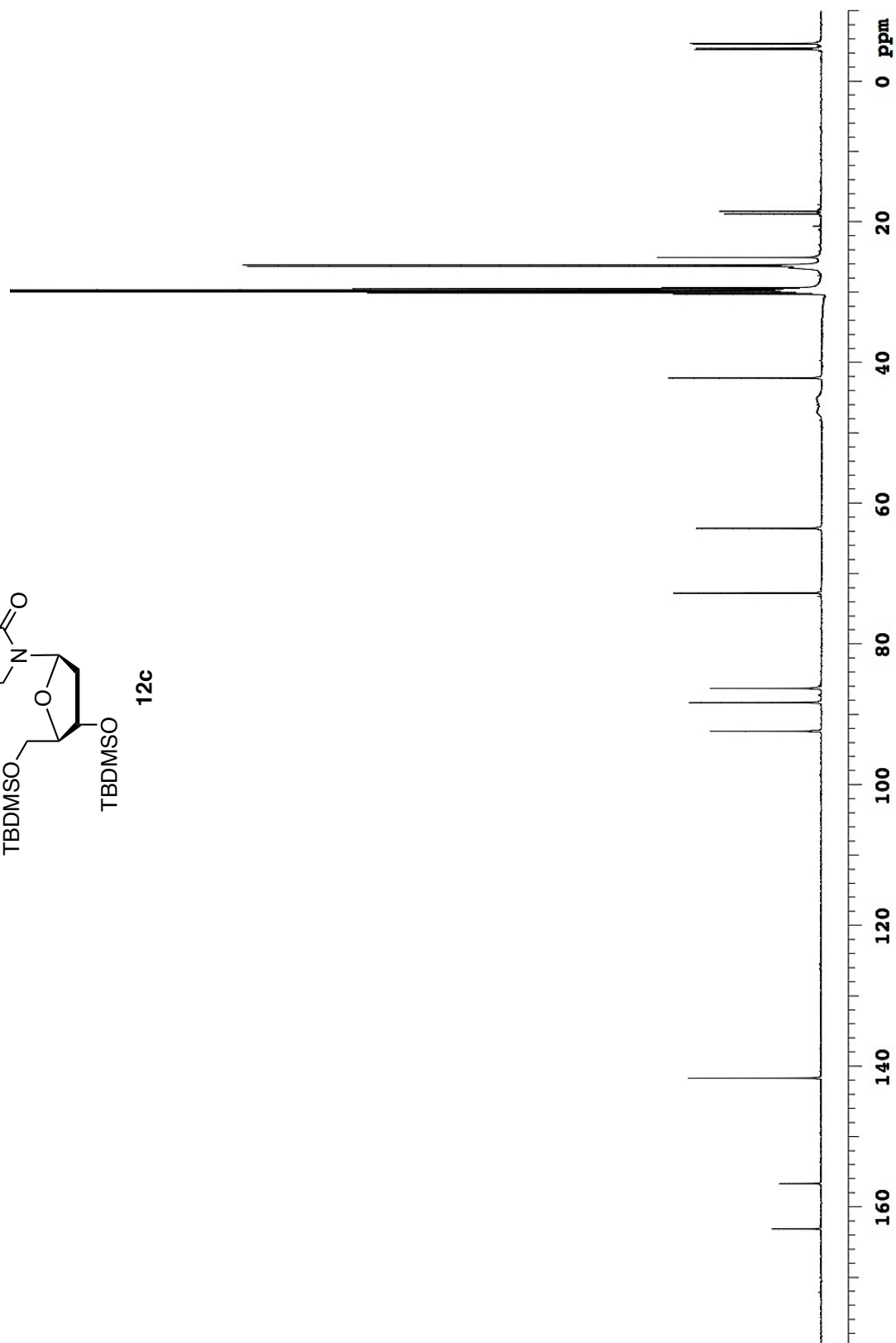
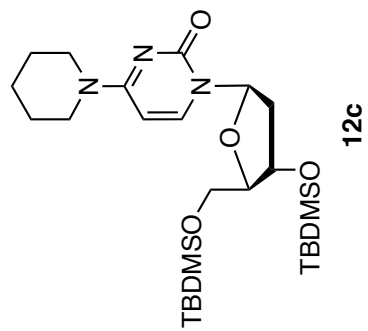

gCOSY spectrum of compound **12c** in acetone-*d*₆

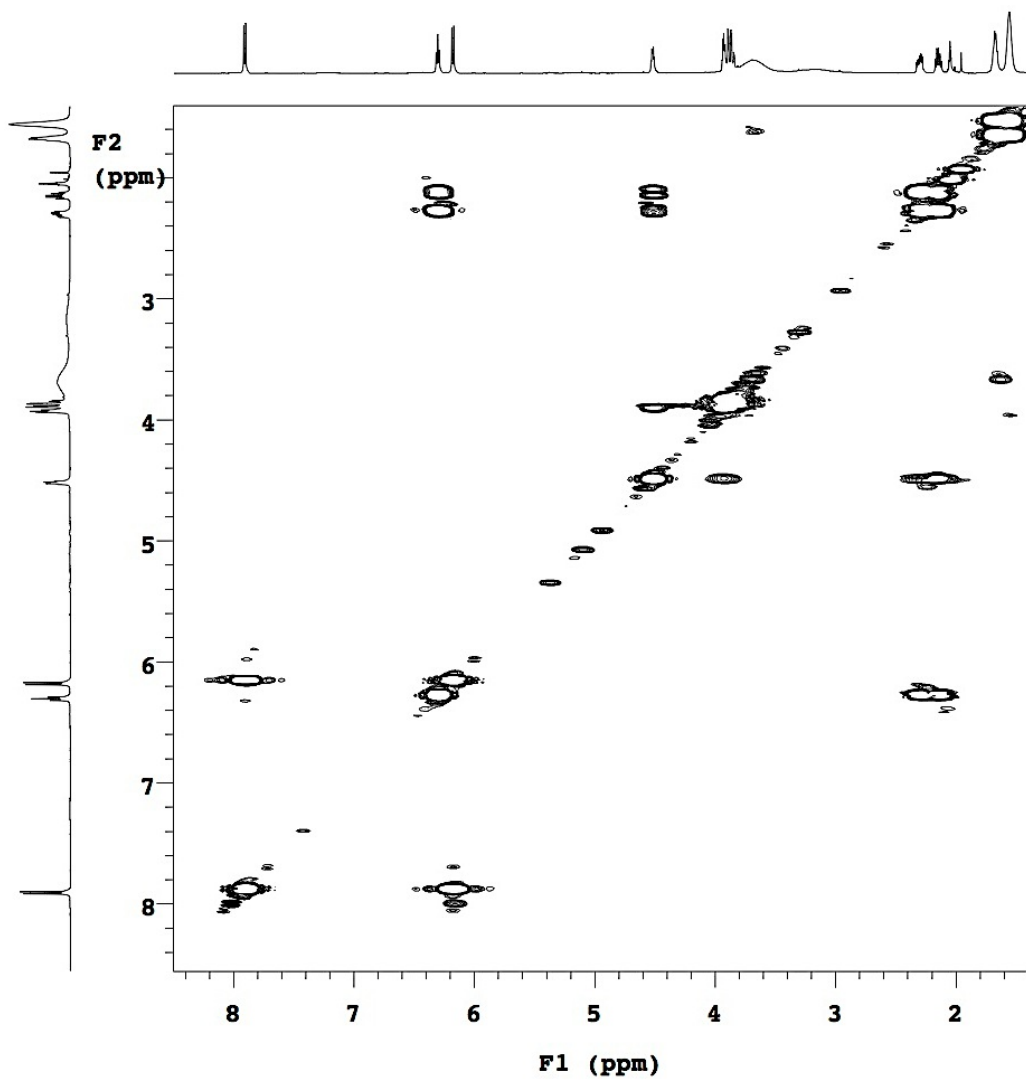
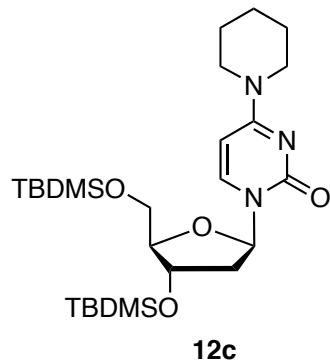

gHMQC spectrum of compound **12c** in acetone- d_6

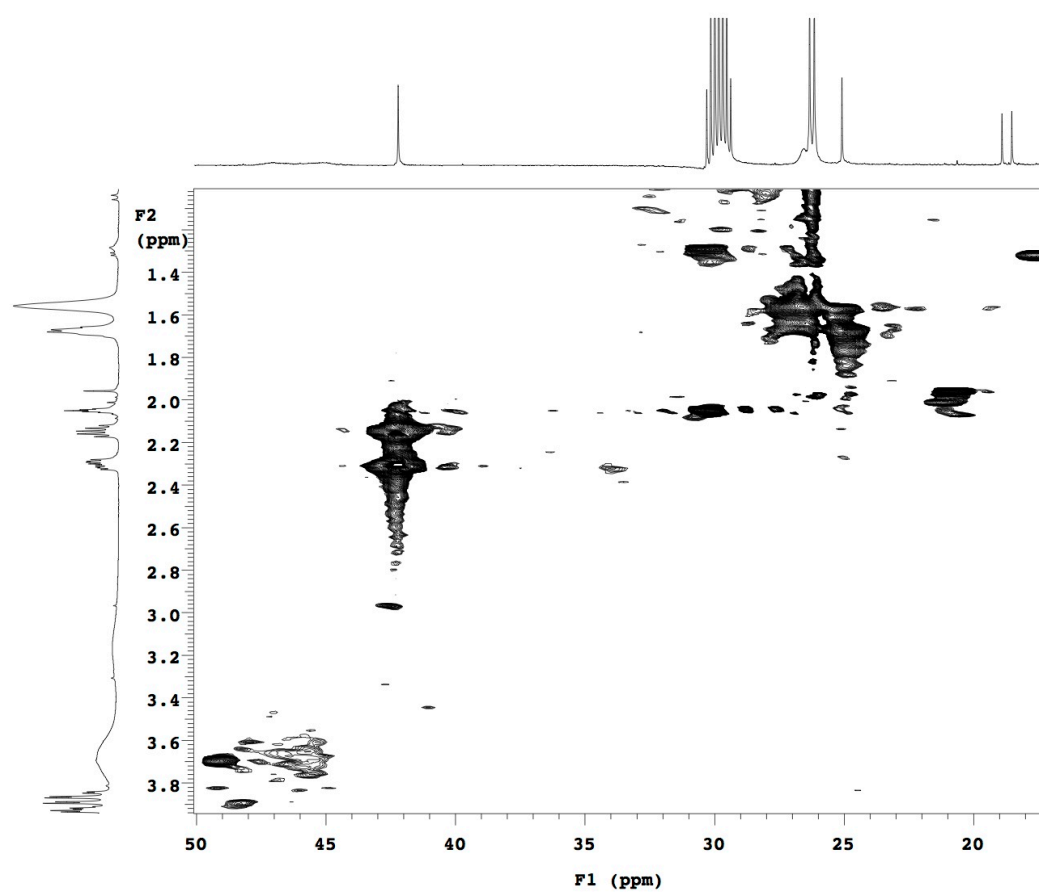
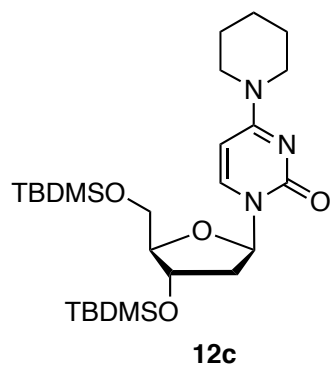

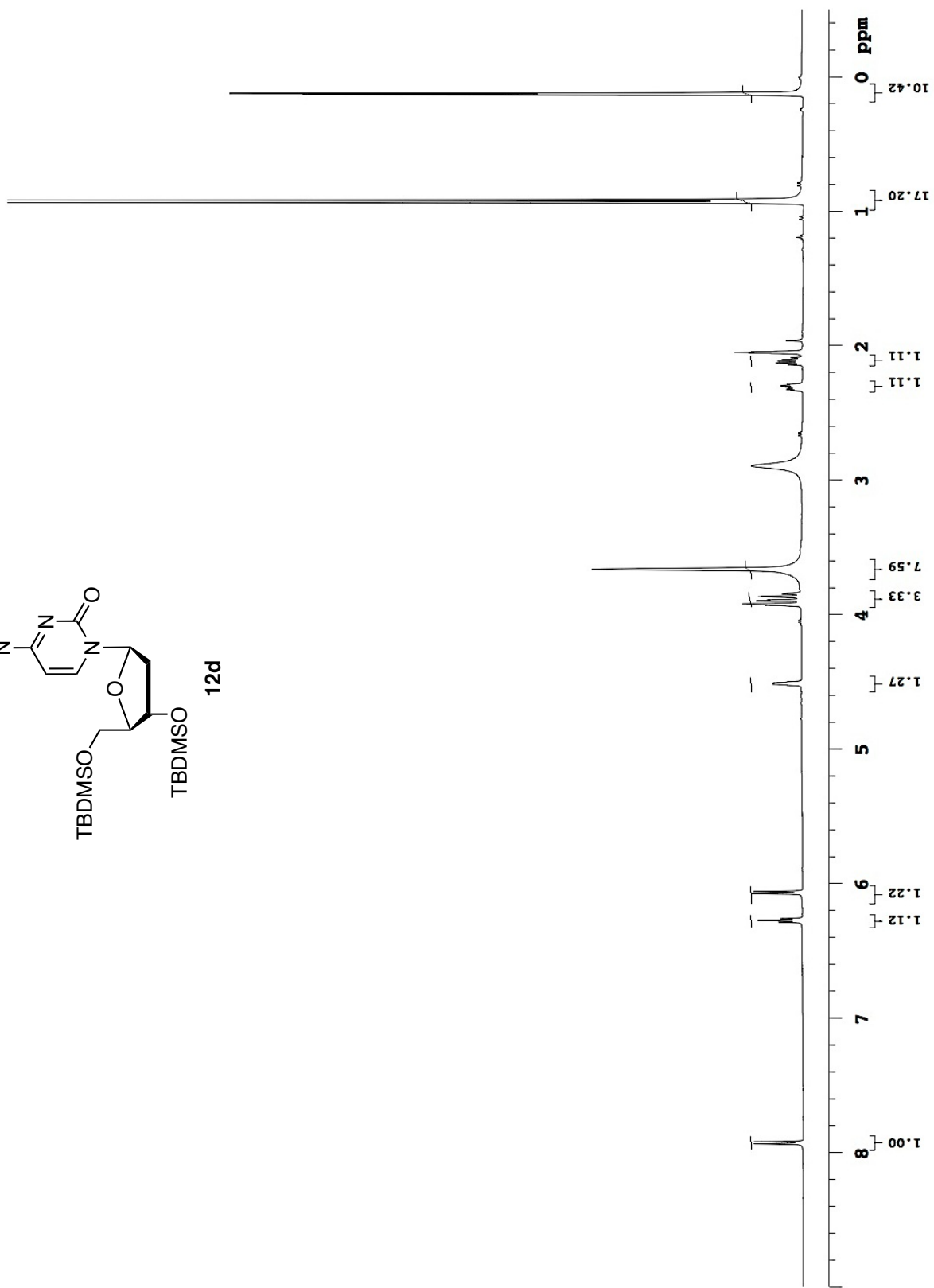
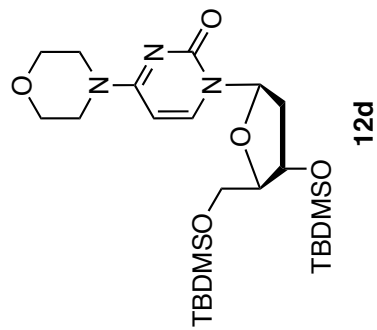

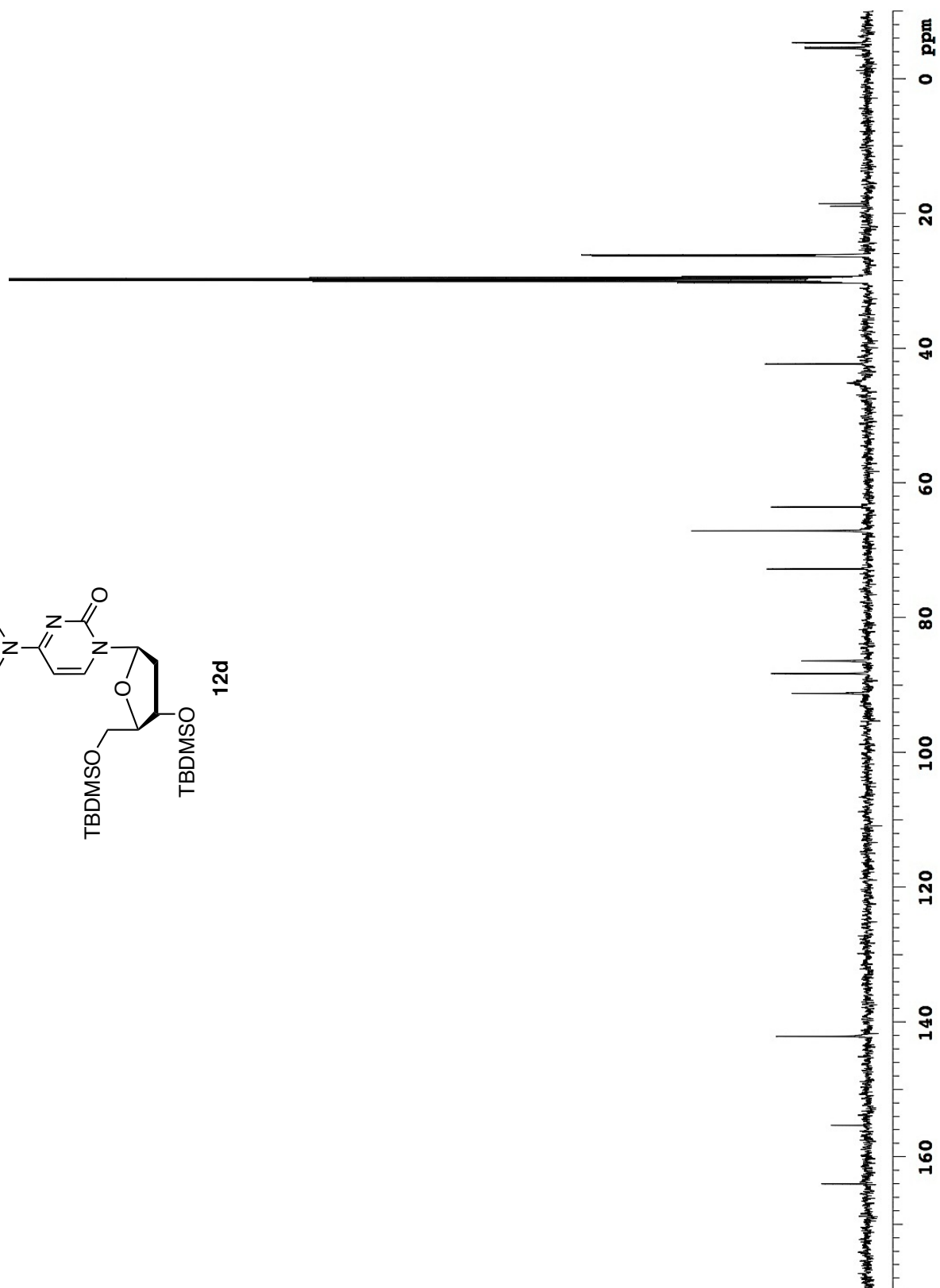
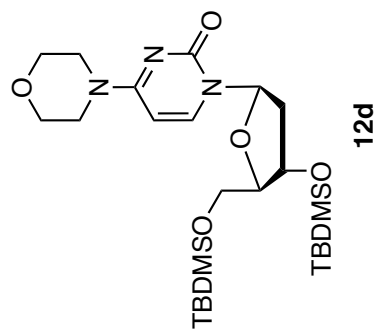

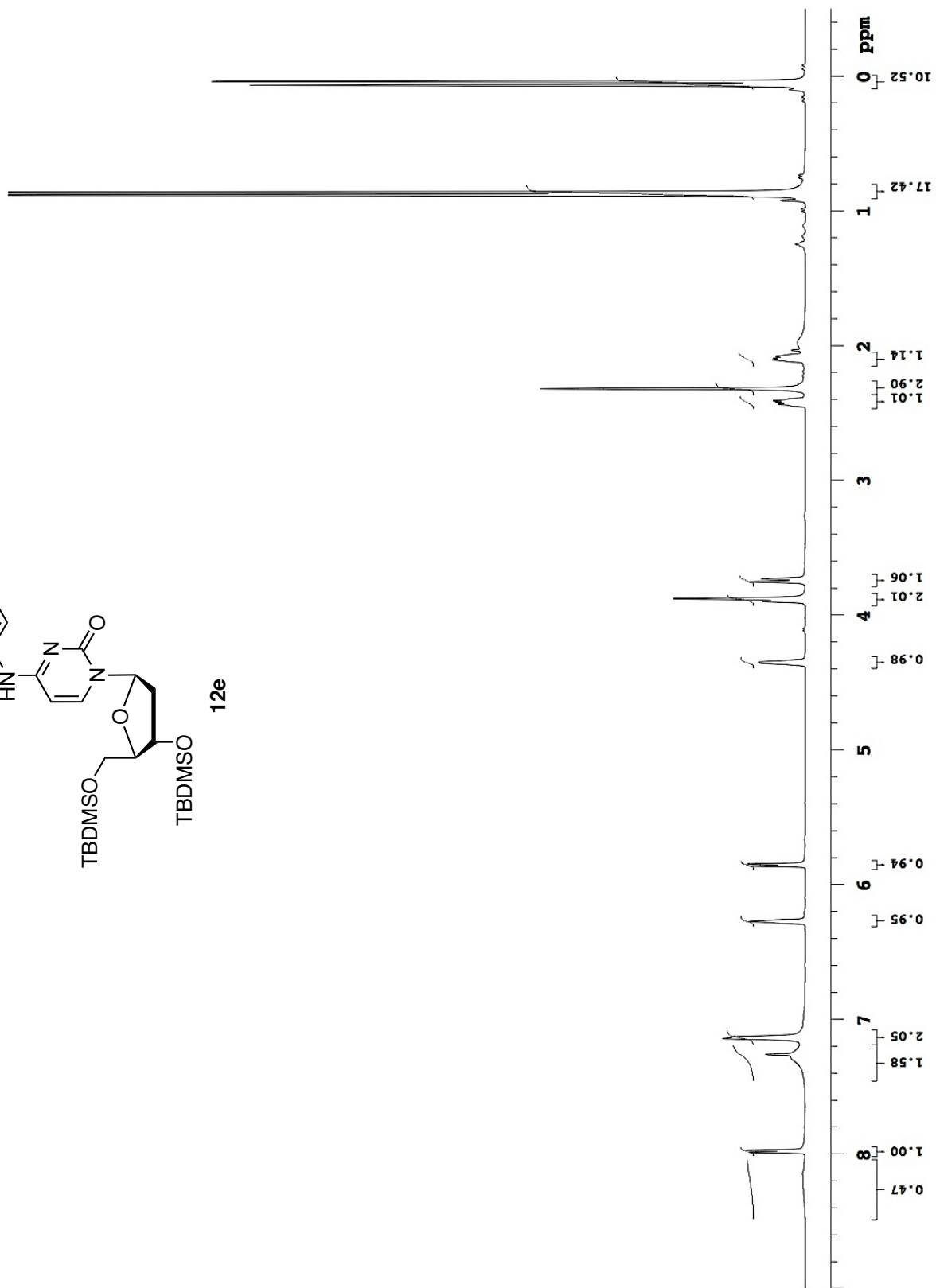
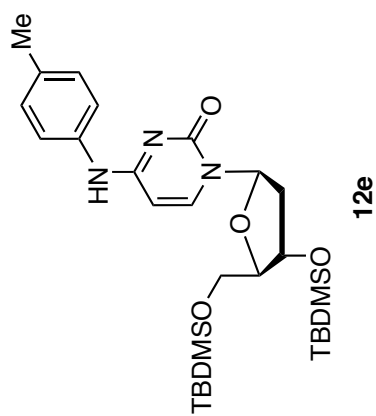

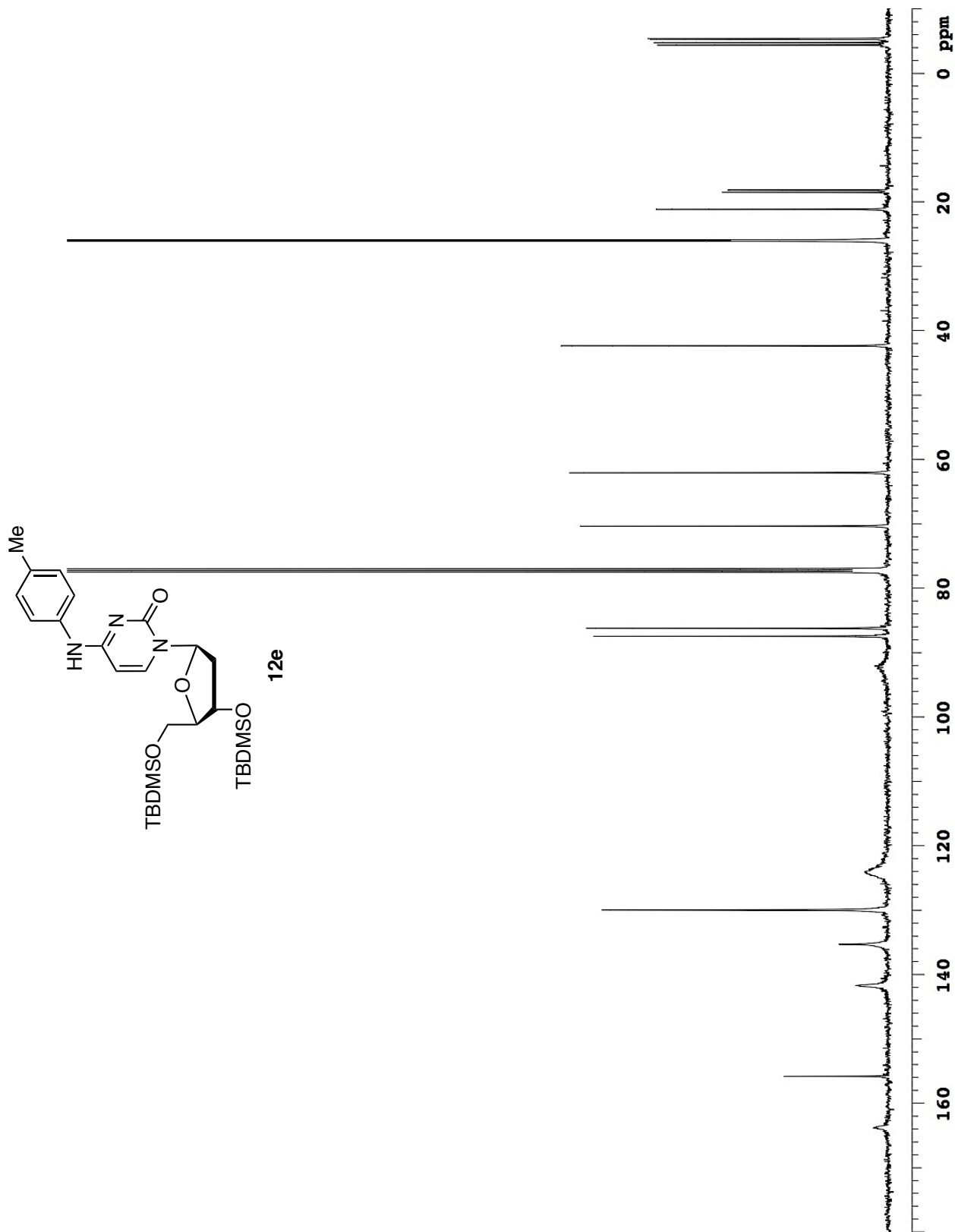

gCOSY spectrum of compound **12e** in CDCl₃

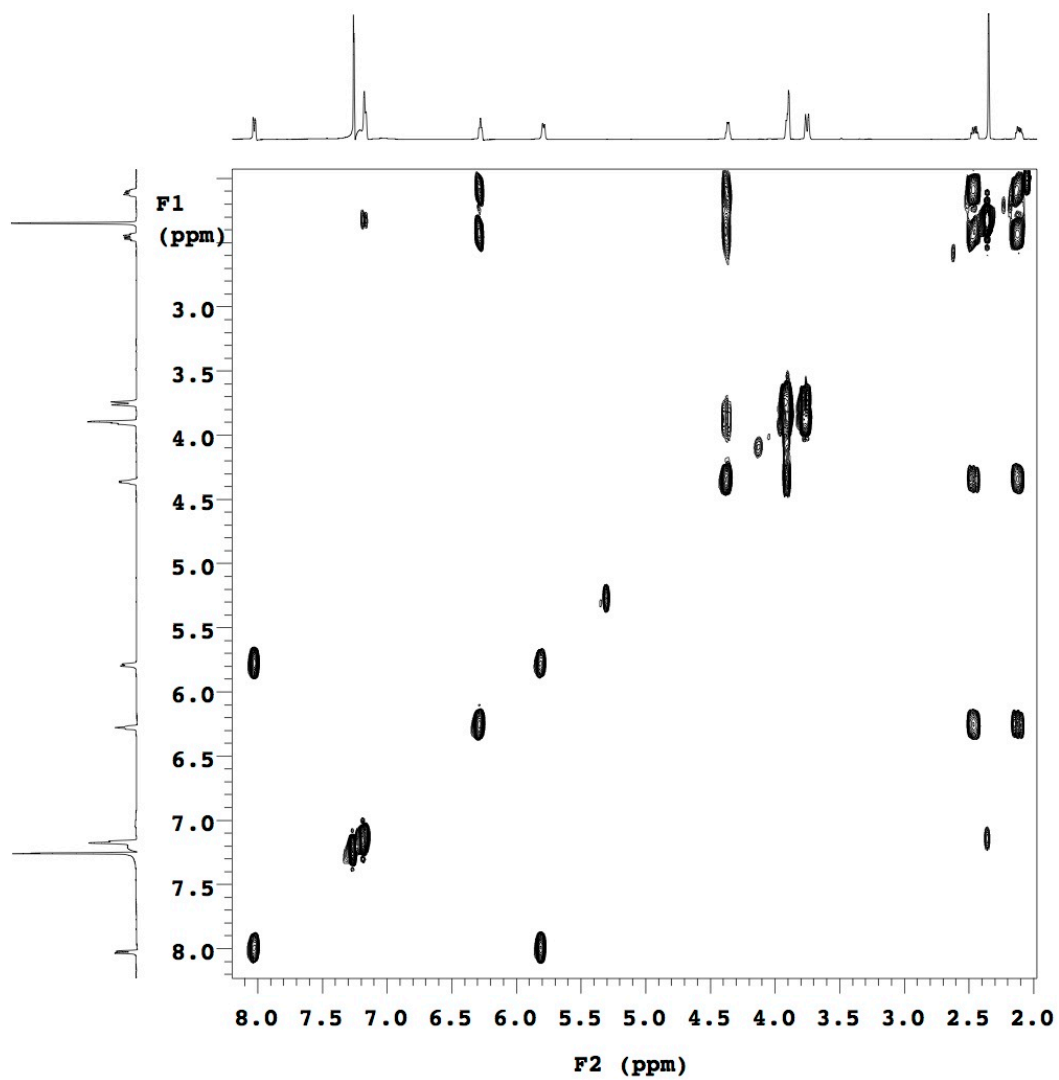
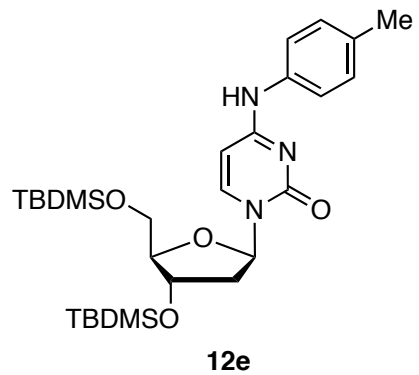

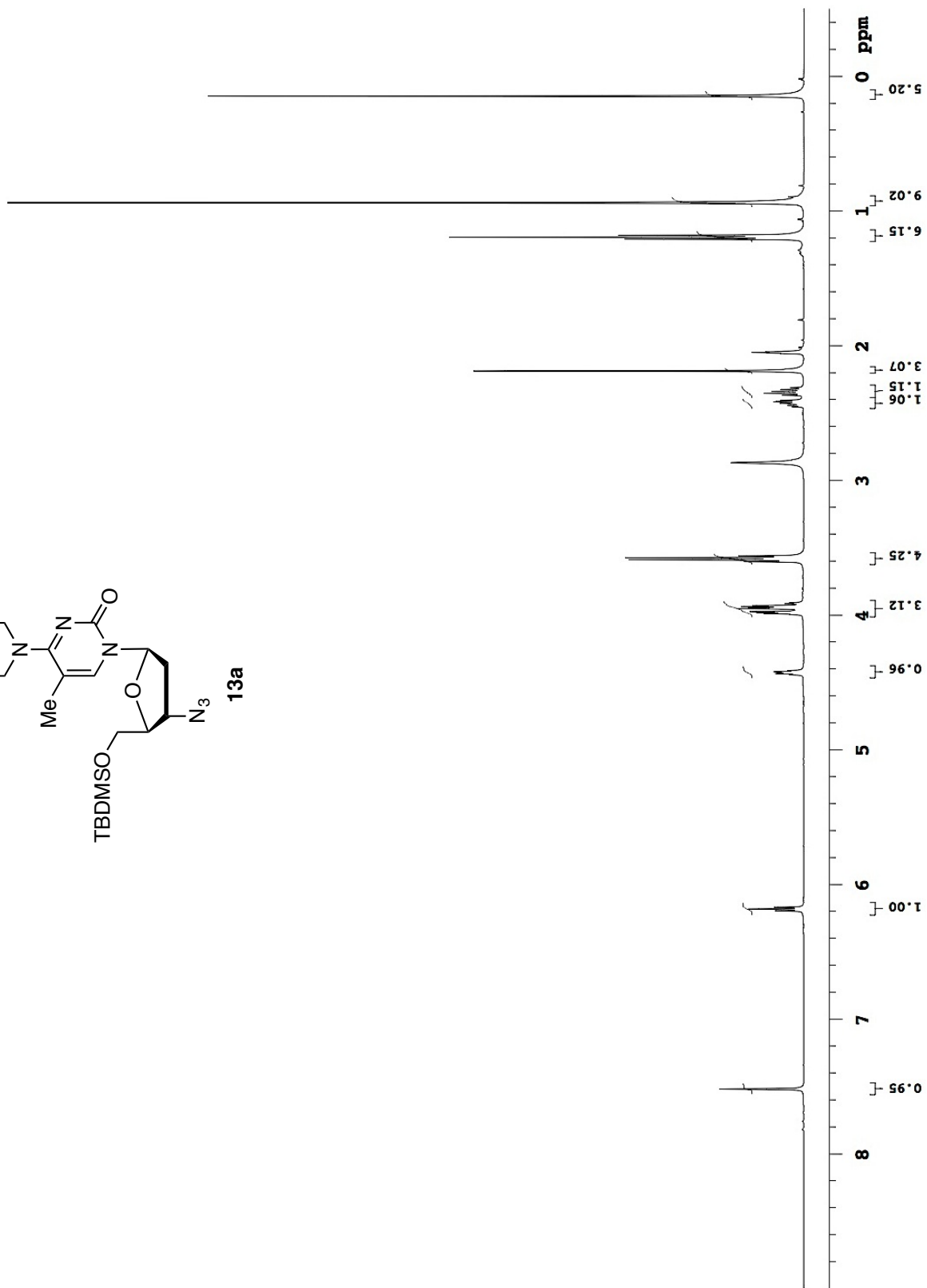
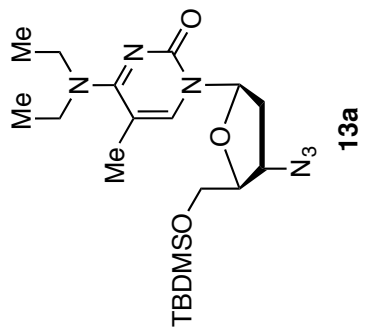

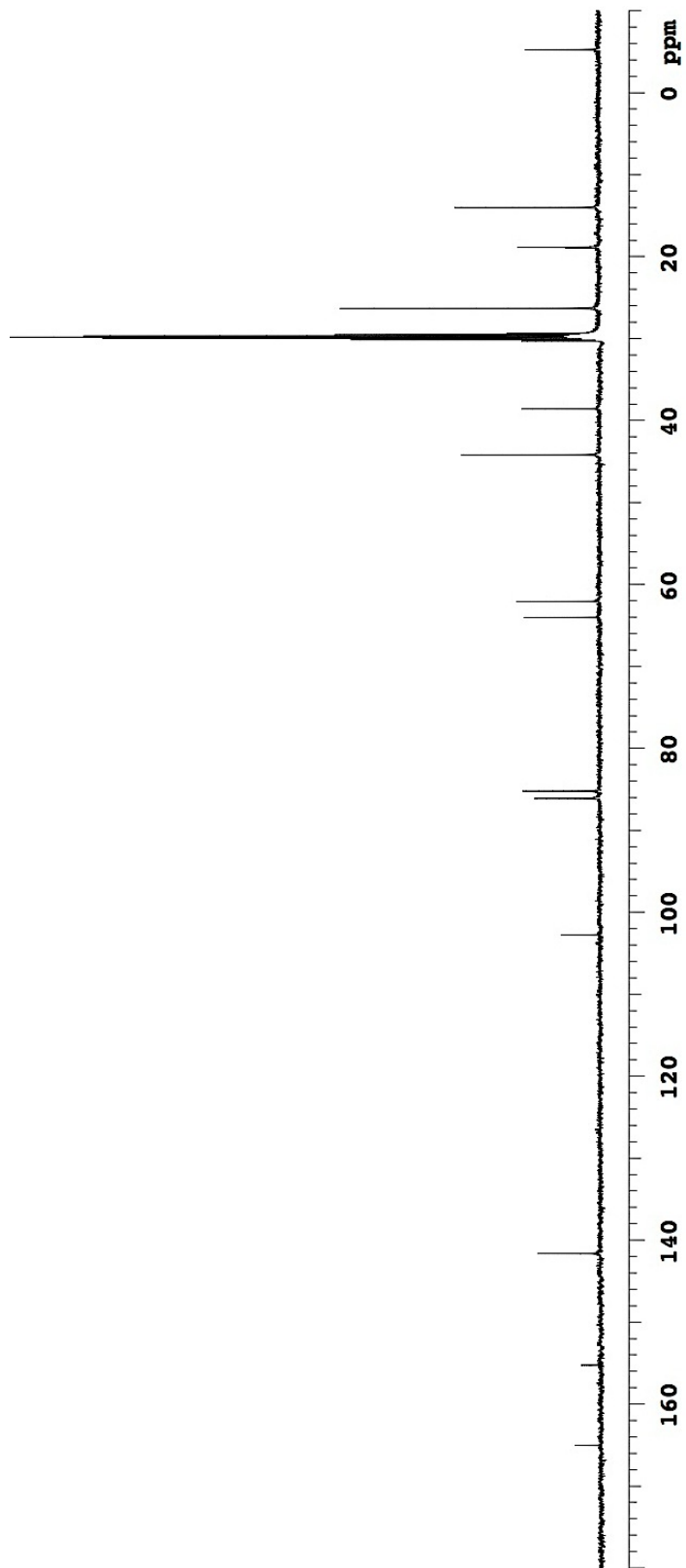
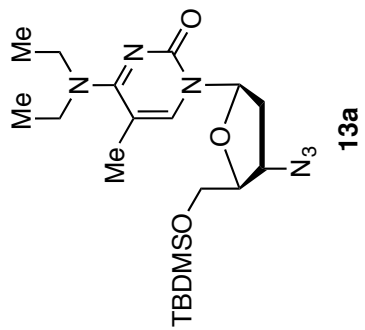

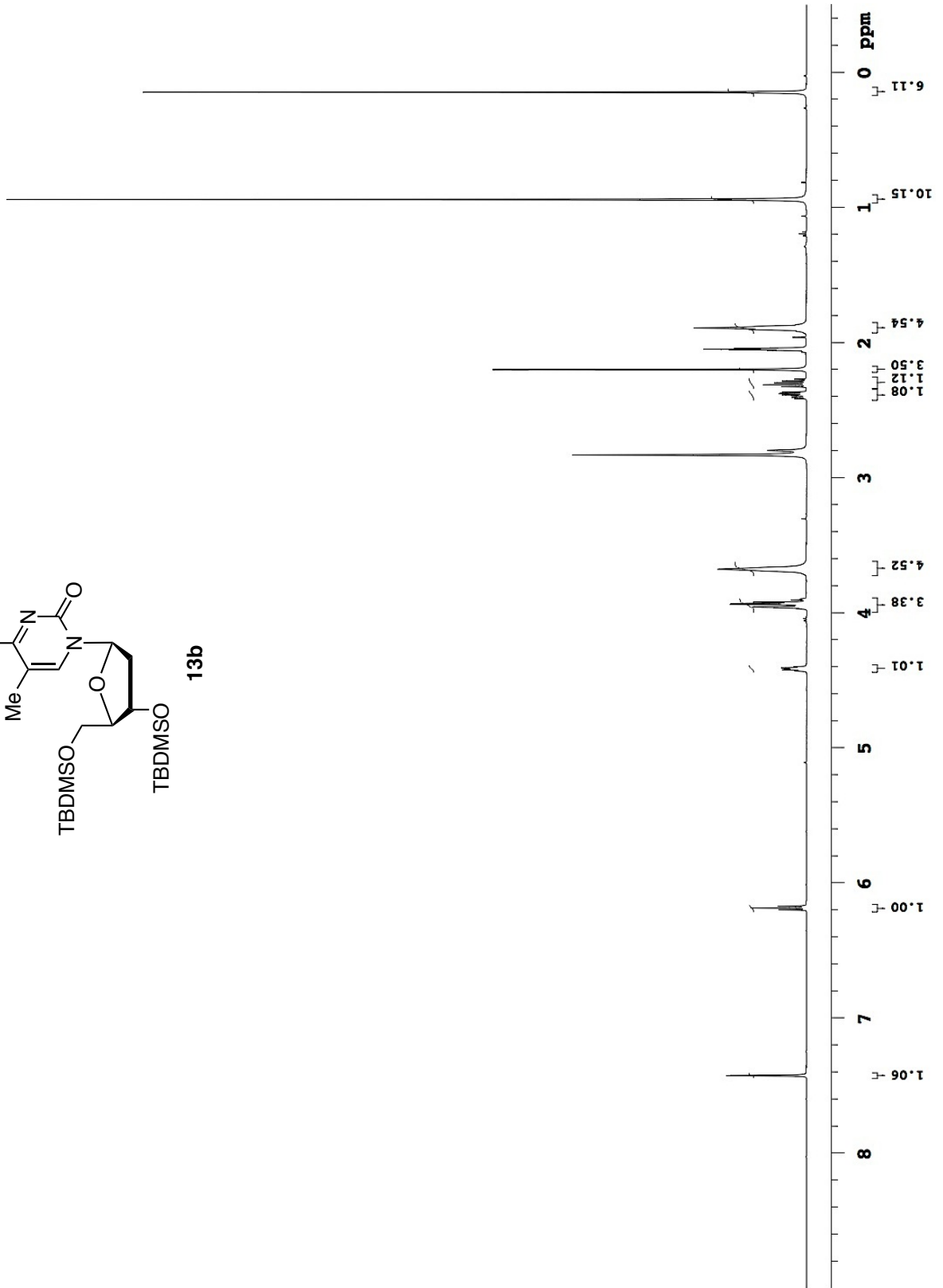
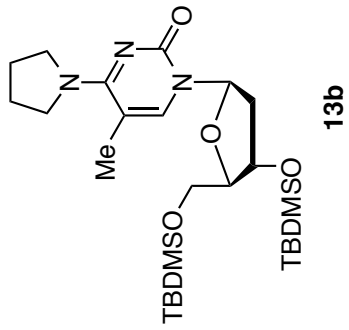

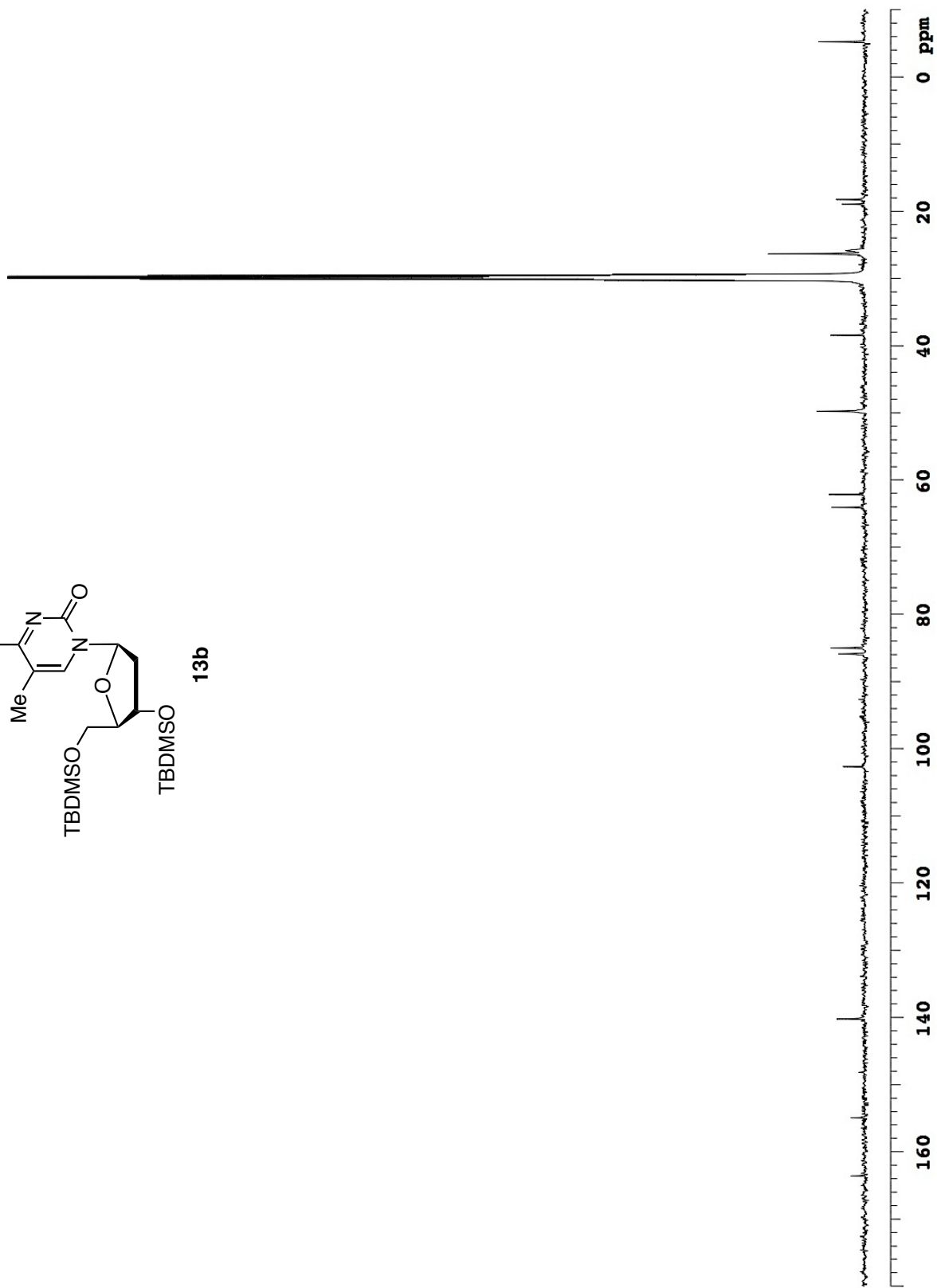
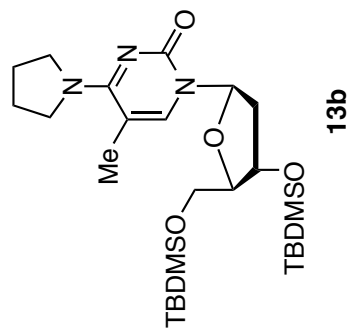

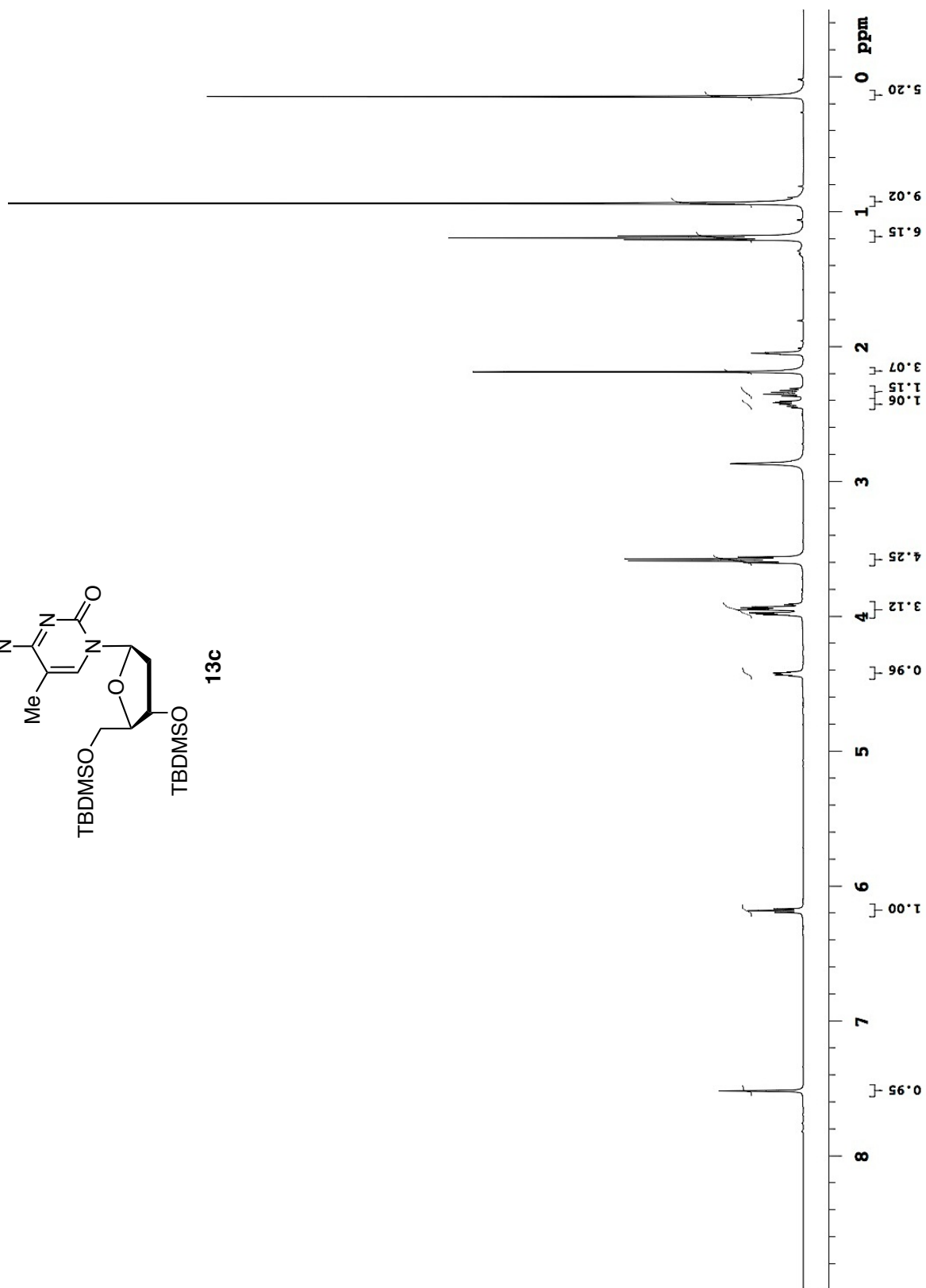
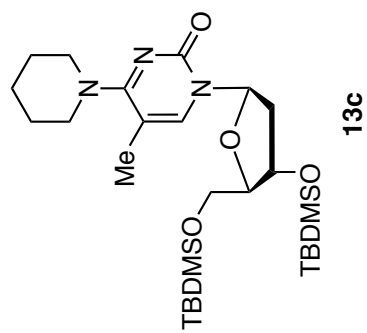

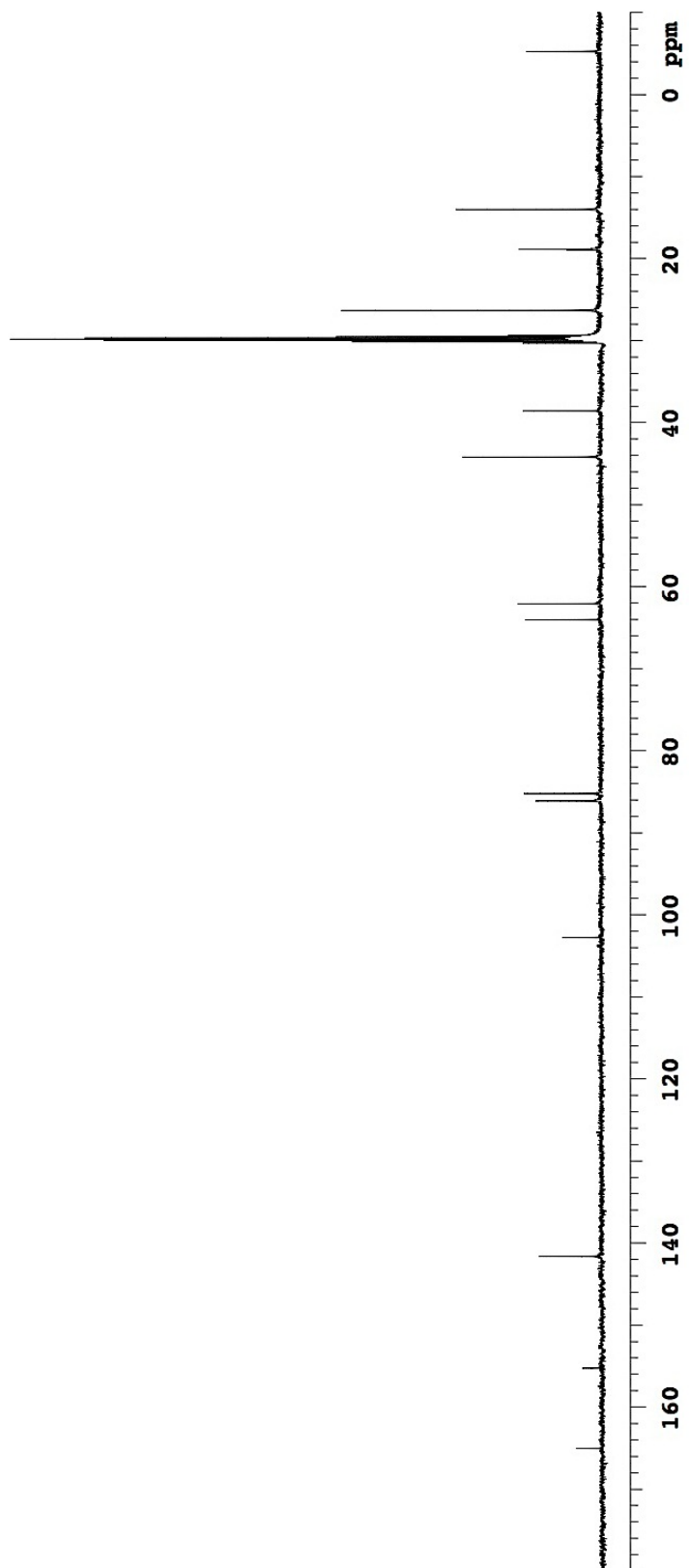
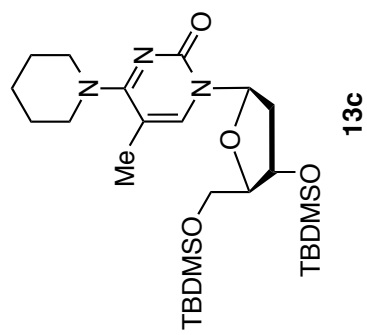

gCOSY spectrum of compound **13c** in acetone-*d*₆

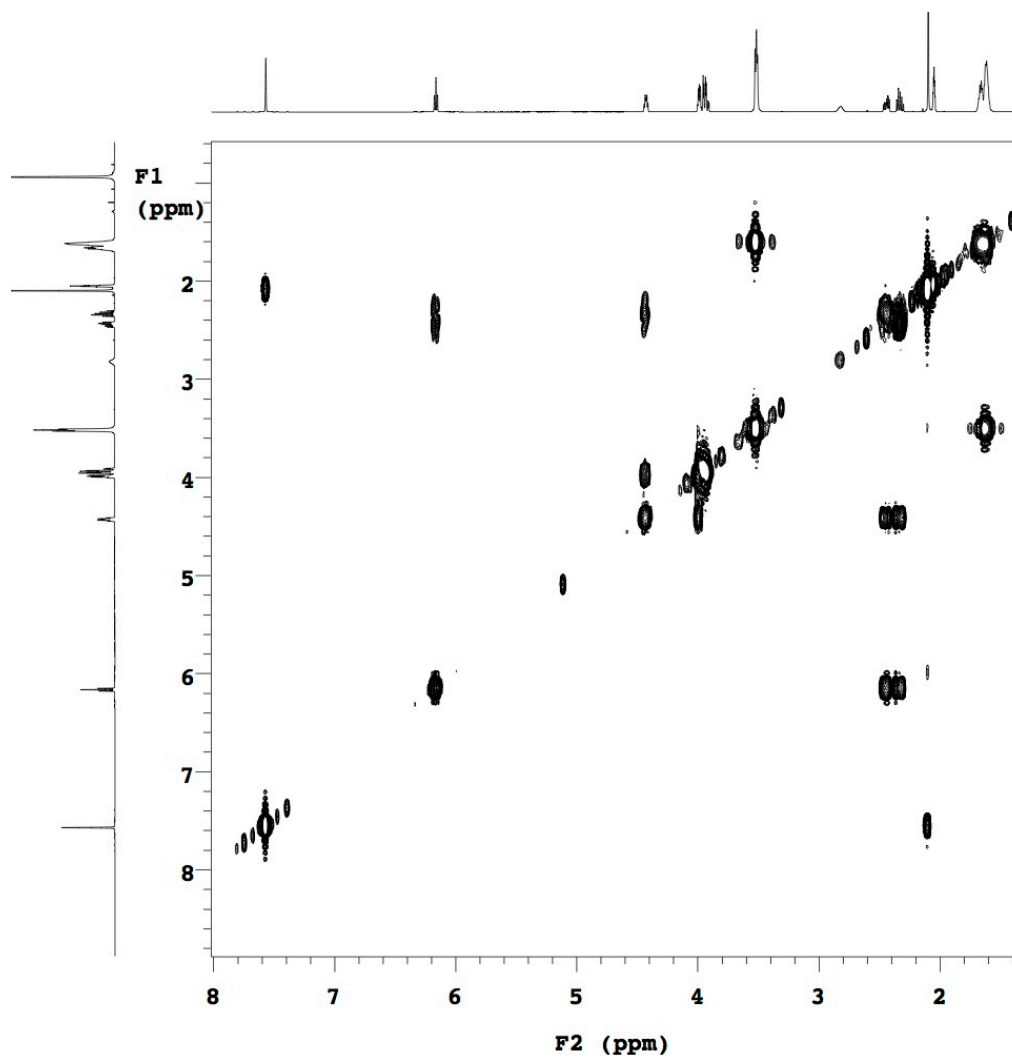
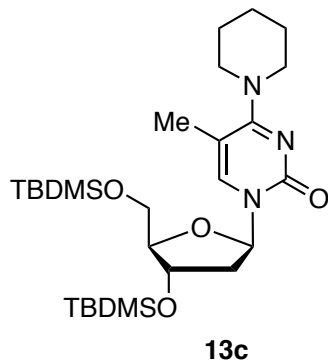

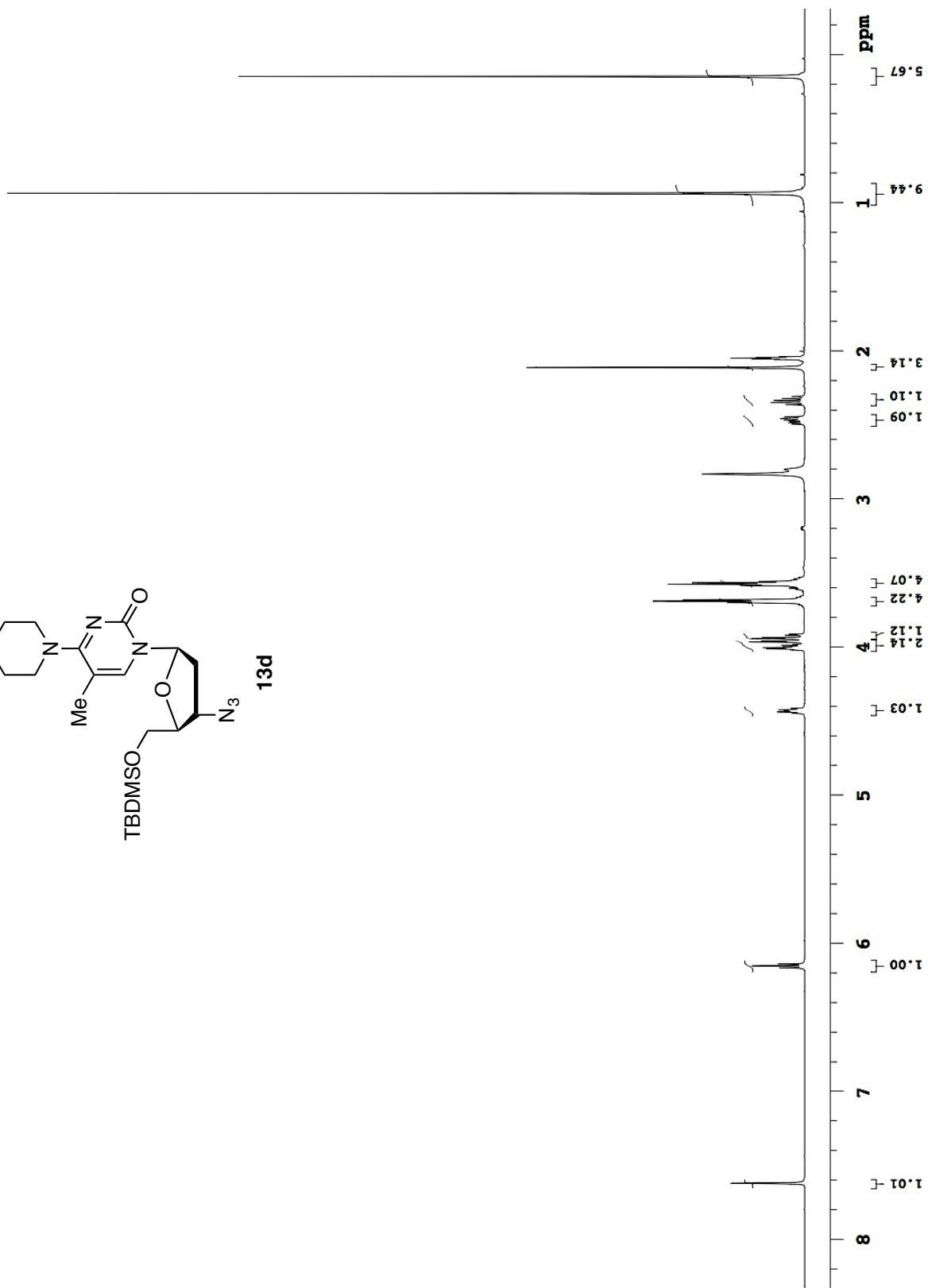
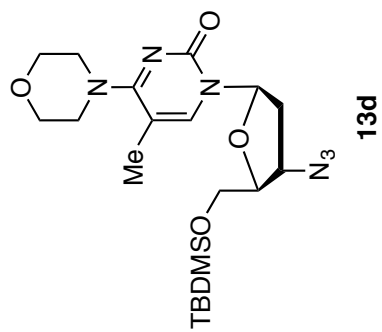

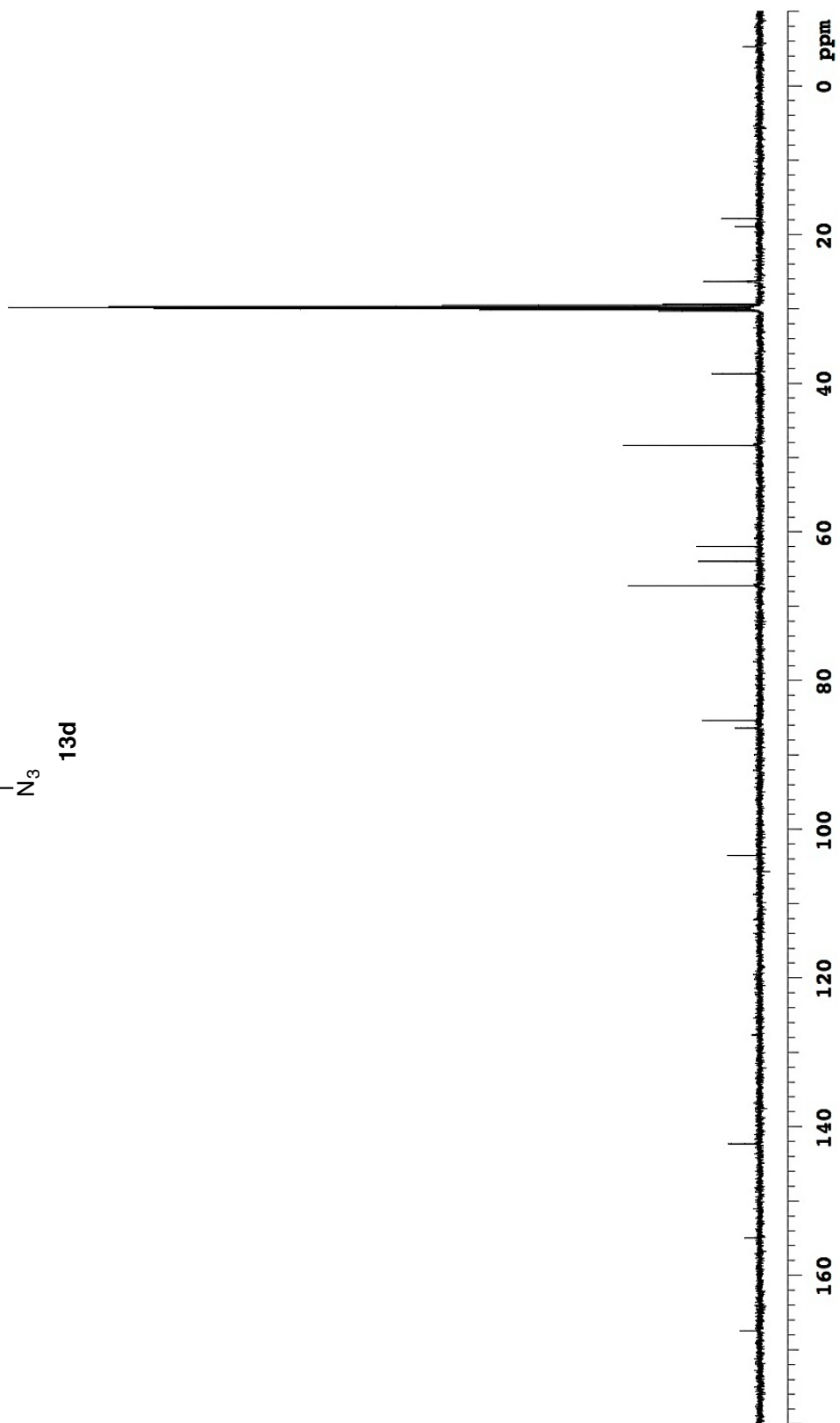
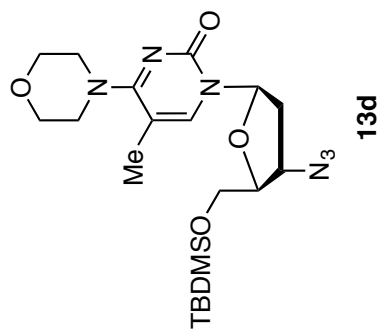

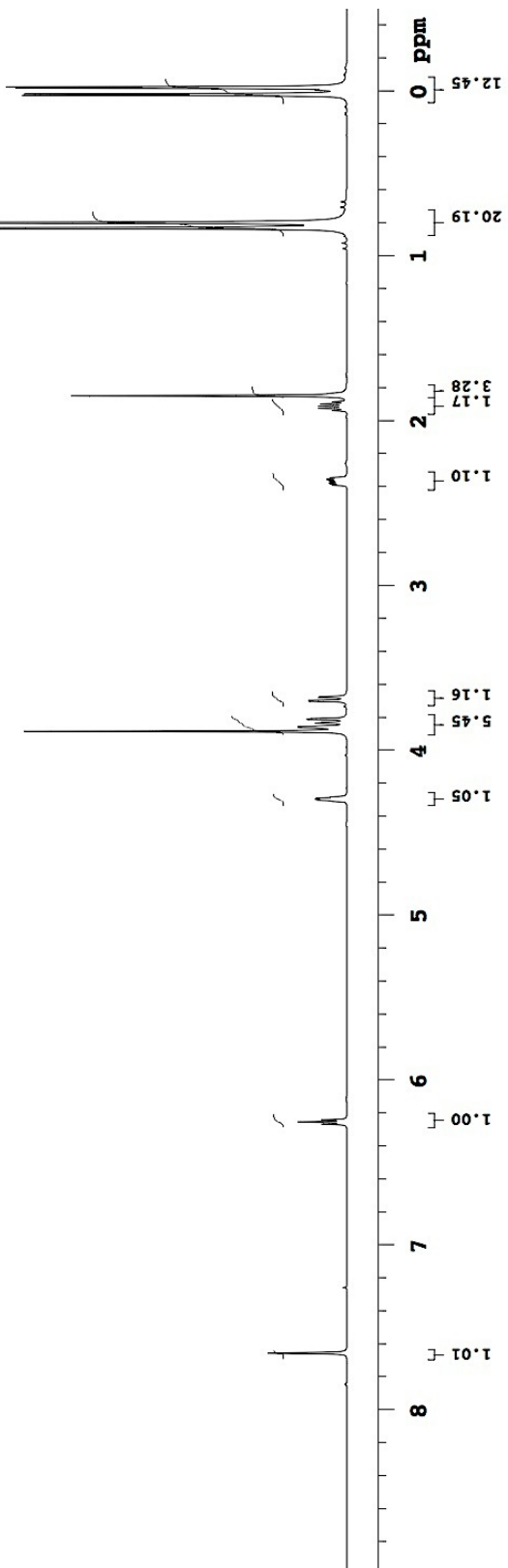
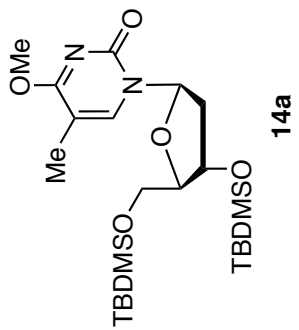

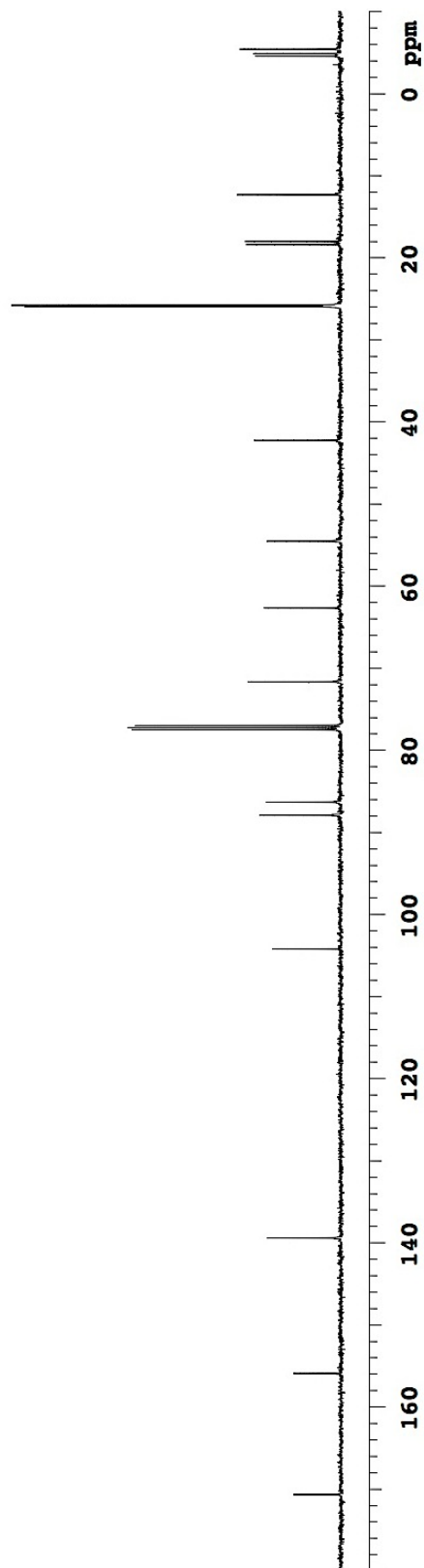
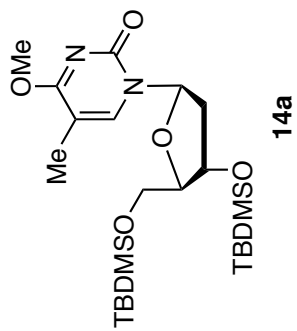

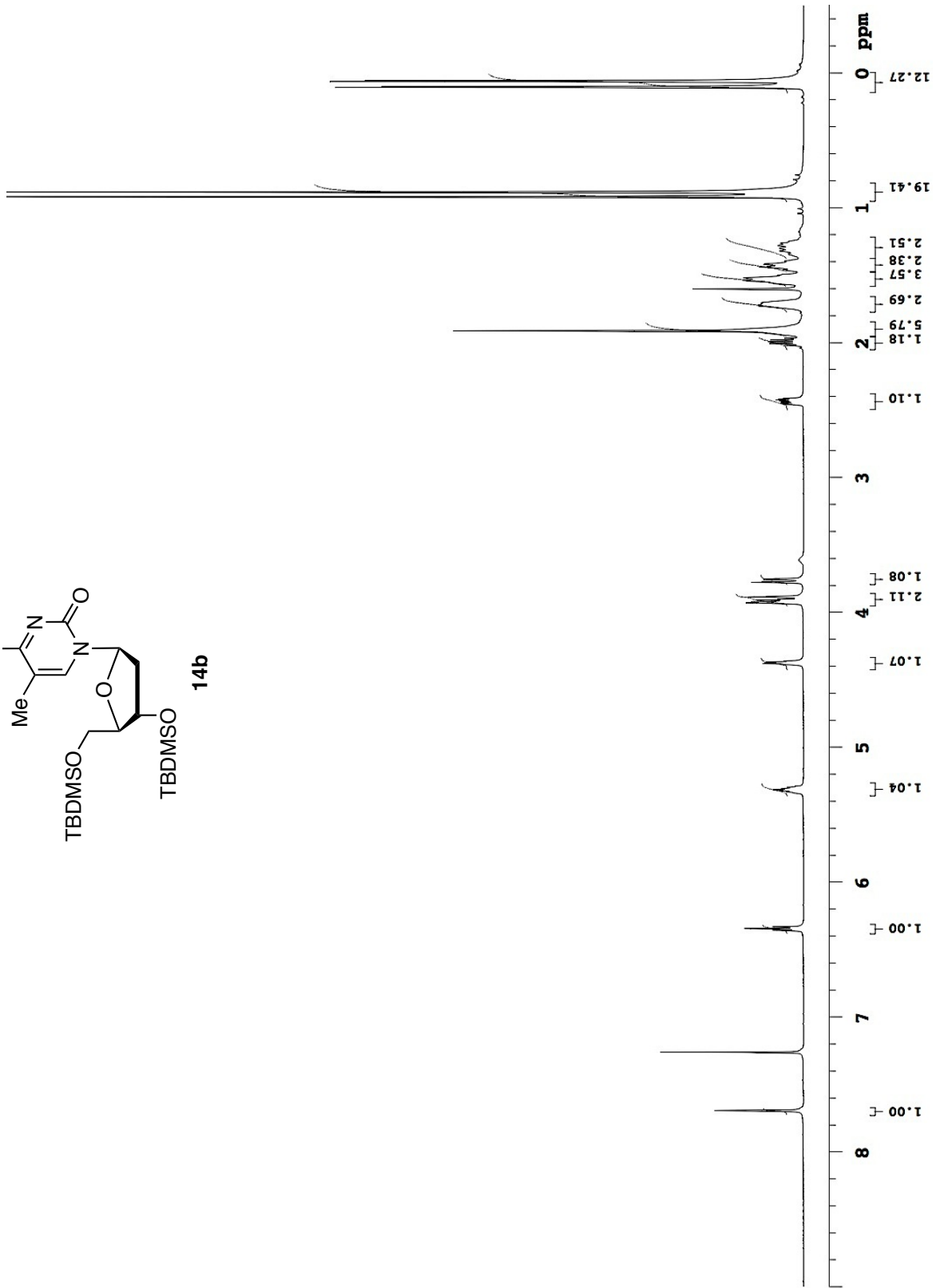
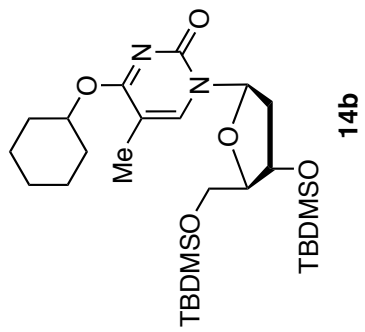

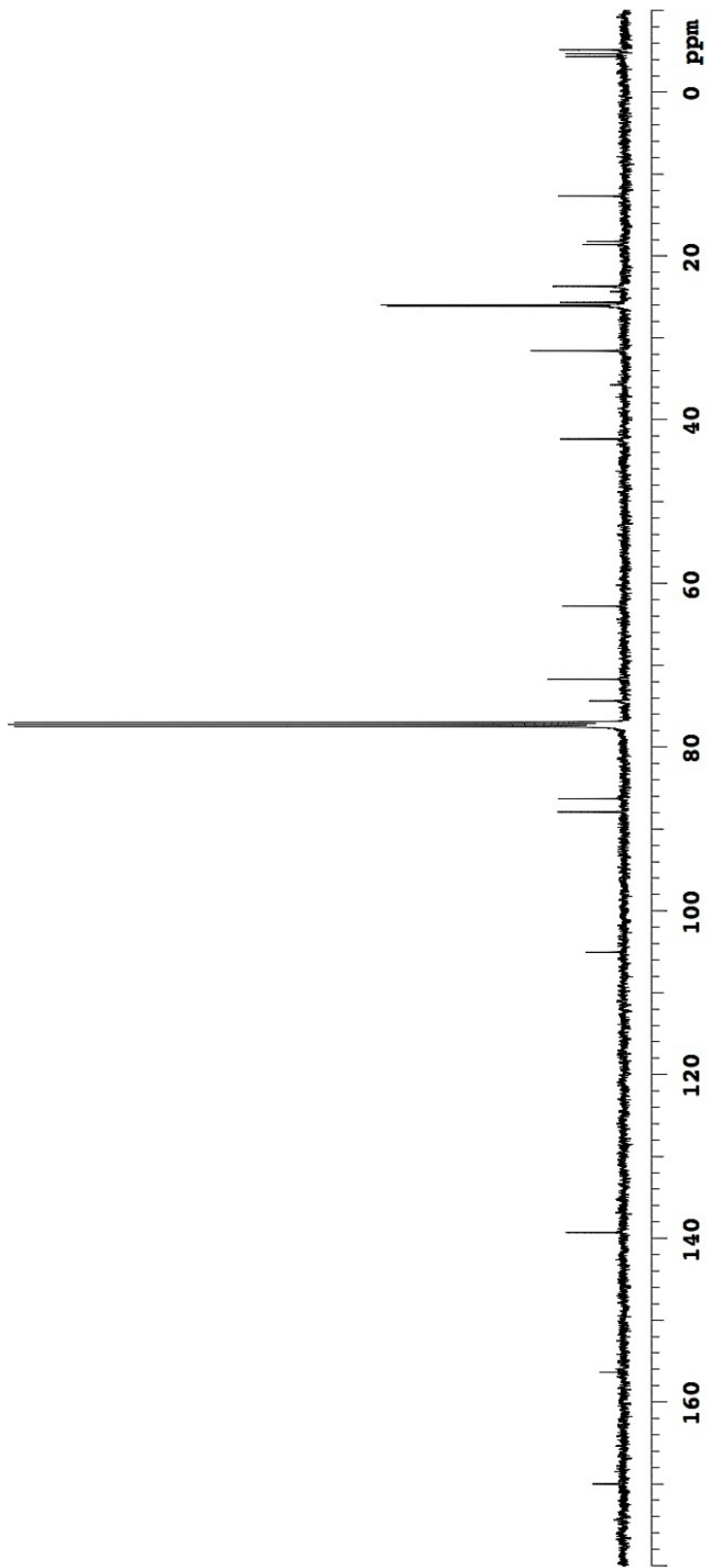
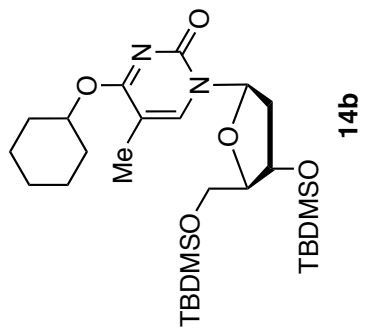

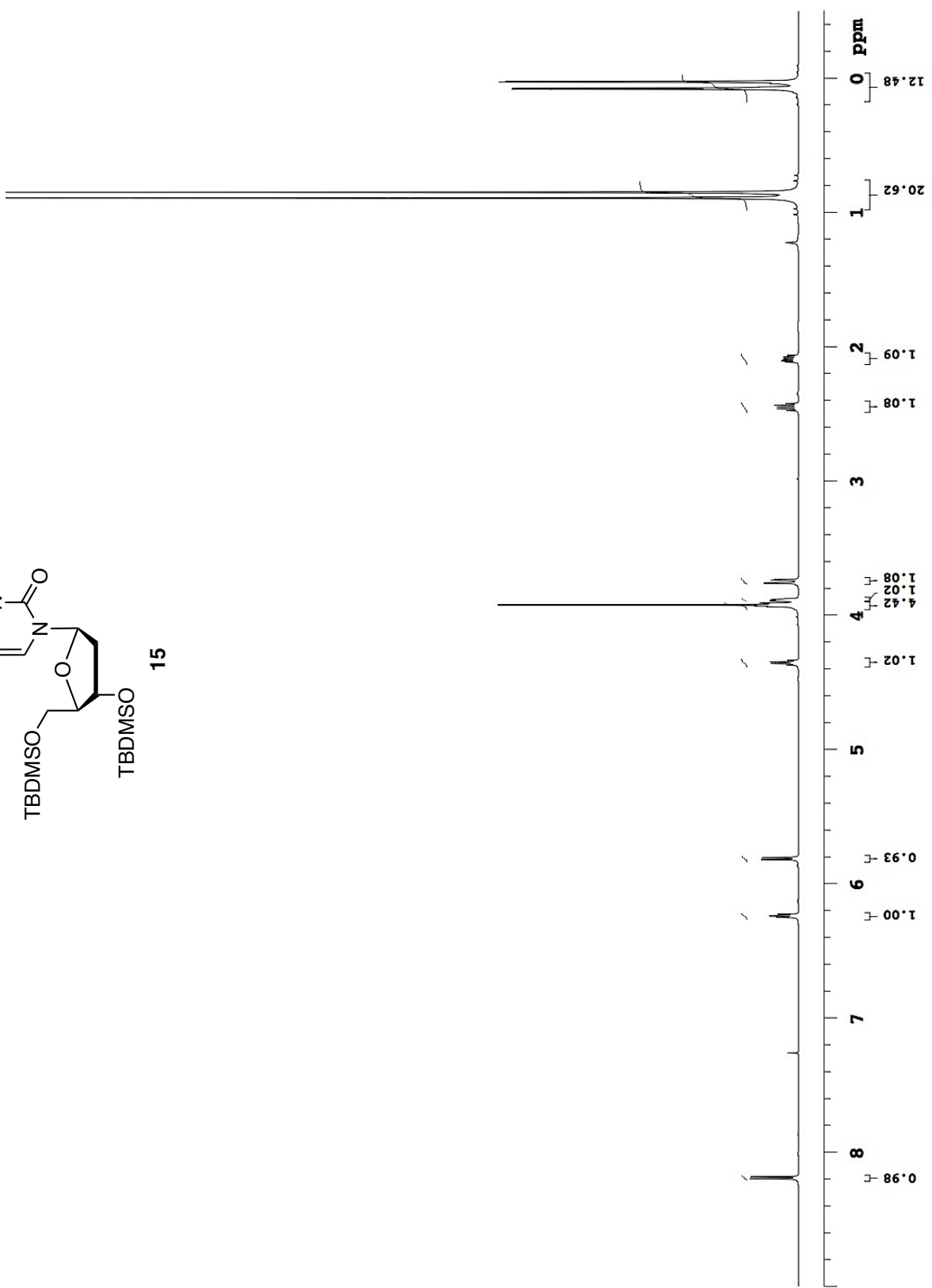
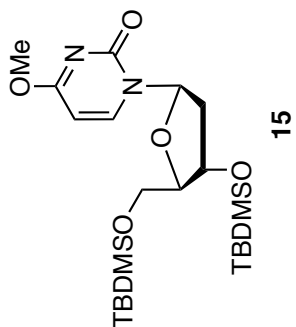

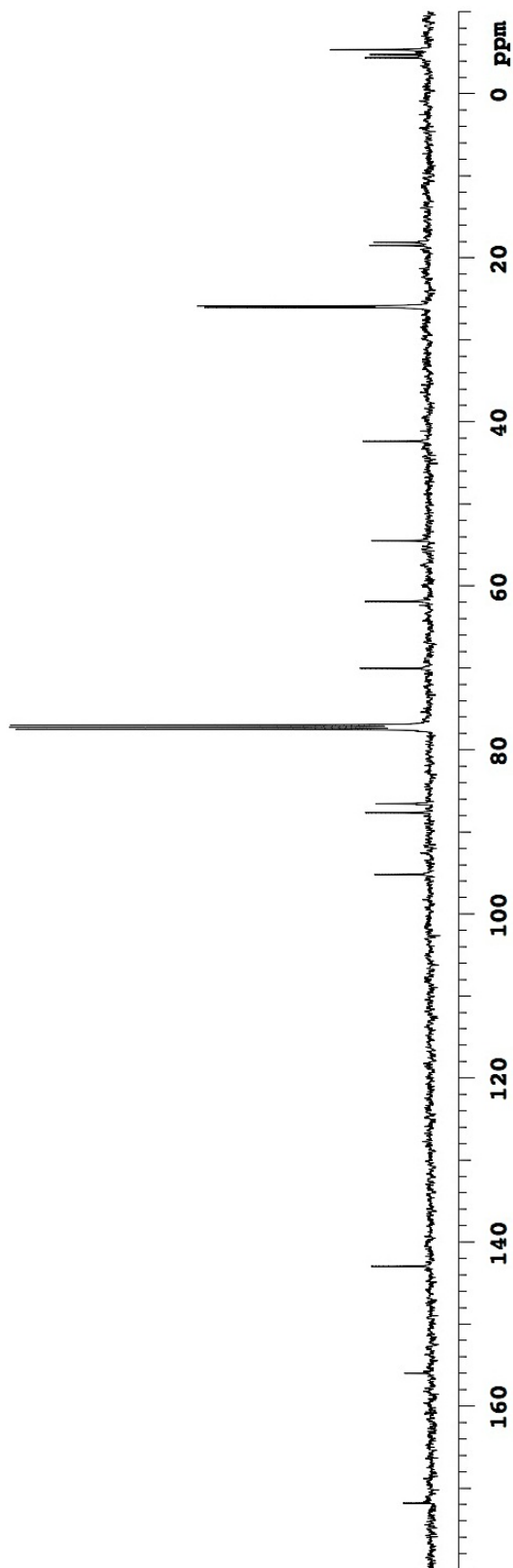
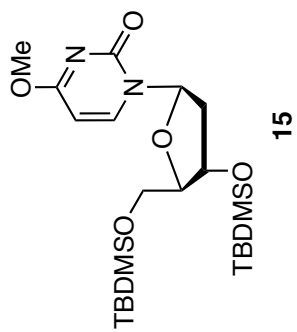

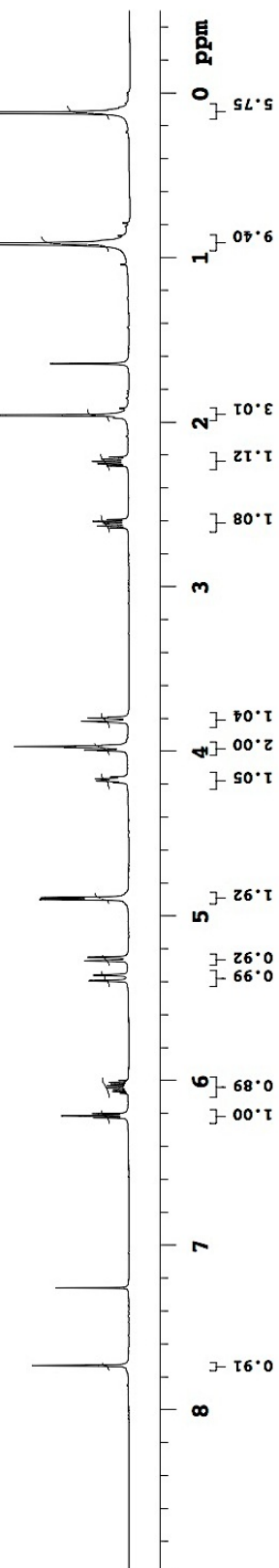
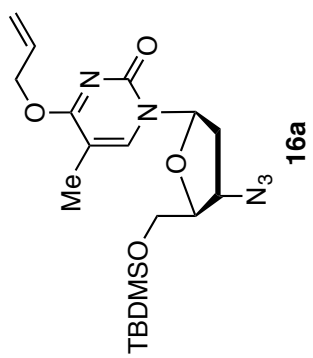

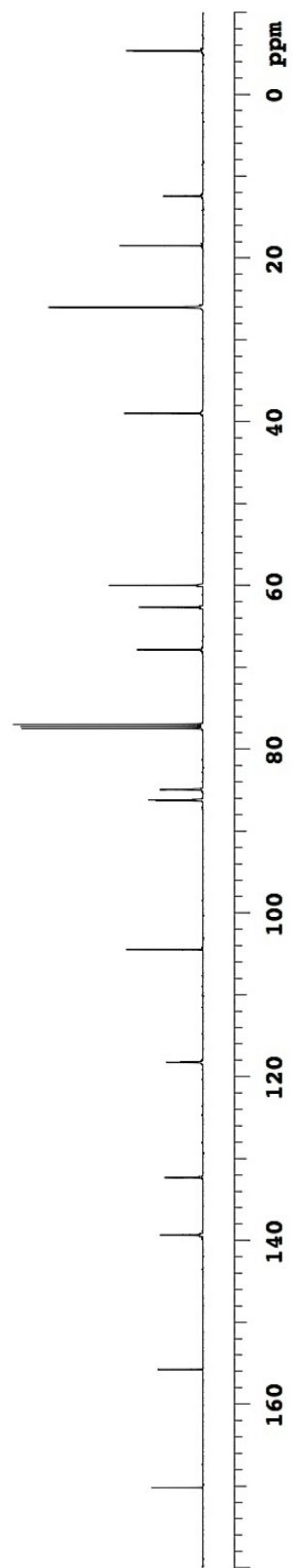
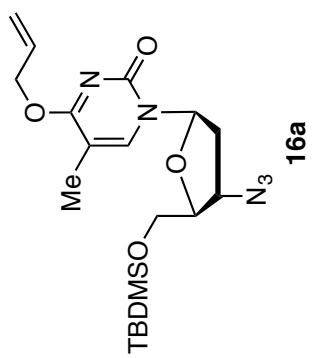

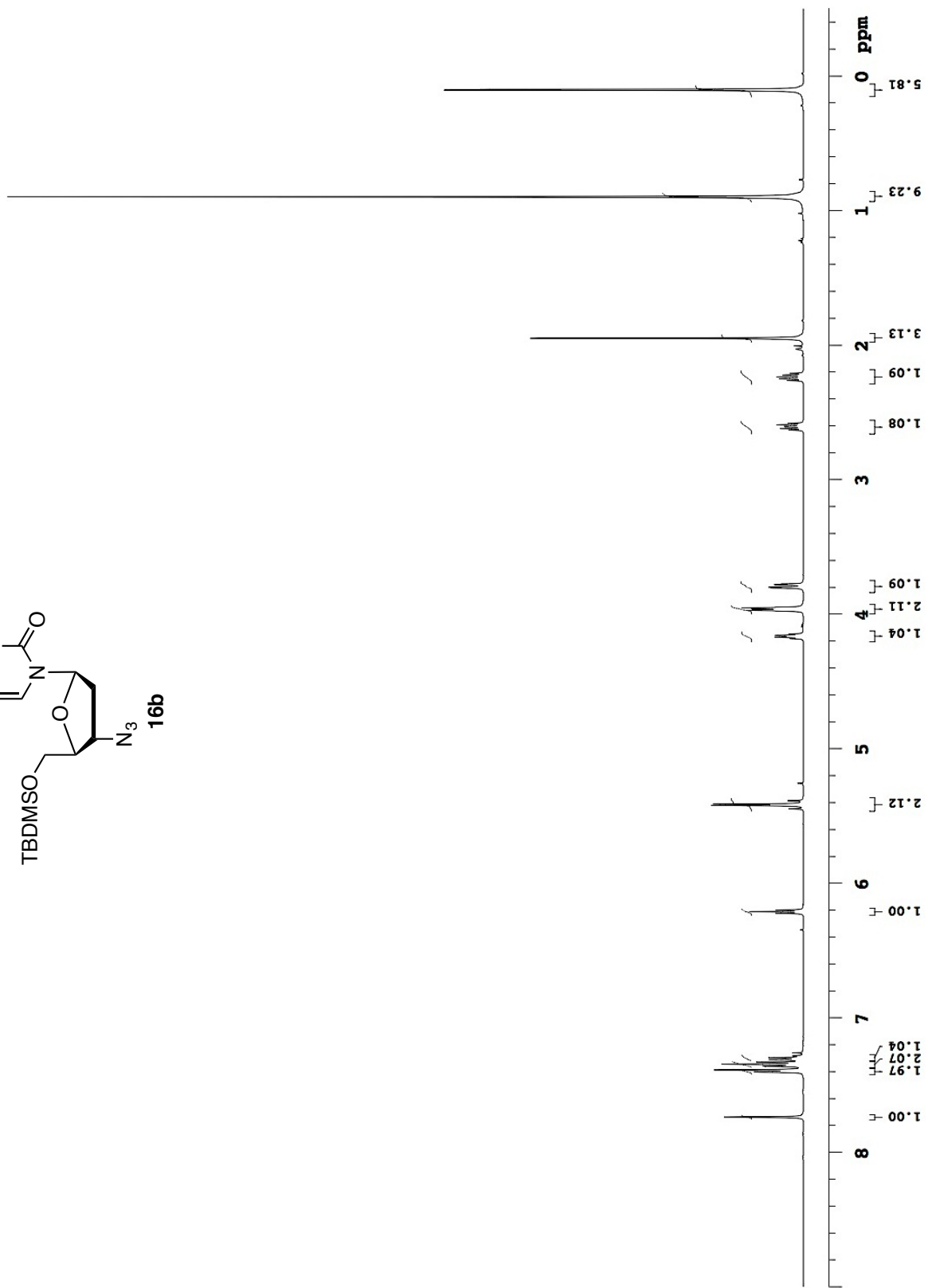
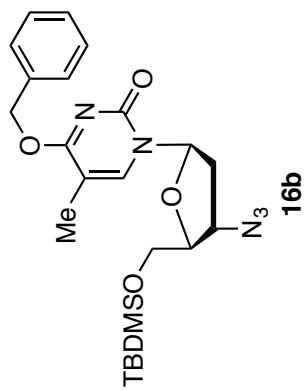

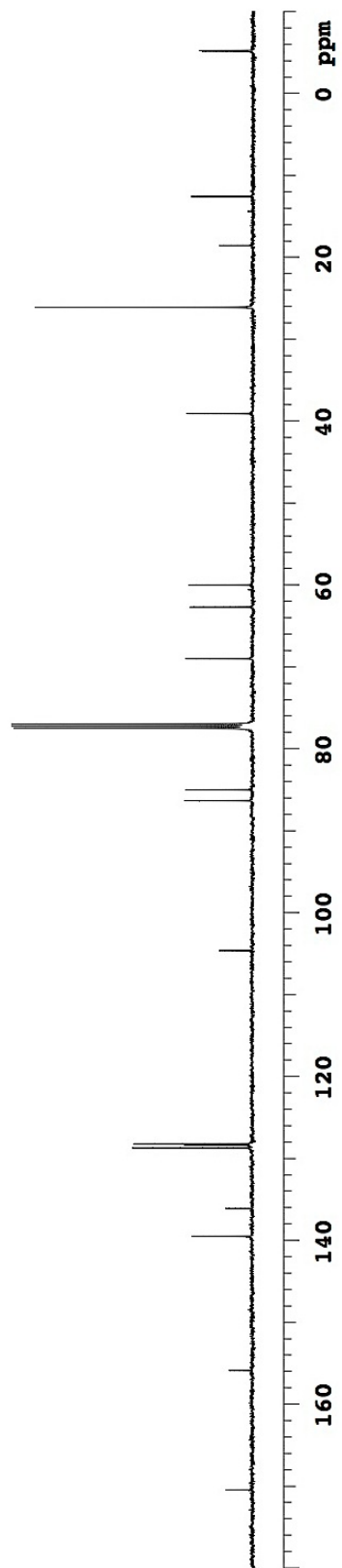
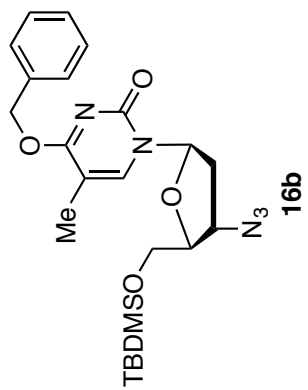

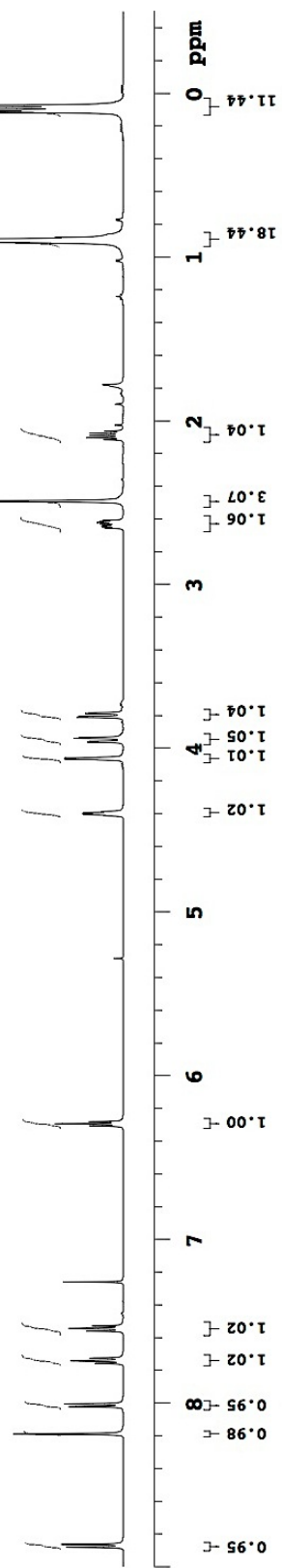
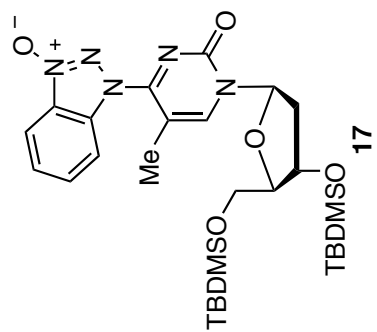

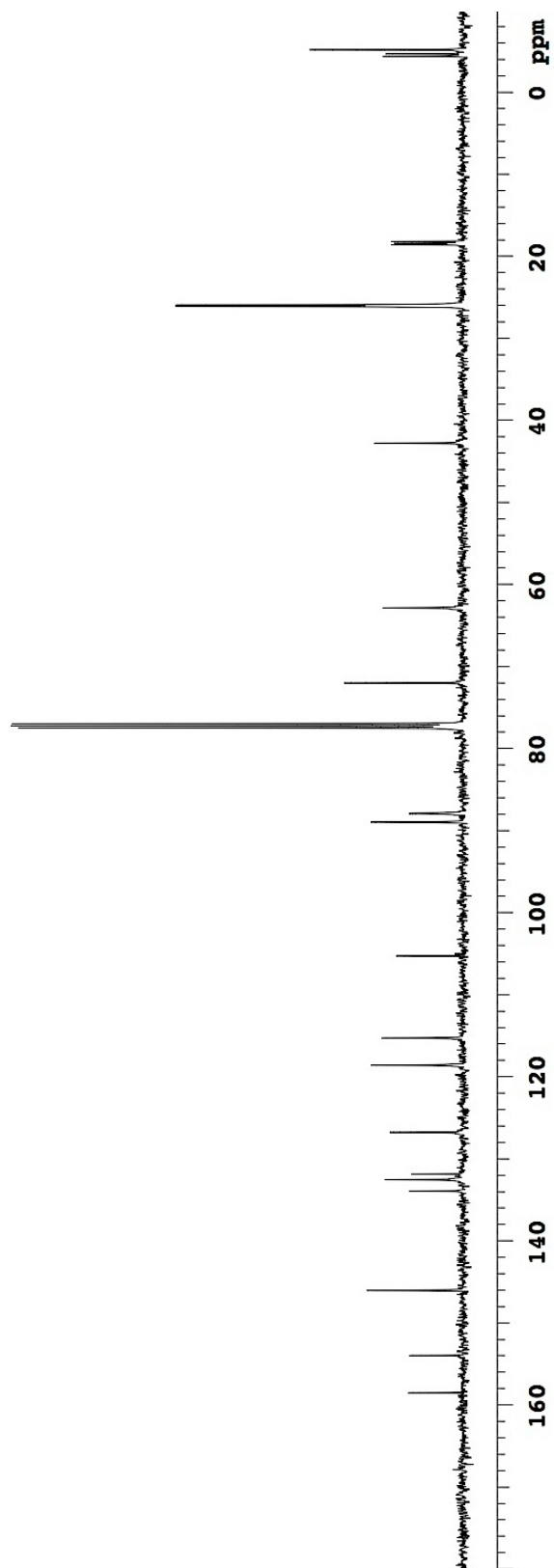
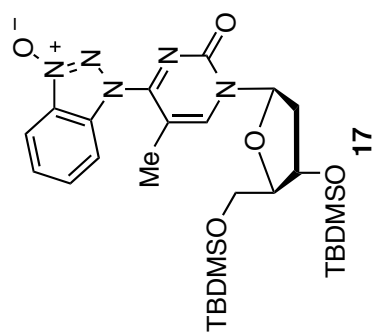

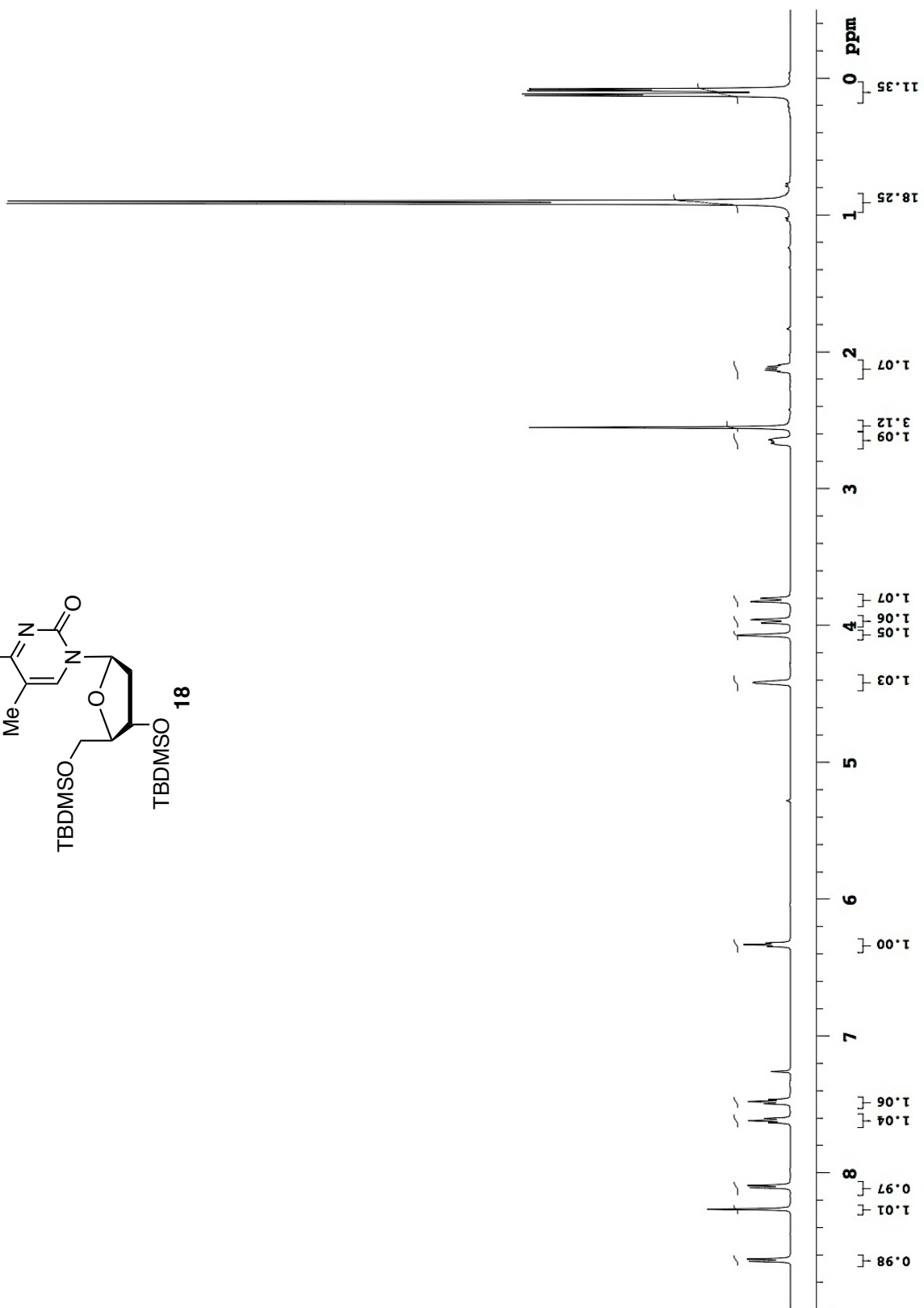
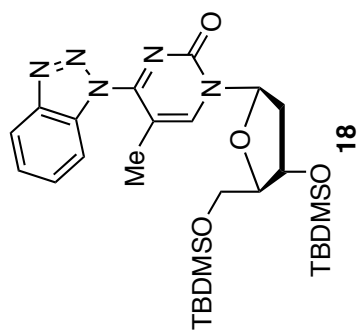

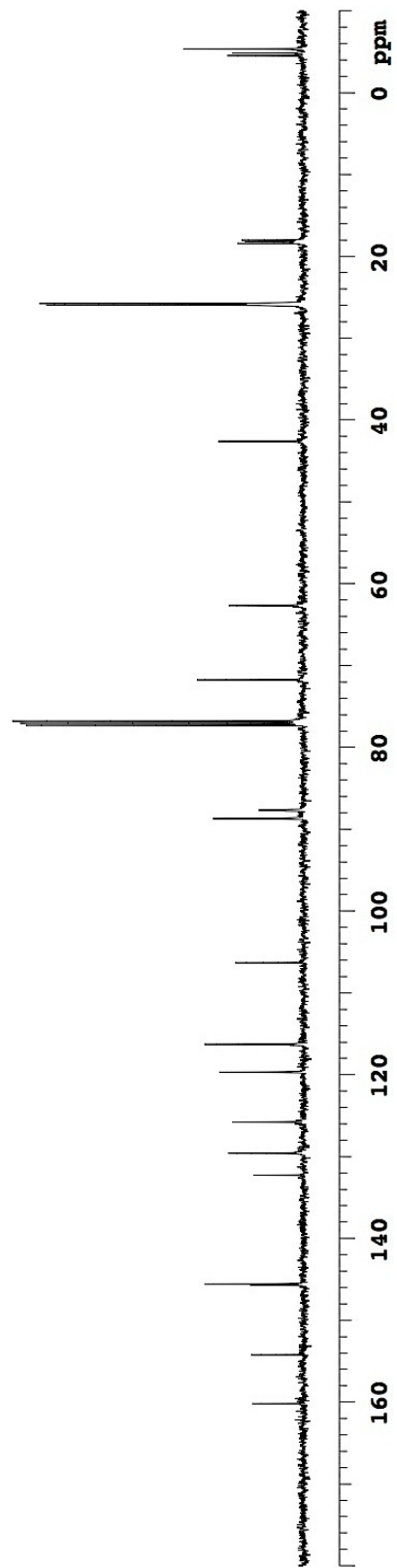
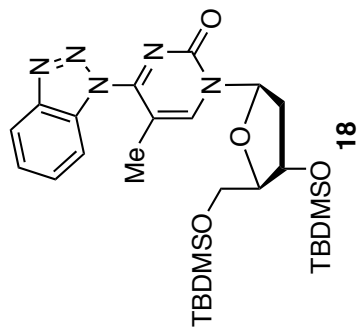

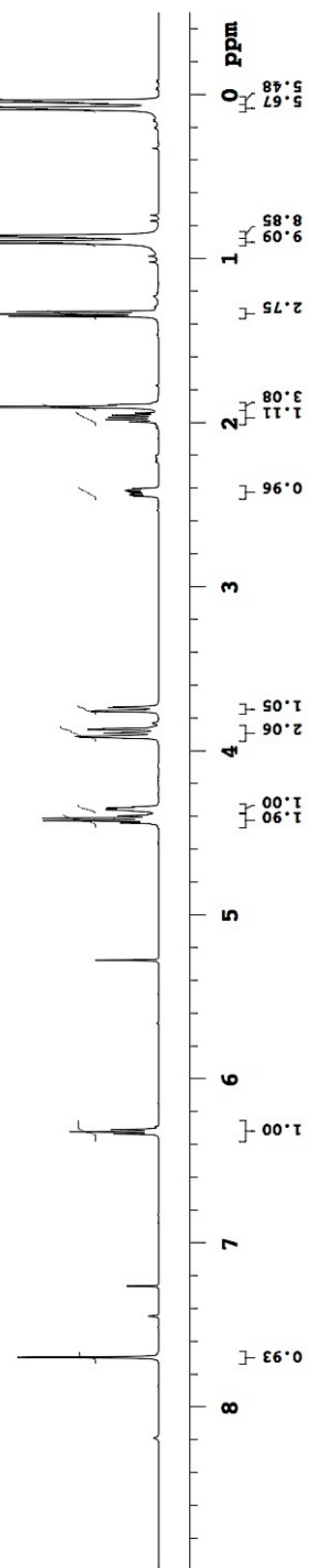
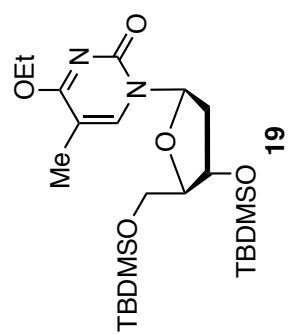

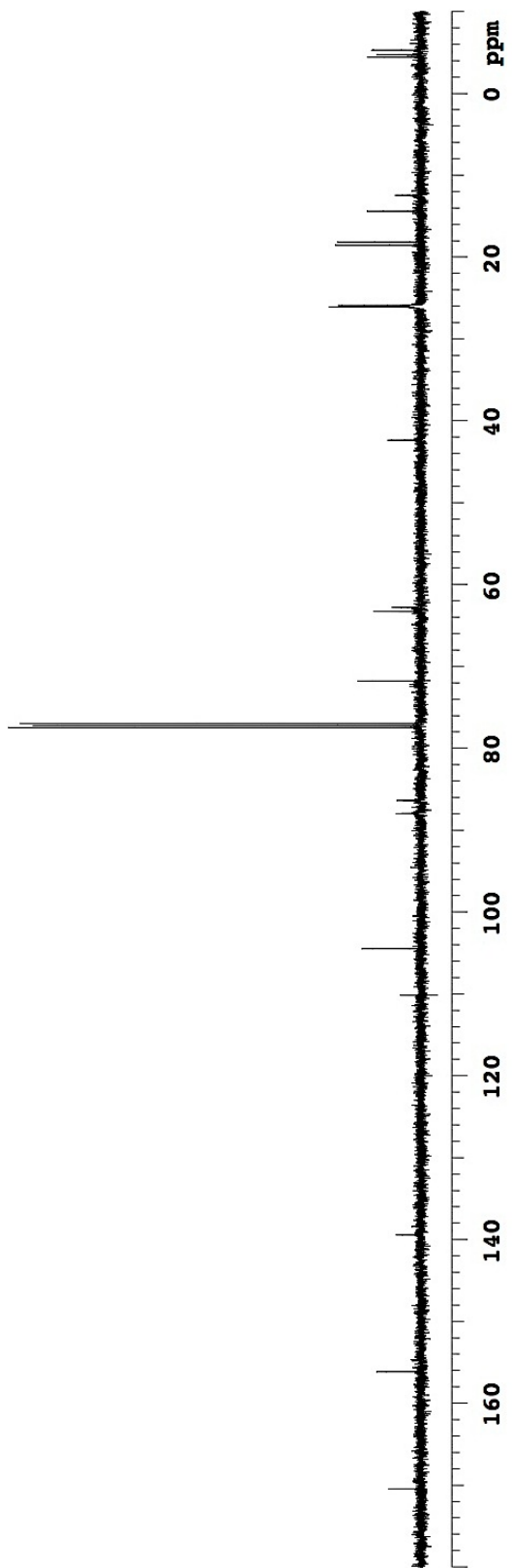
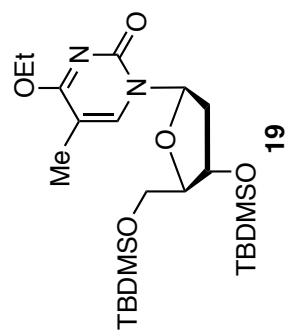

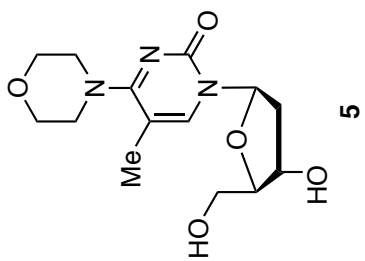

5

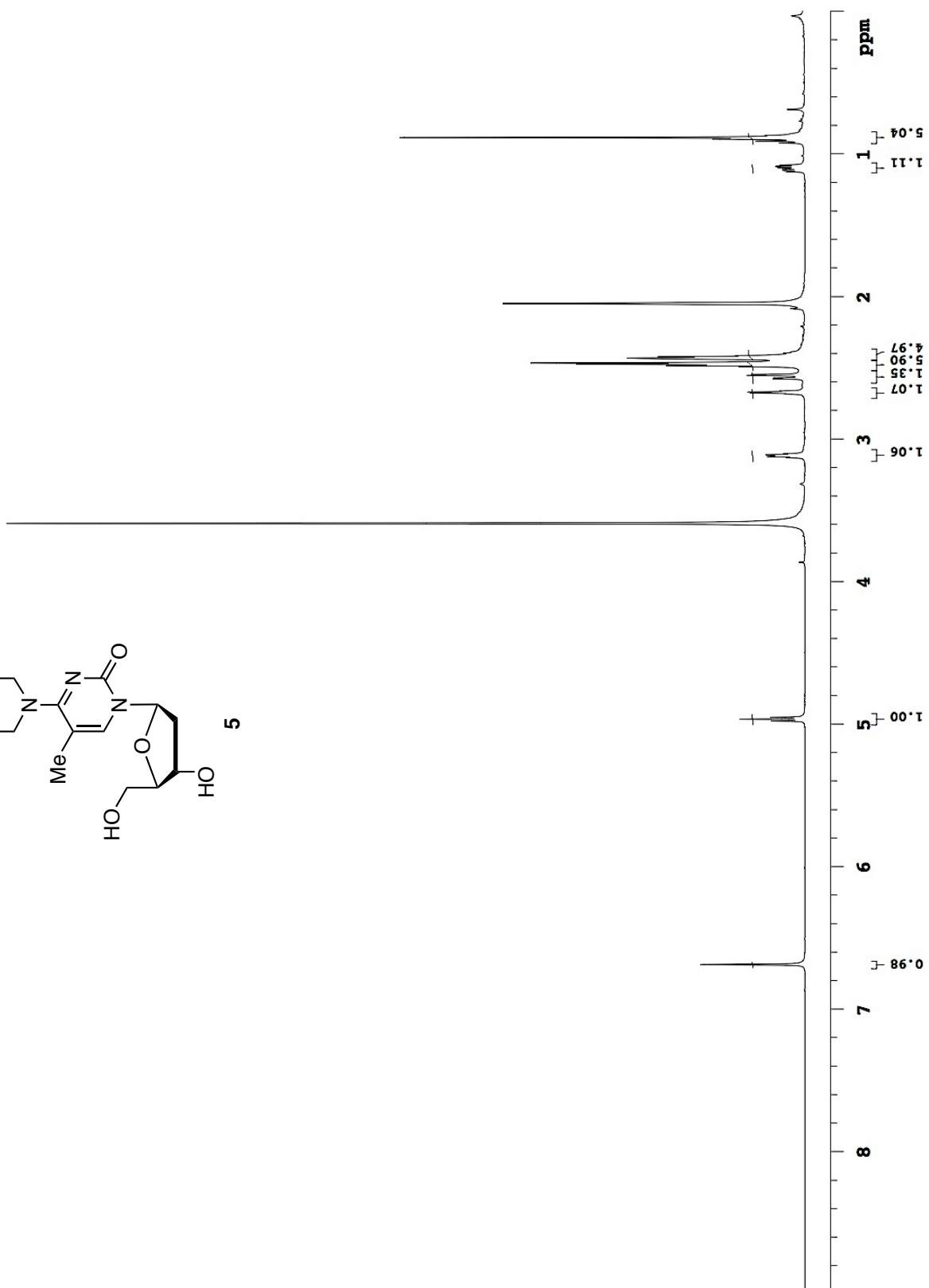

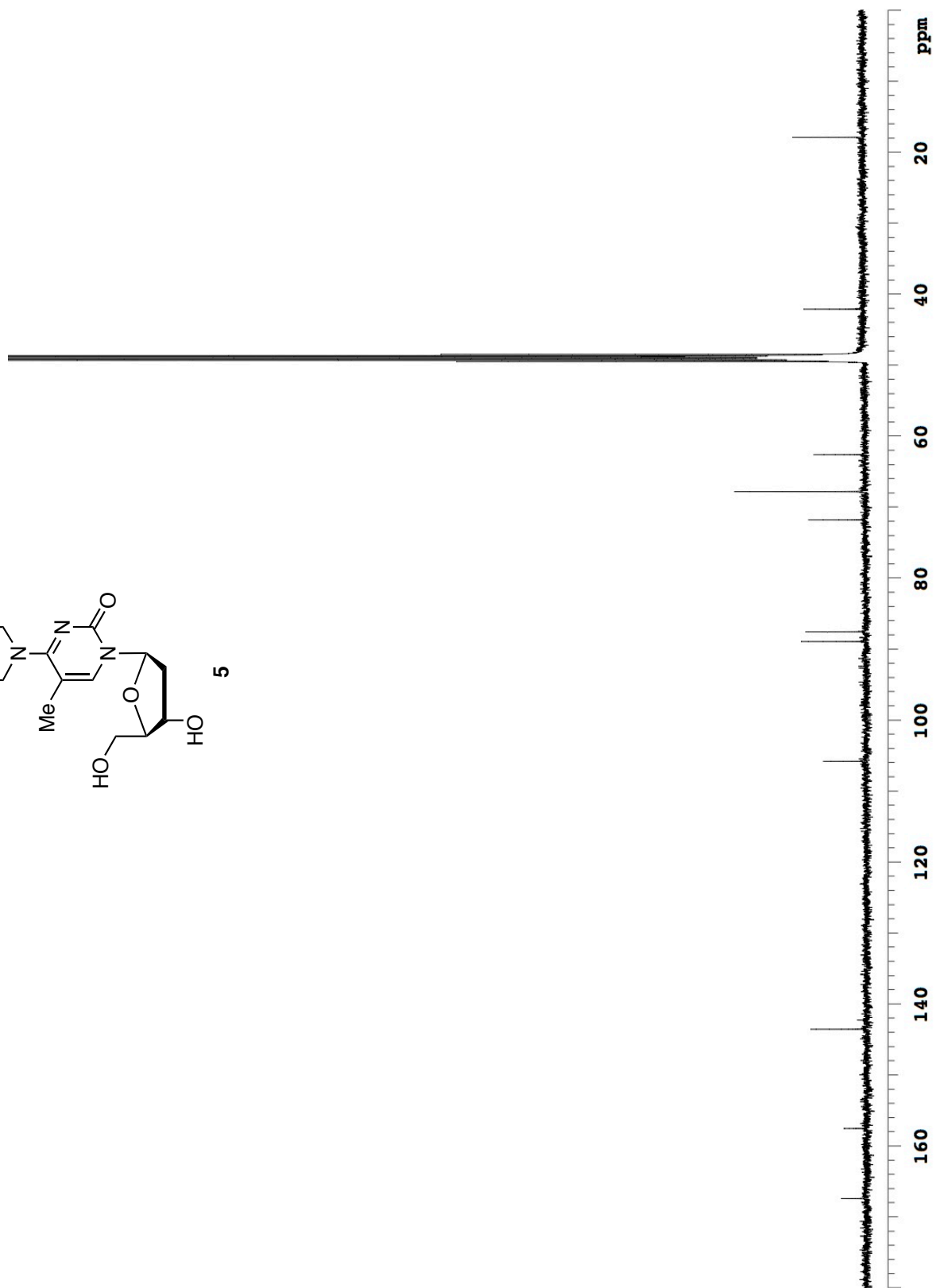
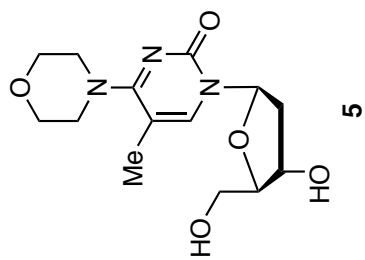

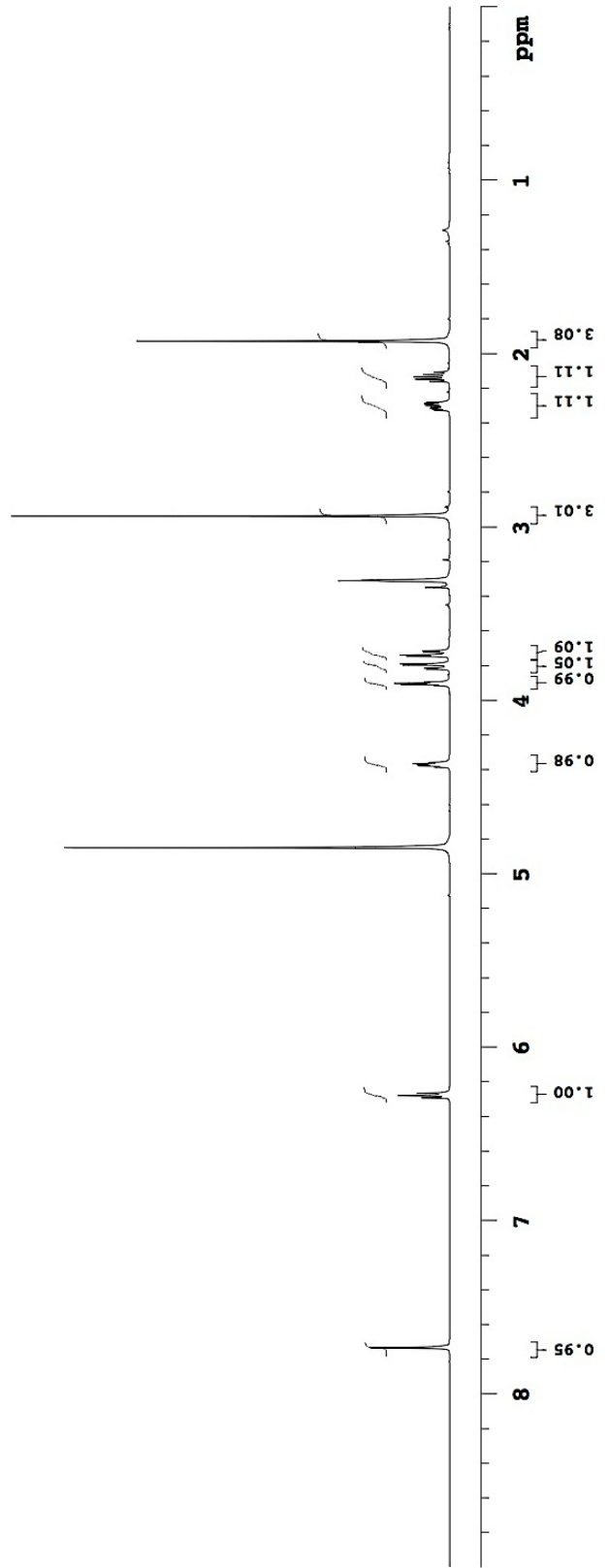
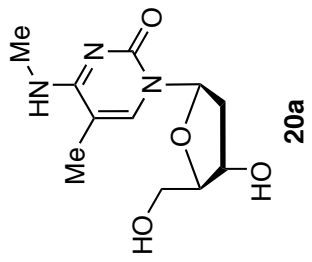

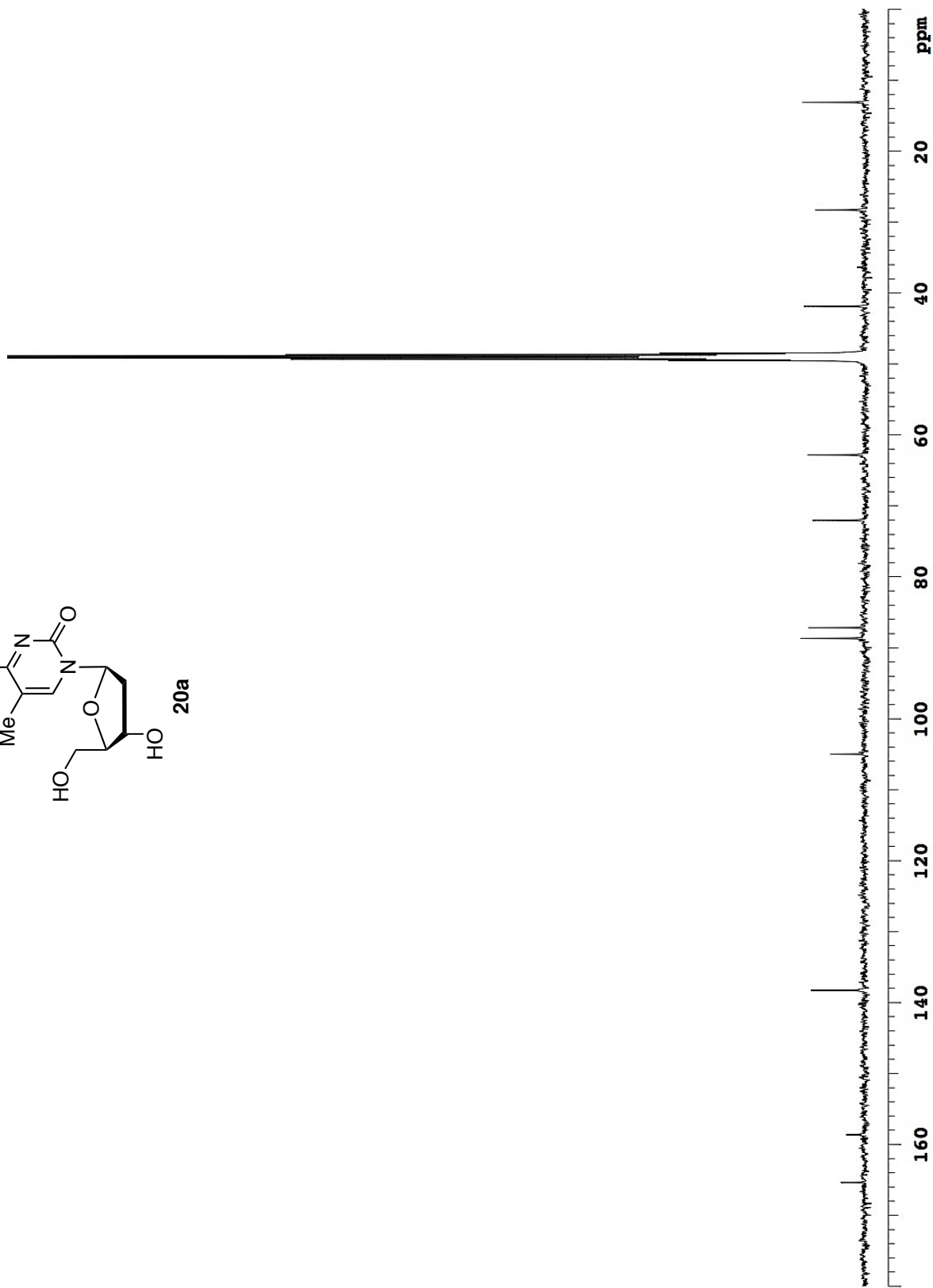
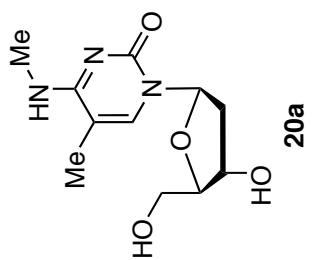

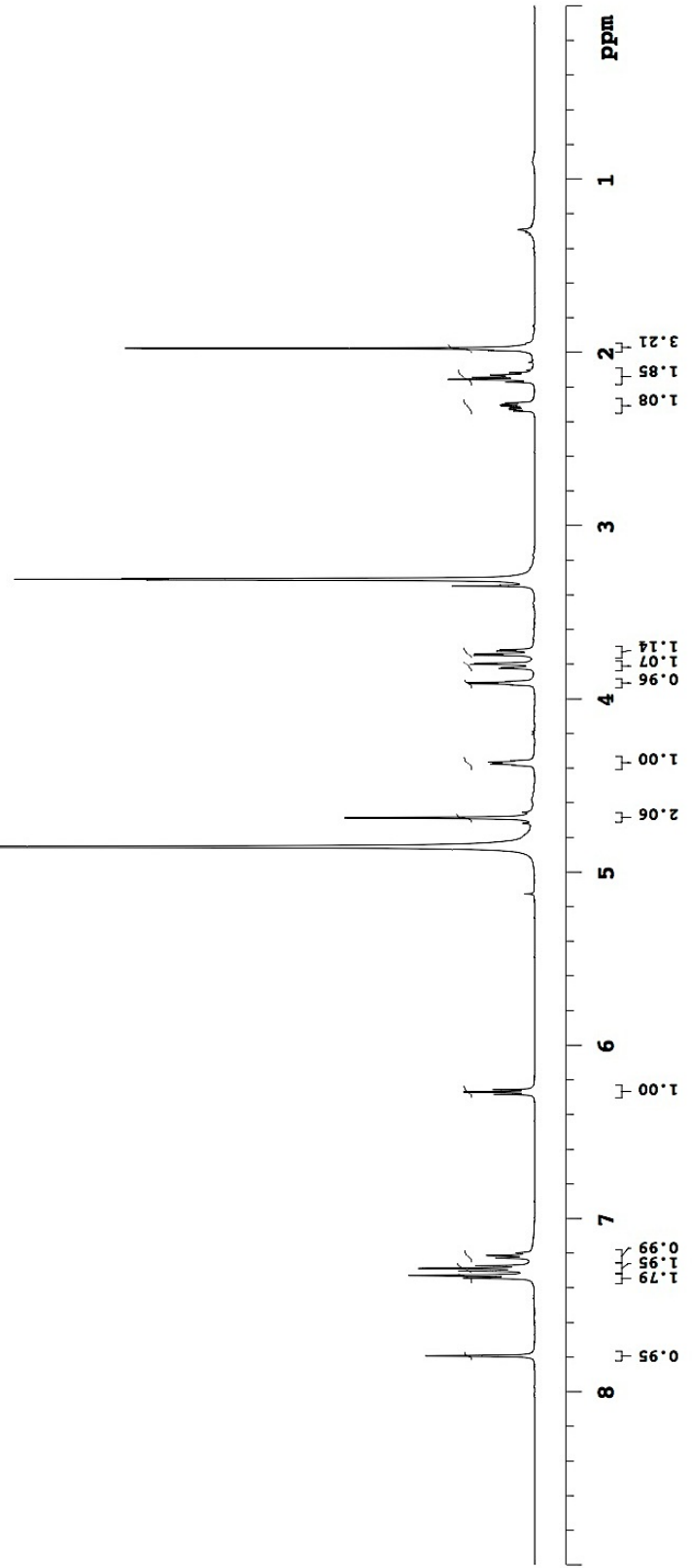
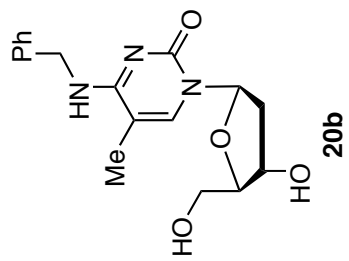

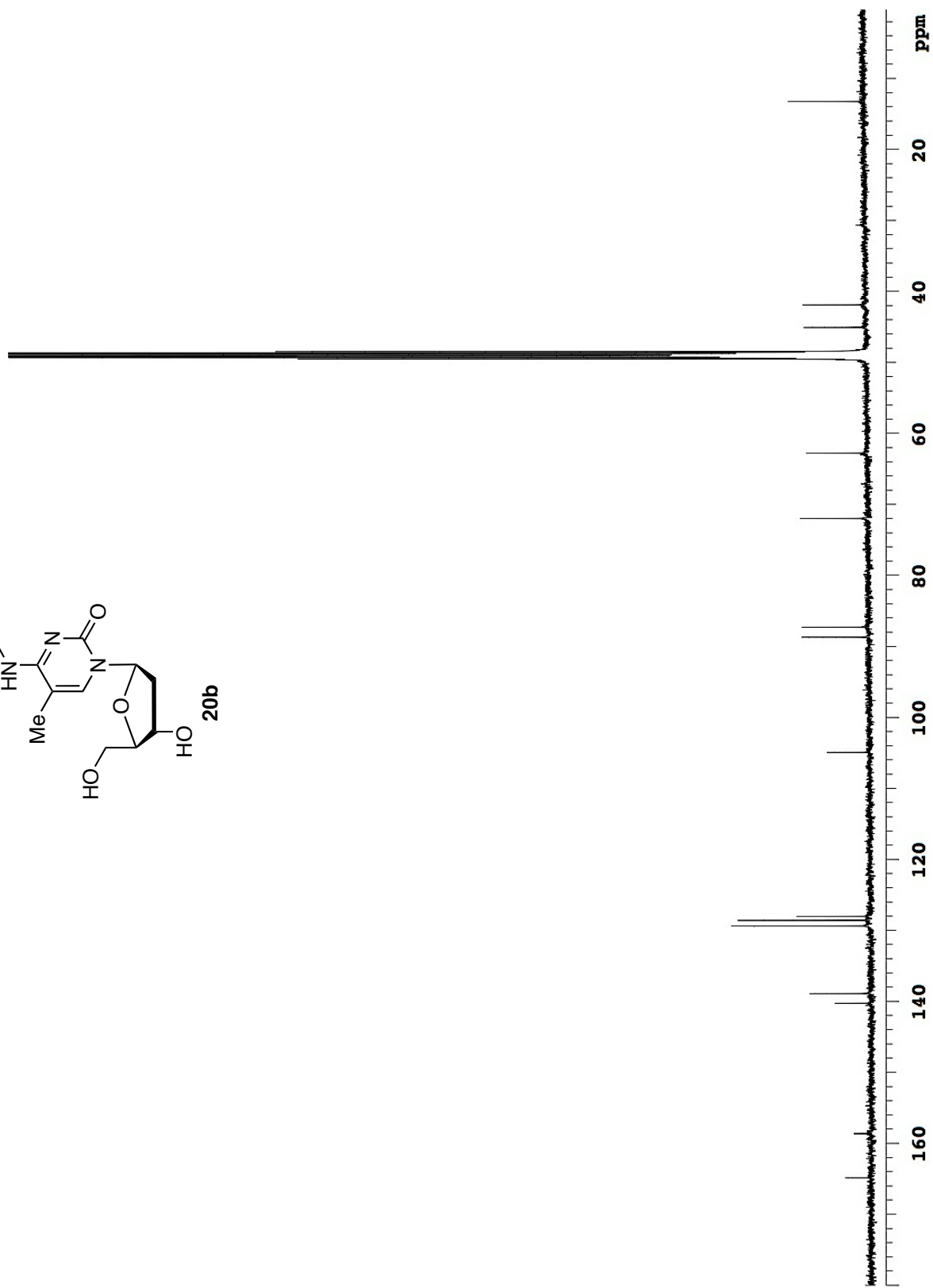
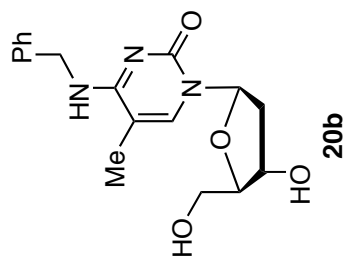

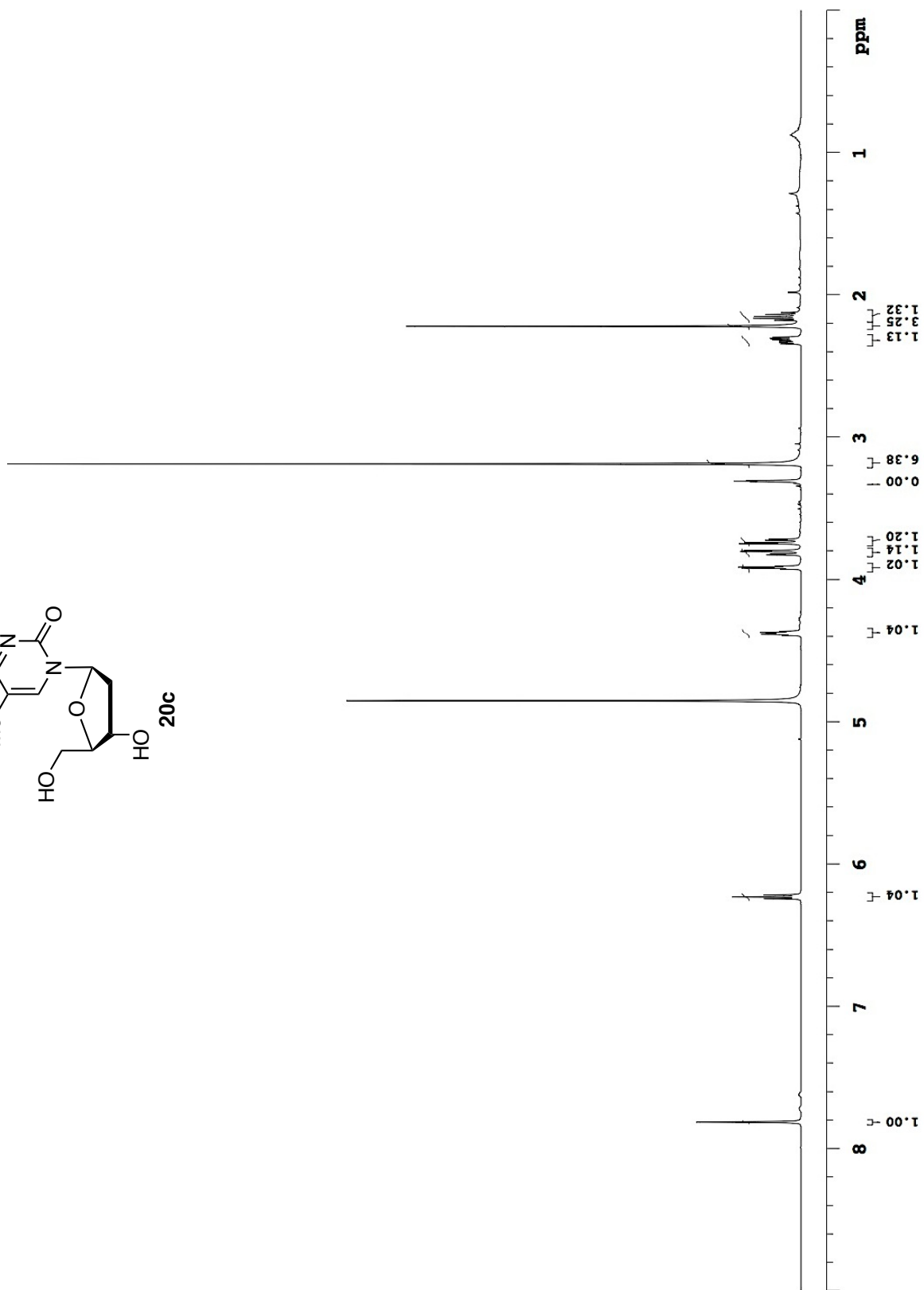
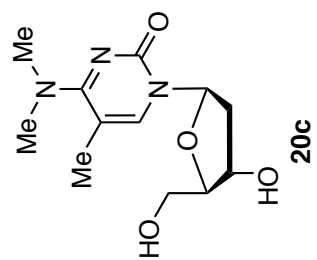

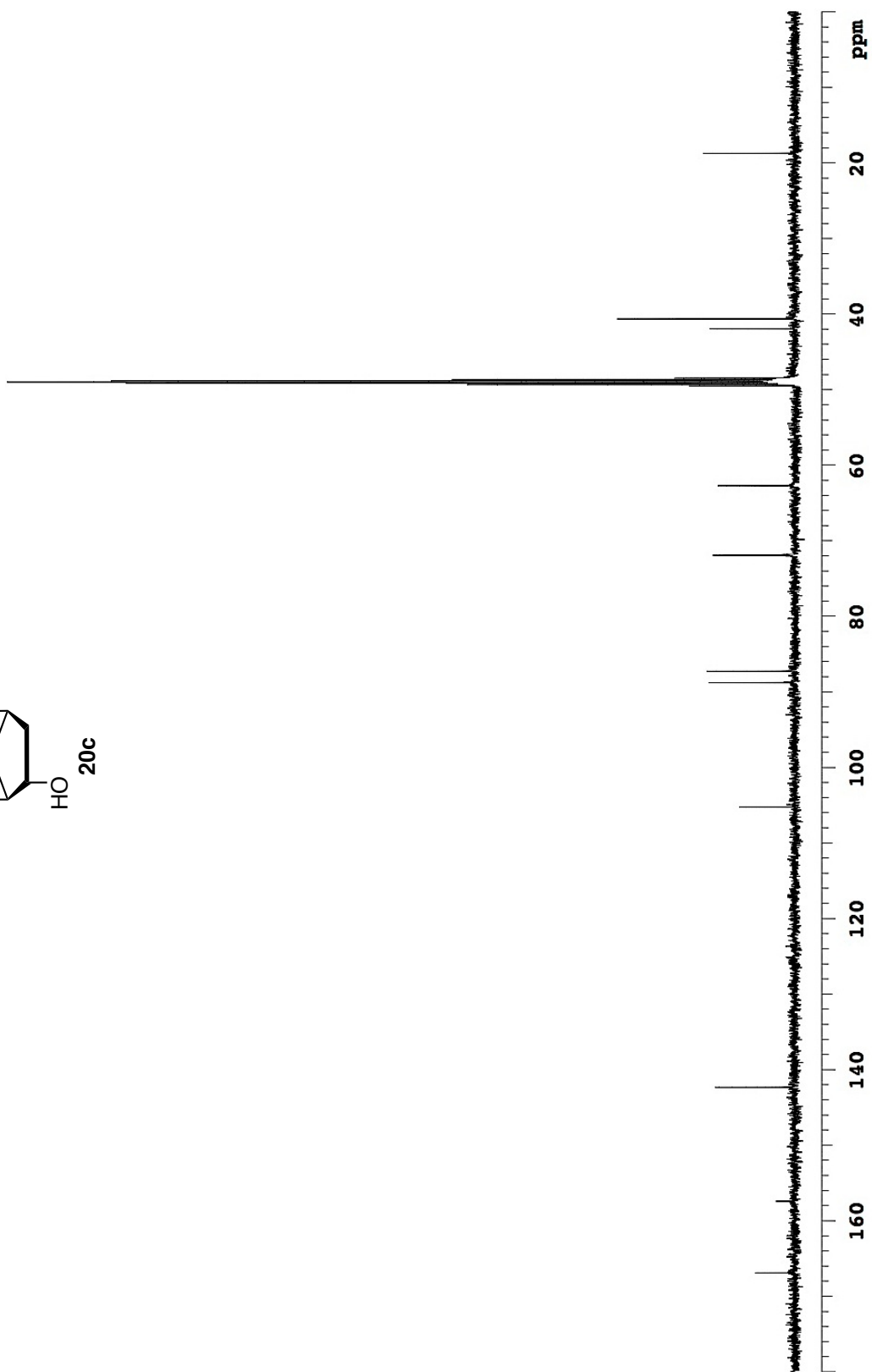
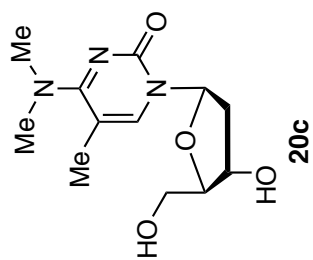

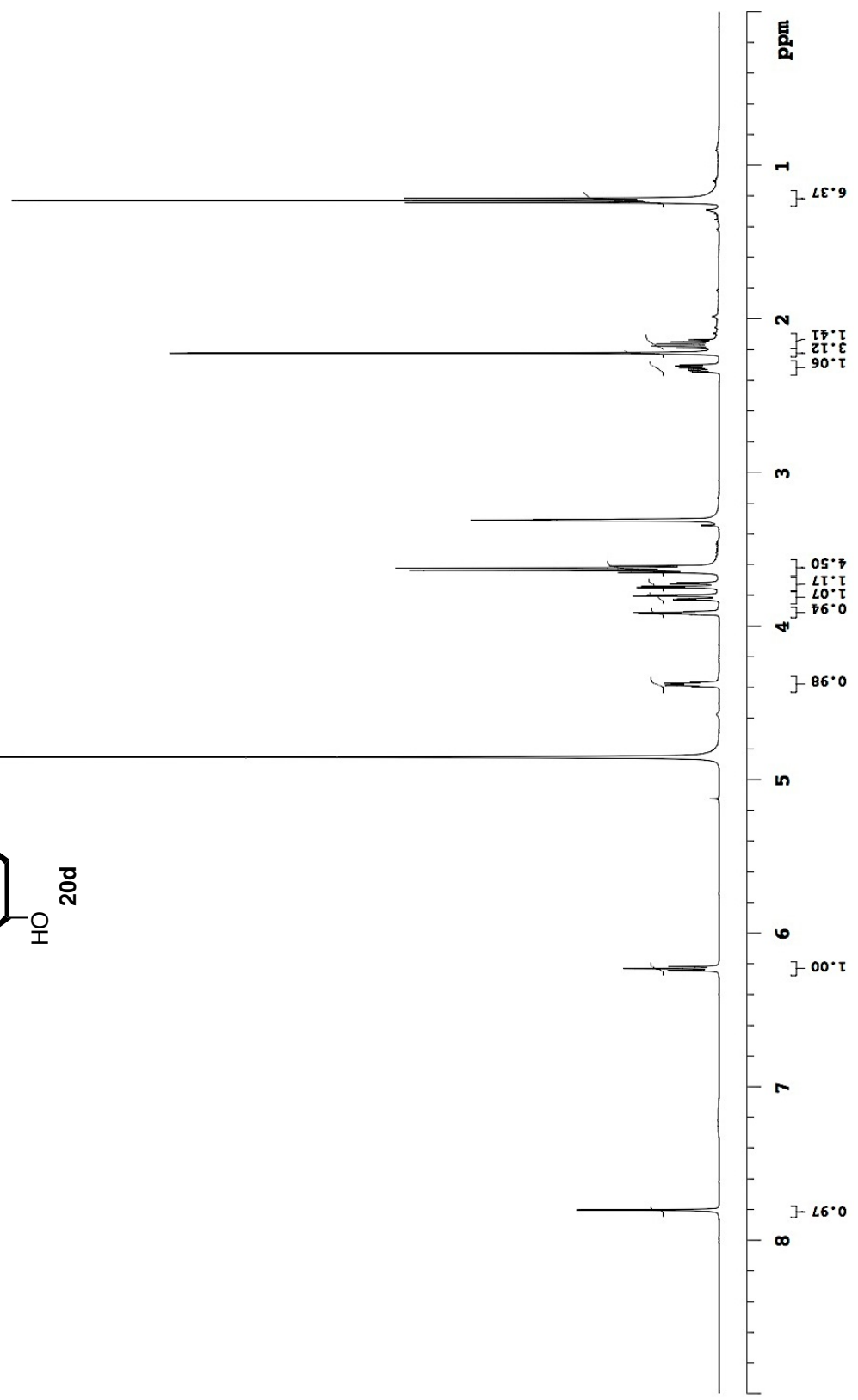
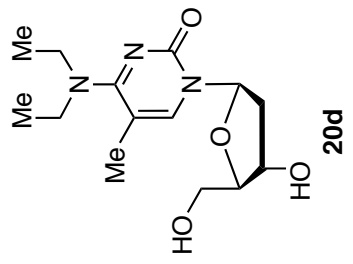

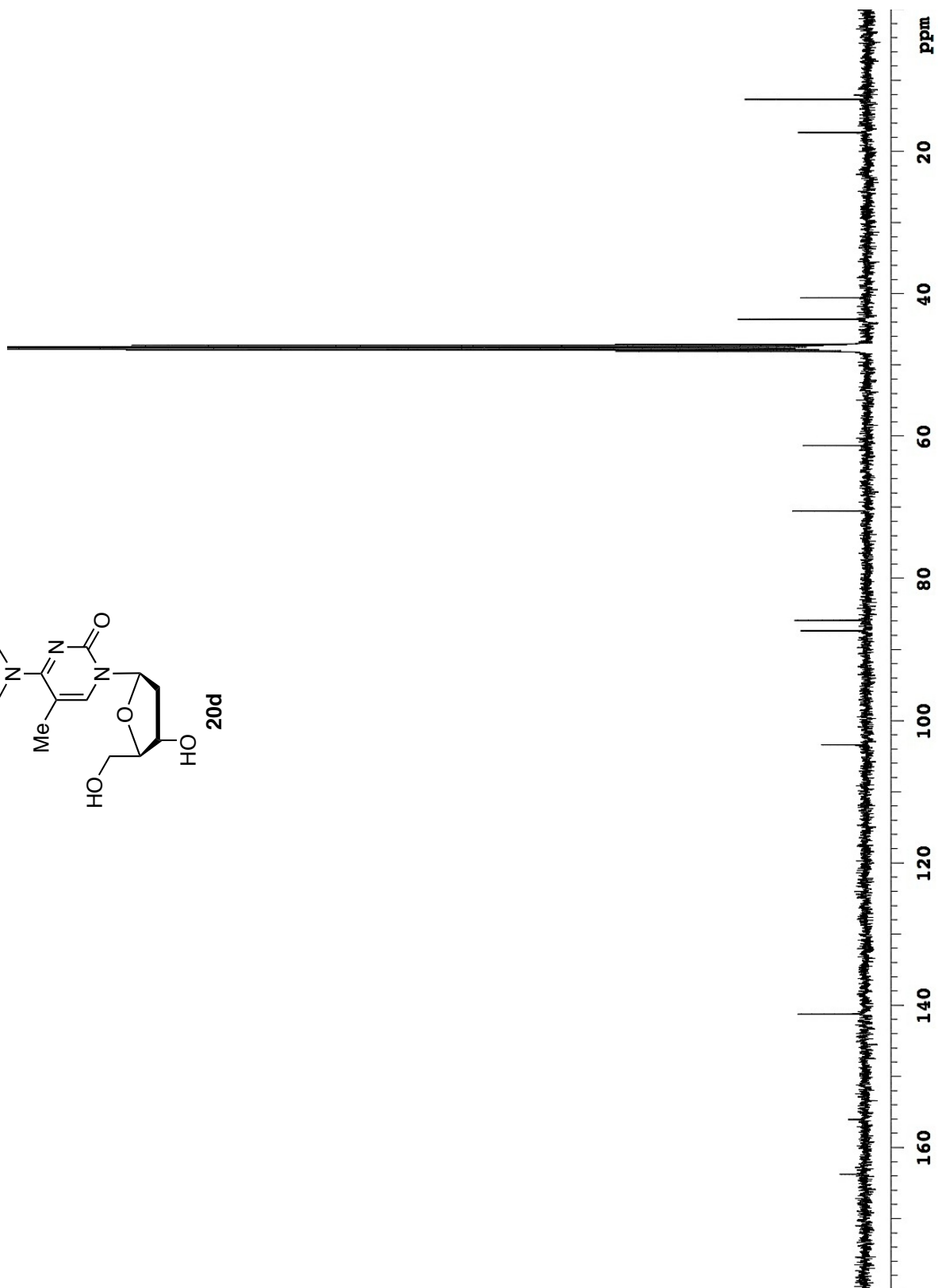
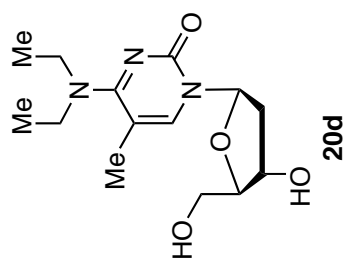

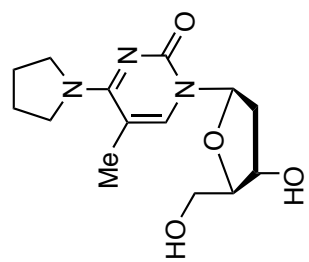

20e

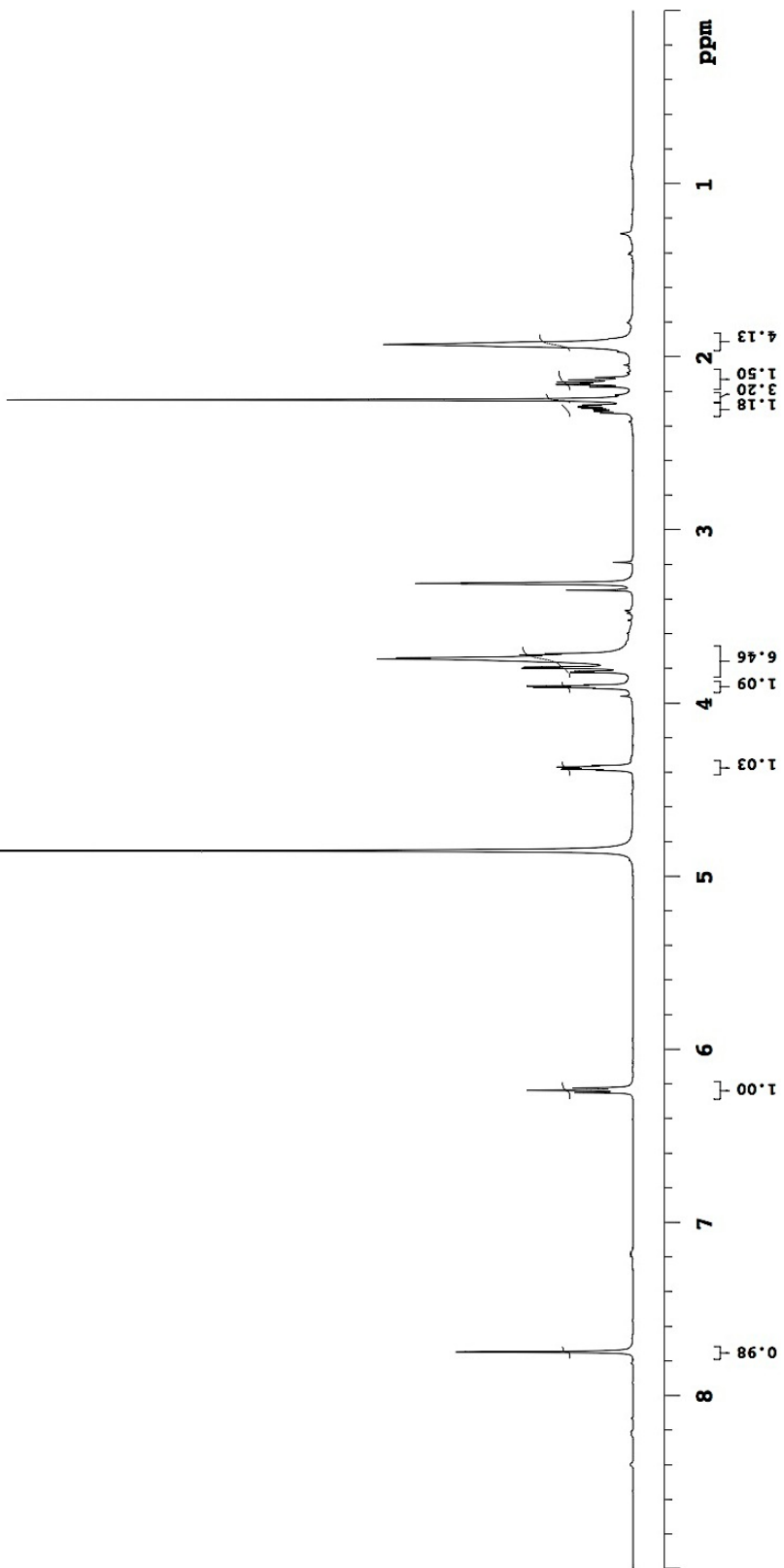

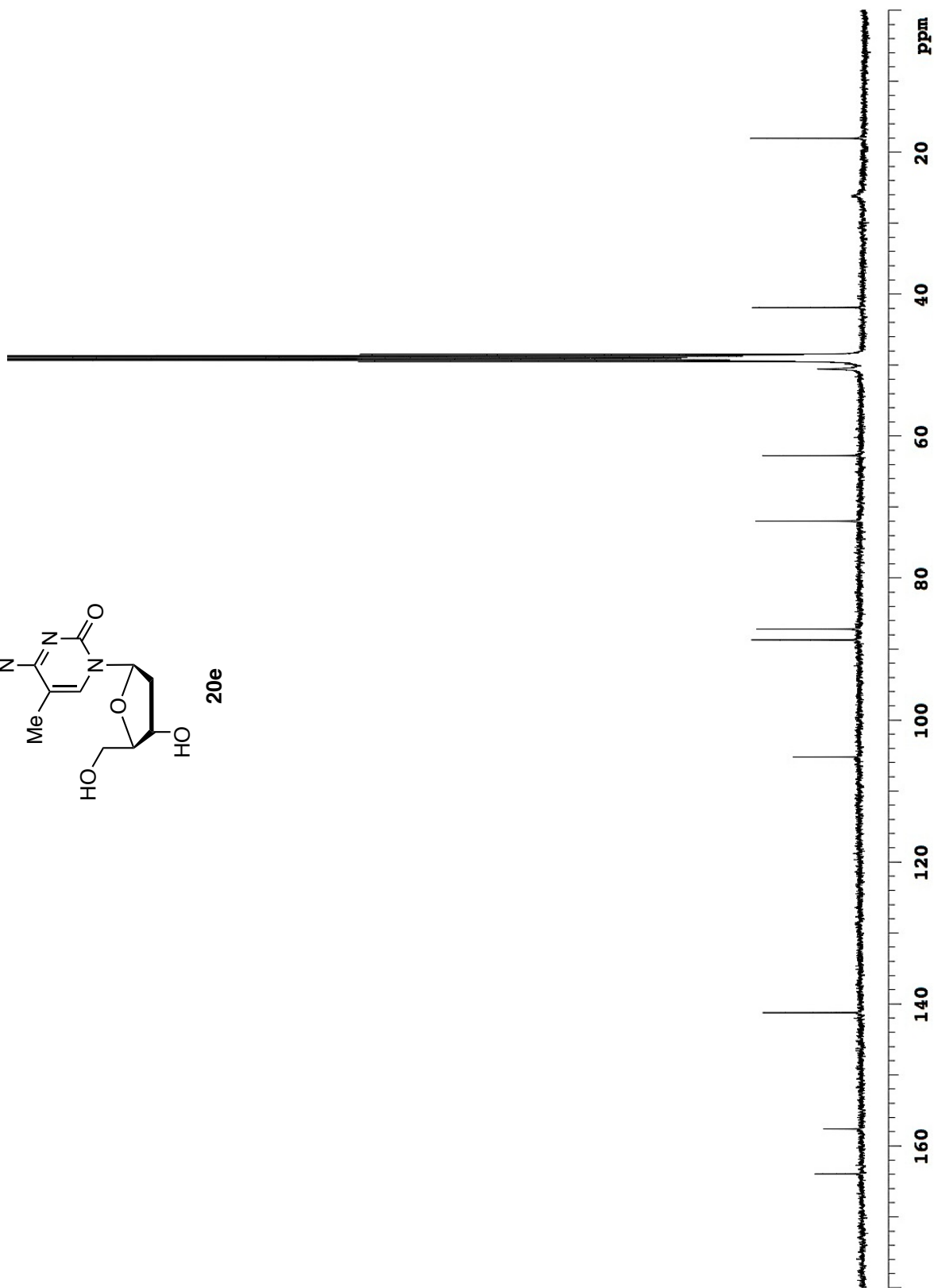
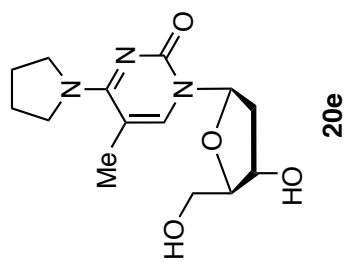

gCOSY spectrum of compound **20e** in CD₃OD

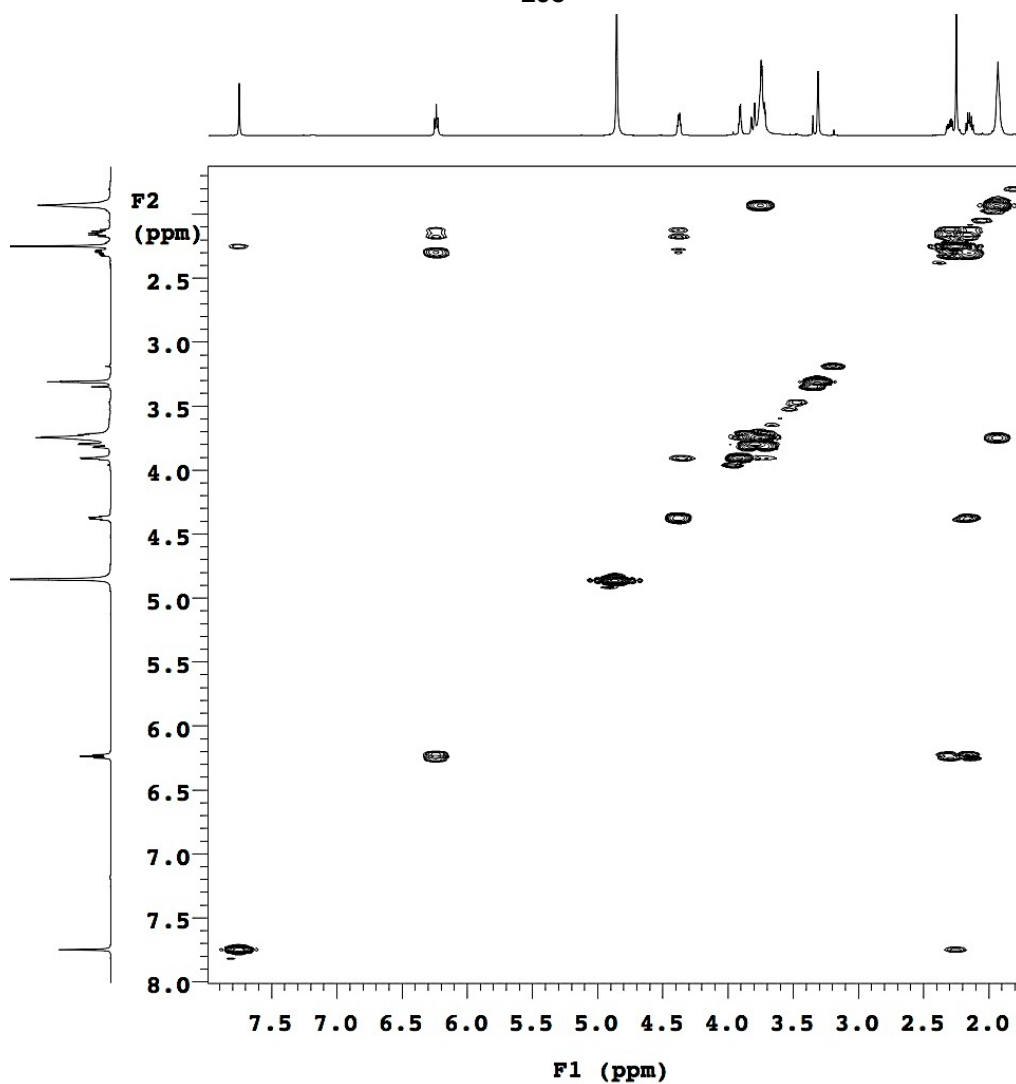
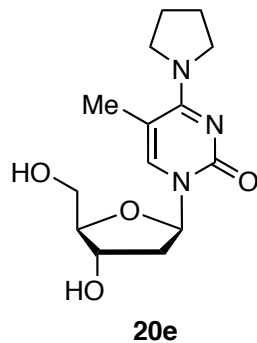

gHMQC spectrum of compound **20e** in CD₃OD

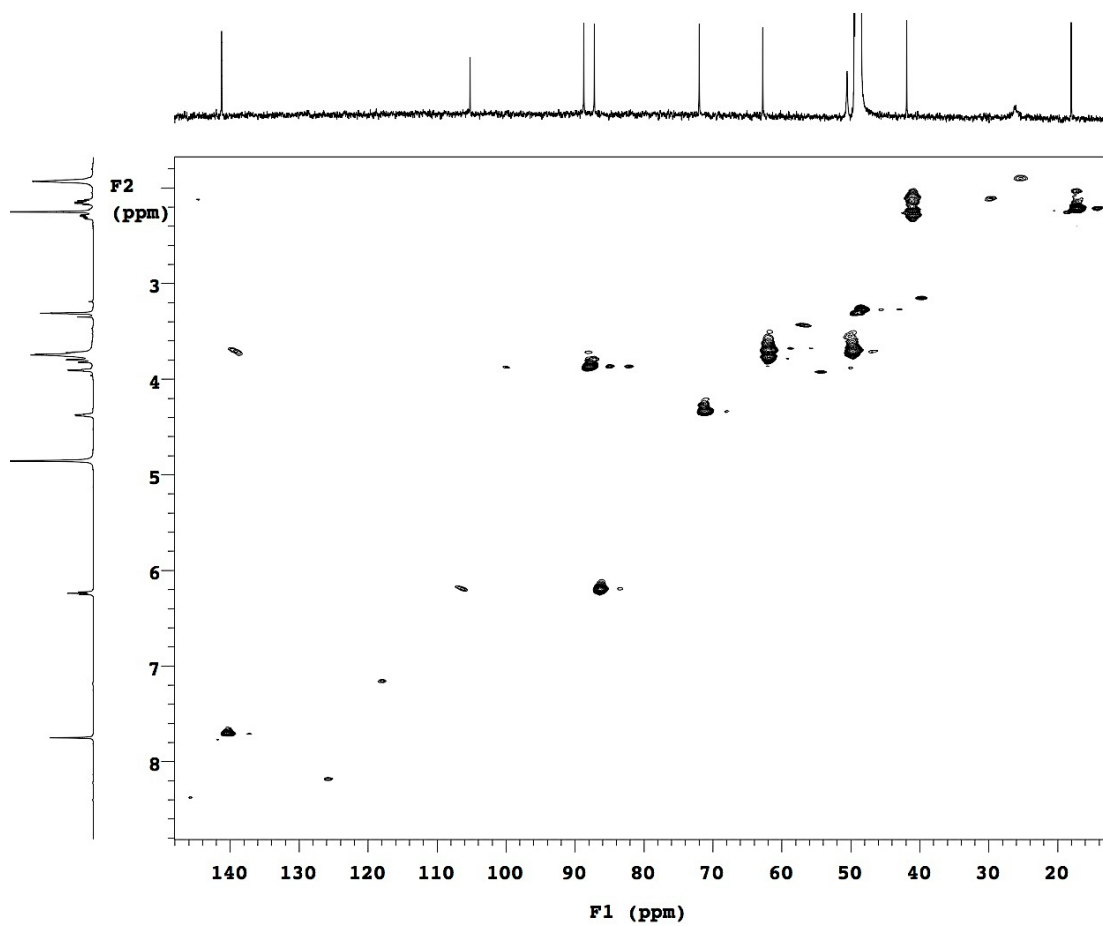
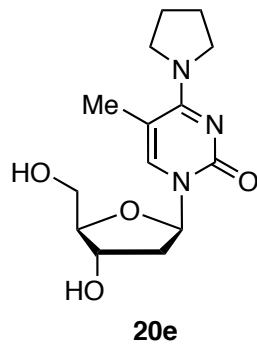

gHMQC spectrum of compound **20e** in CD₃OD

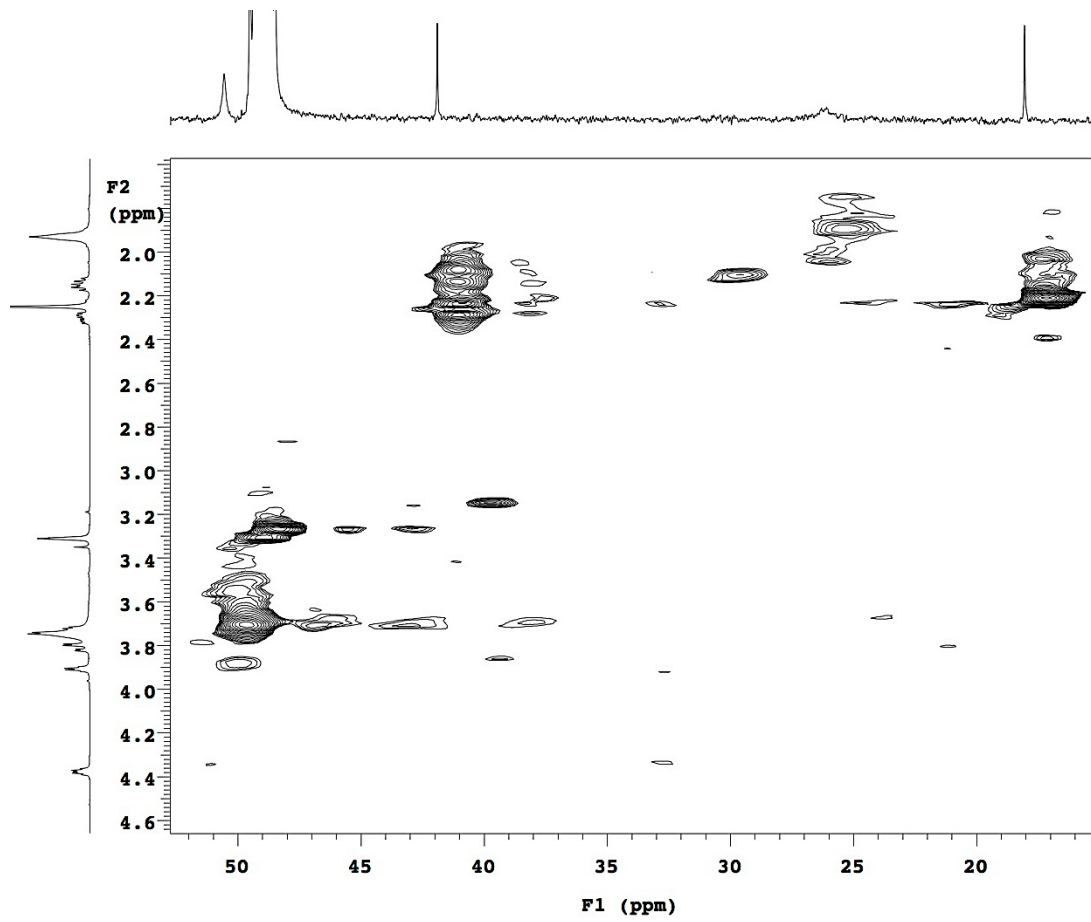
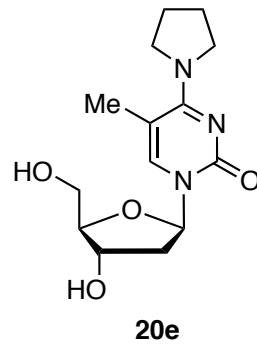

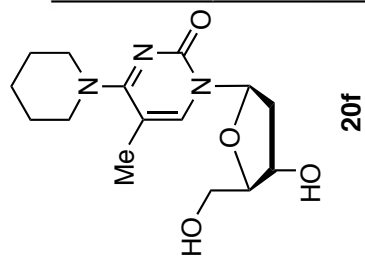

20f

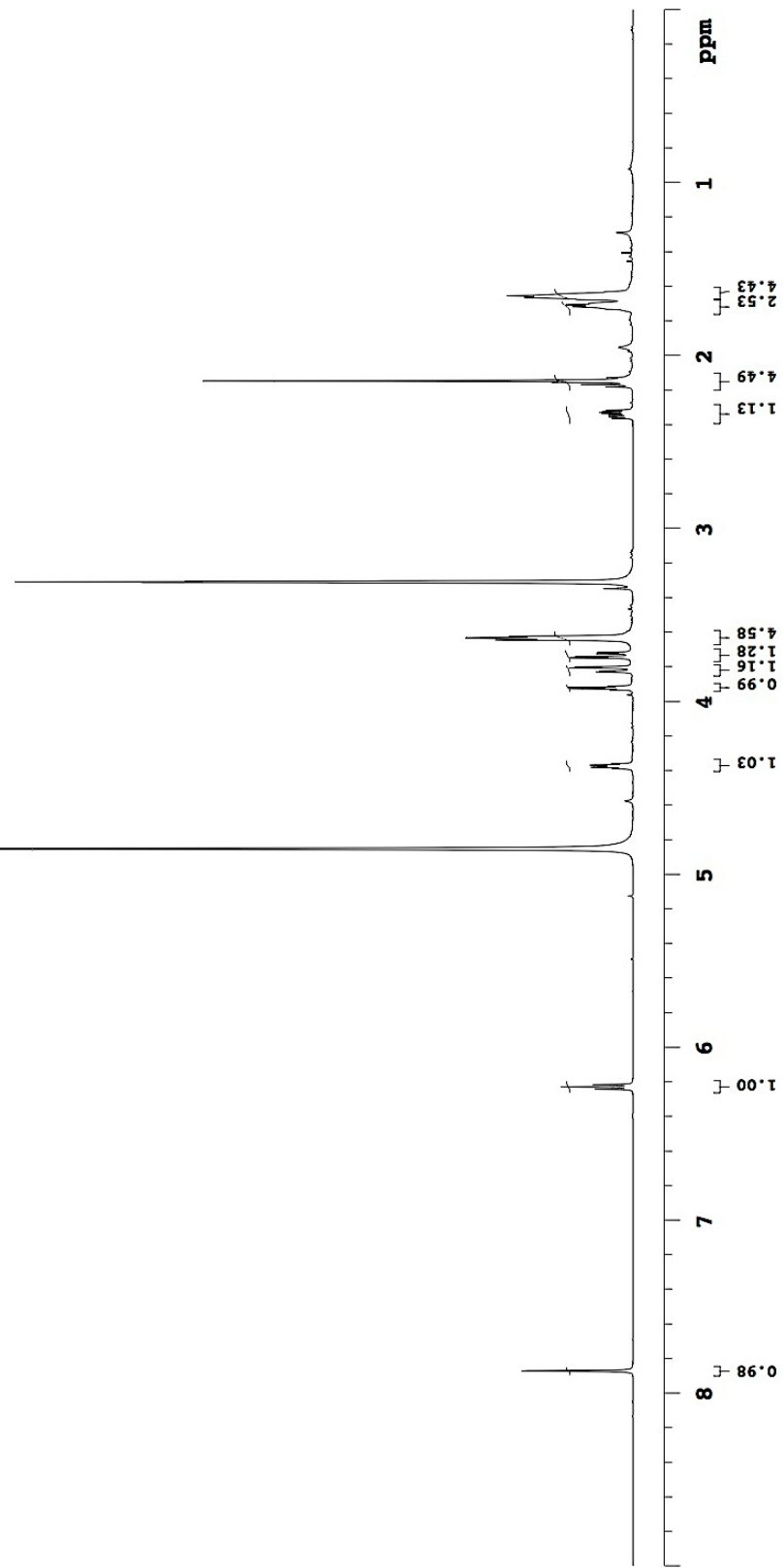

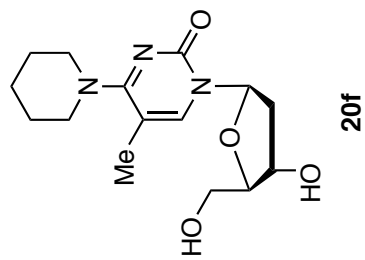

20f

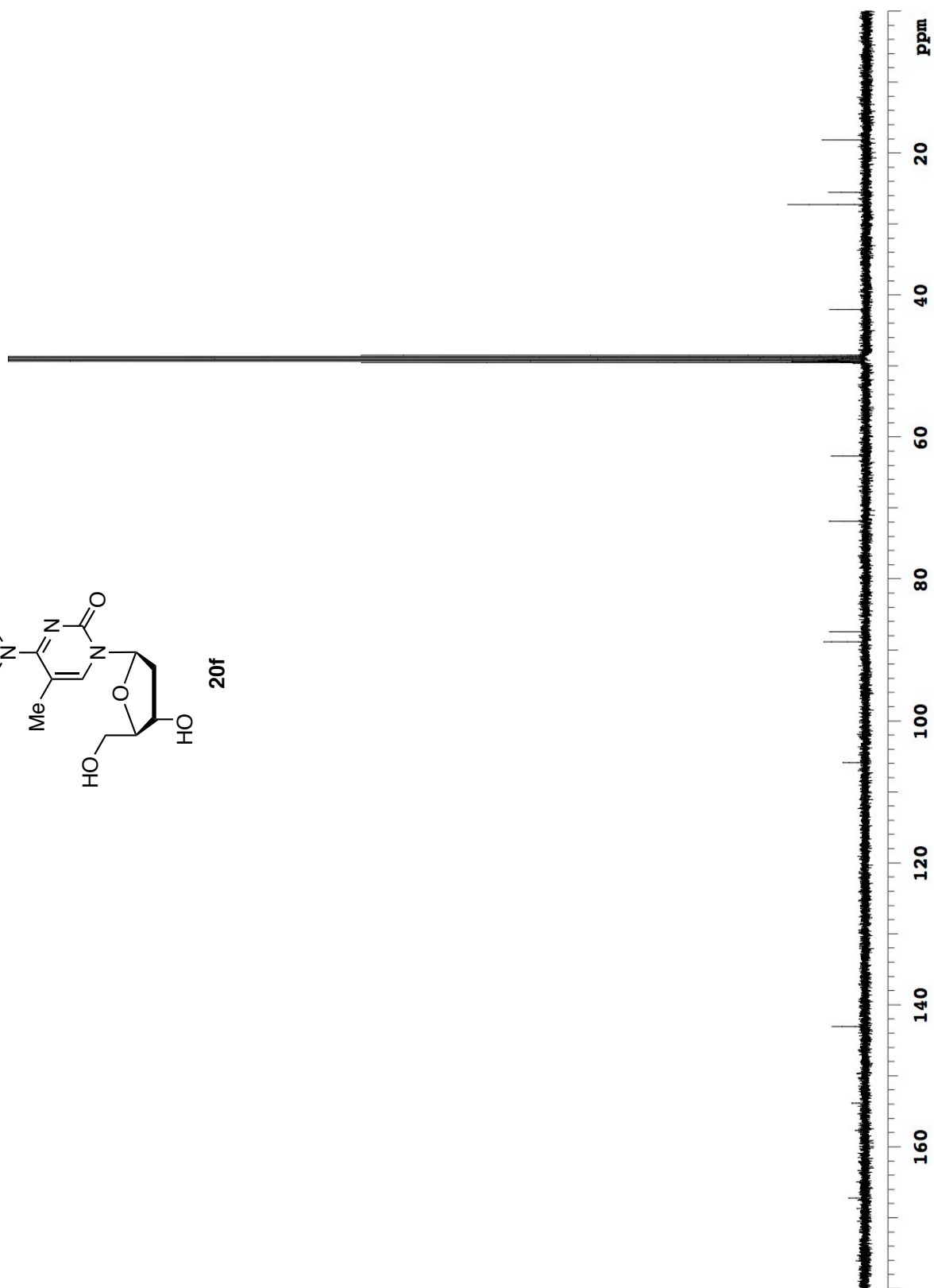

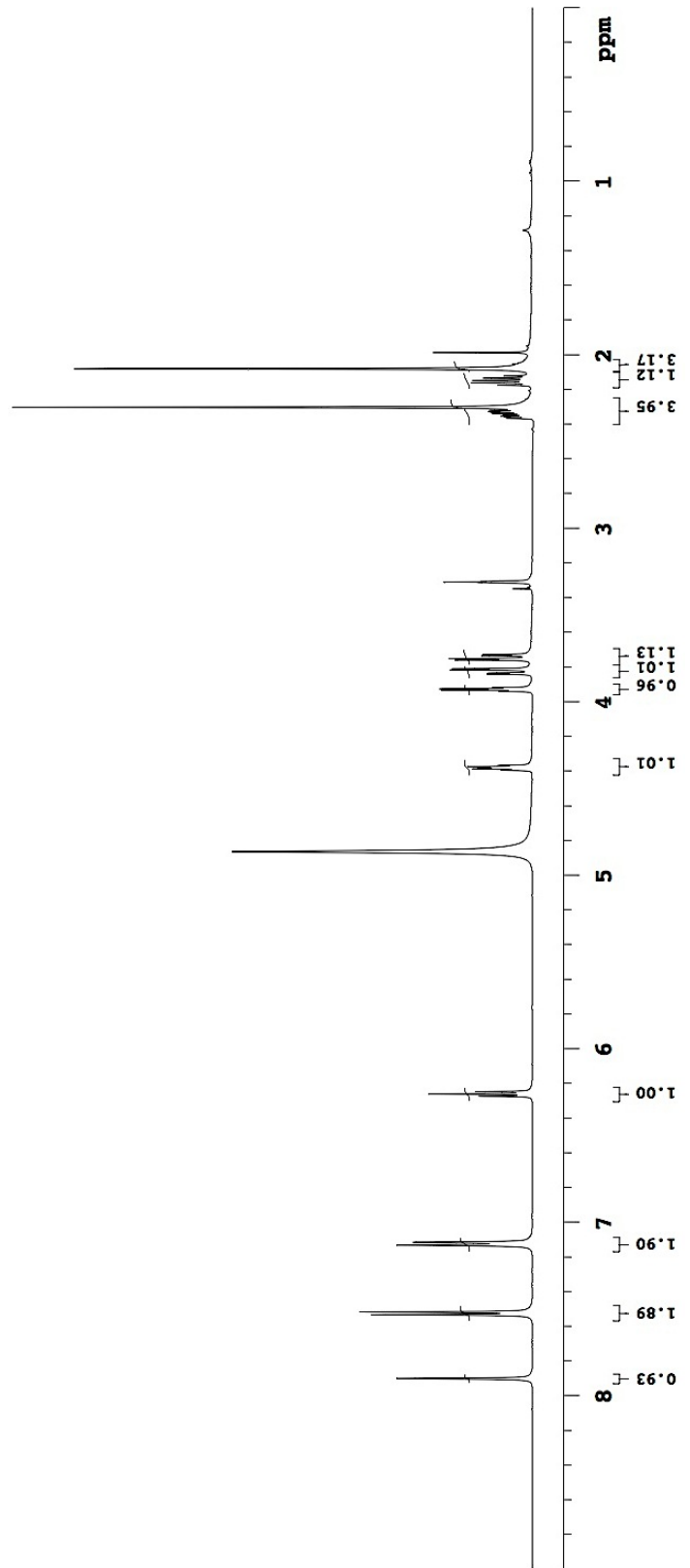
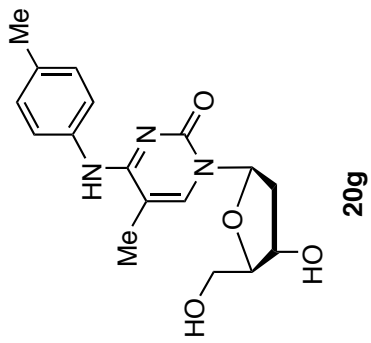

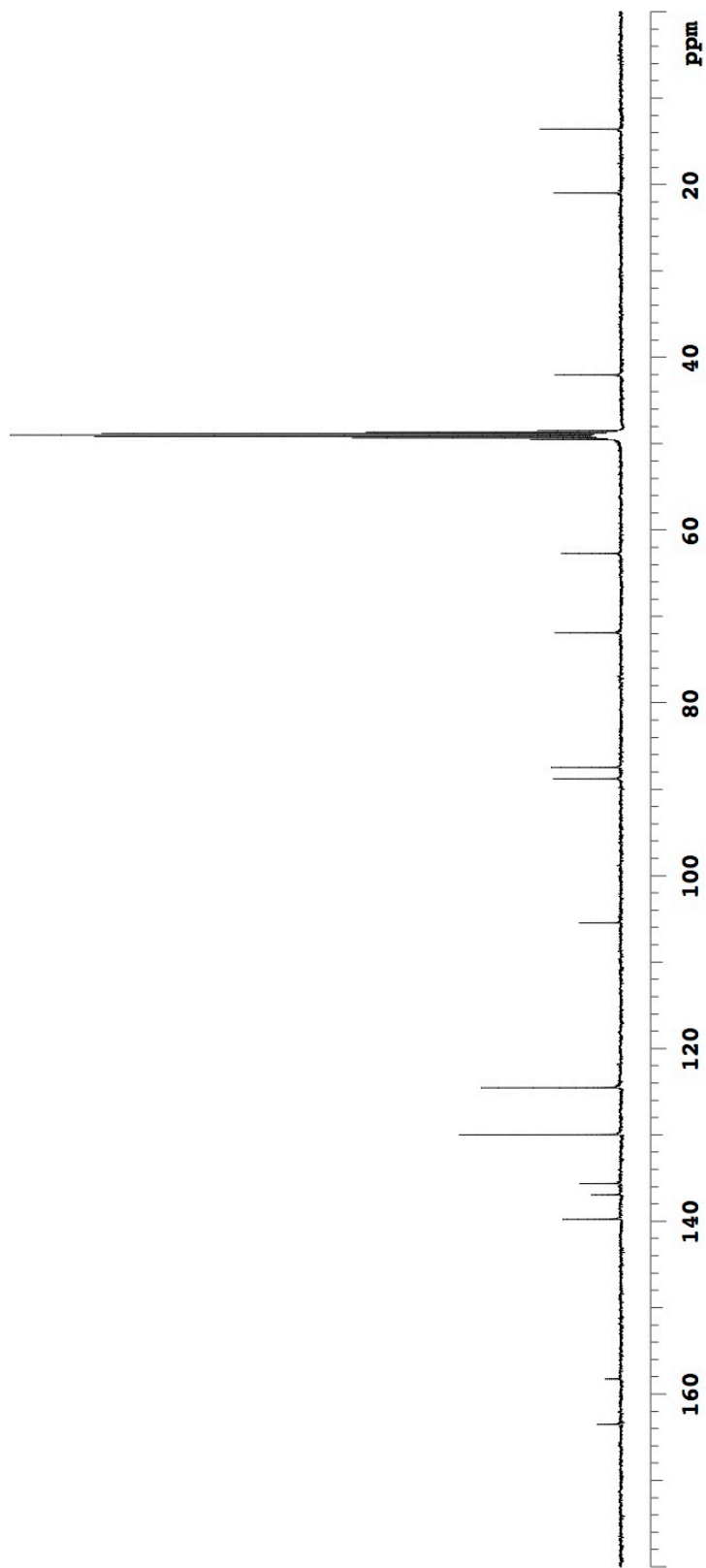
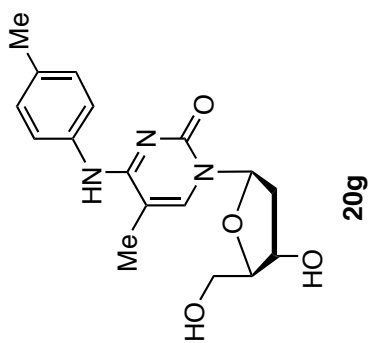

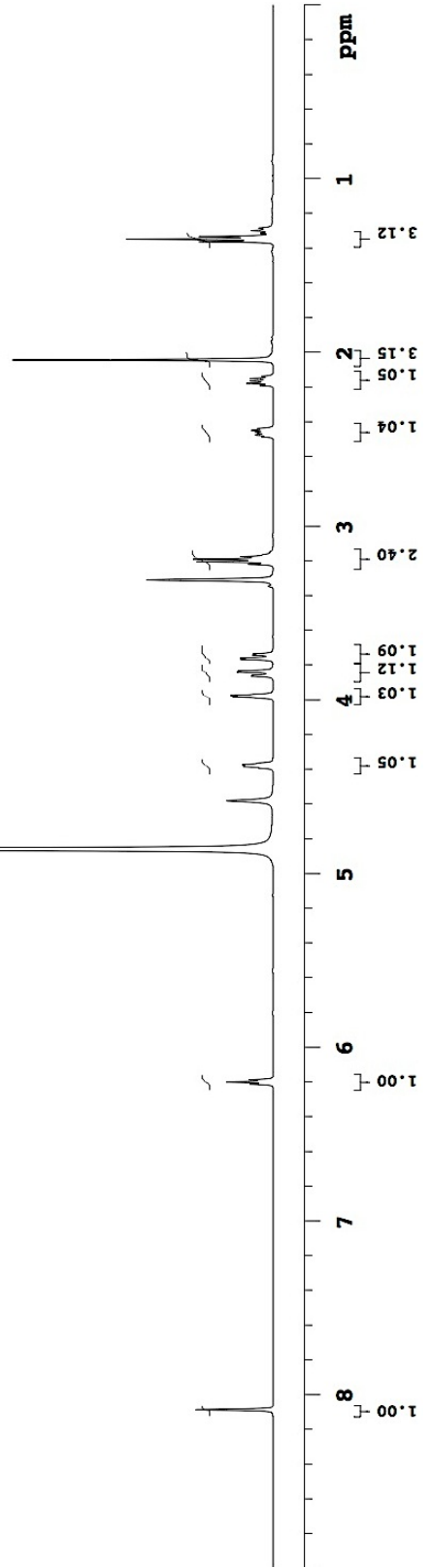
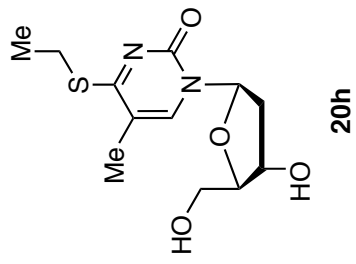

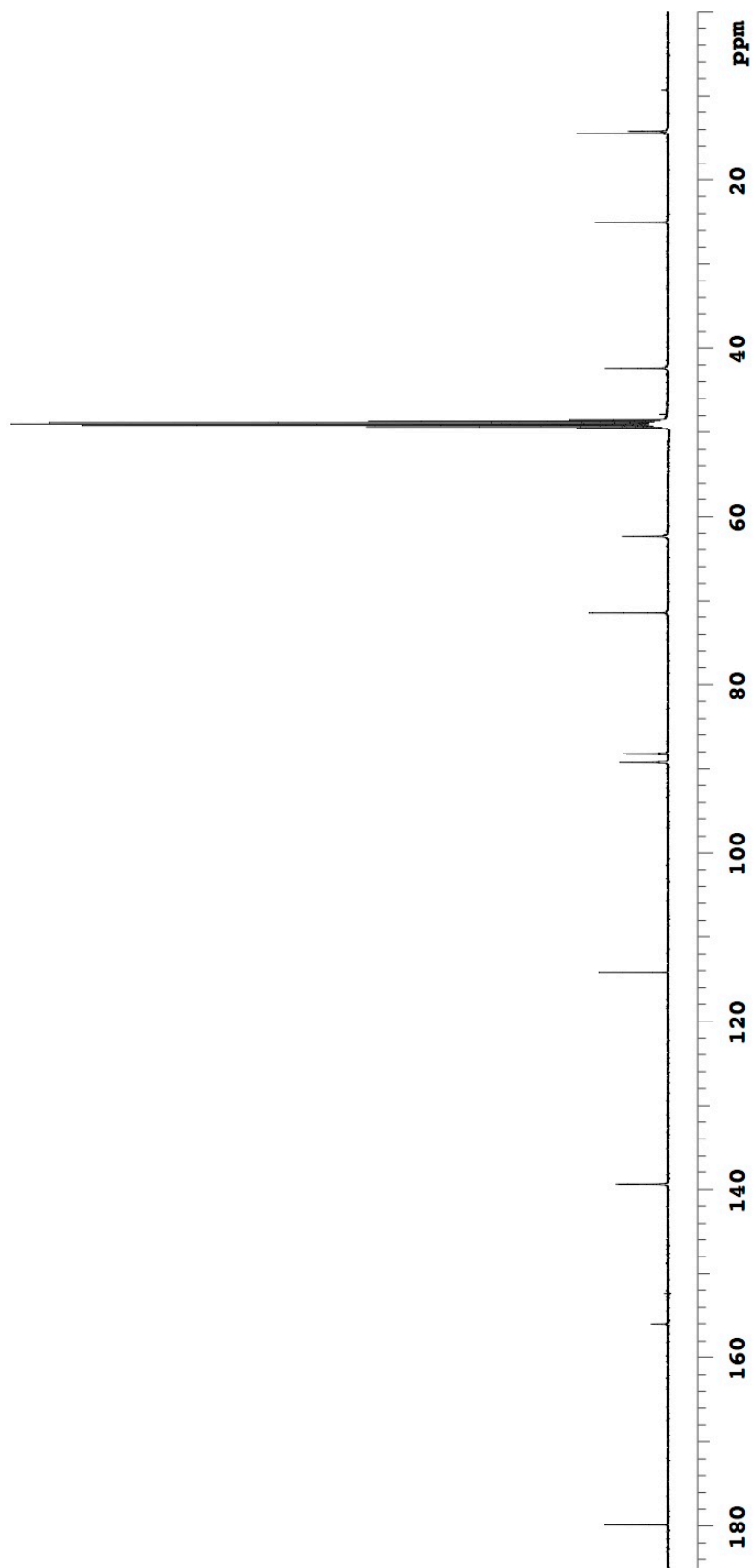
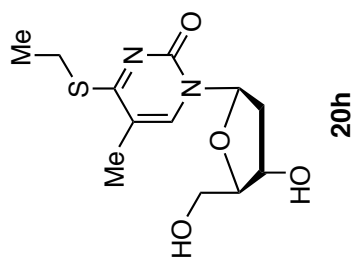

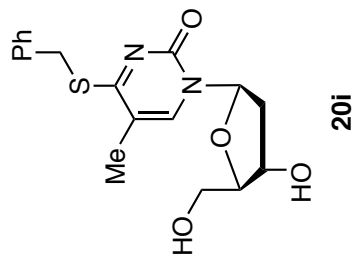

20i

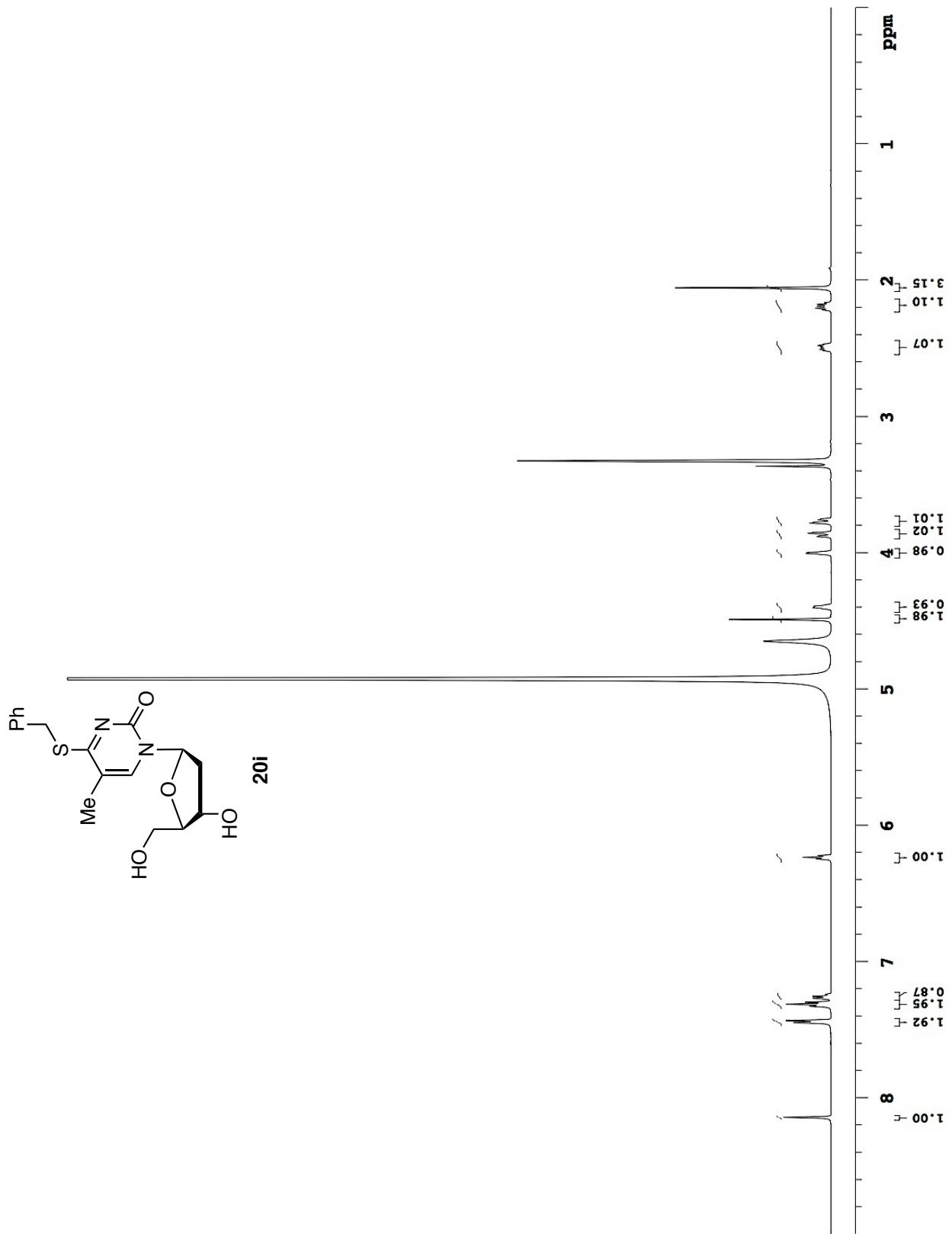

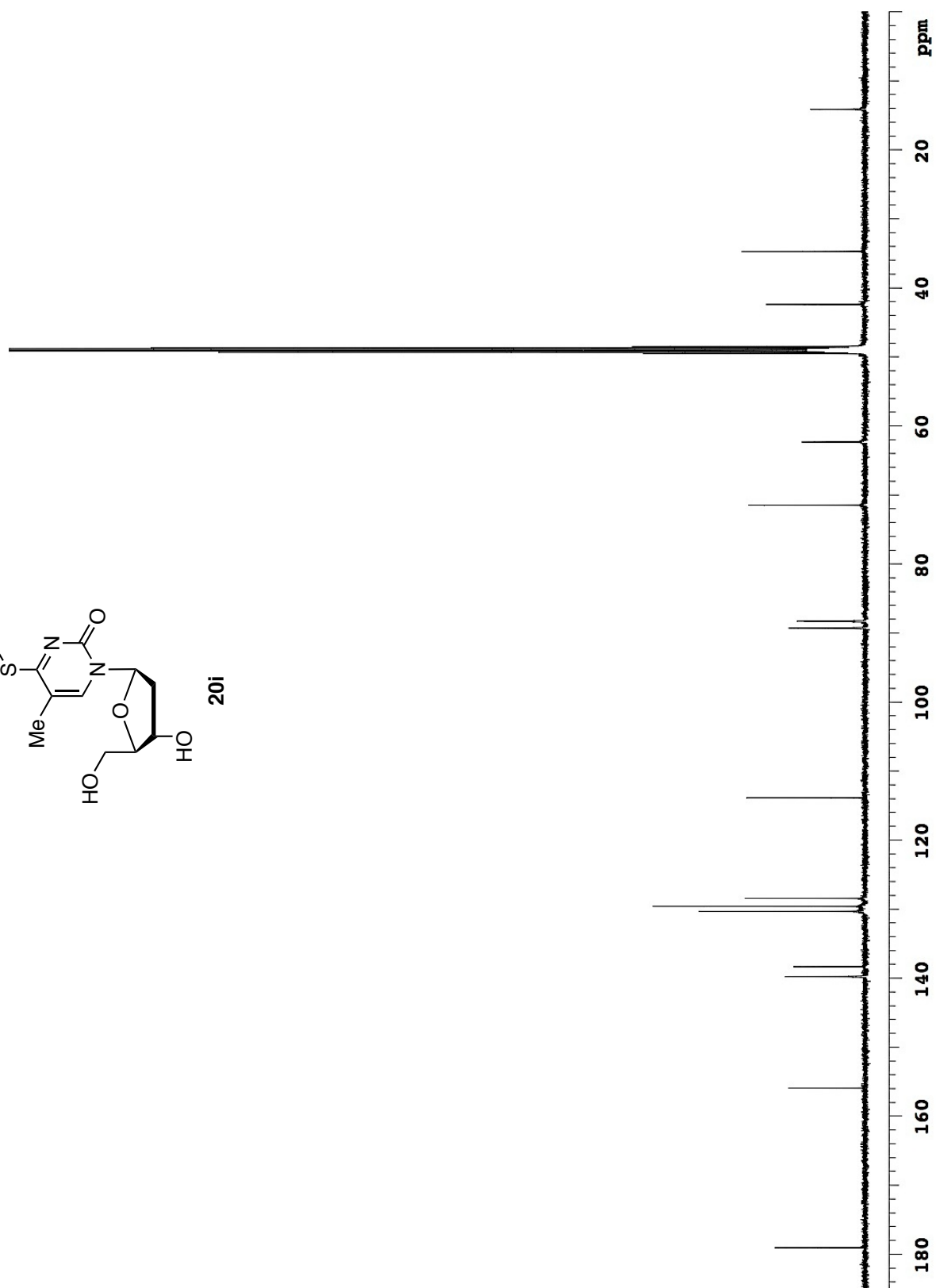
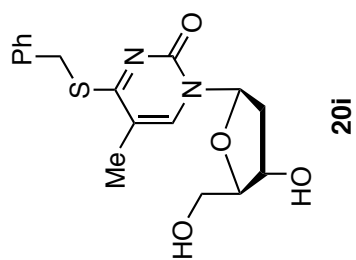

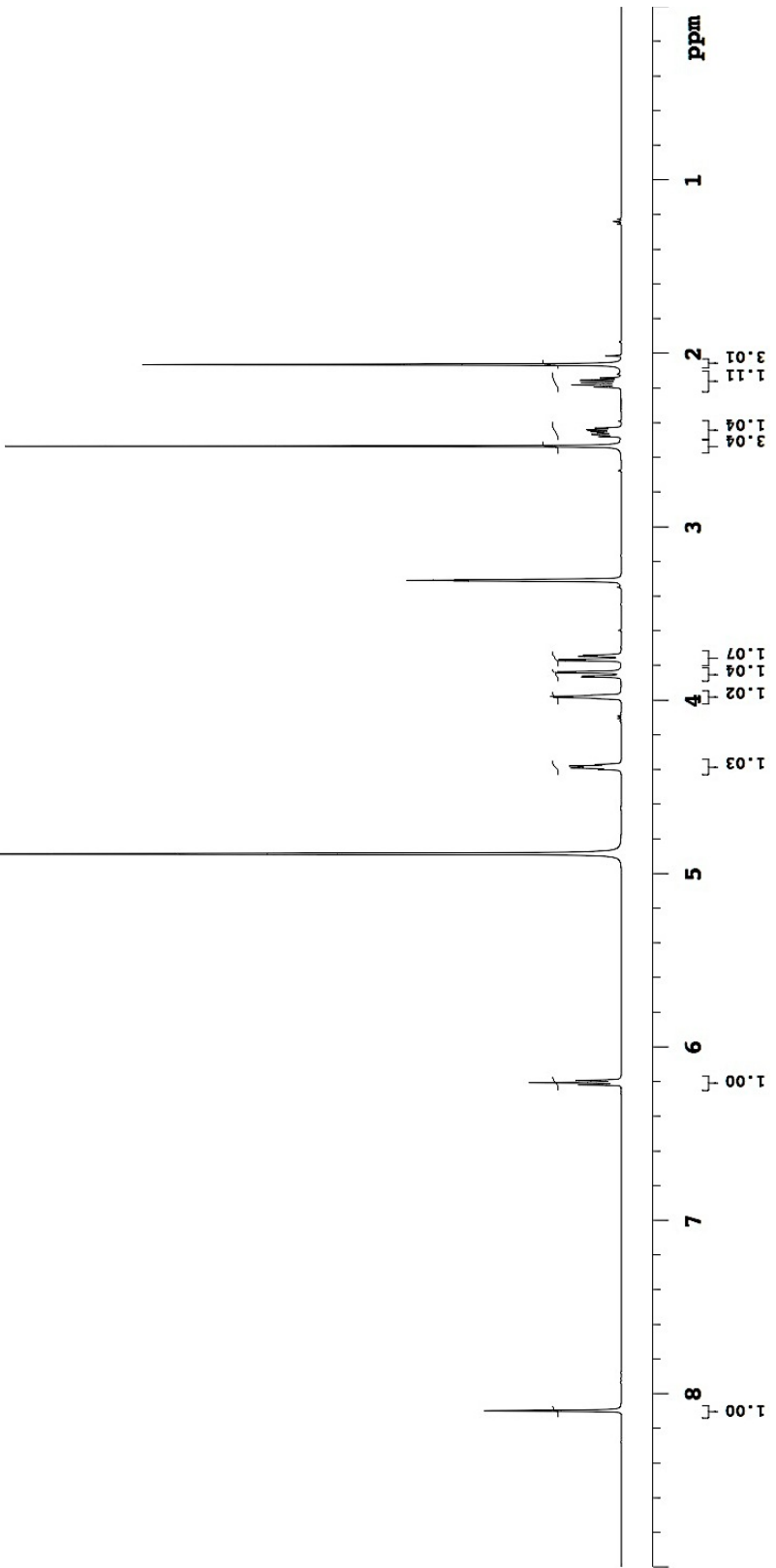
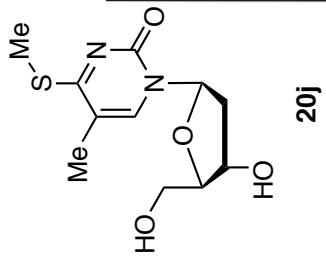

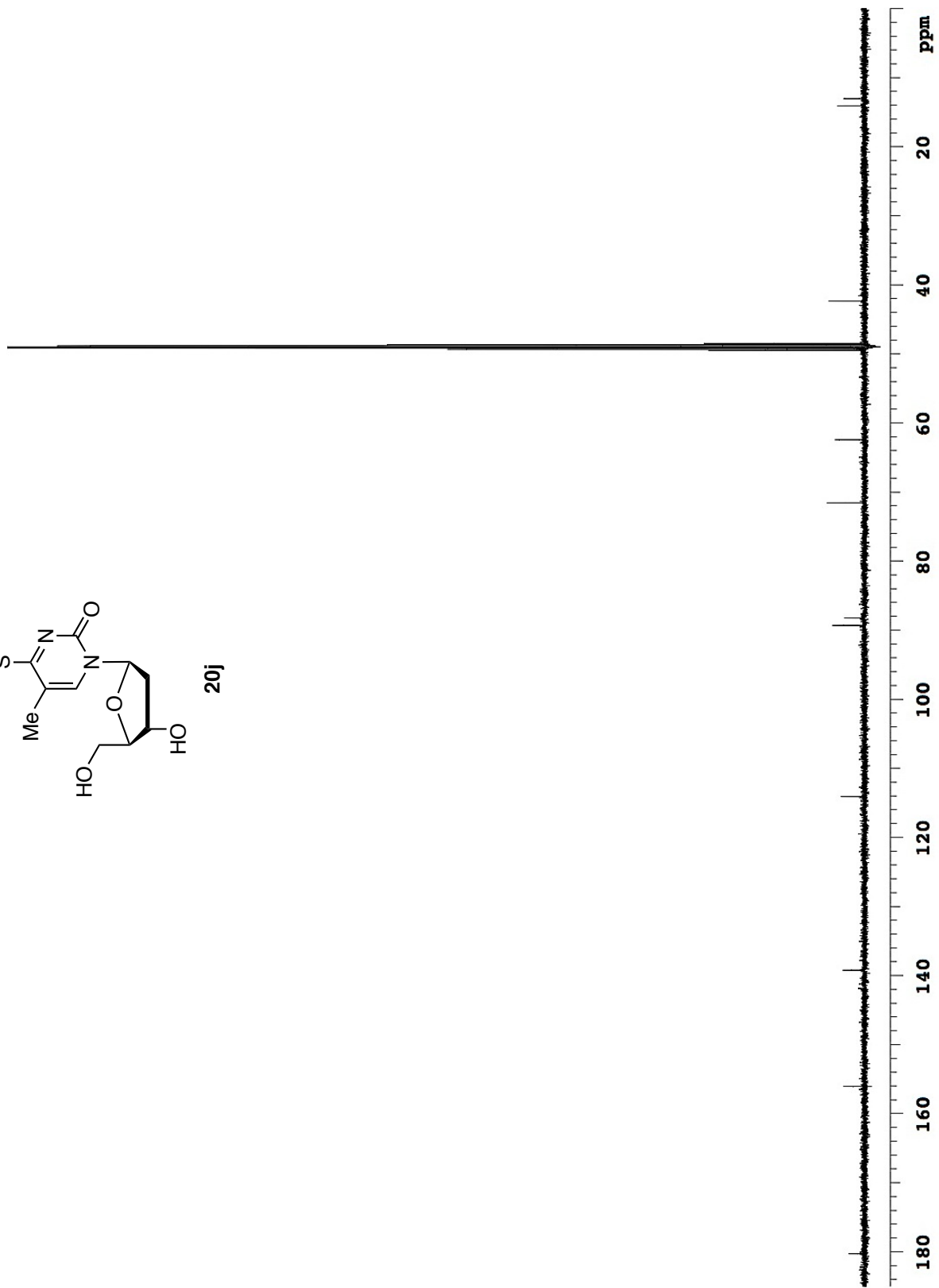
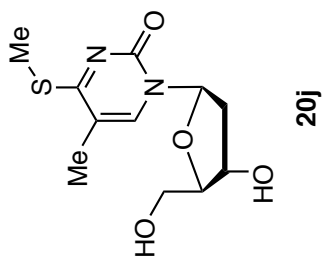

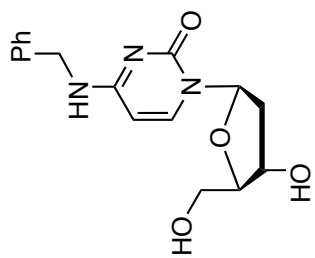

21a

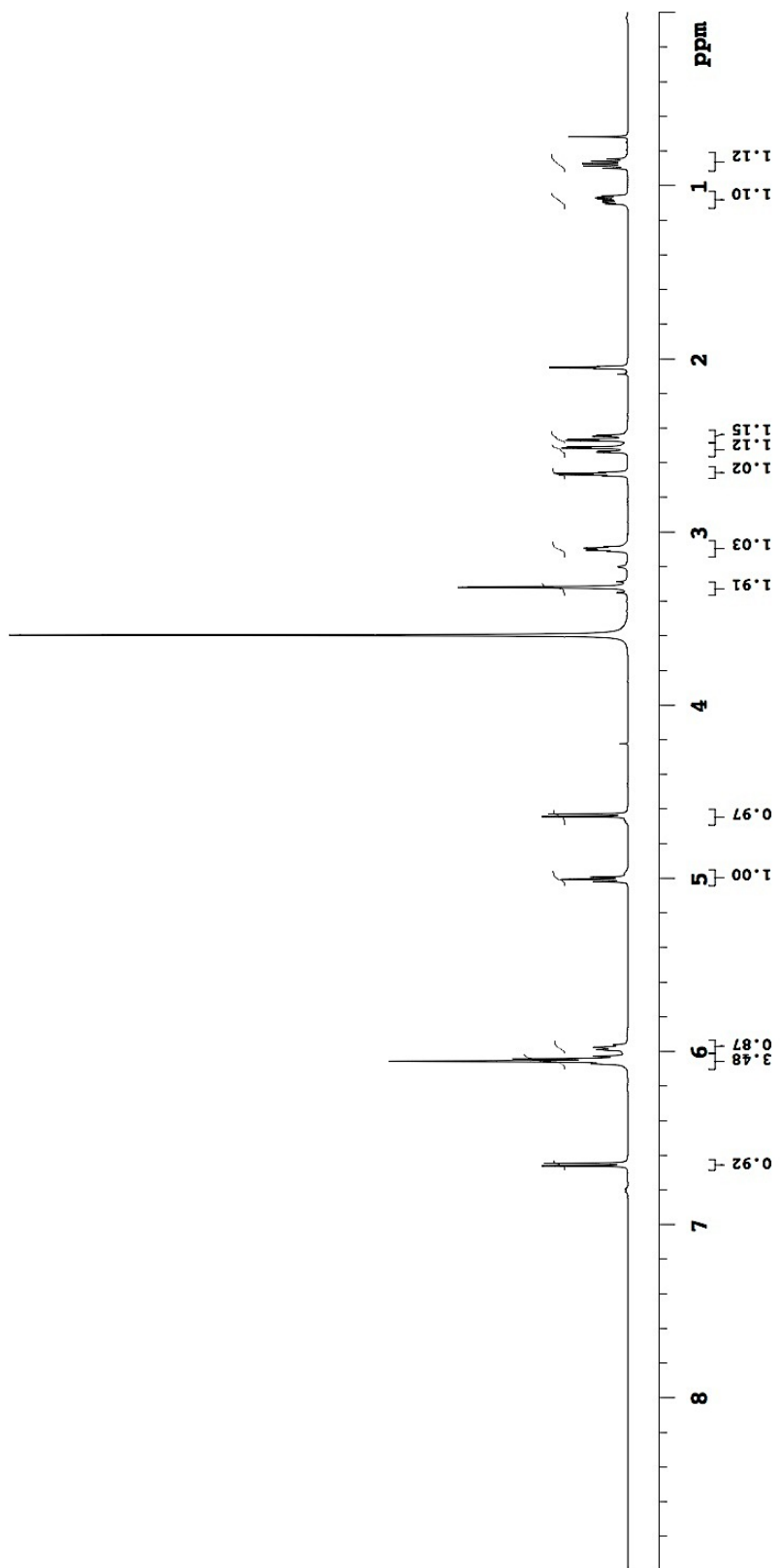

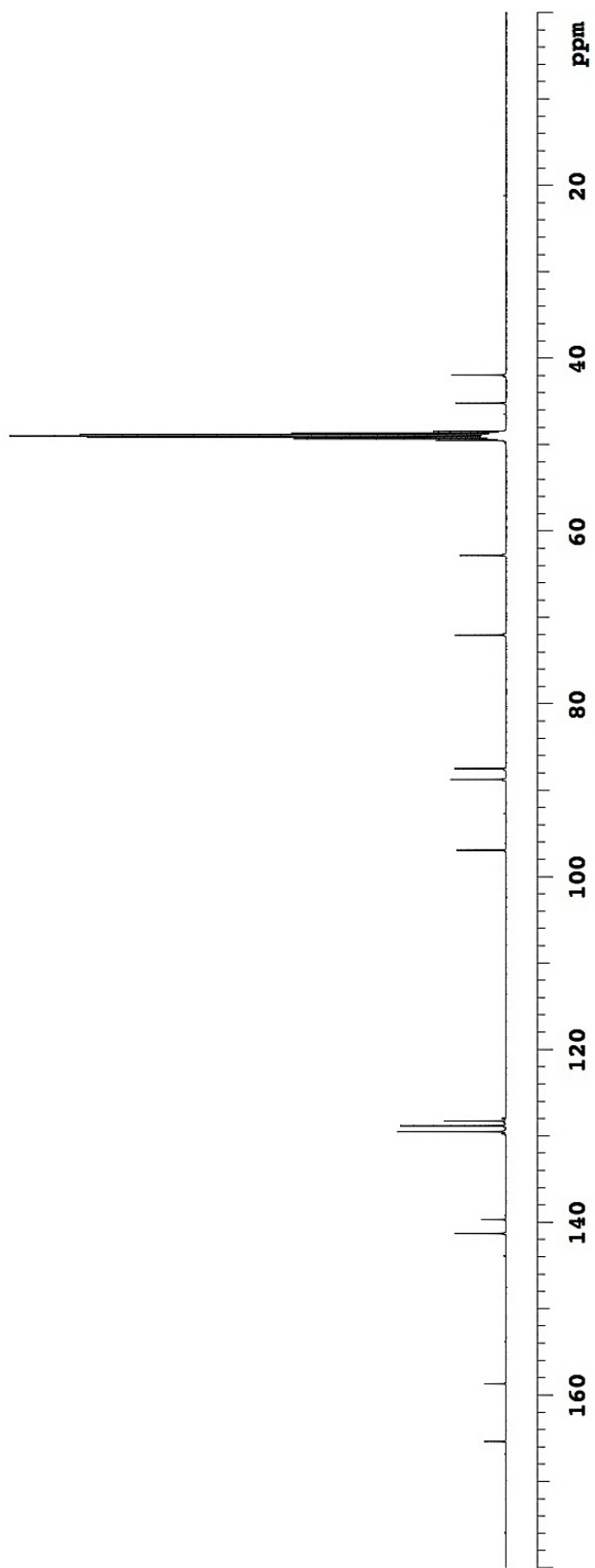
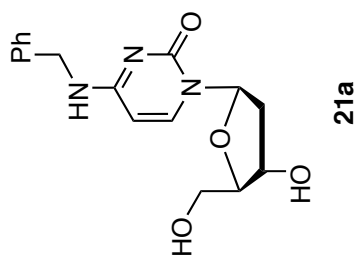

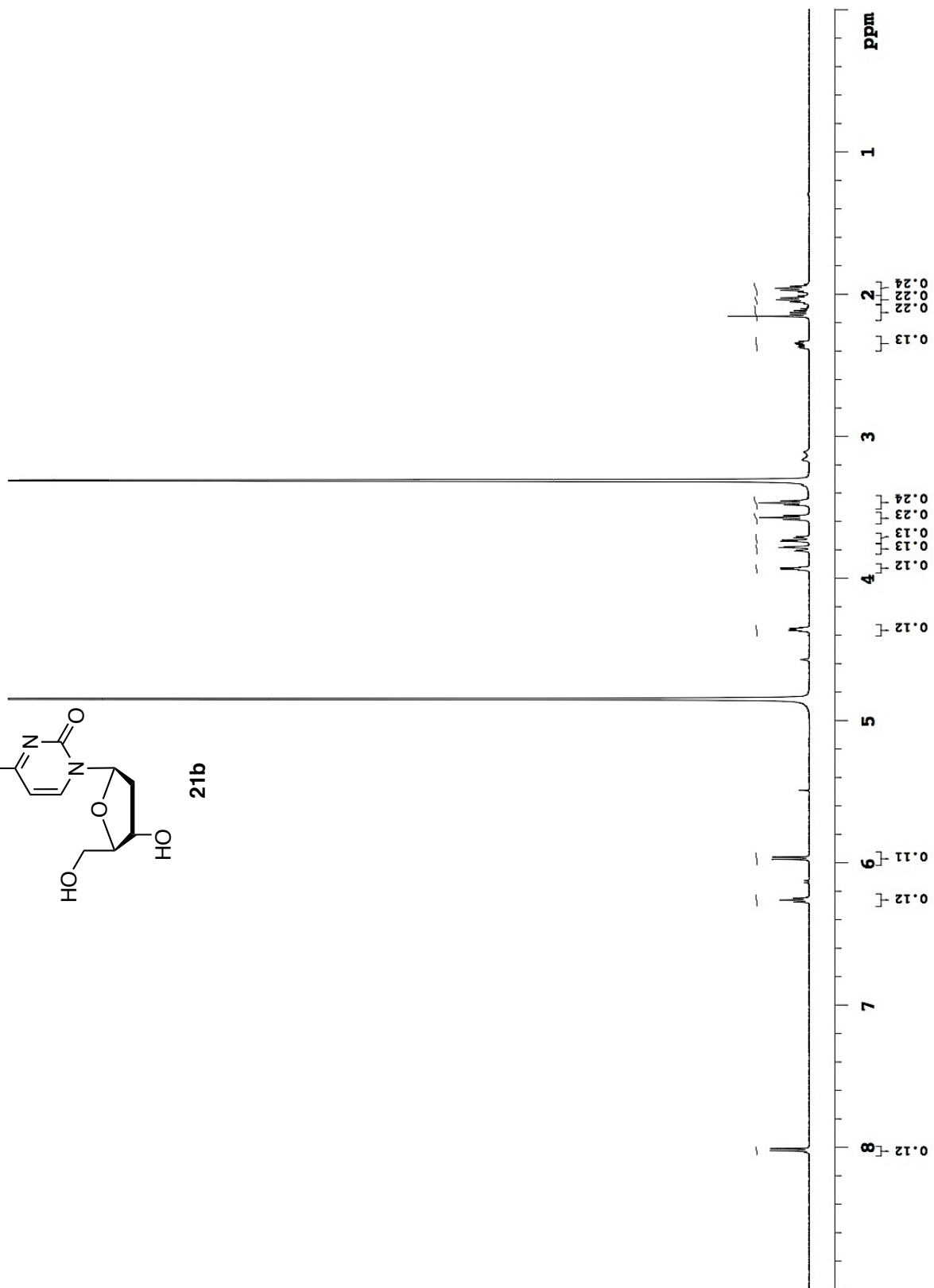
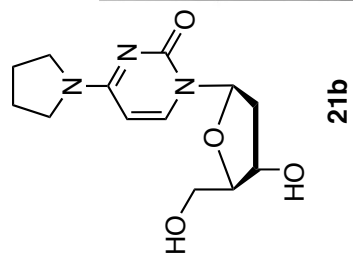

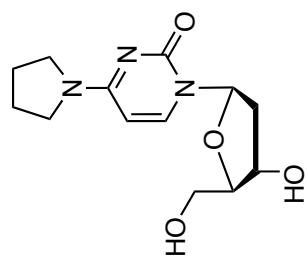

21b

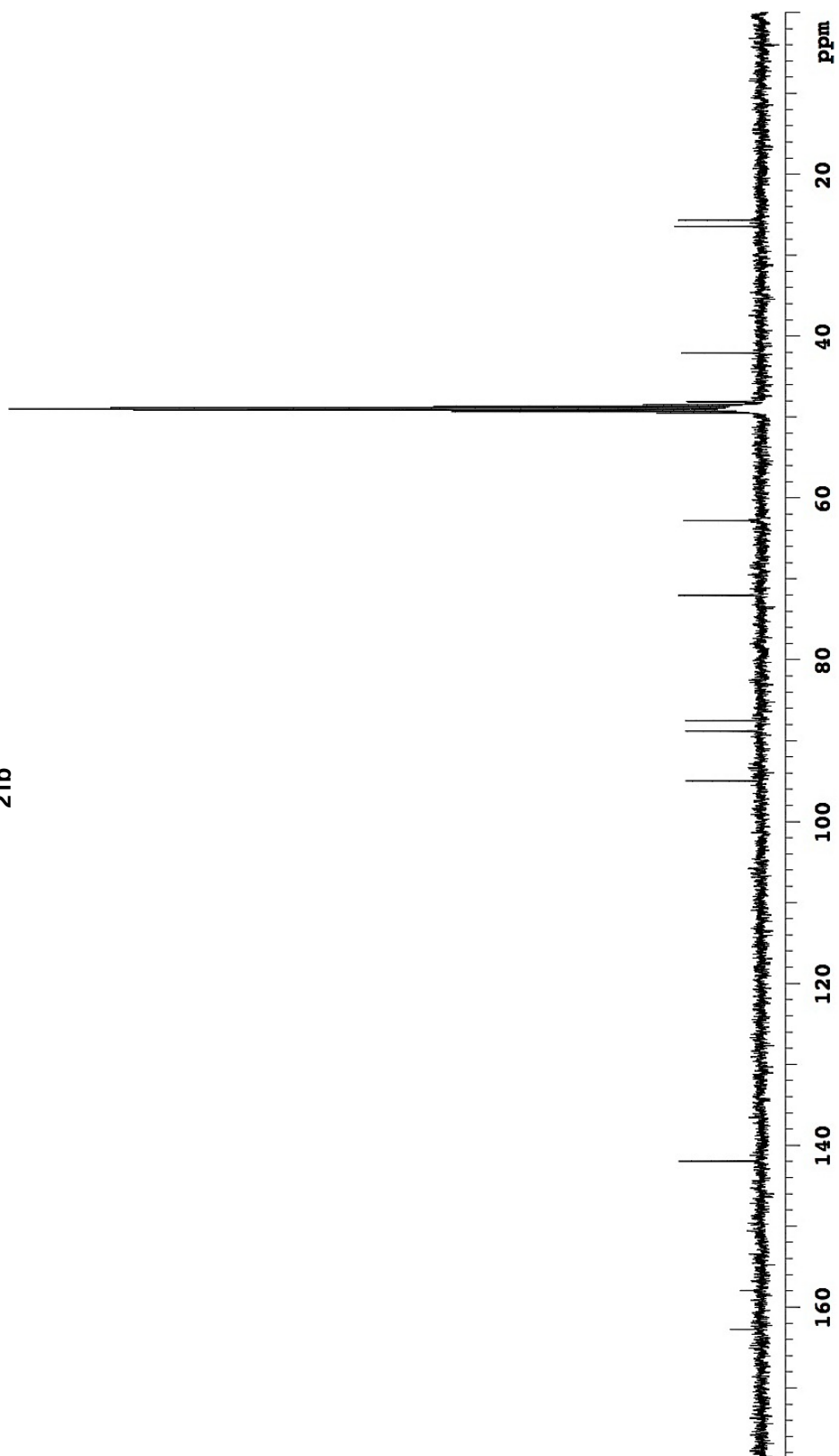

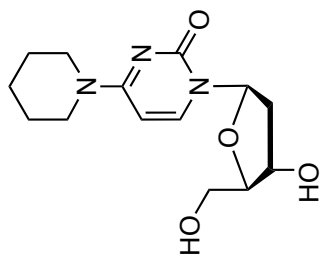

21c

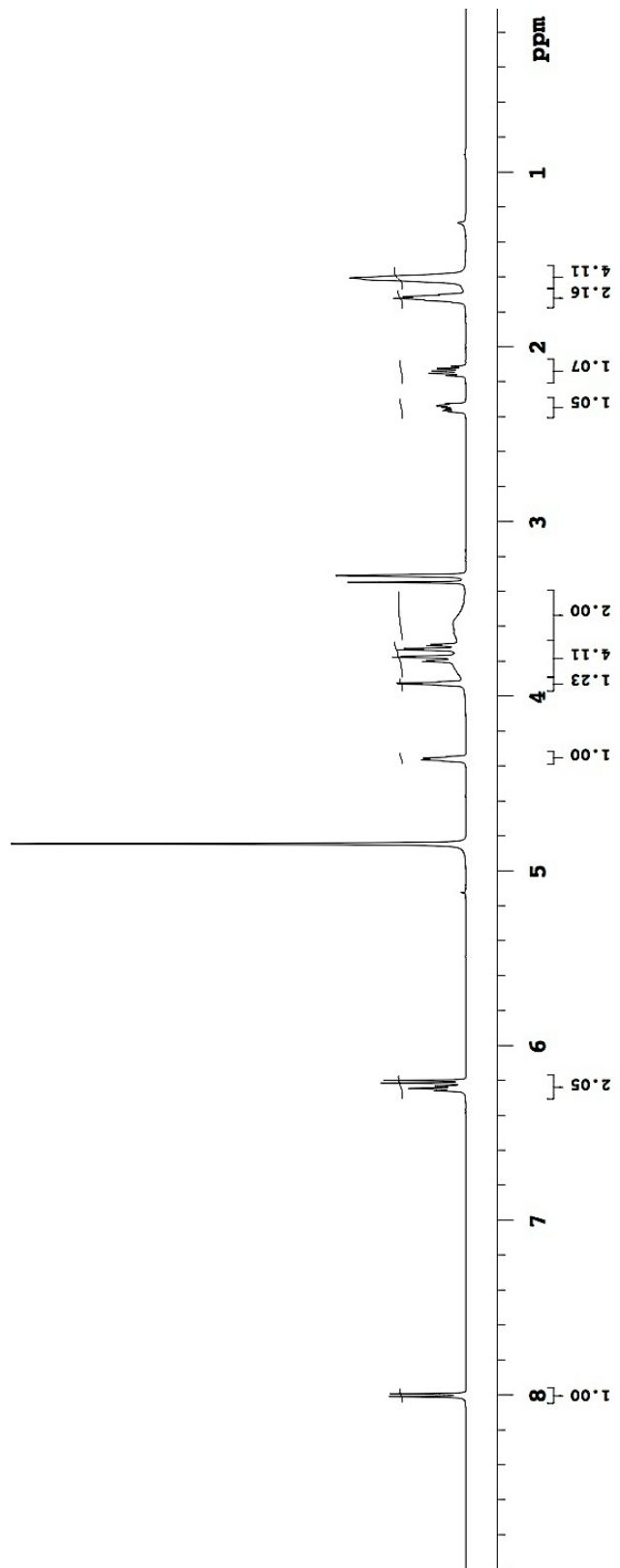

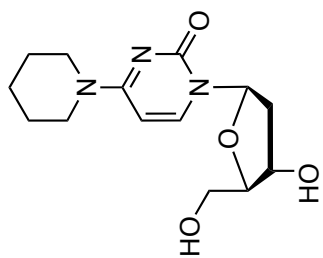

21c

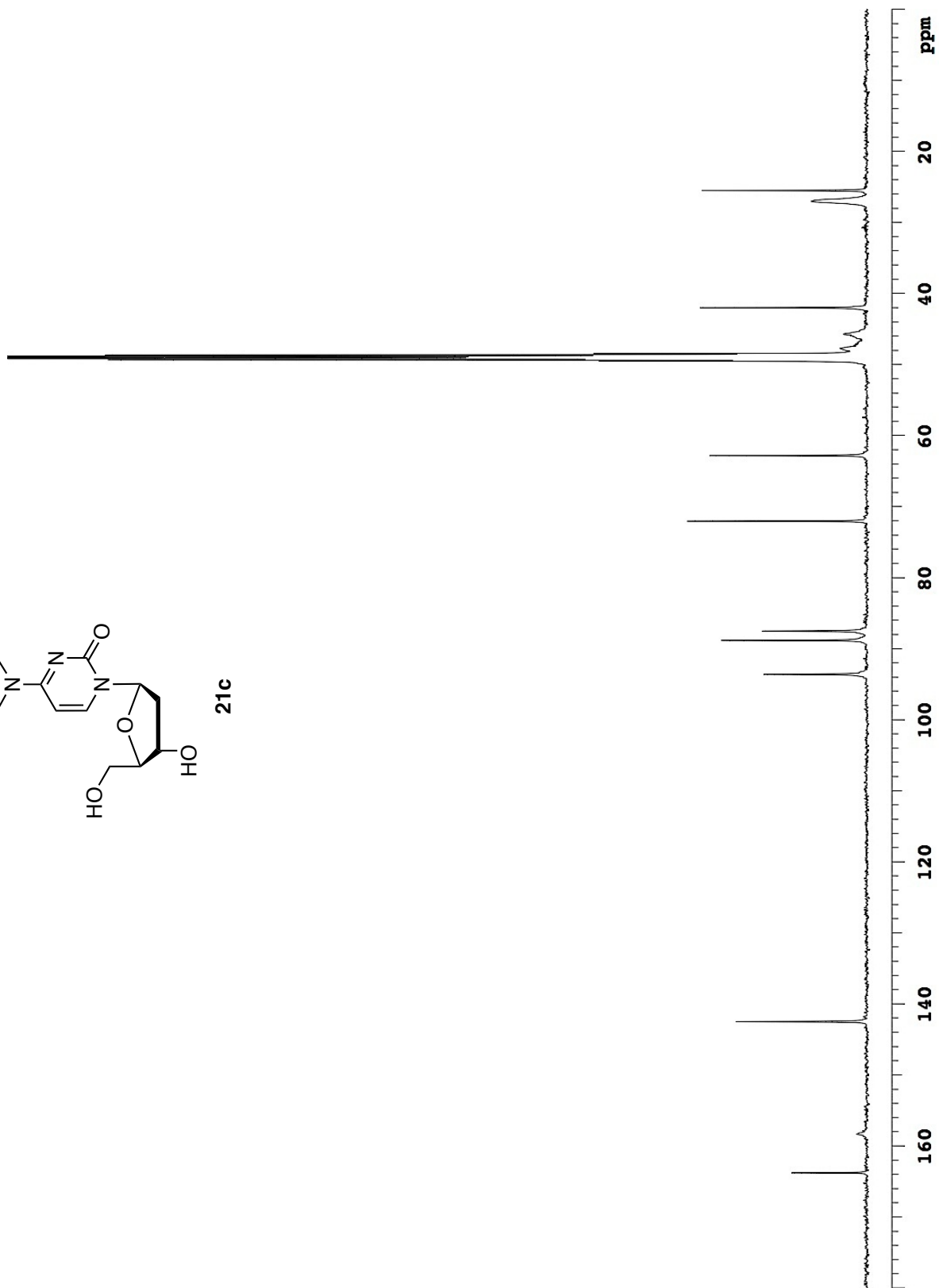

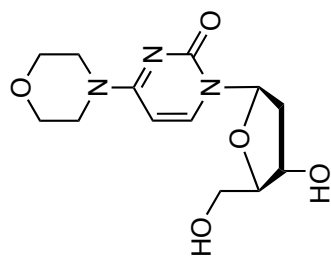

21d

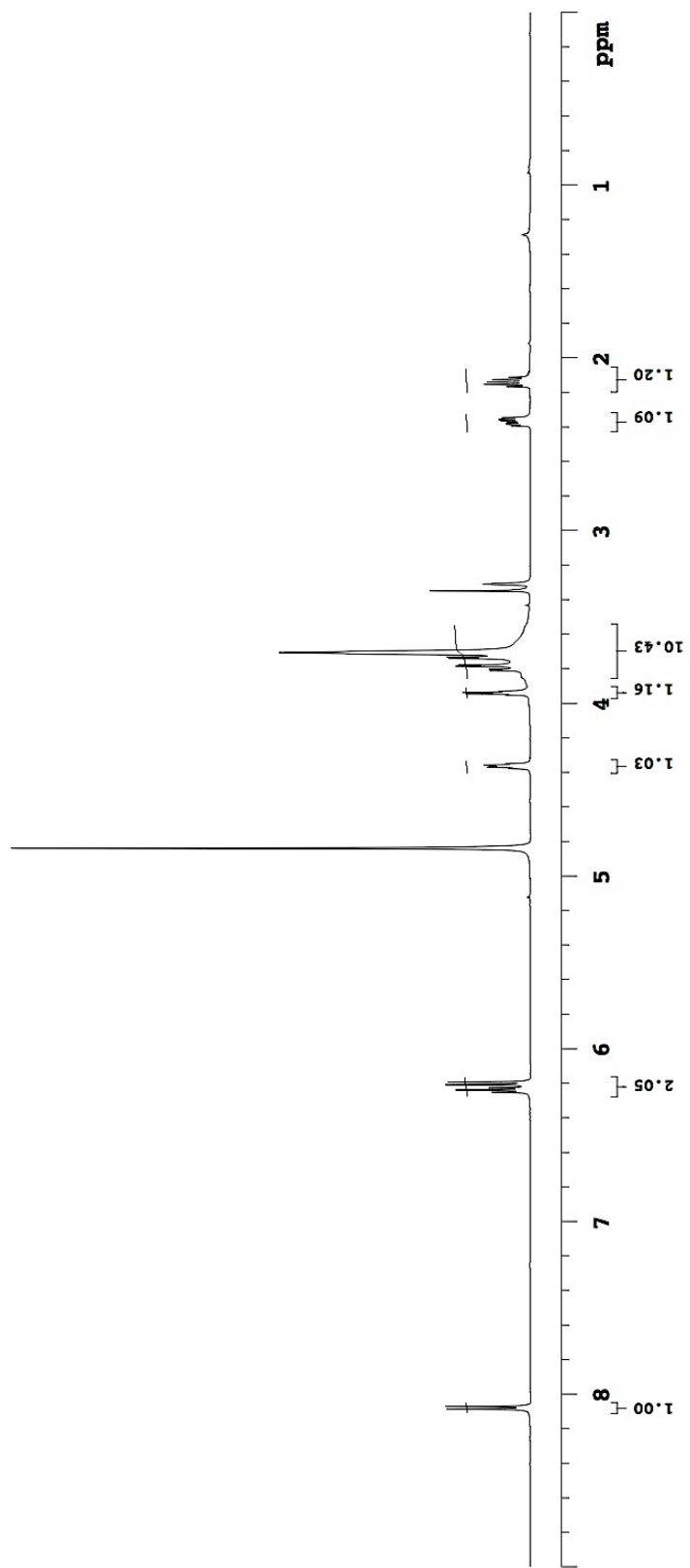

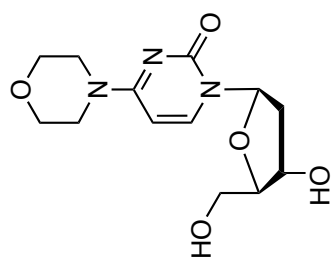

21d

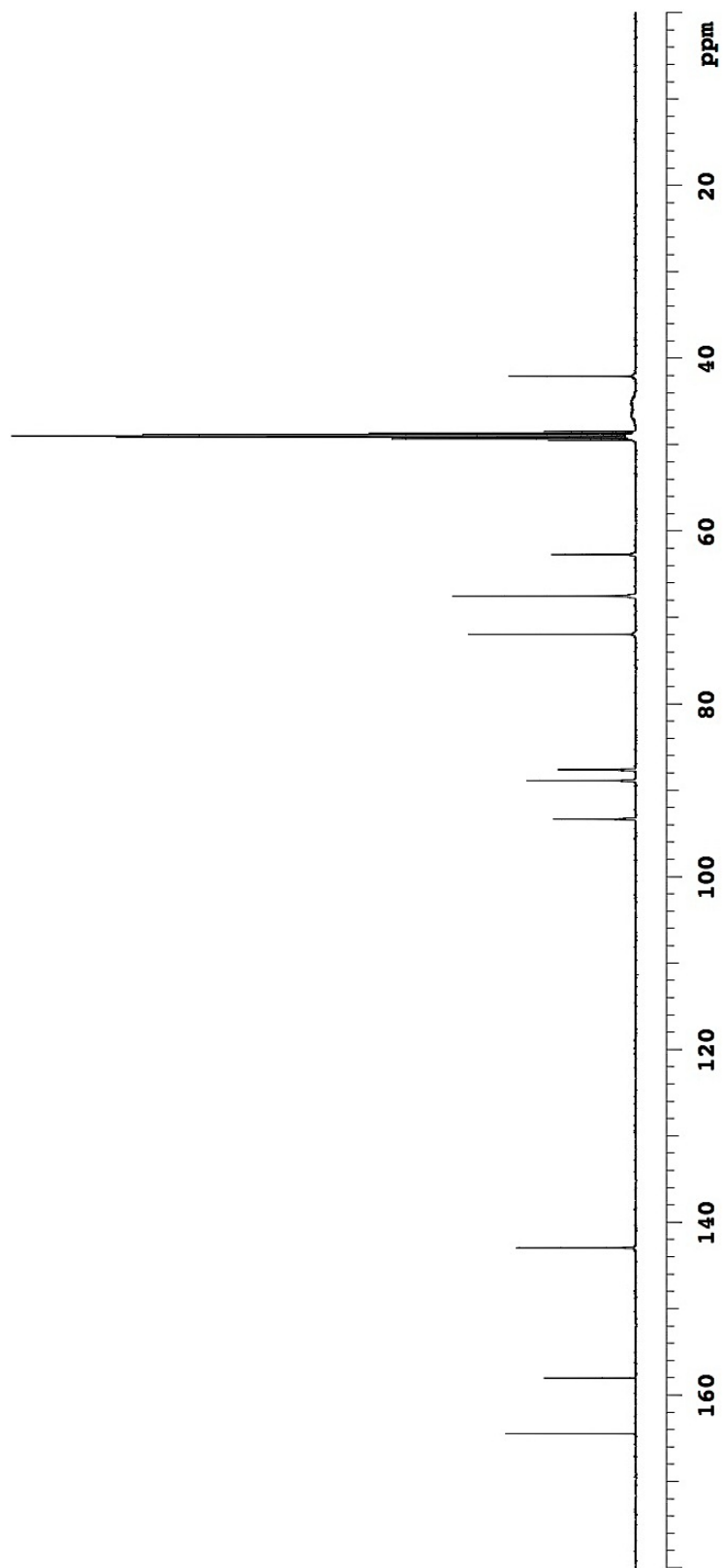

gCOSY spectrum of compound **21d** in CD₃OD

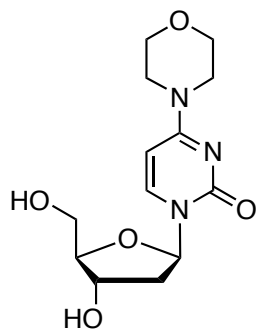

21d

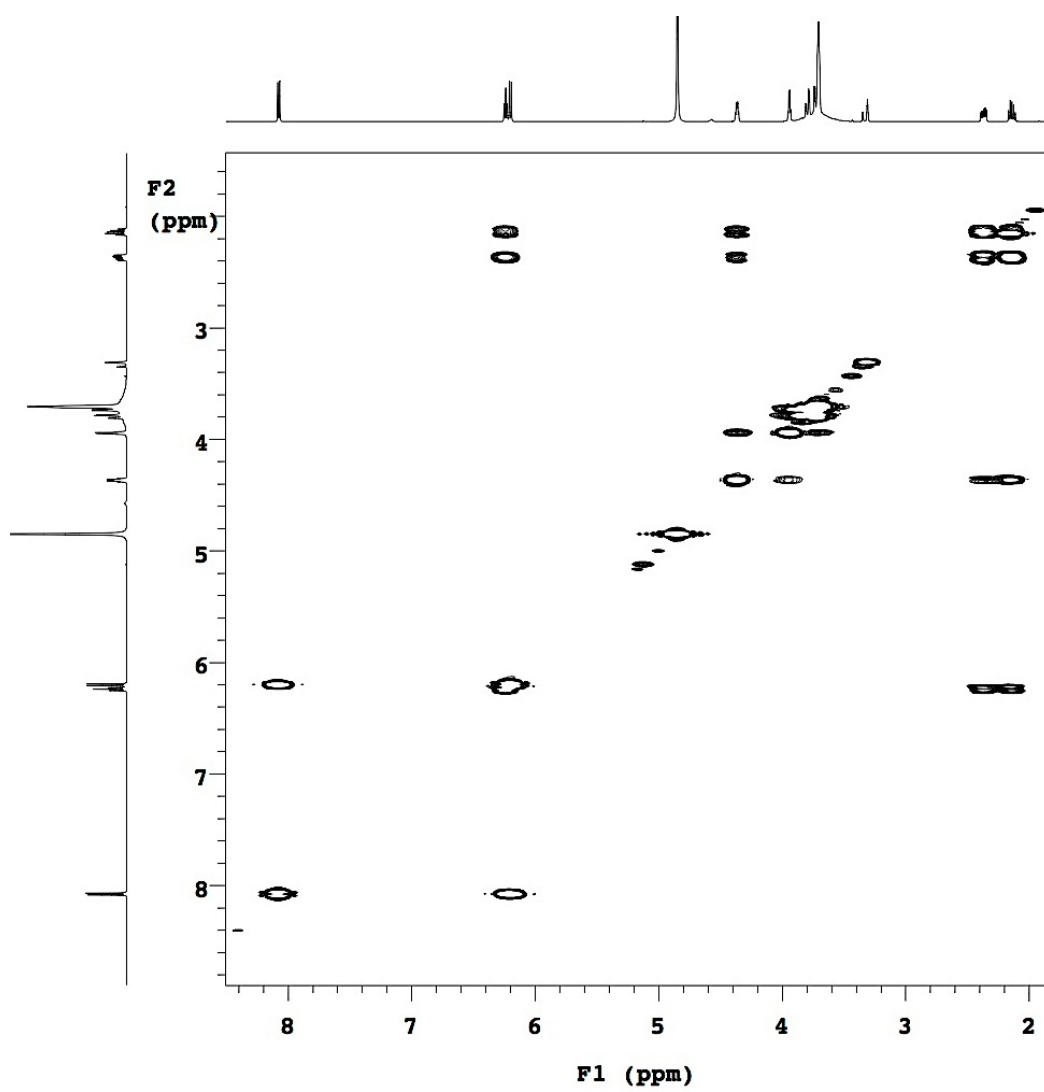

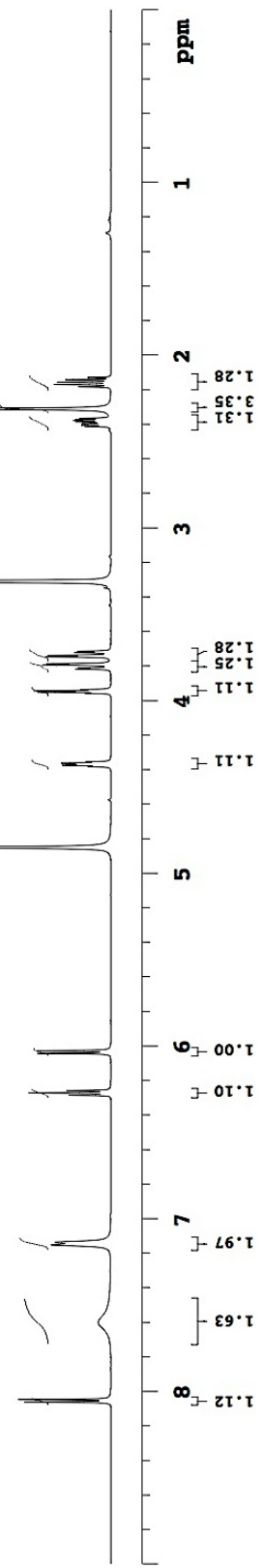
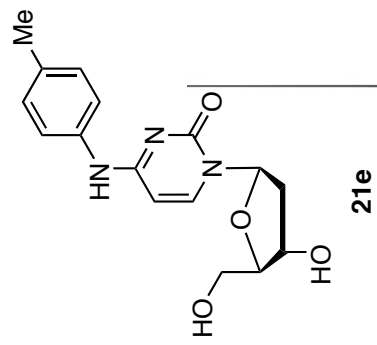

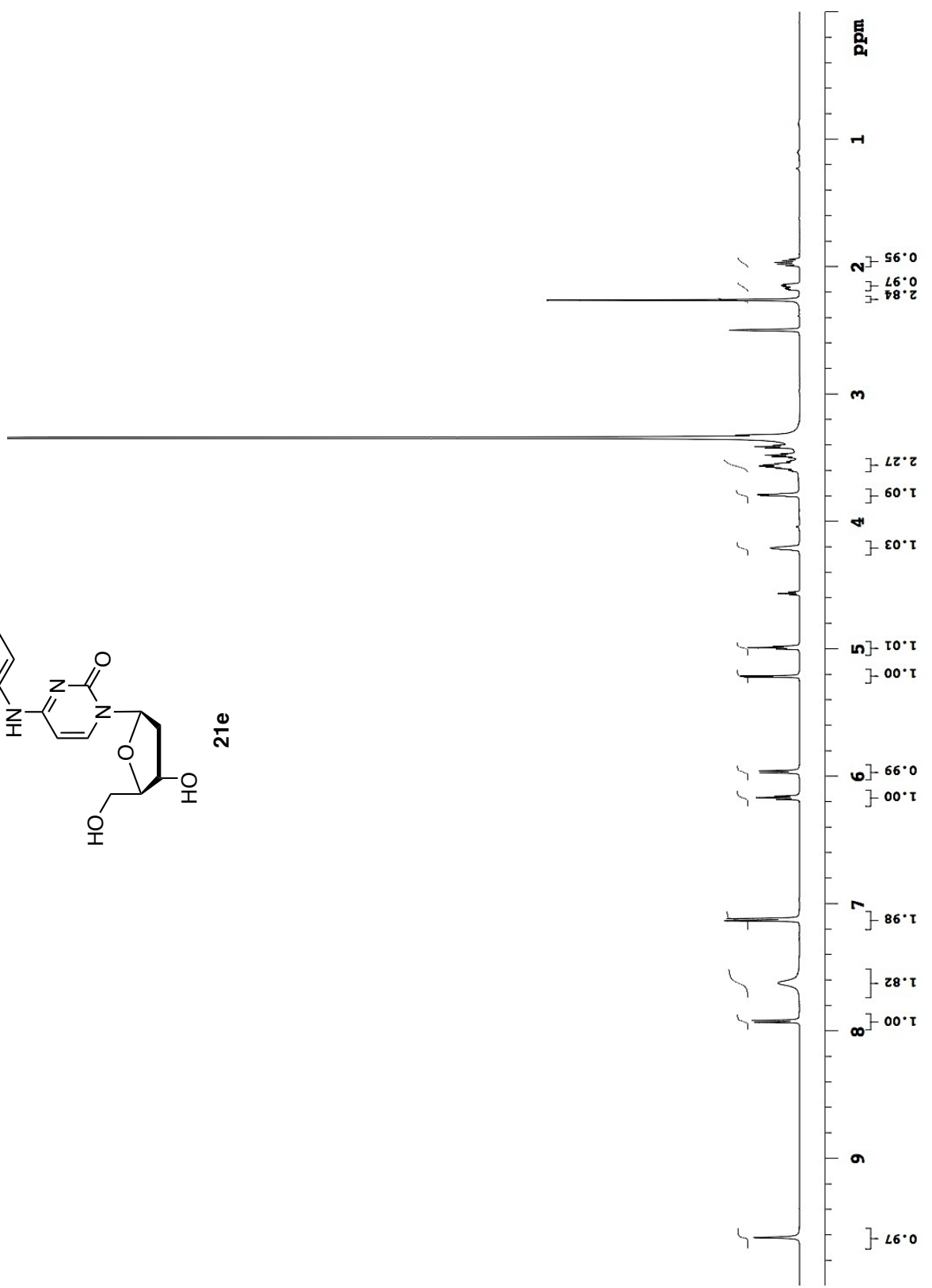
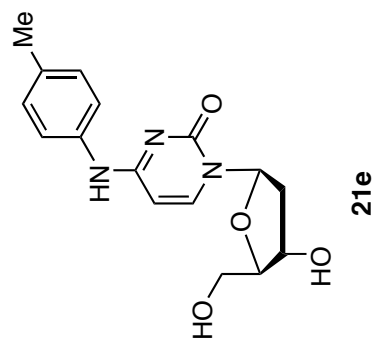

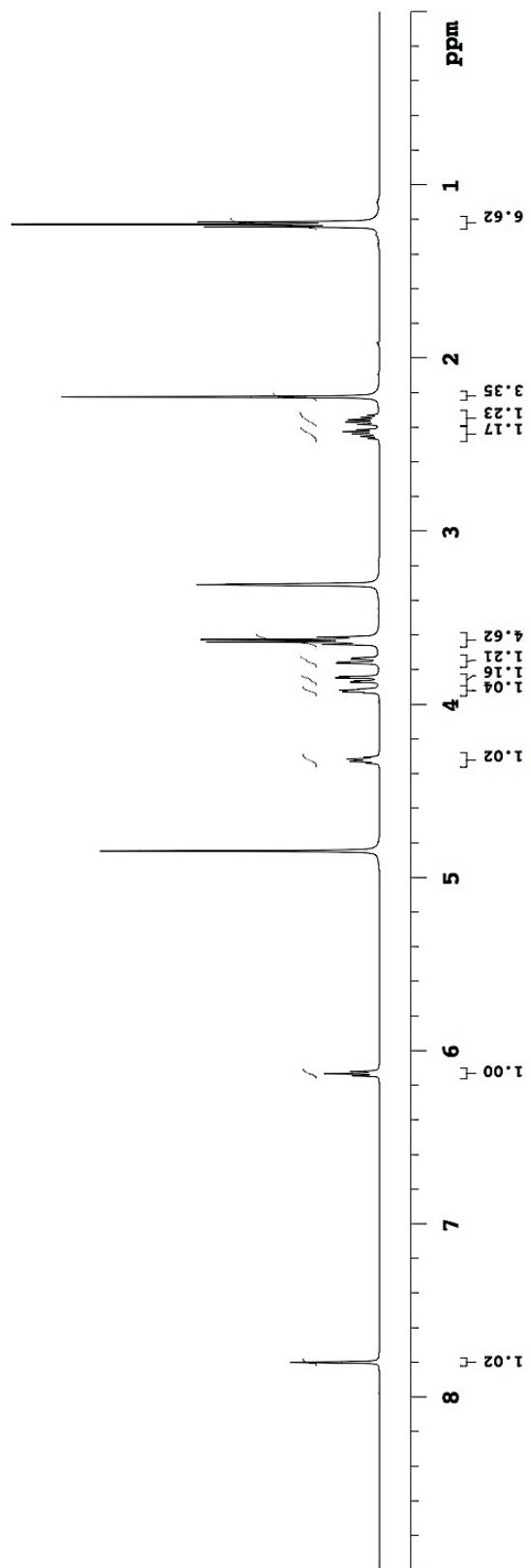
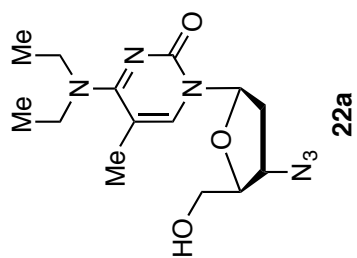

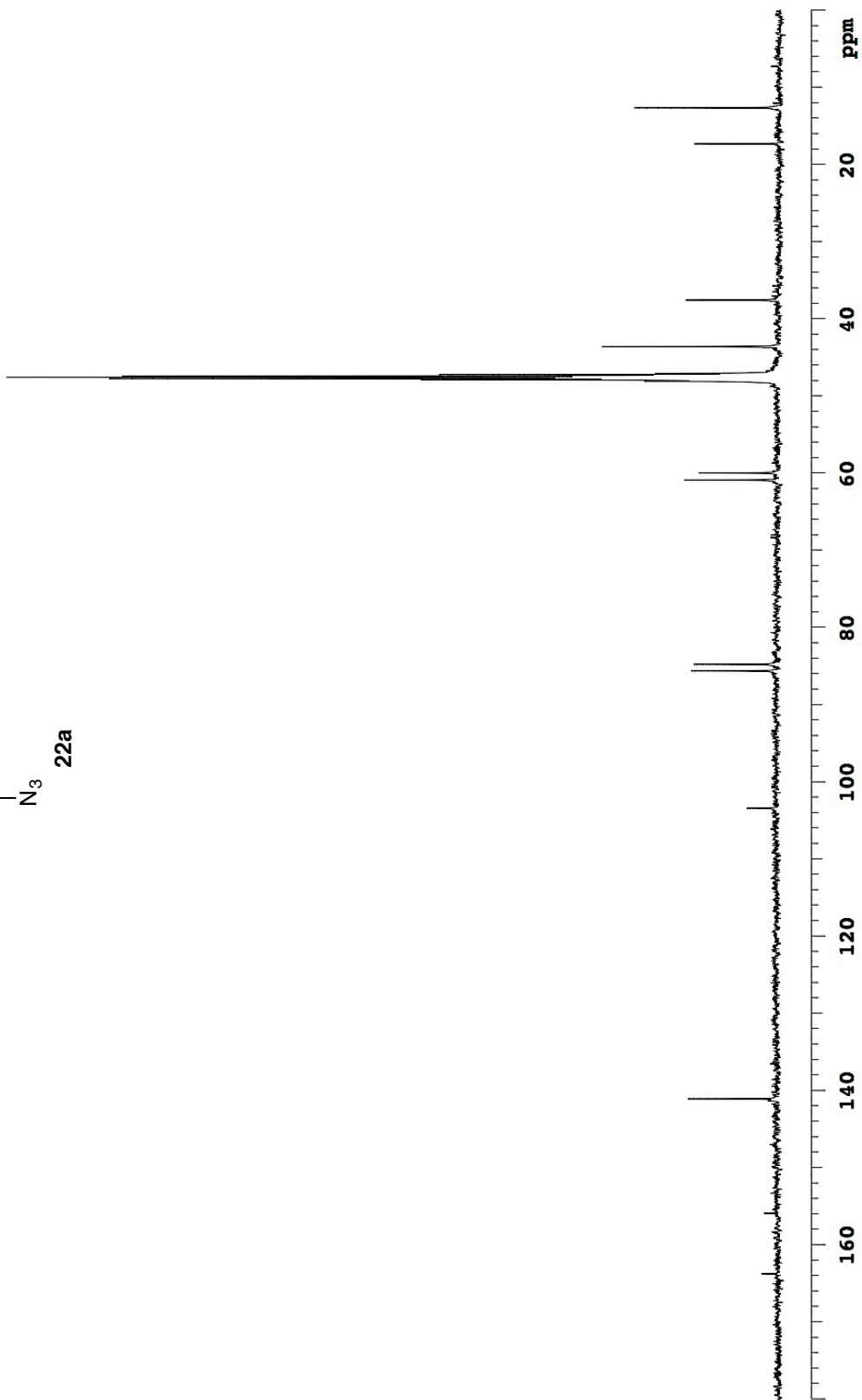
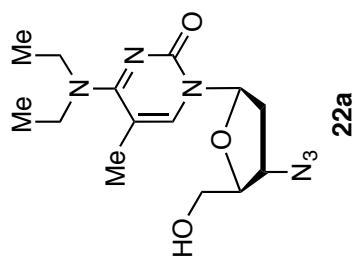

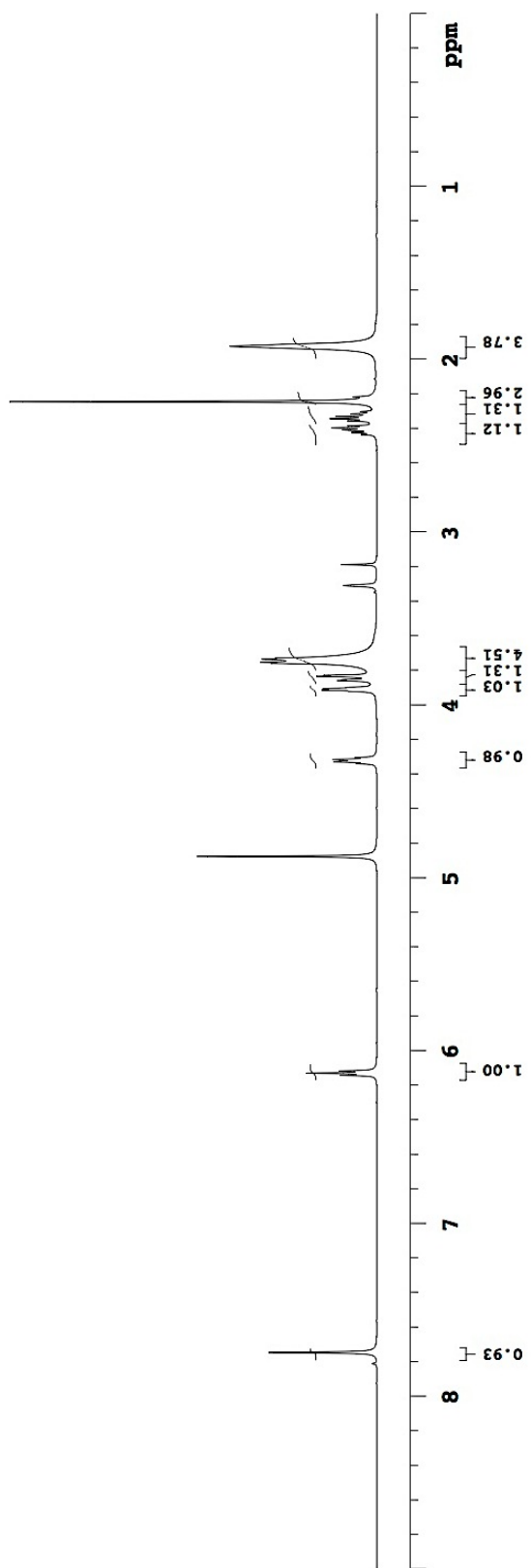
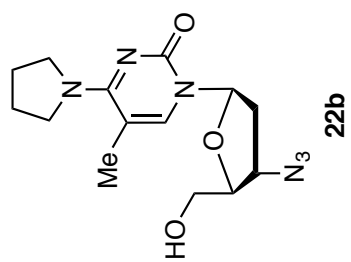

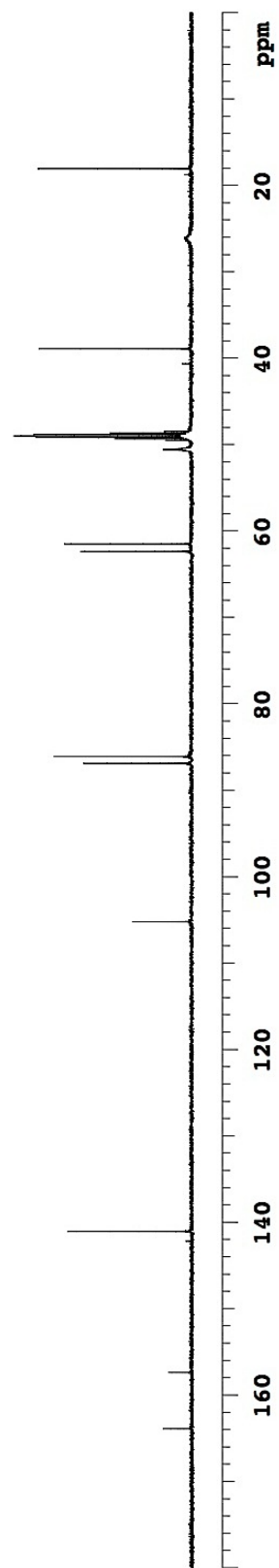
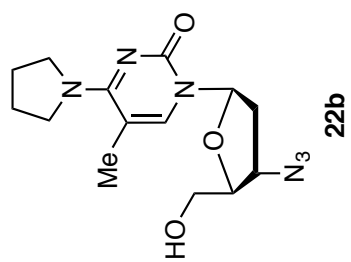

gCOSY spectrum of compound **22b** in CD₃OD

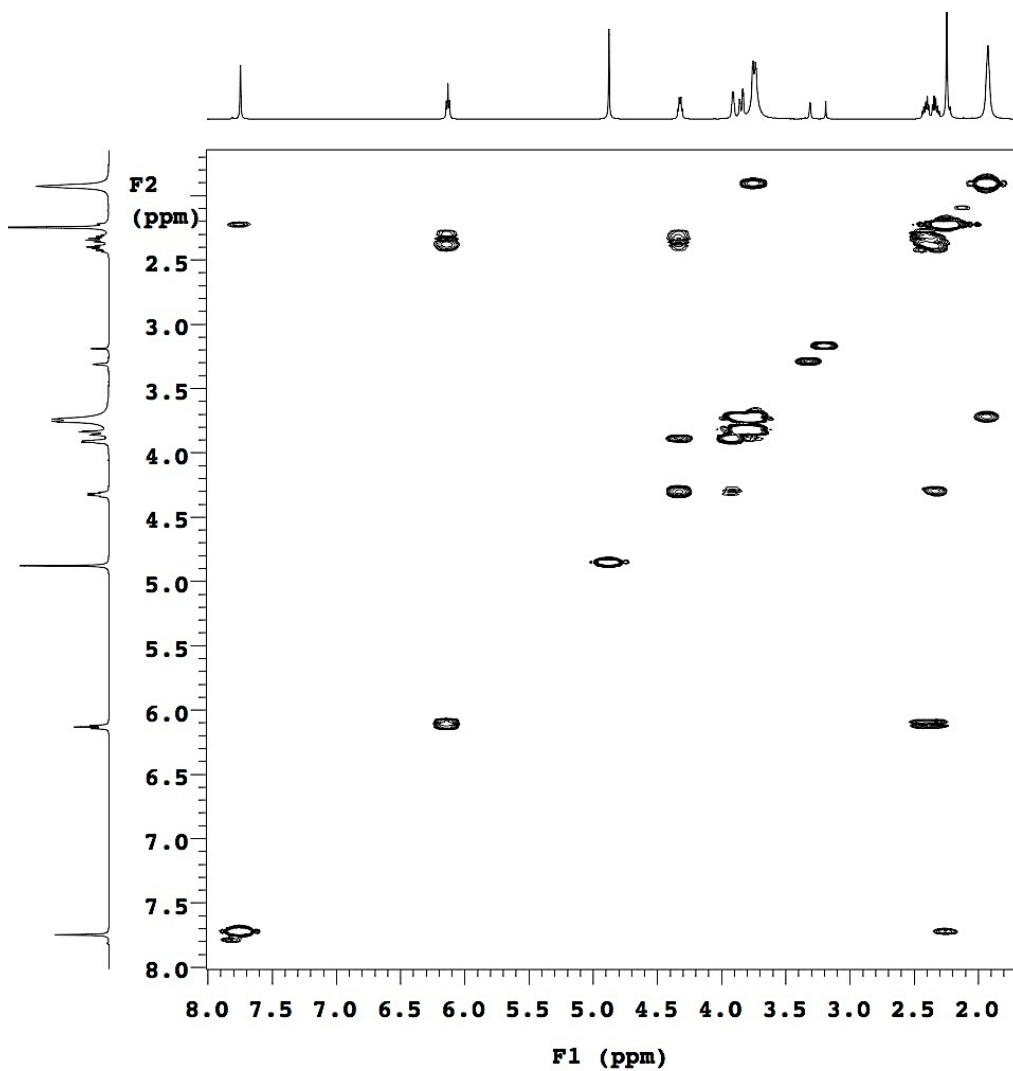
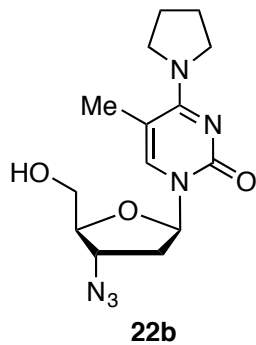

gHMQC spectrum of compound **22b** in CD₃OD

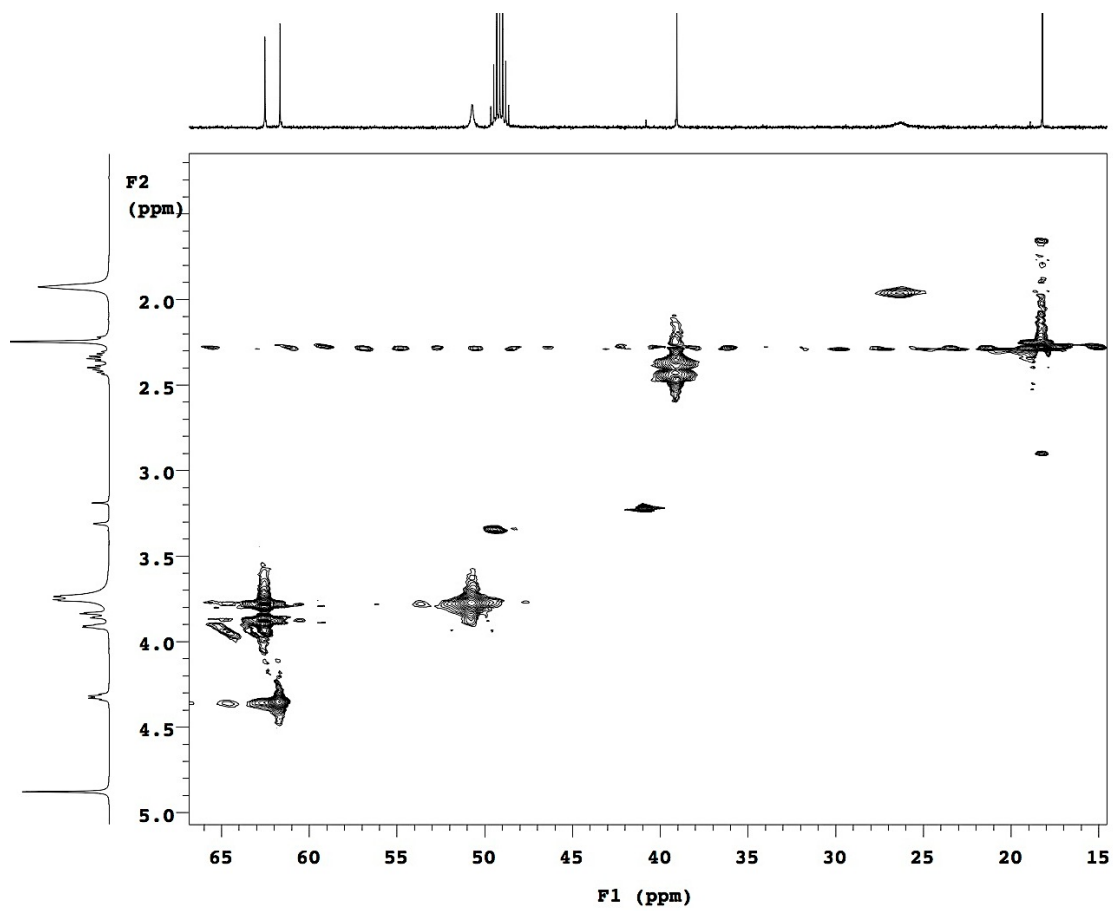
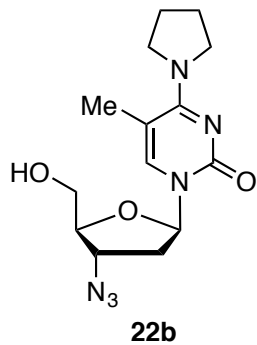

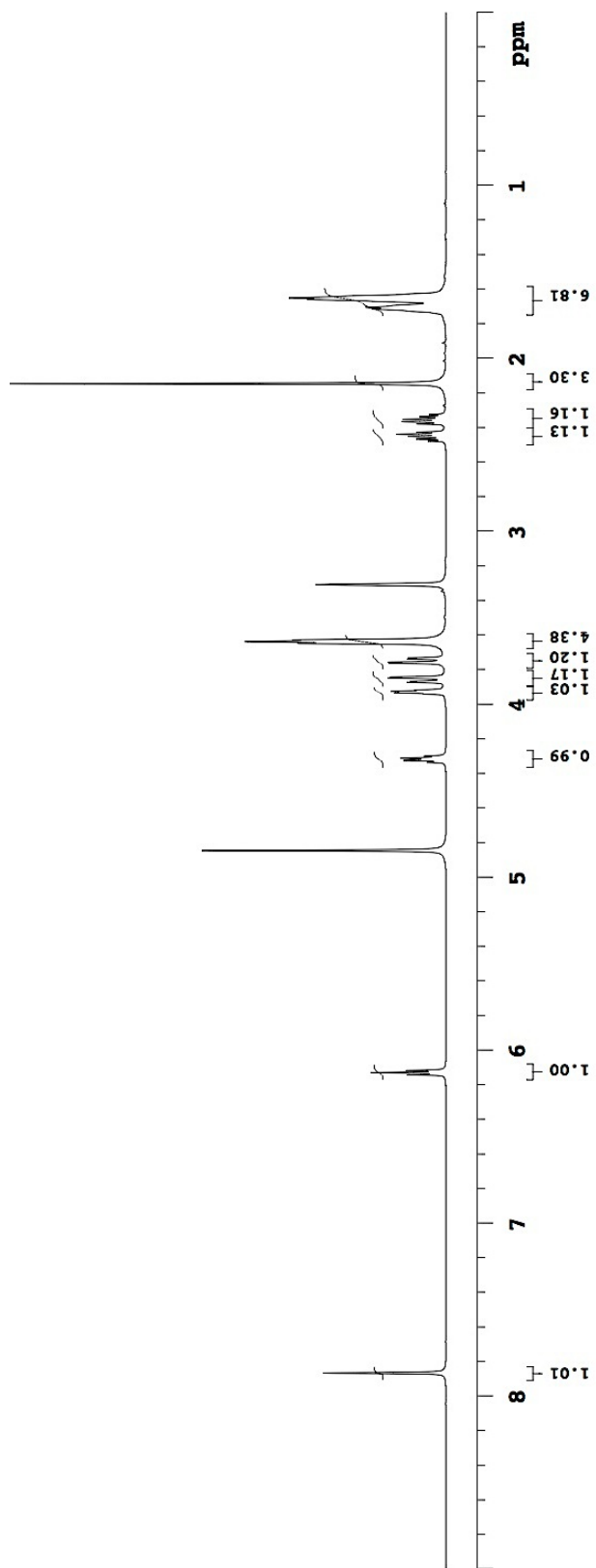
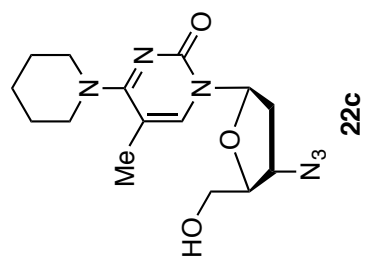

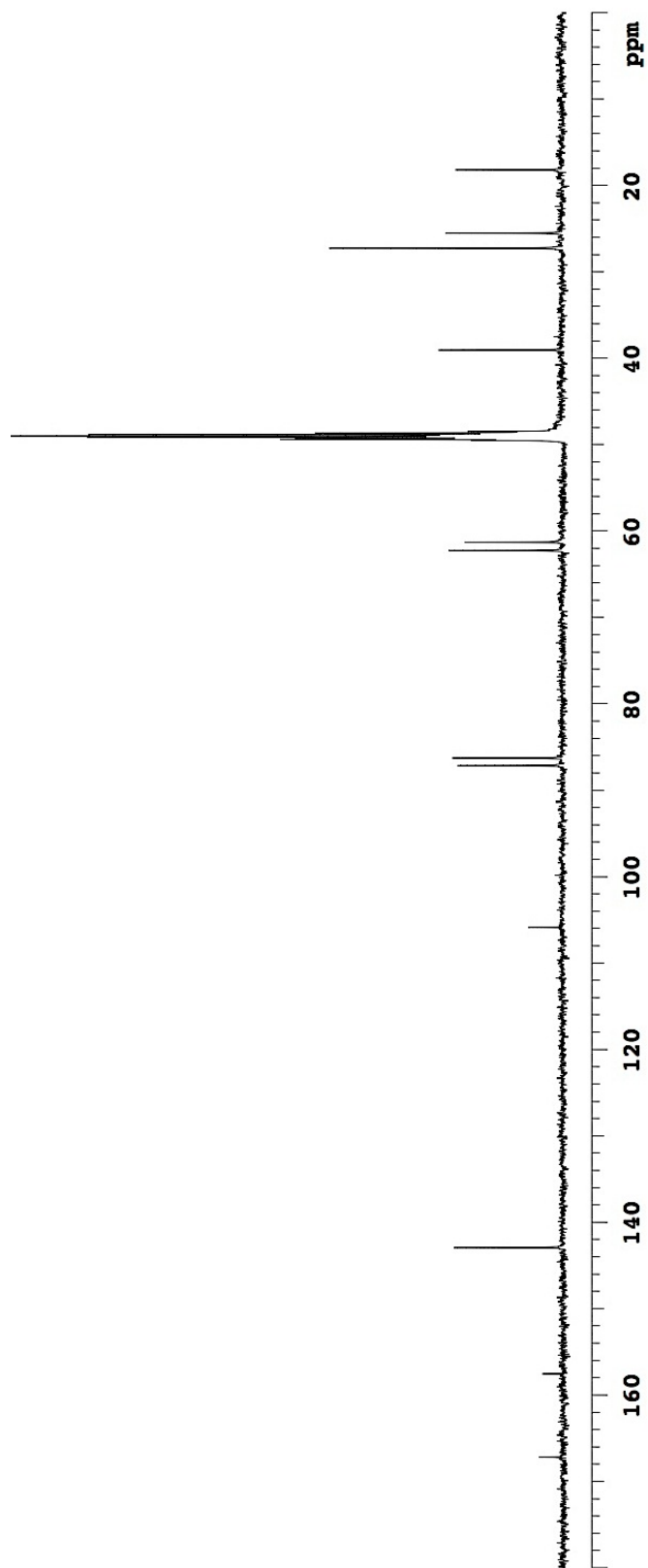
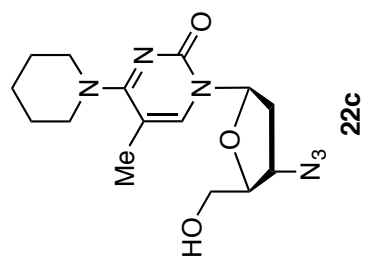

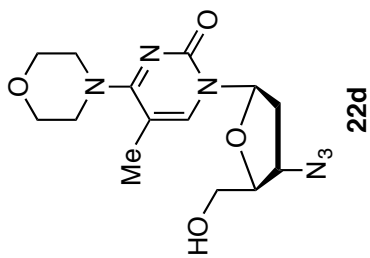

22d

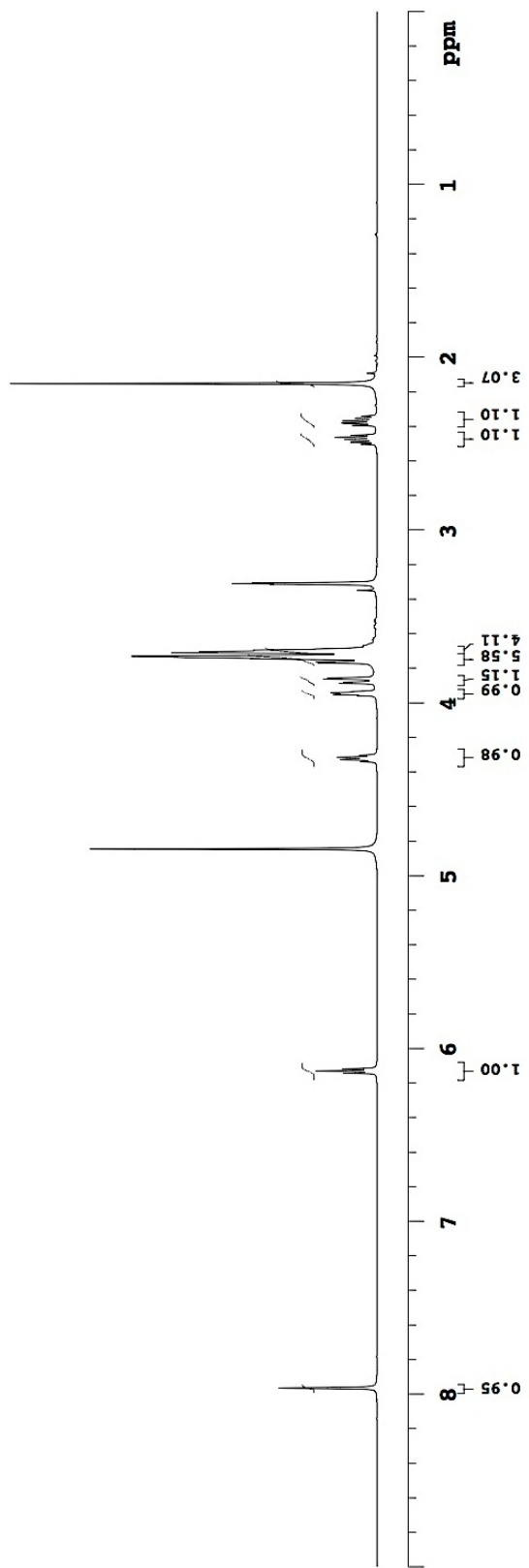

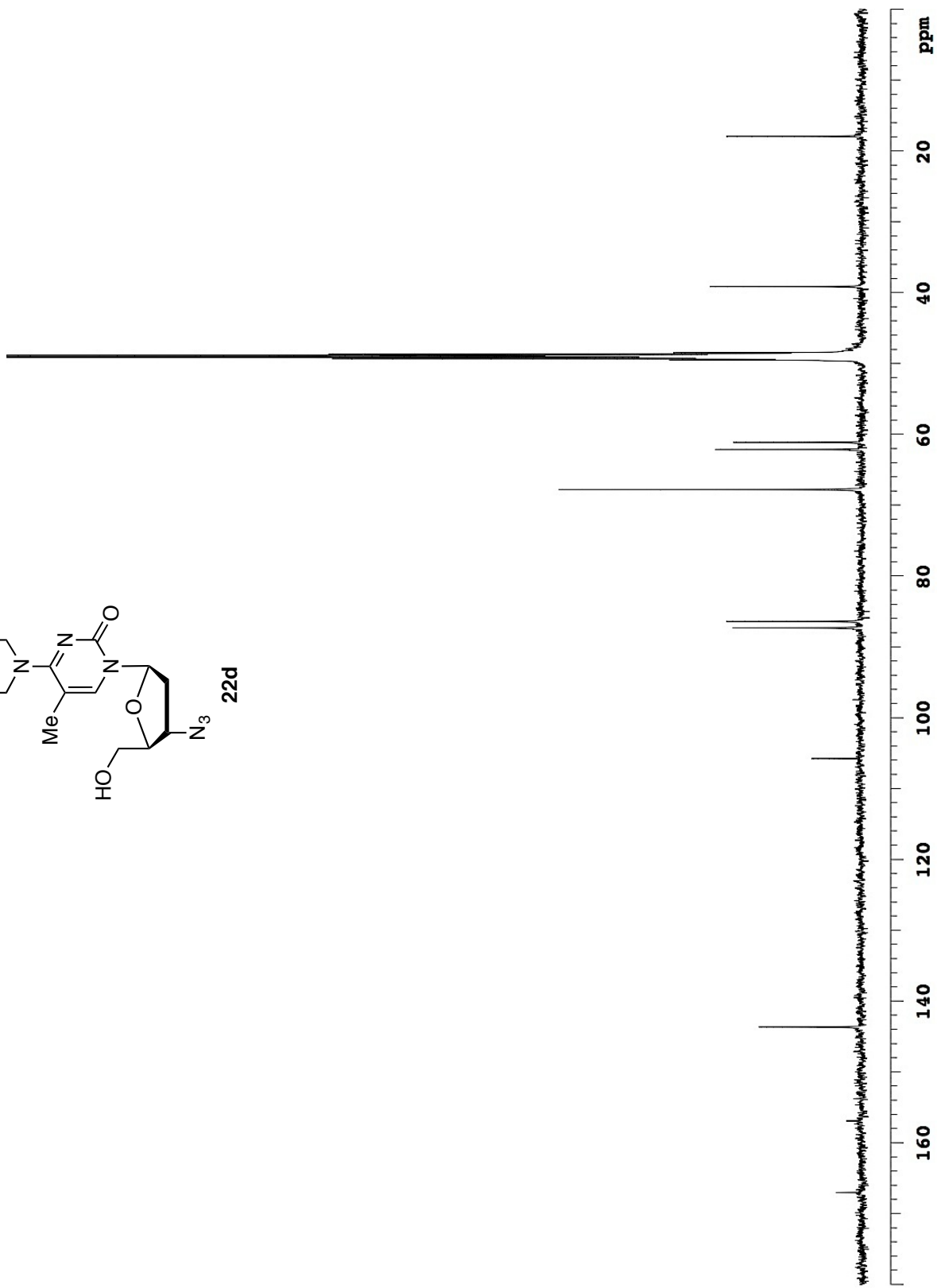
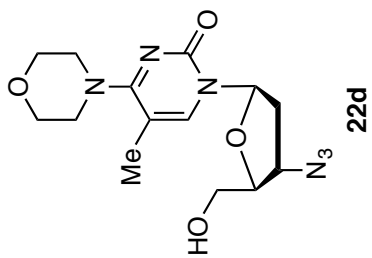

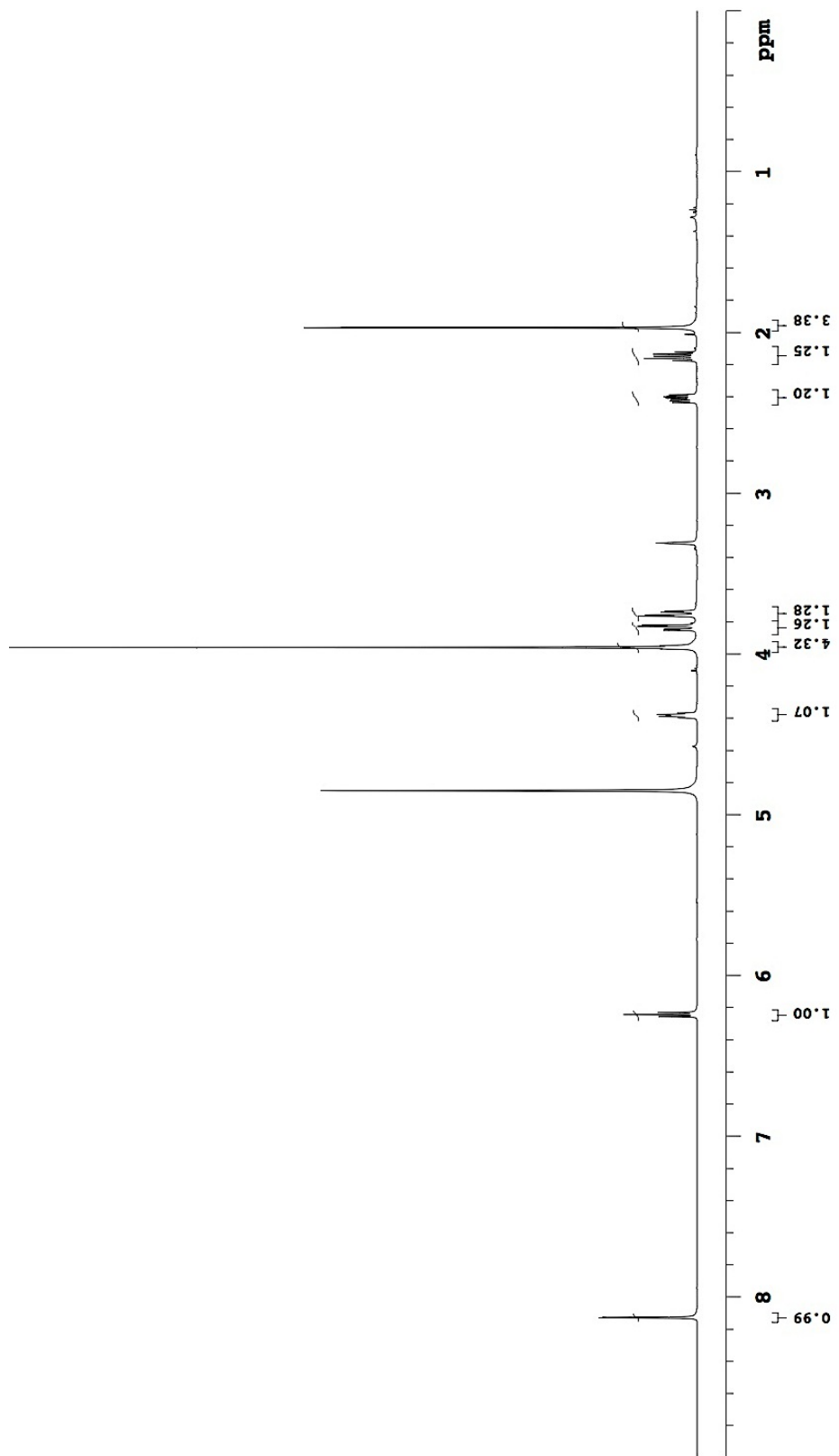
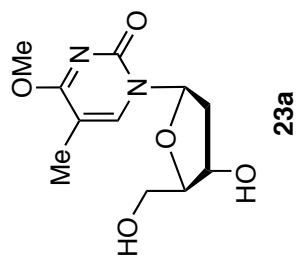

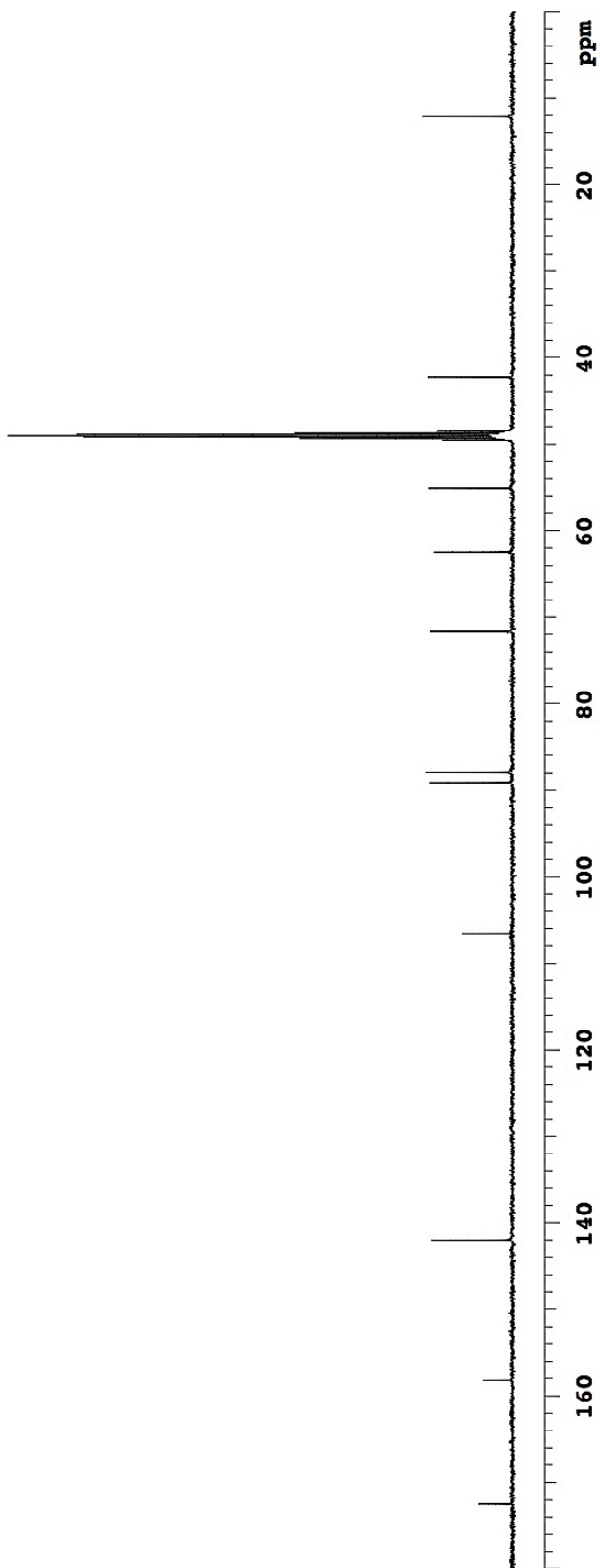
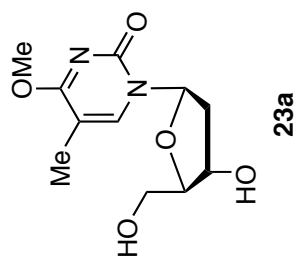

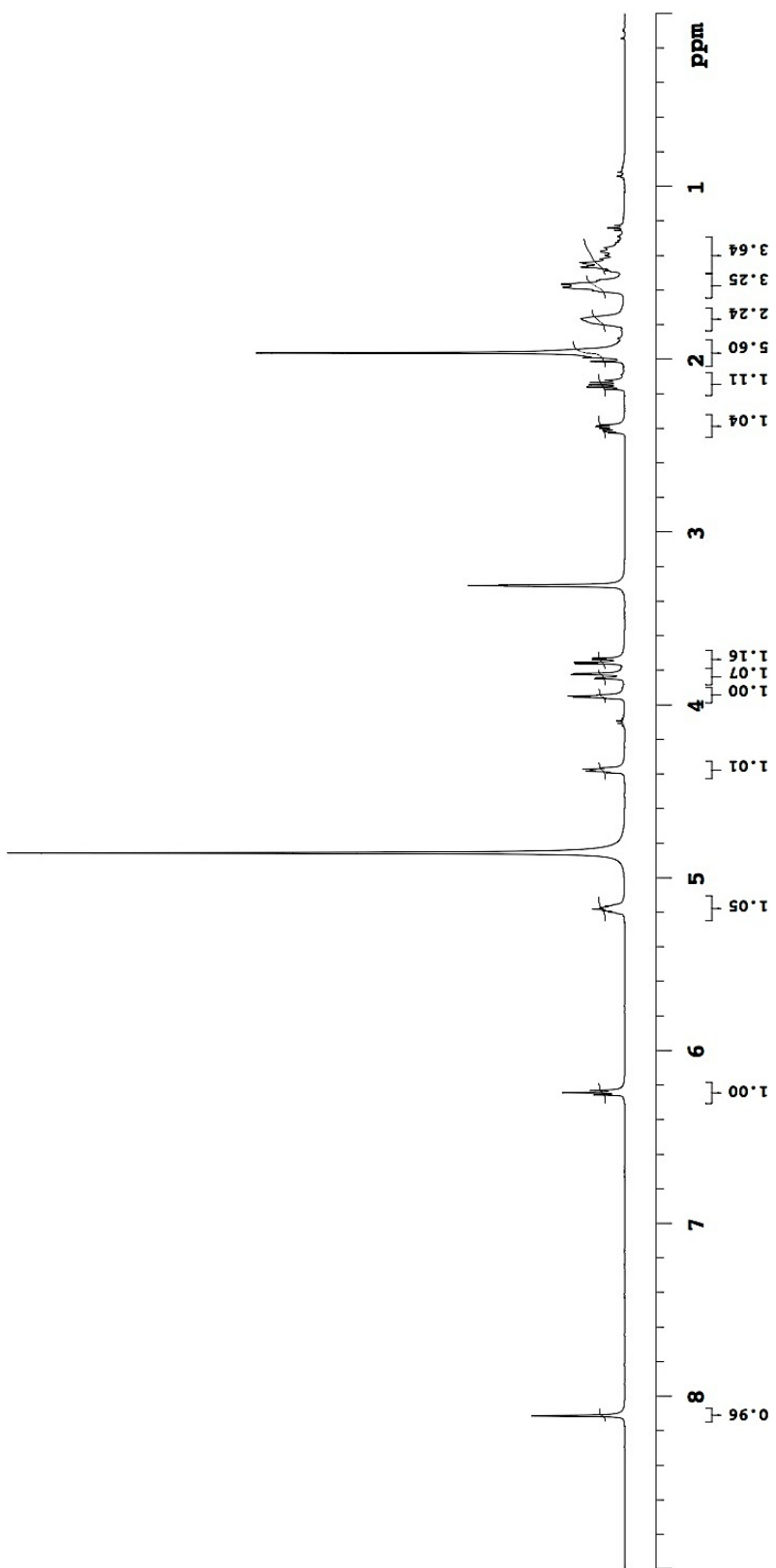
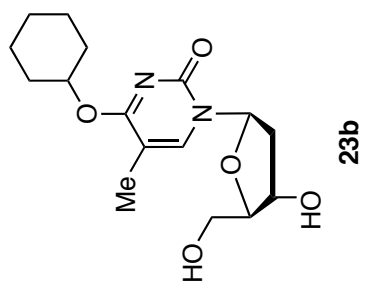

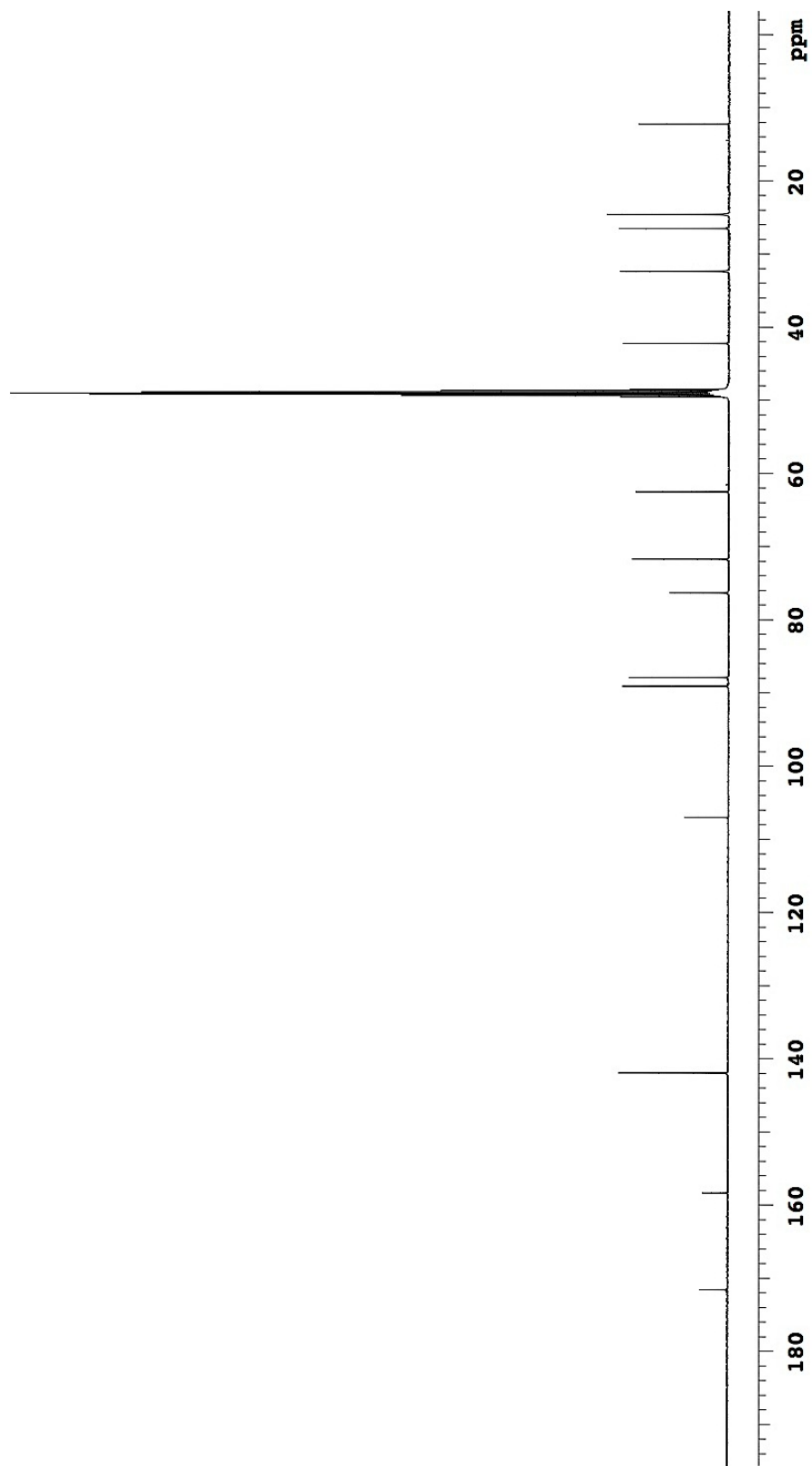
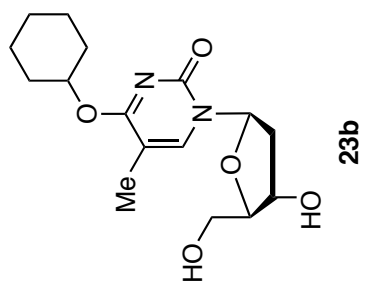

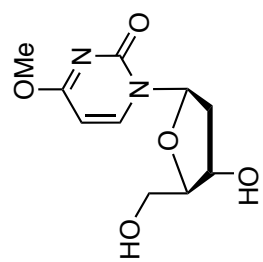

24

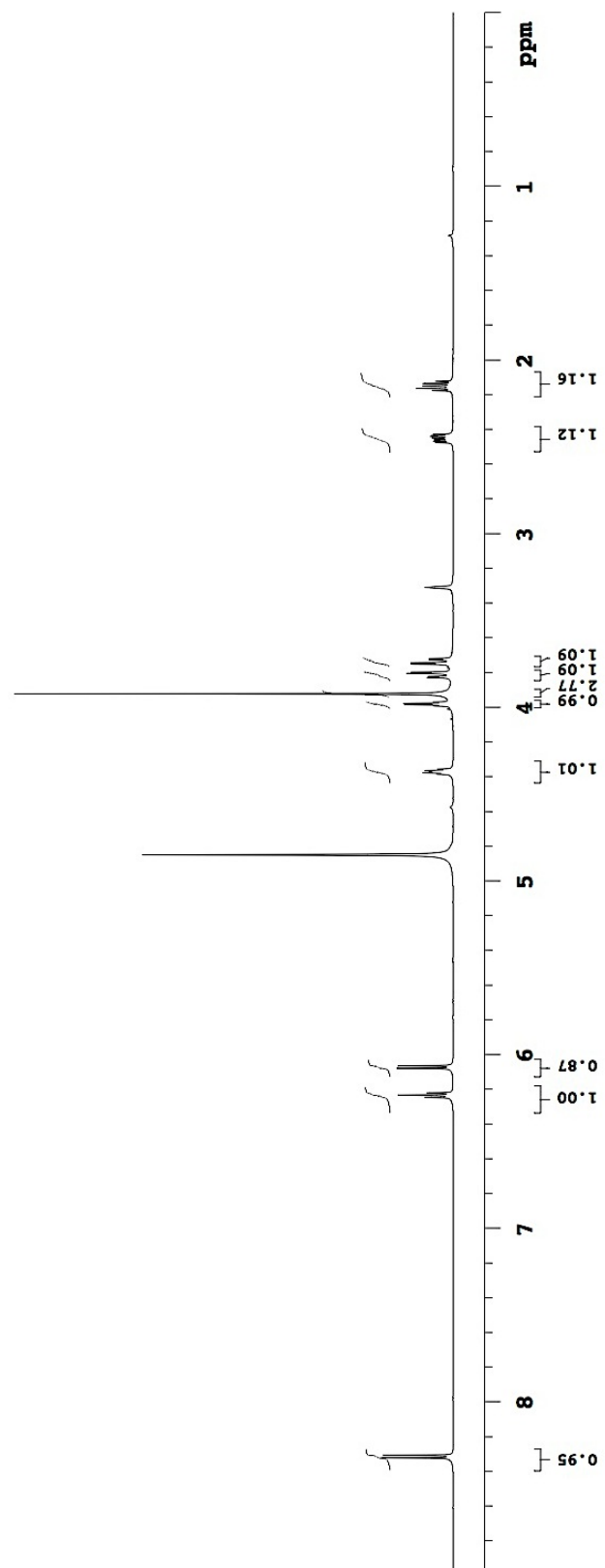

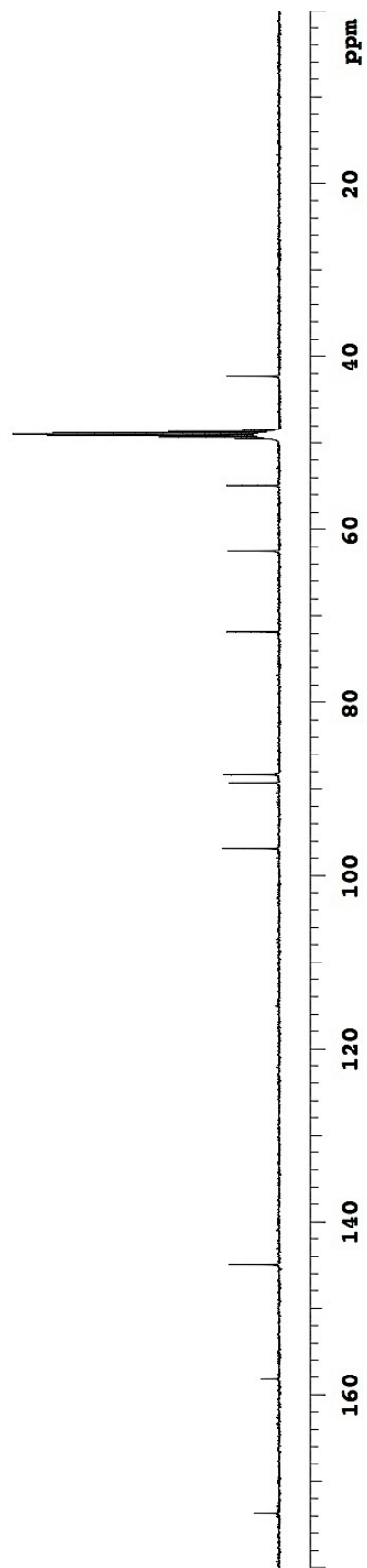
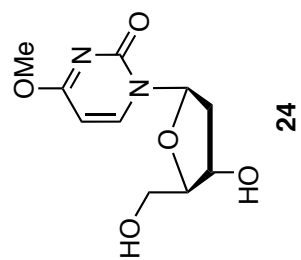

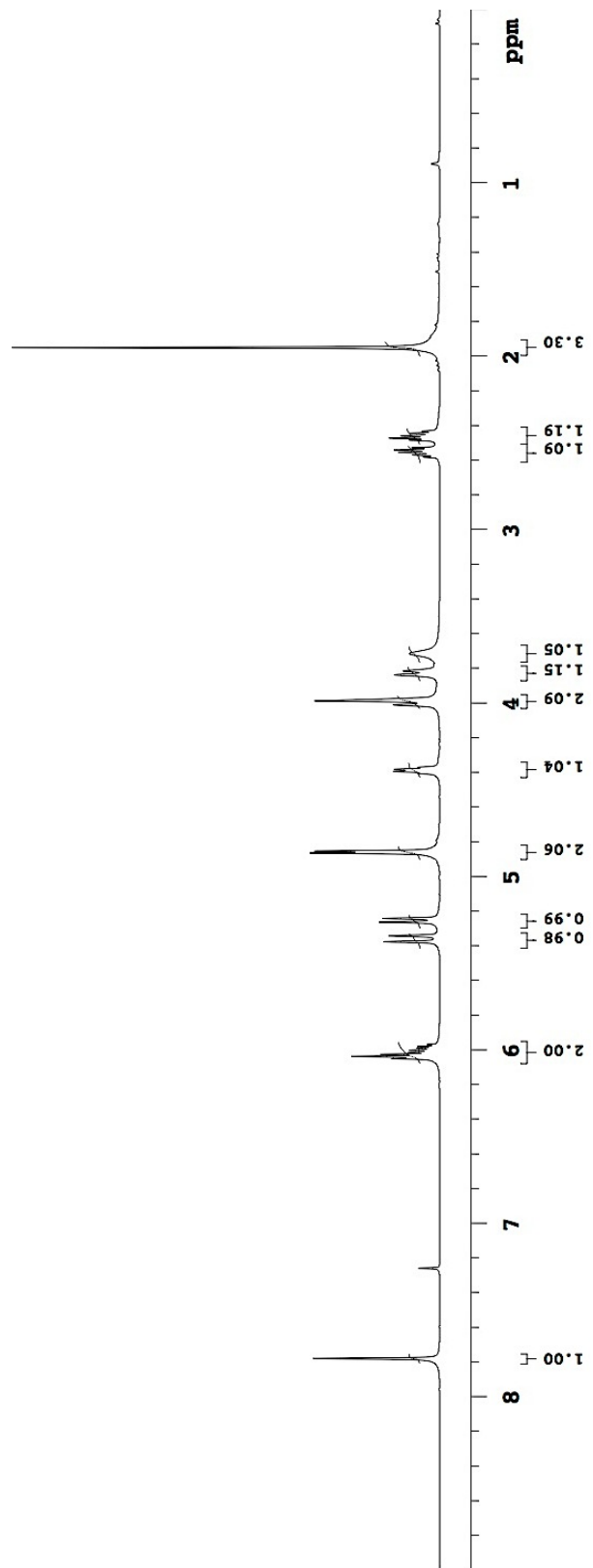
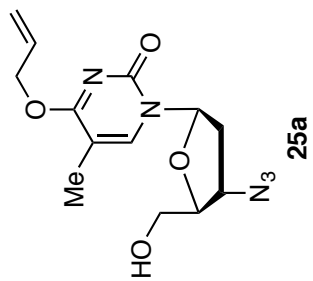

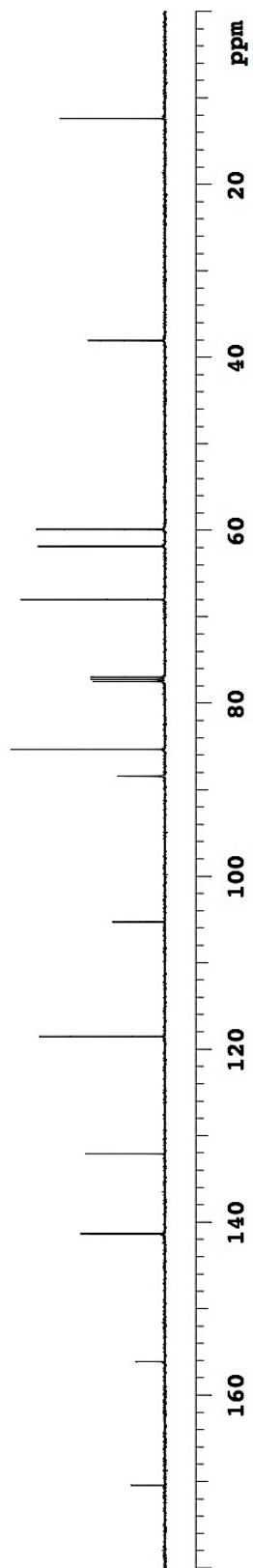
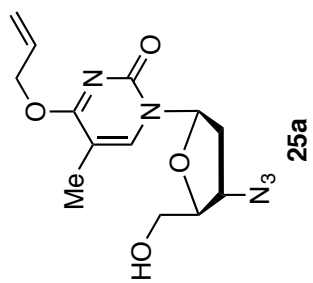

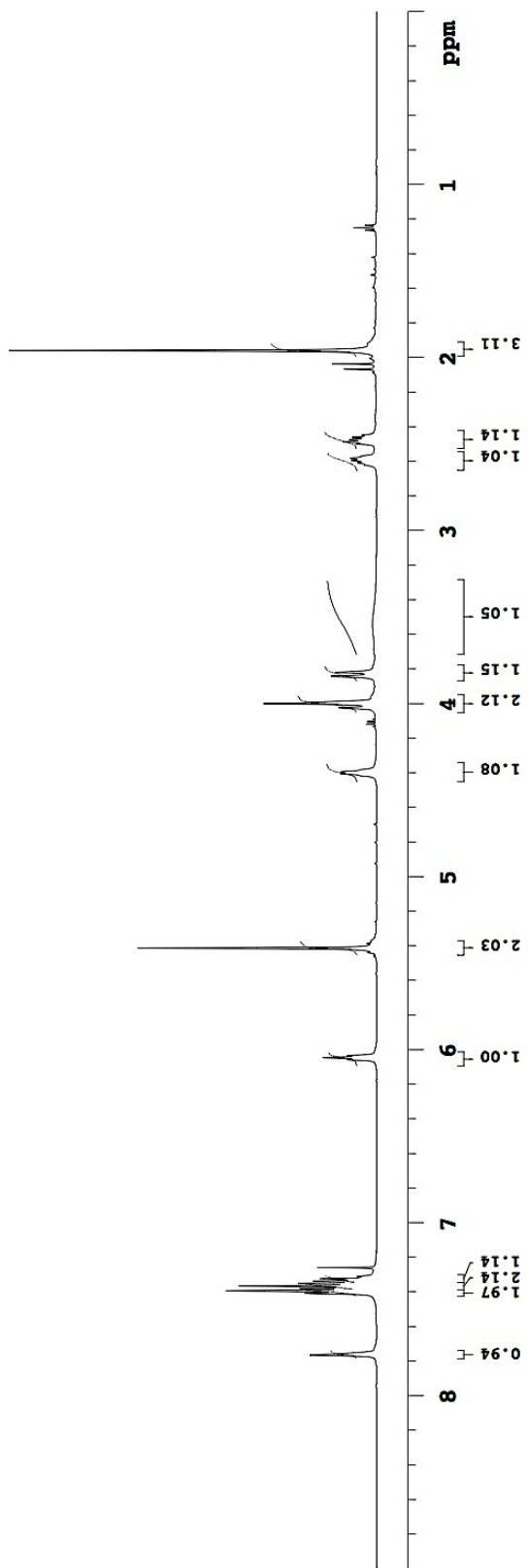
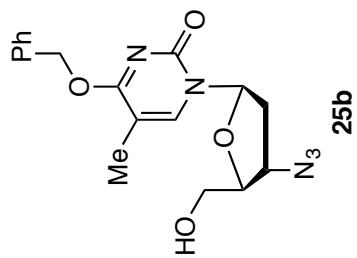

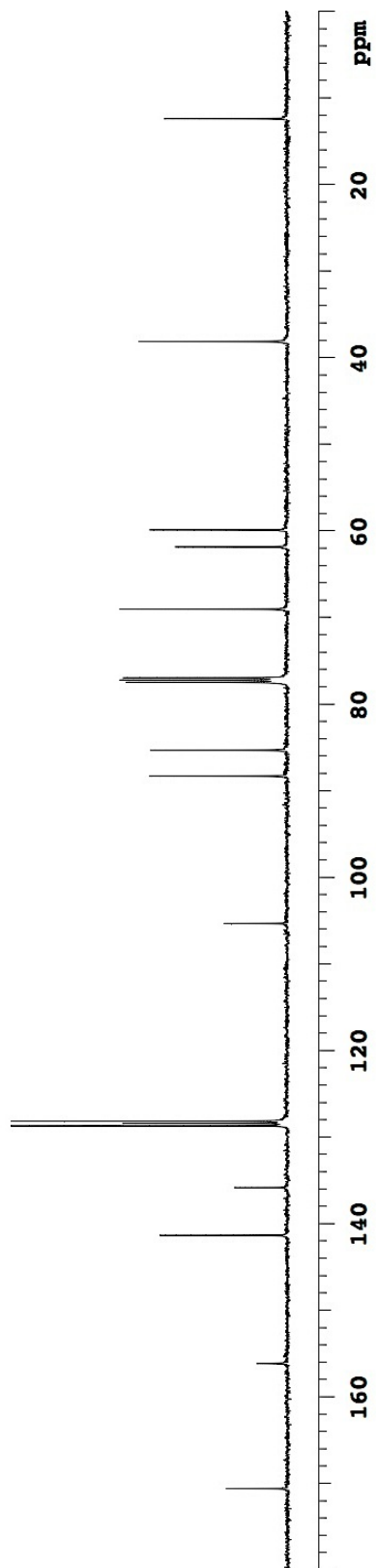
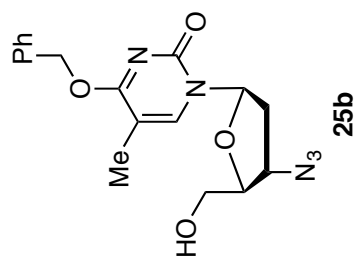

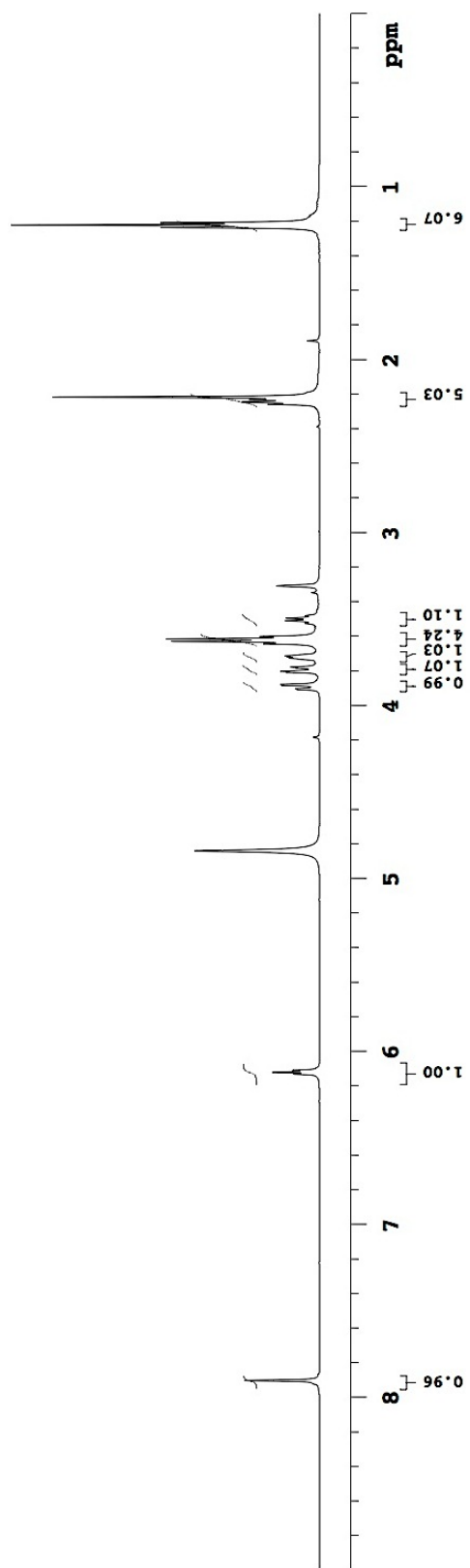
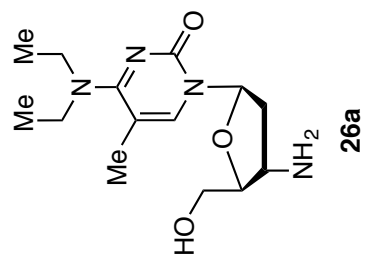

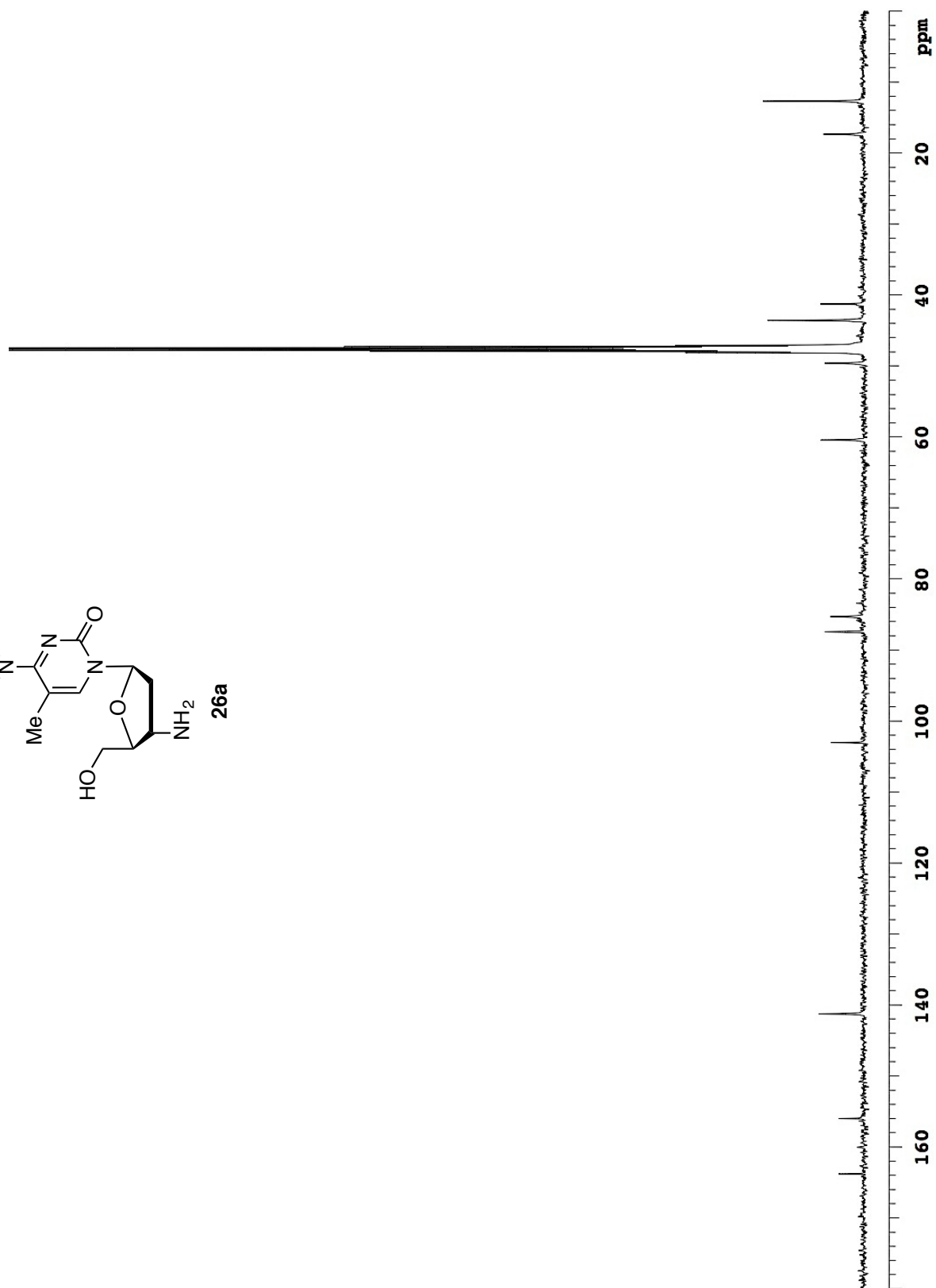
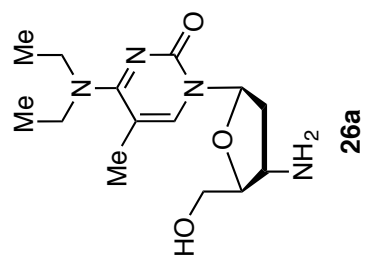

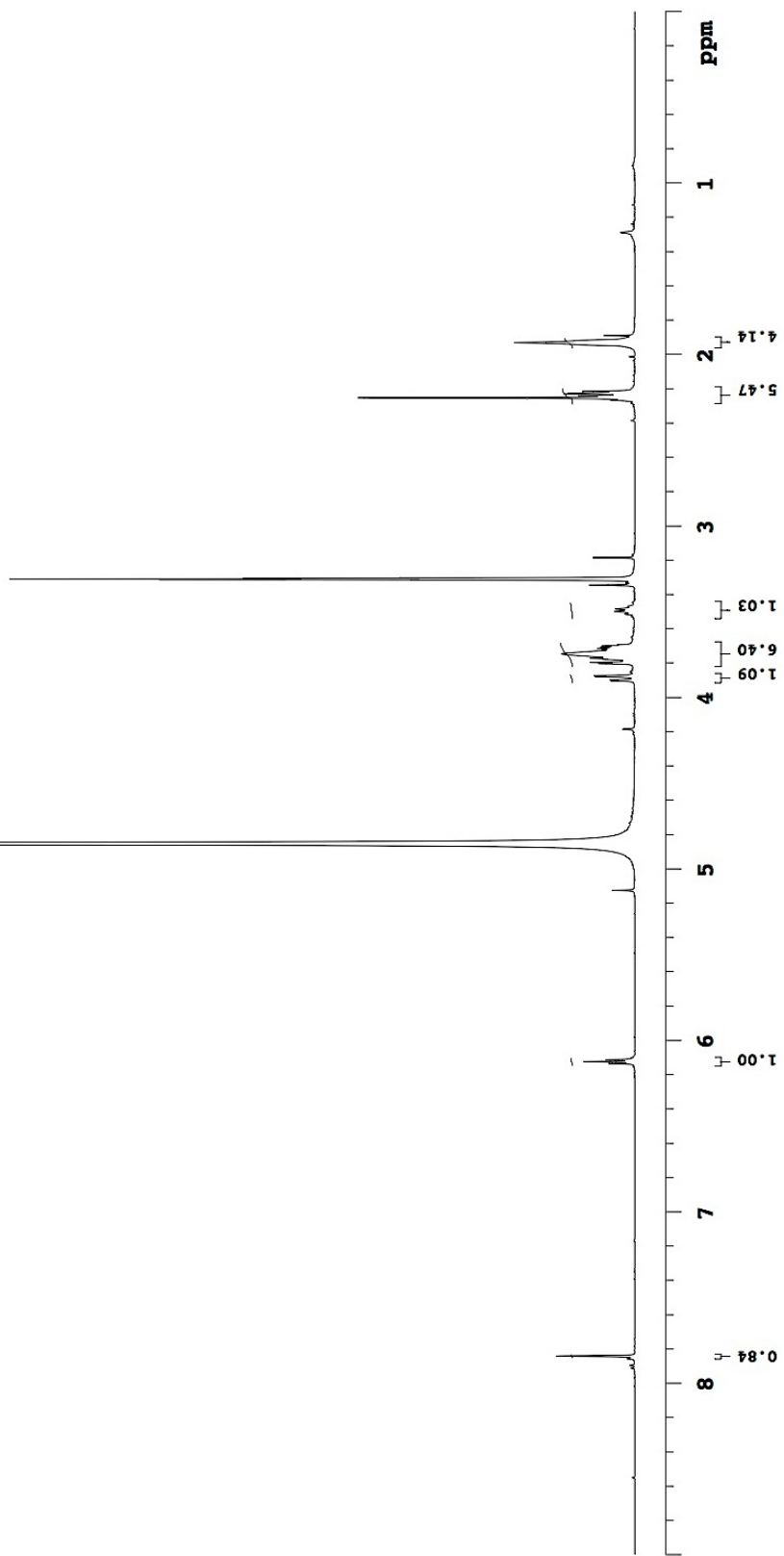
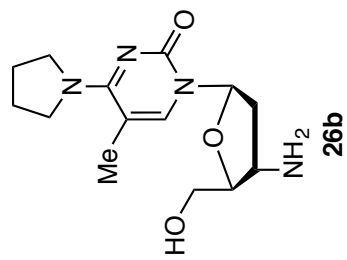

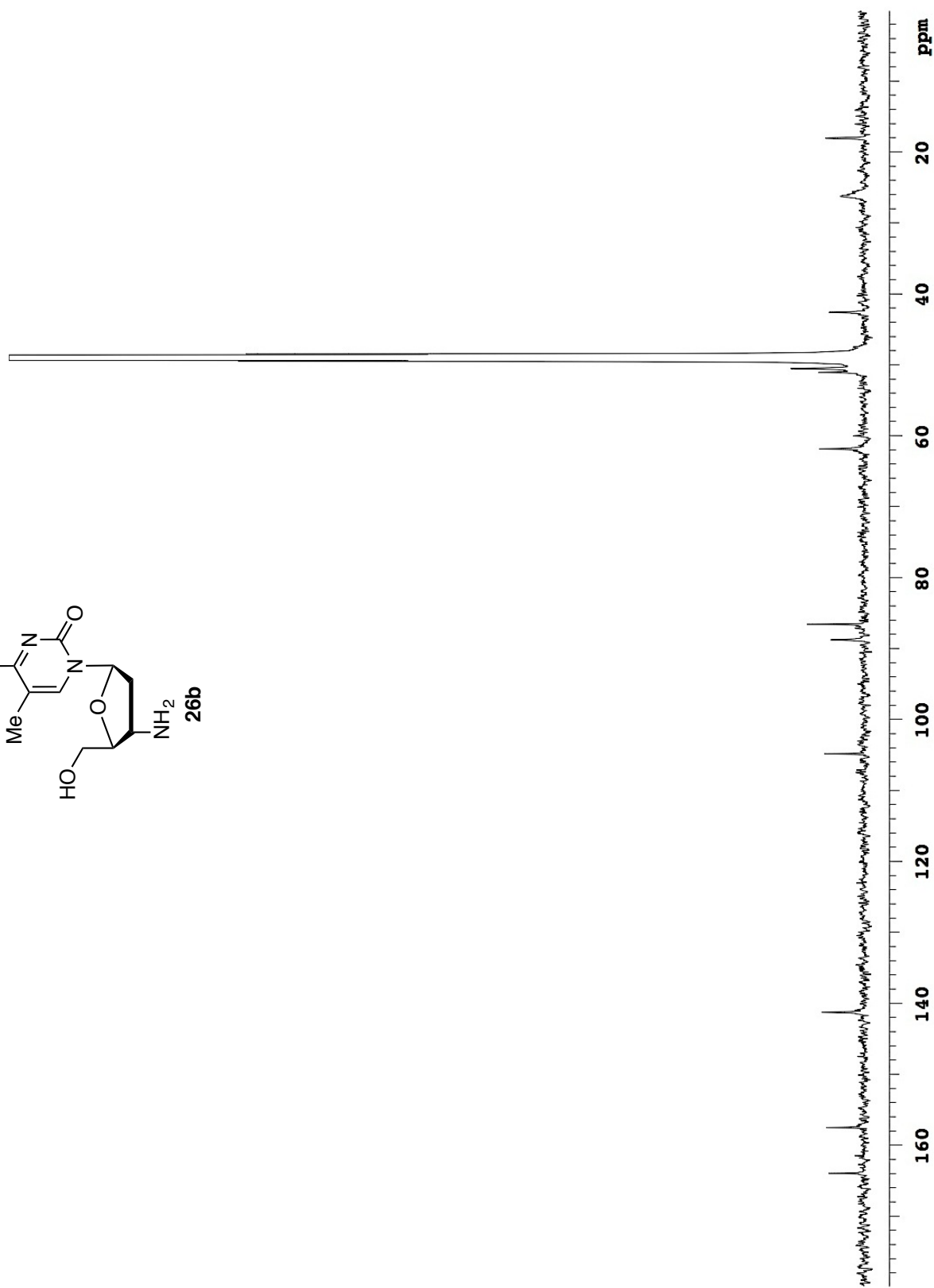
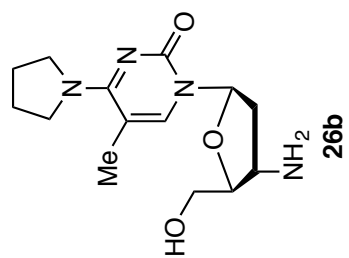

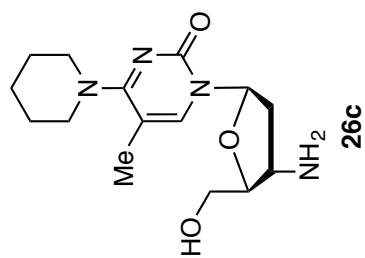

26c

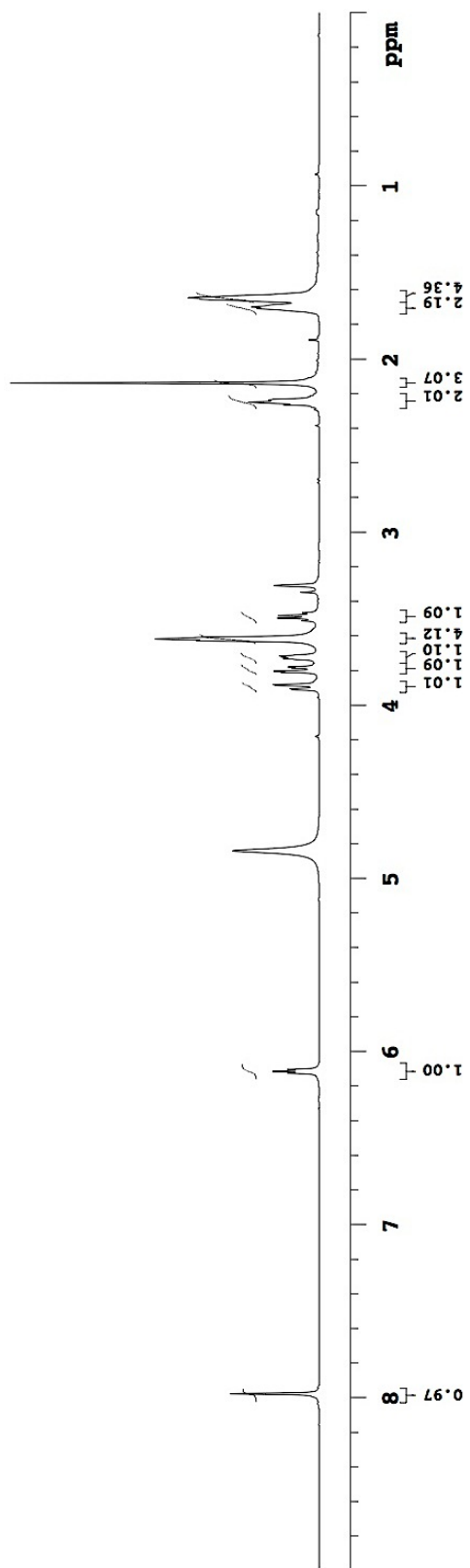

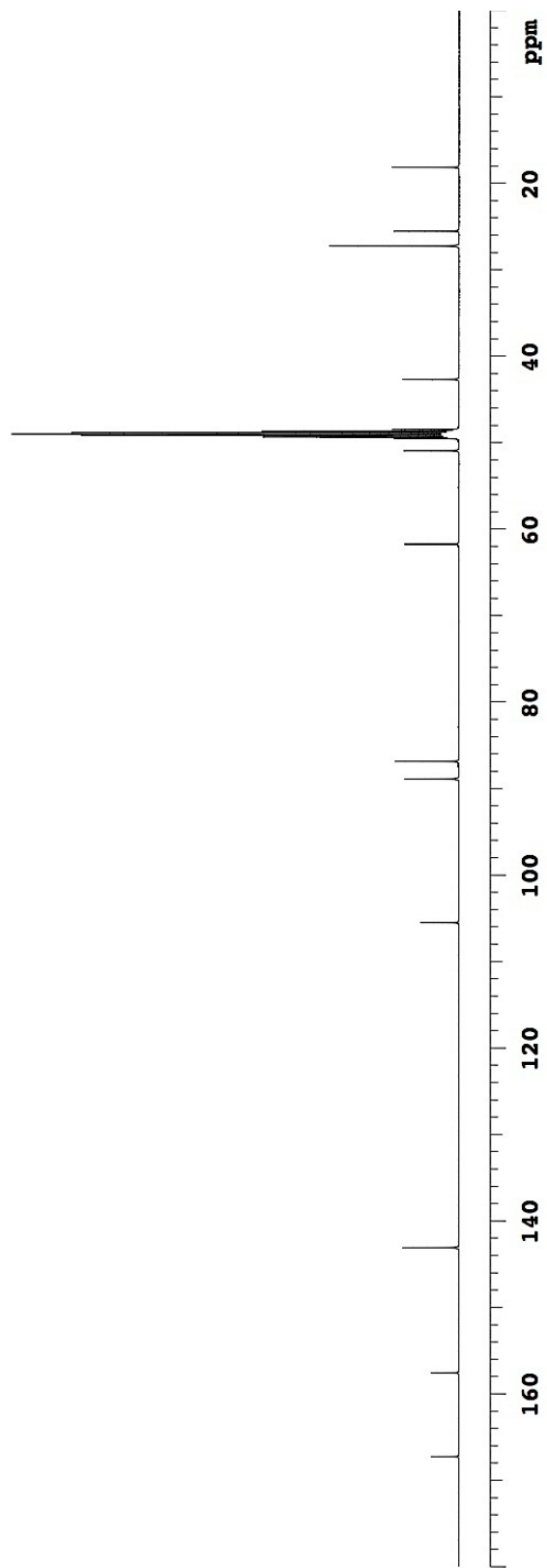
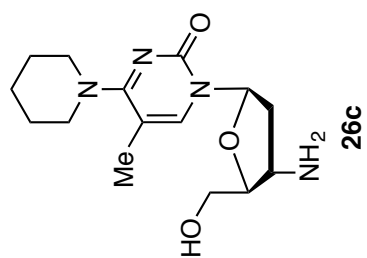

gCOSY spectrum of compound **26c** in CD₃OD

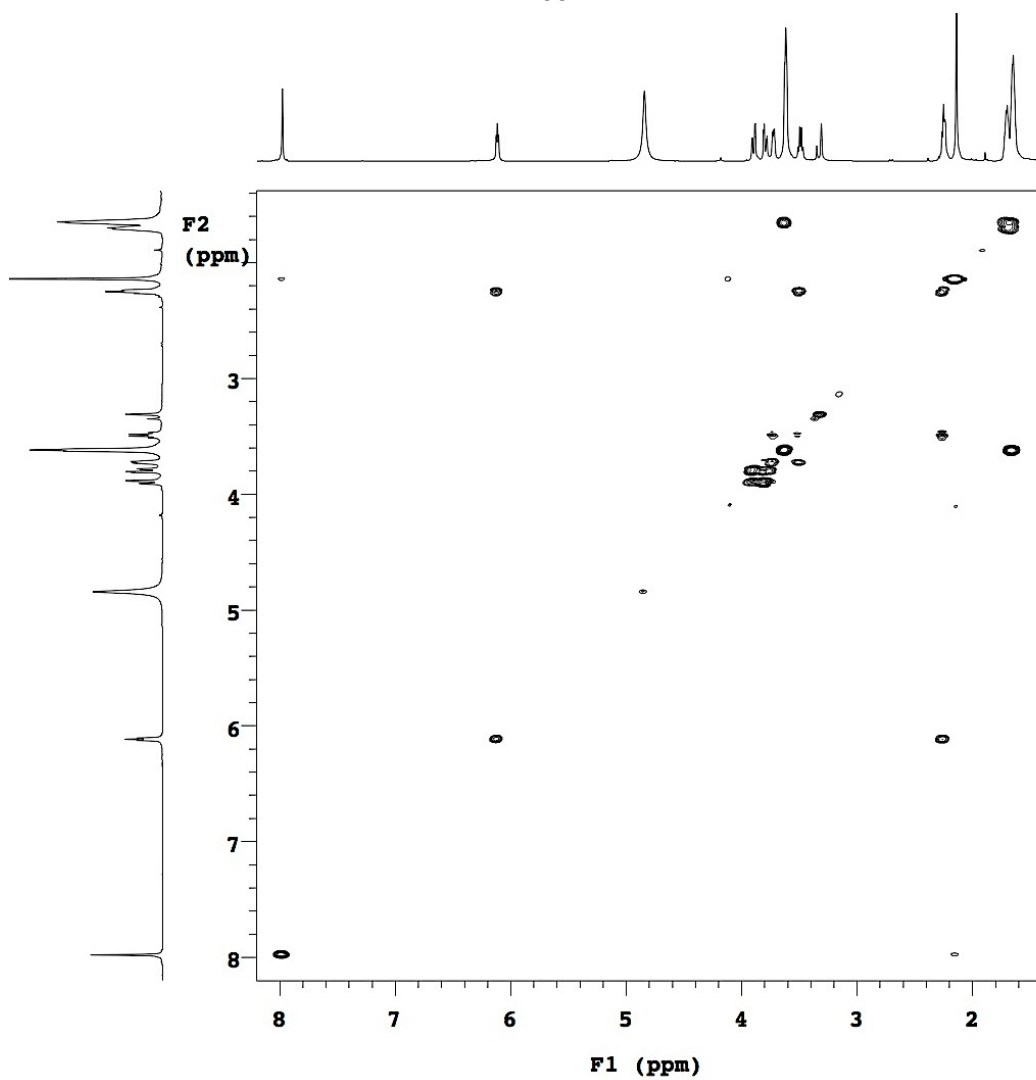
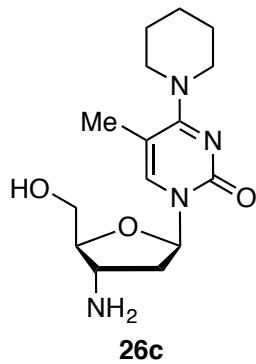

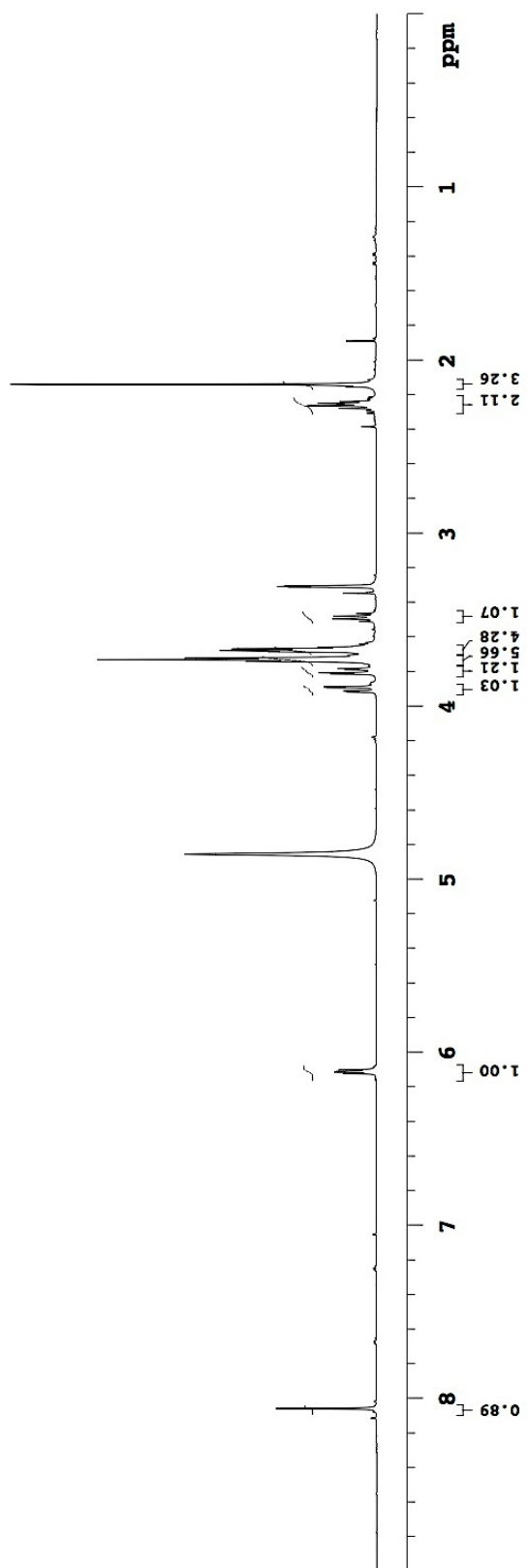
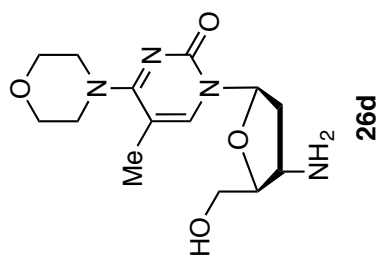

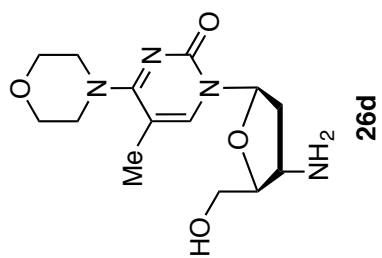

26d

