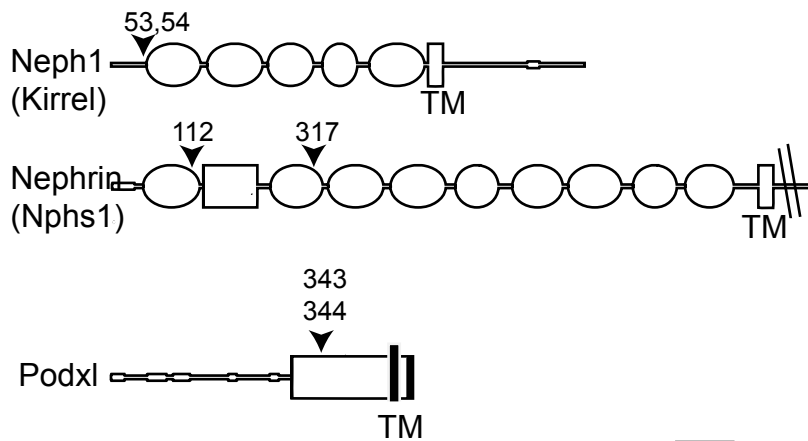
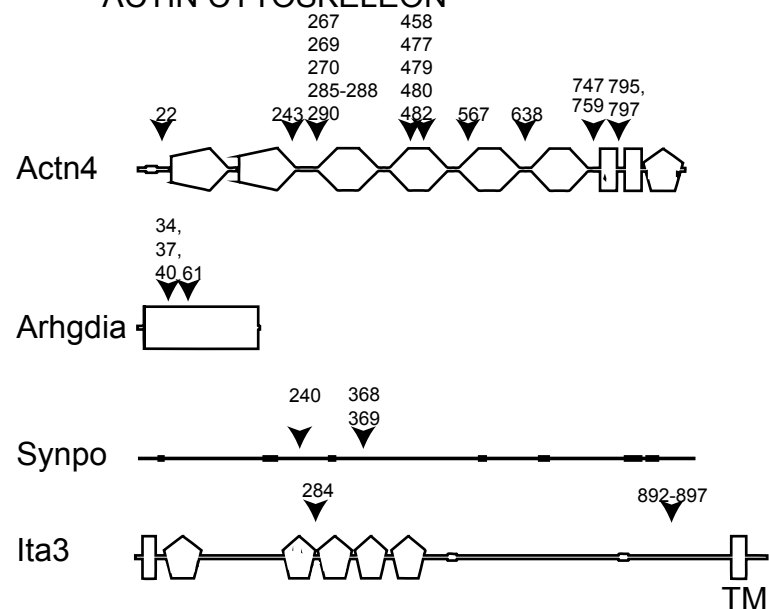
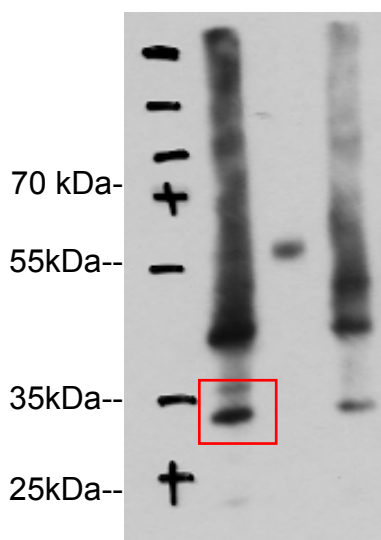
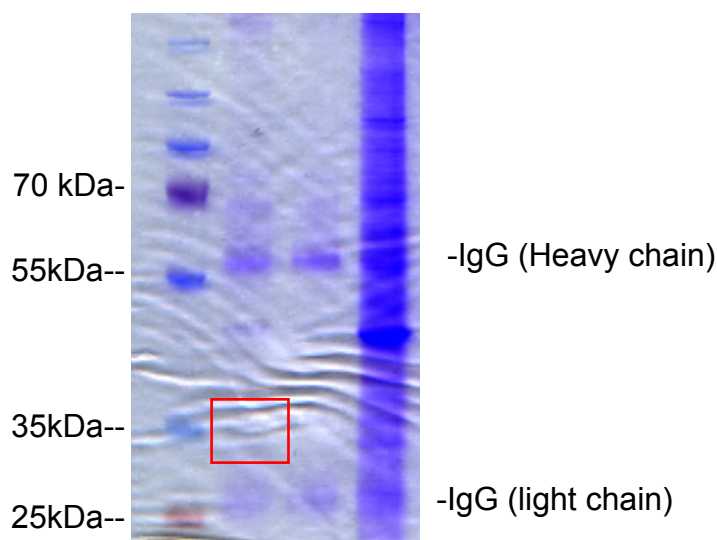
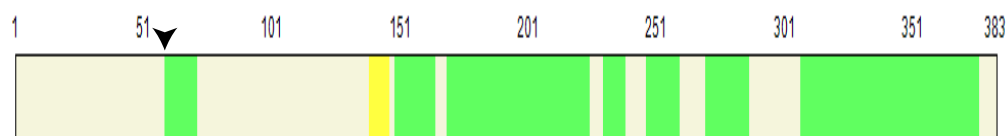

**A****SLIT DIAPHRAGM****B****ACTIN CYTOSKELEON**

100 AA

**C****Immunoblot:  
anti Podocin  
(C-terminal)**IP: anti podocin  
IP: anti FLAG  
Lysate**Coomassie**IP: anti podocin  
IP: anti FLAG  
Lysate**Protein coverage (Green)**

Peptide starting with Pos. 58

**Fig. S1**

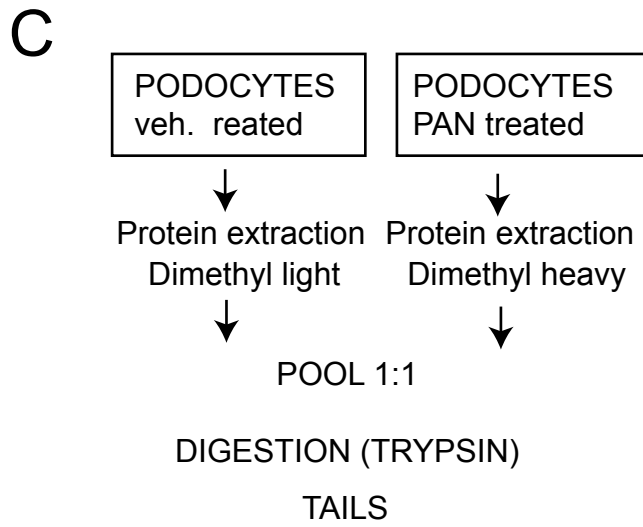
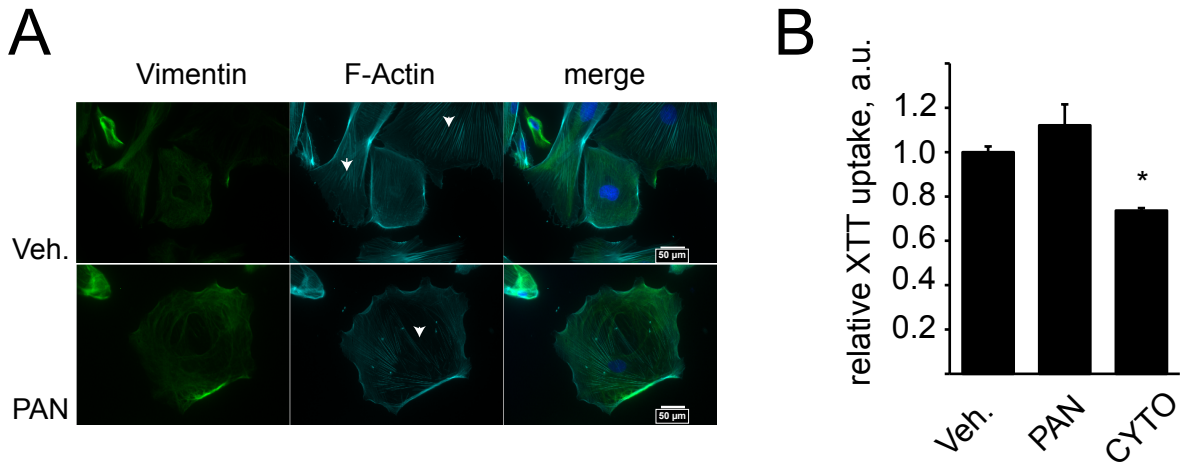

Fig. S2

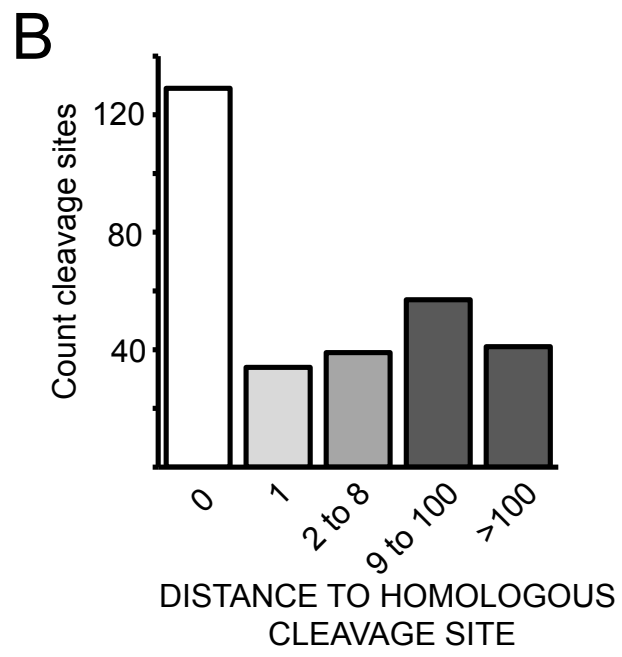
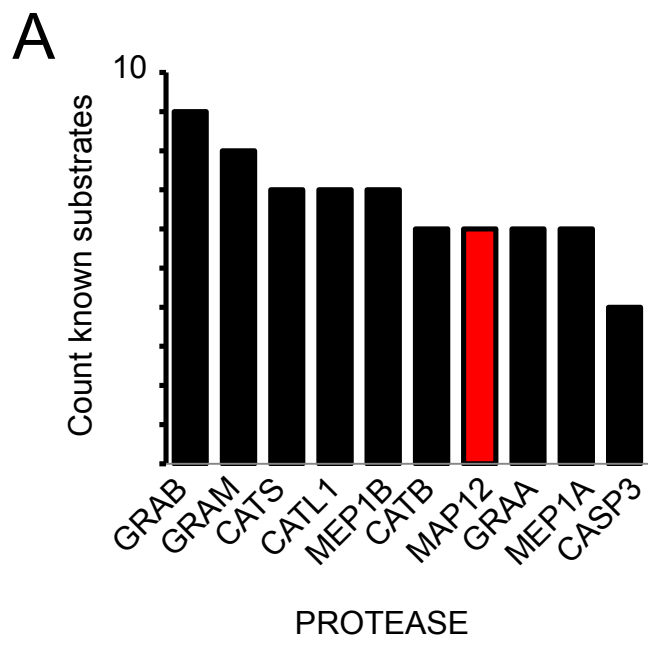

Fig. S3

**A****Cytoskeleton****B****Microtubule****C****Cell adhesion****D****Mitochondrion**

Fig. S4

**A****B****Fig. S5**

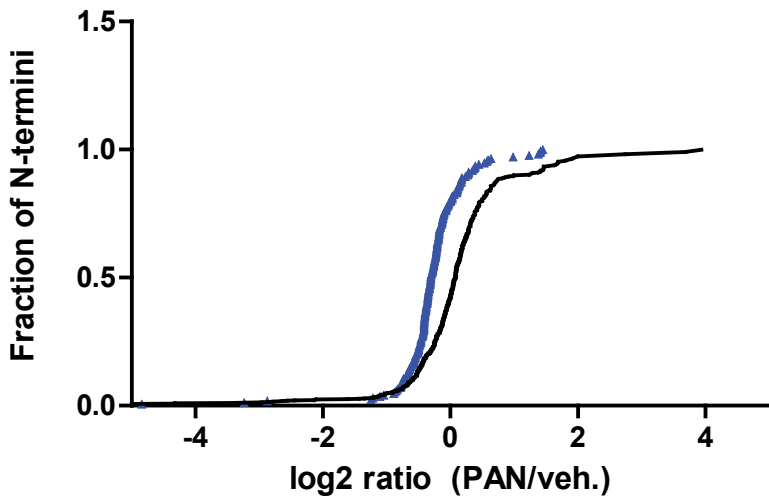
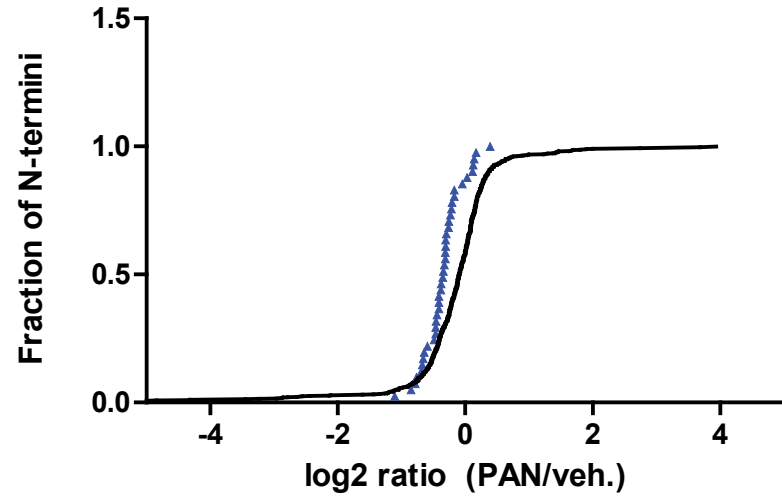
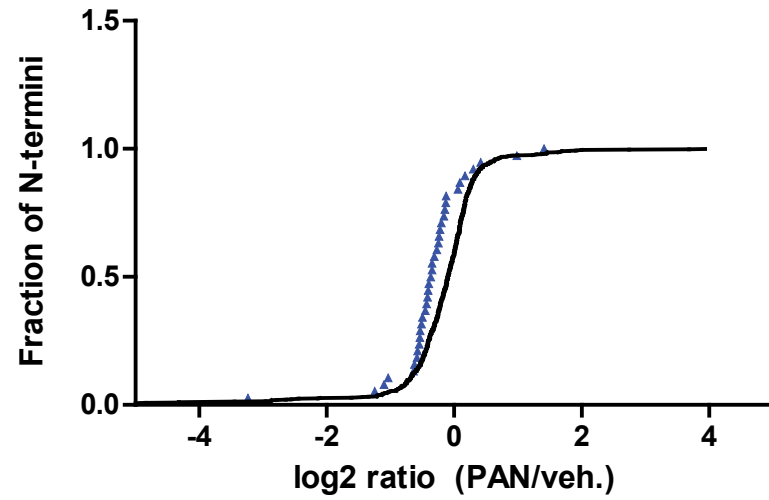
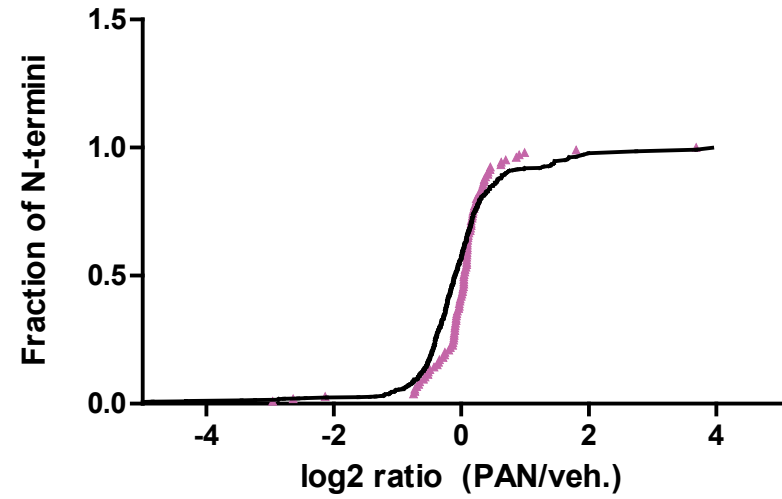
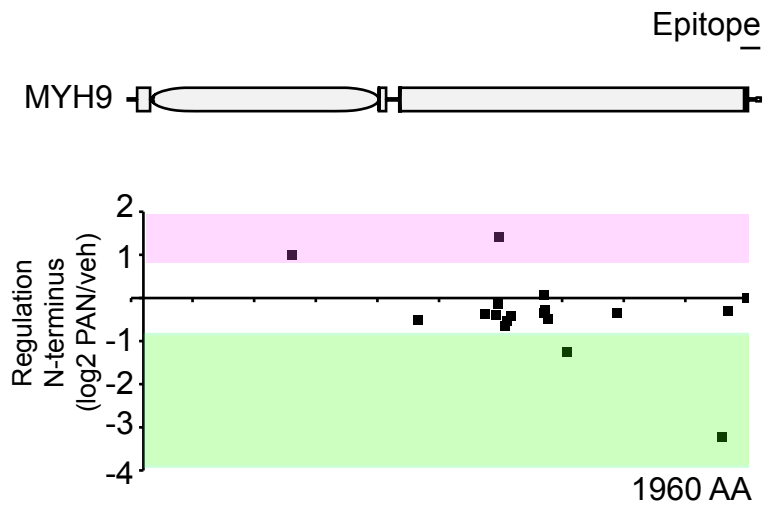
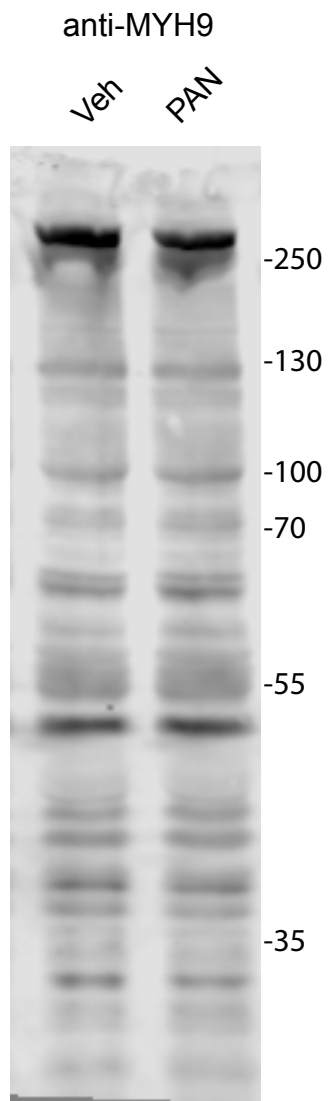
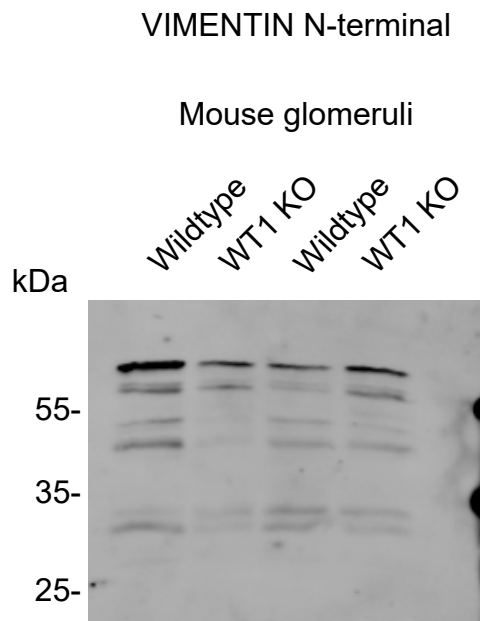

Fig. S6