

**a****b****c****f****d****e**

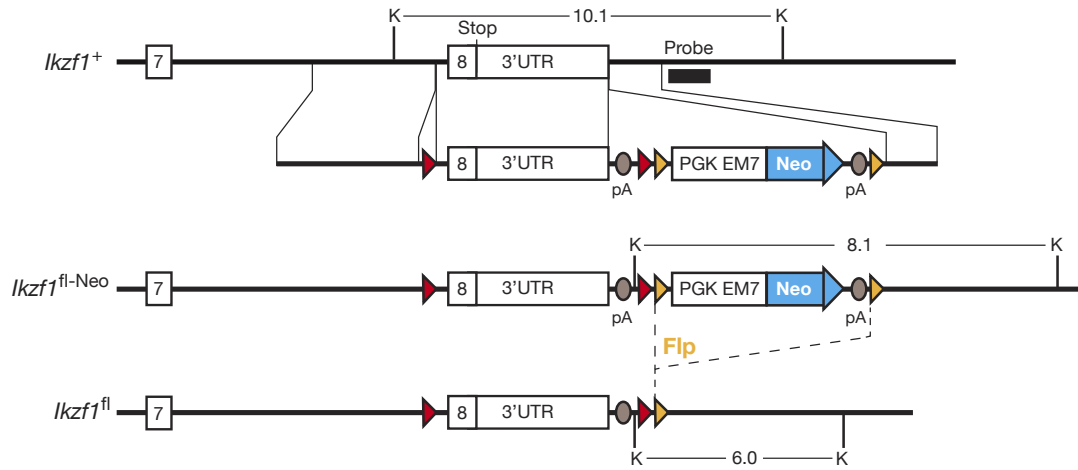

**a****b****c****d****e**

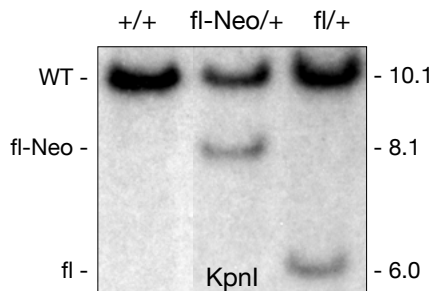
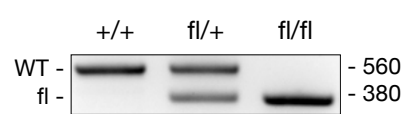
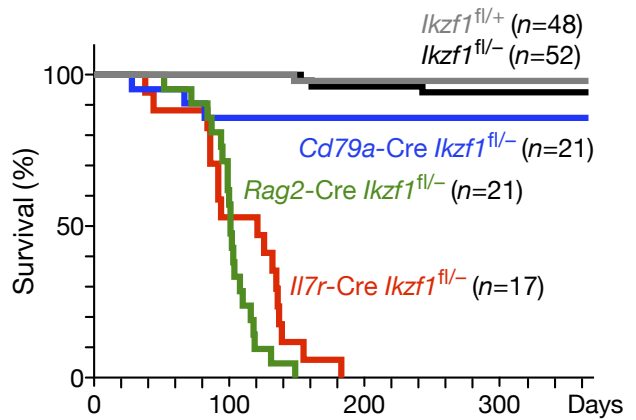
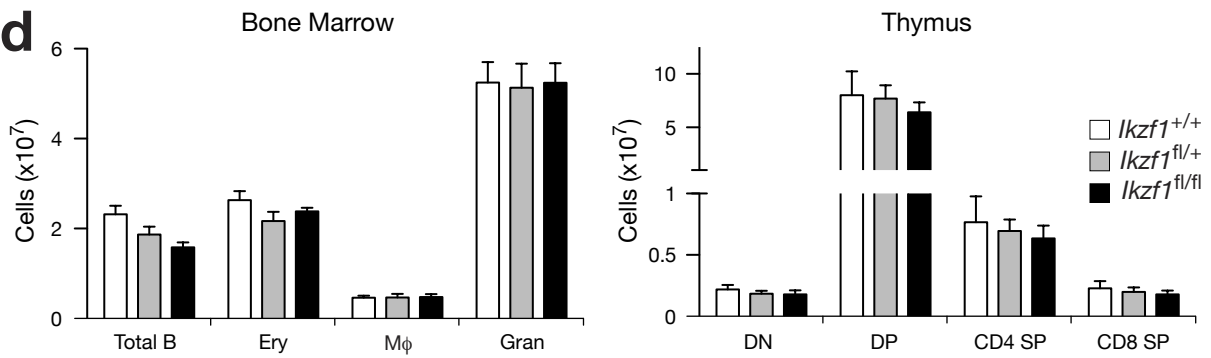
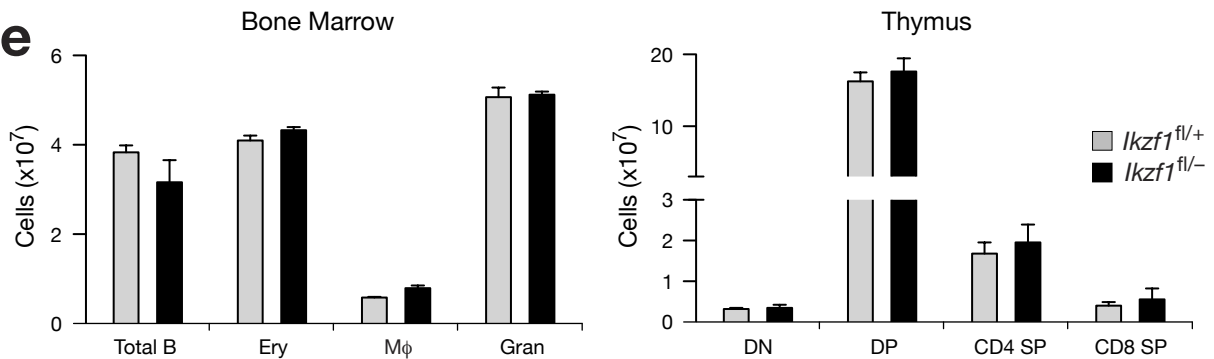
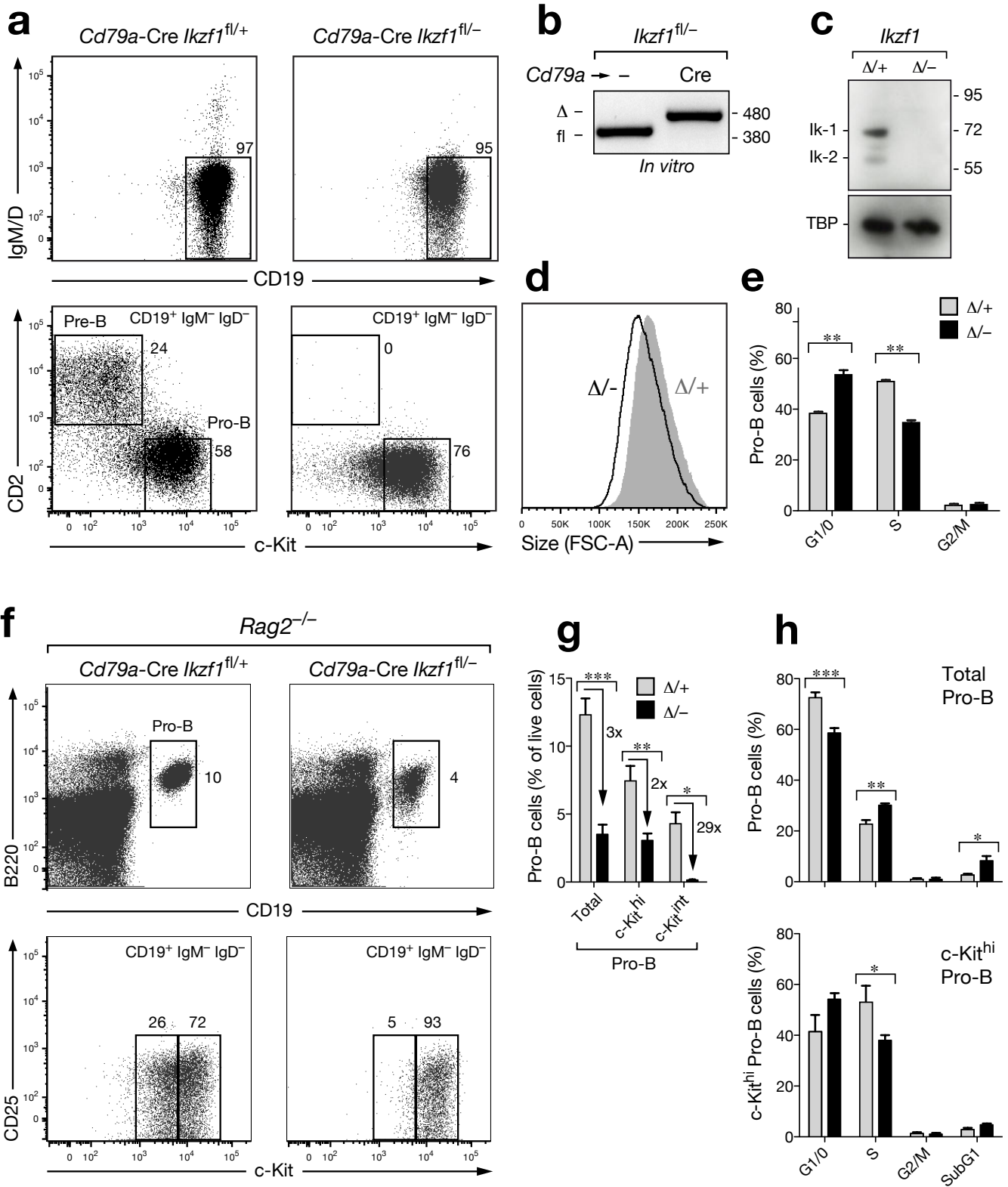
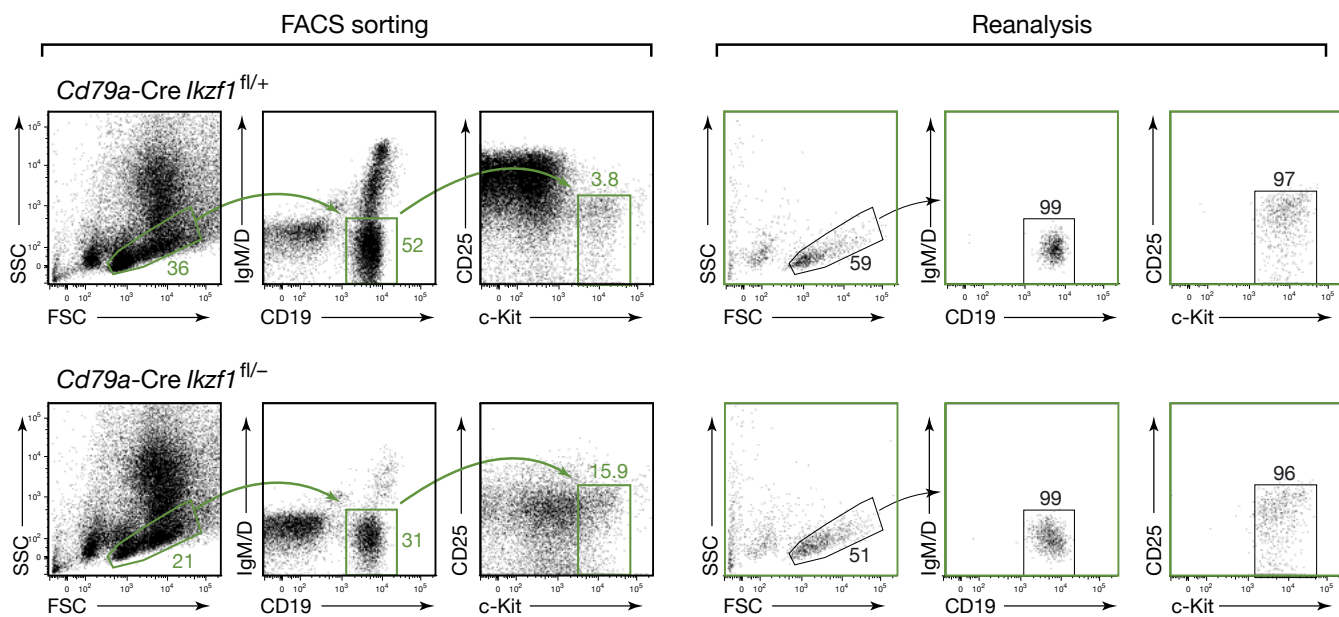
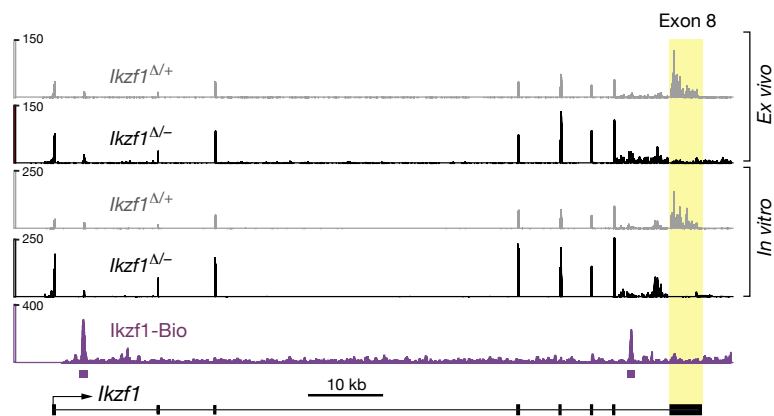
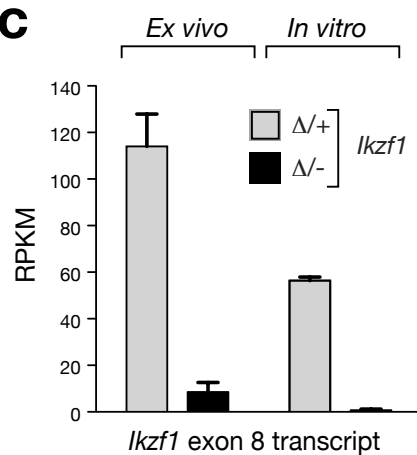
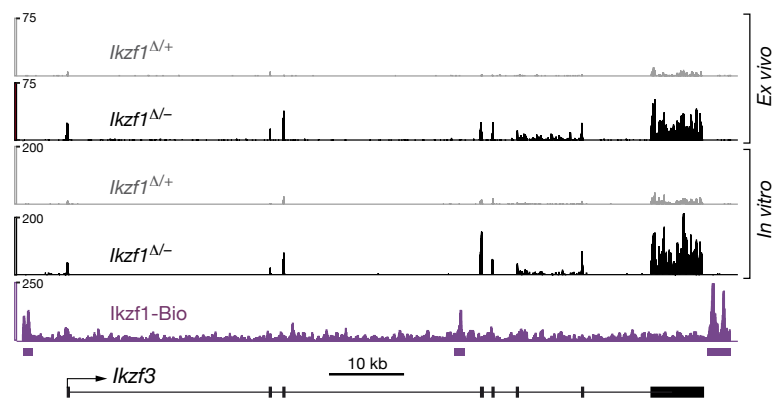
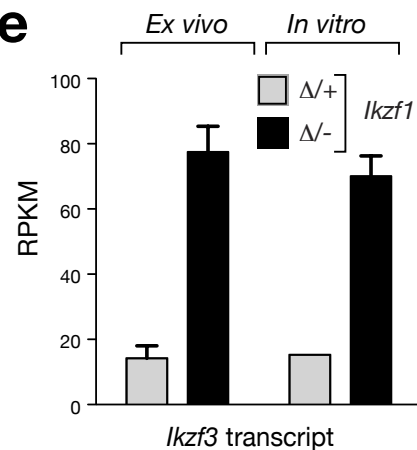

Supplementary Figure 5 (Schwickert et al.)

**a**

## Ikaros target genes

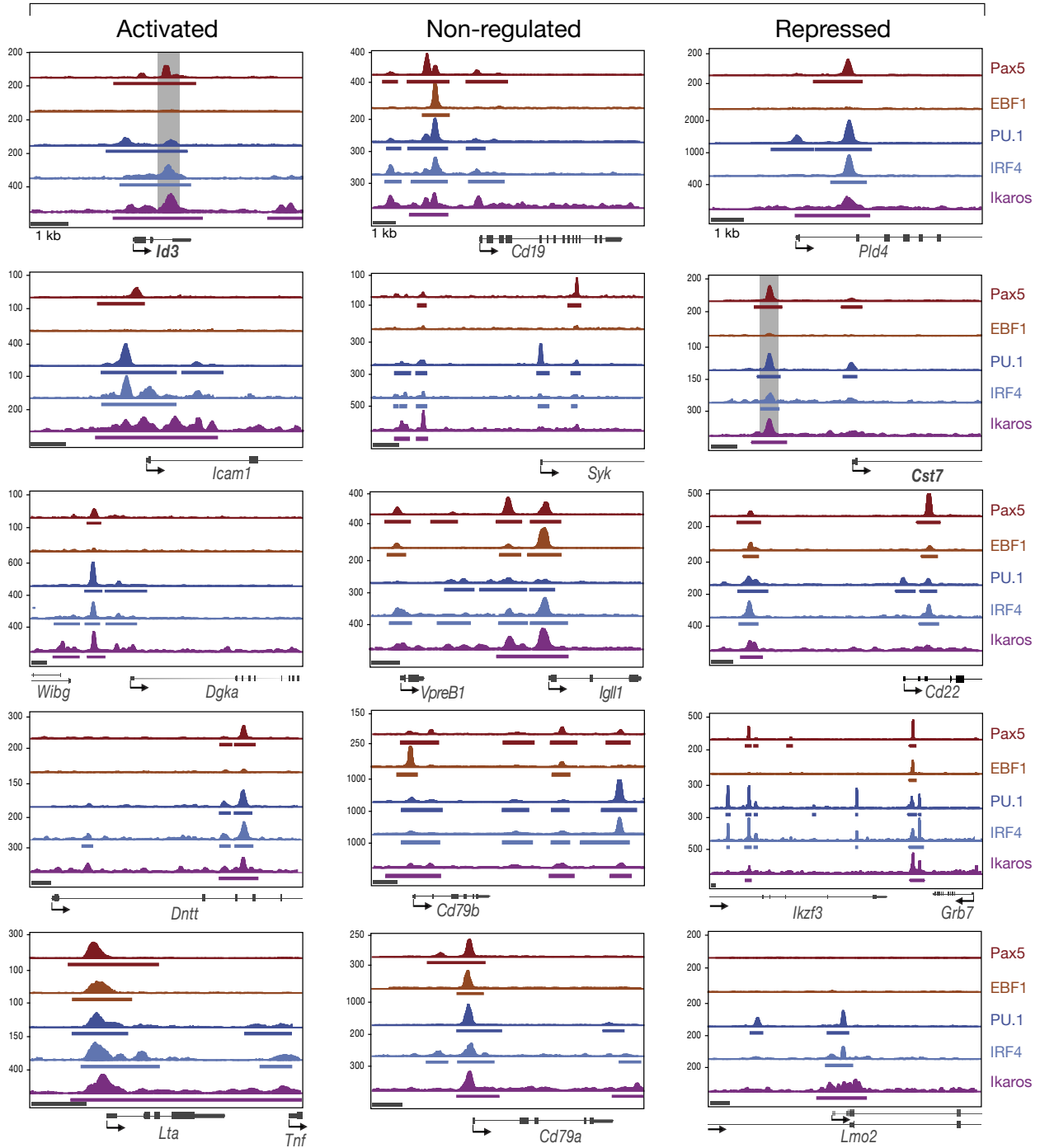
**b**

## Coregulation by Ikaros and Pax5

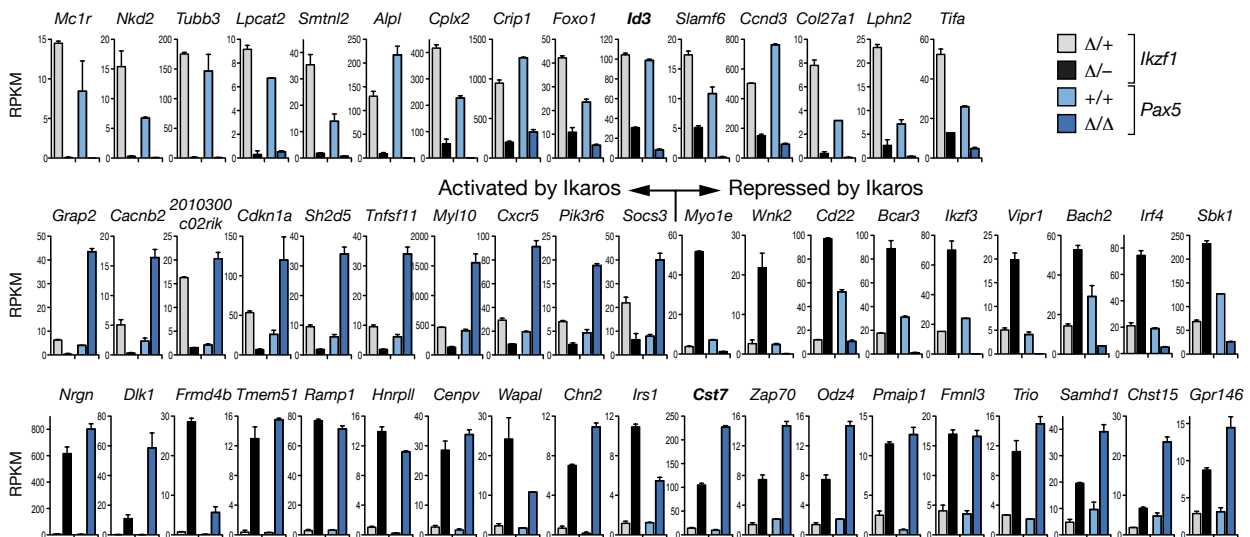

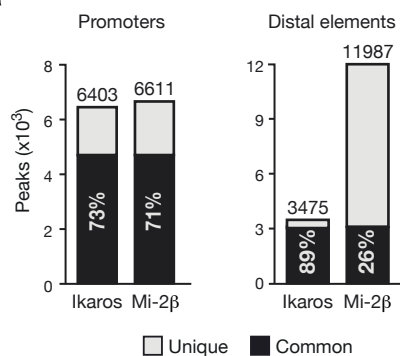
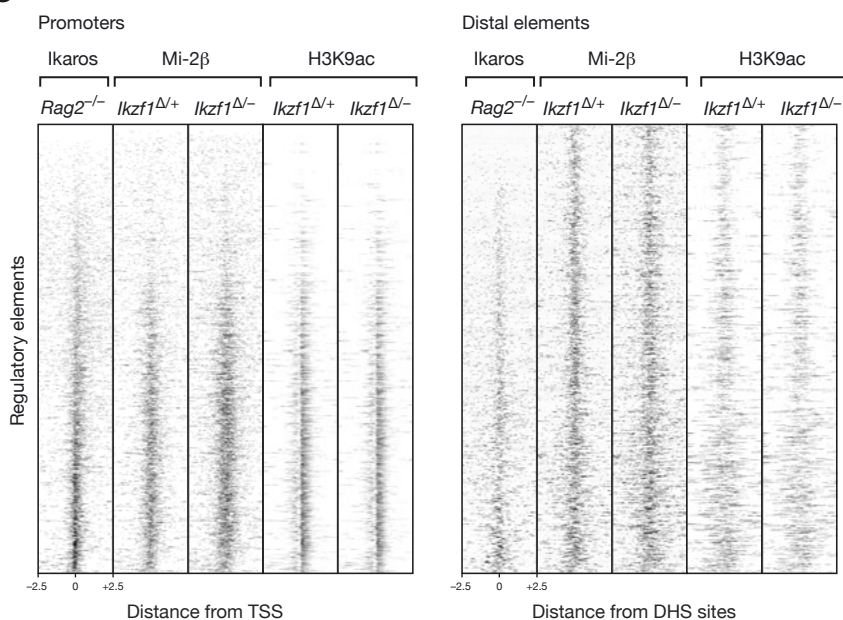
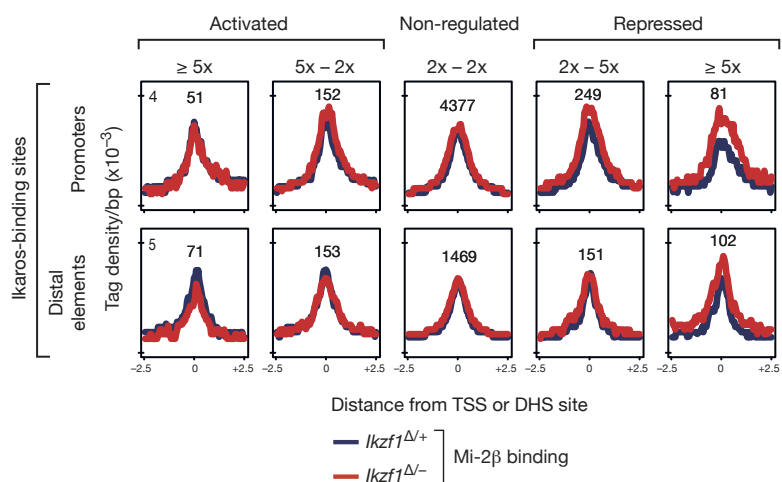
**a****b****c**

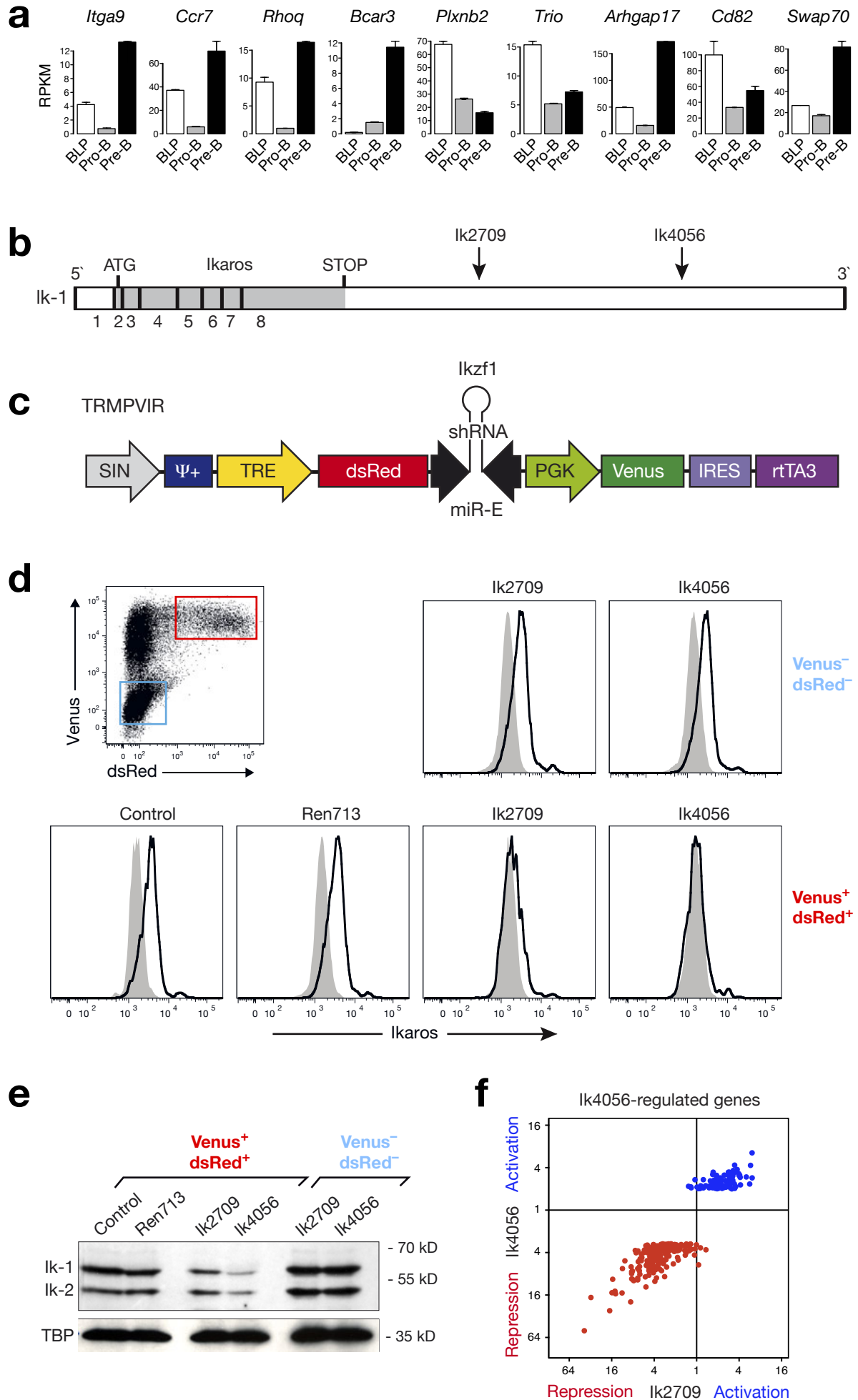

Supplementary Figure 8 (Schwickert et al.)