

G.hi AGC_MAST exon-intron and domain diagram (all)

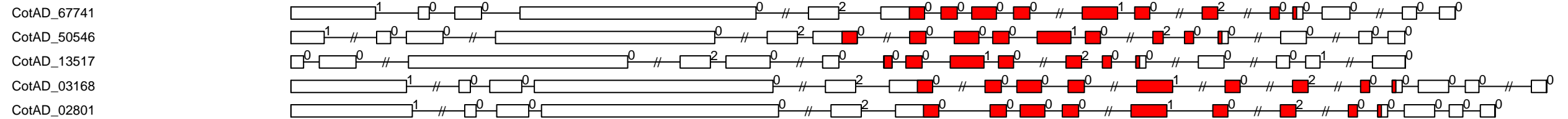

0

2000

4000

6000

G.hi AGC_NDR exon-intron and domain diagram (all)

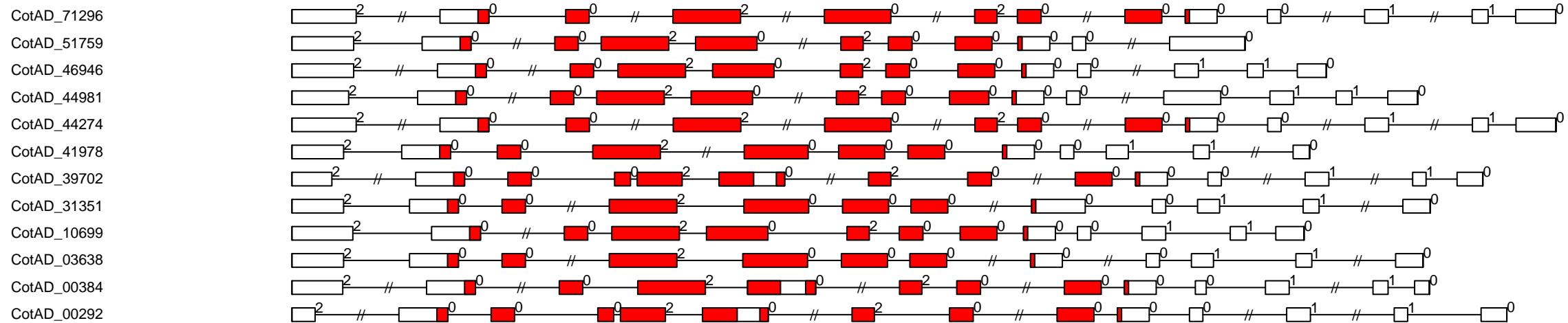

-1000

0

1000

2000

3000

4000

G.hi AGC_PDK1 exon-intron and domain diagram (all)

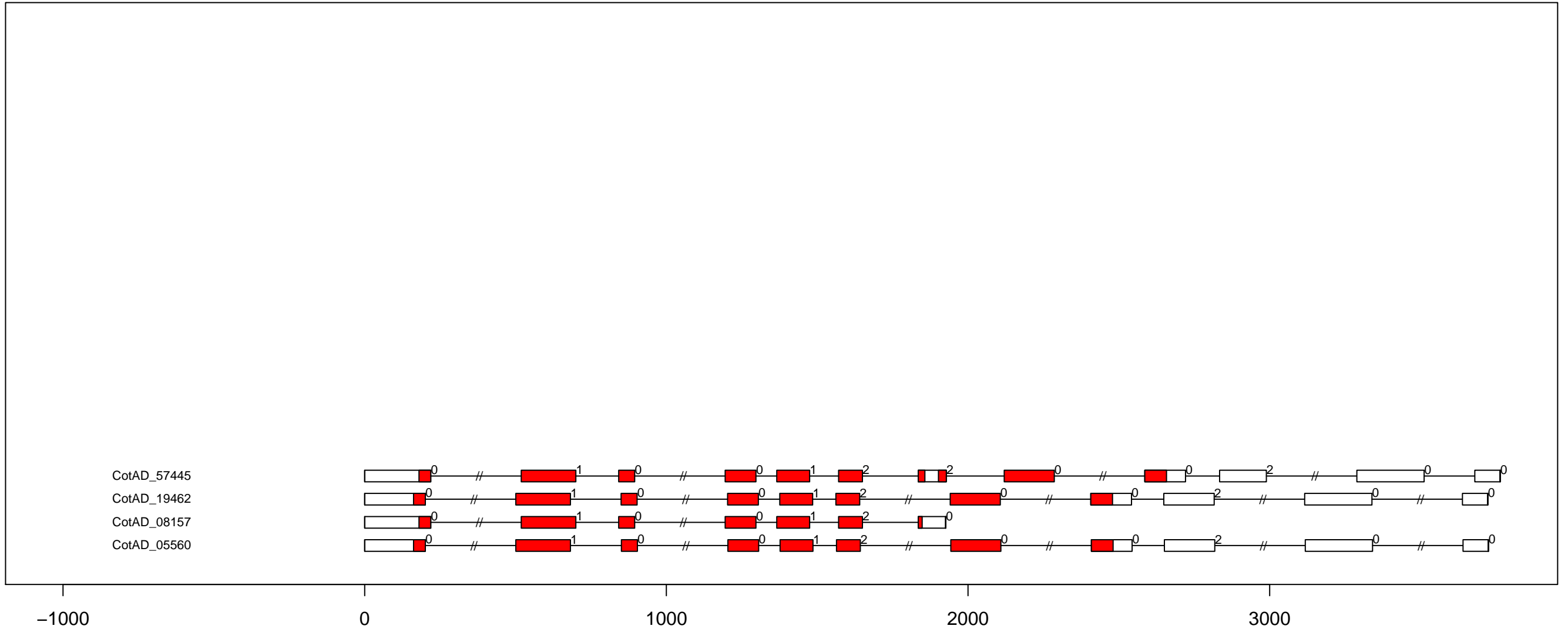

G.hi AGC_PKA-PKG exon-intron and domain diagram (all)

CotAD_29250

CotAD_23771

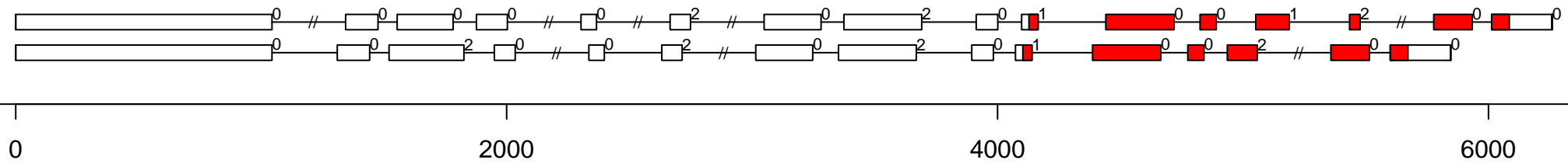

G.hi AGC_RSK-2 exon-intron and domain diagram (part 1)

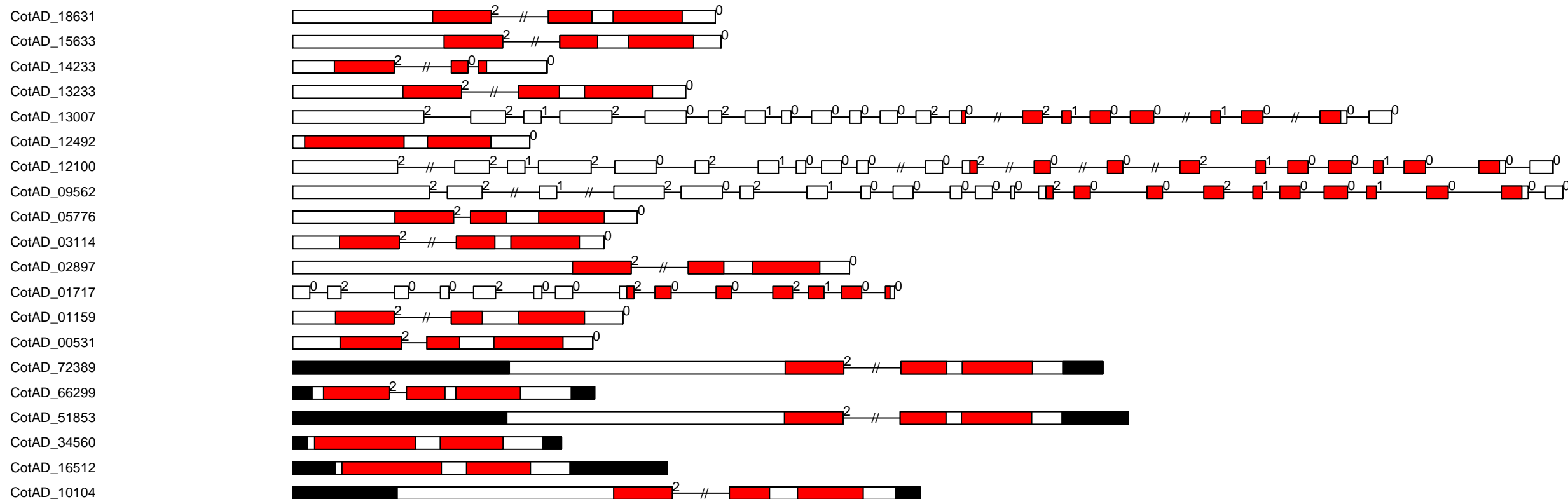

G.hi AGC_RSK-2 exon-intron and domain diagram (part 2)

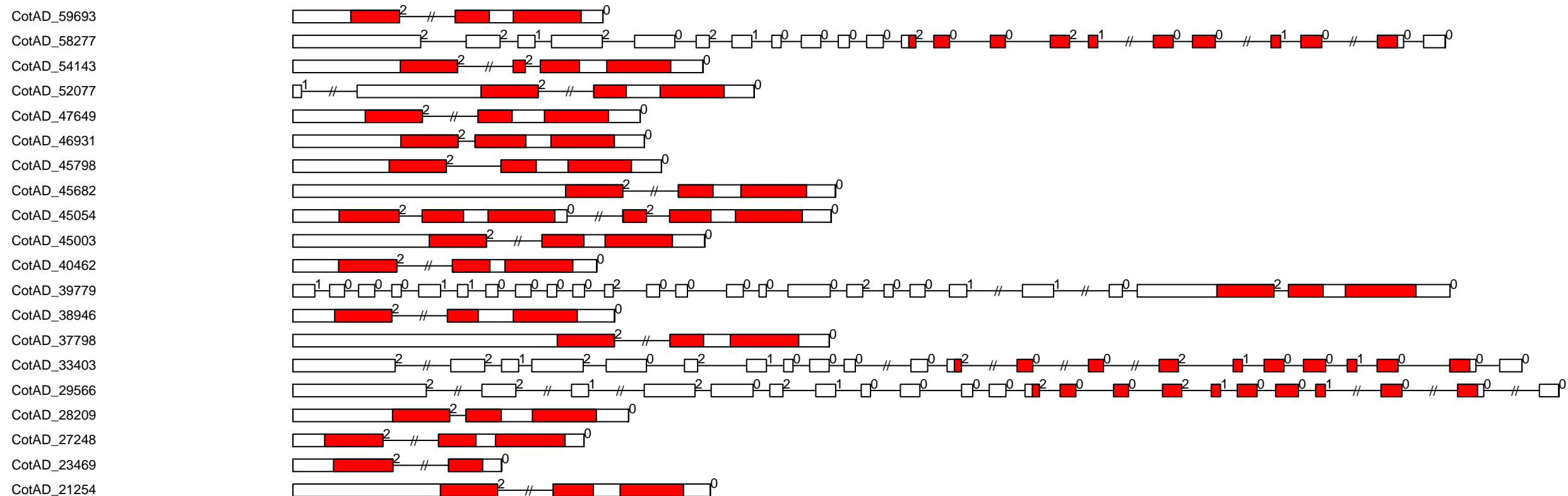

G.hi AGC_RSK-2 exon-intron and domain diagram (part 3)

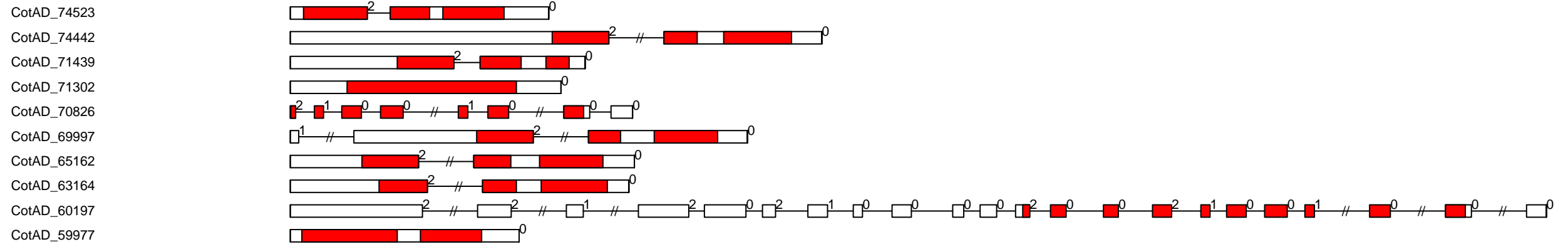

G.hi AGC-PI exon-intron and domain diagram (all)

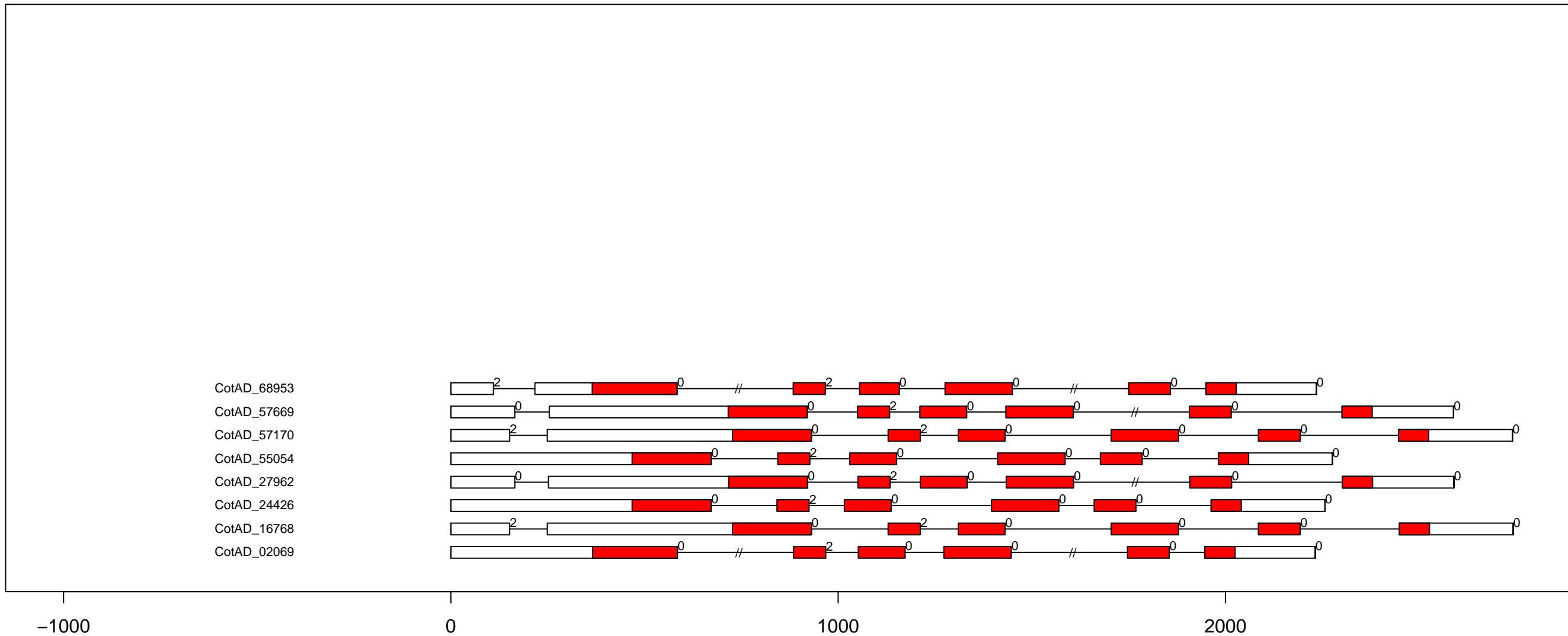

G.hi Aur exon-intron and domain diagram (all)

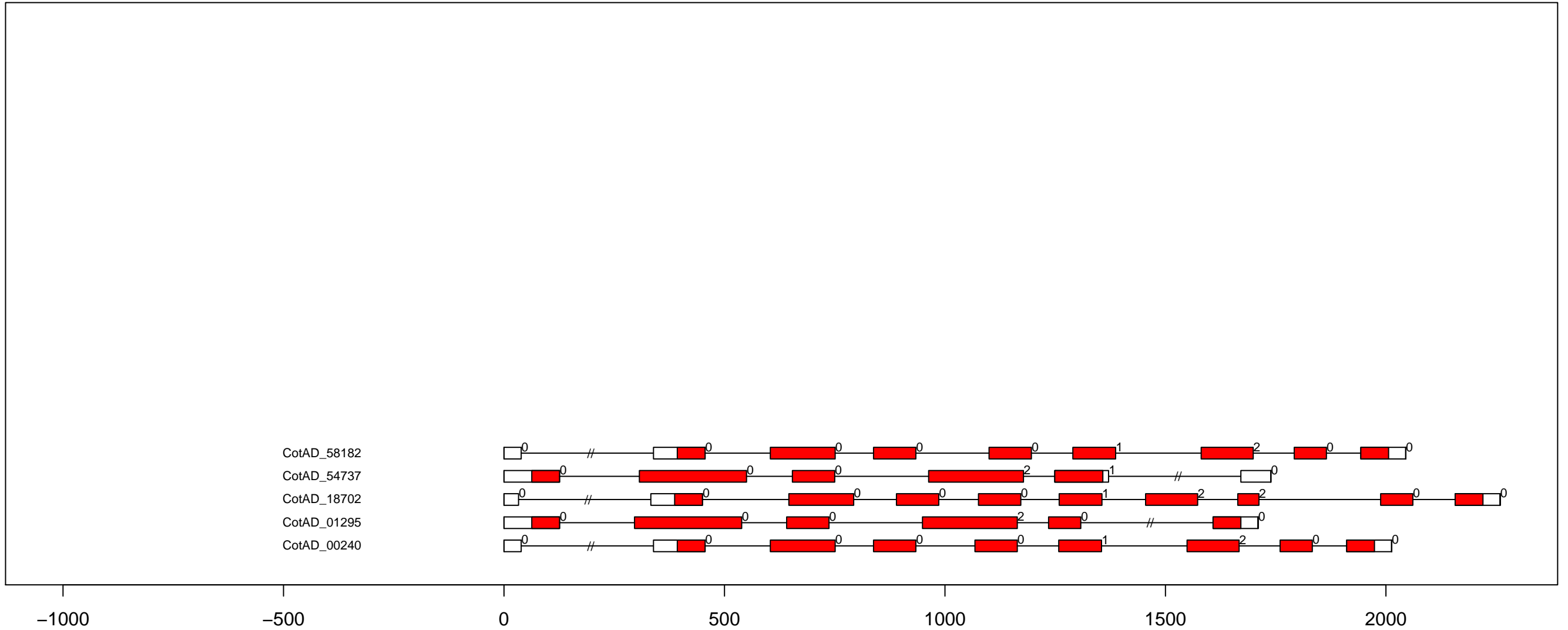

G.hi BUB exon-intron and domain diagram (all)

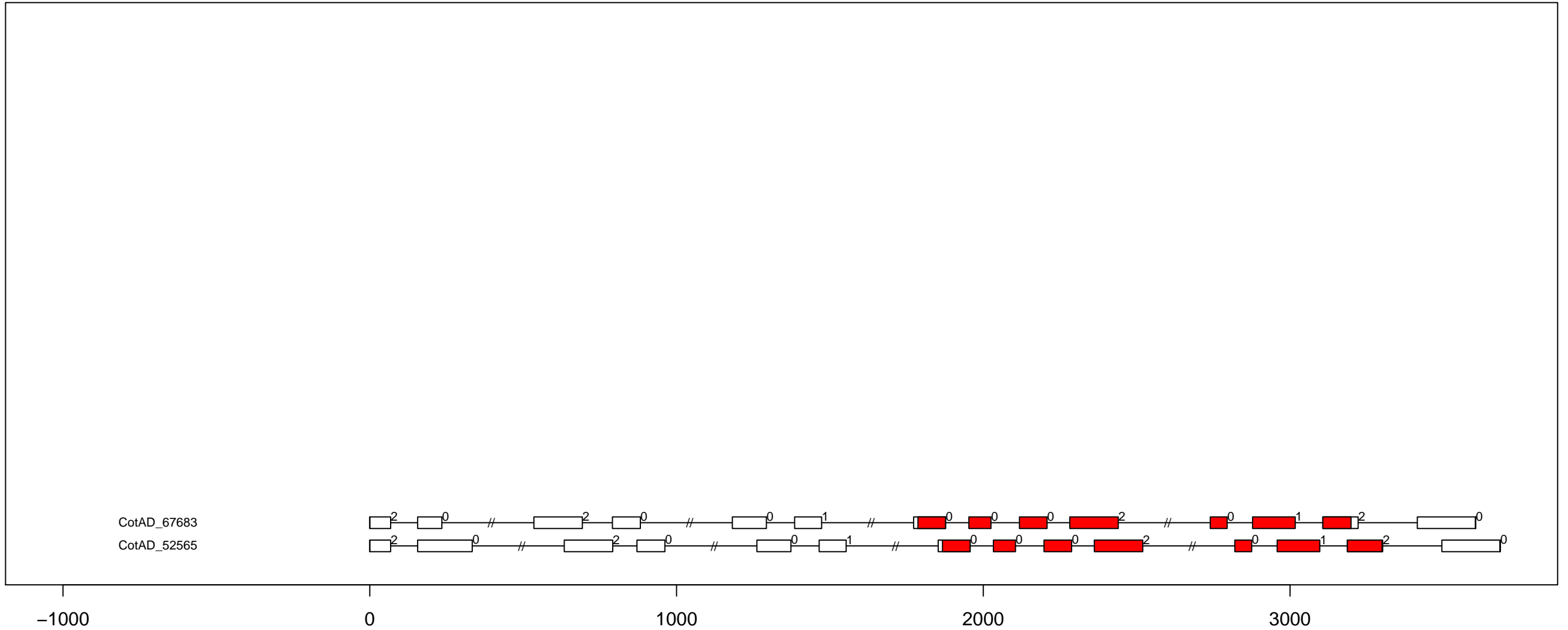

G.hi CAMK_AMPK exon-intron and domain diagram (all)

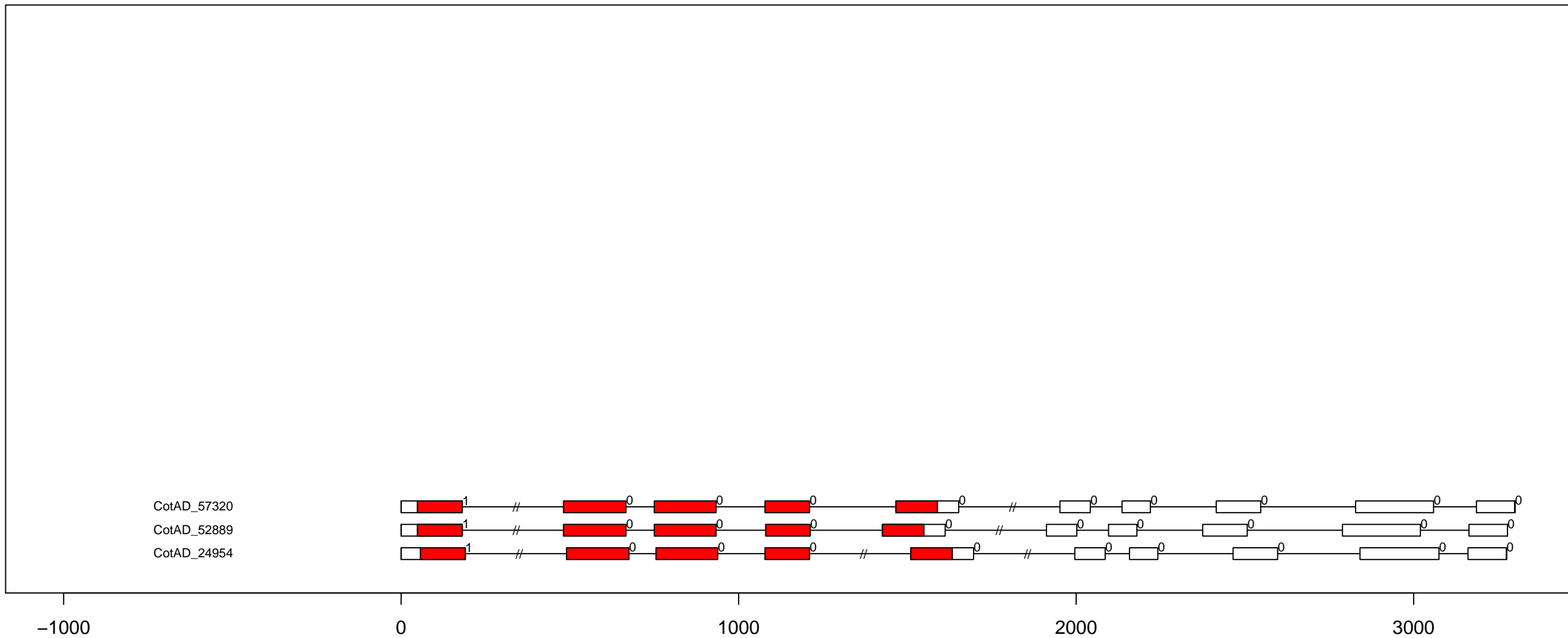

G.hi CAMK_CAMK1-DCAMKL exon-intron and domain diagram (all)

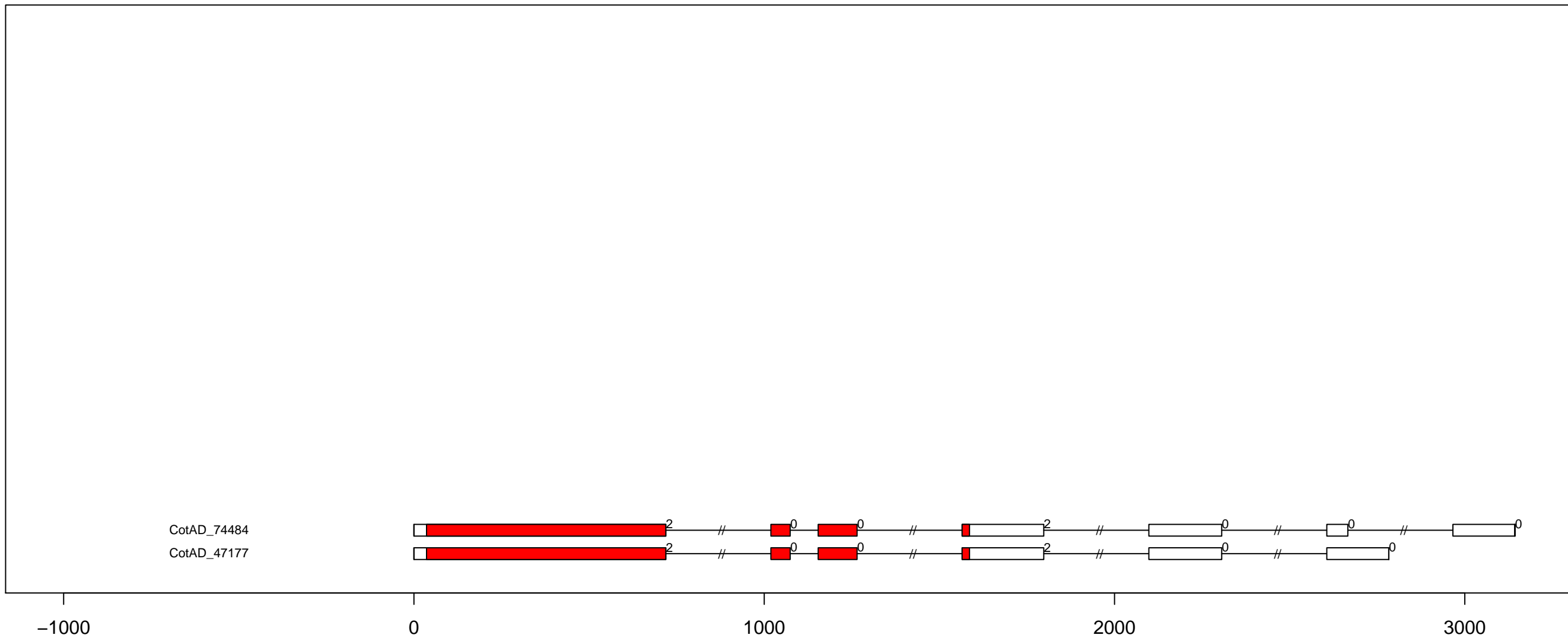

G.hi CAMK_CAMKL-CHK1 exon-intron and domain diagram (part 1)

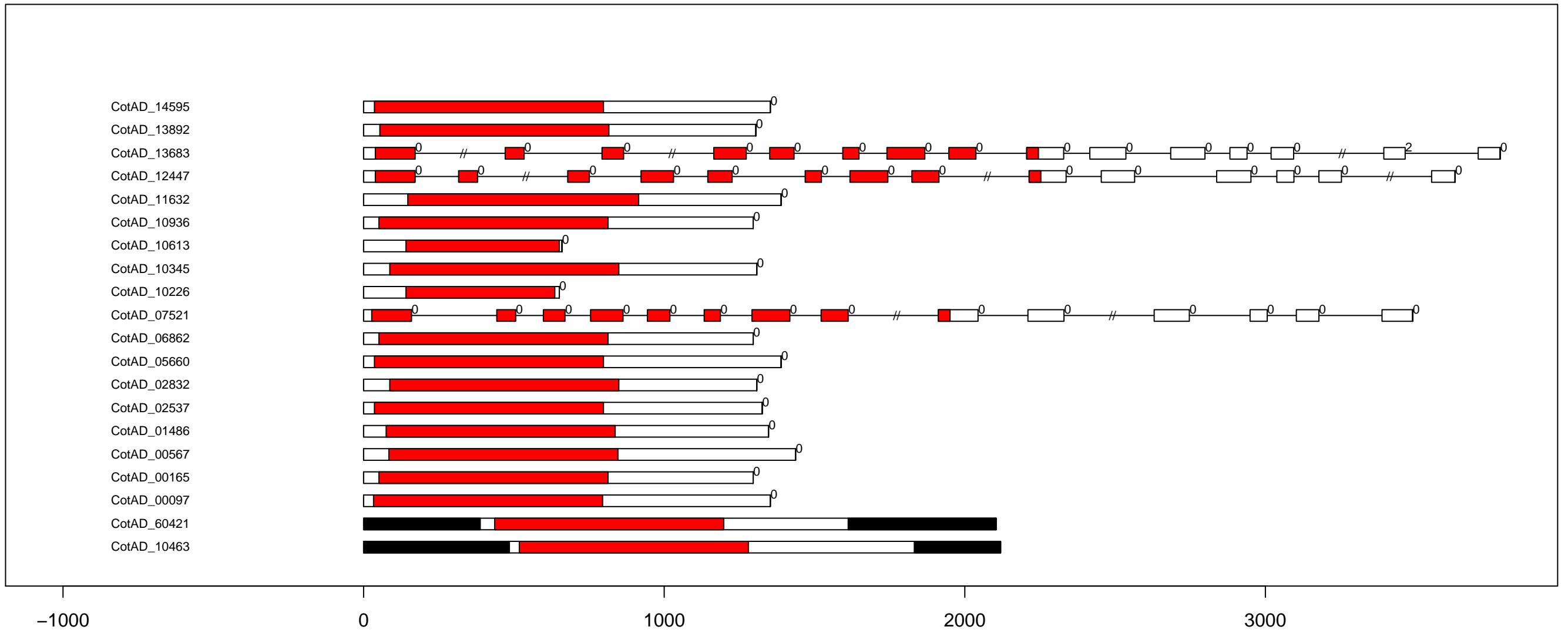

G.hi CAMK_CAMKL-CHK1 exon-intron and domain diagram (part 2)

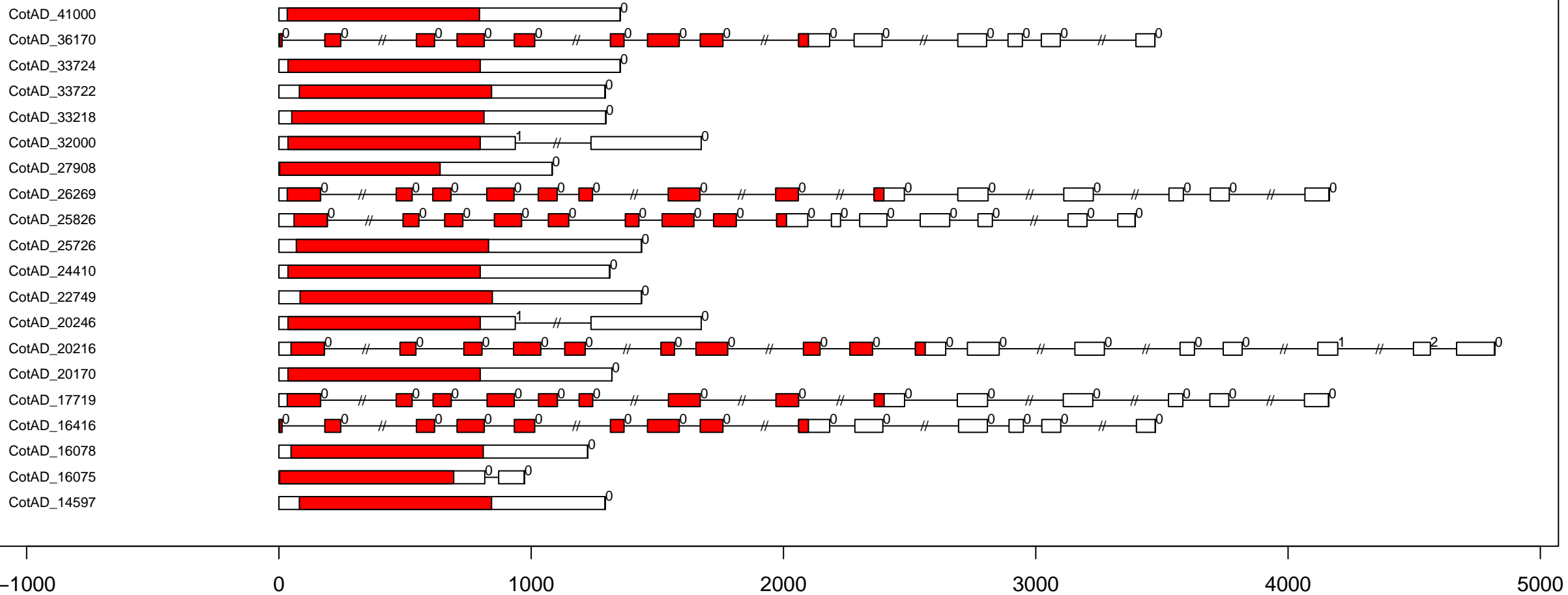

G.hi CAMK_CAMKL-CHK1 exon-intron and domain diagram (part 3)

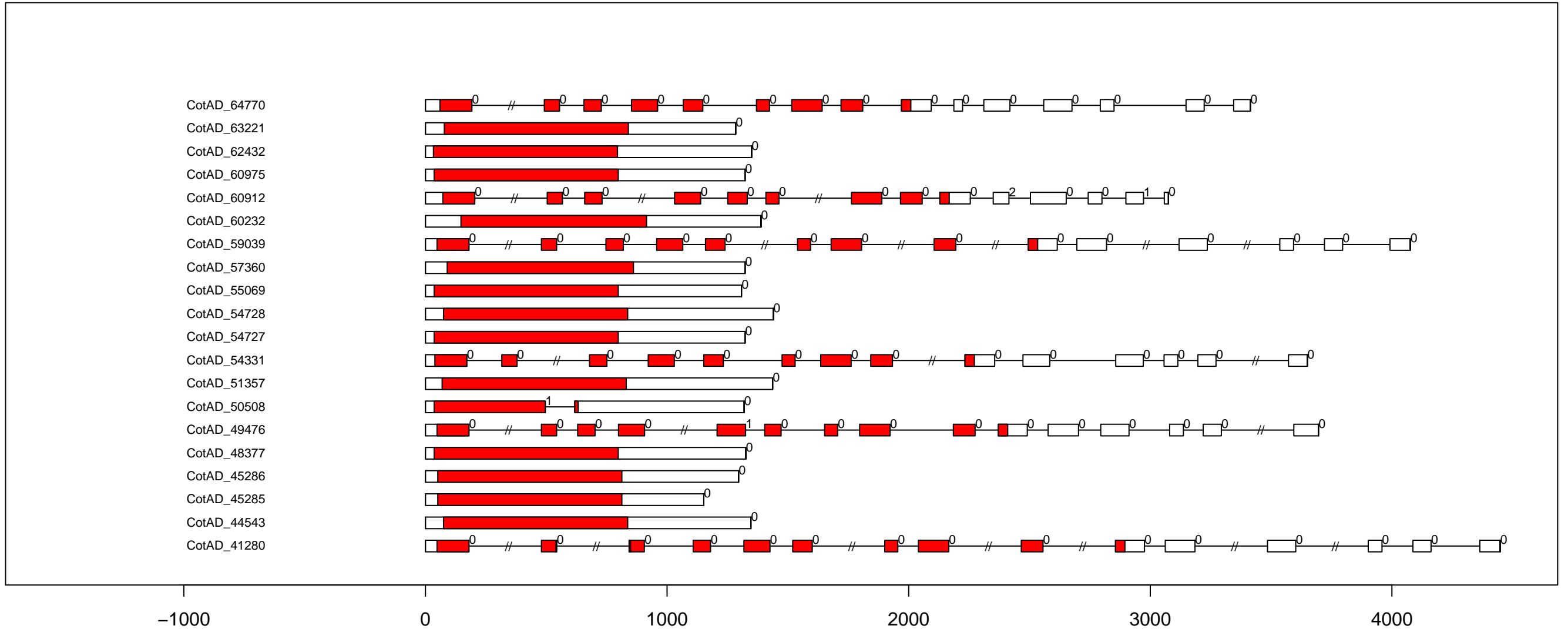

G.hi CAMK_CAMKL-CHK1 exon-intron and domain diagram (part 4)

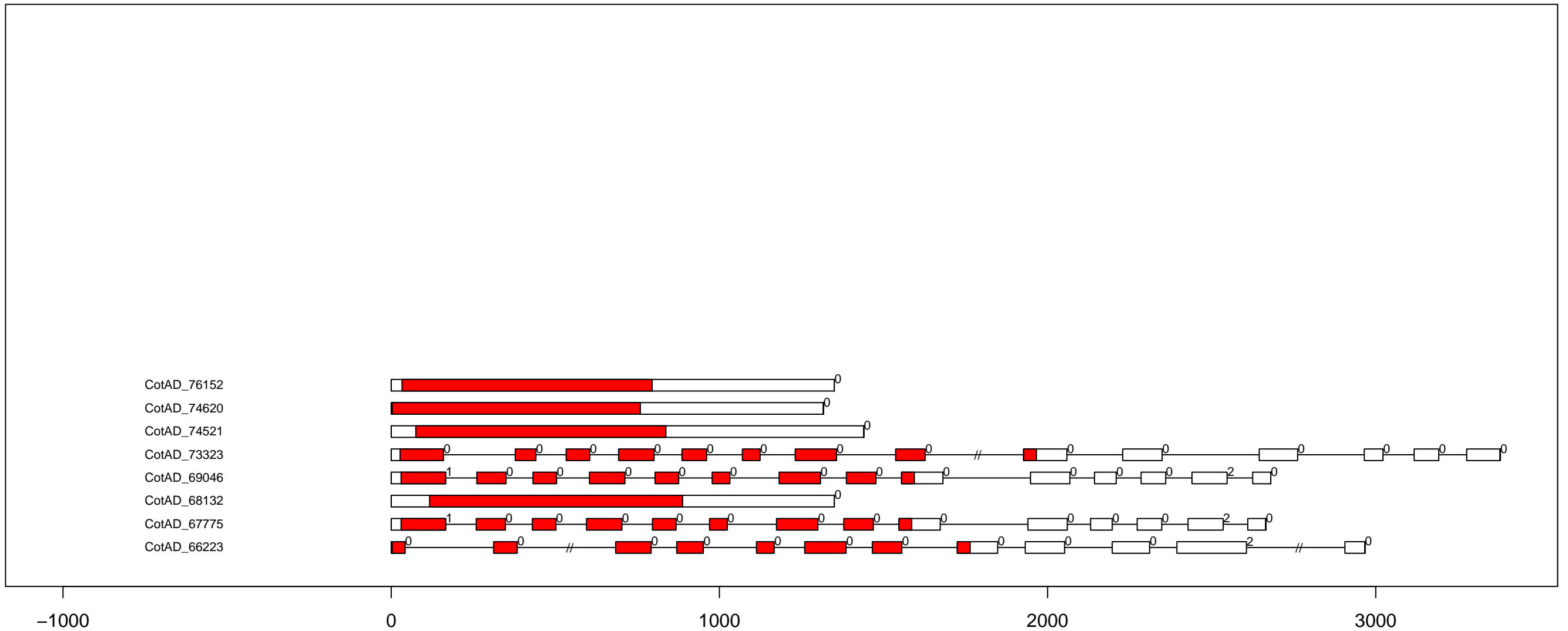

G.hi CAMK_CAMKL-LKB exon-intron and domain diagram (all)

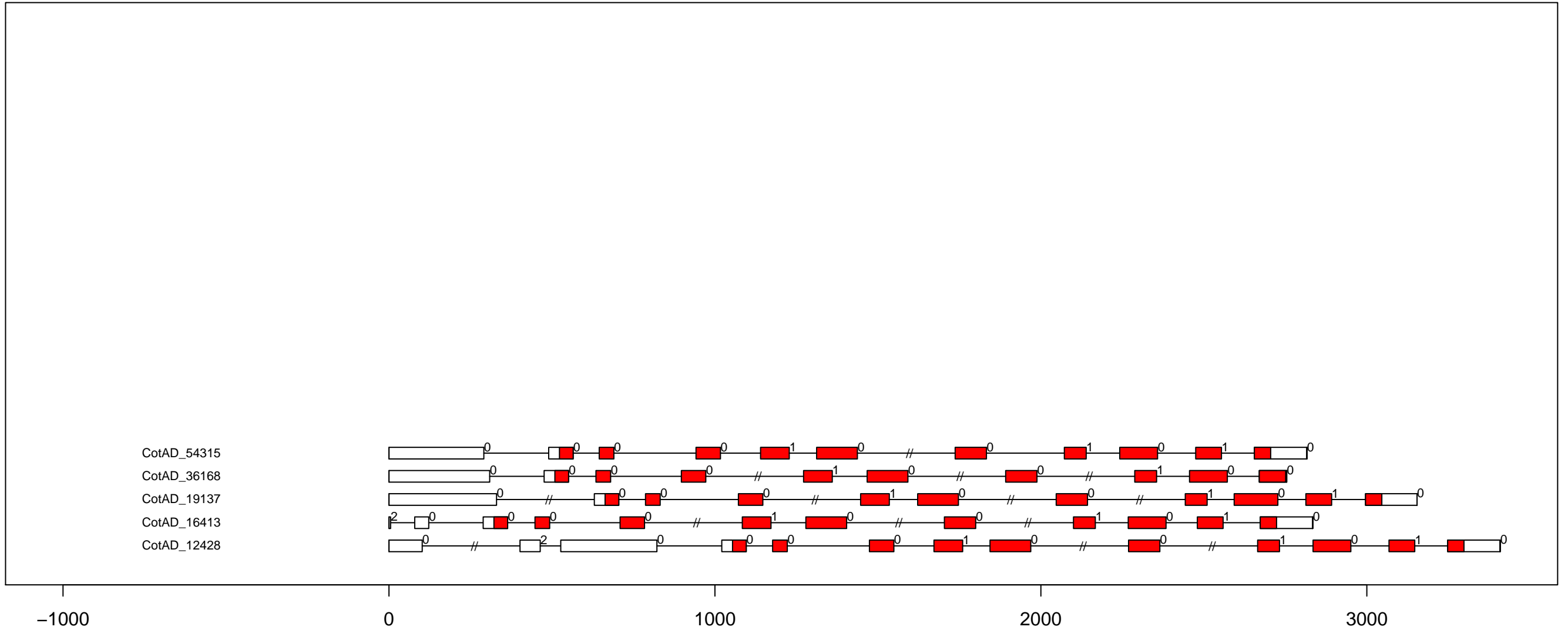

G.hi CAMK_CDPK exon-intron and domain diagram (part 1)

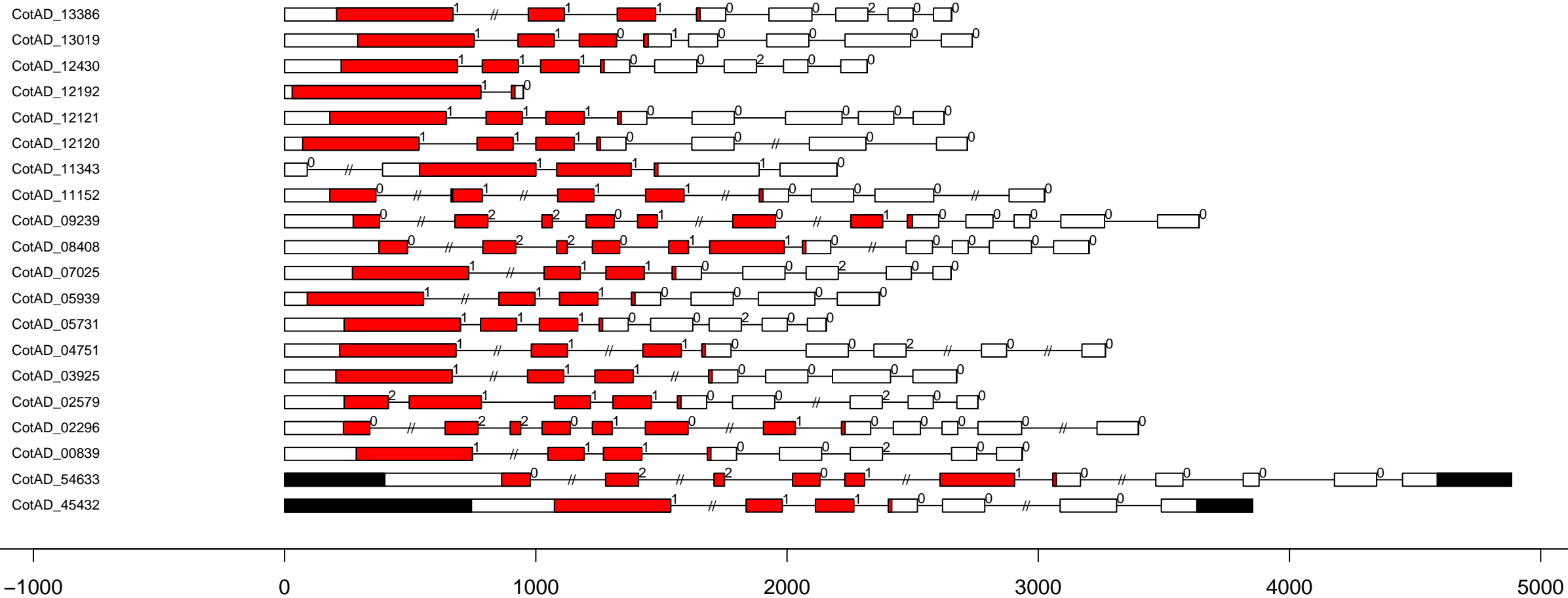

G.hi CAMK_CDPK exon-intron and domain diagram (part 2)

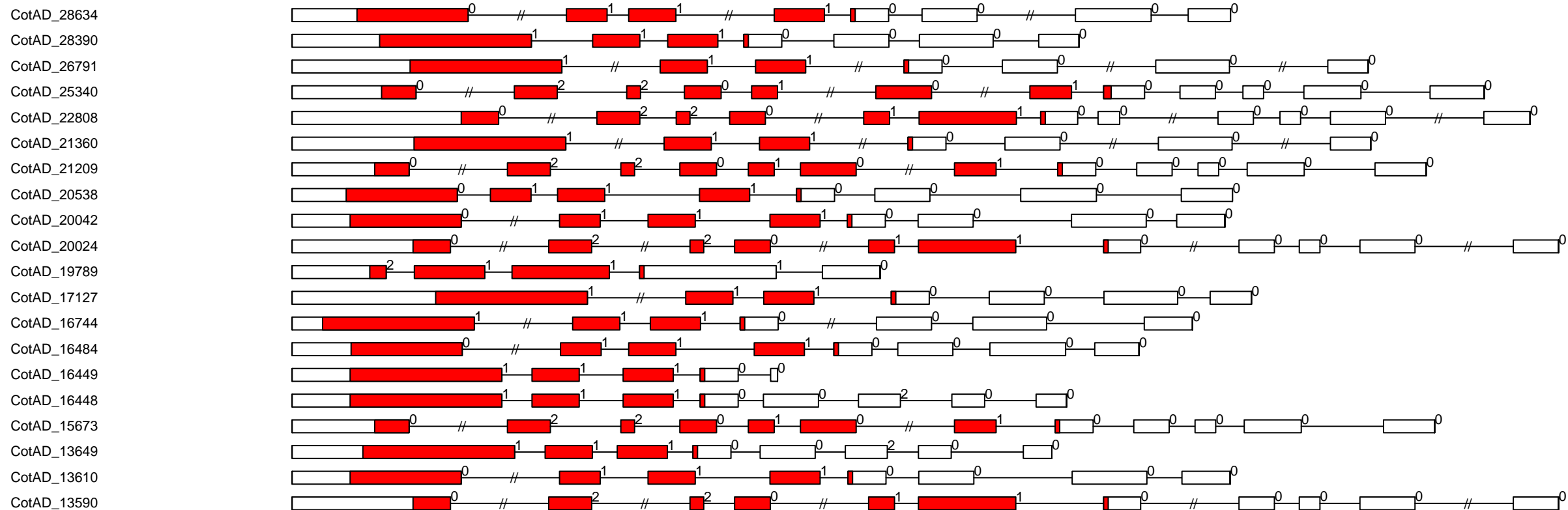

-1000

0

1000

2000

3000

4000

G.hi CAMK_CDPK exon-intron and domain diagram (part 3)

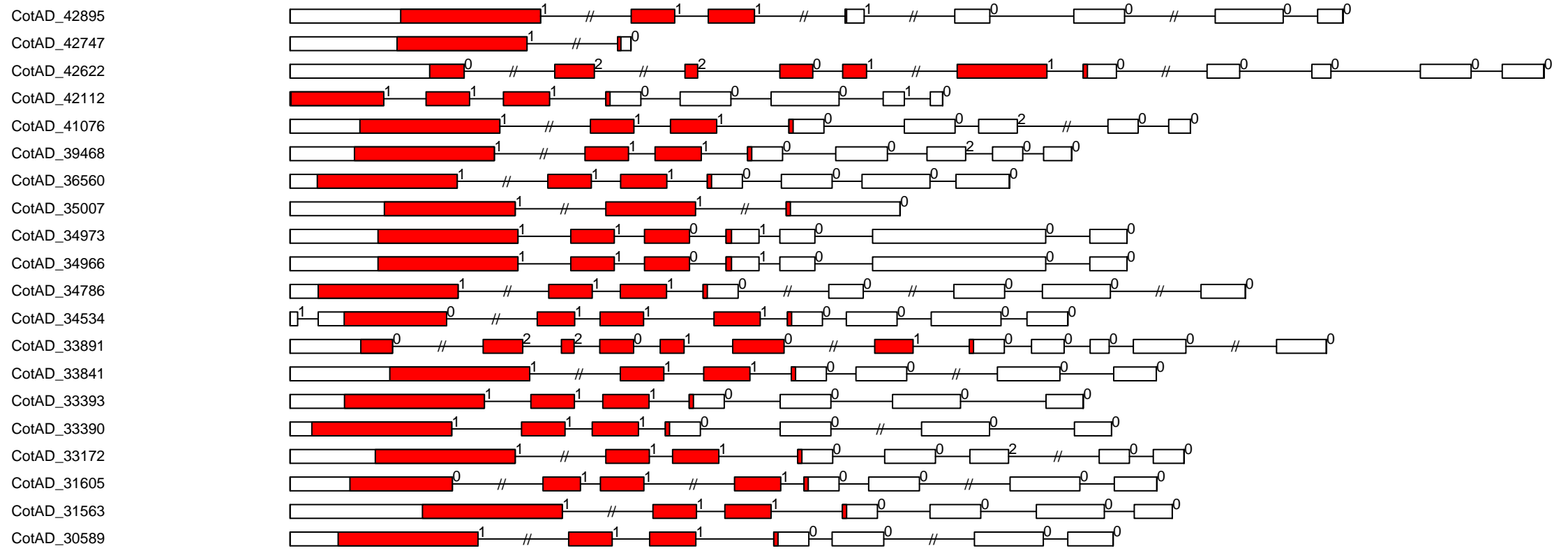

-1000

0

1000

2000

3000

4000

G.hi CAMK_CDPK exon-intron and domain diagram (part 4)

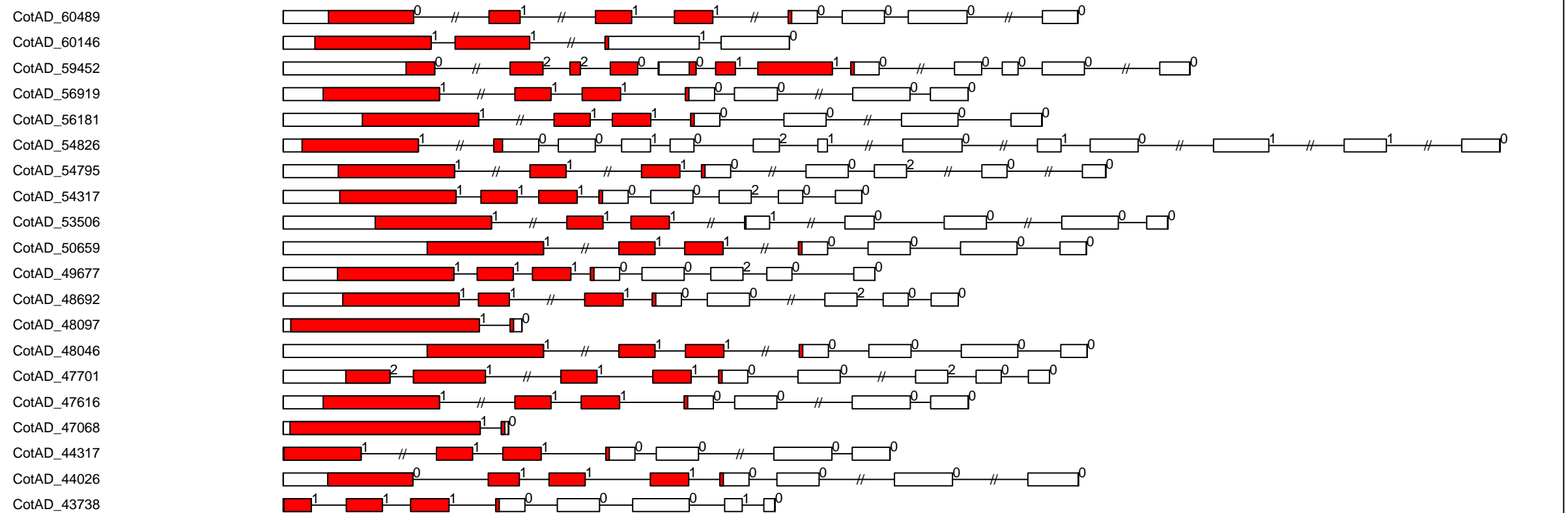

G.hi CAMK_CDPK exon-intron and domain diagram (part 5)

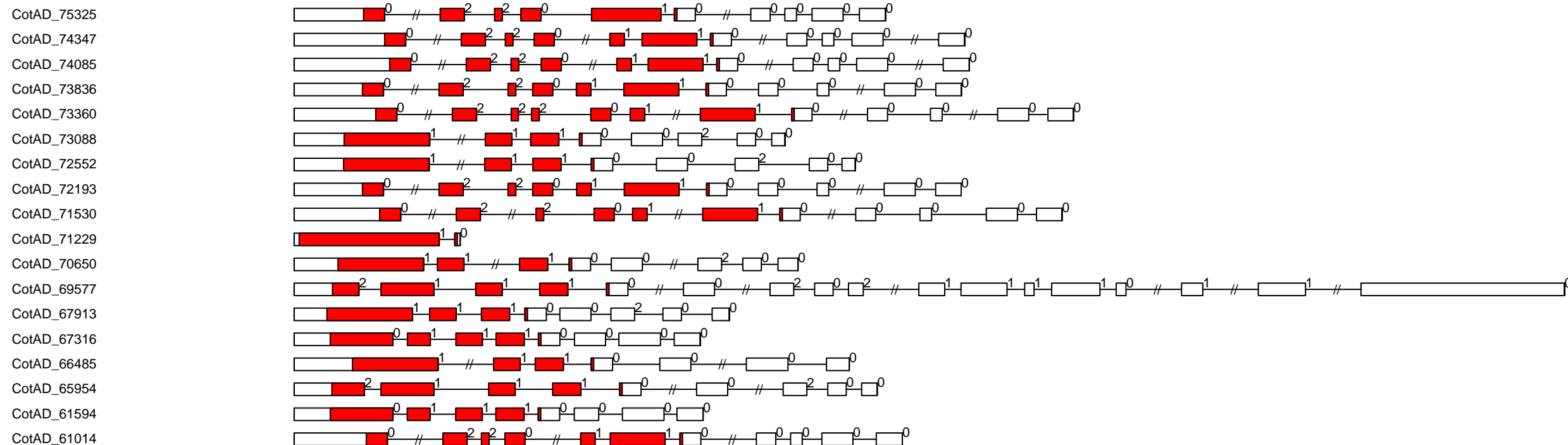

G.hi CAMK_OST1L exon-intron and domain diagram (all)

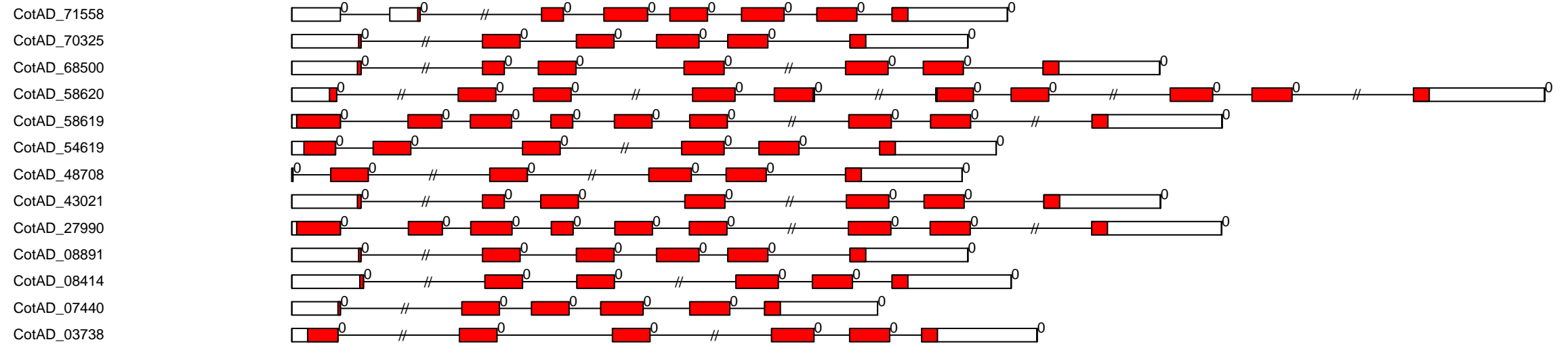

-1000

0

1000

2000

3000

G.hi CK1_CK1 exon-intron and domain diagram (part 1)

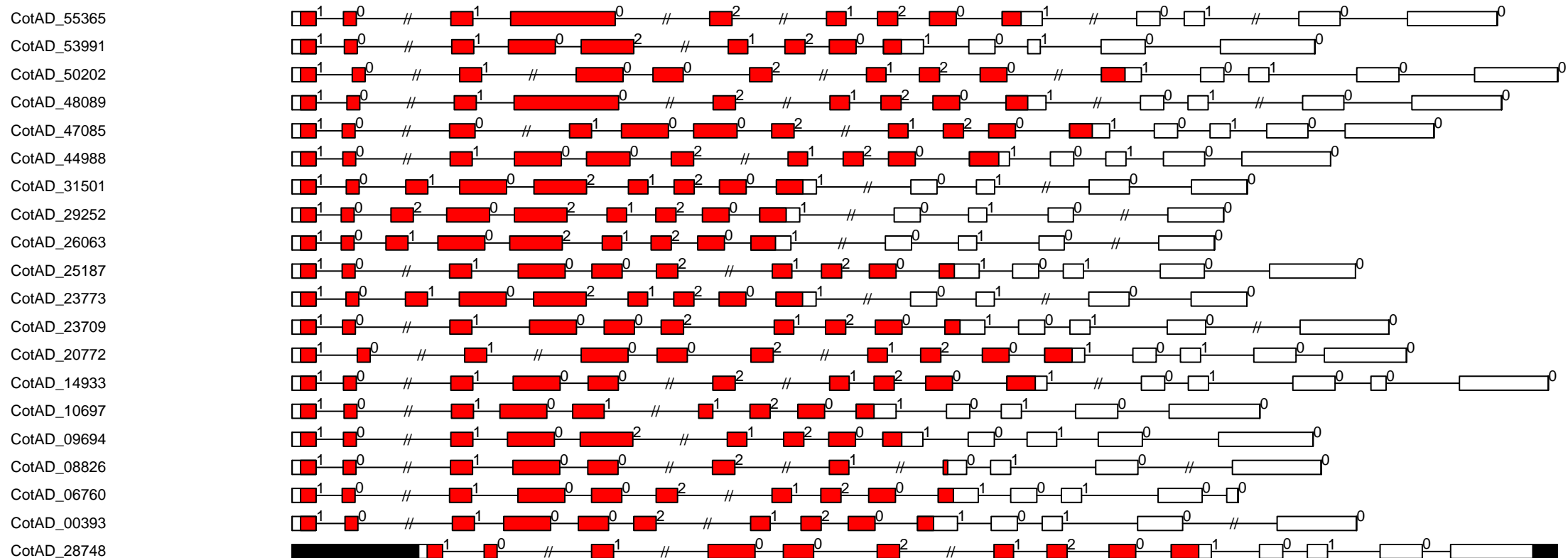

G.hi CK1_CK1 exon-intron and domain diagram (part 2)

CotAD_70399
CotAD_62242
CotAD_61768

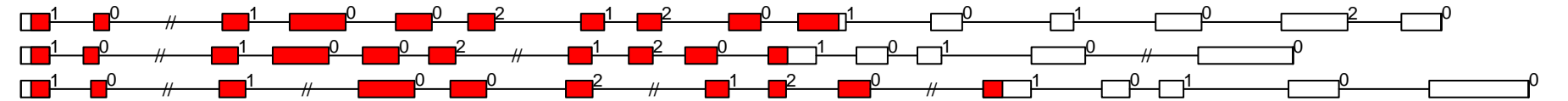

G.hi CK1_CK1-PI exon-intron and domain diagram (part 1)

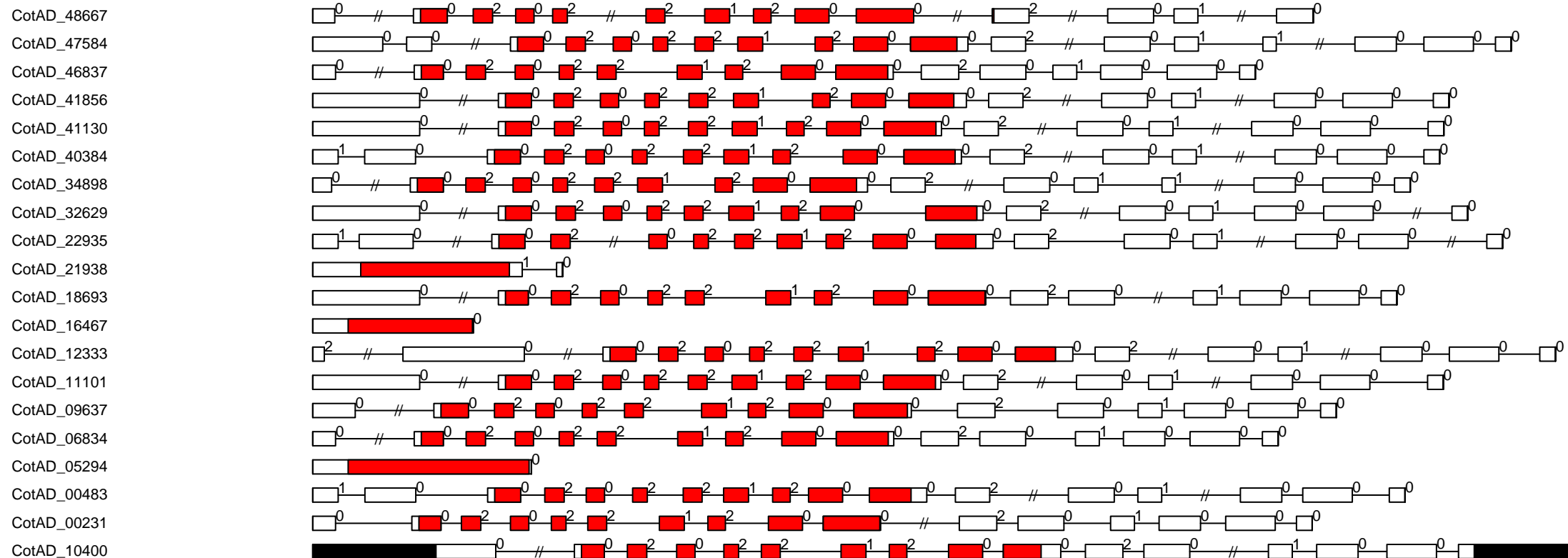

G.hi CK1_CK1-PI exon-intron and domain diagram (part 2)

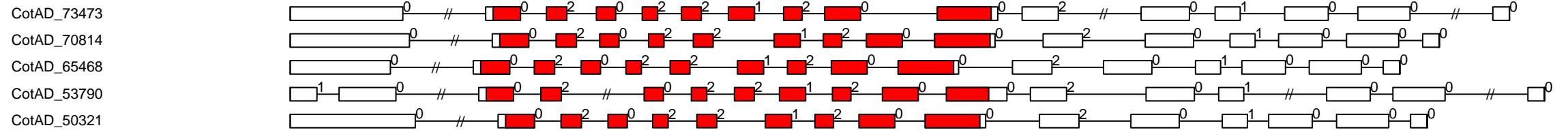

G.hi CMGC_CDK-CCRK exon-intron and domain diagram (all)

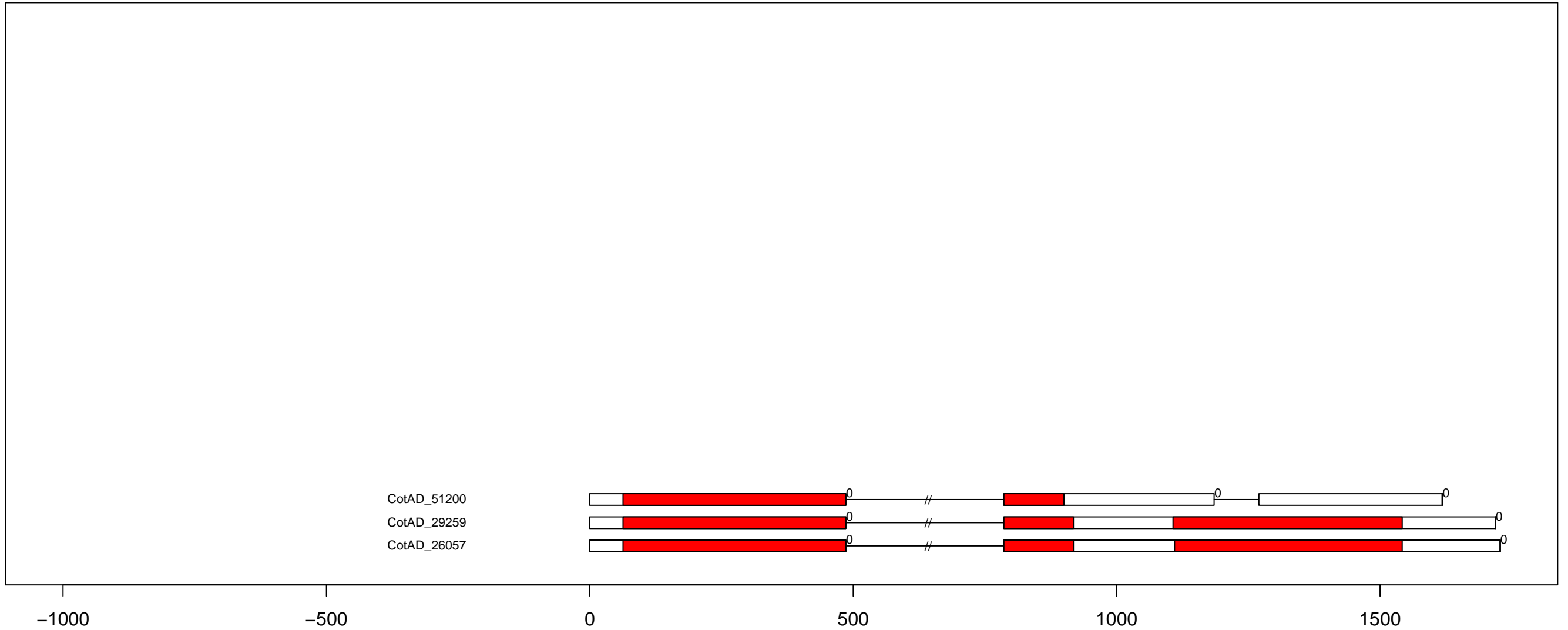

G.hi CMGC_CDK-CDK7 exon-intron and domain diagram (all)

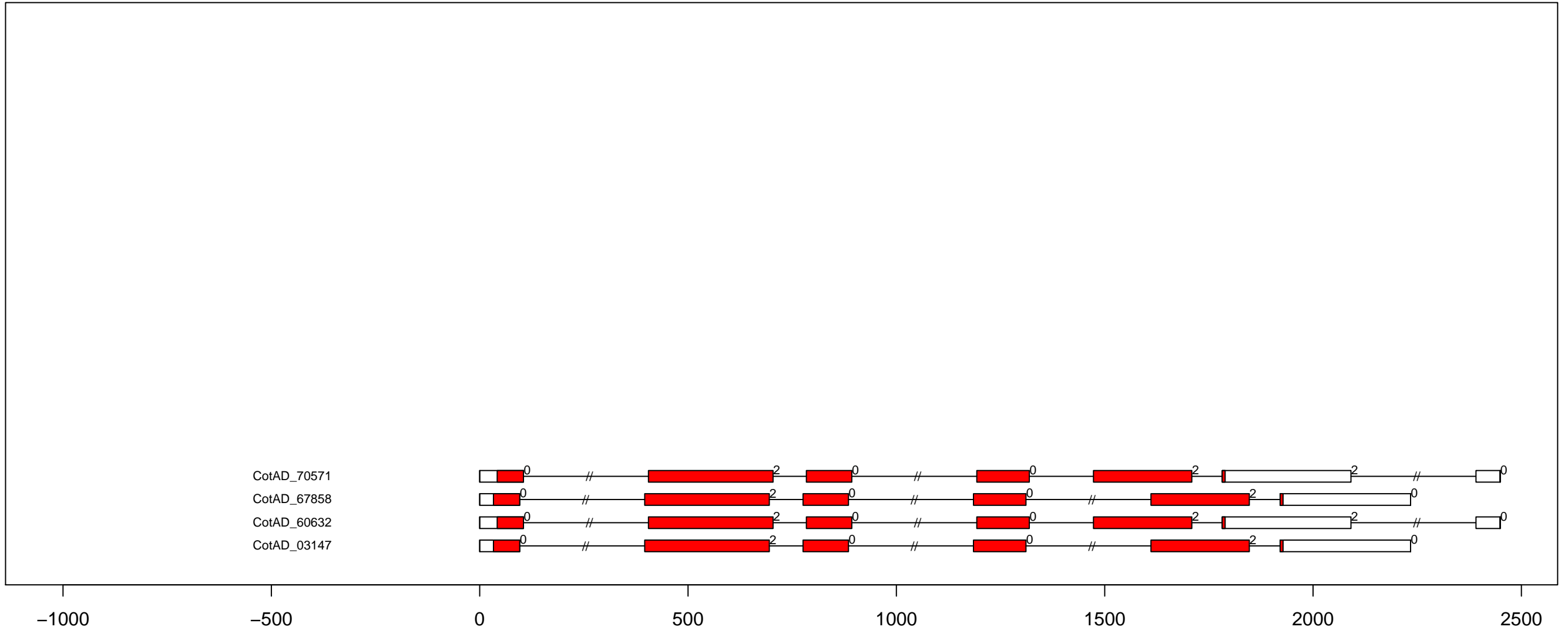

G.hi CMGC_CDK-CDK8 exon-intron and domain diagram (all)

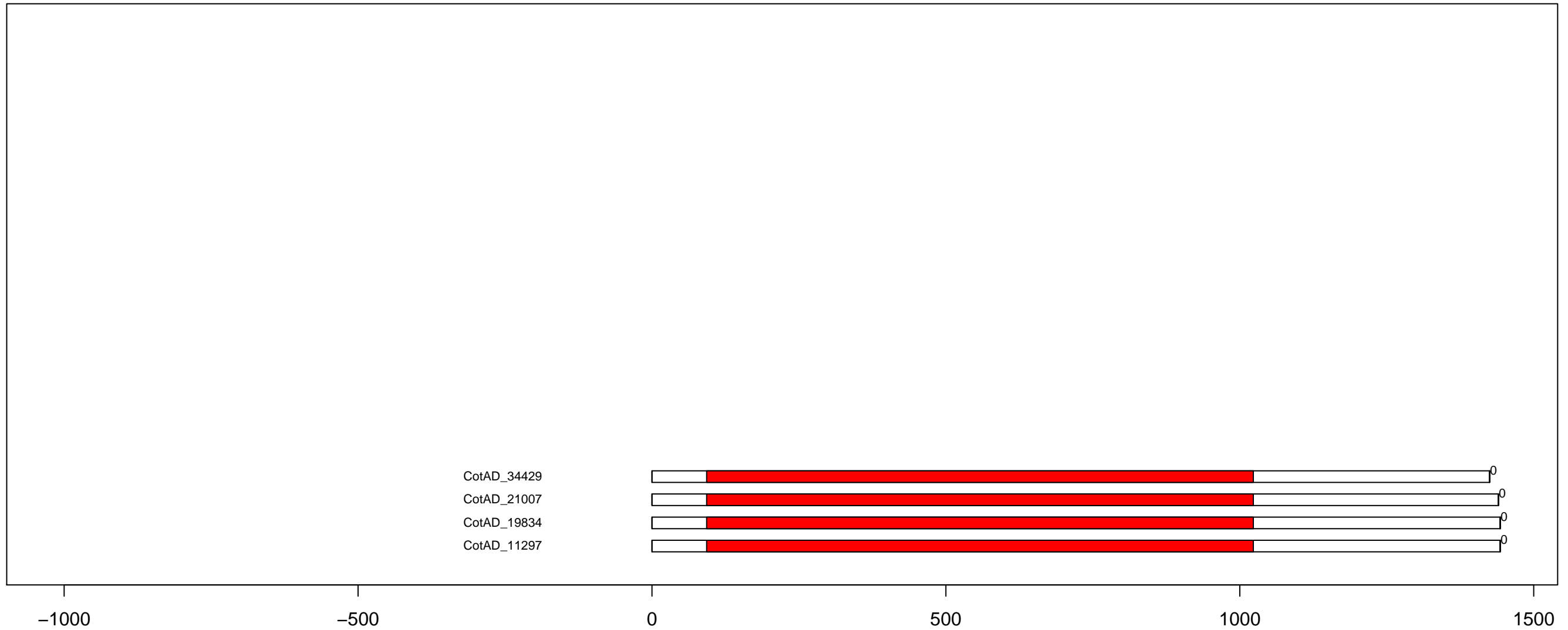

G.hi CMGC_CDK-CRK7-CDK9 exon-intron and domain diagram (part 1)

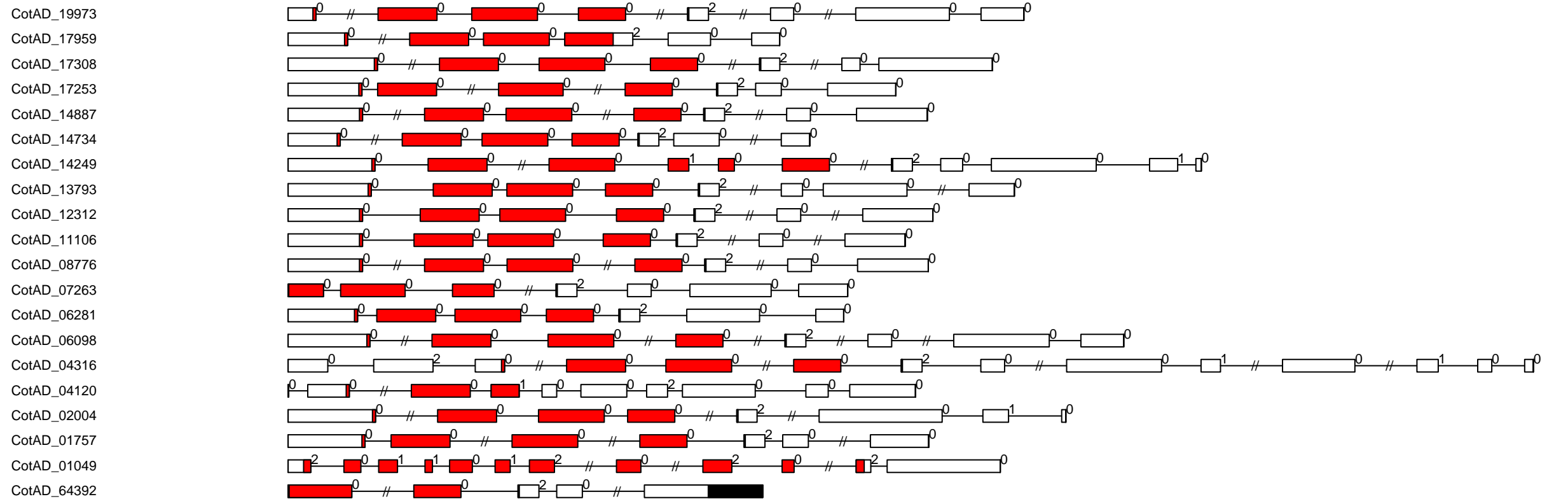

G.hi CMGC_CDK-CRK7-CDK9 exon-intron and domain diagram (part 3)

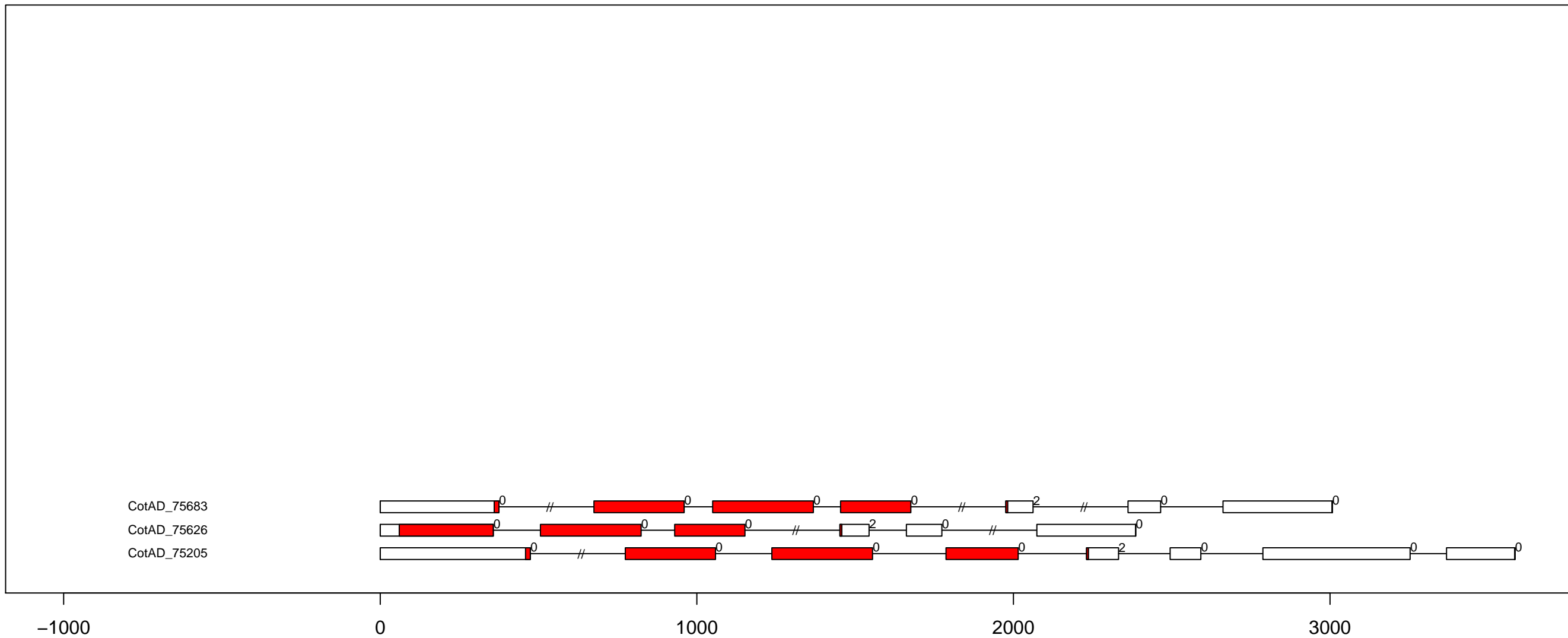

G.hi CMGC_CDK-PITSLRE exon-intron and domain diagram (all)

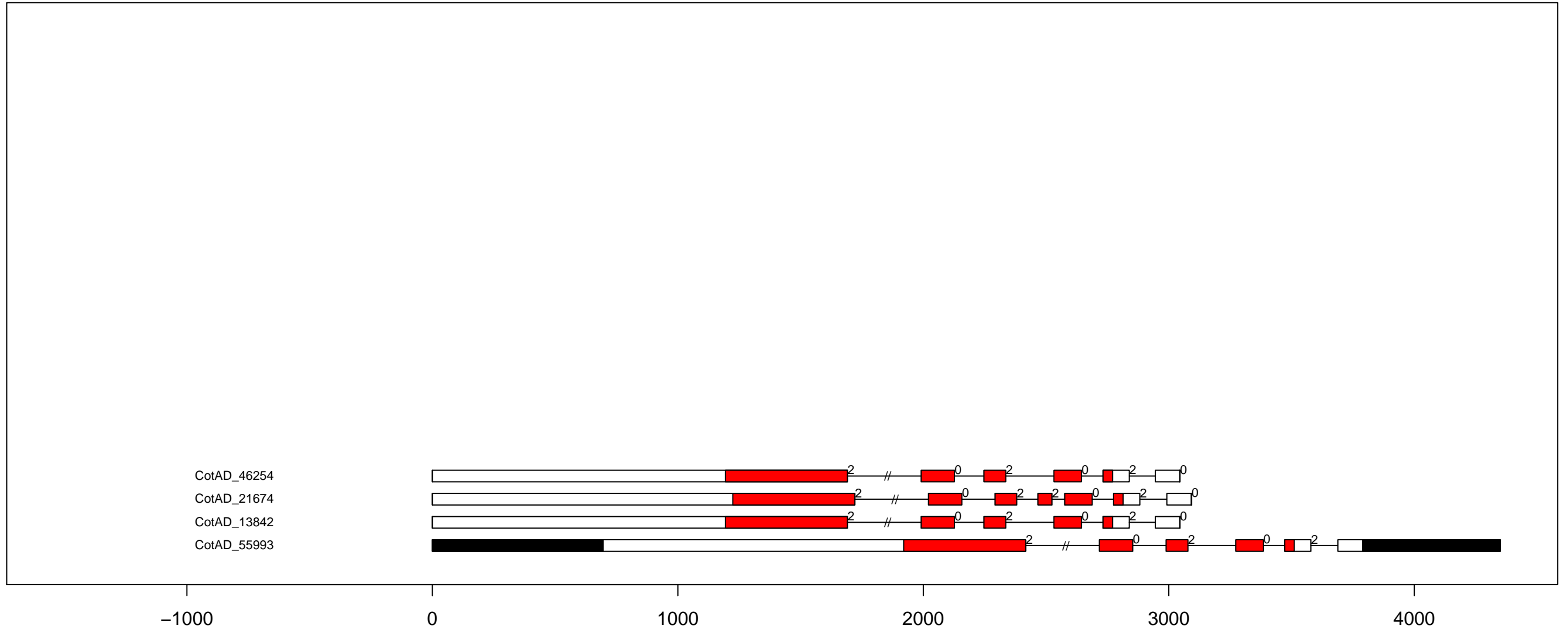

G.hi CMGC_CDK-PI exon-intron and domain diagram (all)

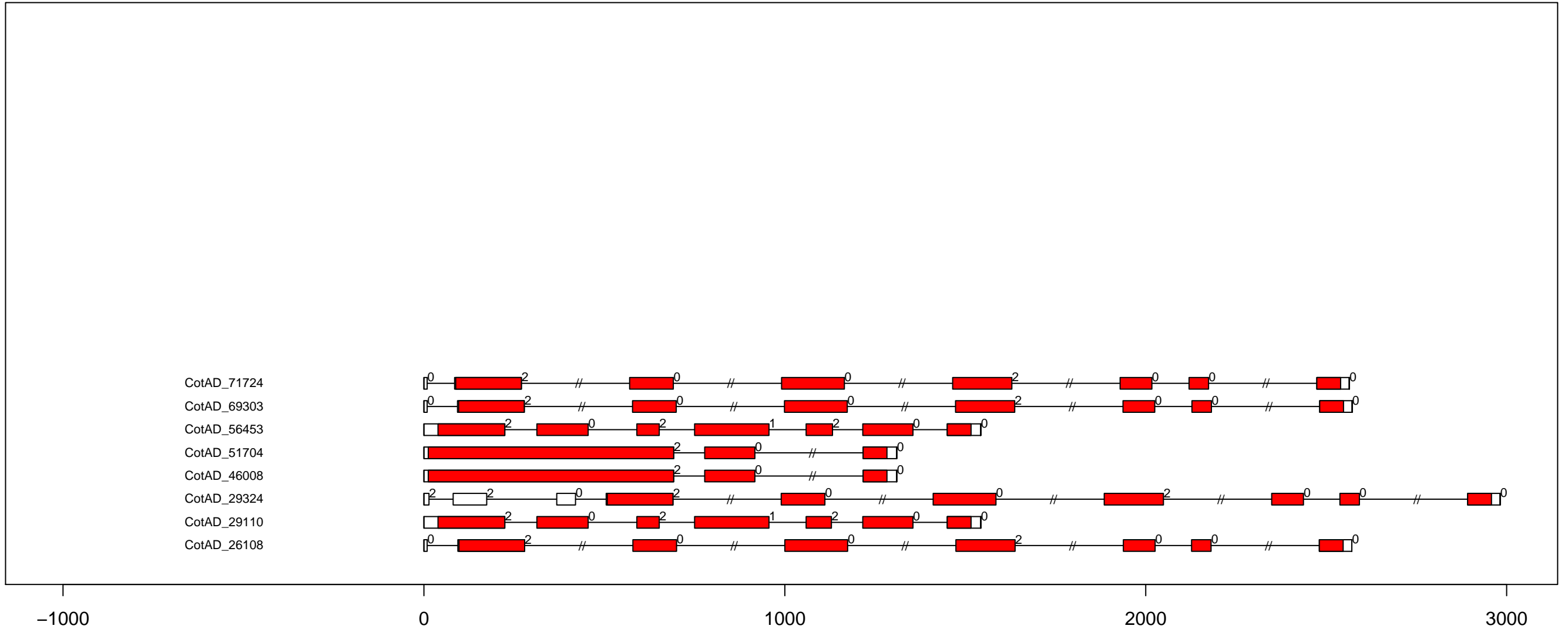

G.hi CMGC_CK2 exon-intron and domain diagram (all)

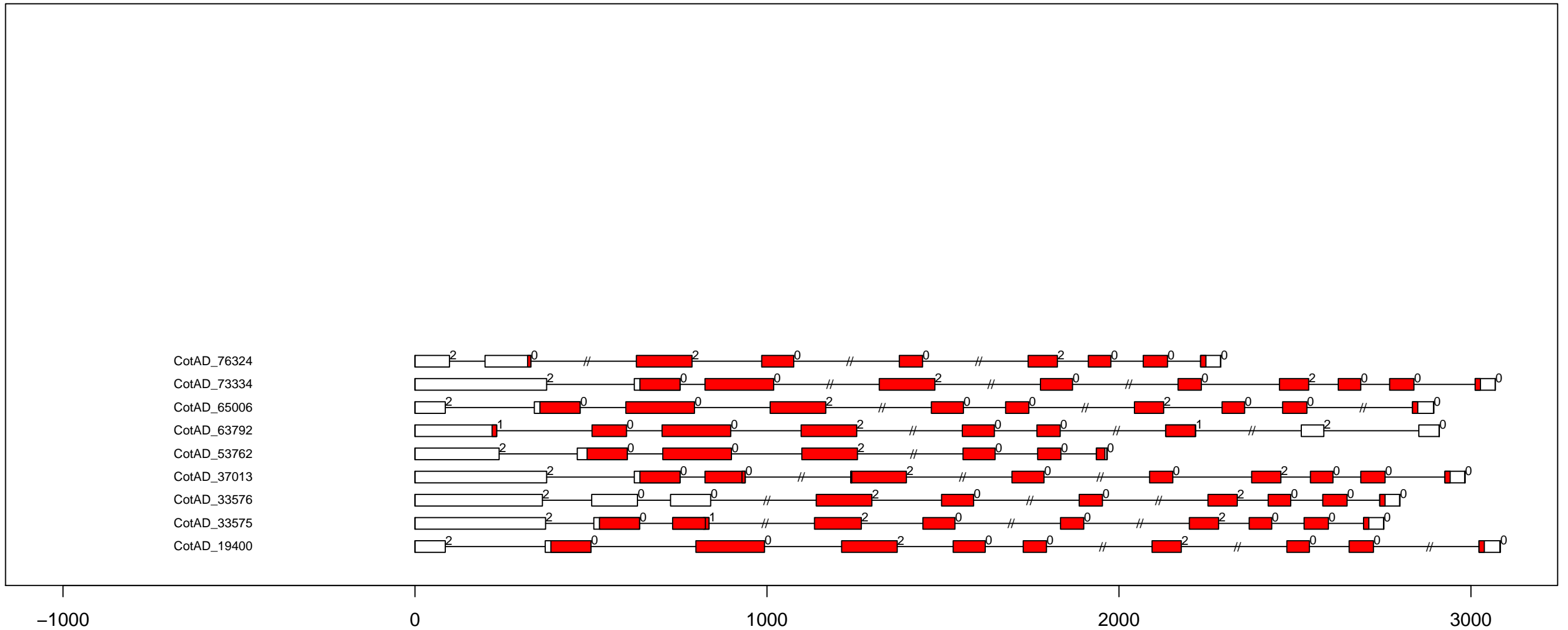

G.hi CMGC_CLK exon-intron and domain diagram (all)

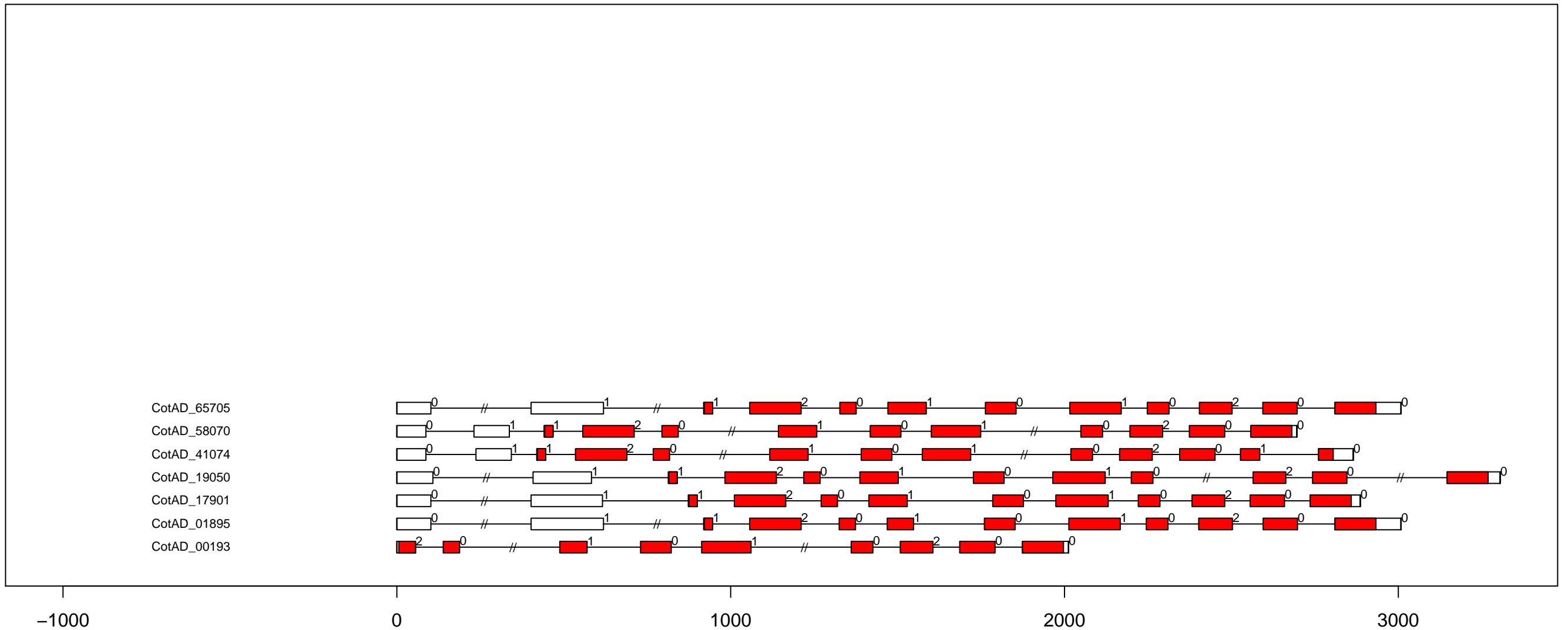

G.hi CMGC_DYRK-PRP4 exon-intron and domain diagram (all)

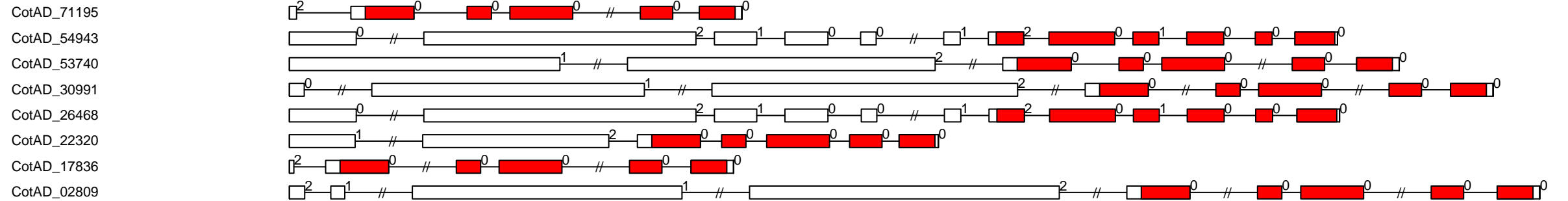

G.hi CMGC_DYRK–YAK exon–intron and domain diagram (all)

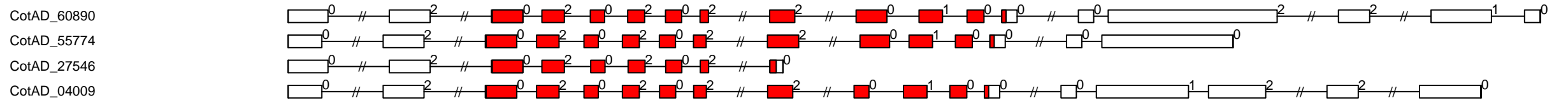

0

2000

4000

6000

G.hi CMGC_GSKL exon-intron and domain diagram (all)

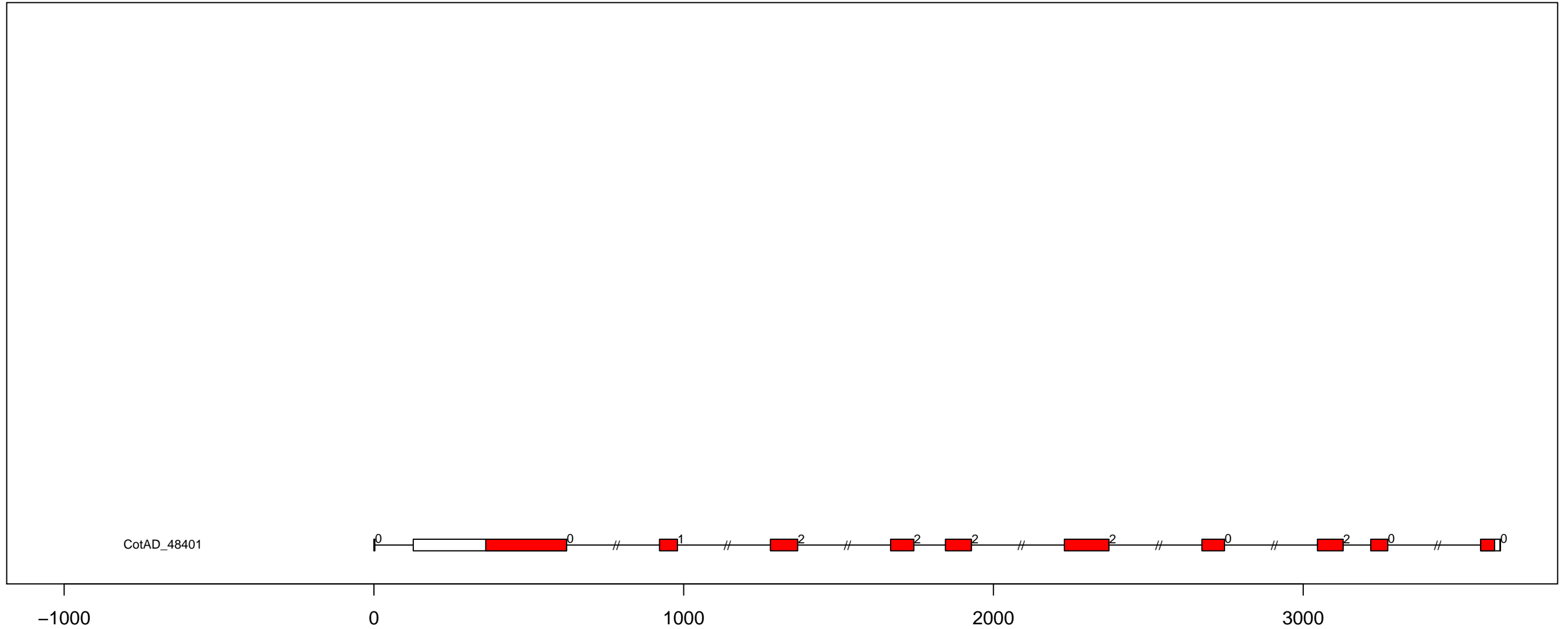

G.hi CMGC_GSK exon-intron and domain diagram (all)

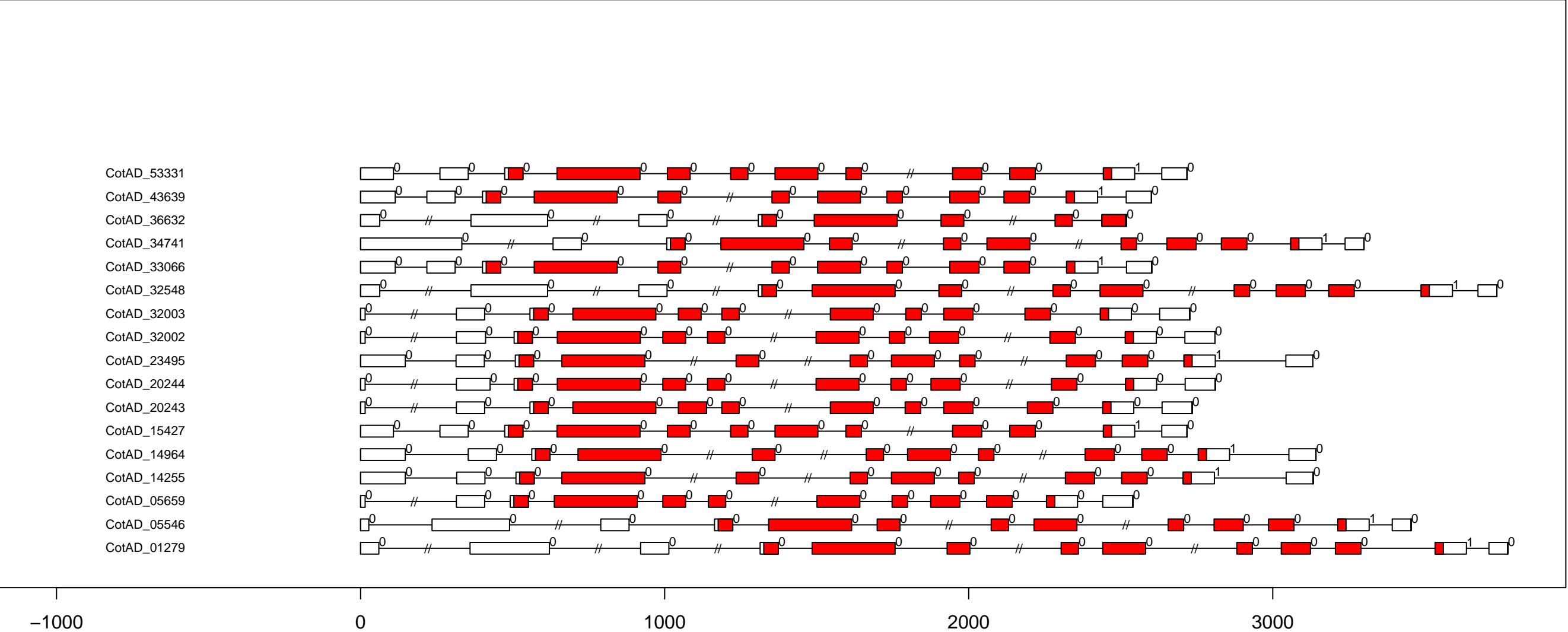

G.hi CMGC_MAPK exon-intron and domain diagram (part 1)

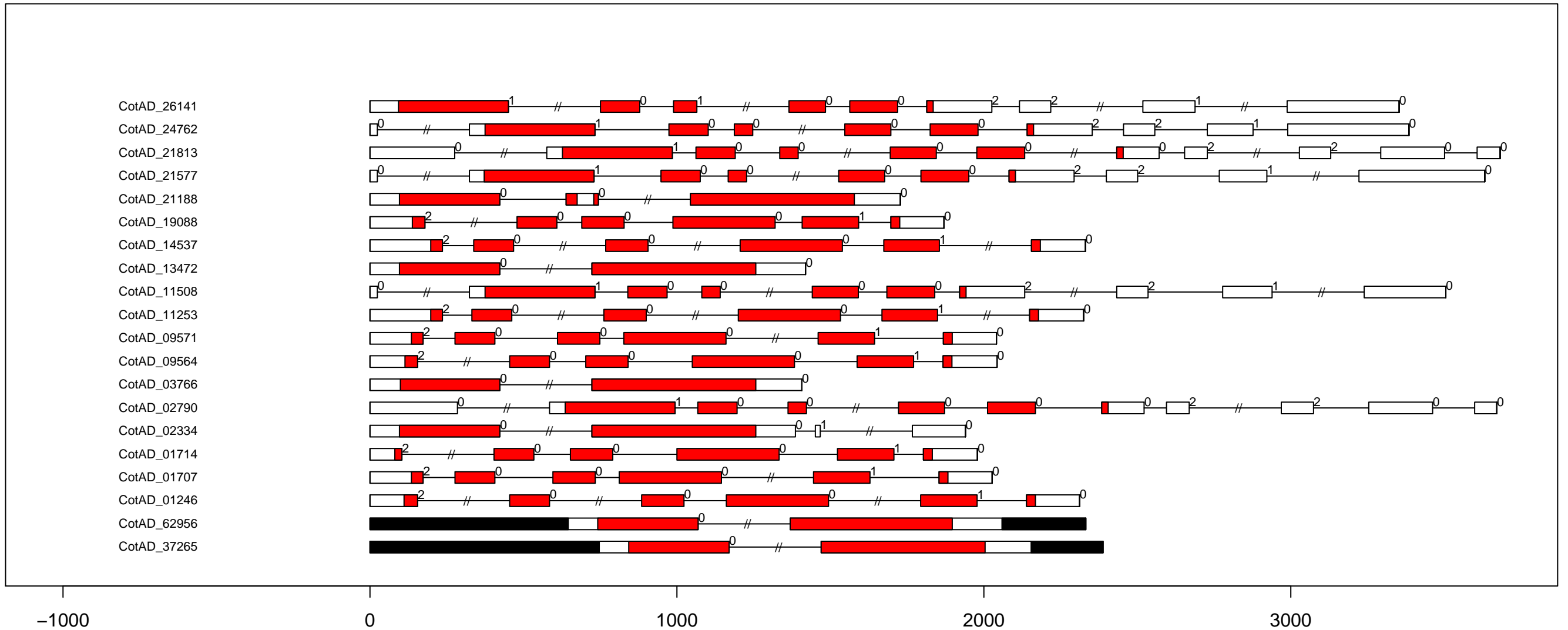

G.hi CMGC_MAPK exon-intron and domain diagram (part 3)

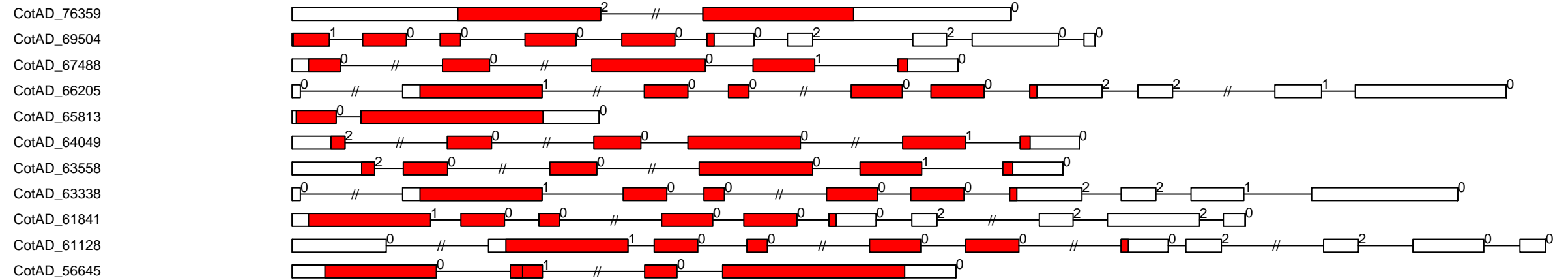

-1000

0

1000

2000

3000

G.hi CMGC_PI-Tthe exon-intron and domain diagram (all)

CotAD_52759

CotAD_00441

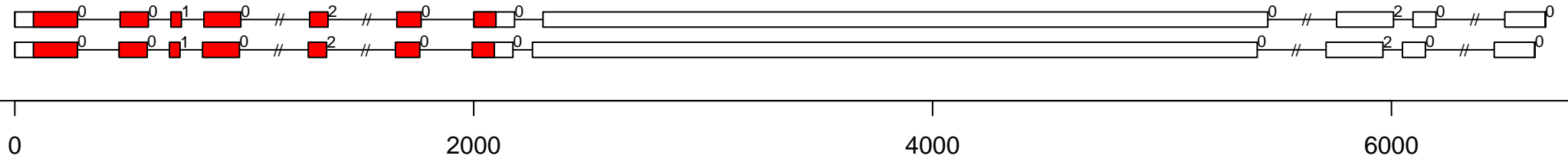

G.hi CMGC_RCK exon-intron and domain diagram (all)

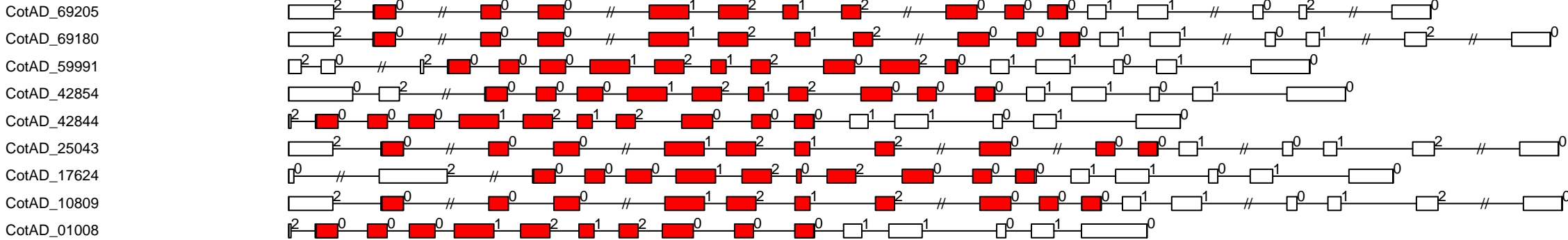

-1000

0

1000

2000

3000

4000

G.hi CMGC_SRPK exon-intron and domain diagram (all)

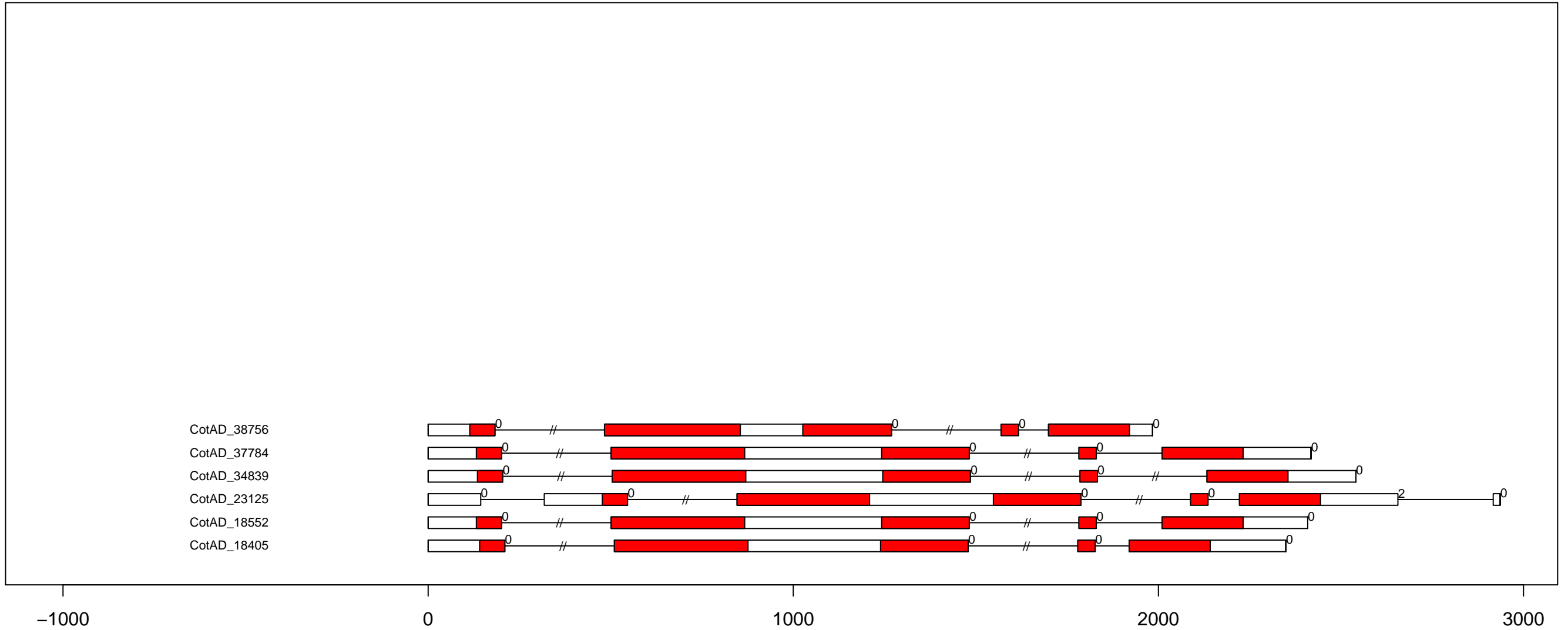

G.hi Group-PI-2 exon-intron and domain diagram (all)

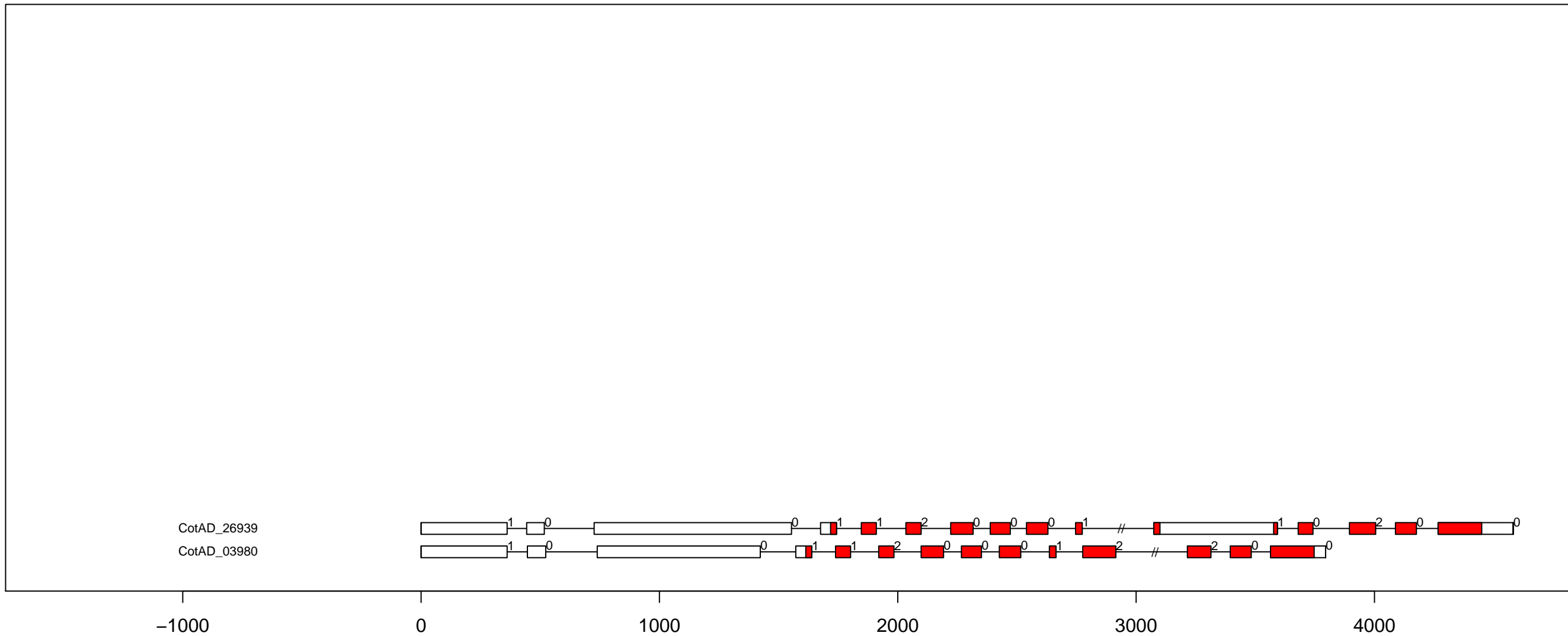

G.hi Group-PI-3 exon-intron and domain diagram (all)

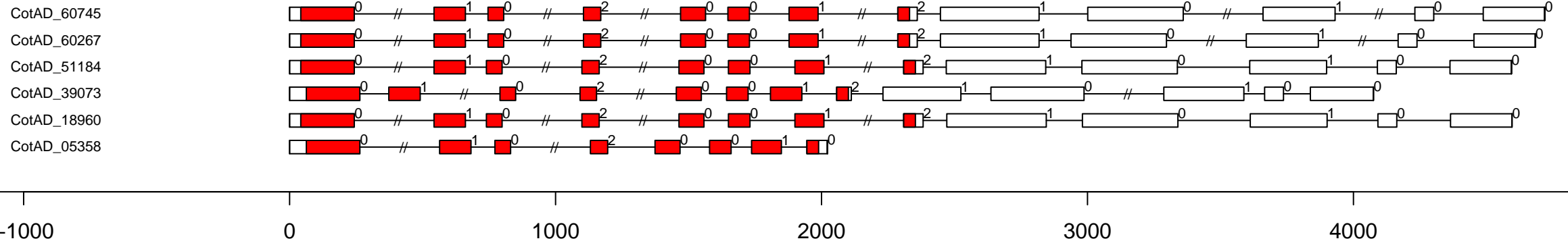

G.hi IRE1 exon-intron and domain diagram (all)

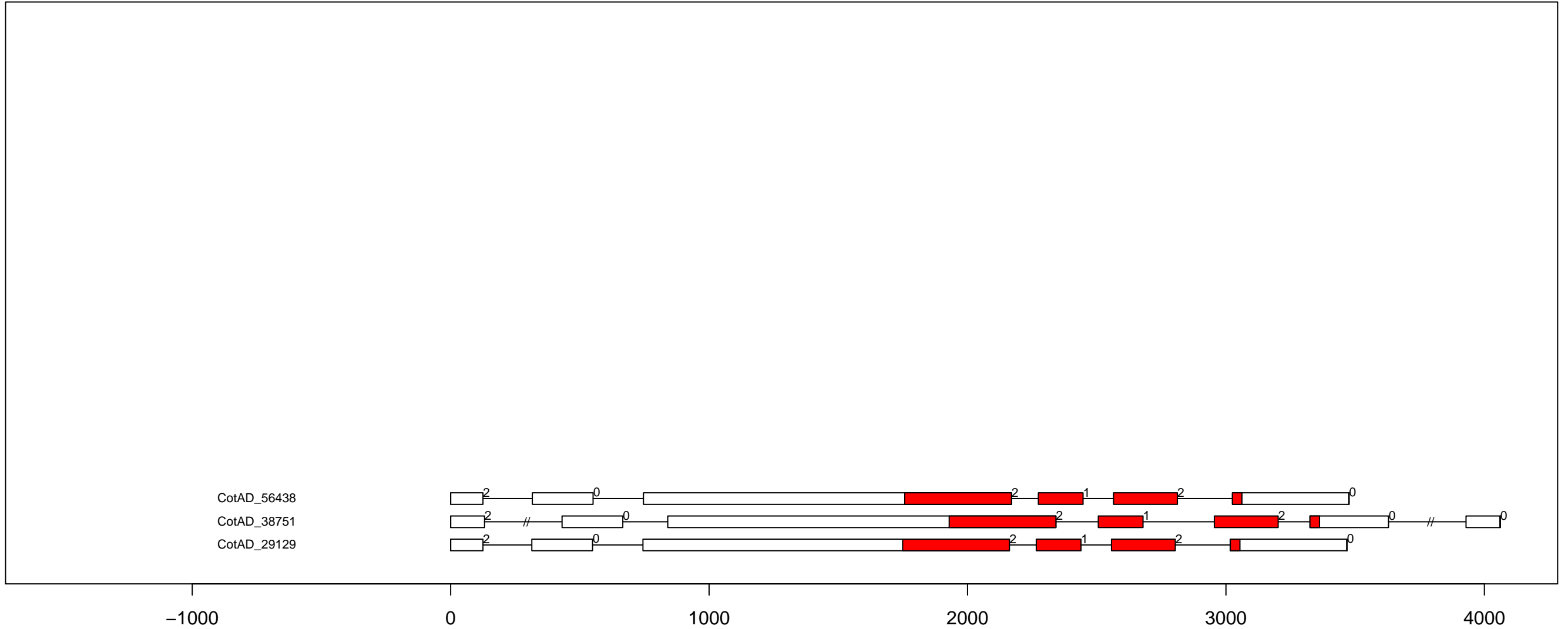

G.hi NAK exon-intron and domain diagram (all)

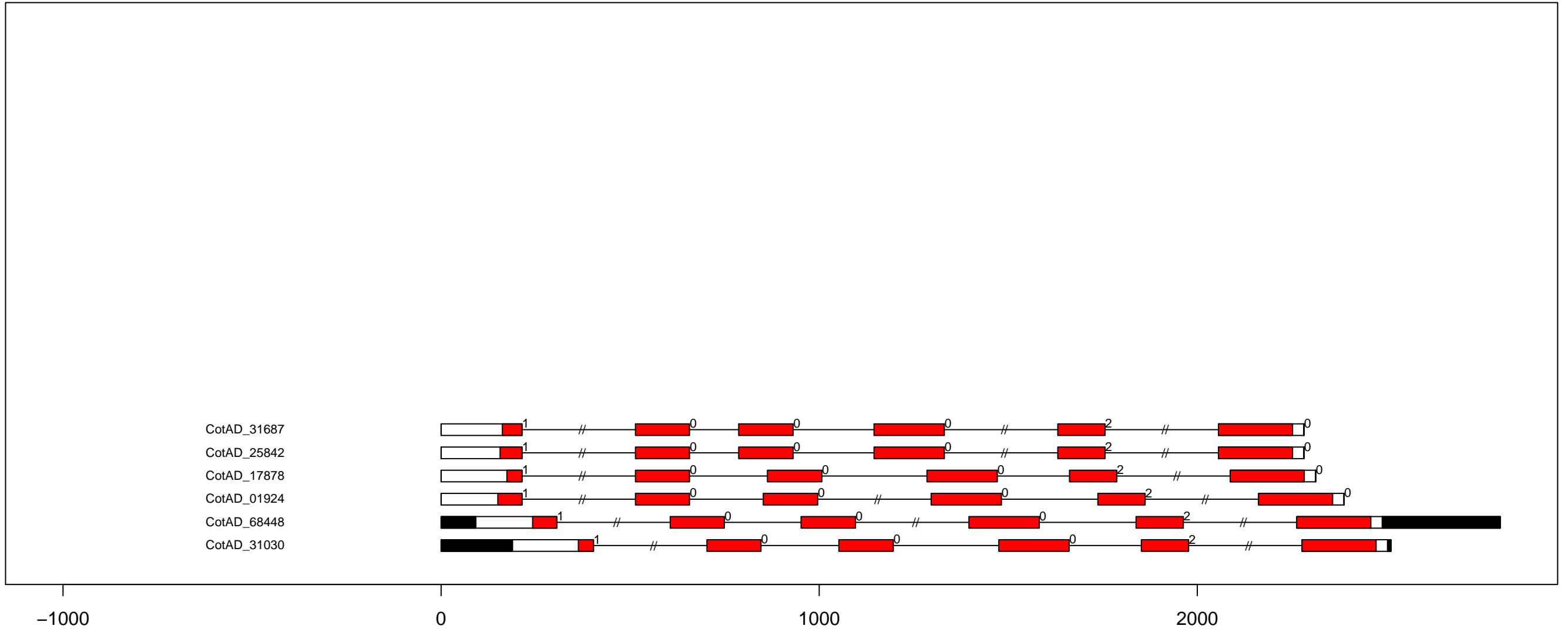

G.hi NEK exon-intron and domain diagram (all)

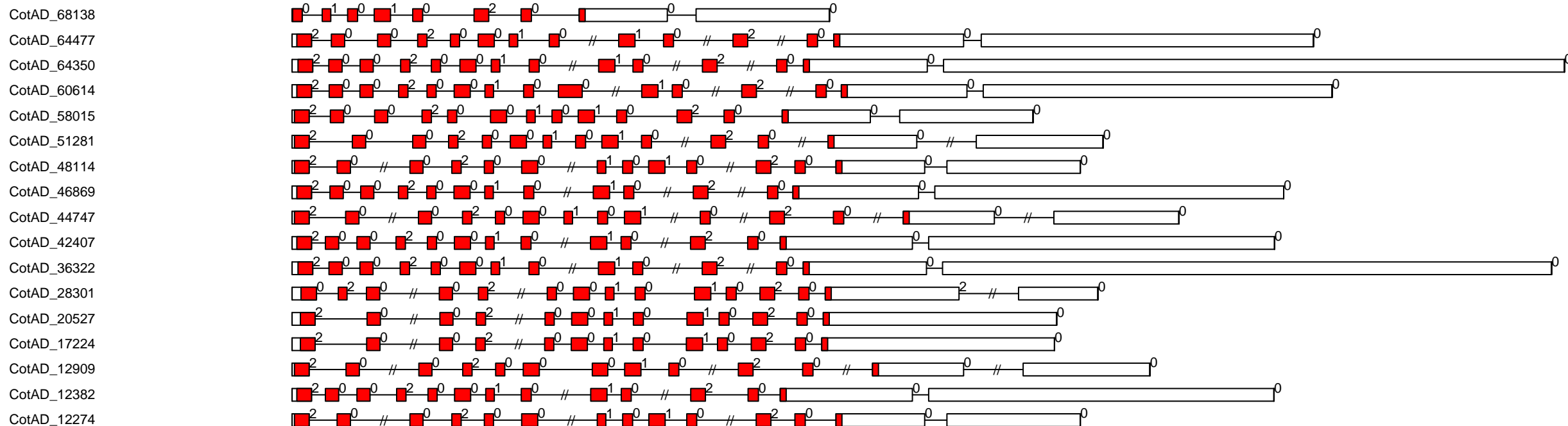

G.hi PEK_GCIN2 exon-intron and domain diagram (all)

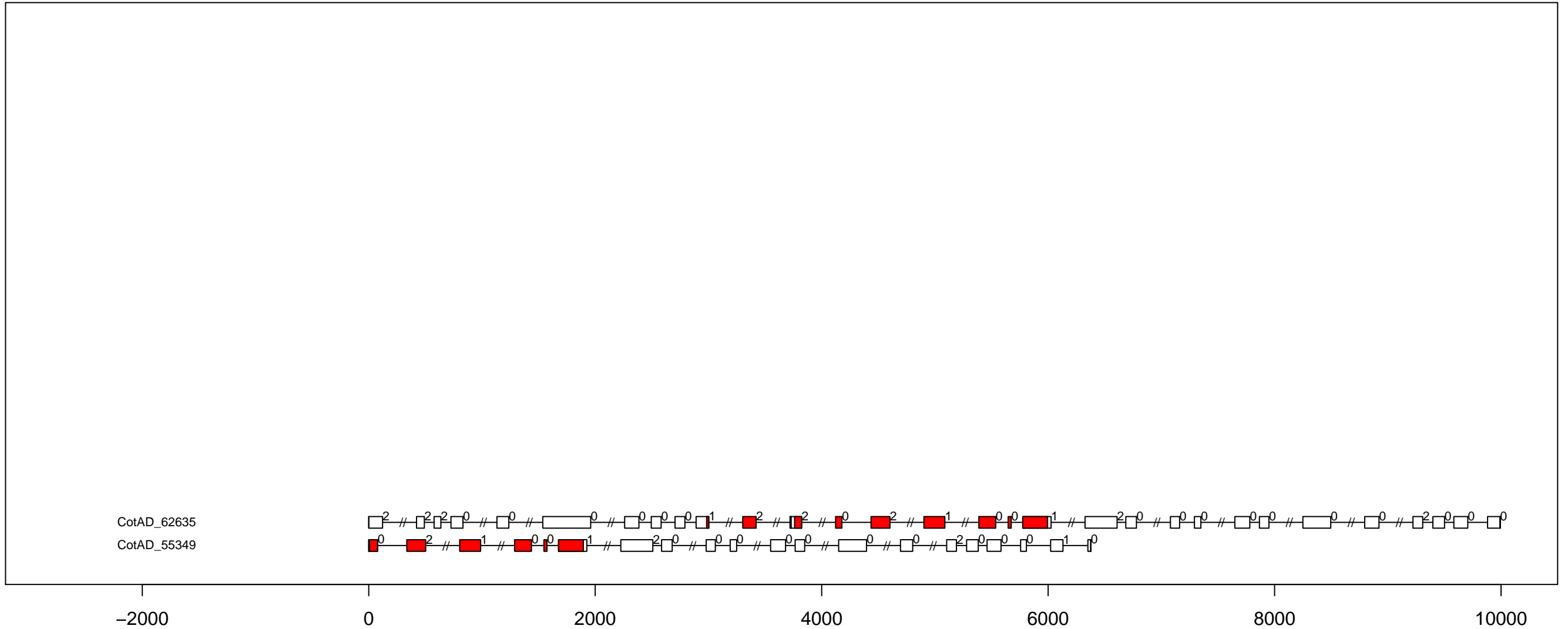

G.hi PEK_PEK exon-intron and domain diagram (all)

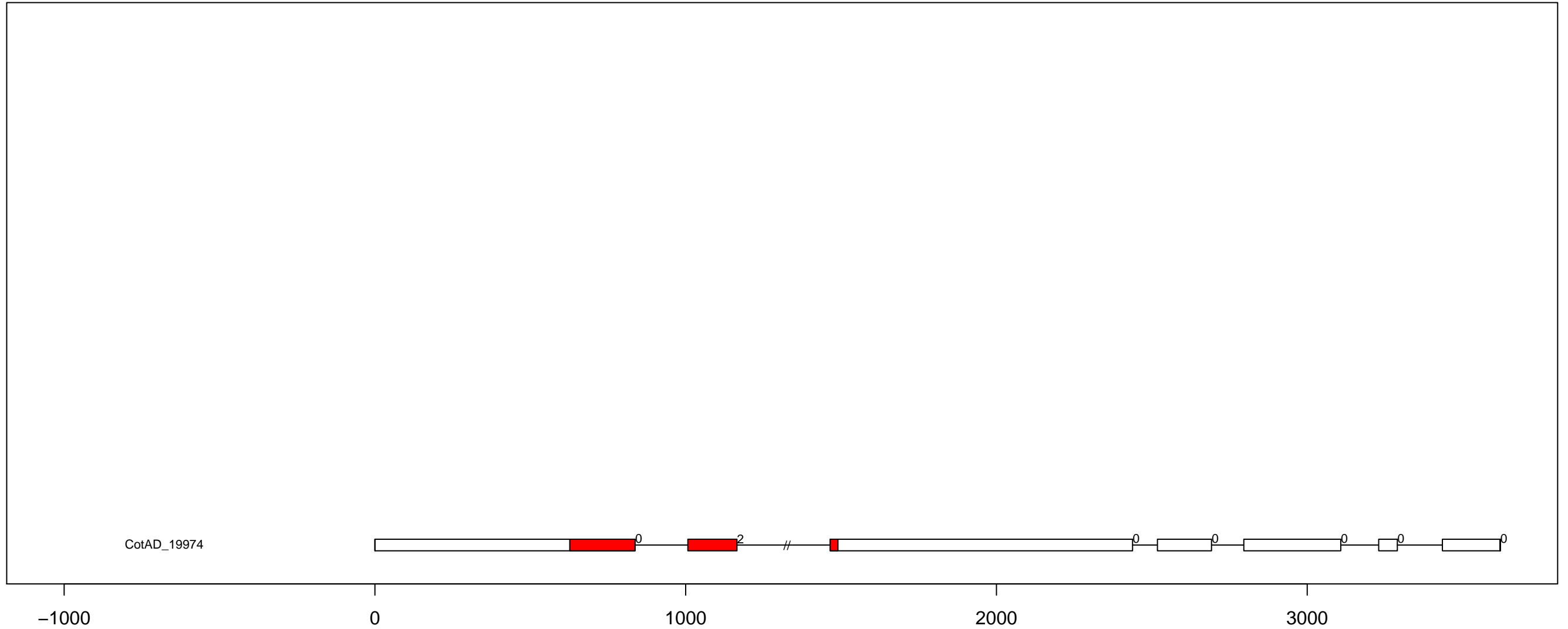

G.hi RLK-Pelle_C-LEC exon-intron and domain diagram (all)

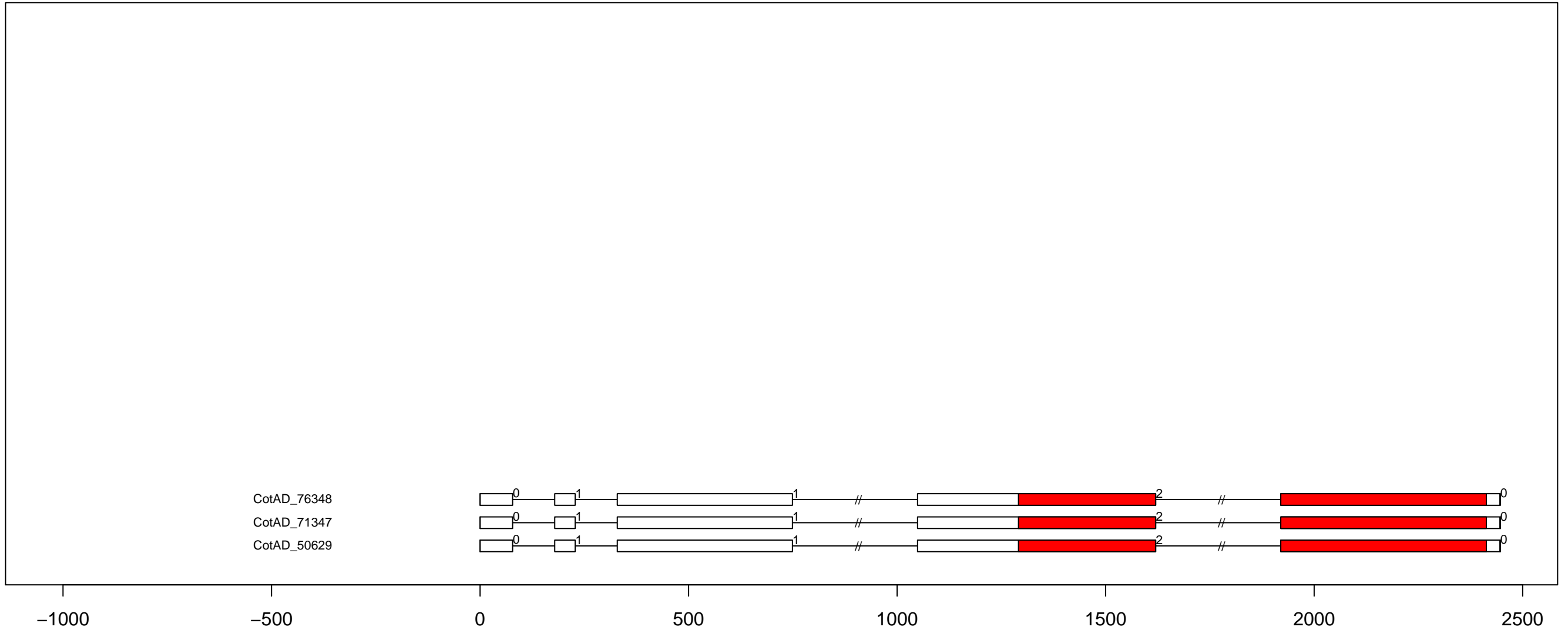

G.hi RLK-Pelle_CR4L exon-intron and domain diagram (part 1)

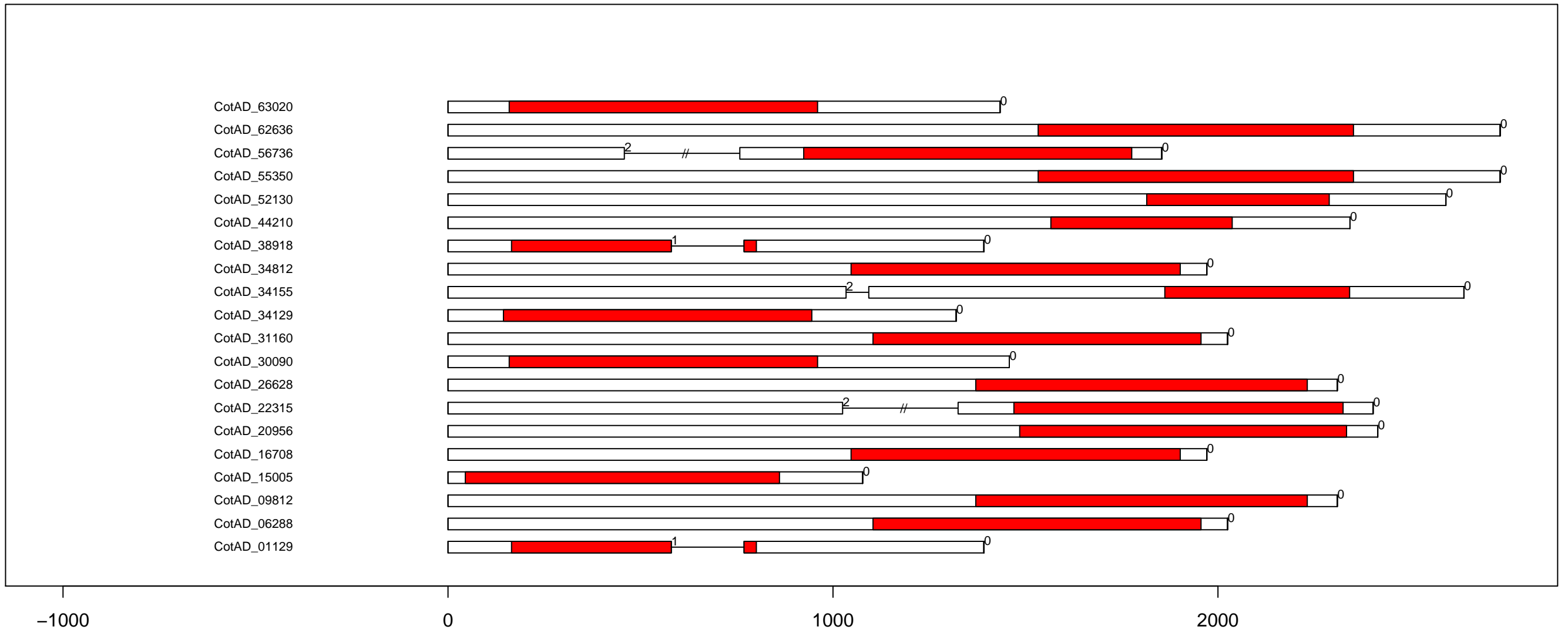

G.hi RLK-Pelle_CR4L exon-intron and domain diagram (part 2)

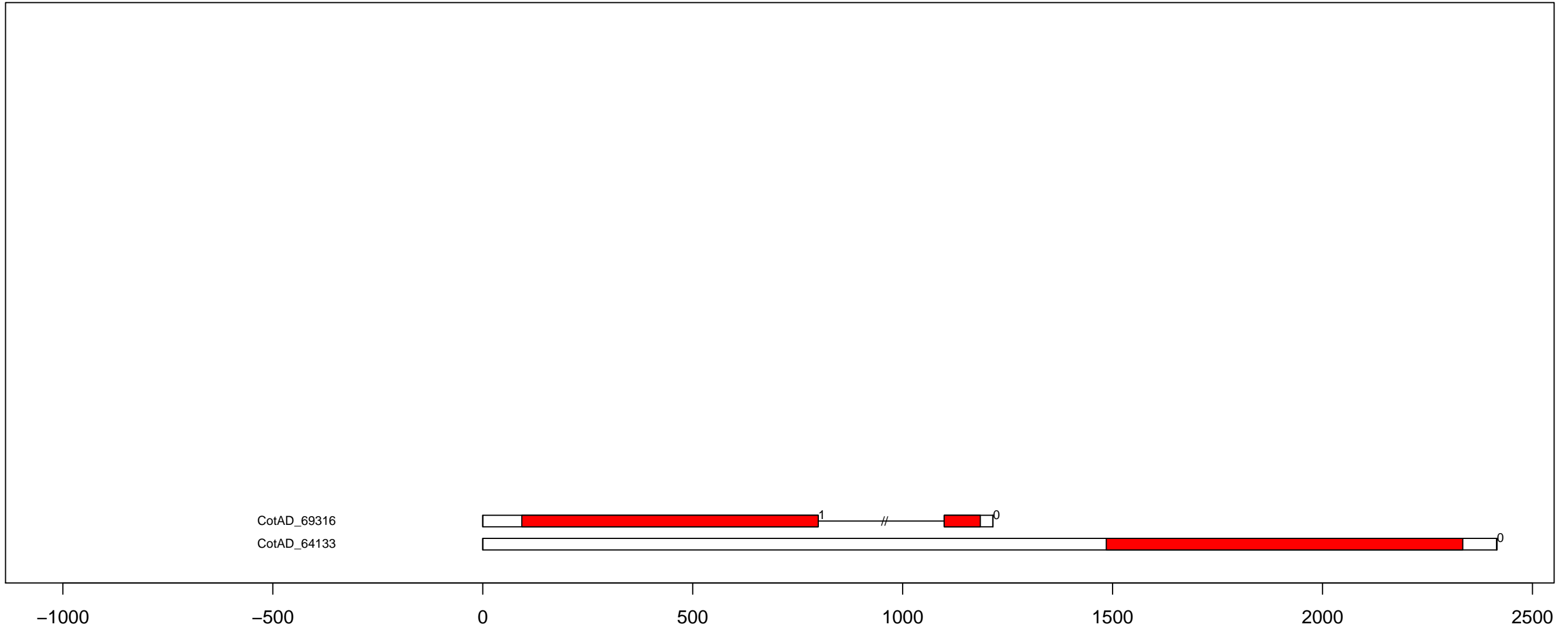

G.hi RLK-Pelle_CrRLK1L-1 exon-intron and domain diagram (part 1)

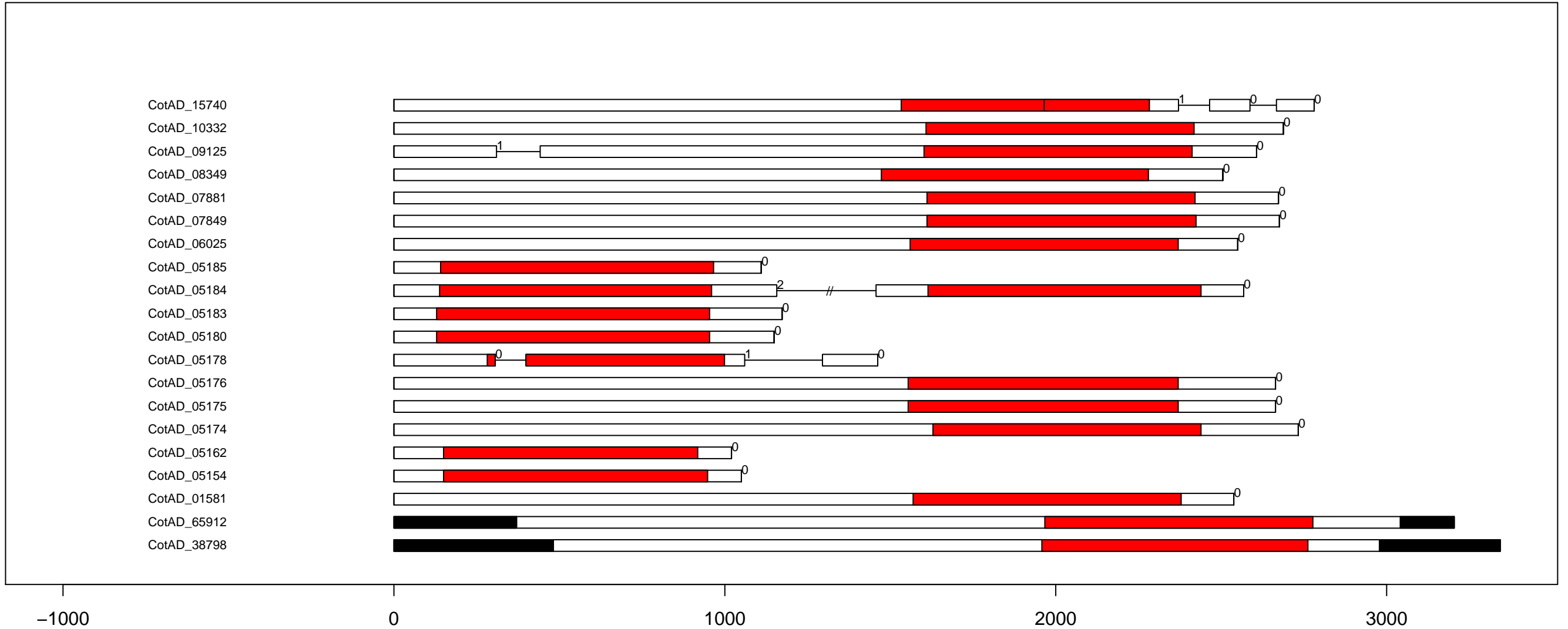

G.hi RLK-Pelle_CrRLK1L-1 exon-intron and domain diagram (part 2)

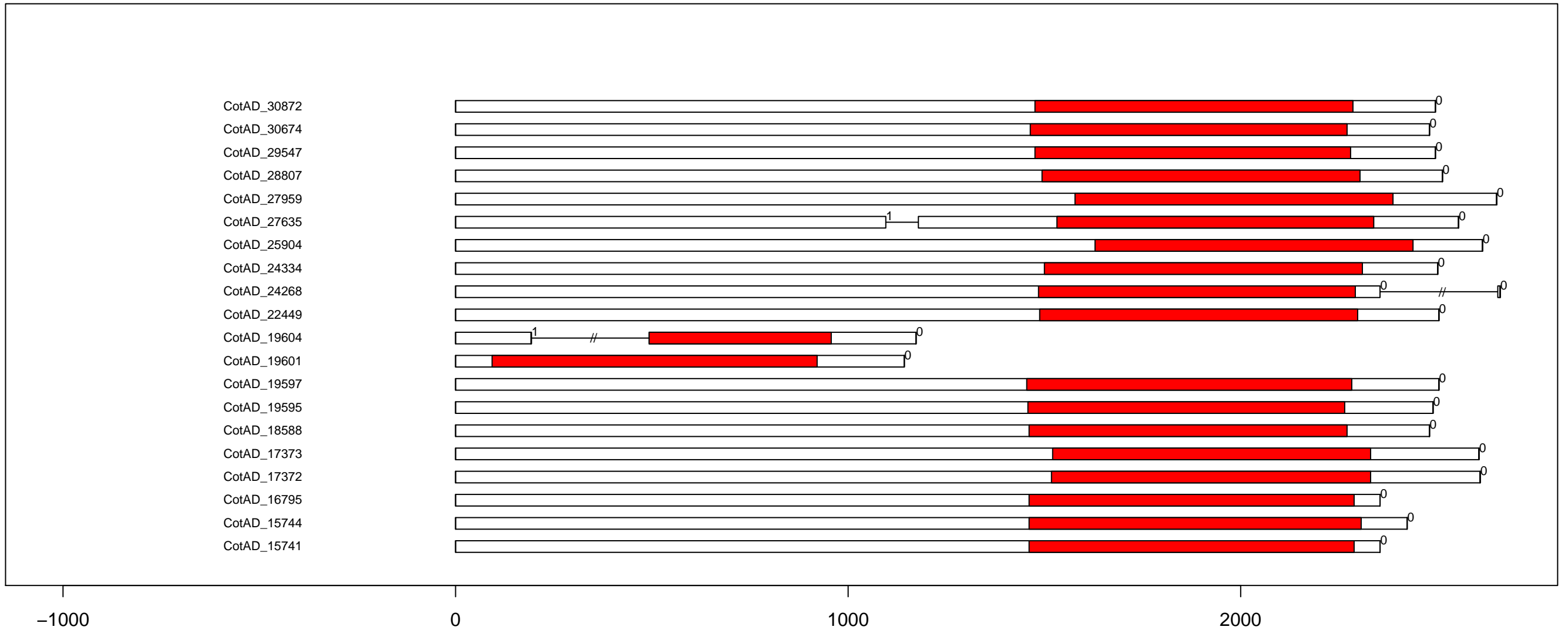

G.hi RLK-Pelle_CrRLK1L-1 exon-intron and domain diagram (part 3)

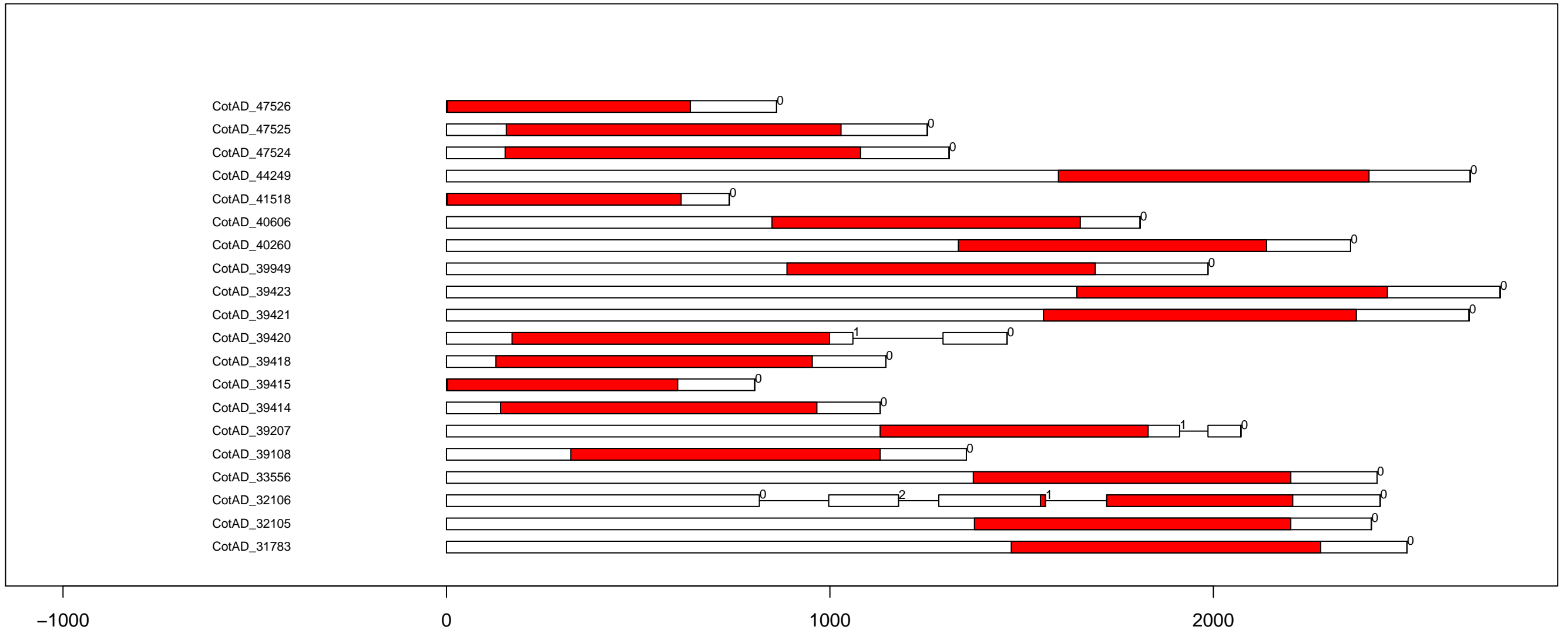

G.hi RLK-Pelle_CrRLK1L-1 exon-intron and domain diagram (part 4)

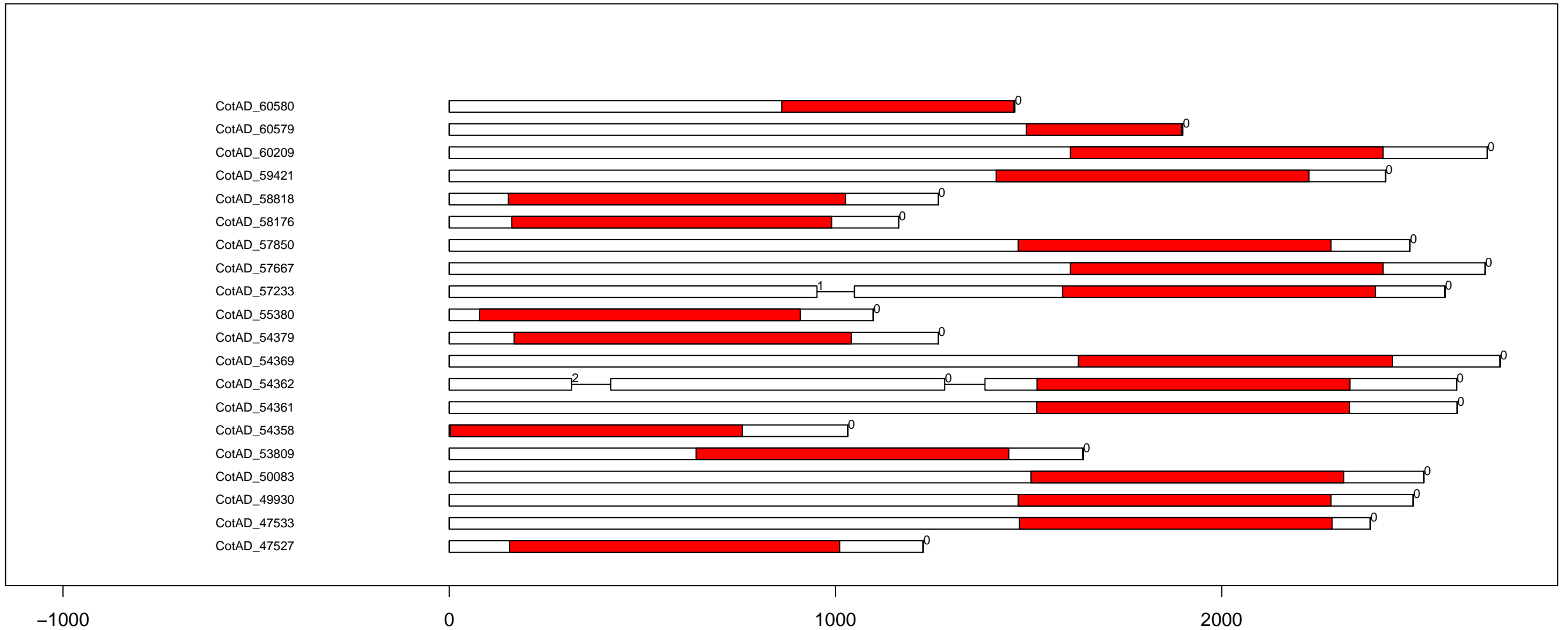

G.hi RLK-Pelle_CrRLK1L-1 exon-intron and domain diagram (part 5)

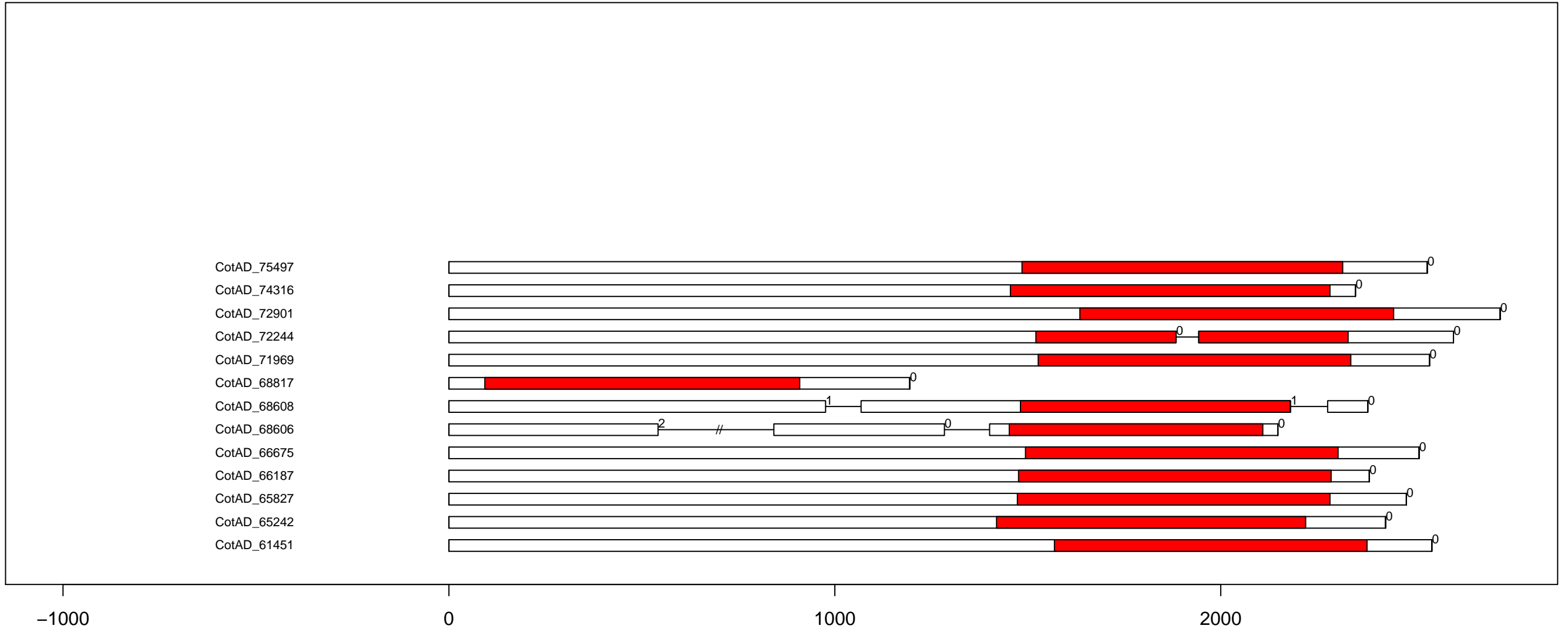

G.hi RLK-Pelle_DLSV exon-intron and domain diagram (part 1)

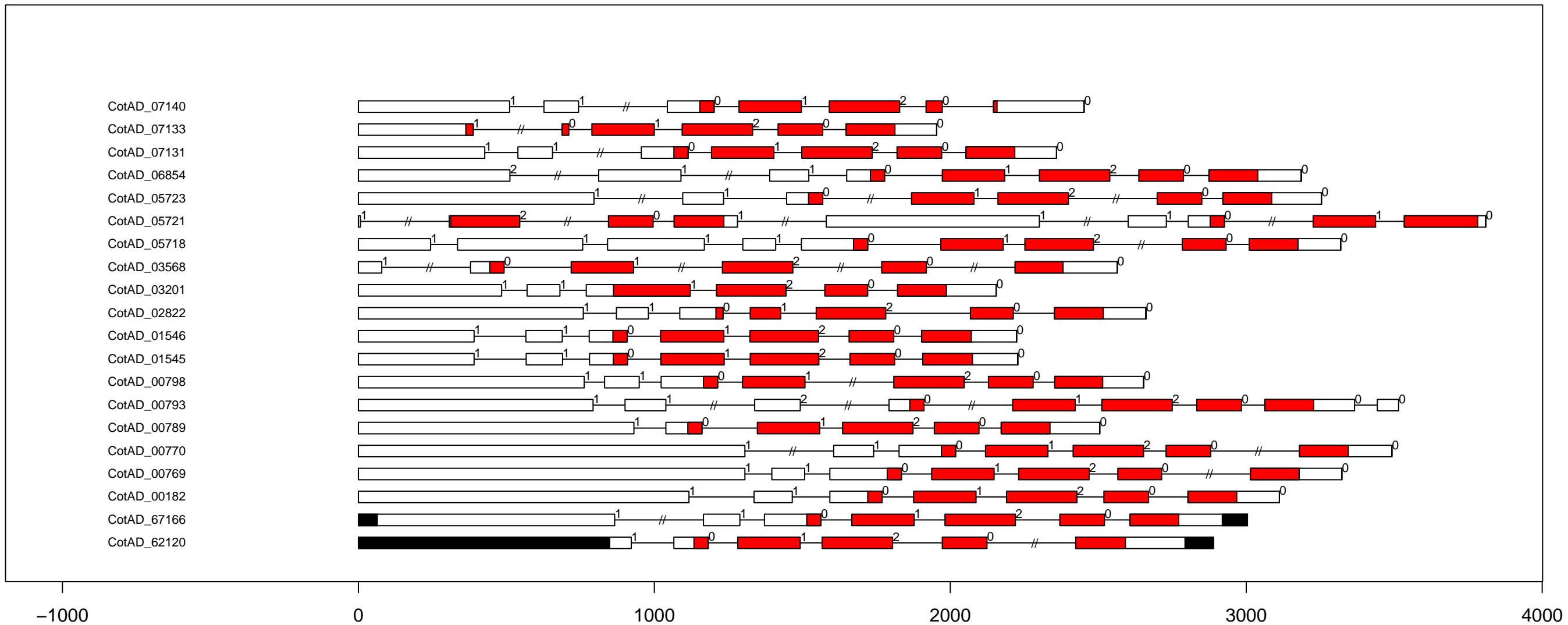

G.hi RLK-Pelle_DLSV exon-intron and domain diagram (part 2)

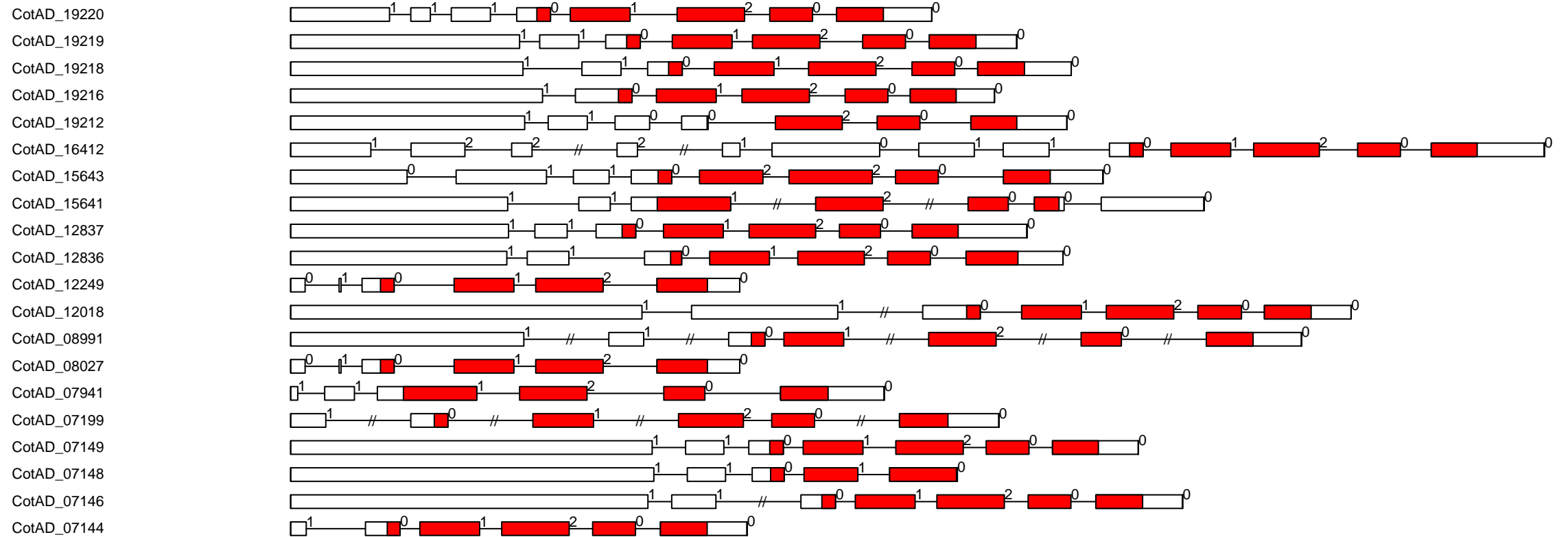

G.hi RLK-Pelle_DLSV exon-intron and domain diagram (part 3)

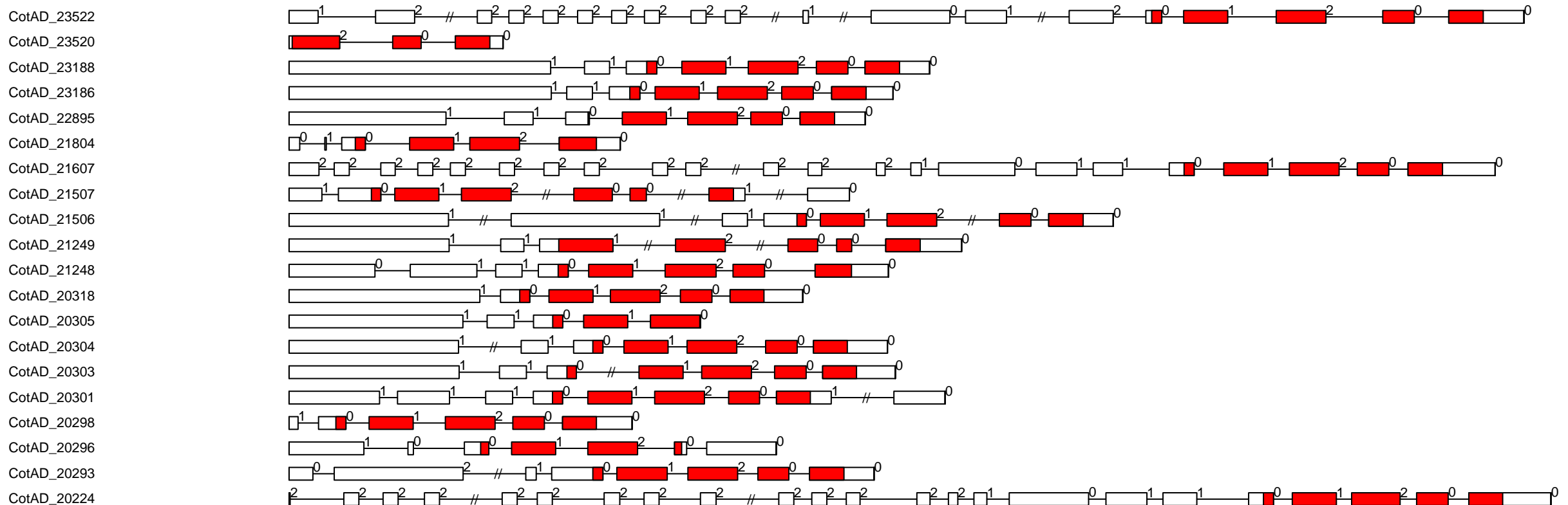

0

2000

4000

6000

G.hi RLK-Pelle_DLSV exon-intron and domain diagram (part 4)

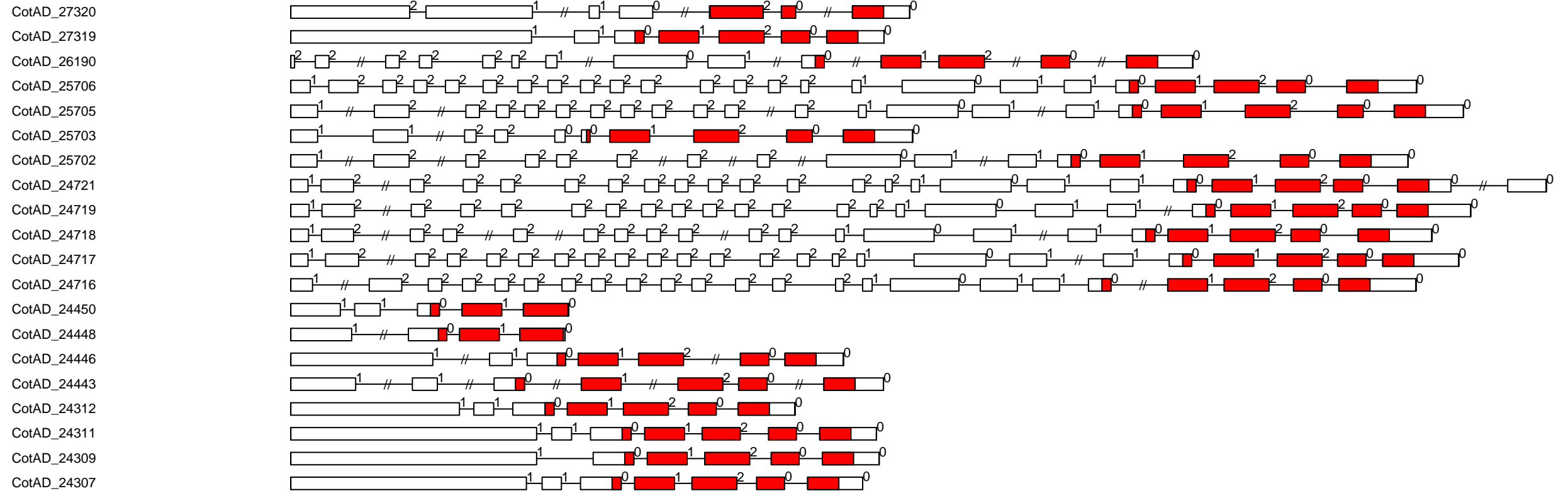

G.hi RLK-Pelle_DLSV exon-intron and domain diagram (part 5)

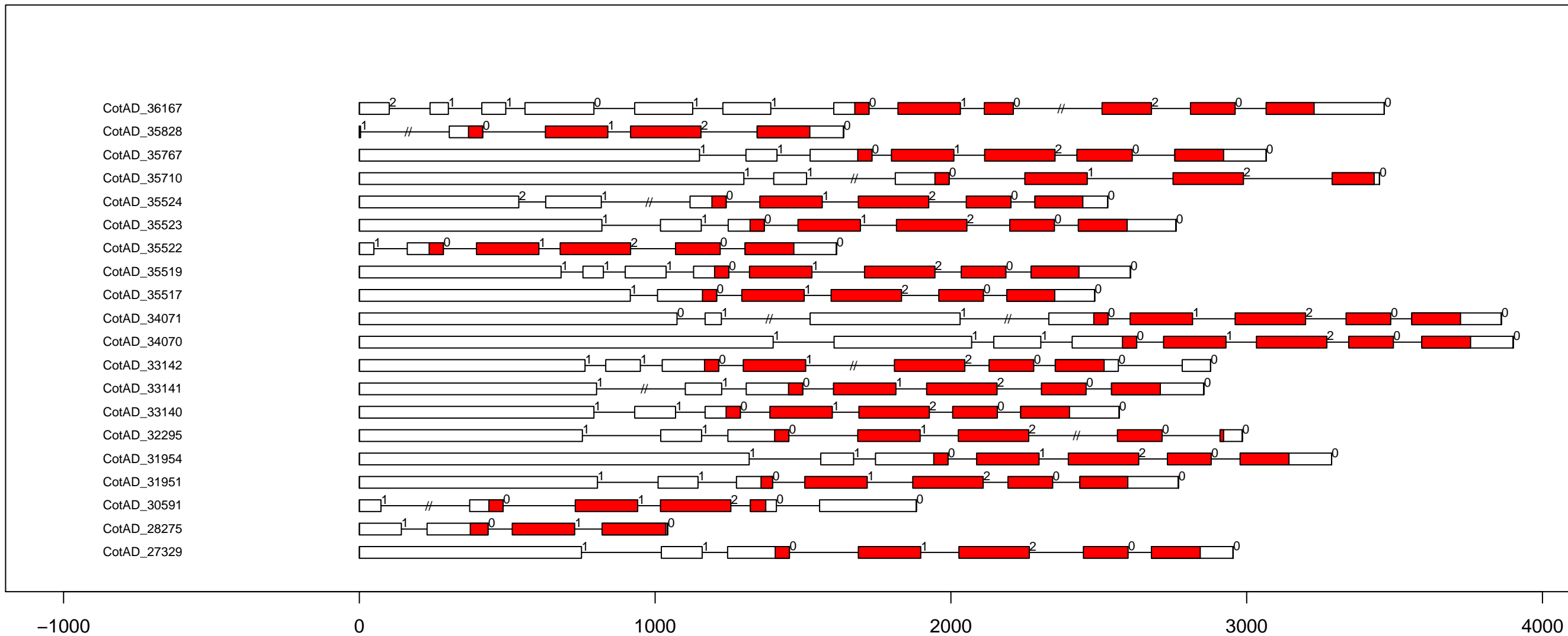

G.hi RLK-Pelle_DLSV exon-intron and domain diagram (part 6)

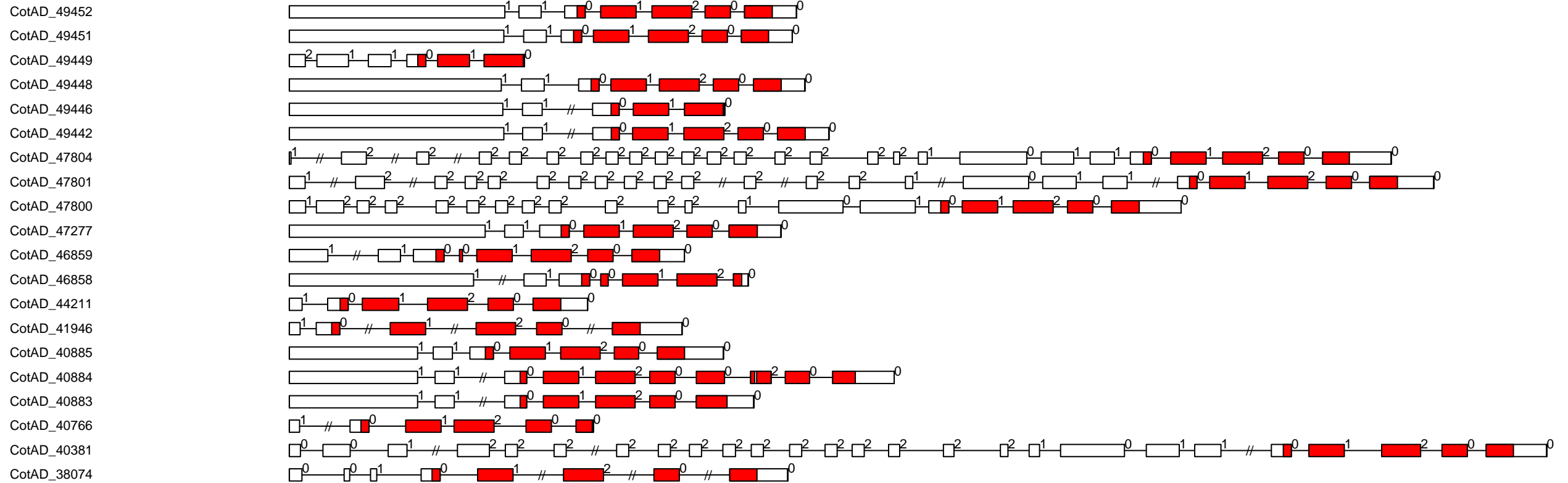

G.hi RLK-Pelle_DLSV exon-intron and domain diagram (part 7)

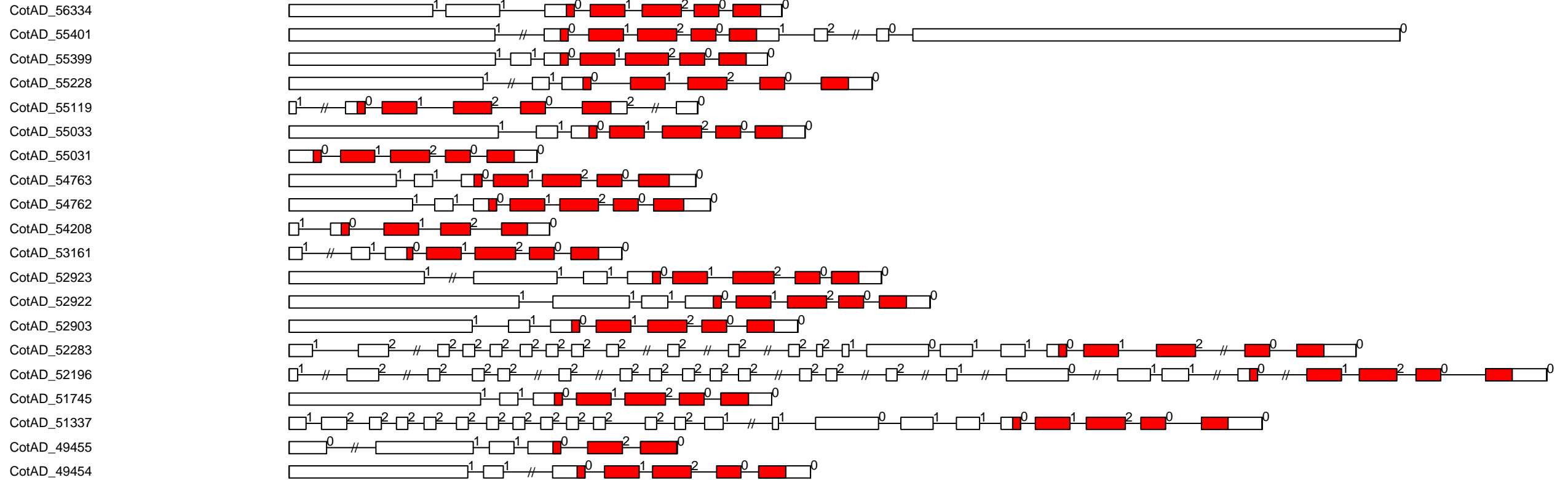

G.hi RLK-Pelle_DLSV exon-intron and domain diagram (part 8)

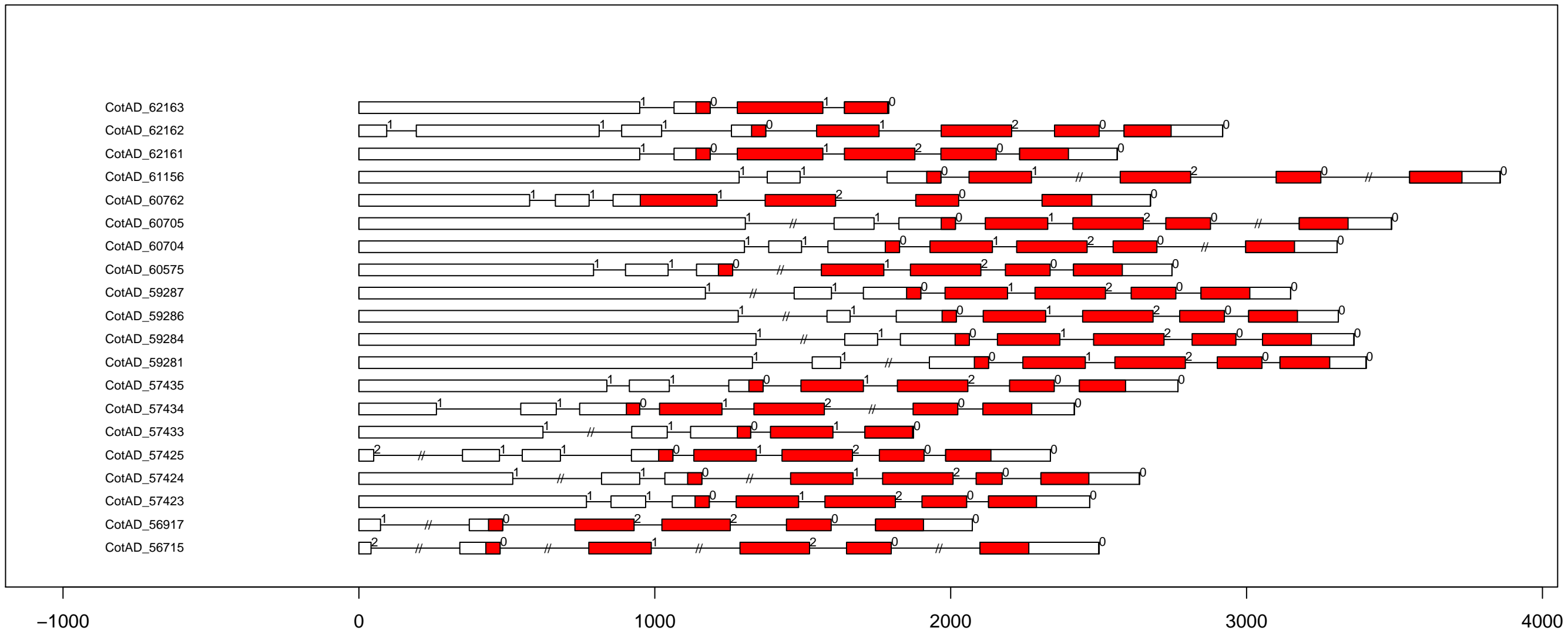

G.hi RLK-Pelle_DLSV exon-intron and domain diagram (part 9)

CotAD_67647
 CotAD_67426
 CotAD_67284
 CotAD_67167
 CotAD_67069
 CotAD_66465
 CotAD_66464
 CotAD_66462
 CotAD_66459
 CotAD_66457
 CotAD_63757
 CotAD_63303
 CotAD_62988
 CotAD_62987
 CotAD_62986
 CotAD_62978
 CotAD_62169
 CotAD_62168
 CotAD_62167
 CotAD_62165

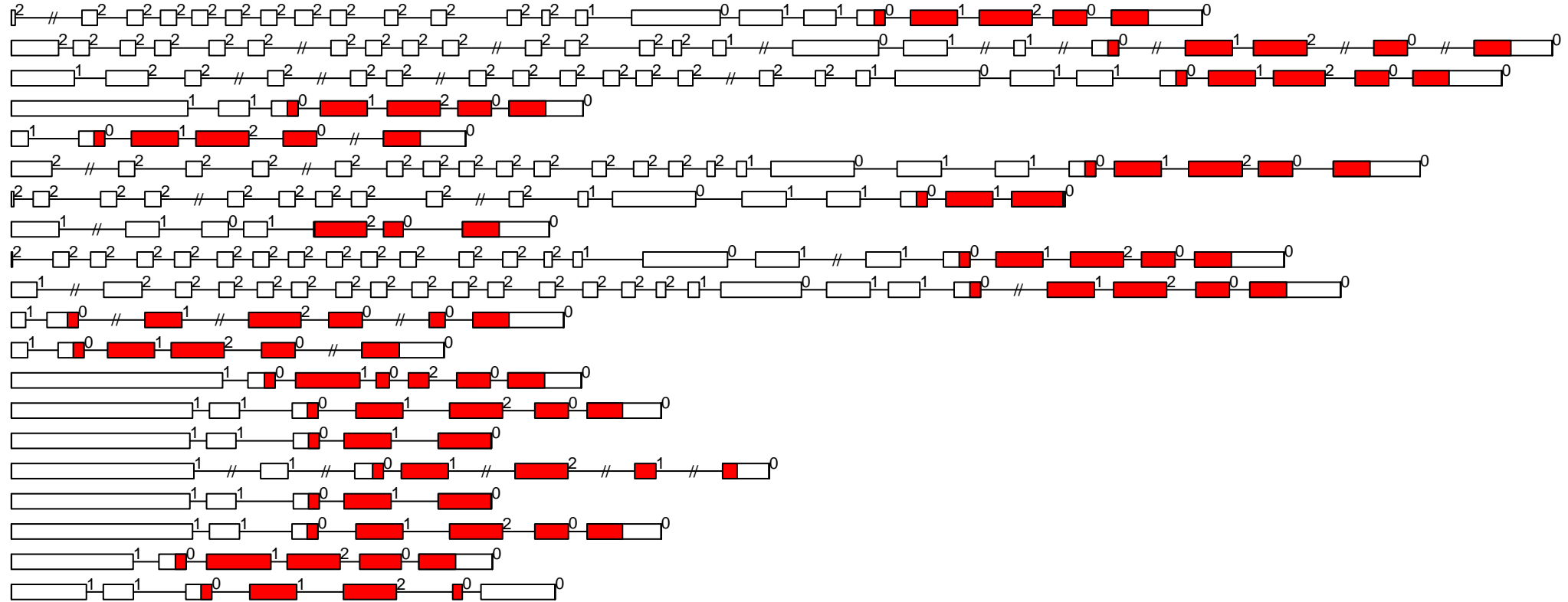

G.hi RLK-Pelle_DLSV exon-intron and domain diagram (part 10)

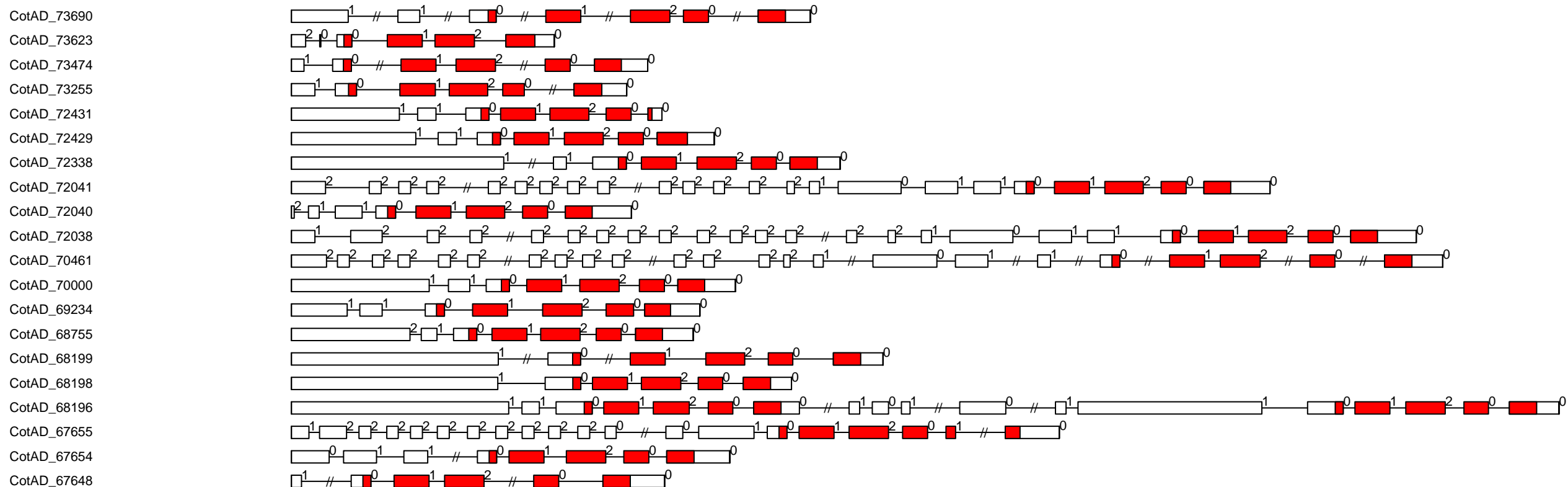

G.hi RLK-Pelle_DLSV exon-intron and domain diagram (part 11)

CotAD_76650

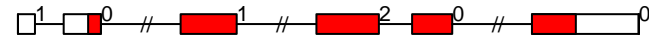

CotAD_75181

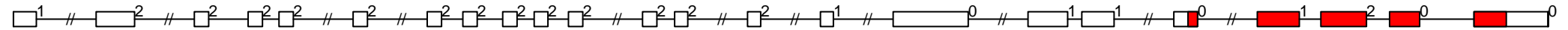

CotAD_73762

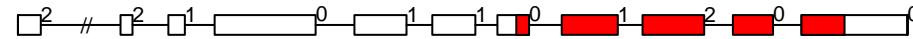

CotAD_73761

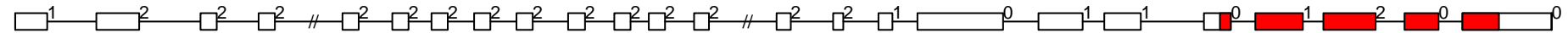

CotAD_73760

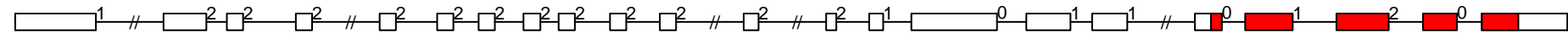

0

2000

4000

6000

8000

G.hi RLK-Pelle_Extensin exon-intron and domain diagram (all)

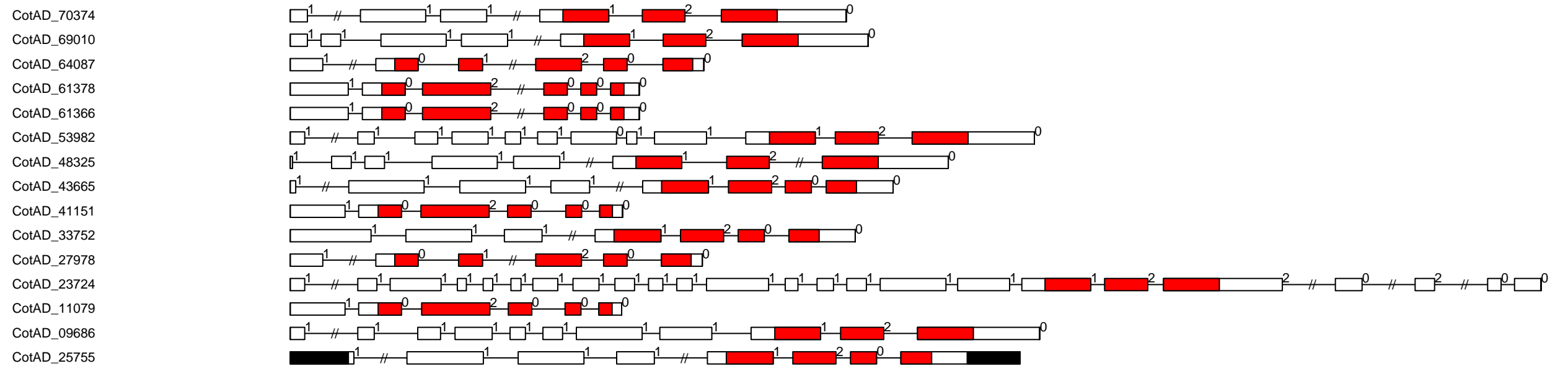

G.hi RLK-Pelle_L-LEC exon-intron and domain diagram (part 1)

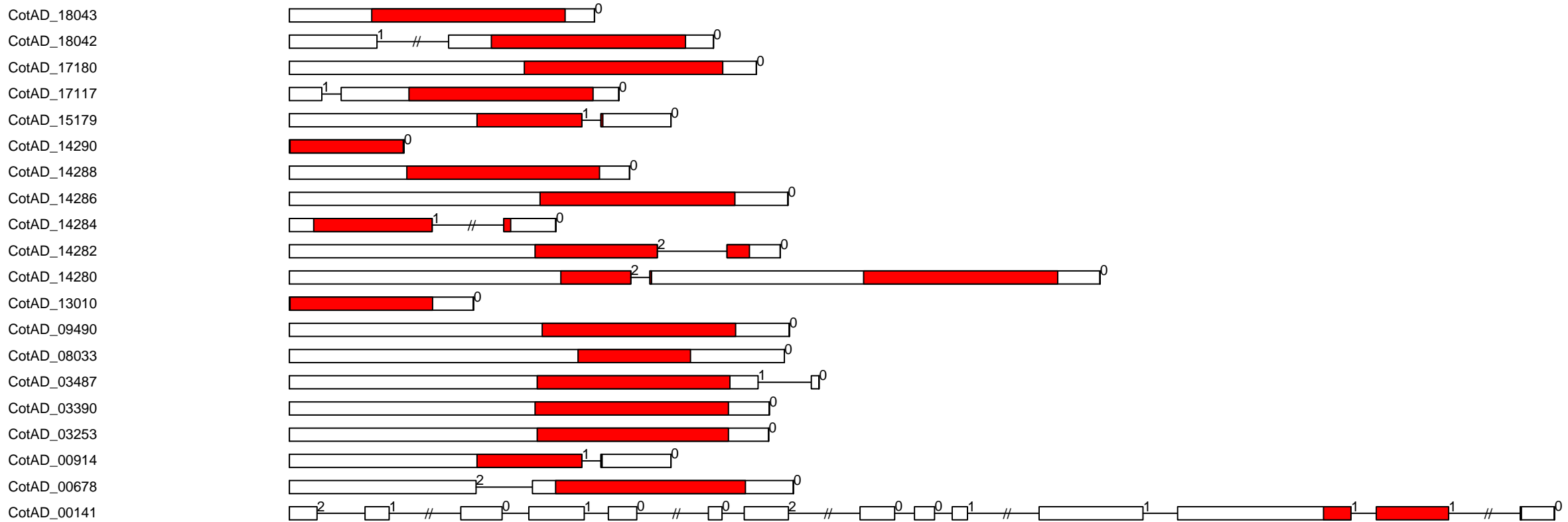

G.hi RLK-Pelle_L-LEC exon-intron and domain diagram (part 2)

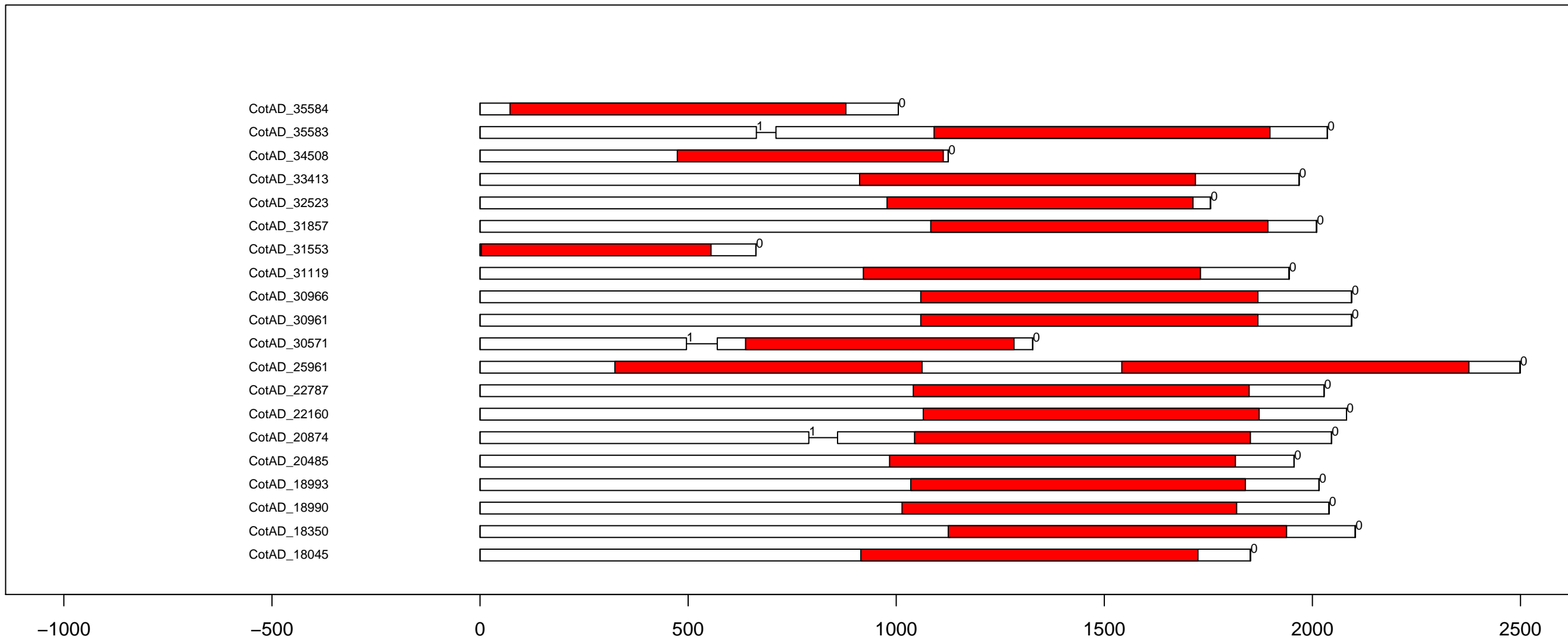

G.hi RLK-Pelle_L-LEC exon-intron and domain diagram (part 3)

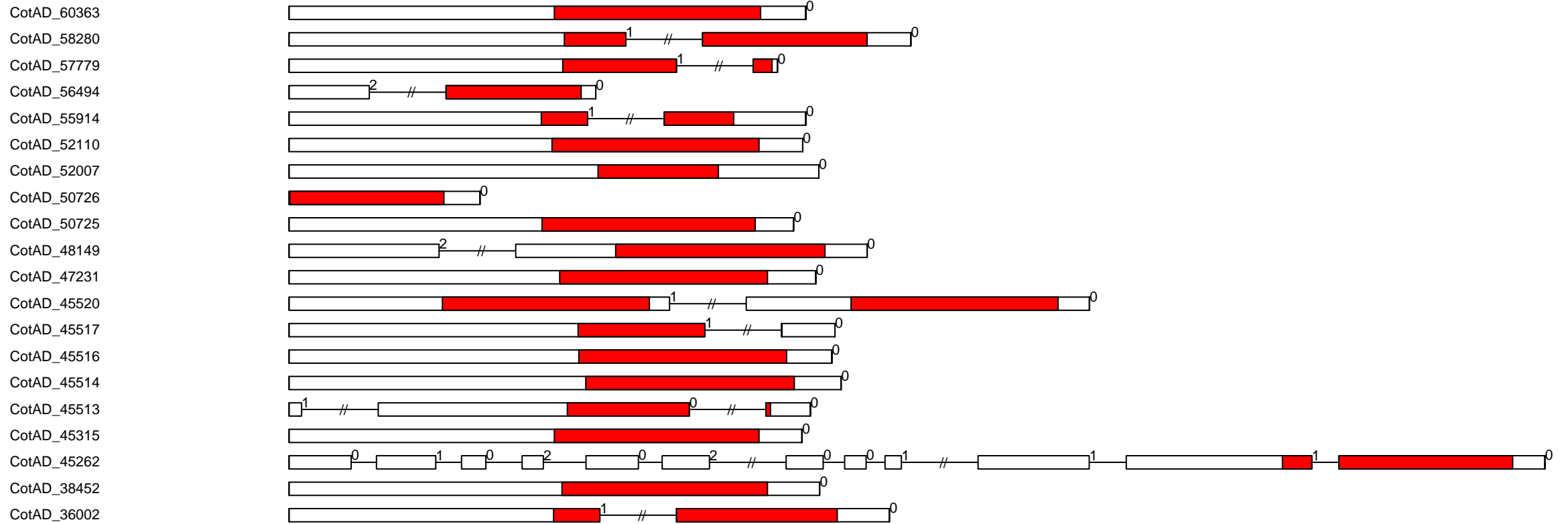

G.hi RLK-Pelle_L-LEC exon-intron and domain diagram (part 4)

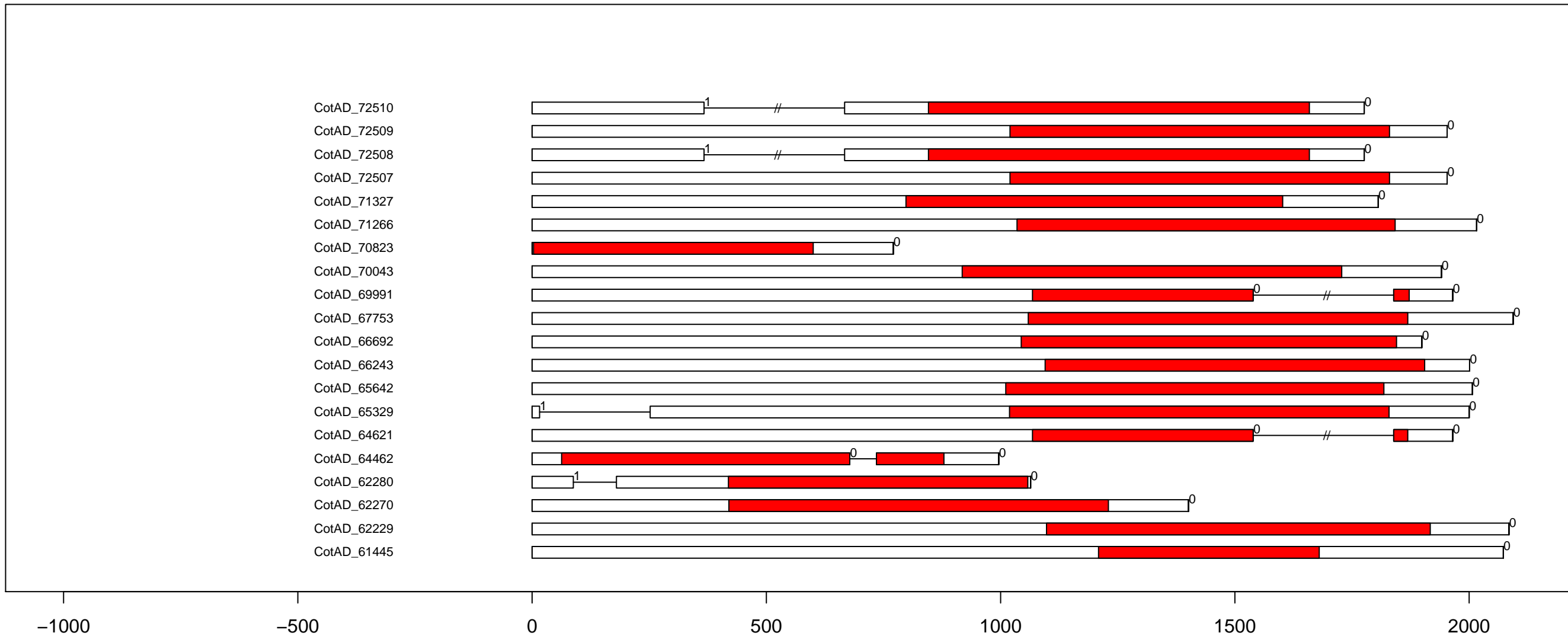

G.hi RLK-Pelle_L-LEC exon-intron and domain diagram (part 5)

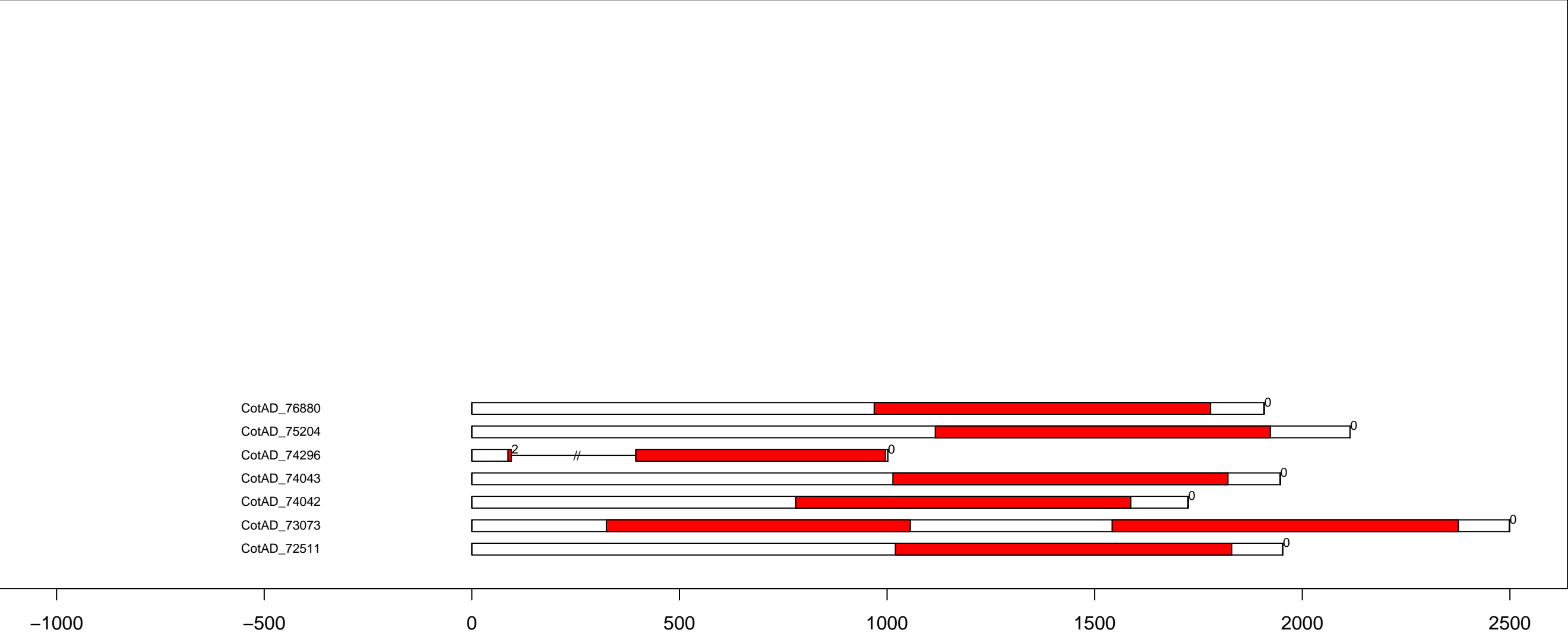

G.hi RLK-Pelle_LRK10L-2 exon-intron and domain diagram (part 2)

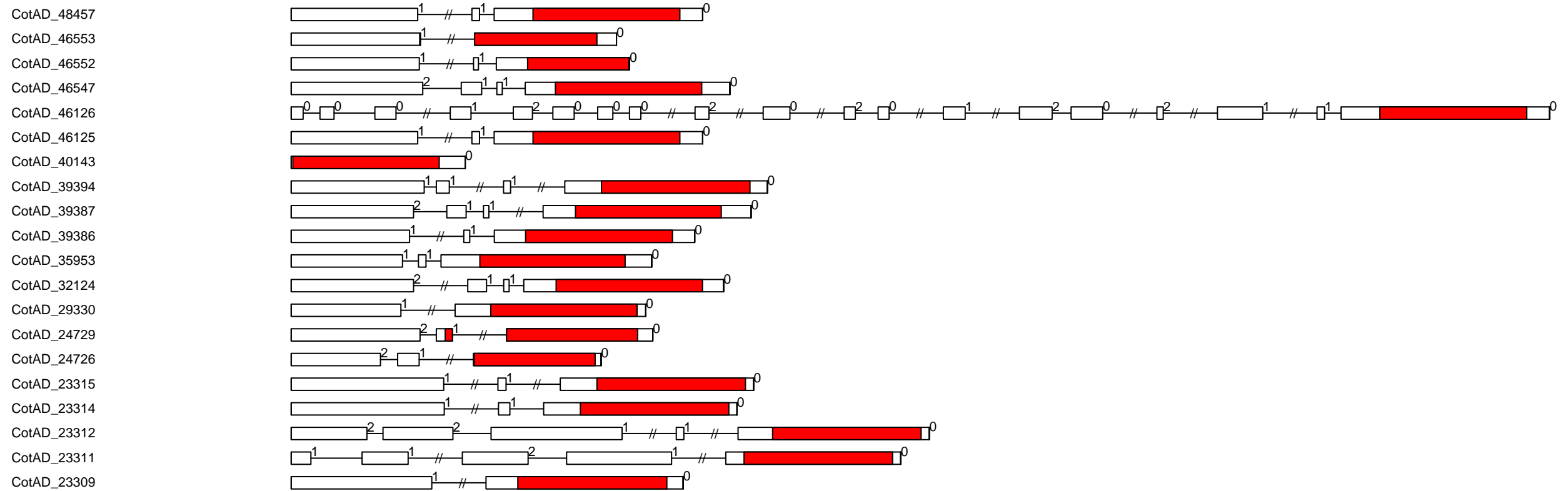

G.hi RLK-Pelle_LRK10L-2 exon-intron and domain diagram (part 3)

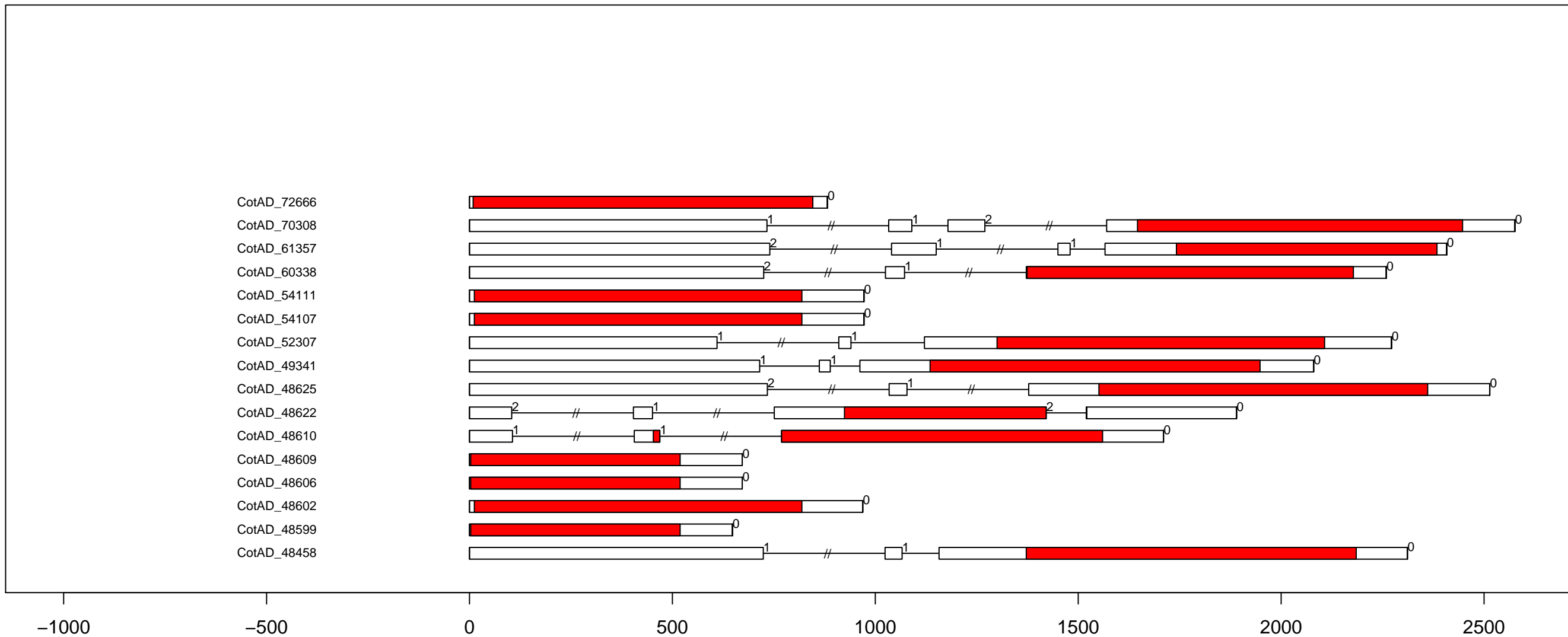

G.hi RLK-Pelle_LRR-I-1 exon-intron and domain diagram (all)

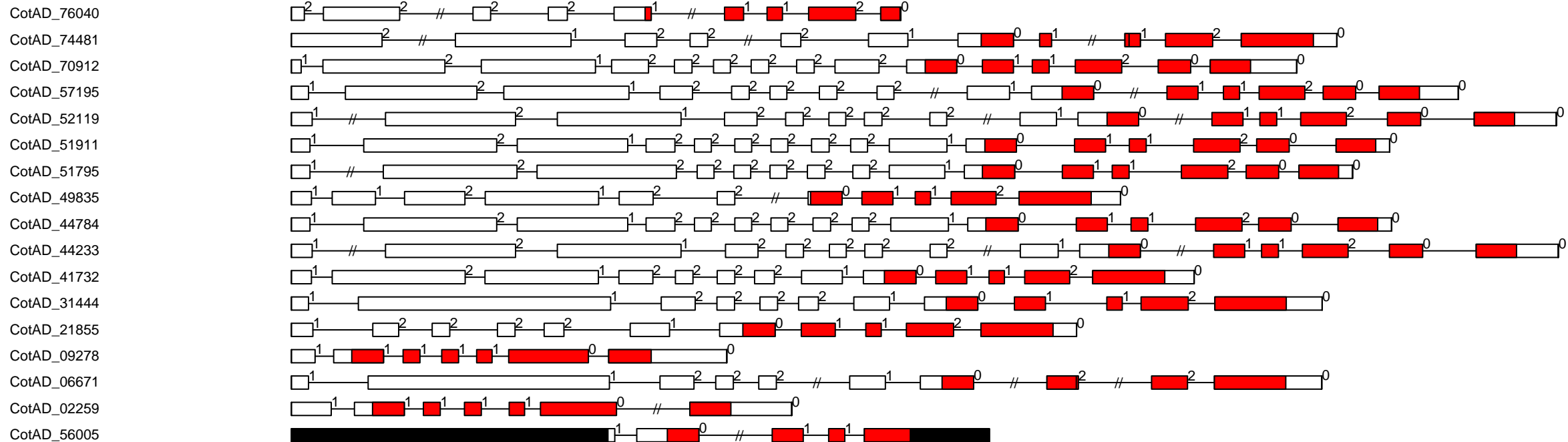

G.hi RLK-Pelle_LRR-I-2 exon-intron and domain diagram (all)

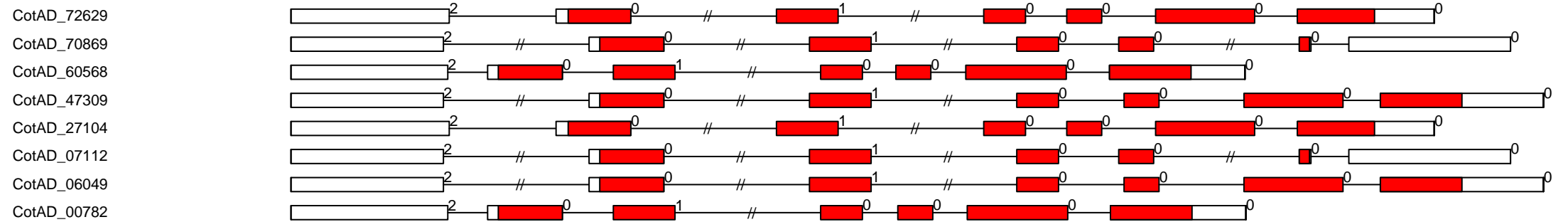

G.hi RLK-Pelle_LRR-III exon-intron and domain diagram (part 3)

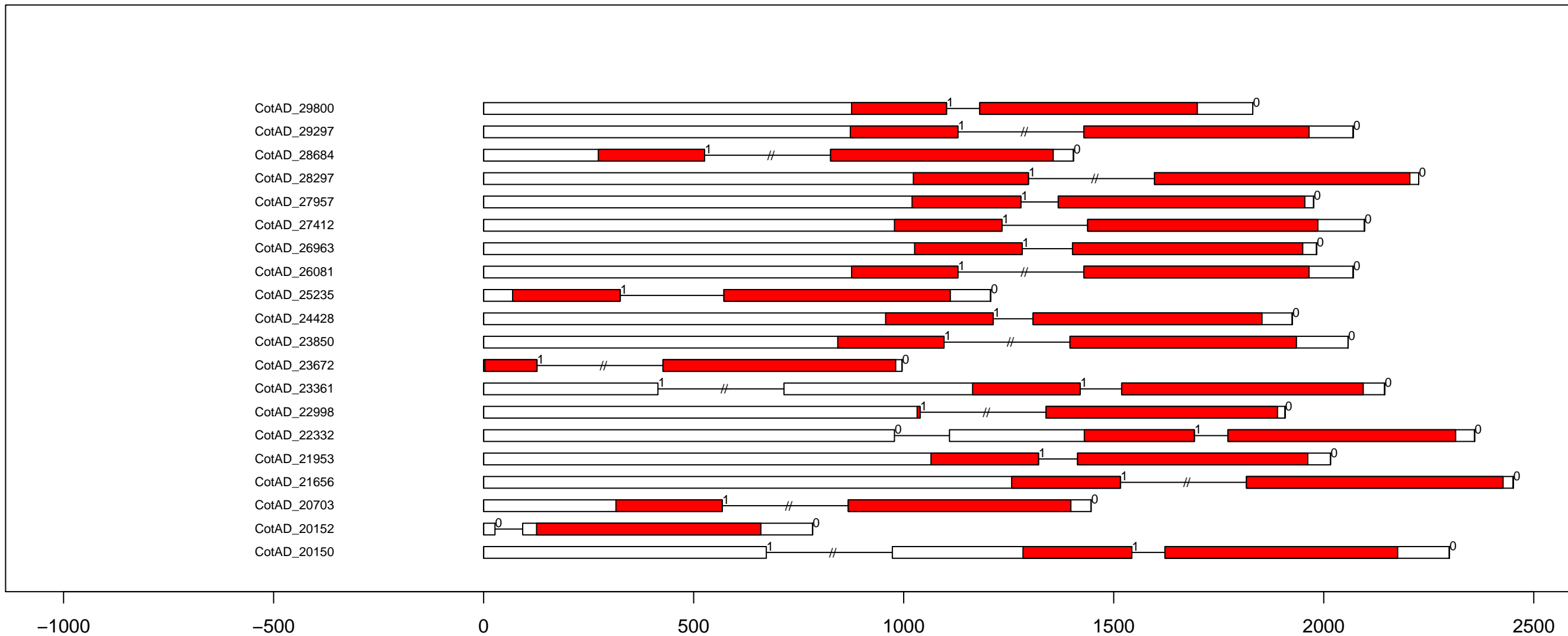

G.hi RLK-Pelle_LRR-III exon-intron and domain diagram (part 4)

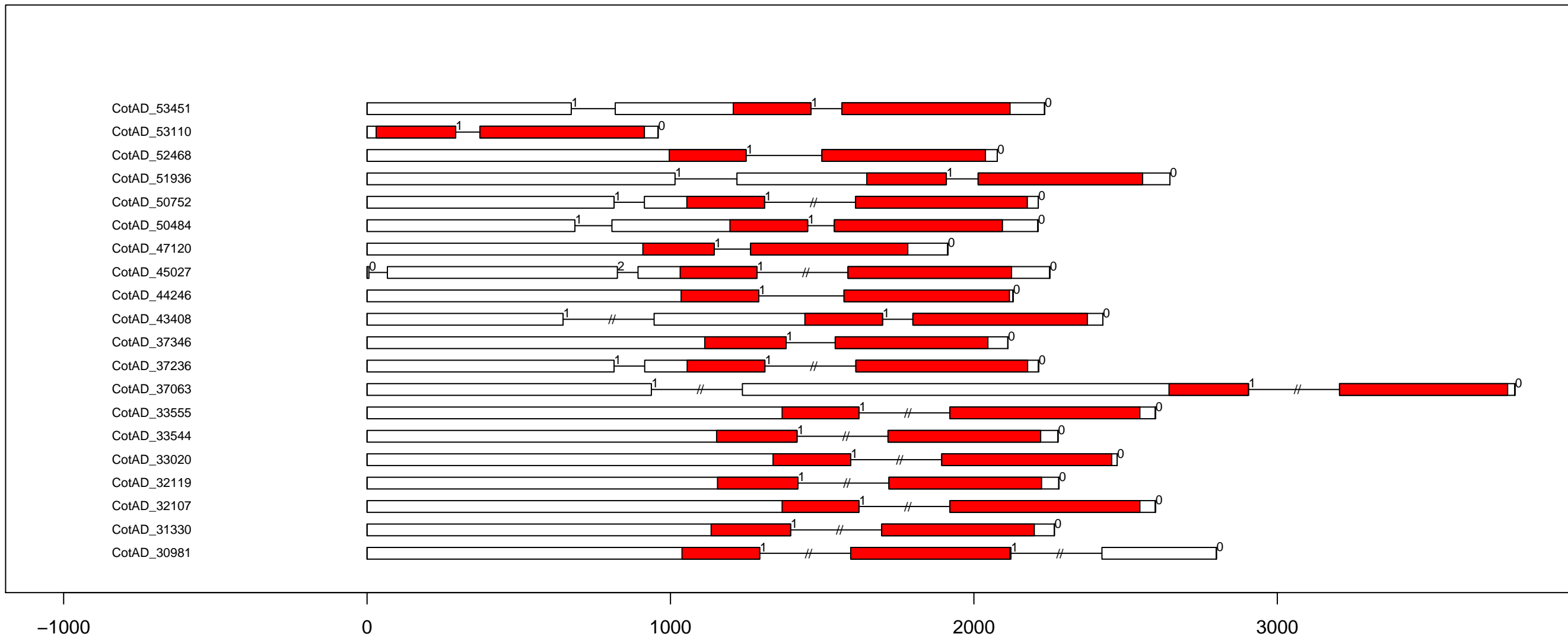

G.hi RLK-Pelle_LRR-III exon-intron and domain diagram (part 5)

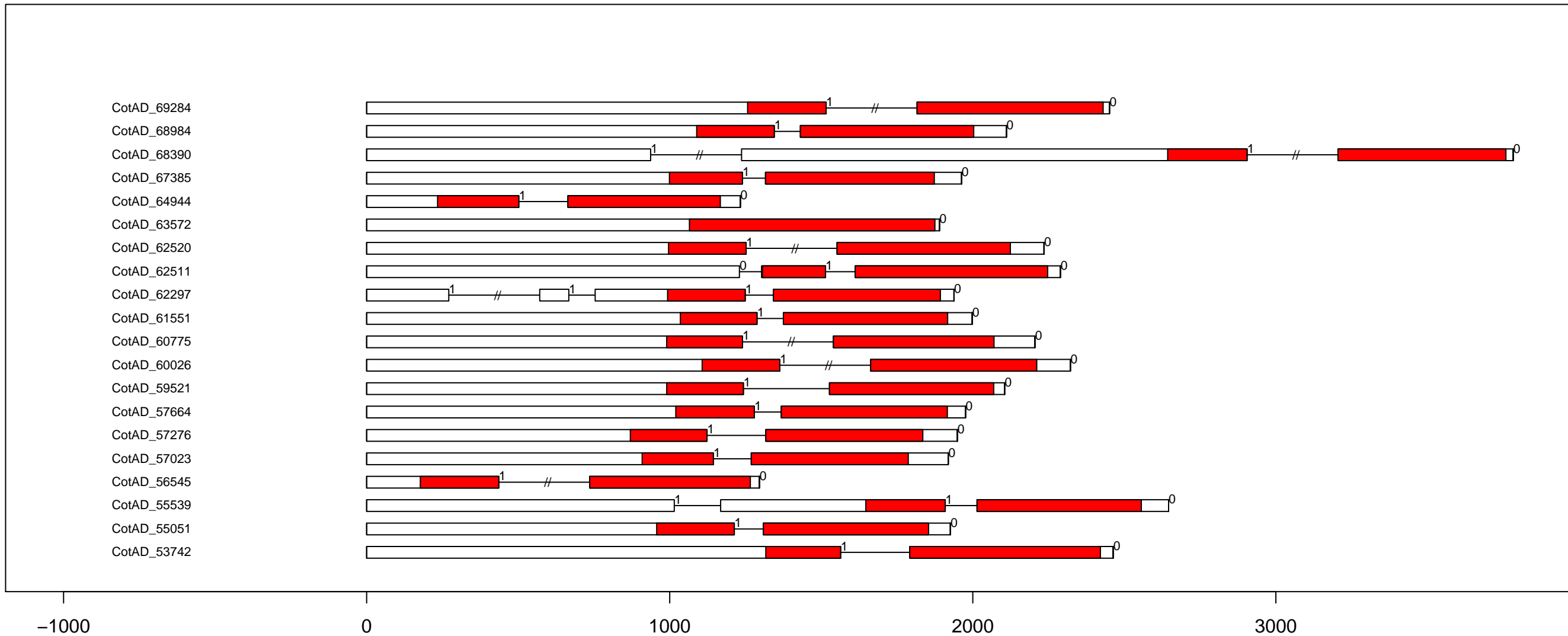

G.hi RLK-Pelle_LRR-III exon-intron and domain diagram (part 6)

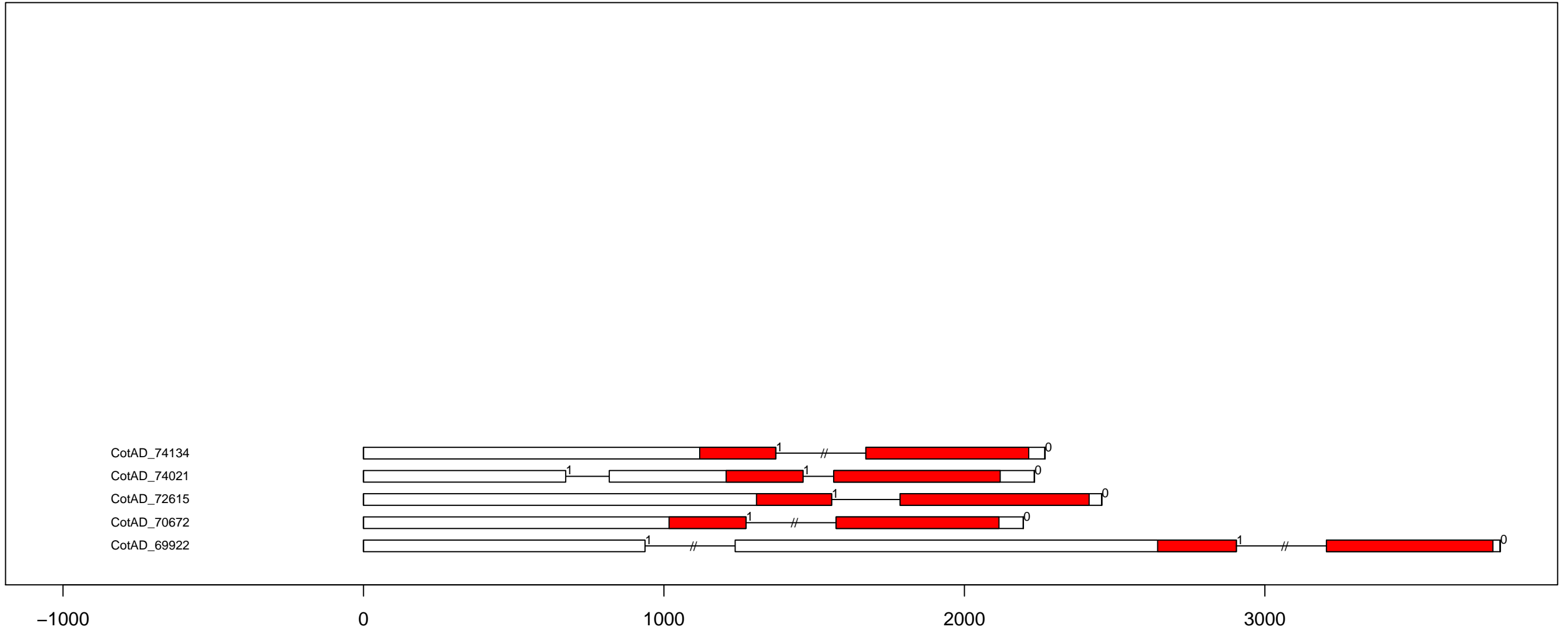

G.hi RLK-Pelle_LRR-II exon-intron and domain diagram (part 1)

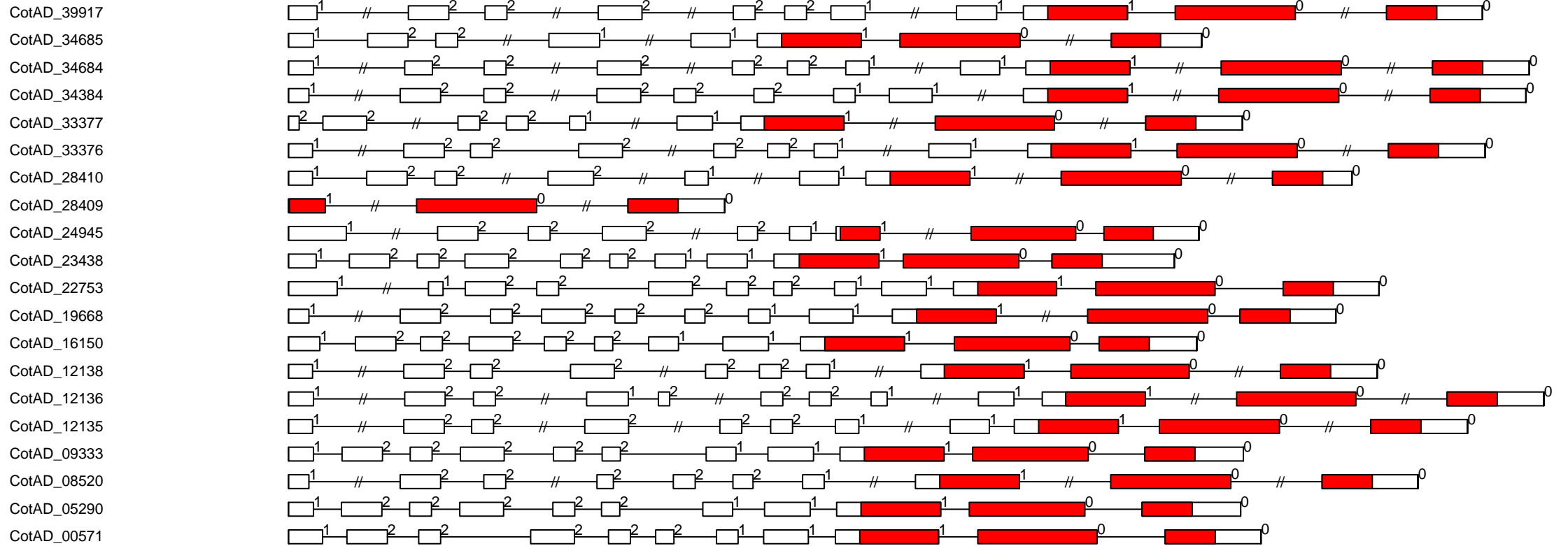

-1000

0

1000

2000

3000

4000

G.hi RLK-Pelle_LRR-II exon-intron and domain diagram (part 2)

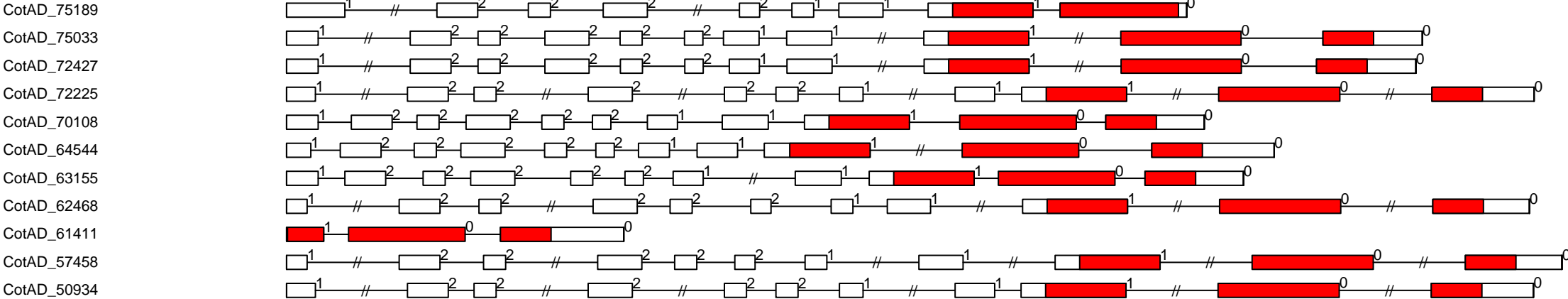

G.hi RLK-Pelle_LRR-IV exon-intron and domain diagram (all)

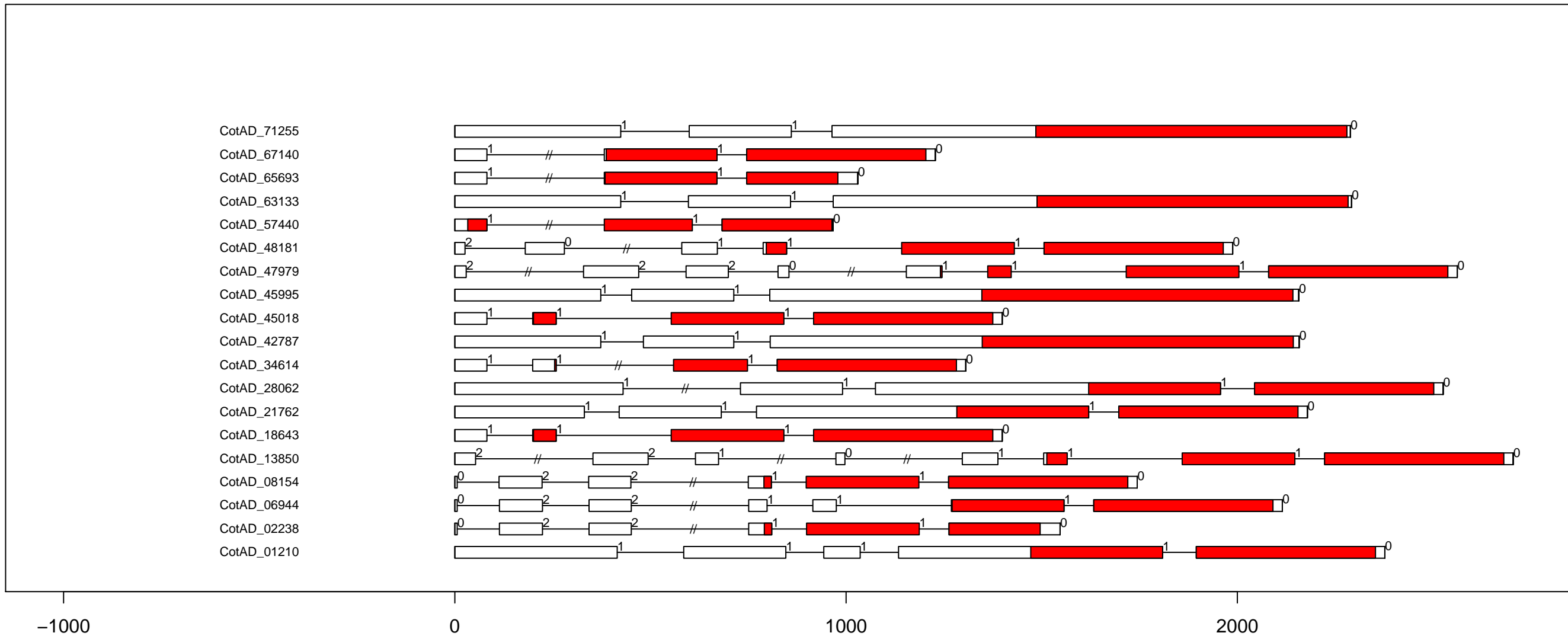

G.hi RLK-Pelle_LRR-IX exon-intron and domain diagram (all)

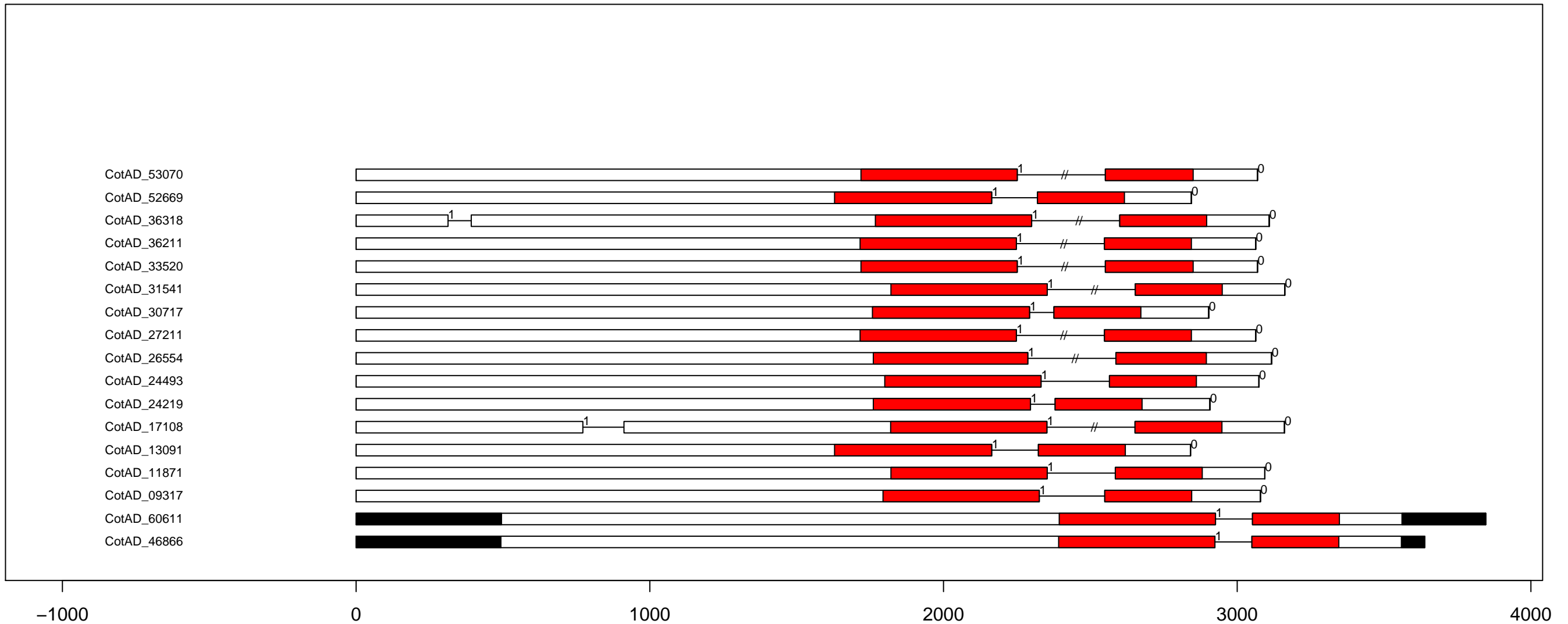

G.hi RLK-Pelle_LRR-VI-1 exon-intron and domain diagram (all)

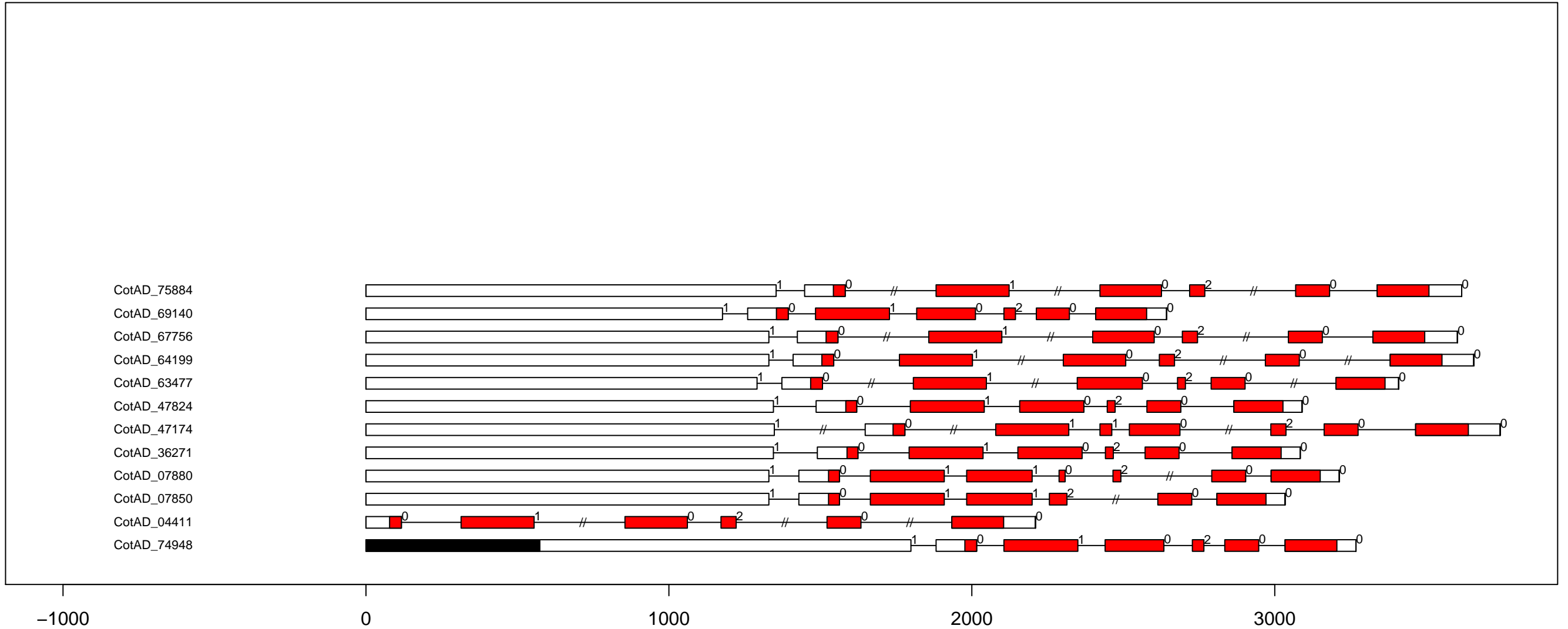

G.hi RLK-Pelle_LRR-VI-2 exon-intron and domain diagram (all)

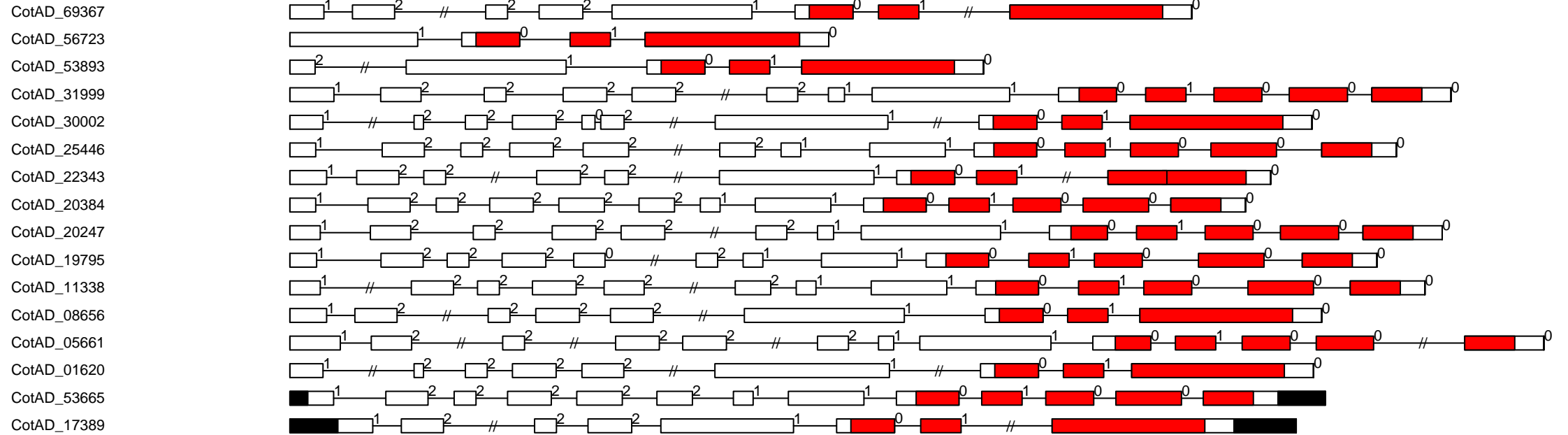

-1000

0

1000

2000

3000

4000

G.hi RLK-Pelle_LRR-VII-1 exon-intron and domain diagram (all)

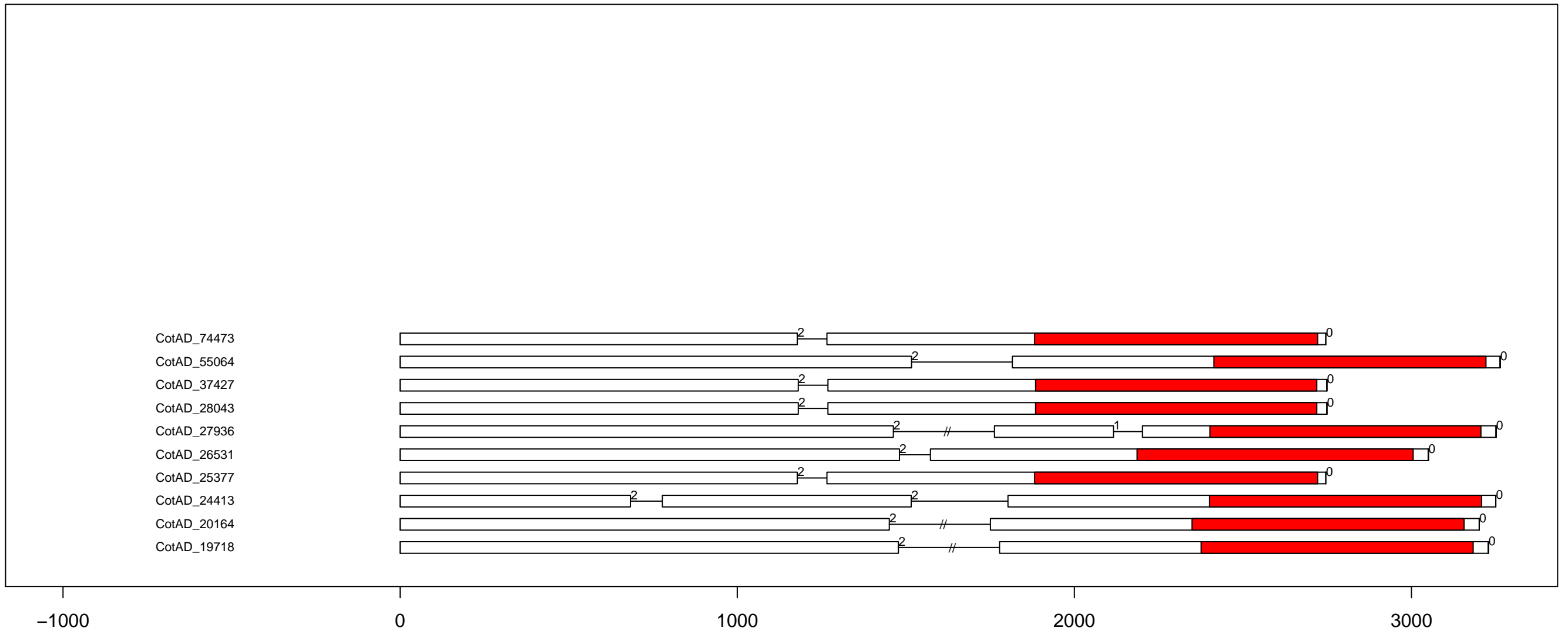

G.hi RLK-Pelle_LRR-VII-2 exon-intron and domain diagram (all)

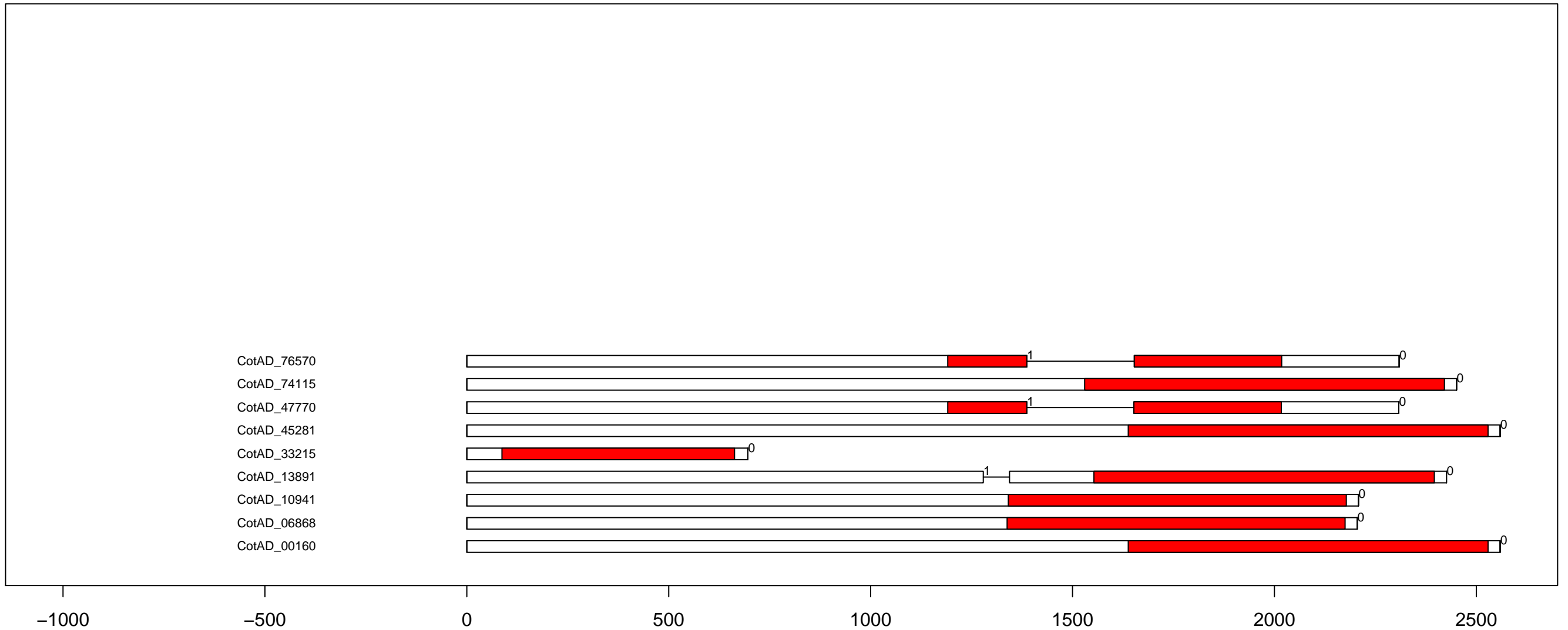

G.hi RLK-Pelle_LRR-VII-3 exon-intron and domain diagram (all)

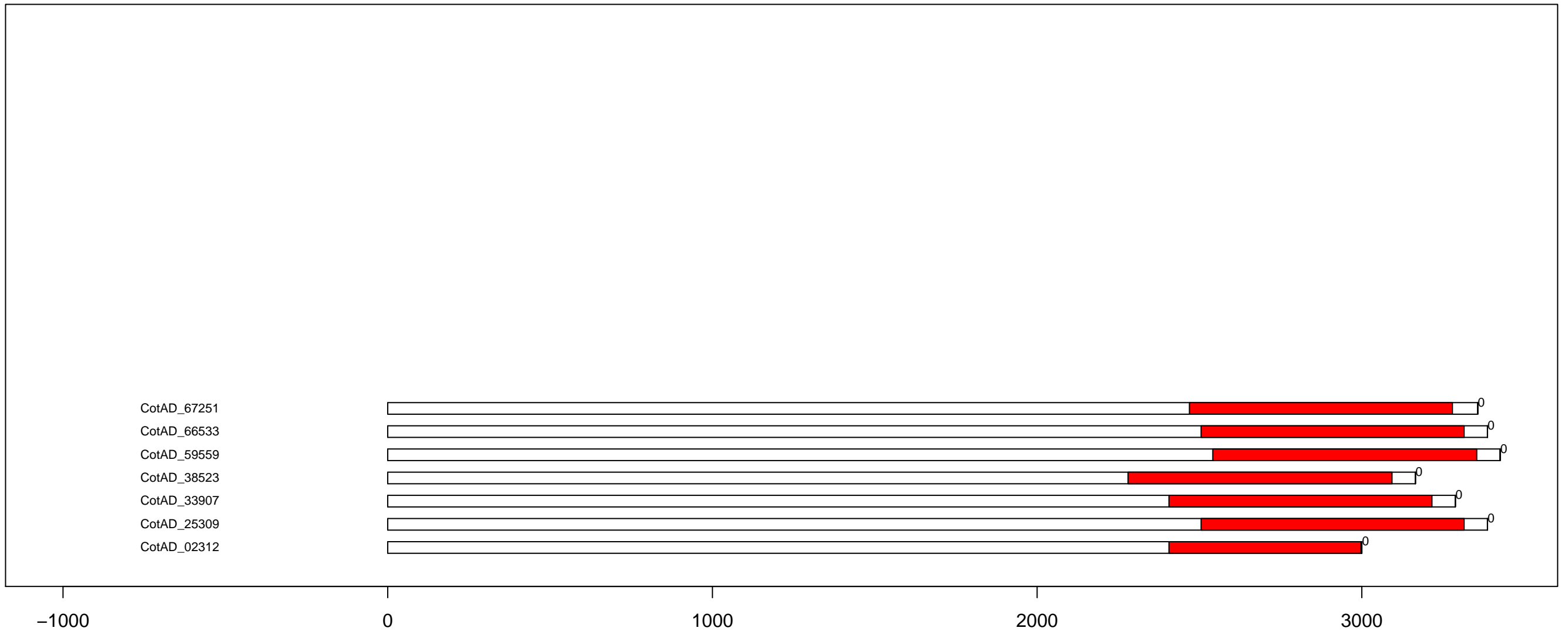

G.hi RLK-Pelle_LRR-VIII-1 exon-intron and domain diagram (all)

CotAD_69673
CotAD_62571
CotAD_61336
CotAD_47228
CotAD_46053
CotAD_37459
CotAD_35146
CotAD_33692
CotAD_27954
CotAD_25154
CotAD_24456
CotAD_22235
CotAD_18948
CotAD_14628

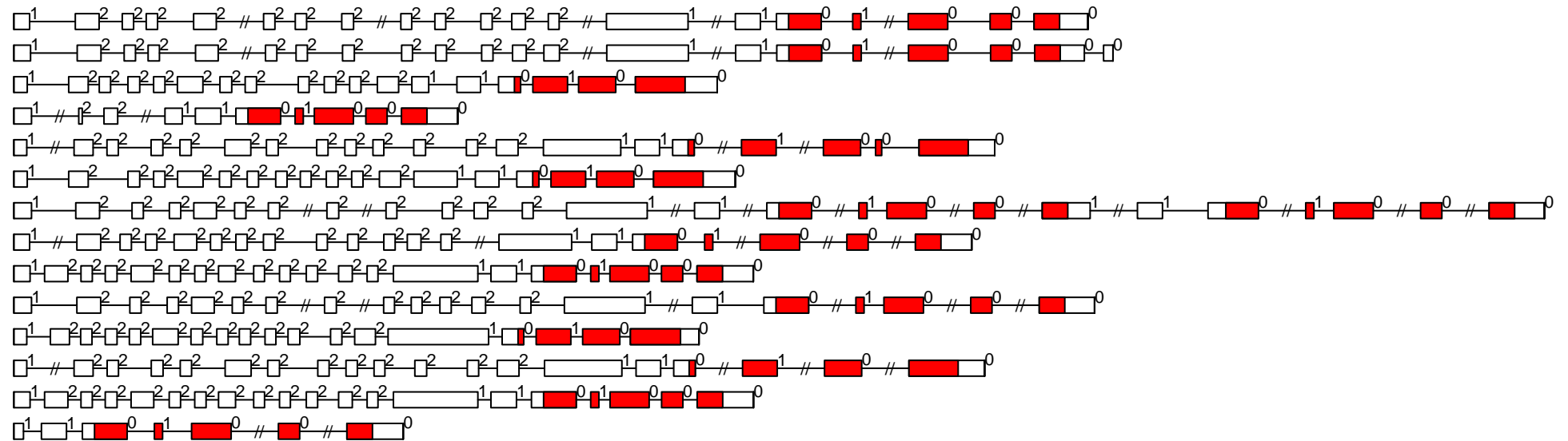

-2000

0

2000

4000

6000

8000

10000

G.hi RLK-Pelle_LRR-V exon-intron and domain diagram (all)

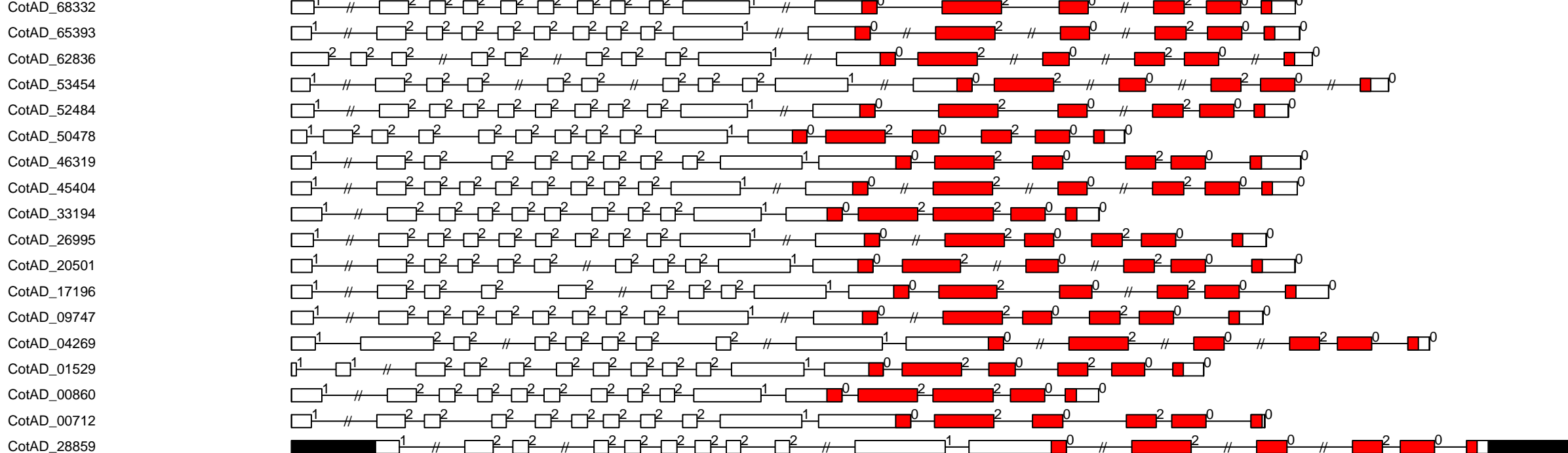

0

2000

4000

6000

G.hi RLK-Pelle_LRR-Xa exon-intron and domain diagram (all)

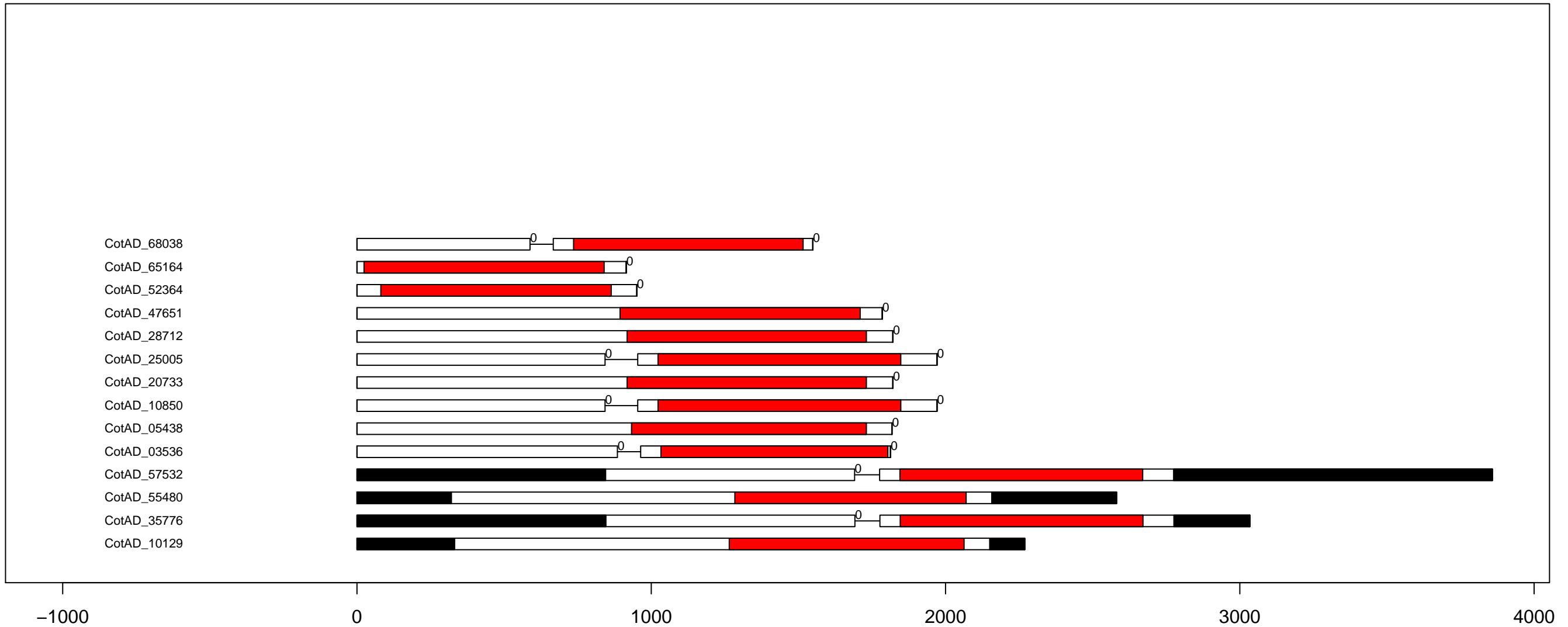

G.hi RLK-Pelle_LRR-Xb-1 exon-intron and domain diagram (all)

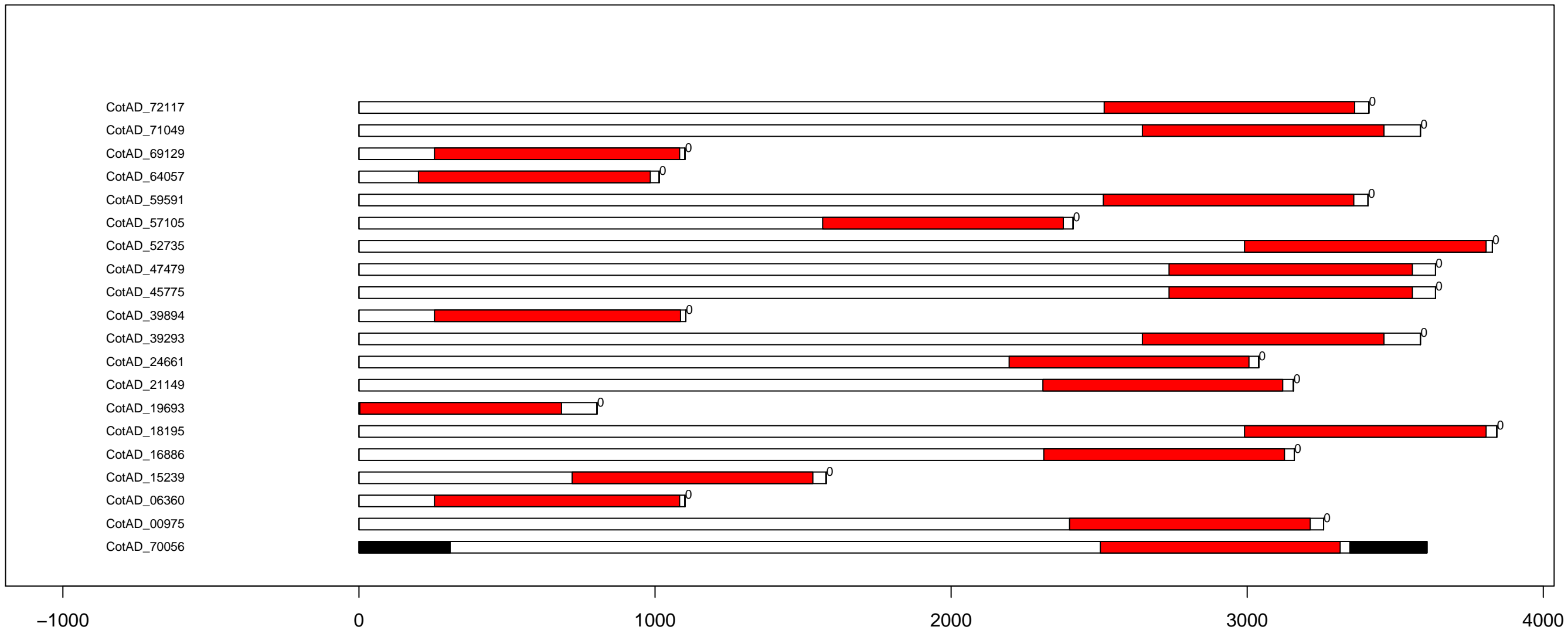

G.hi RLK-Pelle_LRR-Xb-2 exon-intron and domain diagram (all)

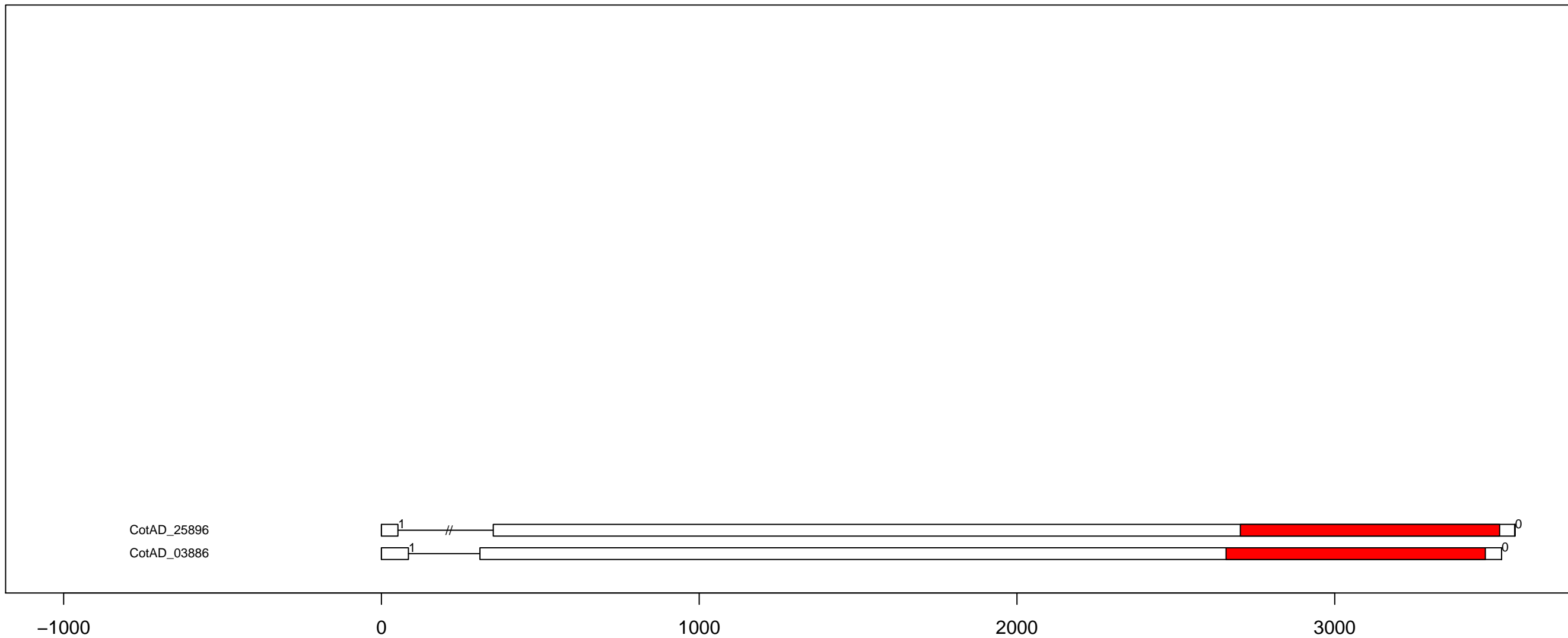

G.hi RLK-Pelle_LRR-XI-1 exon-intron and domain diagram (part 1)

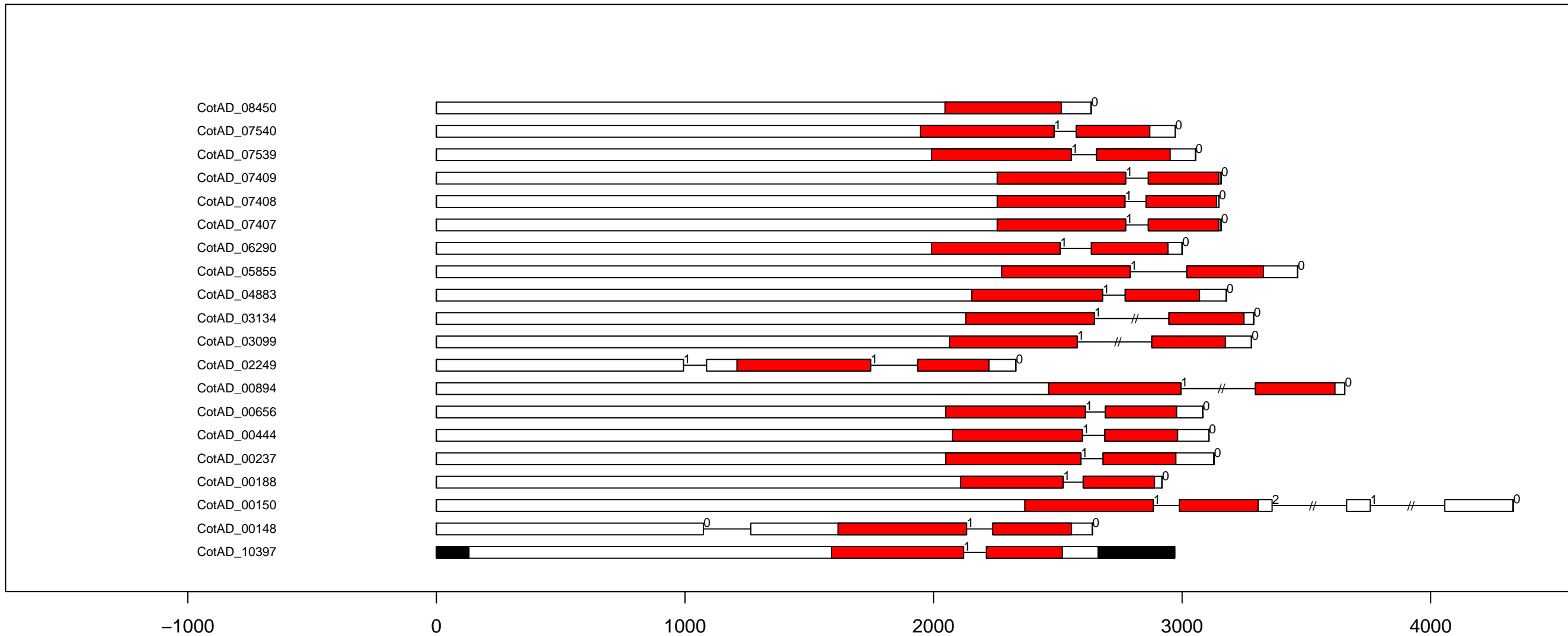

G.hi RLK-Pelle_LRR-XI-1 exon-intron and domain diagram (part 2)

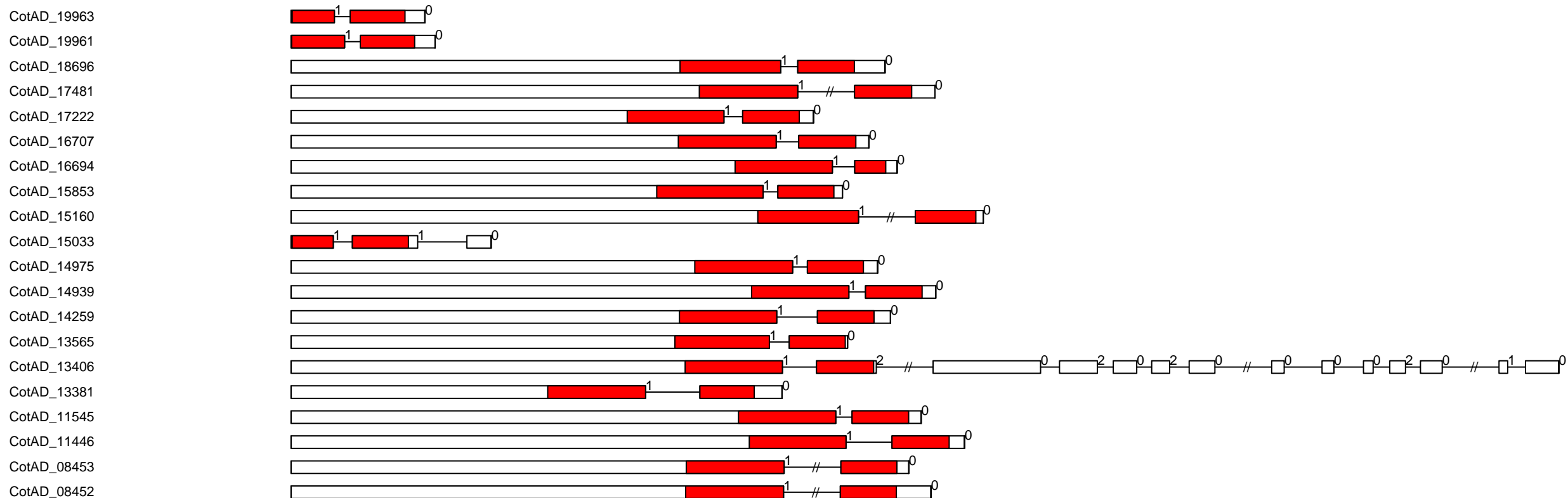

G.hi RLK-Pelle_LRR-XI-1 exon-intron and domain diagram (part 3)

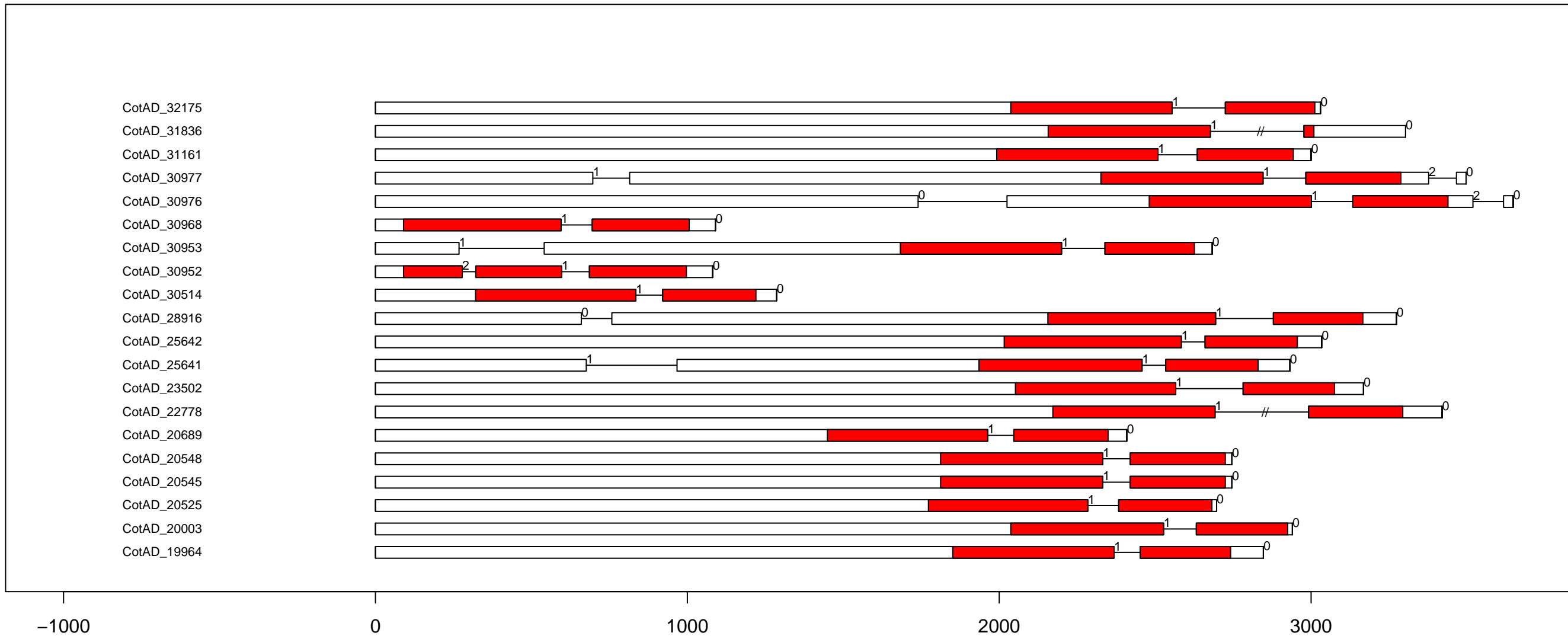

G.hi RLK-Pelle_LRR-XI-1 exon-intron and domain diagram (part 4)

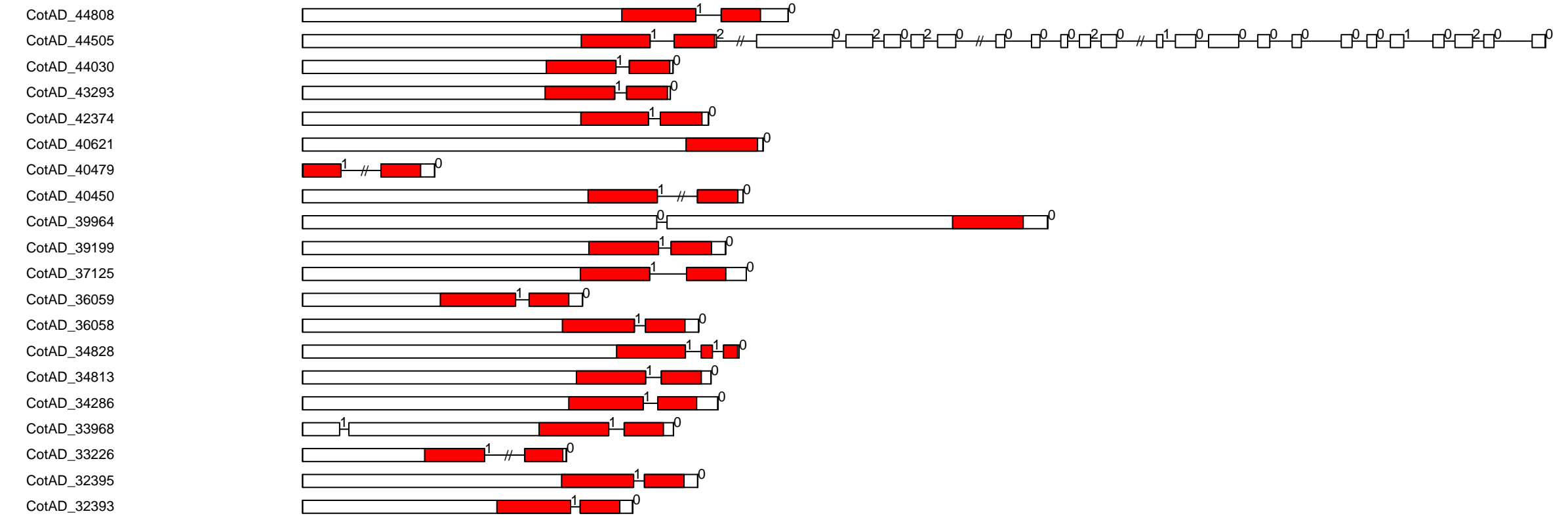

G.hi RLK-Pelle_LRR-XI-1 exon-intron and domain diagram (part 5)

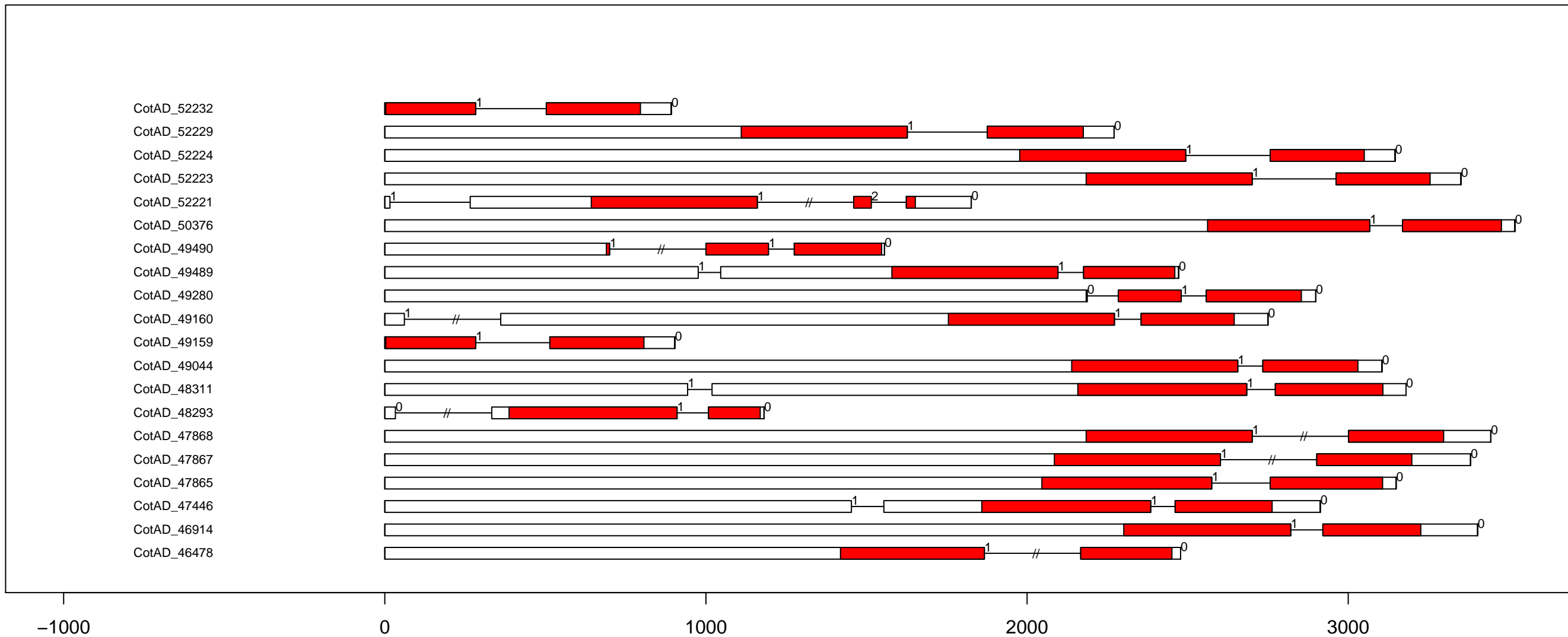

G.hi RLK-Pelle_LRR-XI-1 exon-intron and domain diagram (part 6)

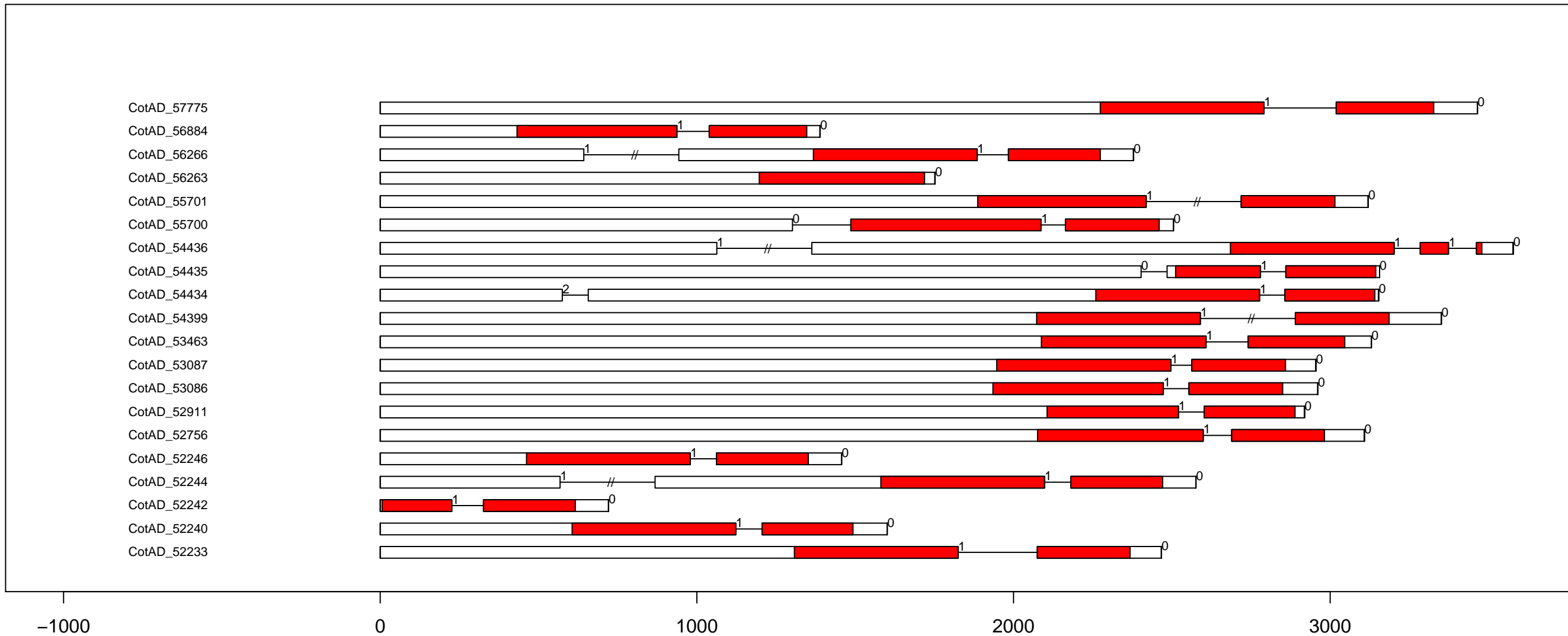

G.hi RLK-Pelle_LRR-XI-1 exon-intron and domain diagram (part 7)

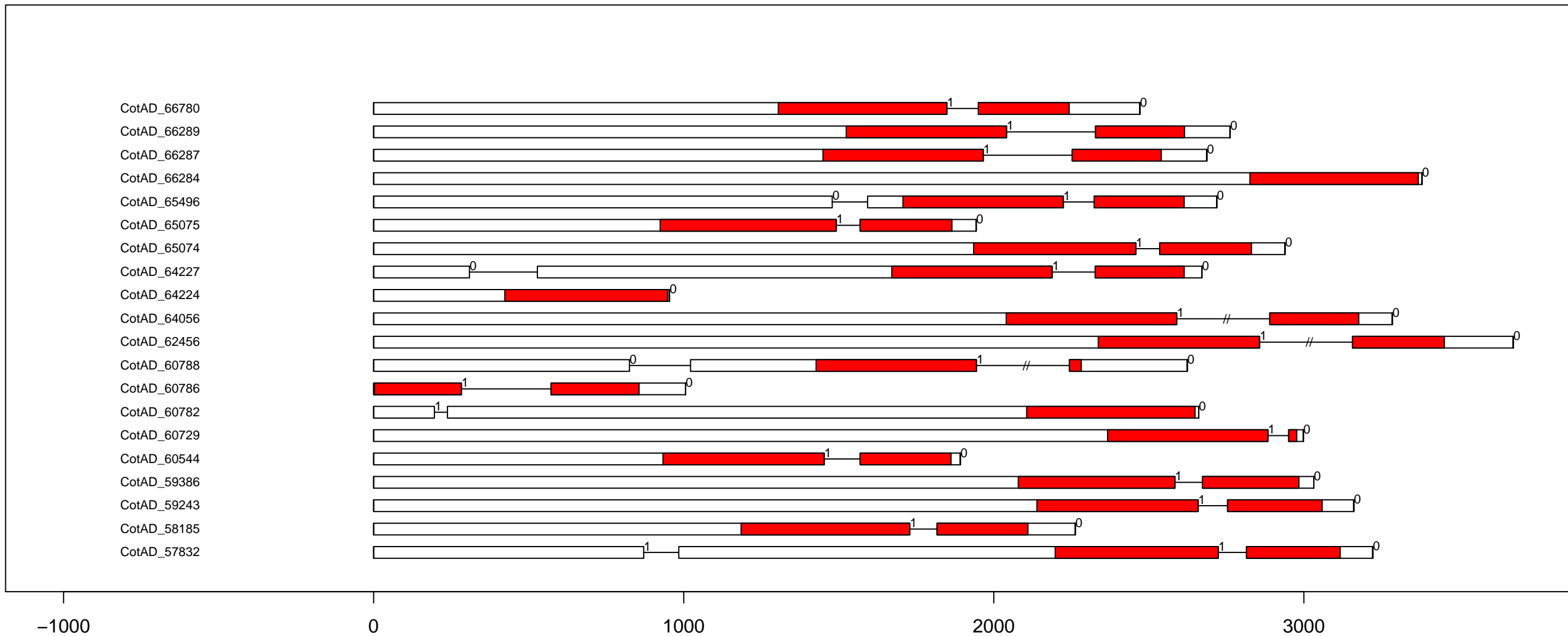

G.hi RLK-Pelle_LRR-XI-1 exon-intron and domain diagram (part 8)

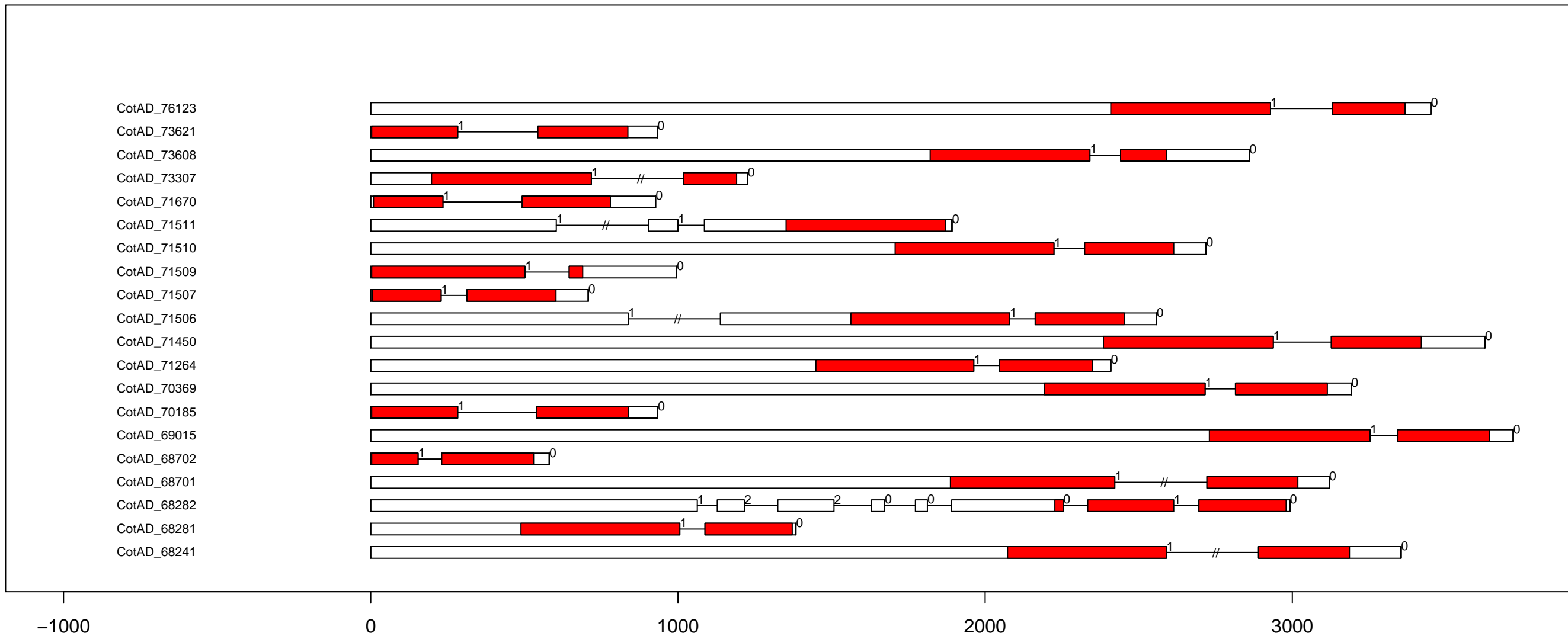

G.hi RLK-Pelle_LRR-XI-1 exon-intron and domain diagram (part 9)

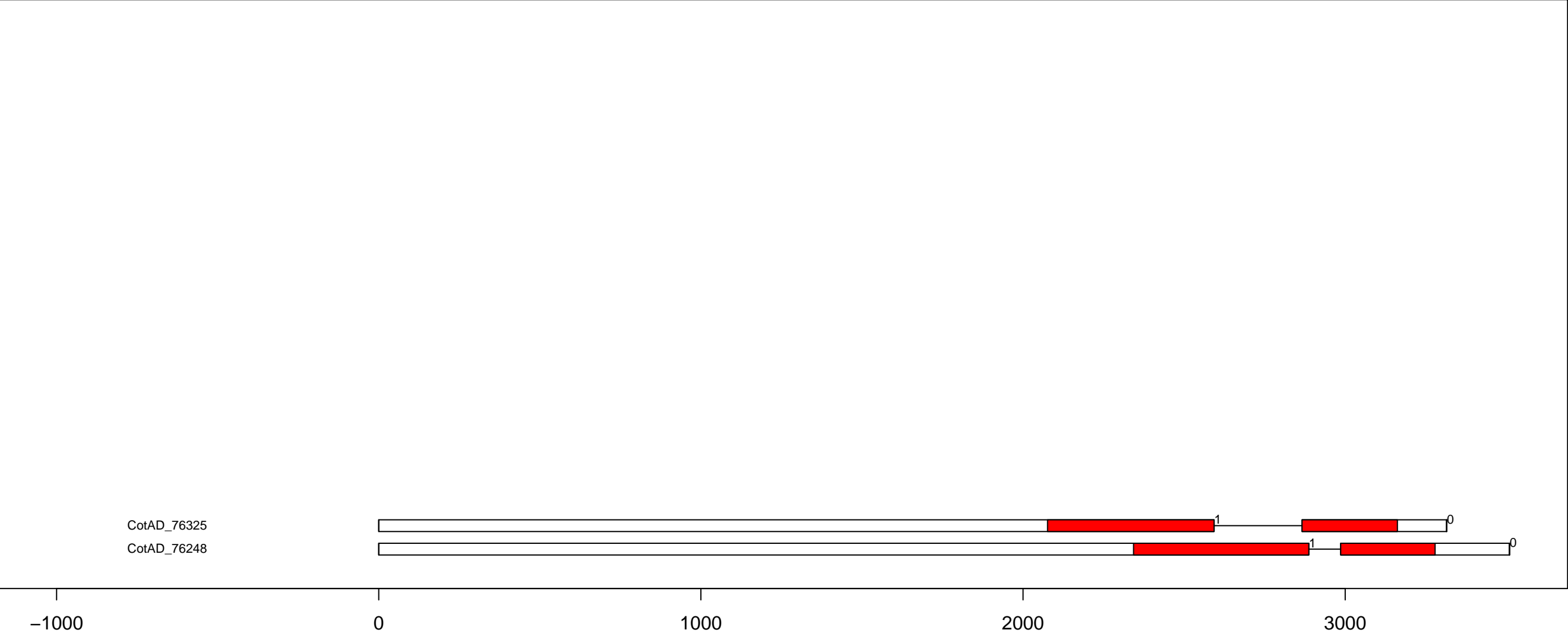

G.hi RLK-Pelle_LRR-XI-2 exon-intron and domain diagram (all)

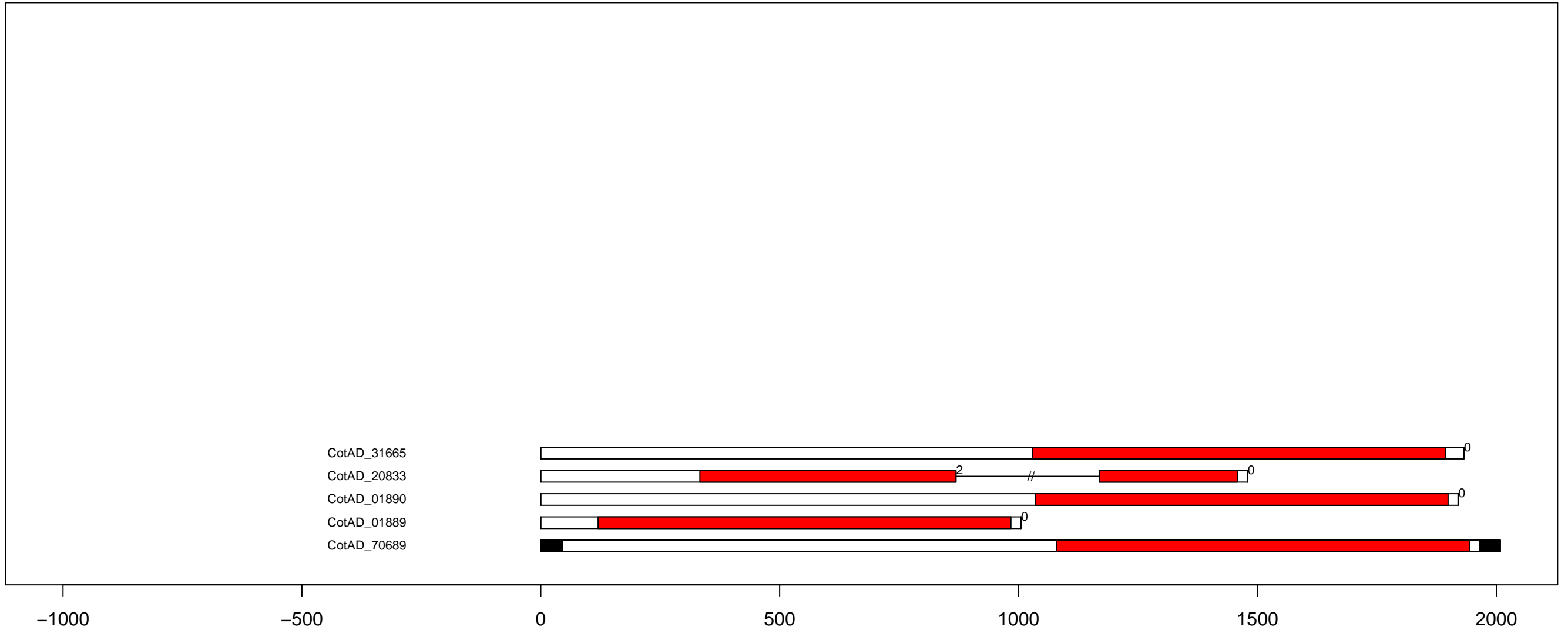

G.hi RLK-Pelle_LRR-XII-1 exon-intron and domain diagram (part 1)

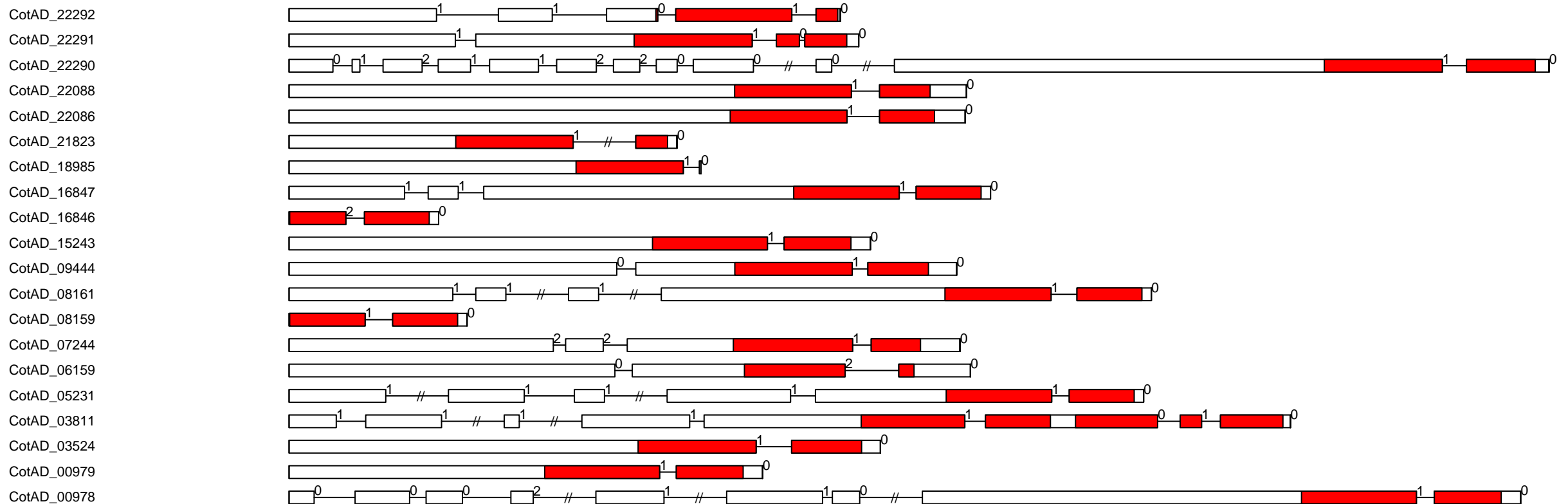

G.hi RLK-Pelle_LRR-XII-1 exon-intron and domain diagram (part 2)

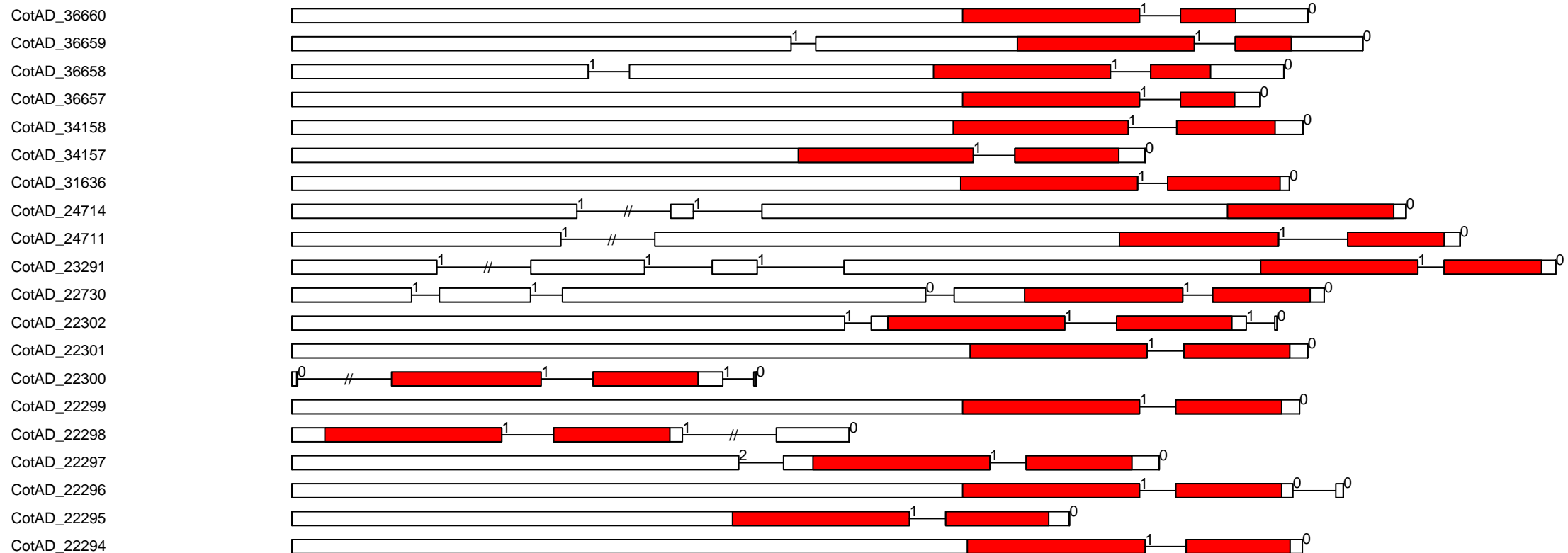

G.hi RLK-Pelle_LRR-XIIIa exon-intron and domain diagram (all)

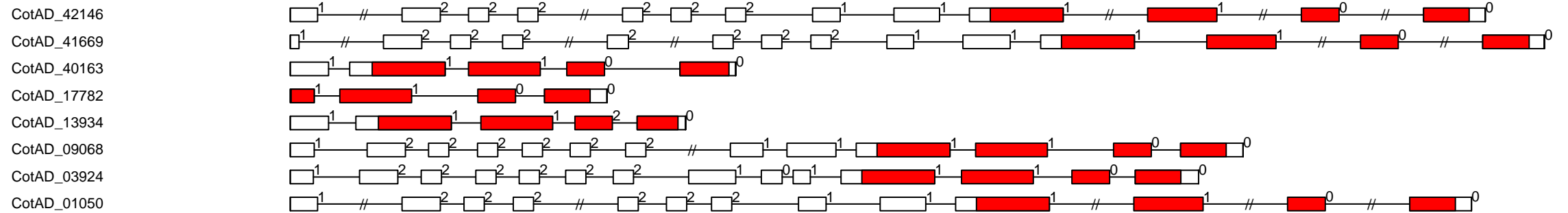

G.hi RLK-Pelle_LRR-XIIIb exon-intron and domain diagram (all)

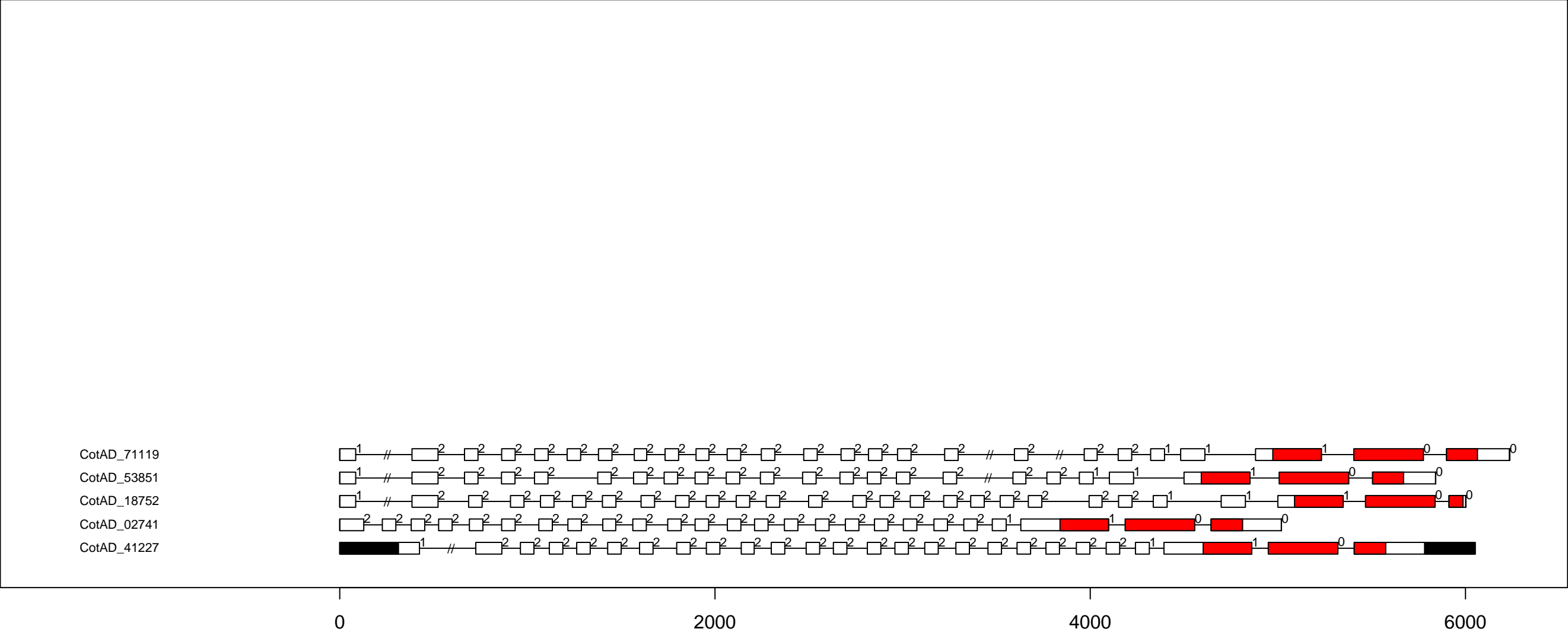

G.hi RLK-Pelle_LRR-XIV exon-intron and domain diagram (all)

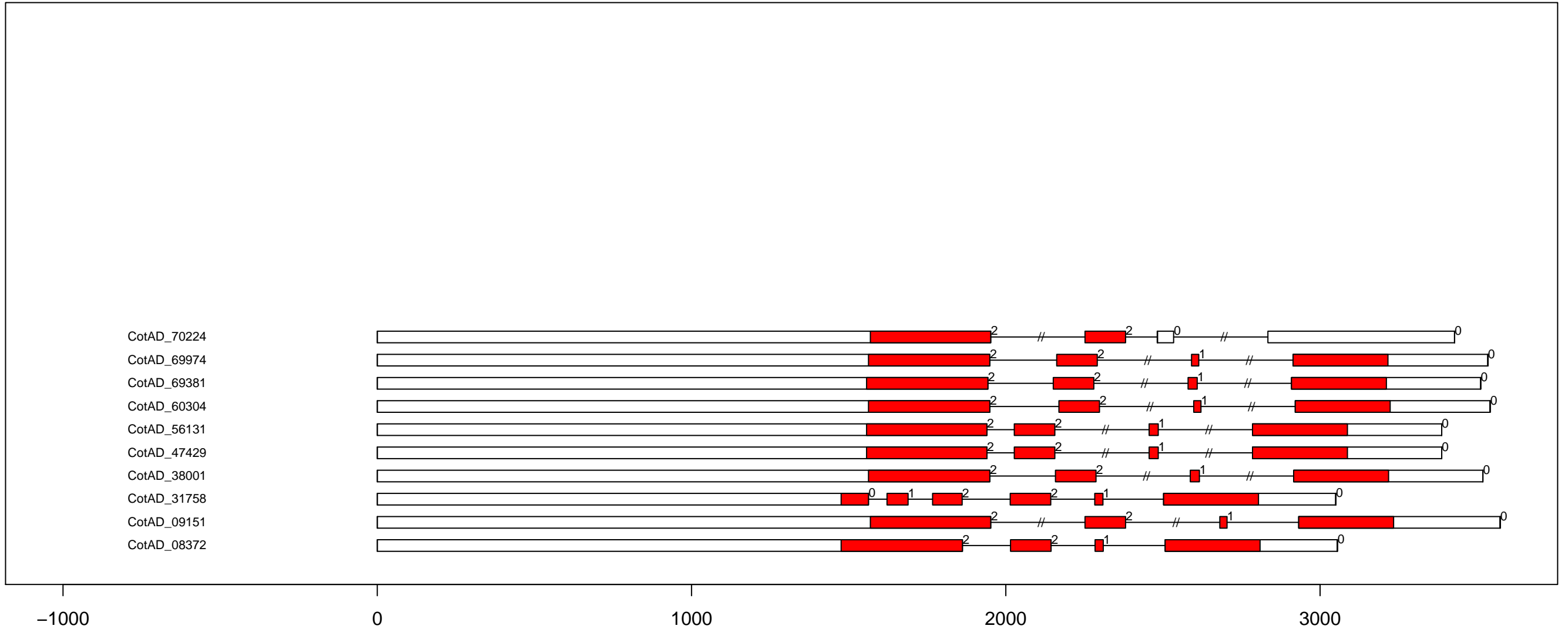

G.hi RLK-Pelle_LRR-XV exon-intron and domain diagram (all)

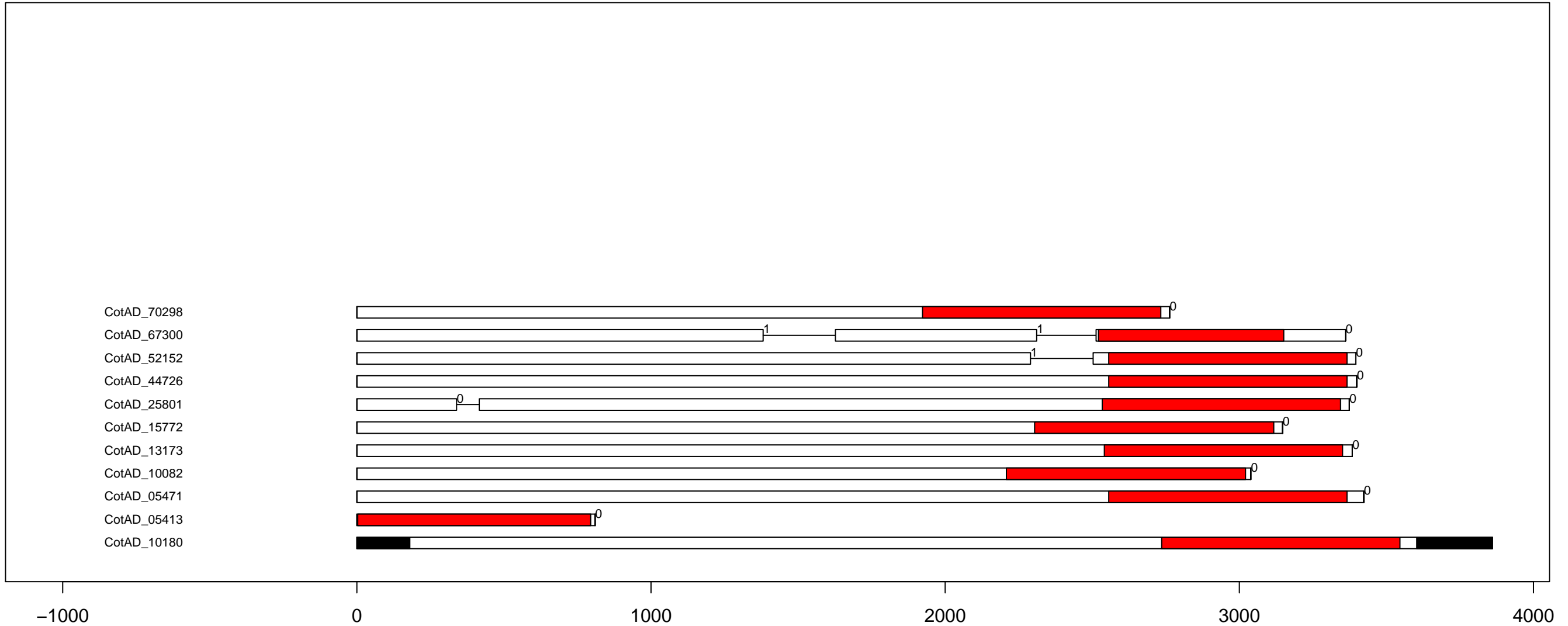

G.hi RLK-Pelle_LysM exon-intron and domain diagram (part 1)

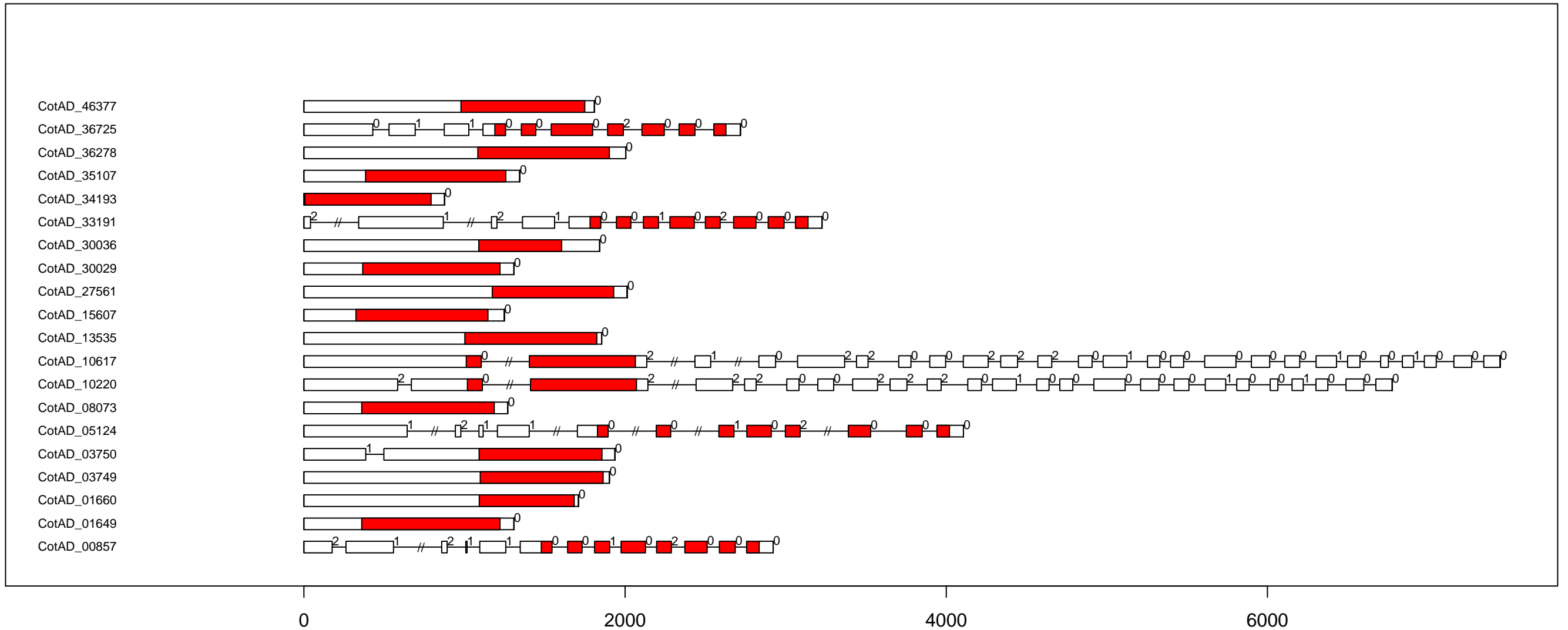

G.hi RLK-Pelle_LysM exon-intron and domain diagram (part 2)

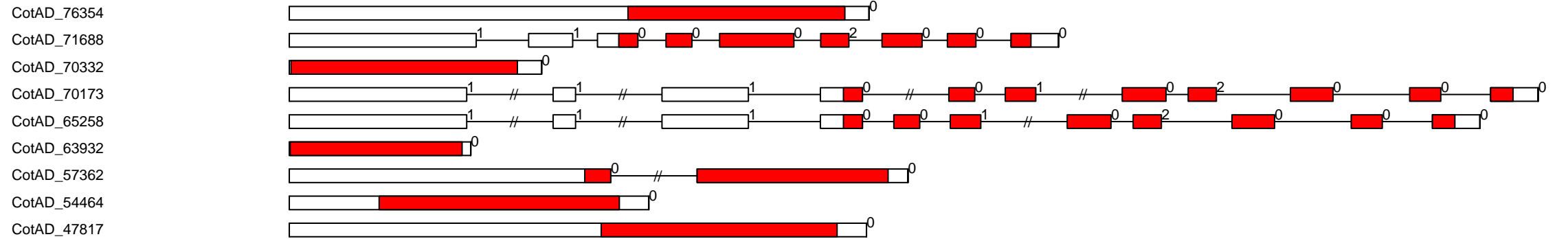

G.hi RLK-Pelle_PERK-1 exon-intron and domain diagram (part 1)

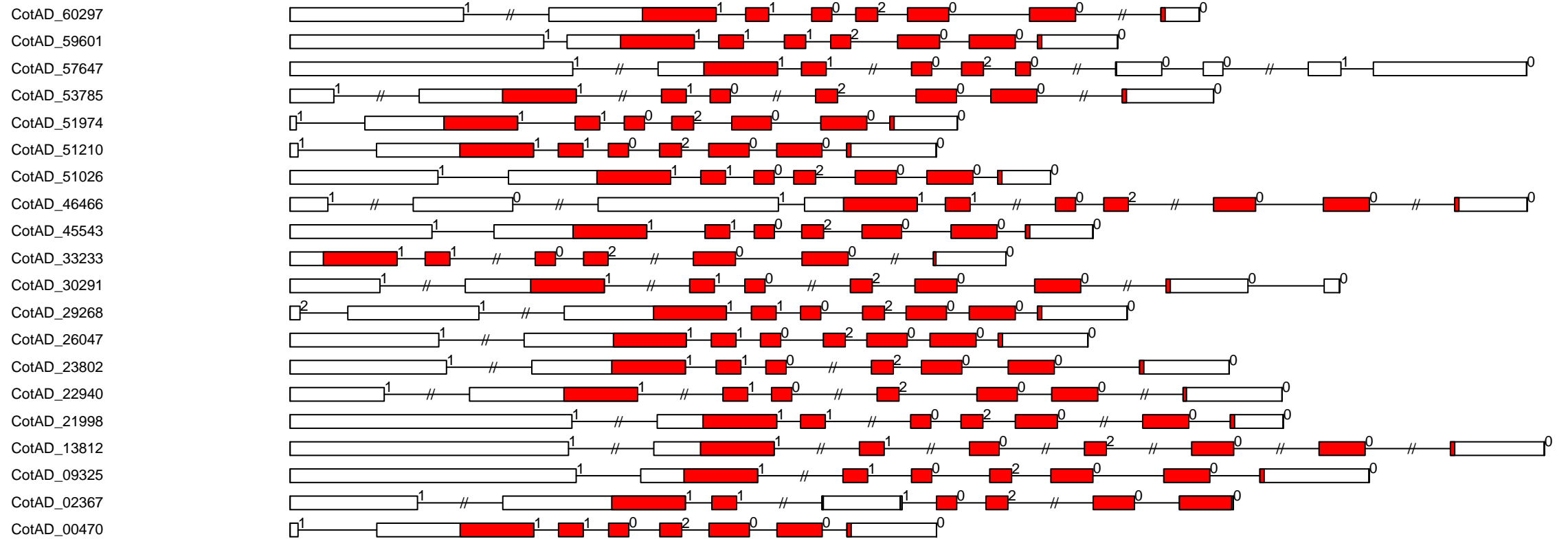

G.hi RLK-Pelle_PERK-1 exon-intron and domain diagram (part 2)

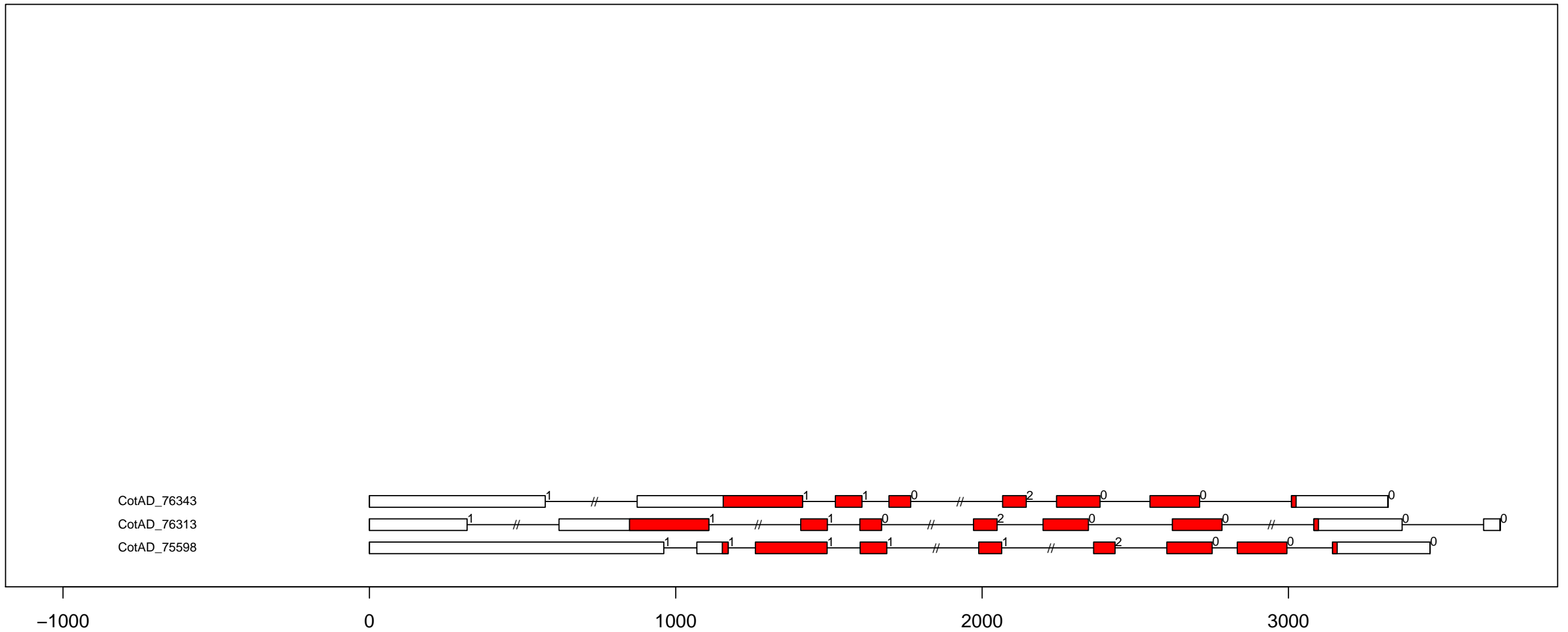

G.hi RLK-Pelle_PERK-2 exon-intron and domain diagram (all)

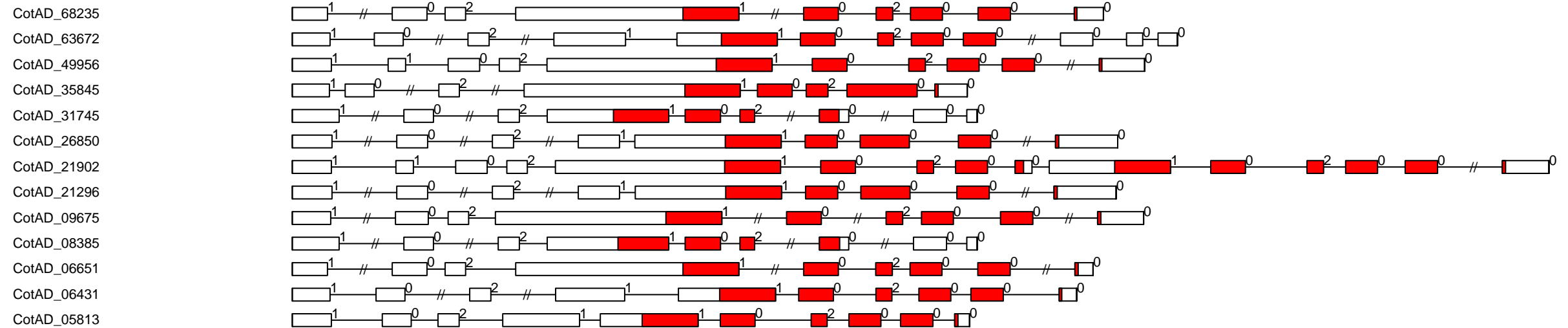

0

2000

4000

6000

G.hi RLK-Pelle_RKF3 exon-intron and domain diagram (all)

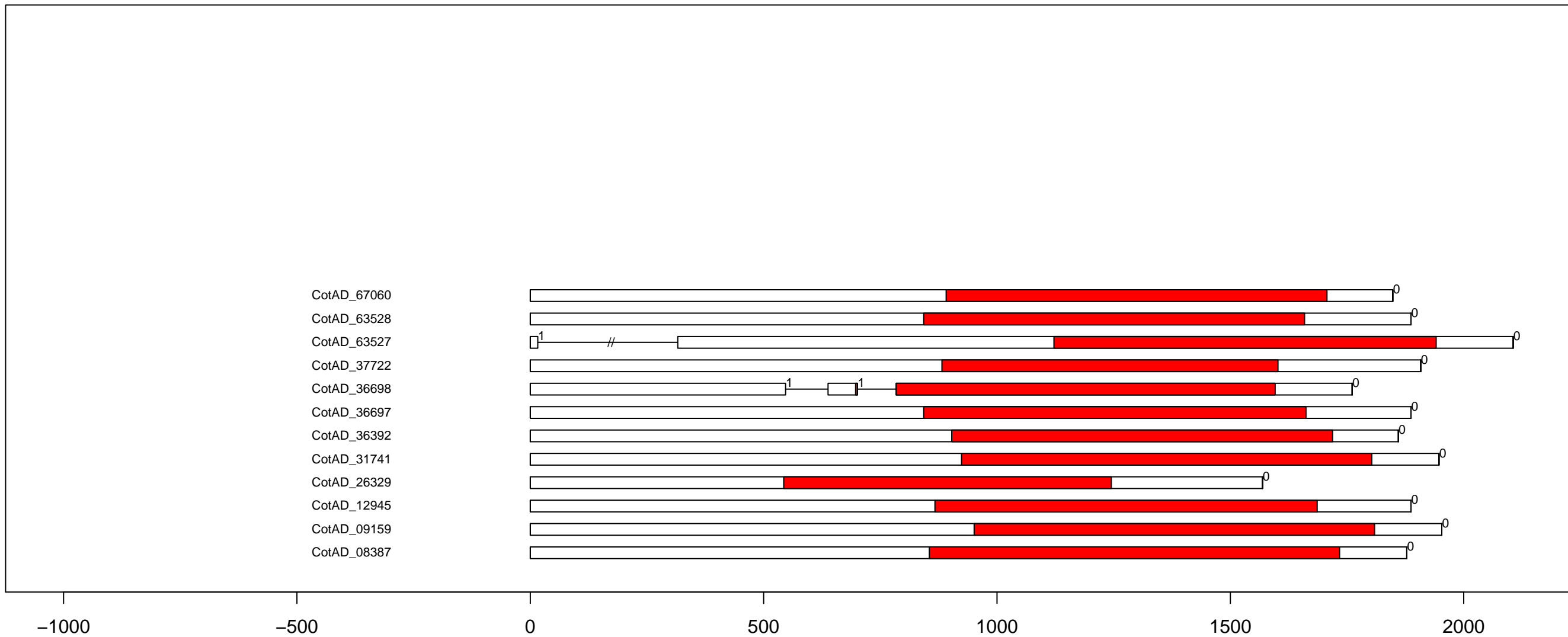

G.hi RLK-Pelle_RLCK-II exon-intron and domain diagram (all)

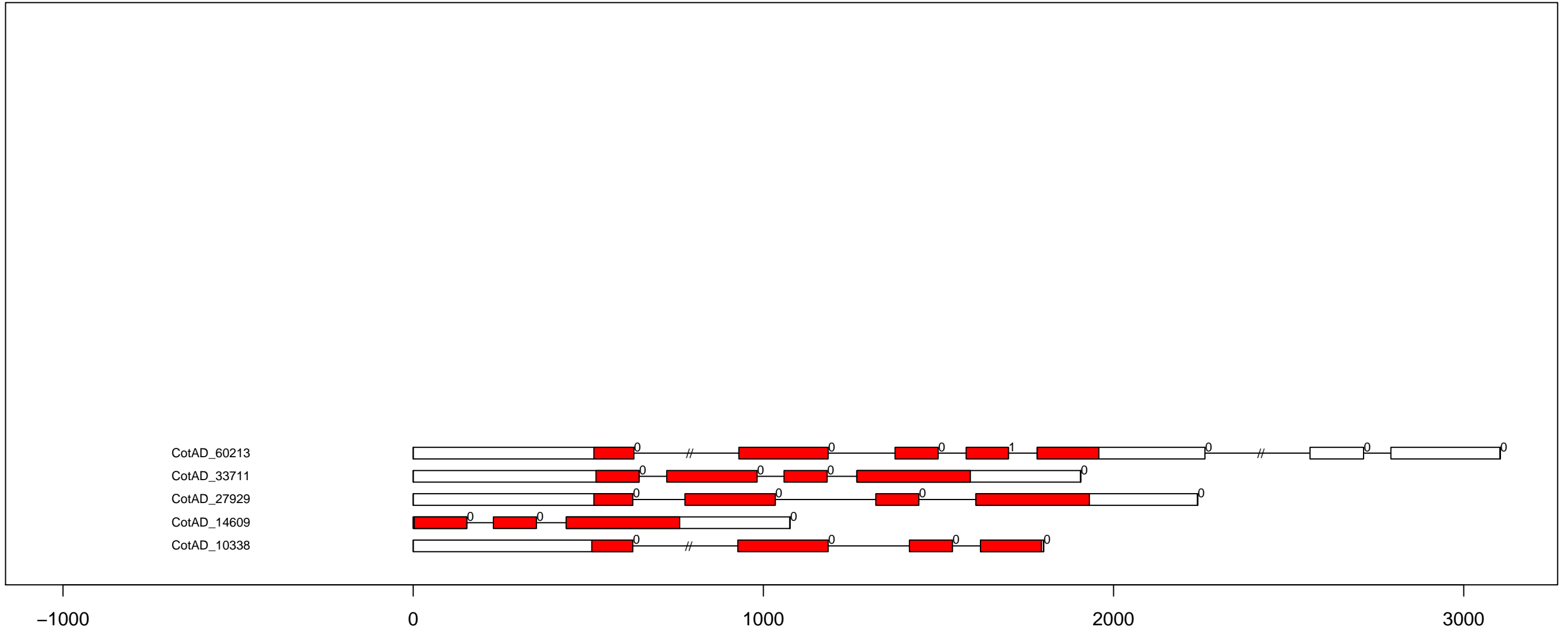

G.hi RLK-Pelle_RLCK-IV exon-intron and domain diagram (all)

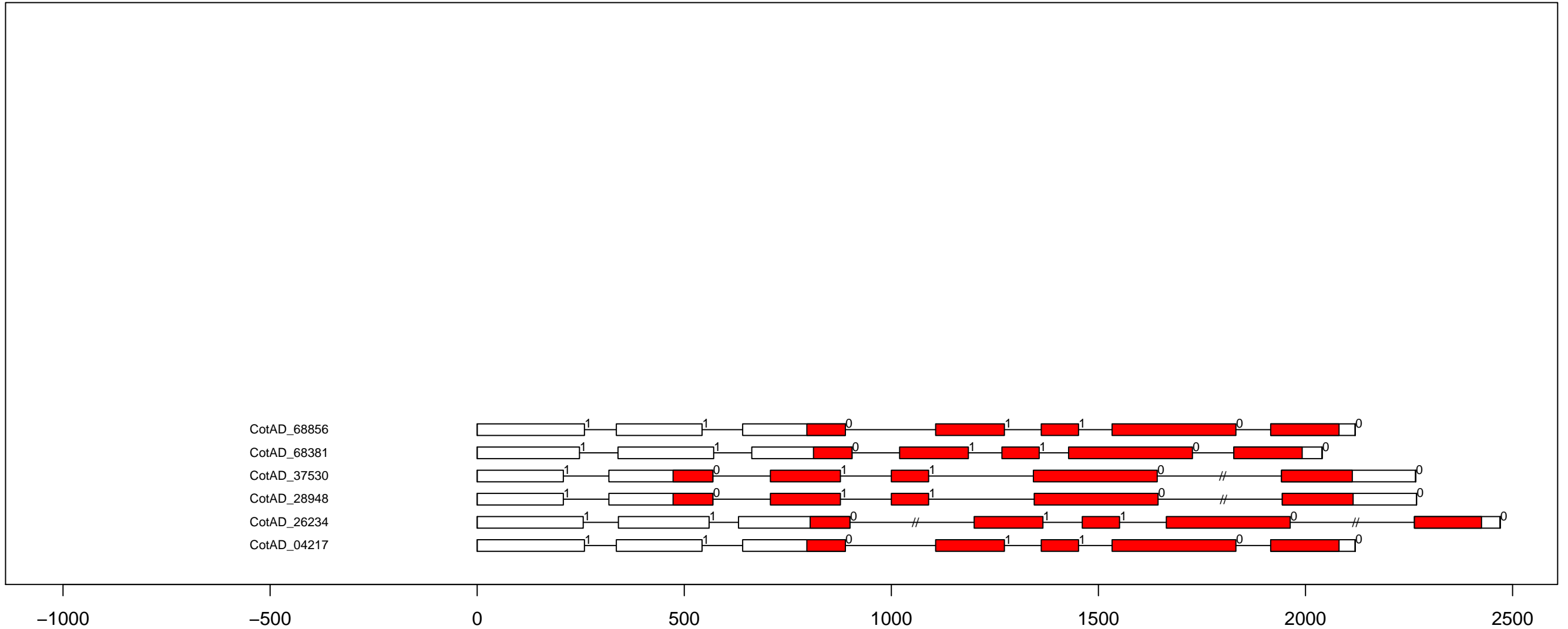

G.hi RLK-Pelle_RLCK-IXa exon-intron and domain diagram (all)

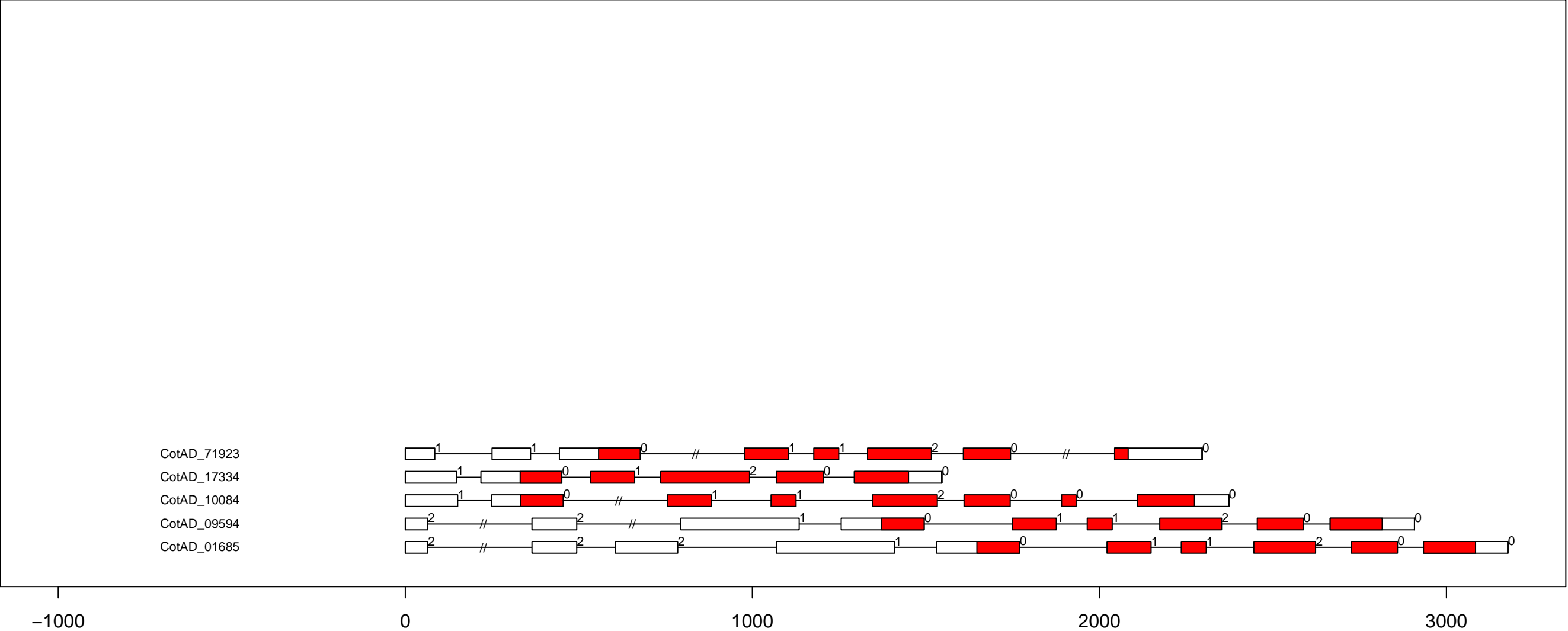

G.hi RLK-Pelle_RLCK-IXb exon-intron and domain diagram (part 1)

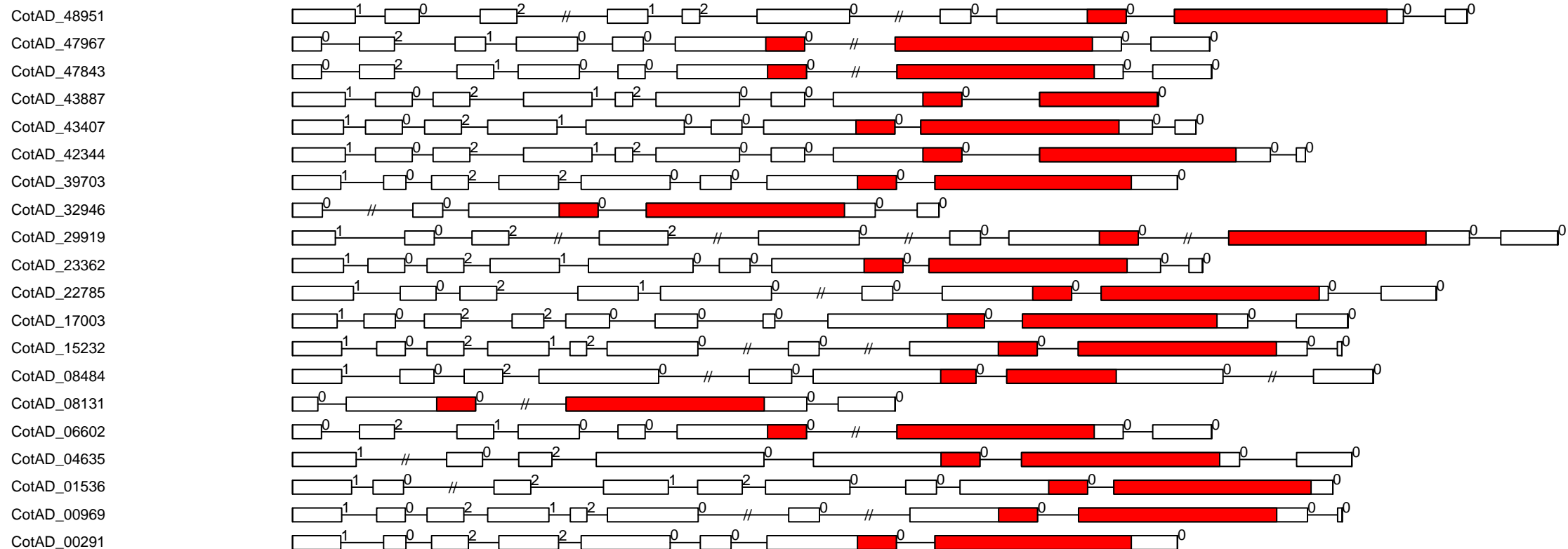

-1000

0

1000

2000

3000

4000

G.hi RLK-Pelle_RLCK-IXb exon-intron and domain diagram (part 2)

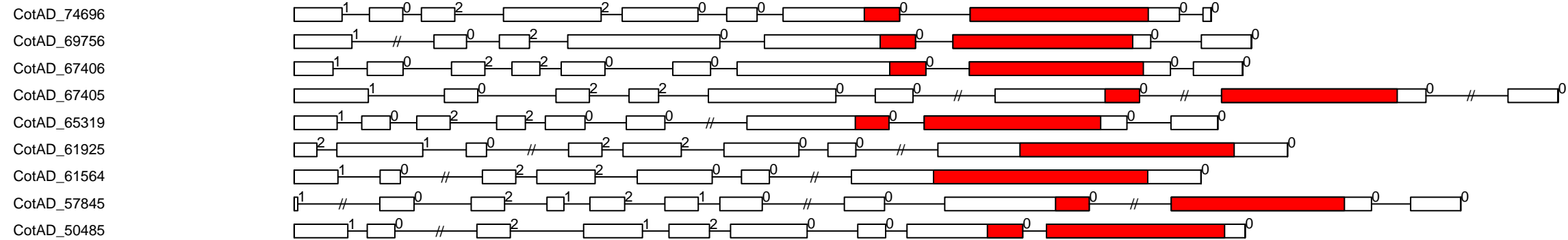

G.hi RLK-Pelle_RLCK-Os exon-intron and domain diagram (all)

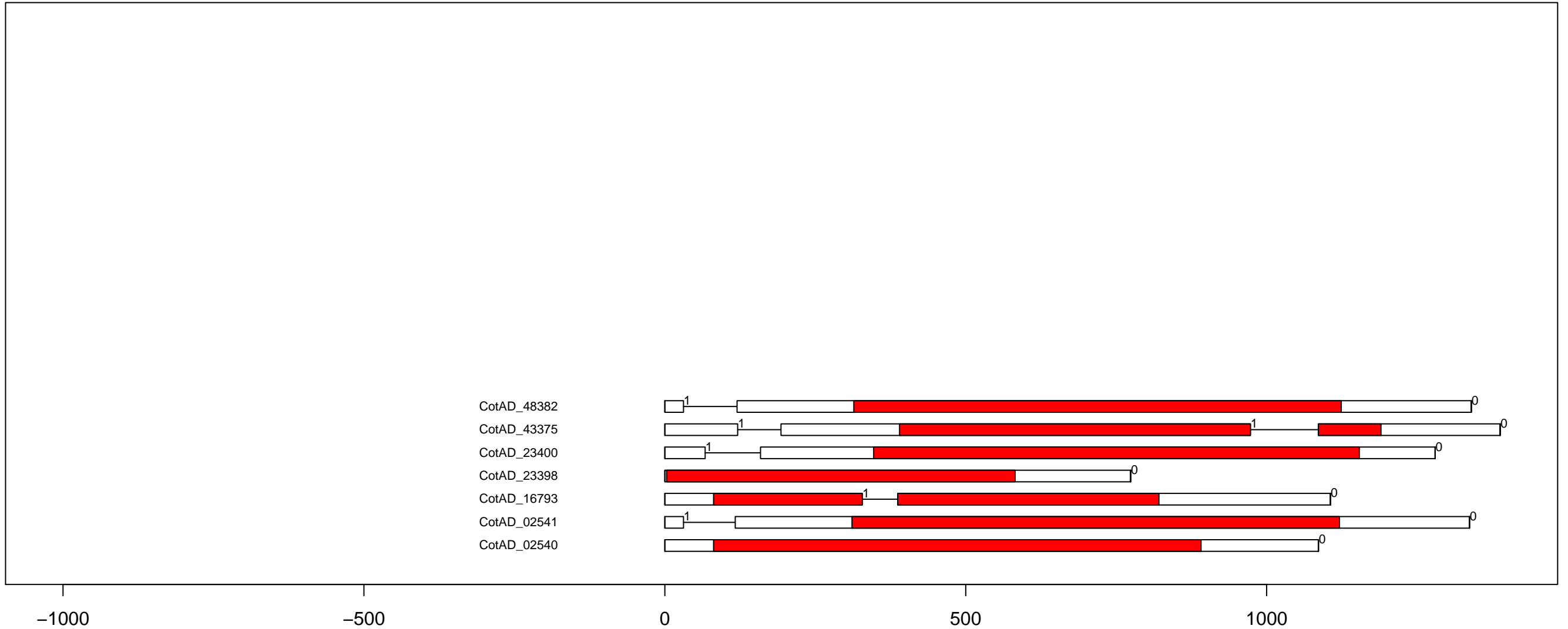

G.hi RLK-Pelle_RLCK-VIIa-1 exon-intron and domain diagram (part 1)

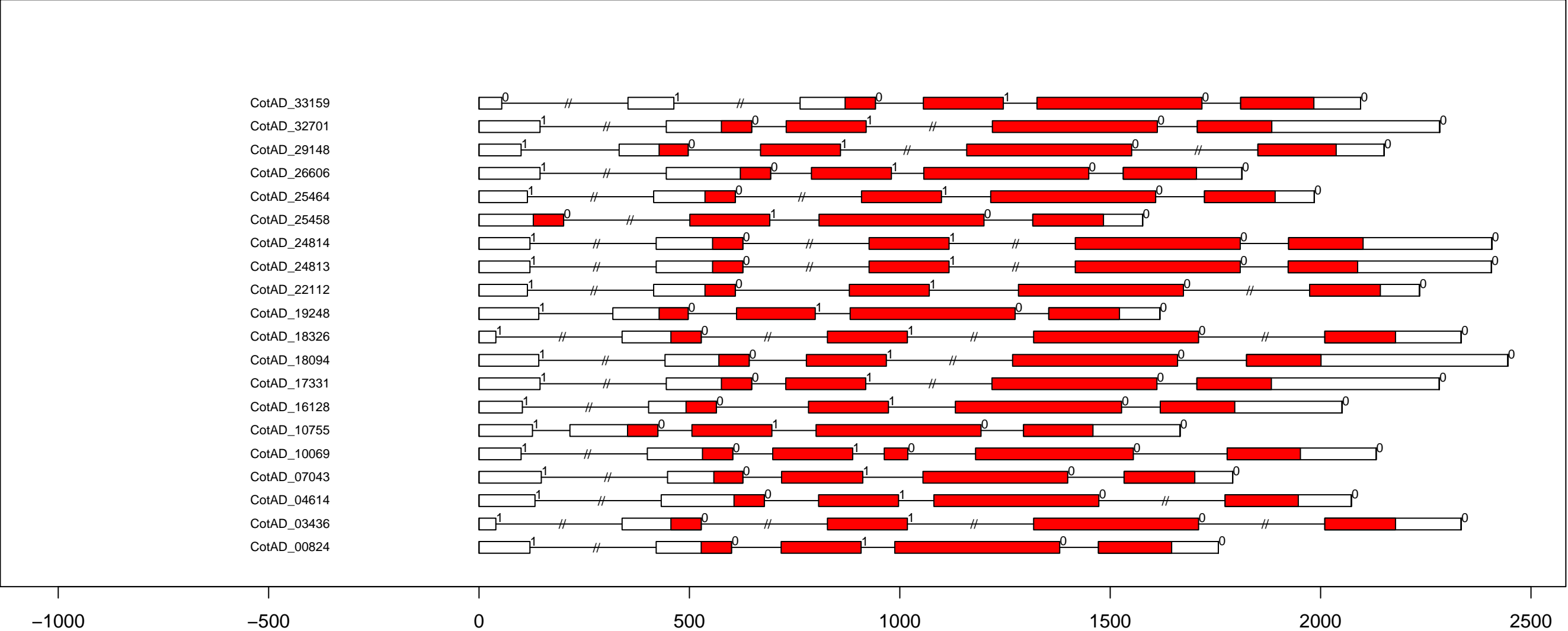

G.hi RLK-Pelle_RLCK-VIIa-1 exon-intron and domain diagram (part 2)

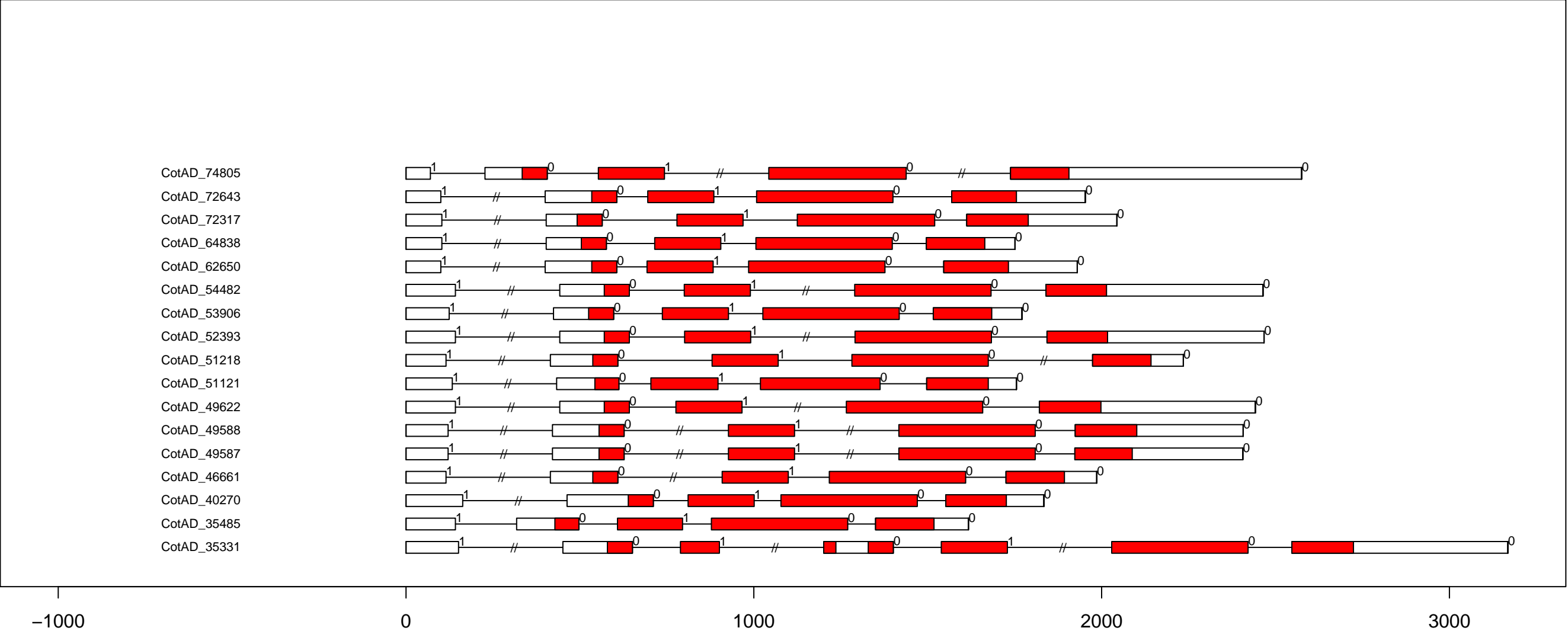

G.hi RLK-Pelle_RLCK-VIIa-2 exon-intron and domain diagram (part 1)

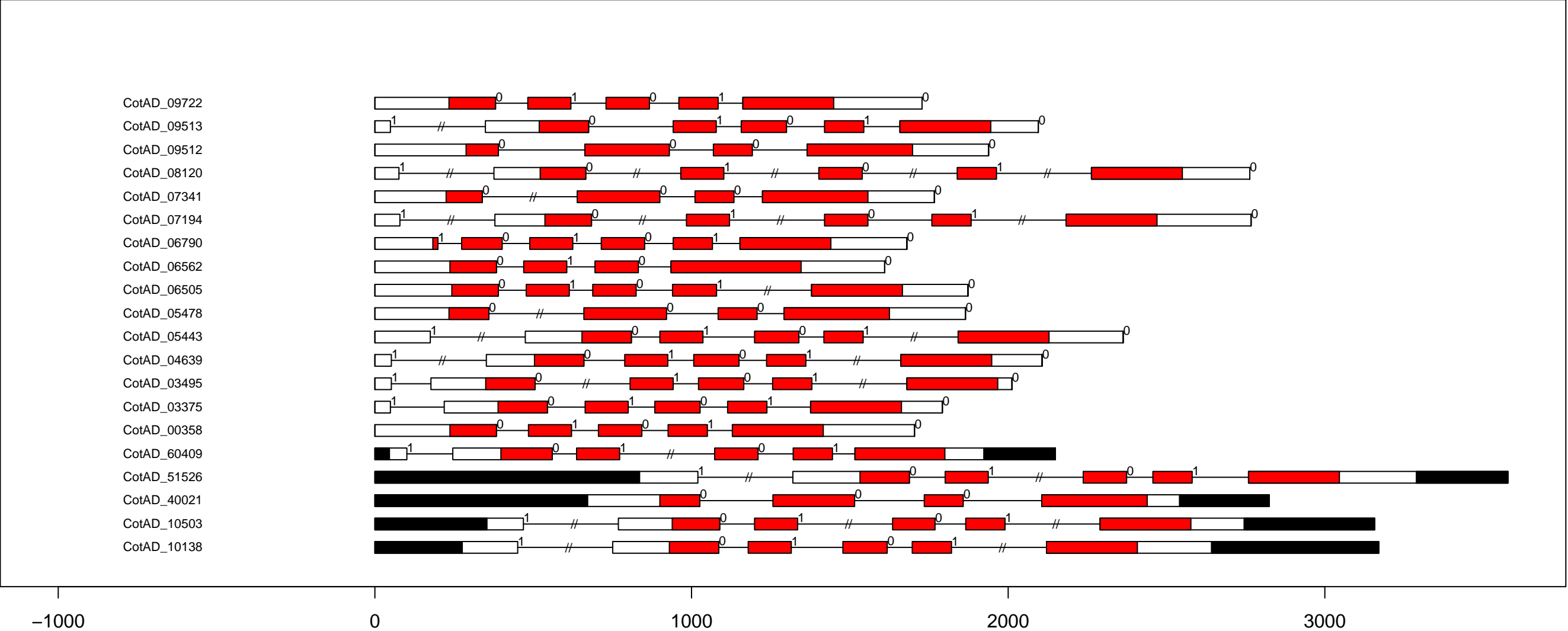

G.hi RLK-Pelle_RLCK-VIIa-2 exon-intron and domain diagram (part 2)

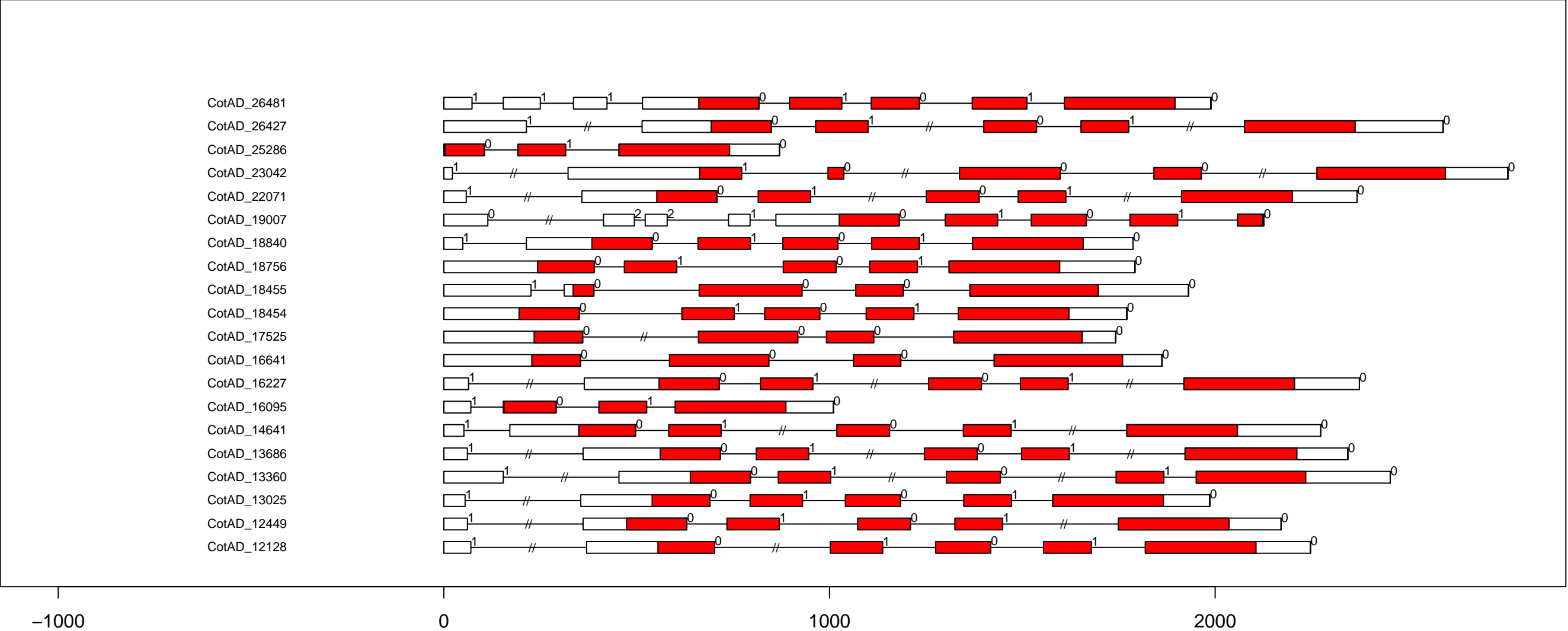

G.hi RLK-Pelle_RLCK-VIIa-2 exon-intron and domain diagram (part 3)

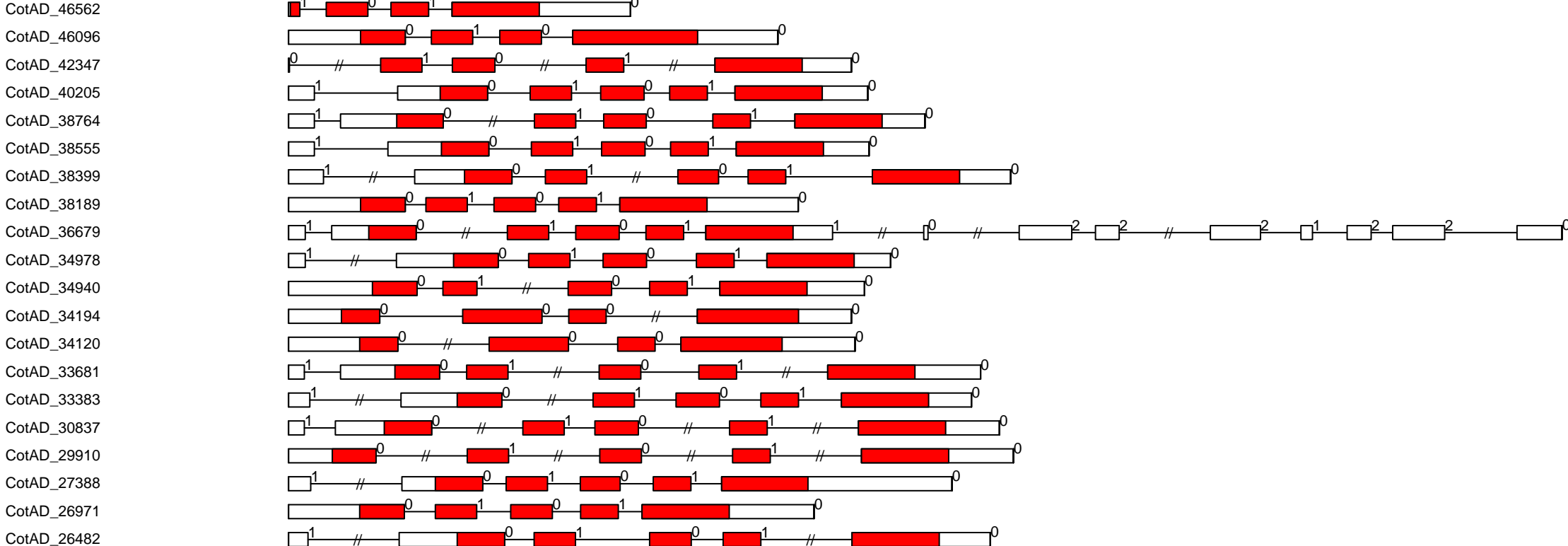

G.hi RLK-Pelle_RLCK-VIIa-2 exon-intron and domain diagram (part 4)

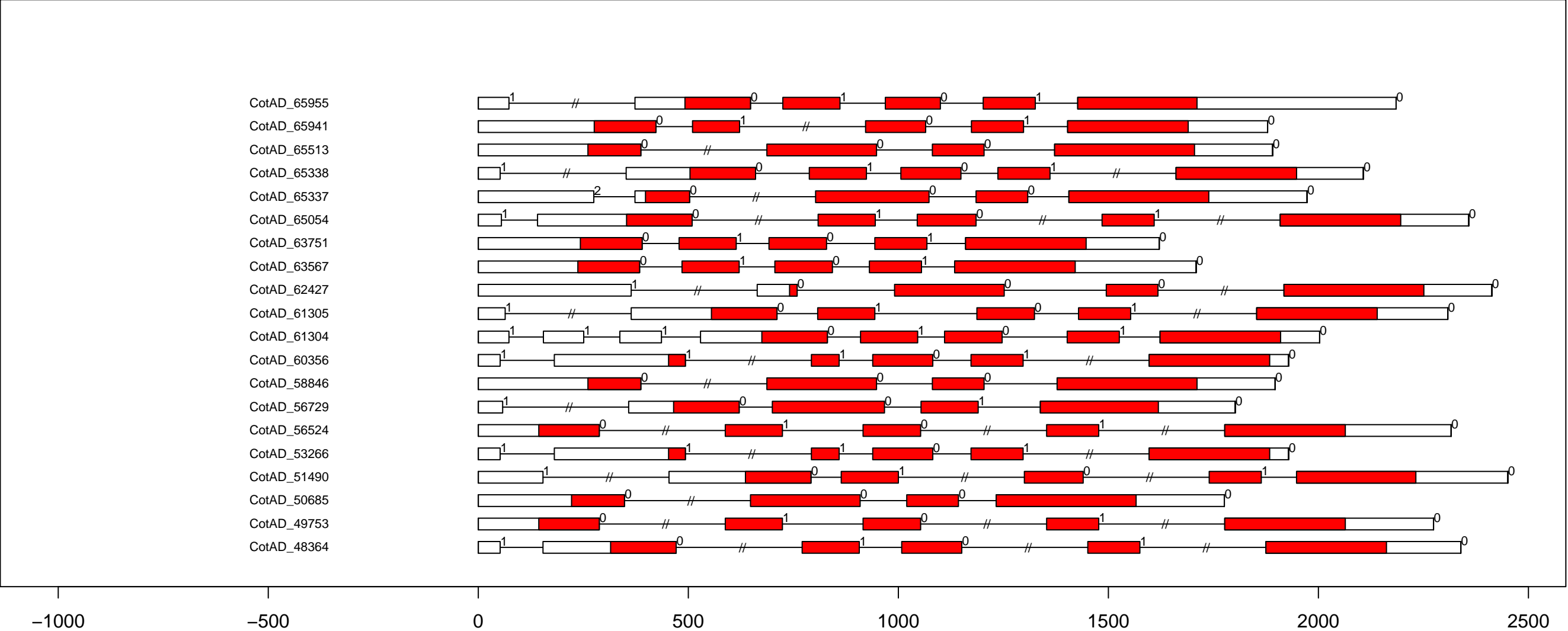

G.hi RLK-Pelle_RLCK-VIIa-2 exon-intron and domain diagram (part 5)

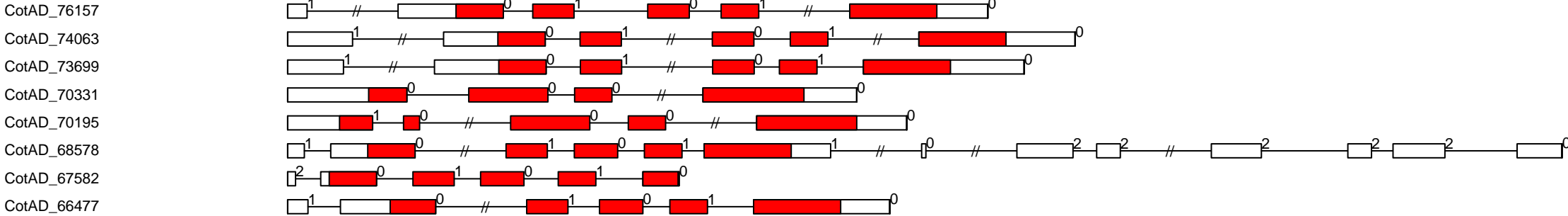

-1000

0

1000

2000

3000

4000

G.hi RLK-Pelle_RLCK-VIIb exon-intron and domain diagram (all)

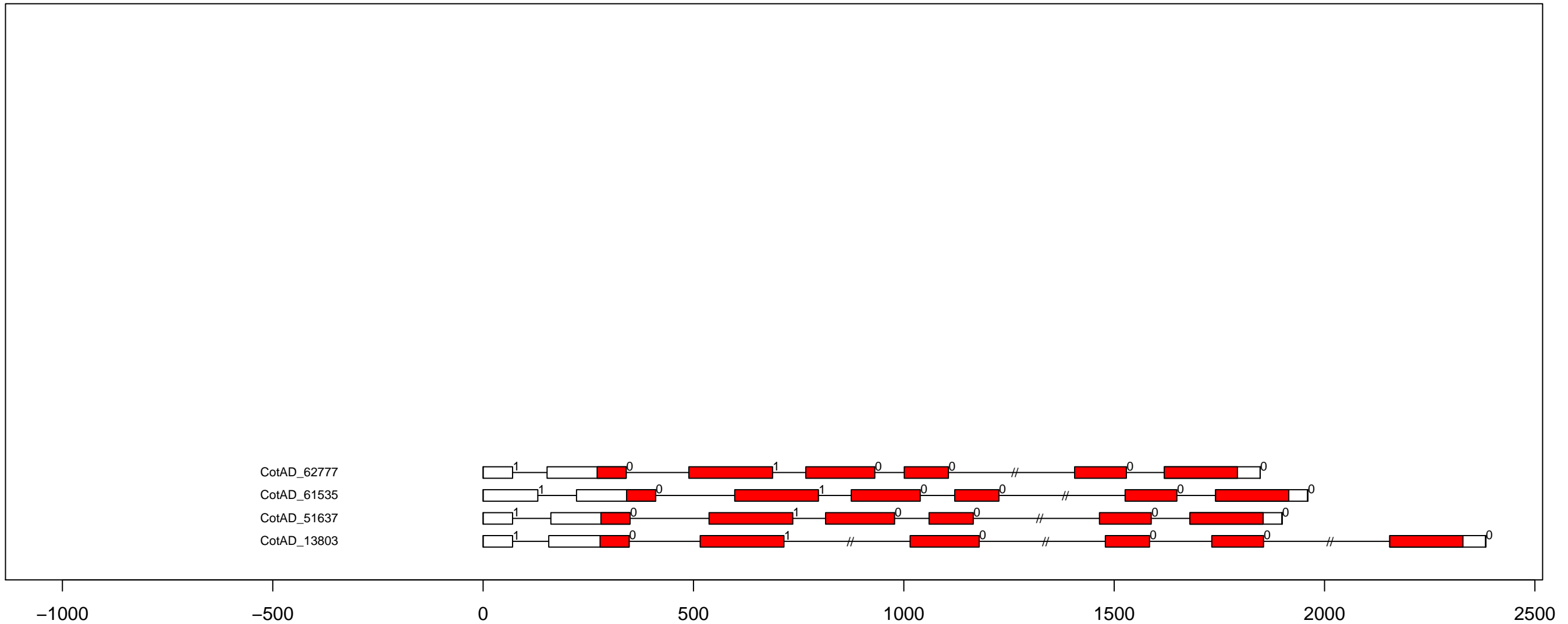

G.hi RLK-Pelle_RLCK-VIII exon-intron and domain diagram (all)

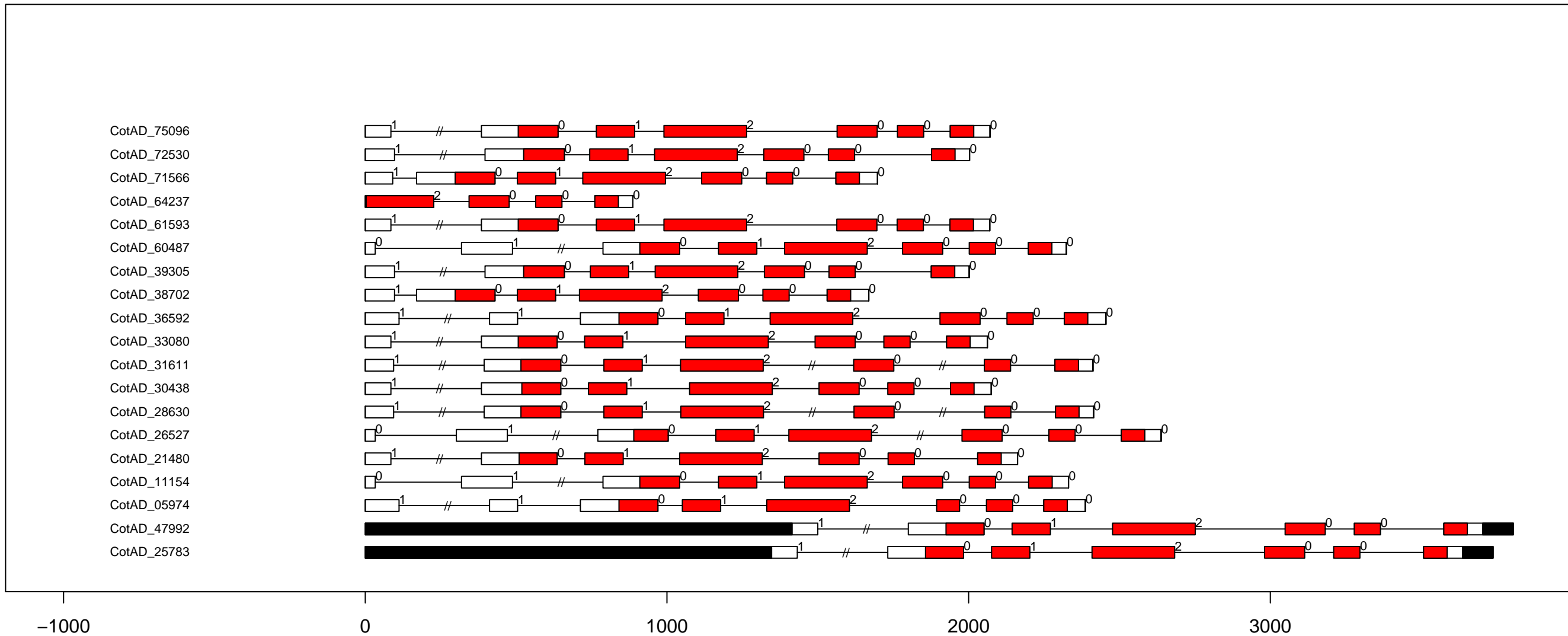

G.hi RLK-Pelle_RLCK-VI exon-intron and domain diagram (part 2)

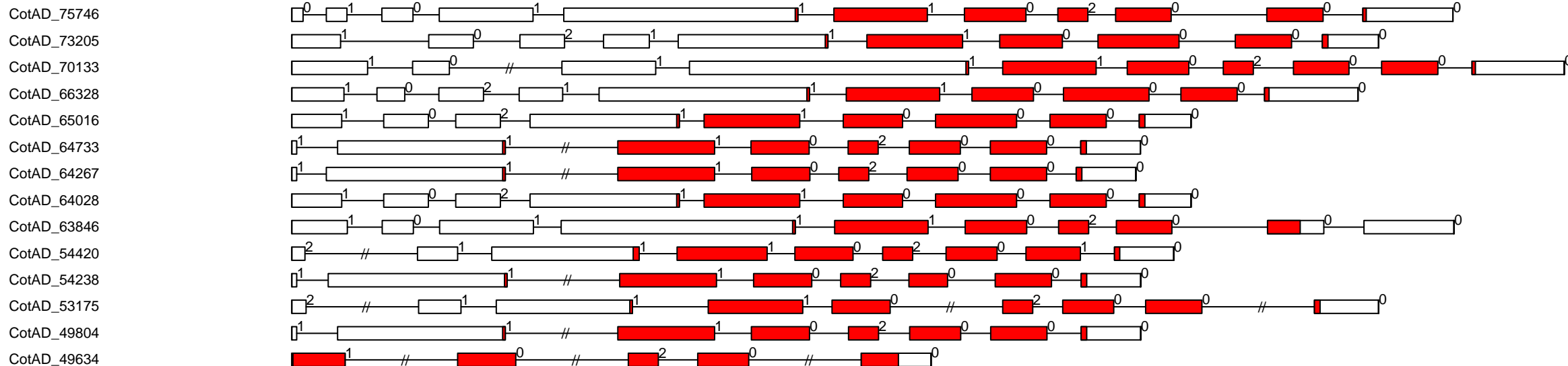

-1000

0

1000

2000

3000

G.hi RLK-Pelle_RLCK-V exon-intron and domain diagram (part 1)

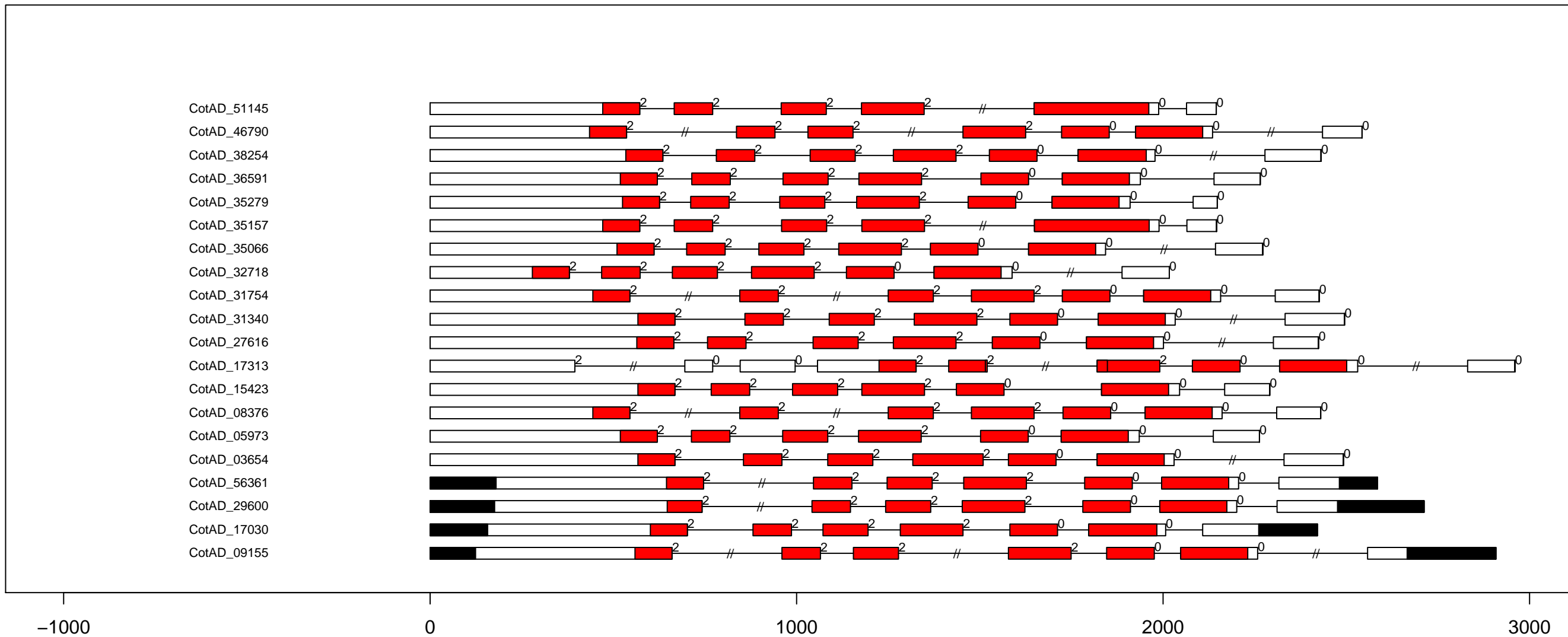

G.hi RLK-Pelle_RLCK-V exon-intron and domain diagram (part 2)

CotAD_62992

CotAD_55942

CotAD_53338

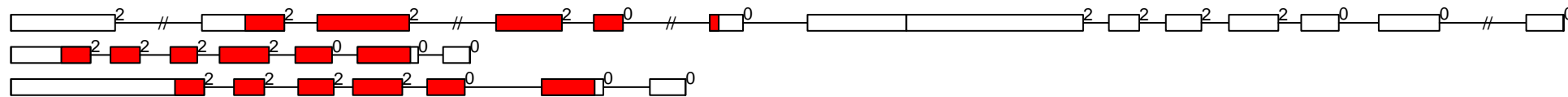

G.hi RLK-Pelle_RLCK-XII-1 exon-intron and domain diagram (part 1)

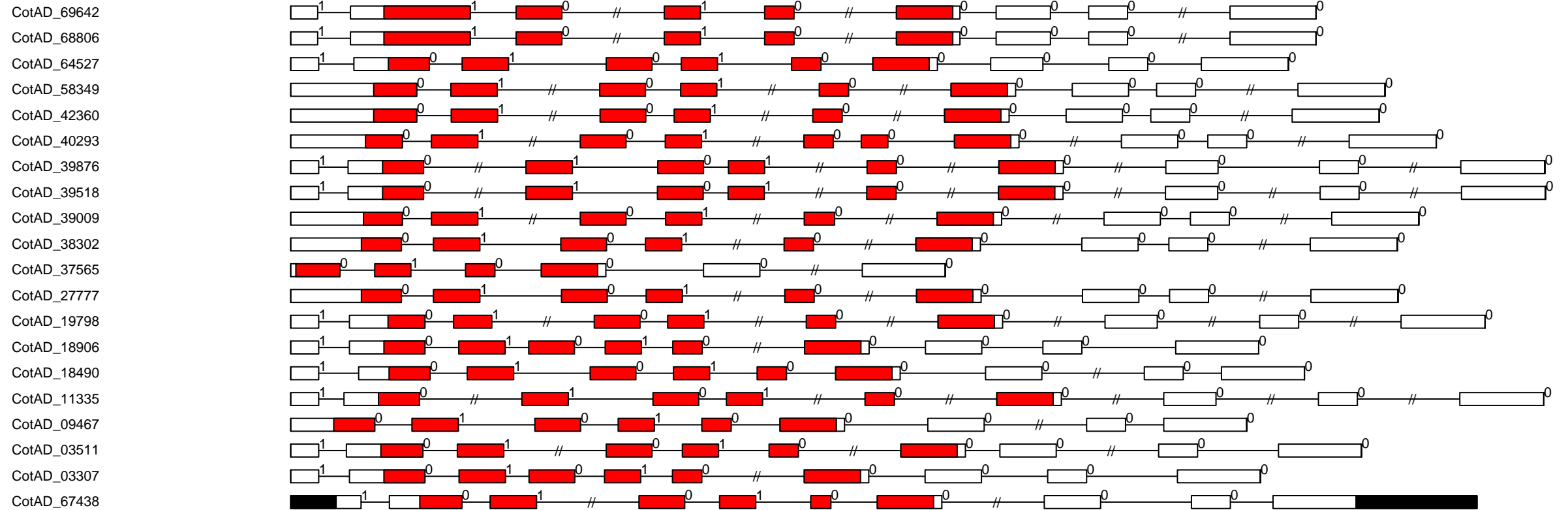

-1000

0

1000

2000

3000

G.hi RLK-Pelle_RLCK-XII-1 exon-intron and domain diagram (part 2)

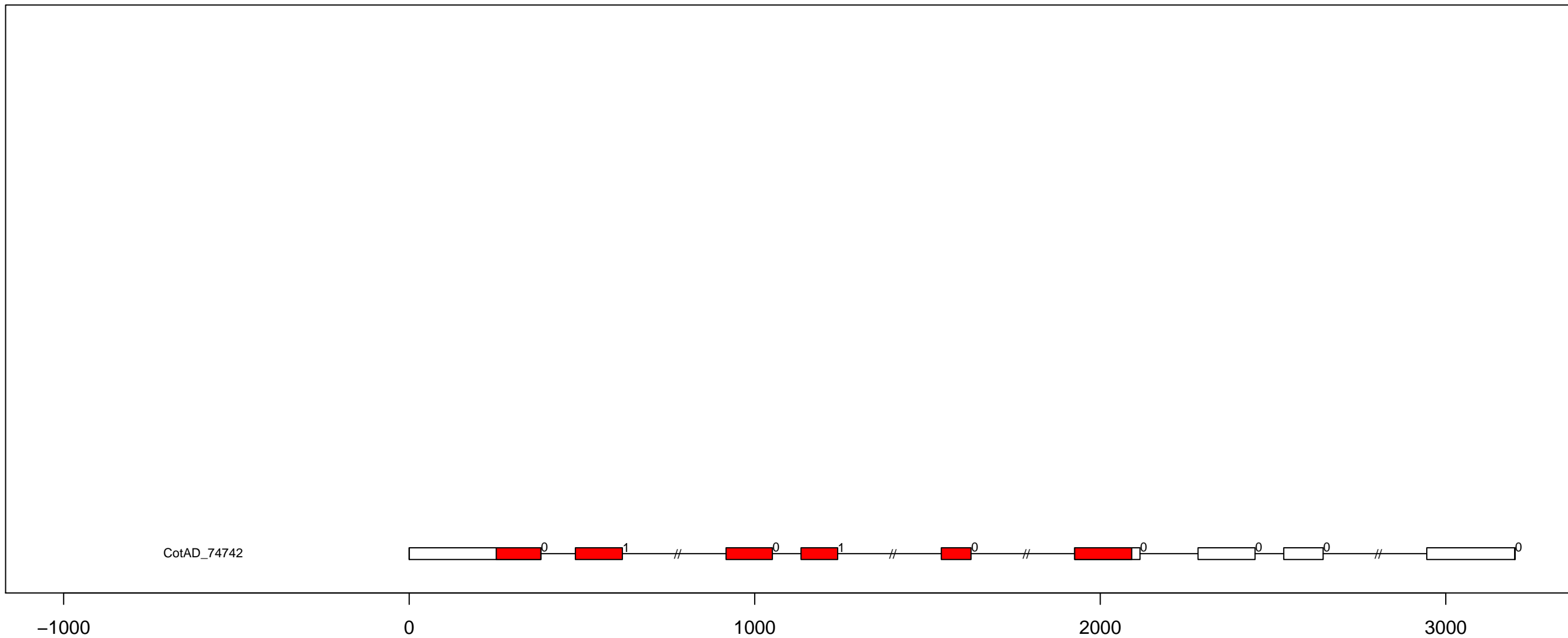

G.hi RLK-Pelle_RLCK-XII-2 exon-intron and domain diagram (all)

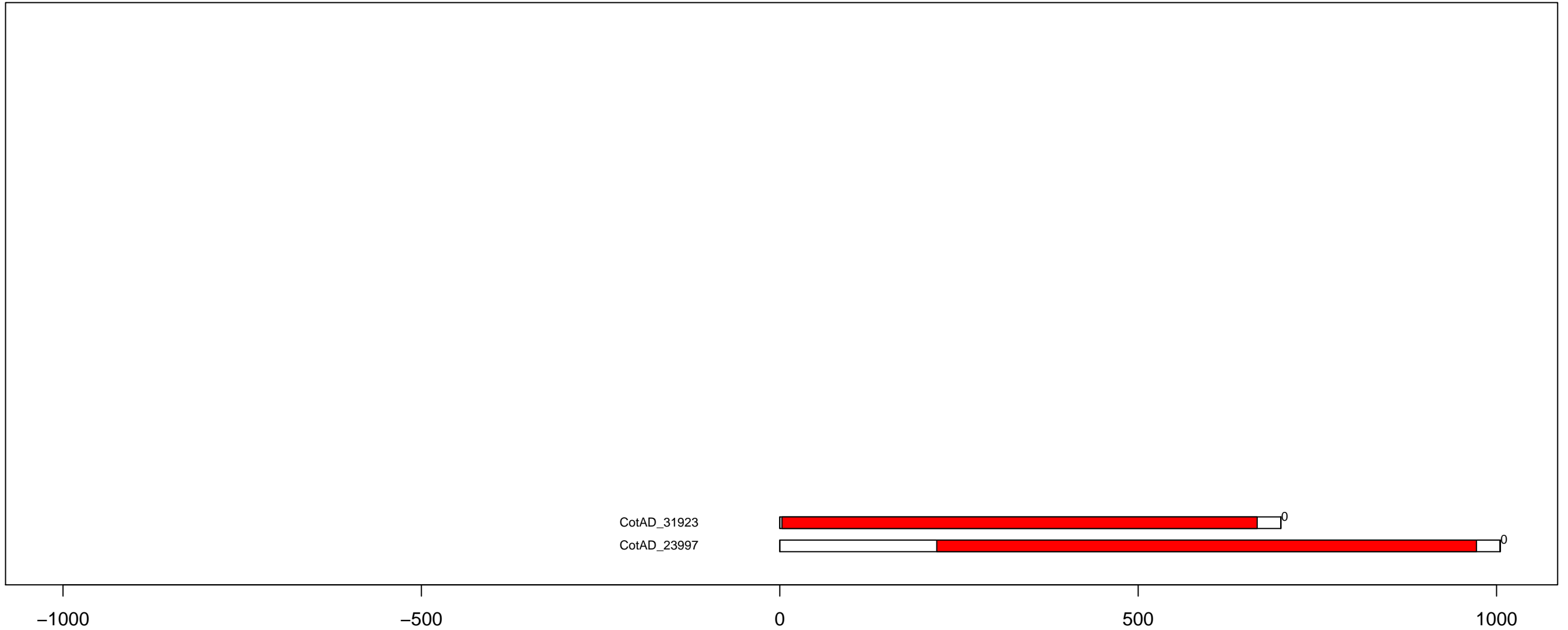

G.hi RLK-Pelle_RLCK-XIII exon-intron and domain diagram (all)

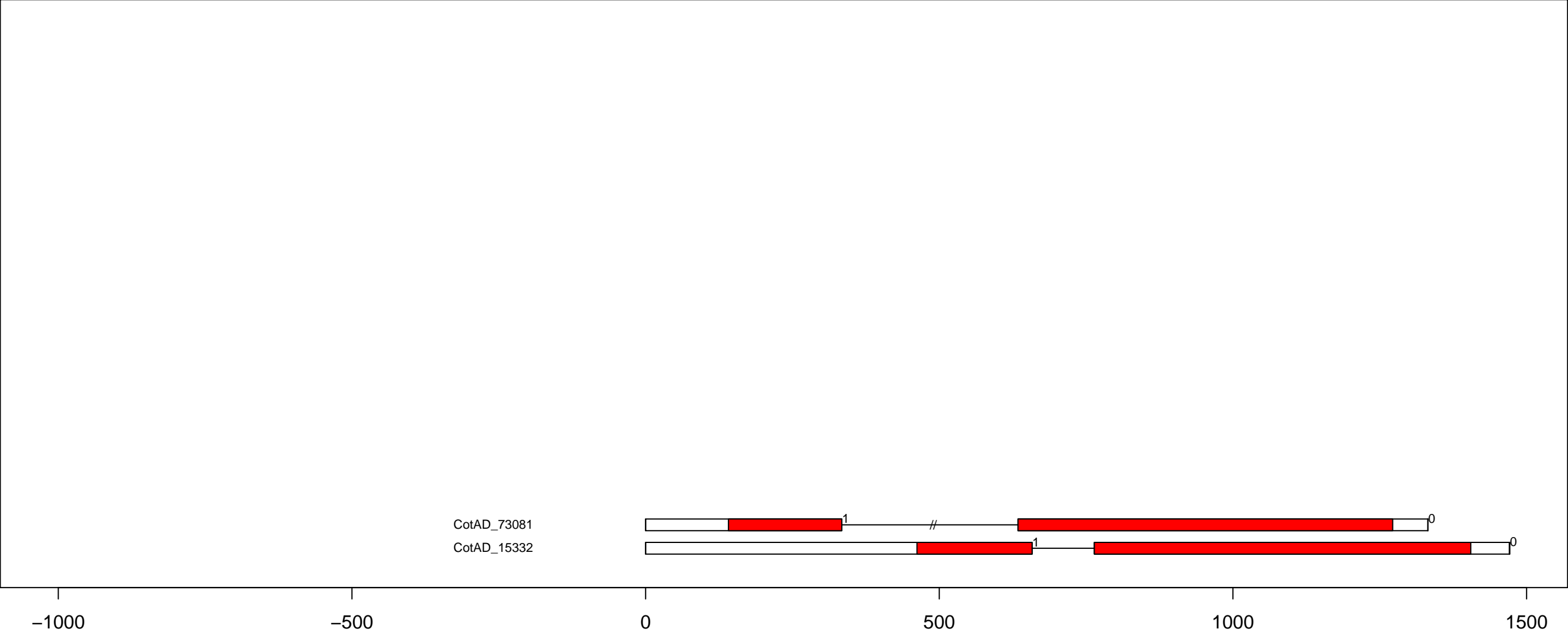

G.hi RLK-Pelle_RLCK-XI exon-intron and domain diagram (all)

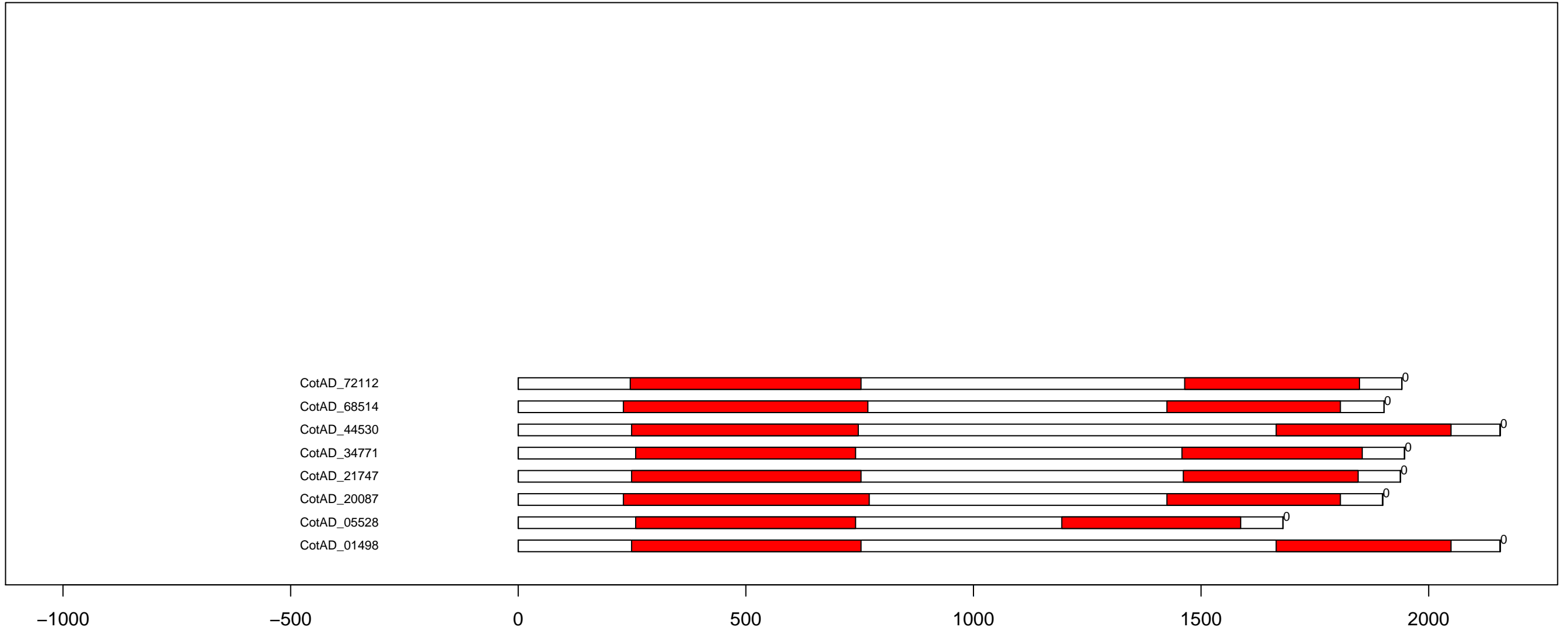

G.hi RLK-Pelle_RLCK-X exon-intron and domain diagram (all)

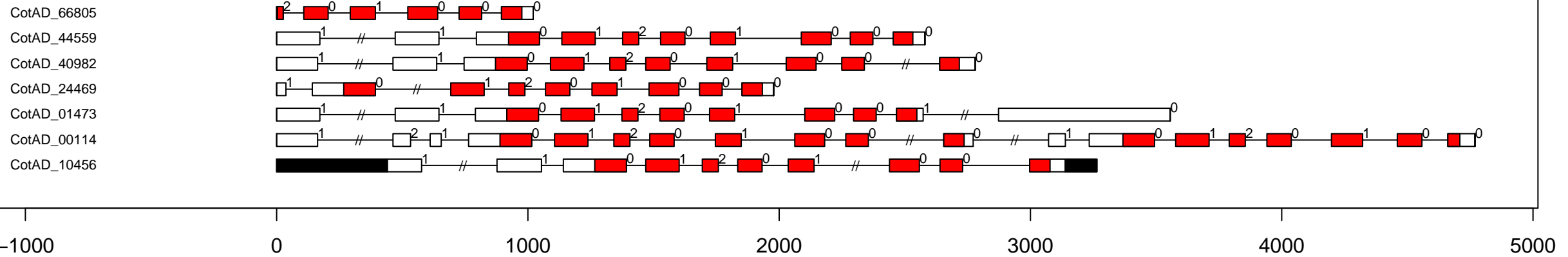

G.hi RLK-Pelle_RLCK-XVI exon-intron and domain diagram (all)

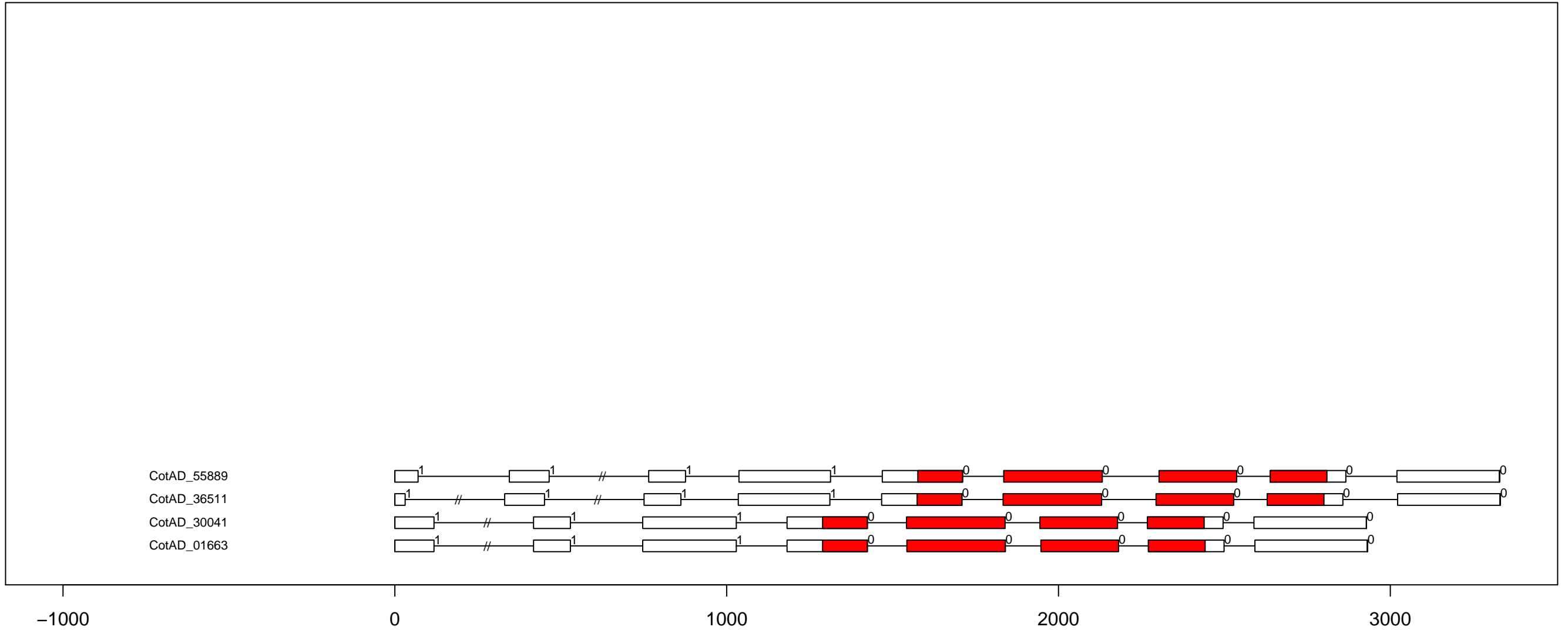

G.hi RLK-Pelle_RLCK-XV exon-intron and domain diagram (all)

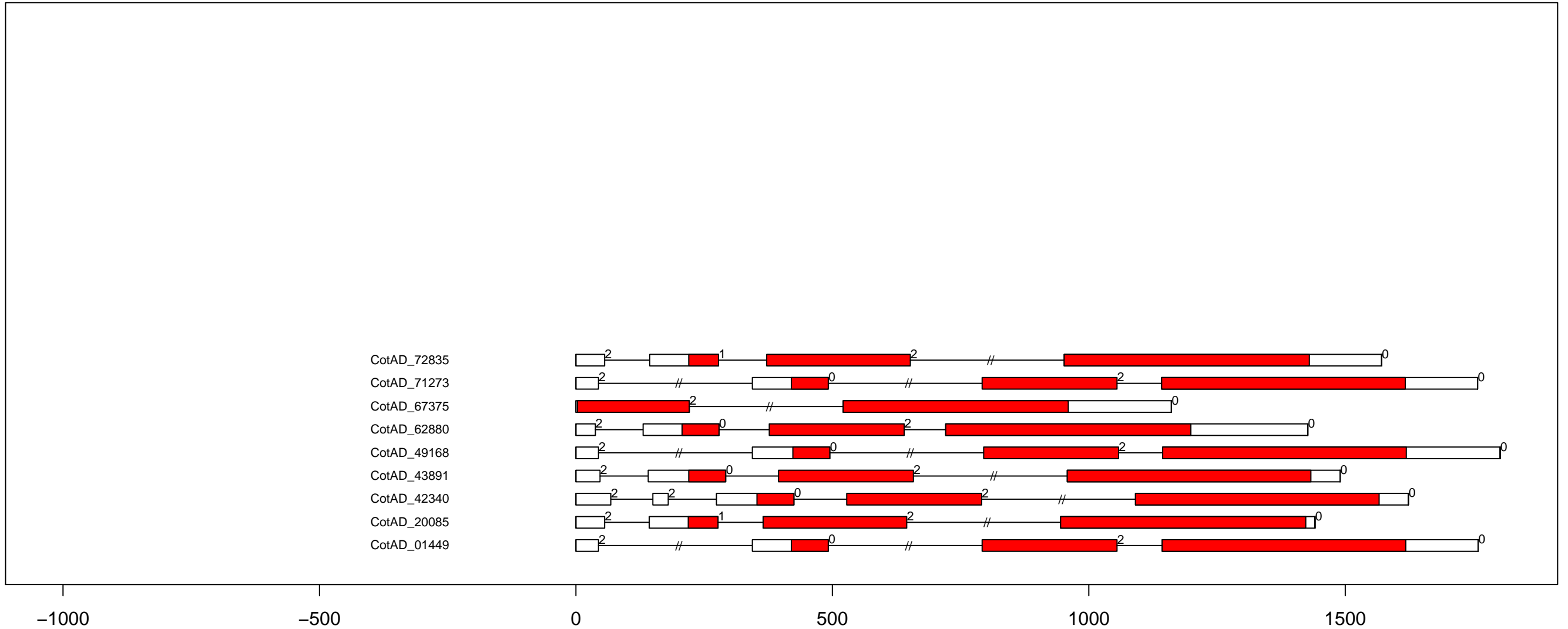

G.hi RLK-Pelle_SD-2b exon-intron and domain diagram (part 1)

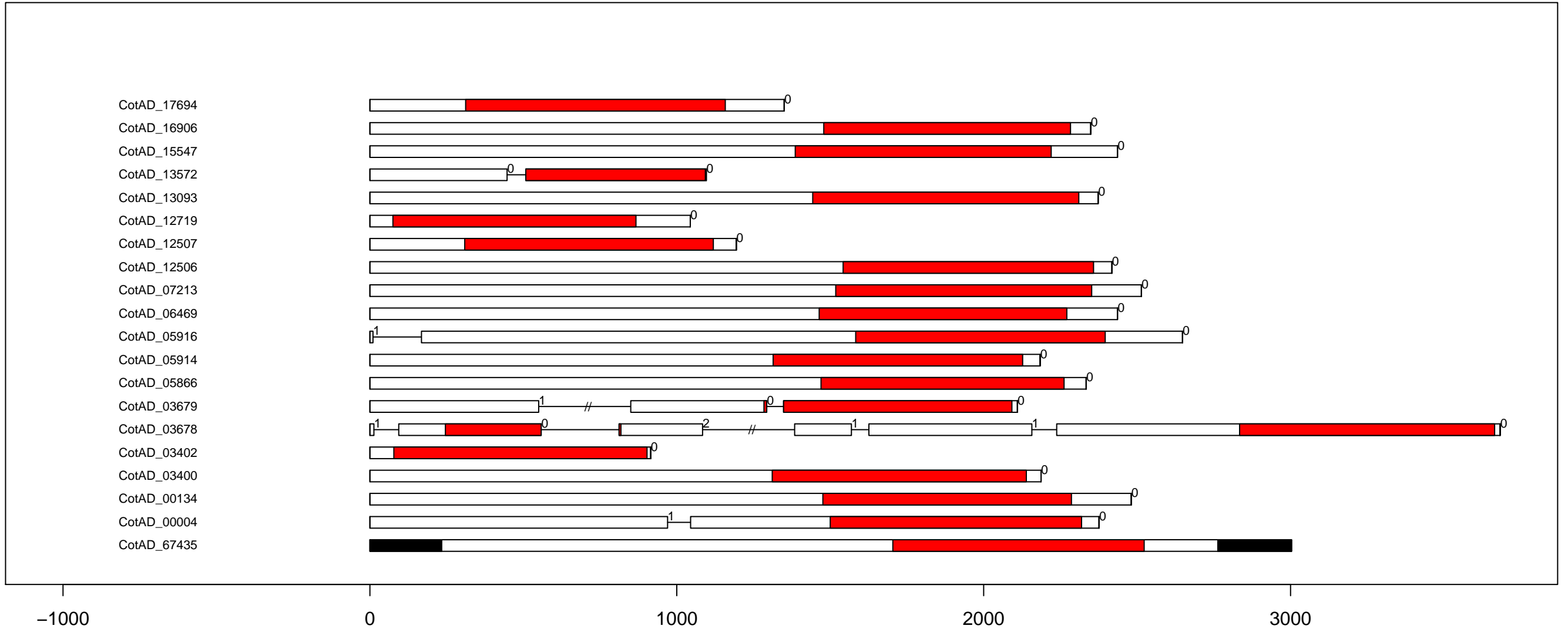

G.hi RLK-Pelle_SD-2b exon-intron and domain diagram (part 2)

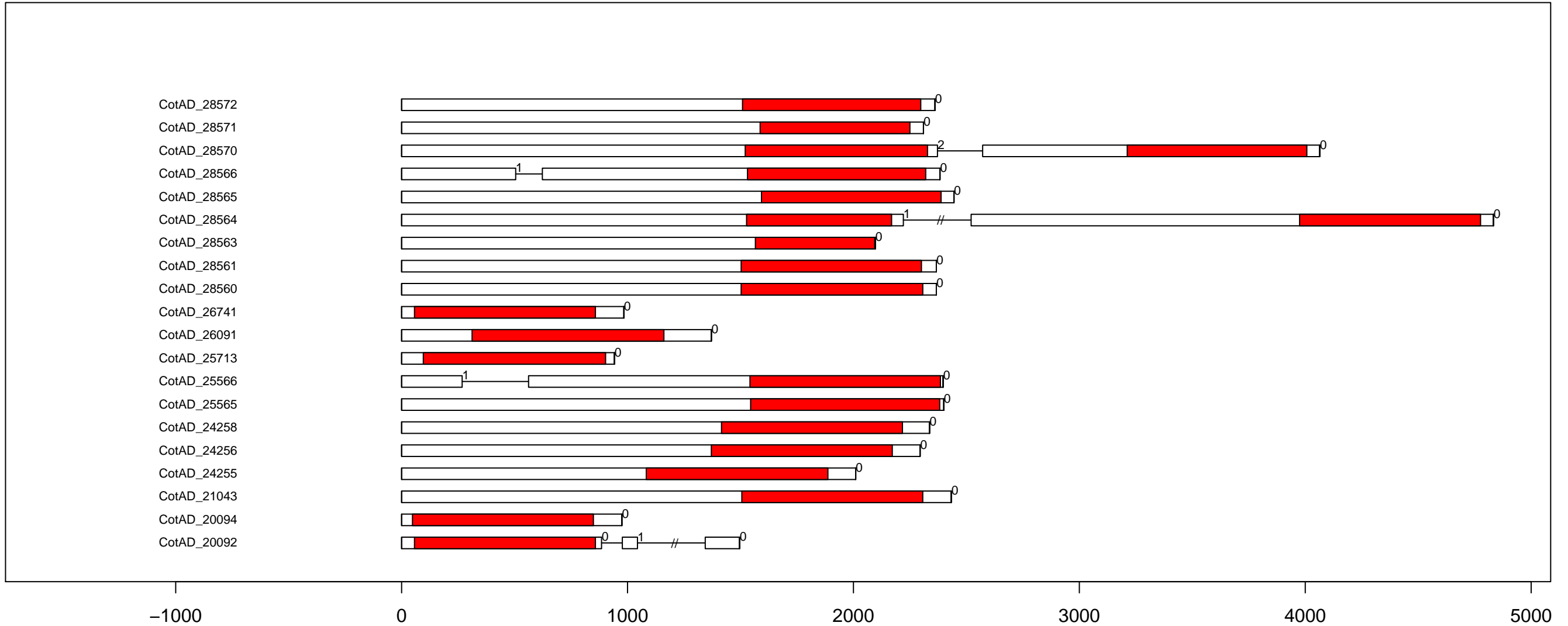

G.hi RLK-Pelle_SD-2b exon-intron and domain diagram (part 3)

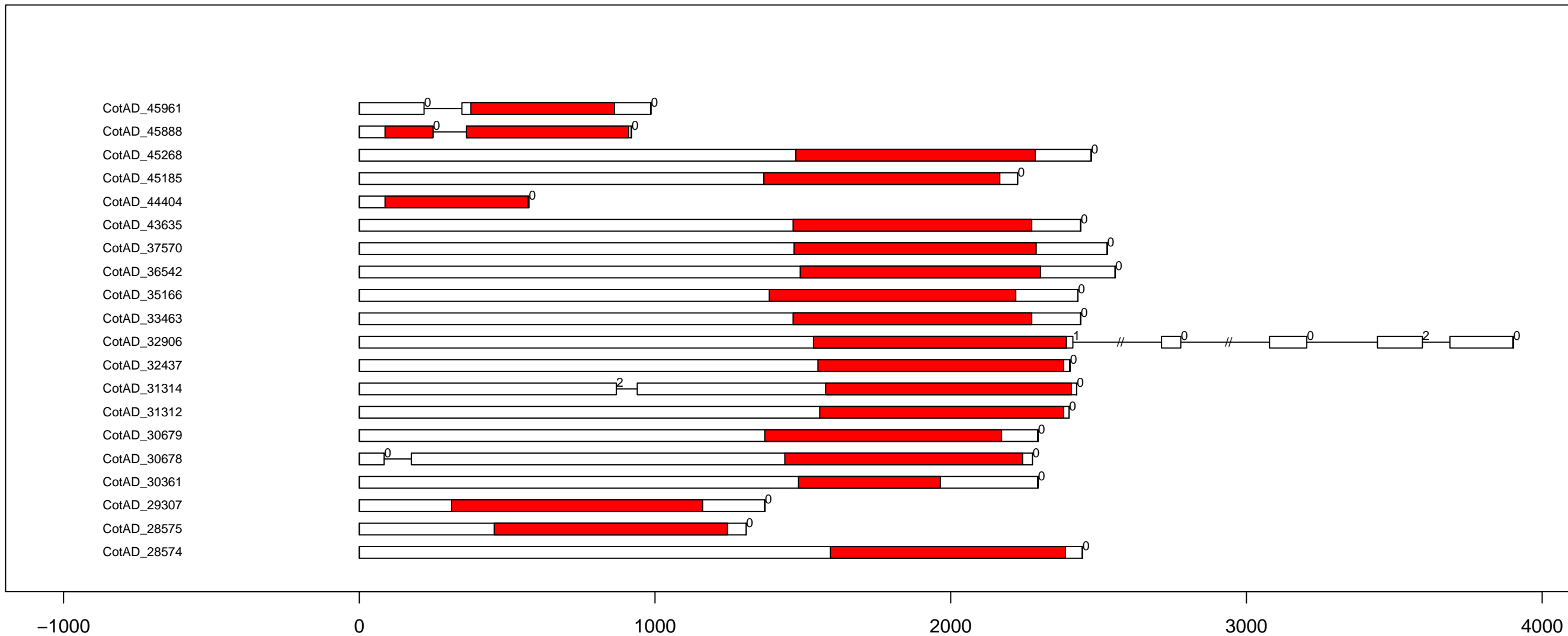

G.hi RLK-Pelle_SD-2b exon-intron and domain diagram (part 4)

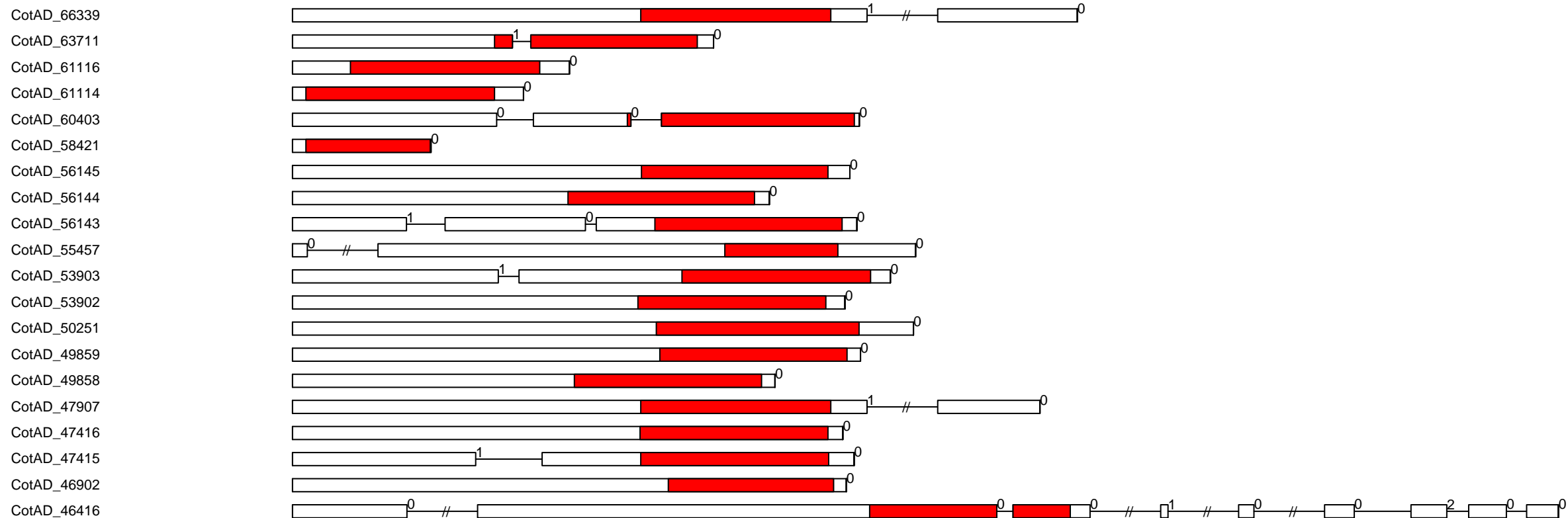

G.hi RLK-Pelle_SD-2b exon-intron and domain diagram (part 5)

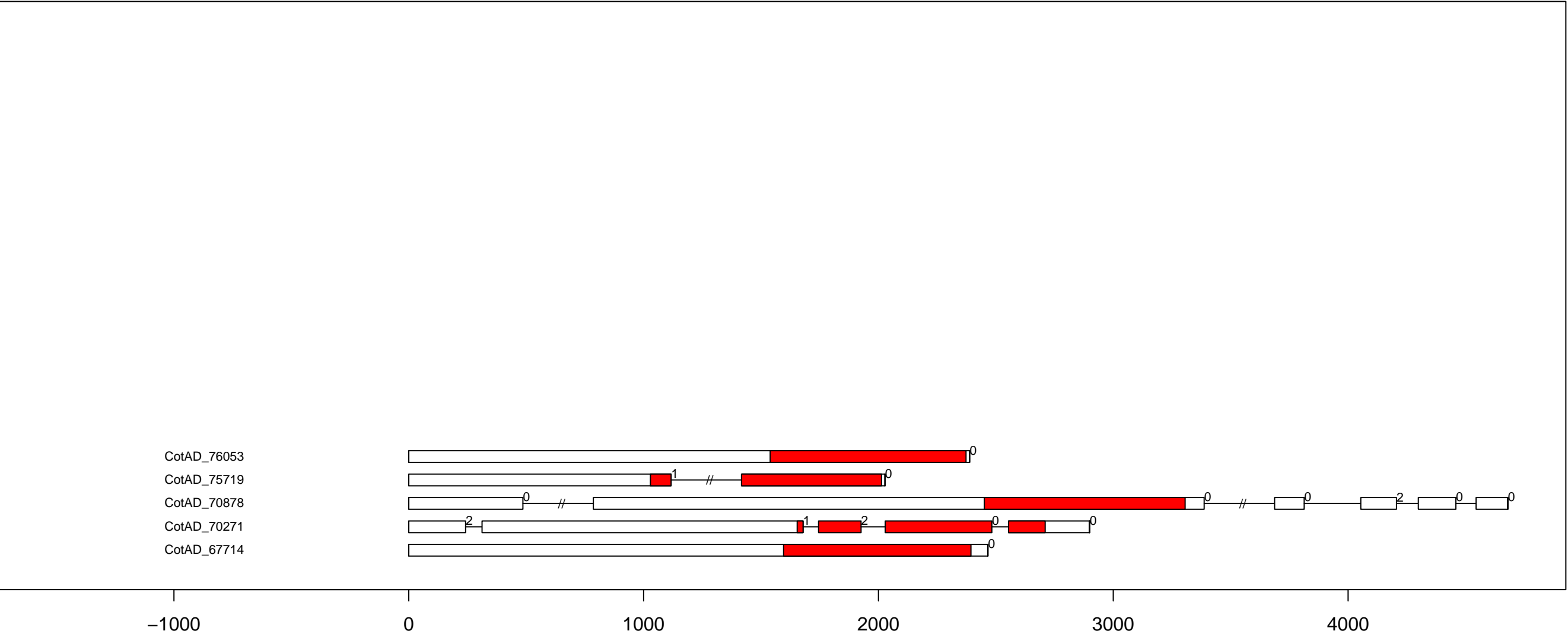

G.hi RLK-Pelle_Singleton exon-intron and domain diagram (all)

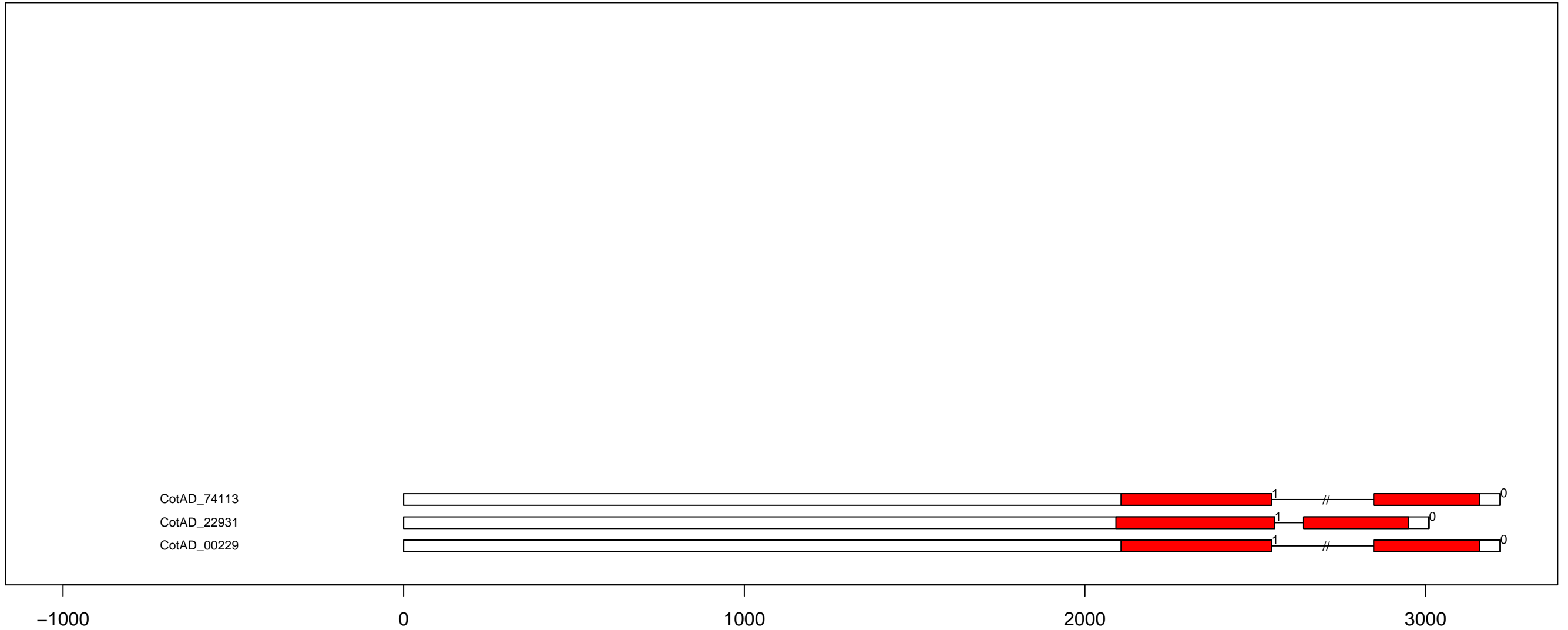

G.hi RLK-Pelle_URK-1 exon-intron and domain diagram (all)

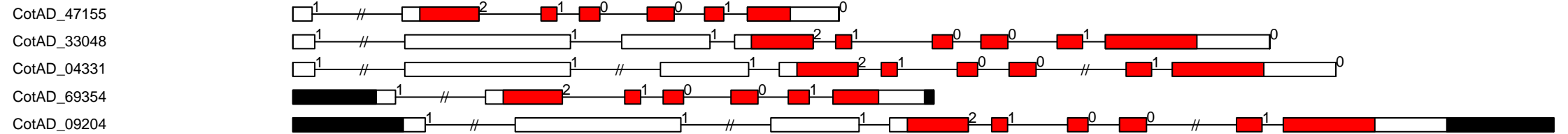

G.hi RLK-Pelle_URK-2 exon-intron and domain diagram (all)

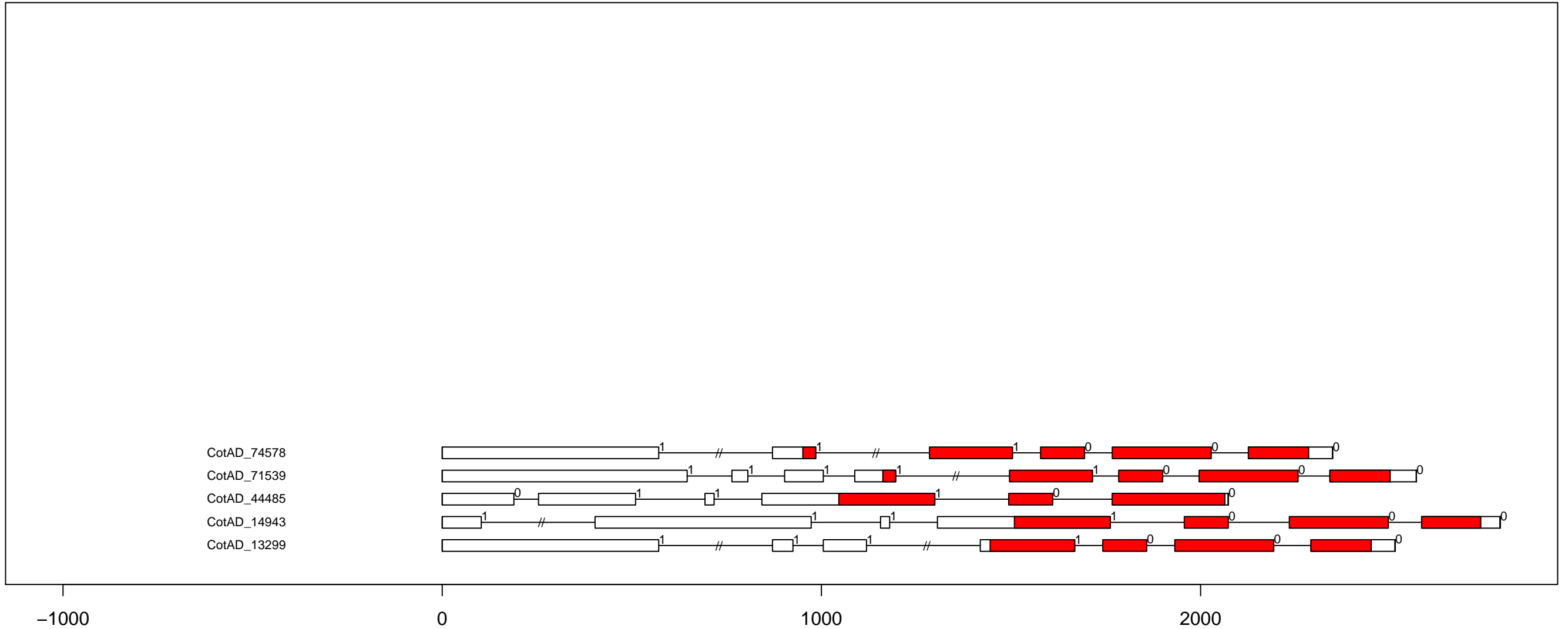

G.hi RLK-Pelle_URK-3 exon-intron and domain diagram (all)

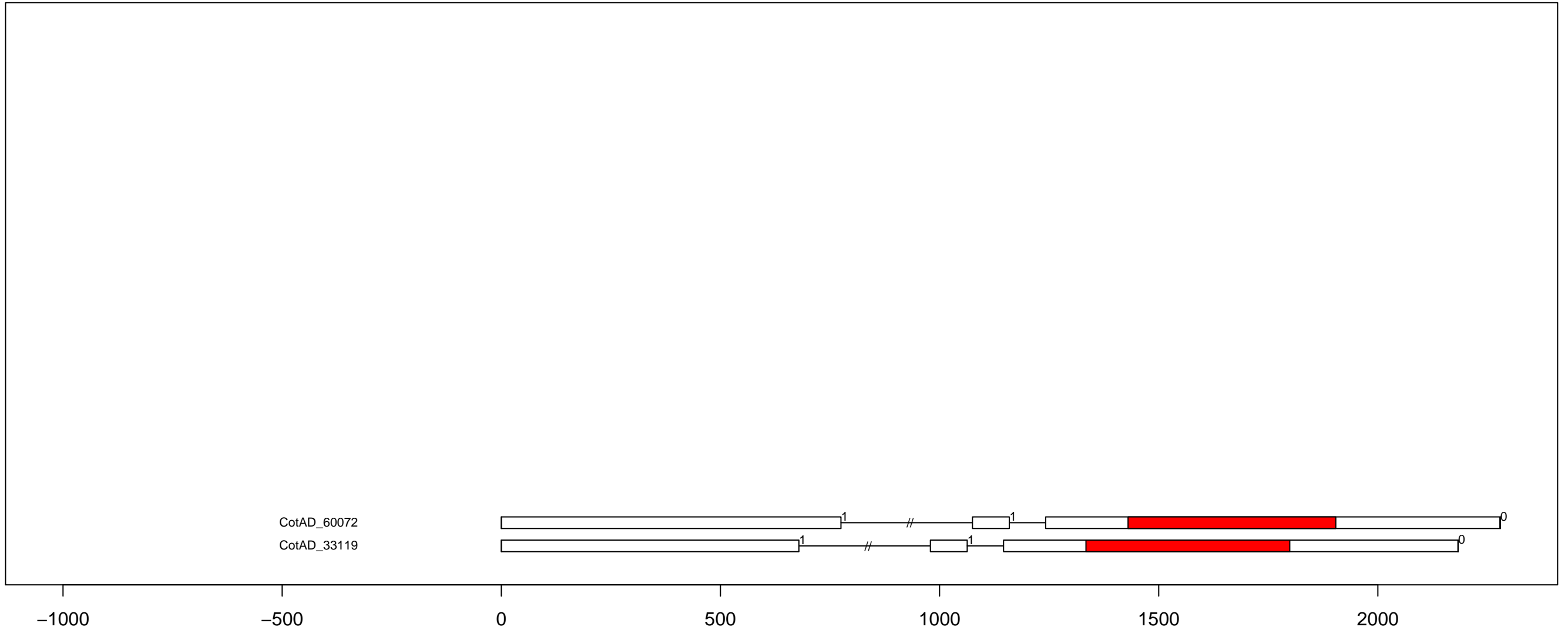

G.hi RLK-Pelle_WAK_LRK10L-1 exon-intron and domain diagram (part 1)

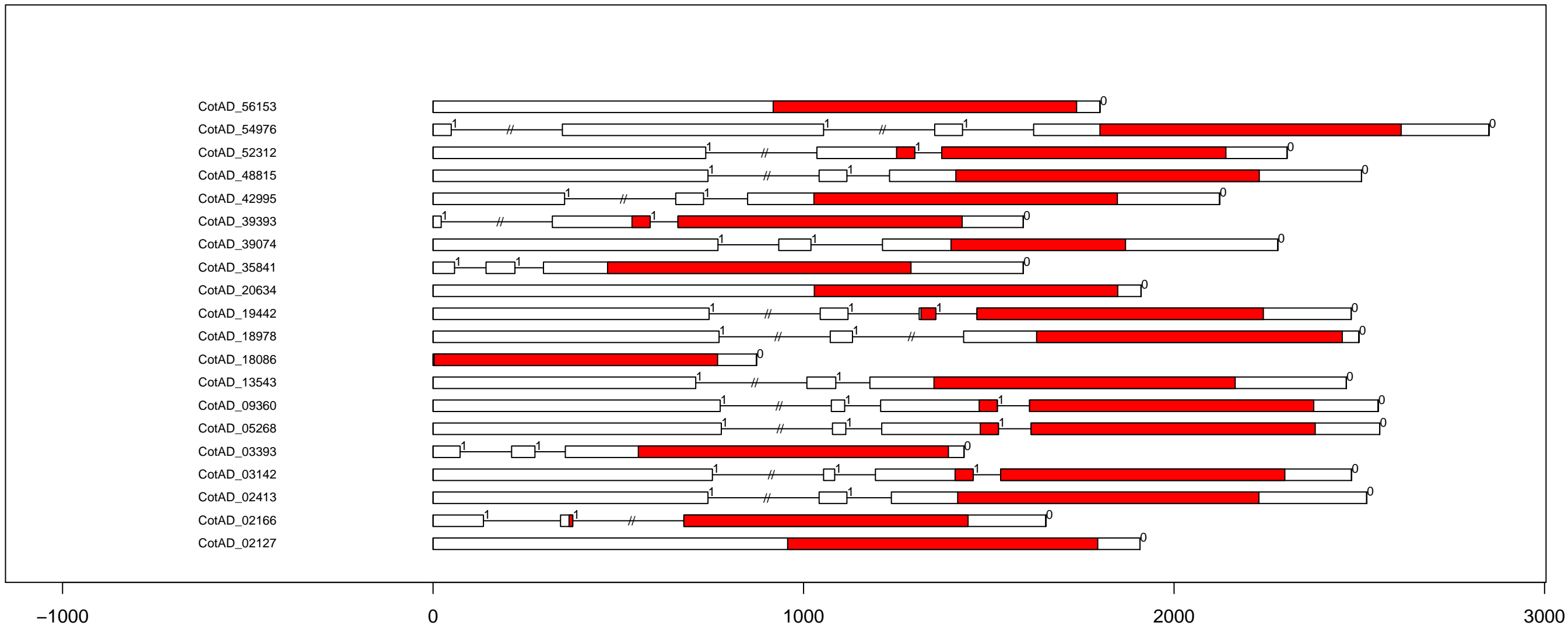

G.hi RLK-Pelle_WAK_LRK10L-1 exon-intron and domain diagram (part 2)

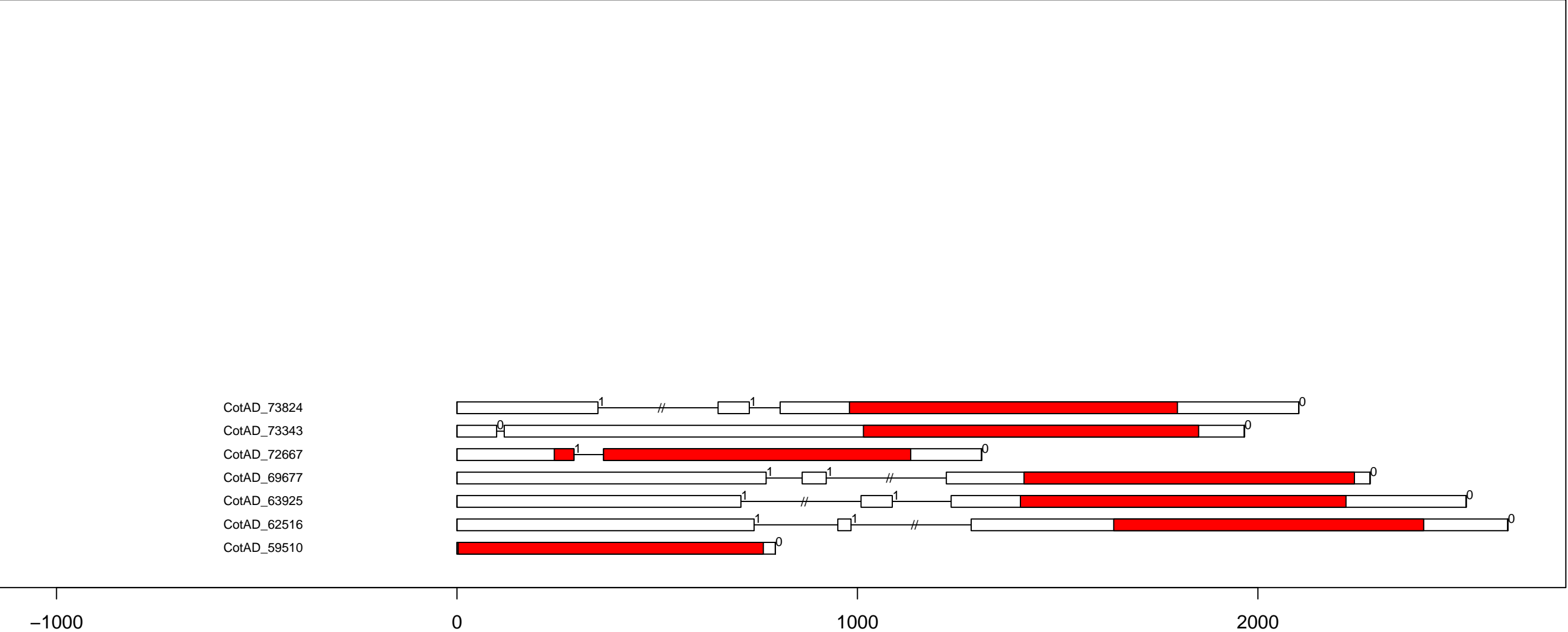

G.hi RLK-Pelle_WAK exon-intron and domain diagram (part 3)

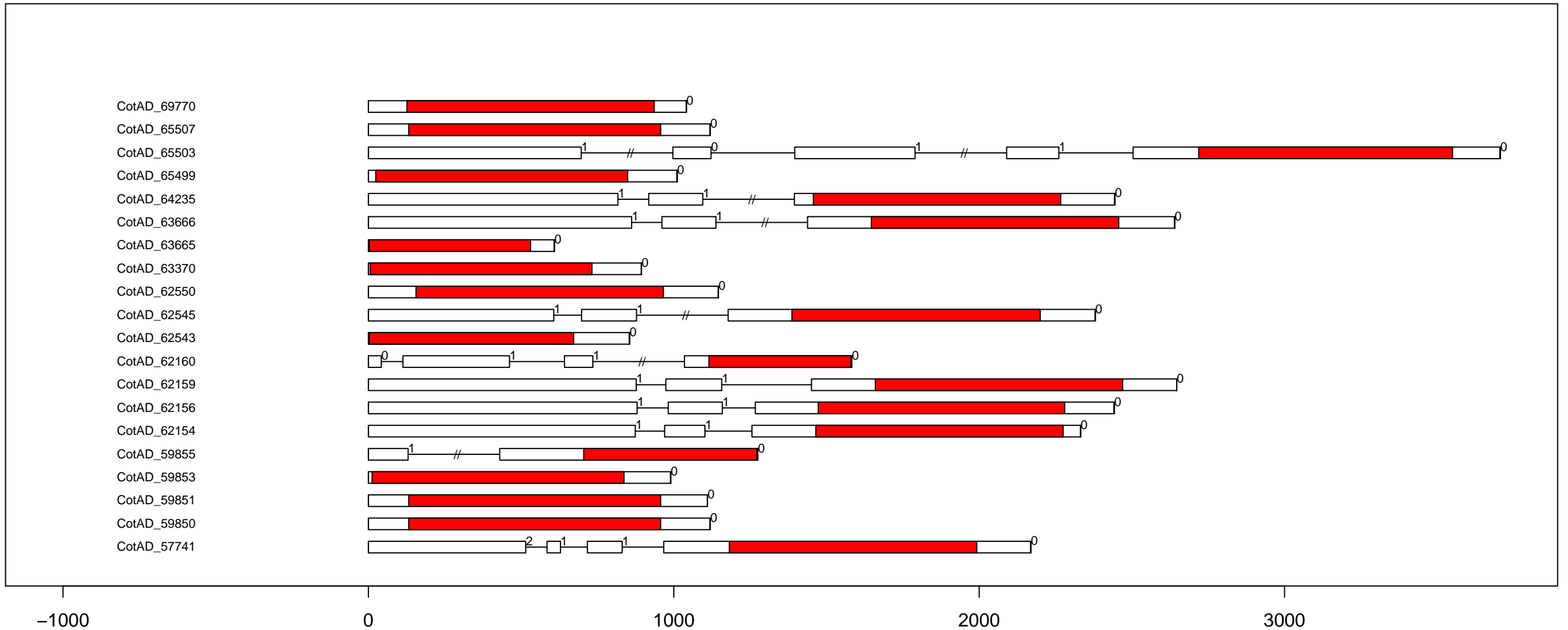

G.hi RLK-Pelle_WAK exon-intron and domain diagram (part 4)



G.hi SCY1_SCYL1 exon-intron and domain diagram (all)

CotAD_57167

CotAD_16773

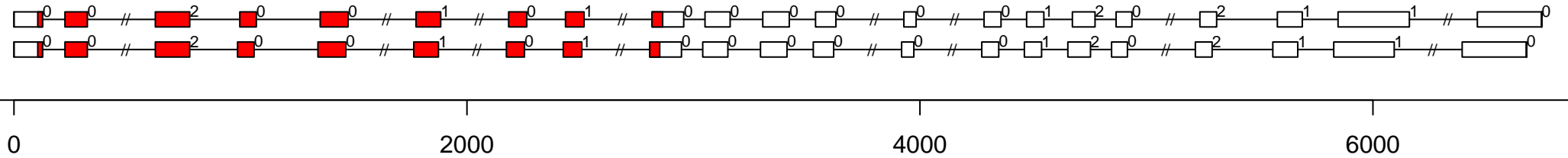

G.hi SCY1_SCYL2 exon-intron and domain diagram (all)

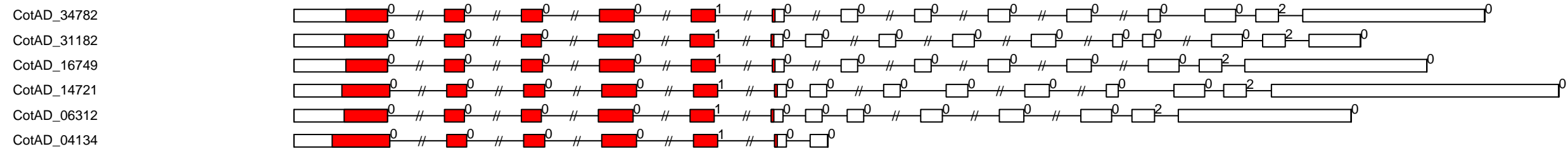

0

2000

4000

6000

G.hi STE_STE11 exon-intron and domain diagram (part 2)

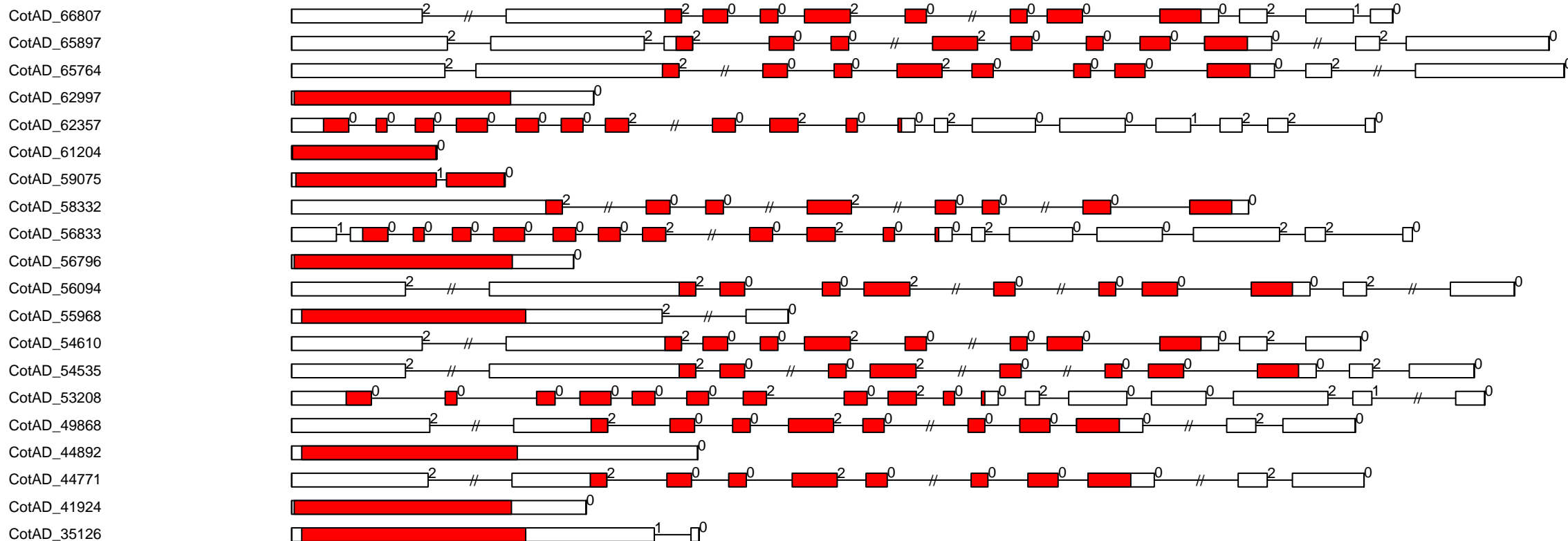

-1000

0

1000

2000

3000

4000

G.hi STE_STE11 exon-intron and domain diagram (part 3)

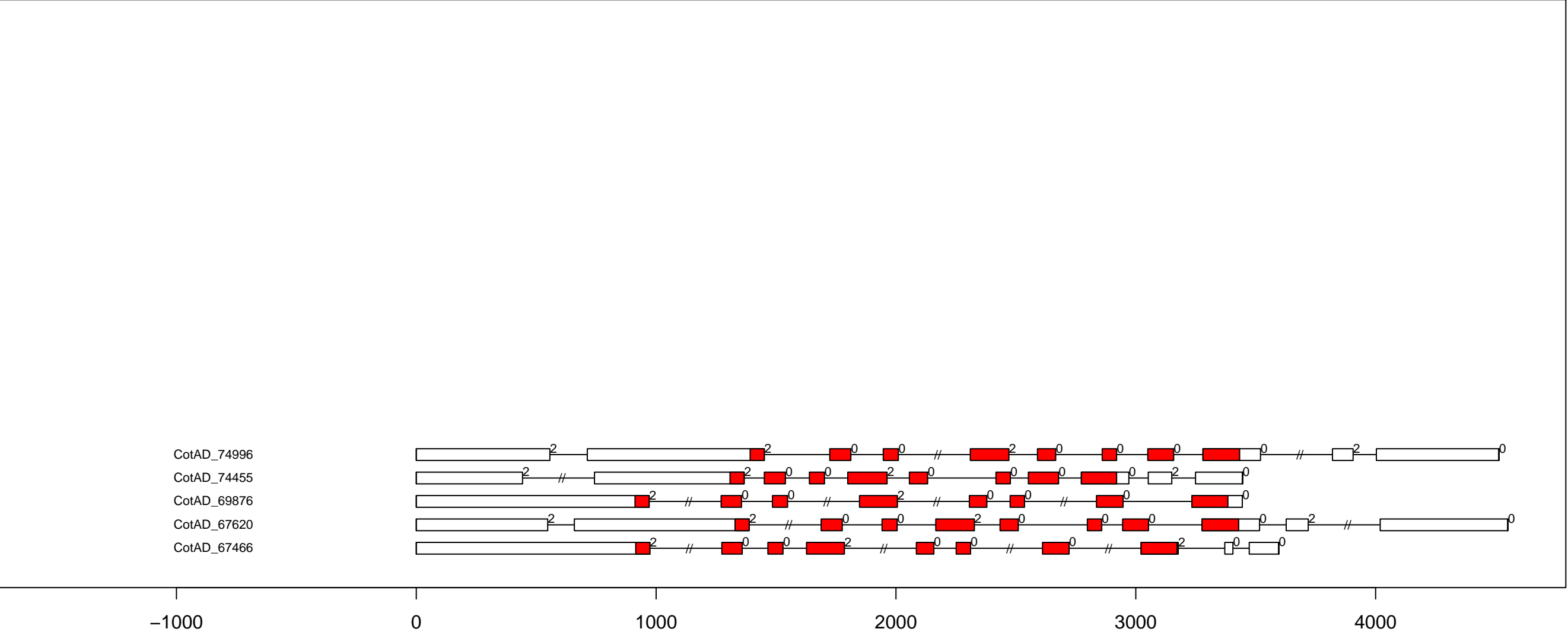

G.hi STE_STE20-Fray exon-intron and domain diagram (part 1)

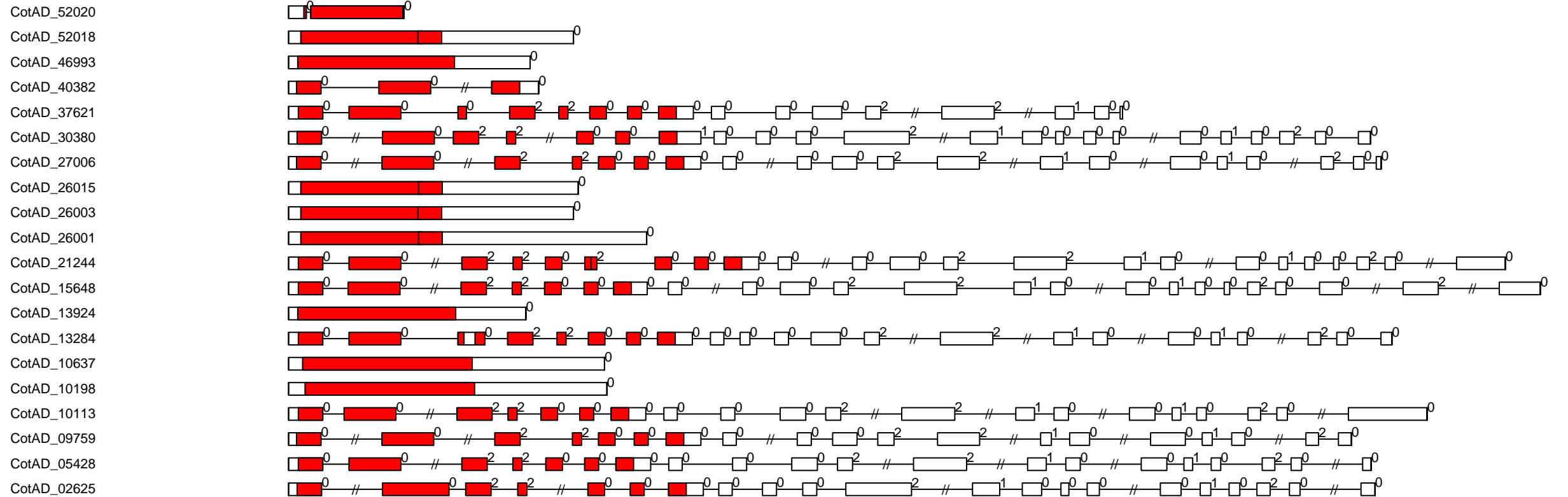

0

2000

4000

6000

G.hi STE_STE20-Fray exon-intron and domain diagram (part 2)

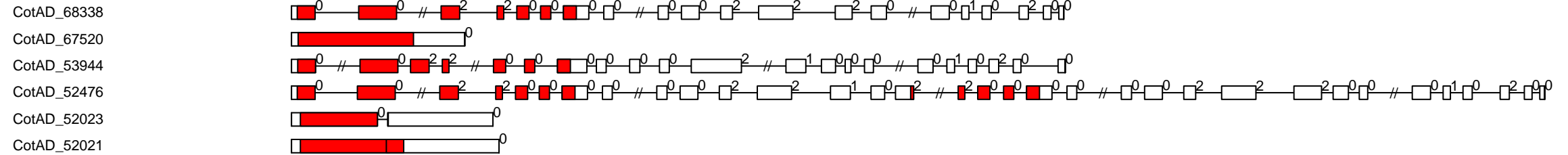

G.hi STE_STE20-PI exon-intron and domain diagram (all)

CotAD_65874
CotAD_44719
CotAD_13166

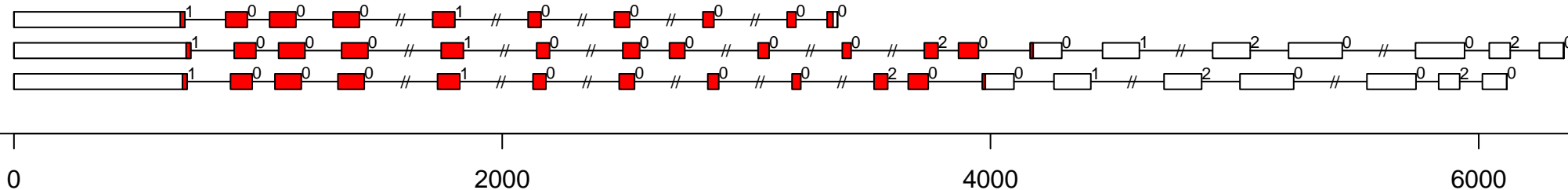

G.hi STE_STE20-YSK exon-intron and domain diagram (all)

CotAD_68945
 CotAD_28130
 CotAD_16880

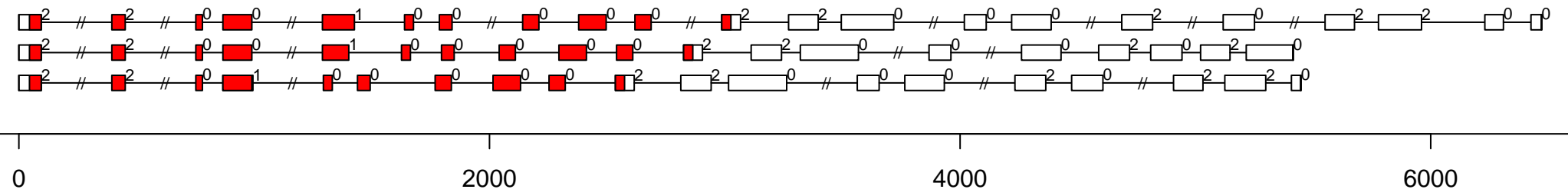

G.hi STE_STE7 exon-intron and domain diagram (all)

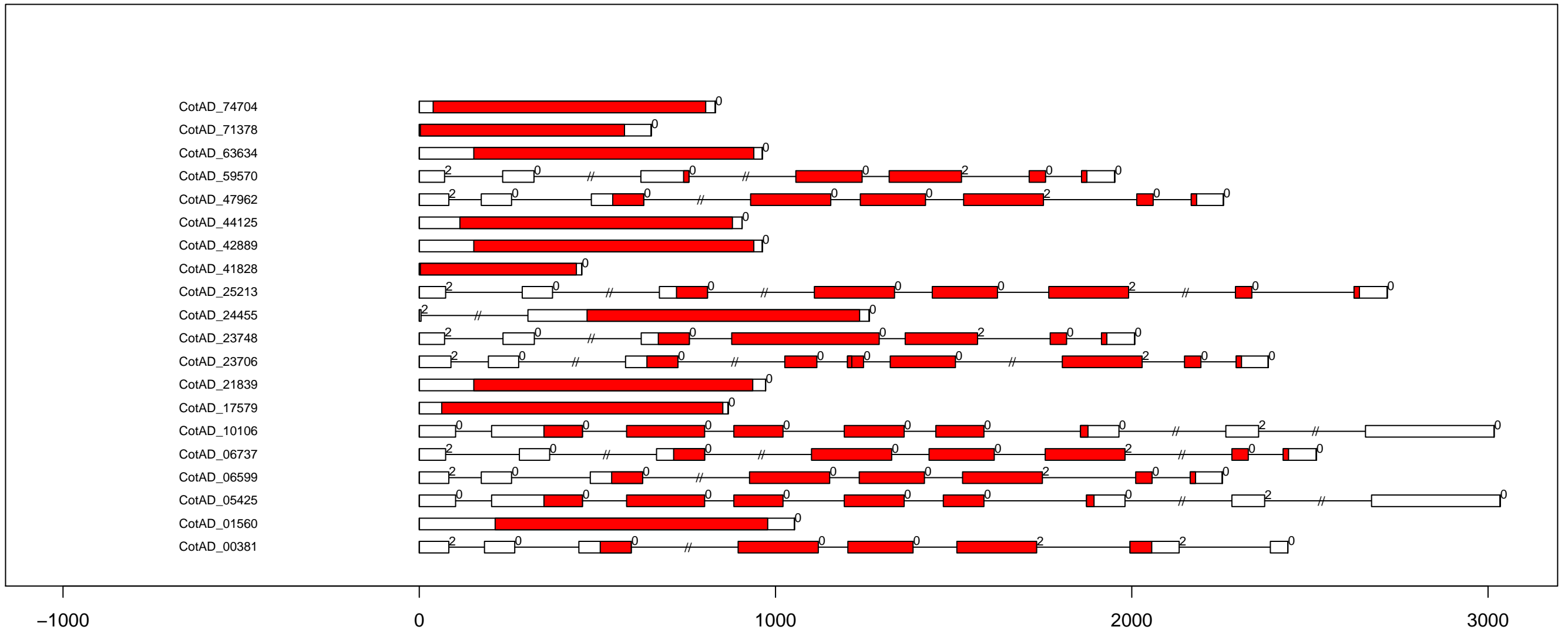

G.hi STE_STE-PI exon-intron and domain diagram (all)

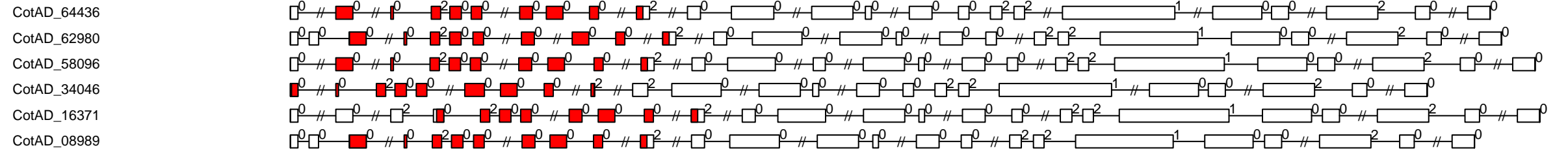

-2000

0

2000

4000

6000

8000

10000

G.hi TKL_CTRL1-DRK-1 exon-intron and domain diagram (all)

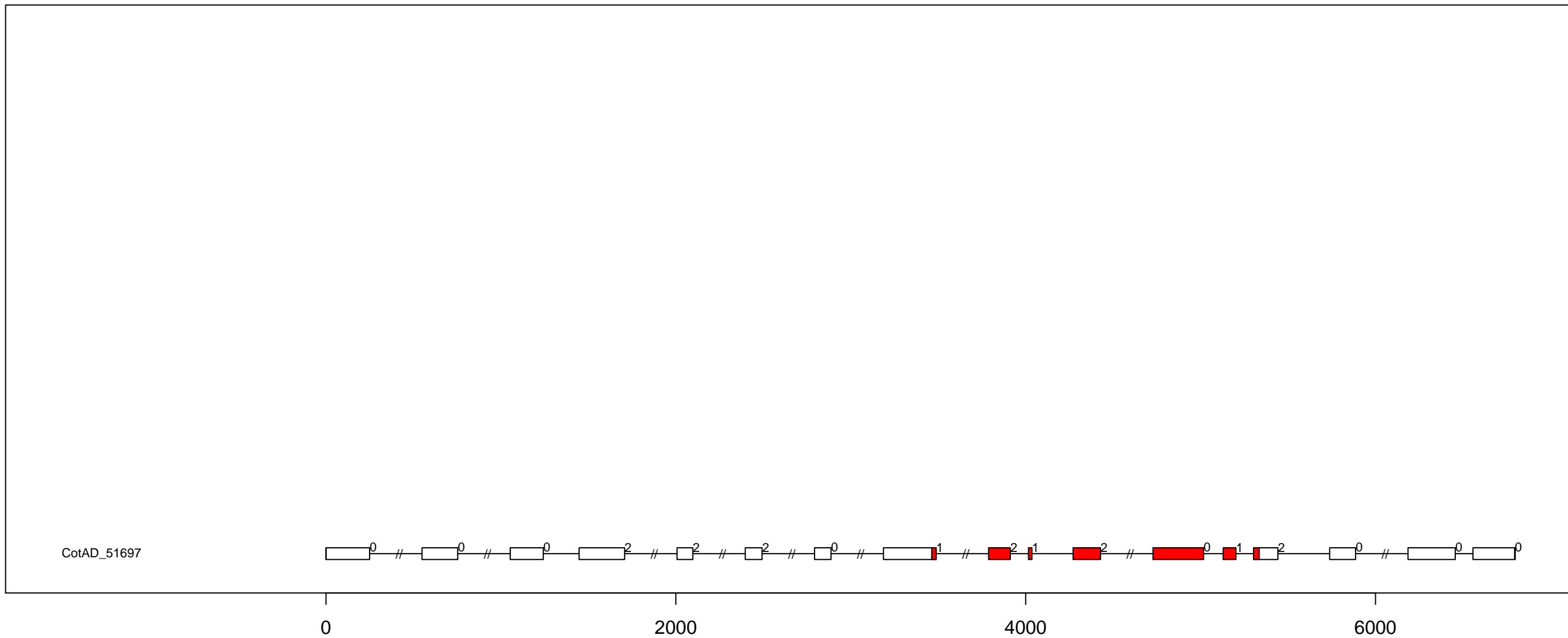

G.hi TKL_CTR1-DRK-2 exon-intron and domain diagram (part 1)

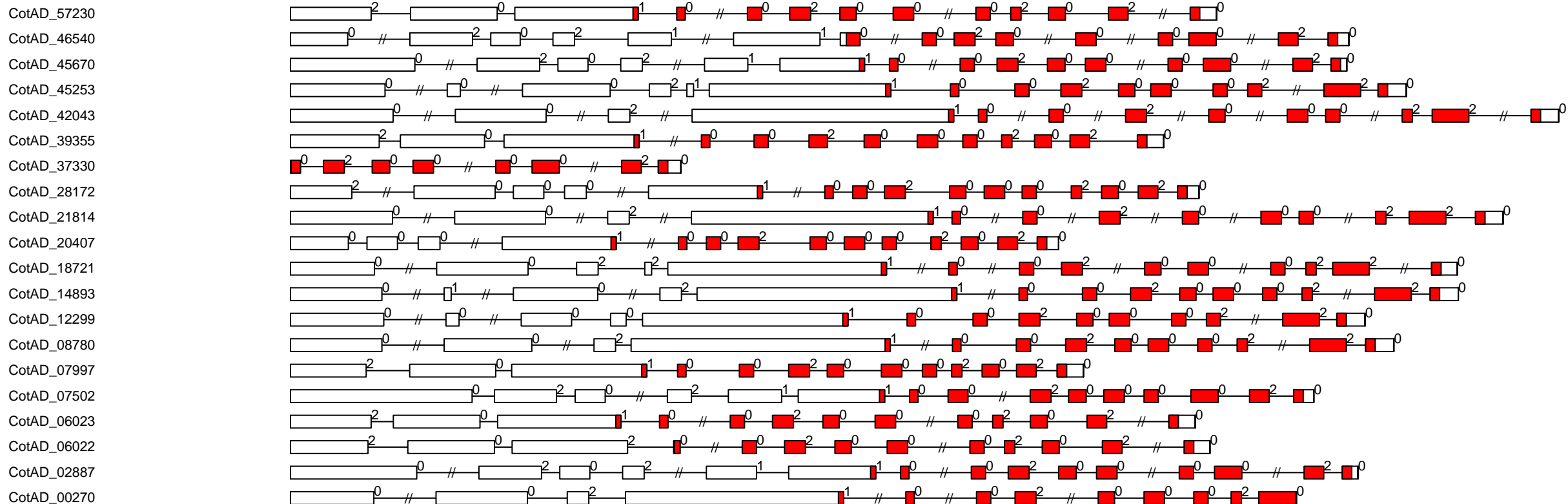

G.hi TKL_CTR1-DRK-2 exon-intron and domain diagram (part 2)

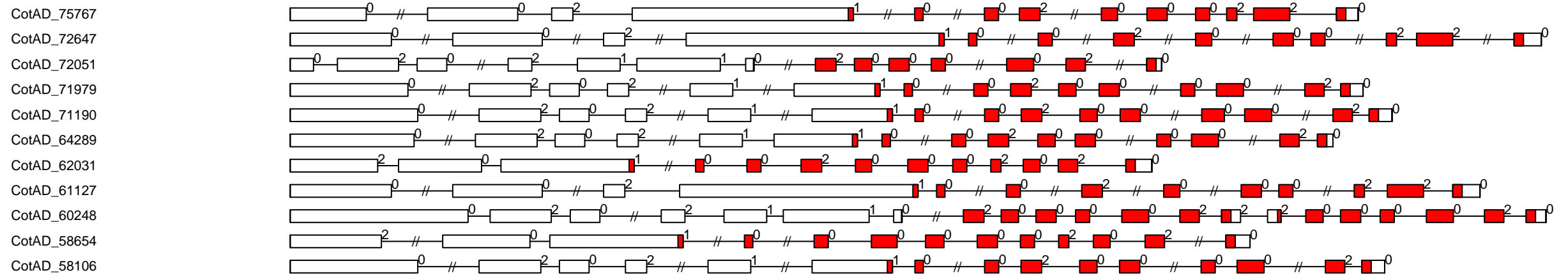

0

2000

4000

6000

G.hi TKL_Gdt exon-intron and domain diagram (all)

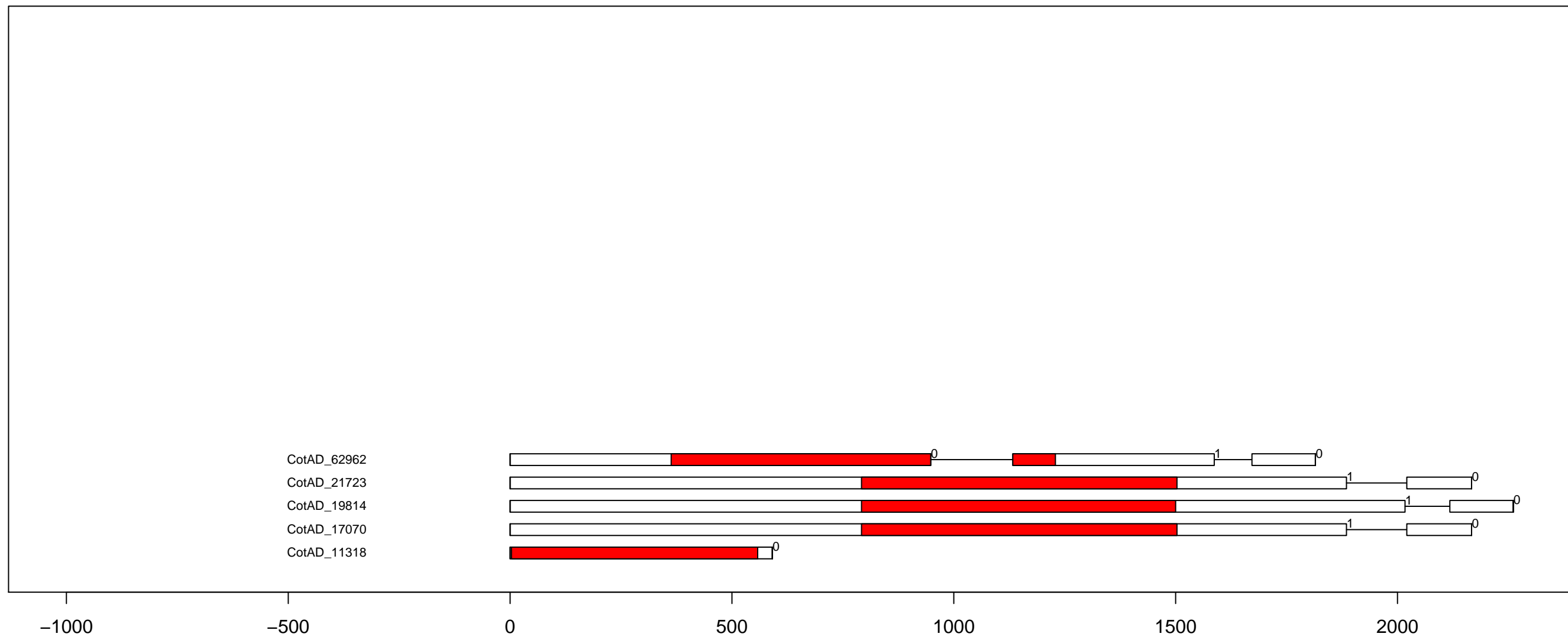

G.hi TKL-PI-1 exon-intron and domain diagram (all)

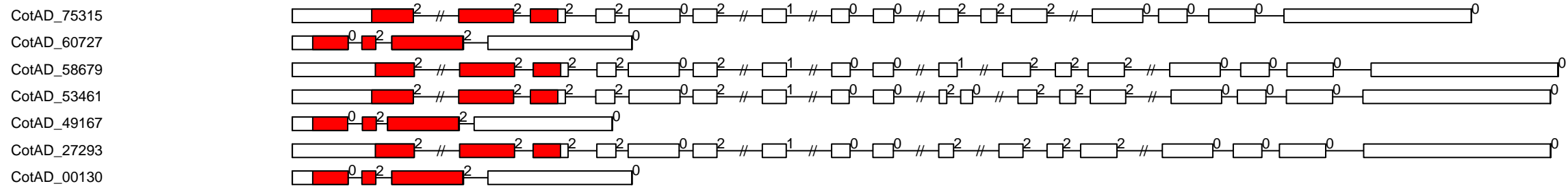

G.hi TKL-PI-2 exon-intron and domain diagram (all)

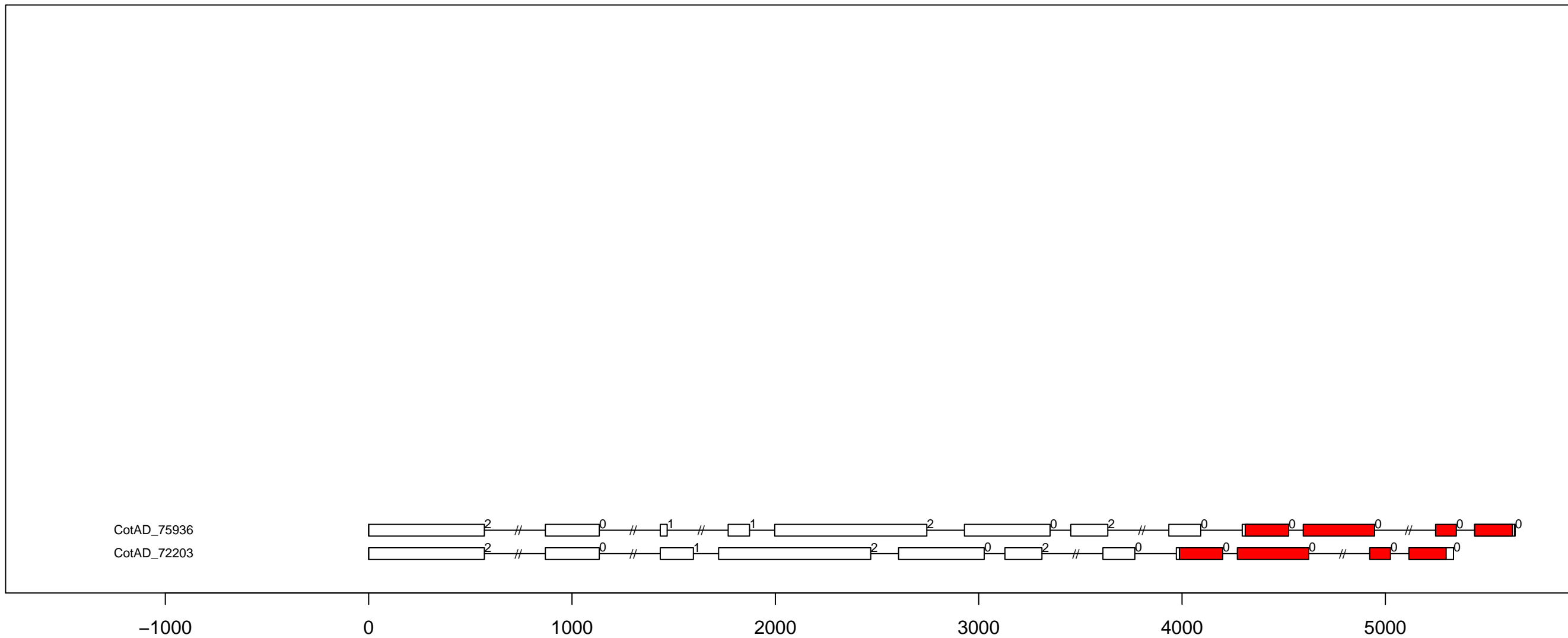

G.hi TKL-PI-3 exon-intron and domain diagram (all)

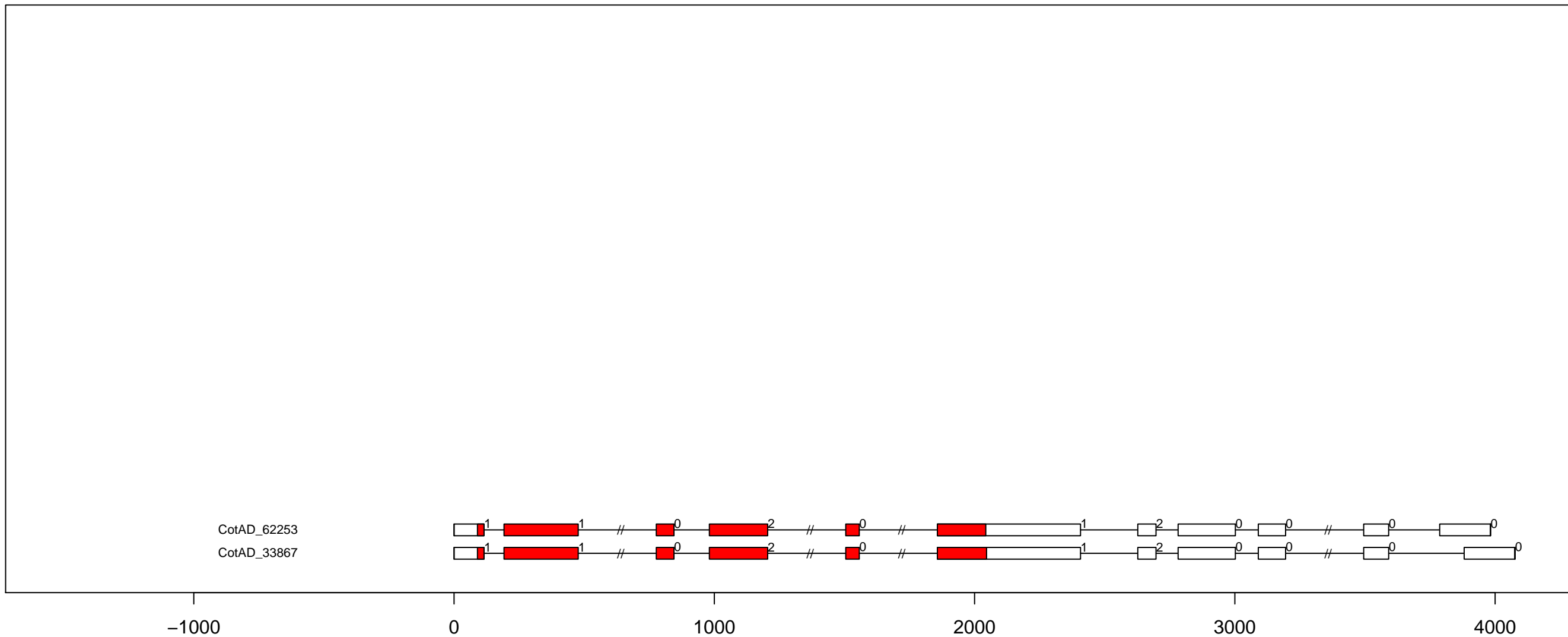

G.hi TKL-PI-4 exon-intron and domain diagram (part 1)

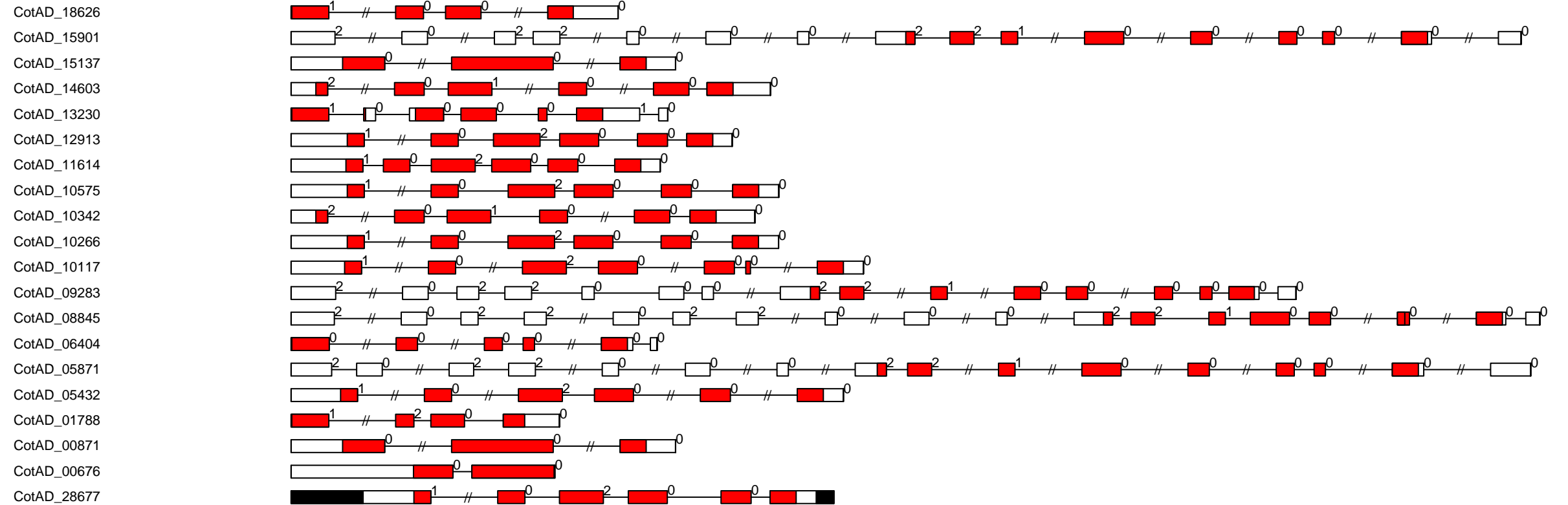

G.hi TKL-PI-4 exon-intron and domain diagram (part 3)

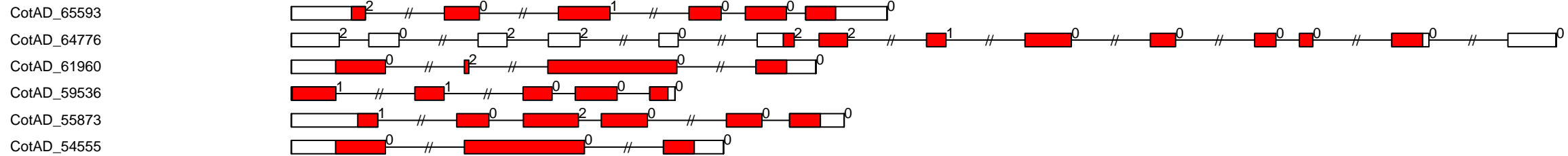

-1000

0

1000

2000

3000

4000

5000

G.hi TKL-PI-5 exon-intron and domain diagram (all)

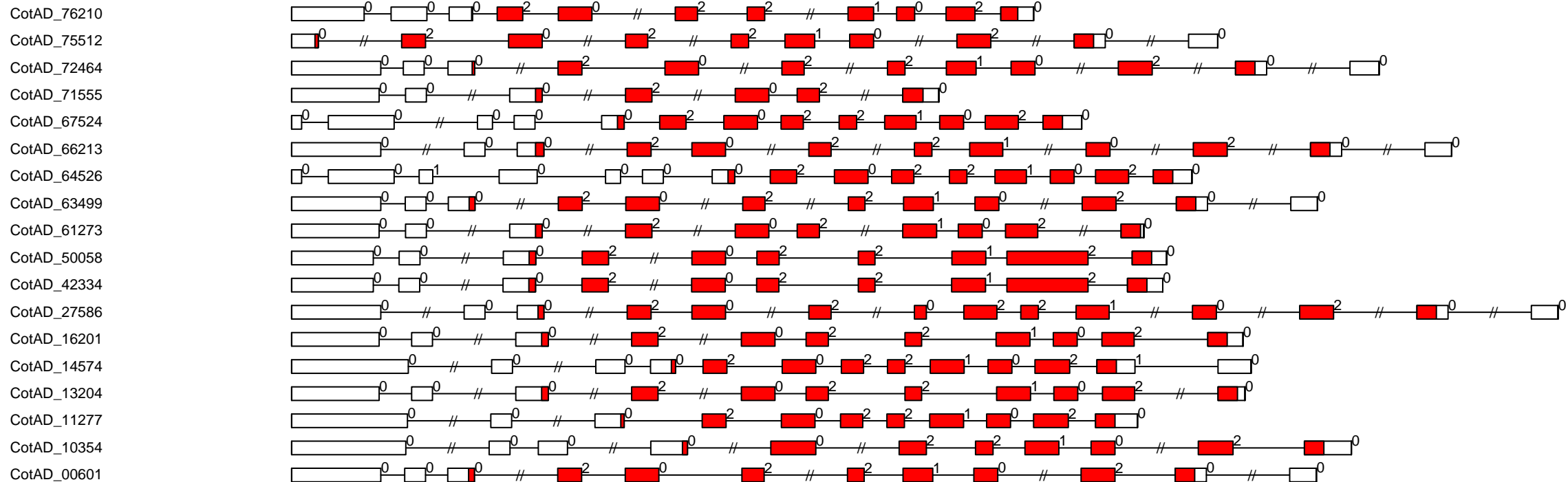

G.hi TKL-PI-6 exon-intron and domain diagram (all)

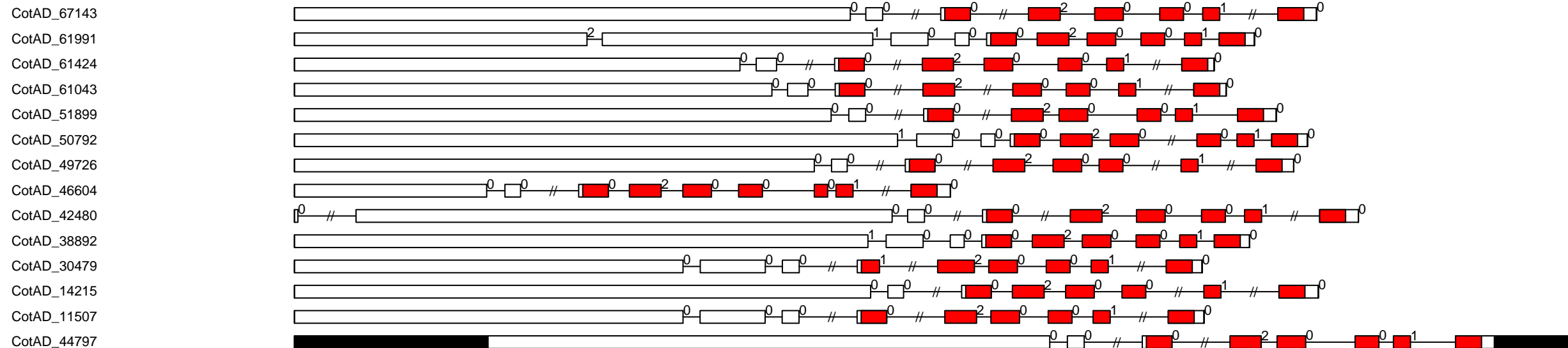

G.hi TKL-PI-7 exon-intron and domain diagram (all)

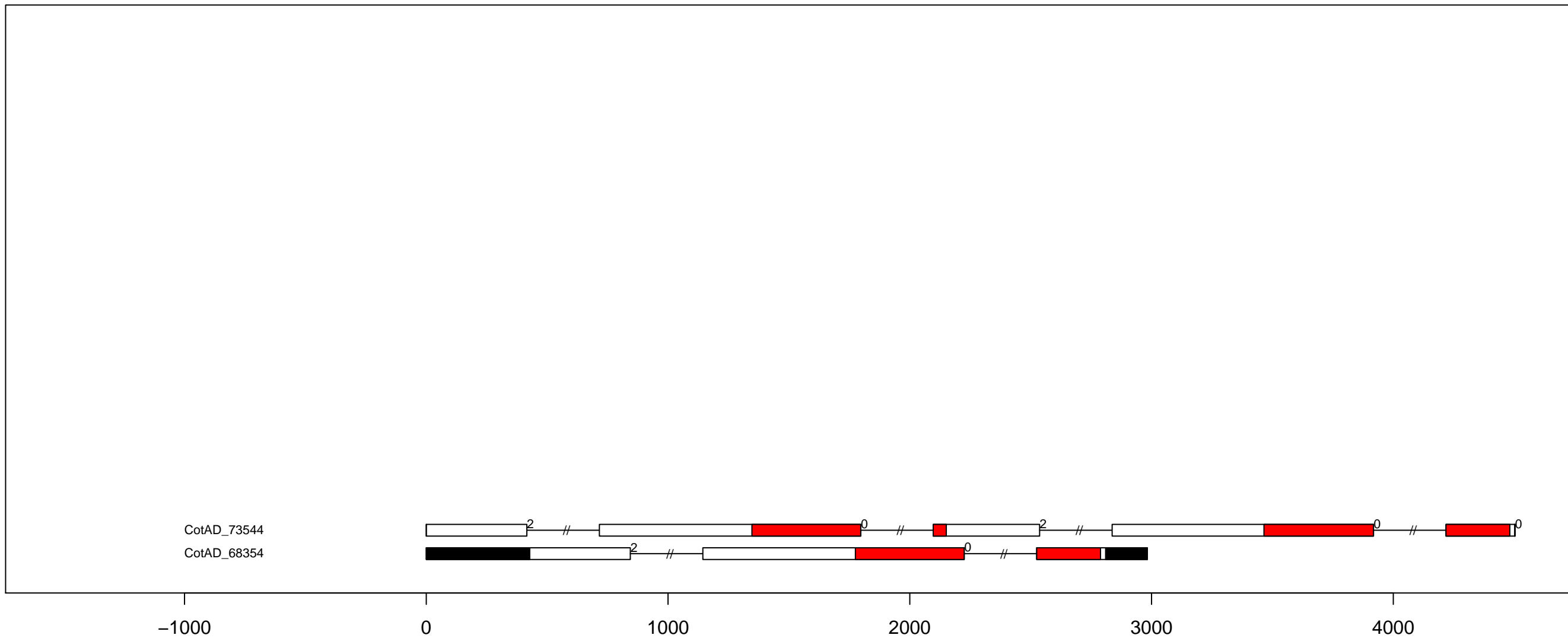

G.hi TKL-PI-8 exon-intron and domain diagram (all)

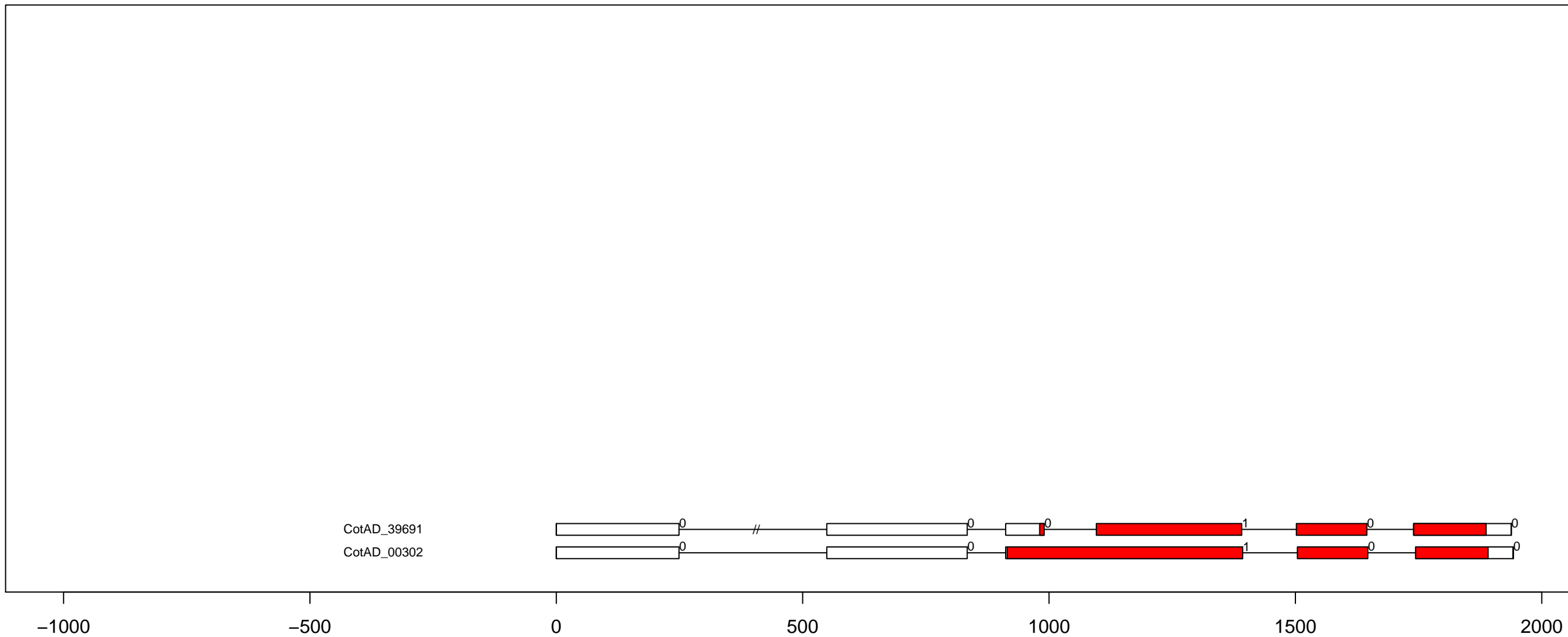

G.hi TLK exon-intron and domain diagram (all)

CotAD_72781

CotAD_64472

CotAD_47144

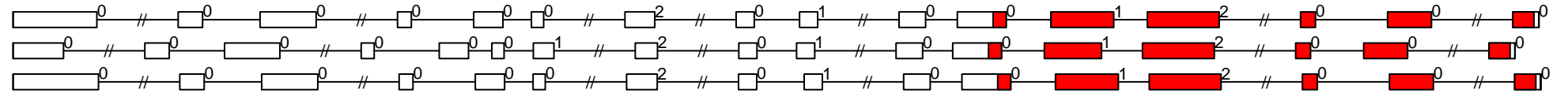

G.hi TTK exon-intron and domain diagram (all)

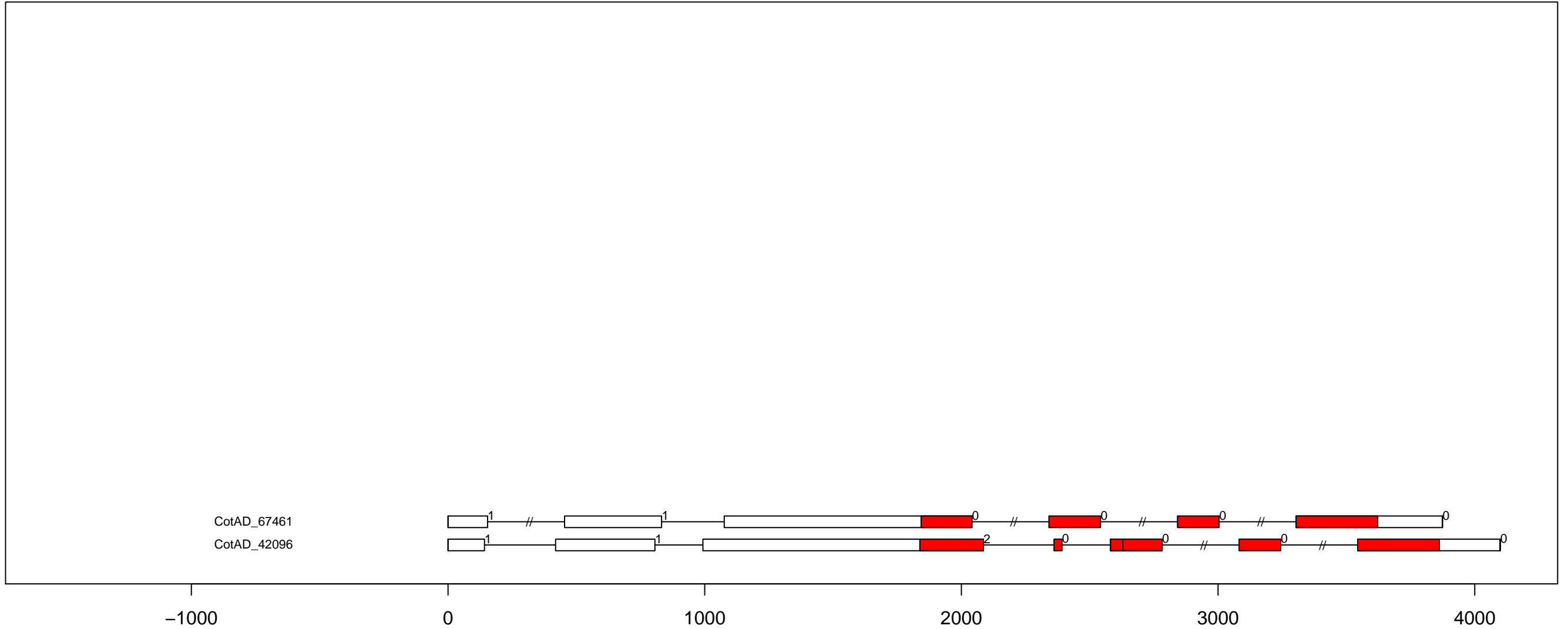

G.hi ULK_Fused exon-intron and domain diagram (all)

CotAD_68878

CotAD_08099

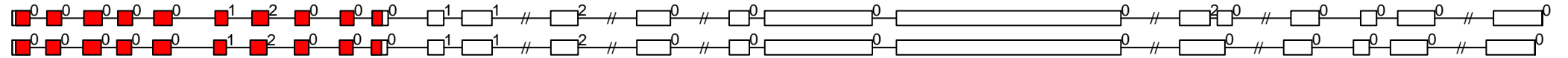

0

2000

4000

6000

8000

G.hi ULK_ULK4 exon-intron and domain diagram (all)



G.hi WEE exon-intron and domain diagram (all)

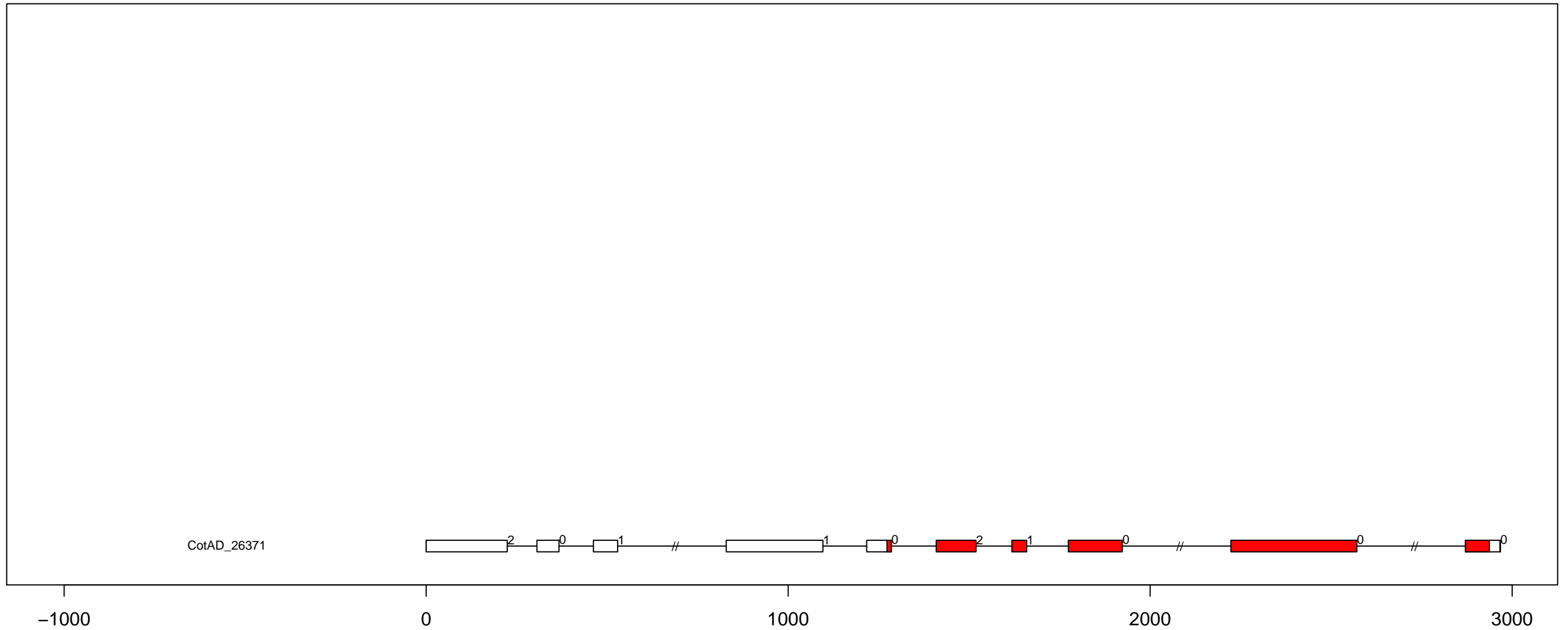

G.hi WNK_NRBP exon-intron and domain diagram (part 1)

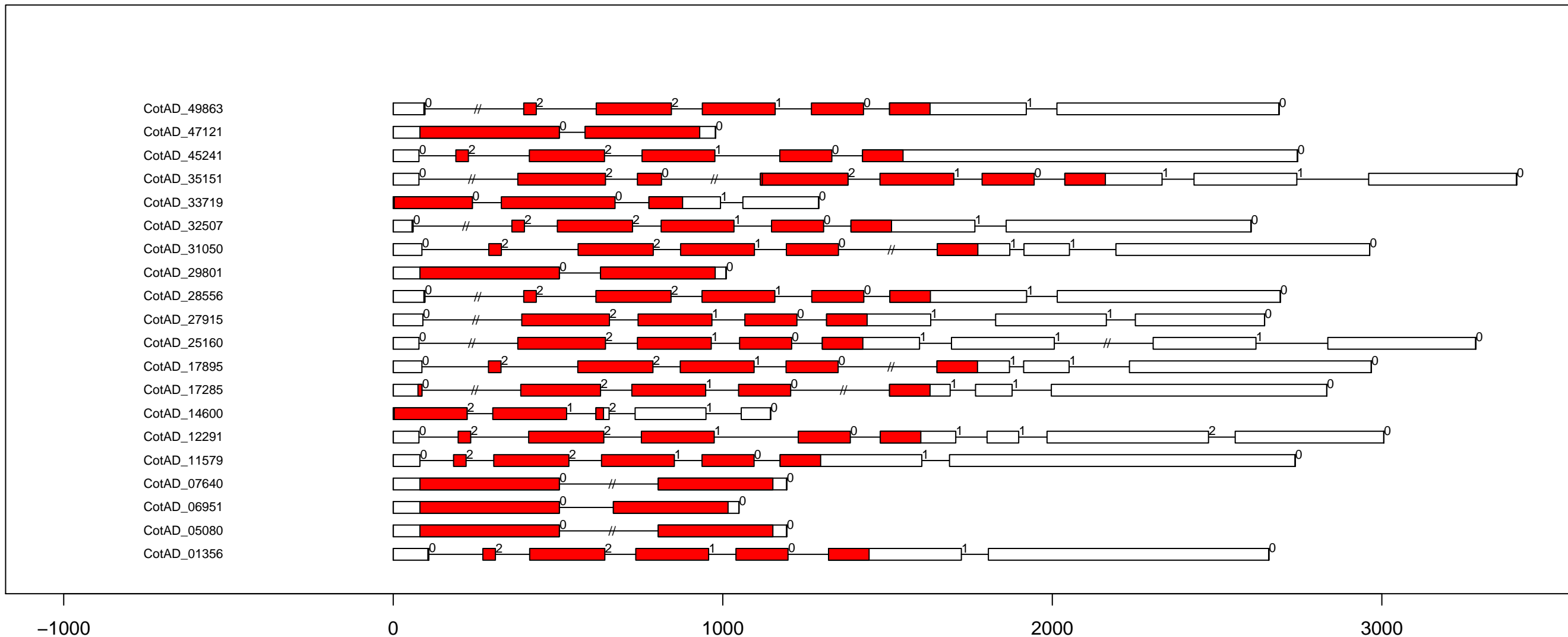

G.hi WNK_NRBP exon-intron and domain diagram (part 2)

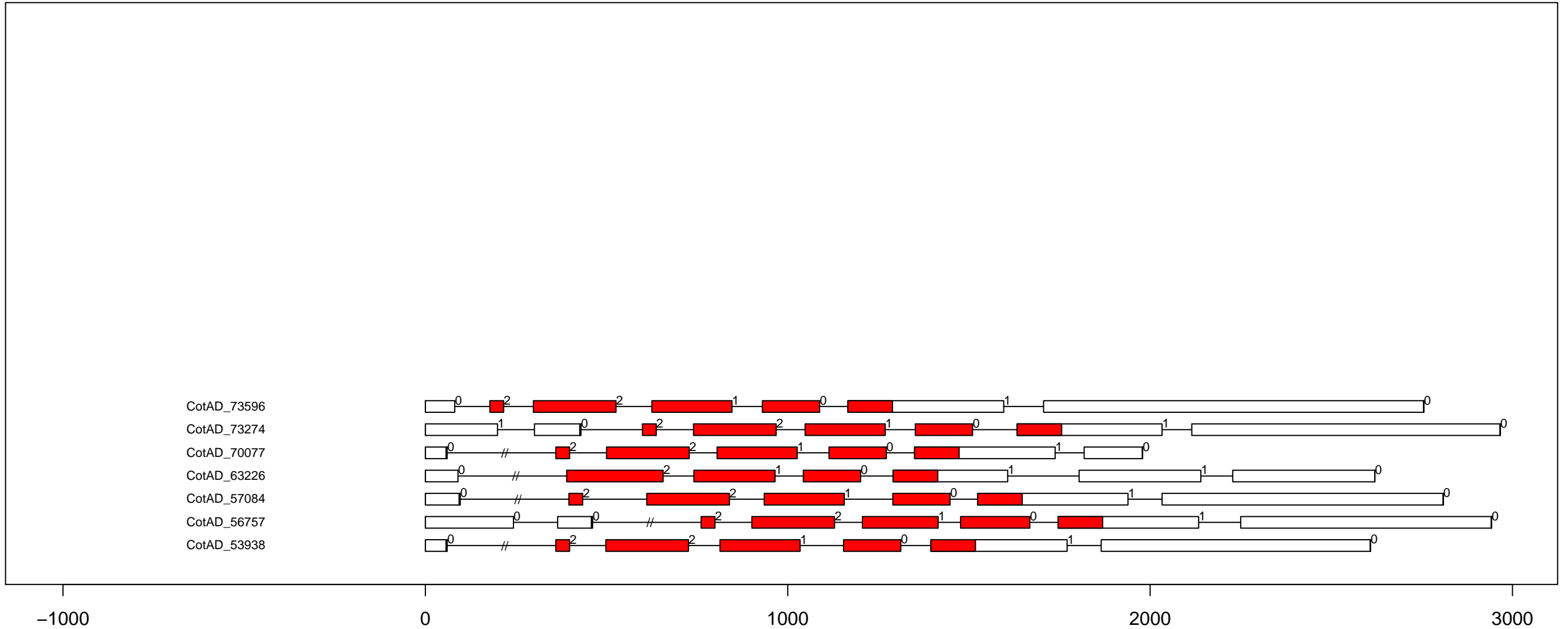

G.ba AGC_MAST exon-intron and domain diagram (all)

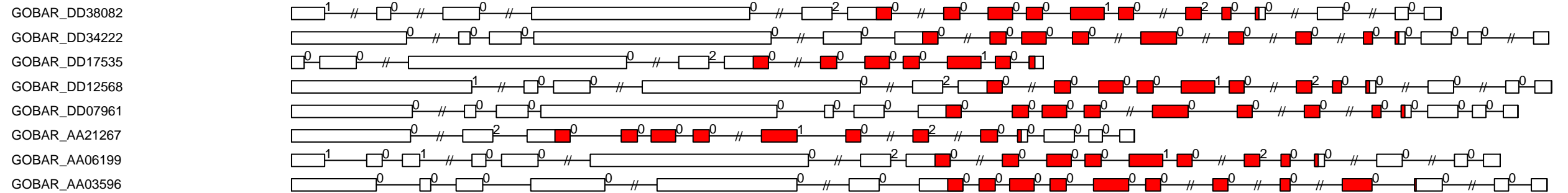

0

2000

4000

6000

G.ba AGC_NDR exon-intron and domain diagram (all)

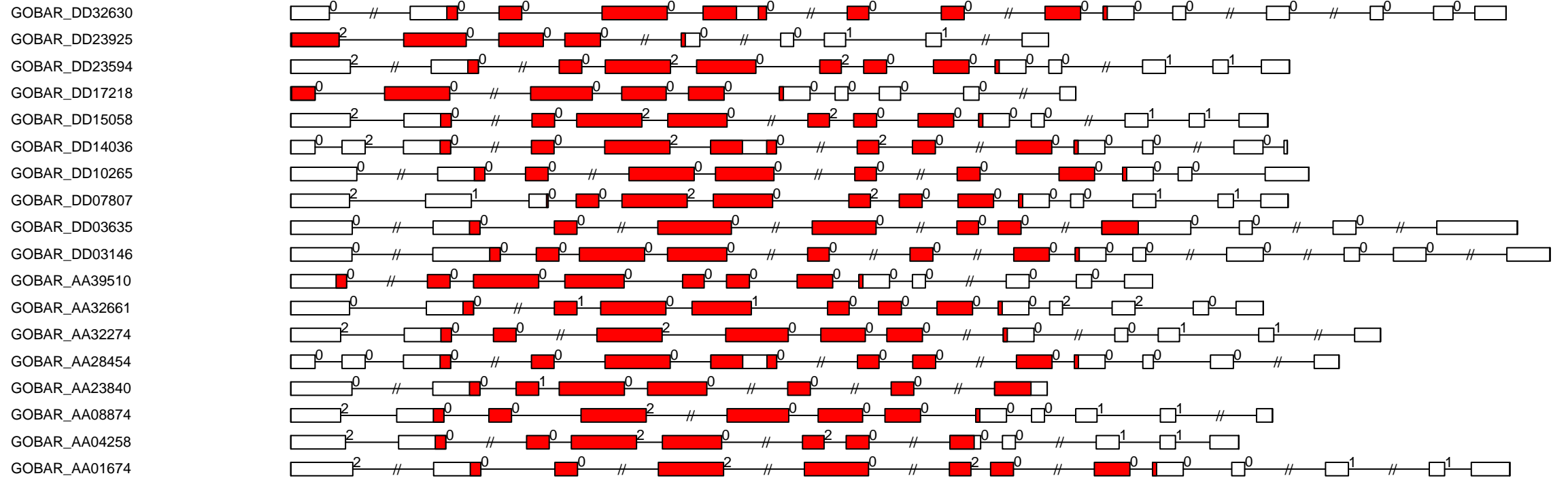

-1000

0

1000

2000

3000

4000

G.ba AGC_PDK1 exon-intron and domain diagram (all)

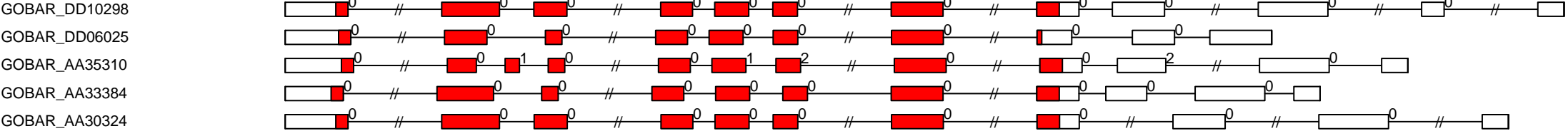

-1000

0

1000

2000

3000

4000

G.ba AGC_PKA-PKG exon-intron and domain diagram (all)

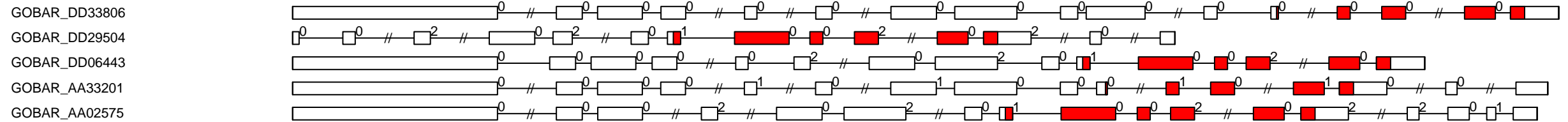

G.ba AGC_RSK-2 exon-intron and domain diagram (part 1)

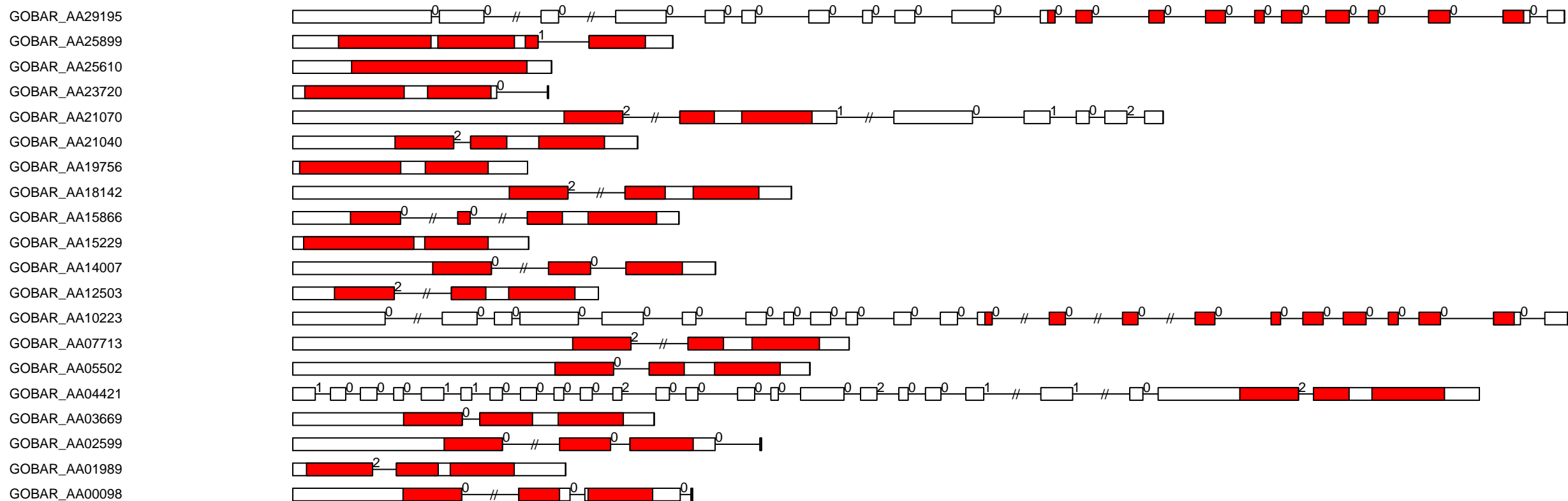

G.ba AGC_RSK-2 exon-intron and domain diagram (part 2)

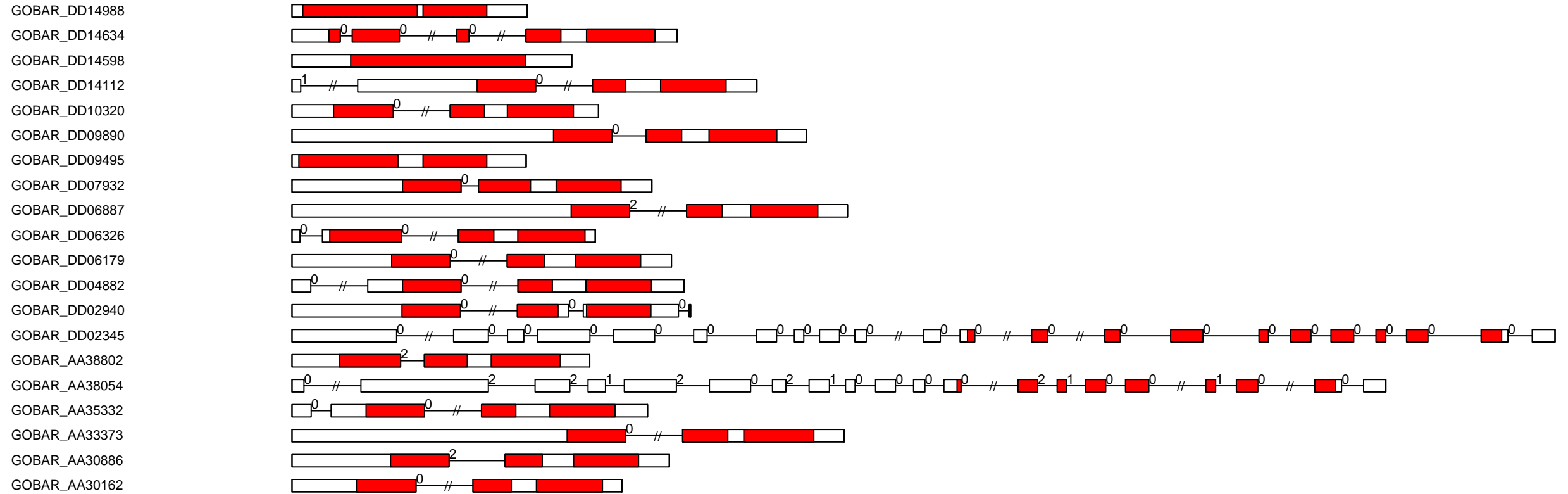

G.ba AGC_RSK-2 exon-intron and domain diagram (part 3)

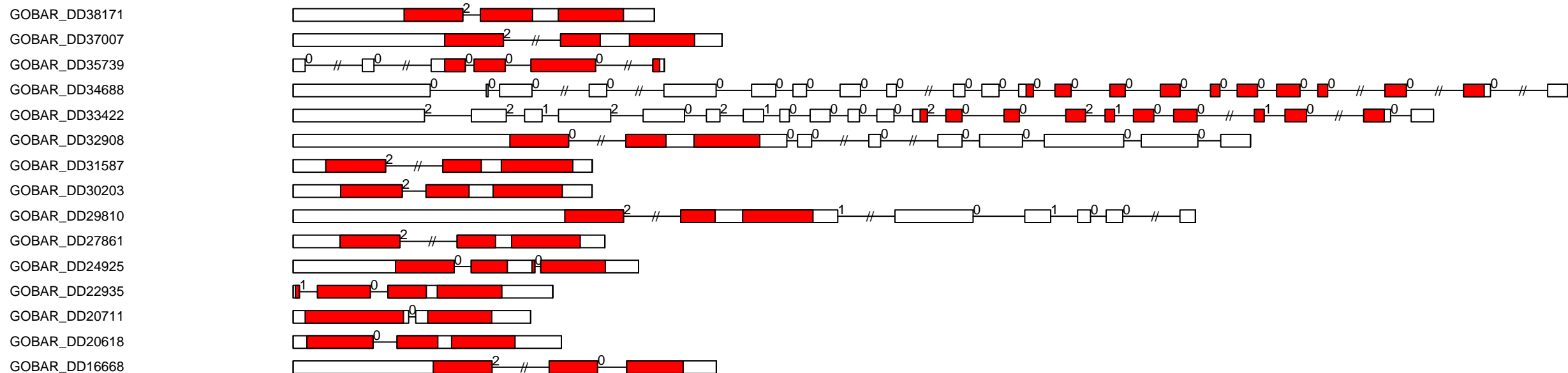

G.ba AGC-PI exon-intron and domain diagram (all)

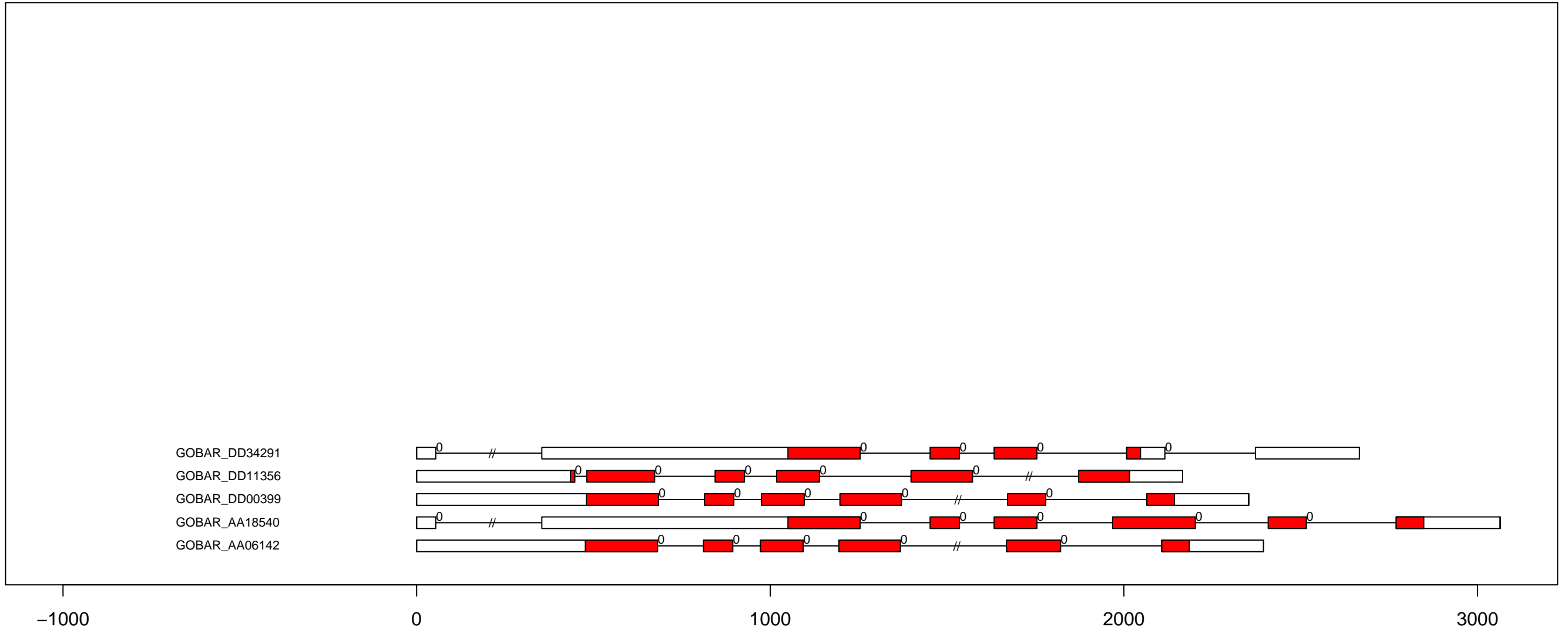

G.ba BUB exon-intron and domain diagram (all)

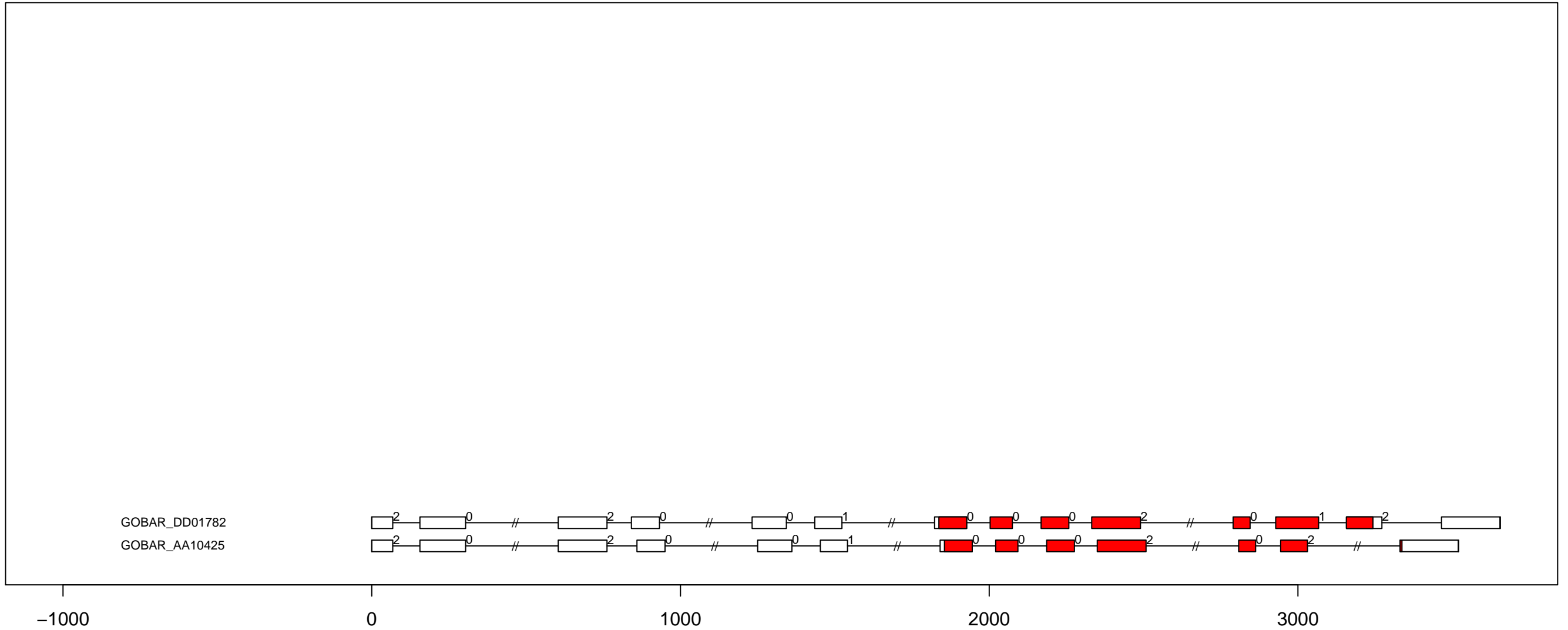

G.ba CAMK_AMPK exon-intron and domain diagram (all)

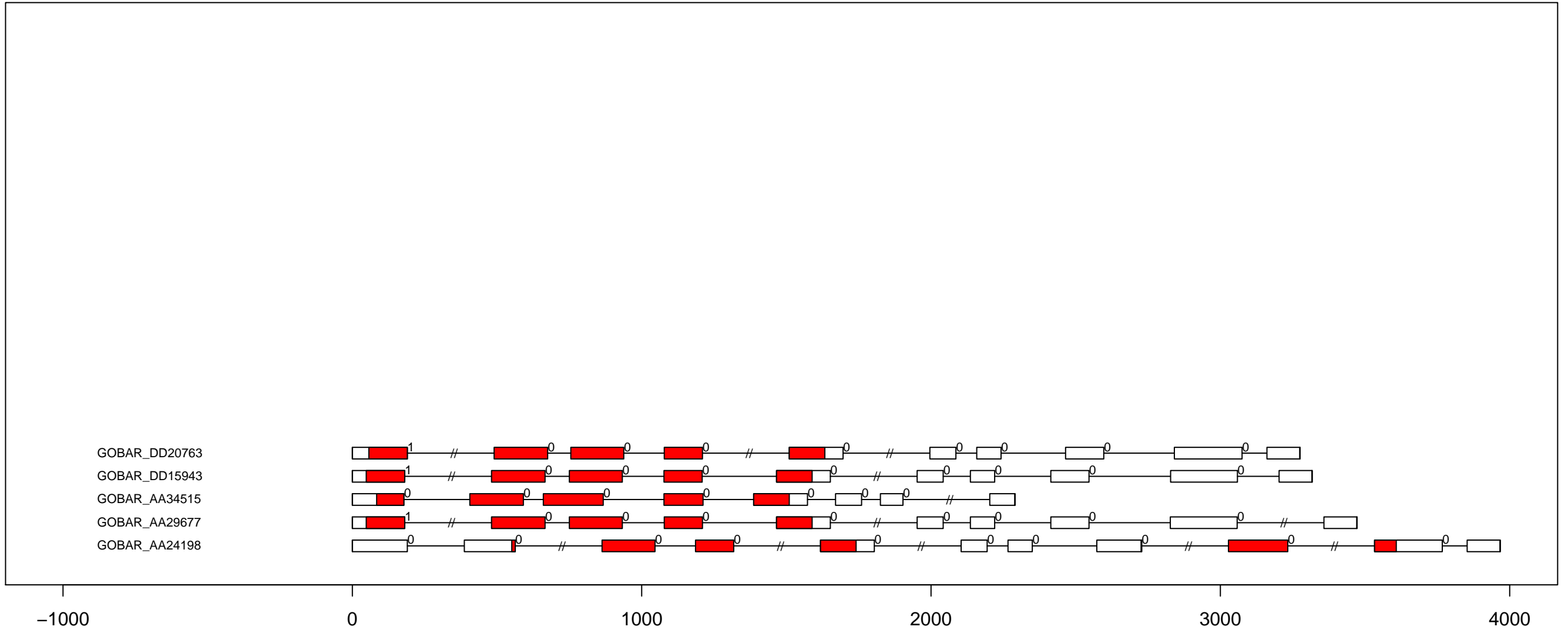

G.ba CAMK_CAMK1-DCAMKL exon-intron and domain diagram (all)

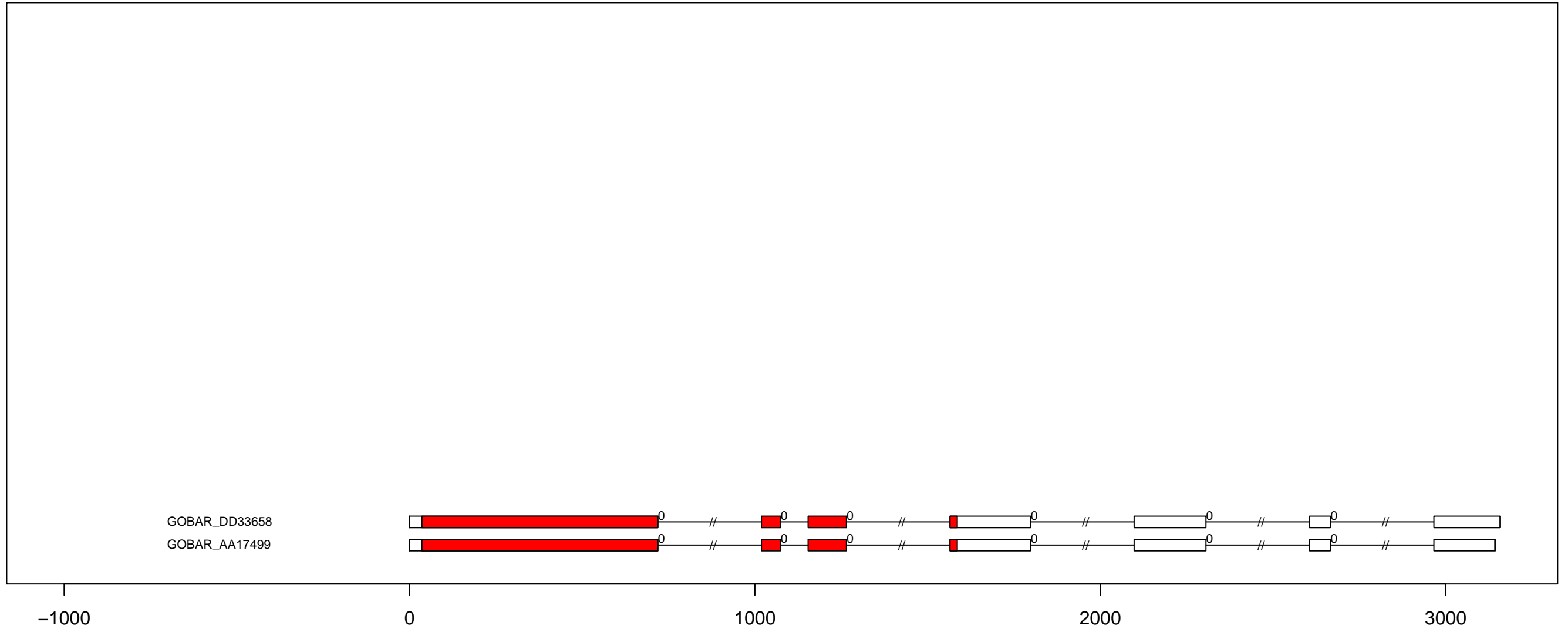

G.ba CAMK_CAMKL-CHK1 exon-intron and domain diagram (part 1)

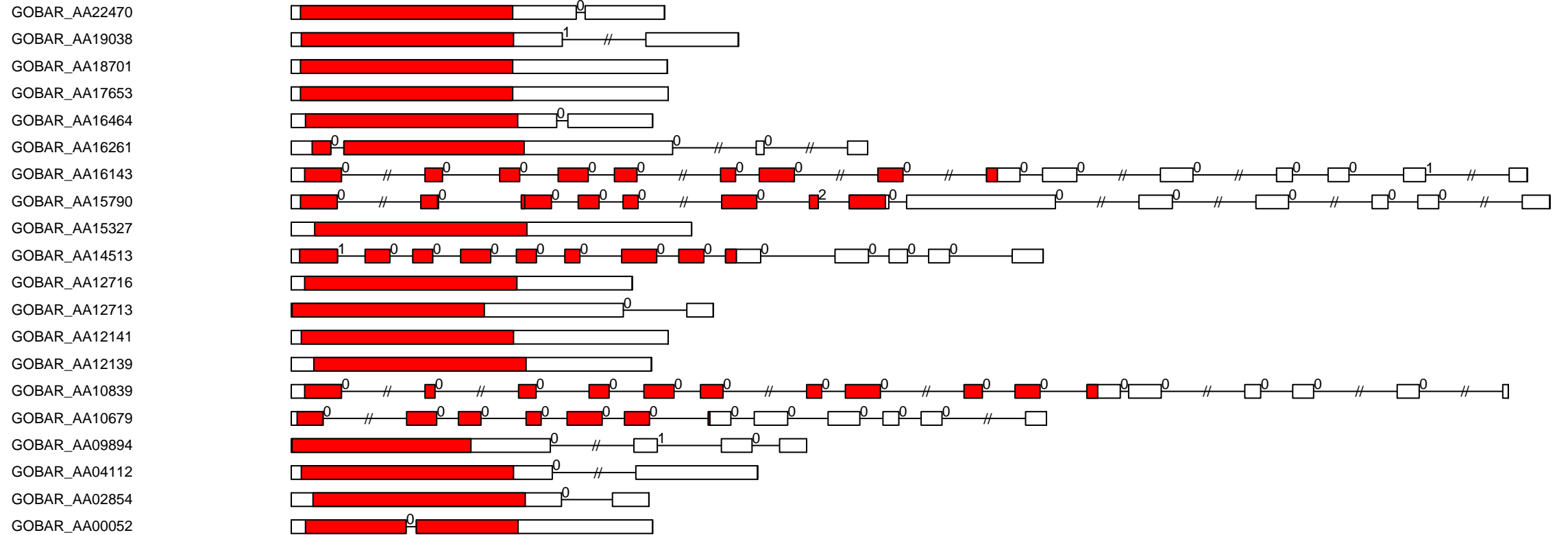

G.ba CAMK_CAMKL-CHK1 exon-intron and domain diagram (part 2)

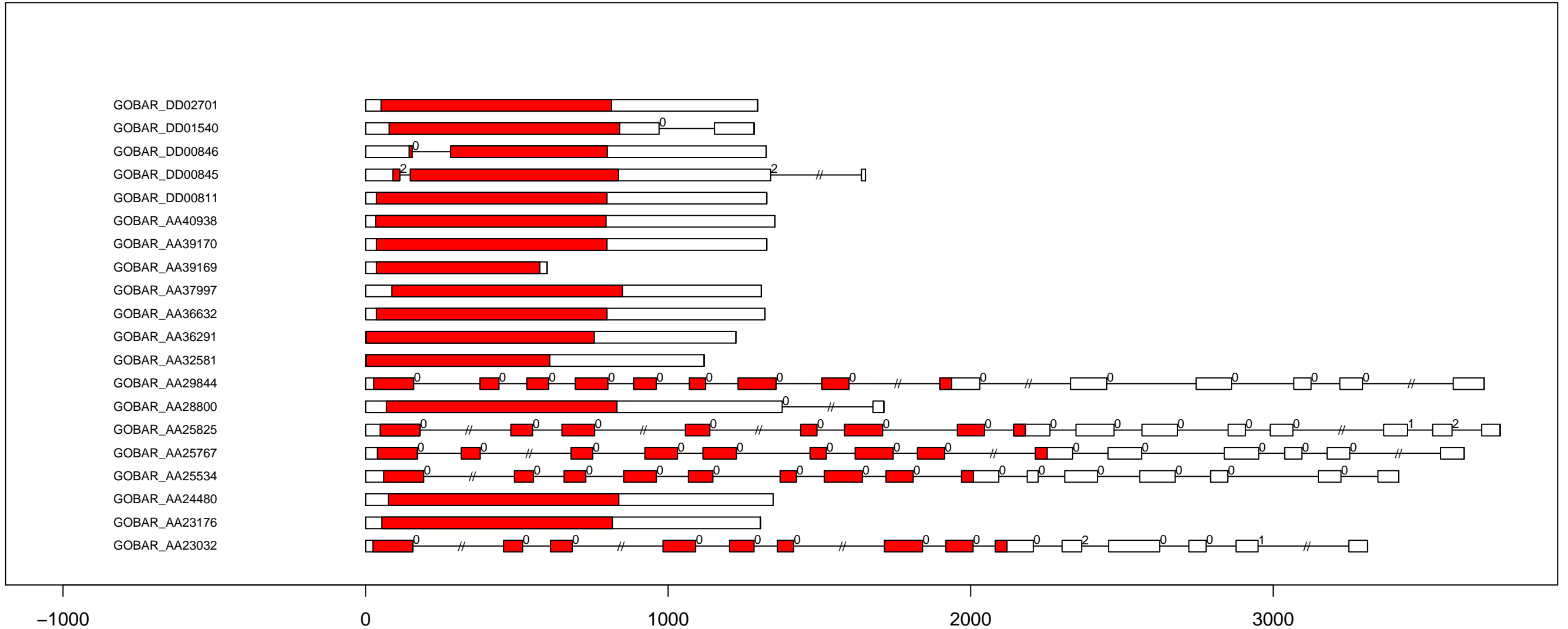

G.ba CAMK_CAMKL-CHK1 exon-intron and domain diagram (part 3)

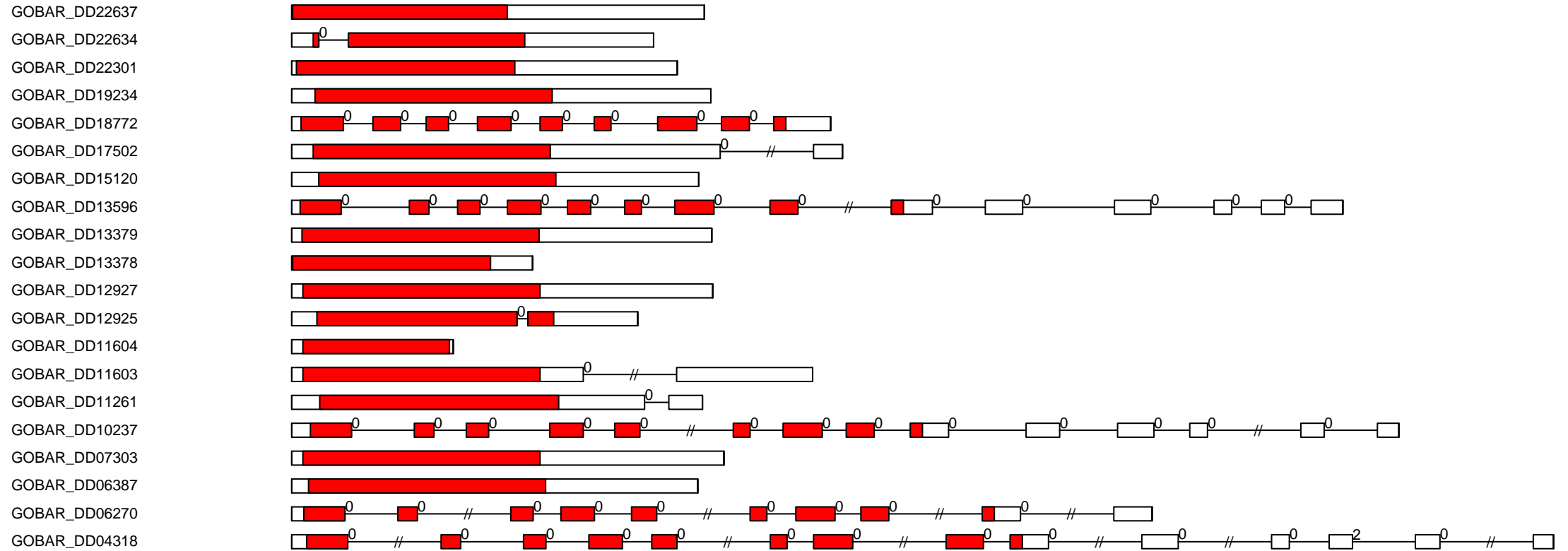

G.ba CAMK_CAMKL-CHK1 exon-intron and domain diagram (part 4)

GOBAR_DD33585
GOBAR_DD33006
GOBAR_DD31250
GOBAR_DD29533
GOBAR_DD29024
GOBAR_DD28630
GOBAR_DD27701
GOBAR_DD27594
GOBAR_DD27510
GOBAR_DD27386
GOBAR_DD27110
GOBAR_DD25339
GOBAR_DD25198
GOBAR_DD25101

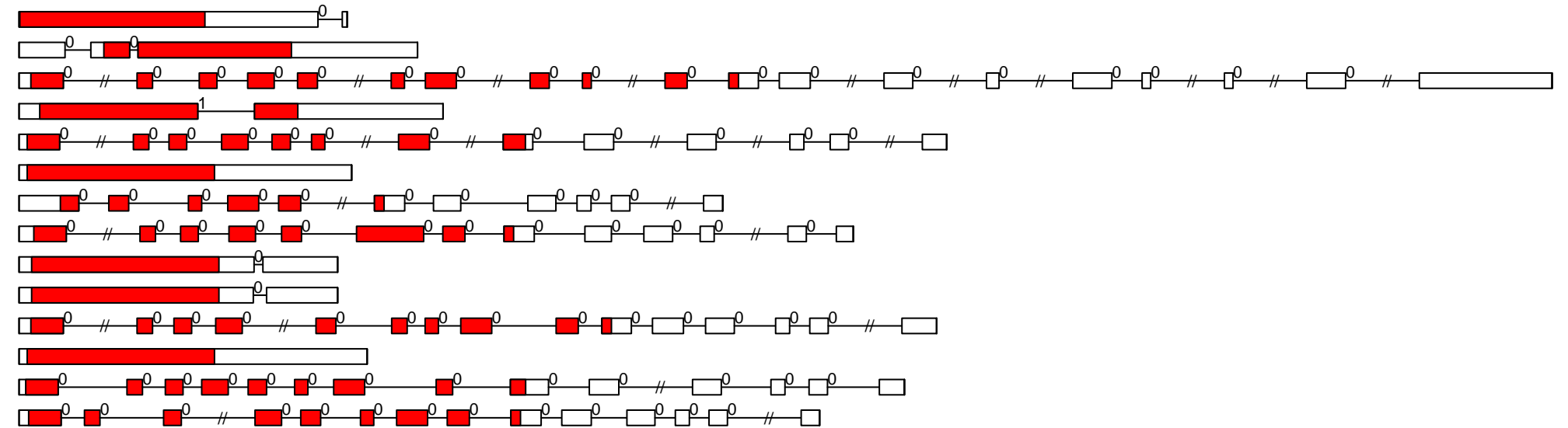

0

2000

4000

6000

G.ba CAMK_CAMKL-LKB exon-intron and domain diagram (all)

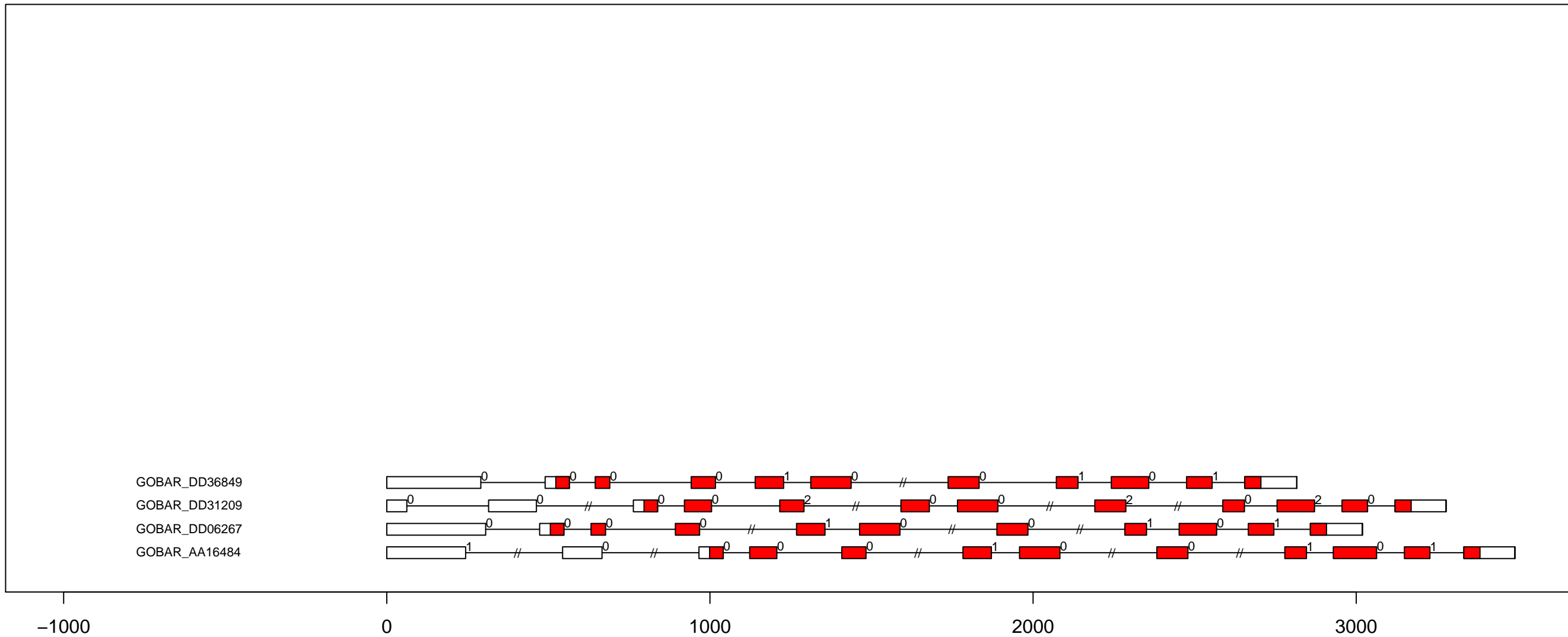

G.ba CAMK_CDPK exon-intron and domain diagram (part 1)

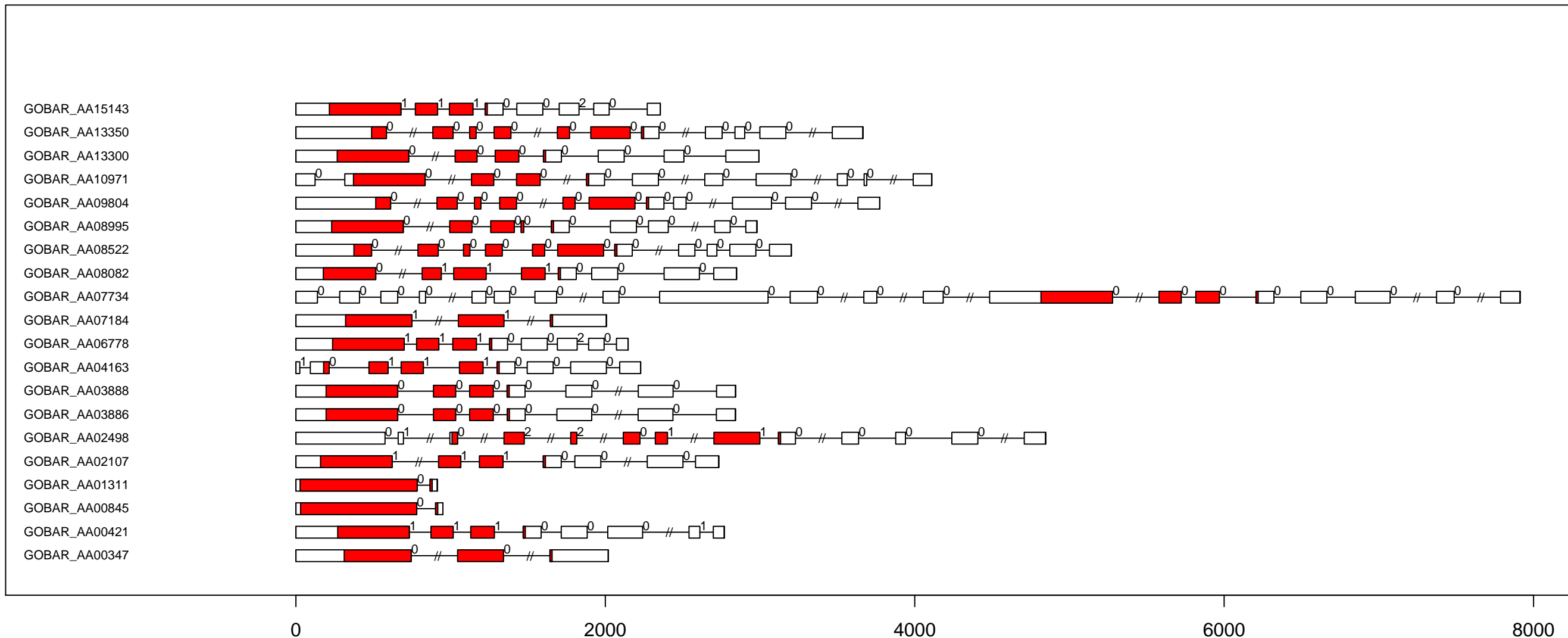

G.ba CAMK_CDPK exon-intron and domain diagram (part 2)

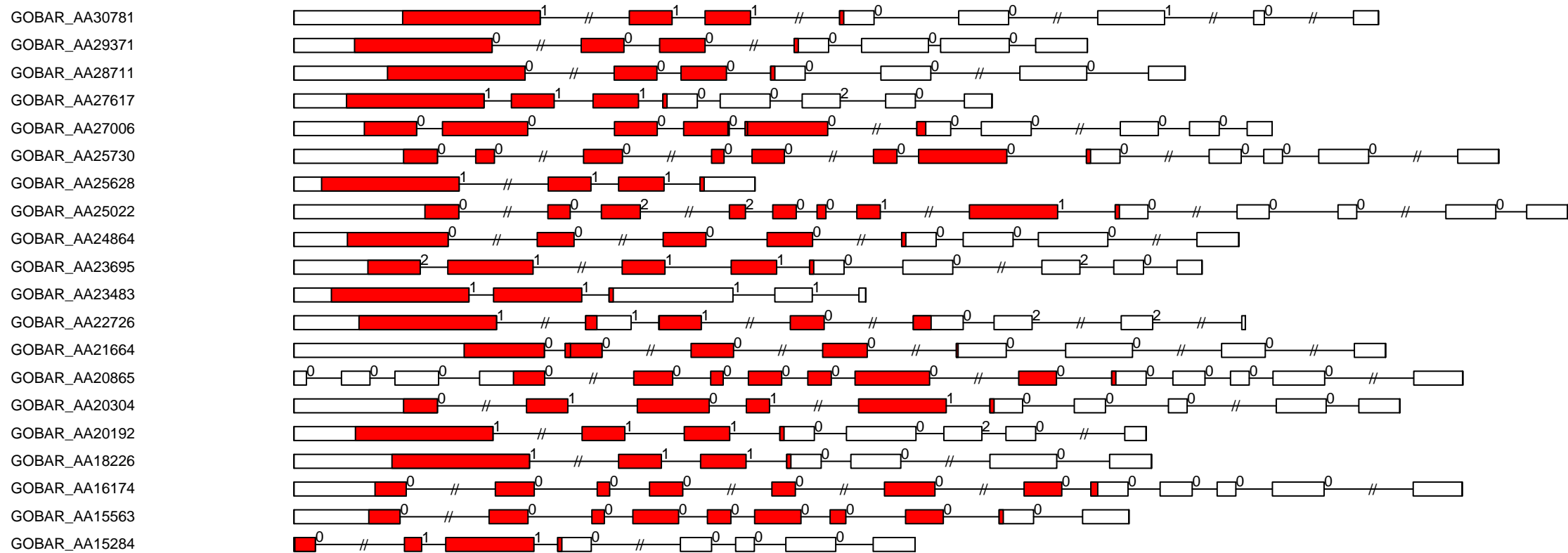

G.ba CAMK_CDPK exon-intron and domain diagram (part 3)

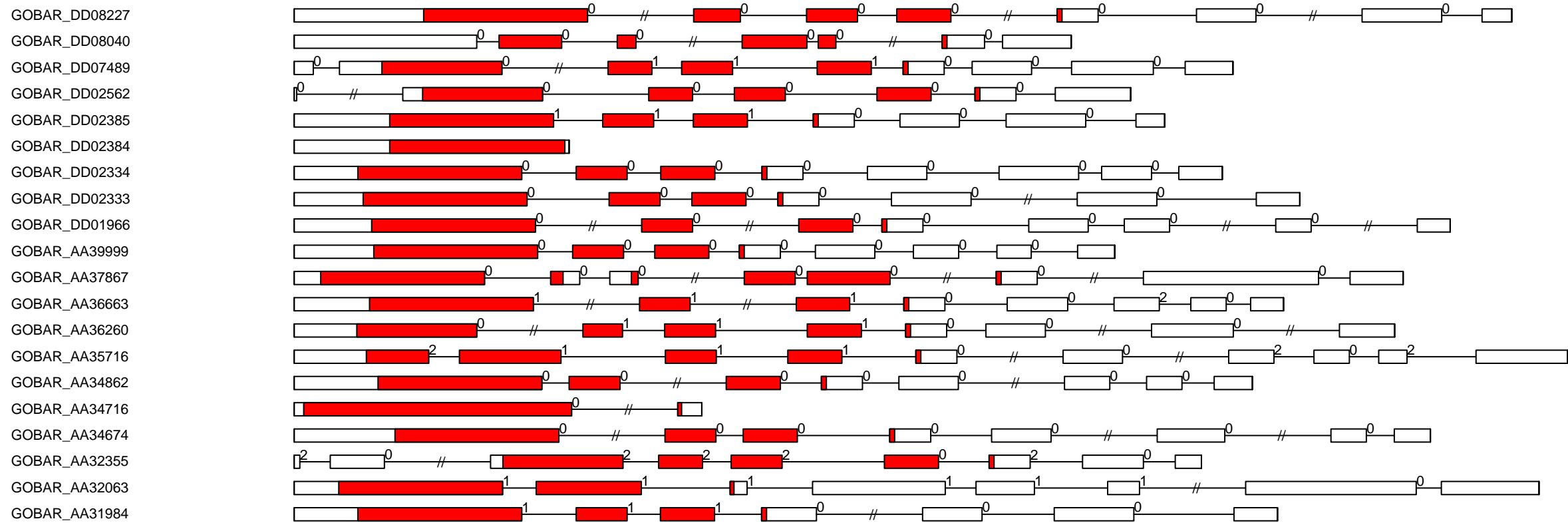

-1000

0

1000

2000

3000

G.ba CAMK_CDPK exon-intron and domain diagram (part 4)

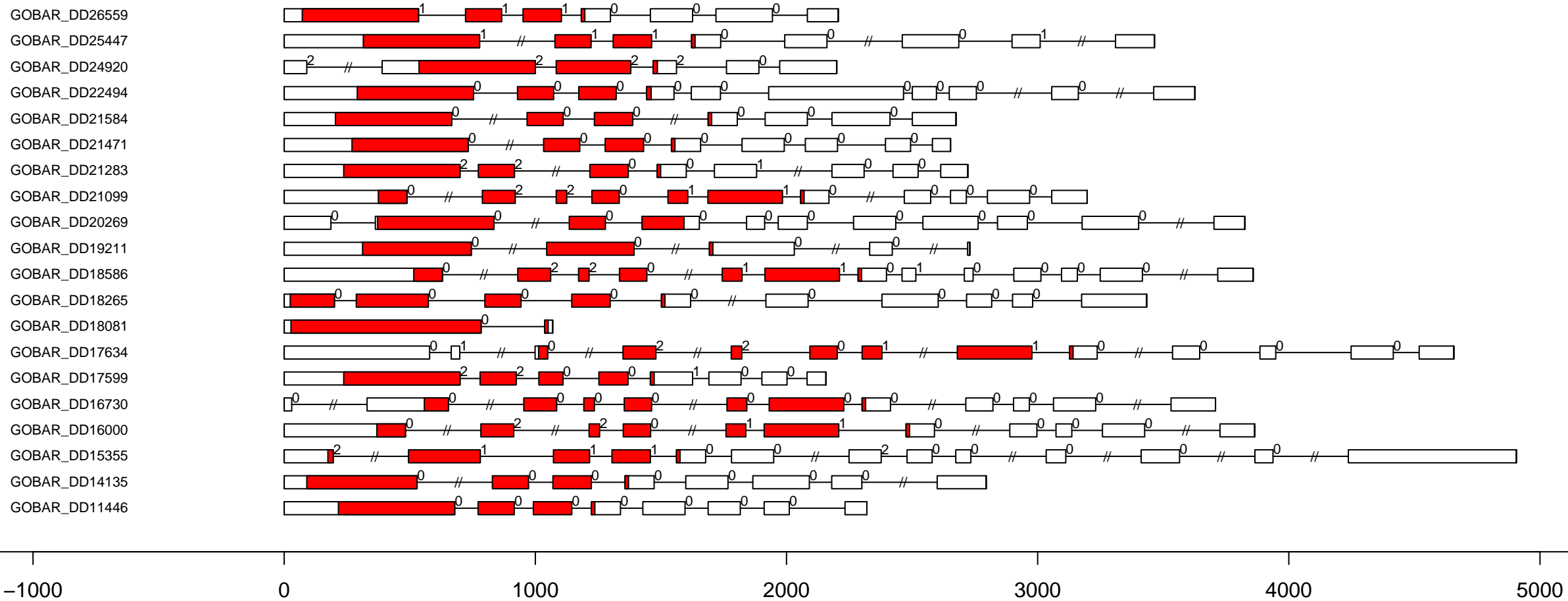

G.ba CAMK_CDPK exon-intron and domain diagram (part 5)

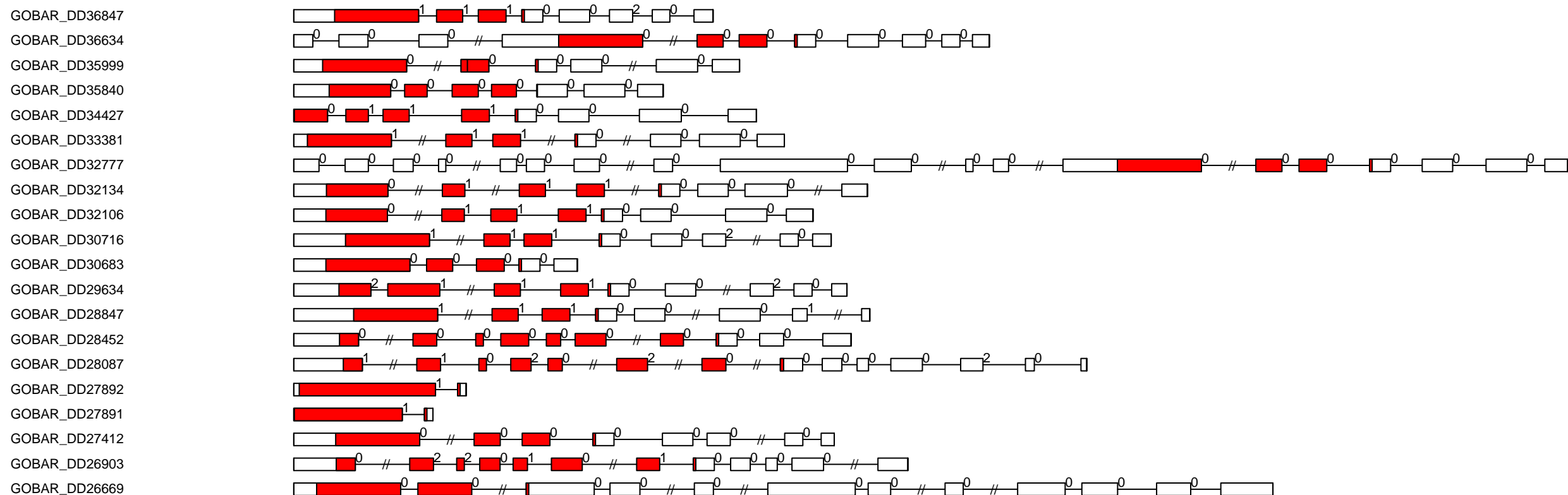

G.ba CAMK_CDPK exon-intron and domain diagram (part 6)

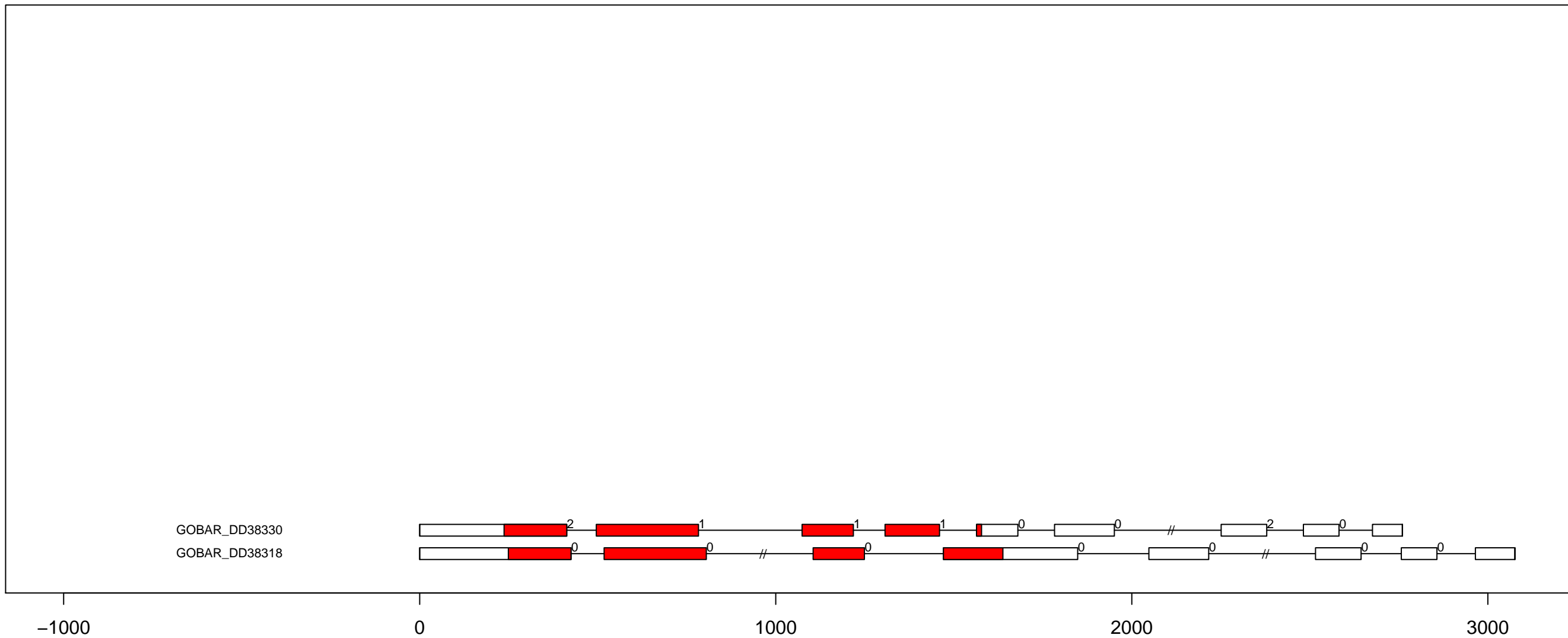

G.ba CAMK_OST1L exon-intron and domain diagram (all)

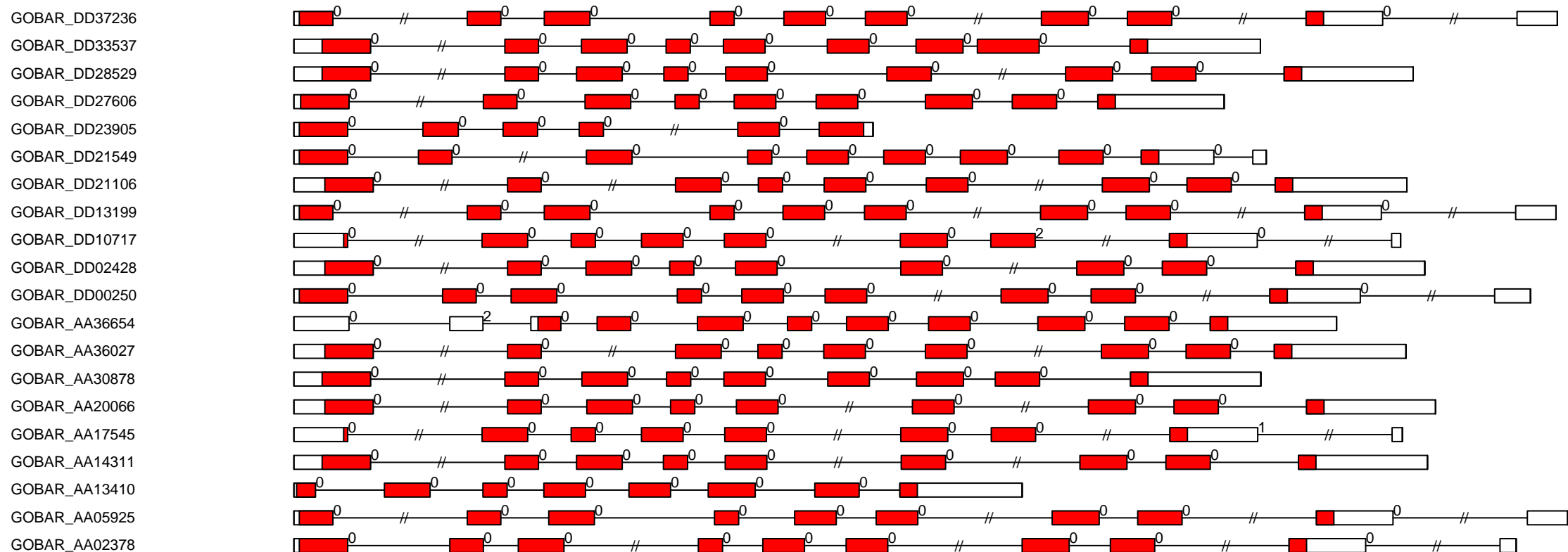

-1000

0

1000

2000

G.ba CK1_CK1 exon-intron and domain diagram (part 1)

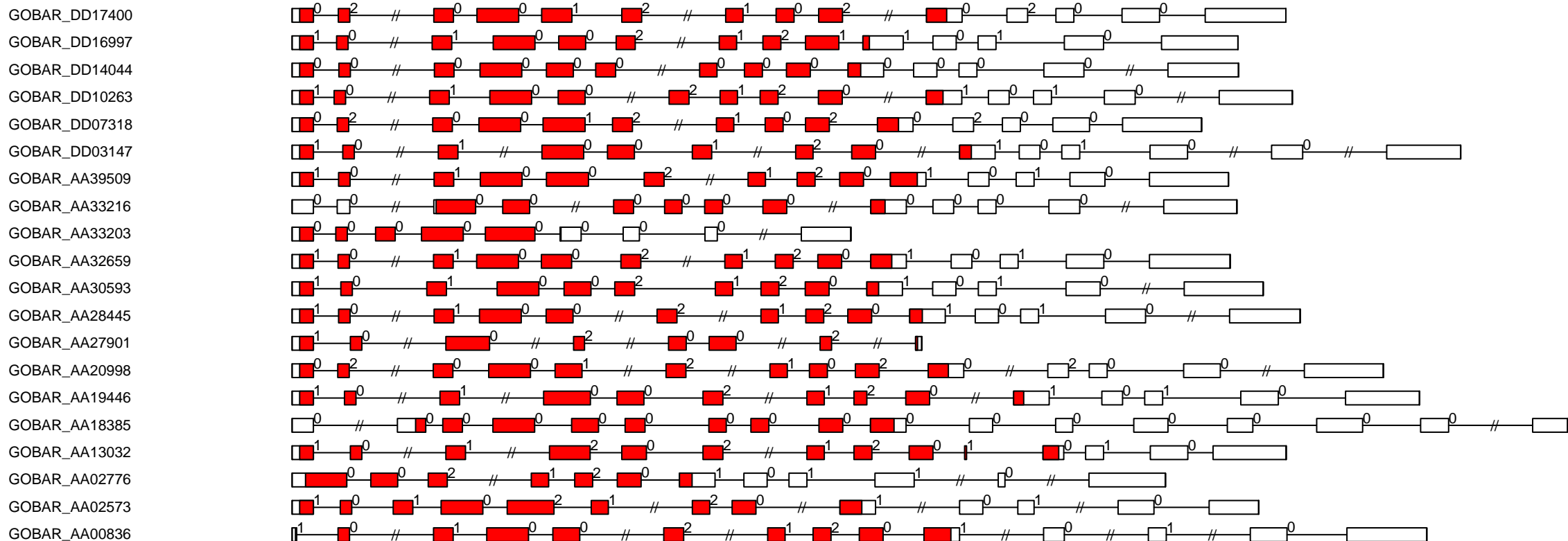

-1000

0

1000

2000

3000

4000

G.ba CK1_CK1 exon-intron and domain diagram (part 2)

GOBAR_DD37825

GOBAR_DD35230

GOBAR_DD33804

GOBAR_DD25264

GOBAR_DD23595

GOBAR_DD17755

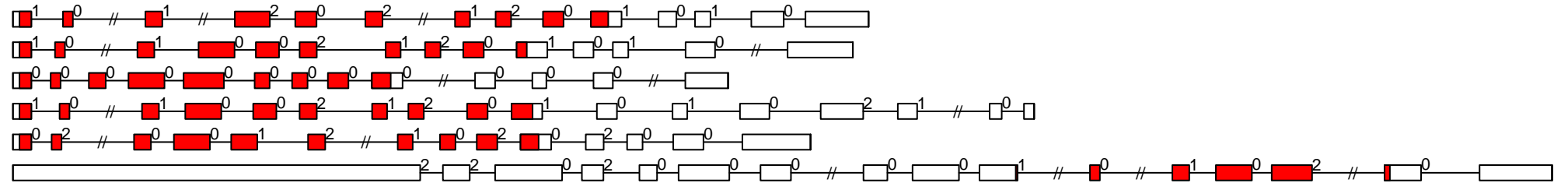

0

2000

4000

6000

G.ba CK1-CK1-PI exon-intron and domain diagram (all)

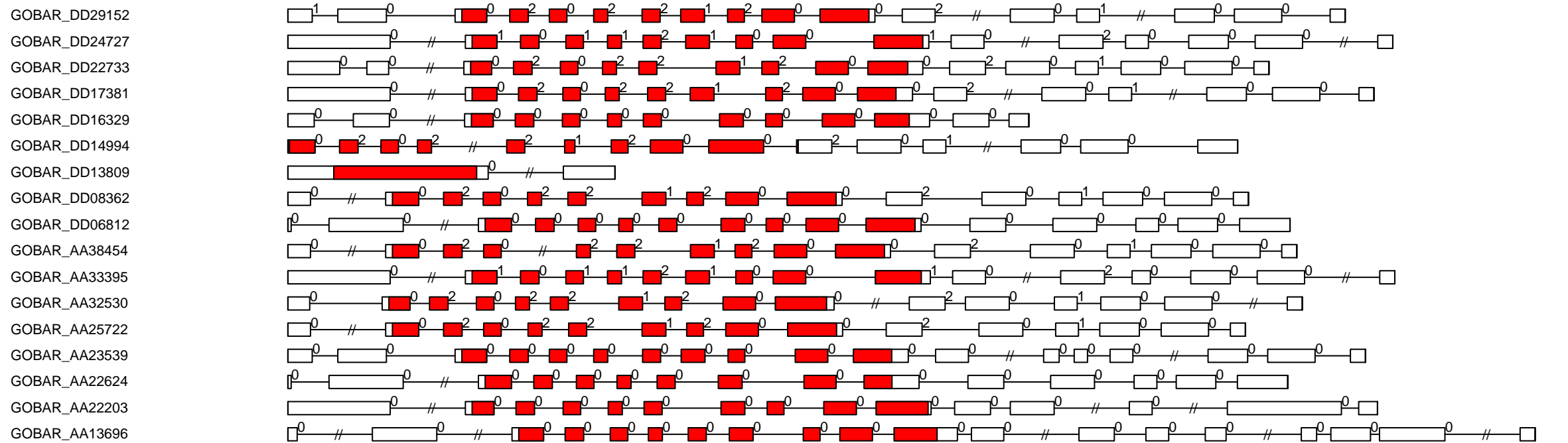

G.ba CMGC_CDK-CCRK exon-intron and domain diagram (all)

GOBAR_DD34703
GOBAR_DD30089
GOBAR_AA24985

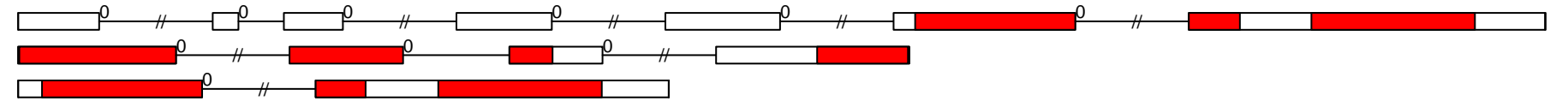

-1000

0

1000

2000

3000

4000

G.ba CMGC_CDK-CDK7 exon-intron and domain diagram (all)

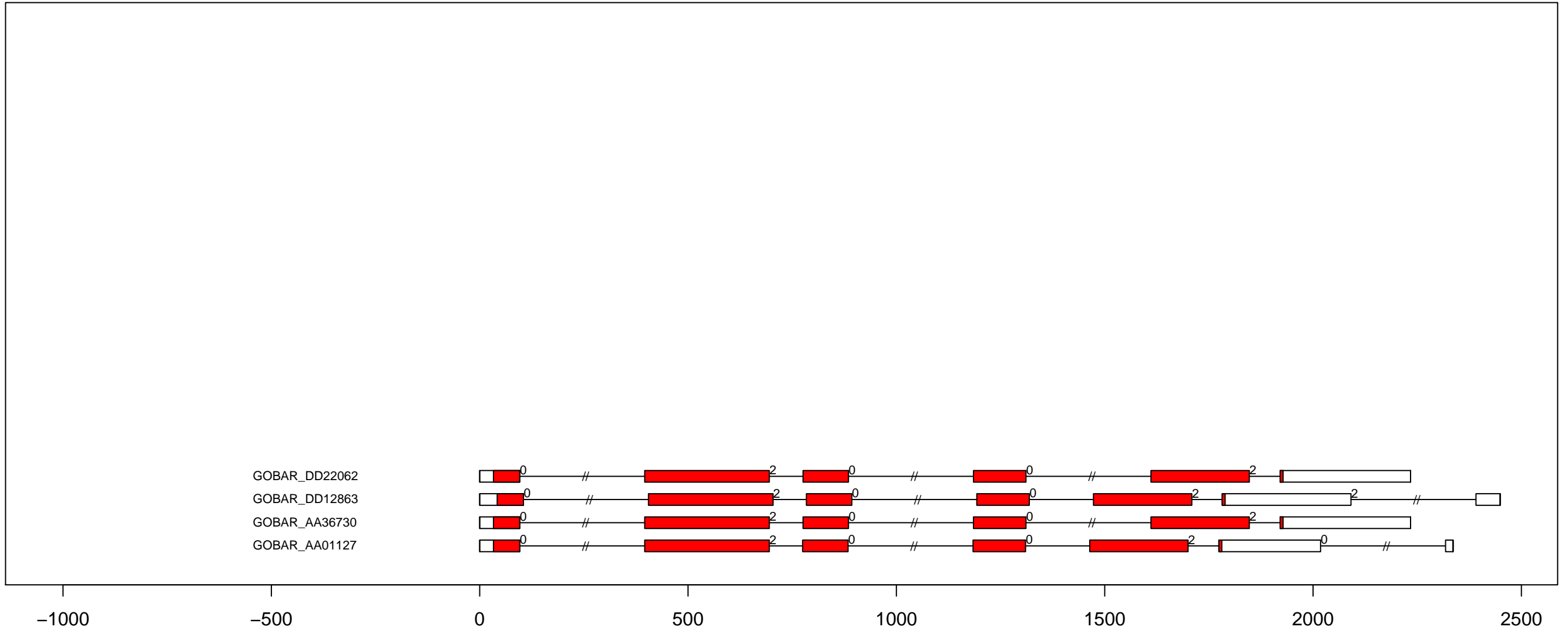

G.ba CMGC_CDK-CDK8 exon-intron and domain diagram (all)

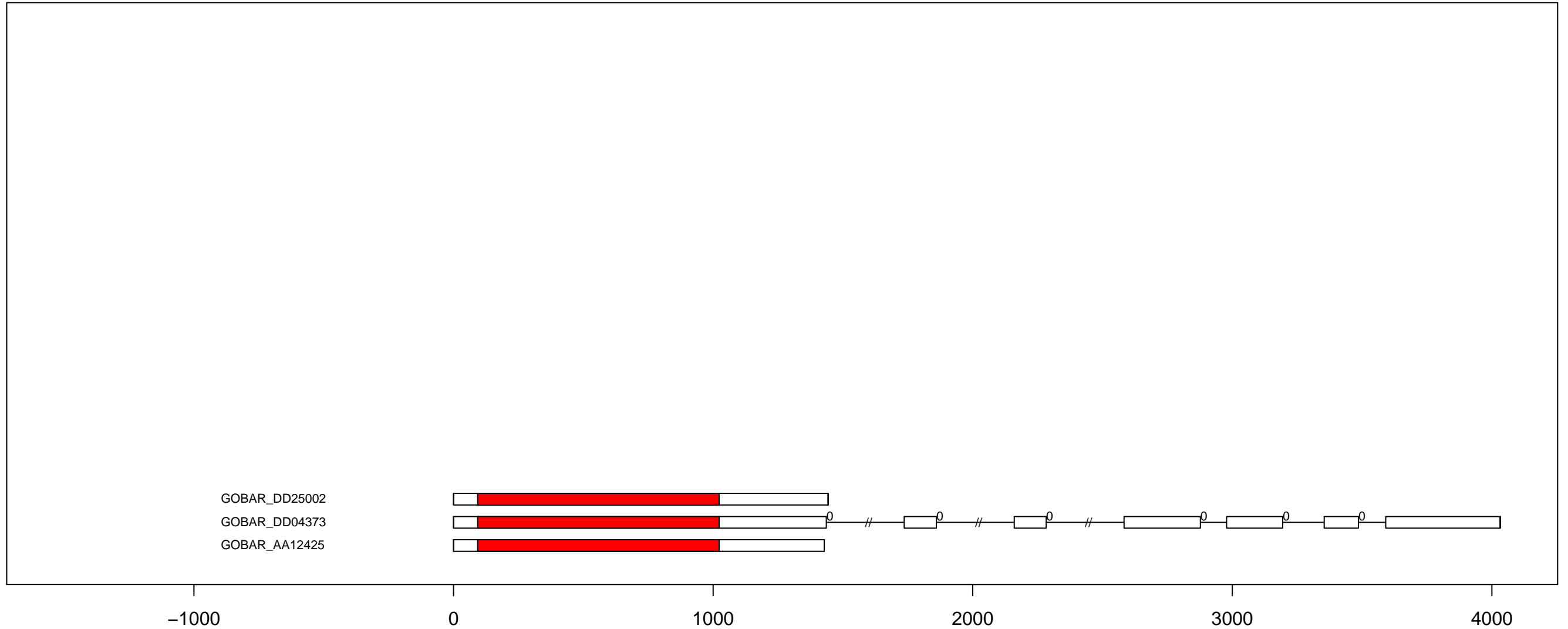

G.ba CMGC_CDK-CRK7-CDK9 exon-intron and domain diagram (part 1)

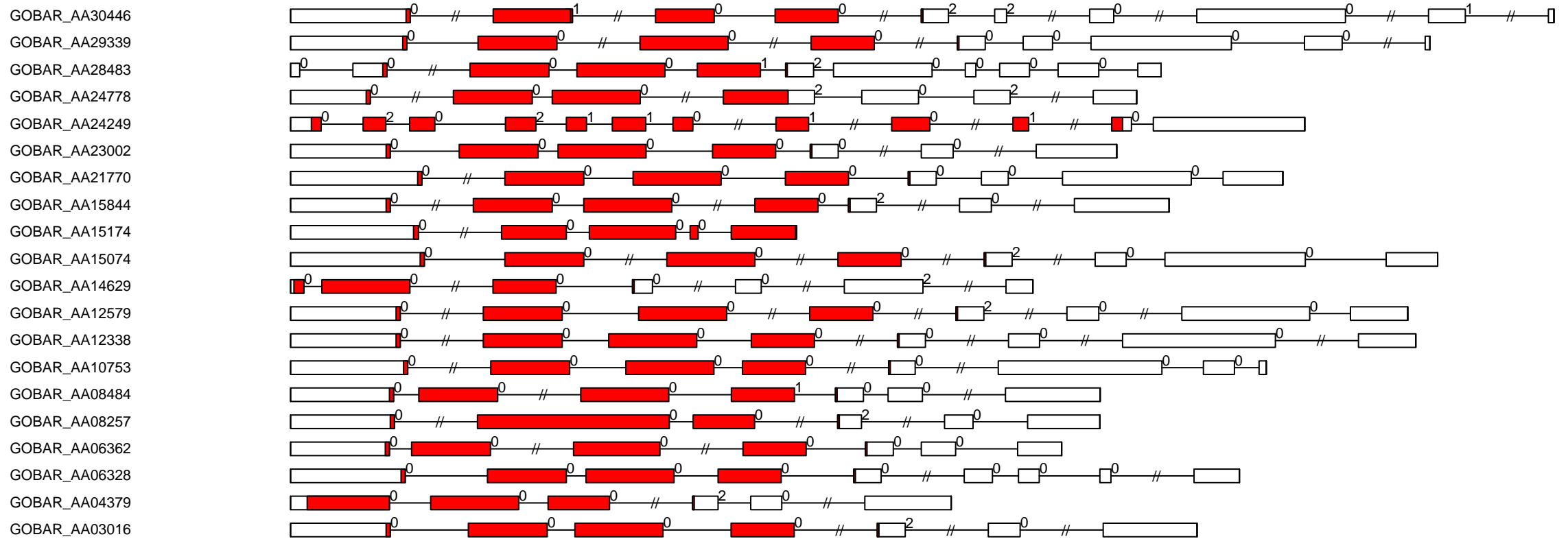

-1000

0

1000

2000

3000

4000

G.ba CMGC_CDK-CRK7-CDK9 exon-intron and domain diagram (part 2)

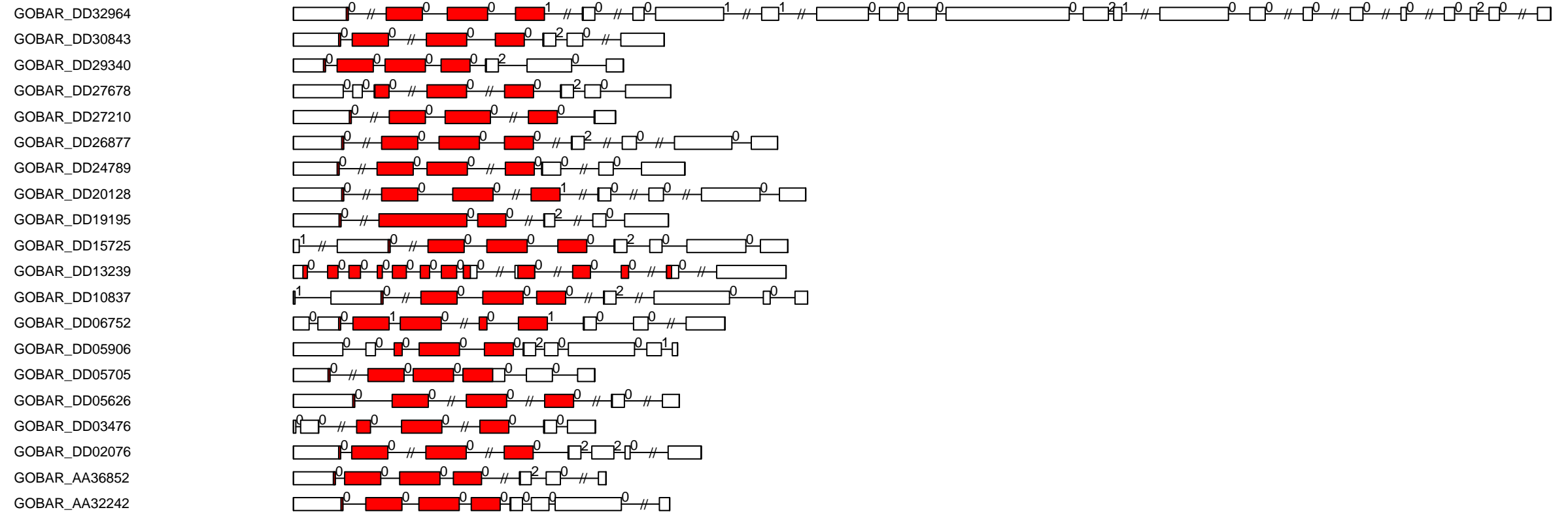

G.ba CMGC_CDK-CRK7-CDK9 exon-intron and domain diagram (part 3)

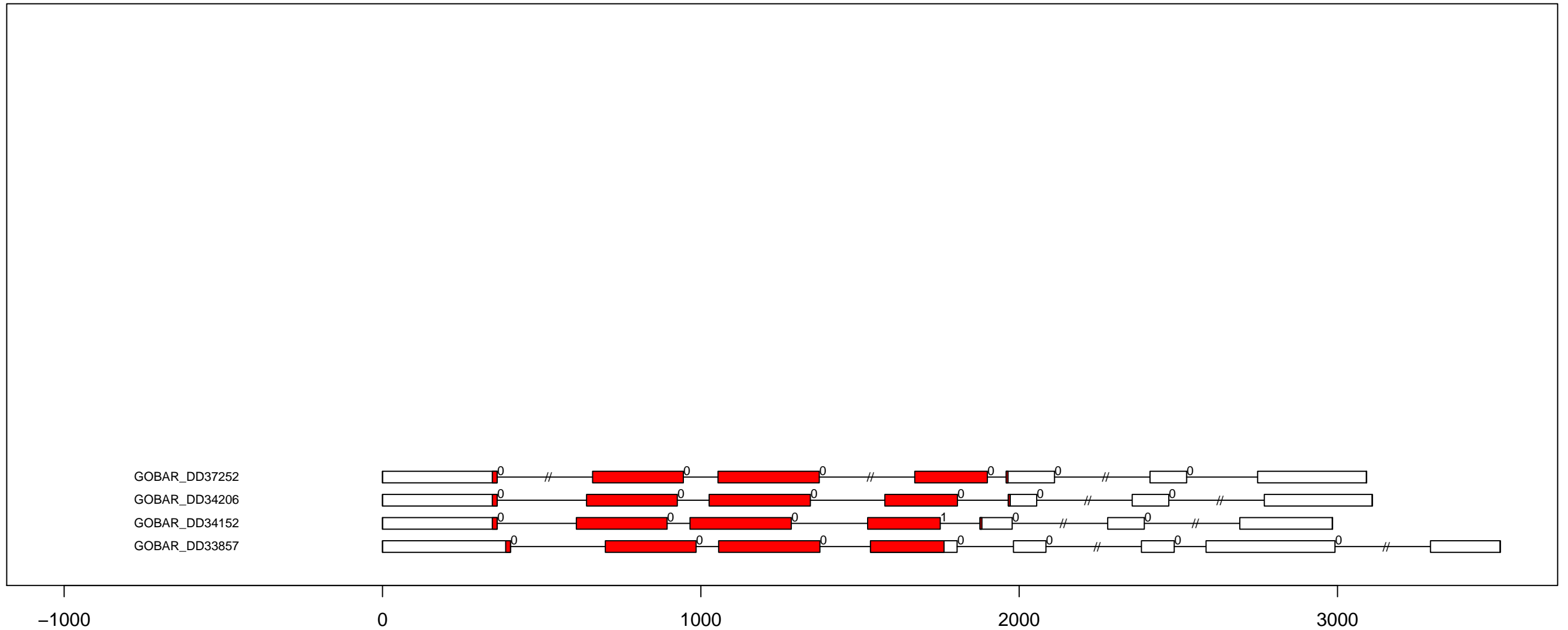

G.ba CMGC_CDK-PITSLRE exon-intron and domain diagram (all)

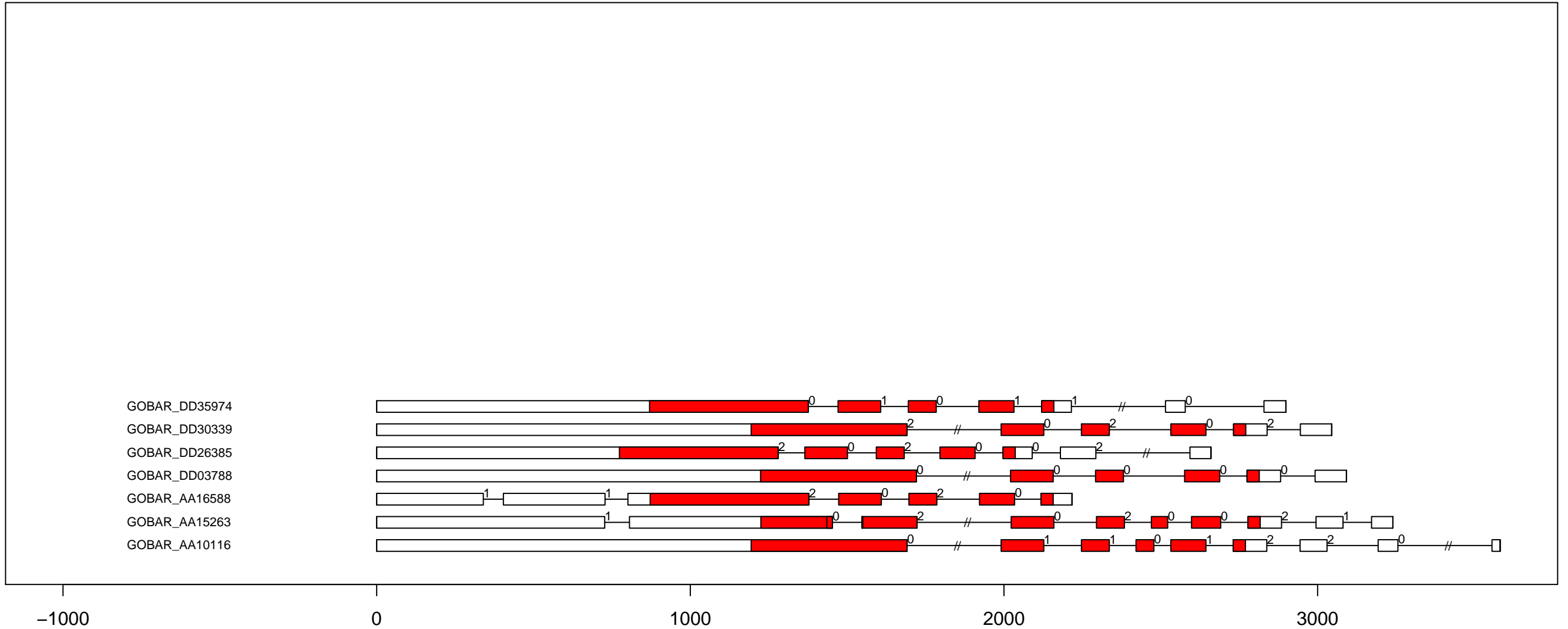

G.ba CMGC_CDK-PI exon-intron and domain diagram (all)

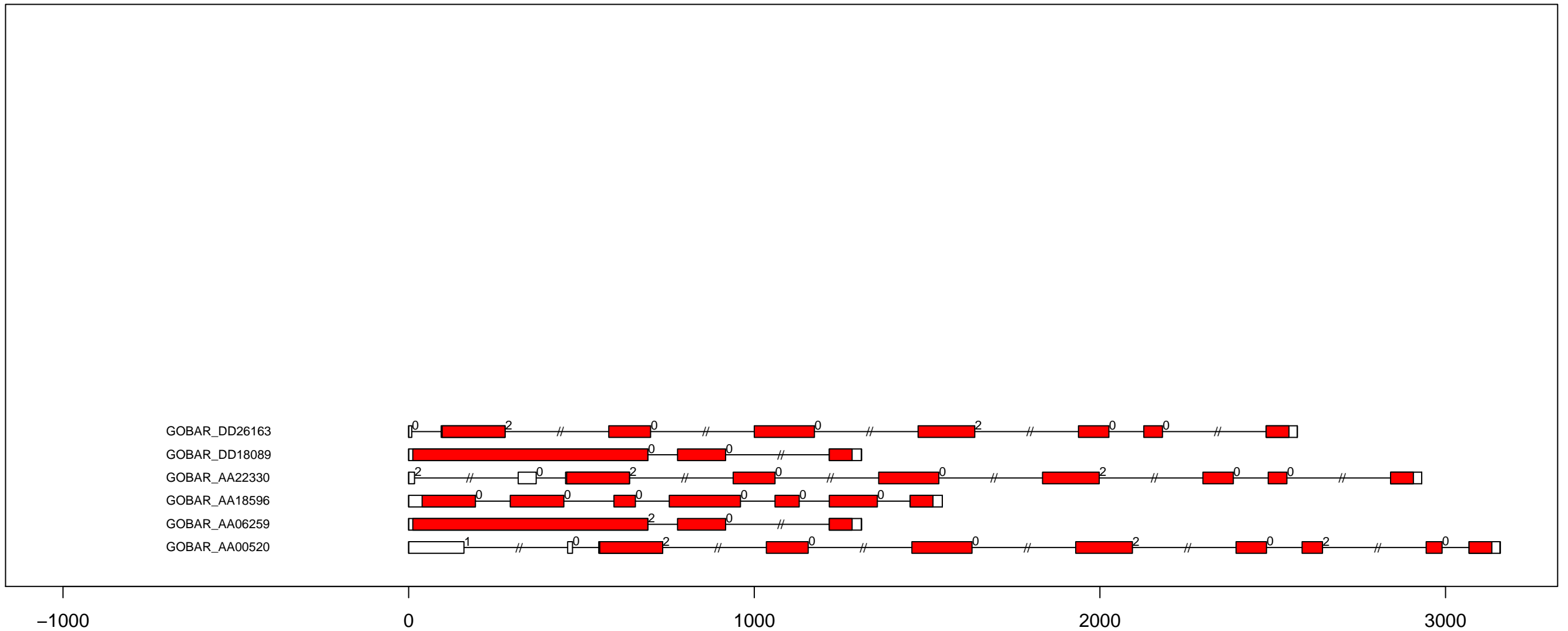

G.ba CMGC_CK2 exon-intron and domain diagram (all)

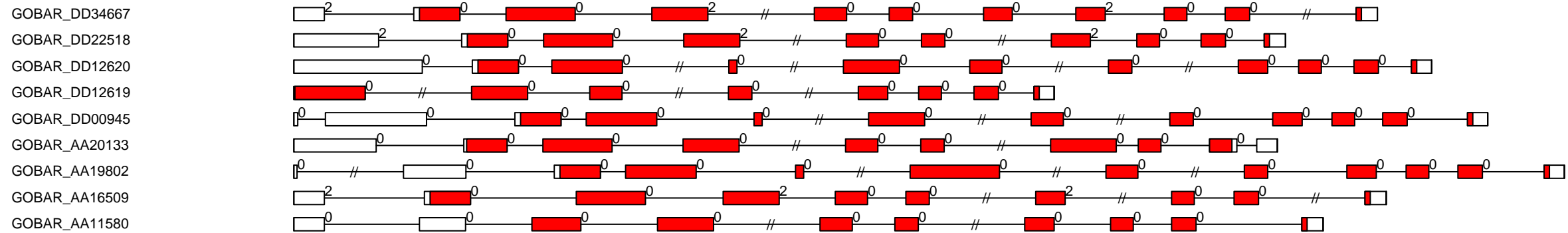

-1000

0

1000

2000

3000

G.ba CMGC_CLK exon-intron and domain diagram (all)

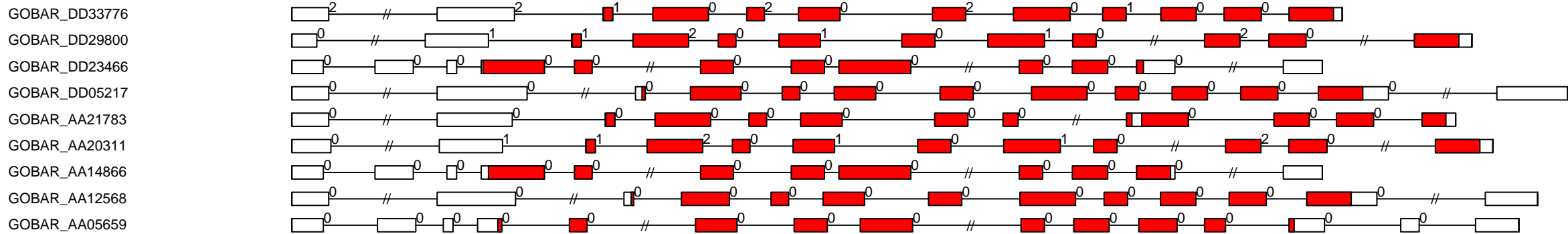

-1000

0

1000

2000

3000

G.ba CMGC_DYRK-PRP4 exon-intron and domain diagram (all)

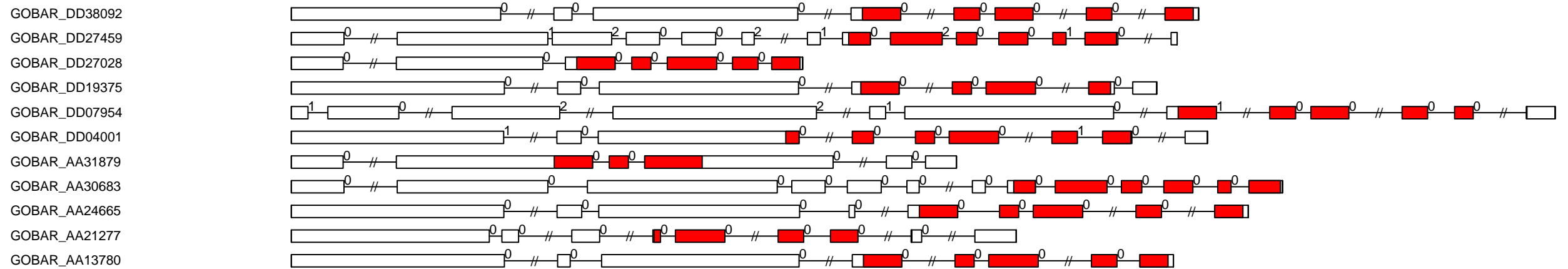

0

2000

4000

6000

G.ba CMGC_DYRK-YAK exon-intron and domain diagram (all)

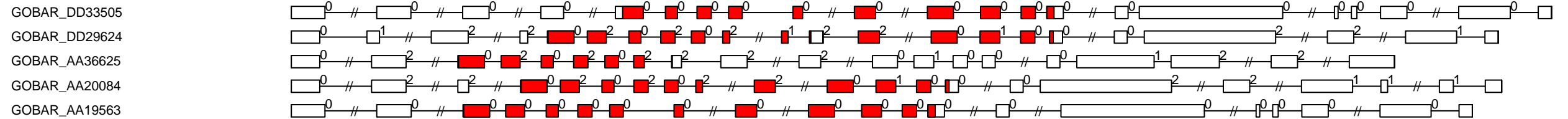

0

2000

4000

6000

G.ba CMGC_GSK exon-intron and domain diagram (all)

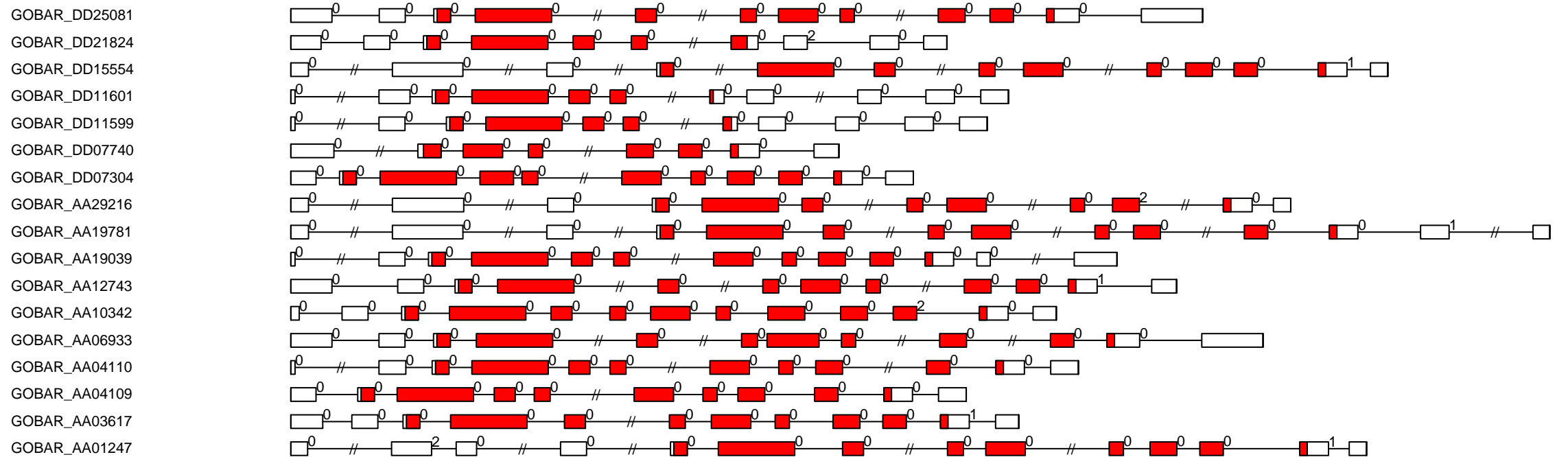

-1000

0

1000

2000

3000

4000

G.ba CMGC_MAPK exon-intron and domain diagram (part 1)

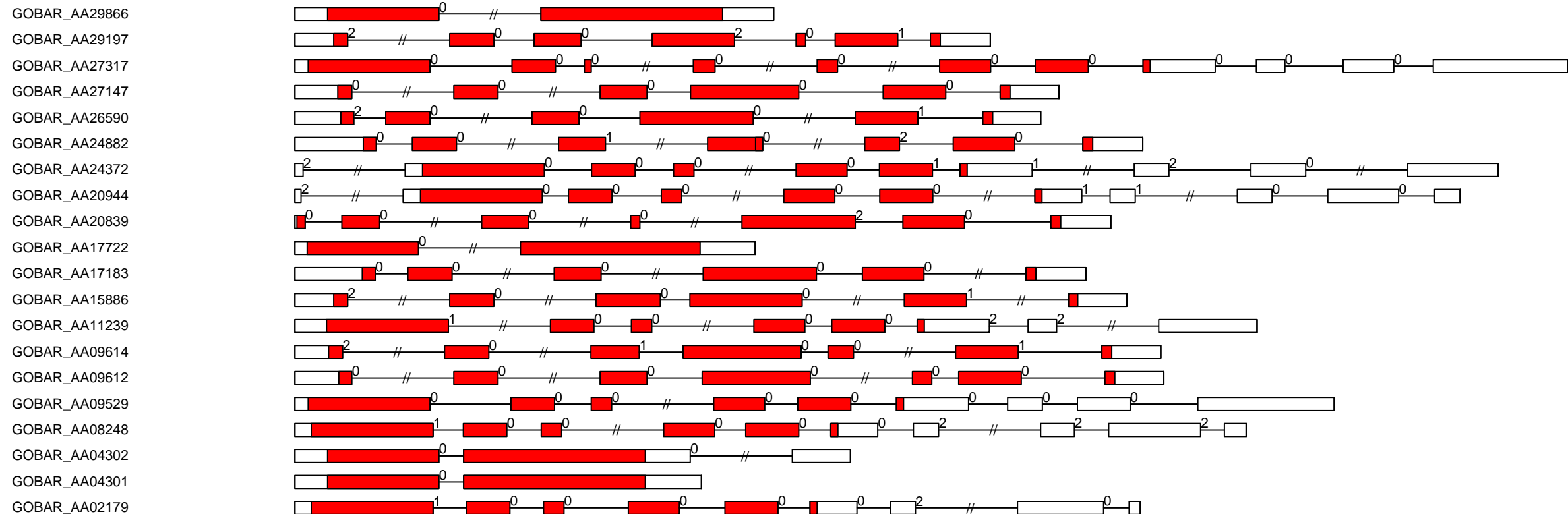

-1000

0

1000

2000

3000

G.ba CMGC_MAPK exon-intron and domain diagram (part 2)

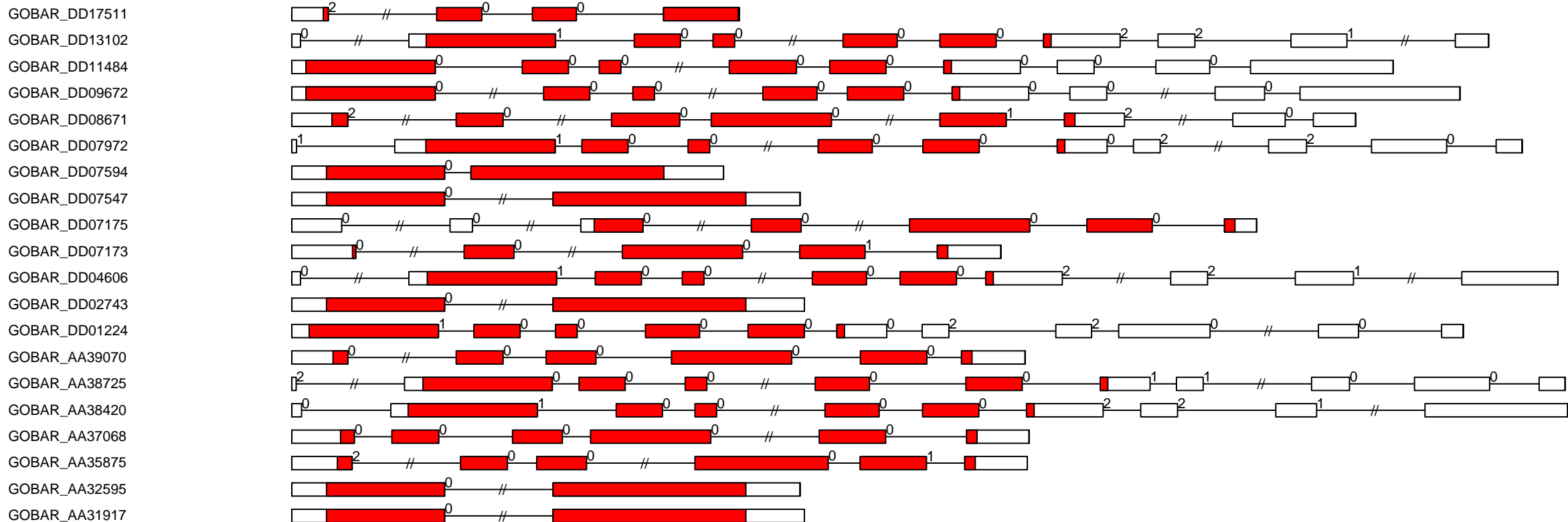

-1000

0

1000

2000

3000

G.ba CMGC_MAPK exon-intron and domain diagram (part 3)

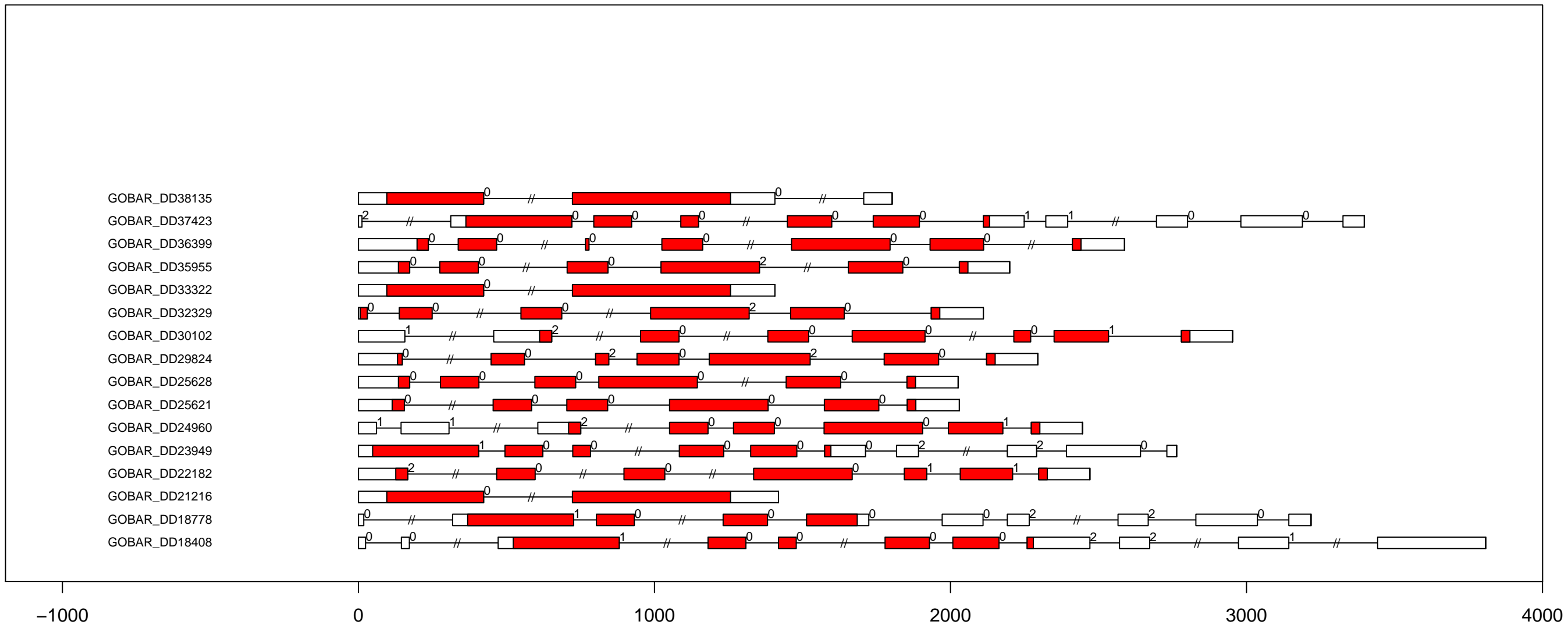

G.ba CMGC_PI-Tthe exon-intron and domain diagram (all)

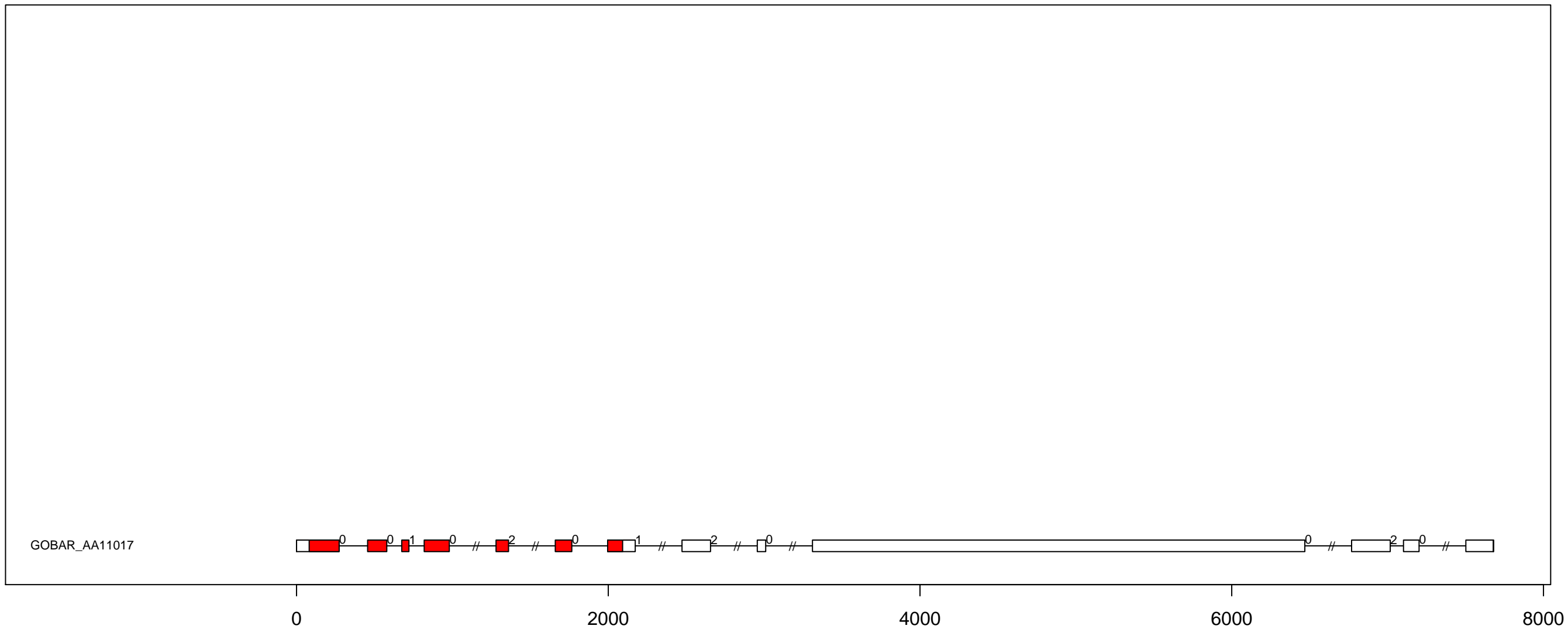

G.ba CMGC_RCK exon-intron and domain diagram (all)

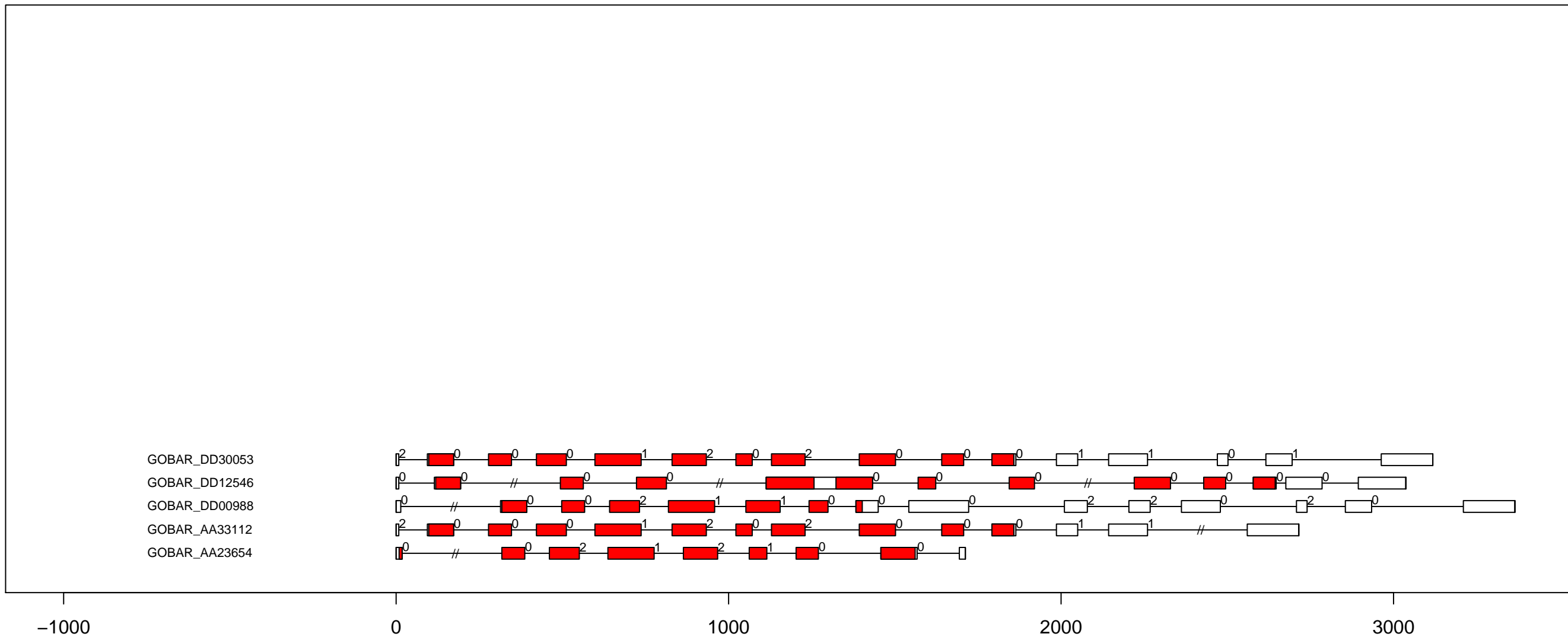

G.ba CMGC_SRPK exon-intron and domain diagram (all)

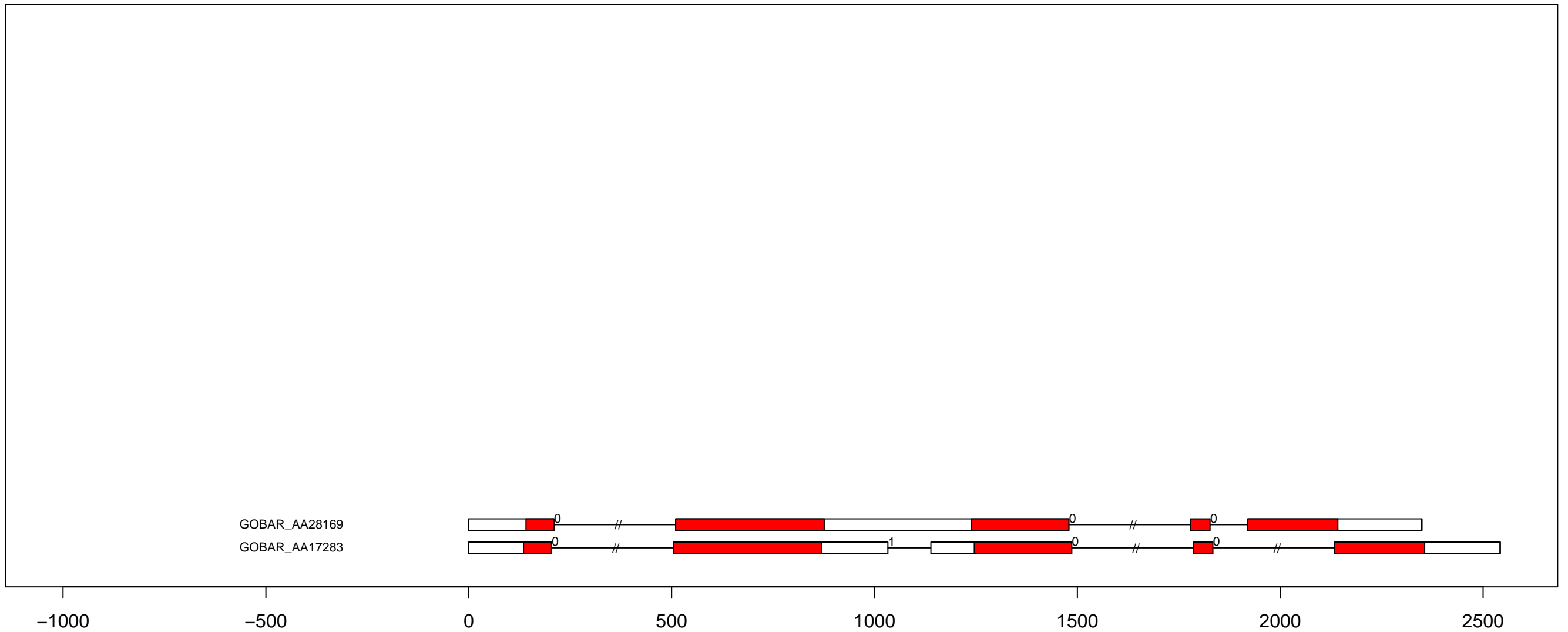

G.ba Group-PI-2 exon-intron and domain diagram (all)

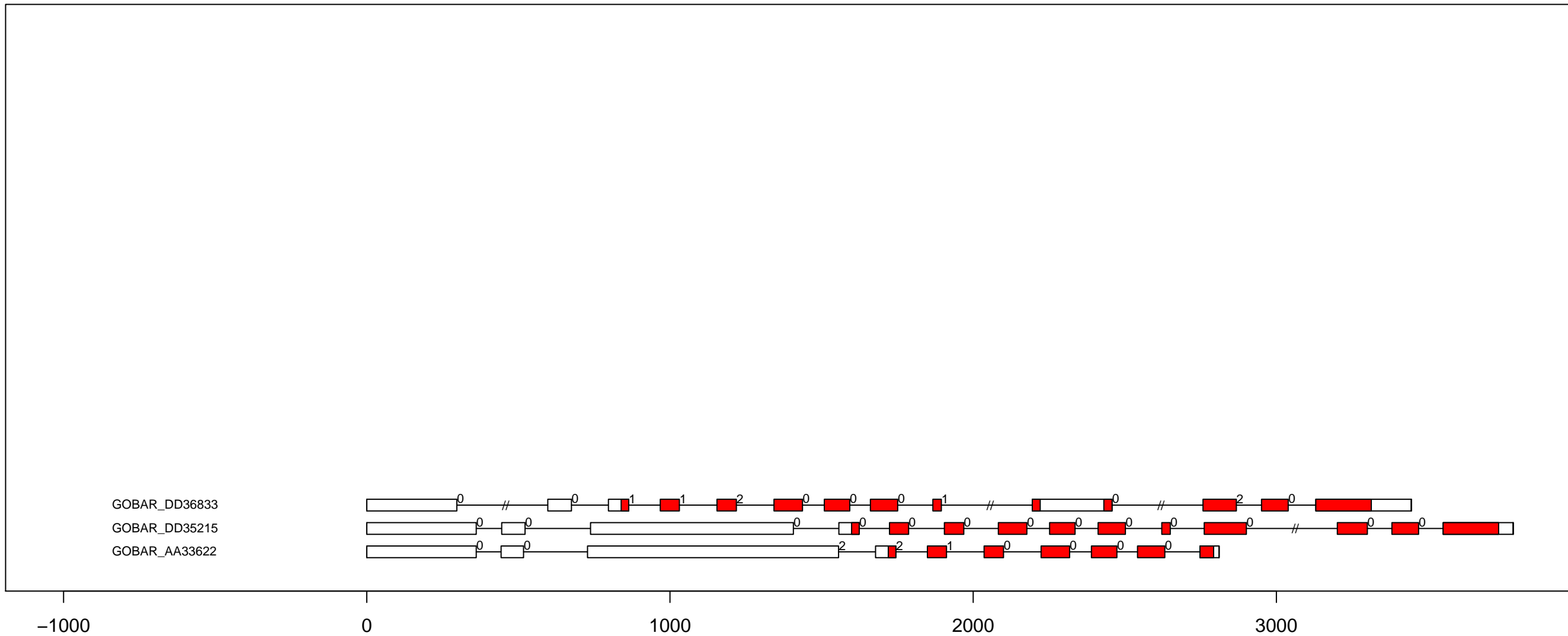

G.ba Group-PI-3 exon-intron and domain diagram (all)

GOBAR_DD18657
GOBAR_DD03531
GOBAR_DD02687
GOBAR_AA33276
GOBAR_AA27656
GOBAR_AA23893

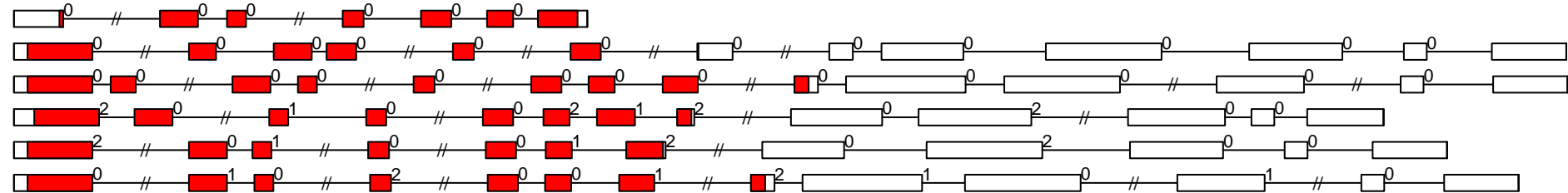

-1000

0

1000

2000

3000

4000

5000

G.ba IRE1 exon-intron and domain diagram (all)

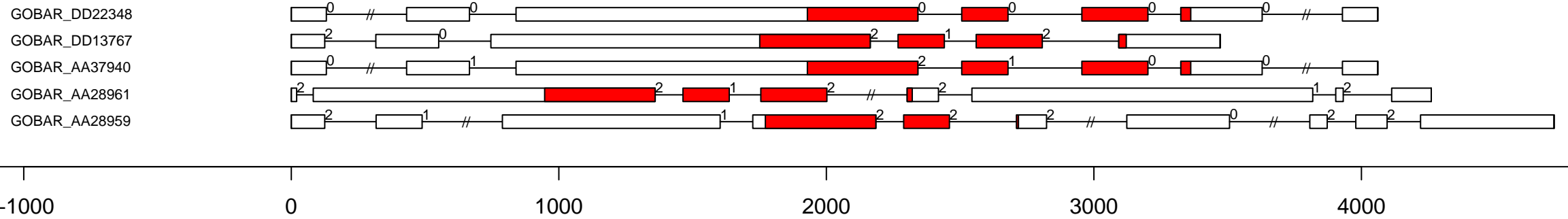

G.ba NAK exon-intron and domain diagram (all)

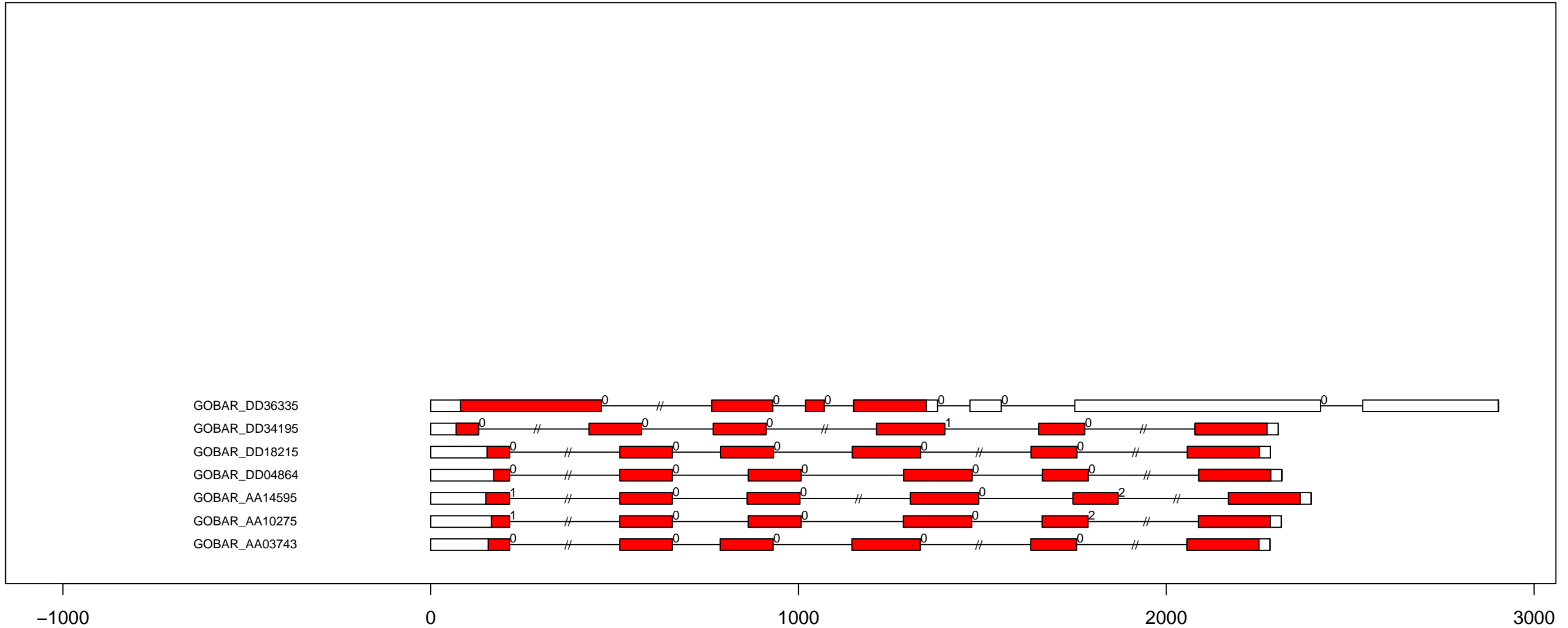

G.ba NEK exon-intron and domain diagram (all)

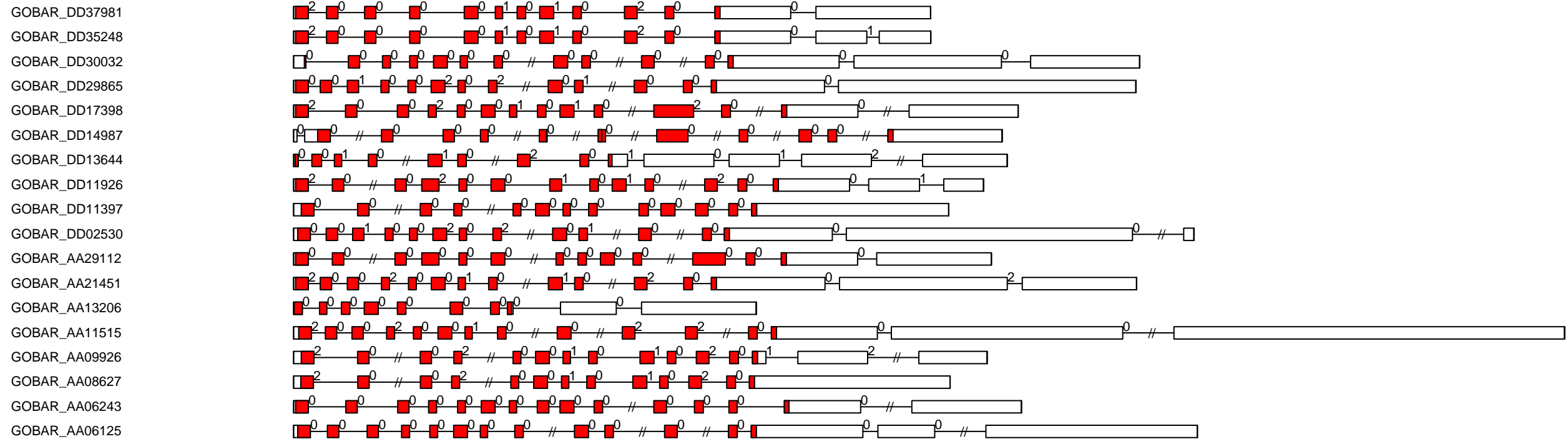

G.ba PEK_GCN2 exon-intron and domain diagram (all)

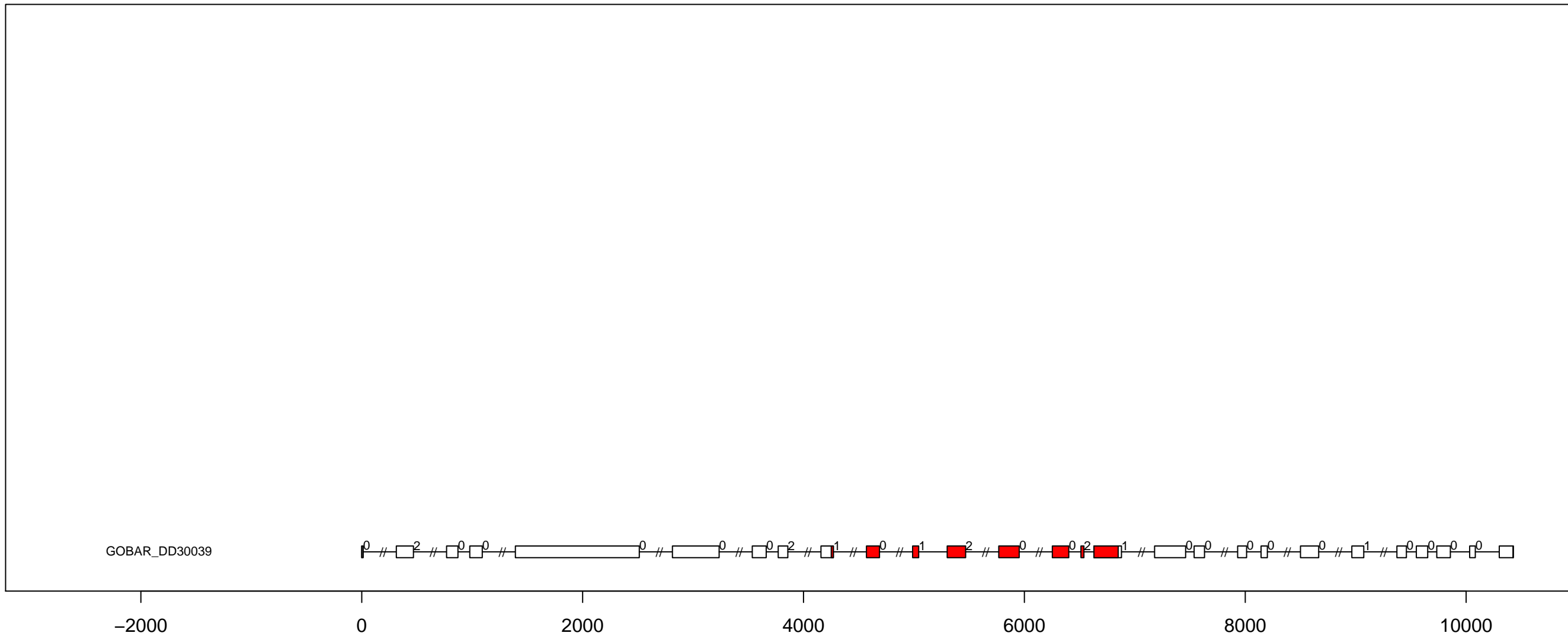

G.ba PEK_PEK exon-intron and domain diagram (all)

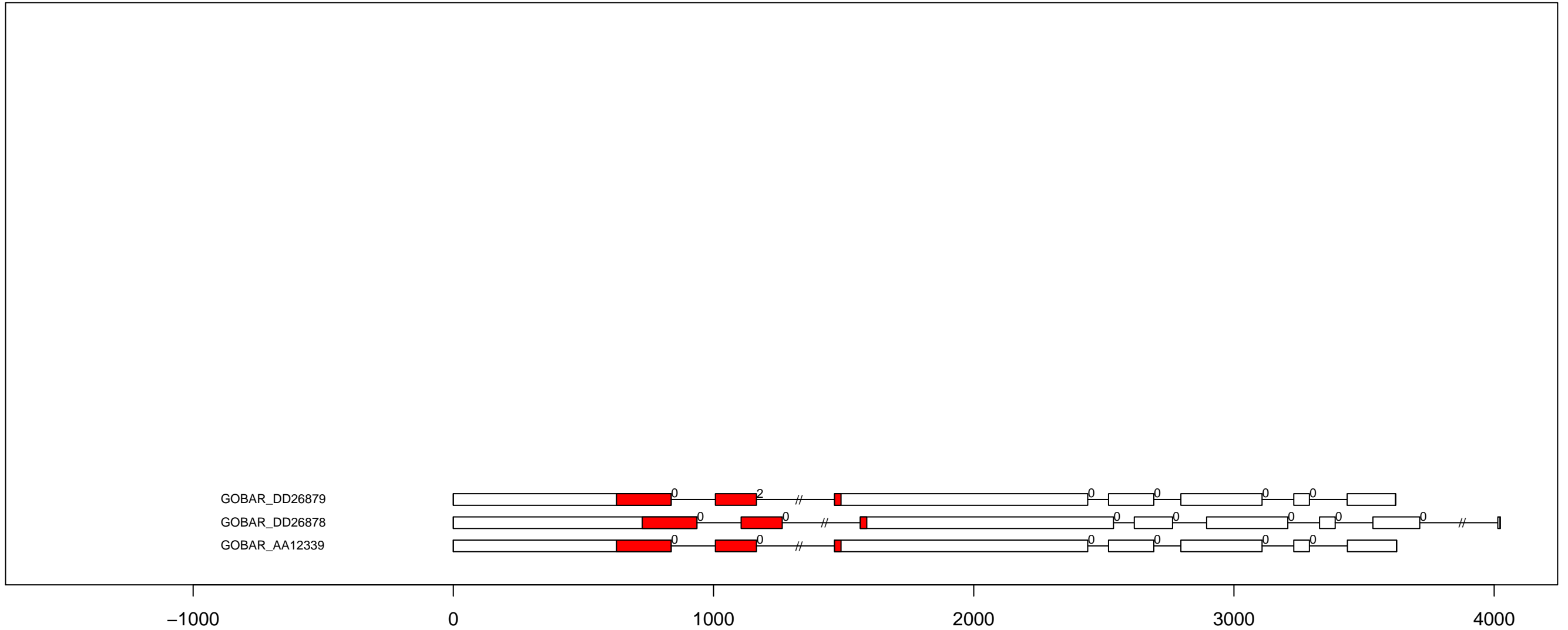

G.ba RLK-Pelle_C-LEC exon-intron and domain diagram (all)

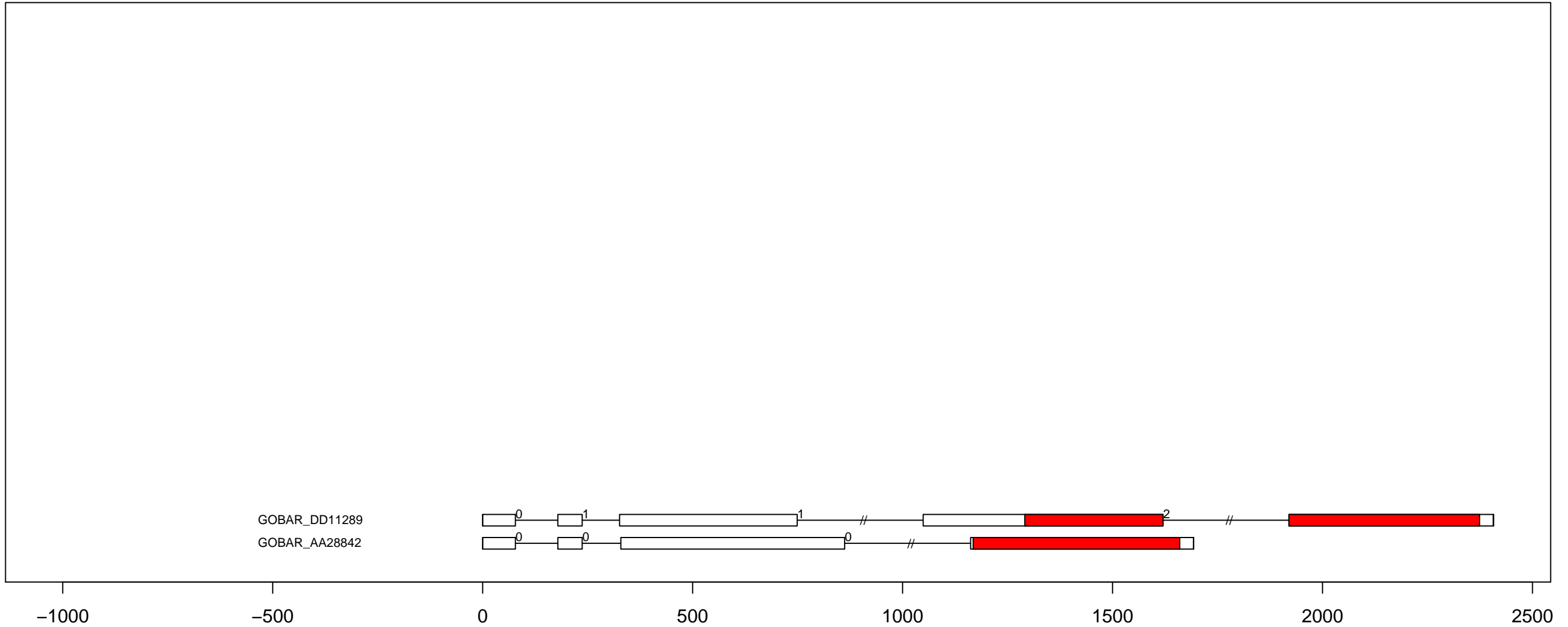

G.ba RLK-Pelle_CR4L exon-intron and domain diagram (part 1)

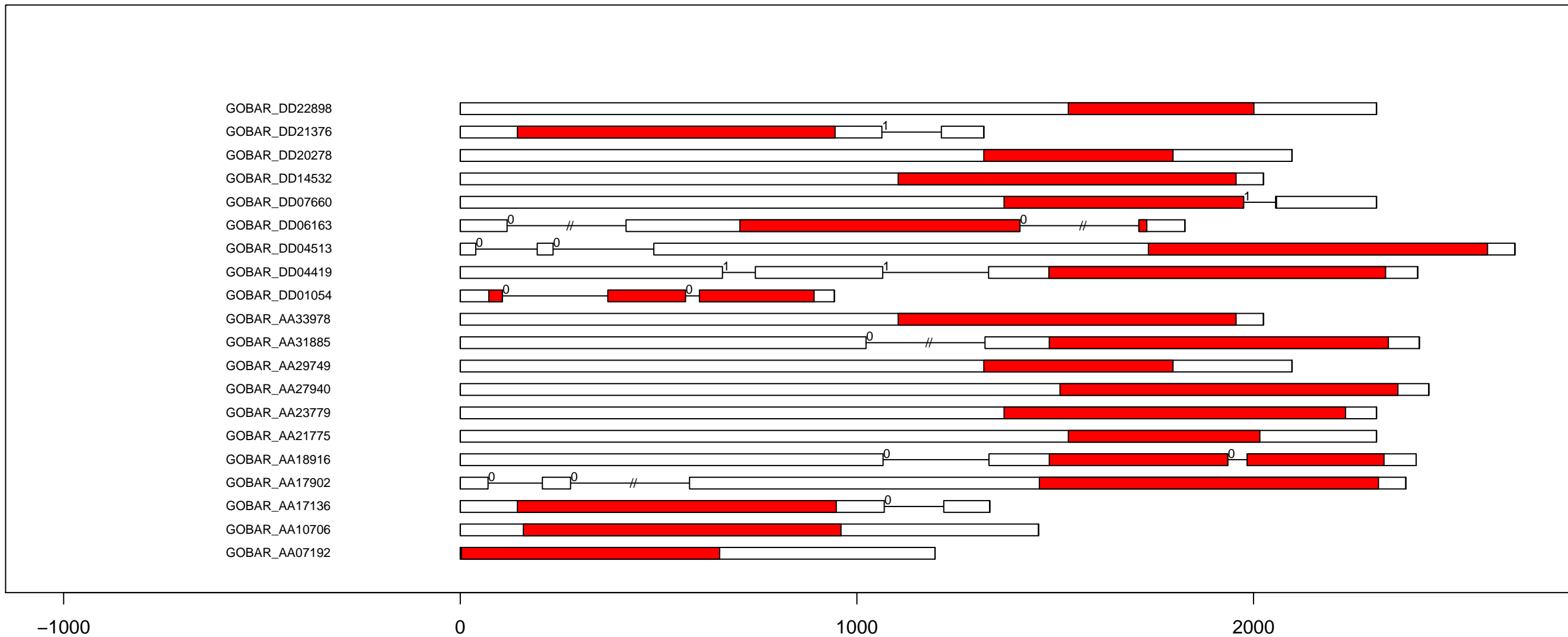

G.ba RLK-Pelle_CR4L exon-intron and domain diagram (part 2)

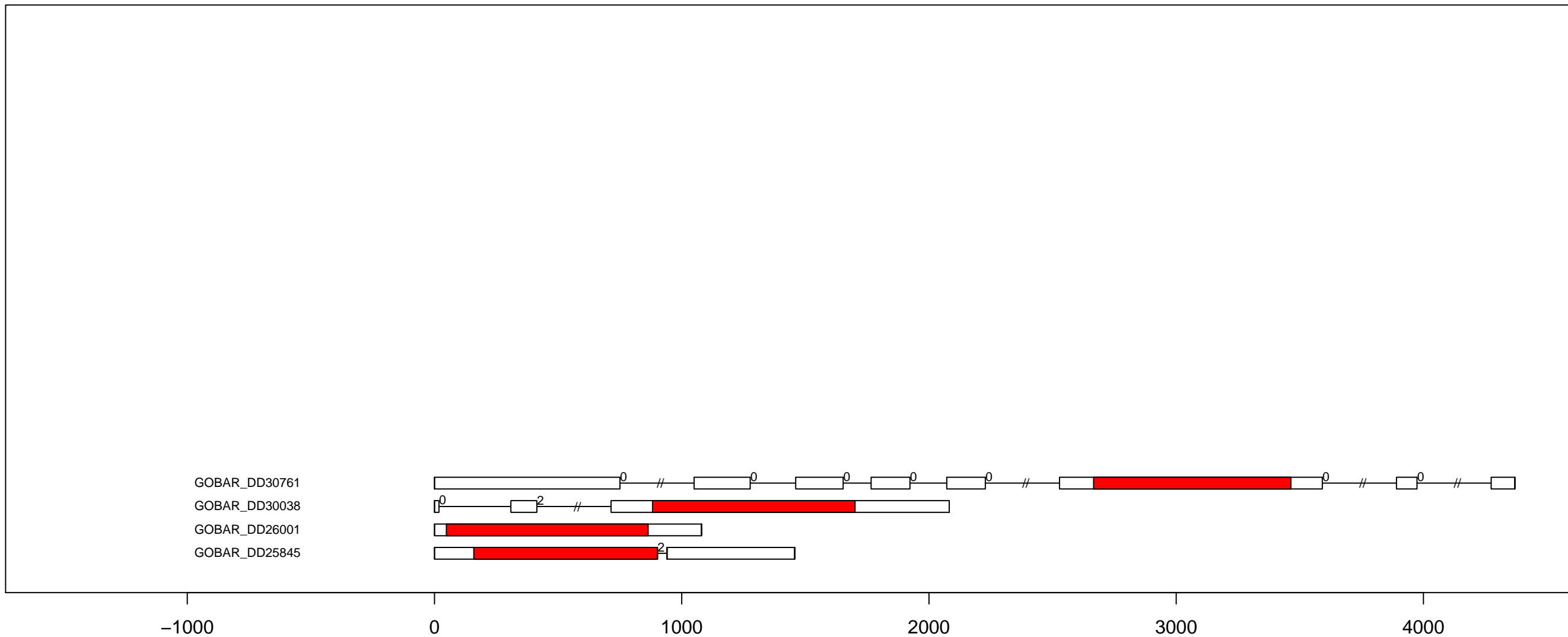

G.ba RLK-Pelle_CrRLK1L-1 exon-intron and domain diagram (part 1)

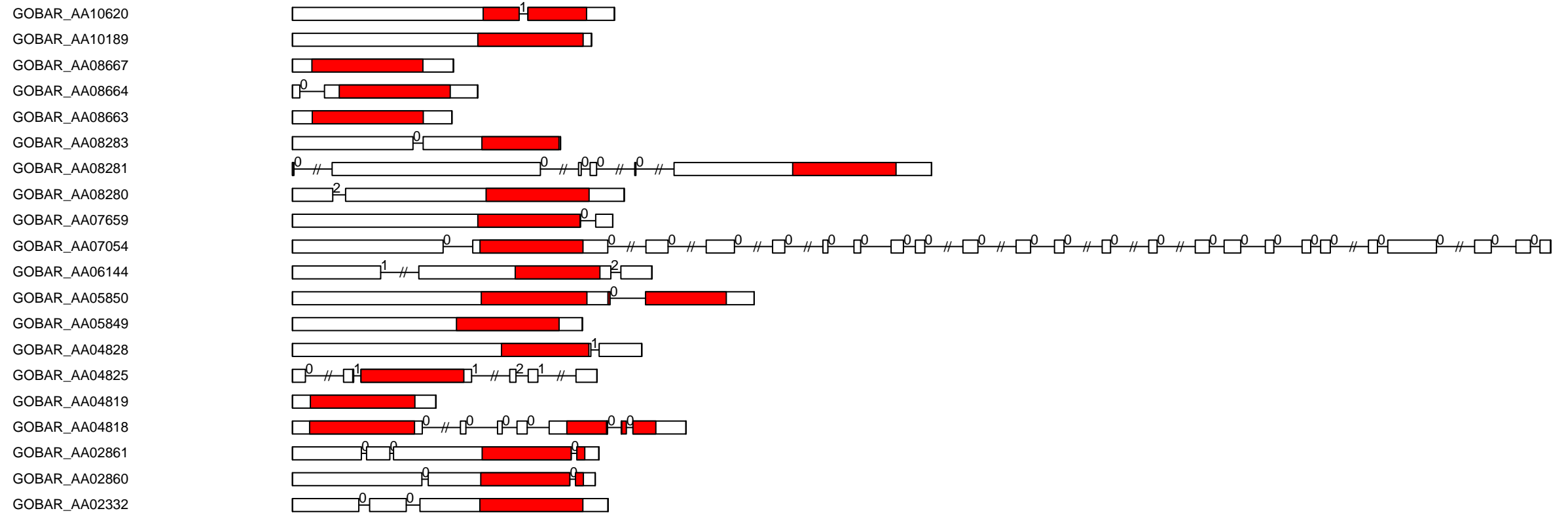

G.ba RLK-Pelle_CrRLK1L-1 exon-intron and domain diagram (part 3)

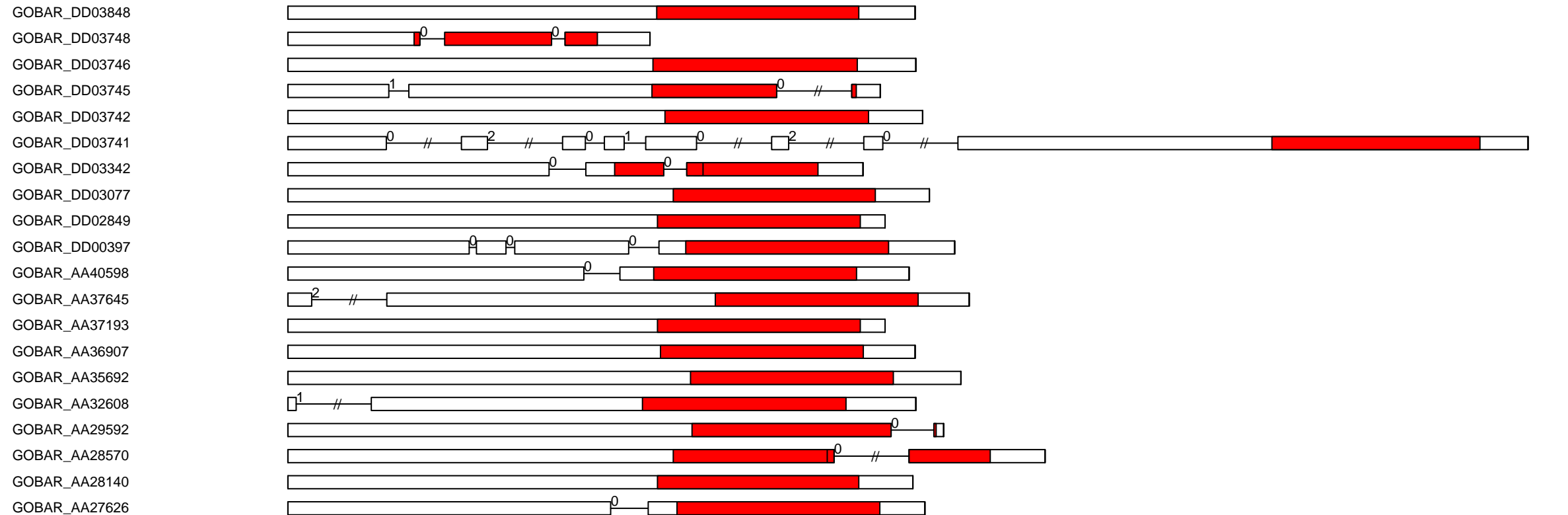

G.ba RLK-Pelle_CrRLK1L-1 exon-intron and domain diagram (part 4)

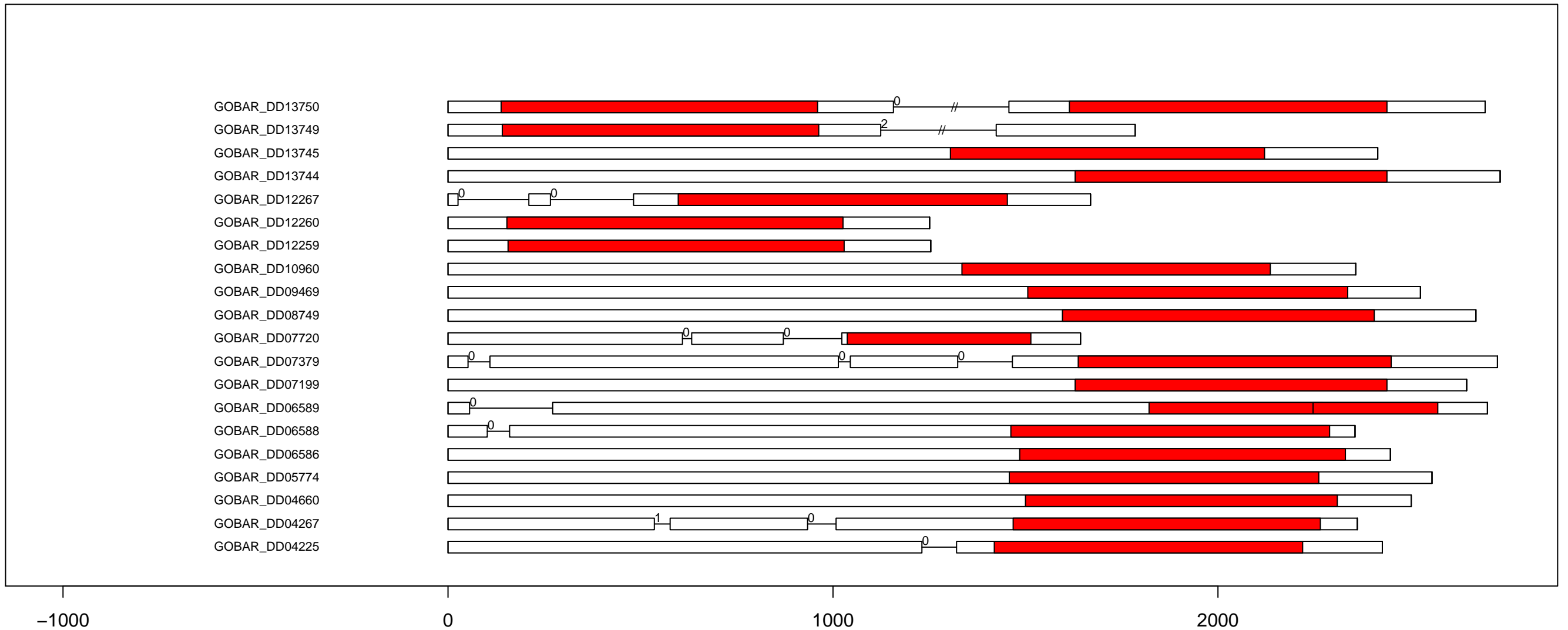

G.ba RLK-Pelle_CrRLK1L-1 exon-intron and domain diagram (part 5)

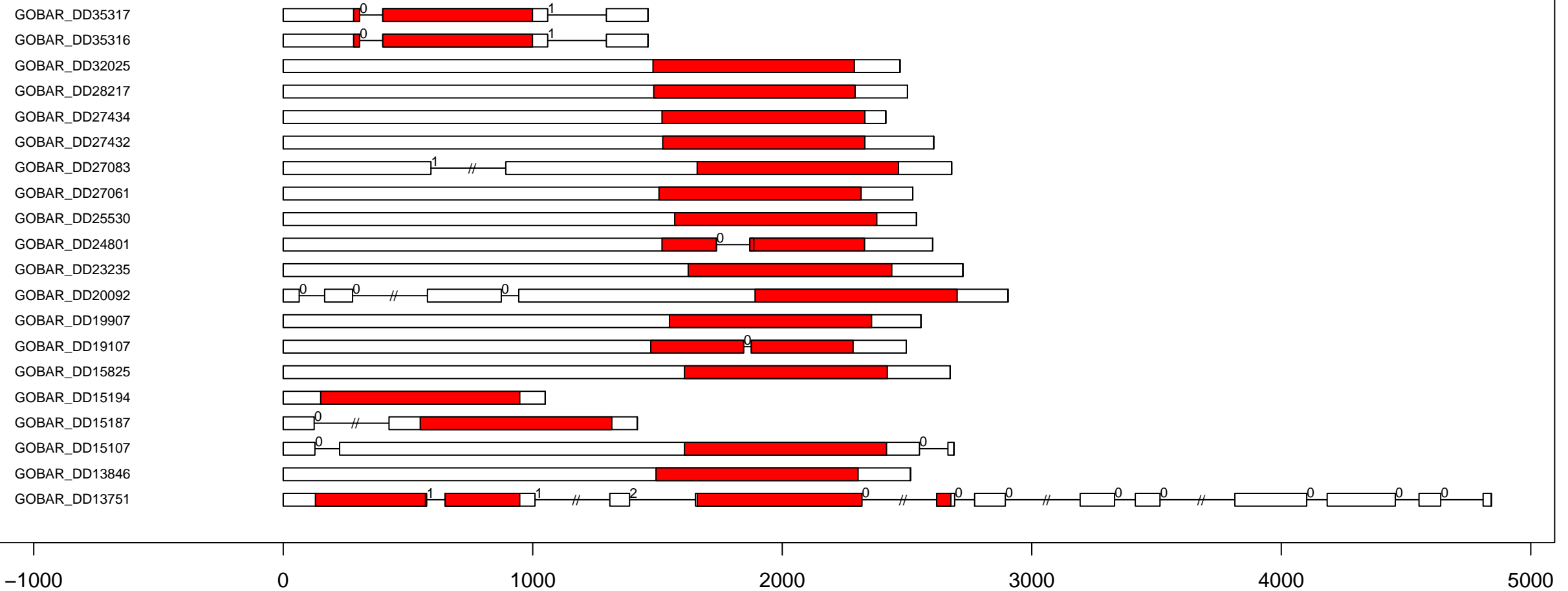

G.ba RLK-Pelle_CrRLK1L-1 exon-intron and domain diagram (part 6)

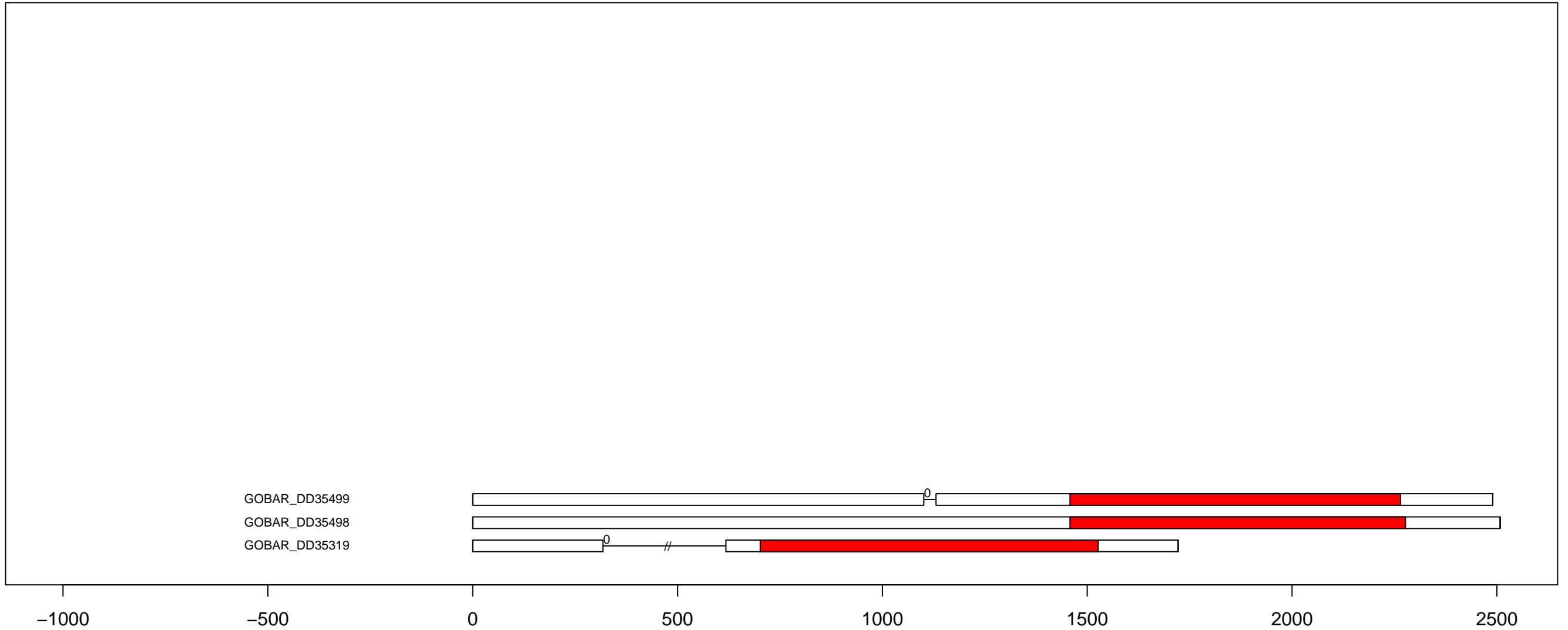

G.ba RLK-Pelle_DLSV exon-intron and domain diagram (part 1)

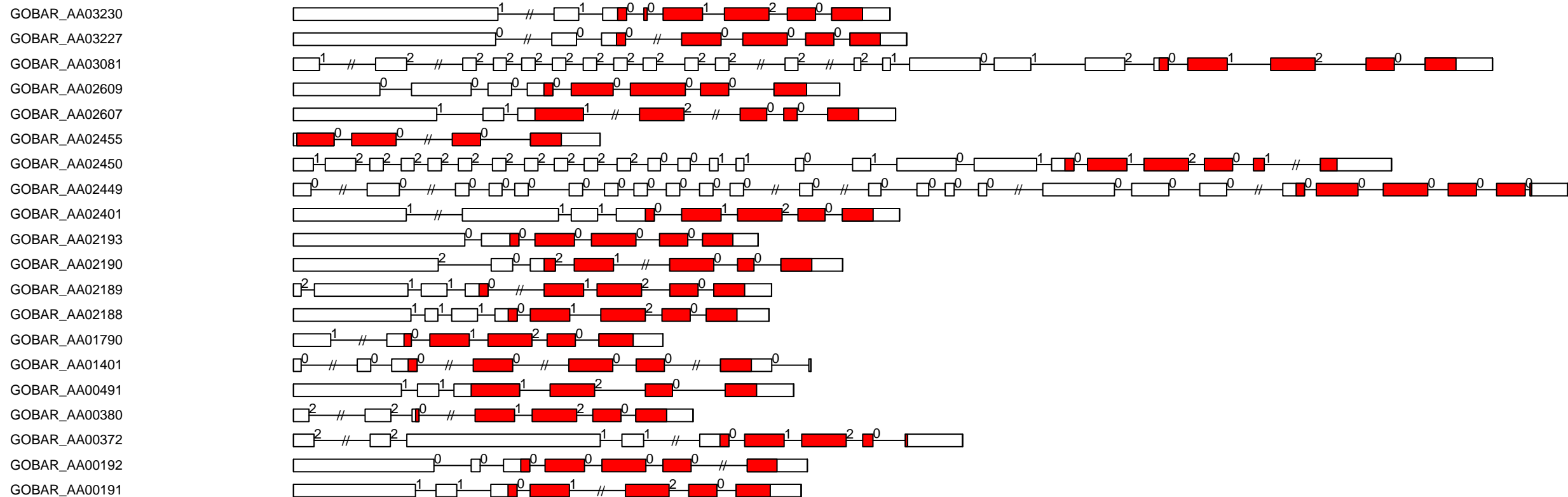

G.ba RLK-Pelle_DLSV exon-intron and domain diagram (part 2)

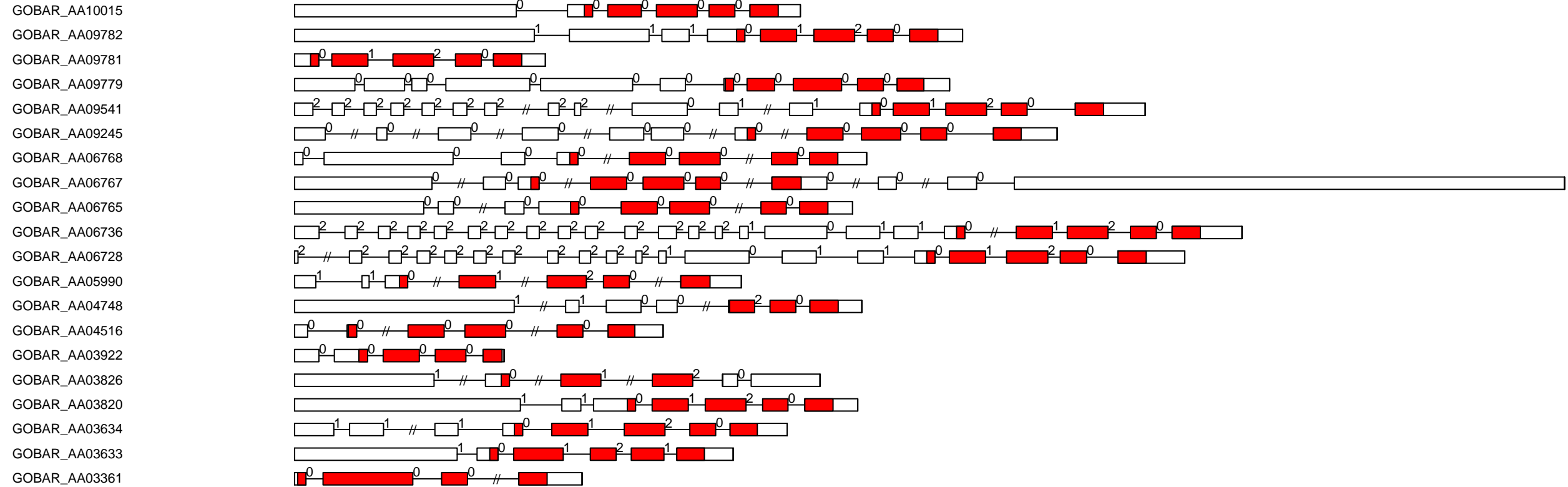

G.ba RLK-Pelle_DLSV exon-intron and domain diagram (part 4)

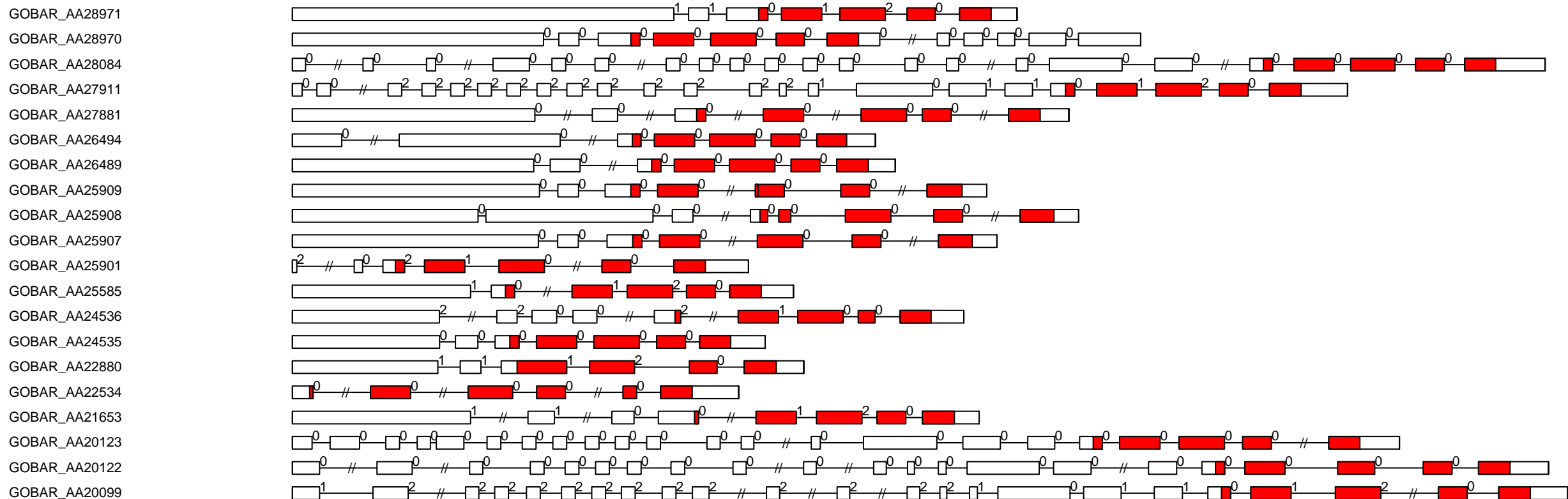

G.ba RLK-Pelle_DLSV exon-intron and domain diagram (part 5)

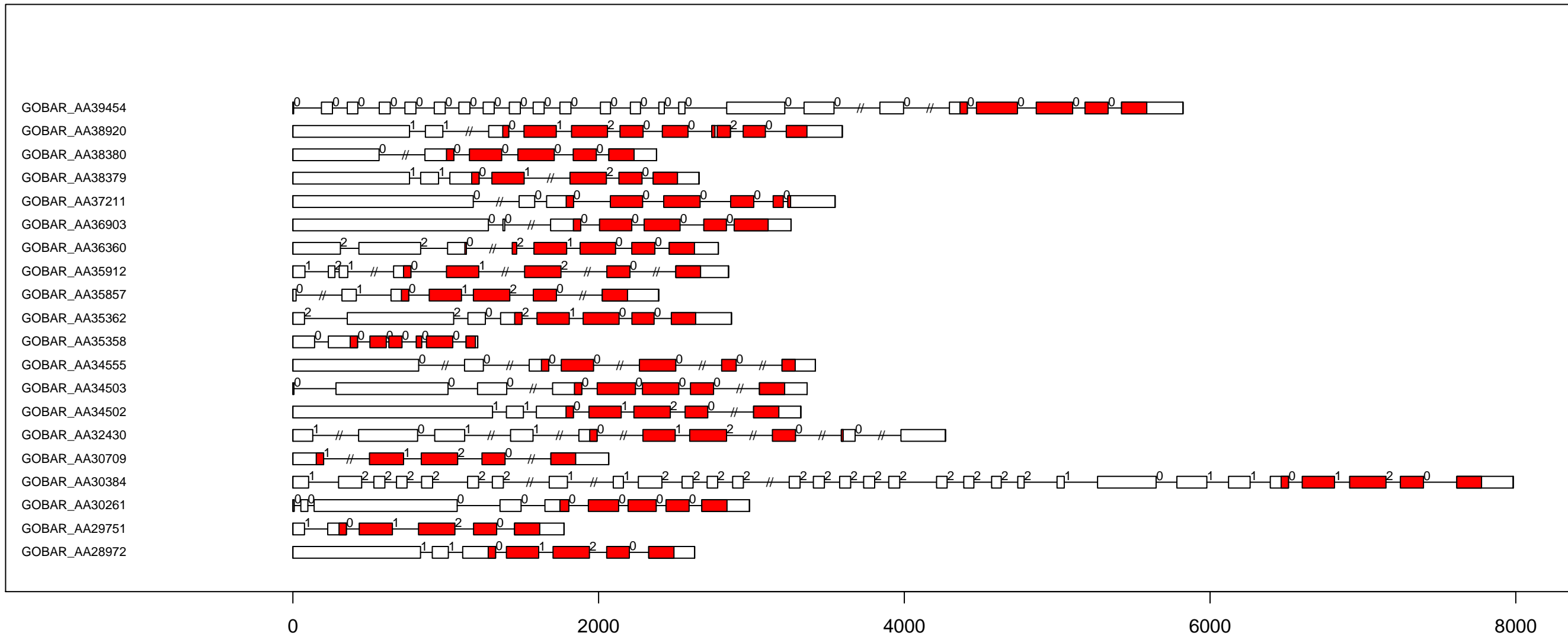

G.ba RLK-Pelle_DLSV exon-intron and domain diagram (part 6)

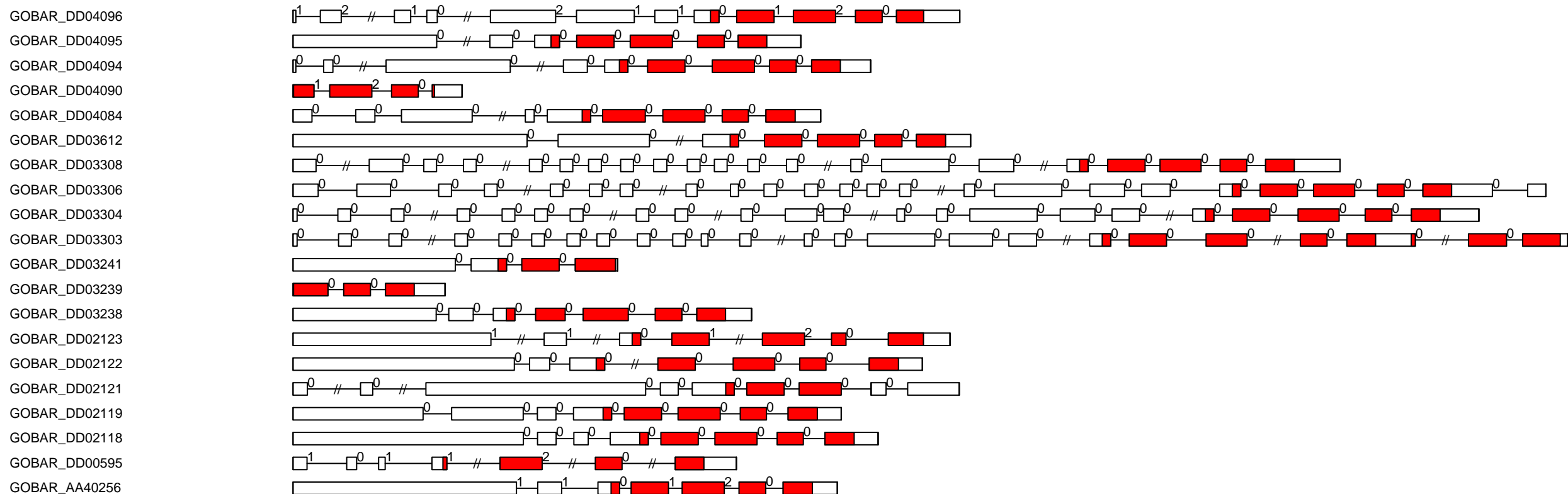

0

2000

4000

6000

G.ba RLK-Pelle_DLSV exon-intron and domain diagram (part 7)

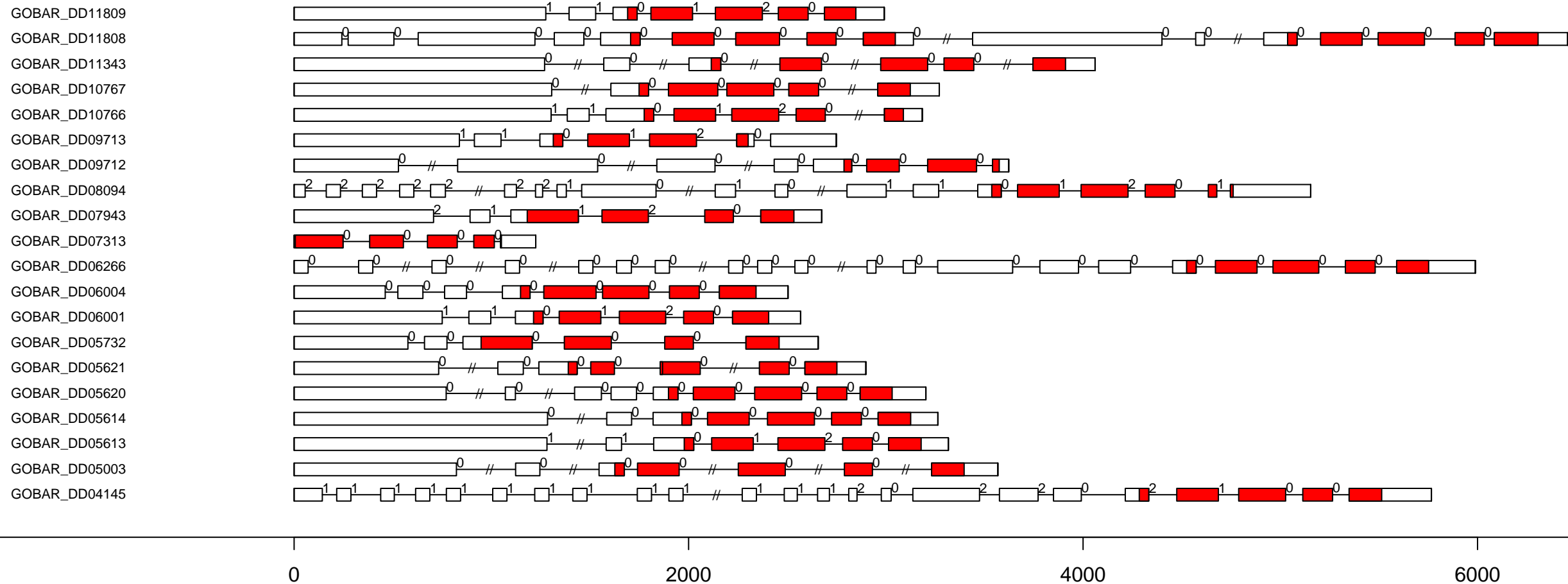

G.ba RLK-Pelle_DLSV exon-intron and domain diagram (part 8)

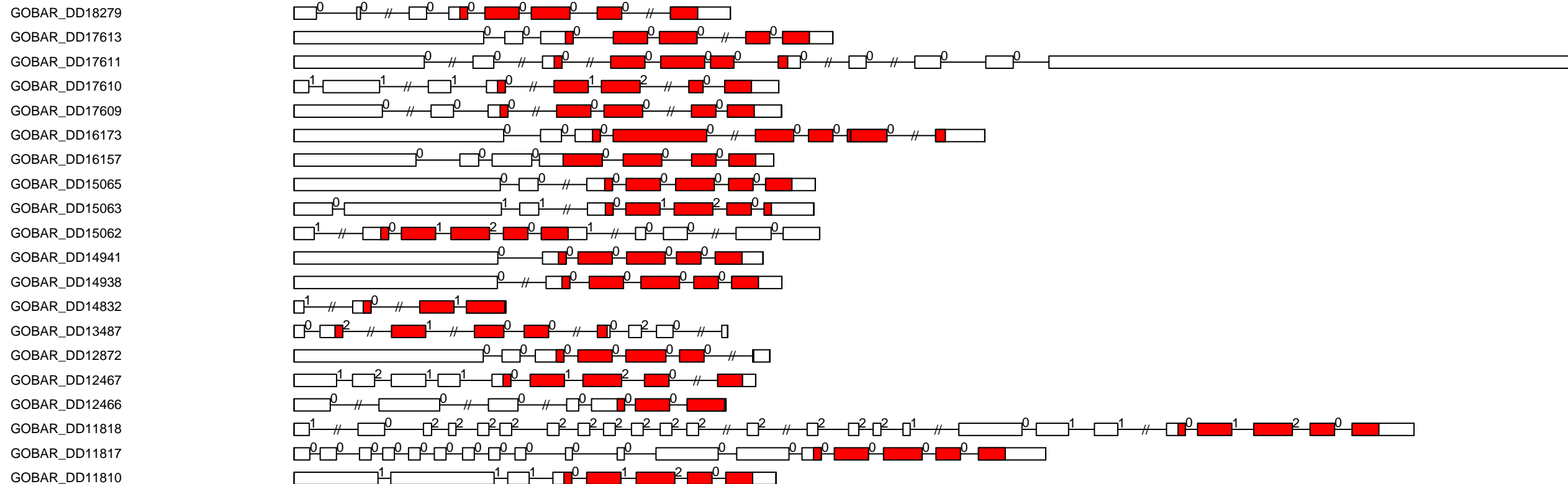

G.ba RLK-Pelle_DLSV exon-intron and domain diagram (part 9)

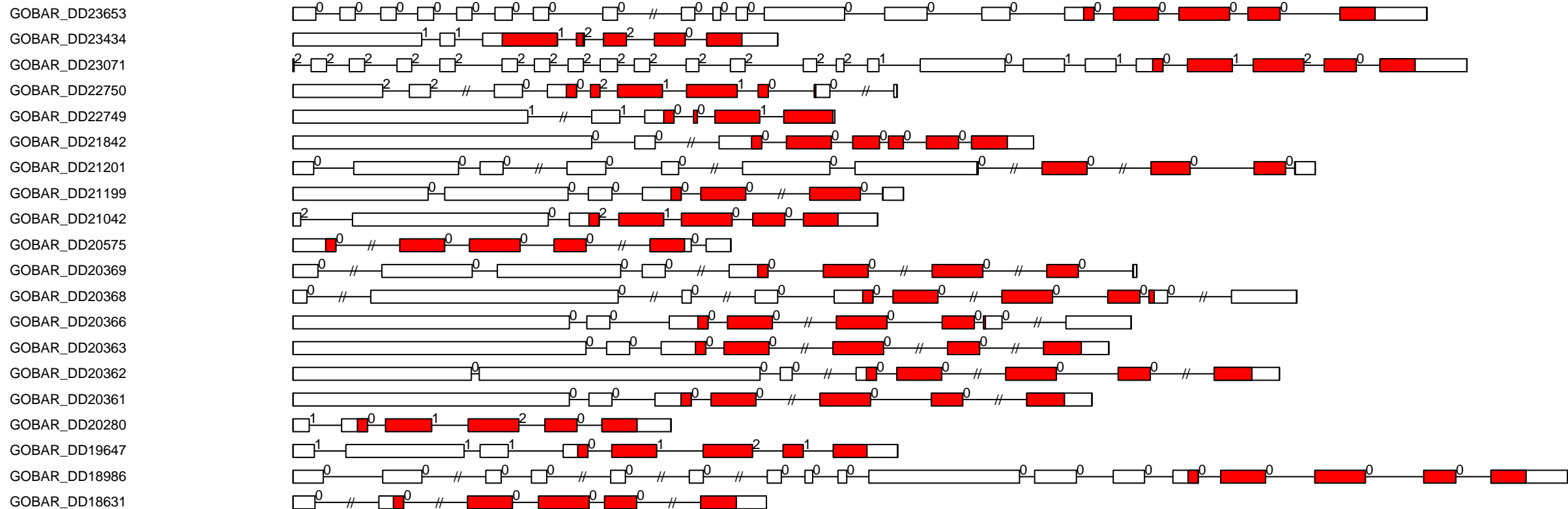

G.ba RLK-Pelle_DLSV exon-intron and domain diagram (part 10)

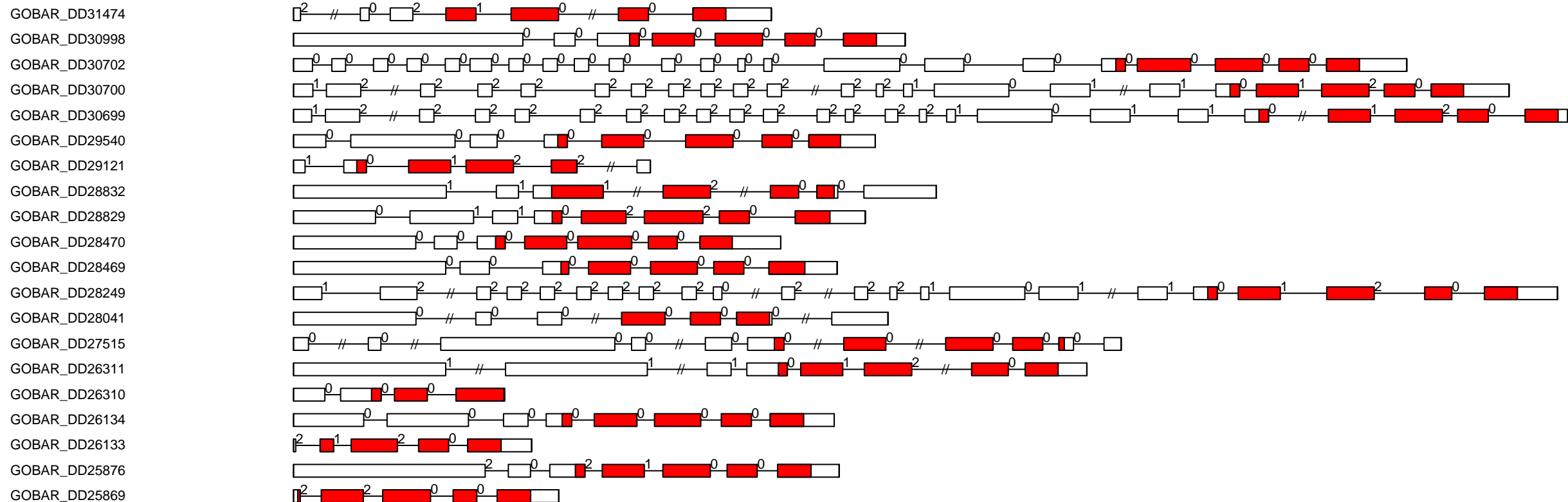

0

2000

4000

6000

G.ba RLK-Pelle_DLSV exon-intron and domain diagram (part 11)

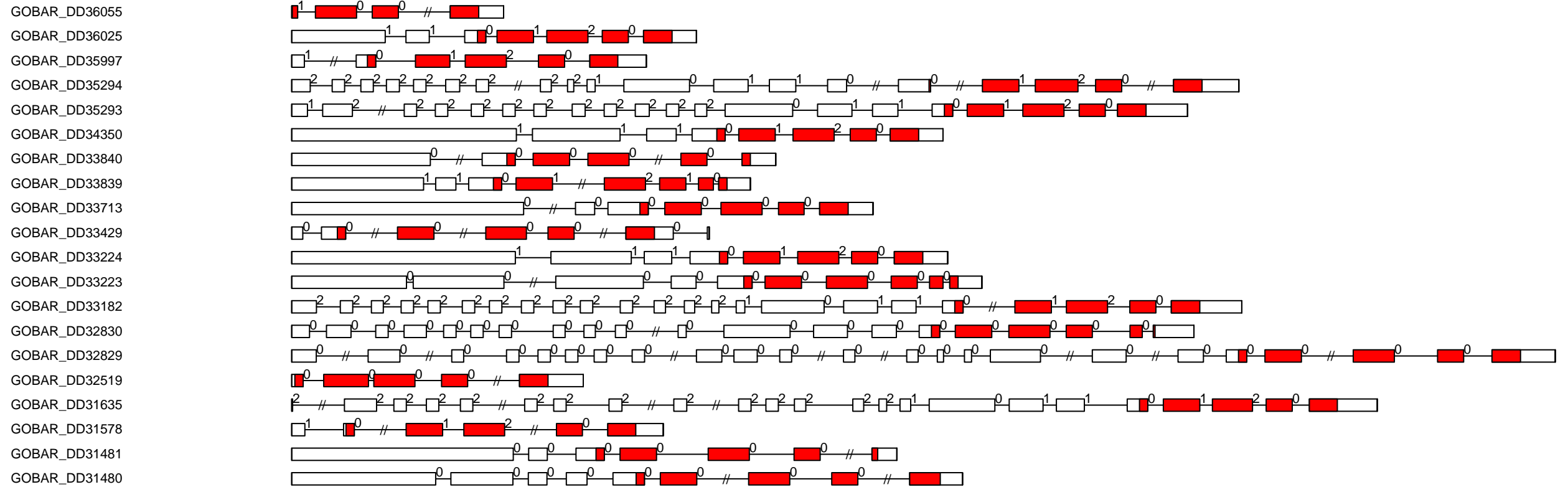

G.ba RLK-Pelle_DLSV exon-intron and domain diagram (part 12)

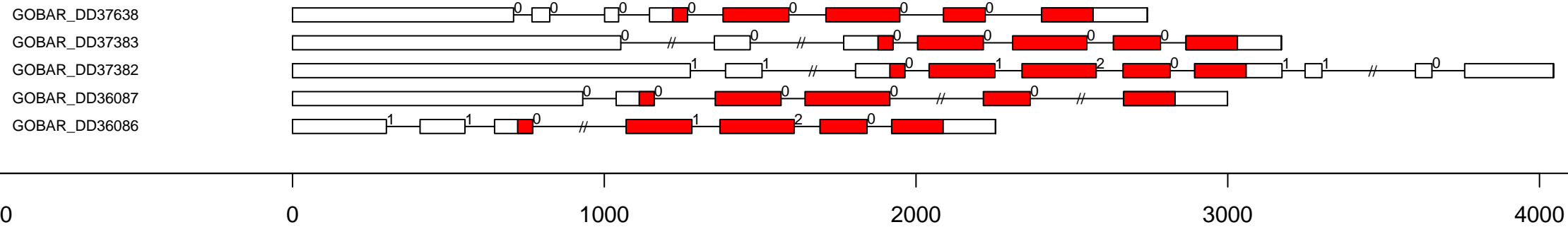

G.ba RLK-Pelle_Extensin exon-intron and domain diagram (all)

GOBAR_DD27466
 GOBAR_DD17762
 GOBAR_DD16581
 GOBAR_DD10255
 GOBAR_DD04944
 GOBAR_DD02976
 GOBAR_AA33194
 GOBAR_AA27774
 GOBAR_AA09955
 GOBAR_AA09158
 GOBAR_AA05611
 GOBAR_AA05049

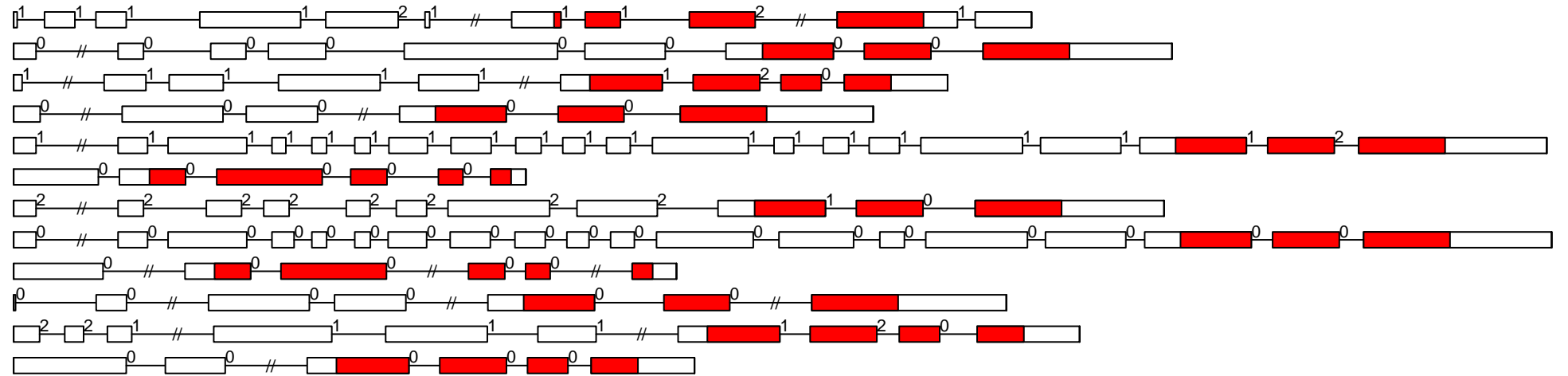

G.ba RLK-Pelle_L-LEC exon-intron and domain diagram (part 1)

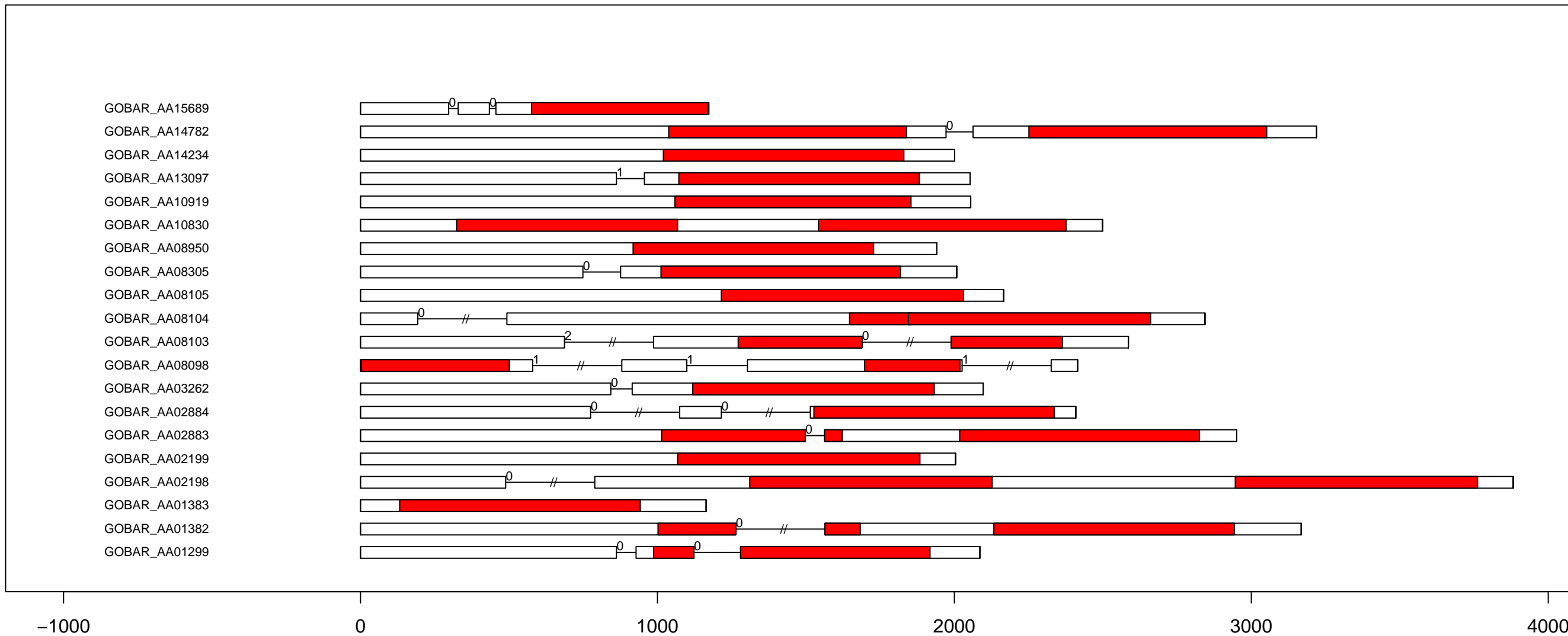

G.ba RLK-Pelle_L-LEC exon-intron and domain diagram (part 2)

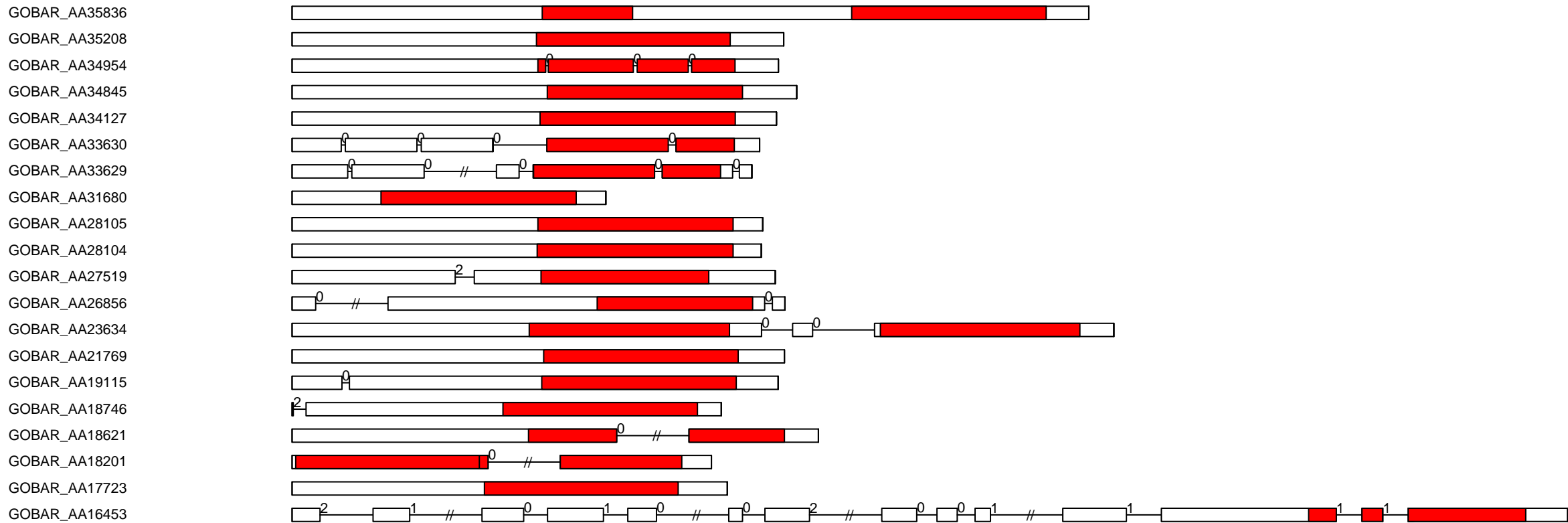

G.ba RLK-Pelle_L-LEC exon-intron and domain diagram (part 3)

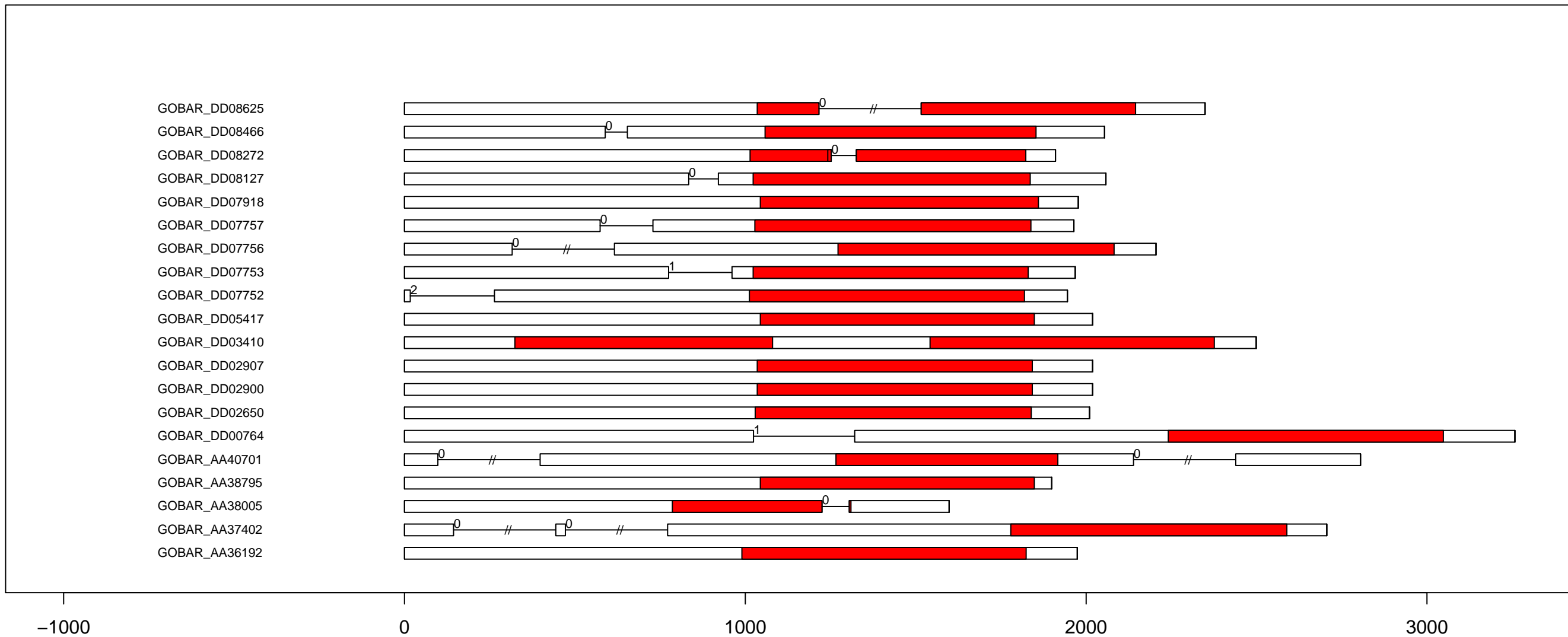

G.ba RLK-Pelle_L-LEC exon-intron and domain diagram (part 4)

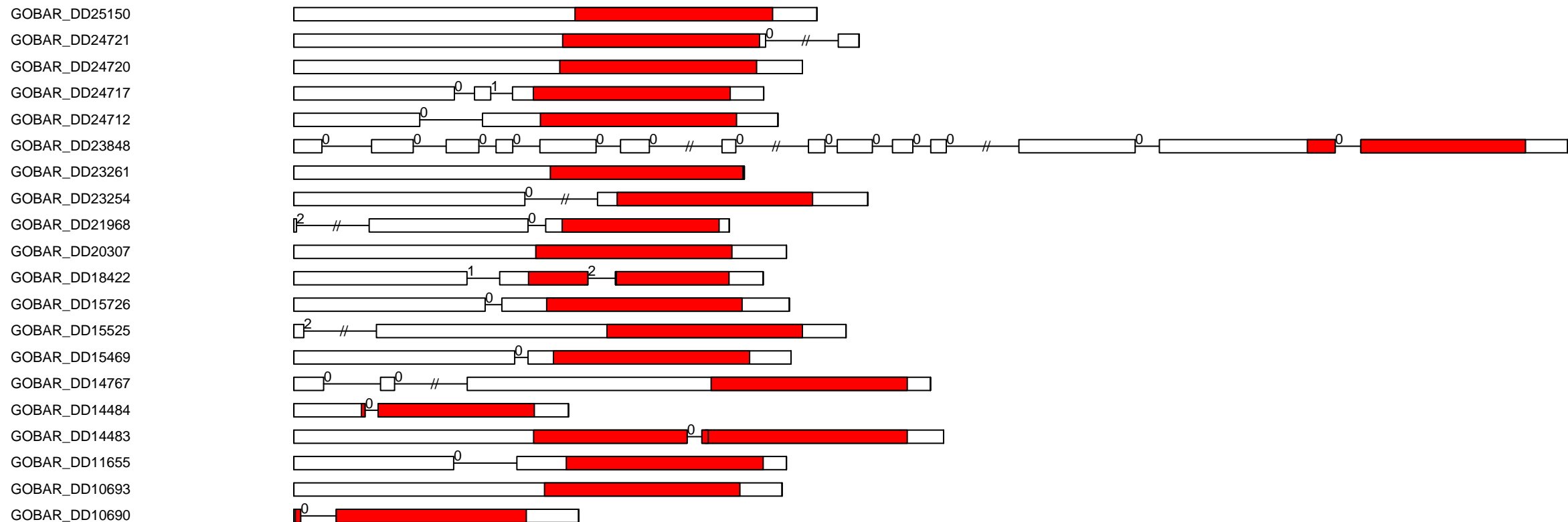

G.ba RLK-Pelle_L-LEC exon-intron and domain diagram (part 5)

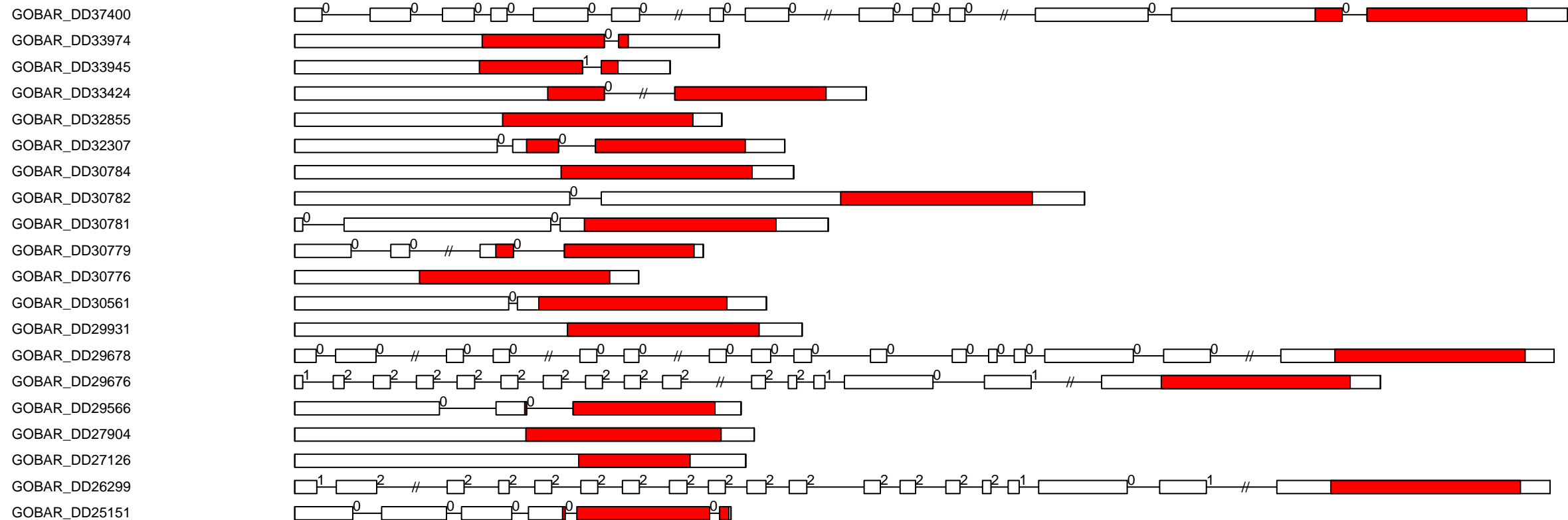

G.ba RLK-Pelle_L-LEC exon-intron and domain diagram (part 6)

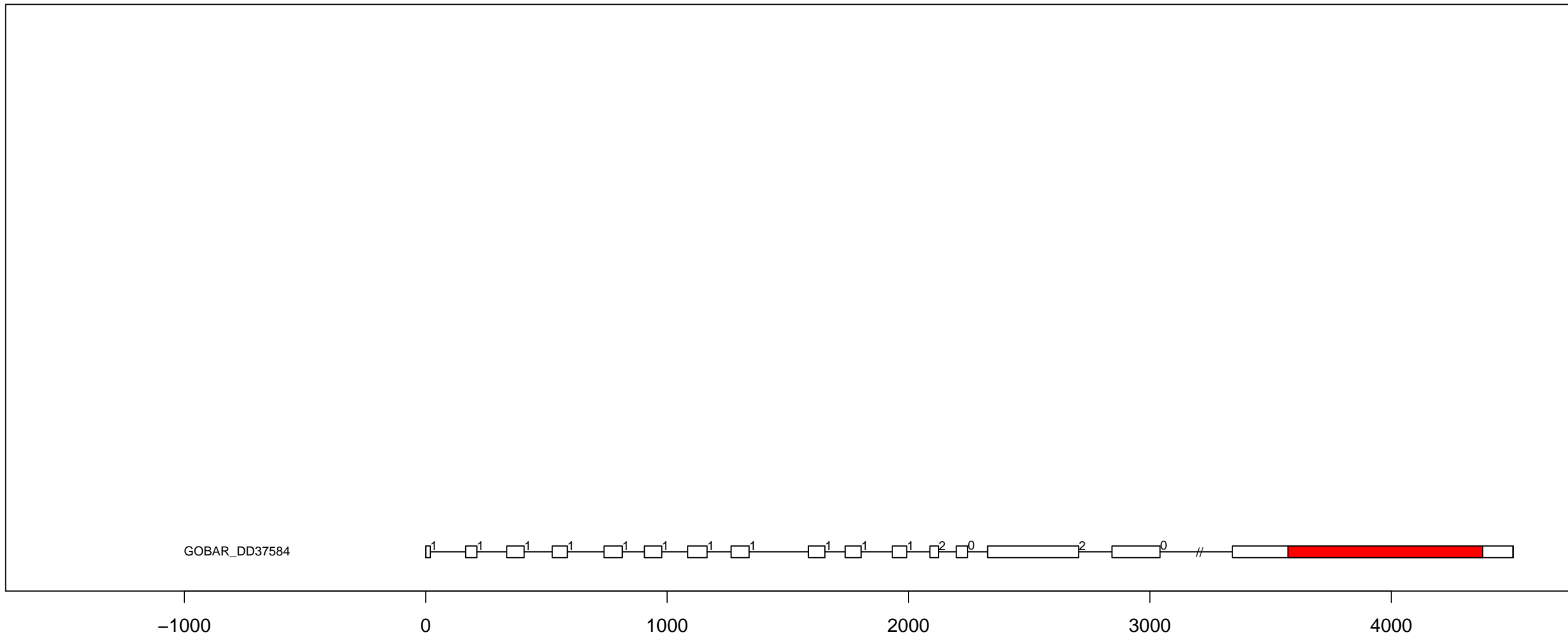

G.ba RLK-Pelle_LRK10L-2 exon-intron and domain diagram (part 1)

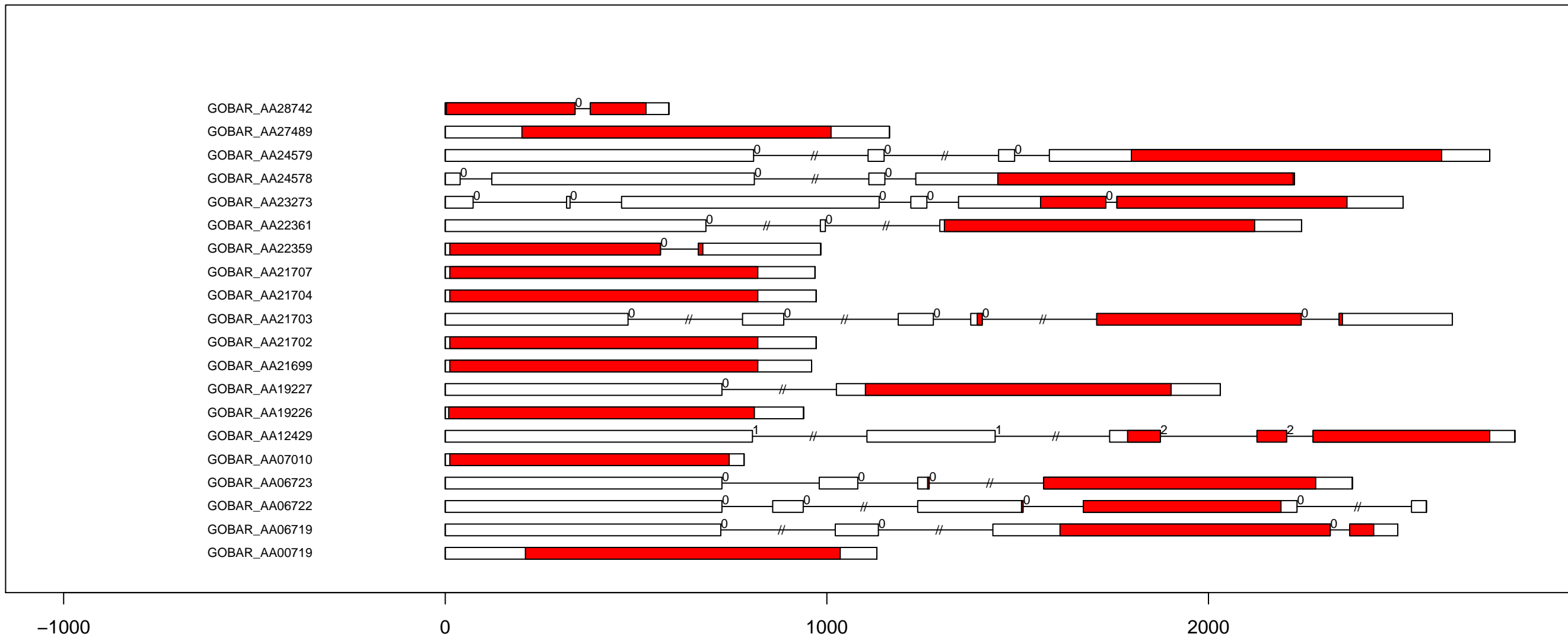

G.ba RLK-Pelle_LRK10L-2 exon-intron and domain diagram (part 3)

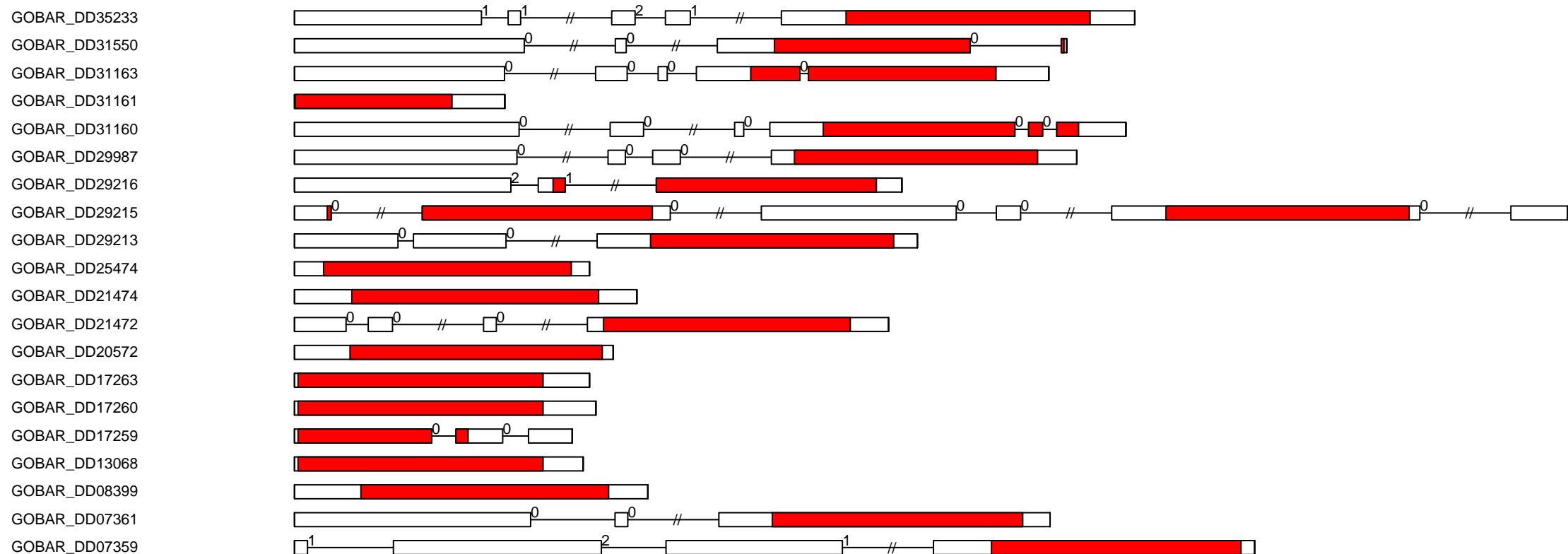

G.ba RLK-Pelle_LRK10L-2 exon-intron and domain diagram (part 4)

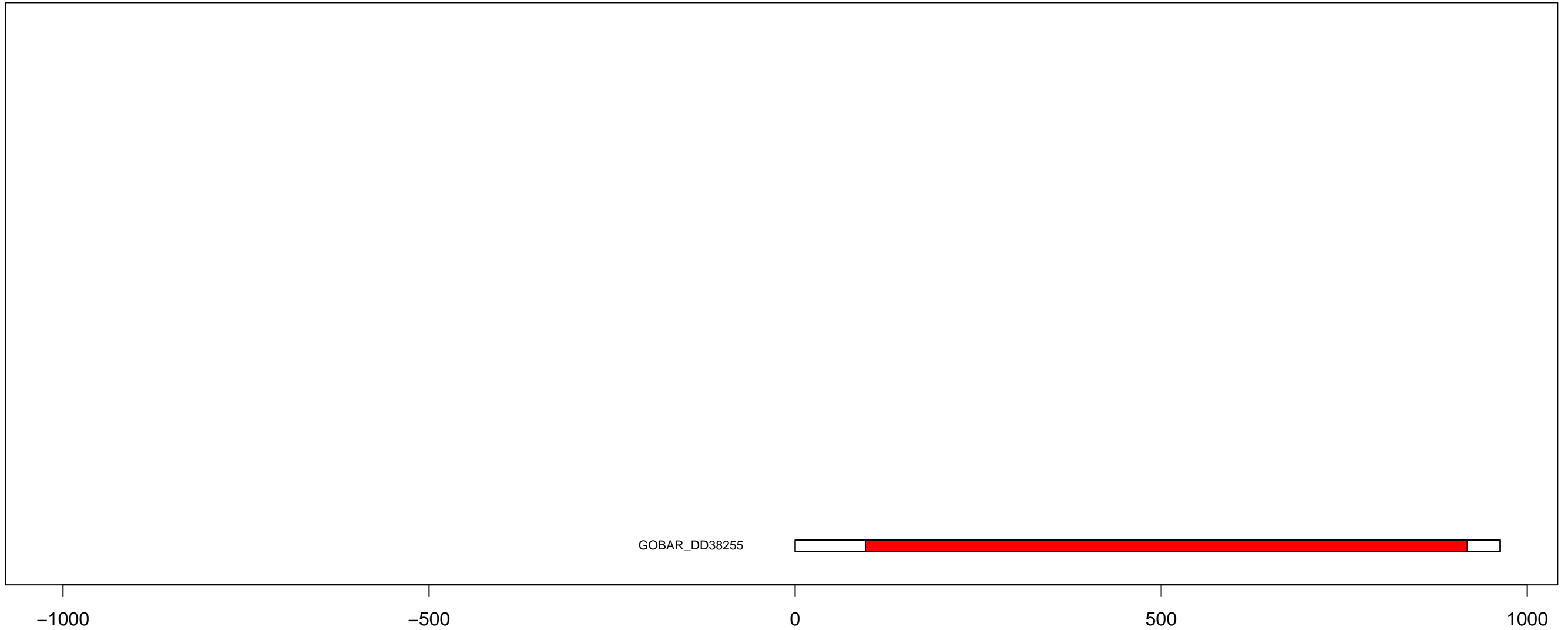

G.ba RLK-Pelle_LRR-I-1 exon-intron and domain diagram (all)

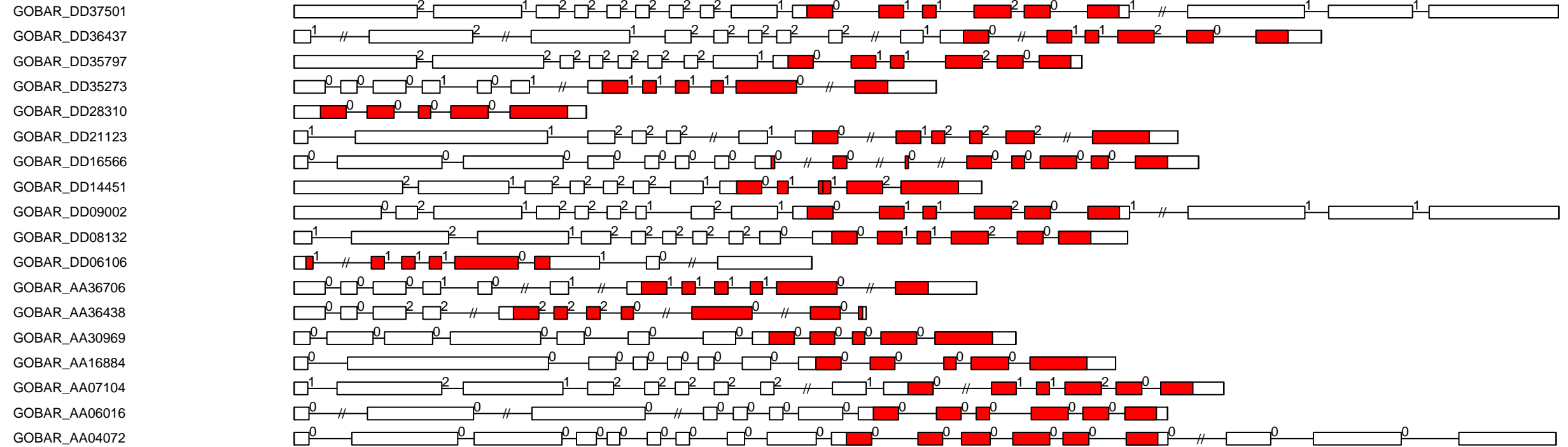

G.ba RLK-Pelle_LRR-I-2 exon-intron and domain diagram (all)

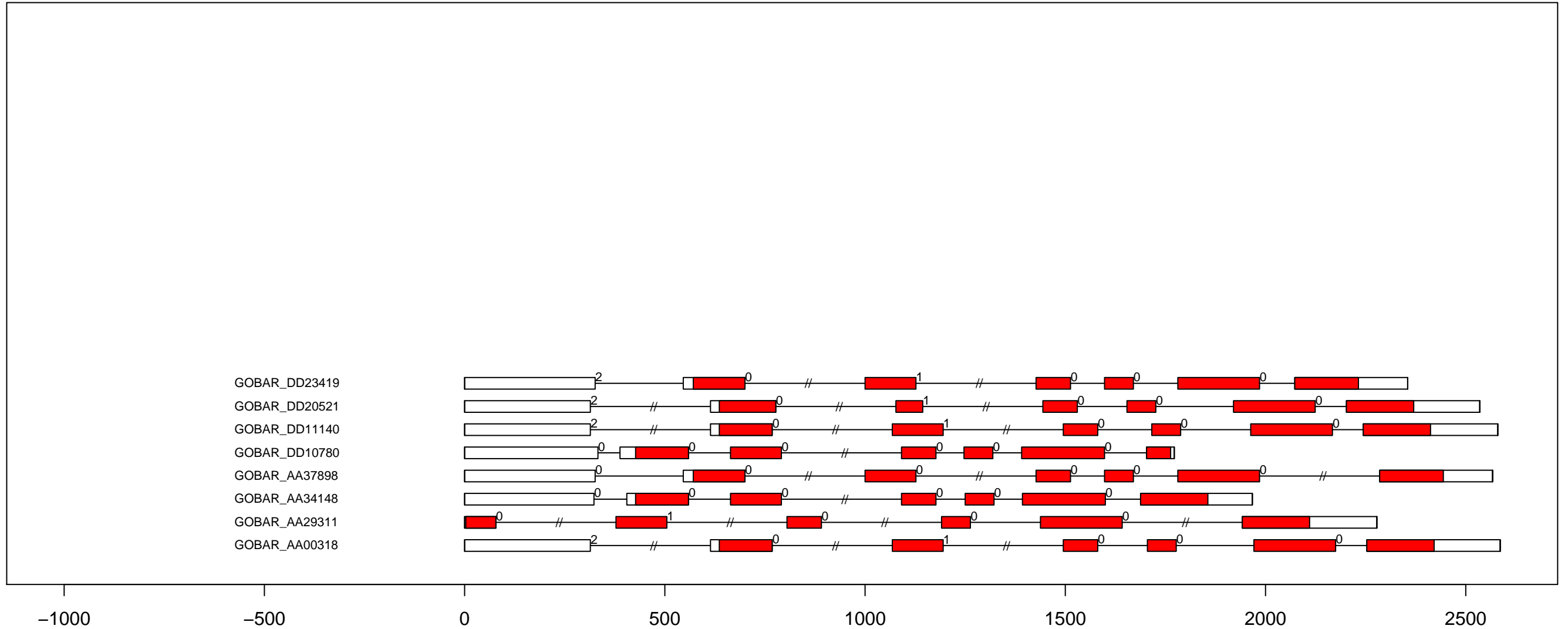

G.ba RLK-Pelle_LRR-III exon-intron and domain diagram (part 1)

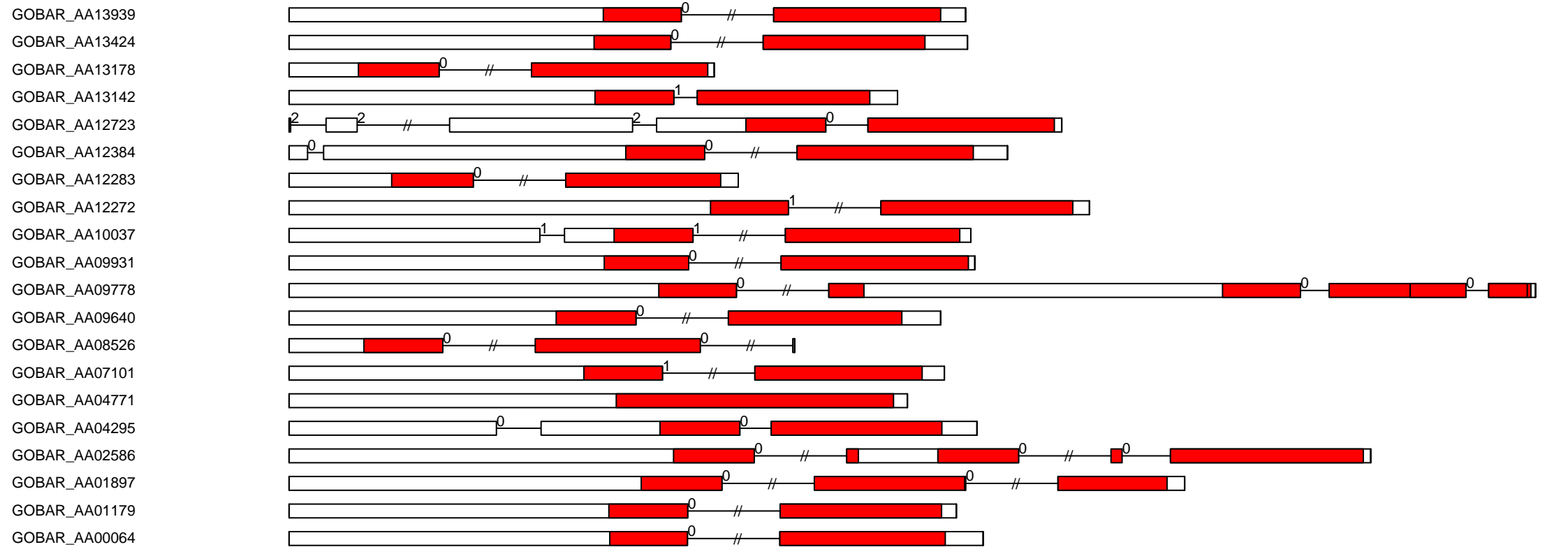

G.ba RLK-Pelle_LRR-III exon-intron and domain diagram (part 2)

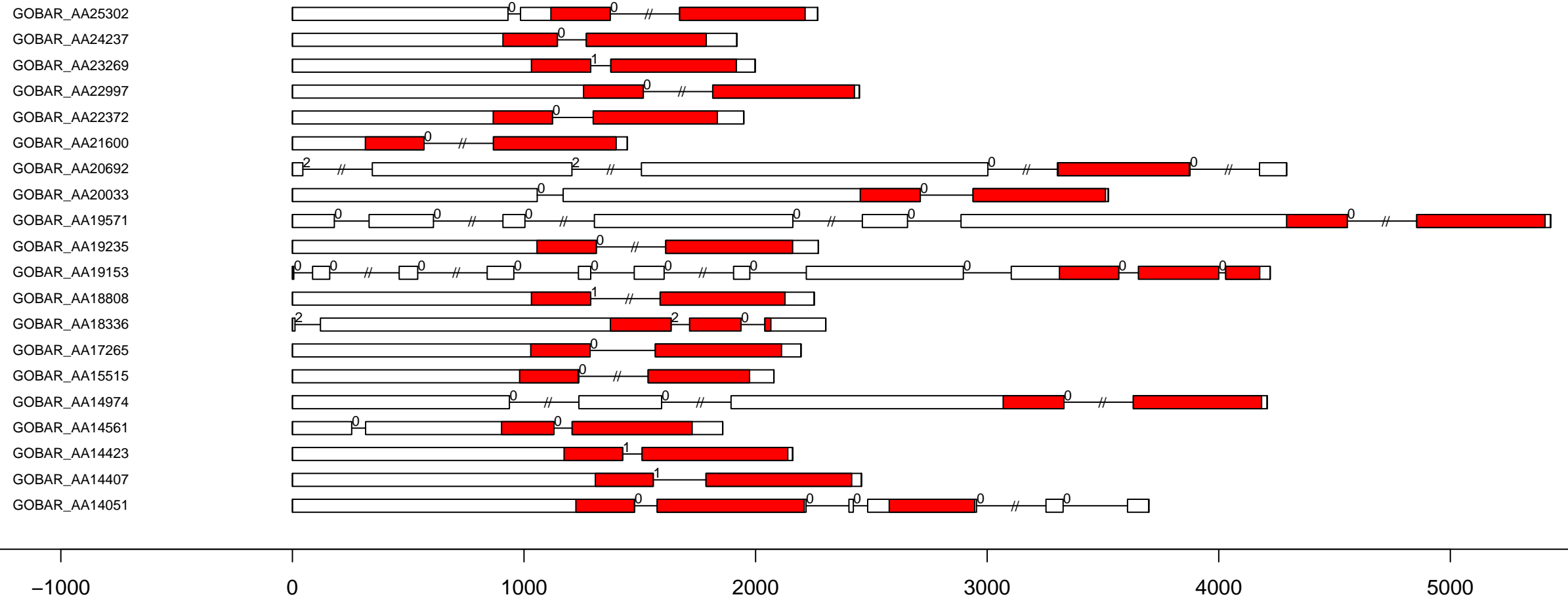

G.ba RLK-Pelle_LRR-III exon-intron and domain diagram (part 3)

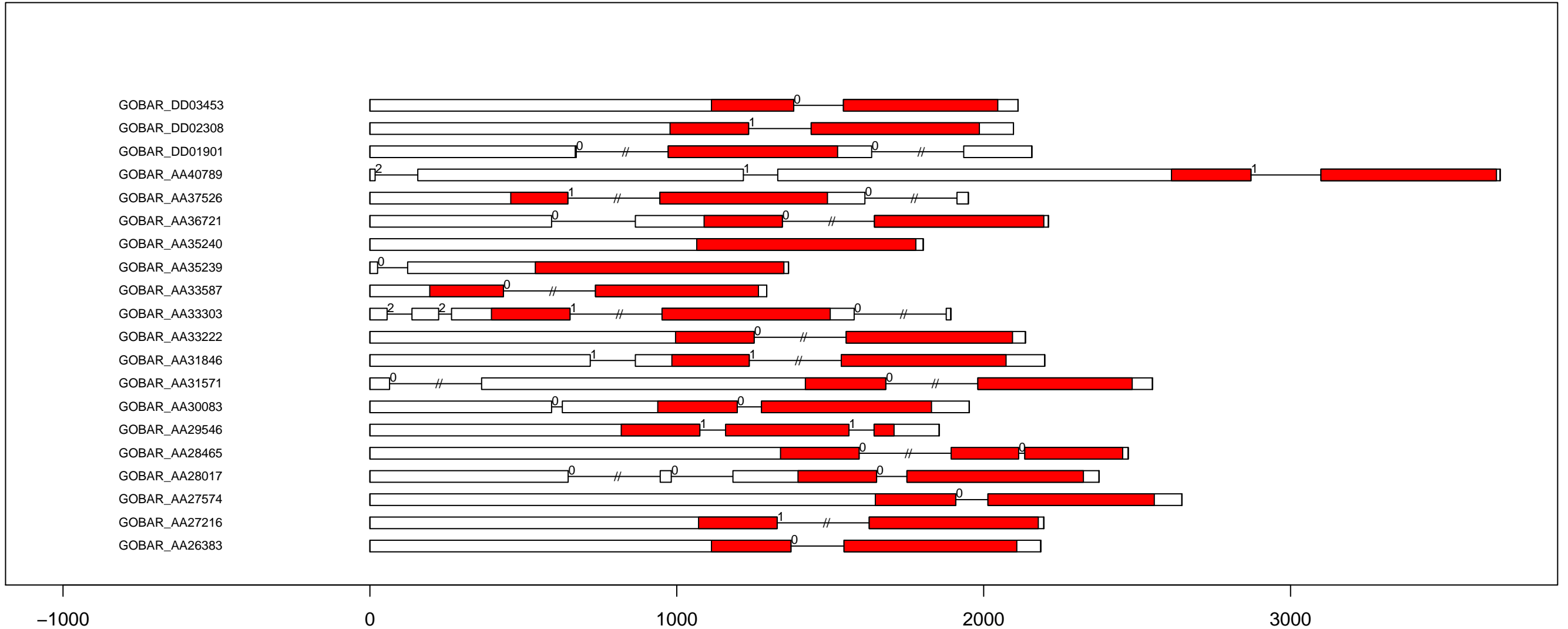

G.ba RLK-Pelle_LRR-III exon-intron and domain diagram (part 4)

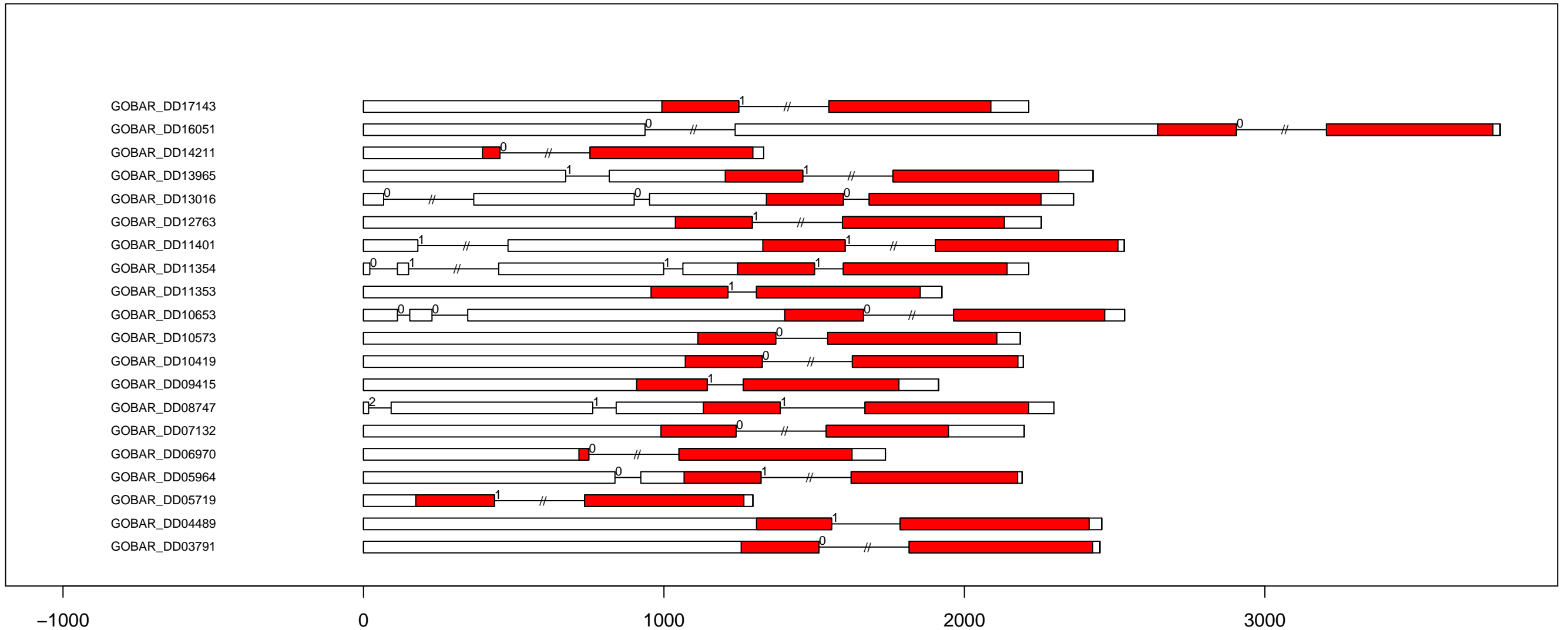

G.ba RLK-Pelle_LRR-III exon-intron and domain diagram (part 5)

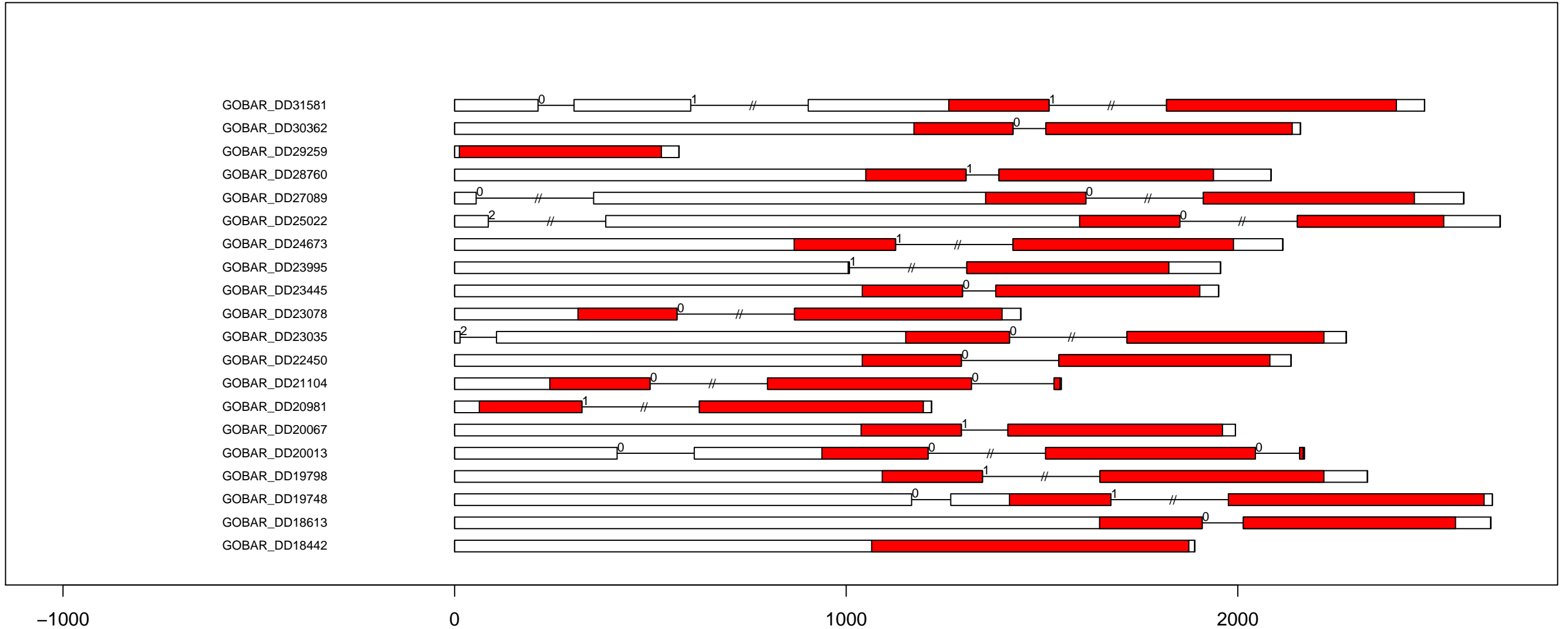

G.ba RLK-Pelle_LRR-III exon-intron and domain diagram (part 6)

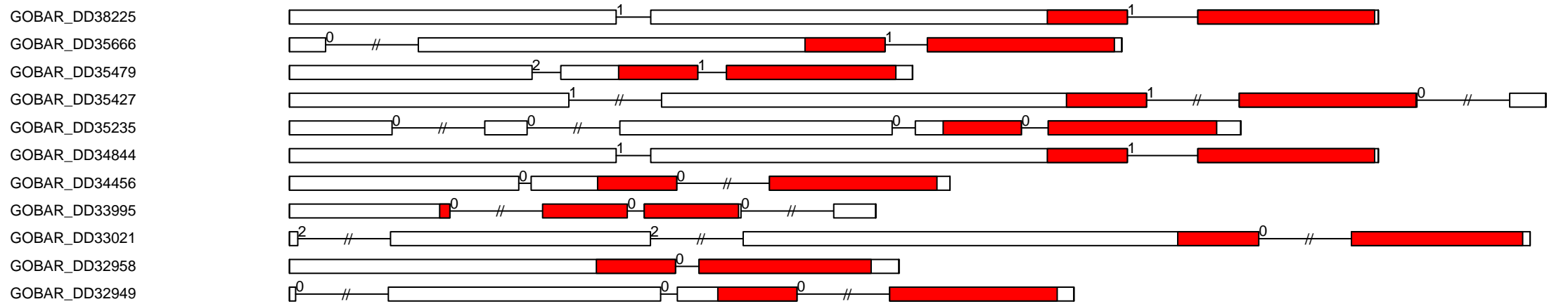

G.ba RLK-Pelle_LRR-II exon-intron and domain diagram (part 1)

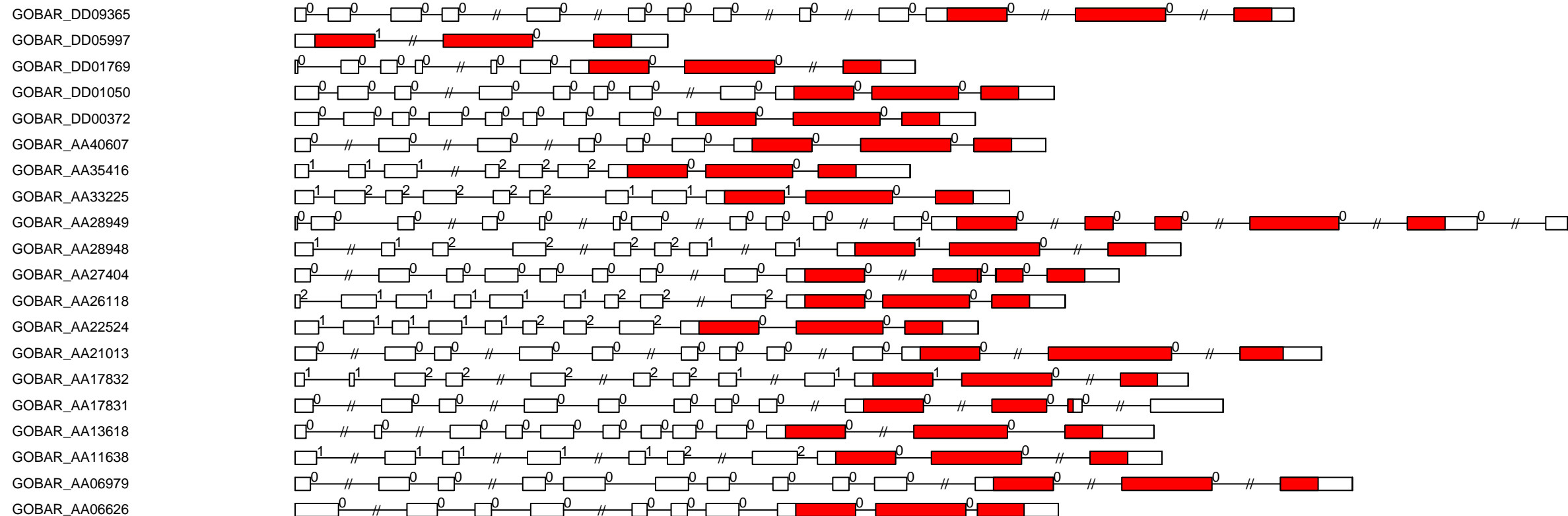

G.ba RLK-Pelle_LRR-II exon-intron and domain diagram (part 2)

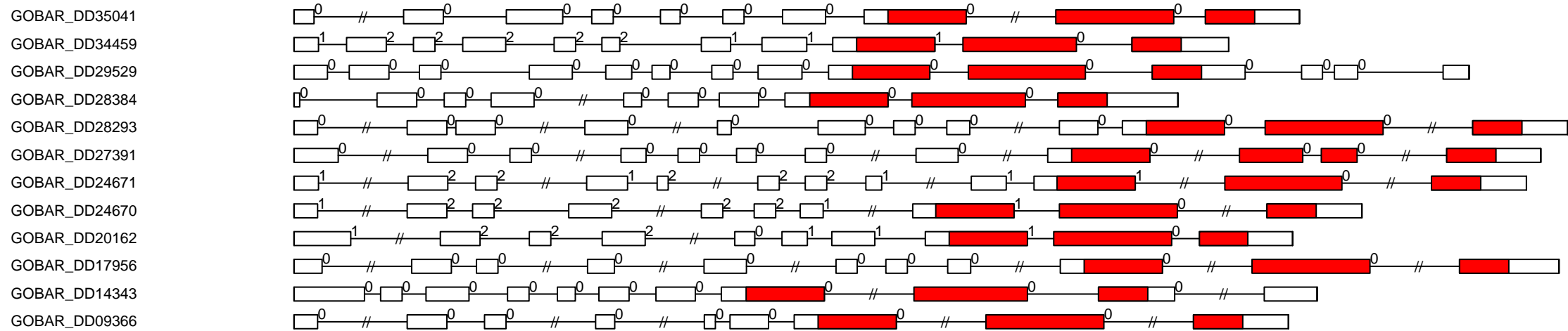

G.ba RLK-Pelle_LRR-IV exon-intron and domain diagram (all)

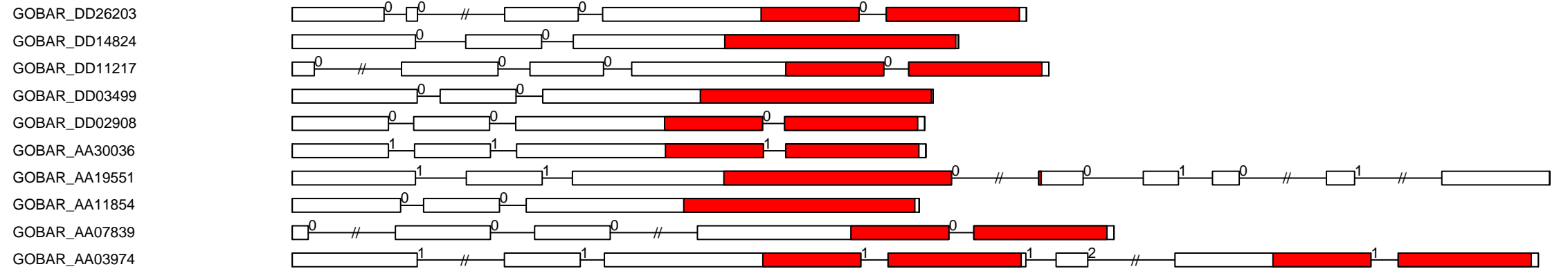

-1000

0

1000

2000

3000

4000

G.ba RLK-Pelle_LRR-IX exon-intron and domain diagram (all)

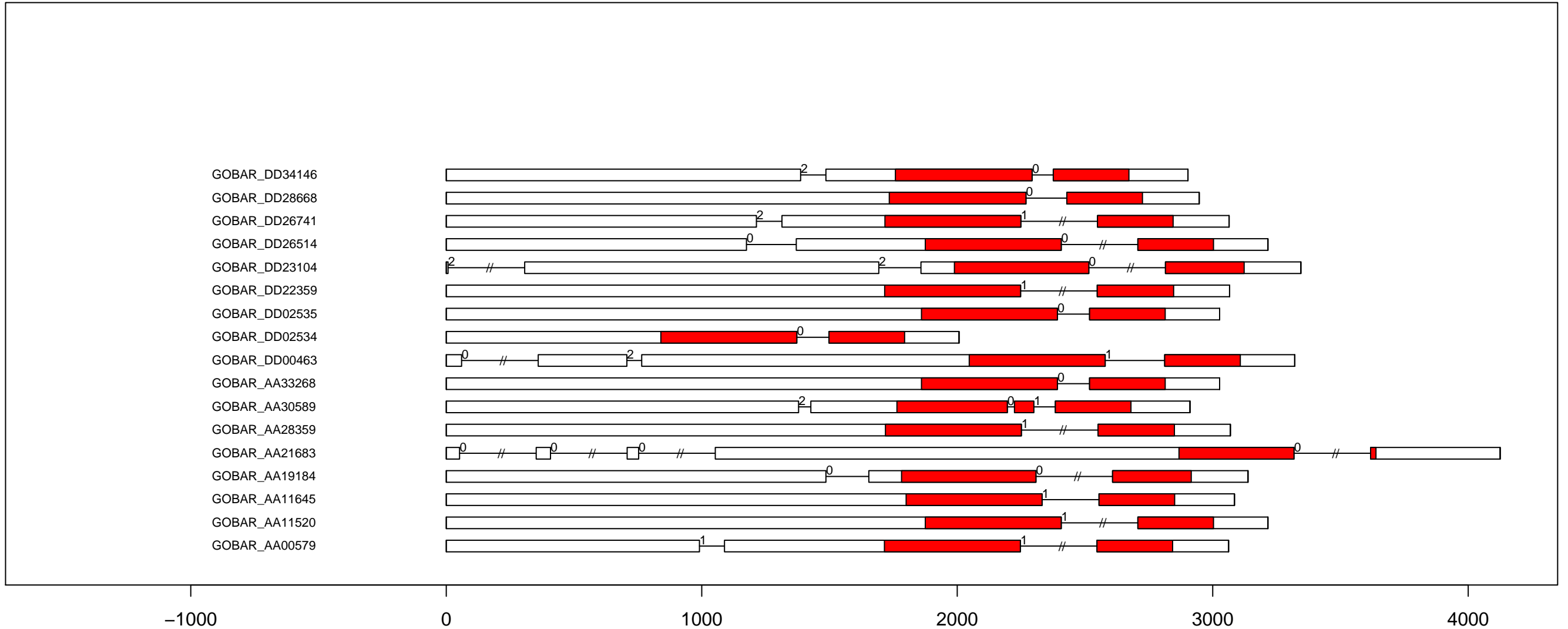

G.ba RLK-Pelle_LRR-VI-1 exon-intron and domain diagram (all)

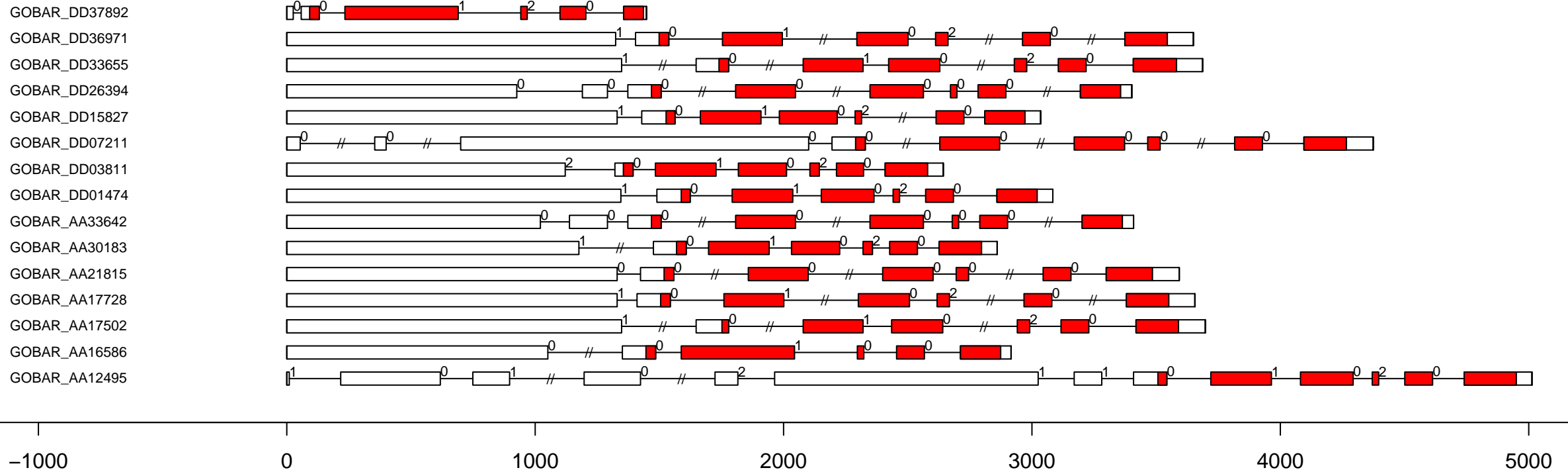

G.ba RLK-Pelle_LRR-VII-2 exon-intron and domain diagram (all)

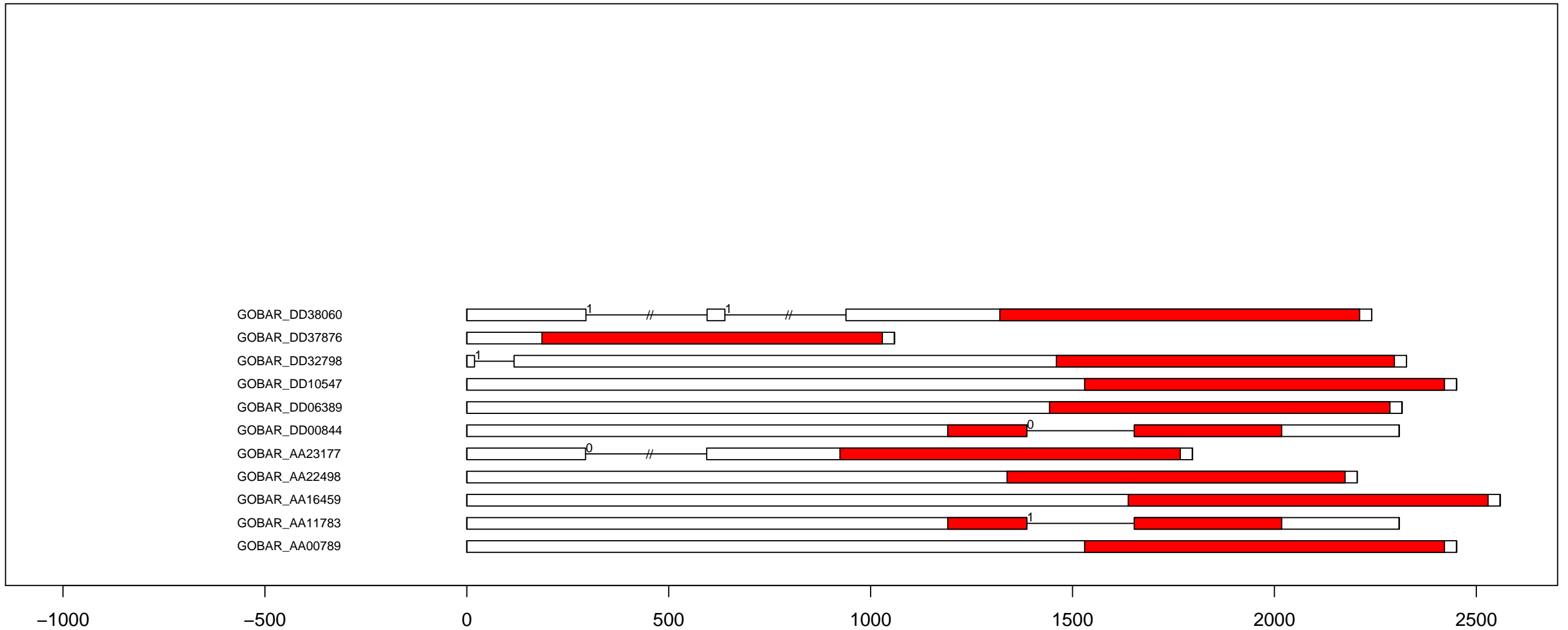

G.ba RLK-Pelle_LRR-VII-3 exon-intron and domain diagram (all)

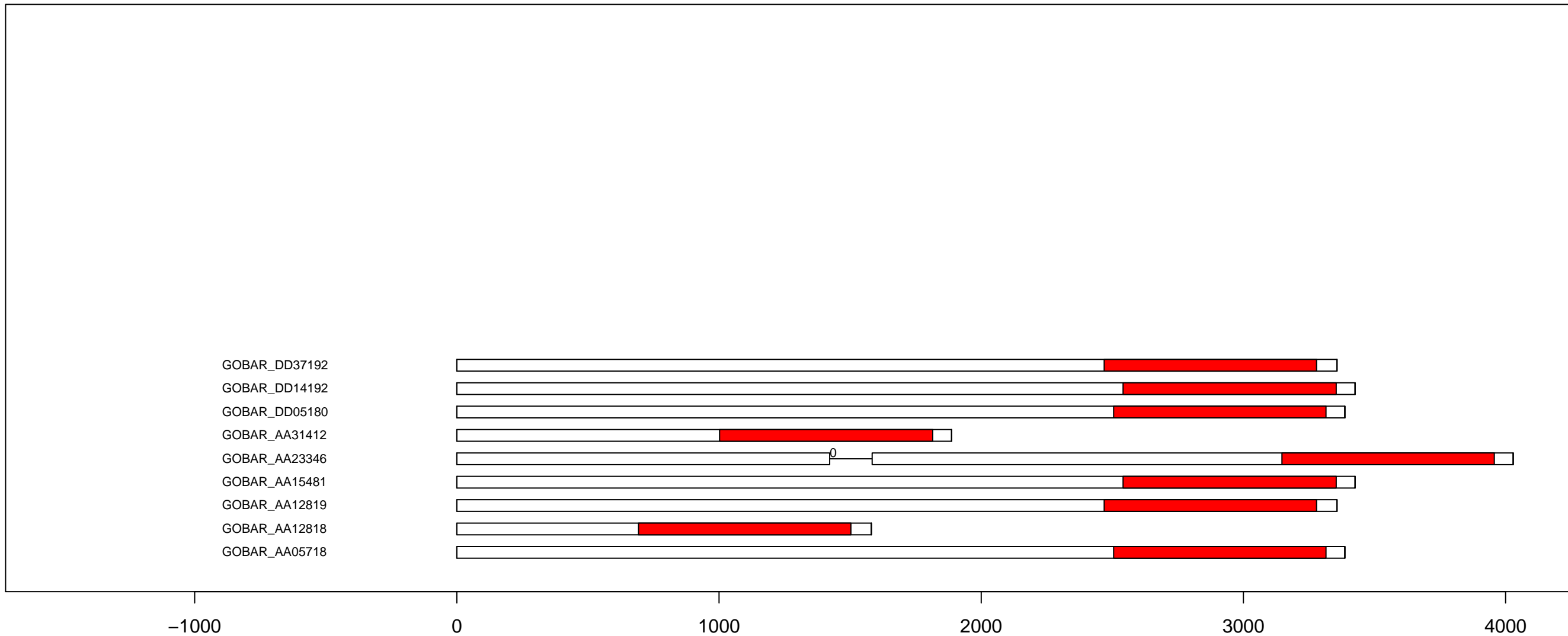

G.ba RLK-Pelle_LRR-VIII-1 exon-intron and domain diagram (all)

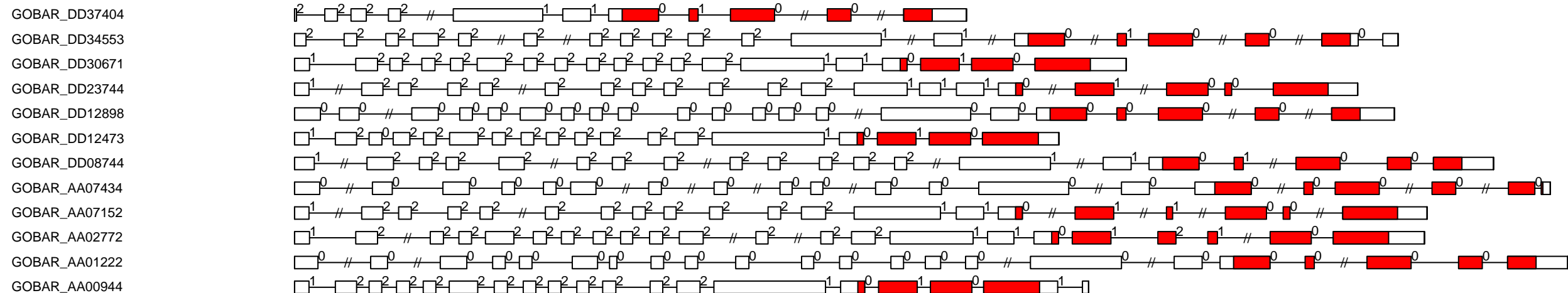

0

2000

4000

6000

G.ba RLK-Pelle_LRR-V exon-intron and domain diagram (all)

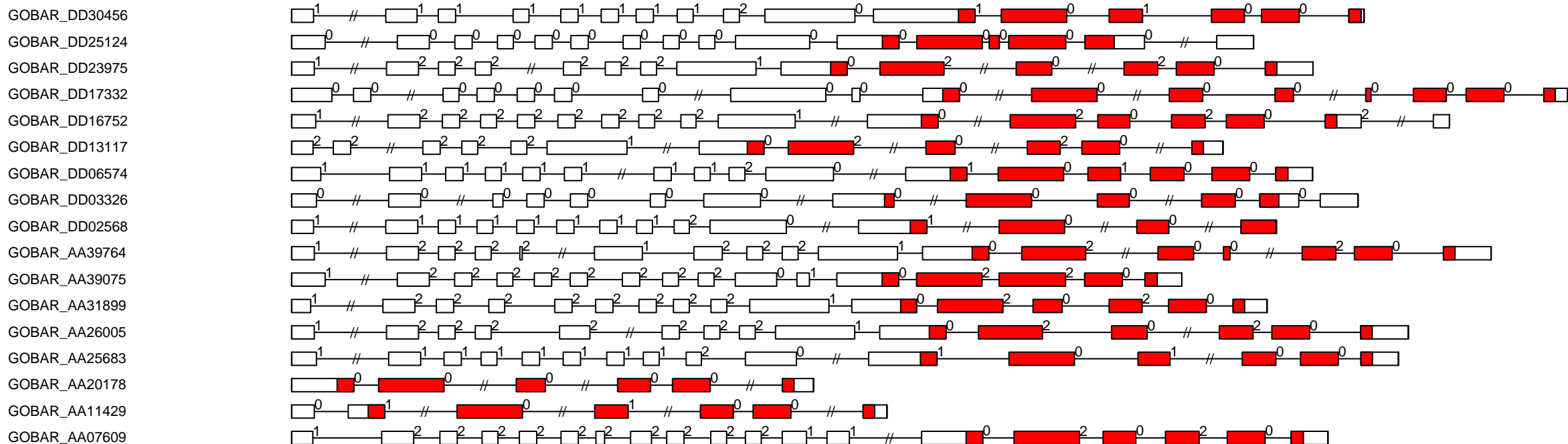

G.ba RLK-Pelle_LRR-Xa exon-intron and domain diagram (all)

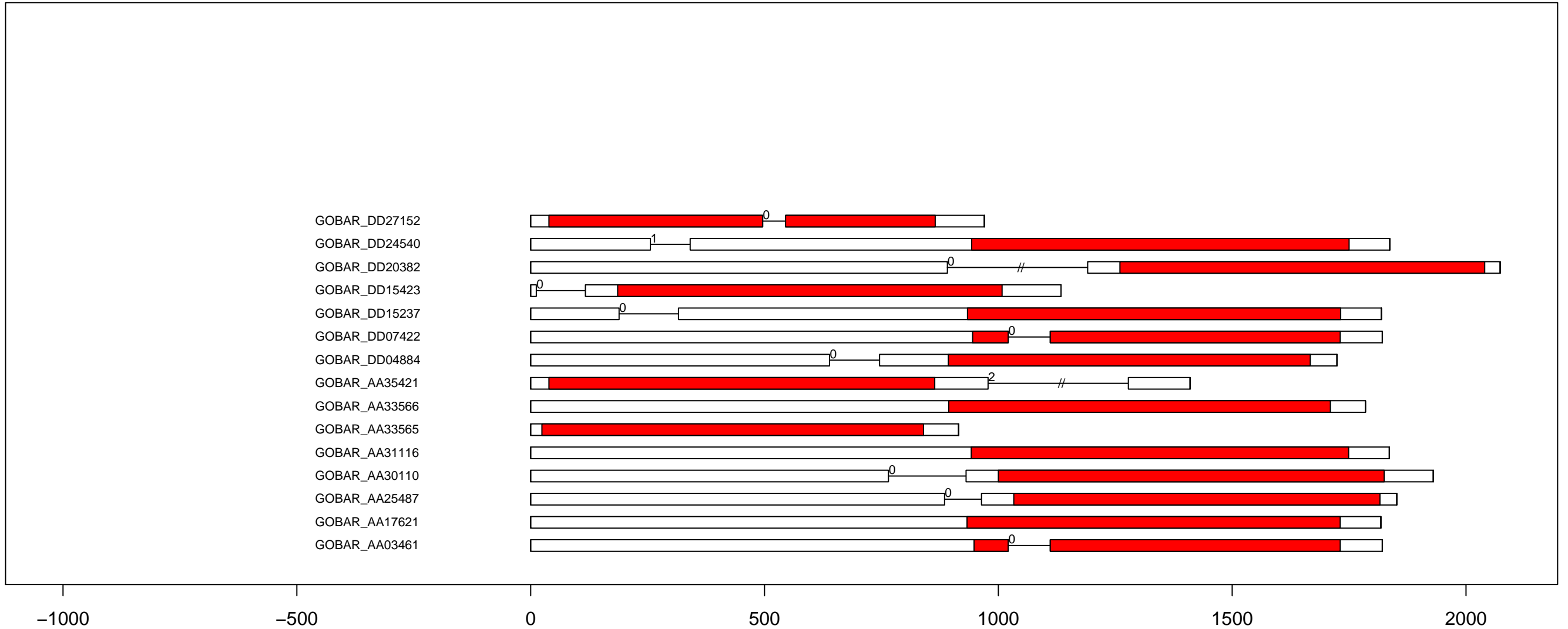

G.ba RLK-Pelle_LRR-Xb-1 exon-intron and domain diagram (part 1)

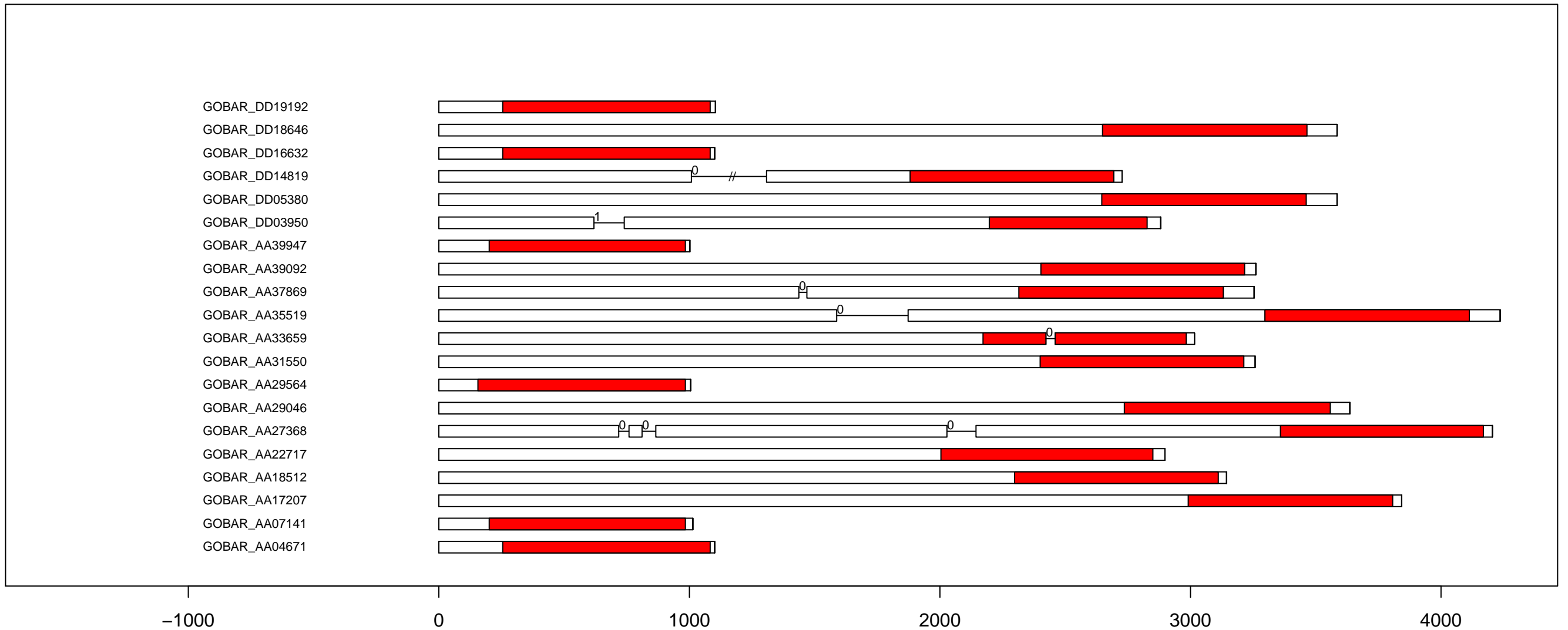

G.ba RLK-Pelle_LRR-Xb-1 exon-intron and domain diagram (part 2)

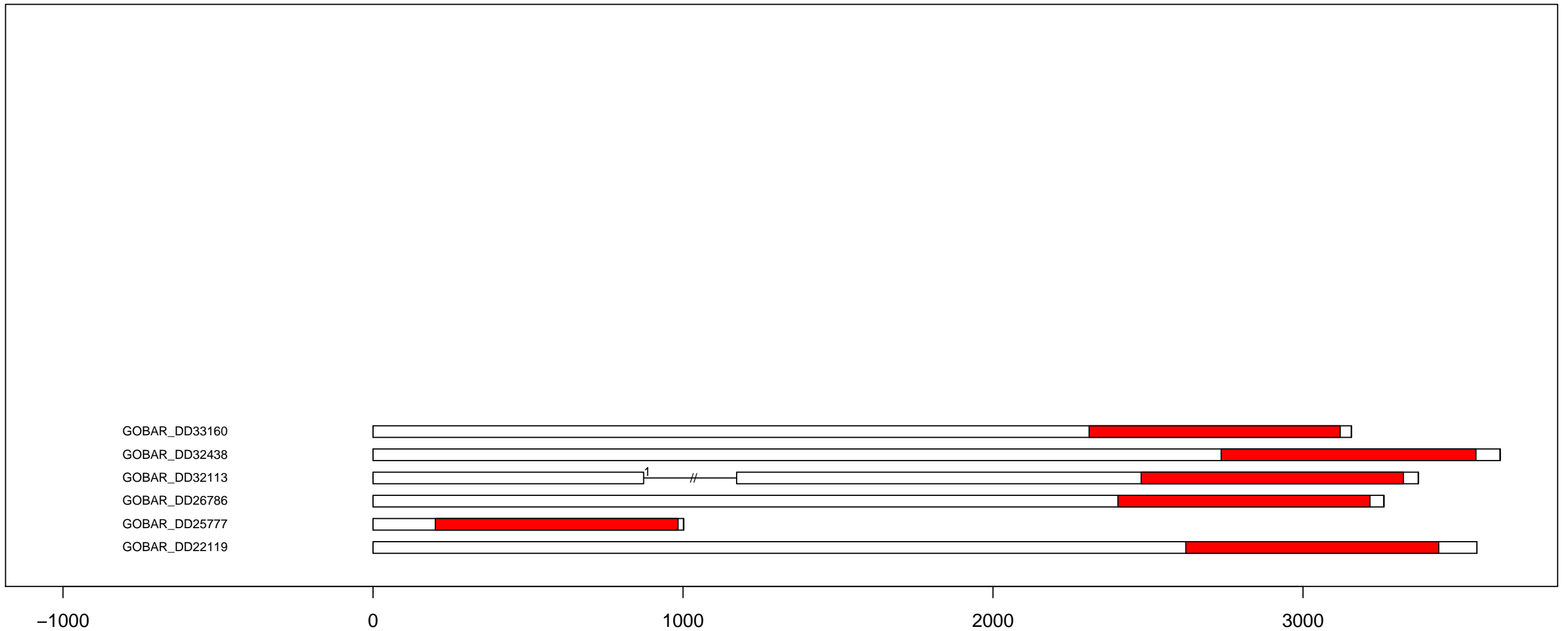

G.ba RLK-Pelle_LRR-Xb-2 exon-intron and domain diagram (all)

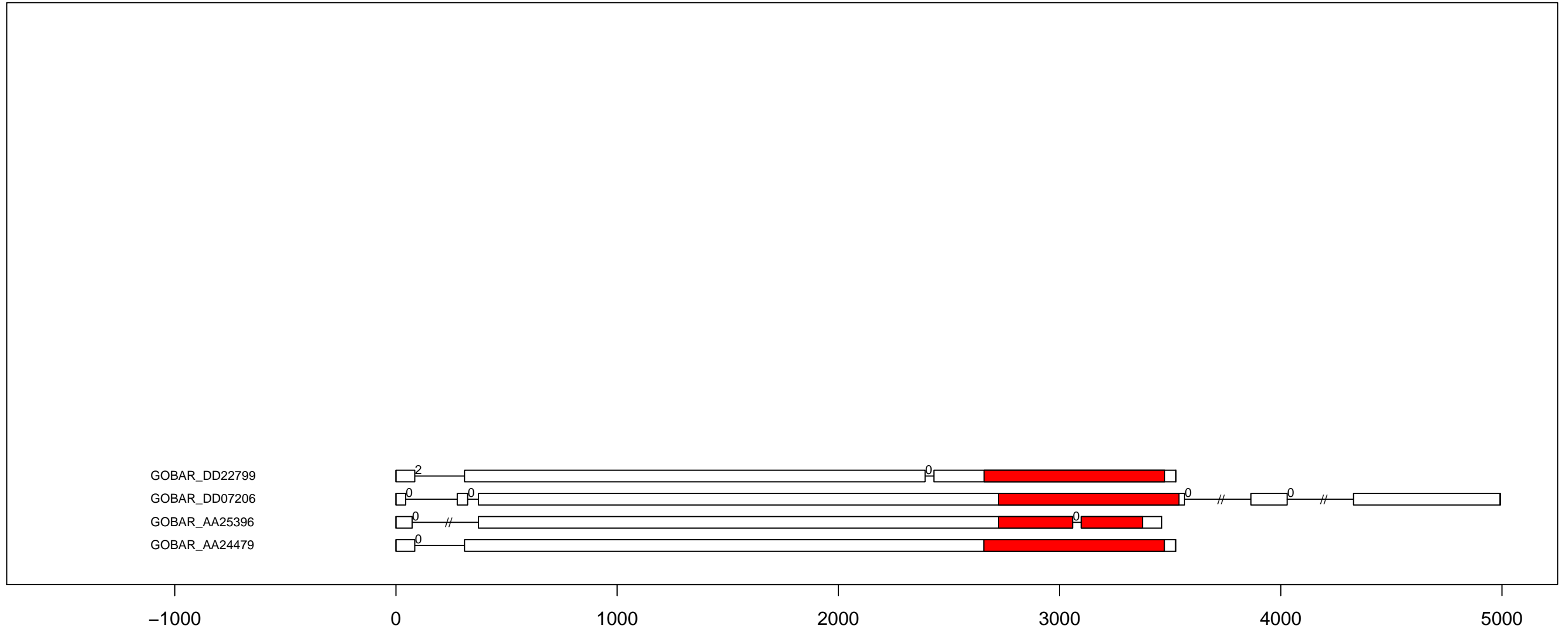

G.ba RLK-Pelle_LRR-XI-1 exon-intron and domain diagram (part 1)

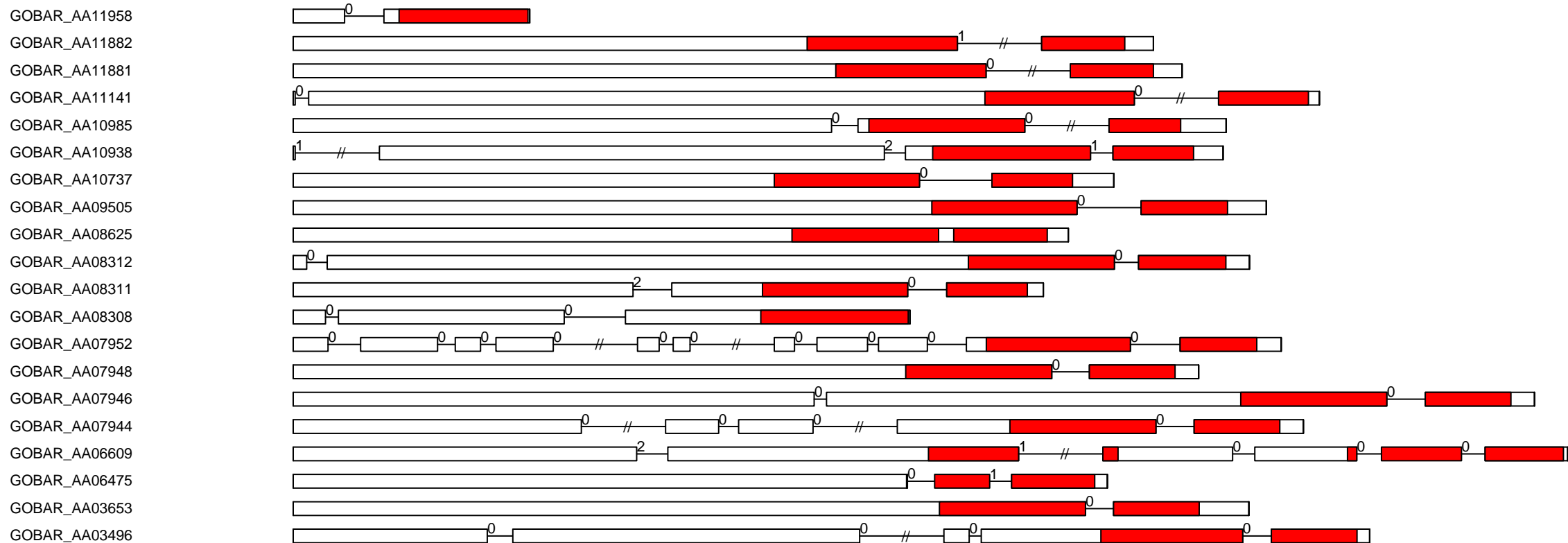

G.ba RLK-Pelle_LRR-XI-1 exon-intron and domain diagram (part 2)

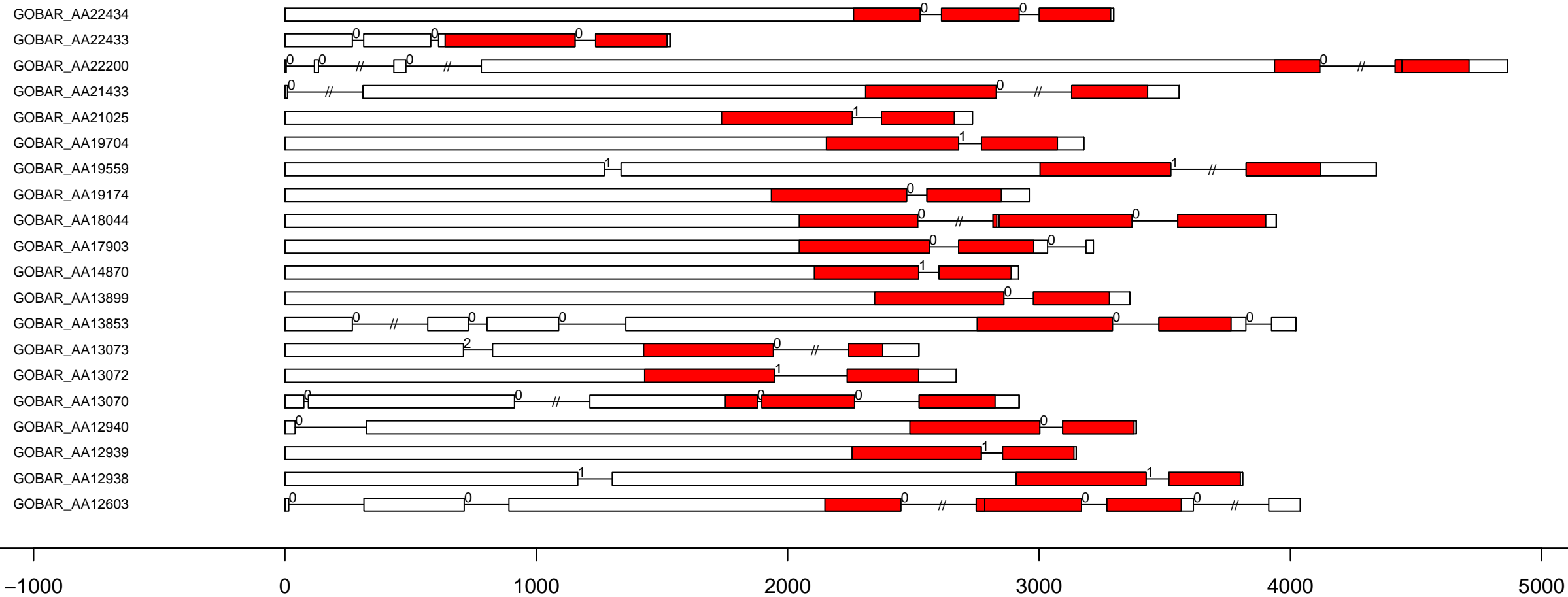

G.ba RLK-Pelle_LRR-XI-1 exon-intron and domain diagram (part 4)

GOBAR_DD02711
 GOBAR_DD02282
 GOBAR_DD02092
 GOBAR_DD01734
 GOBAR_DD01733
 GOBAR_DD00005
 GOBAR_DD00003
 GOBAR_AA40857
 GOBAR_AA40366
 GOBAR_AA40214
 GOBAR_AA40063
 GOBAR_AA39946
 GOBAR_AA39781
 GOBAR_AA37640
 GOBAR_AA37572
 GOBAR_AA37571
 GOBAR_AA37429
 GOBAR_AA36842
 GOBAR_AA36837
 GOBAR_AA35019

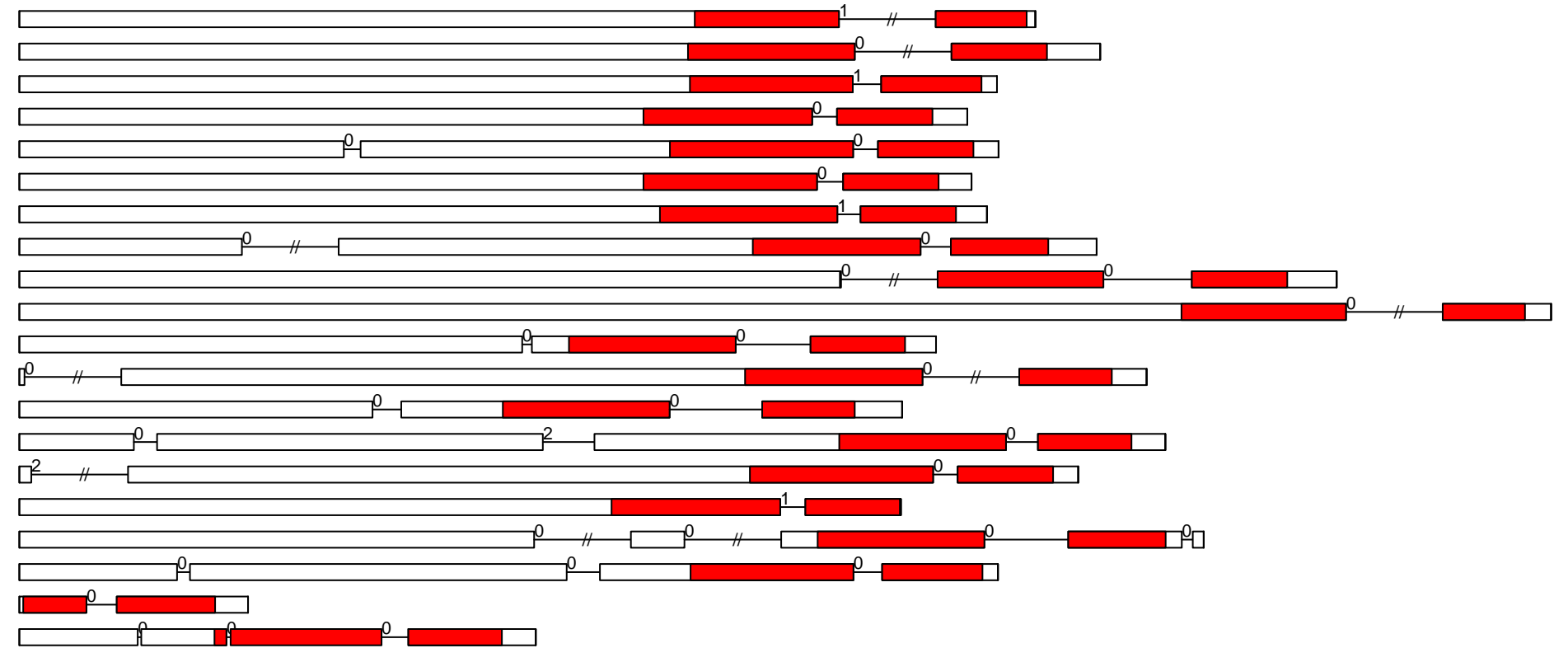

-1000

0

1000

2000

3000

4000

G.ba RLK-Pelle_LRR-XI-1 exon-intron and domain diagram (part 5)

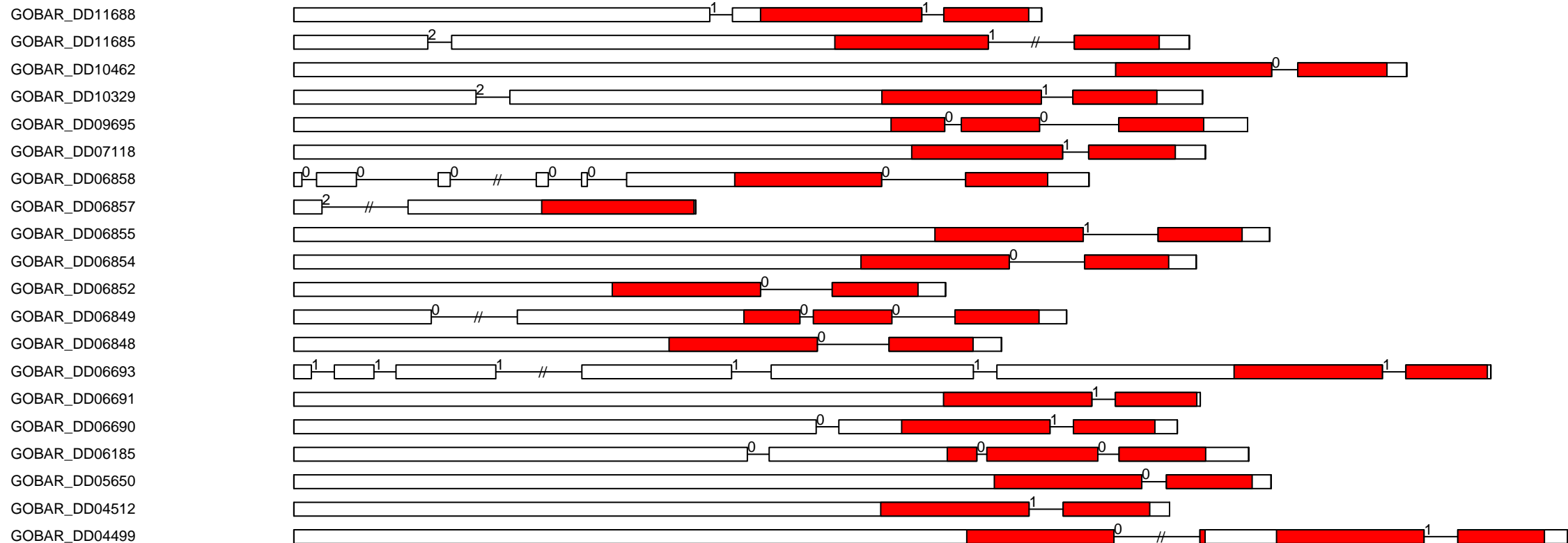

G.ba RLK-Pelle_LRR-XI-1 exon-intron and domain diagram (part 6)

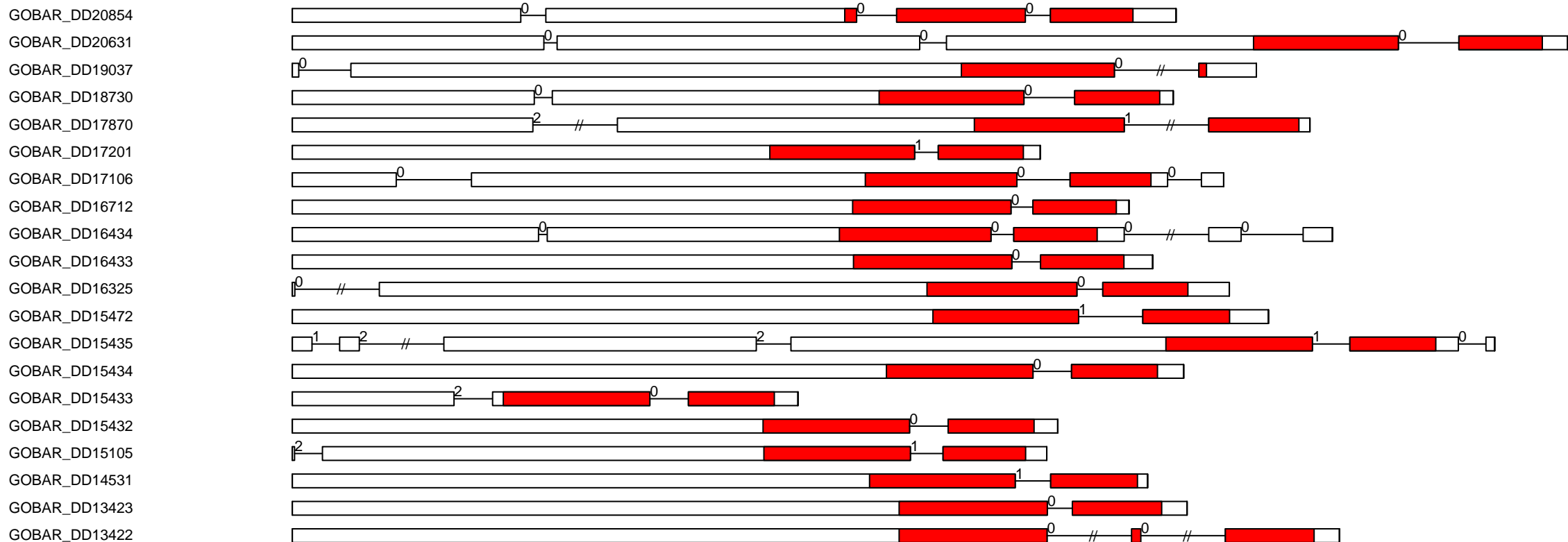

-1000

0

1000

2000

3000

4000

G.ba RLK-Pelle_LRR-XI-1 exon-intron and domain diagram (part 7)

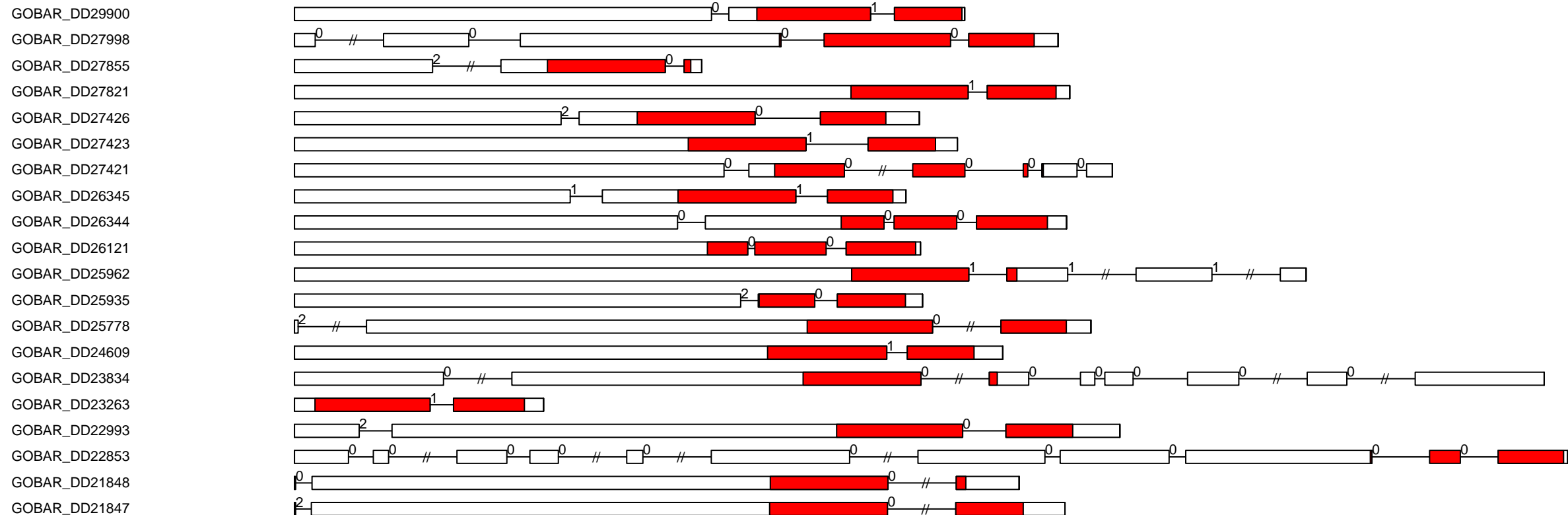

G.ba RLK-Pelle_LRR-XI-1 exon-intron and domain diagram (part 8)

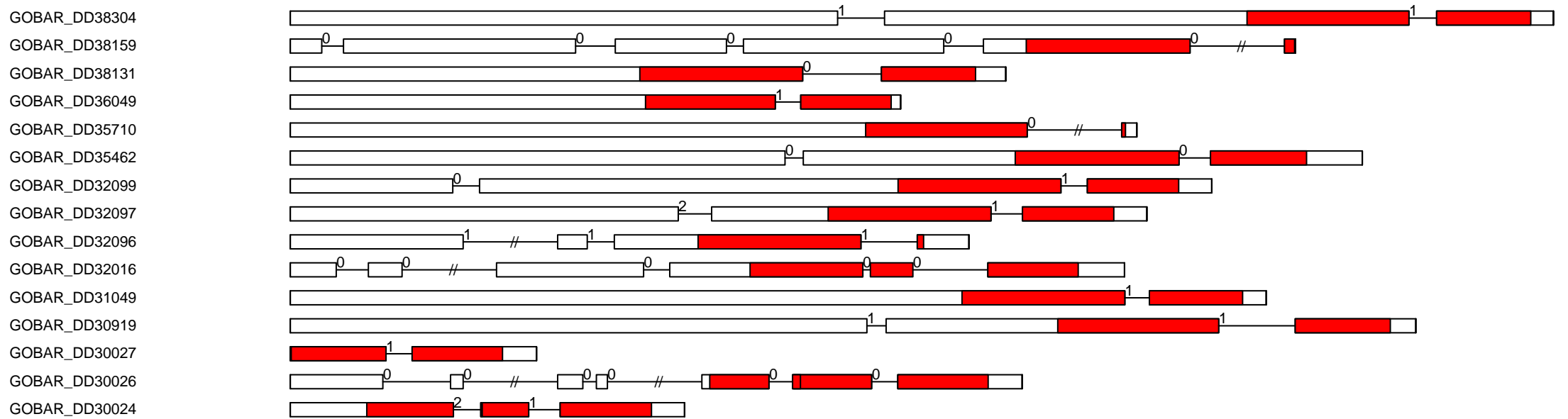

G.ba RLK-Pelle_LRR-XI-2 exon-intron and domain diagram (all)

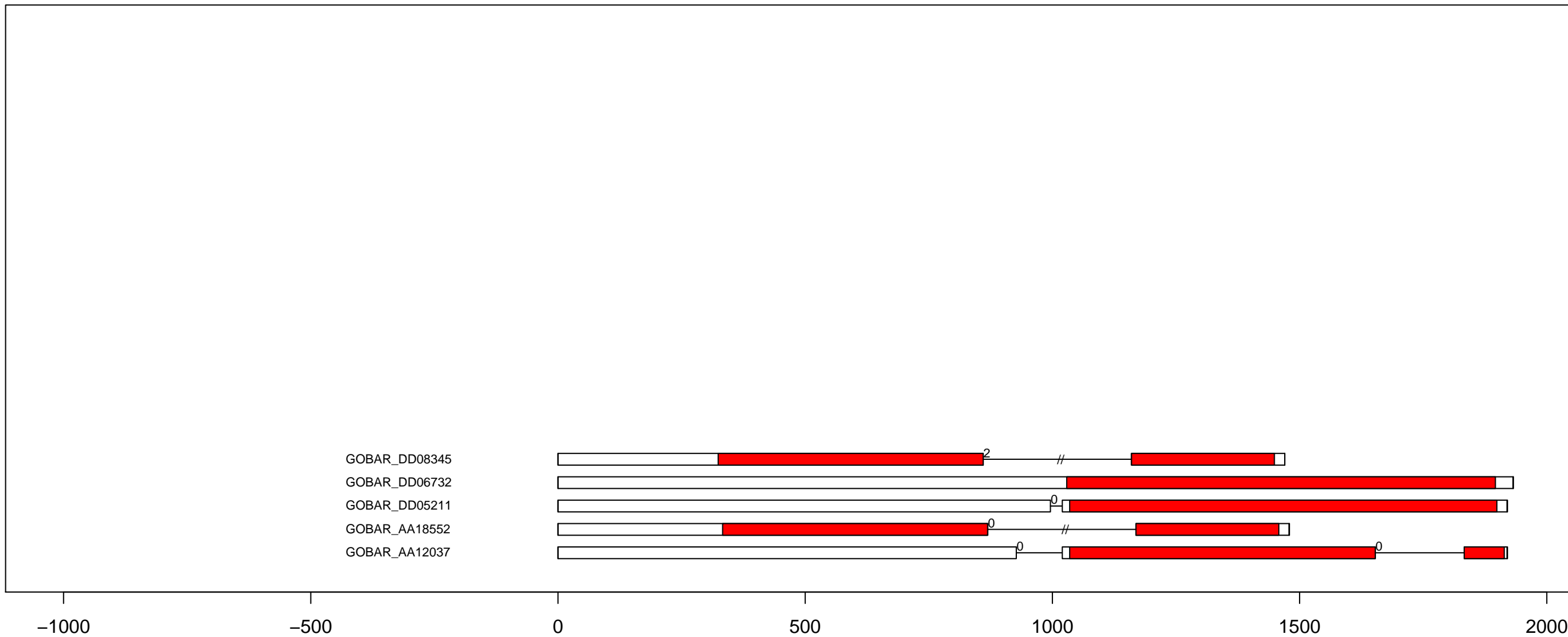

G.ba RLK-Pelle_LRR-XII-1 exon-intron and domain diagram (part 1)

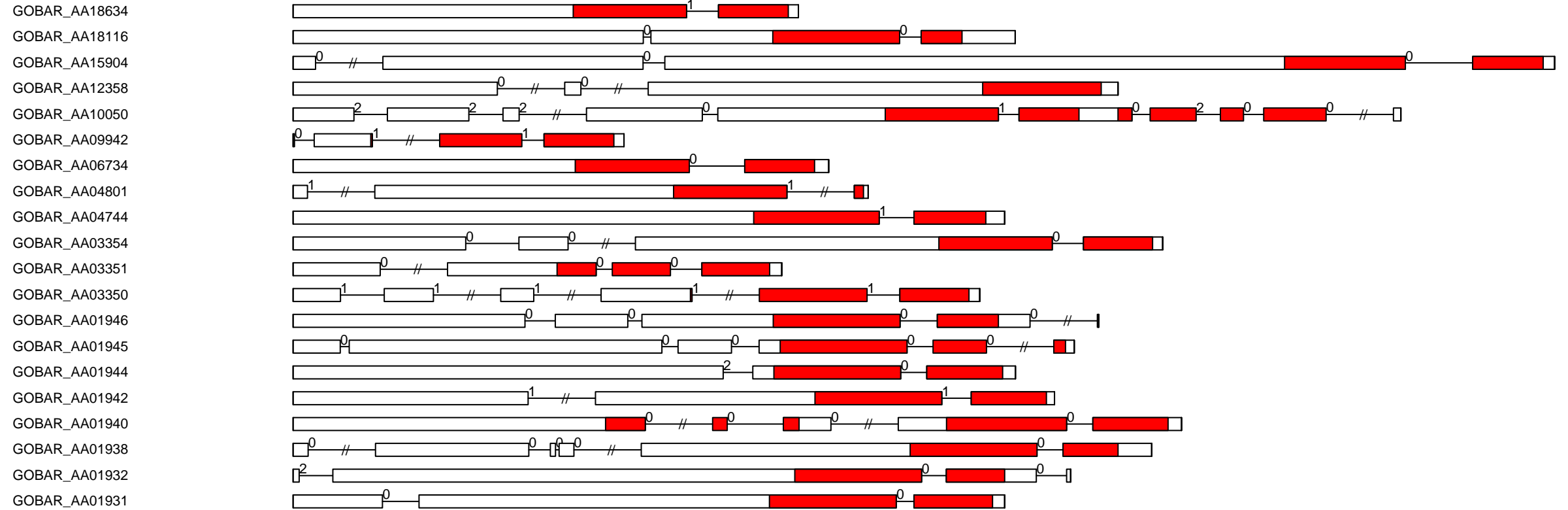

G.ba RLK-Pelle_LRR-XII-1 exon-intron and domain diagram (part 2)

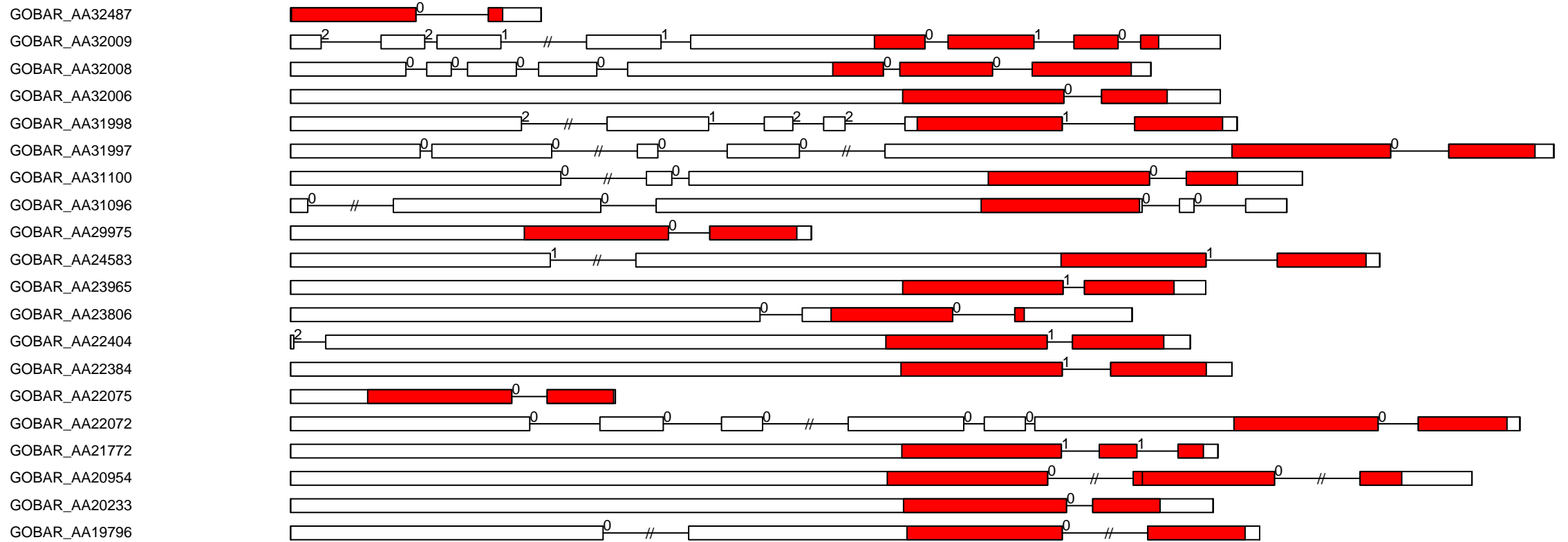

G.ba RLK-Pelle_LRR-XII-1 exon-intron and domain diagram (part 4)

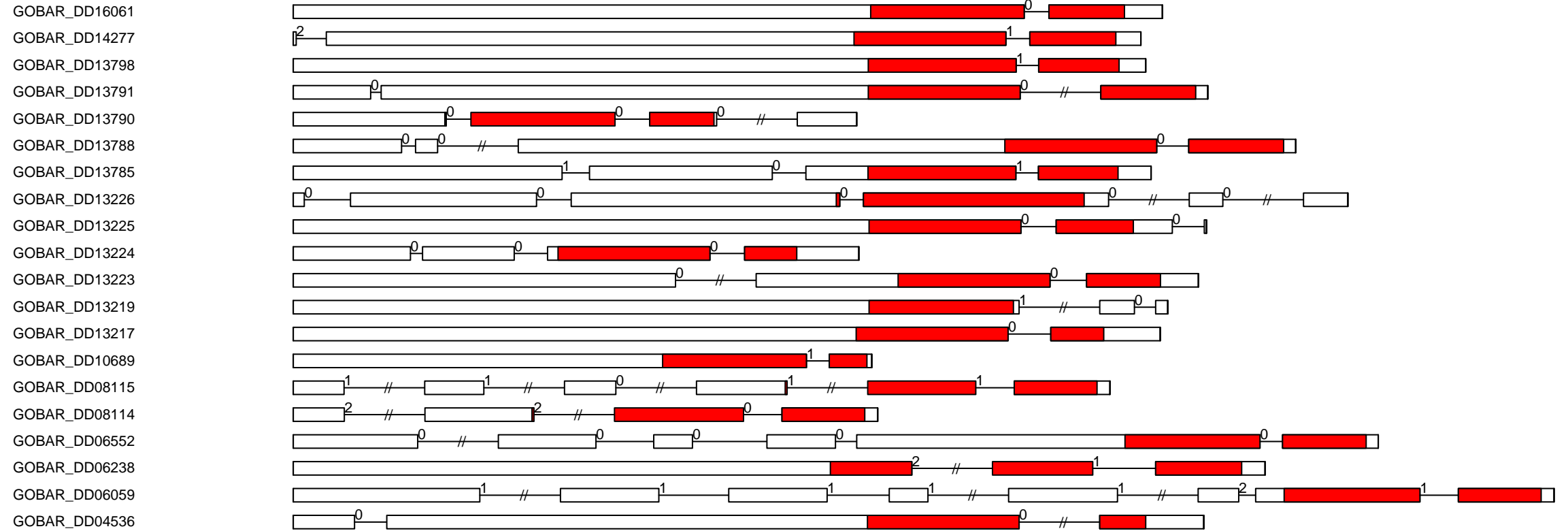

G.ba RLK-Pelle_LRR-XII-1 exon-intron and domain diagram (part 5)

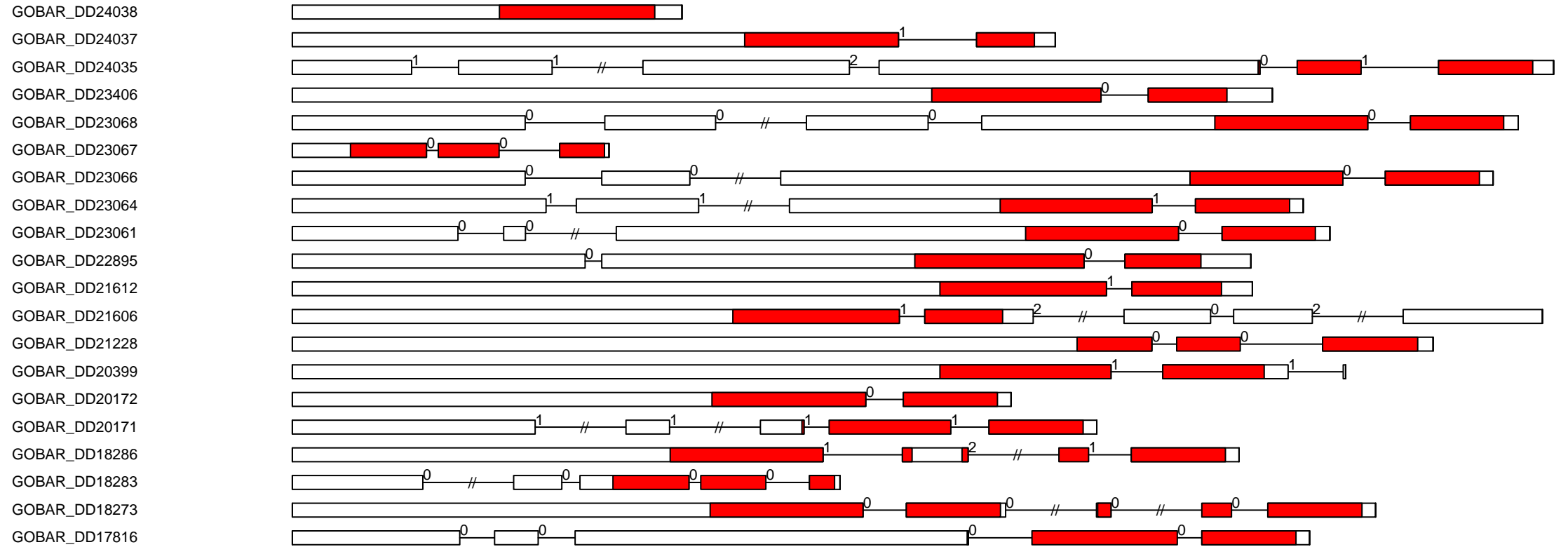

G.ba RLK-Pelle_LRR-XII-1 exon-intron and domain diagram (part 6)

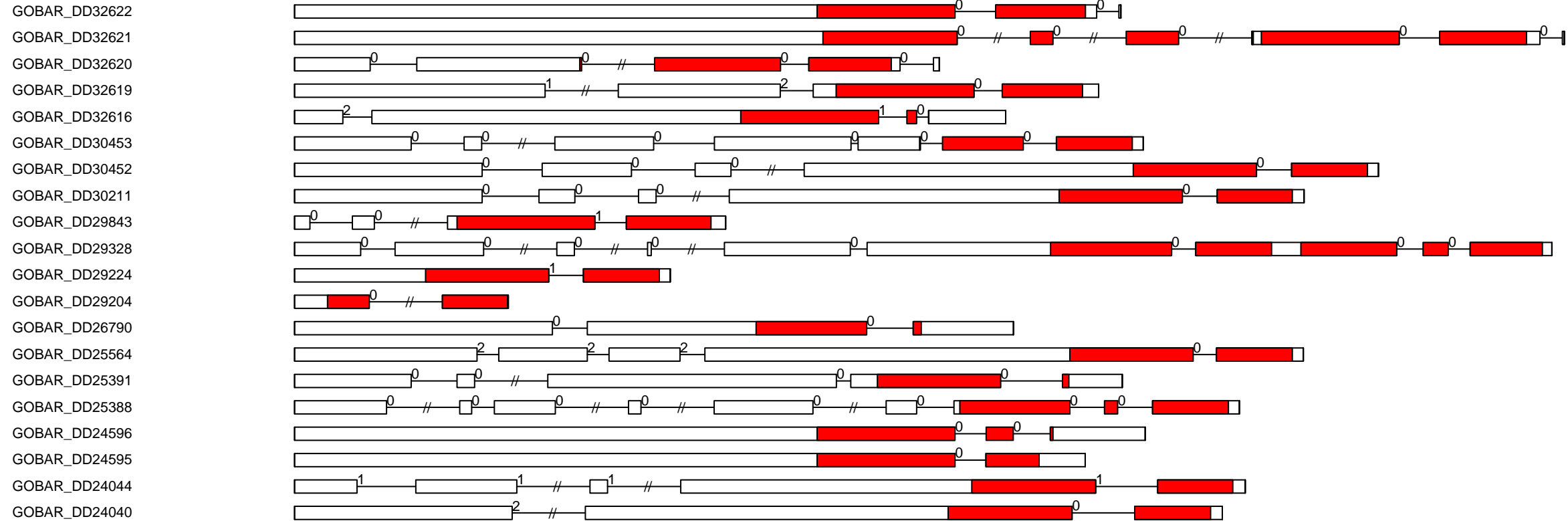

G.ba RLK-Pelle_LRR-XII-1 exon-intron and domain diagram (part 7)

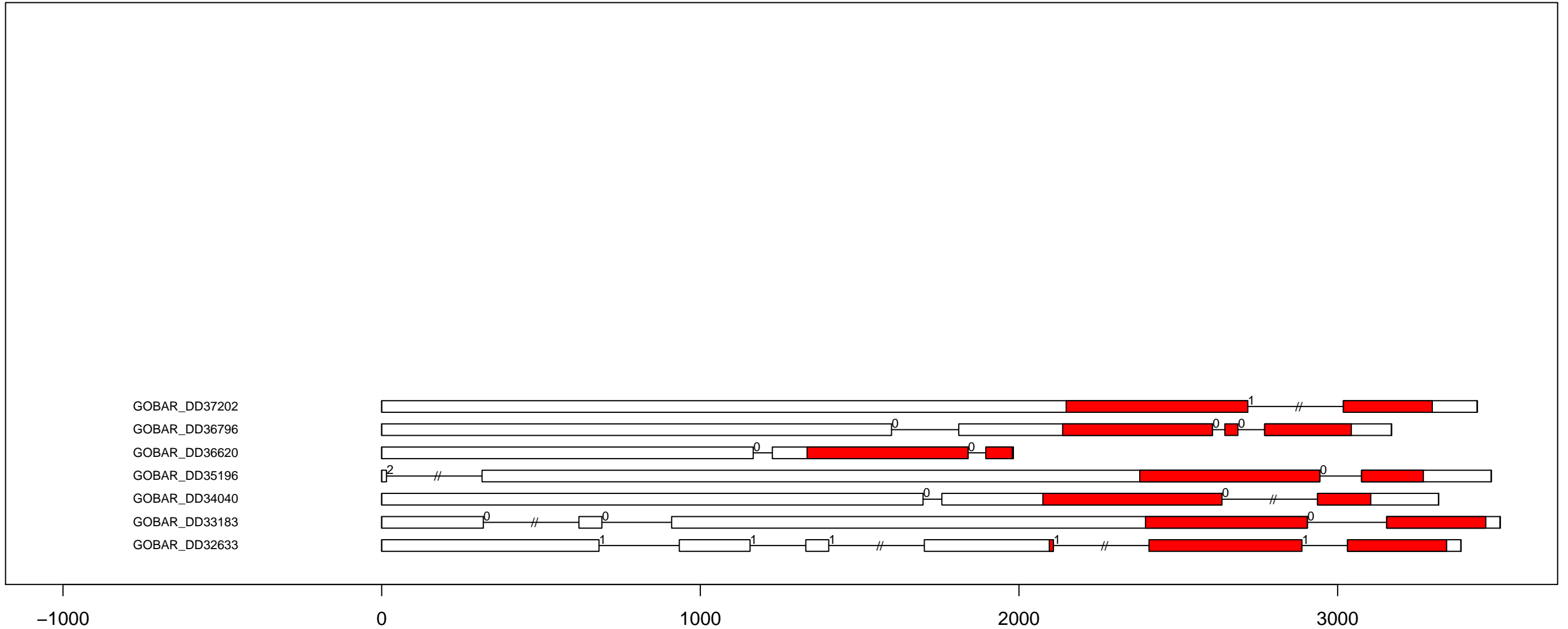

G.ba RLK-Pelle_LRR-XIIIa exon-intron and domain diagram (all)

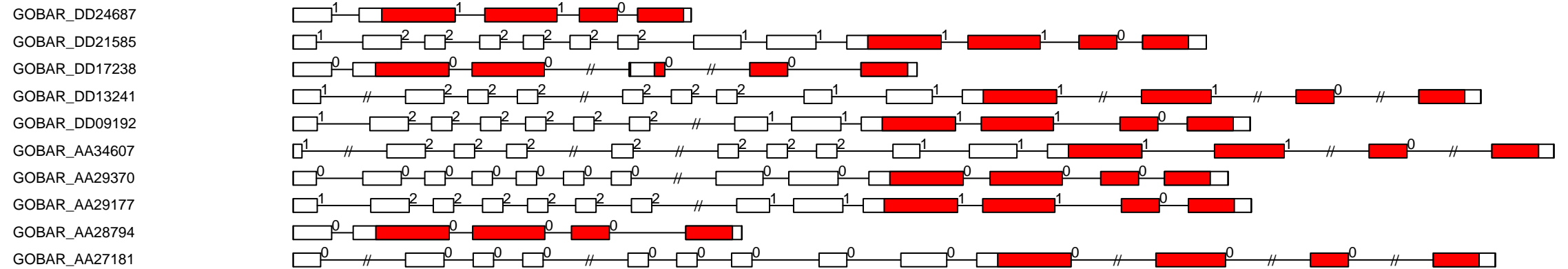

G.ba RLK-Pelle_LRR-XIIIb exon-intron and domain diagram (all)

GOBAR_DD25858

GOBAR_DD20603

GOBAR_DD04068

GOBAR_AA36304

GOBAR_AA18091

GOBAR_AA11772

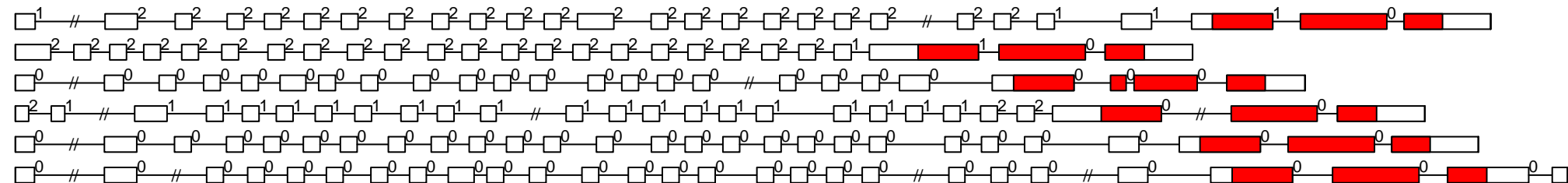

0

2000

4000

6000

G.ba RLK-Pelle_LRR-XIV exon-intron and domain diagram (all)

GOBAR_DD24411
GOBAR_DD19141
GOBAR_DD03868
GOBAR_DD00263
GOBAR_AA29303
GOBAR_AA25693
GOBAR_AA17358
GOBAR_AA02674
GOBAR_AA02368

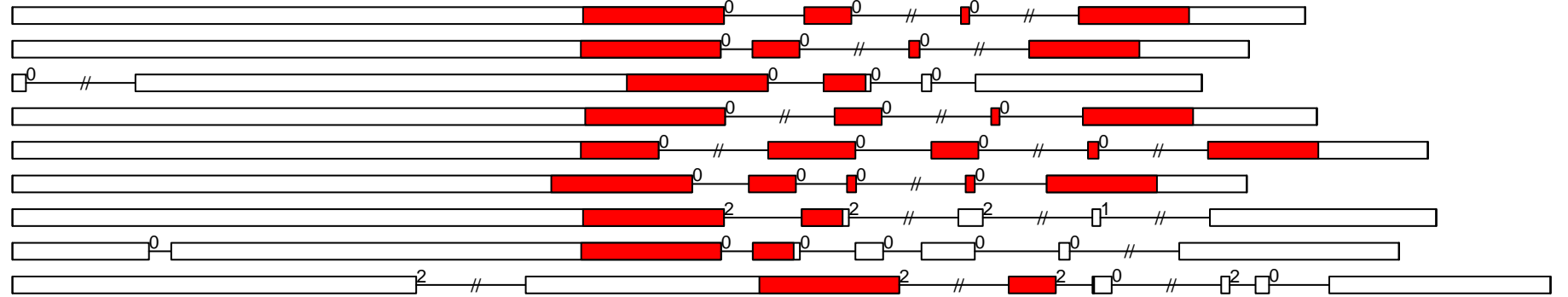

G.ba RLK-Pelle_LRR-XV exon-intron and domain diagram (all)

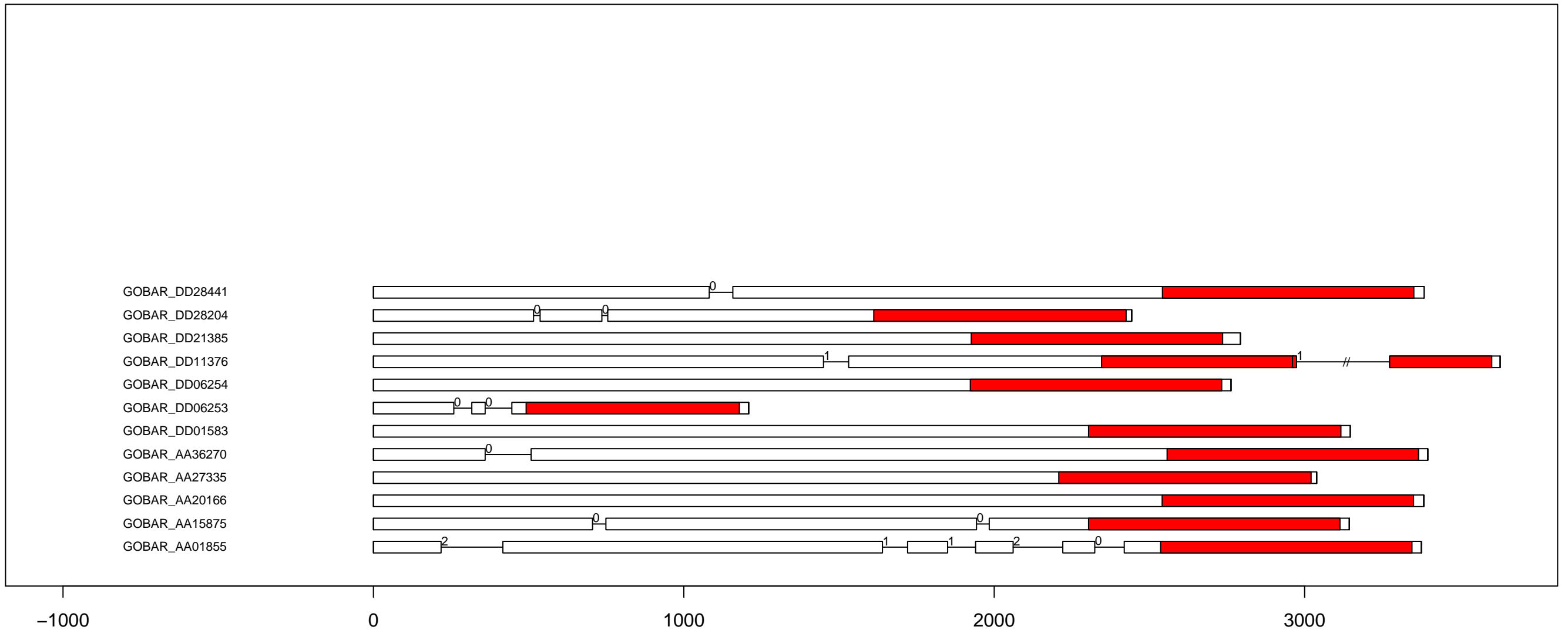

G.ba RLK-Pelle_LysM exon-intron and domain diagram (part 1)

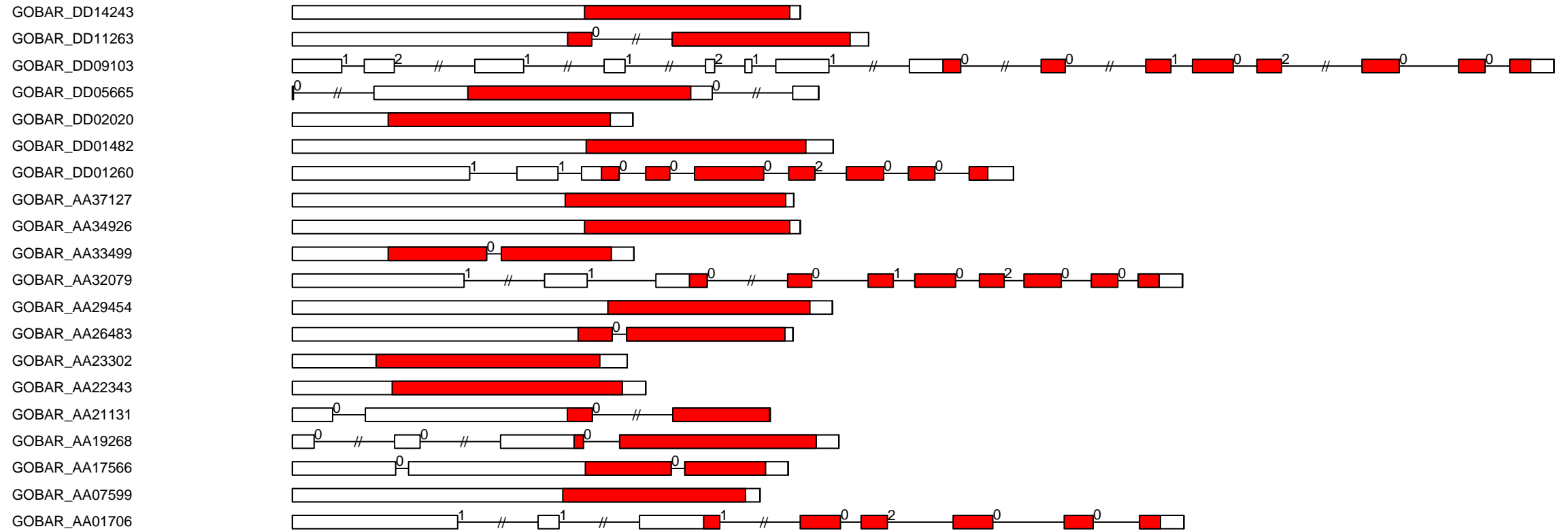

G.ba RLK-Pelle_LysM exon-intron and domain diagram (part 2)

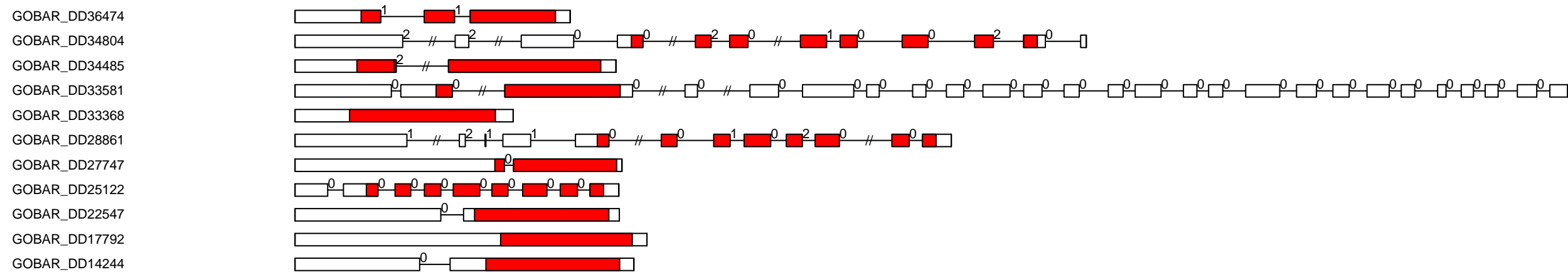

G.ba RLK-Pelle_PERK-1 exon-intron and domain diagram (part 1)

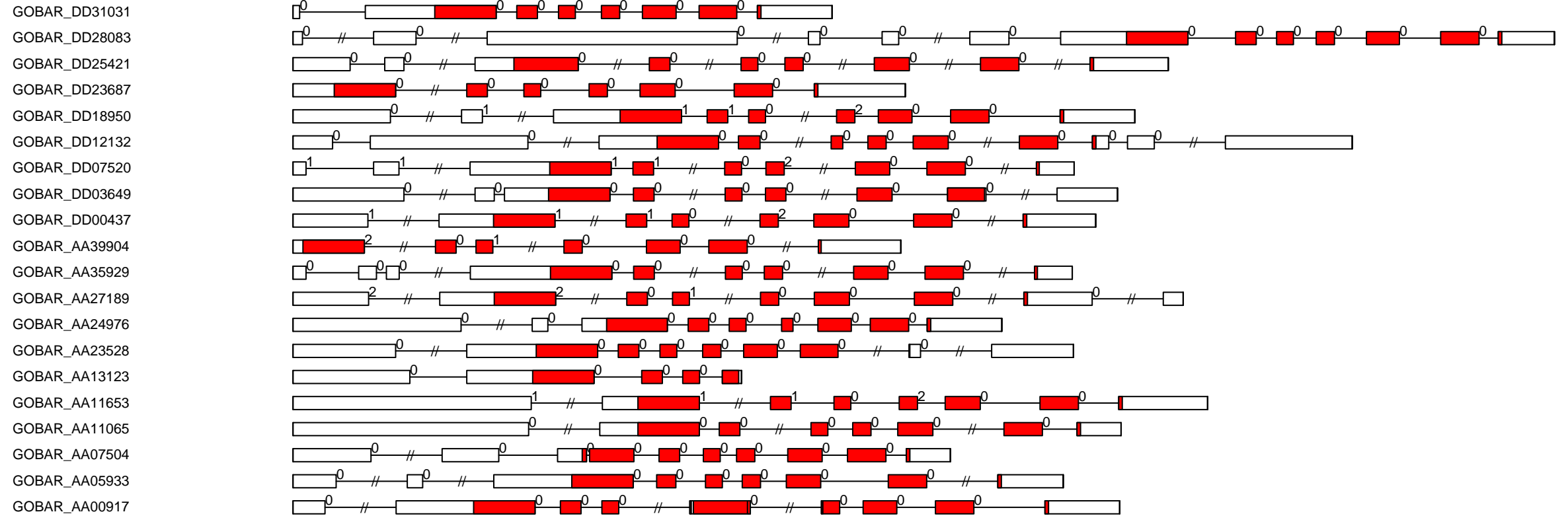

-1000

0

1000

2000

3000

4000

5000

G.ba RLK-Pelle_PERK-1 exon-intron and domain diagram (part 2)

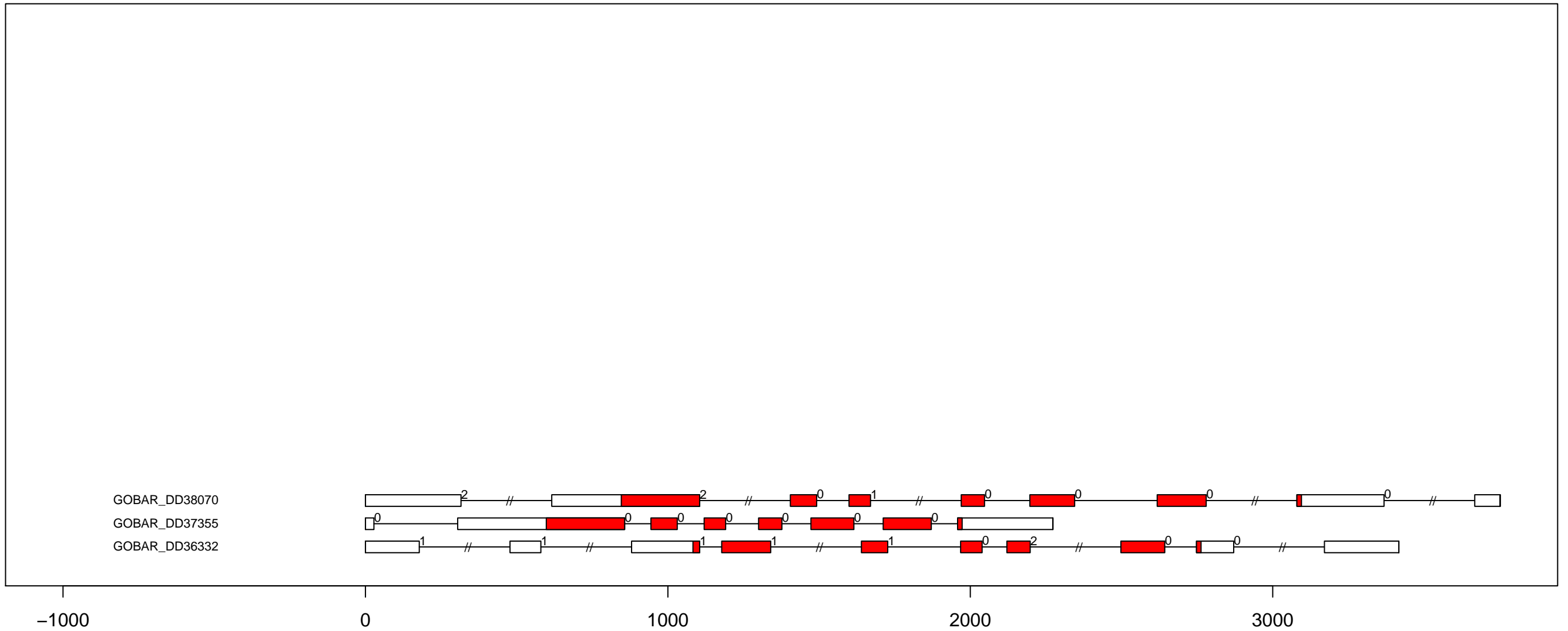

G.ba RLK-Pelle_RKF3 exon-intron and domain diagram (all)

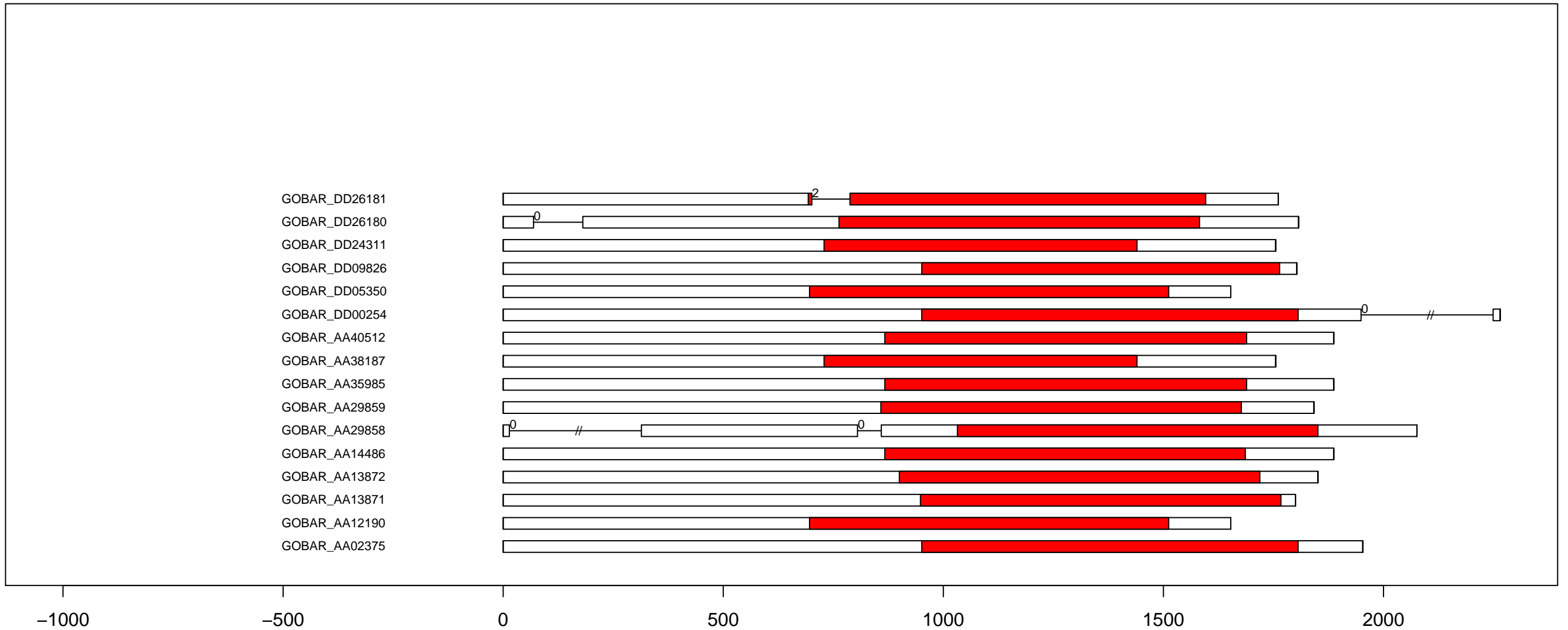

G.ba RLK-Pelle_RLCK-II exon-intron and domain diagram (all)

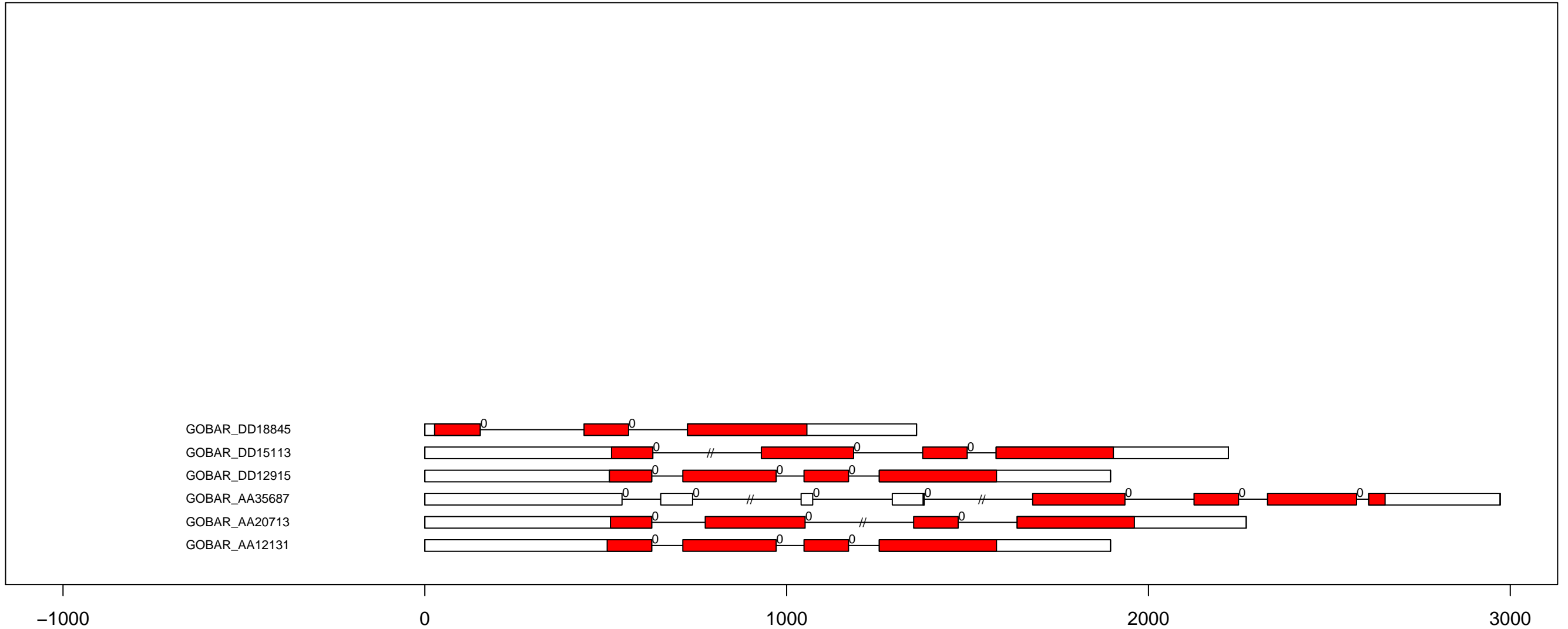

G.ba RLK-Pelle_RLCK-IXa exon-intron and domain diagram (all)

GOBAR_DD28203
 GOBAR_DD17576
 GOBAR_DD16228
 GOBAR_AA28414
 GOBAR_AA27333
 GOBAR_AA15587

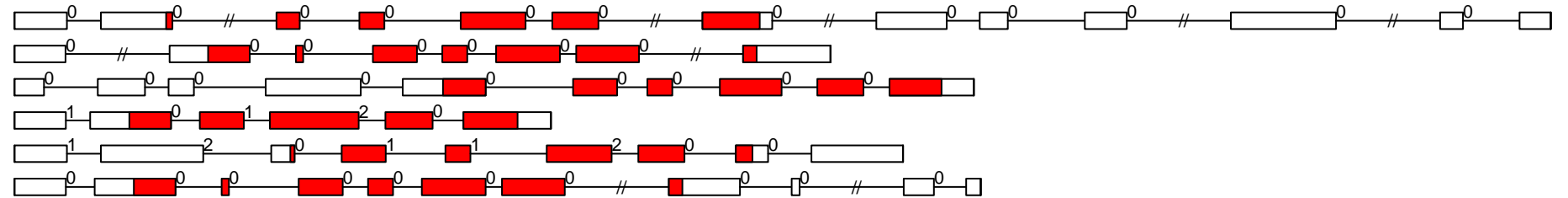

-1000

0

1000

2000

3000

4000

G.ba RLK-Pelle_RLCK-IXb exon-intron and domain diagram (part 1)

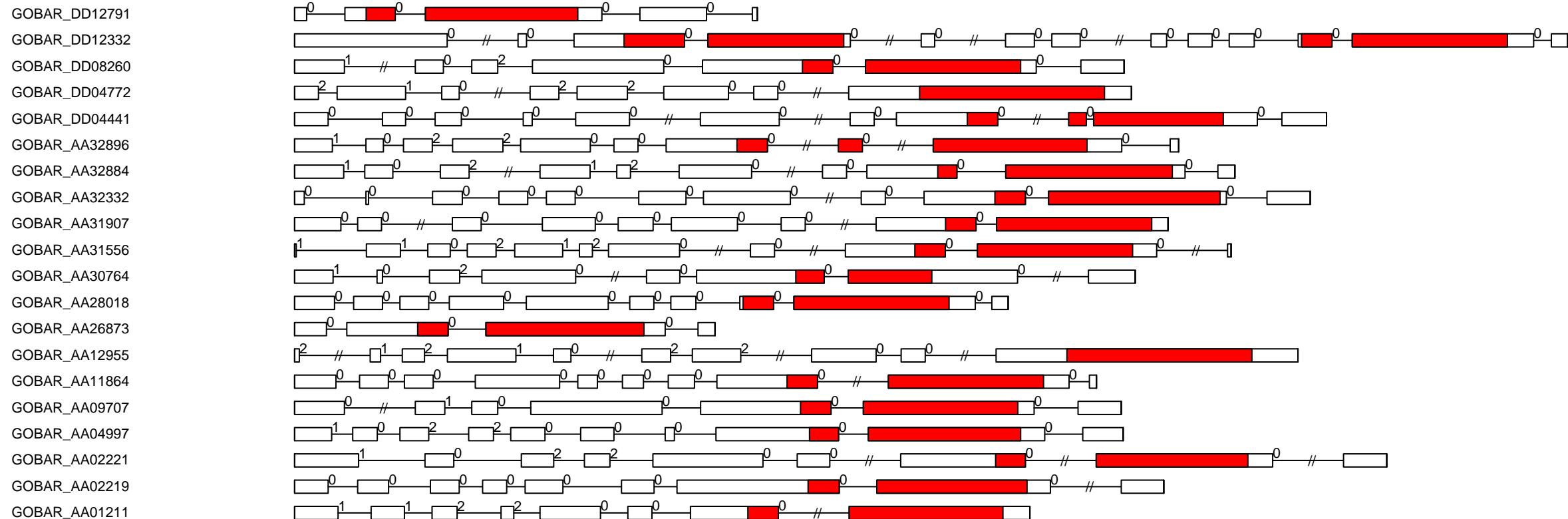

G.ba RLK-Pelle_RLCK-Os exon-intron and domain diagram (all)

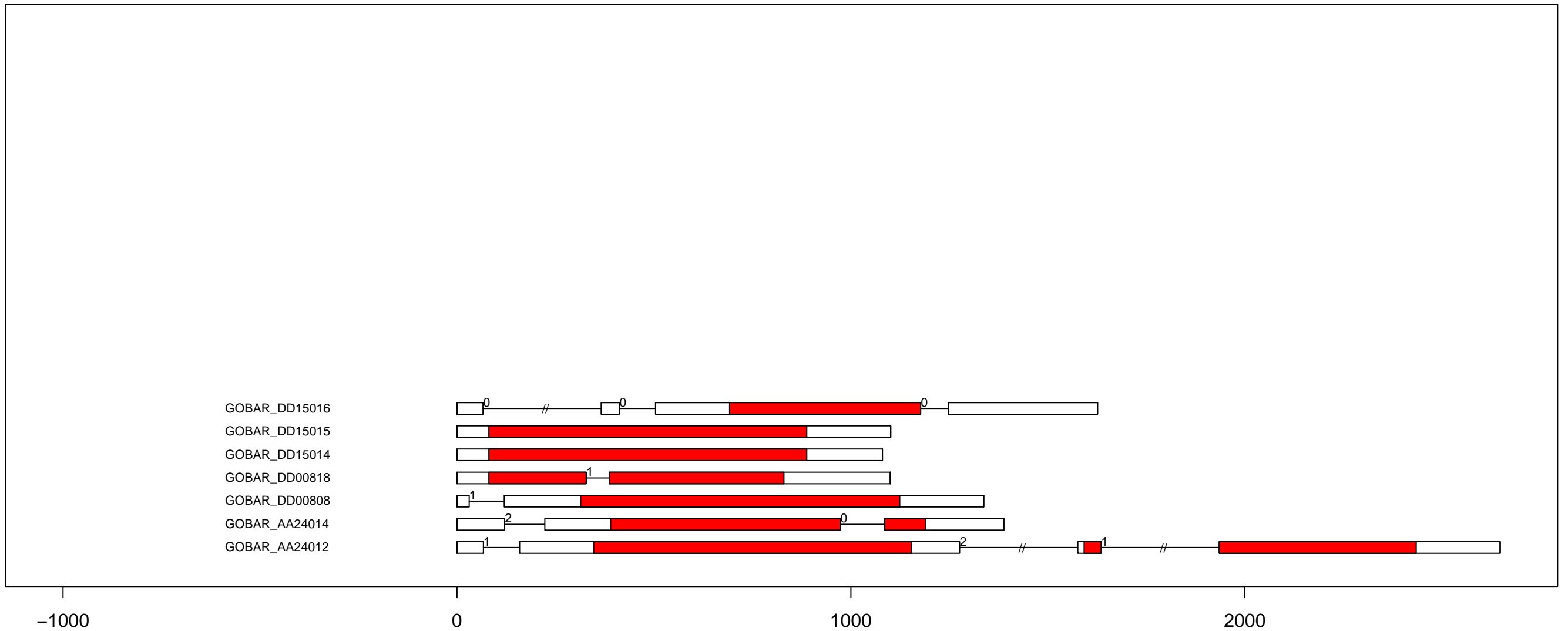

G.ba RLK-Pelle_RLCK-VIIa-1 exon-intron and domain diagram (part 1)

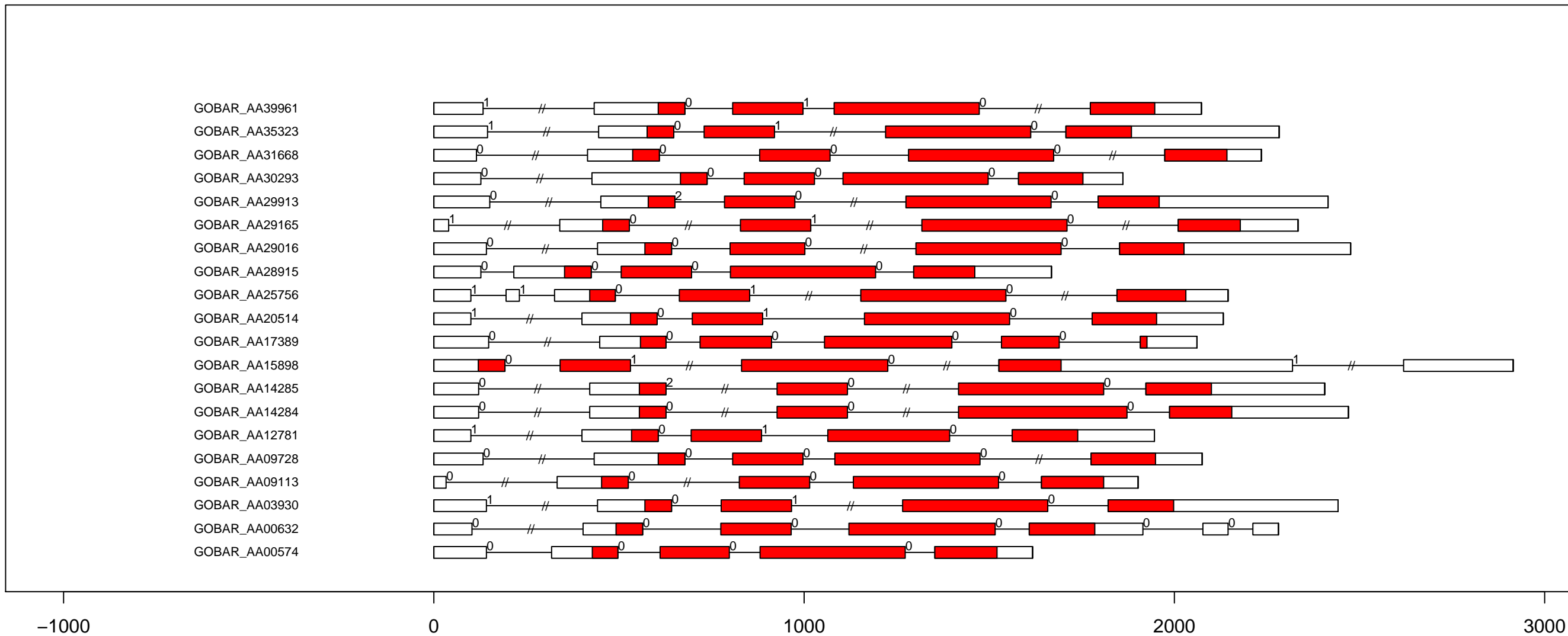

G.ba RLK-Pelle_RLCK-VIIa-1 exon-intron and domain diagram (part 2)

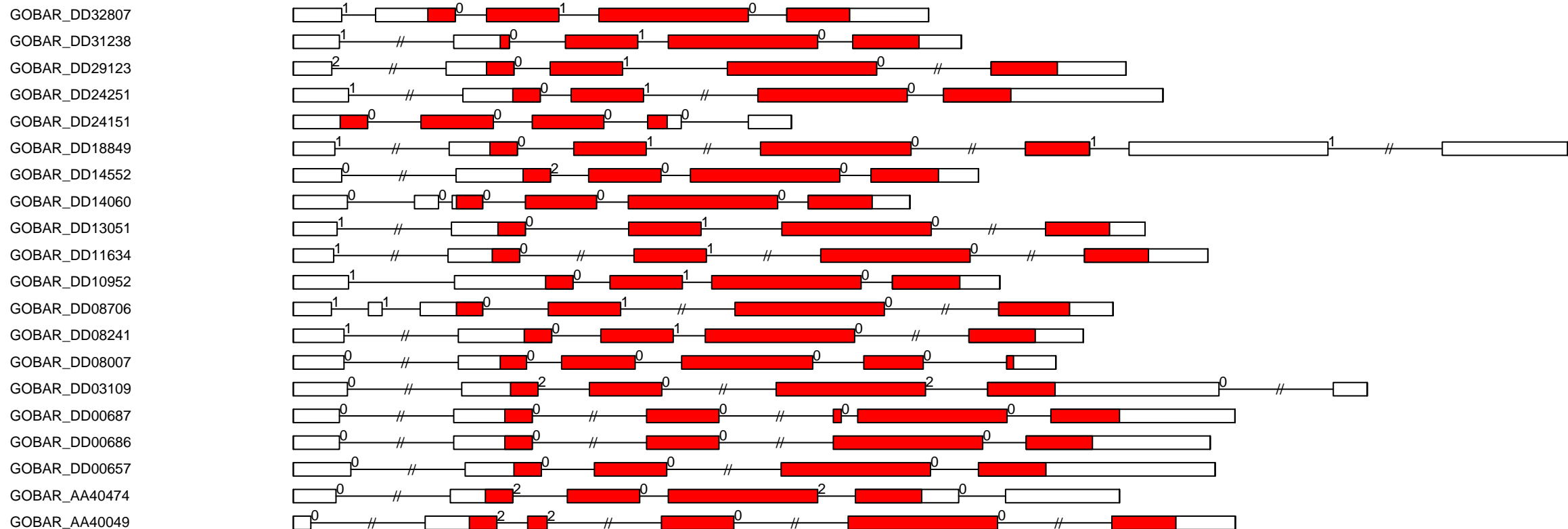

-1000

0

1000

2000

3000

G.ba RLK-Pelle_RLCK-VIIa-1 exon-intron and domain diagram (part 3)

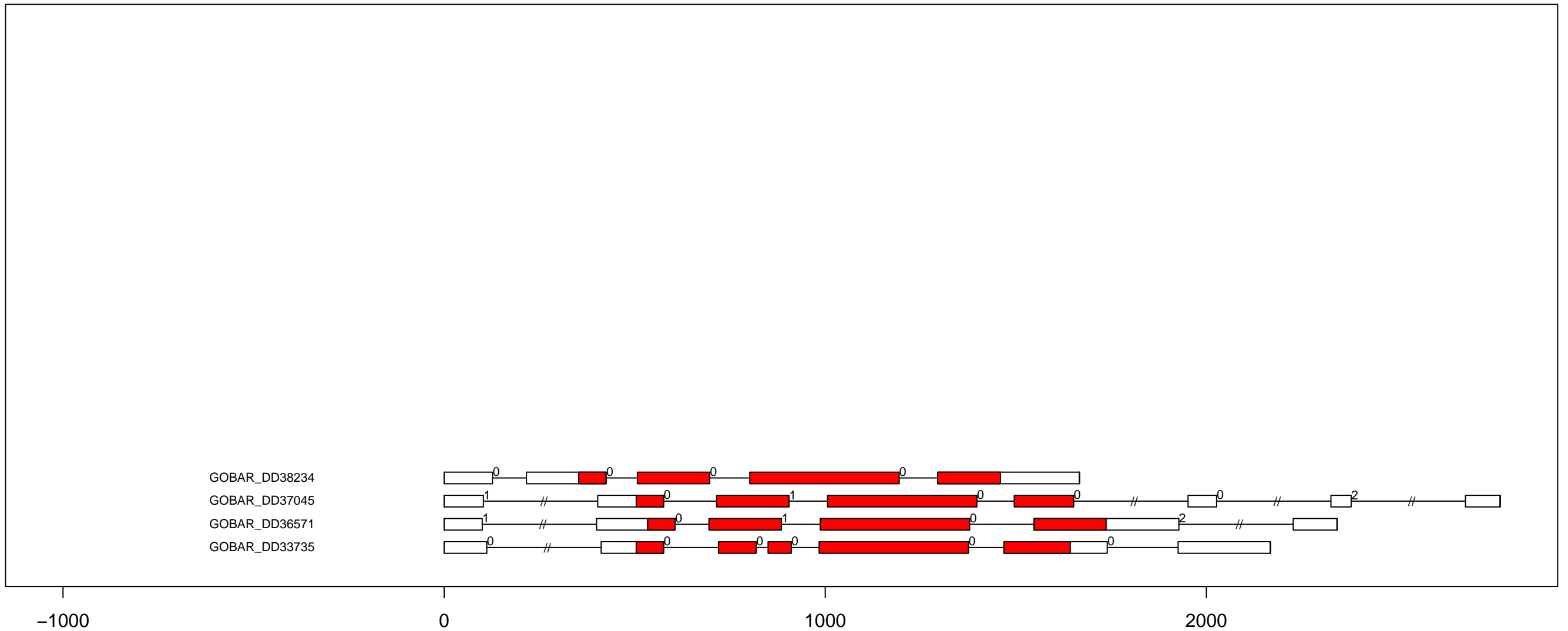

G.ba RLK-Pelle_RLCK-VIIa-2 exon-intron and domain diagram (part 1)

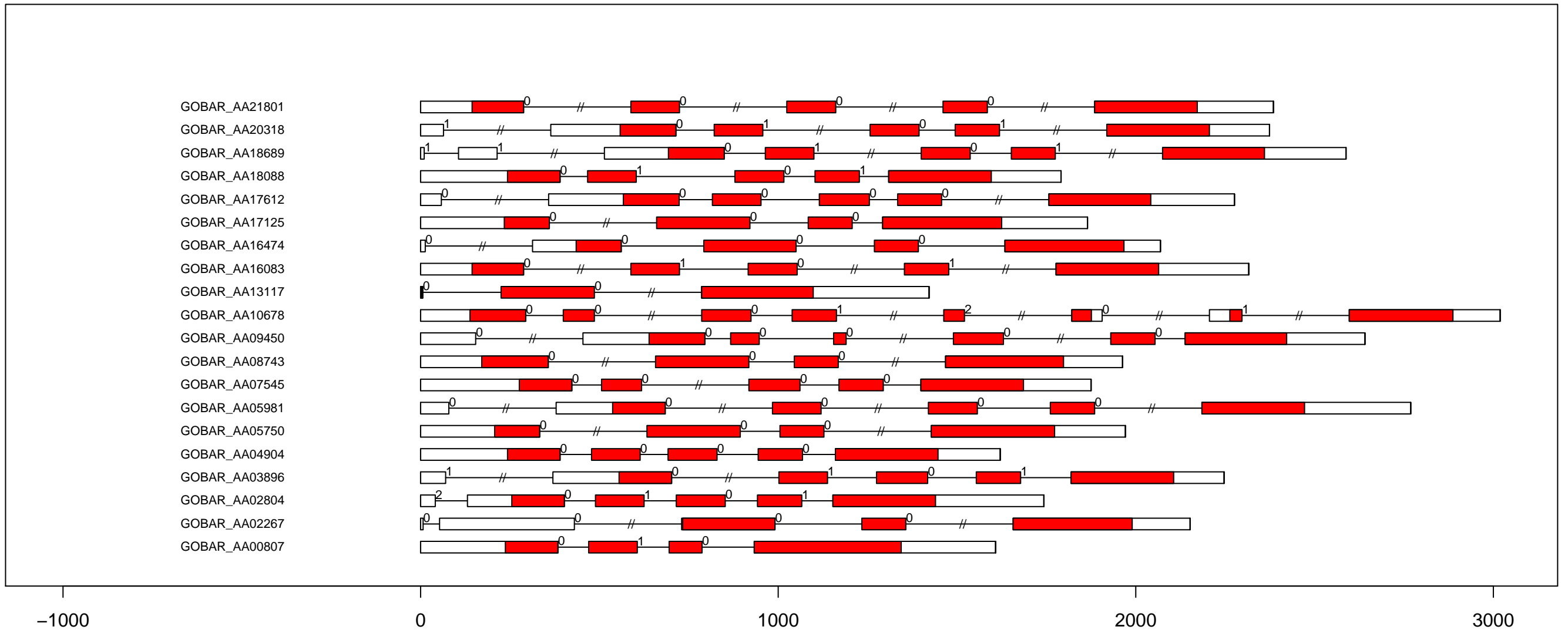

G.ba RLK-Pelle_RLCK-VIIa-2 exon-intron and domain diagram (part 3)

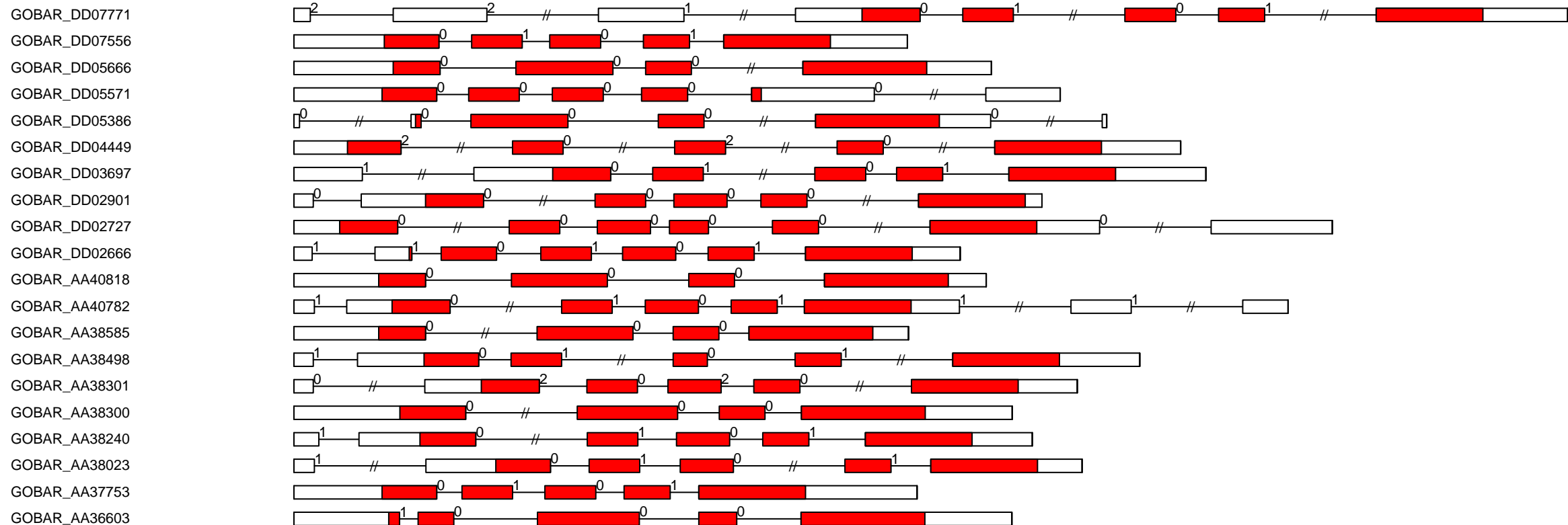

-1000

0

1000

2000

3000

G.ba RLK-Pelle_RLCK-VIIa-2 exon-intron and domain diagram (part 4)

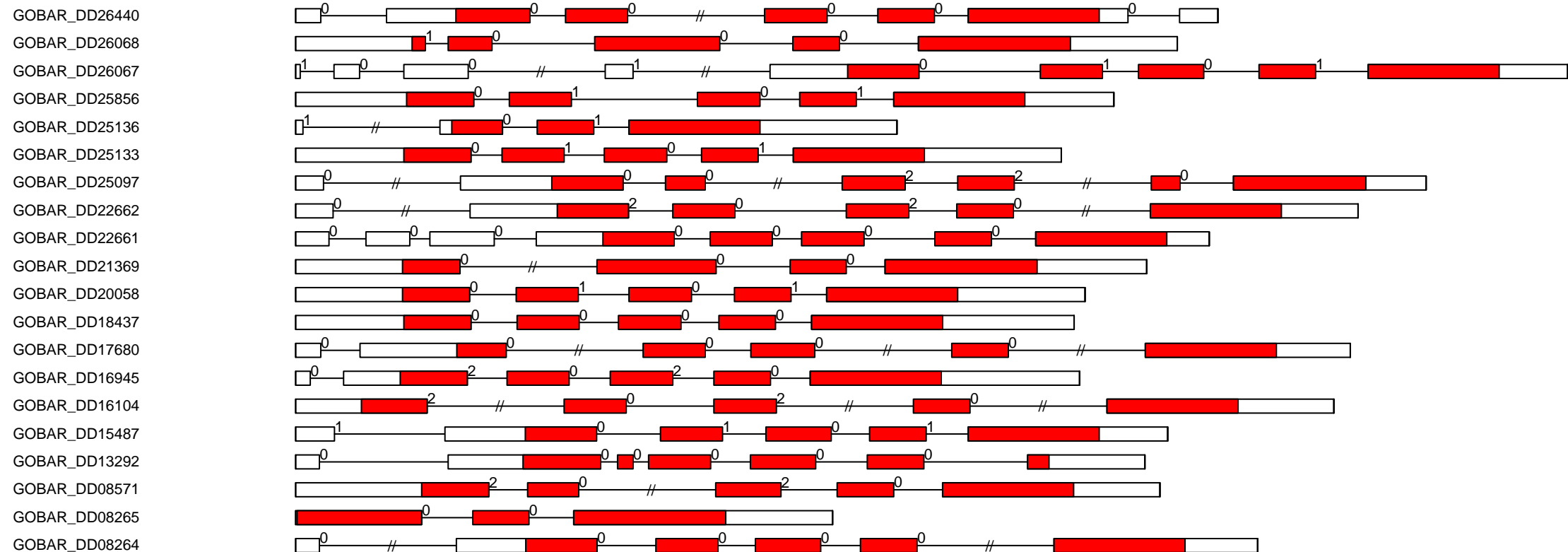

-1000

0

1000

2000

G.ba RLK-Pelle_RLCK-VIIa-2 exon-intron and domain diagram (part 5)

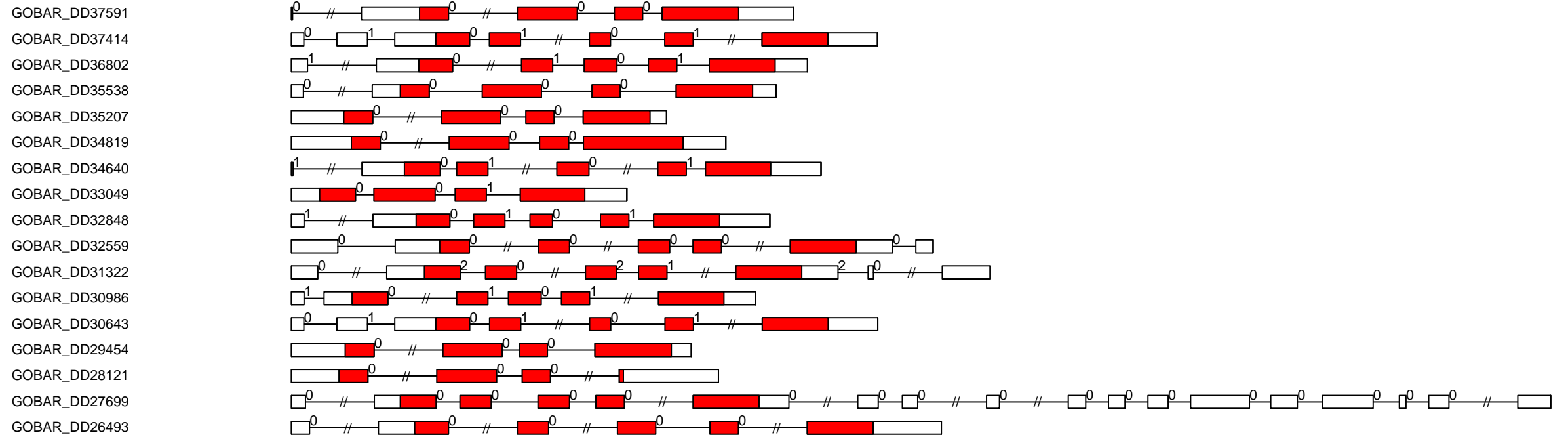

G.ba RLK-Pelle_RLCK-VIII exon-intron and domain diagram (all)

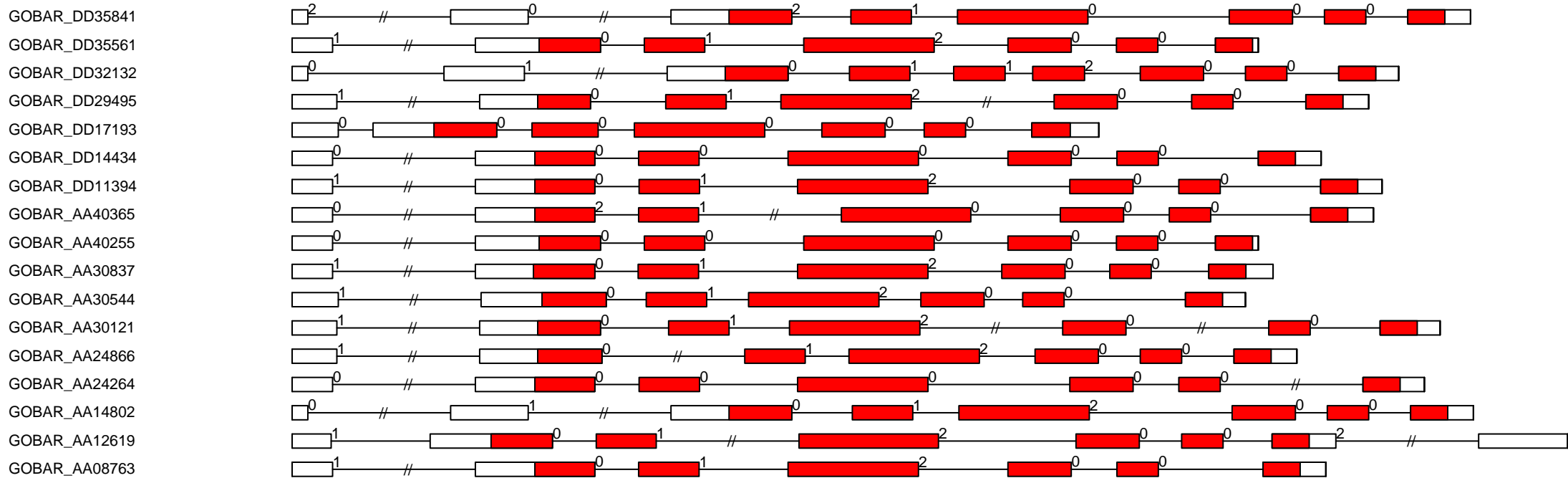

-1000

0

1000

2000

G.ba RLK-Pelle_RLCK-VI exon-intron and domain diagram (part 1)

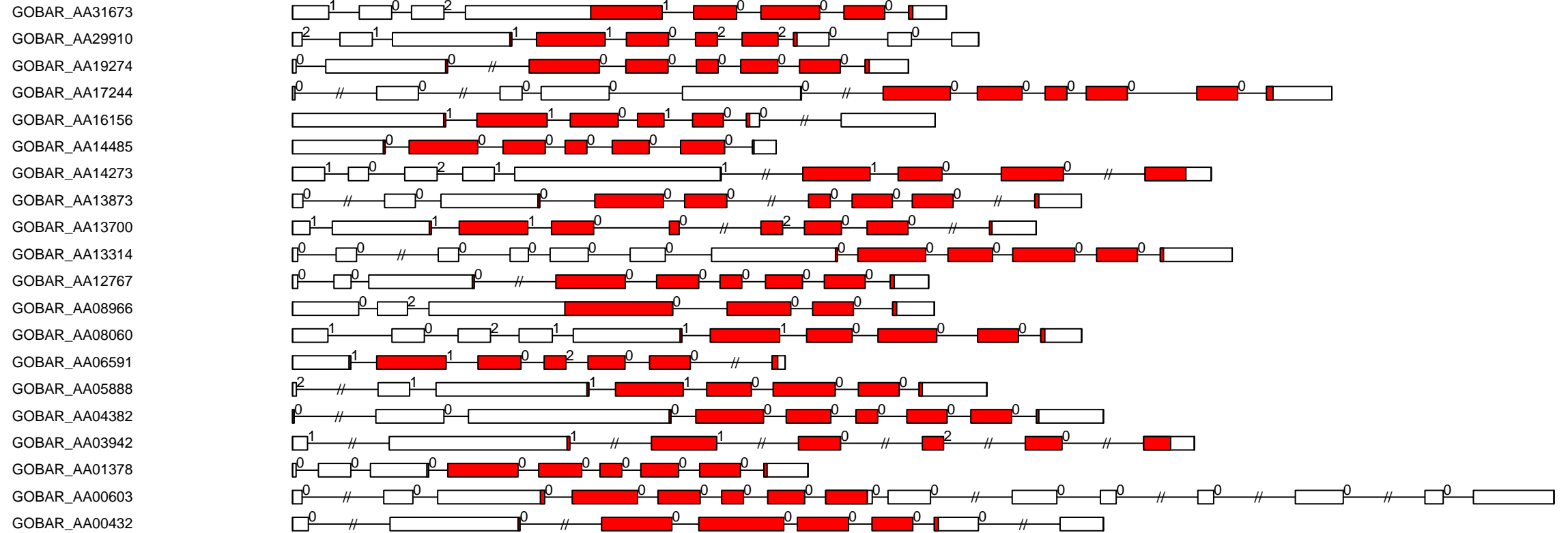

G.ba RLK-Pelle_RLCK-VI exon-intron and domain diagram (part 2)

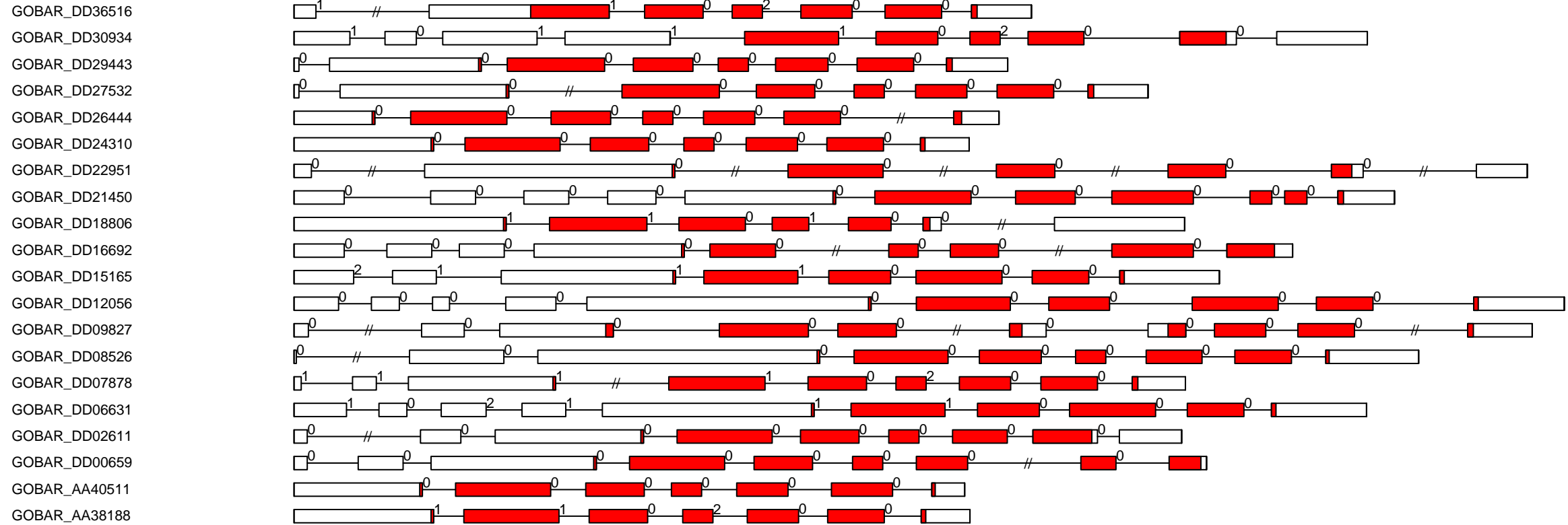

-1000

0

1000

2000

3000

G.ba RLK-Pelle_RLCK-V exon-intron and domain diagram (part 2)

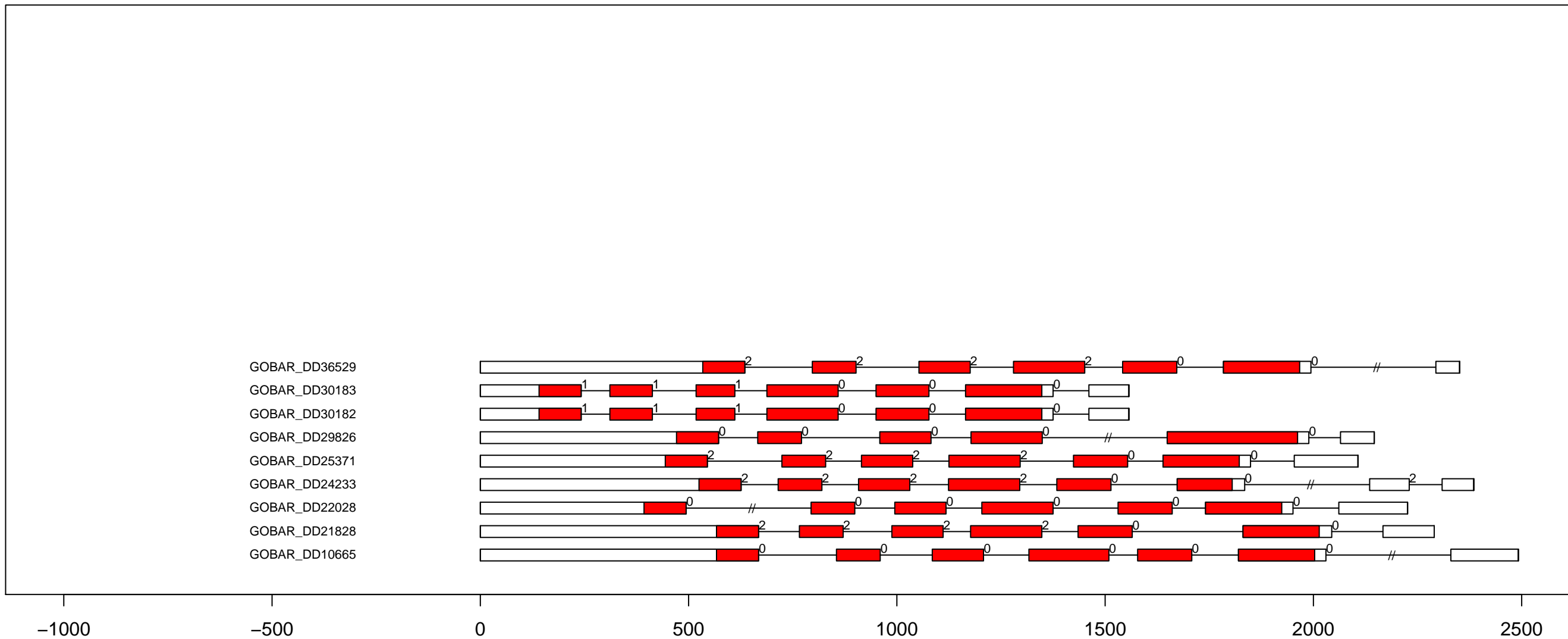

G.ba RLK-Pelle_RLCK-XII-1 exon-intron and domain diagram (part 1)

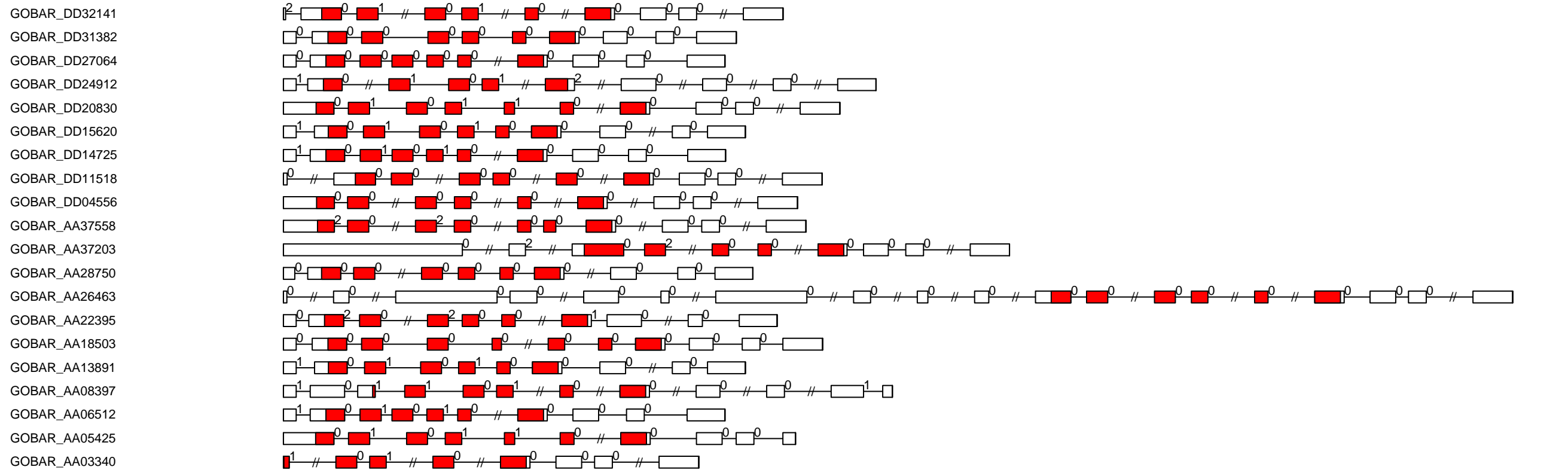

G.ba RLK-Pelle_RLCK-XII-1 exon-intron and domain diagram (part 2)

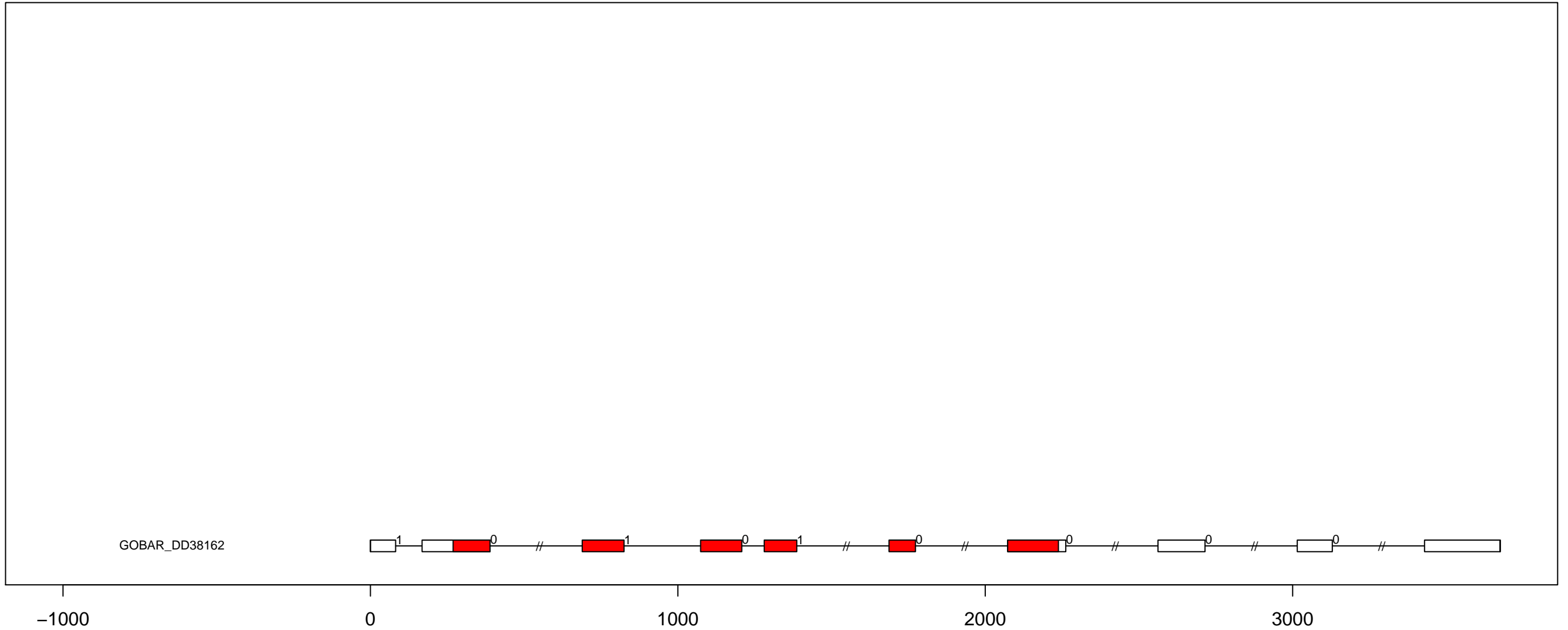

G.ba RLK-Pelle_RLCK-XII-2 exon-intron and domain diagram (all)

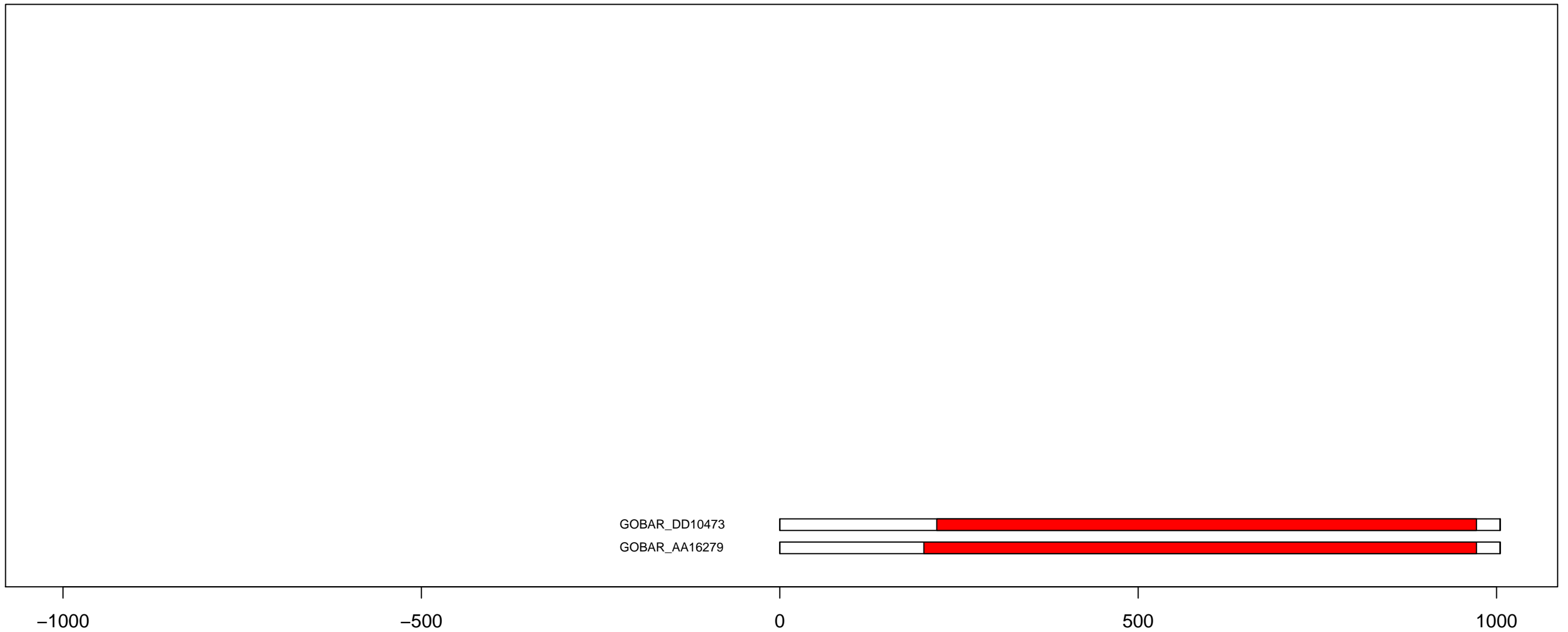

G.ba RLK-Pelle_RLCK-XIII exon-intron and domain diagram (all)

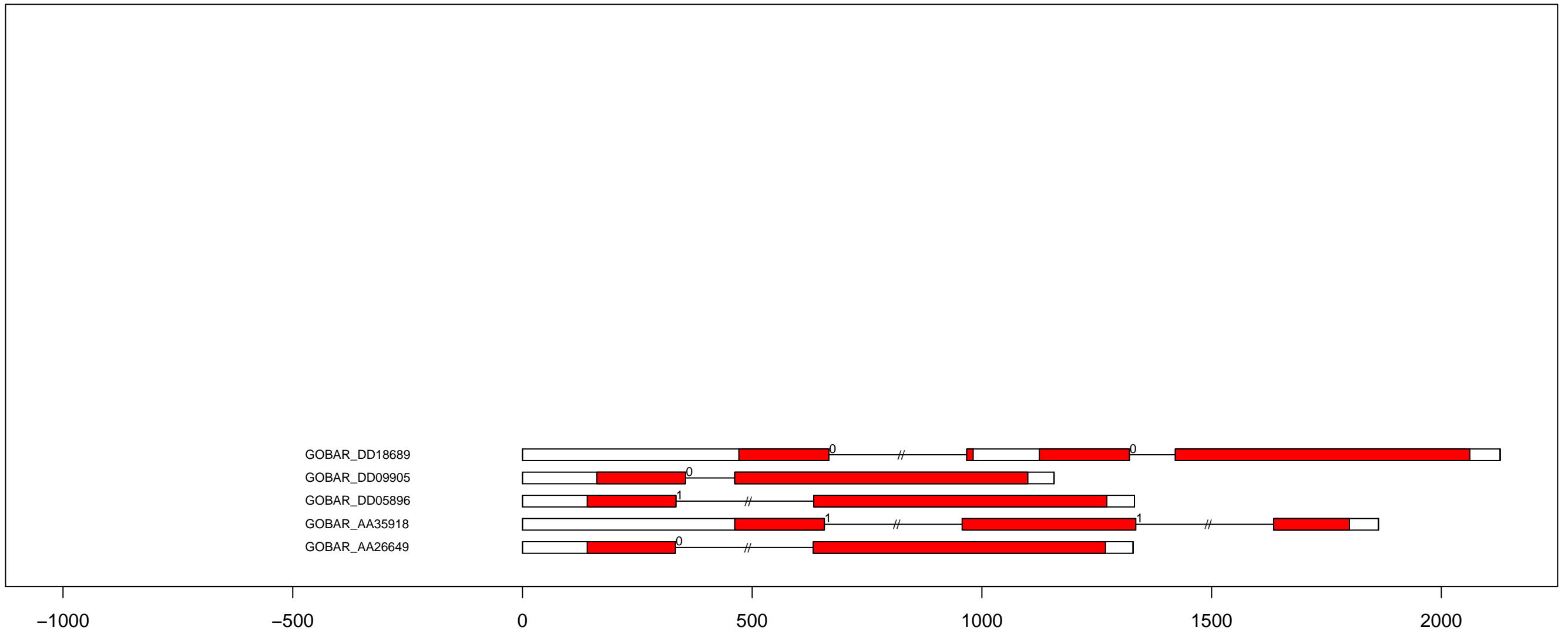

G.ba RLK-Pelle_RLCK-XI exon-intron and domain diagram (all)

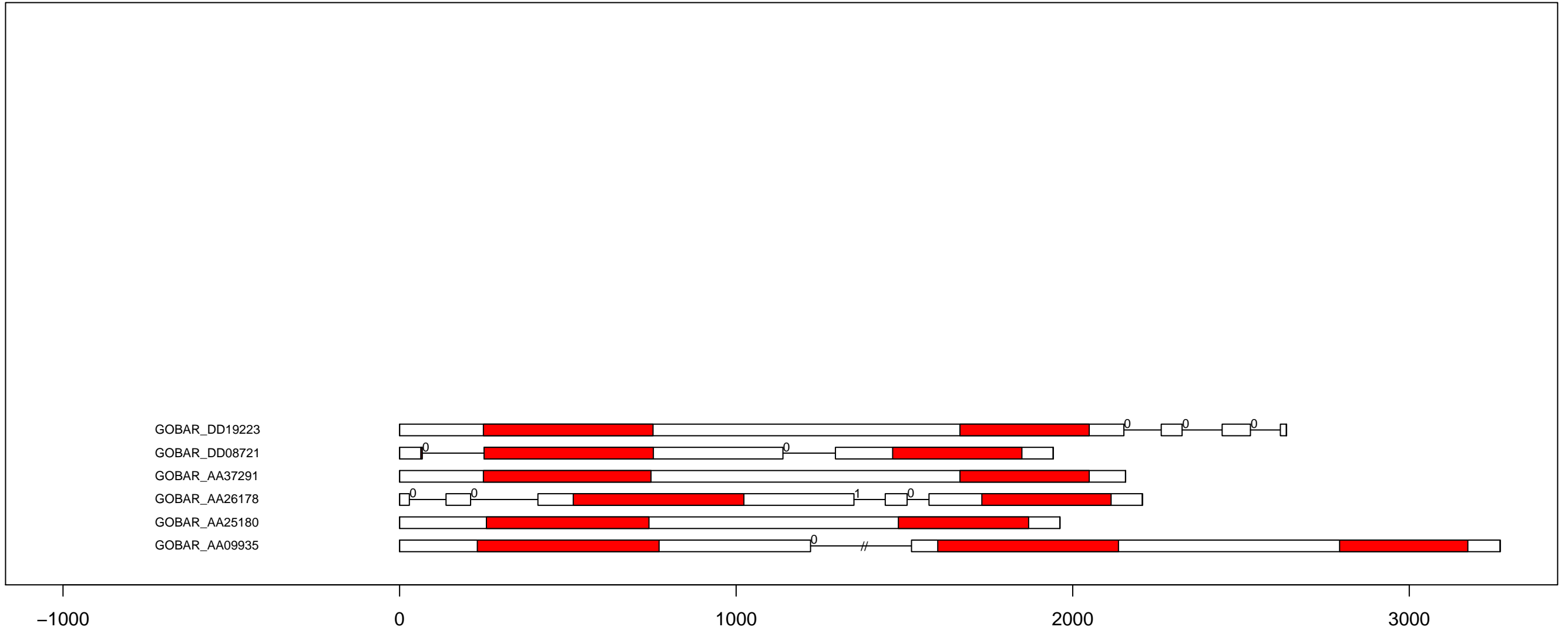

G.ba RLK-Pelle_RLCK-XVI exon-intron and domain diagram (all)



G.ba RLK-Pelle_RLCK-XV exon-intron and domain diagram (all)

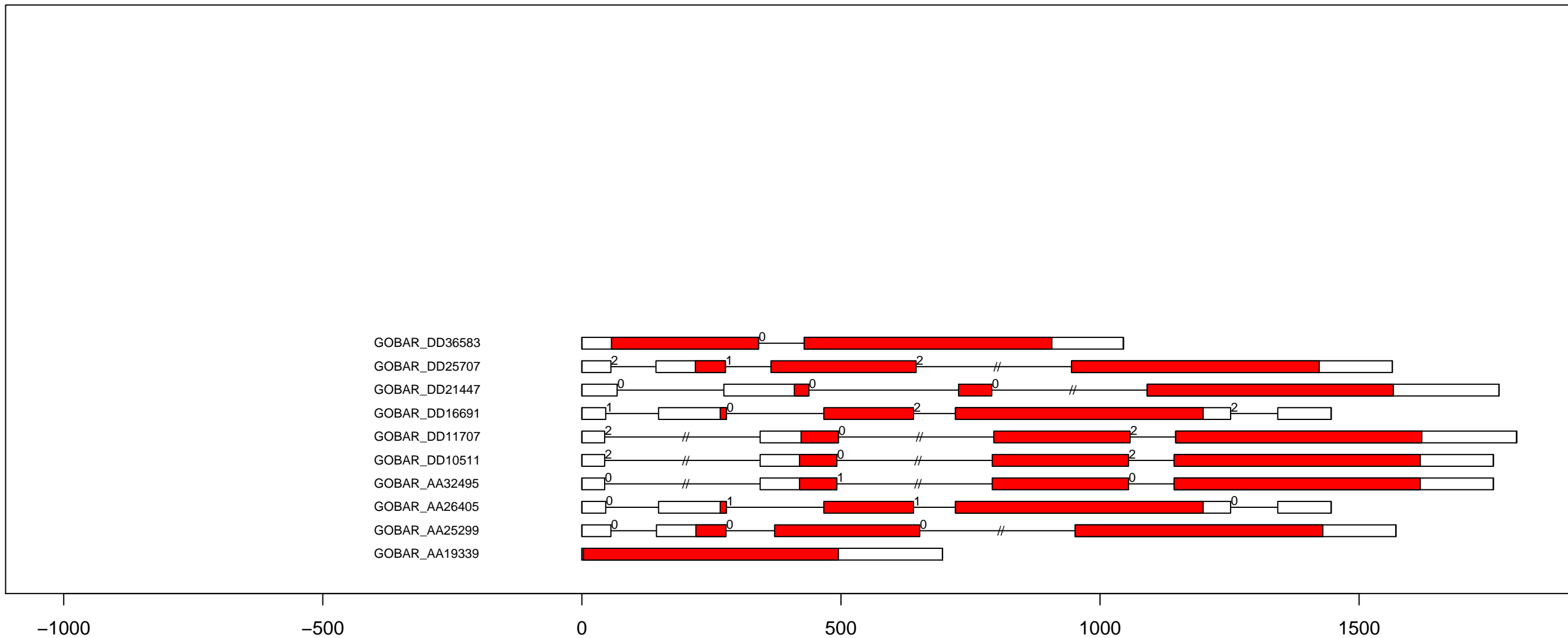

G.ba RLK-Pelle_SD-2b exon-intron and domain diagram (part 1)

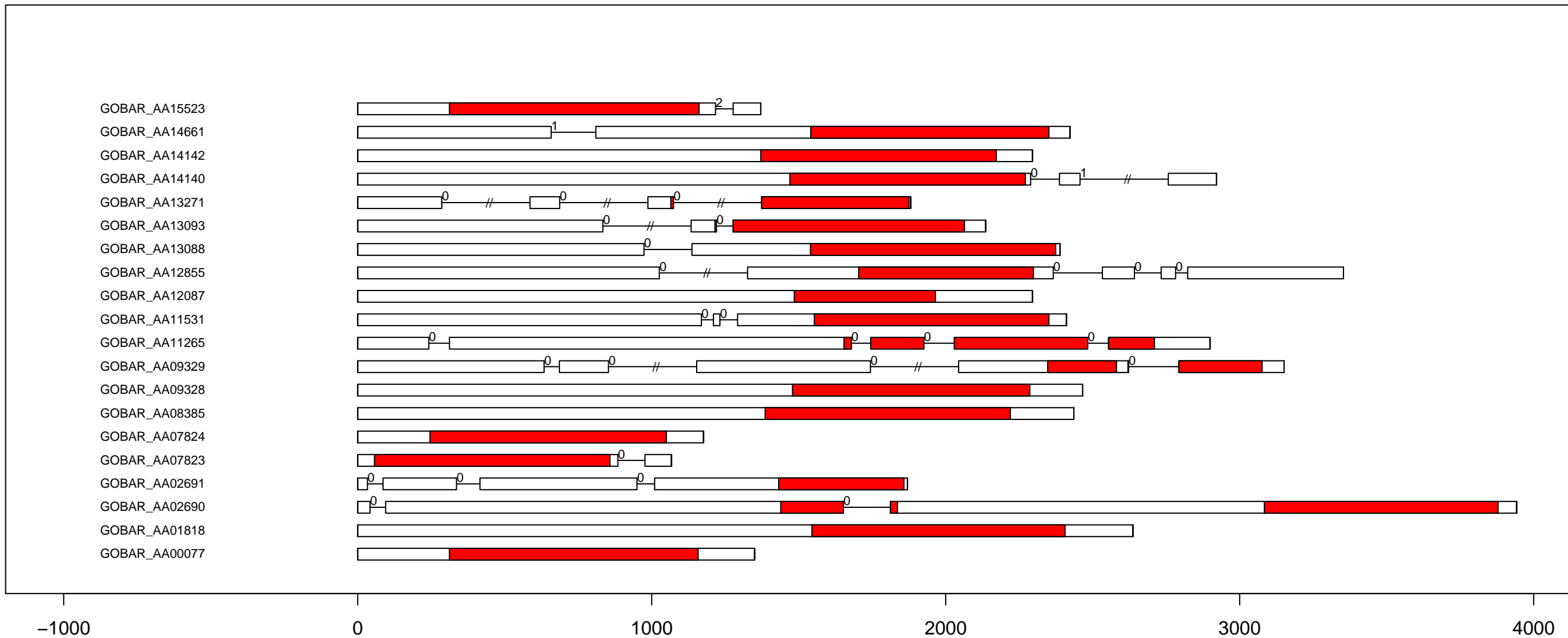

G.ba RLK-Pelle_SD-2b exon-intron and domain diagram (part 2)

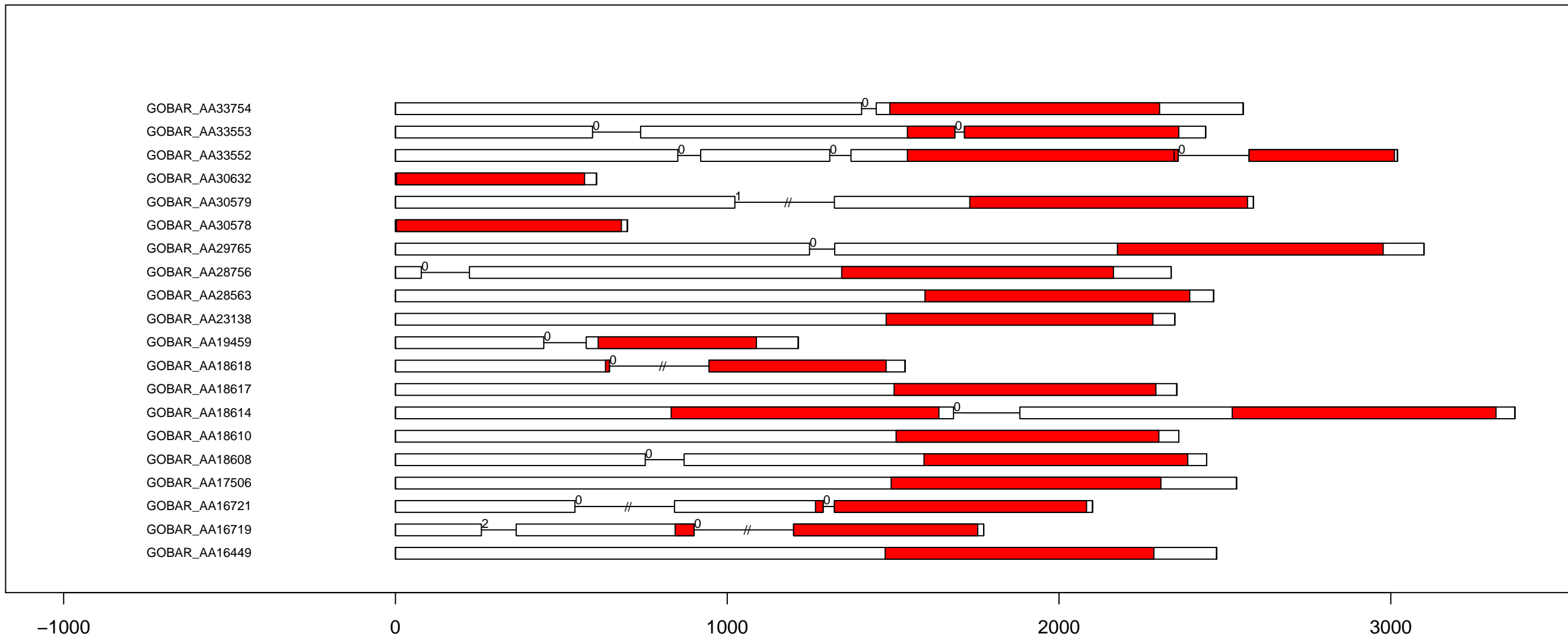

G.ba RLK-Pelle_SD-2b exon-intron and domain diagram (part 3)

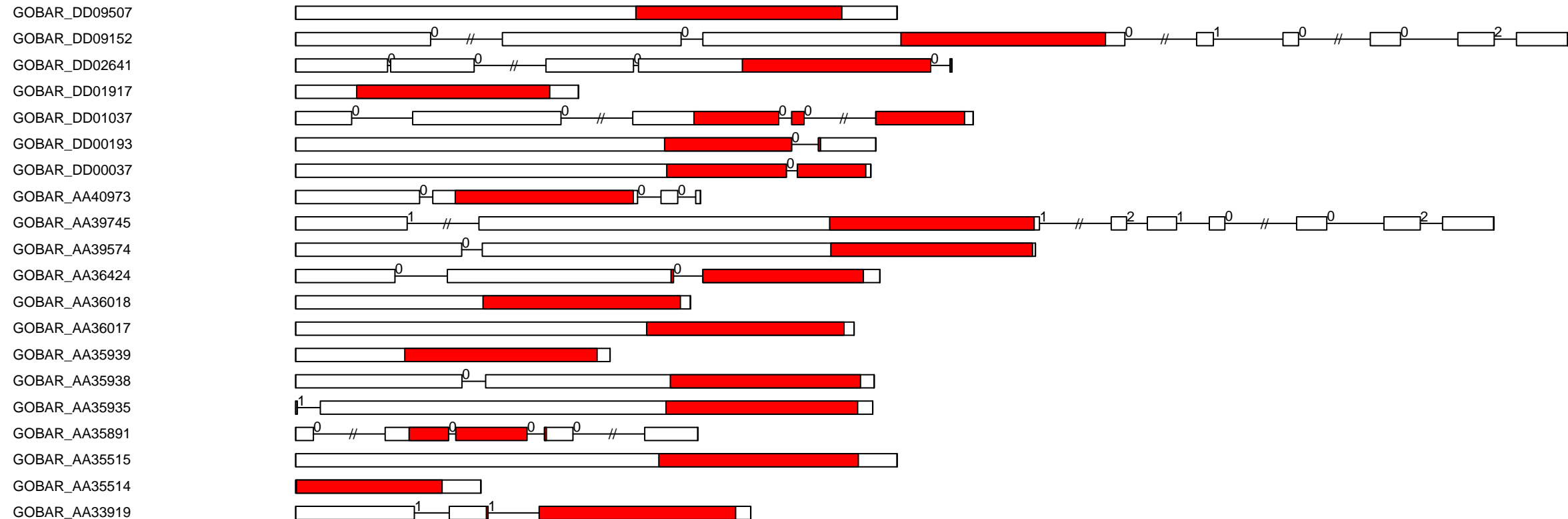

G.ba RLK-Pelle_SD-2b exon-intron and domain diagram (part 5)

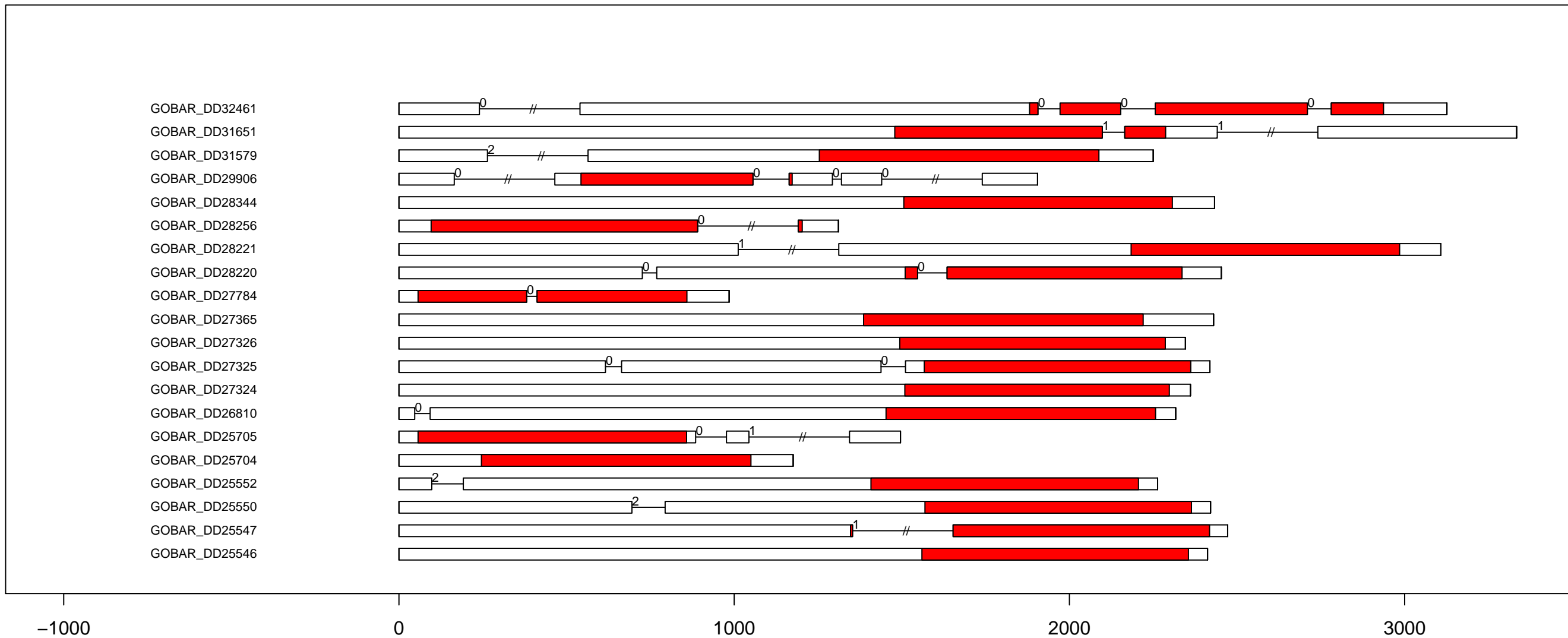

G.ba RLK-Pelle_SD-2b exon-intron and domain diagram (part 6)

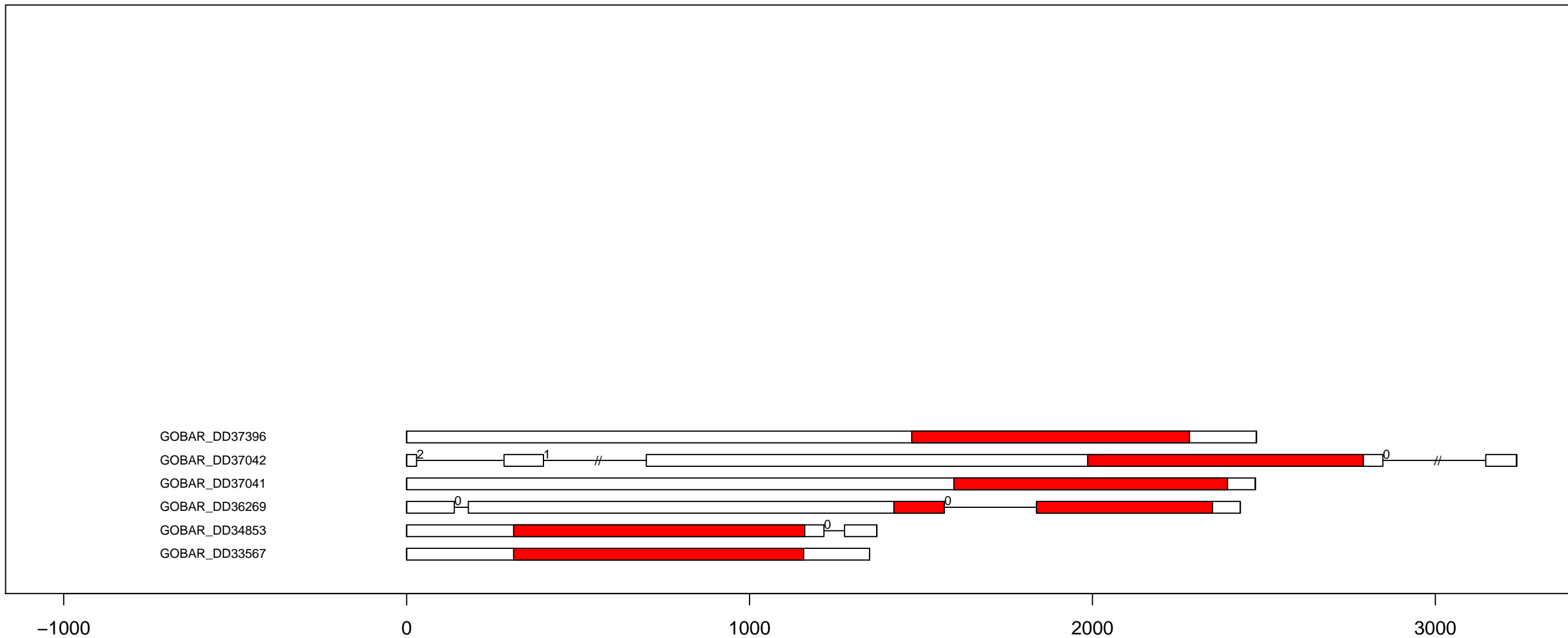

G.ba RLK-Pelle_Singleton exon-intron and domain diagram (all)

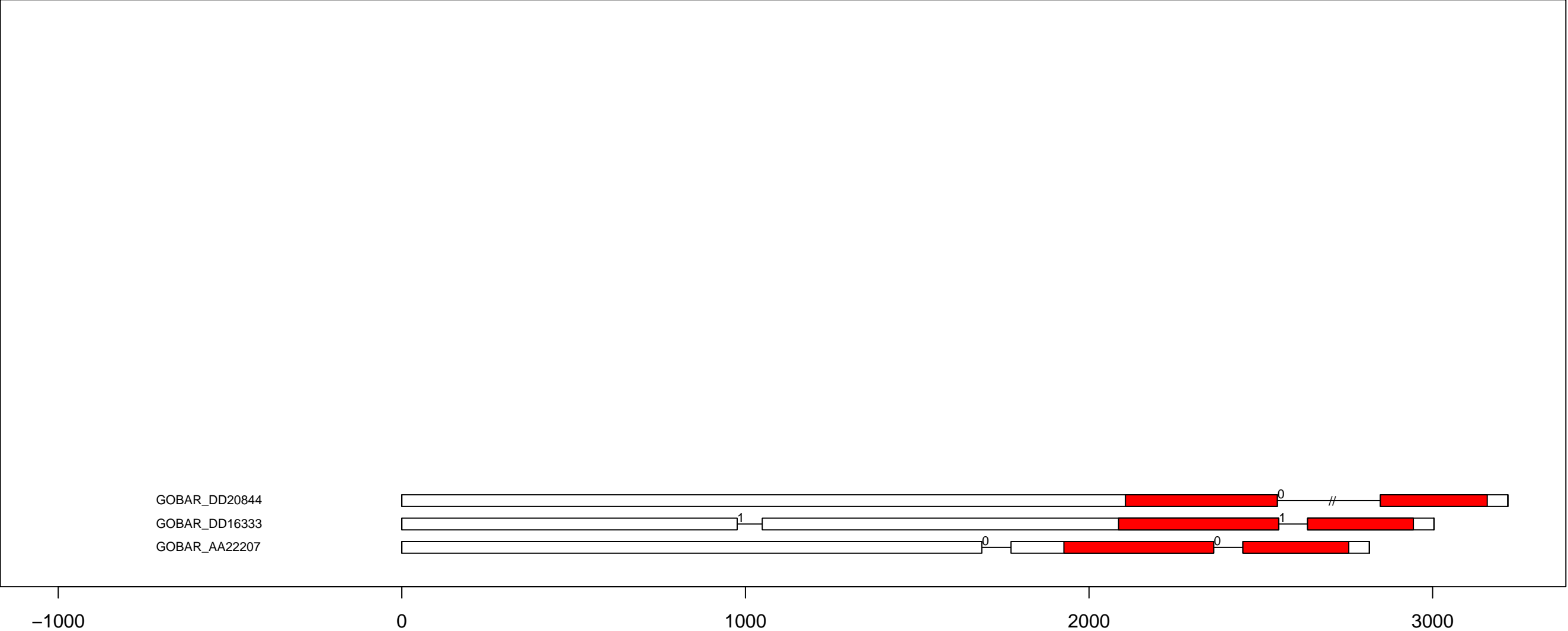

G.ba RLK-Pelle_URK-1 exon-intron and domain diagram (all)

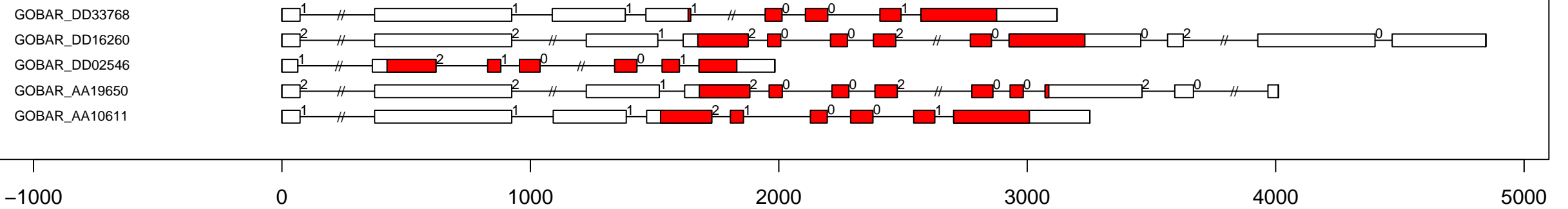

G.ba RLK-Pelle_URK-2 exon-intron and domain diagram (all)

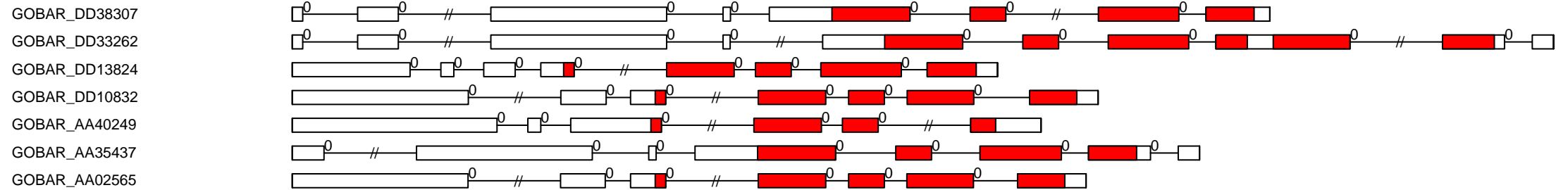

G.ba RLK-Pelle_URK-3 exon-intron and domain diagram (all)

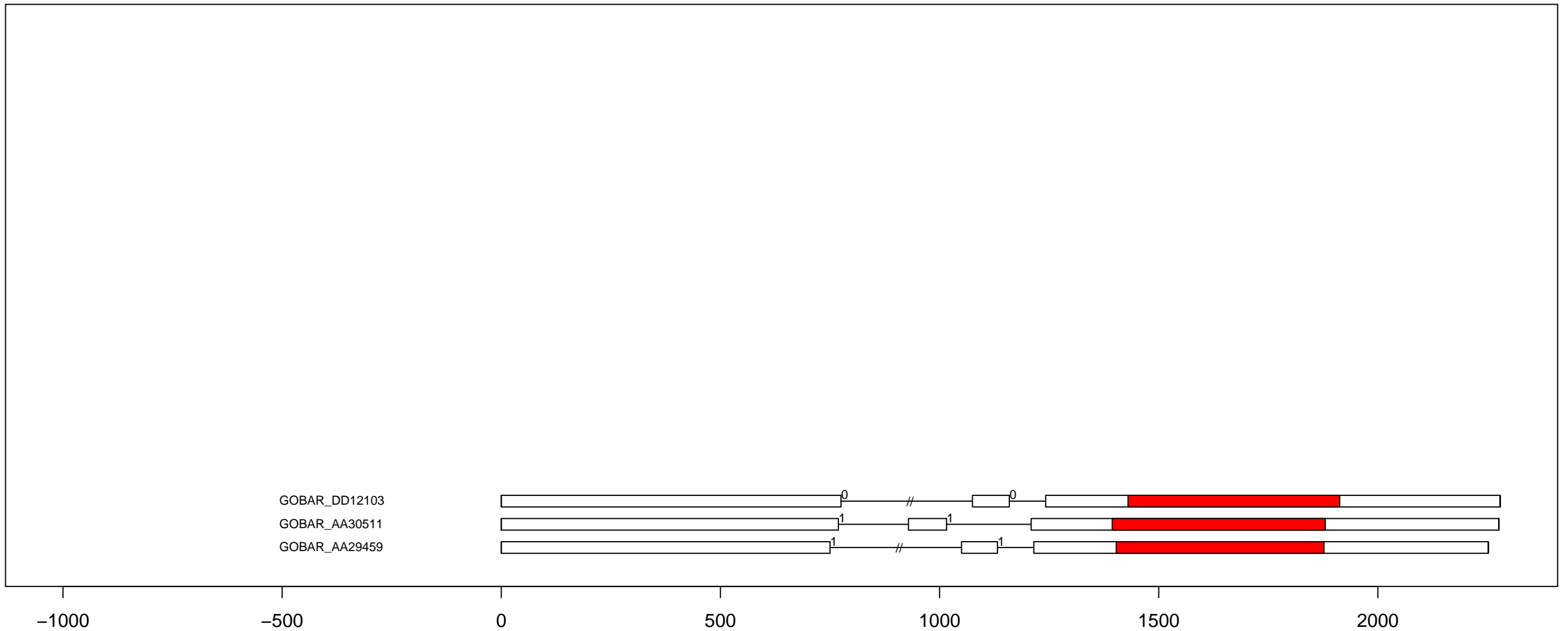

G.ba RLK-Pelle_WAK_LRK10L-1 exon-intron and domain diagram (part 1)

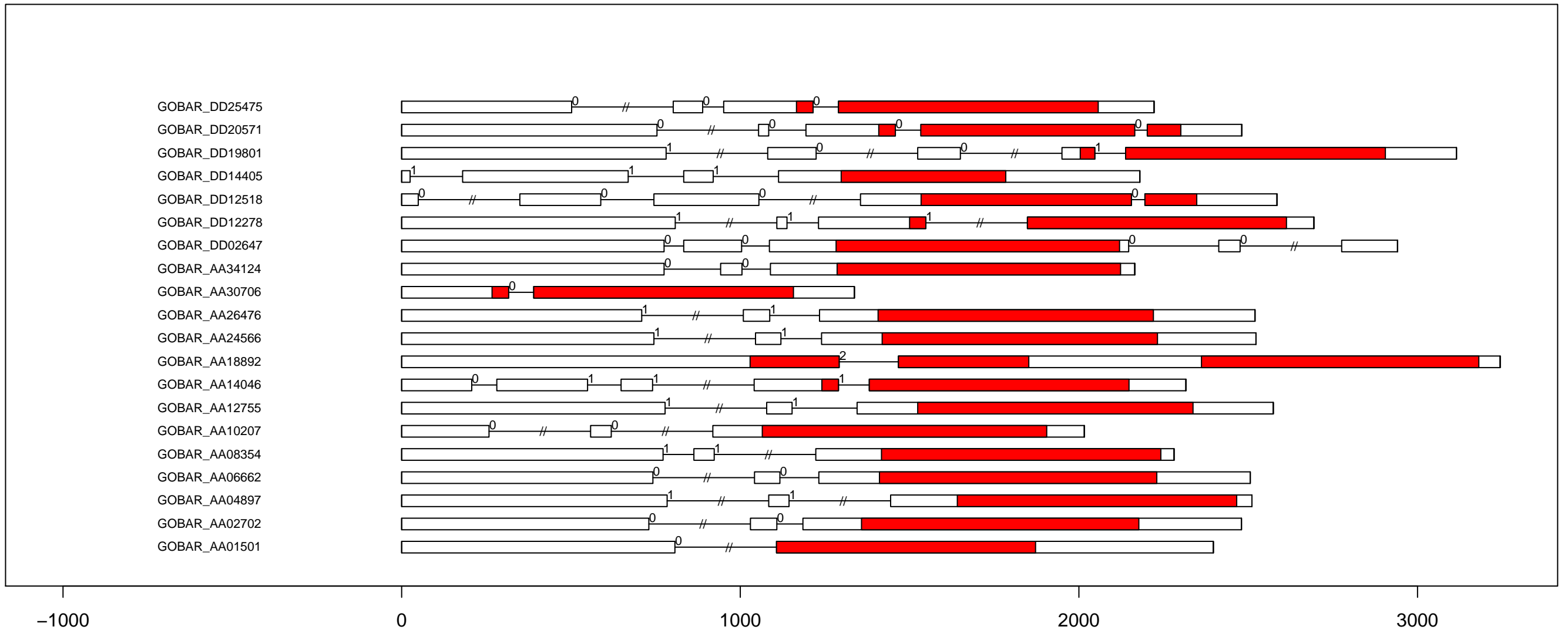

G.ba RLK-Pelle_WAK_LRK10L-1 exon-intron and domain diagram (part 2)

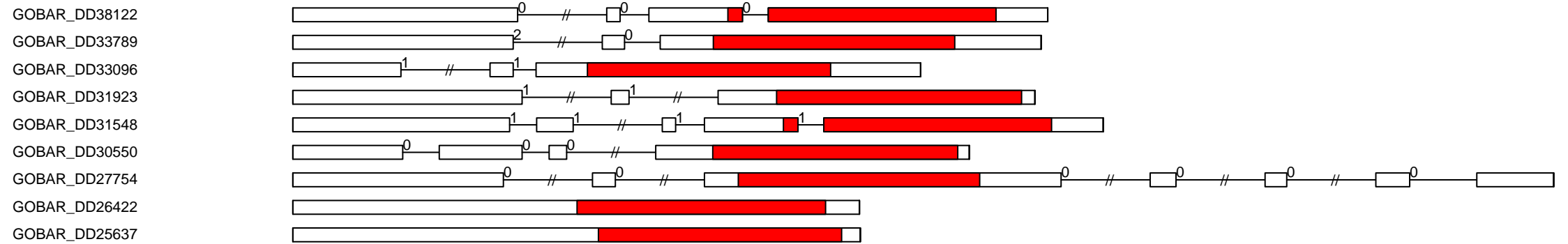

G.ba RLK-Pelle_WAK exon-intron and domain diagram (part 1)

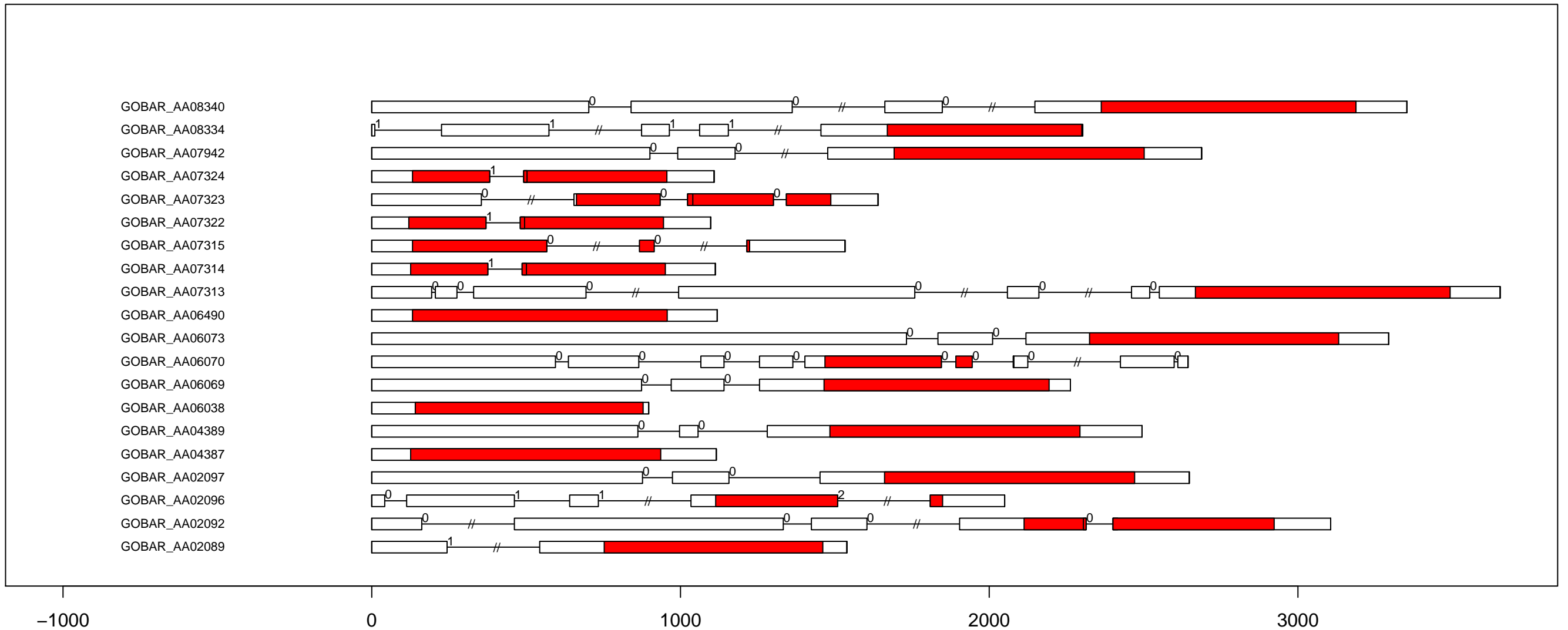

G.ba RLK-Pelle_WAK exon-intron and domain diagram (part 2)

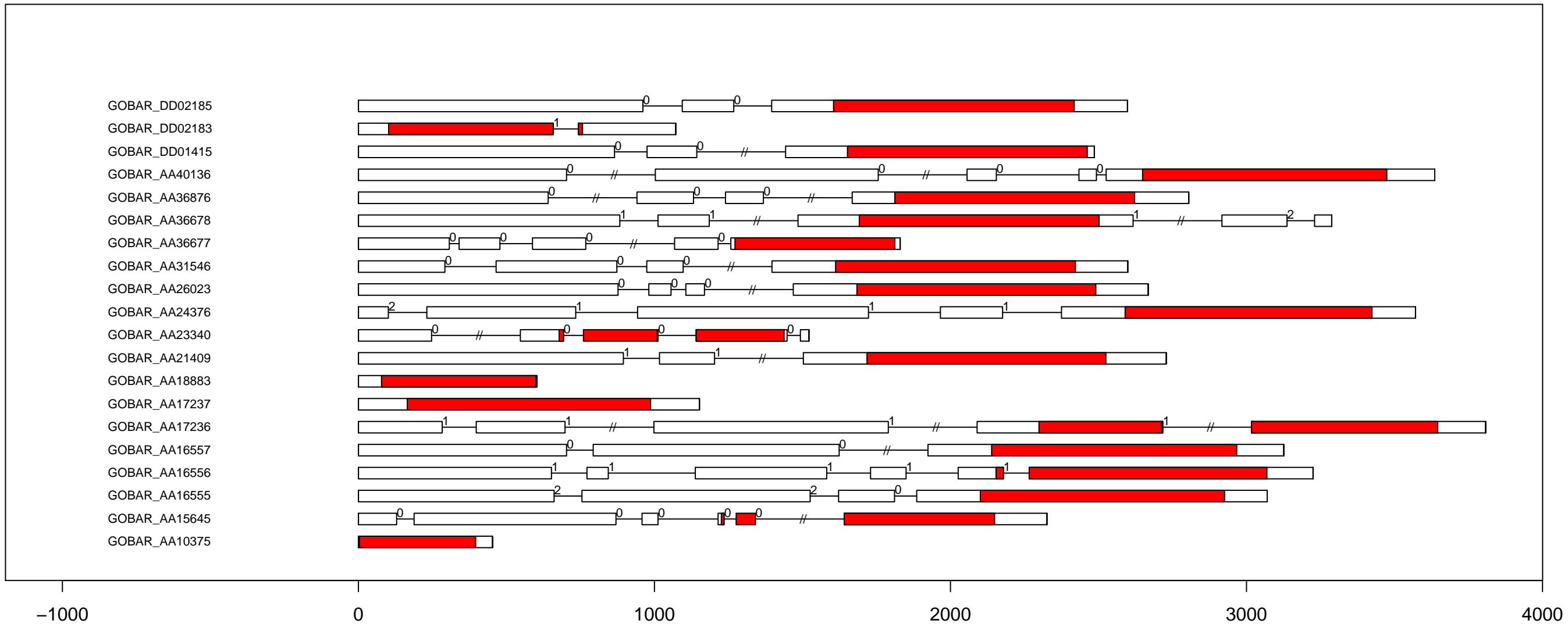

G.ba RLK-Pelle_WAK exon-intron and domain diagram (part 4)

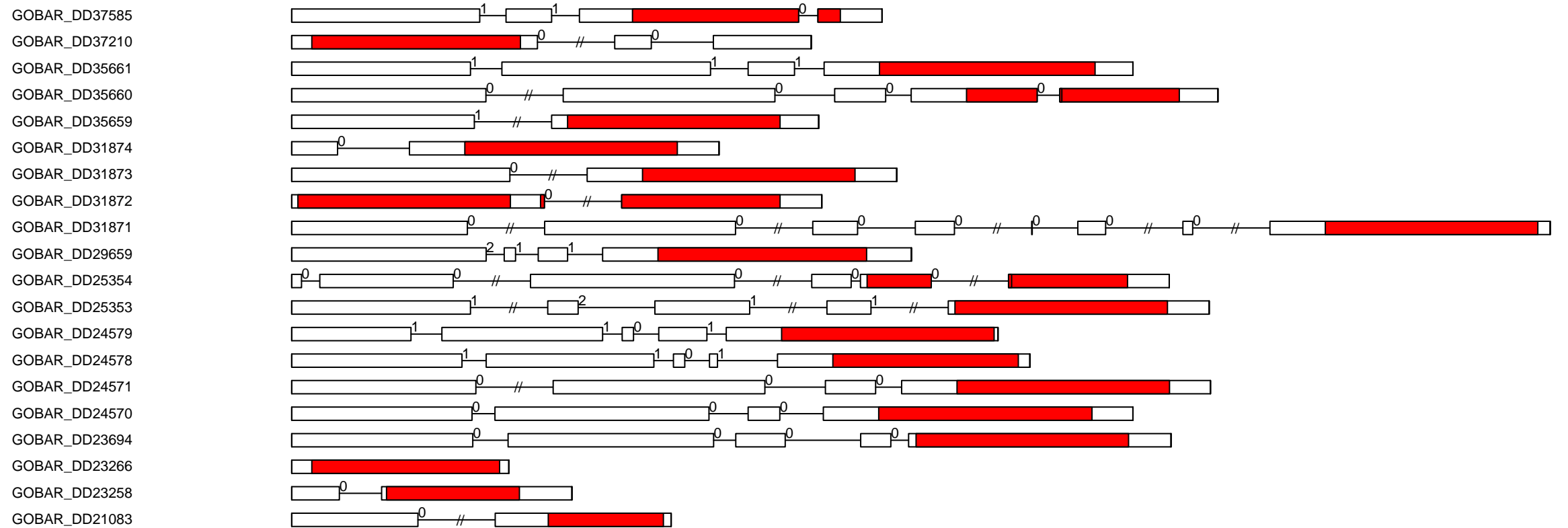

G.ba RLK-Pelle_WAK exon-intron and domain diagram (part 5)

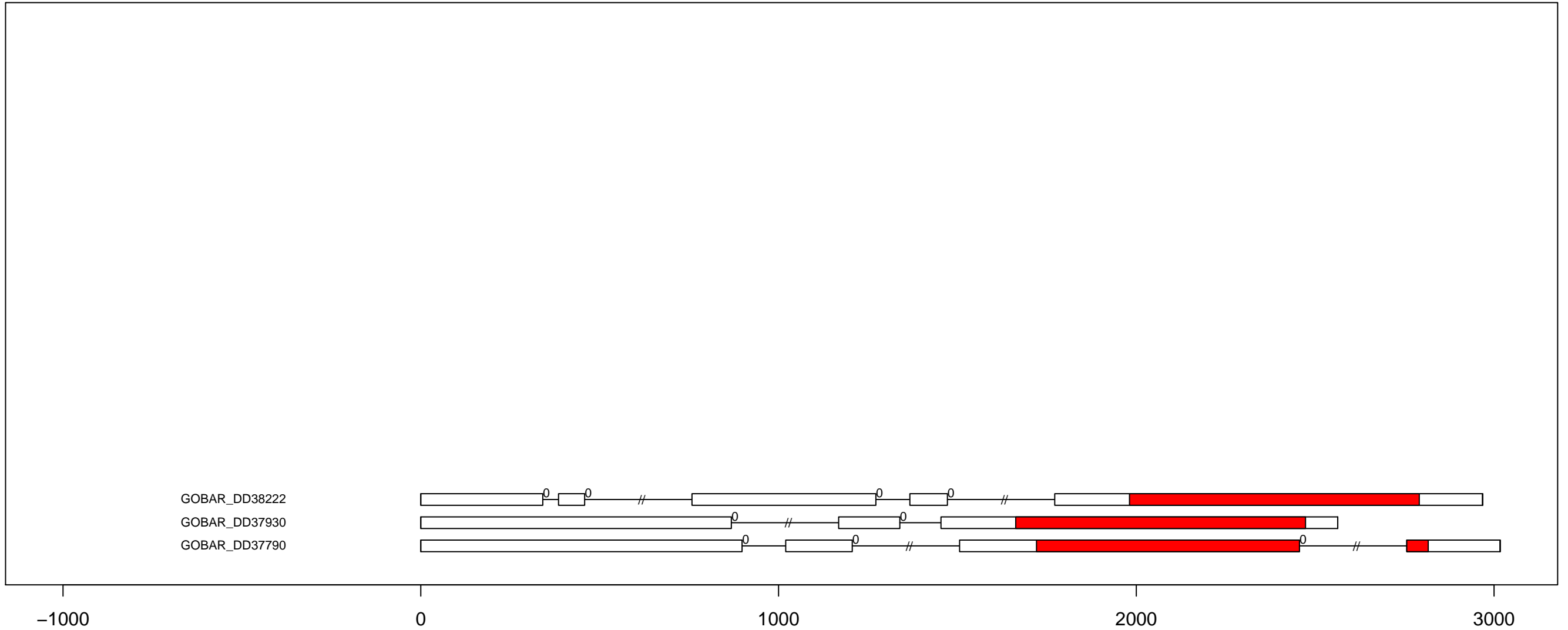

G.ba SCY1_SCYL1 exon-intron and domain diagram (all)

GOBAR_DD34998
GOBAR_DD11359

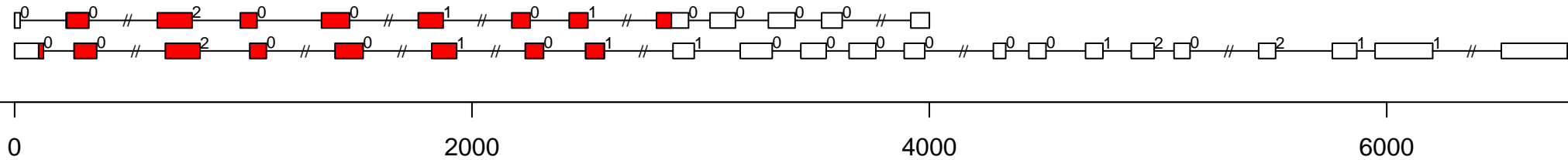

G.ba SCY1_SCYL2 exon-intron and domain diagram (all)

GOBAR_DD34339

GOBAR_DD19395

GOBAR_DD15267

GOBAR_AA25969

GOBAR_AA25748

GOBAR_AA08897

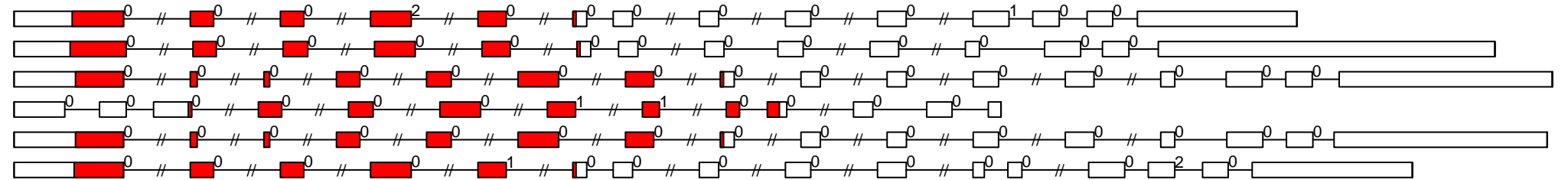

0

2000

4000

6000

G.ba STE_STE11 exon-intron and domain diagram (part 1)

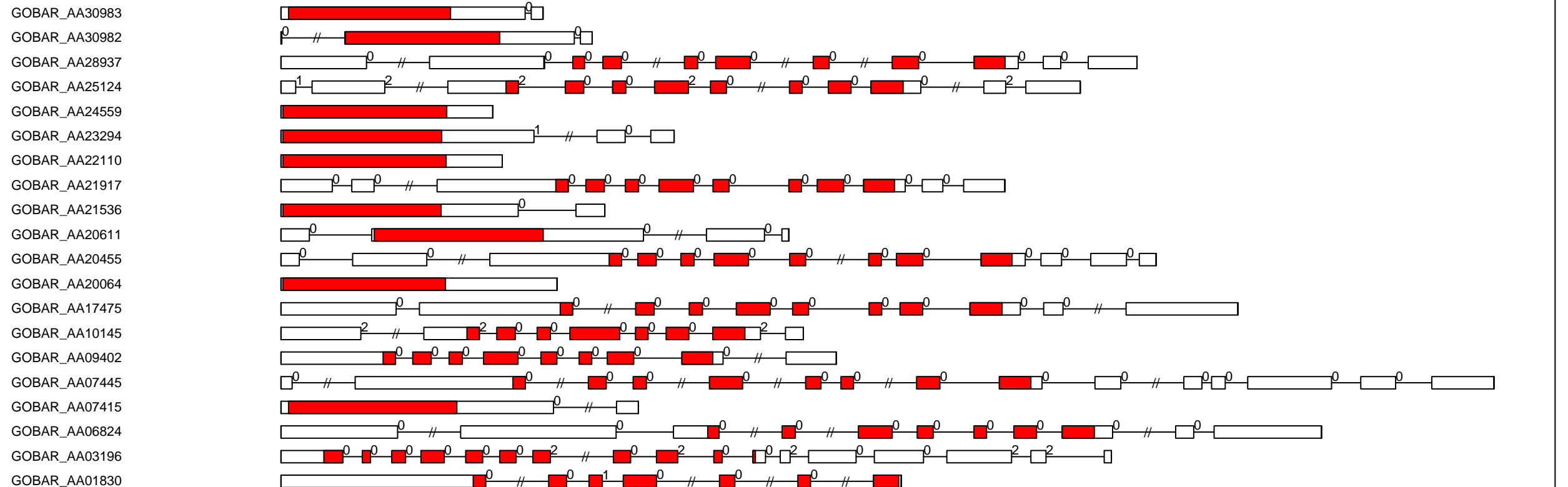

G.ba STE_STE11 exon-intron and domain diagram (part 2)

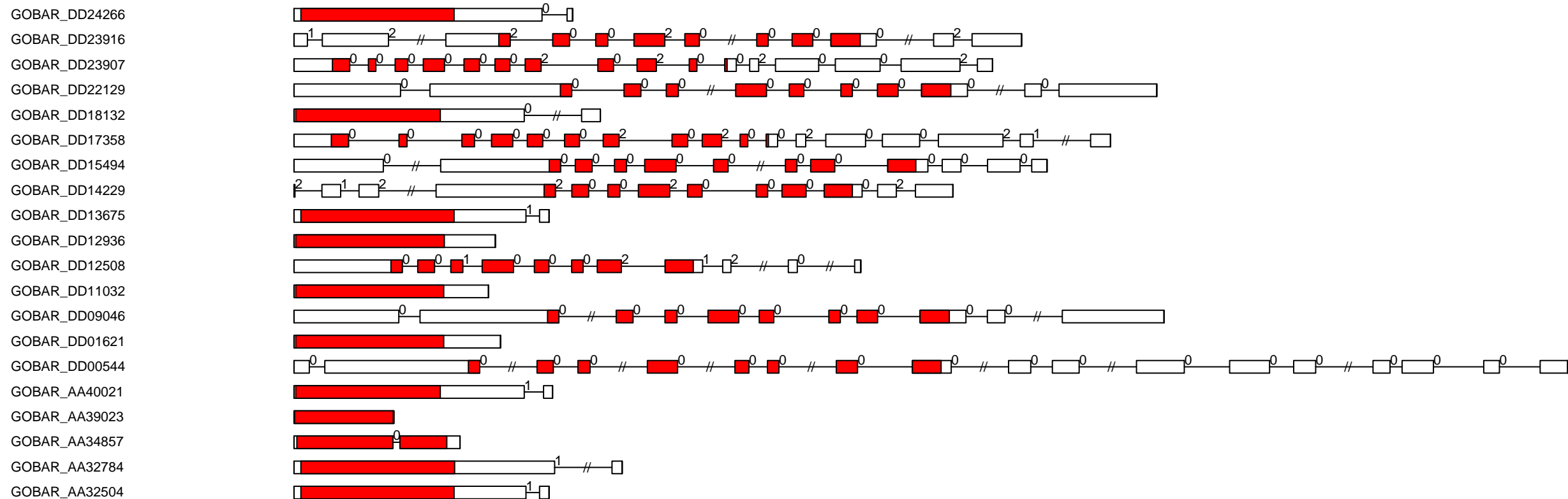

G.ba STE_STE11 exon-intron and domain diagram (part 3)

GOBAR_DD37476
GOBAR_DD35765
GOBAR_DD33035
GOBAR_DD28558
GOBAR_DD26795
GOBAR_DD25307
GOBAR_DD25222
GOBAR_DD25115

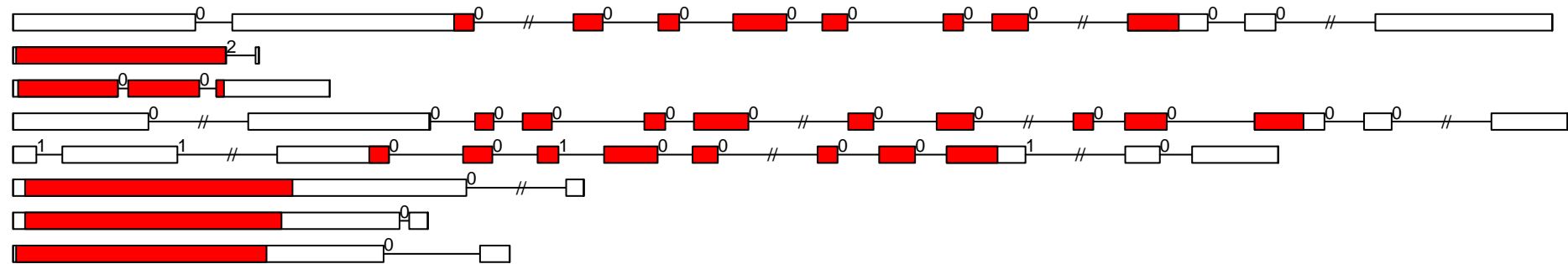

-1000

0

1000

2000

3000

4000

G.ba STE_STE20-Fray exon-intron and domain diagram (part 1)

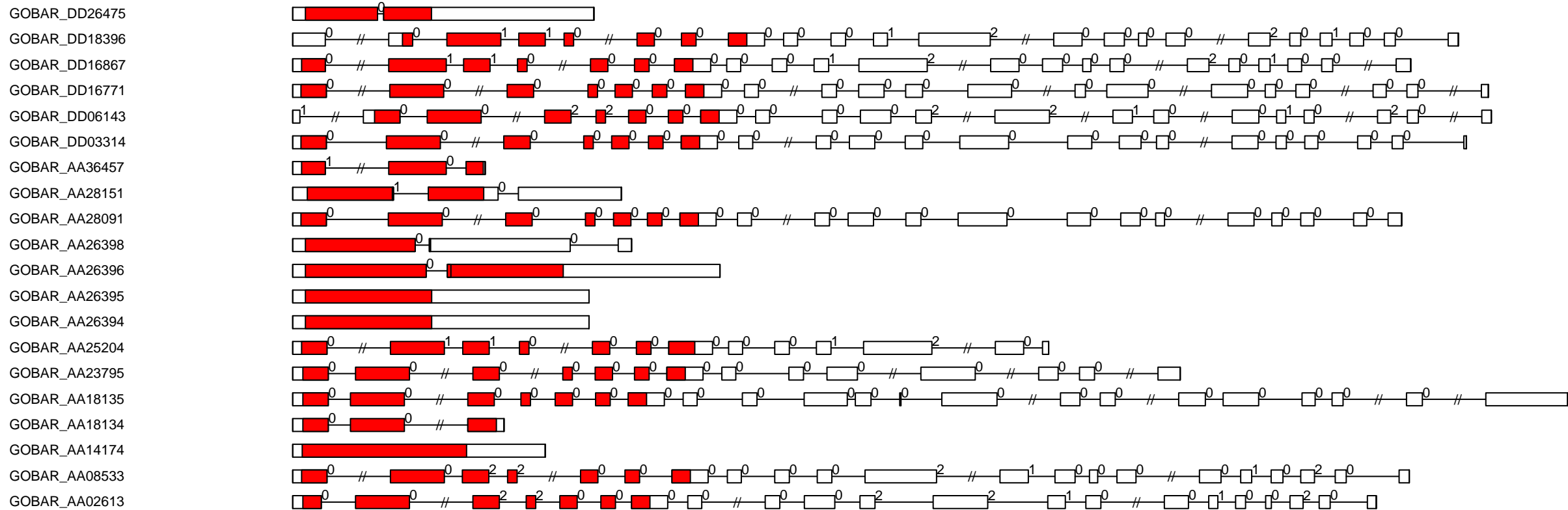

G.ba STE_STE20-Fray exon-intron and domain diagram (part 2)

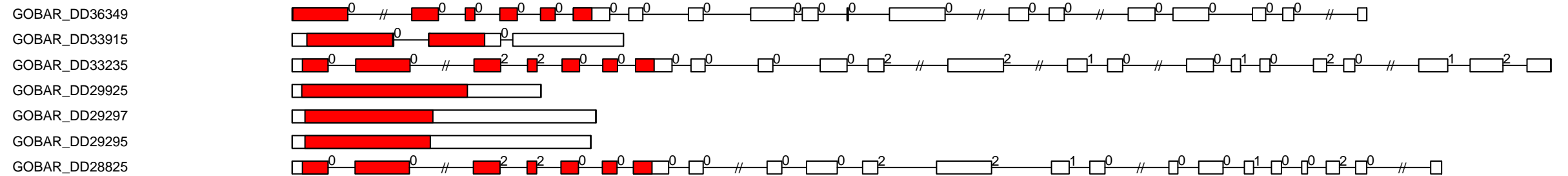

0

2000

4000

6000

G.ba STE_STE20-PI exon-intron and domain diagram (all)

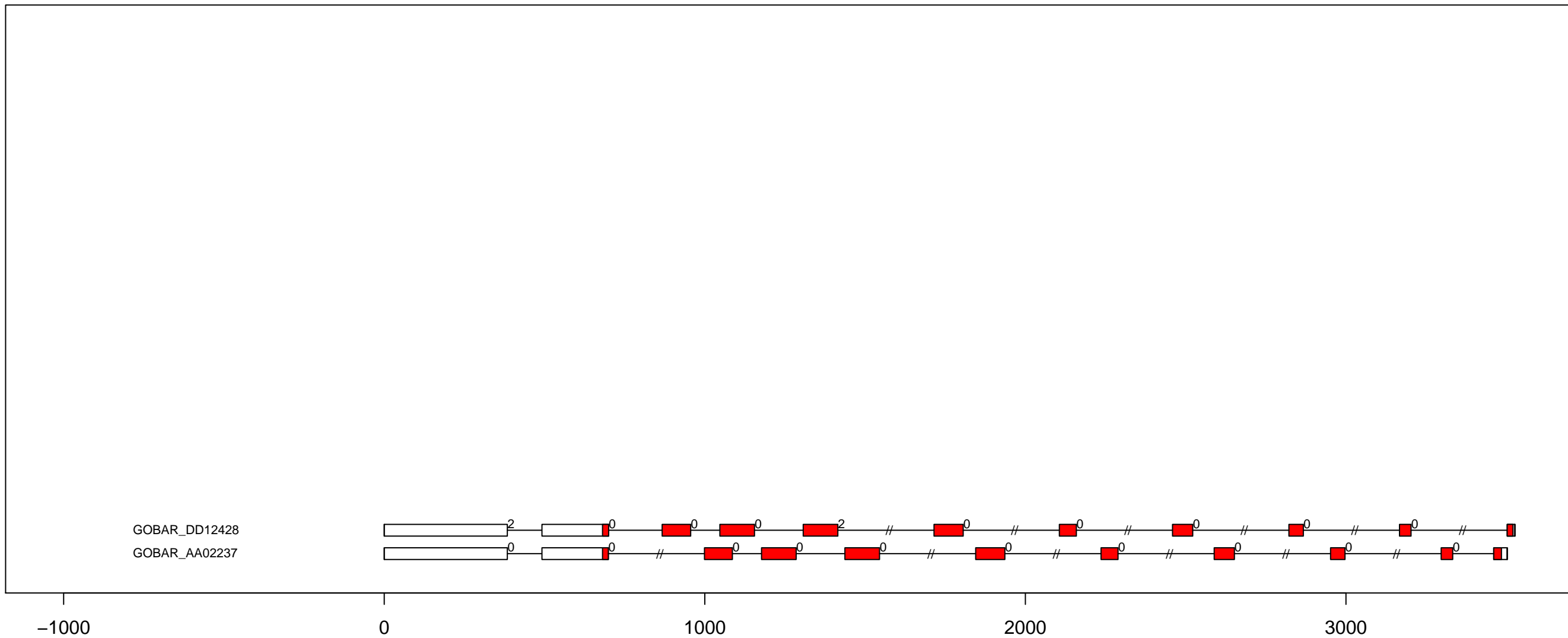

G.ba STE_STE20-YSK exon-intron and domain diagram (all)

GOBAR_DD28897
GOBAR_DD19995
GOBAR_AA32147

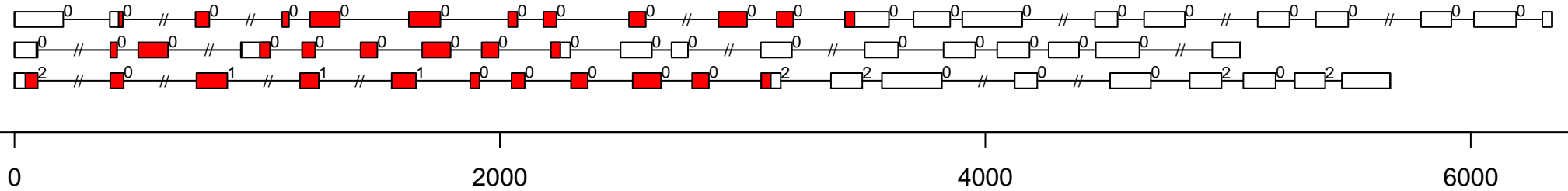

G.ba STE_STE7 exon-intron and domain diagram (part 1)

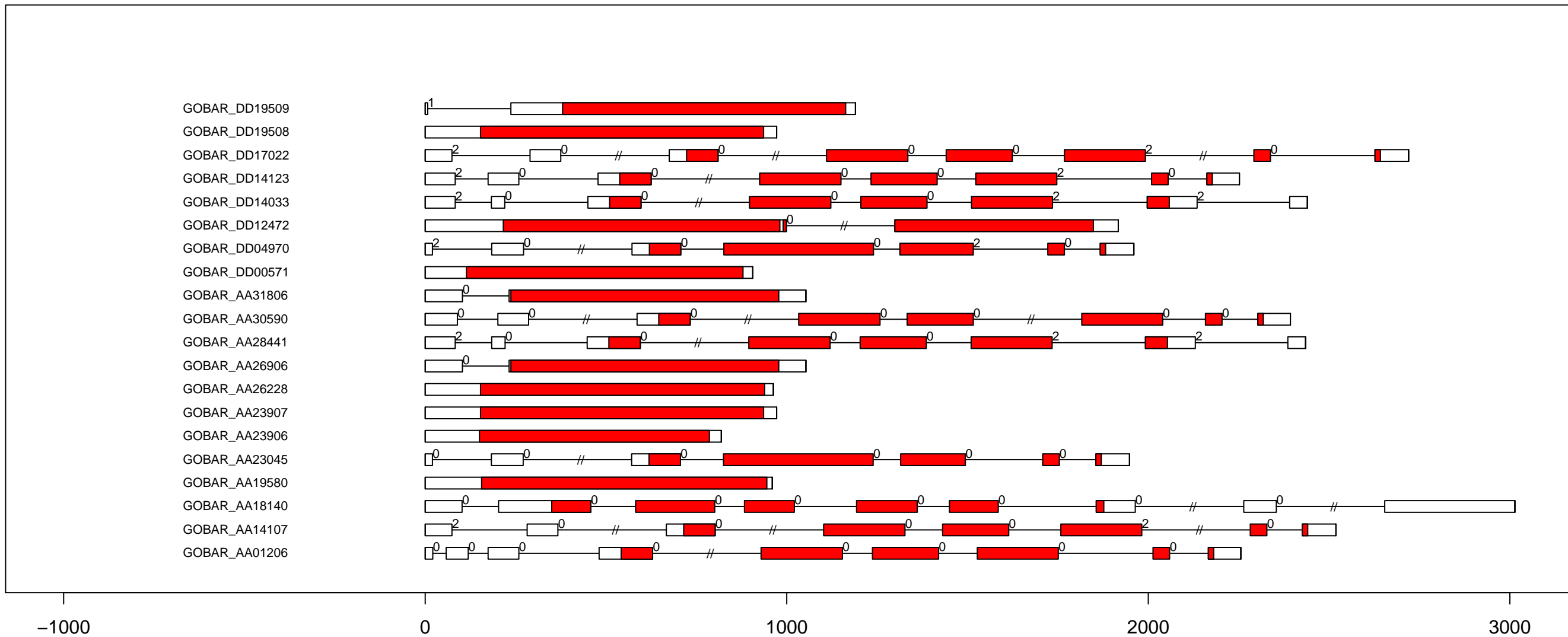

G.ba STE_STE7 exon-intron and domain diagram (part 2)

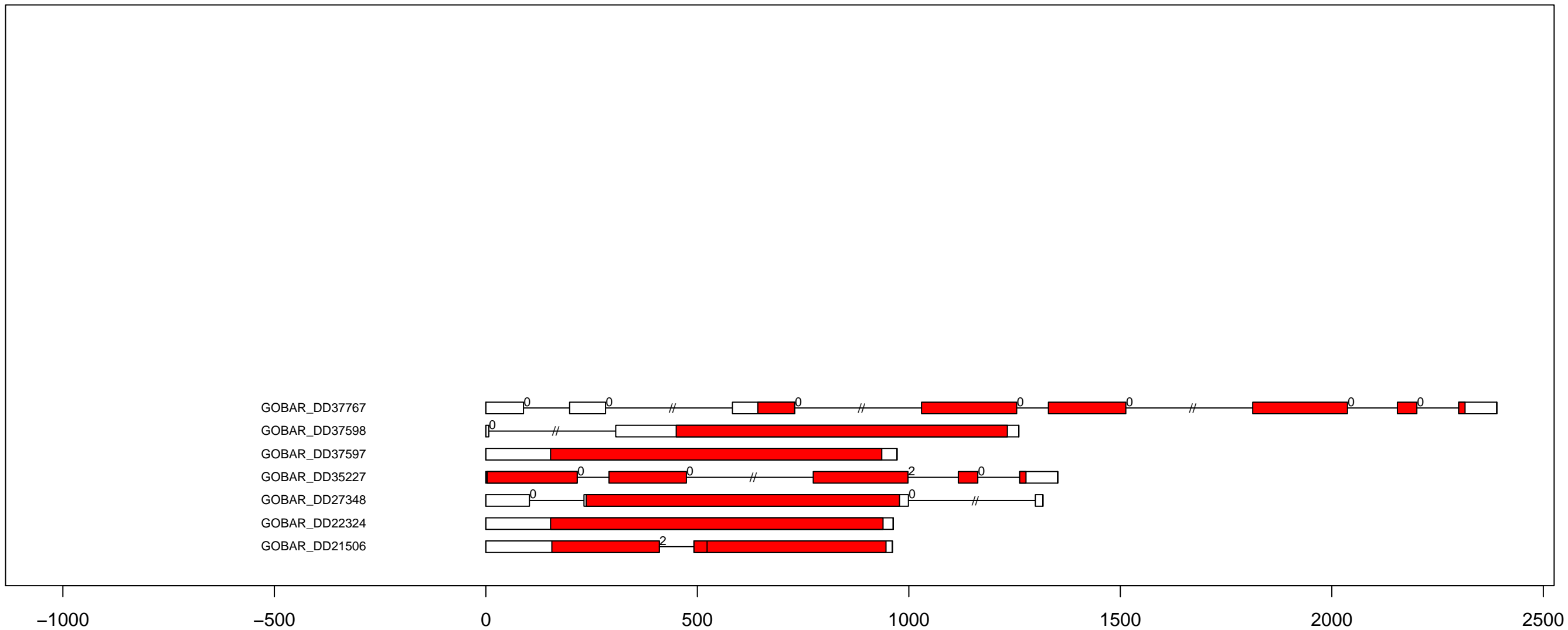

G.ba STE_STE-PI exon-intron and domain diagram (all)

GOBAR_DD24292

GOBAR_DD05005

GOBAR_AA34700

GOBAR_AA18638

GOBAR_AA05264

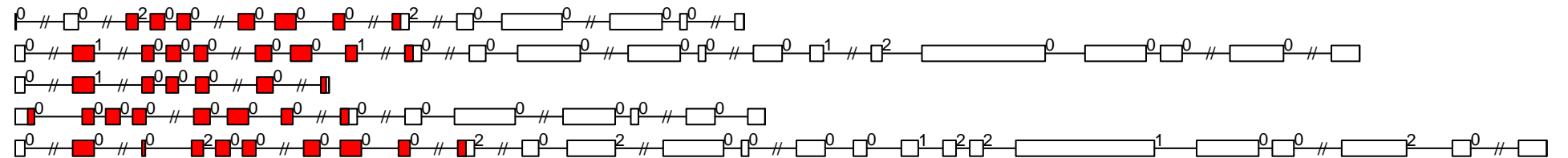

-2000

0

2000

4000

6000

8000

10000

G.ba TKL_CTRL1-DRK-1 exon-intron and domain diagram (all)

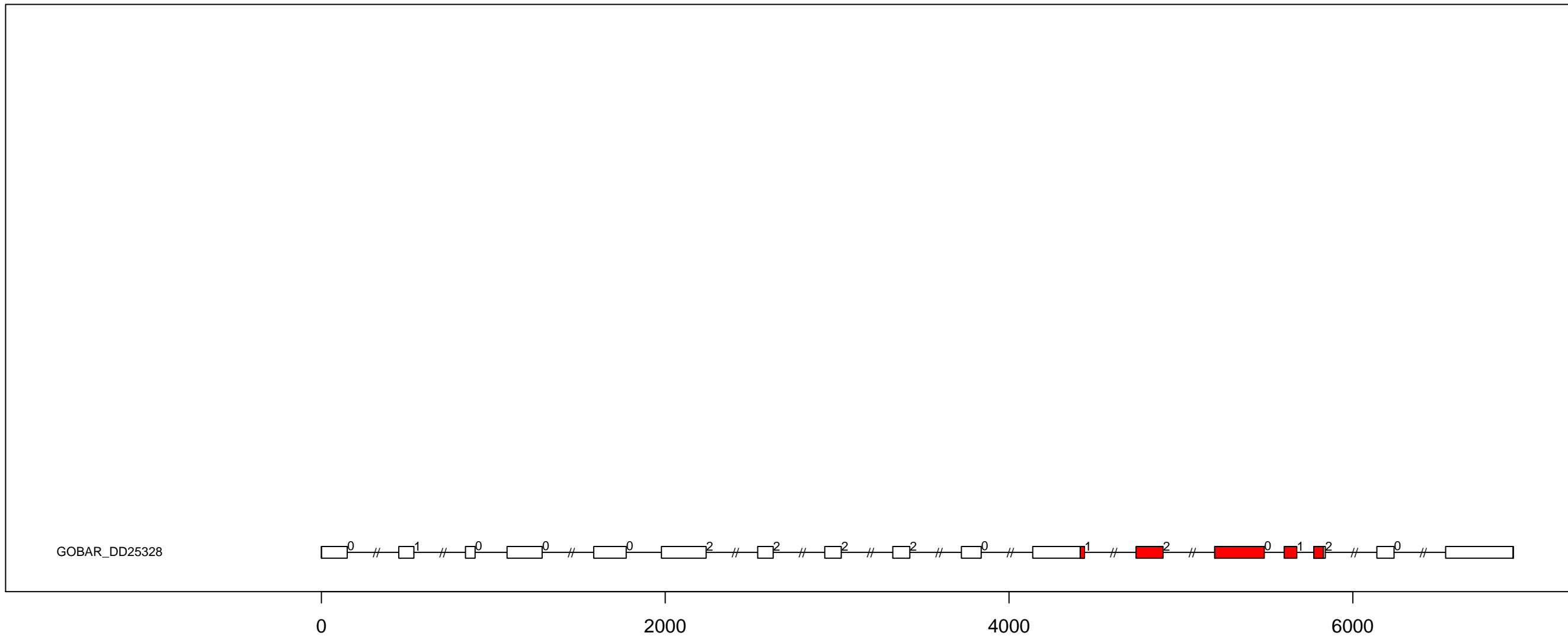

G.ba TKL_CTR1-DRK-2 exon-intron and domain diagram (part 1)

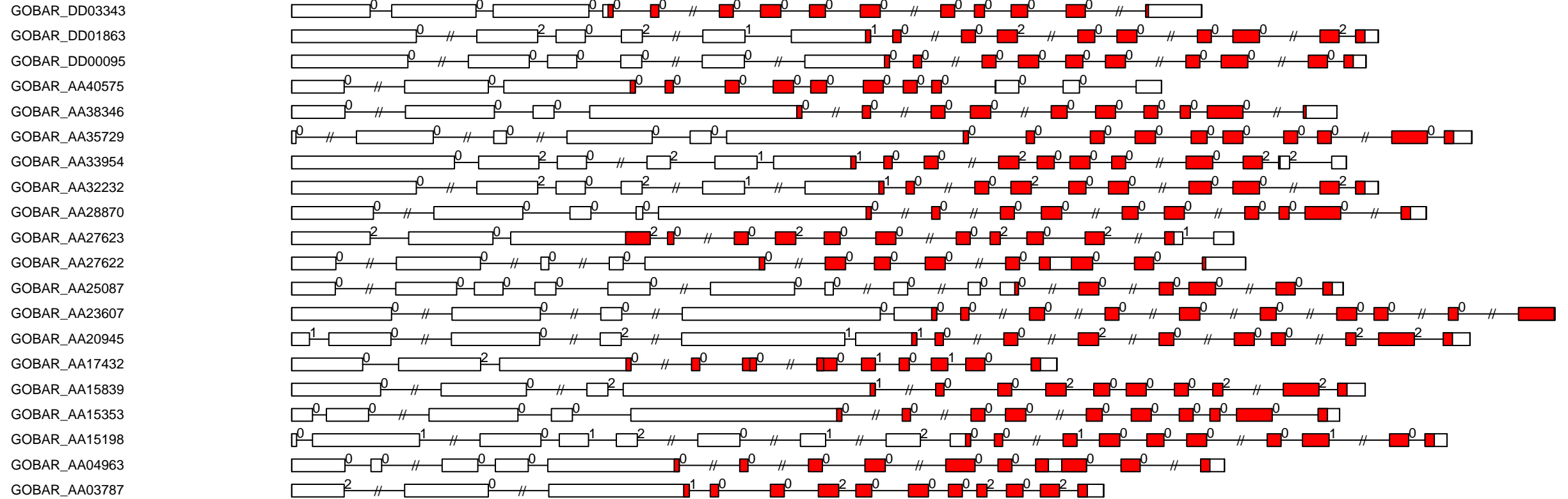

G.ba TKL_CTR1-DRK-2 exon-intron and domain diagram (part 2)

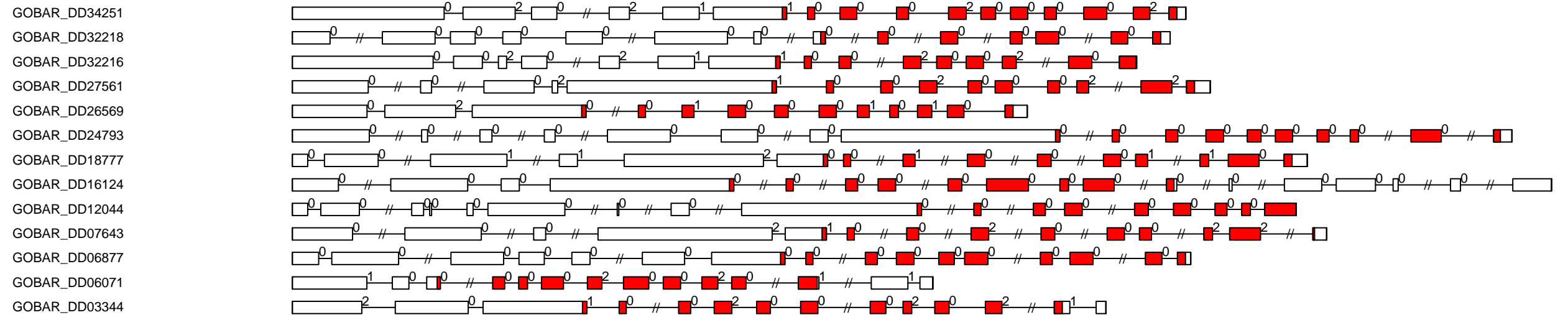

G.ba TKL_Gdt exon-intron and domain diagram (all)

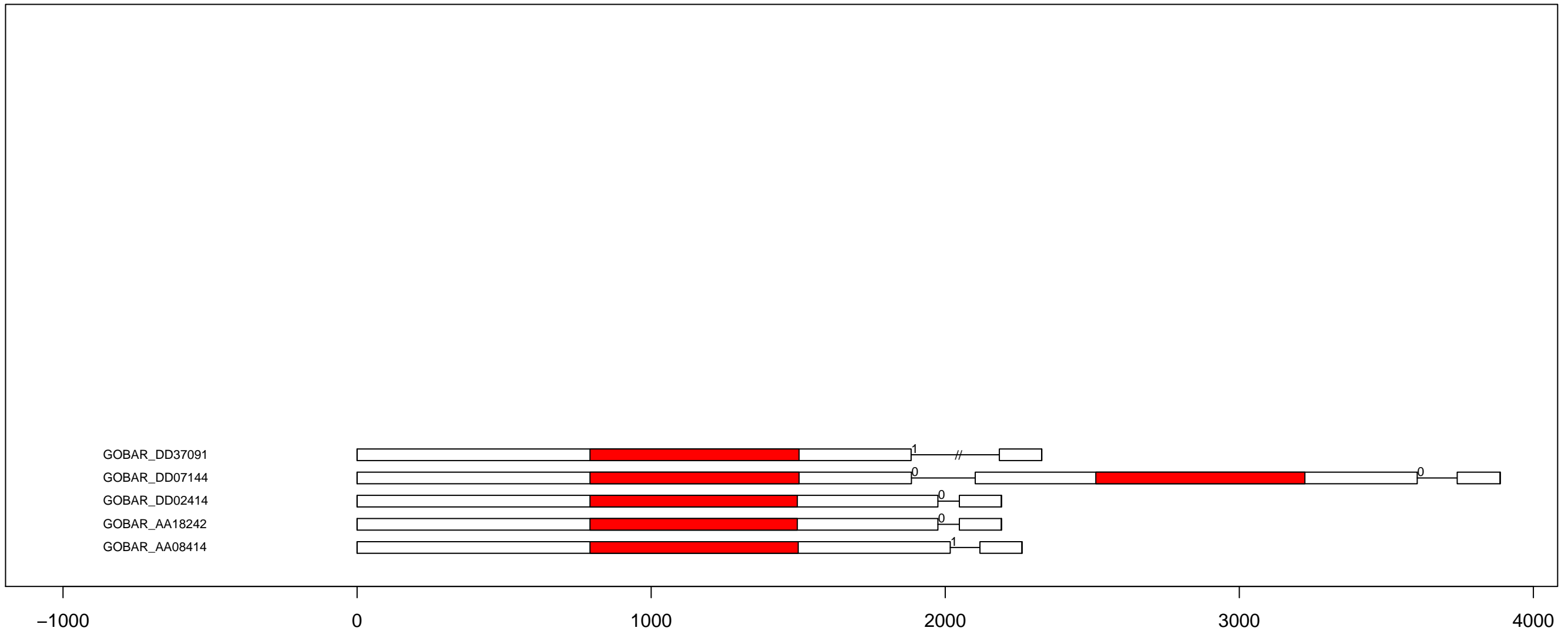

G.ba TKL-PI-1 exon-intron and domain diagram (all)

GOBAR_DD23840
GOBAR_DD22139
GOBAR_DD11709
GOBAR_DD01308
GOBAR_AA38342
GOBAR_AA31170
GOBAR_AA19497

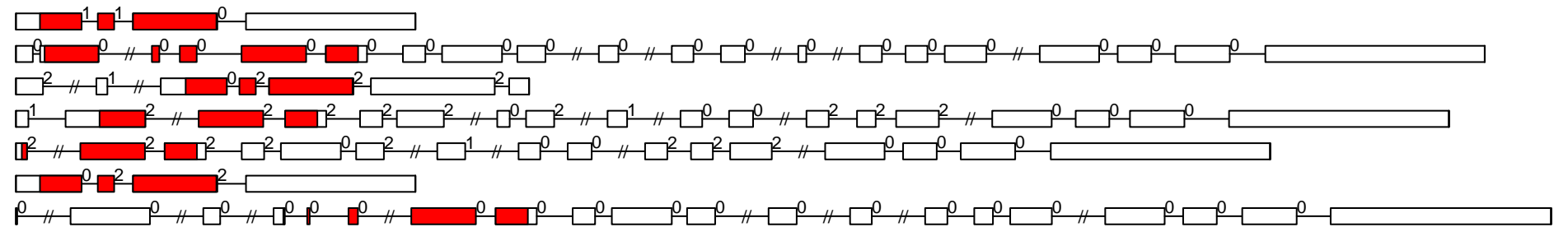

-2000

0

2000

4000

6000

8000

G.ba TKL-PI-2 exon-intron and domain diagram (all)



G.ba TKL-PI-3 exon-intron and domain diagram (all)

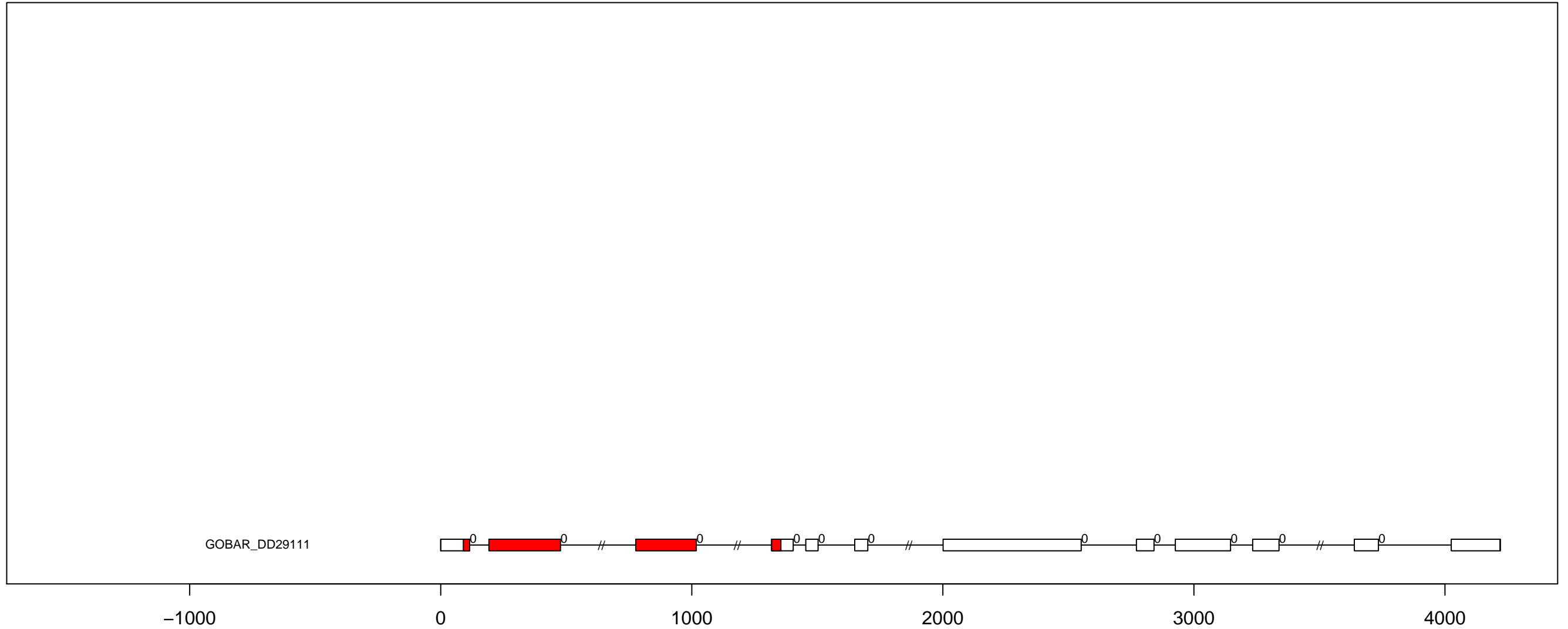

G.ba TKL-PI-4 exon-intron and domain diagram (part 1)

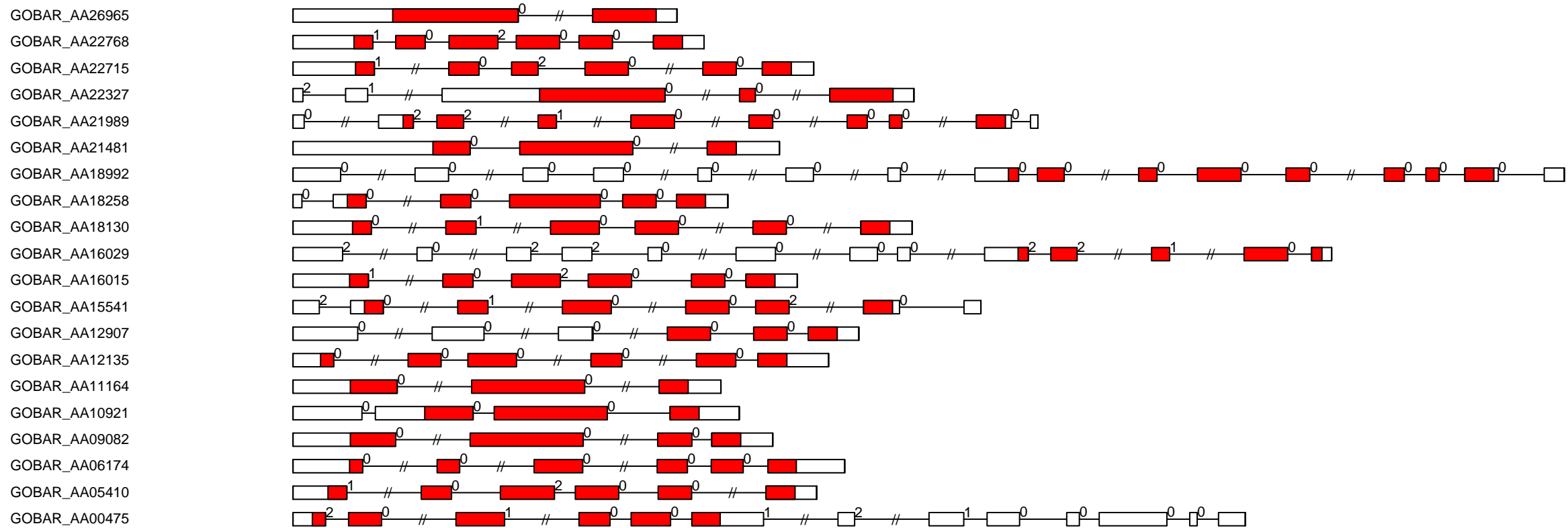

G.ba TKL-PI-4 exon-intron and domain diagram (part 2)

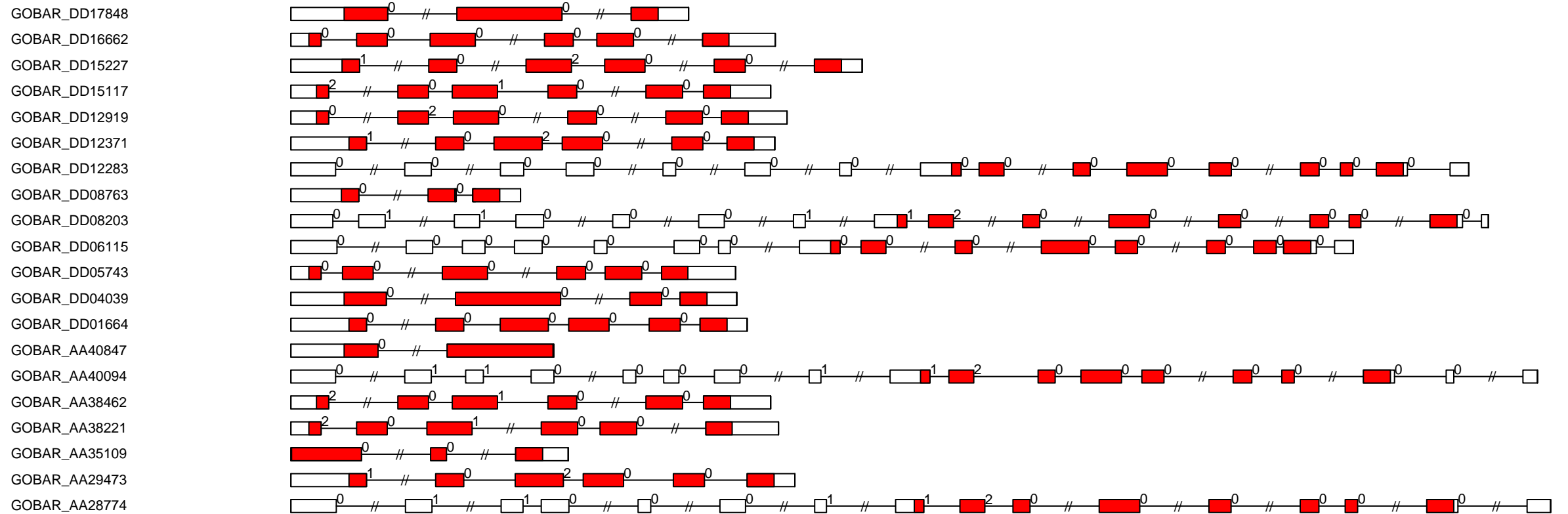

G.ba TKL-PI-4 exon-intron and domain diagram (part 3)

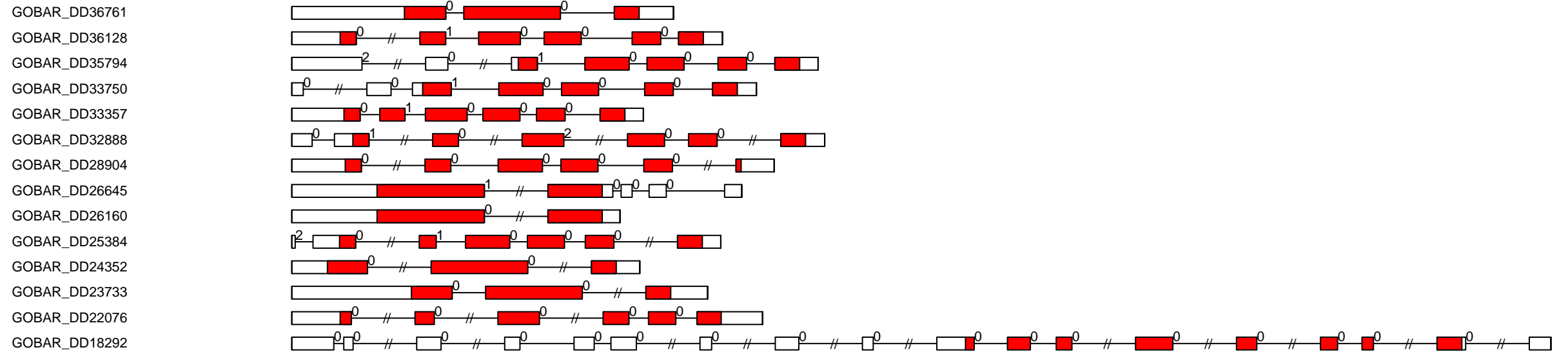

G.ba TKL-PI-5 exon-intron and domain diagram (all)

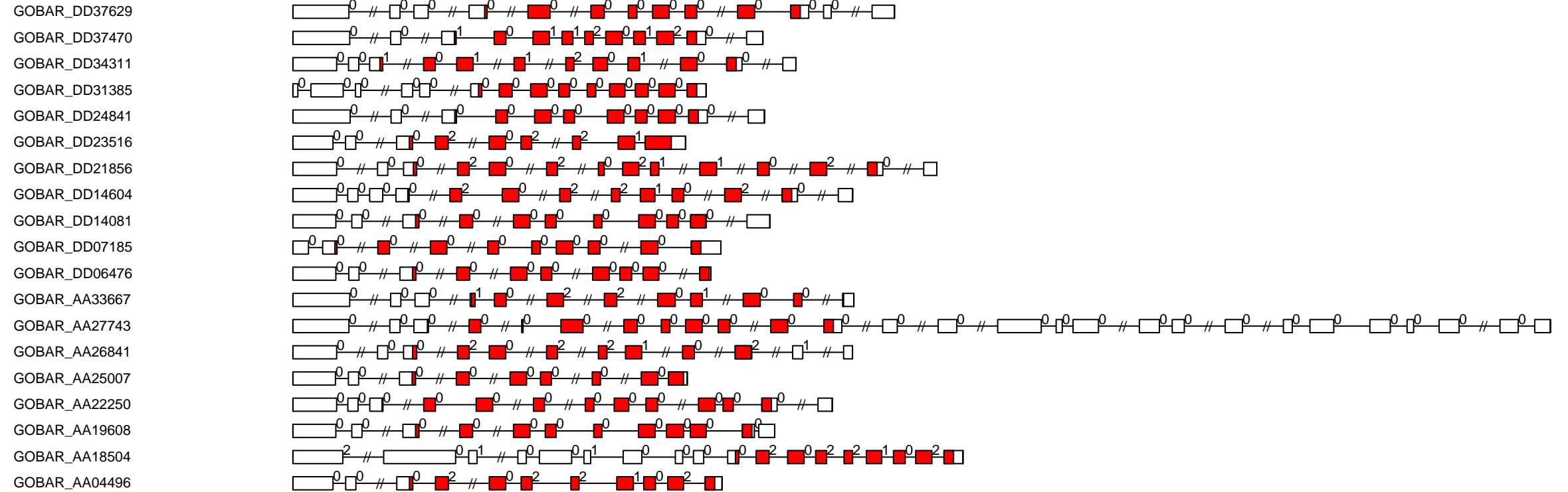

G.ba TKL-PI-6 exon-intron and domain diagram (all)

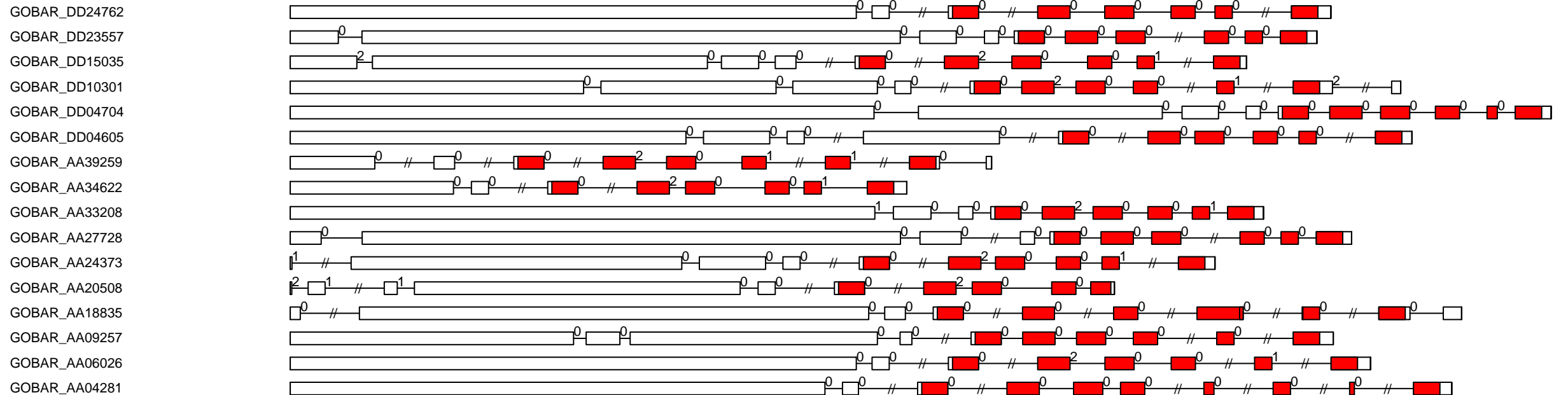

G.ba TKL-PI-7 exon-intron and domain diagram (all)

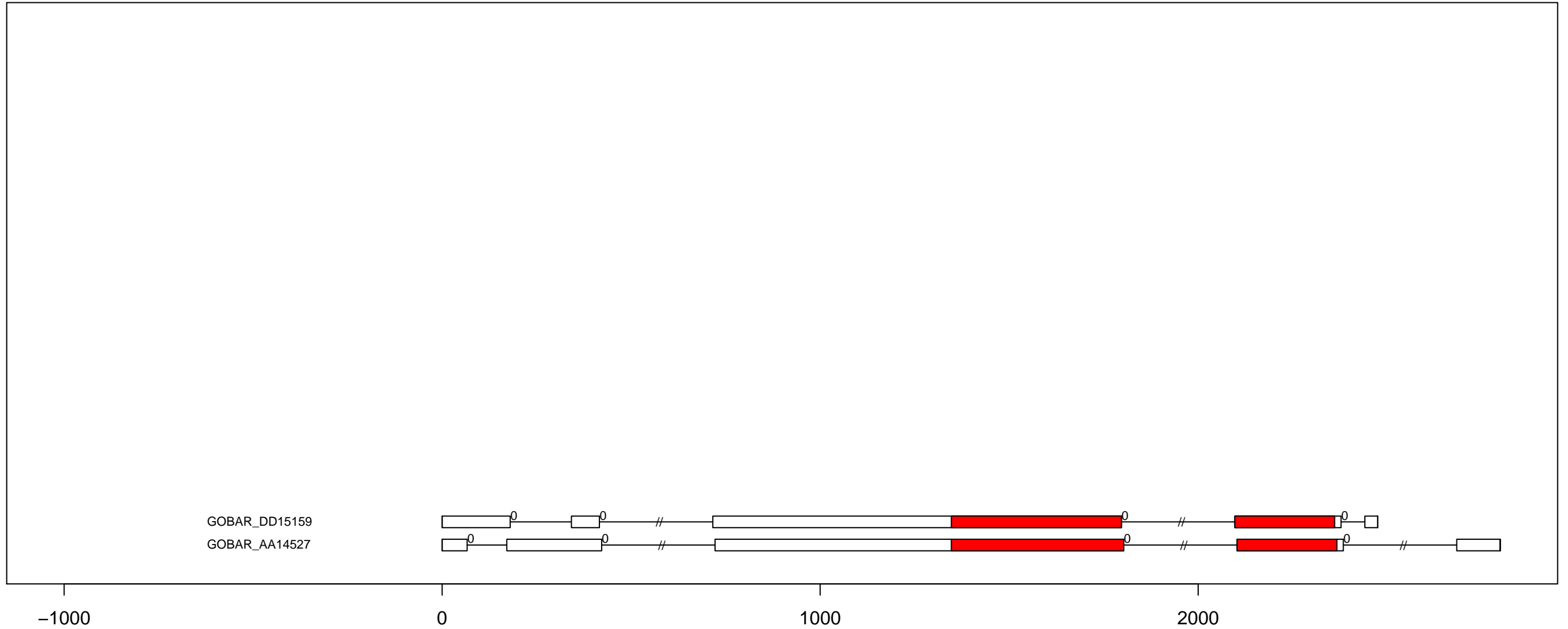

G.ba TKL-PI-8 exon-intron and domain diagram (all)

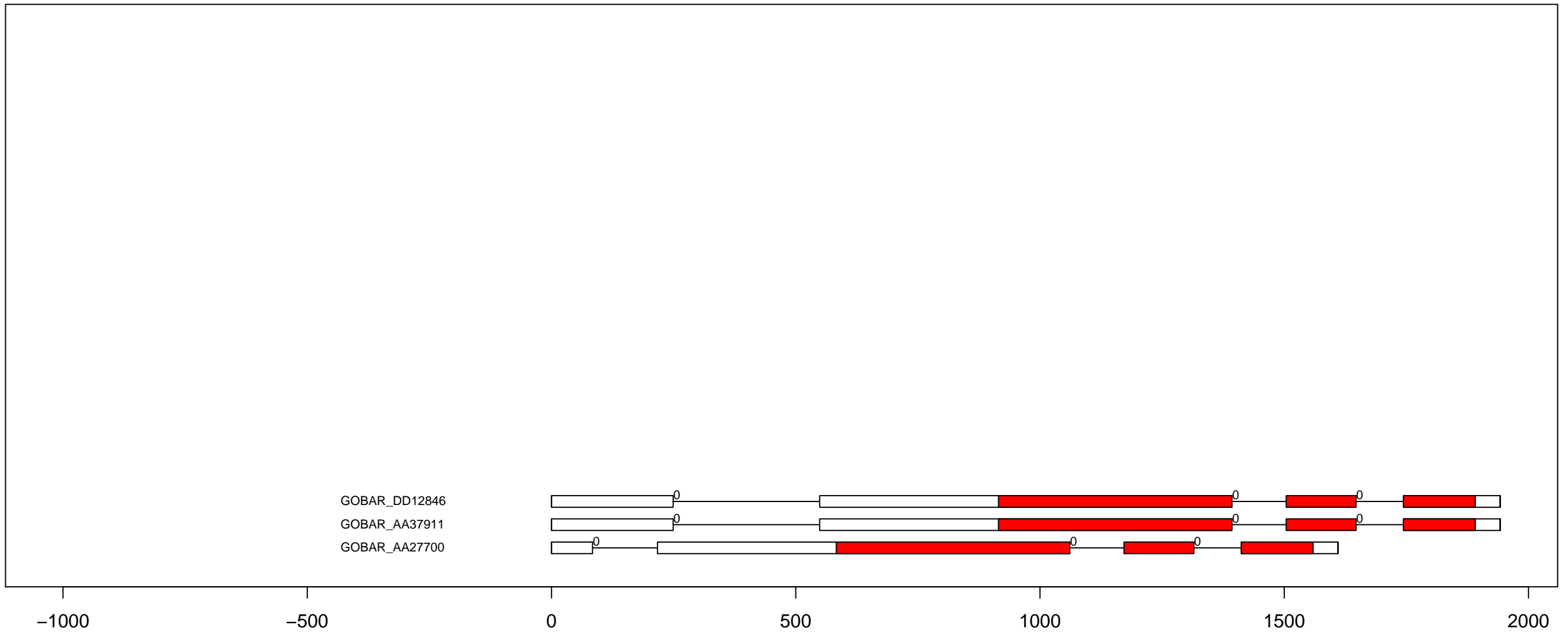

G.ba TLK exon-intron and domain diagram (all)

GOBAR_DD34016
GOBAR_DD30036
GOBAR_DD01926
GOBAR_AA26245
GOBAR_AA06122

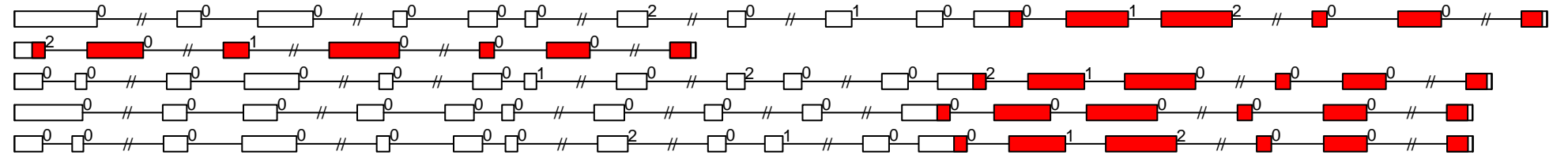

0

2000

4000

6000

G.ba TTK exon-intron and domain diagram (all)

GOBAR_DD09503
GOBAR_DD09158
GOBAR_AA01825

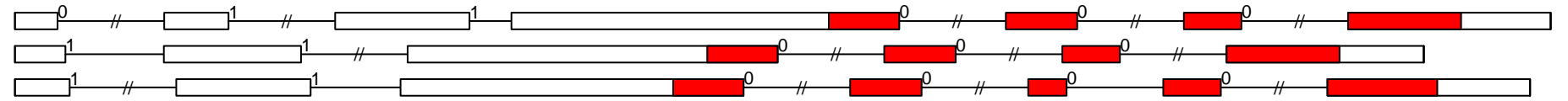

-1000

0

1000

2000

3000

4000

G.ba ULK_Fused exon-intron and domain diagram (all)

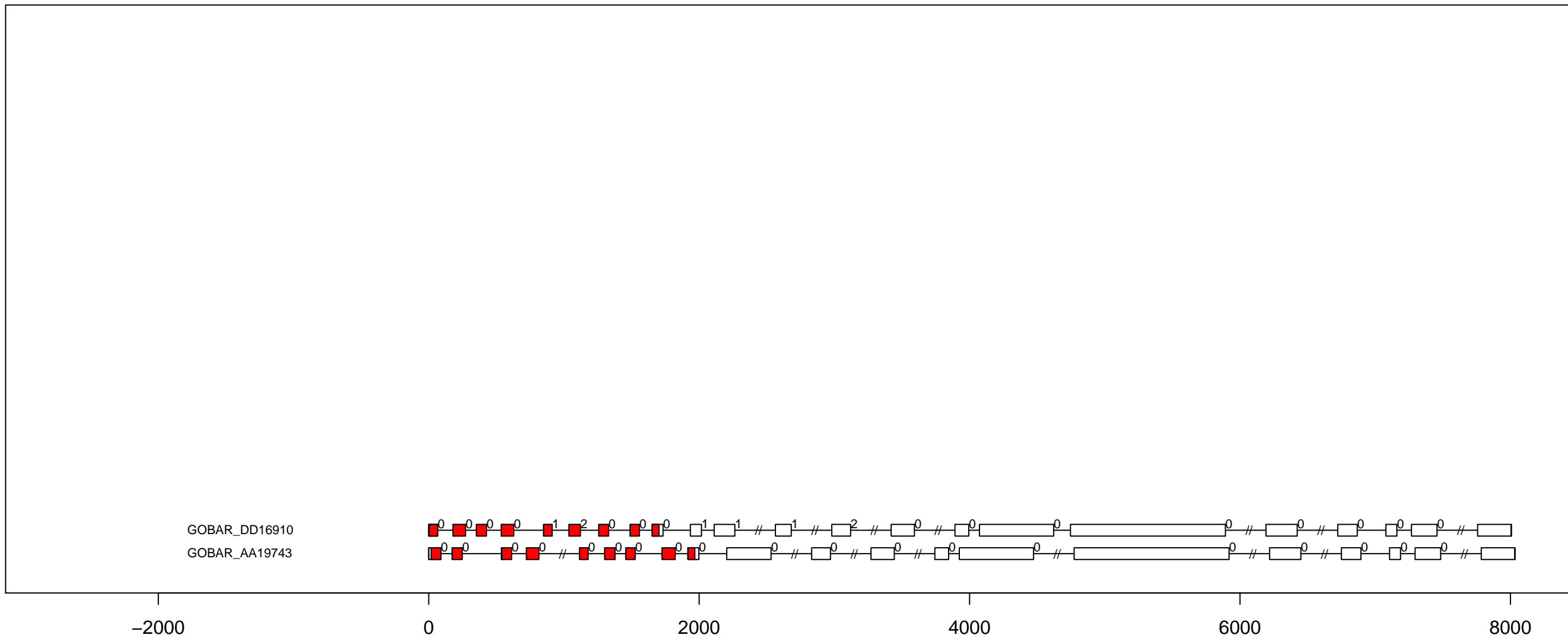

G.ba WEE exon-intron and domain diagram (all)

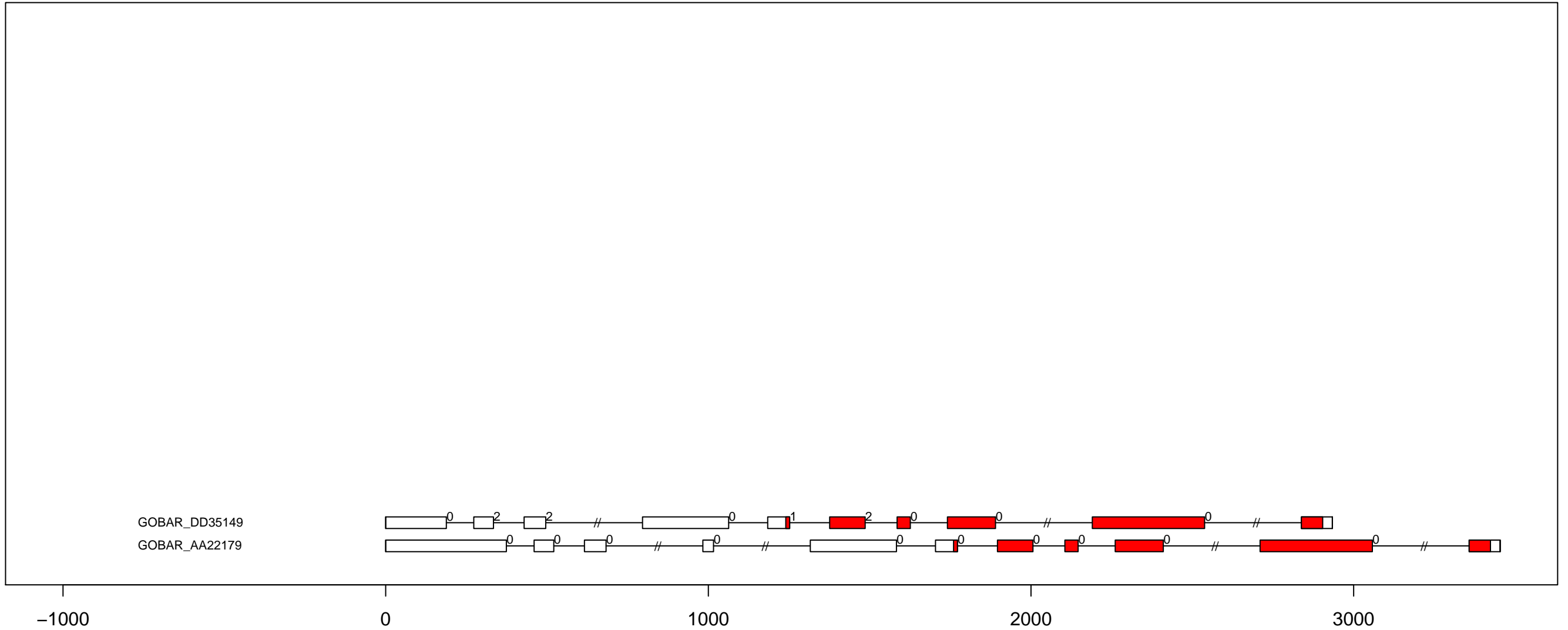

G.ba WNK_NRBP exon-intron and domain diagram (part 1)

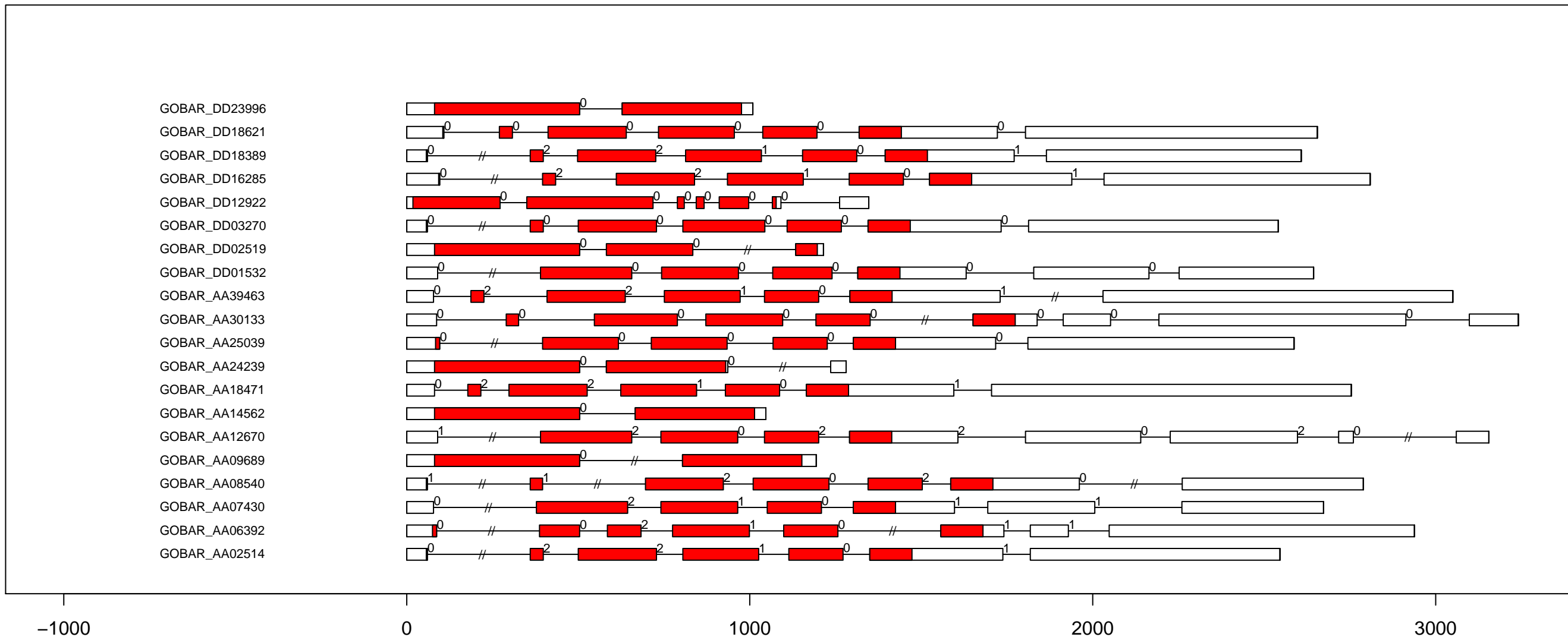

G.ba WNK_NRBP exon-intron and domain diagram (part 2)

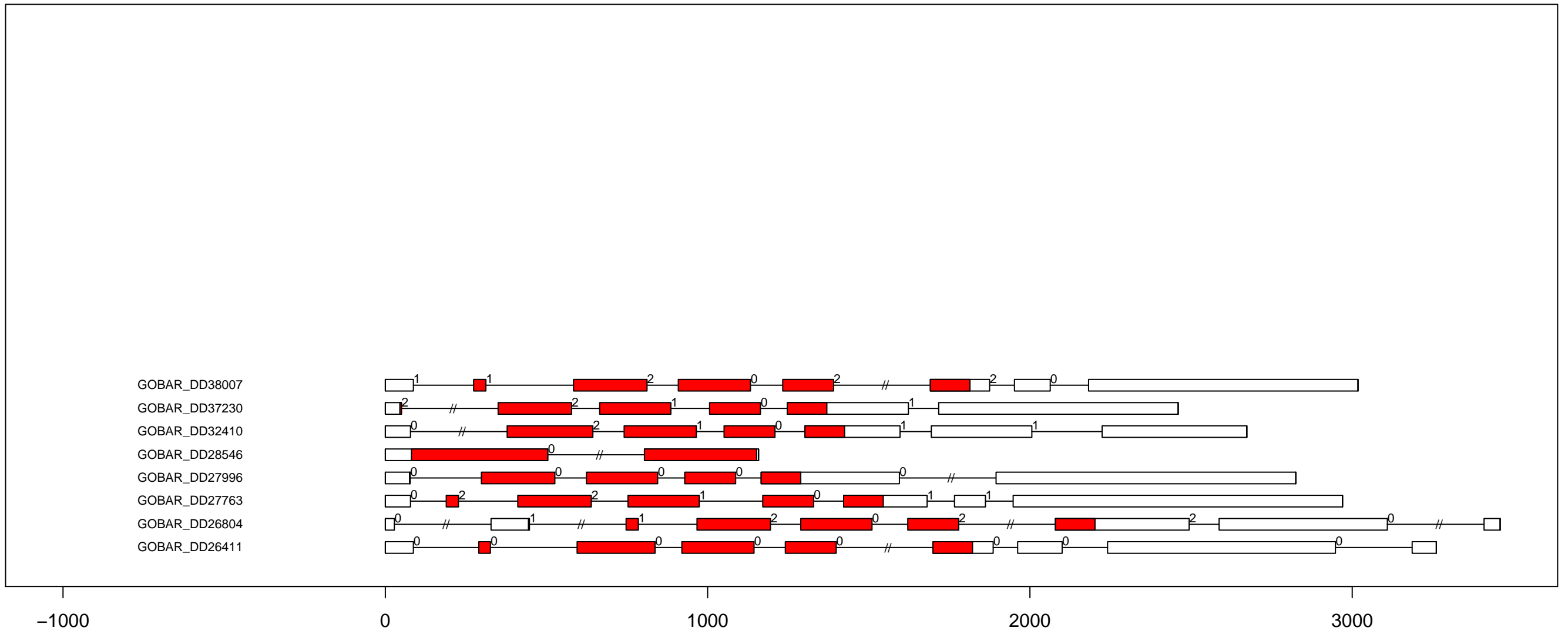

G.ar AGC_MAST exon-intron and domain diagram (all)

Cotton_A_13739
Cotton_A_13057
Cotton_A_13056
Cotton_A_10287
Cotton_A_07615

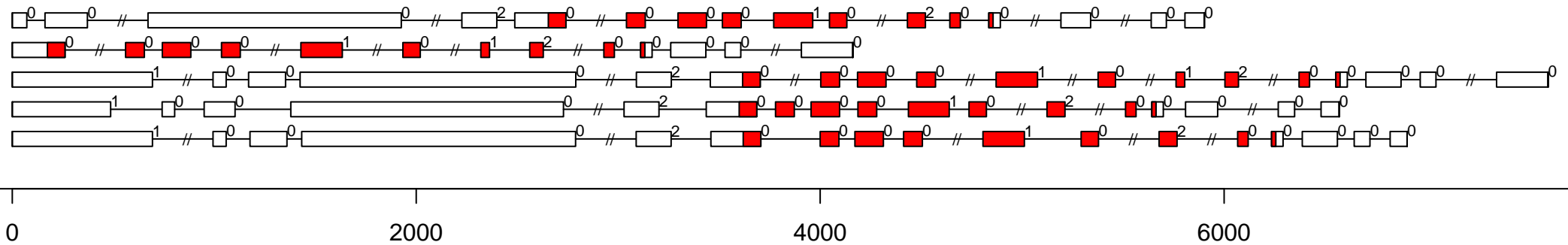

G.ar AGC_NDR exon-intron and domain diagram (all)

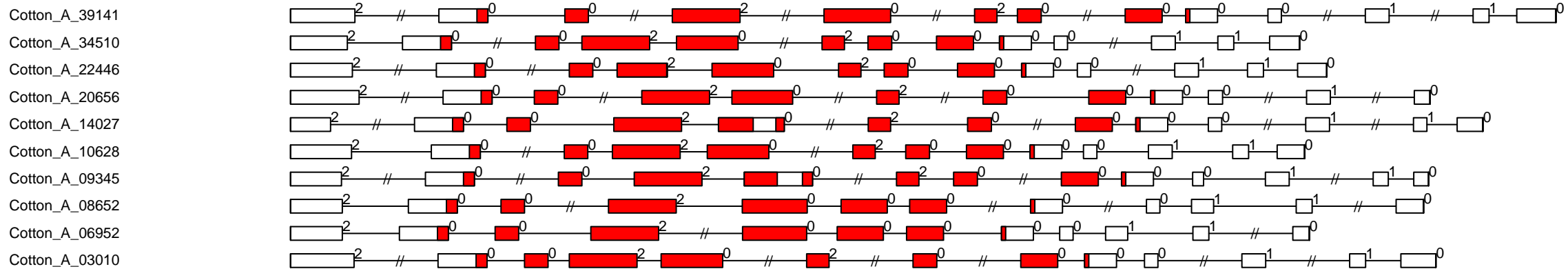

-1000

0

1000

2000

3000

4000

G.ar AGC_PDK1 exon-intron and domain diagram (all)

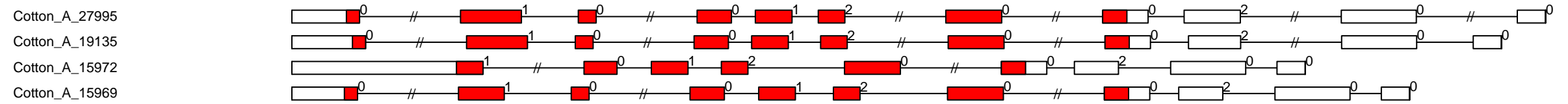

-1000

0

1000

2000

3000

G.ar AGC_PKA-PKG exon-intron and domain diagram (all)

Cotton_A_18867

Cotton_A_10339

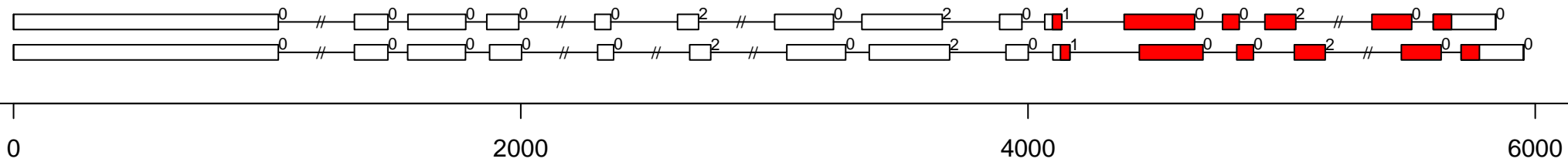

G.ar AGC_RSK-2 exon-intron and domain diagram (part 1)

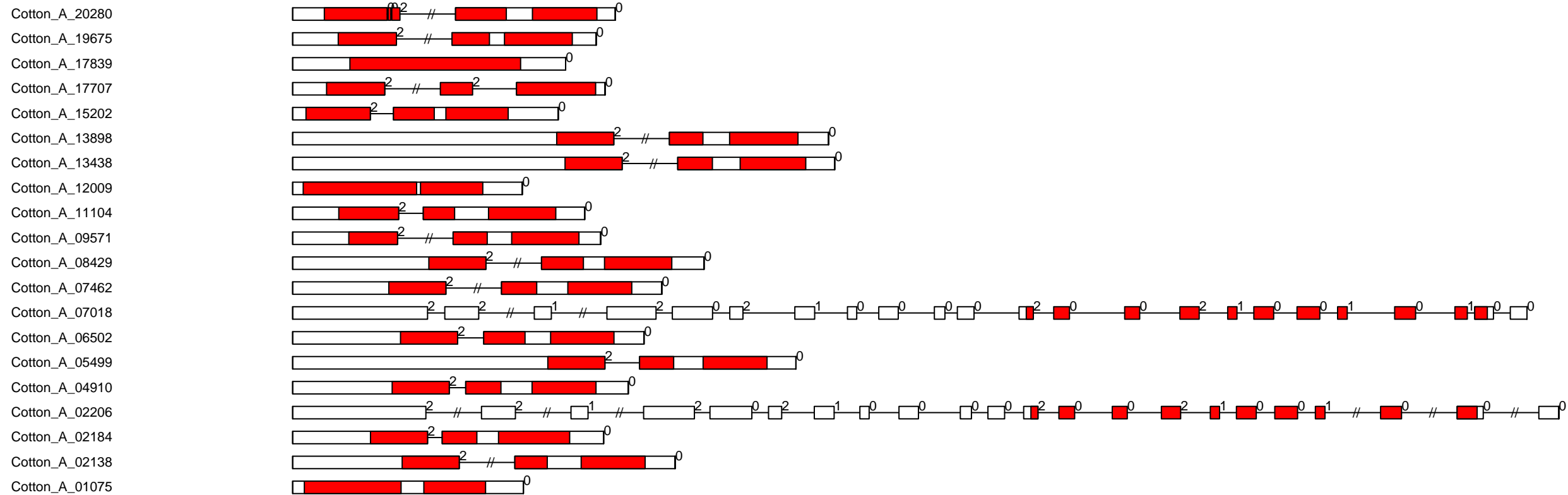

G.ar AGC_RSK-2 exon-intron and domain diagram (part 2)

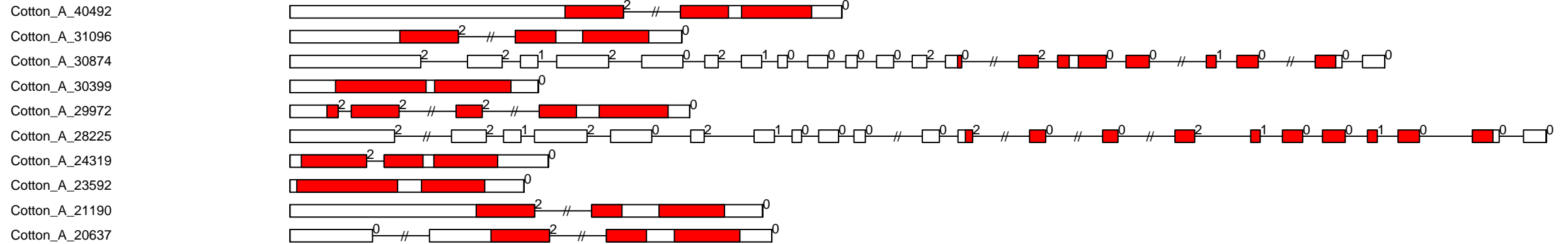

G.ar AGC-PI exon-intron and domain diagram (all)

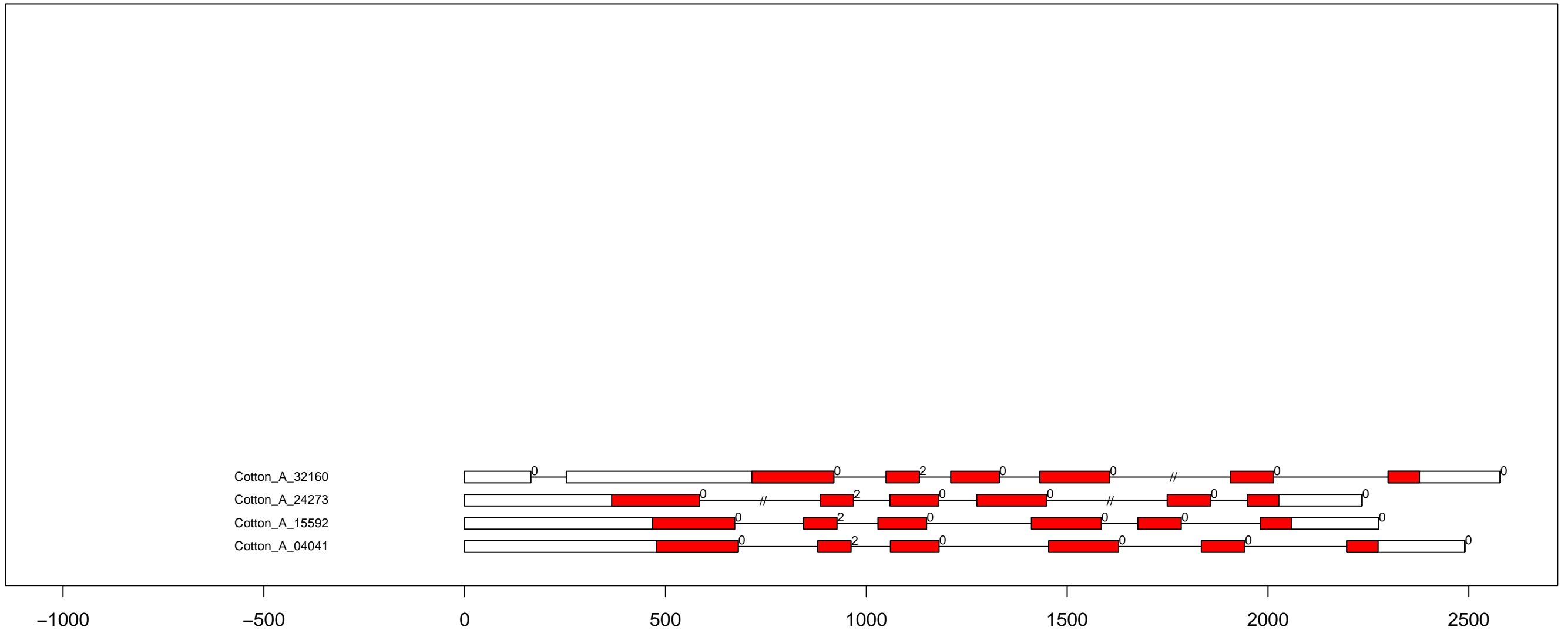

G.ar Aur exon-intron and domain diagram (all)

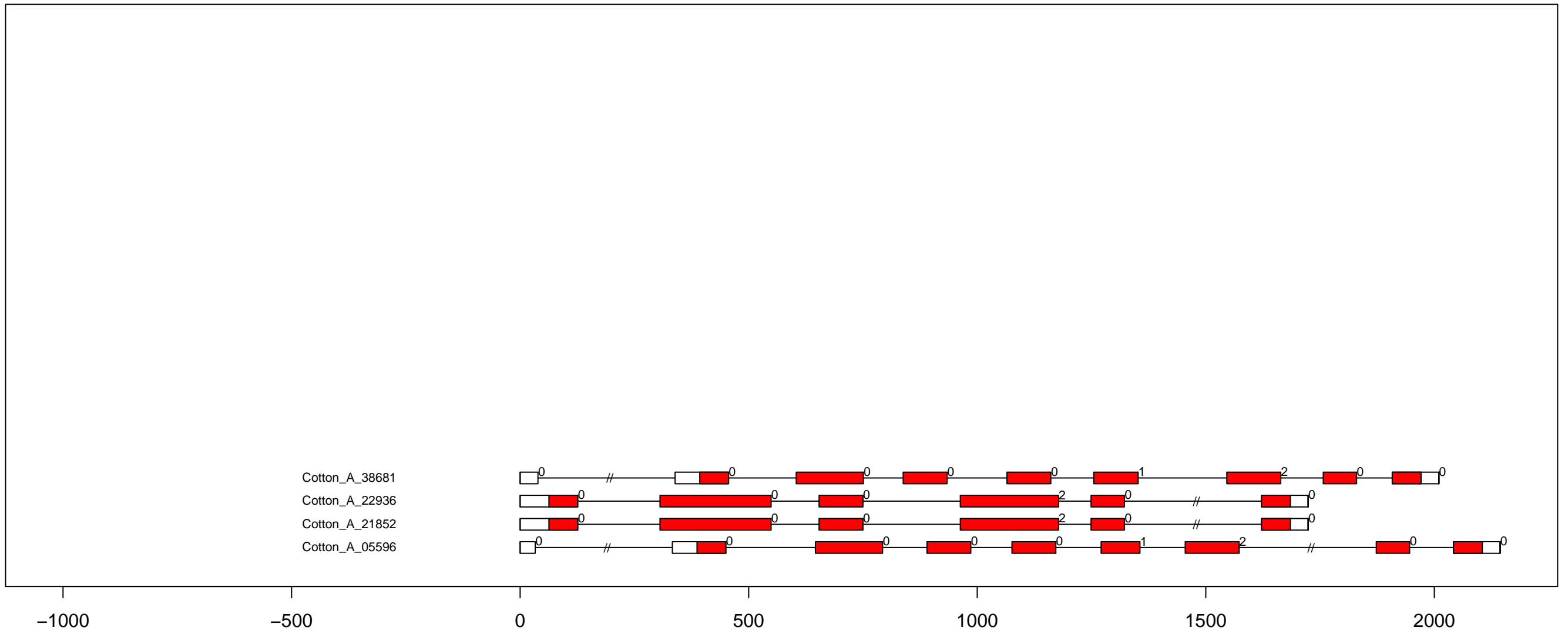

G.ar BUB exon-intron and domain diagram (all)

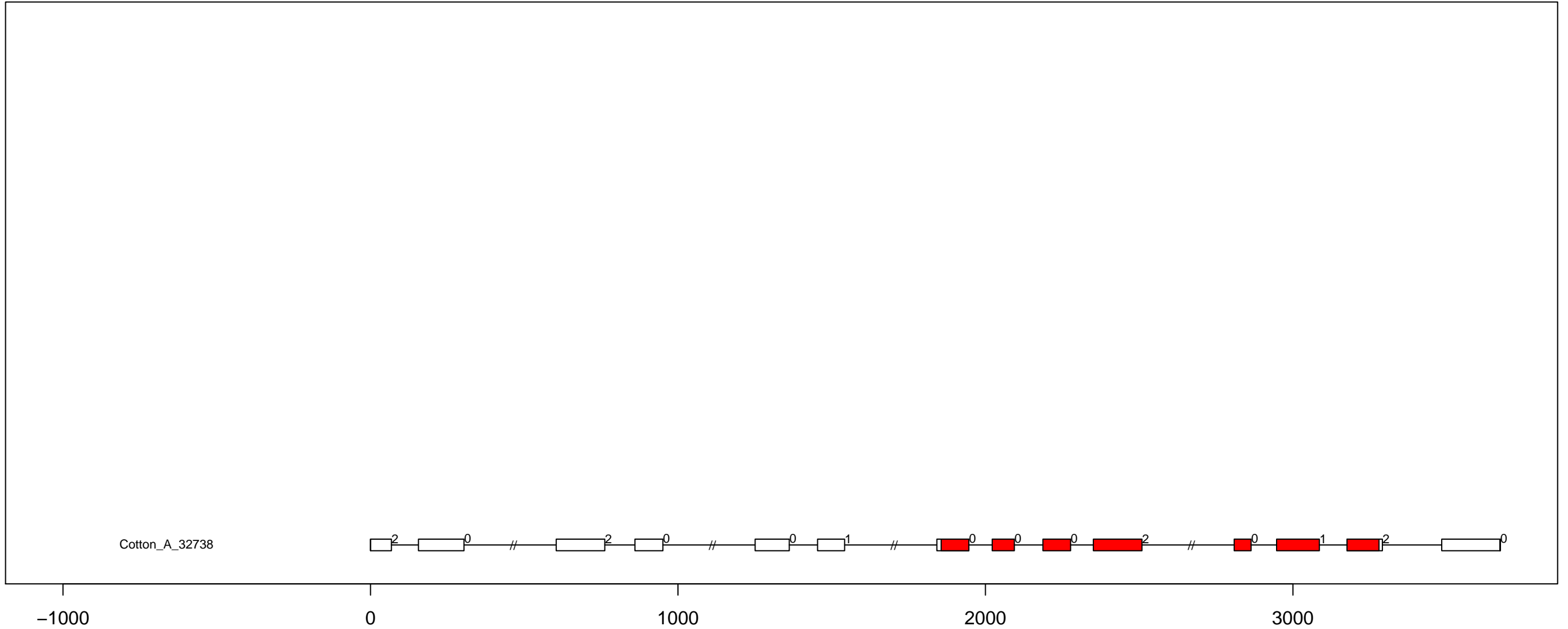

G.ar CAMK_AMPK exon-intron and domain diagram (all)

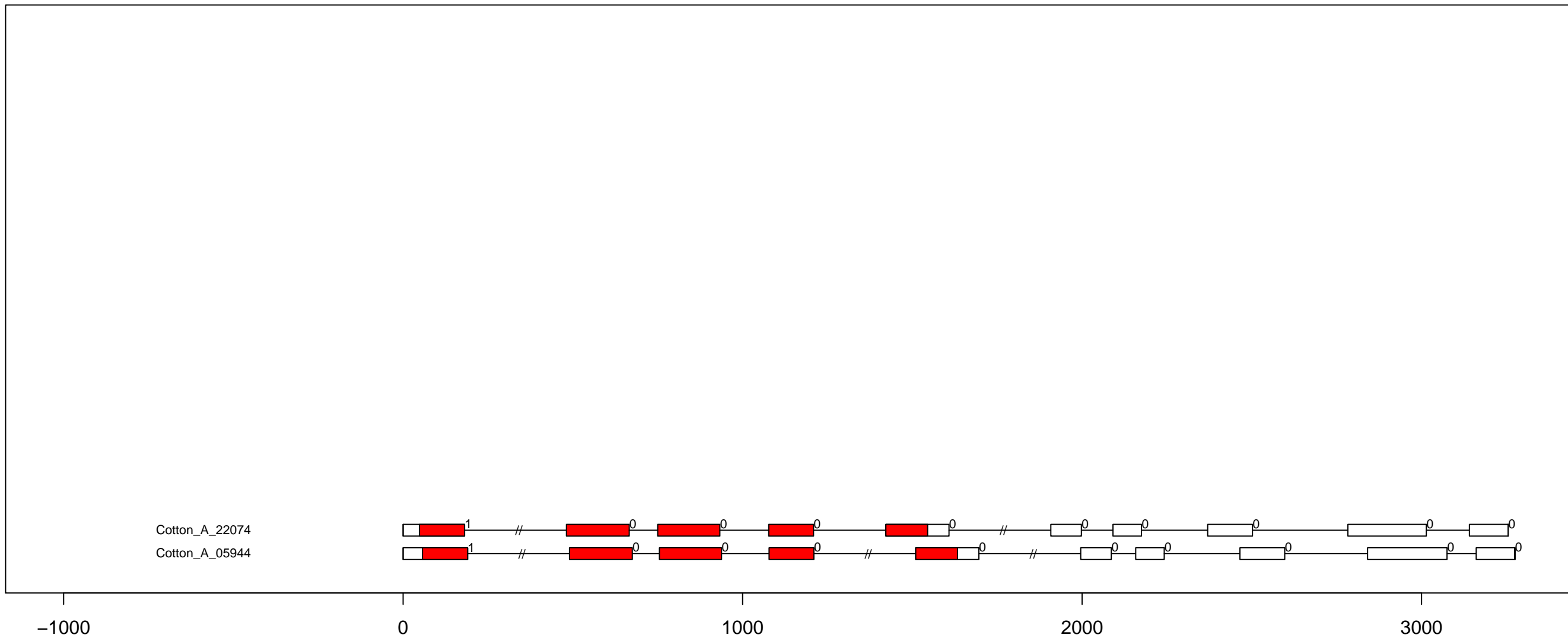

G.ar CAMK_CAMK1-DCAMKL exon-intron and domain diagram (all)

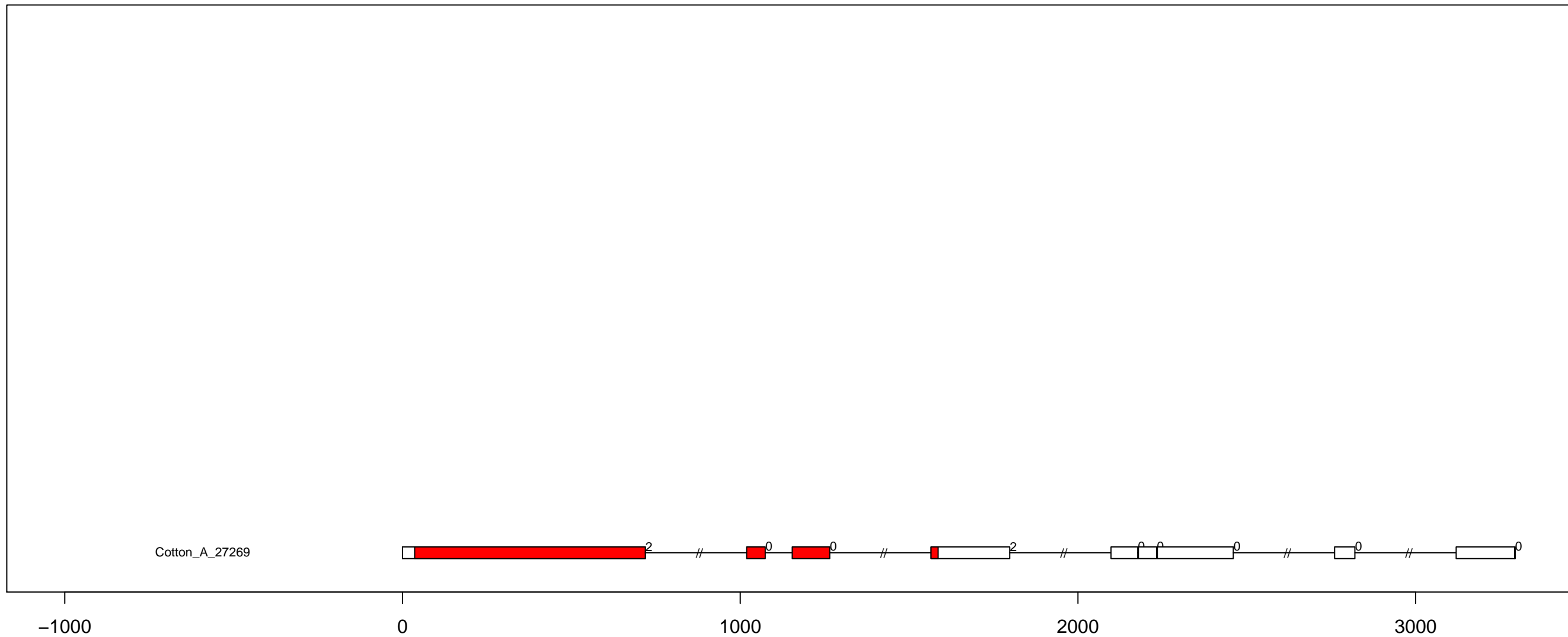

G.ar CAMK_CAMKL-CHK1 exon-intron and domain diagram (part 1)

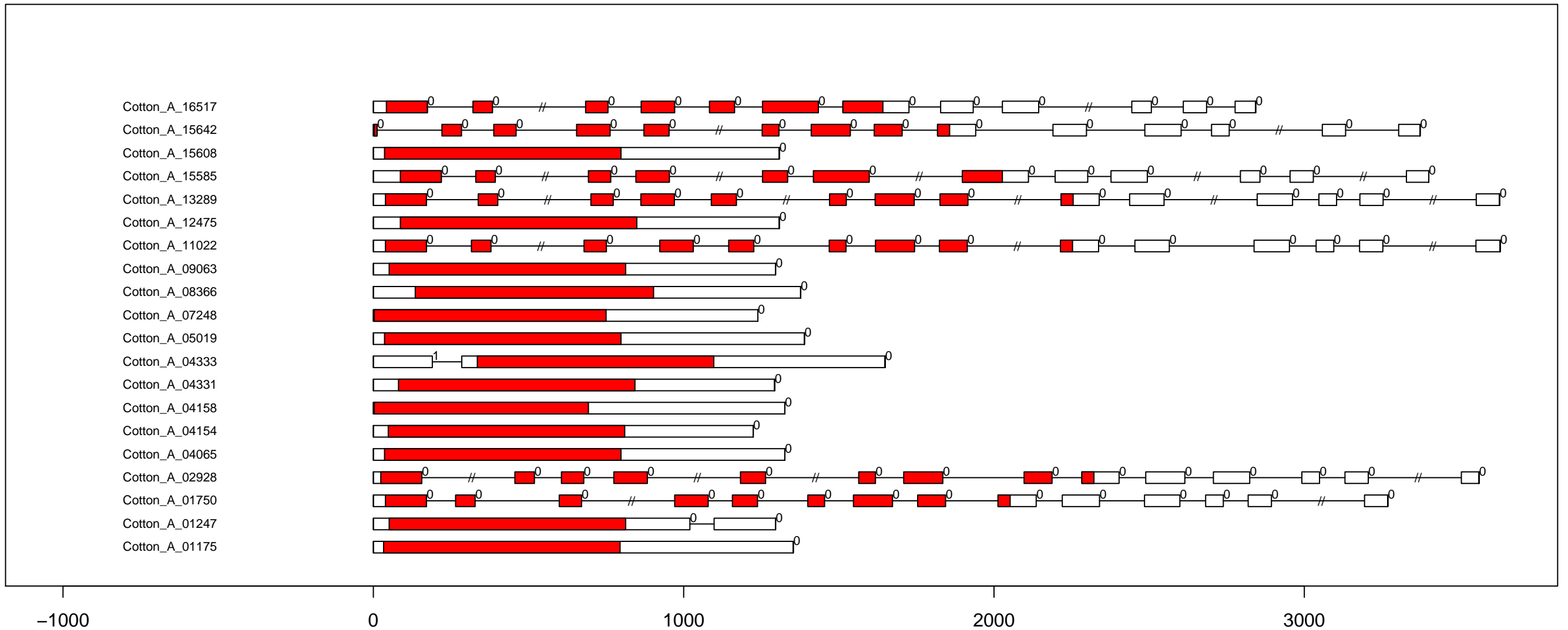

G.ar CAMK_CAMKL-CHK1 exon-intron and domain diagram (part 2)

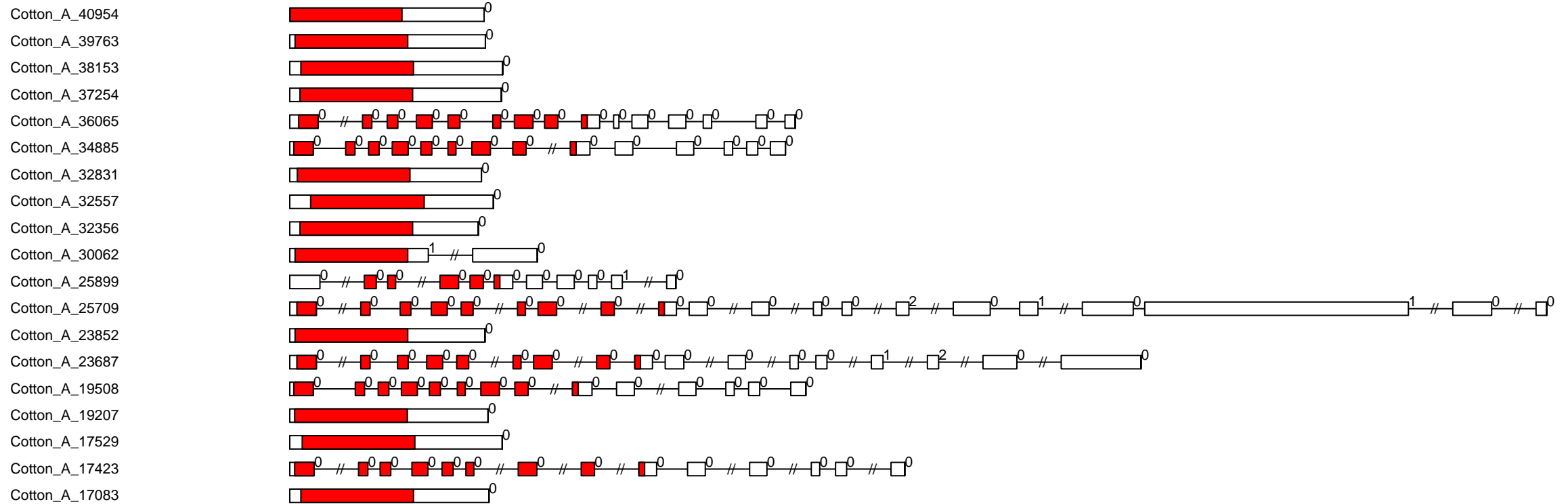

G.ar CAMK_CAMKL-LKB exon-intron and domain diagram (all)

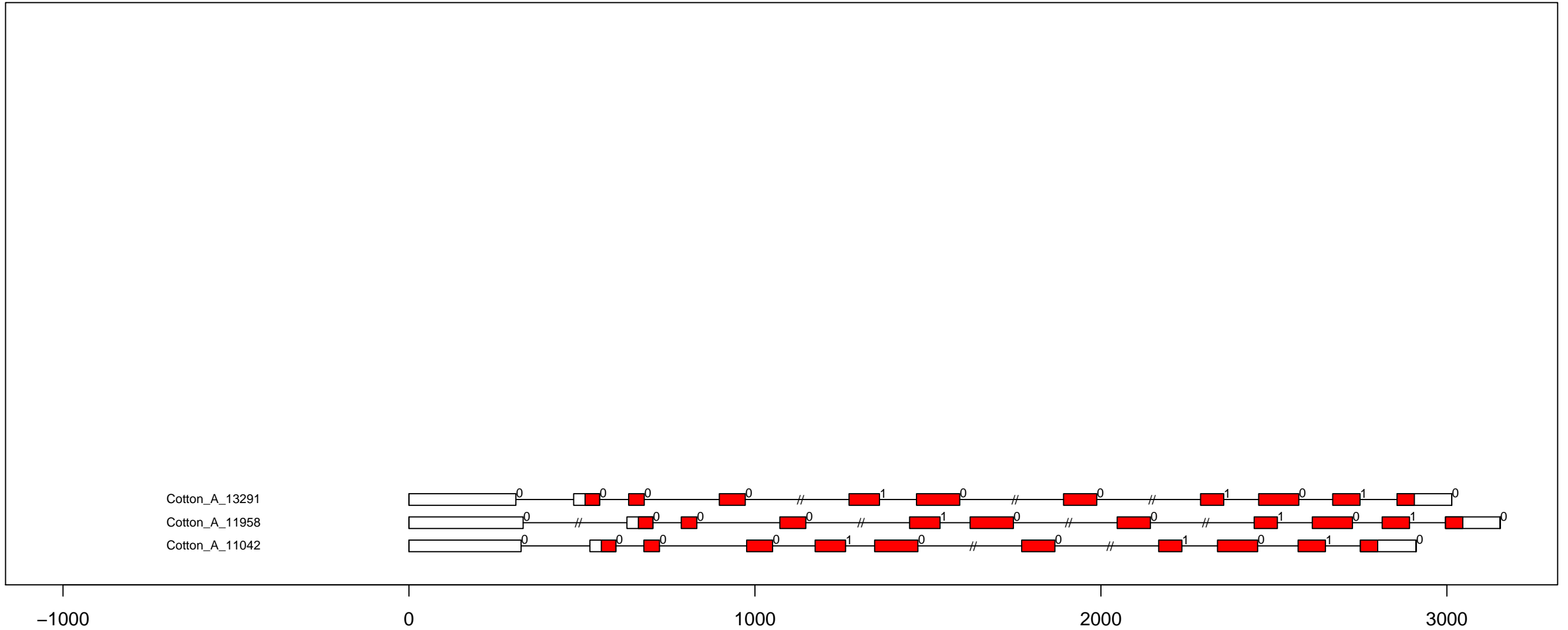

G.ar CAMK_CDPK exon-intron and domain diagram (part 1)

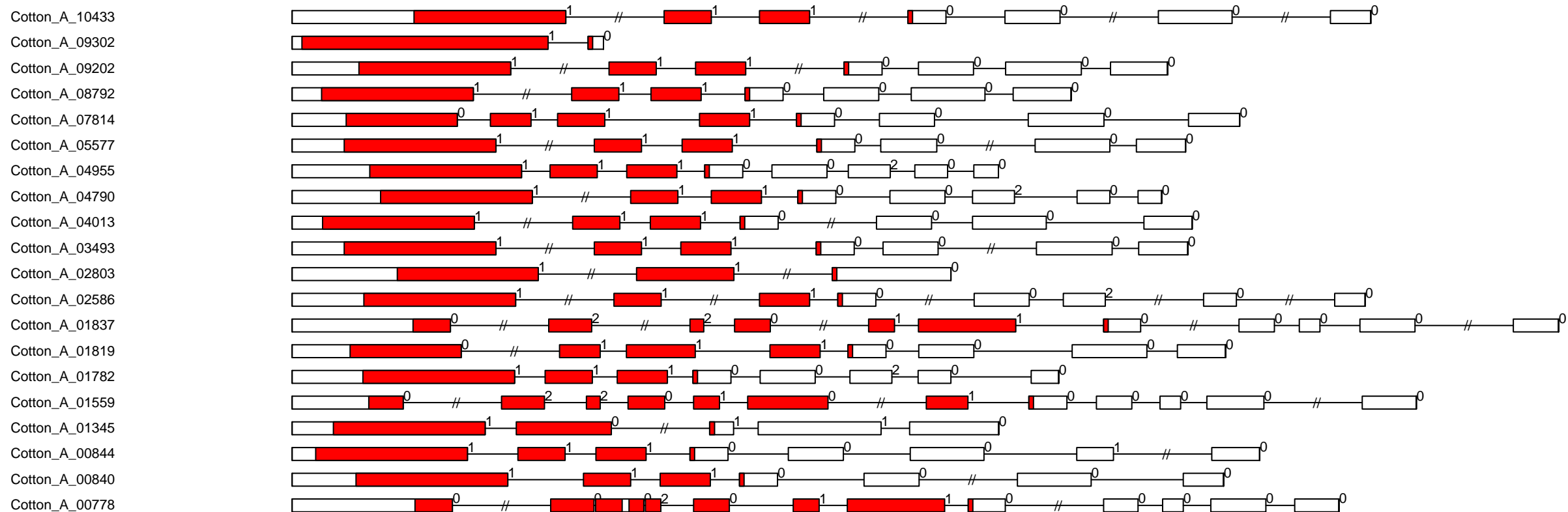

-1000

0

1000

2000

3000

4000

G.ar CAMK_CDPK exon-intron and domain diagram (part 2)

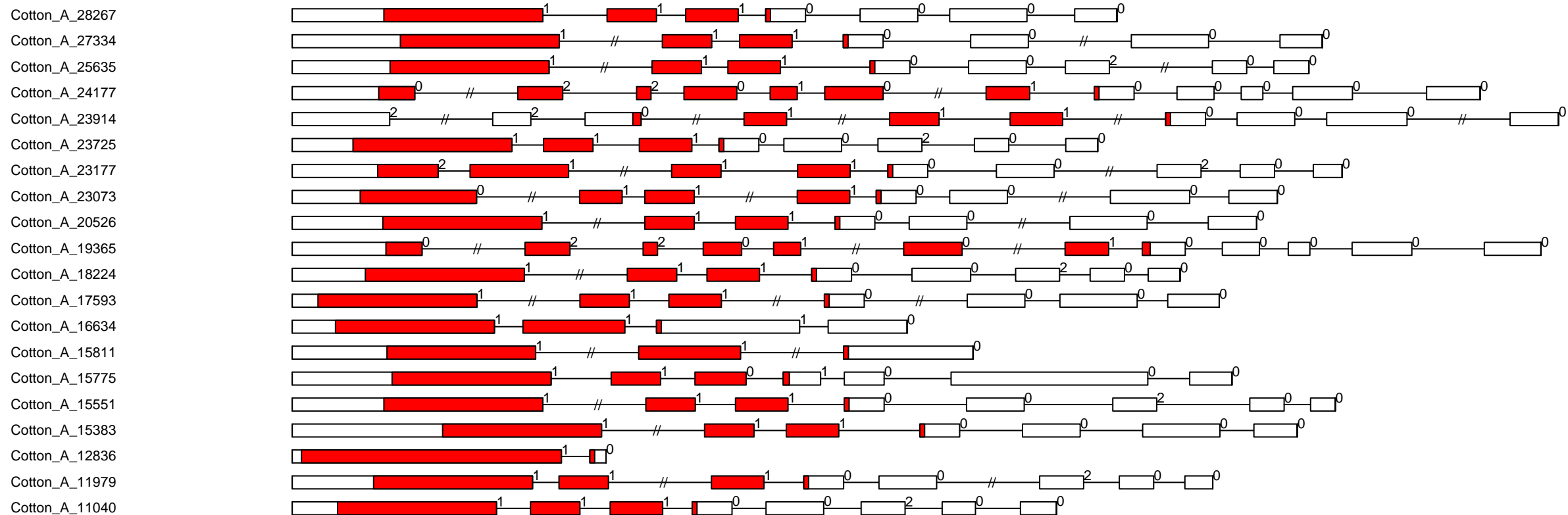

-1000

0

1000

2000

3000

G.ar CAMK_OST1L exon-intron and domain diagram (all)

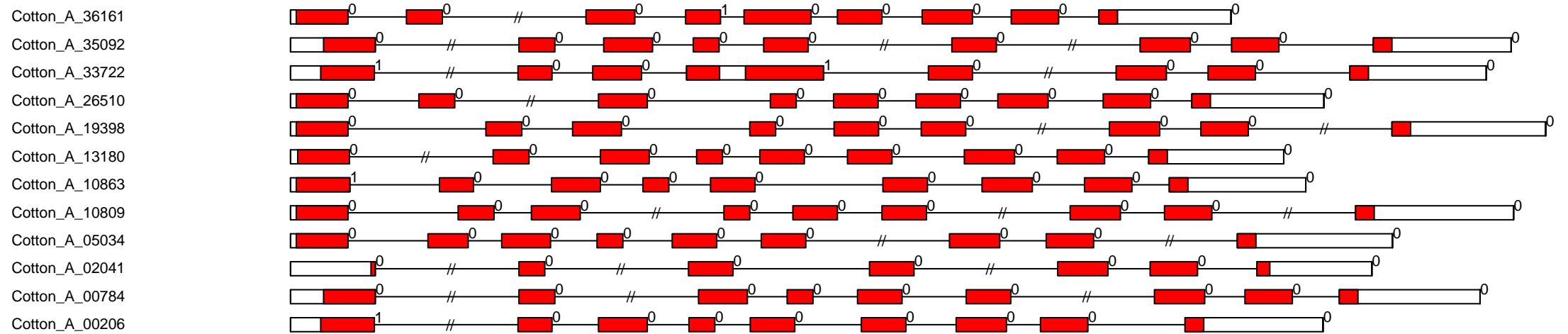

-1000

0

1000

2000

G.ar CK1_CK1 exon-intron and domain diagram (all)

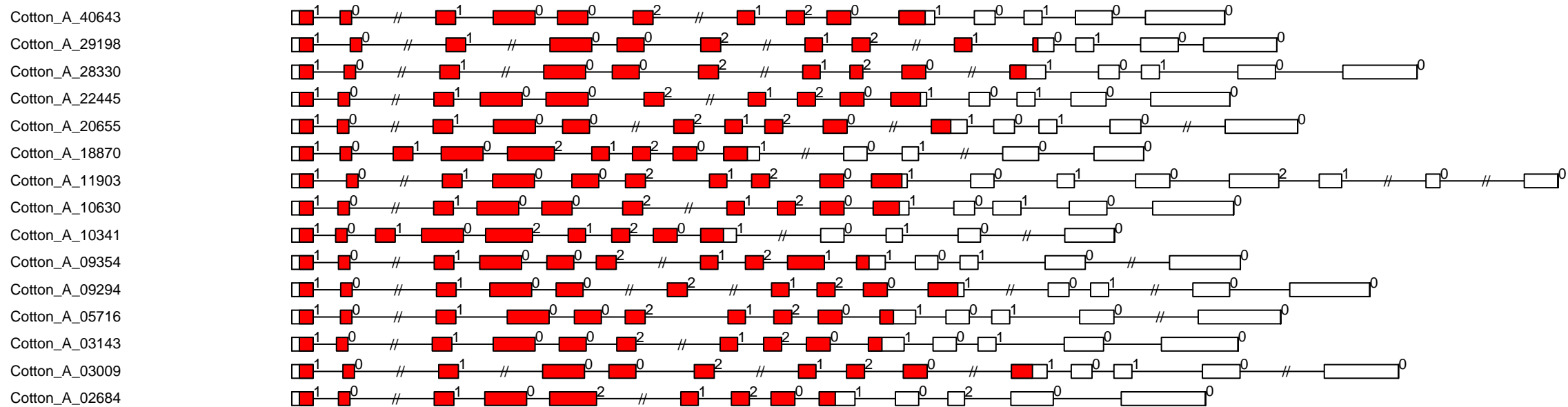

G.ar CK1_CK1-PI exon-intron and domain diagram (all)

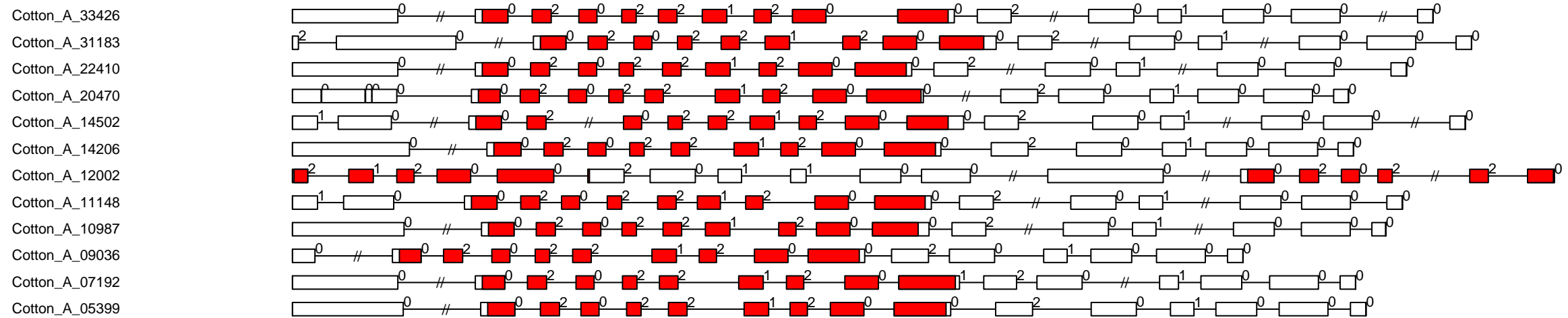

-1000

0

1000

2000

3000

4000

5000

G.ar CMGC_CDK-CCRK exon-intron and domain diagram (all)

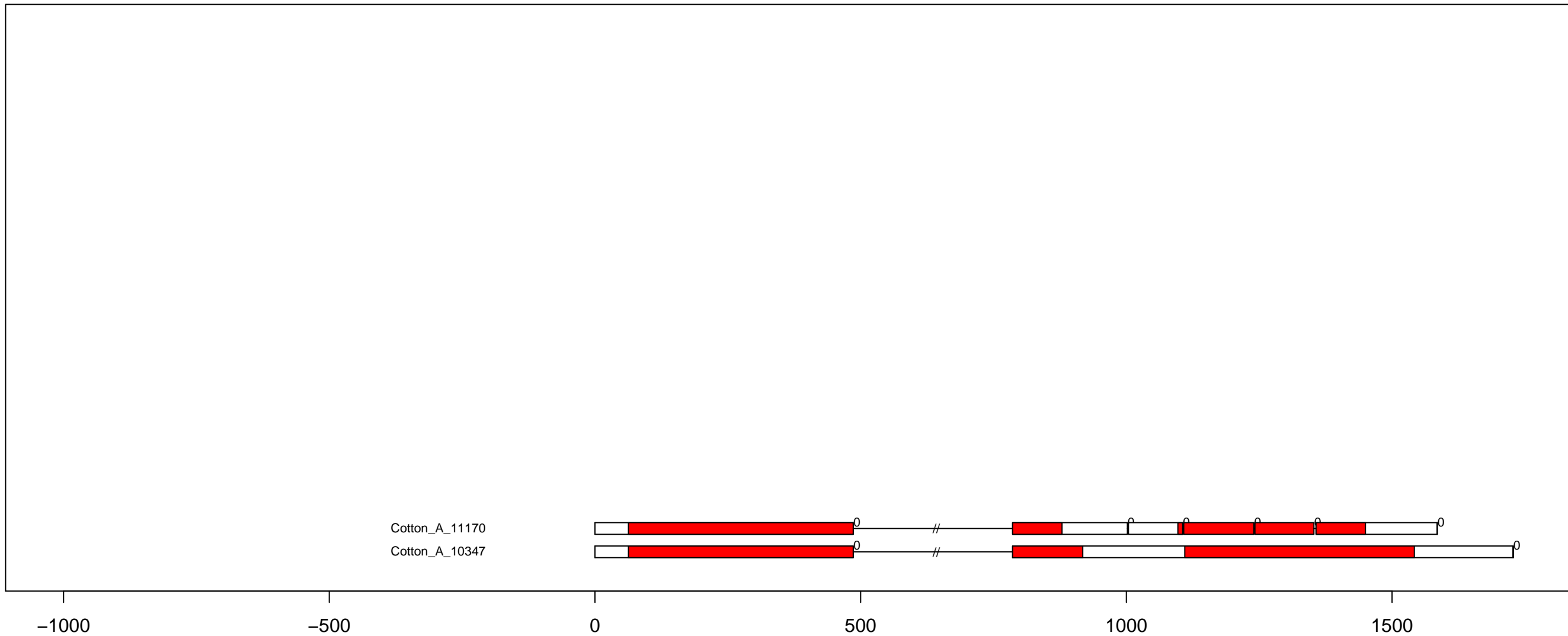

G.ar CMGC_CDK-CDK7 exon-intron and domain diagram (all)

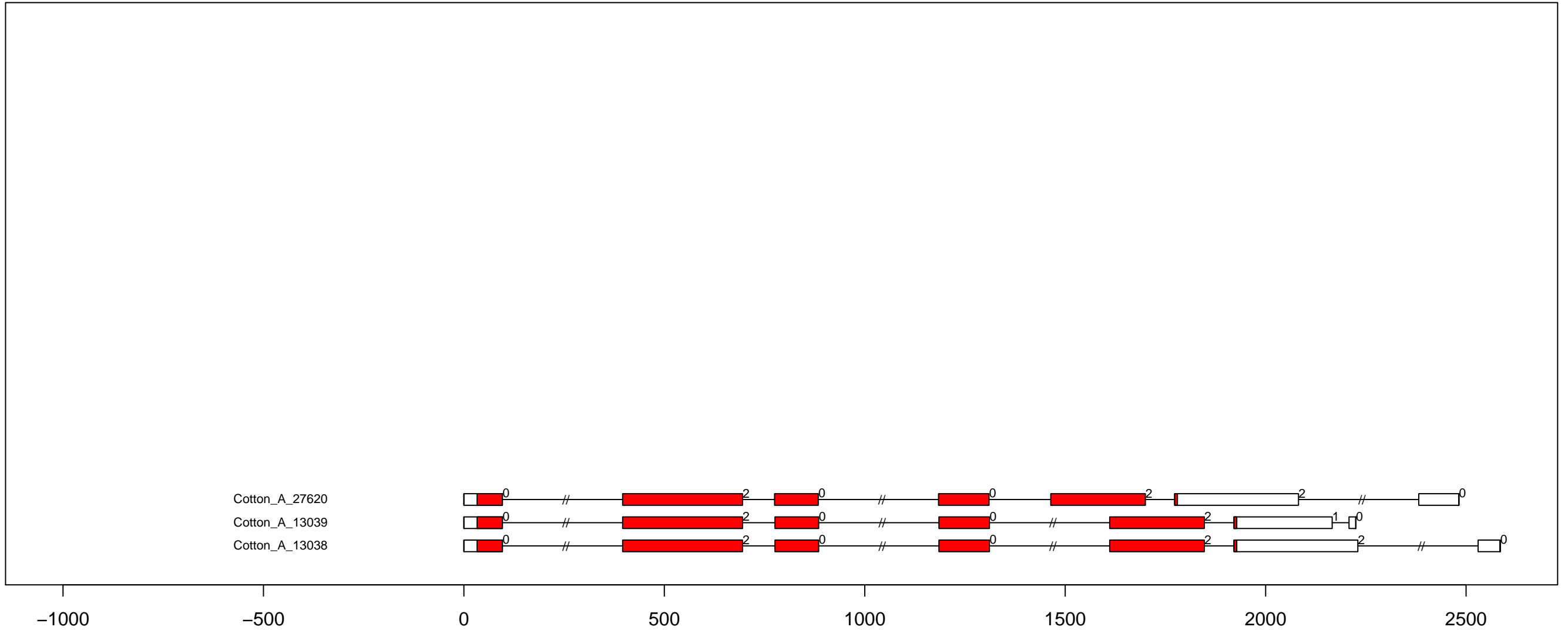

G.ar CMGC_CDK-CDK8 exon-intron and domain diagram (all)

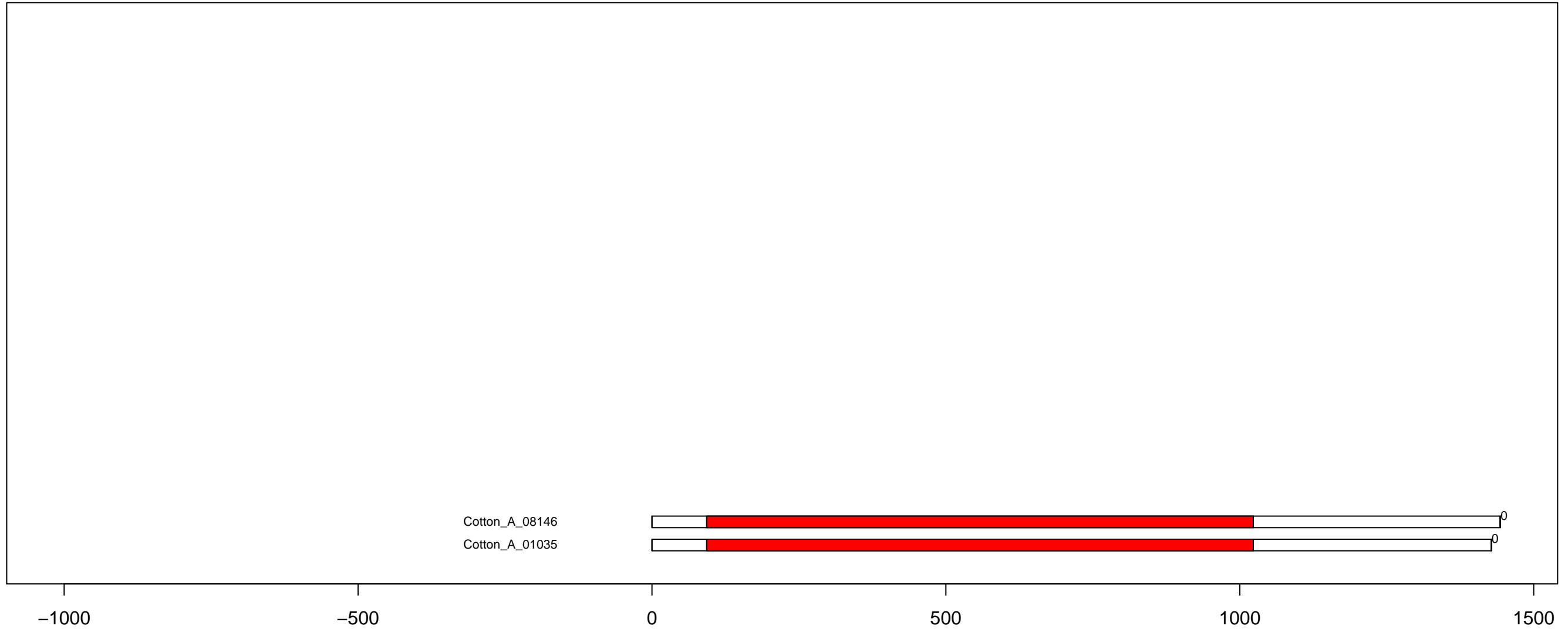

G.ar CMGC_CDK-CRK7-CDK9 exon-intron and domain diagram (part 1)

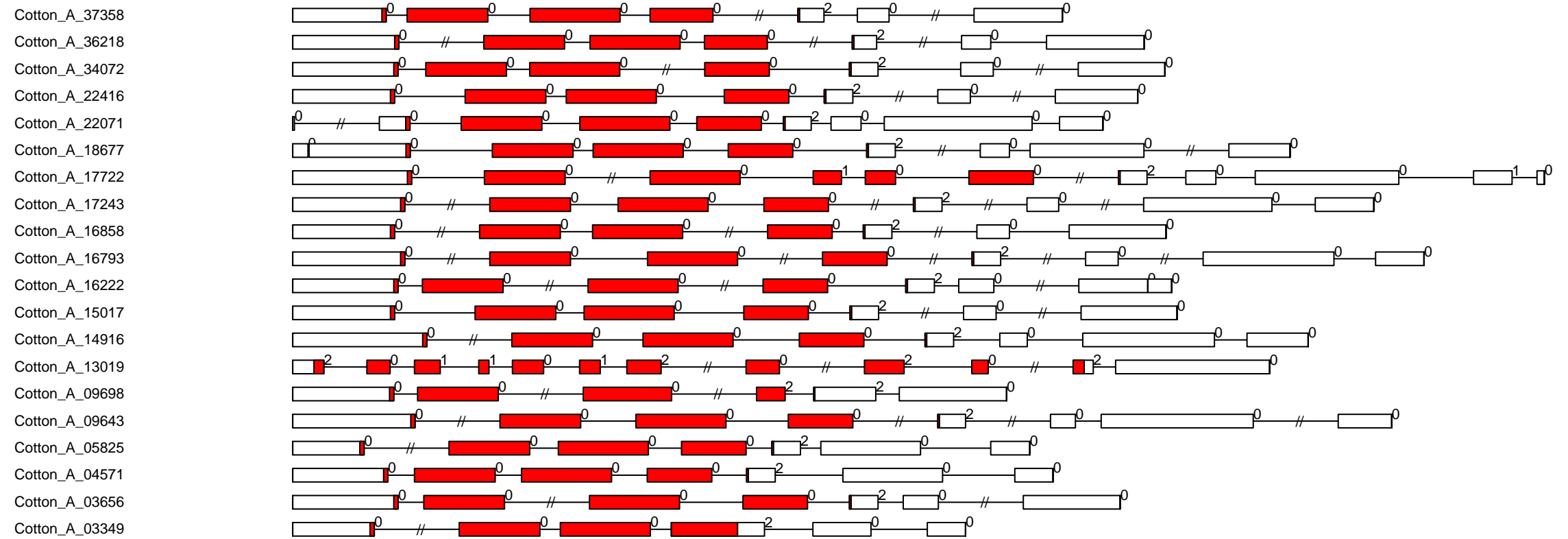

G.ar CMGC_CDK-CRK7-CDK9 exon-intron and domain diagram (part 2)

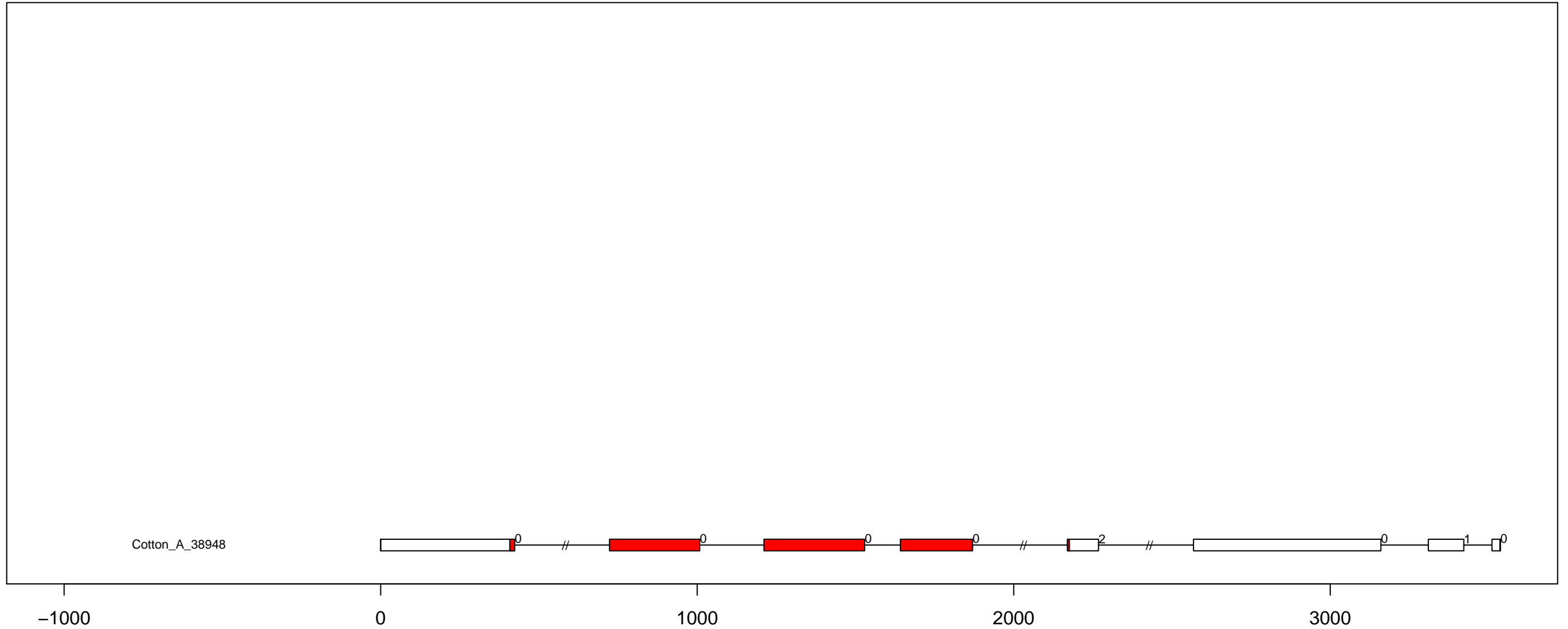

G.ar CMGC_CDK-PITSLRE exon-intron and domain diagram (all)

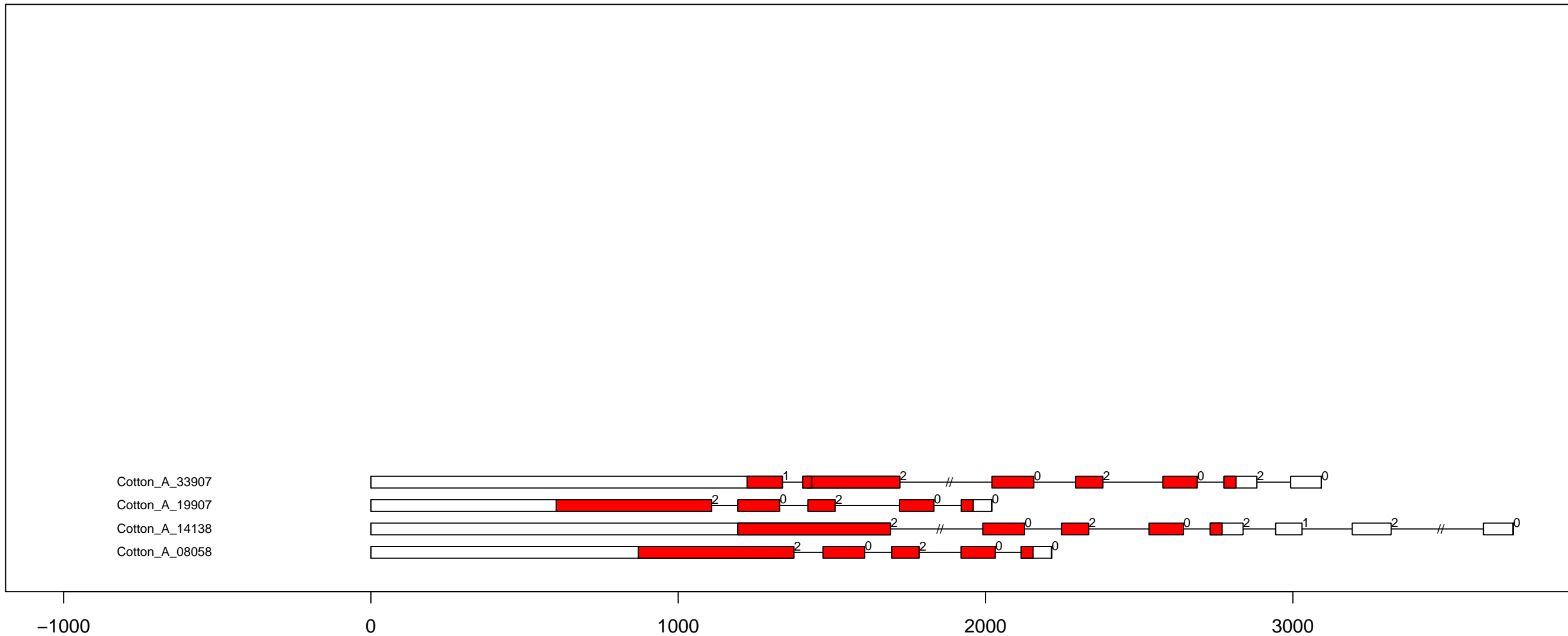

G.ar CMGC_CDK-PI exon-intron and domain diagram (all)

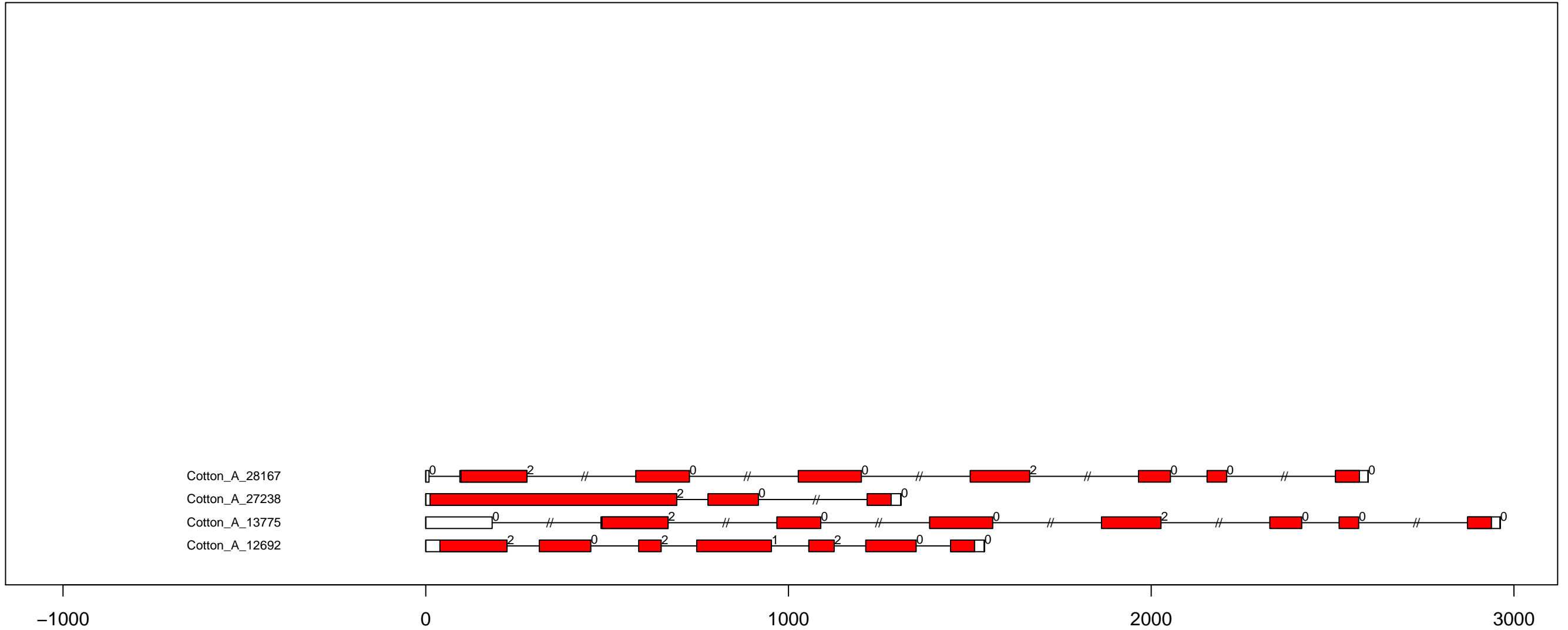

G.ar CMGC_CLK exon-intron and domain diagram (all)

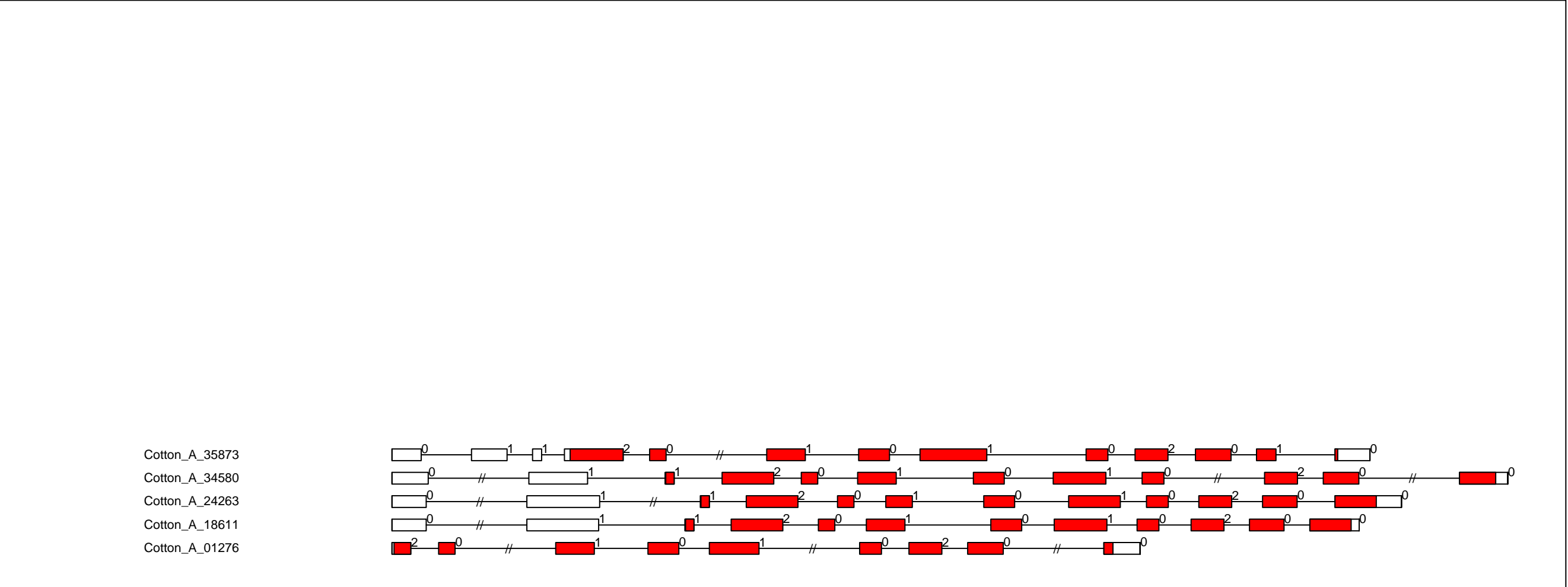

-1000

0

1000

2000

3000

G.ar CMGC_DYRK-PRP4 exon-intron and domain diagram (all)

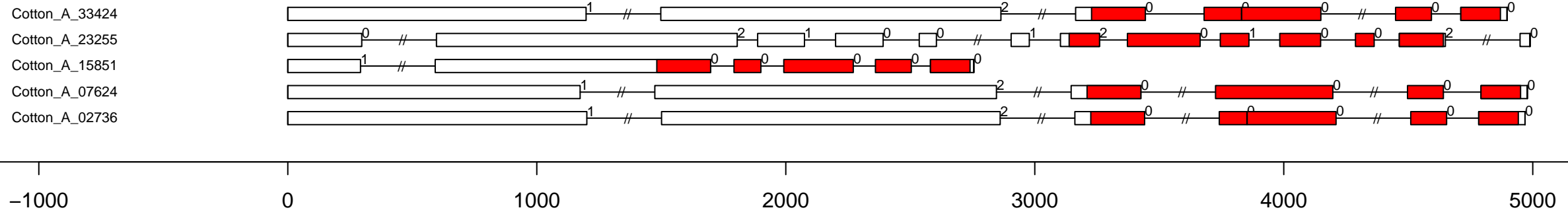

G.ar CMGC_DYRK-YAK exon-intron and domain diagram (all)

Cotton_A_32071

Cotton_A_29534

Cotton_A_23503

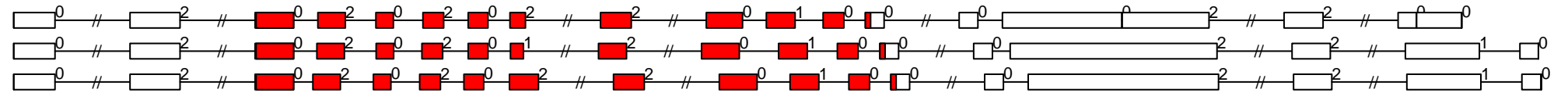

0

2000

4000

6000

G.ar CMGC_GSKL exon-intron and domain diagram (all)

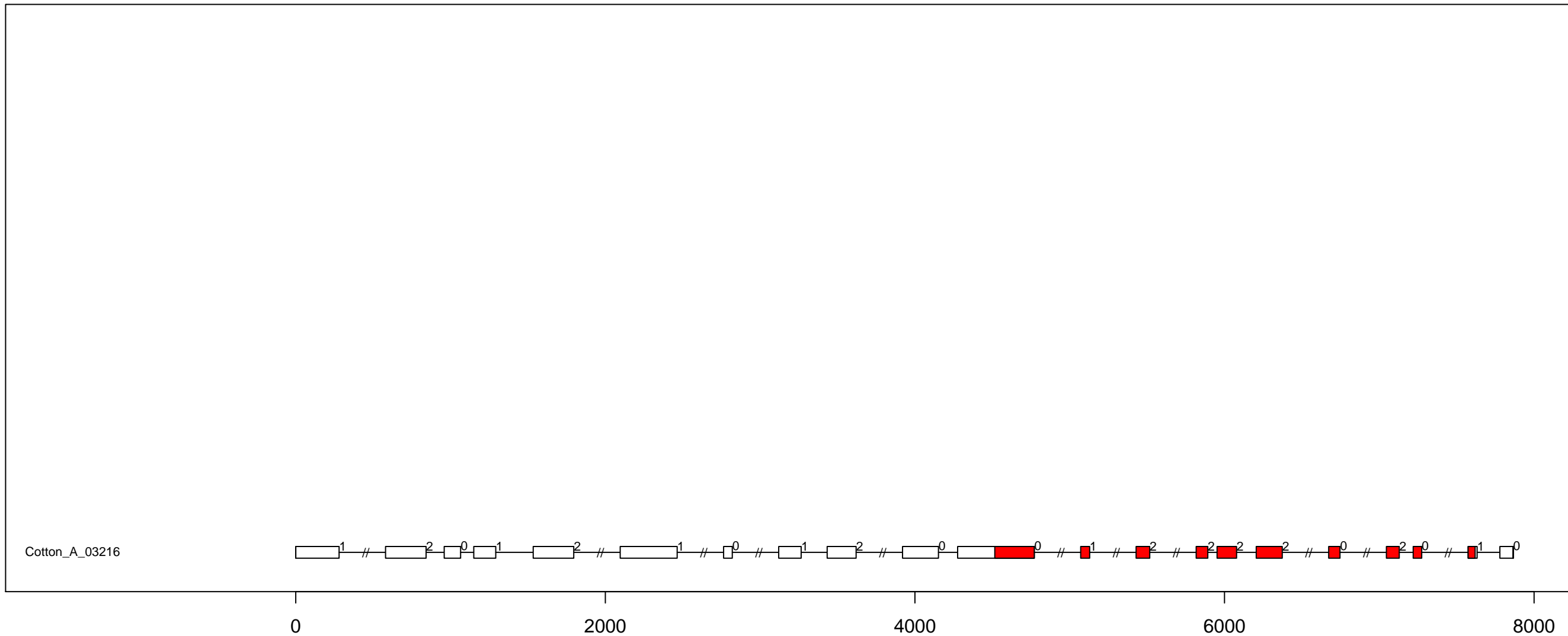

G.ar CMGC_GSK exon-intron and domain diagram (all)

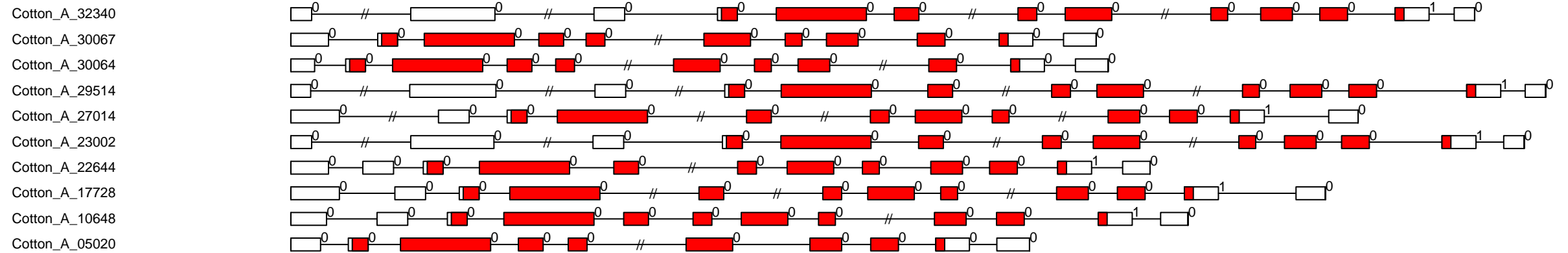

G.ar CMGC_MAPK exon-intron and domain diagram (part 1)

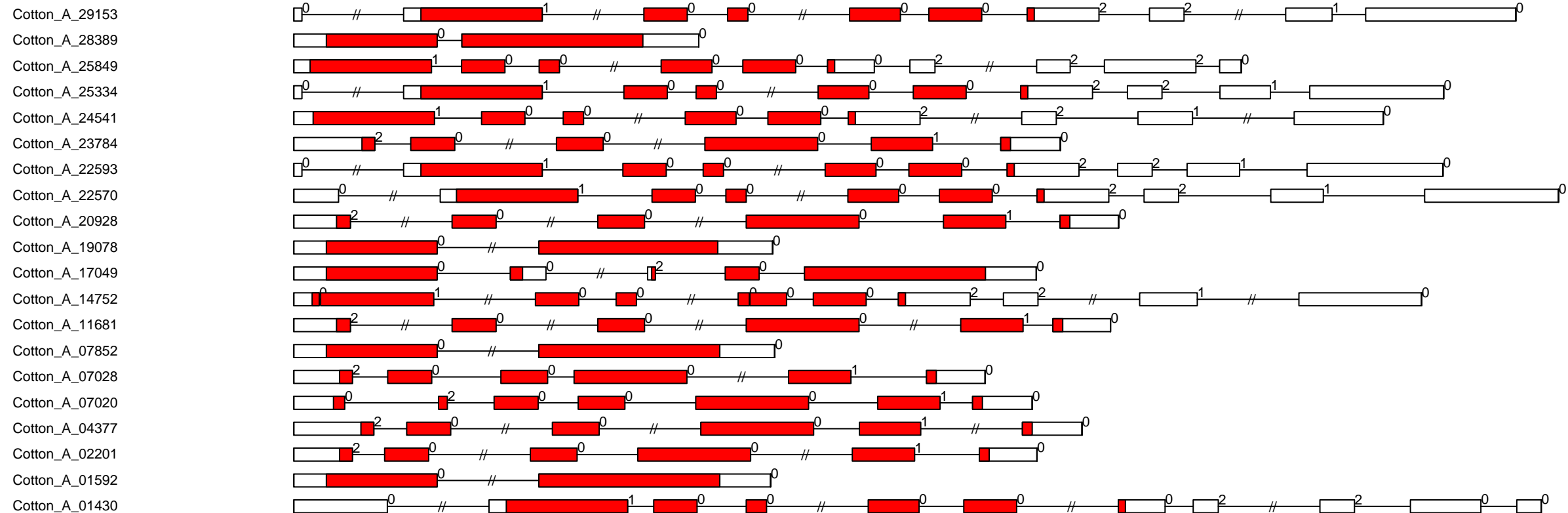

-1000

0

1000

2000

3000

G.ar CMGC_MAPK exon-intron and domain diagram (part 2)

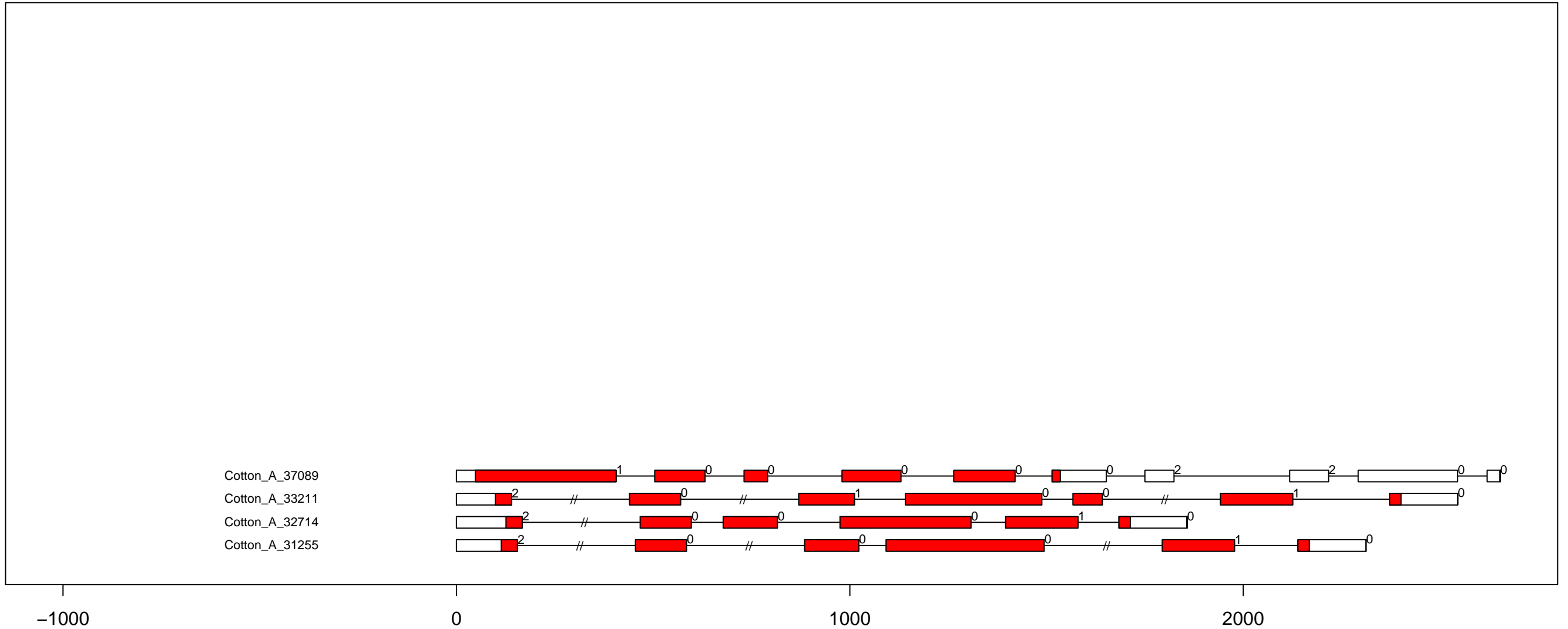

G.ar CMGC_PI-Tthe exon-intron and domain diagram (all)

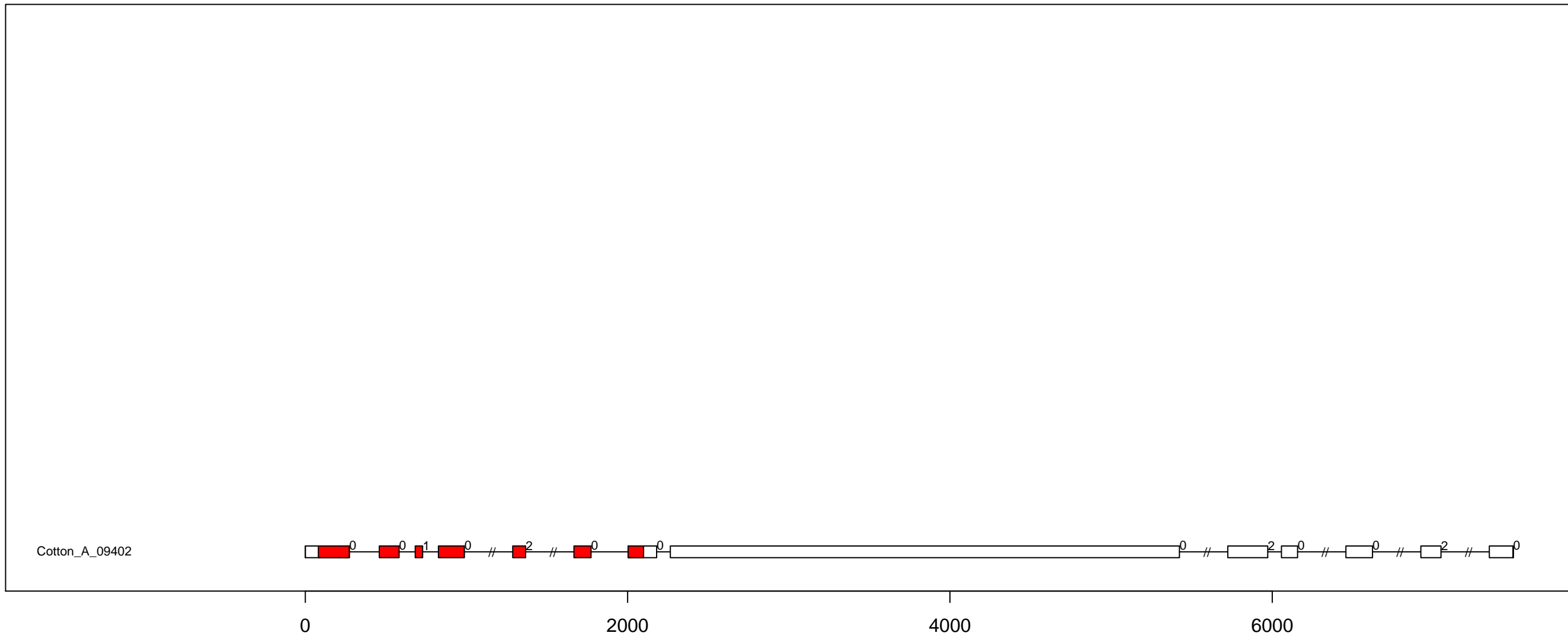

G.ar CMGC_RCK exon-intron and domain diagram (all)

Cotton_A_25379
Cotton_A_15191
Cotton_A_14275
Cotton_A_07964
Cotton_A_03795

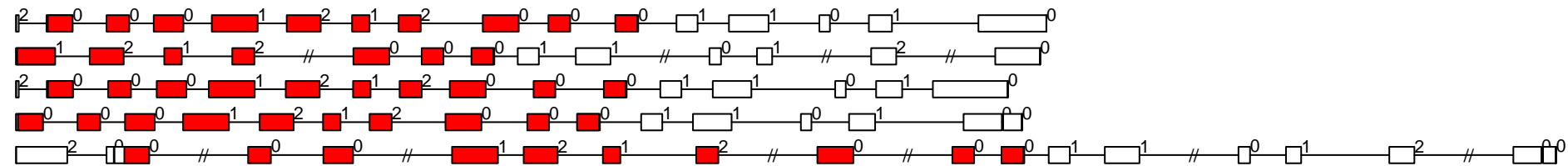

-1000

0

1000

2000

3000

4000

G.ar CMGC_SRPK exon-intron and domain diagram (all)

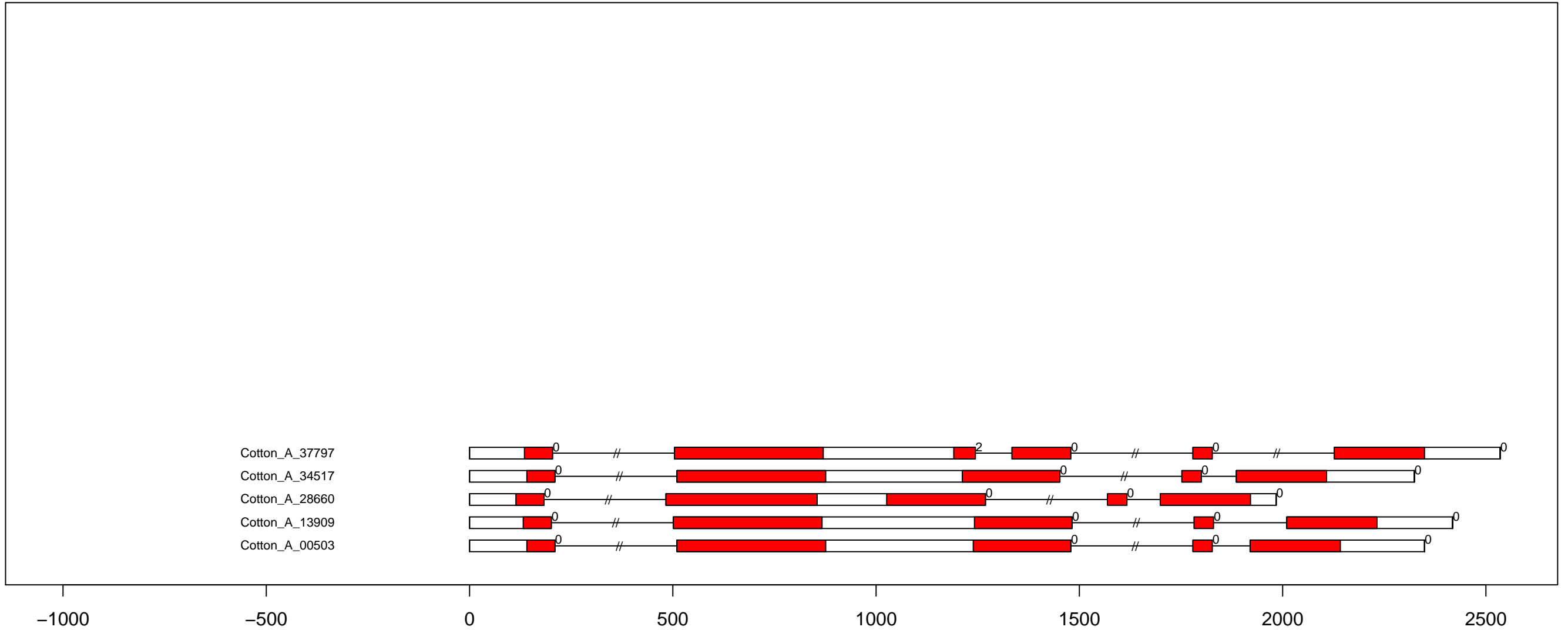

G.ar Group-PI-2 exon-intron and domain diagram (all)

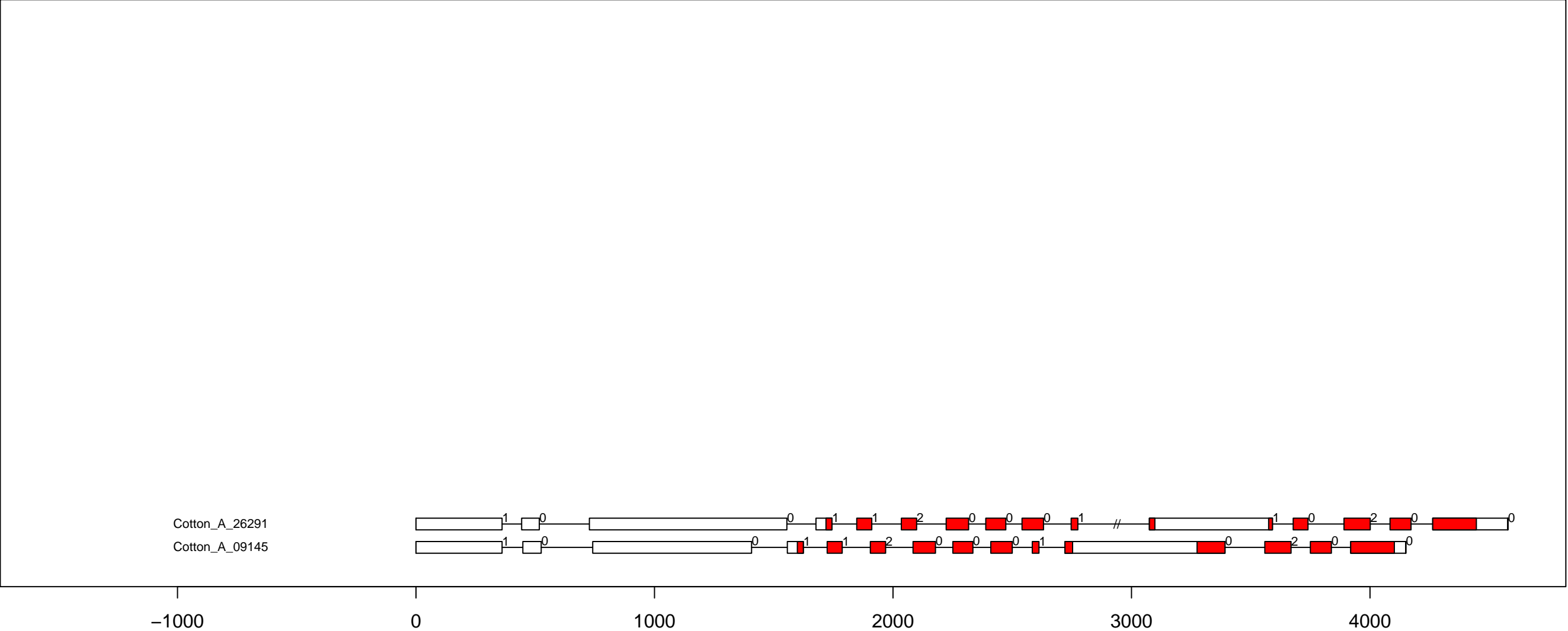

G.ar Group-PI-3 exon-intron and domain diagram (all)

Cotton_A_33556
 Cotton_A_22675
 Cotton_A_15660
 Cotton_A_10908

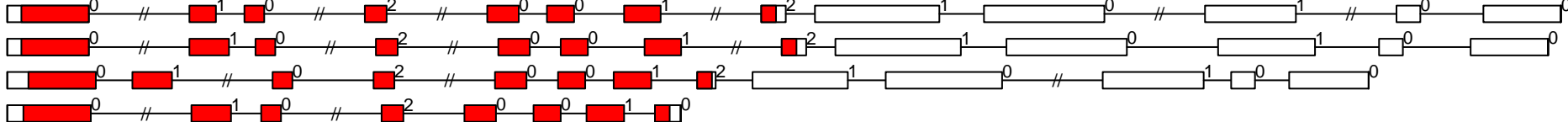

-1000

0

1000

2000

3000

4000

G.ar Group-PI-4 exon-intron and domain diagram (all)

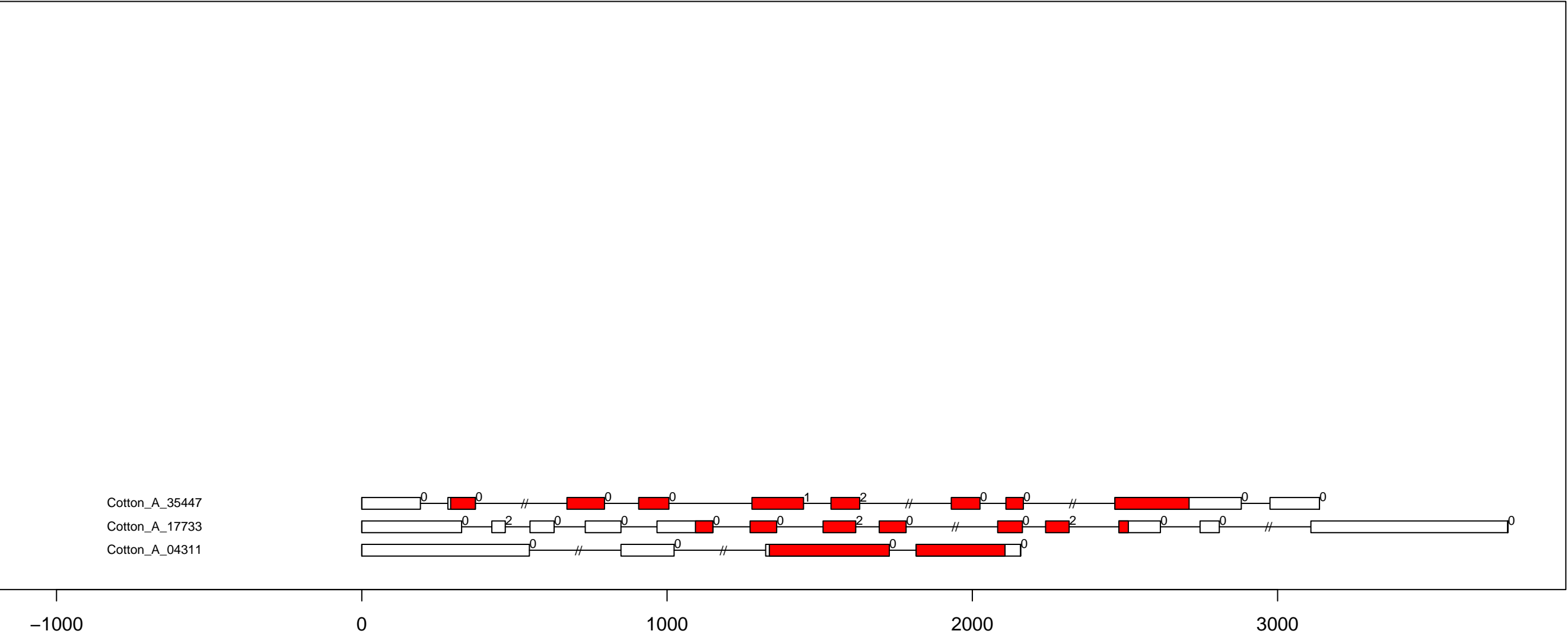

G.ar IRE1 exon-intron and domain diagram (all)

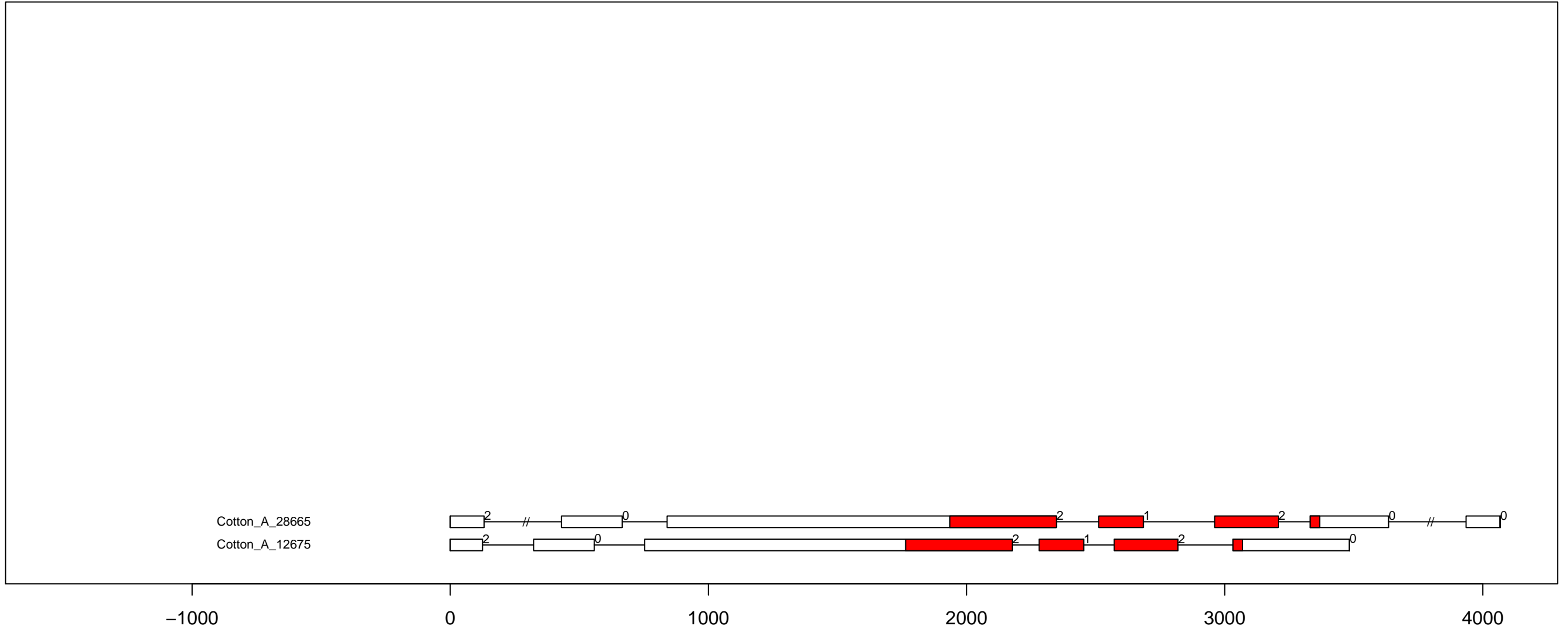

G.ar NAK exon-intron and domain diagram (all)

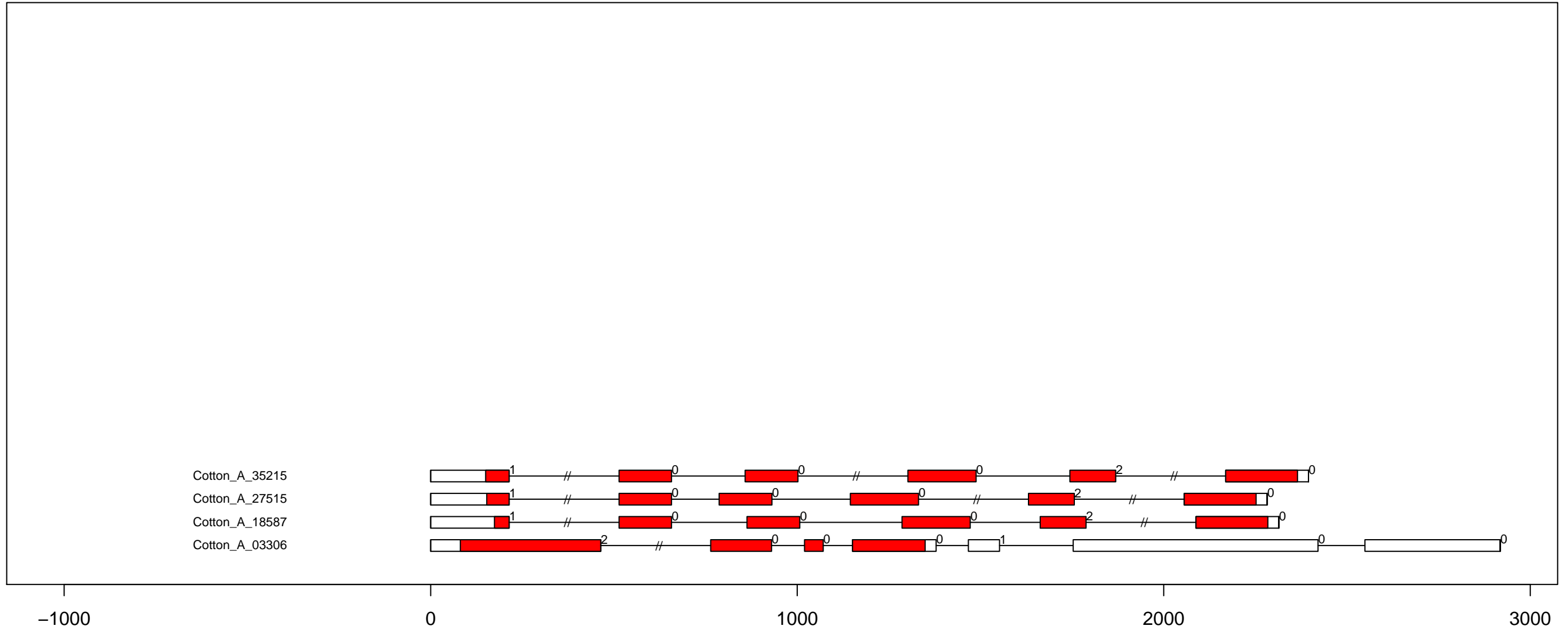

G.ar NEK exon-intron and domain diagram (all)

Cotton_A_35259

Cotton_A_30266

Cotton_A_22020

Cotton_A_16984

Cotton_A_15339

Cotton_A_14978

Cotton_A_12869

Cotton_A_11088

Cotton_A_07798

Cotton_A_02624

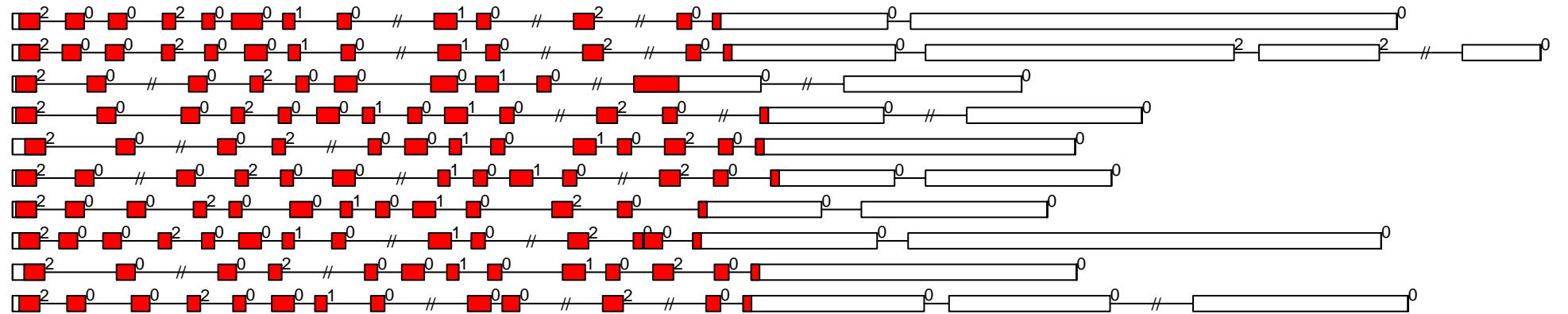

-1000

0

1000

2000

3000

4000

5000

G.ar PEK_GCN2 exon-intron and domain diagram (all)

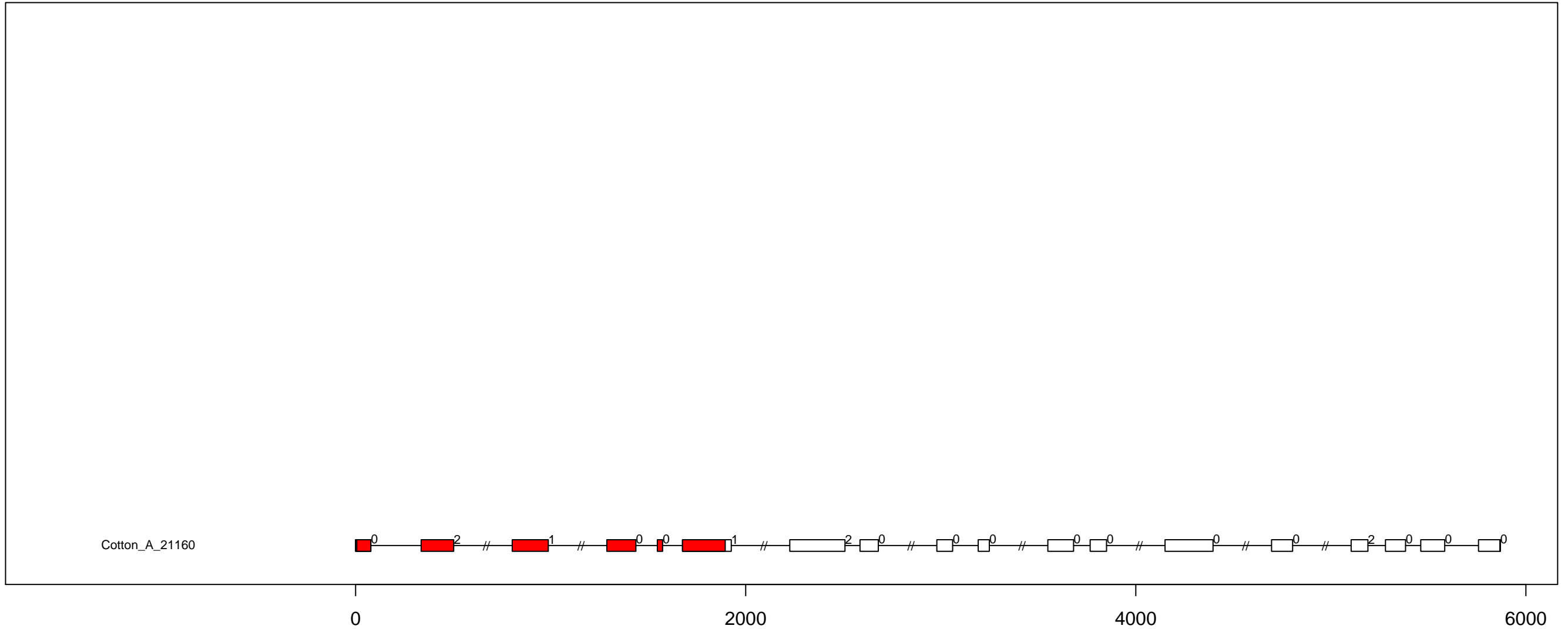

G.ar PEK_PEK exon-intron and domain diagram (all)

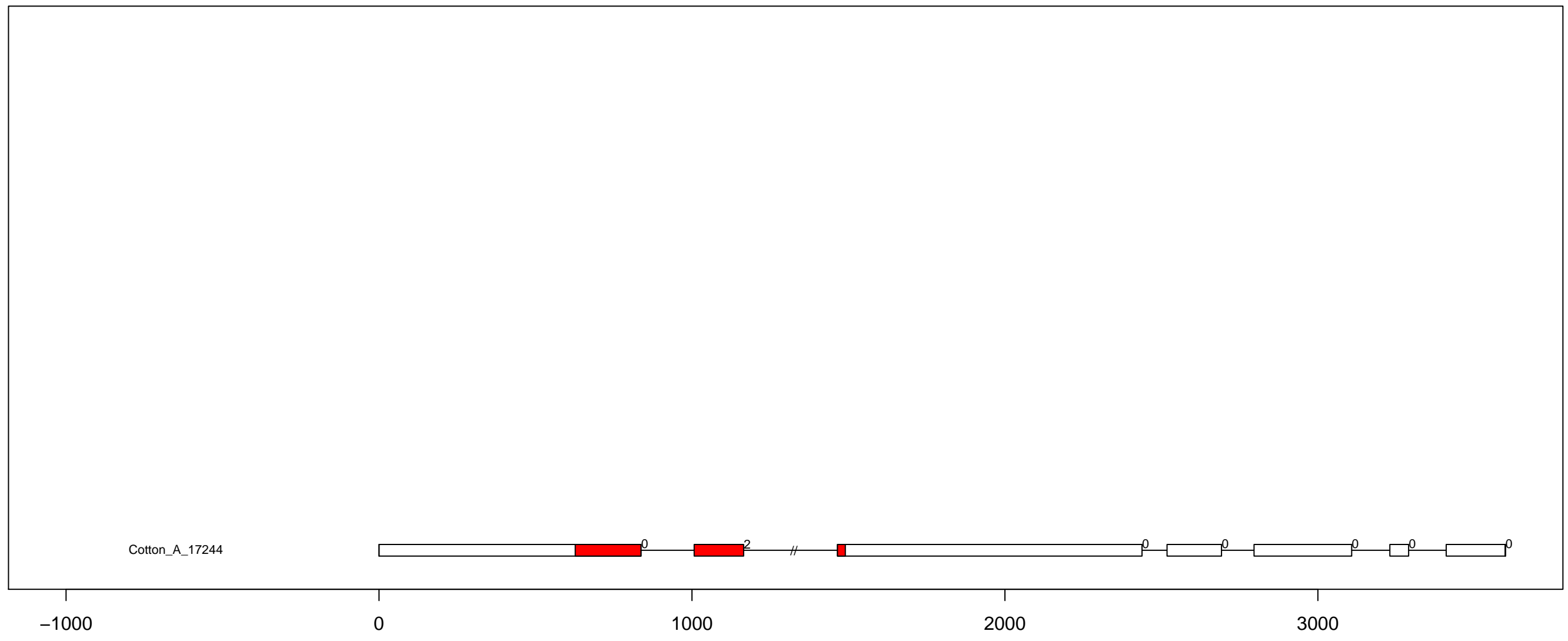

G.ar RLK-Pelle_C-LEC exon-intron and domain diagram (all)

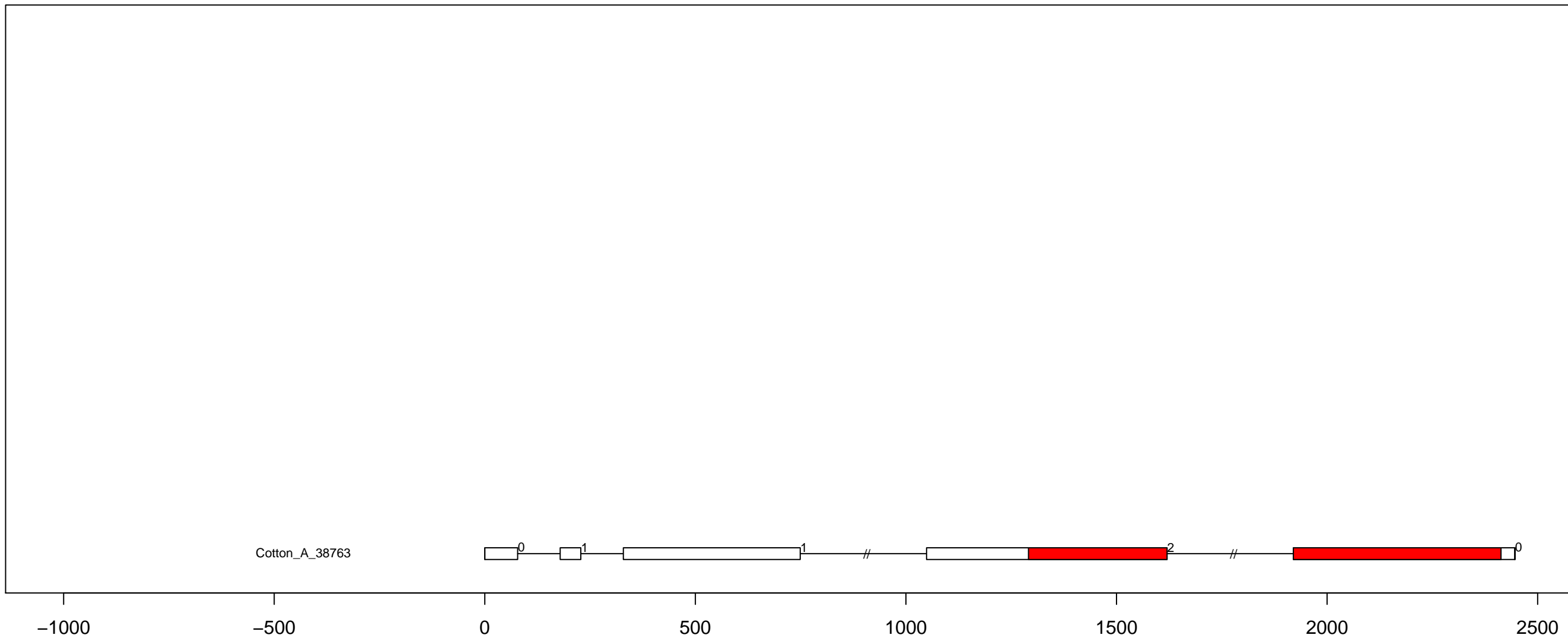

G.ar RLK-Pelle_CR4L exon-intron and domain diagram (all)

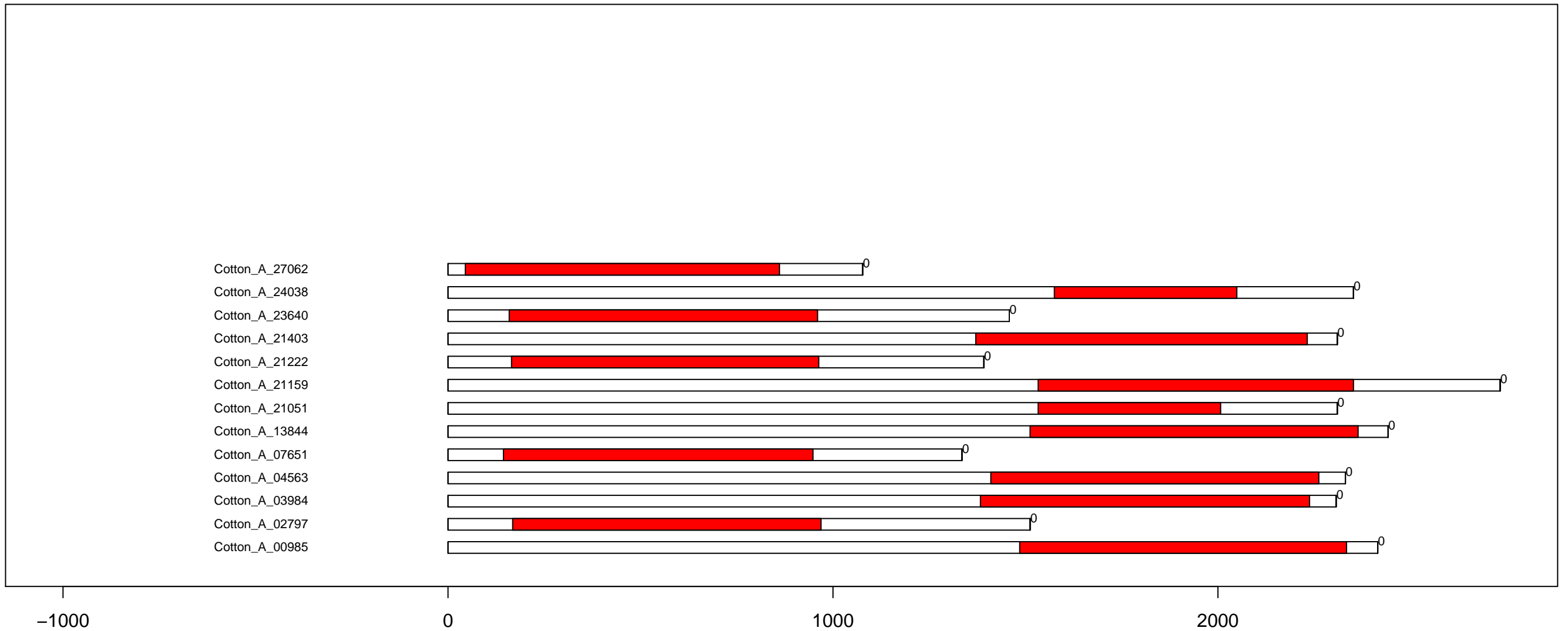

G.ar RLK-Pelle_CrRLK1L-1 exon-intron and domain diagram (part 1)

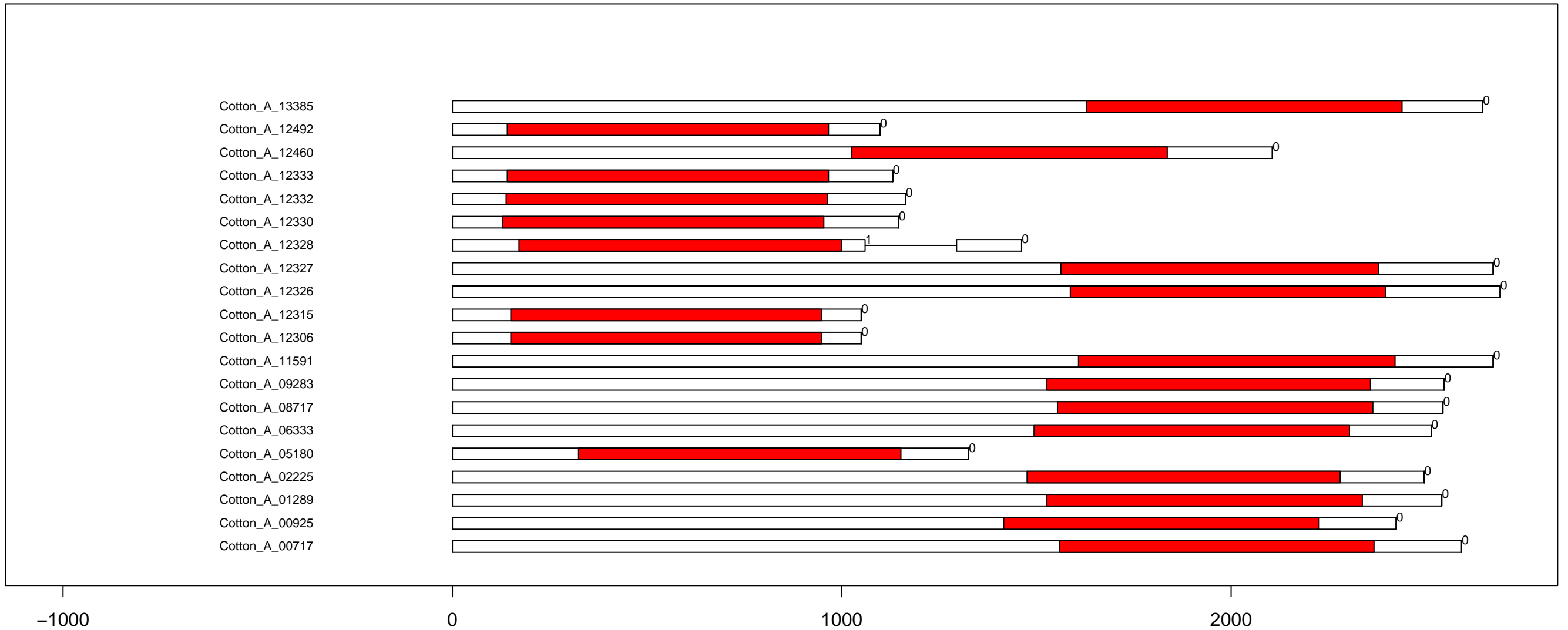

G.ar RLK-Pelle_CrRLK1L-1 exon-intron and domain diagram (part 3)

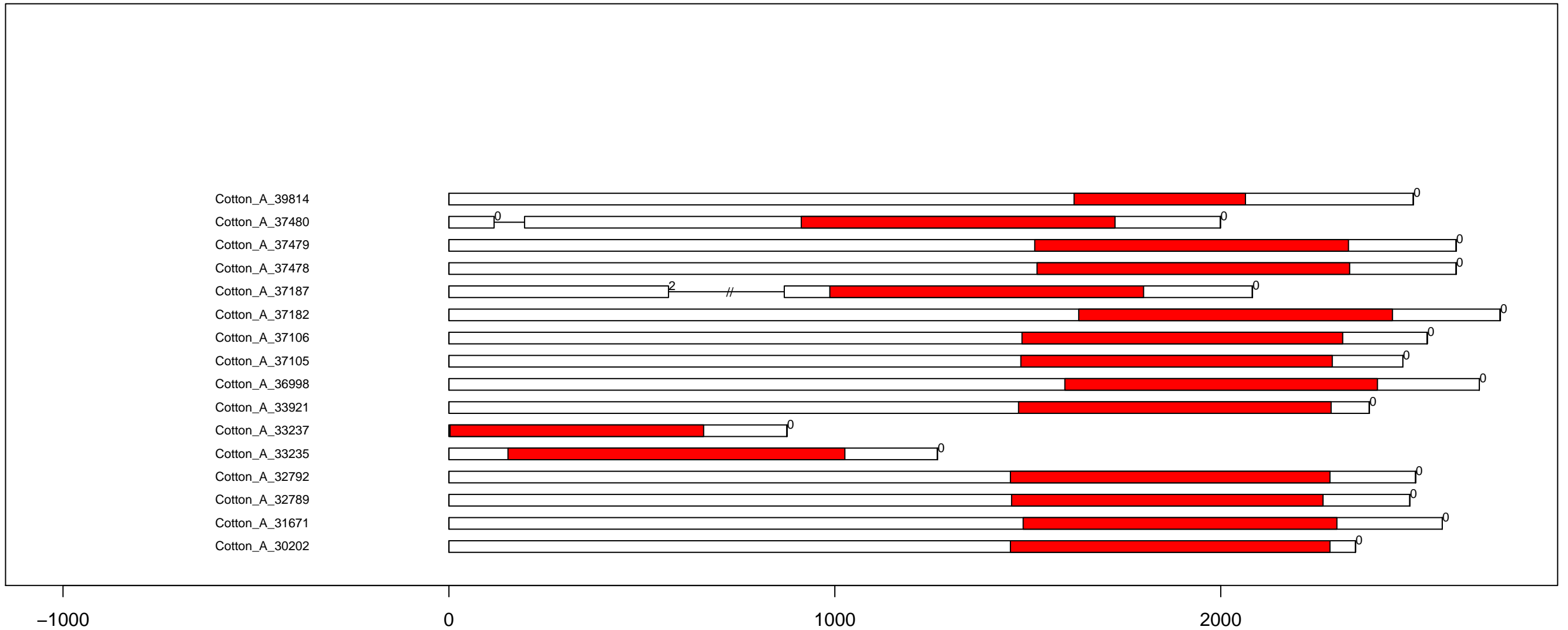

G.ar RLK-Pelle_DLSV exon-intron and domain diagram (part 1)

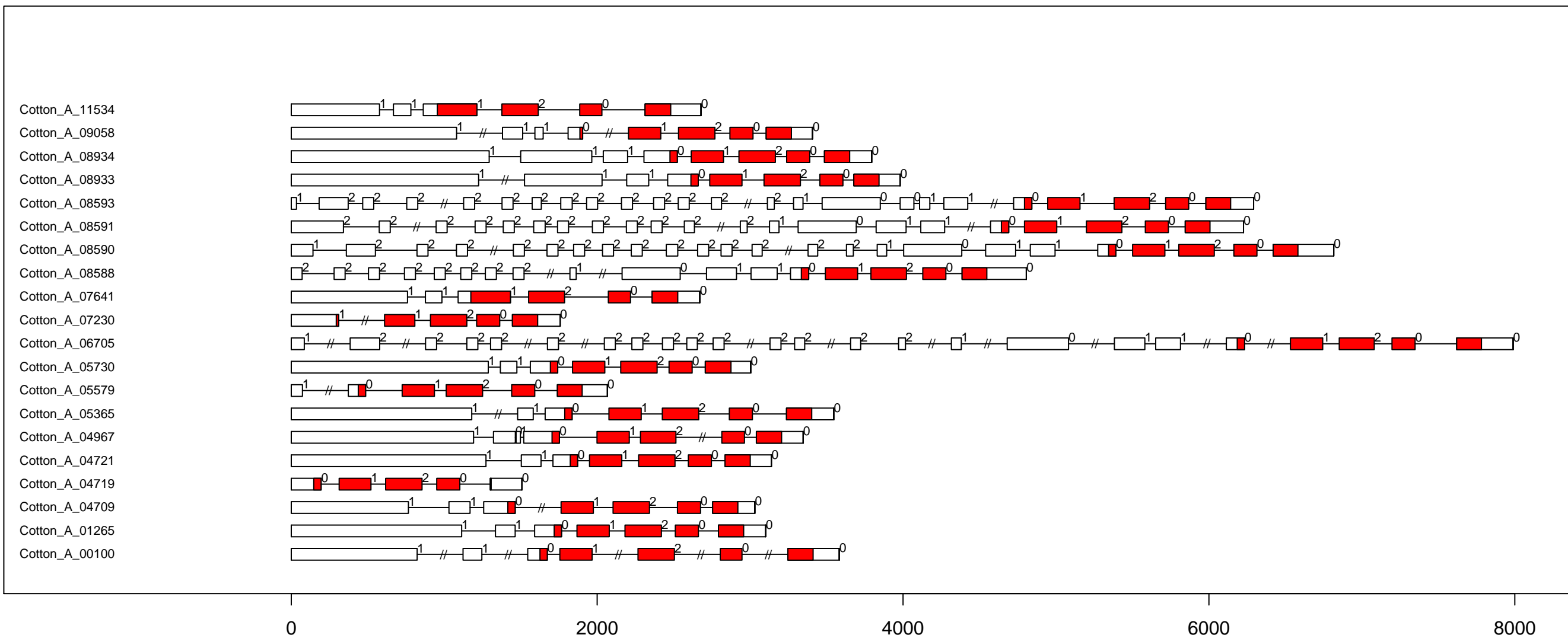

G.ar RLK-Pelle_DLSV exon-intron and domain diagram (part 2)

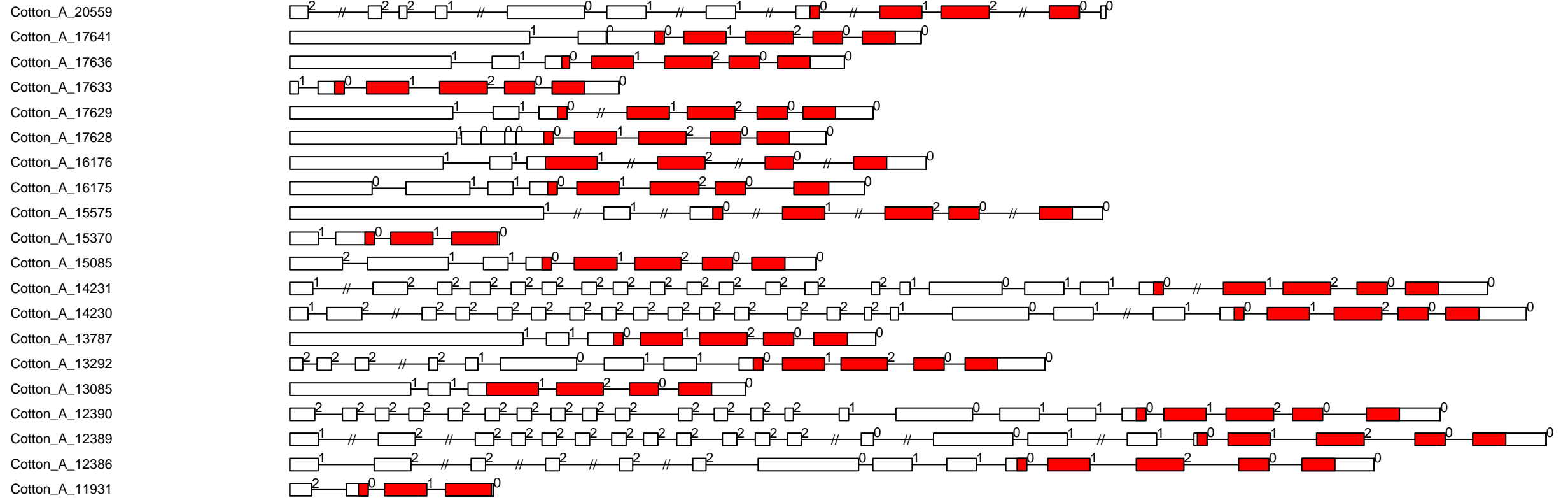

G.ar RLK-Pelle_DLSV exon-intron and domain diagram (part 3)

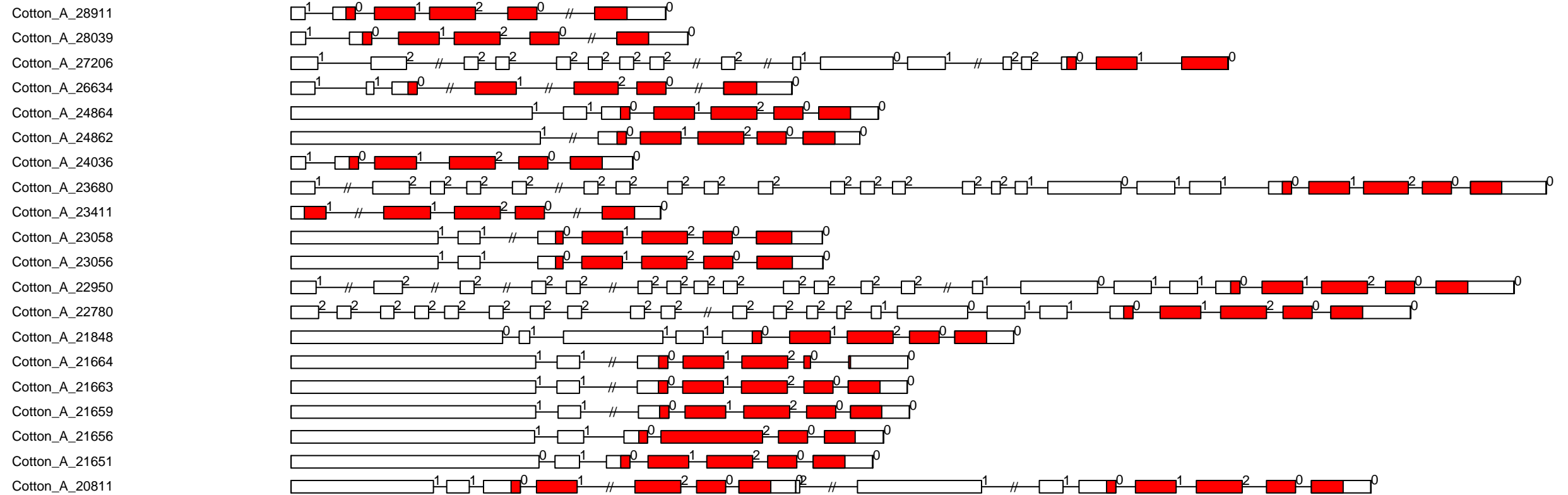

G.ar RLK-Pelle_DLSV exon-intron and domain diagram (part 4)

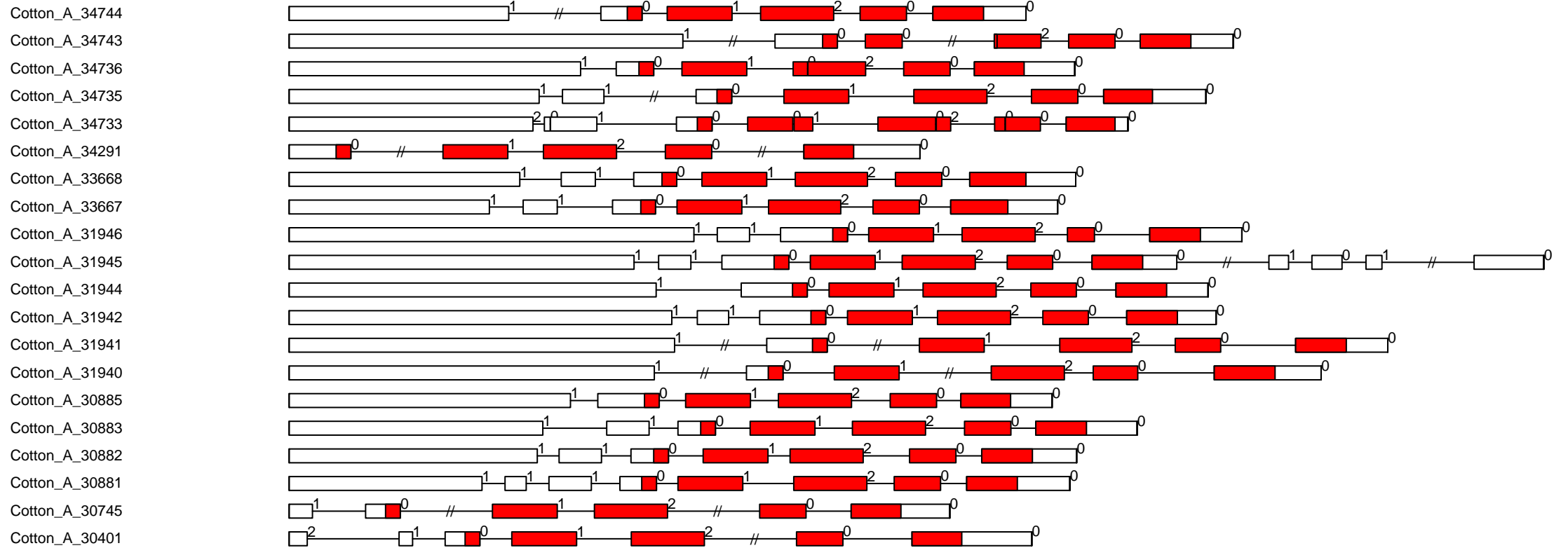

G.ar RLK-Pelle_DLSV exon-intron and domain diagram (part 5)

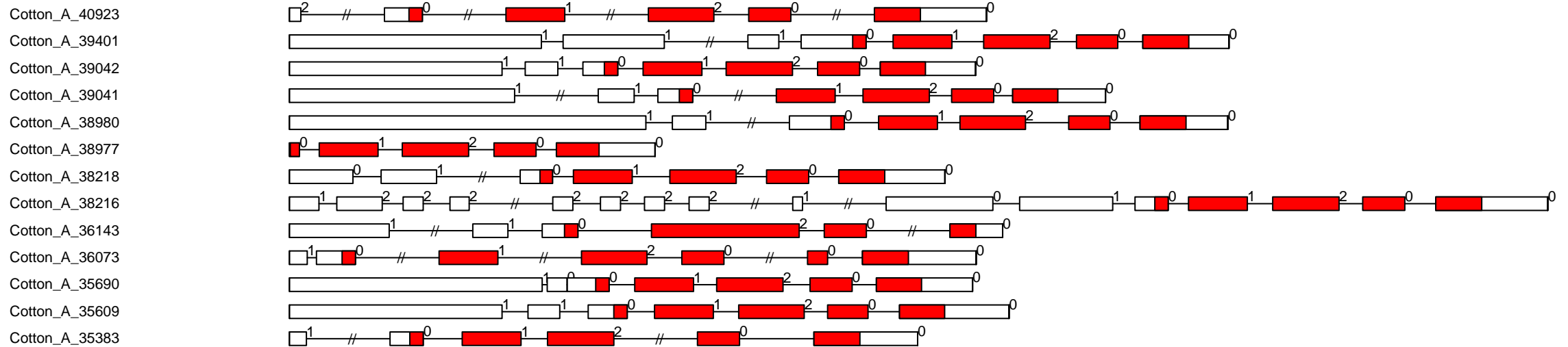

G.ar RLK-Pelle_Extensin exon-intron and domain diagram (all)

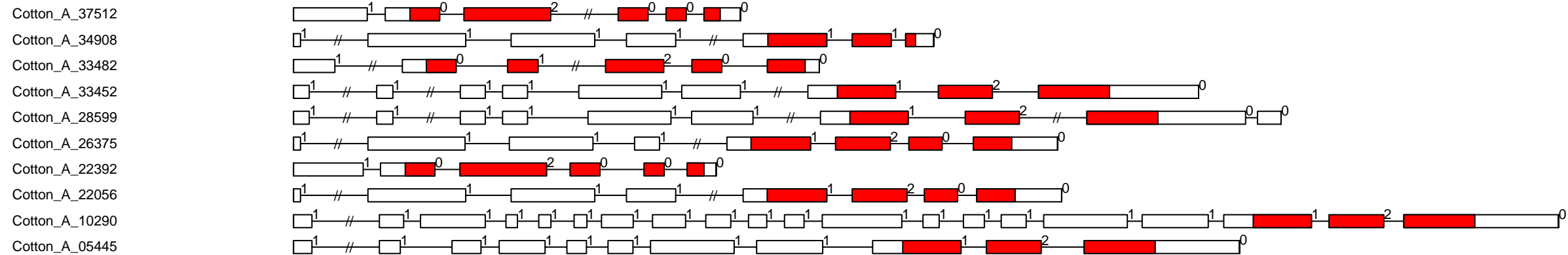

G.ar RLK-Pelle_L-LEC exon-intron and domain diagram (part 1)

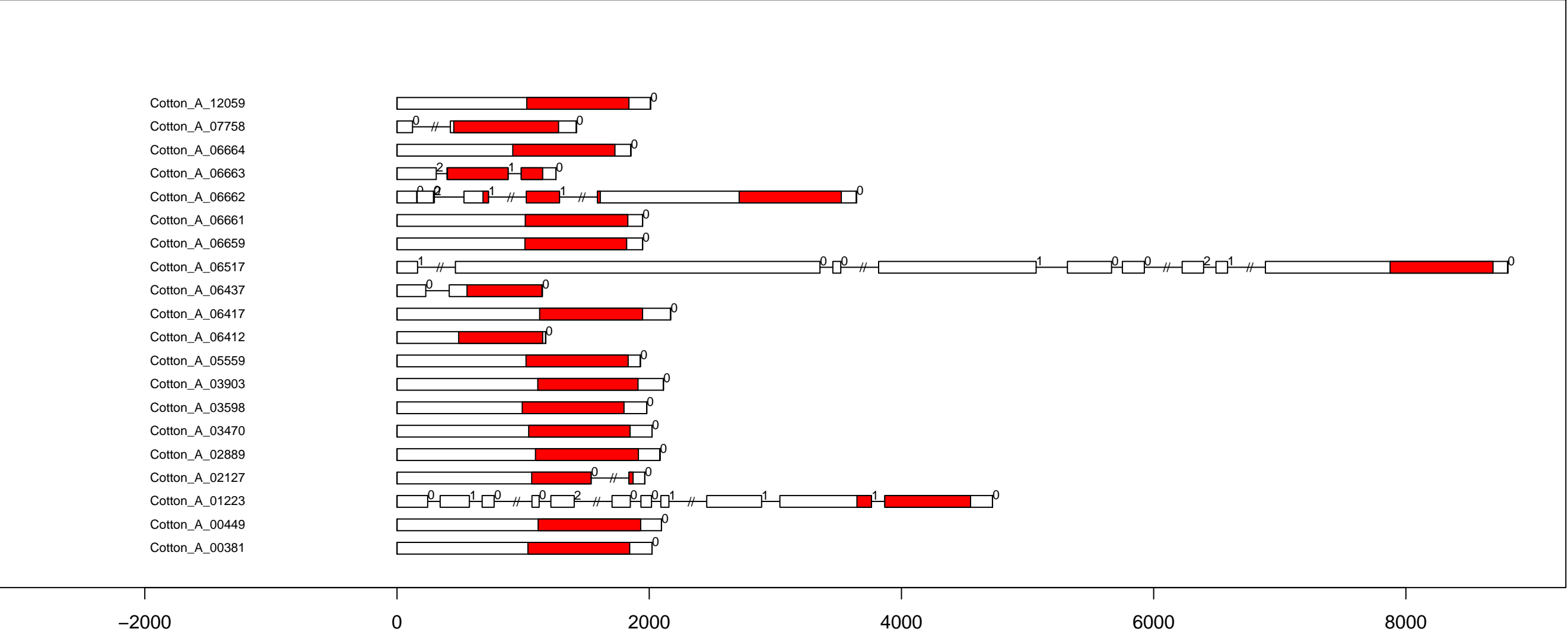

G.ar RLK-Pelle_L-LEC exon-intron and domain diagram (part 2)

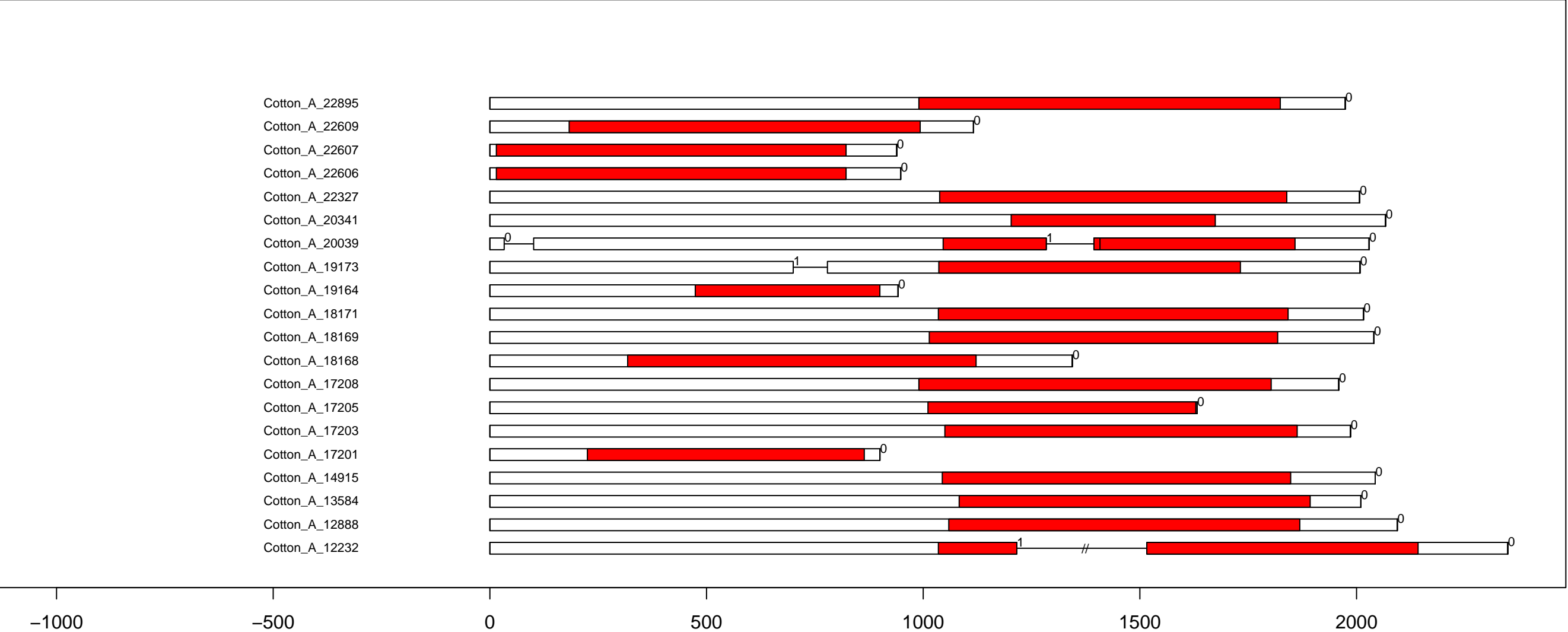

G.ar RLK-Pelle_L-LEC exon-intron and domain diagram (part 3)

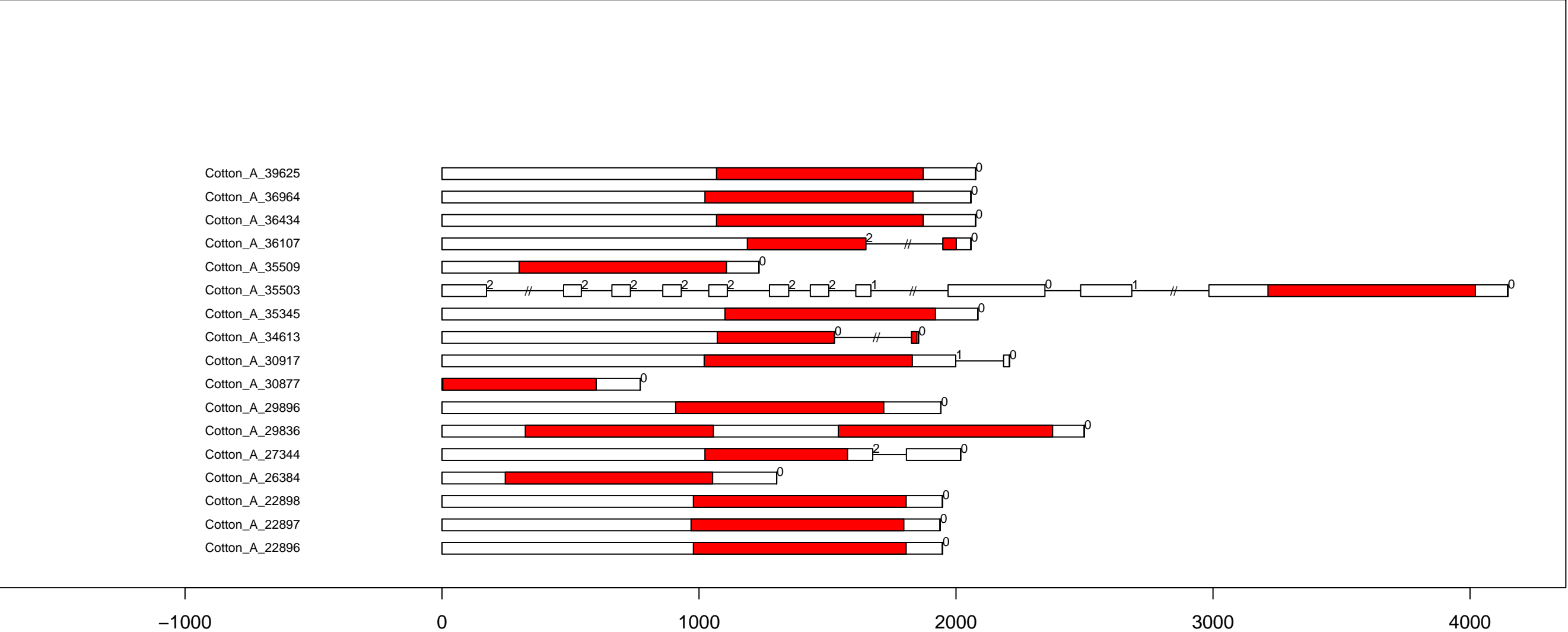

G.ar RLK-Pelle_LRK10L-2 exon-intron and domain diagram (part 1)

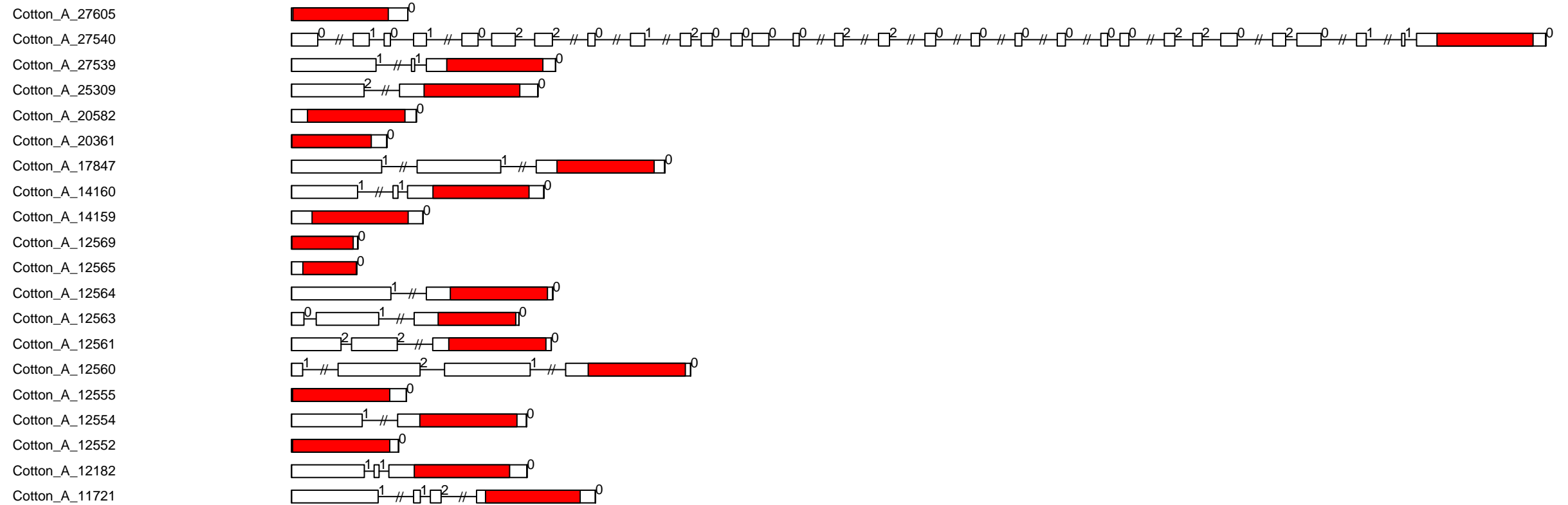

G.ar RLK-Pelle_LRK10L-2 exon-intron and domain diagram (part 2)

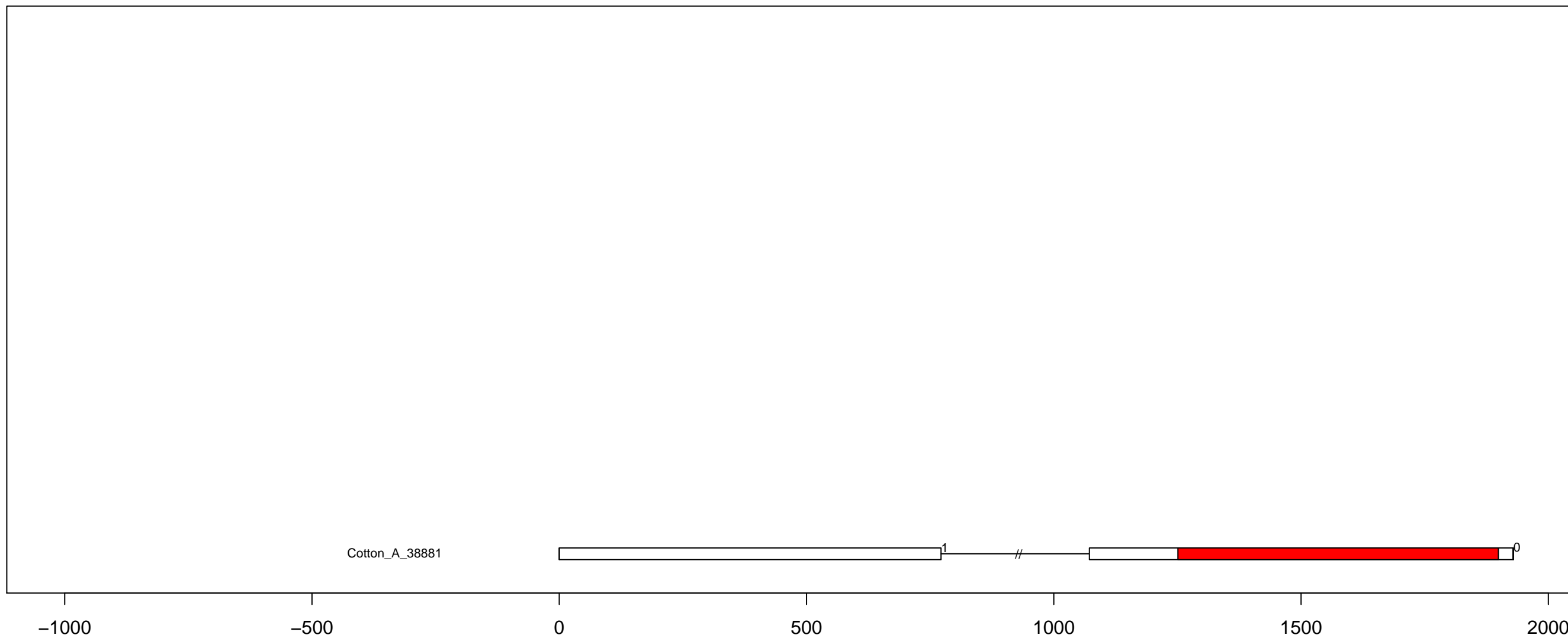

G.ar RLK-Pelle_LRR-I-1 exon-intron and domain diagram (all)

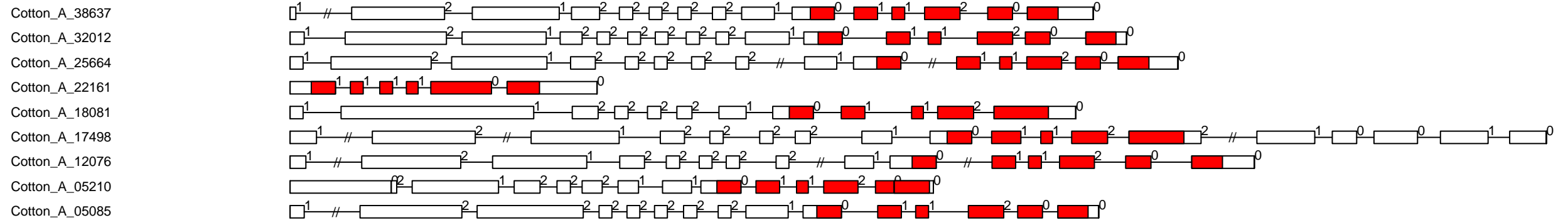

0

2000

4000

6000

G.ar RLK-Pelle_LRR-I-2 exon-intron and domain diagram (all)

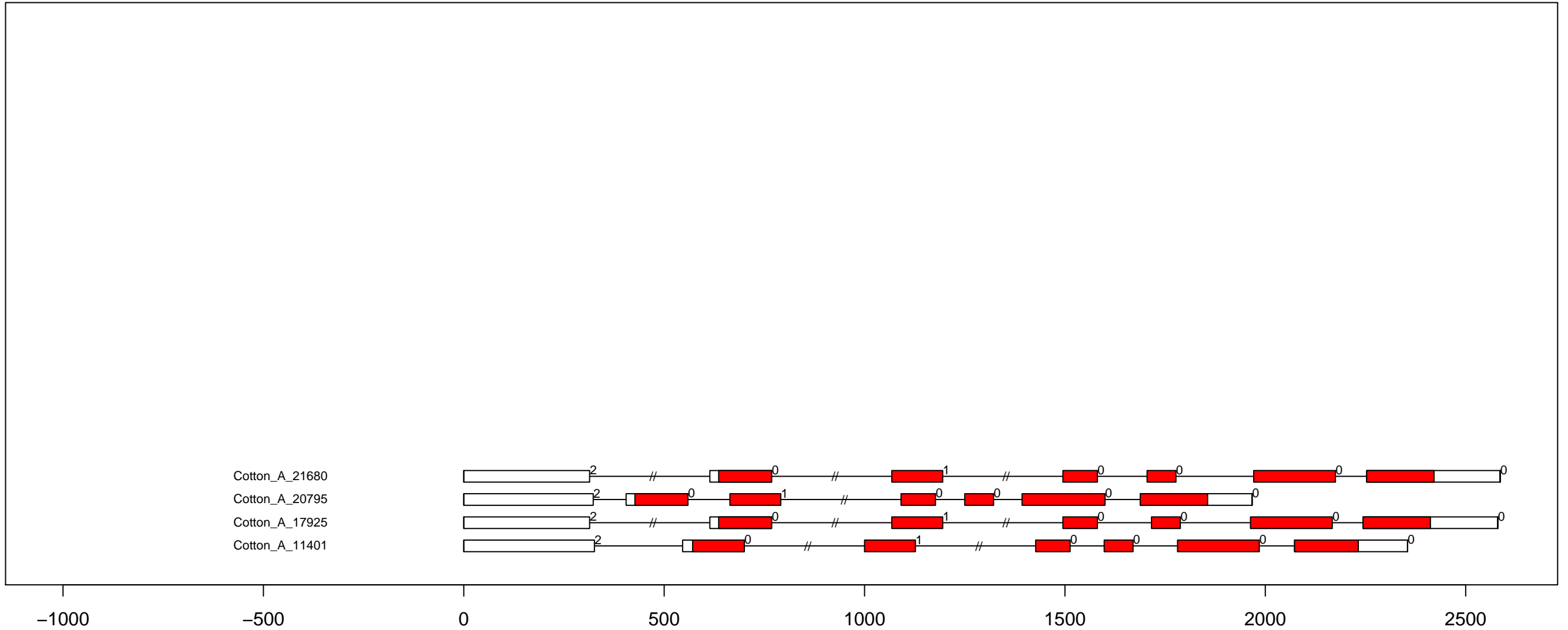

G.ar RLK-Pelle_LRR-III exon-intron and domain diagram (part 1)

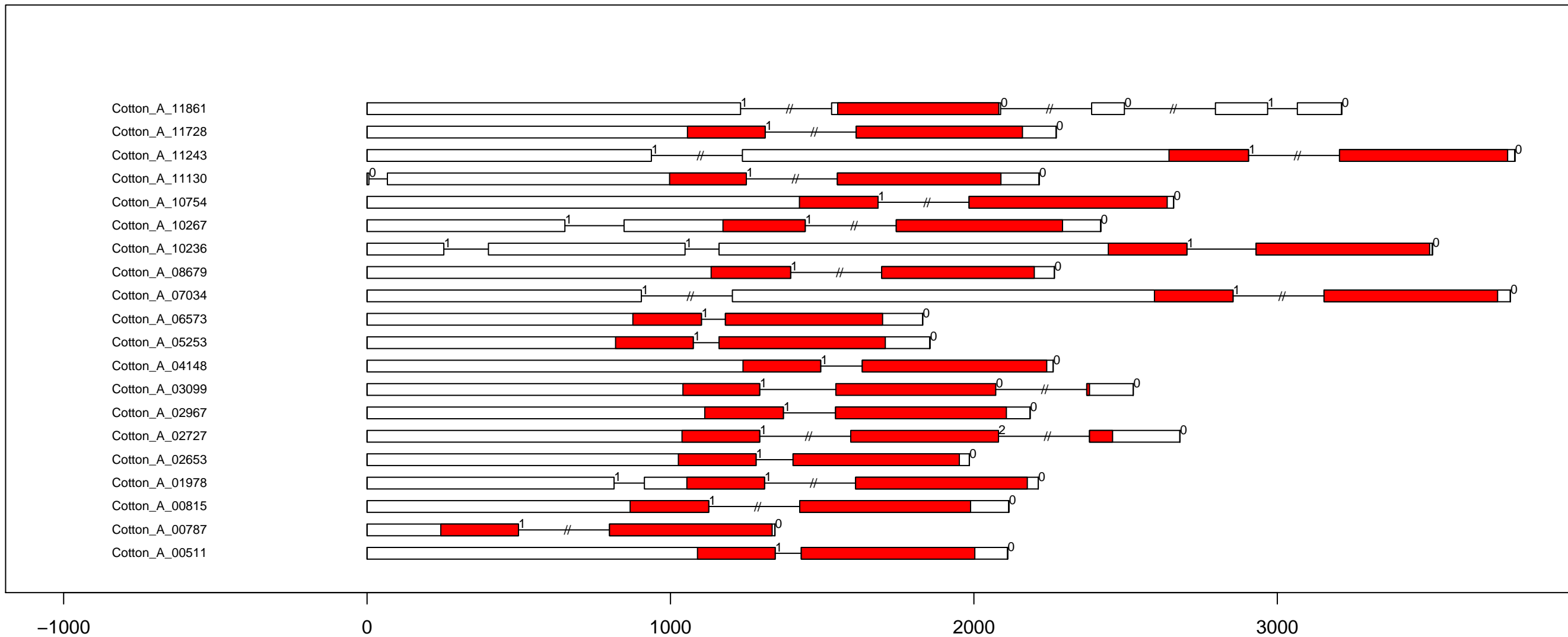

G.ar RLK-Pelle_LRR-III exon-intron and domain diagram (part 2)

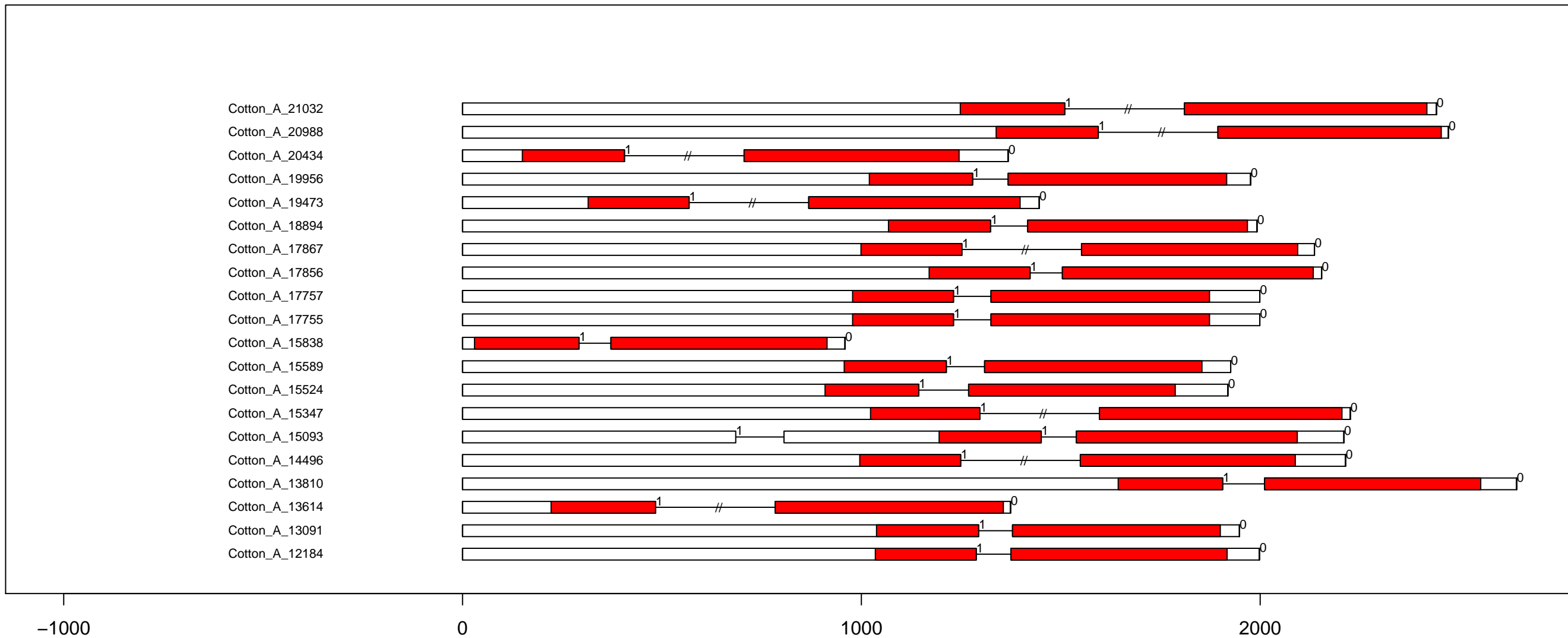

G.ar RLK-Pelle_LRR-III exon-intron and domain diagram (part 3)

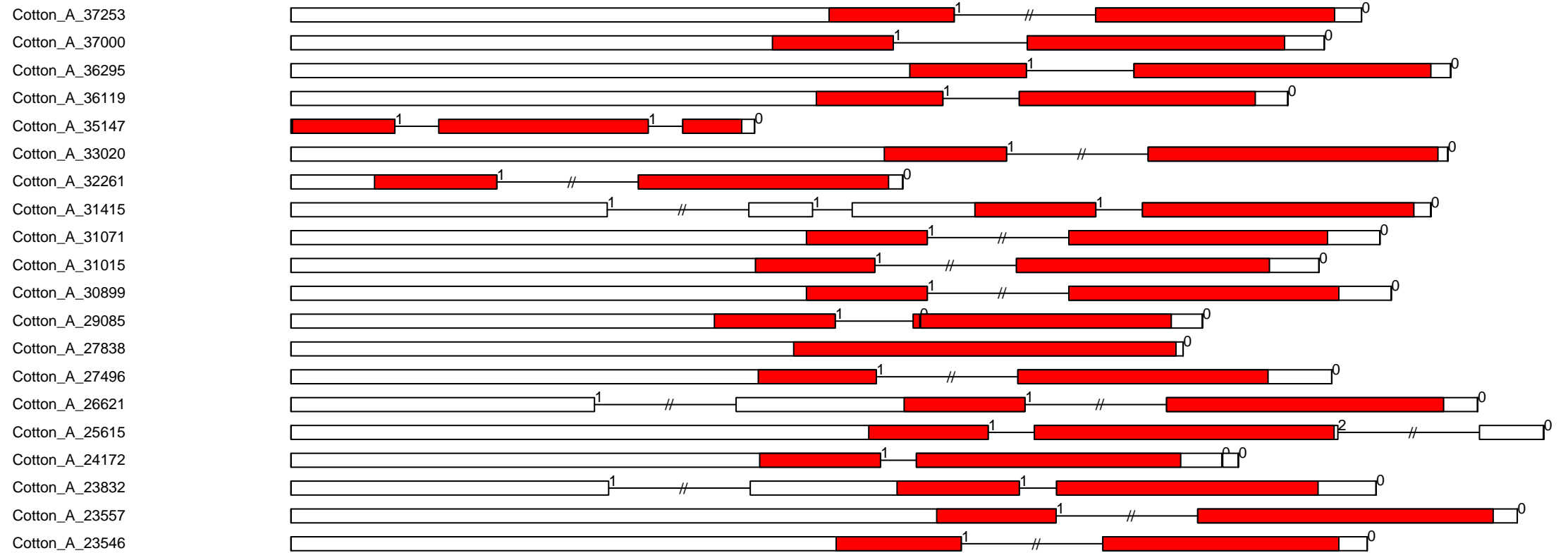

-1000

0

1000

2000

G.ar RLK-Pelle_LRR-III exon-intron and domain diagram (part 4)

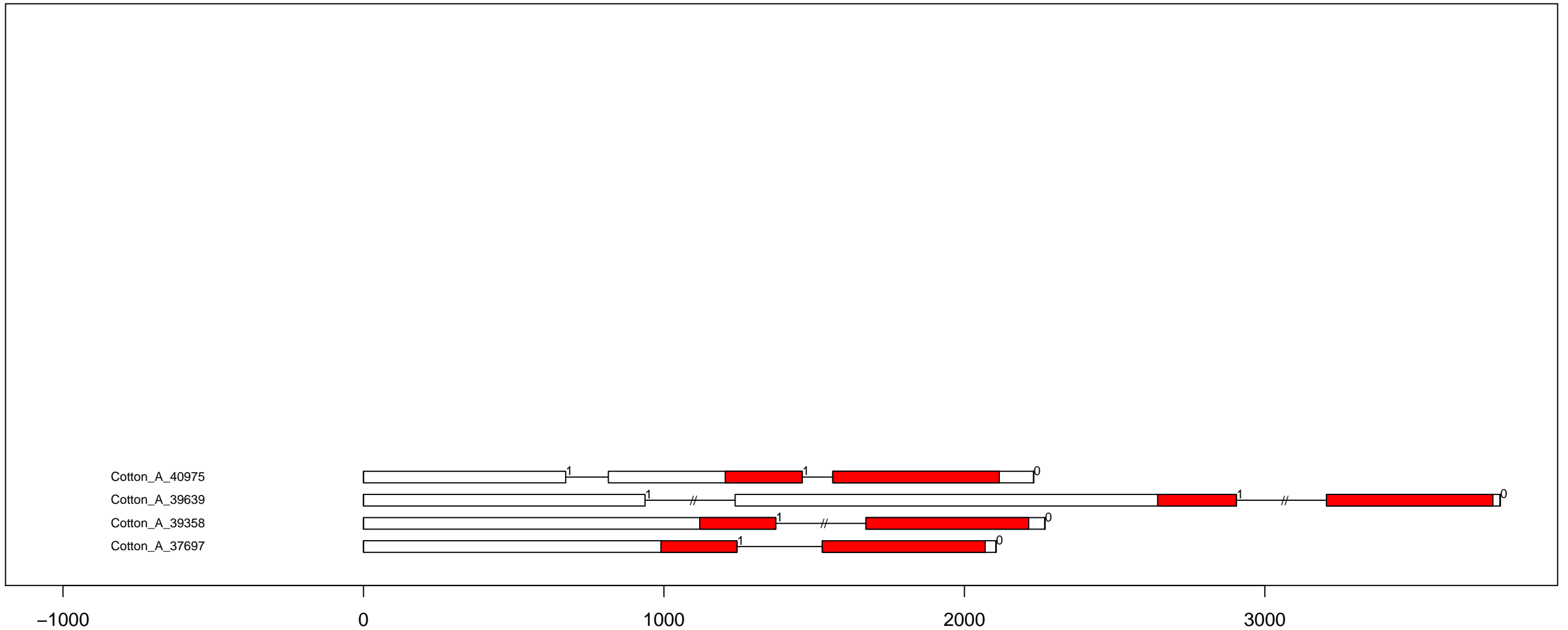

G.ar RLK-Pelle_LRR-II exon-intron and domain diagram (all)

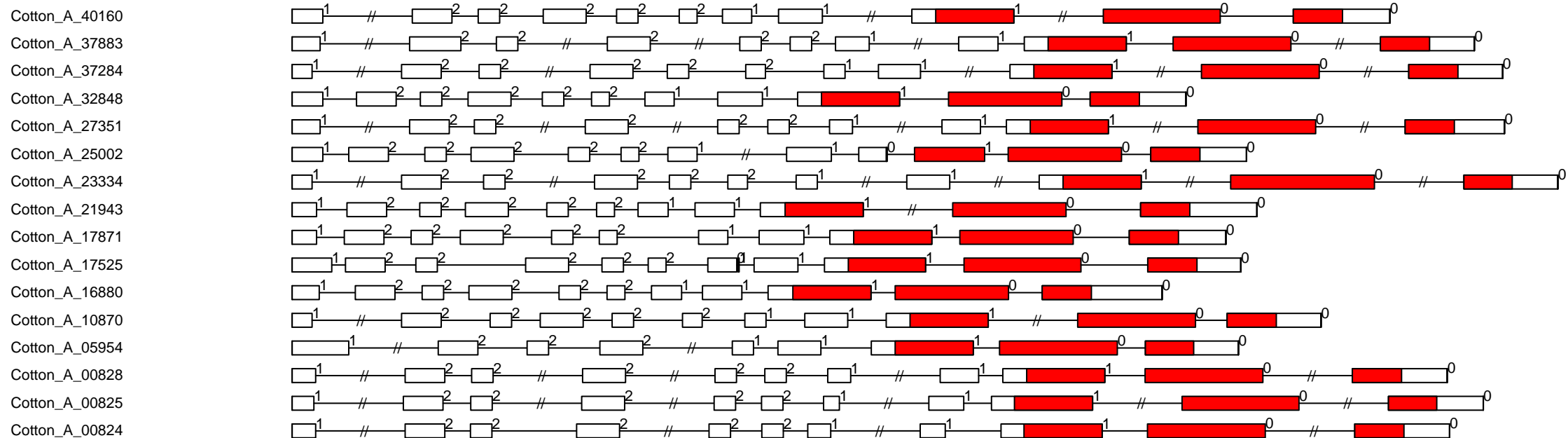

-1000

0

1000

2000

3000

4000

G.ar RLK-Pelle_LRR-IV exon-intron and domain diagram (all)

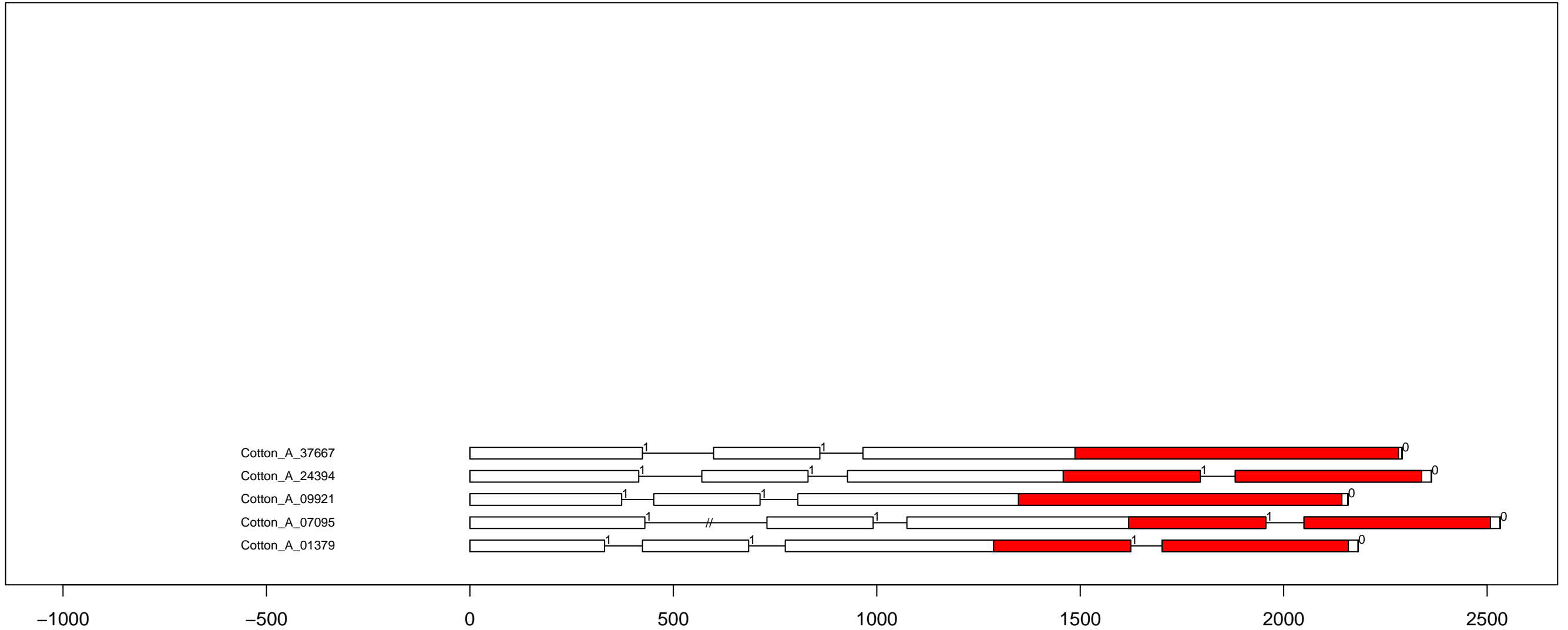

G.ar RLK-Pelle_LRR-IX exon-intron and domain diagram (all)

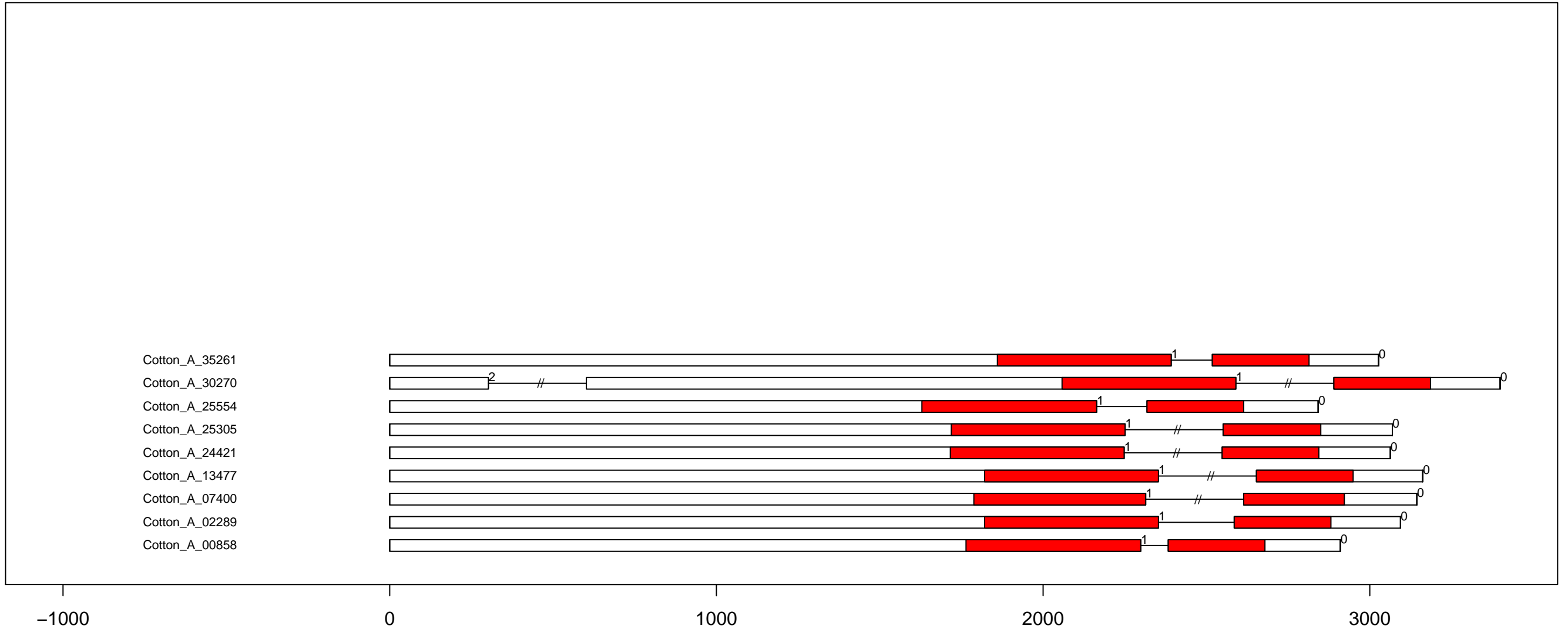

G.ar RLK-Pelle_LRR-VI-1 exon-intron and domain diagram (all)

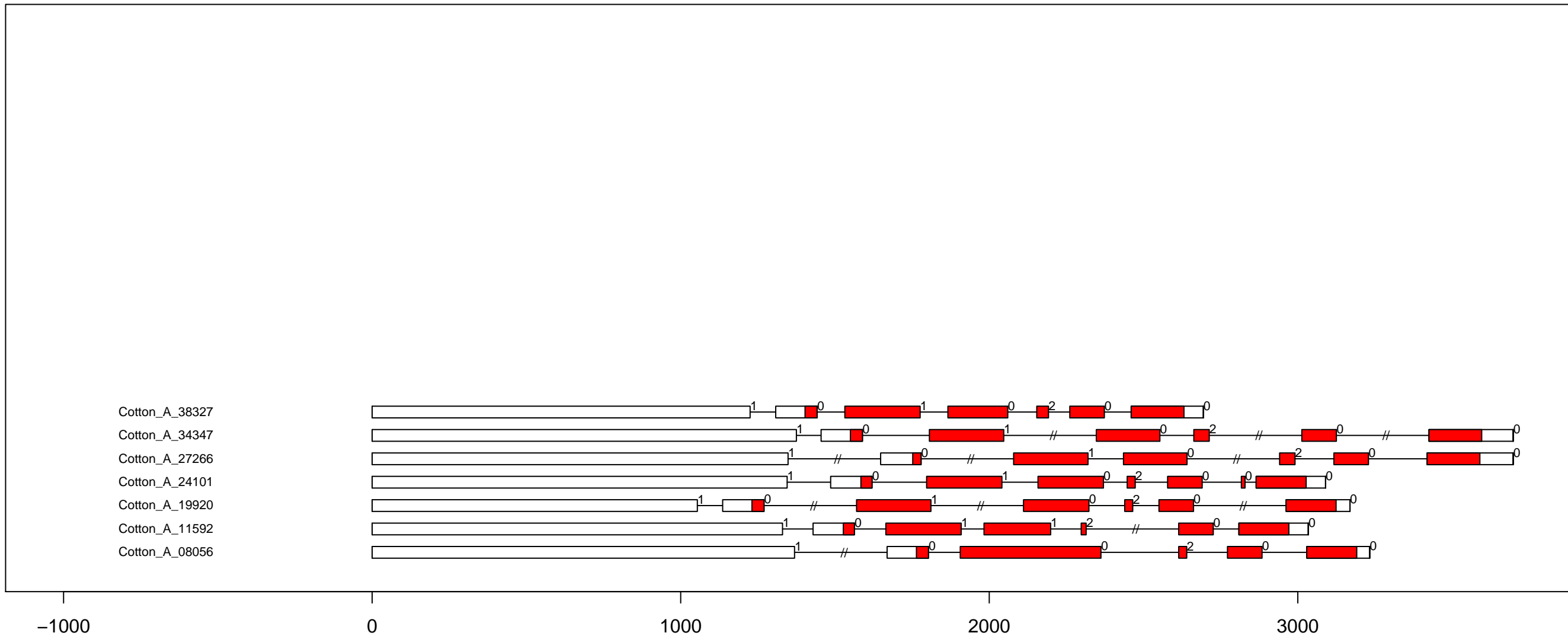

G.ar RLK-Pelle_LRR-VI-2 exon-intron and domain diagram (all)

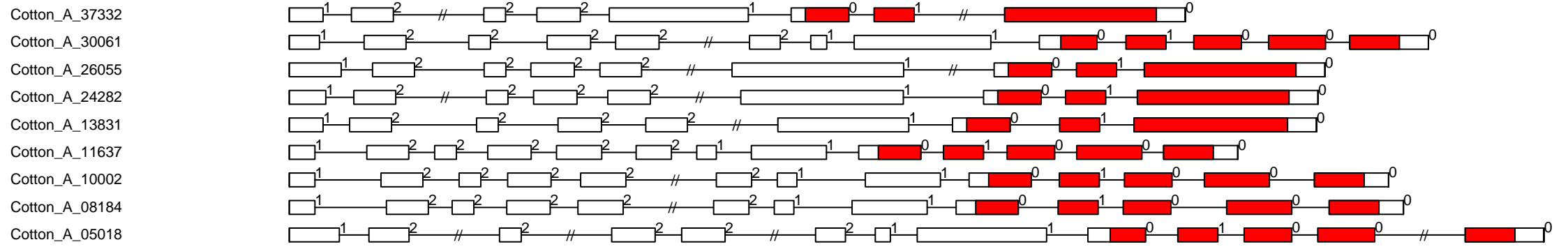

G.ar RLK-Pelle_LRR-VII-1 exon-intron and domain diagram (all)

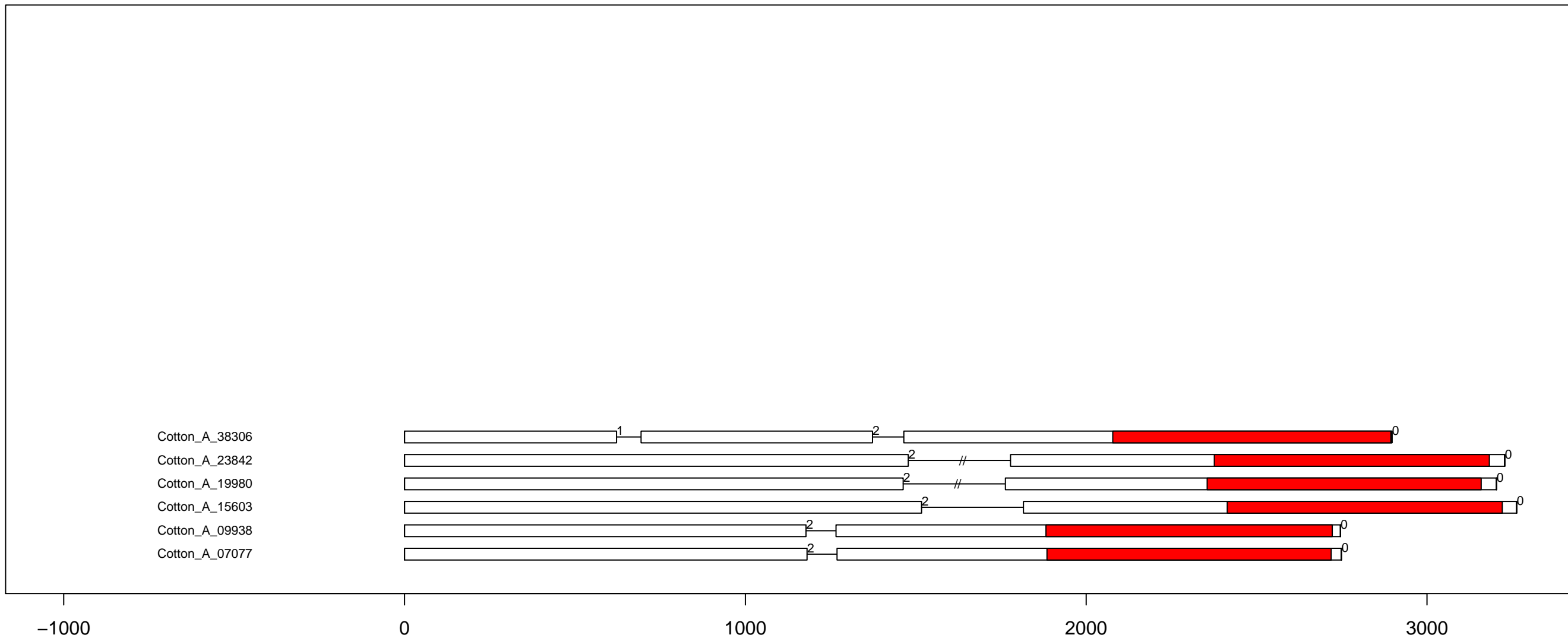

G.ar RLK-Pelle_LRR-VII-2 exon-intron and domain diagram (all)

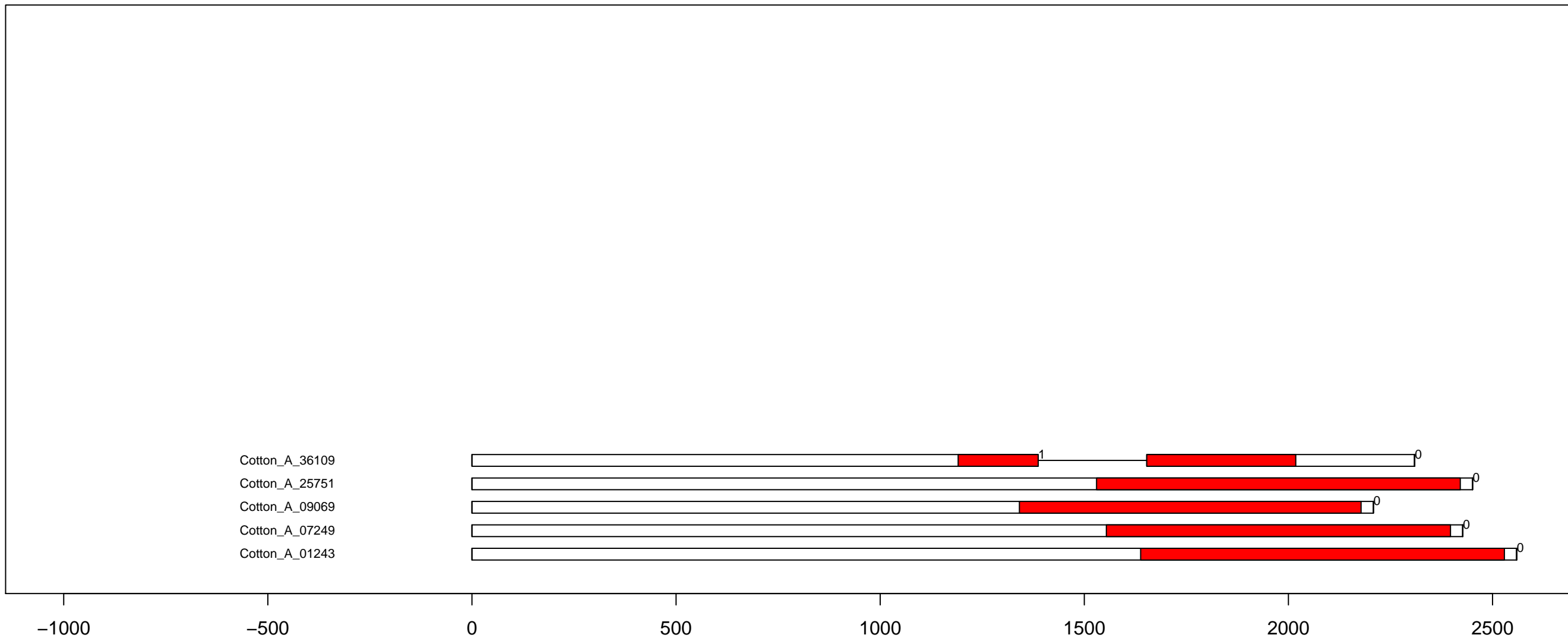

G.ar RLK-Pelle_LRR-VII-3 exon-intron and domain diagram (all)

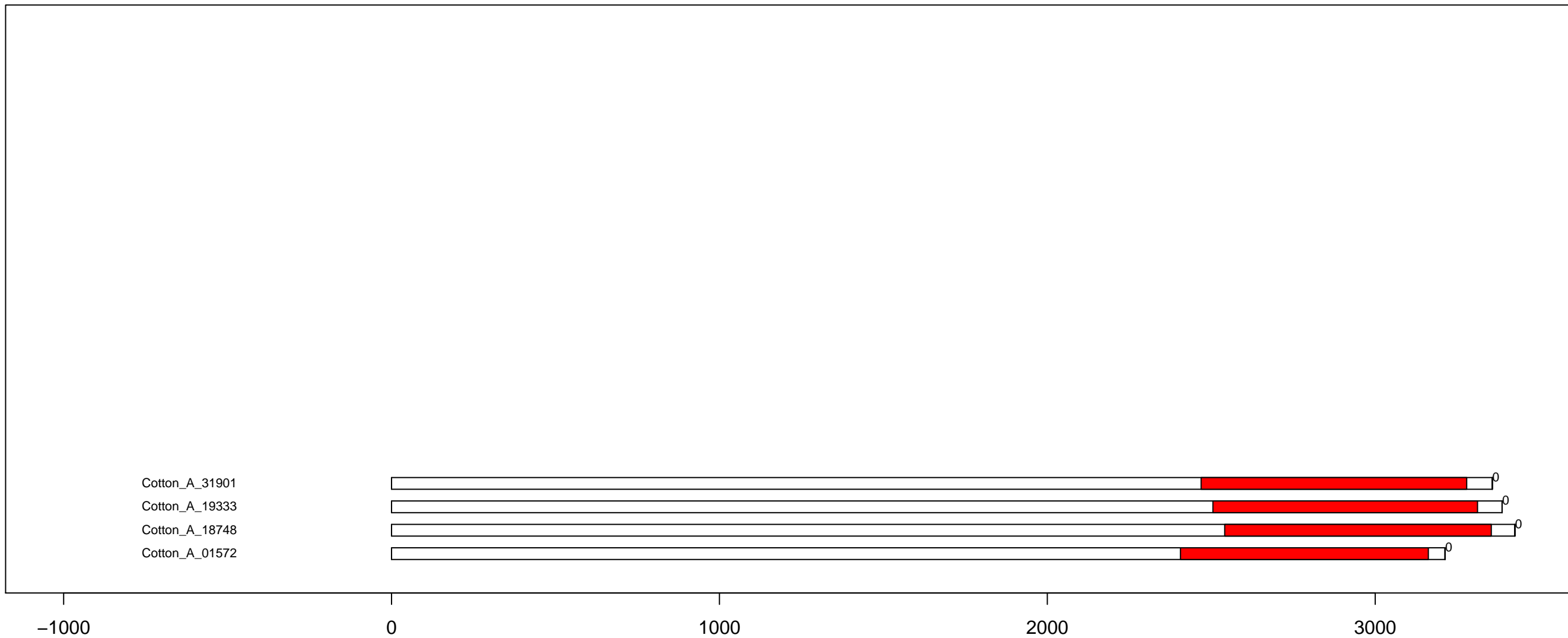

G.ar RLK-Pelle_LRR-VIII-1 exon-intron and domain diagram (all)

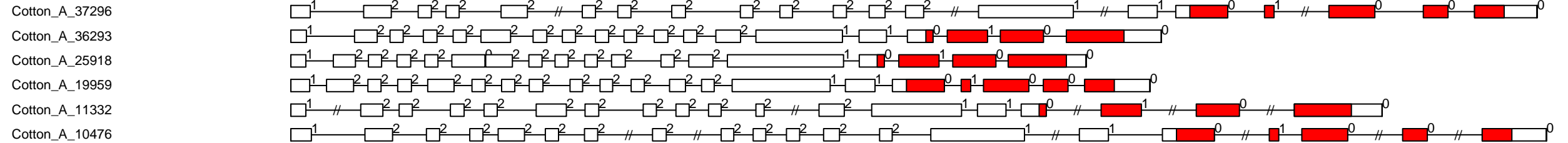

0 2000 4000 6000

G.ar RLK-Pelle_LRR-V exon-intron and domain diagram (all)

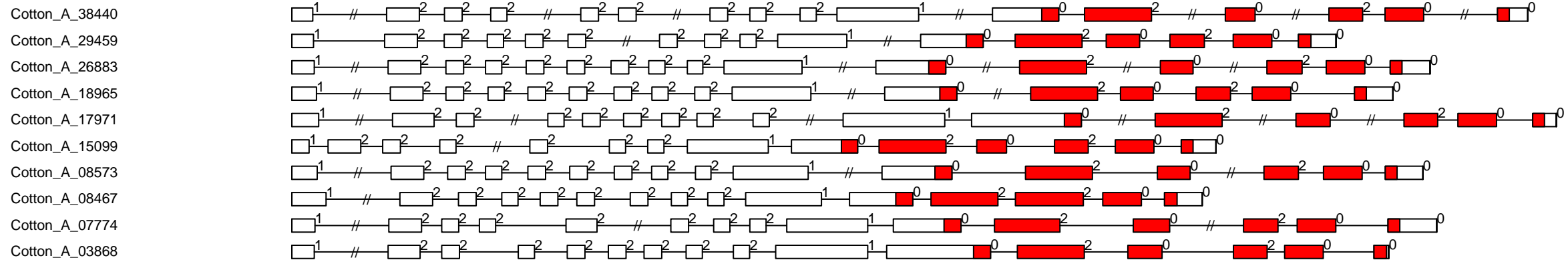

G.ar RLK-Pelle_LRR-Xa exon-intron and domain diagram (all)

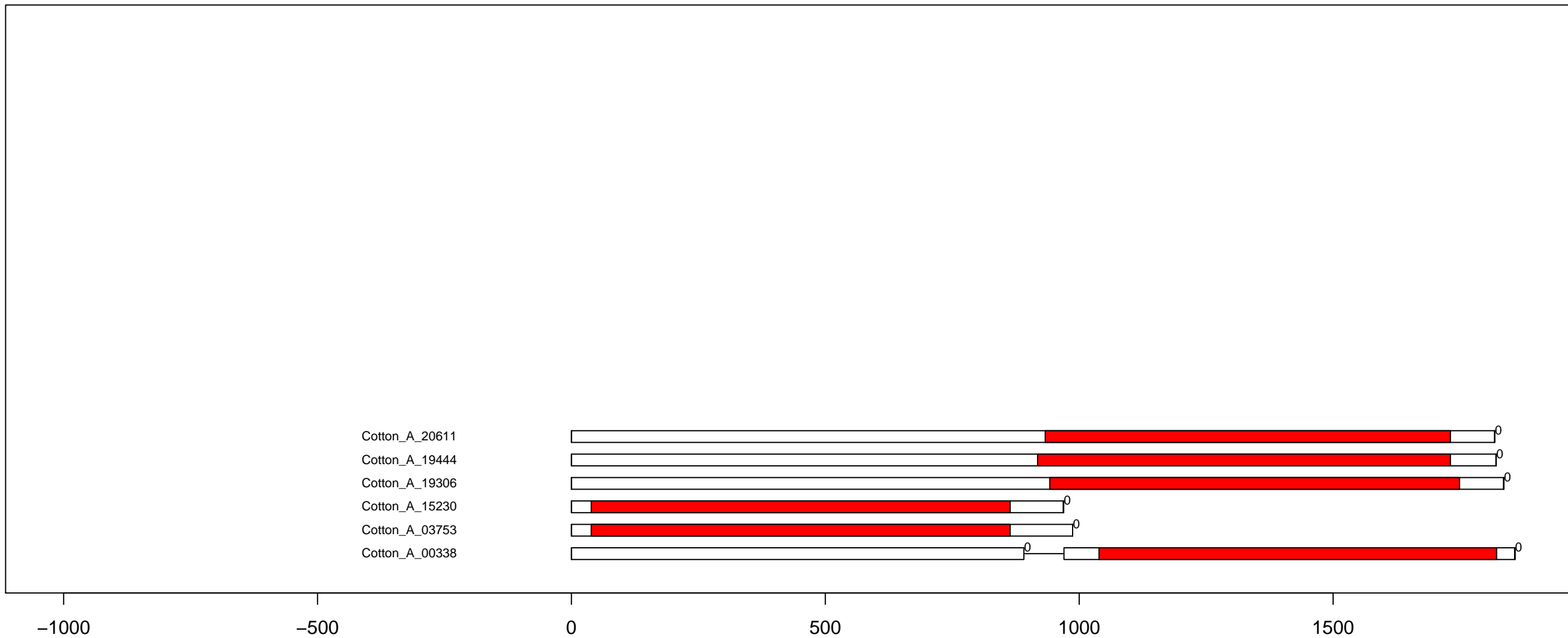

G.ar RLK-Pelle_LRR-Xb-1 exon-intron and domain diagram (all)

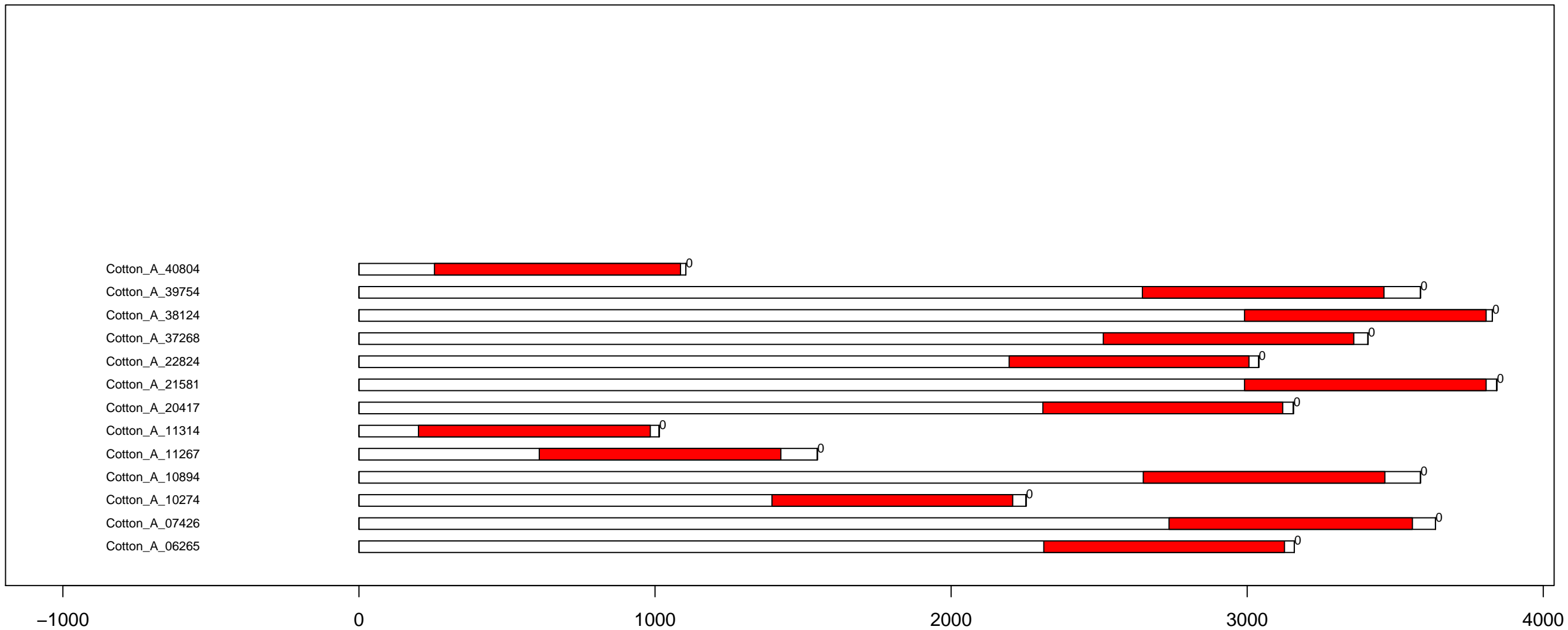

G.ar RLK-Pelle_LRR-Xb-2 exon-intron and domain diagram (all)

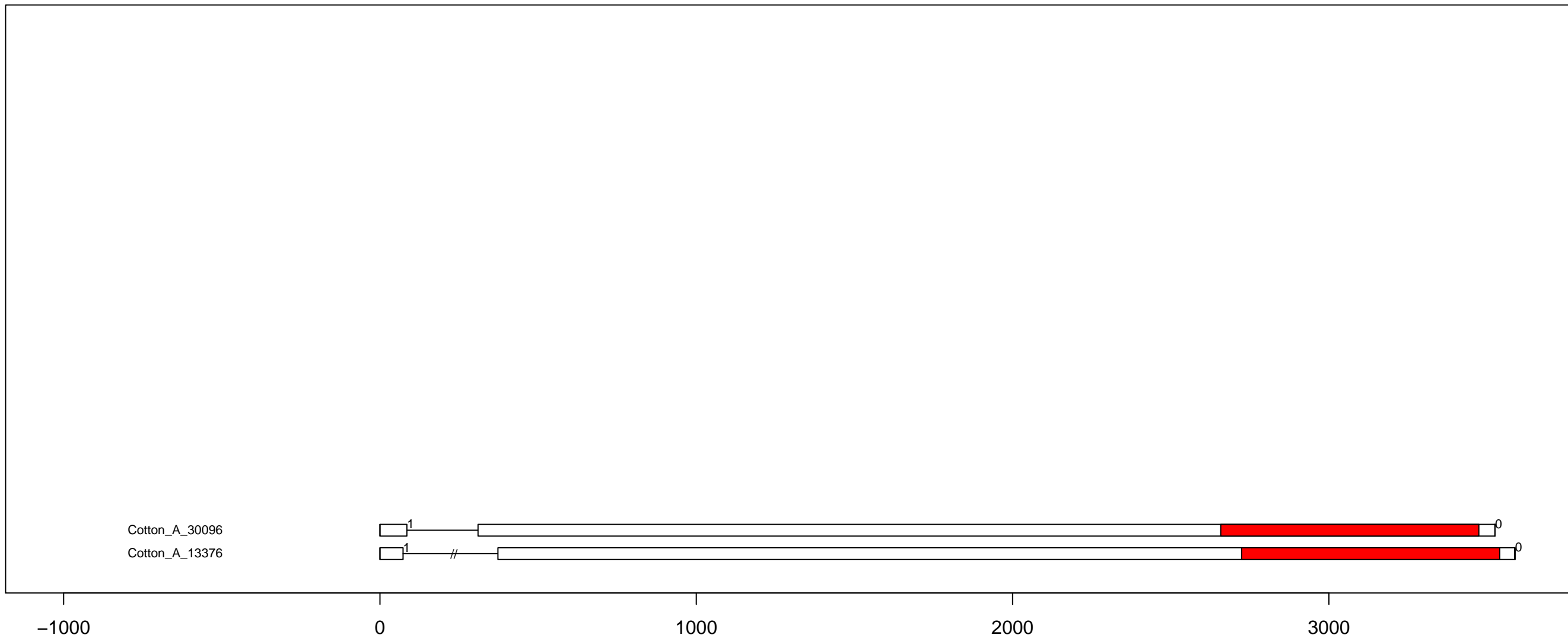

G.ar RLK-Pelle_LRR-XI-1 exon-intron and domain diagram (part 1)

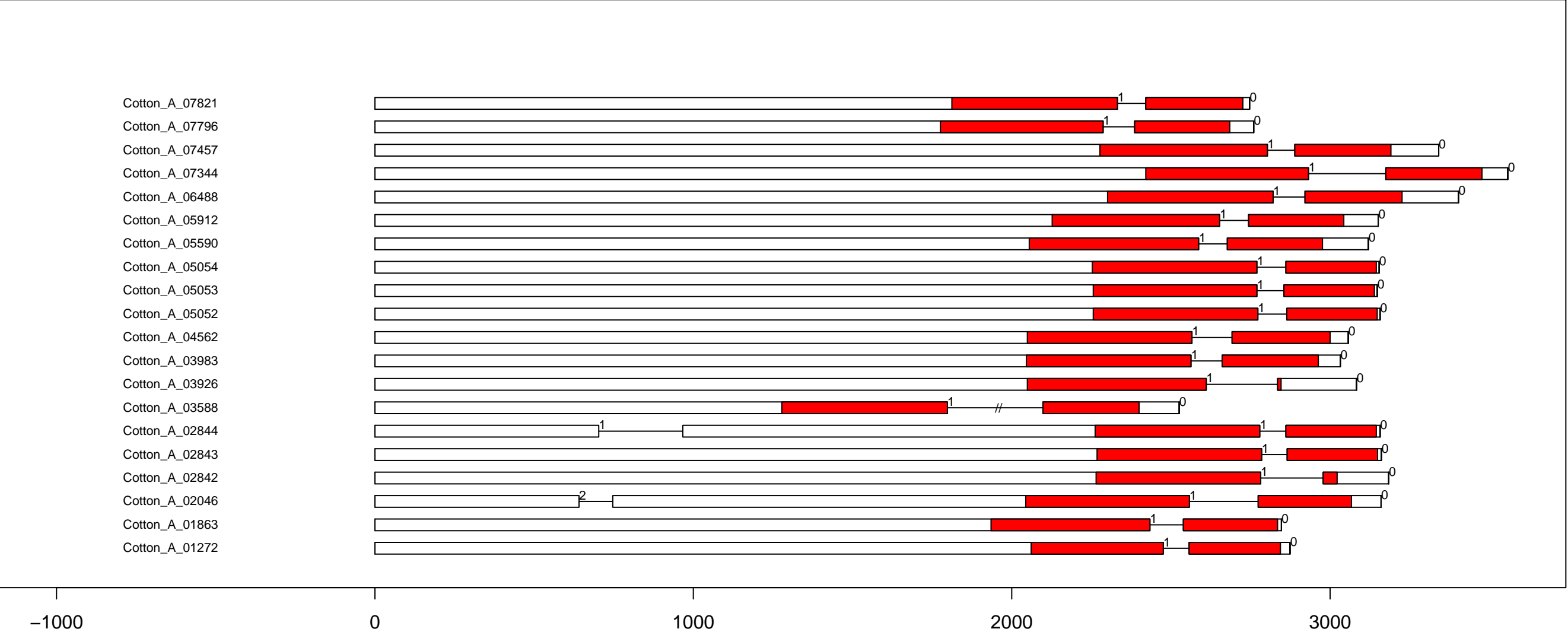

G.ar RLK-Pelle_LRR-XI-1 exon-intron and domain diagram (part 2)

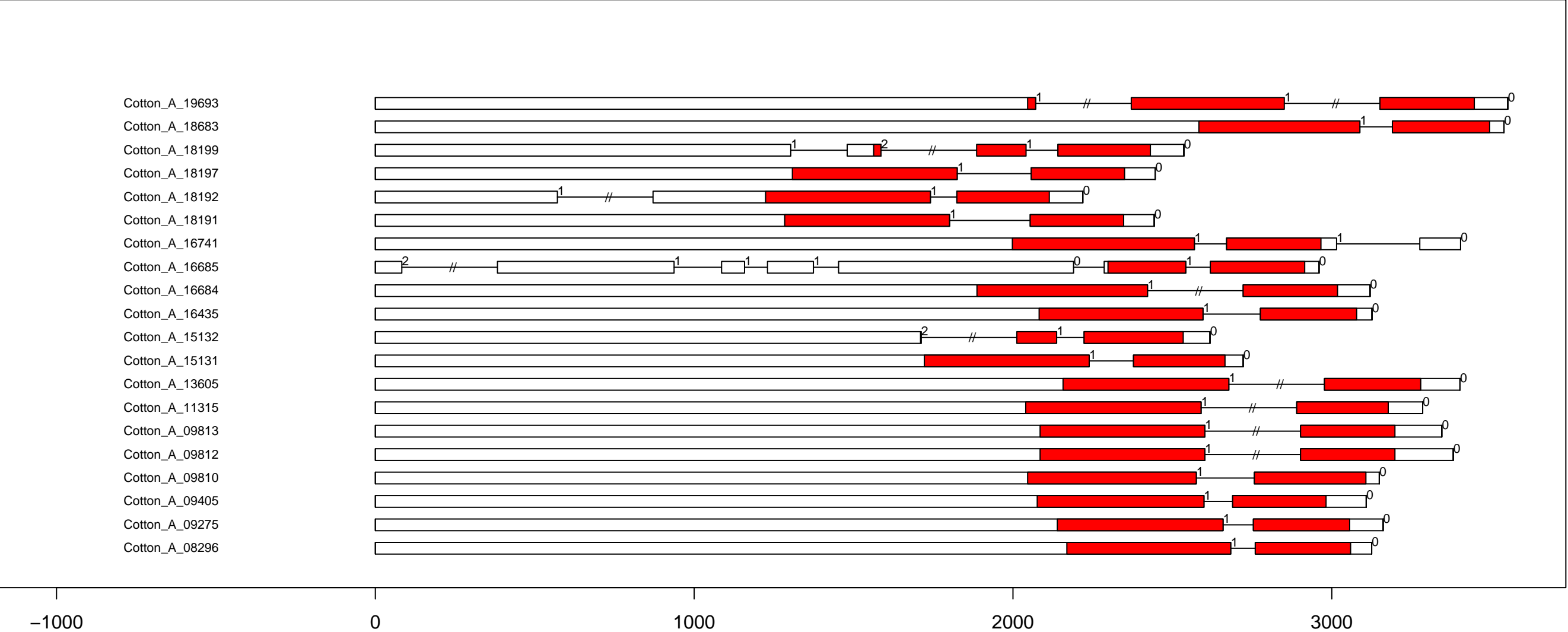

G.ar RLK-Pelle_LRR-XI-1 exon-intron and domain diagram (part 3)

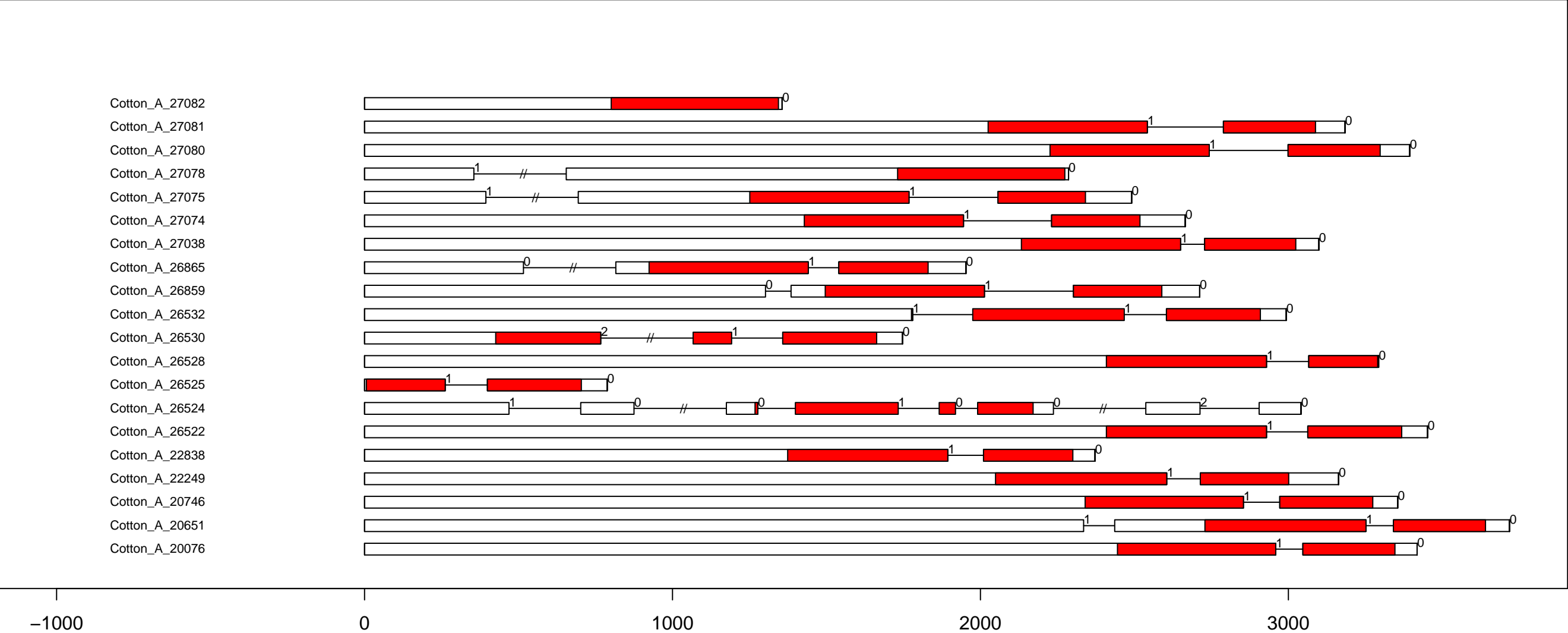

G.ar RLK-Pelle_LRR-XI-1 exon-intron and domain diagram (part 4)

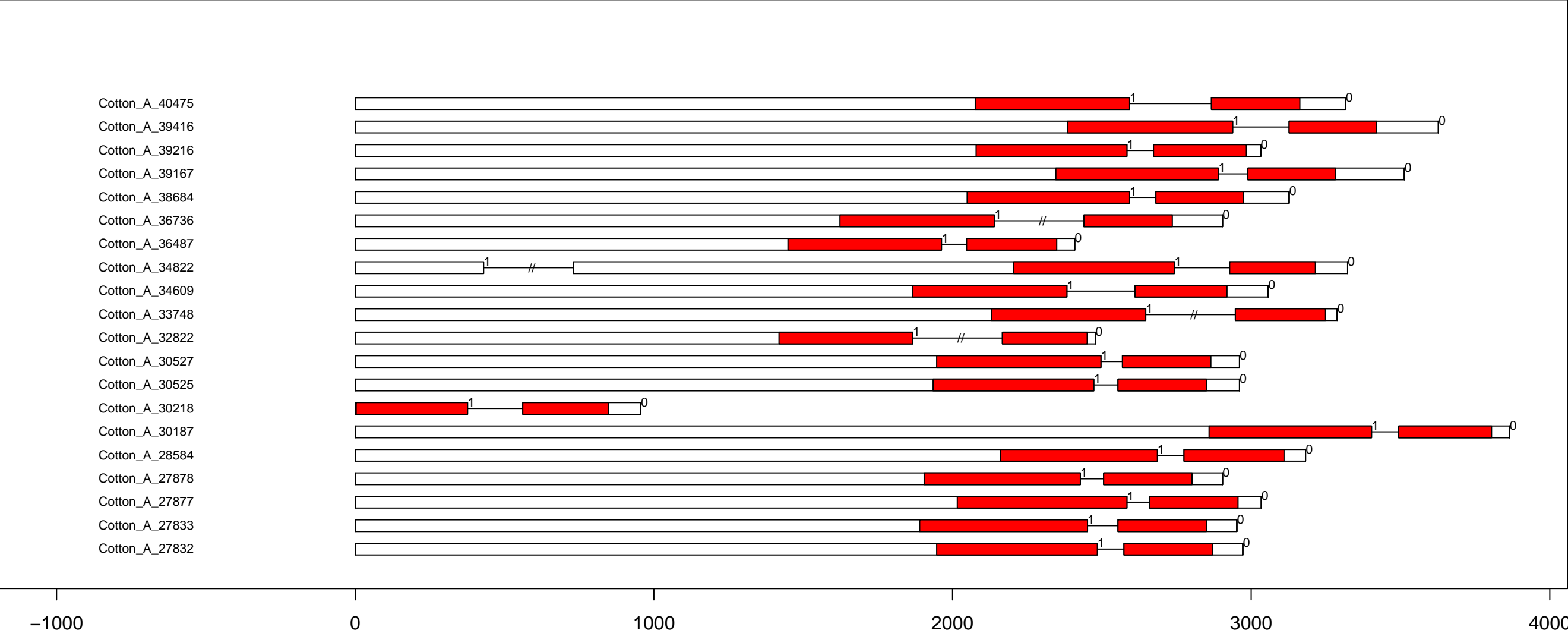

G.ar RLK-Pelle_LRR-XI-2 exon-intron and domain diagram (all)

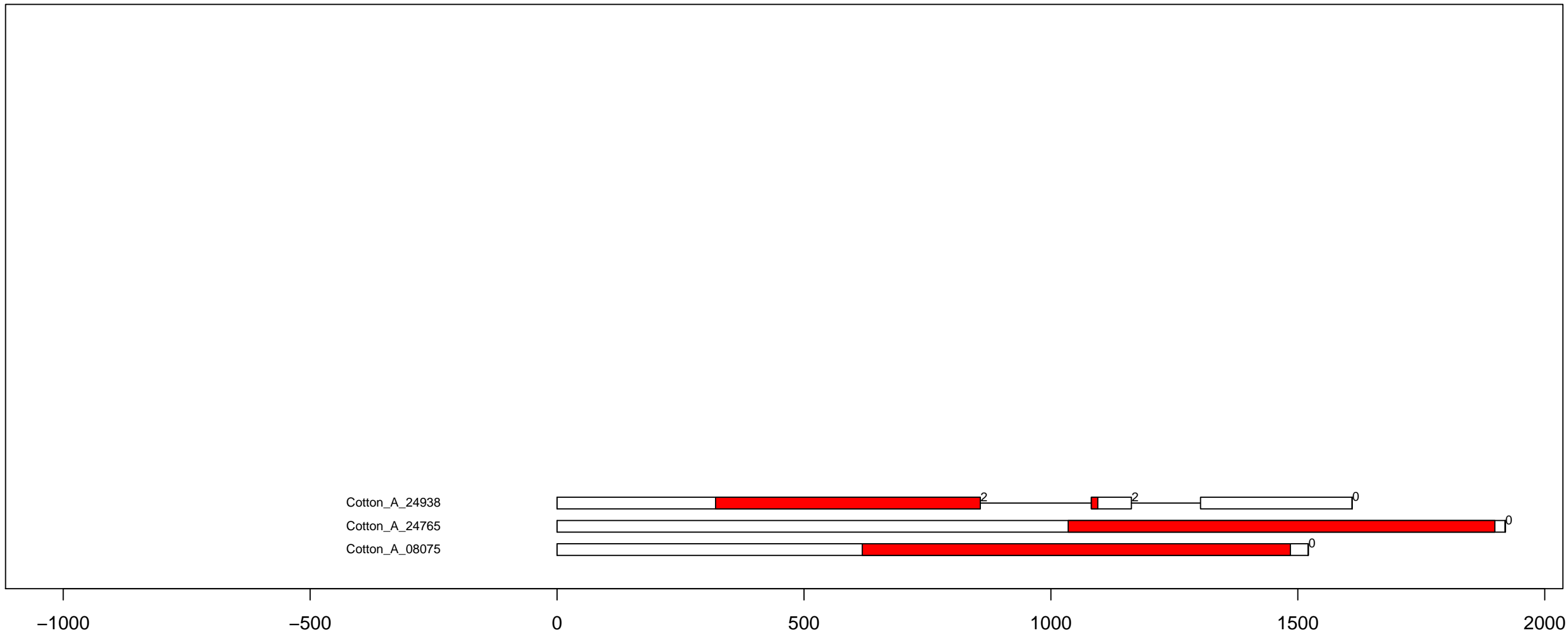

G.ar RLK-Pelle_LRR-XII-1 exon-intron and domain diagram (part 1)

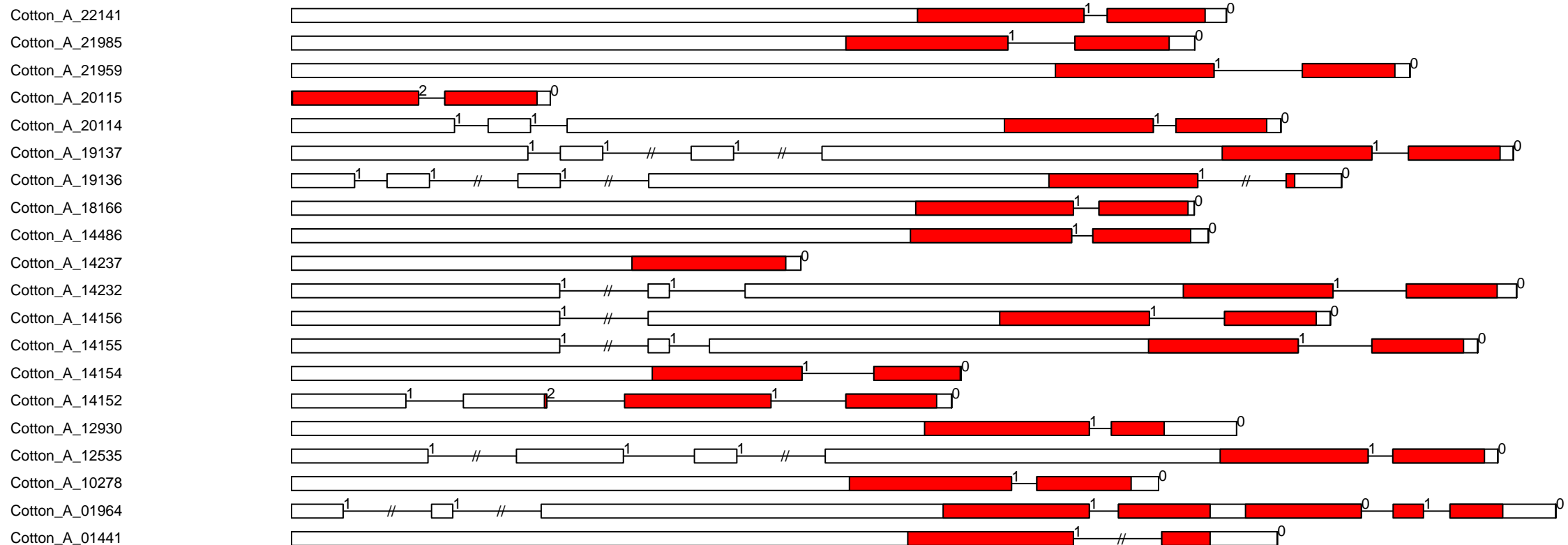

G.ar RLK-Pelle_LRR-XII-1 exon-intron and domain diagram (part 2)

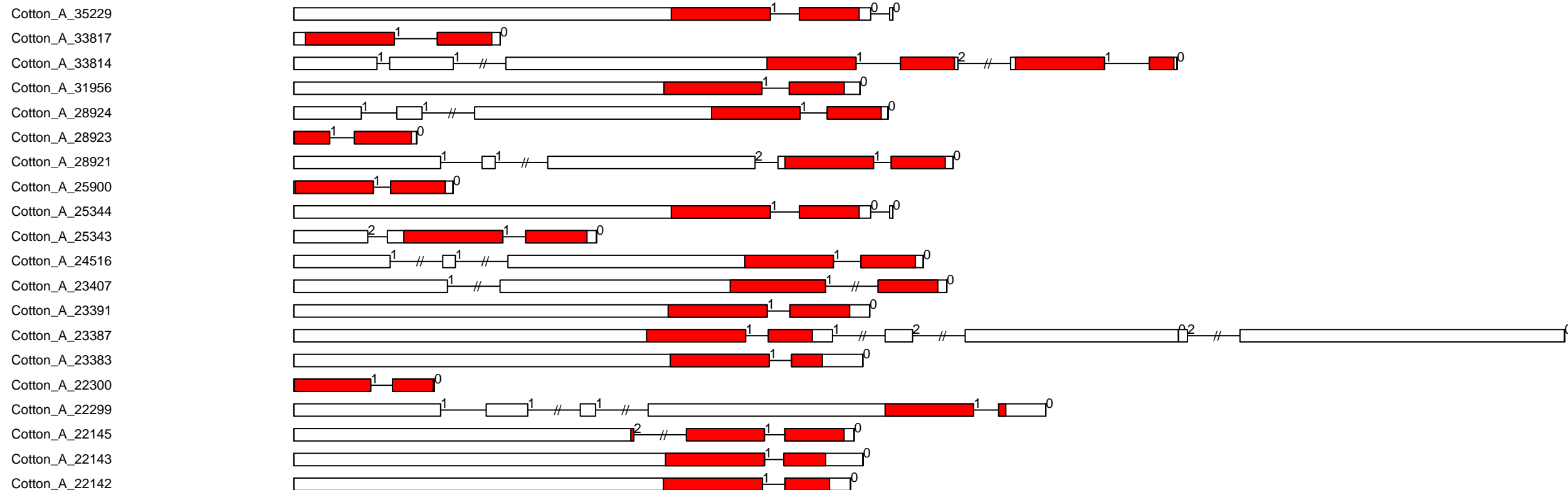

G.ar RLK-Pelle_LRR-XII-1 exon-intron and domain diagram (part 3)

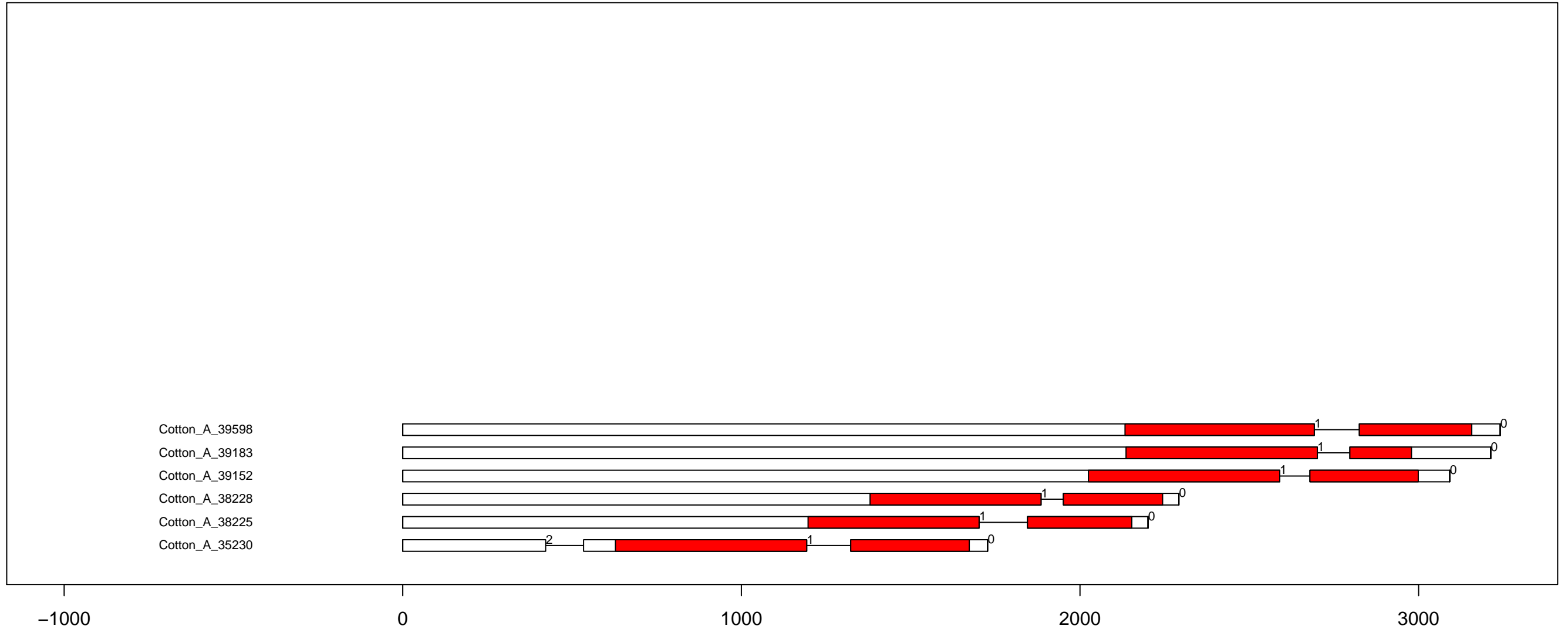

G.ar RLK-Pelle_LRR-XIIIa exon-intron and domain diagram (all)

Cotton_A_25325
Cotton_A_13017
Cotton_A_09204
Cotton_A_07327
Cotton_A_02688

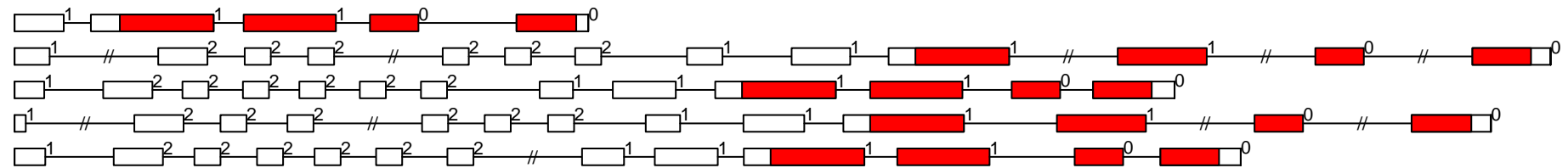

-1000

0

1000

2000

3000

4000

G.ar RLK-Pelle_LRR-XIIIb exon-intron and domain diagram (all)

Cotton_A_39203
Cotton_A_07558
Cotton_A_05648

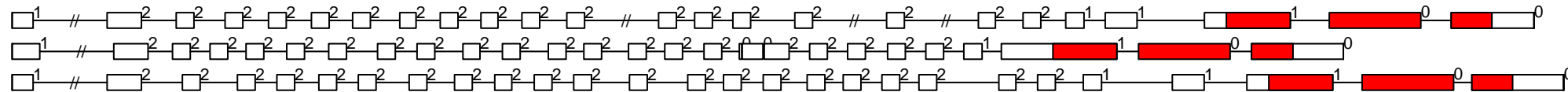

0

2000

4000

6000

G.ar RLK-Pelle_LRR-XIV exon-intron and domain diagram (all)

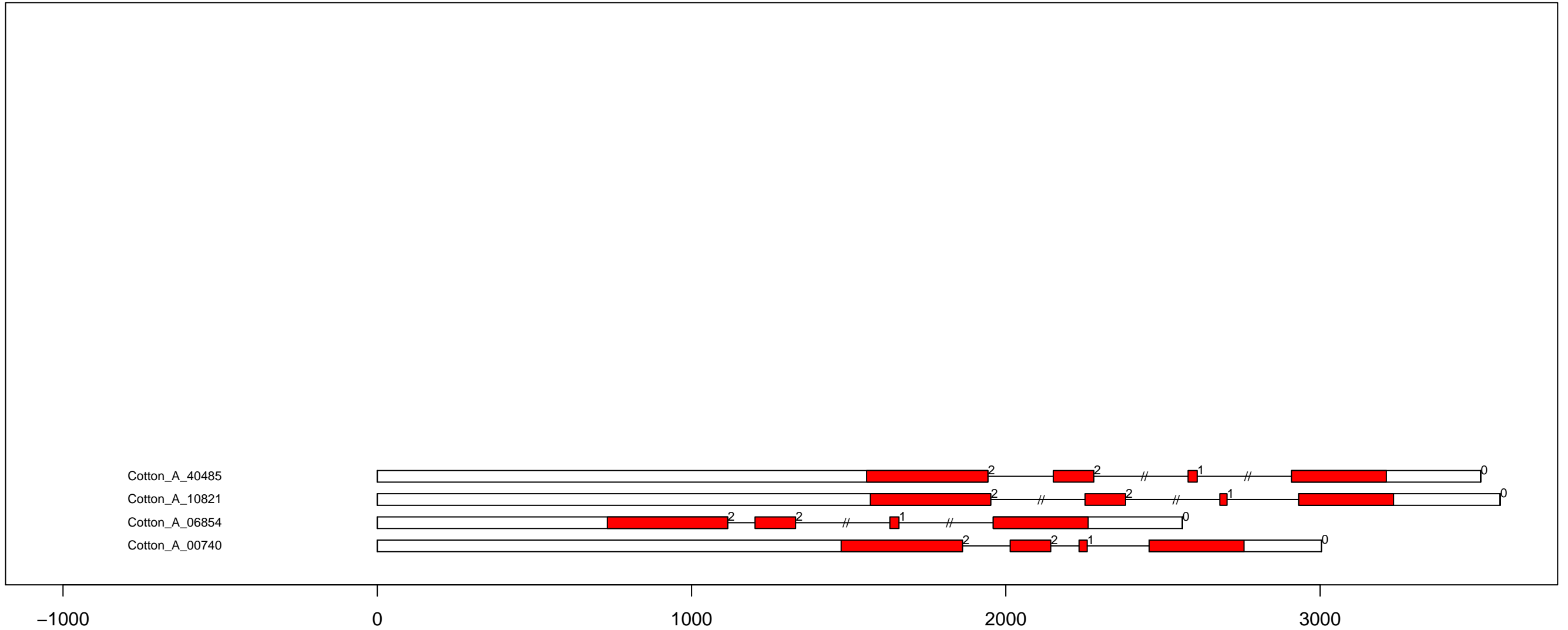

G.ar RLK-Pelle_LRR-XV exon-intron and domain diagram (all)

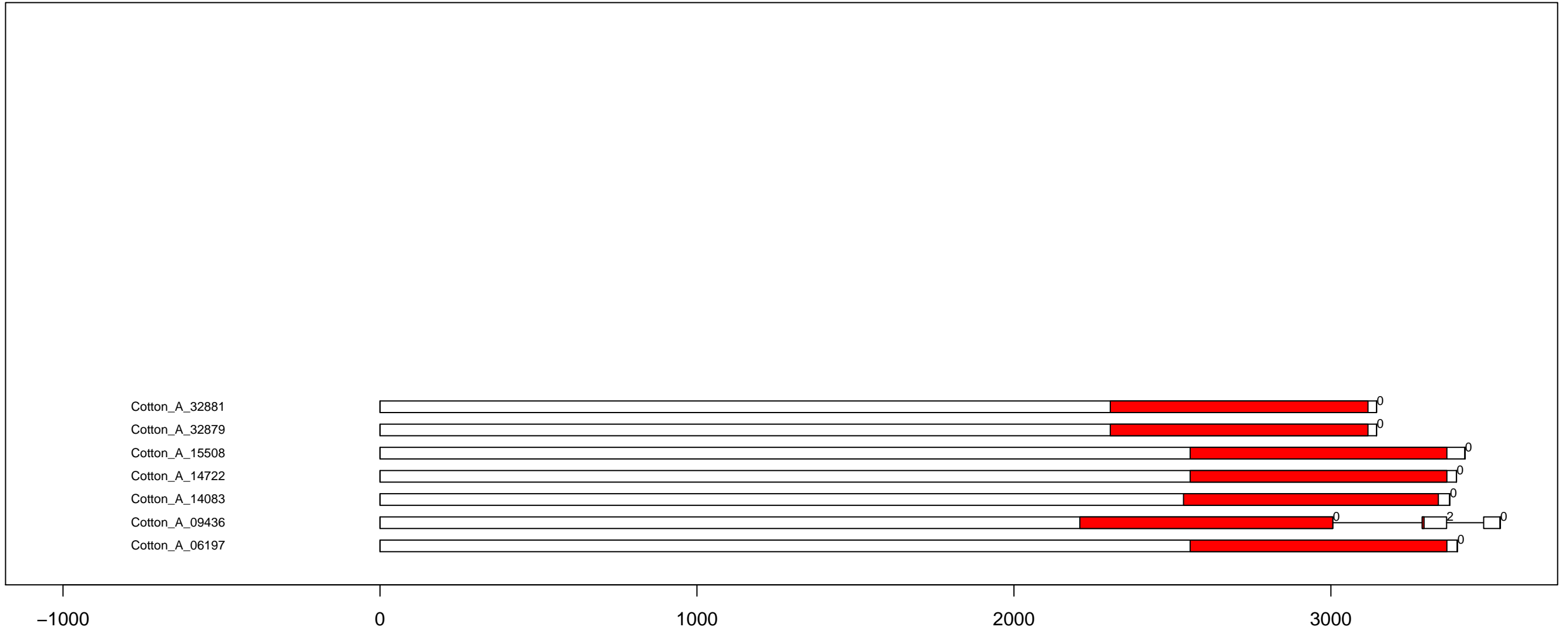

G.ar RLK-Pelle_LysM exon-intron and domain diagram (all)

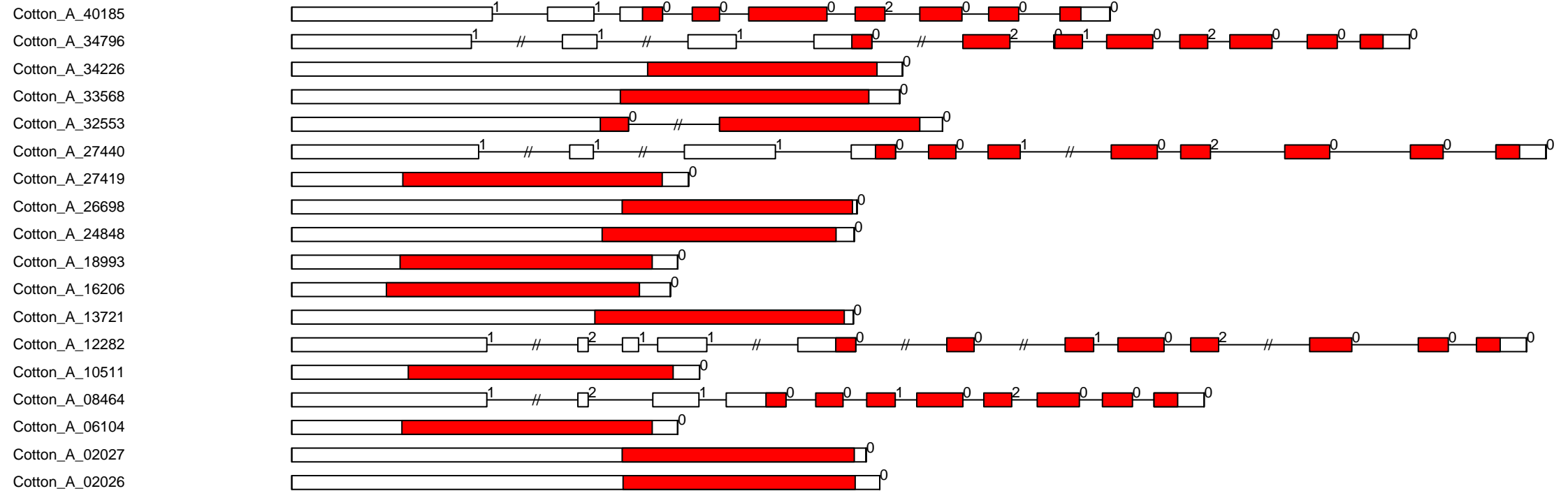

G.ar RLK-Pelle_PERK-1 exon-intron and domain diagram (all)

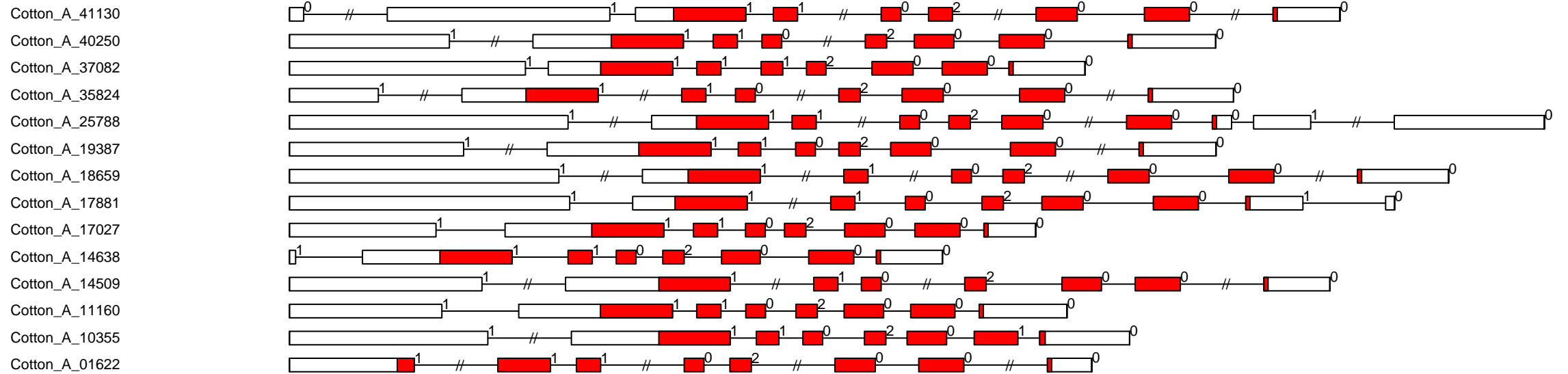

-1000

0

1000

2000

3000

4000

G.ar RLK-Pelle_PERK-2 exon-intron and domain diagram (all)

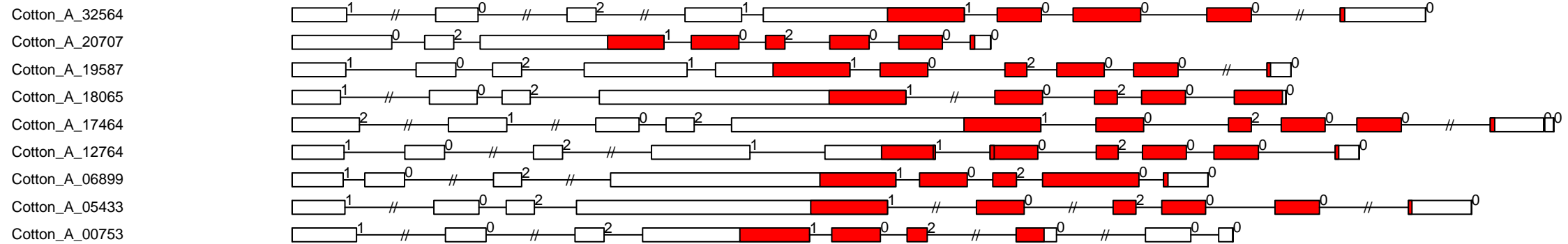

G.ar RLK-Pelle_RKF3 exon-intron and domain diagram (all)

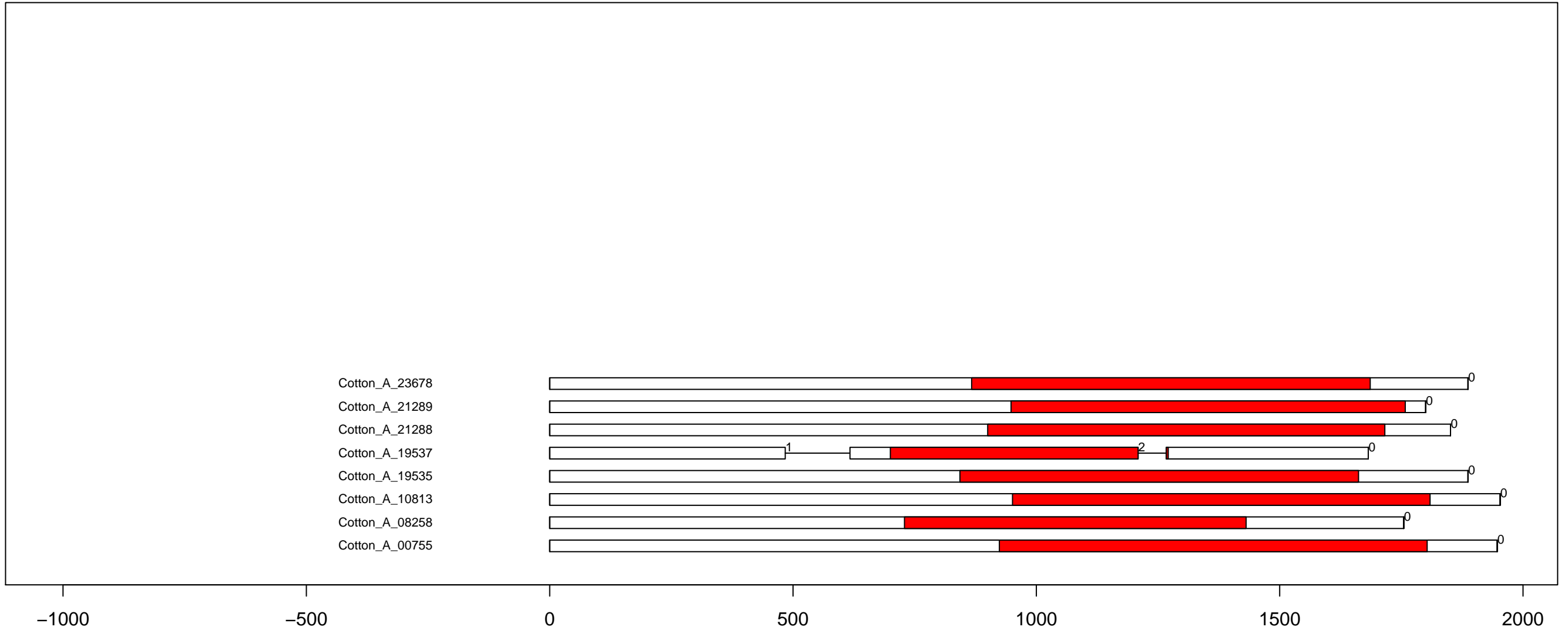

G.ar RLK-Pelle_RLCK-II exon-intron and domain diagram (all)

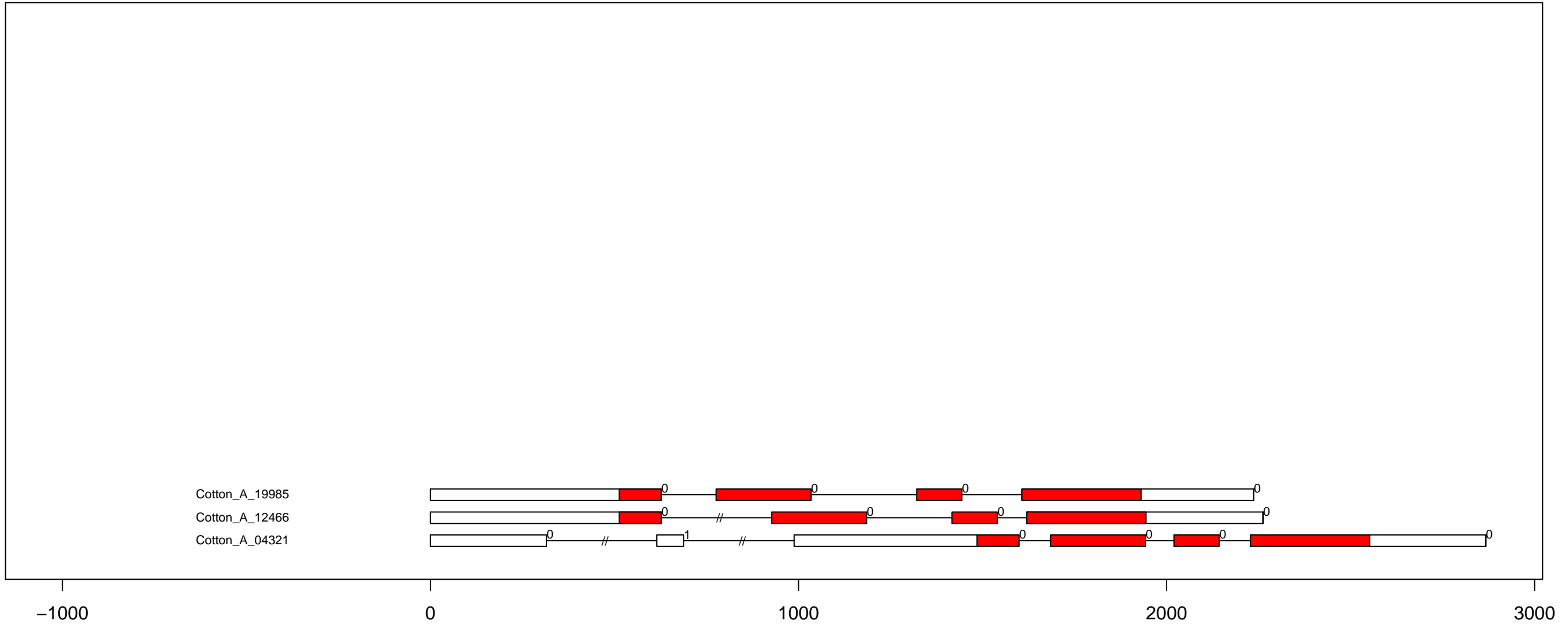

G.ar RLK-Pelle_RLCK-IV exon-intron and domain diagram (all)

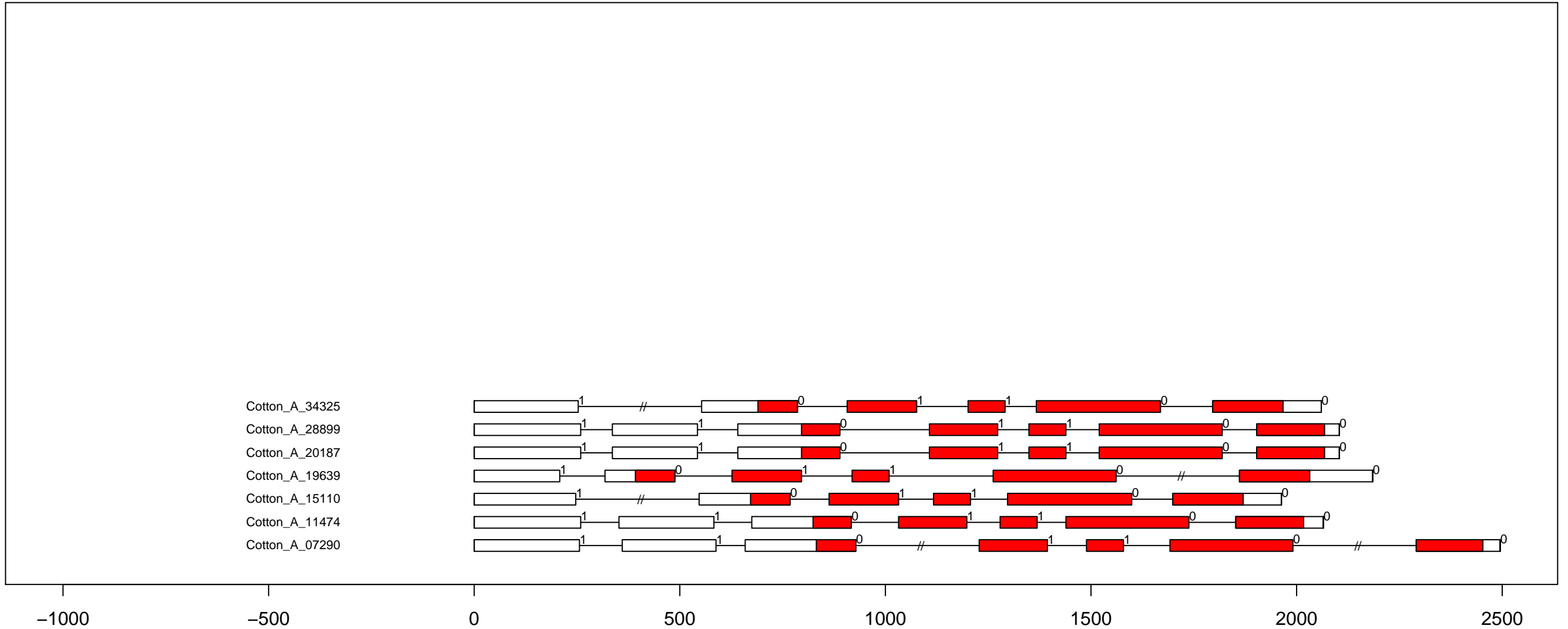

G.ar RLK-Pelle_RLCK-IXa exon-intron and domain diagram (all)

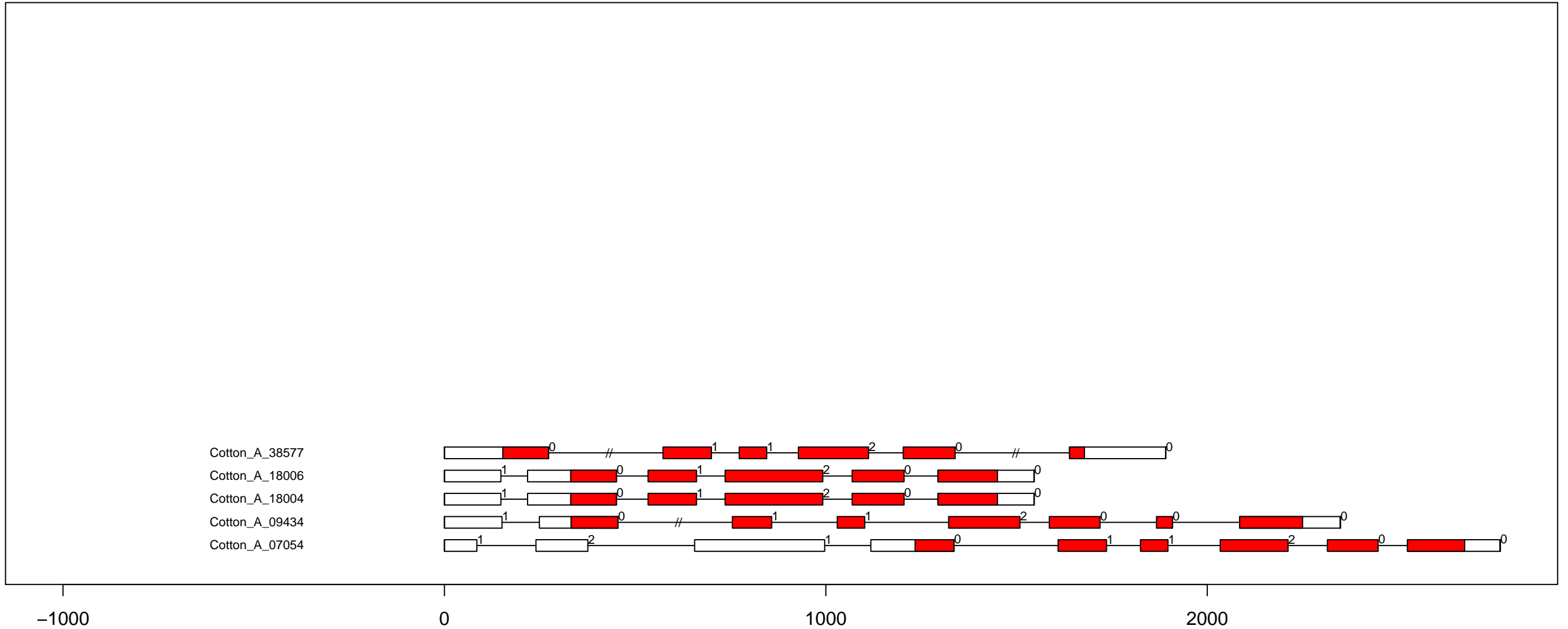

G.ar RLK-Pelle_RLCK-IXb exon-intron and domain diagram (all)

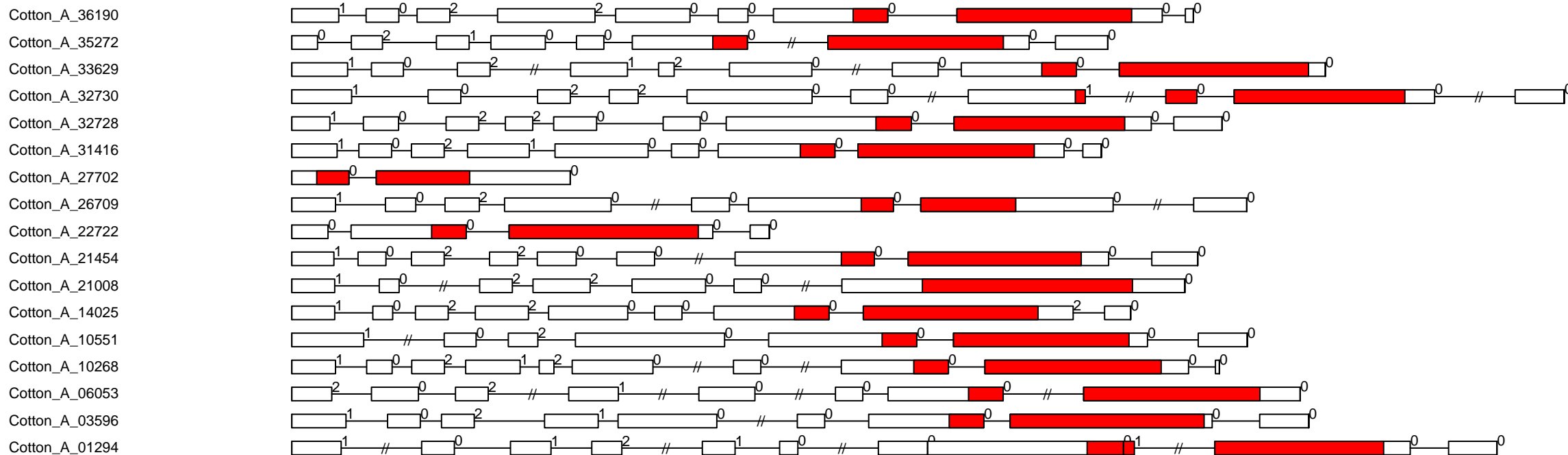

-1000

0

1000

2000

3000

4000

G.ar RLK-Pelle_RLCK-Os exon-intron and domain diagram (all)

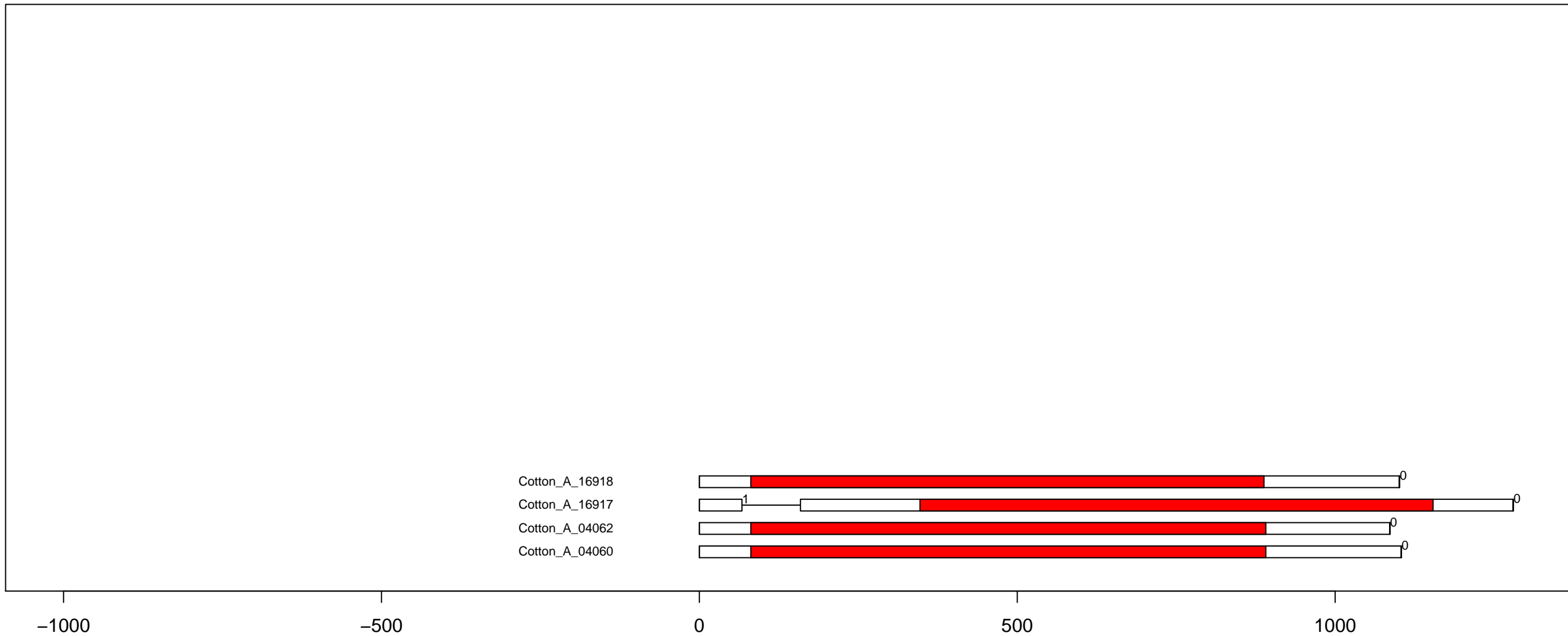

G.ar RLK-Pelle_RLCK-VIIa-1 exon-intron and domain diagram (all)

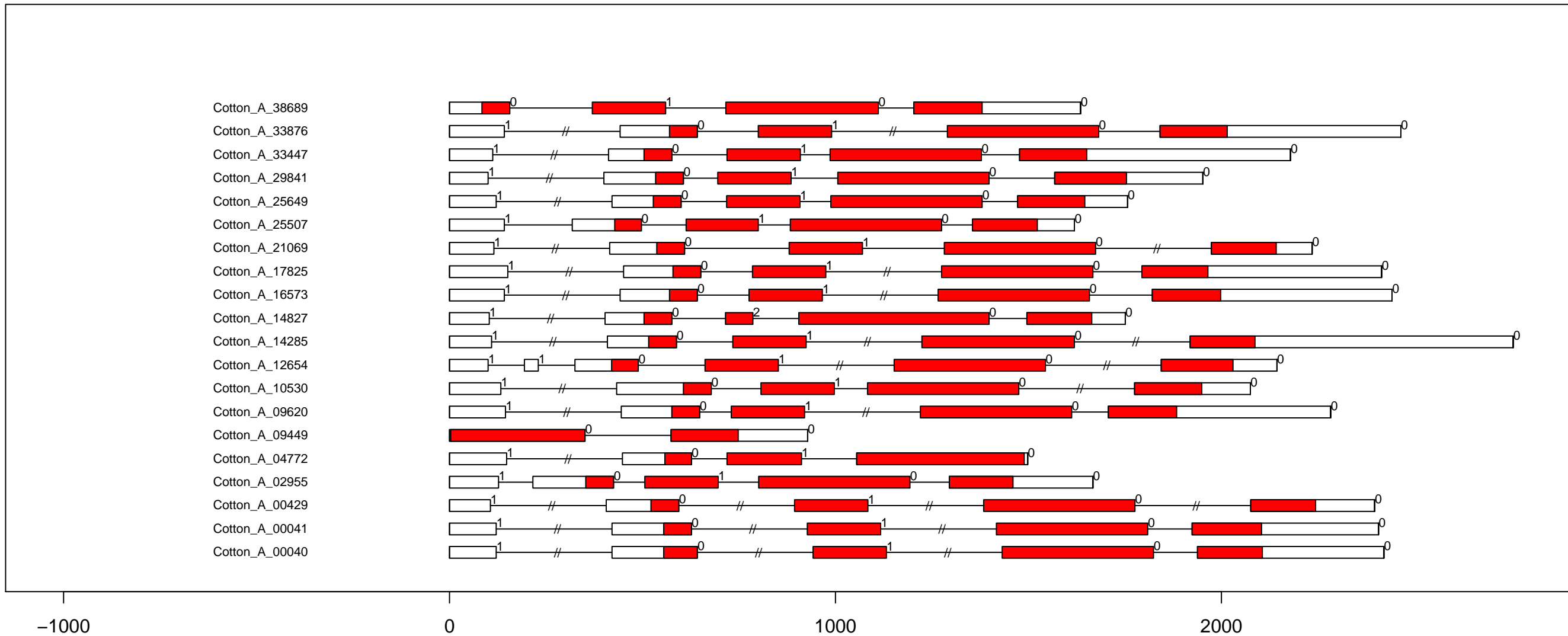

G.ar RLK-Pelle_RLCK-VIIa-2 exon-intron and domain diagram (part 1)

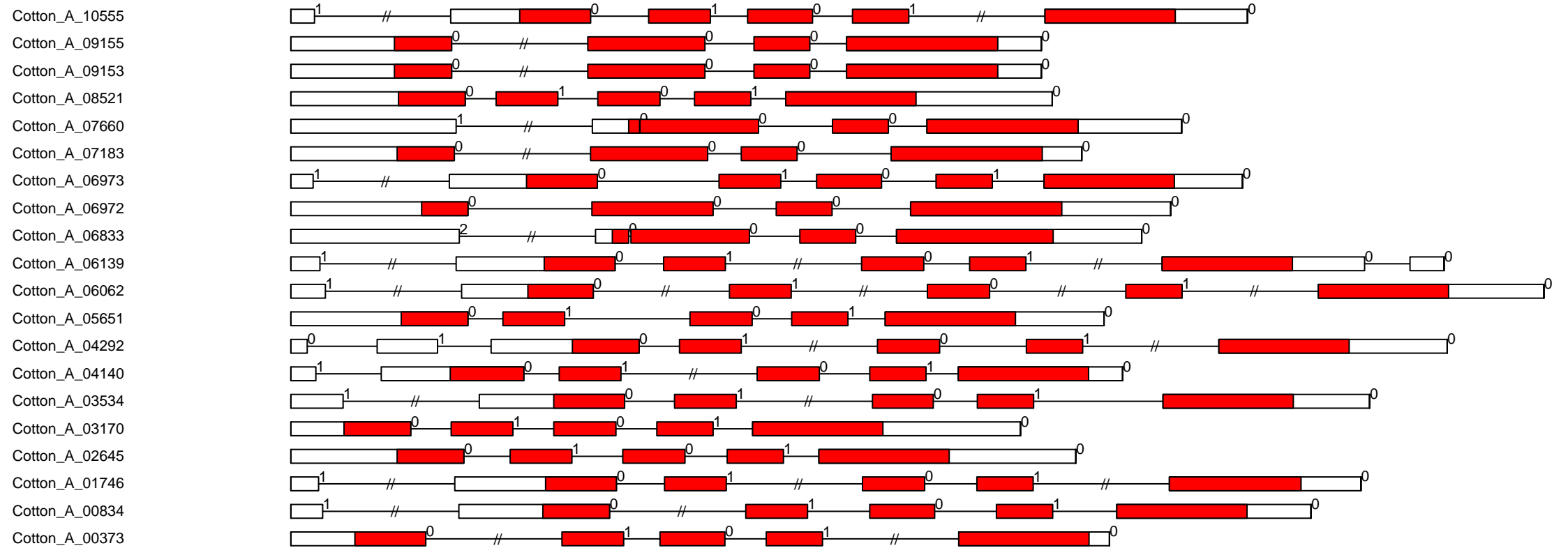

-1000

0

1000

2000

G.ar RLK-Pelle_RLCK-VIIa-2 exon-intron and domain diagram (part 2)

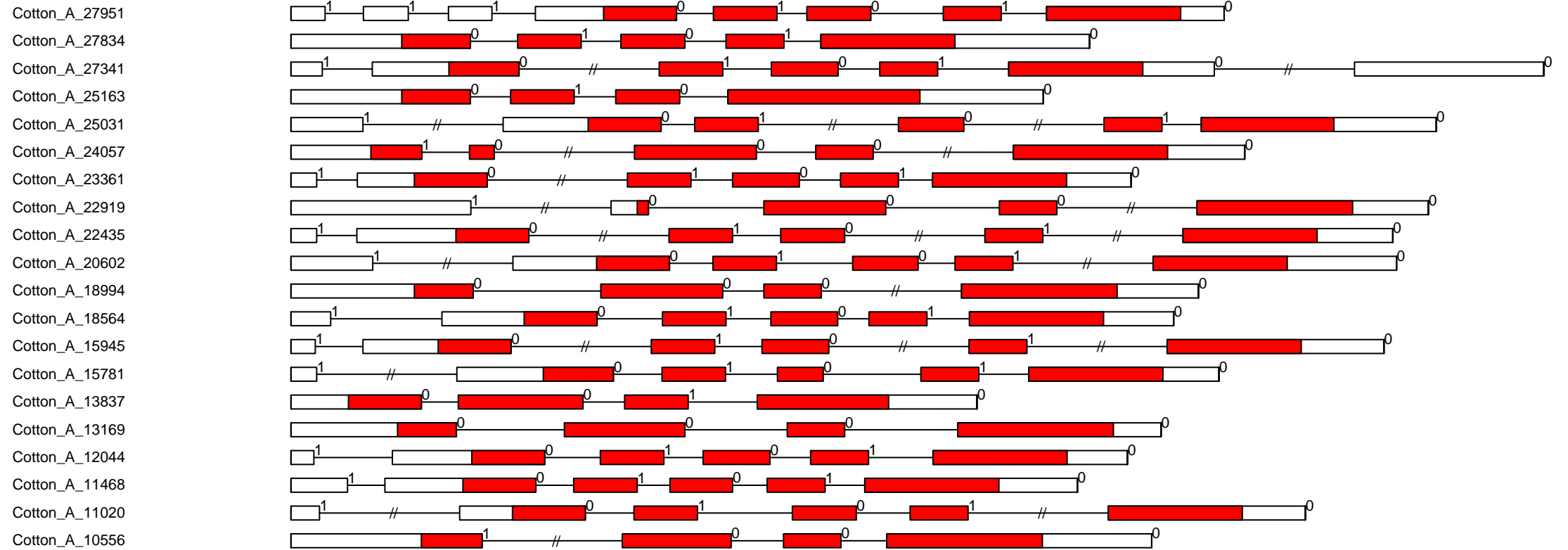

-1000

0

1000

2000

G.ar RLK-Pelle_RLCK-VIIa-2 exon-intron and domain diagram (part 3)

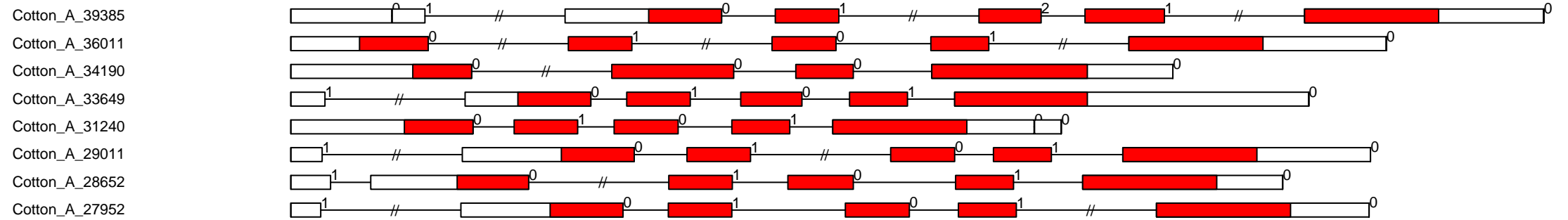

-1000

0

1000

2000

G.ar RLK-Pelle_RLCK-VIIb exon-intron and domain diagram (all)

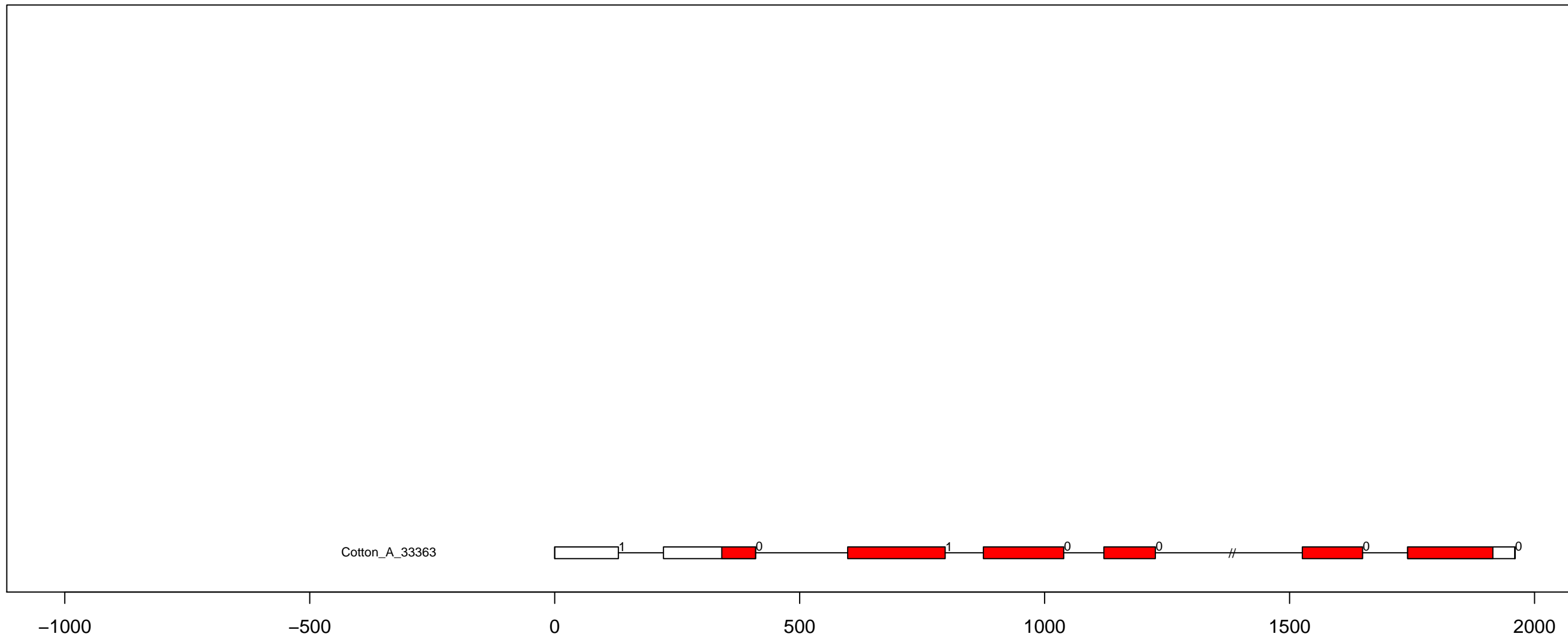

G.ar RLK-Pelle_RLCK-VIII exon-intron and domain diagram (all)

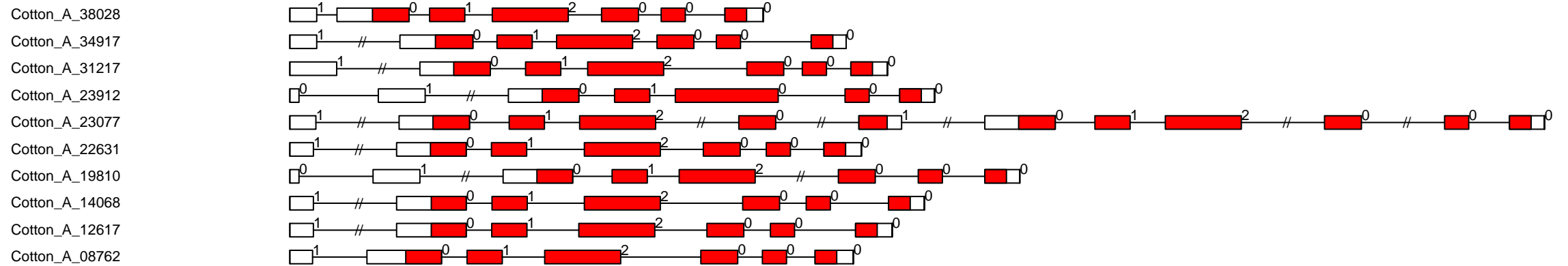

-1000

0

1000

2000

3000

4000

G.ar RLK-Pelle_RLCK-V exon-intron and domain diagram (all)

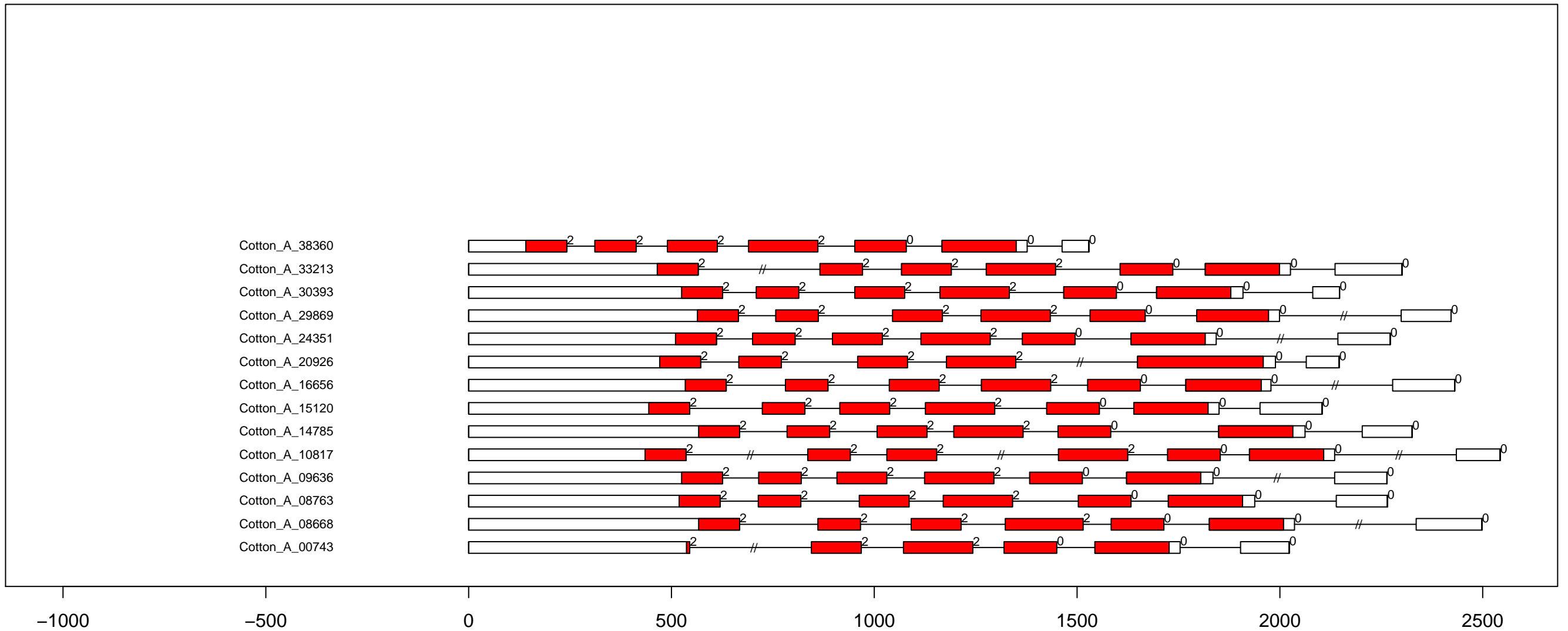

G.ar RLK-Pelle_RLCK-XII-1 exon-intron and domain diagram (all)

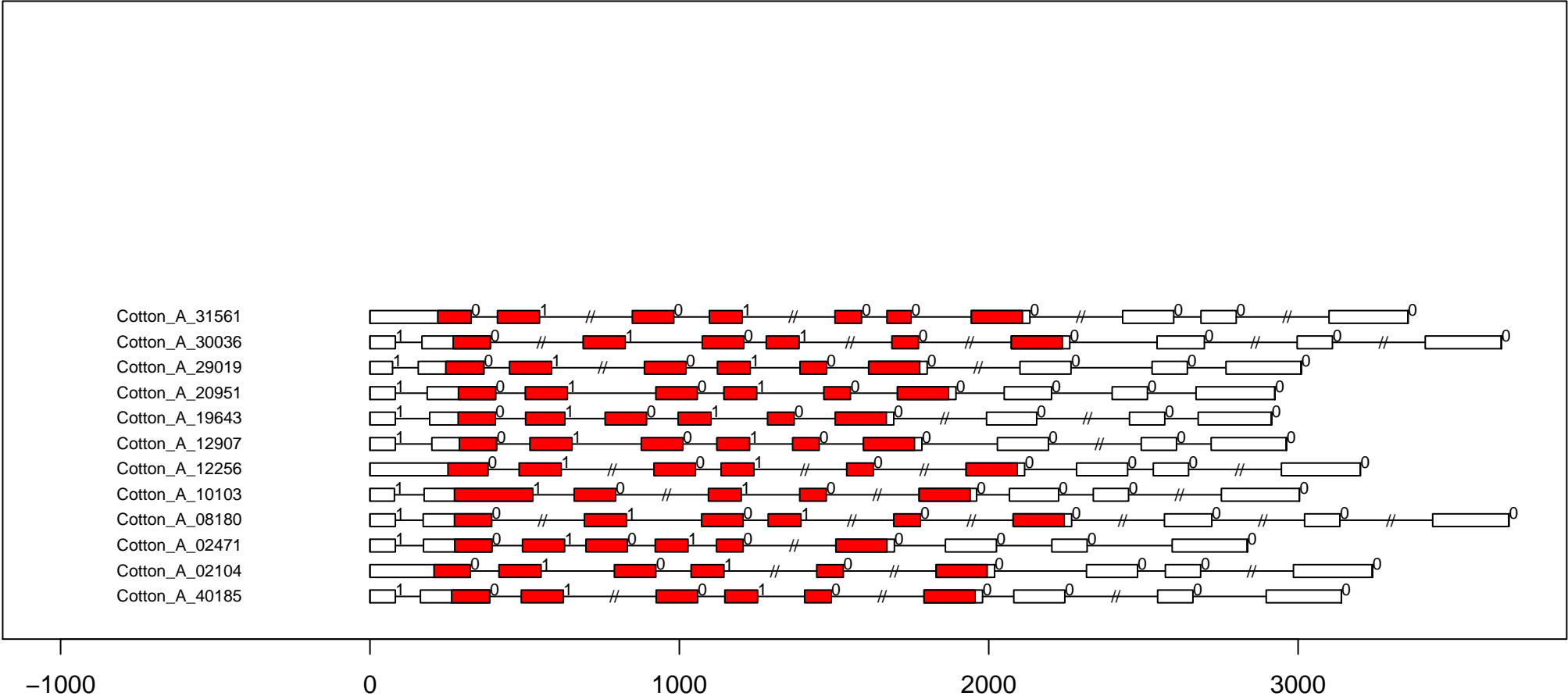

G.ar RLK-Pelle_RLCK-XII-2 exon-intron and domain diagram (all)

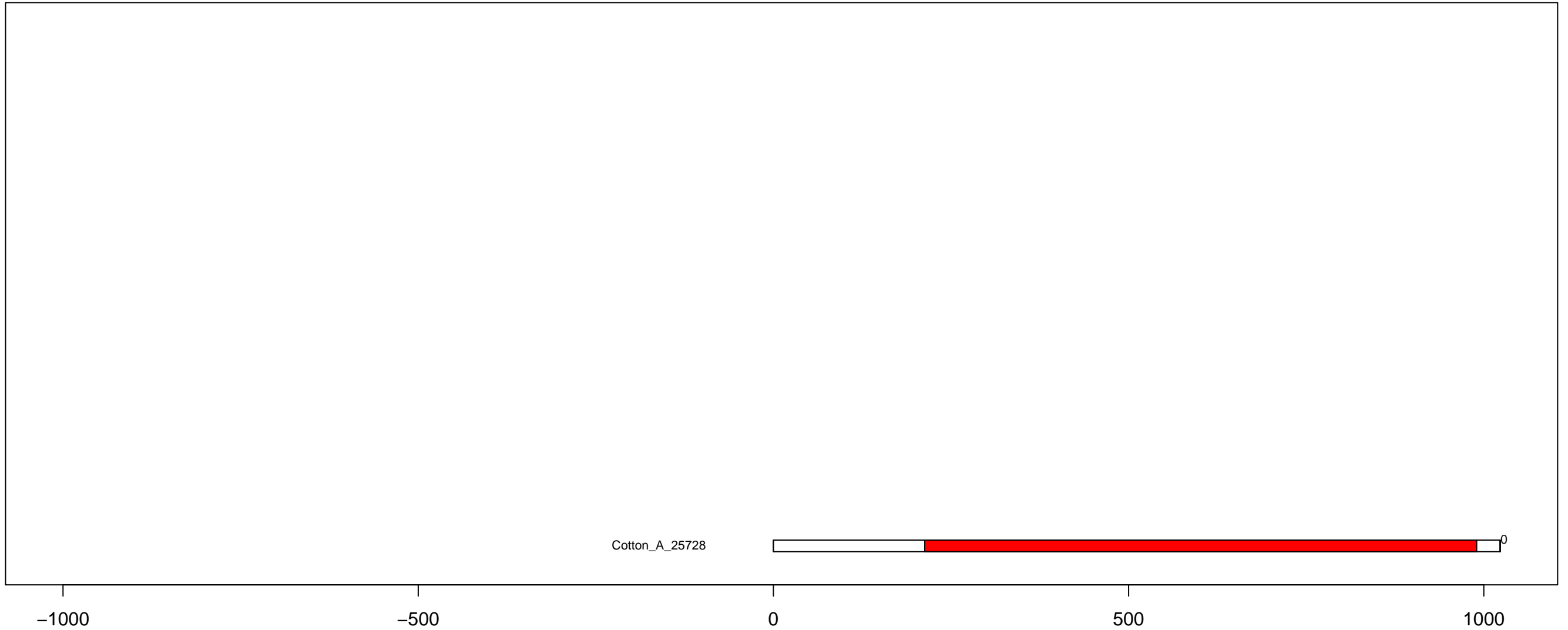

G.ar RLK-Pelle_RLCK-XIII exon-intron and domain diagram (all)

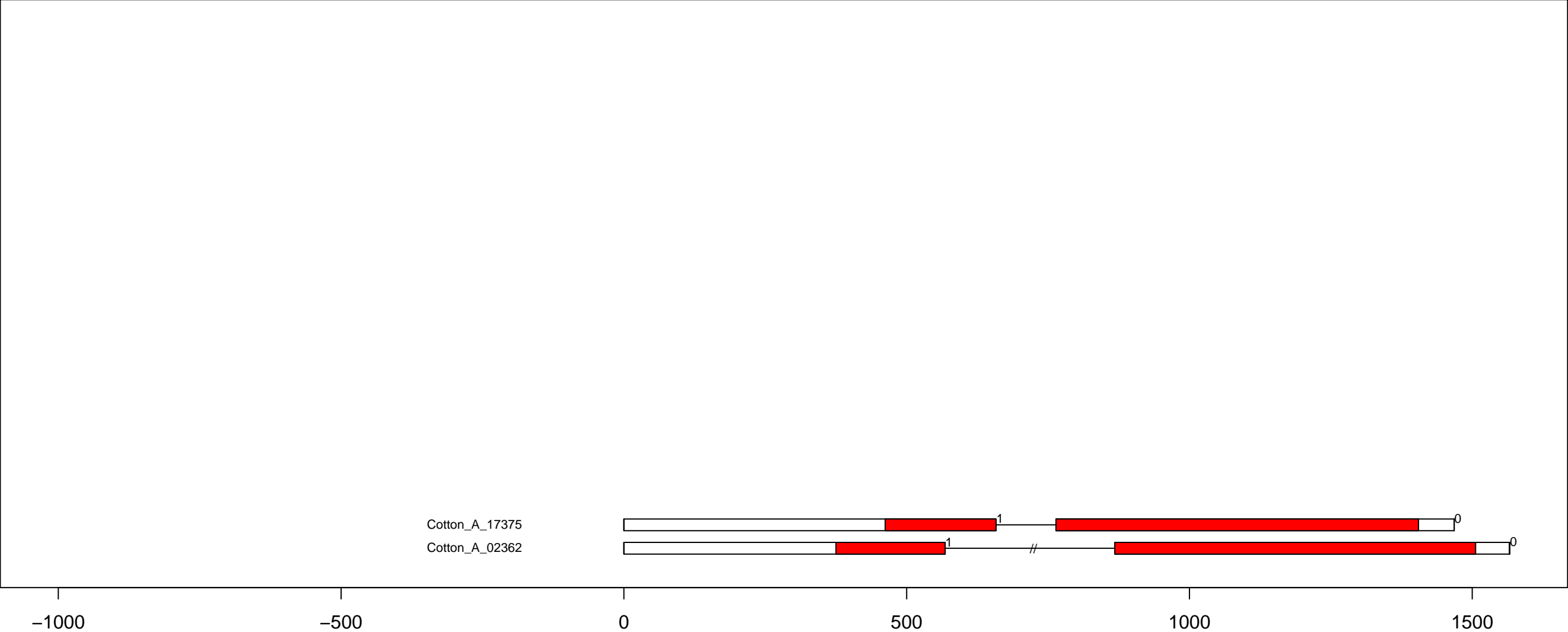

G.ar RLK-Pelle_RLCK-XI exon-intron and domain diagram (all)

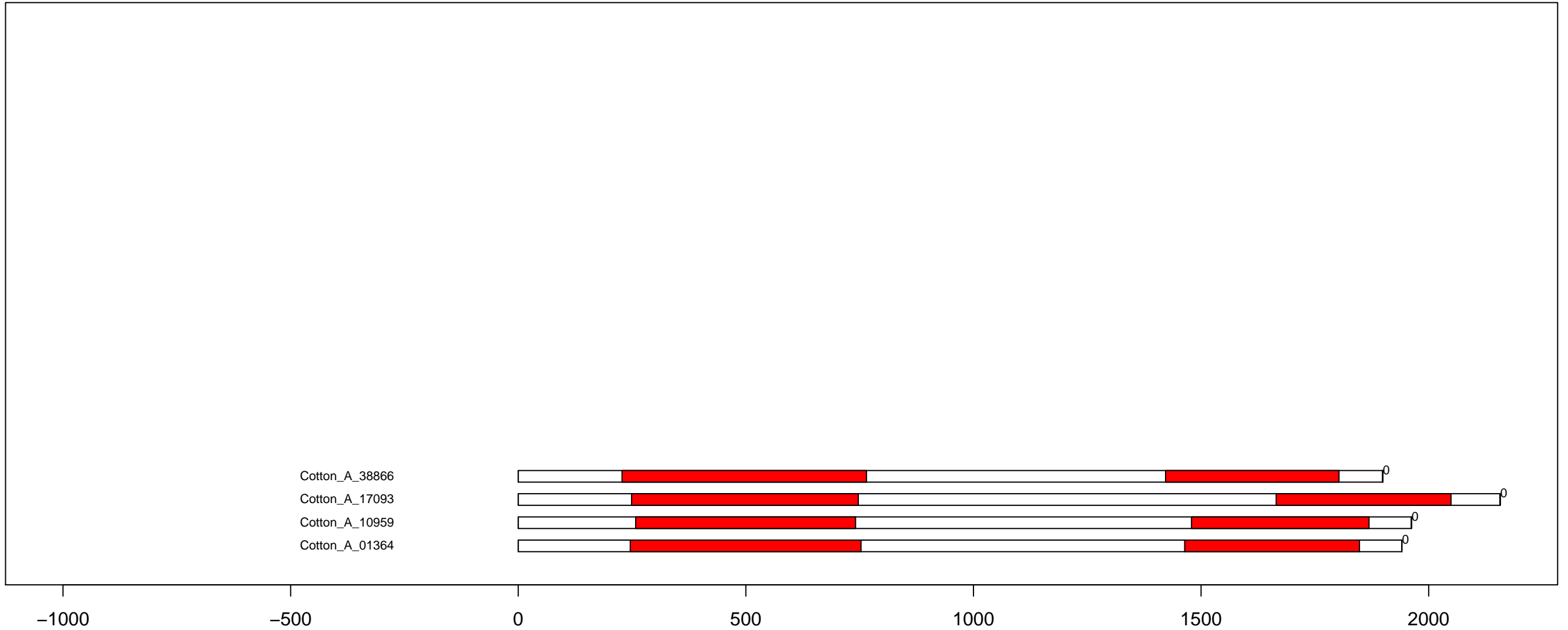

G.ar RLK-Pelle_RLCK-X exon-intron and domain diagram (all)

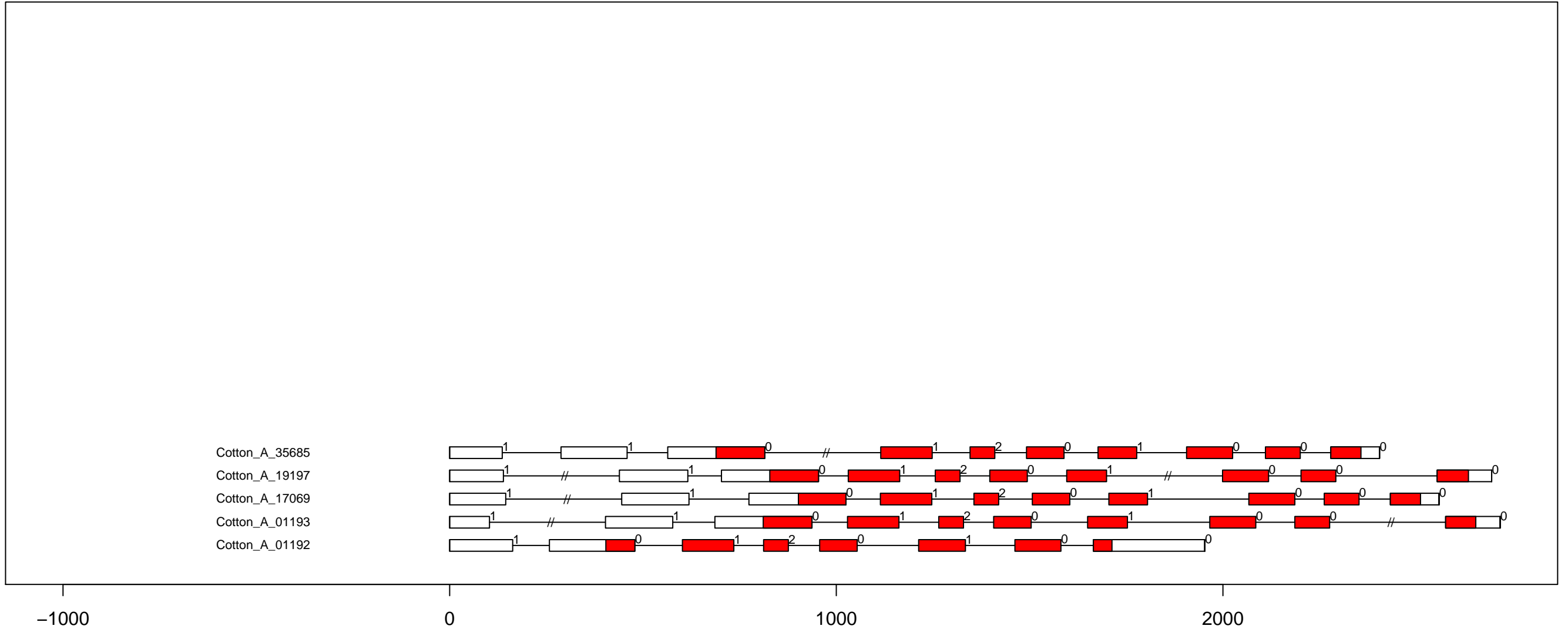

G.ar RLK-Pelle_RLCK-XVI exon-intron and domain diagram (all)

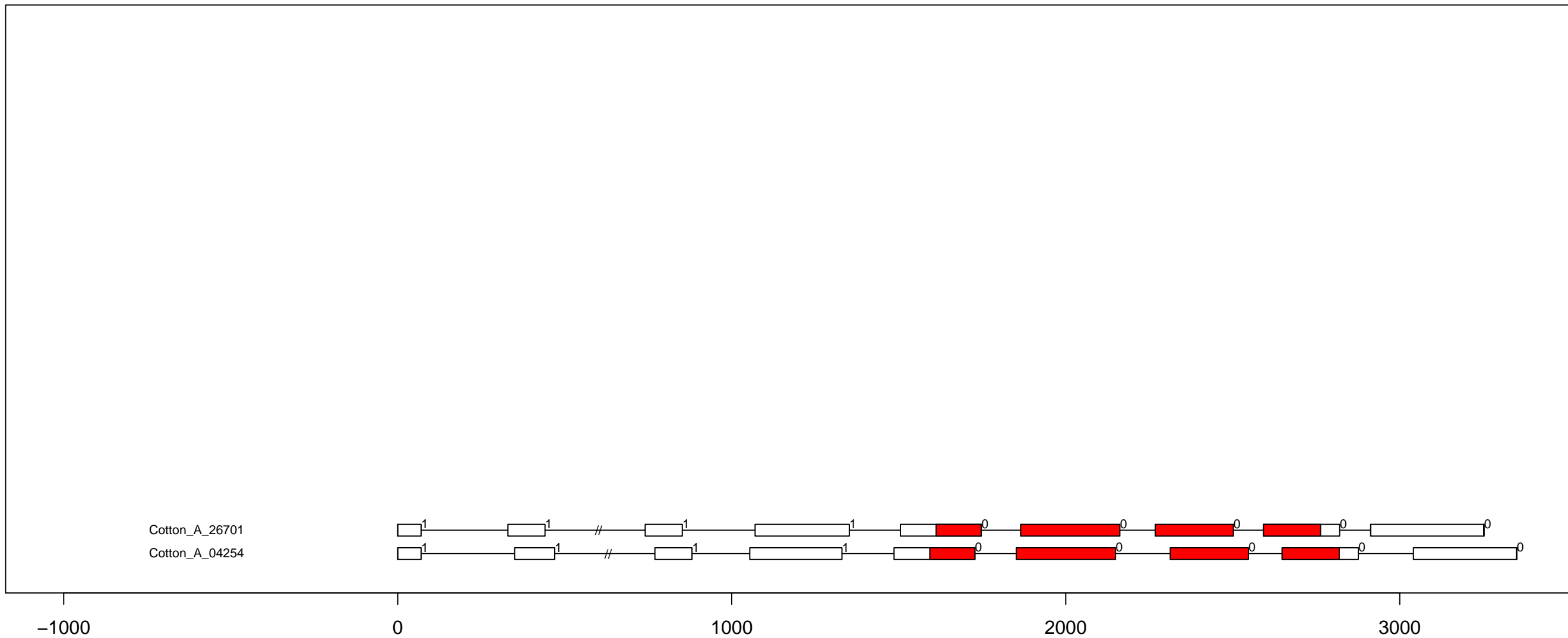

G.ar RLK-Pelle_RLCK-XV exon-intron and domain diagram (all)

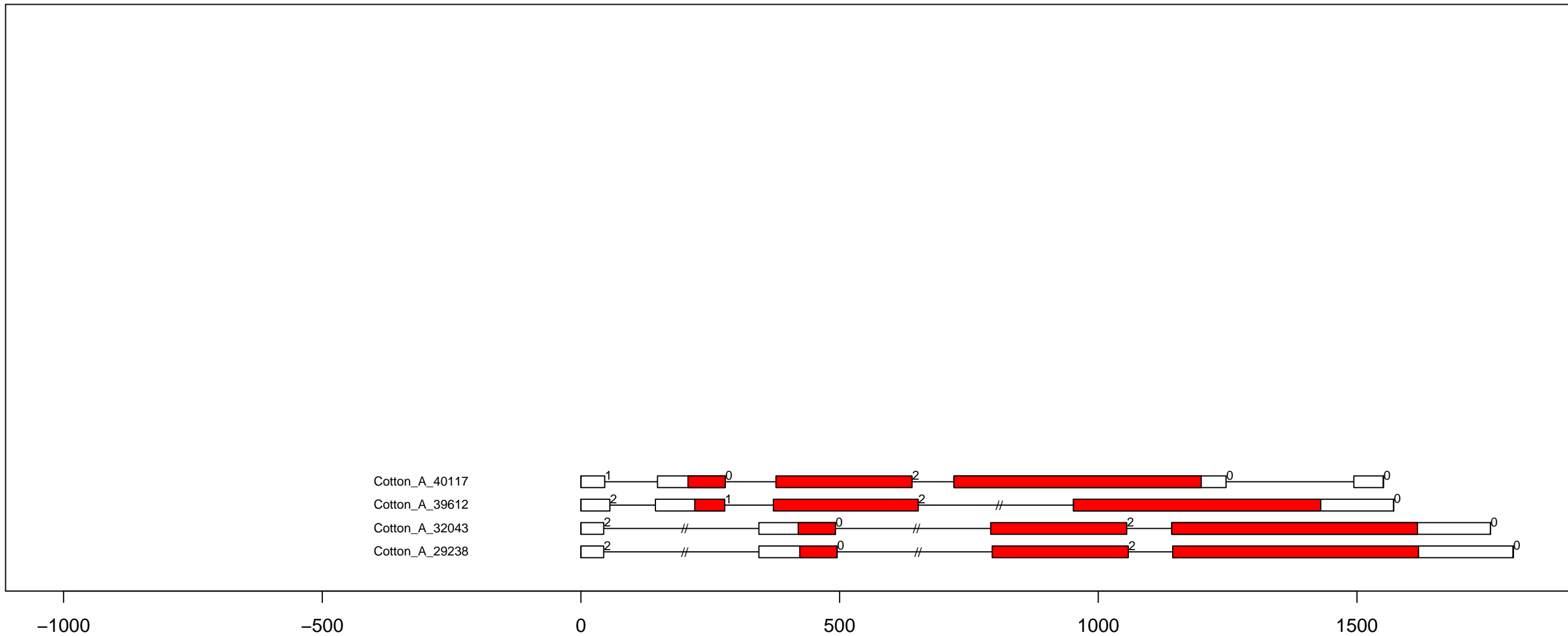

G.ar RLK-Pelle_SD-2b exon-intron and domain diagram (part 1)

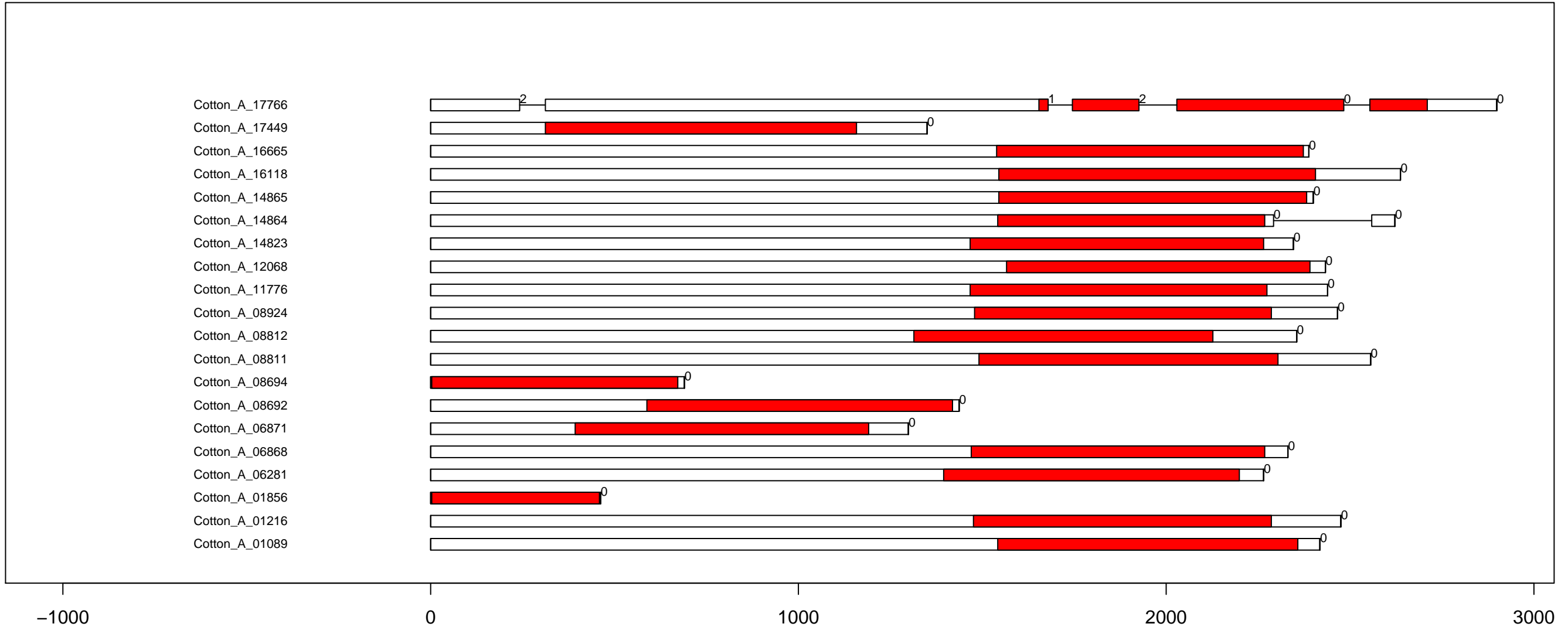

G.ar RLK-Pelle_SD-2b exon-intron and domain diagram (part 2)

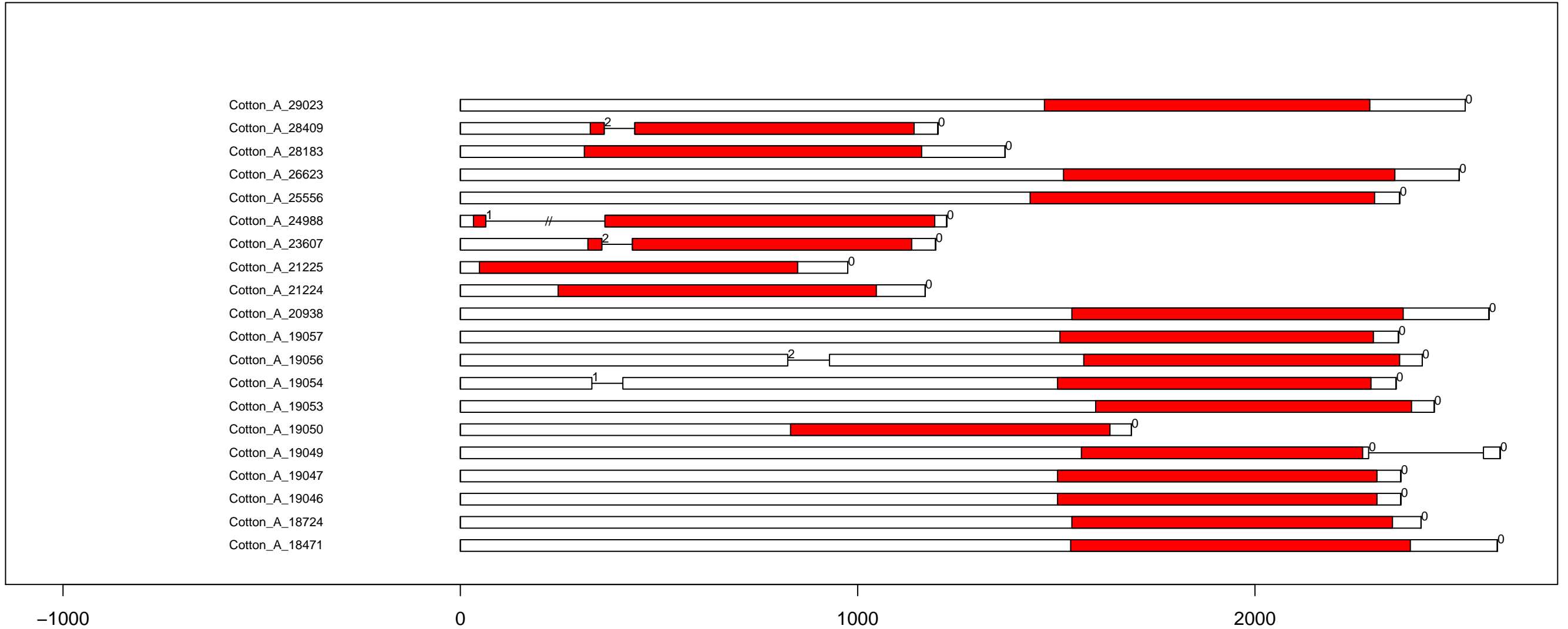

G.ar RLK-Pelle_SD-2b exon-intron and domain diagram (part 3)

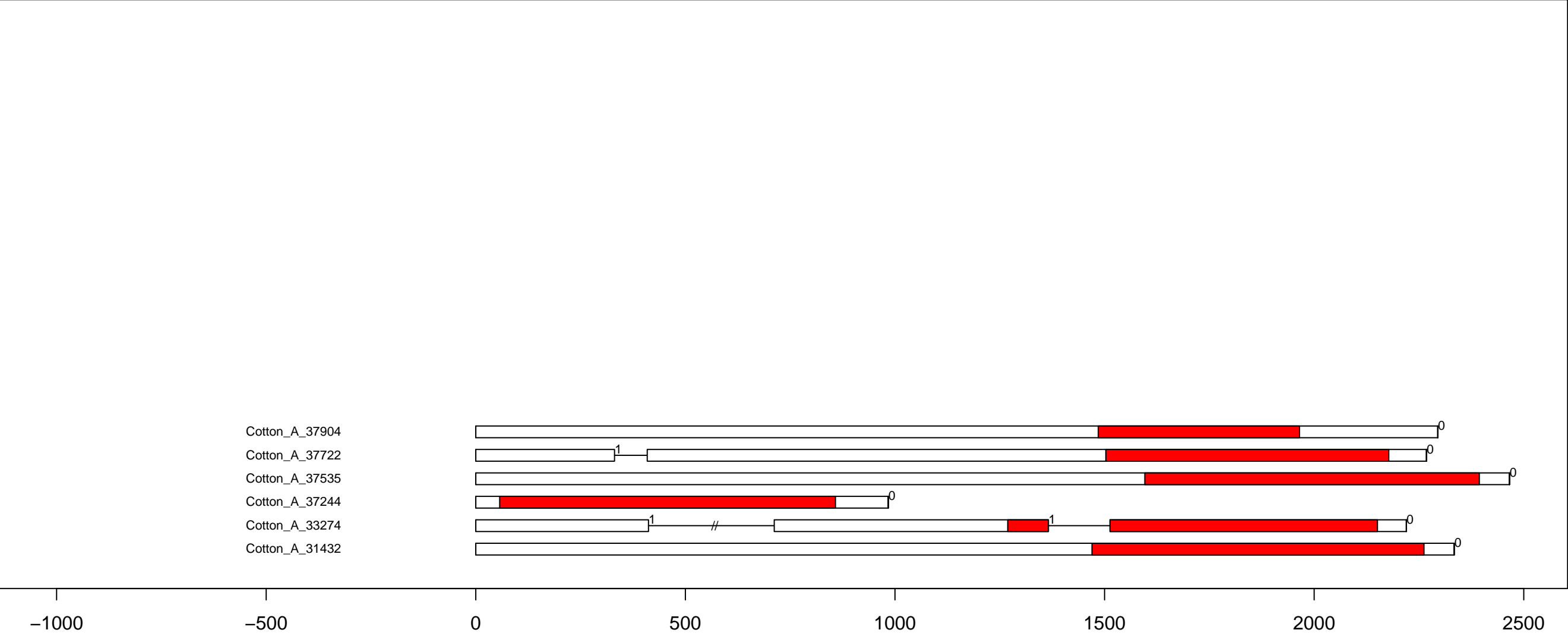

G.ar RLK-Pelle_Singleton exon-intron and domain diagram (all)

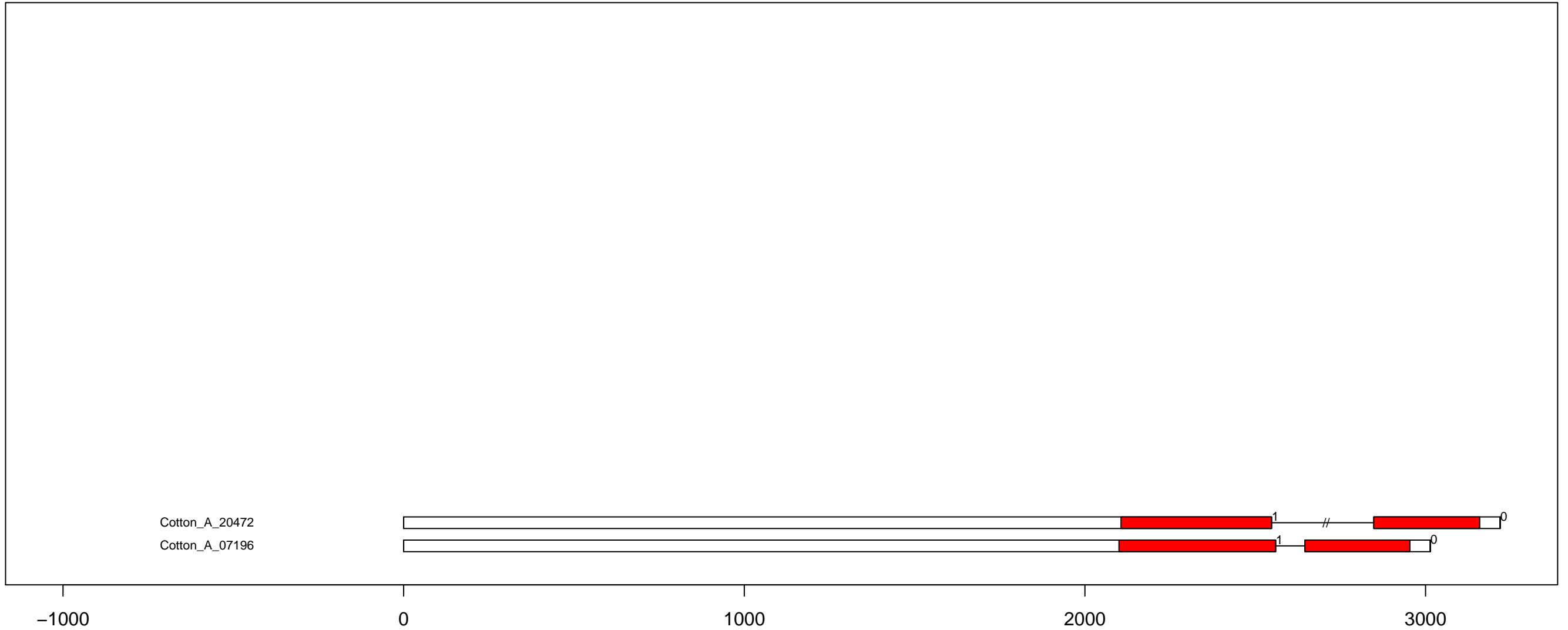

G.ar RLK-Pelle_URK-1 exon-intron and domain diagram (all)

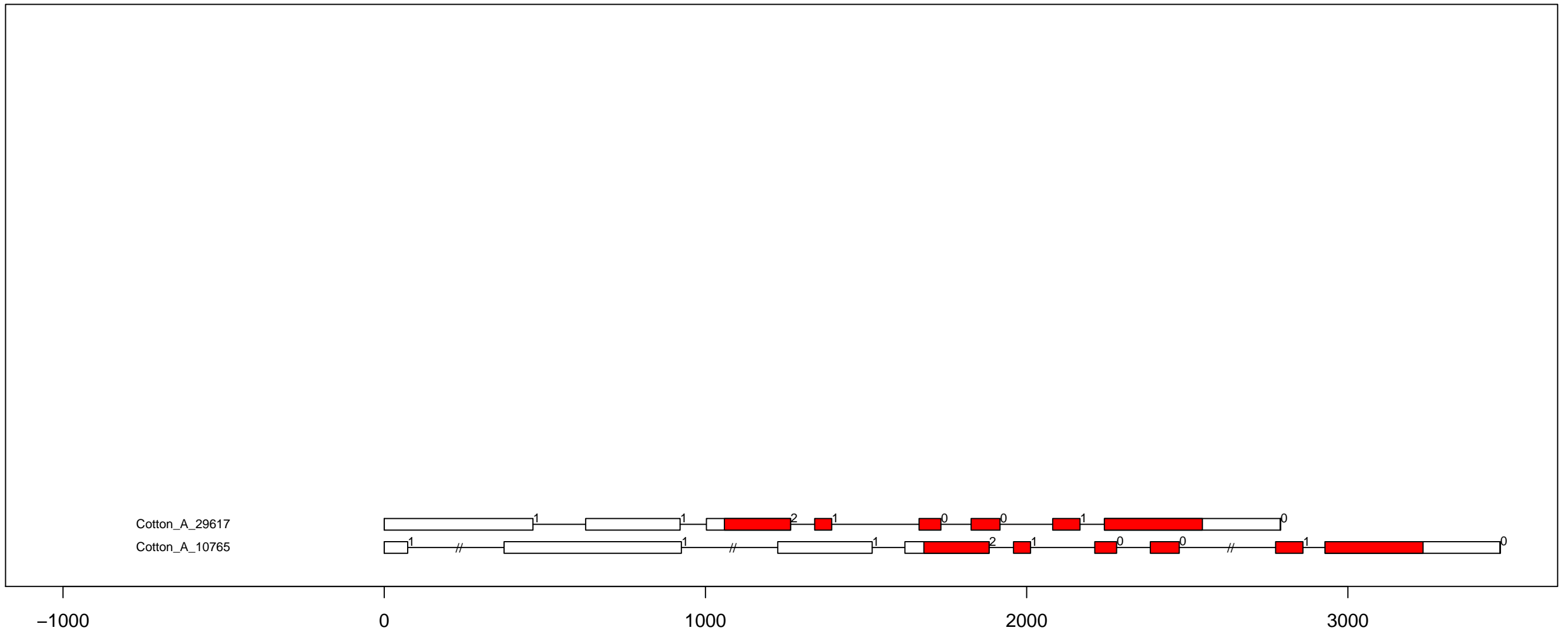

G.ar RLK-Pelle_URK-3 exon-intron and domain diagram (all)

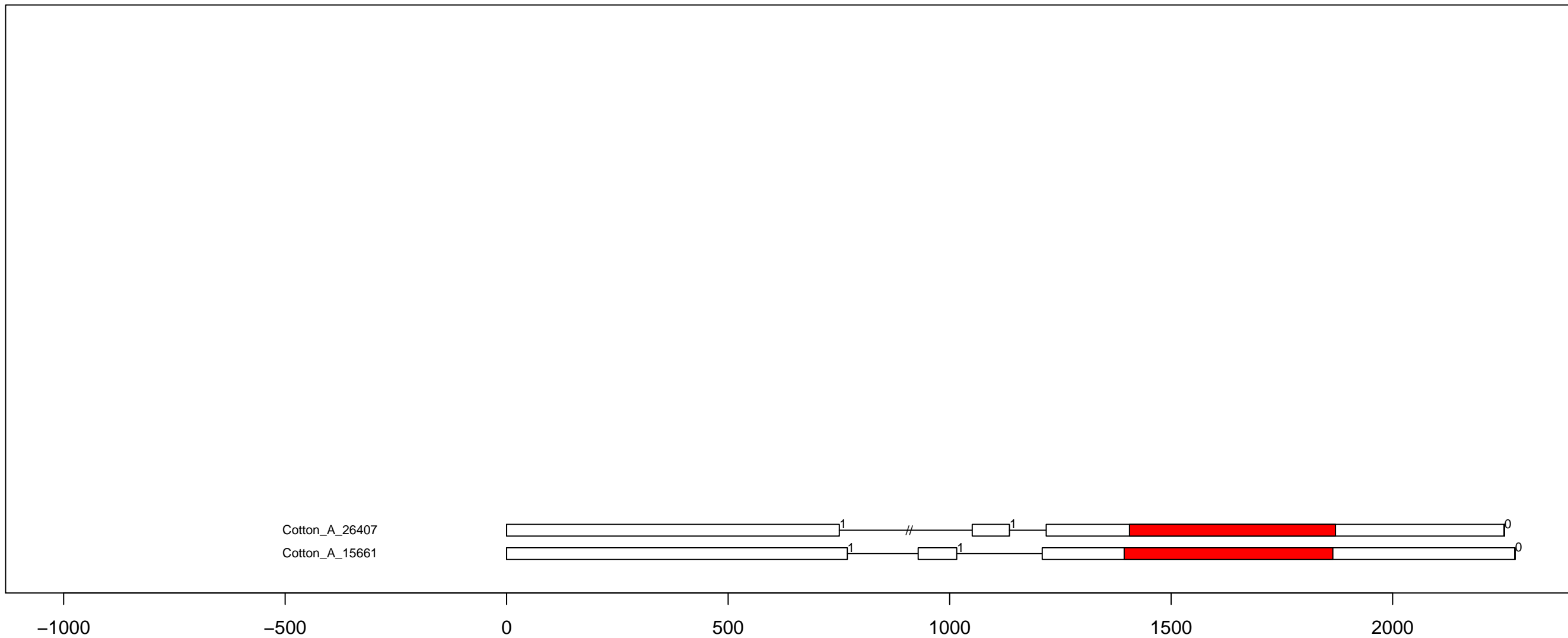

G.ar RLK-Pelle_WAK_LRK10L-1 exon-intron and domain diagram (all)

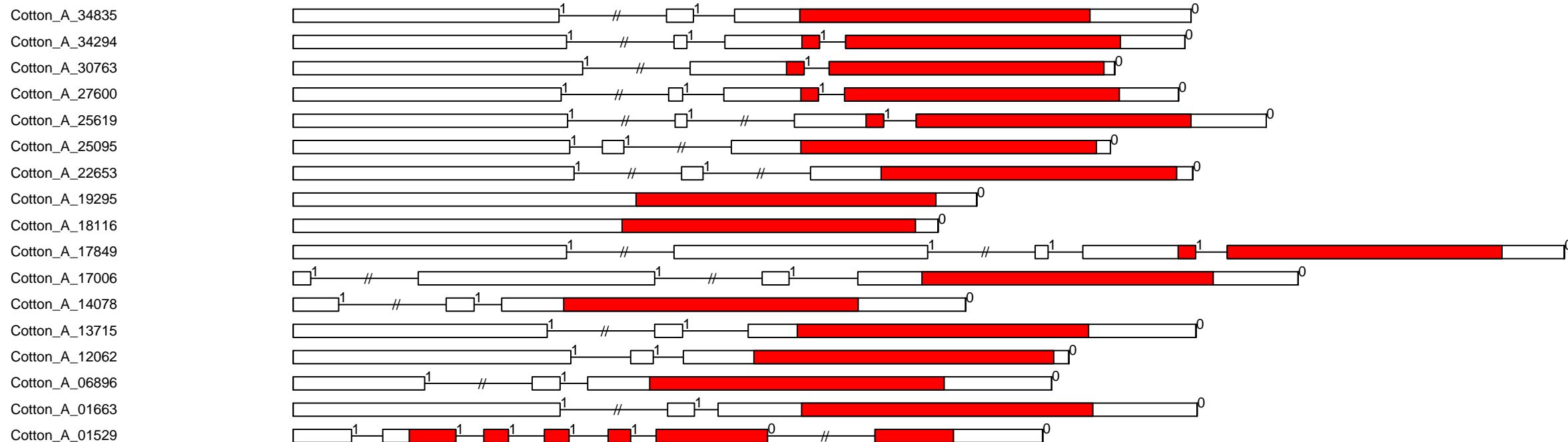

-1000

0

1000

2000

3000

G.ar RLK-Pelle_WAK exon-intron and domain diagram (part 1)

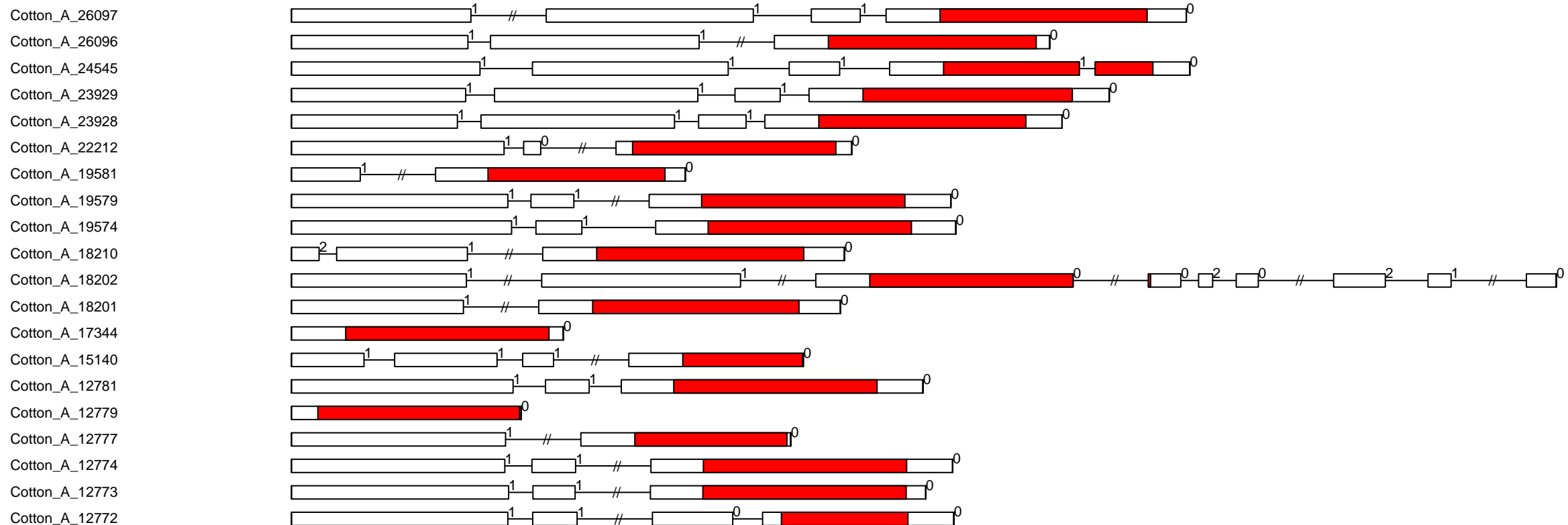

G.ar RLK-Pelle_WAK exon-intron and domain diagram (part 2)

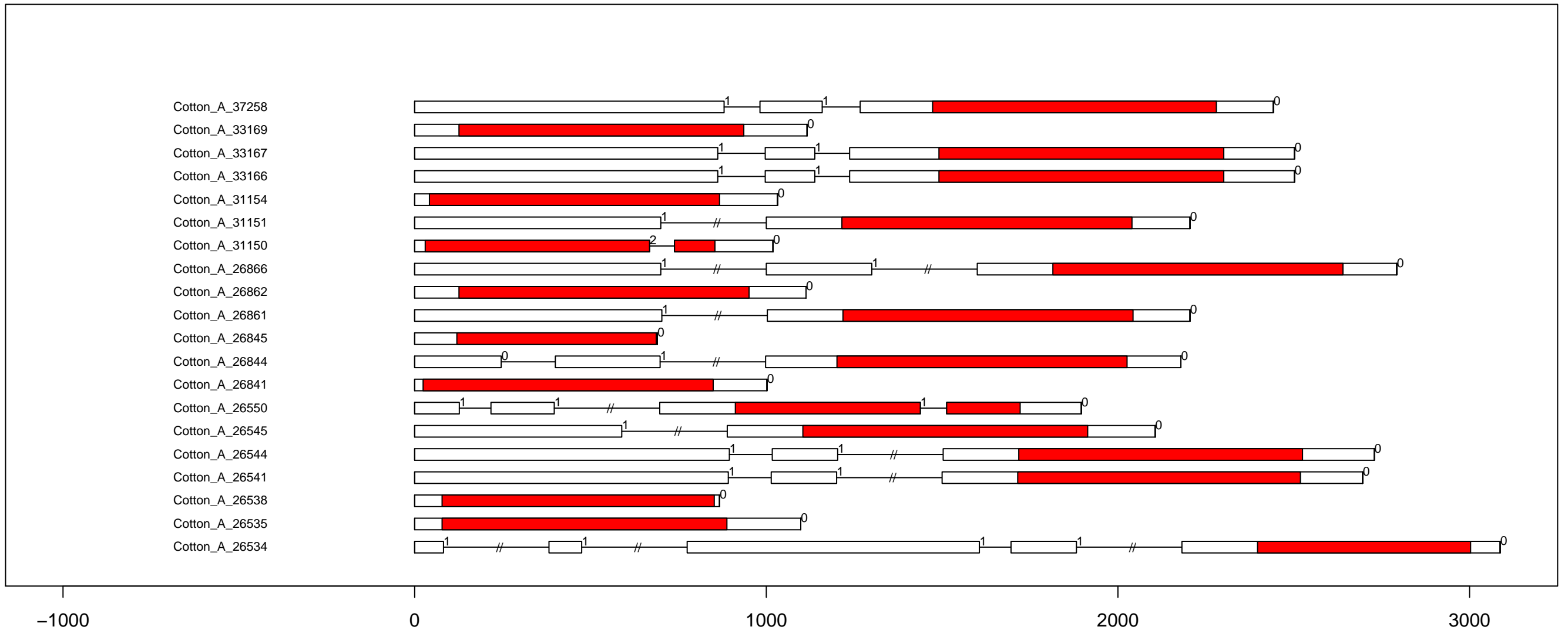

G.ar SCY1_SCYL1 exon-intron and domain diagram (all)

Cotton_A_15596
Cotton_A_04045

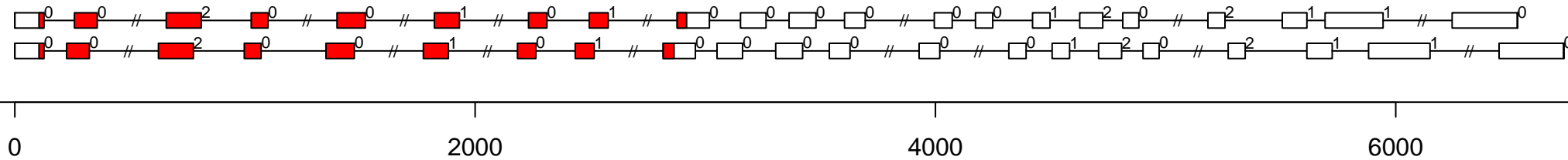

G.ar SCY1_SCYL2 exon-intron and domain diagram (all)

Cotton_A_05837

Cotton_A_04541

Cotton_A_04017

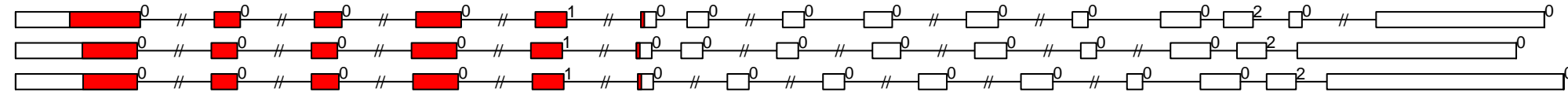

0

2000

4000

6000

G.ar STE_STE11 exon-intron and domain diagram (part 1)

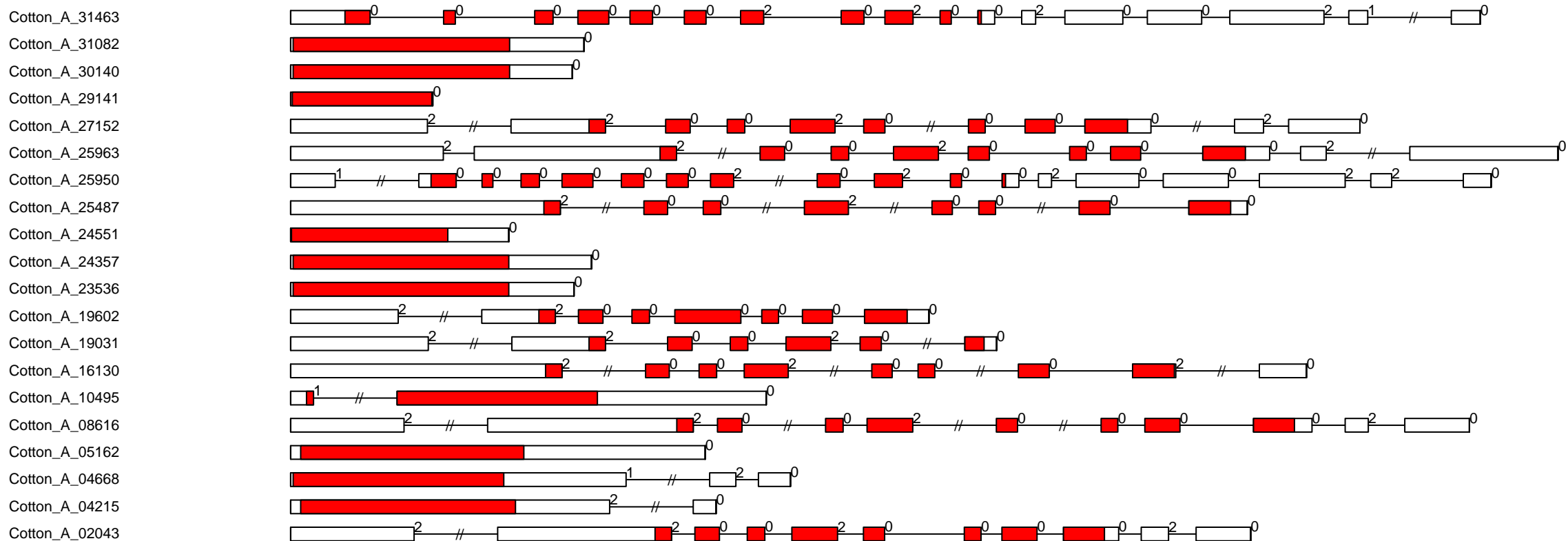

G.ar STE_STE20-Fray exon-intron and domain diagram (all)

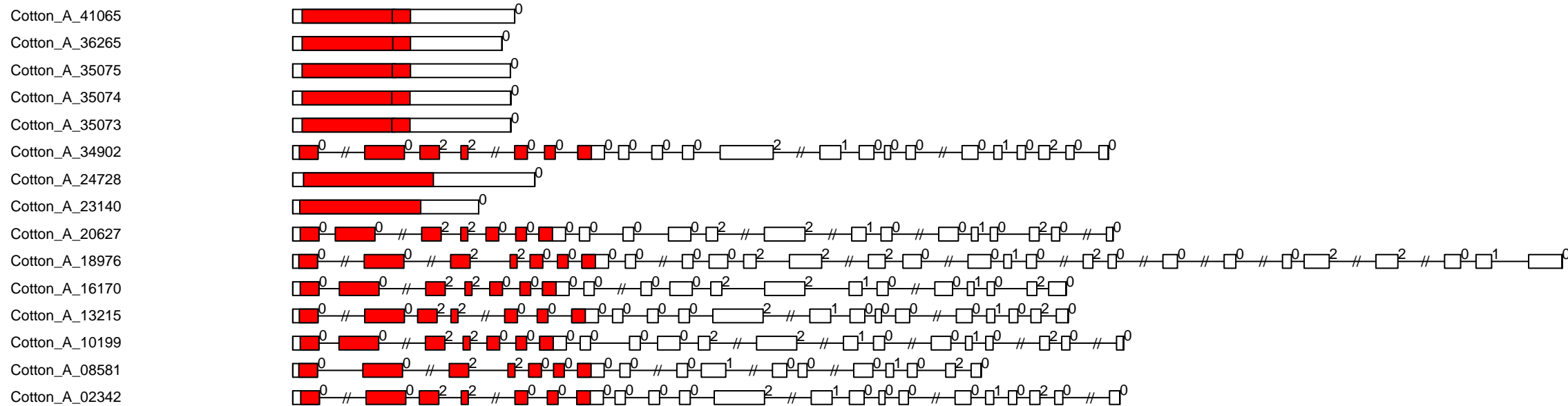

G.ar STE_STE20-PI exon-intron and domain diagram (all)

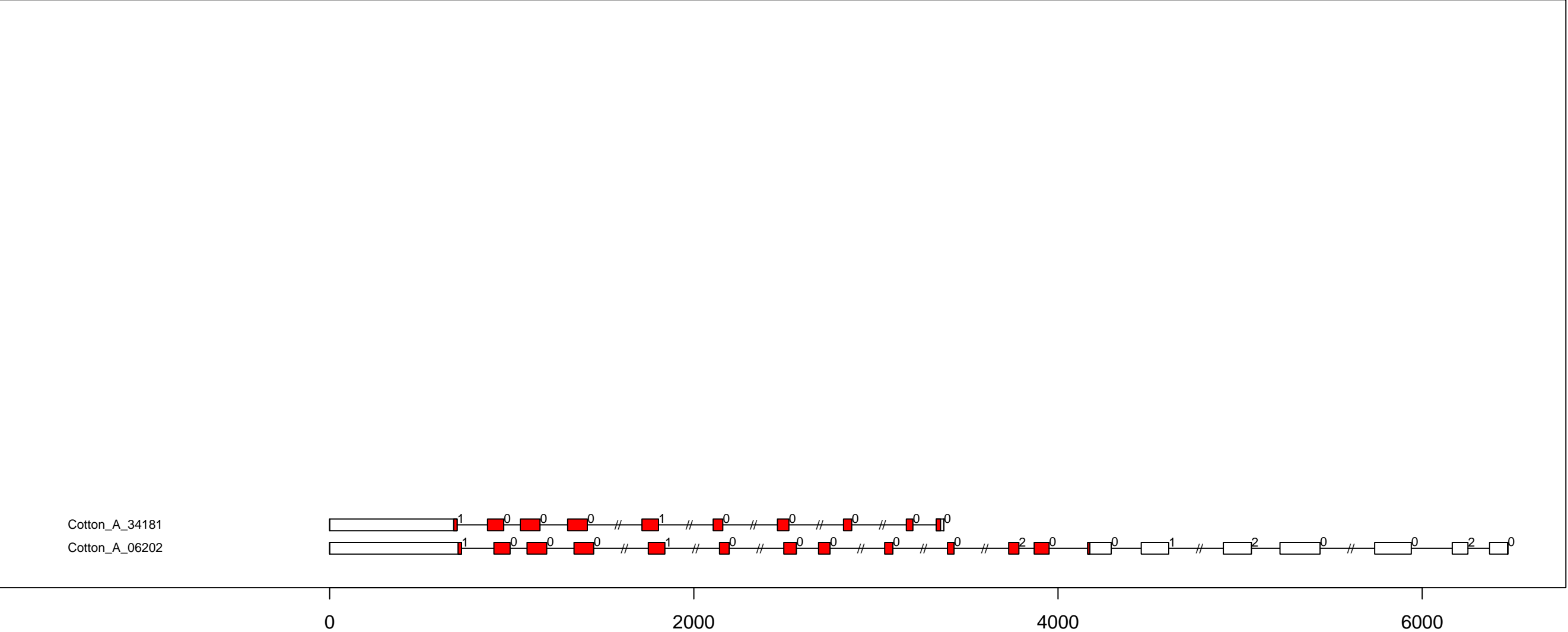

G.ar STE_STE20-YSK exon-intron and domain diagram (all)

Cotton_A_16780

Cotton_A_06259

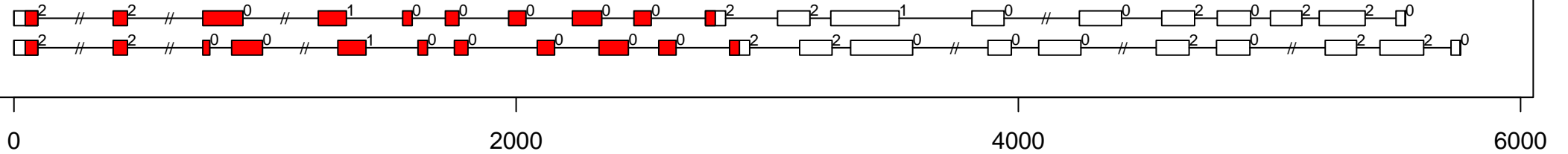

G.ar STE_STE-PI exon-intron and domain diagram (all)

Cotton_A_14578

Cotton_A_08956

Cotton_A_00102

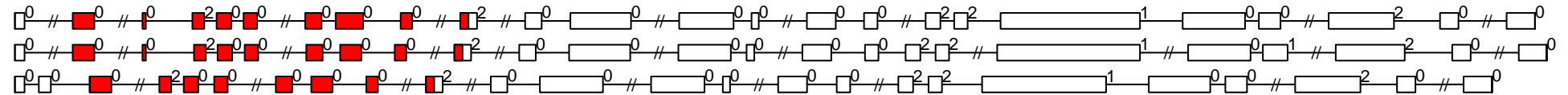

-2000

0

2000

4000

6000

8000

10000

G.ar TKL_CTR1-DRK-1 exon-intron and domain diagram (all)

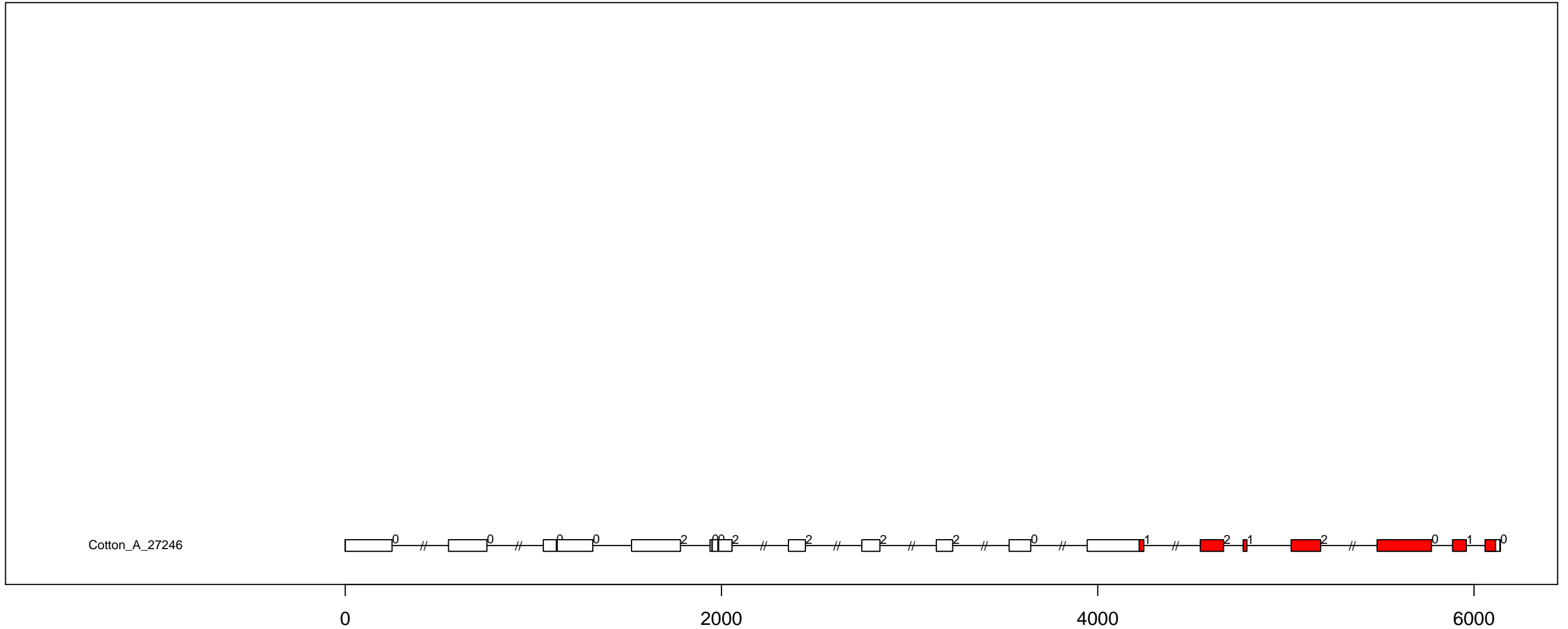

G.ar TKL_CTR1-DRK-2 exon-intron and domain diagram (all)

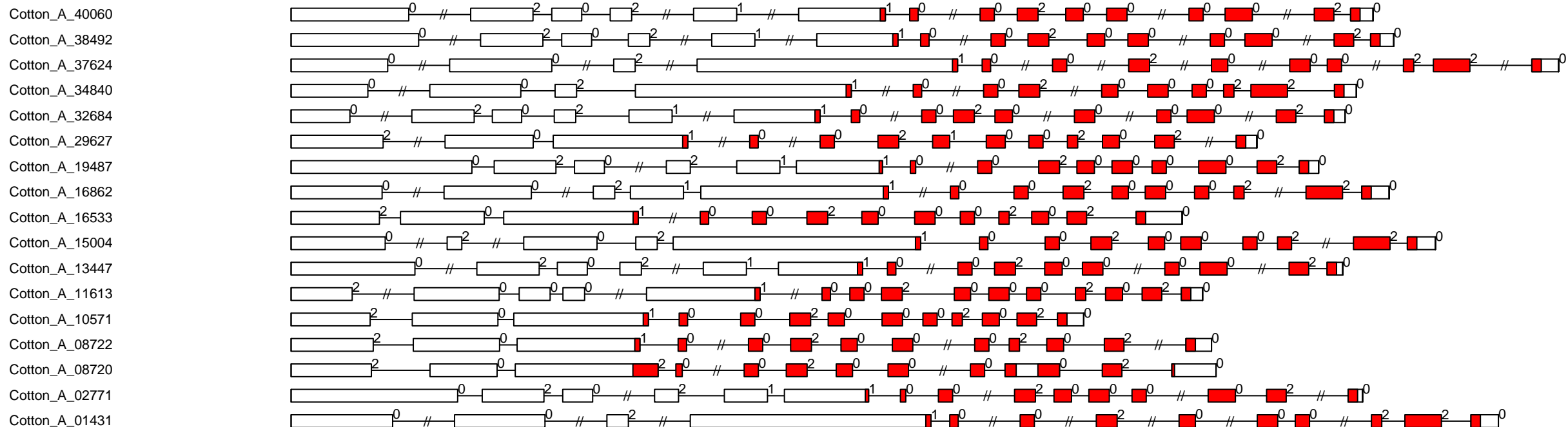

0

2000

4000

6000

G.ar TKL_Gdt exon-intron and domain diagram (all)

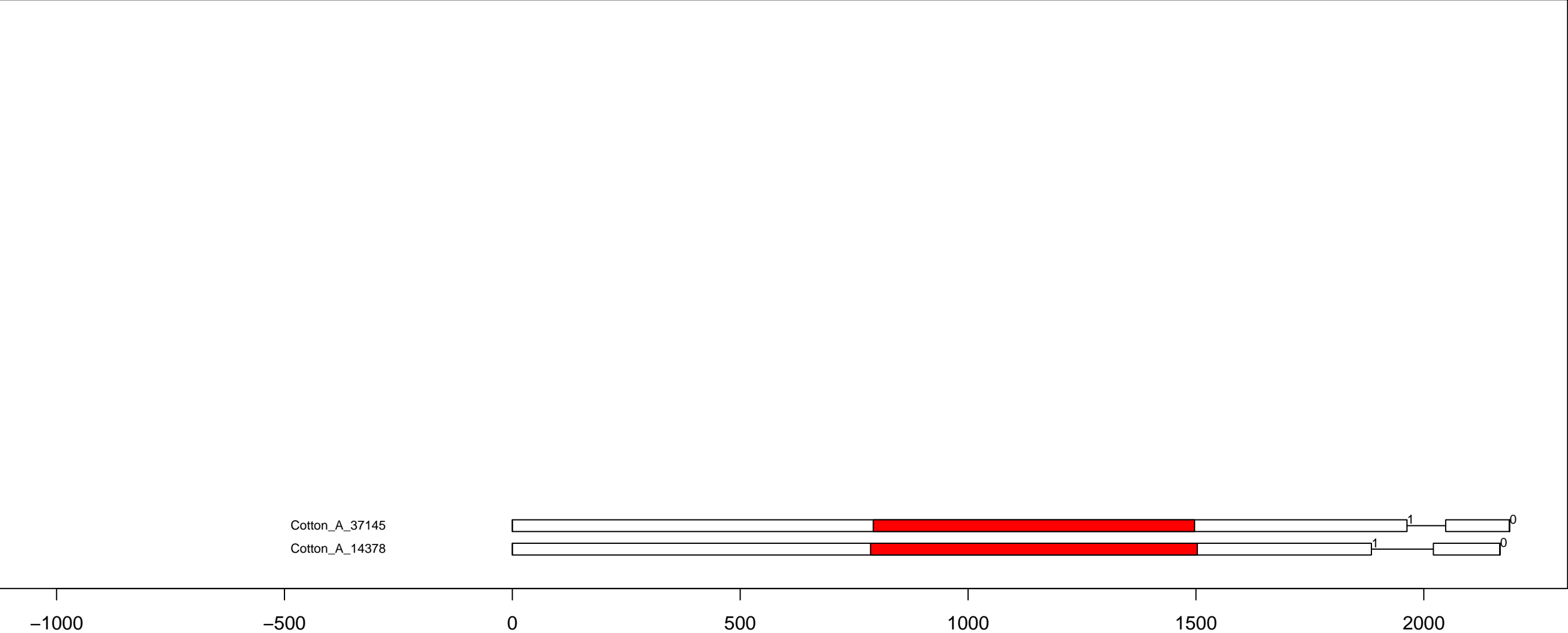

G.ar TKL-PI-1 exon-intron and domain diagram (all)

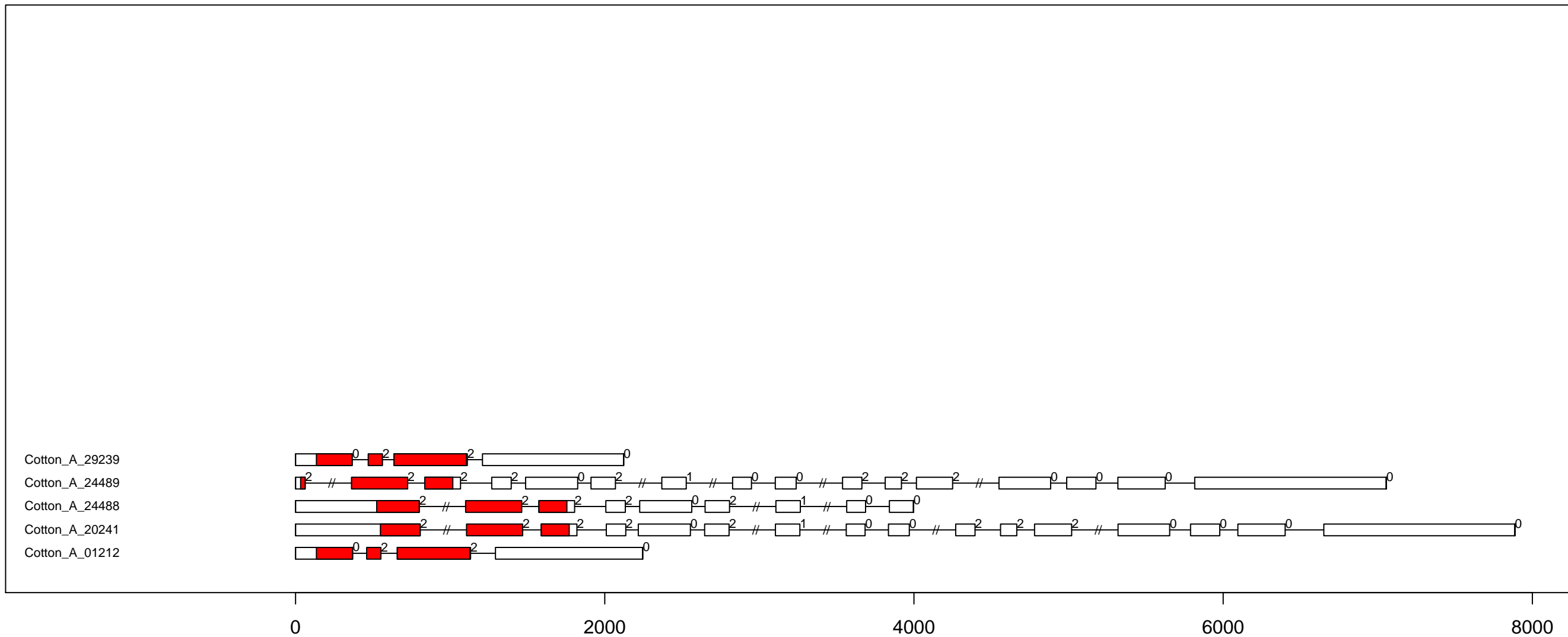

G.ar TKL-PI-2 exon-intron and domain diagram (all)

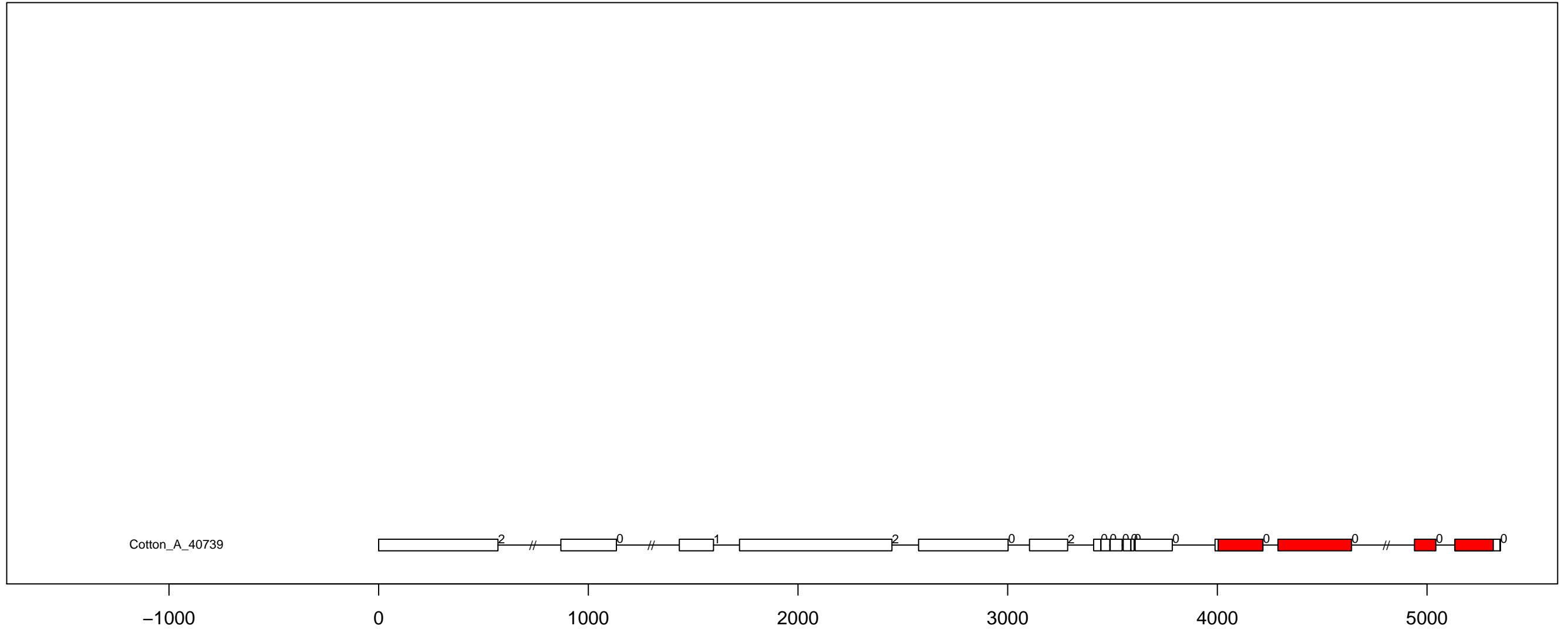

G.ar TKL-PI-3 exon-intron and domain diagram (all)

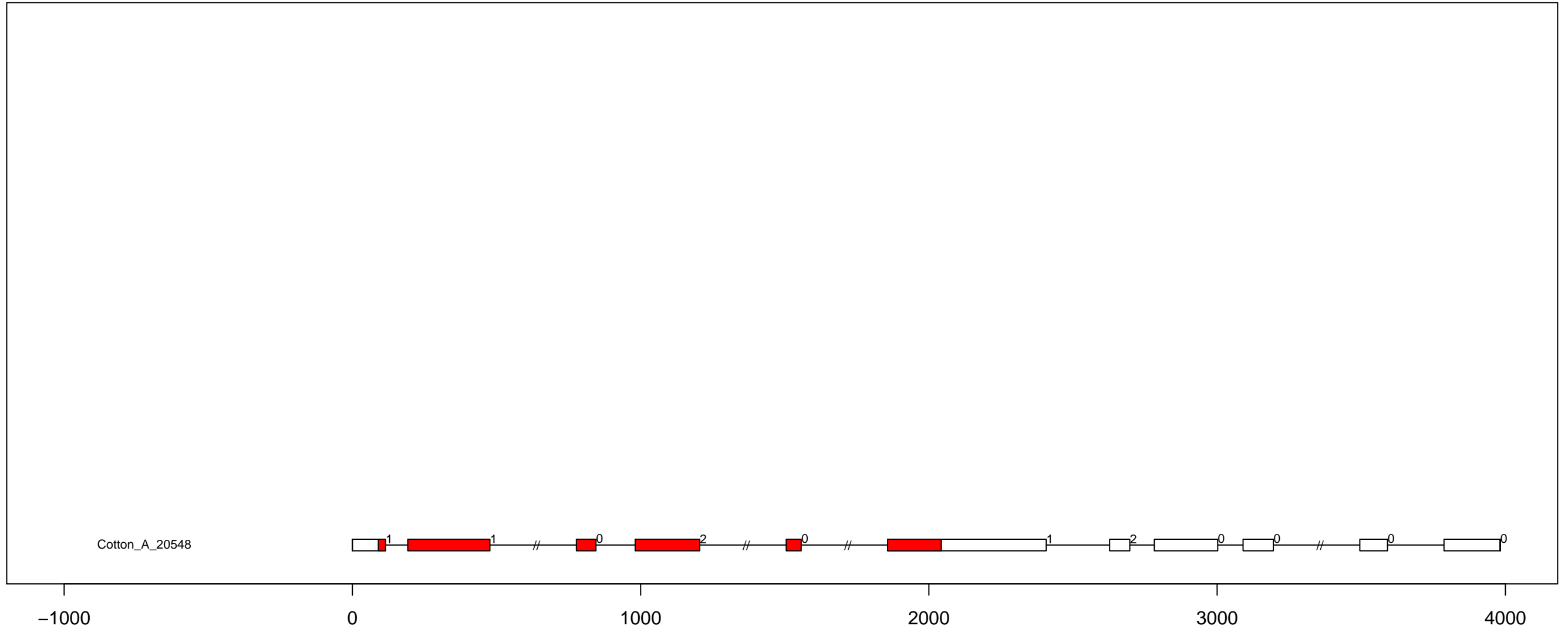

G.ar TKL-PI-4 exon-intron and domain diagram (part 1)

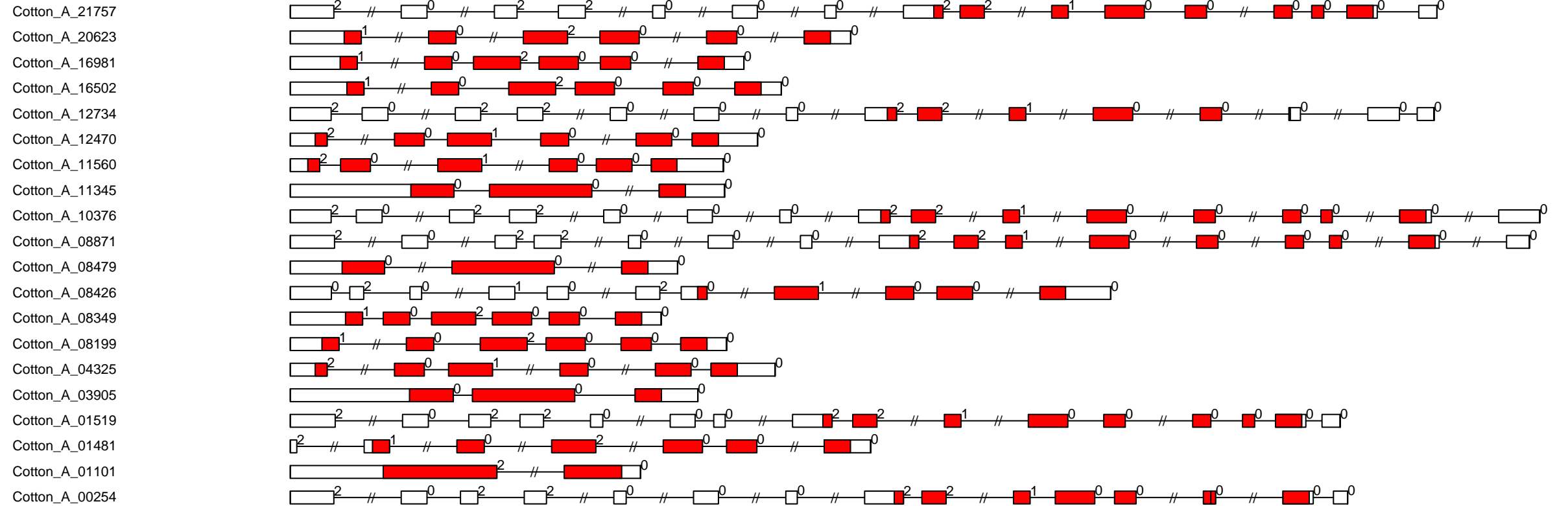

-1000

0

1000

2000

3000

4000

5000

G.ar TKL-PI-5 exon-intron and domain diagram (all)

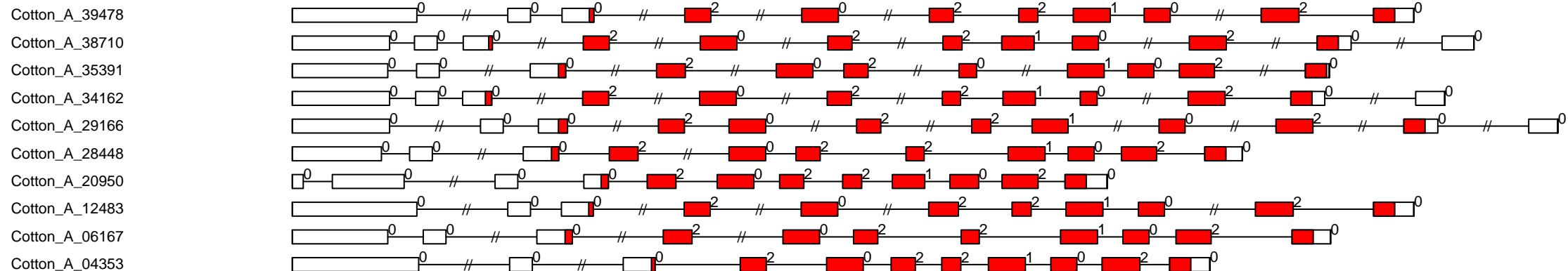

G.ar TKL-PI-6 exon-intron and domain diagram (all)

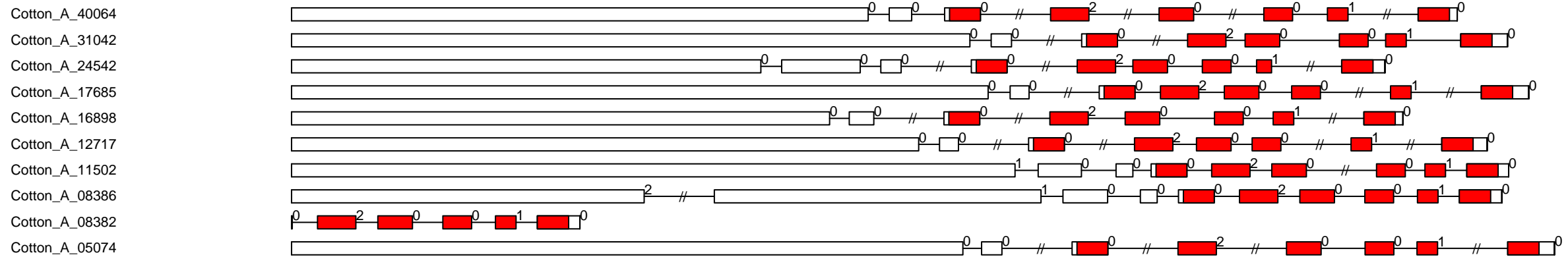

-1000

0

1000

2000

3000

4000

5000

G.ar TKL-PI-7 exon-intron and domain diagram (all)

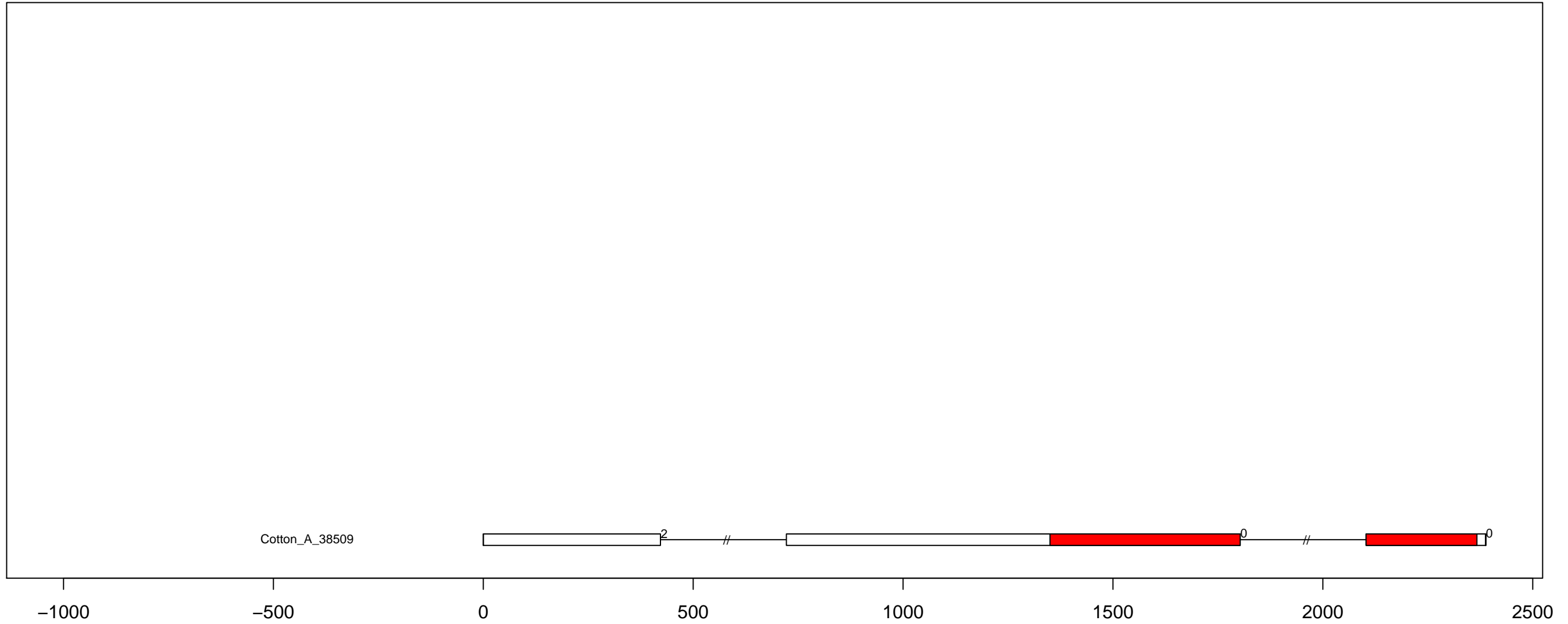

G.ar TLK exon-intron and domain diagram (all)

Cotton_A_20505
Cotton_A_02620

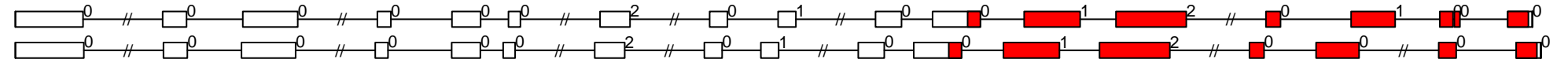

G.ar TTK exon-intron and domain diagram (all)

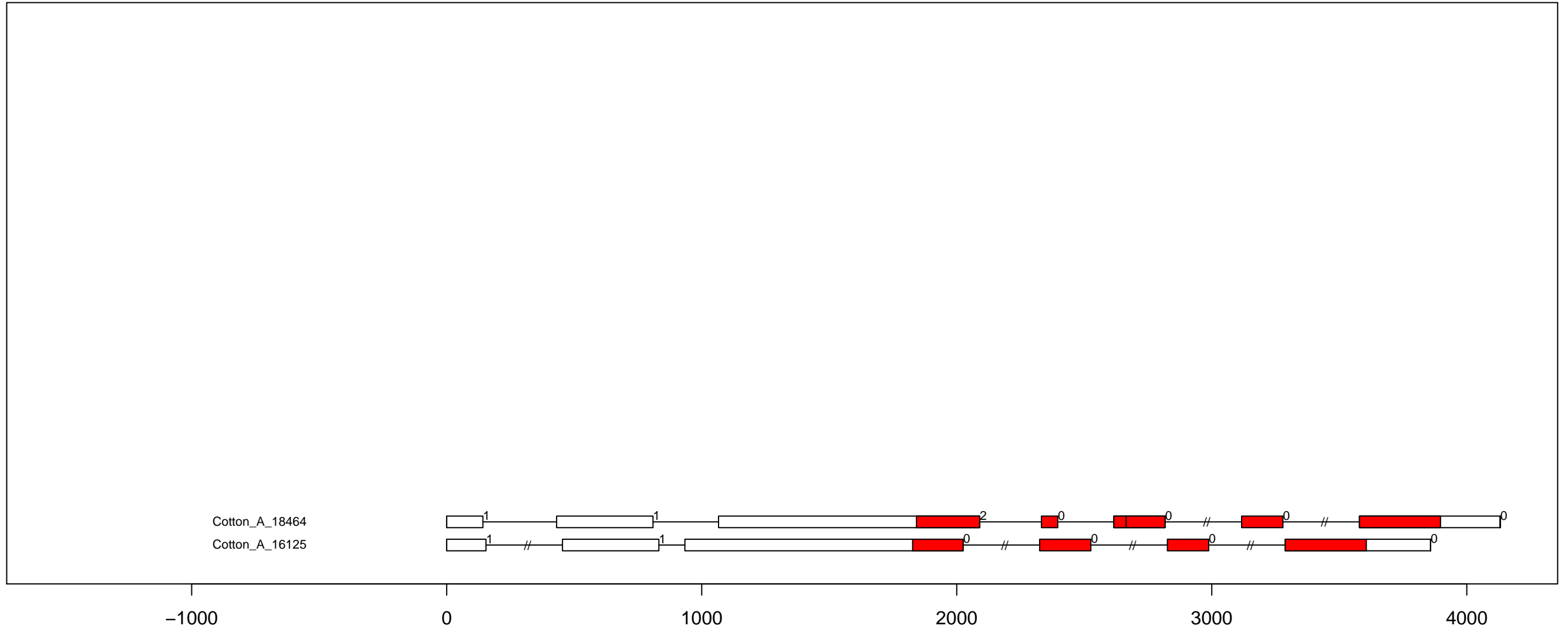

G.ar ULK_Fused exon-intron and domain diagram (all)

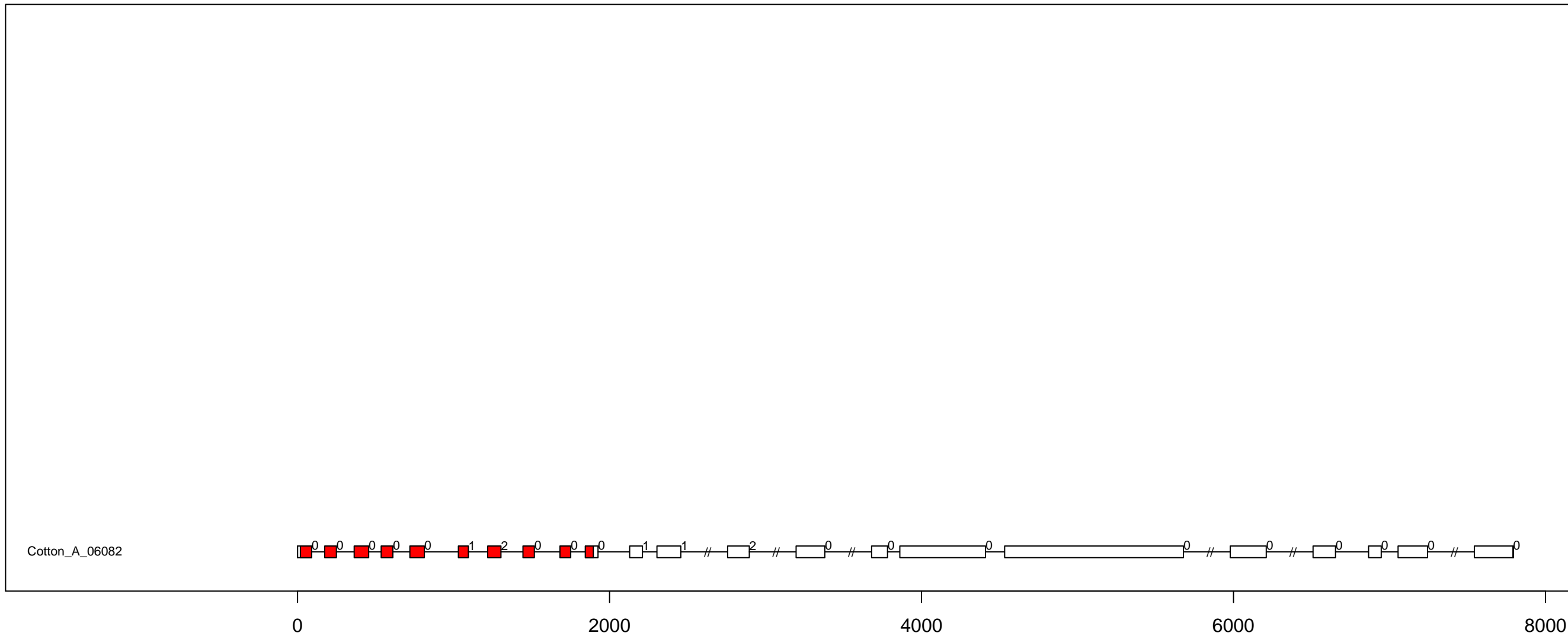

G.ar ULK_ULK4 exon-intron and domain diagram (all)

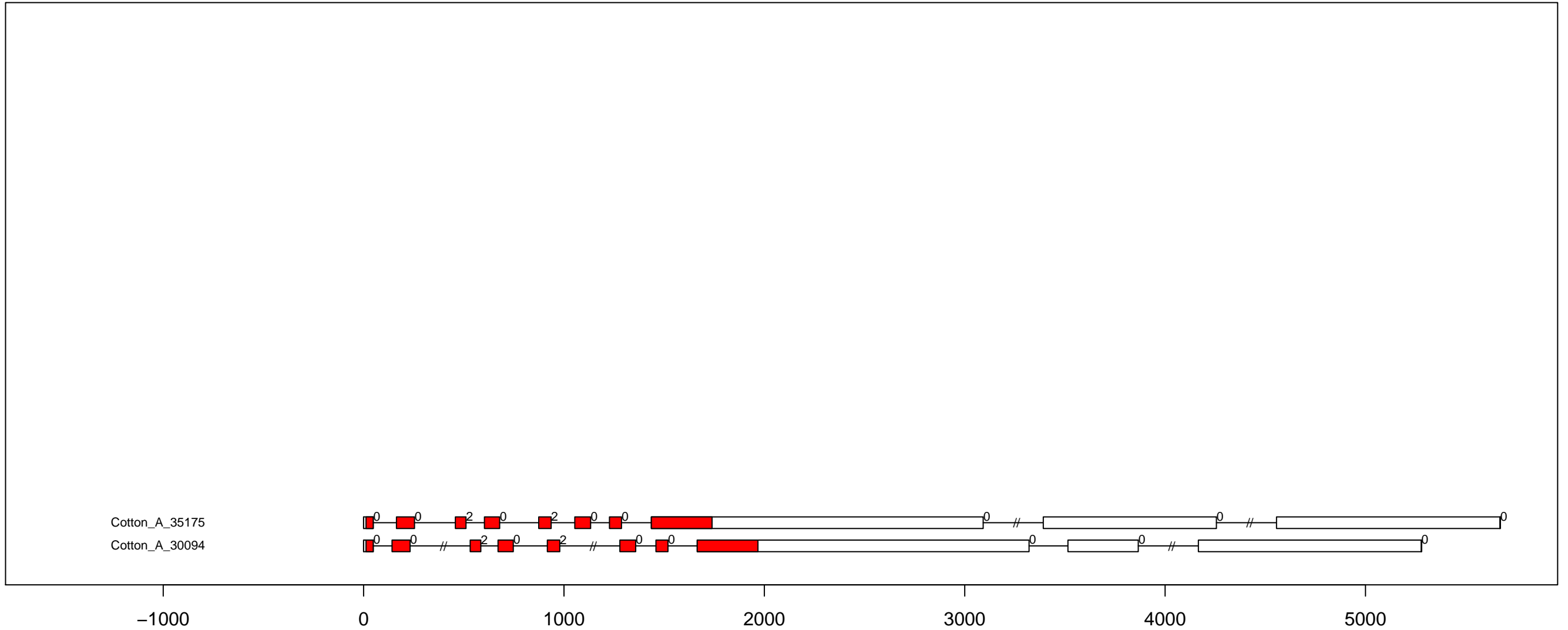

G.ar WEE exon-intron and domain diagram (all)

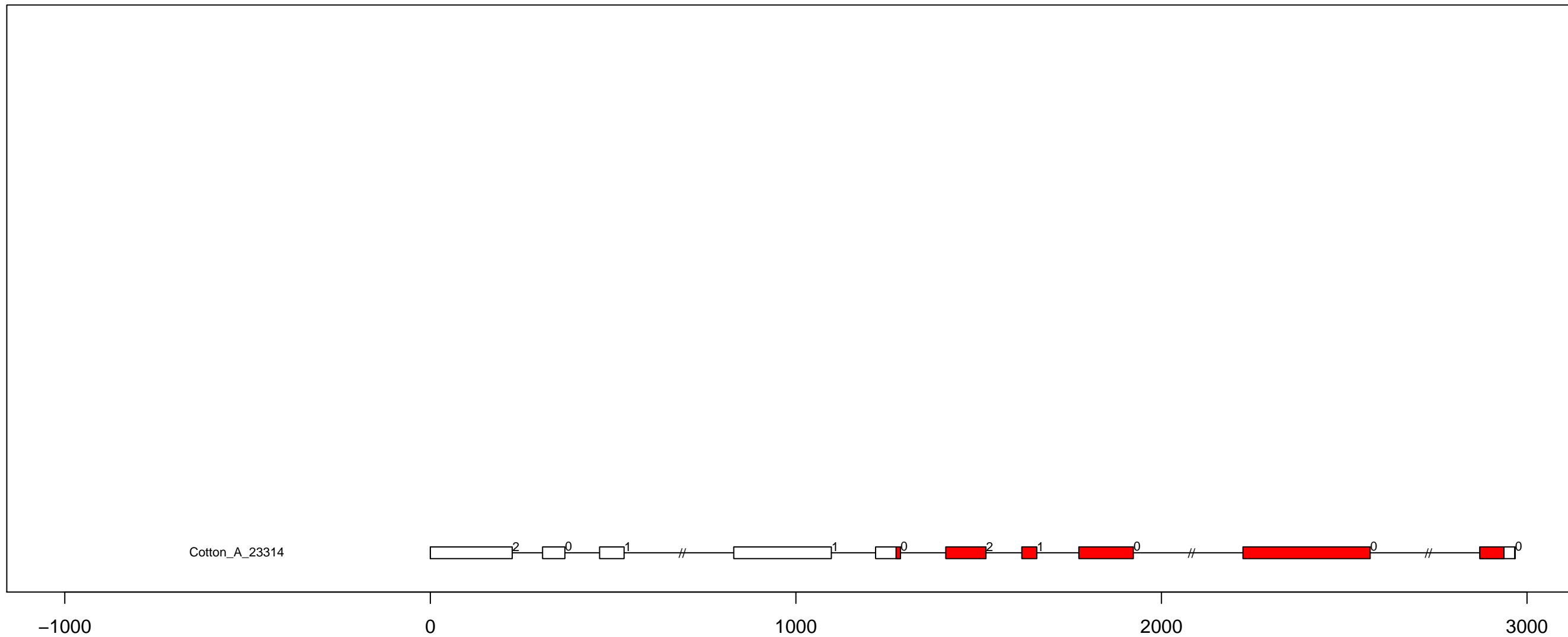

G.ar WNK_NRBP exon-intron and domain diagram (all)

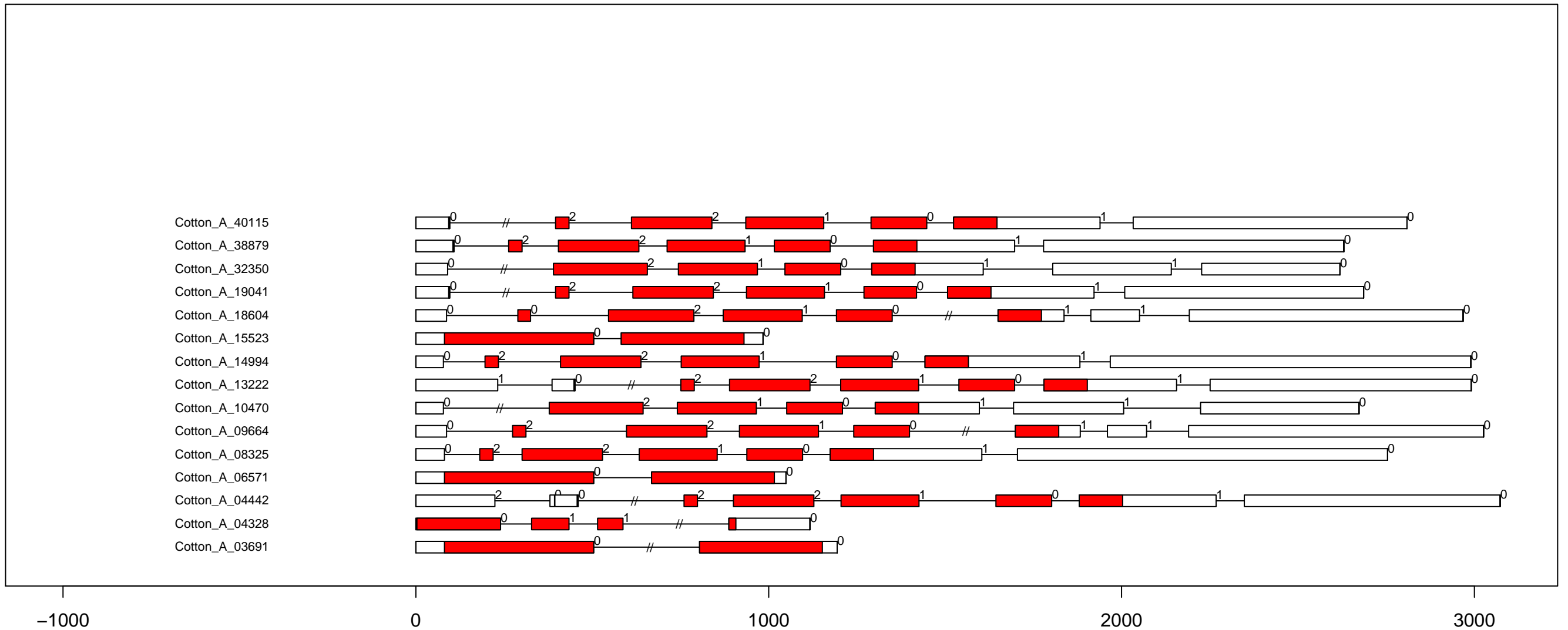

G.ra AGC_MAST exon-intron and domain diagram (all)

Gorai.009G203700.1
Gorai.007G003300.2
Gorai.006G191300.1
Gorai.006G064300.1

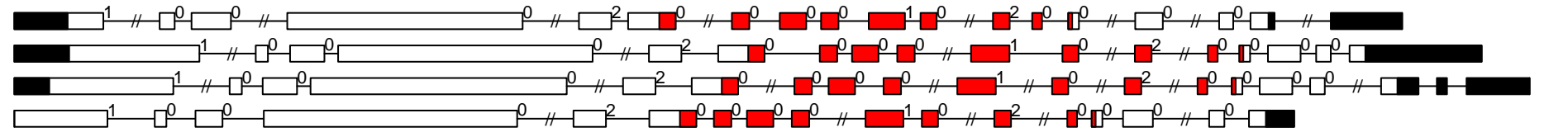

G.ra AGC_NDR exon-intron and domain diagram (all)

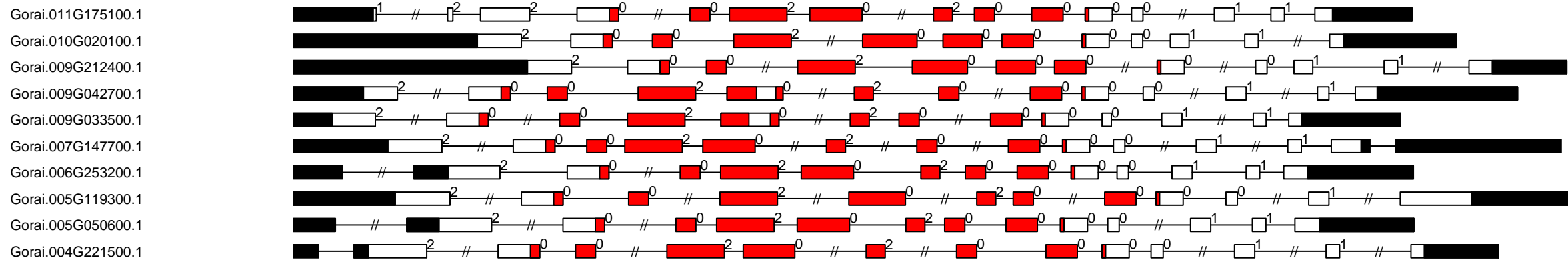

-1000

0

1000

2000

3000

4000

5000

G.ra AGC_PDK1 exon-intron and domain diagram (all)

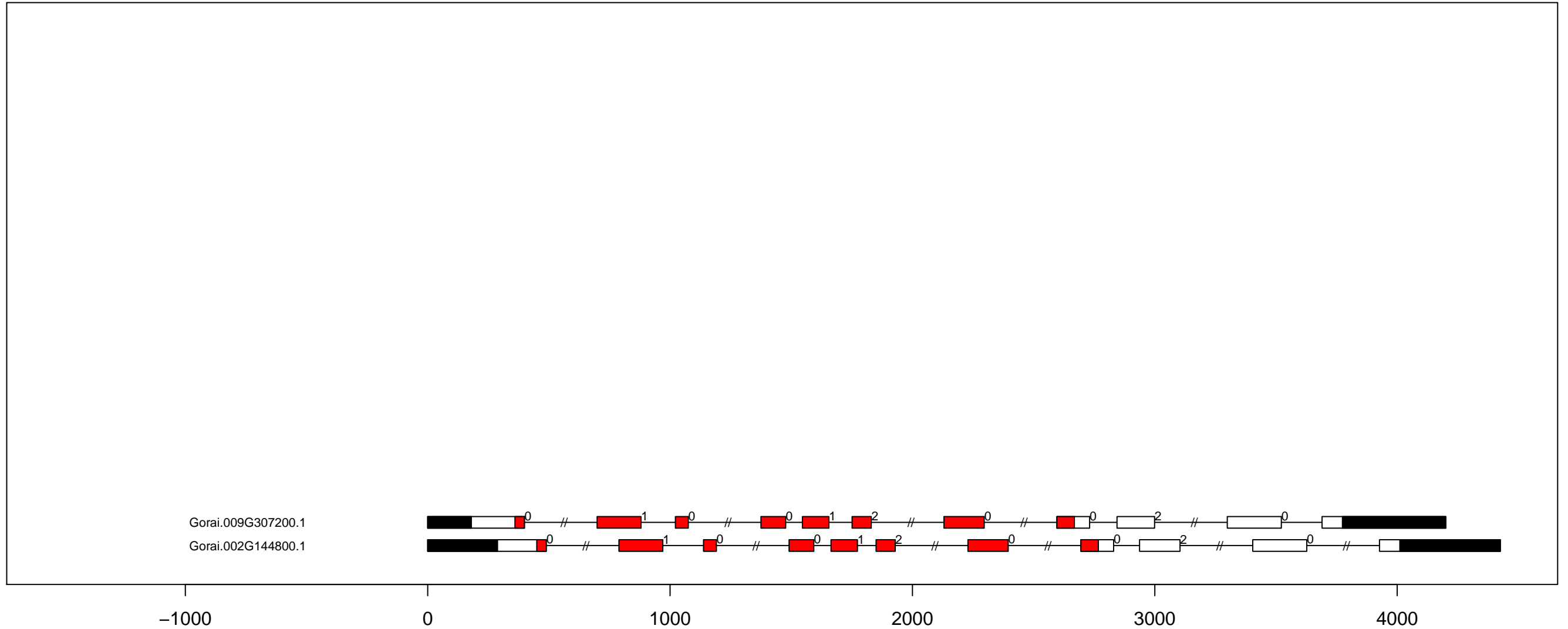

G.ra AGC_PKA-PKG exon-intron and domain diagram (all)

Gorai.010G074600.1

Gorai.001G007600.1

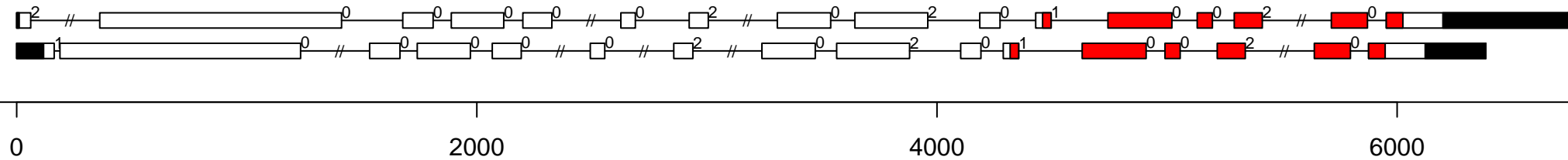

G.ra AGC_RSK-2 exon-intron and domain diagram (part 1)

Gorai.009G451500.2

Gorai.009G405700.1

Gorai.009G353100.1

Gorai.009G072200.1

Gorai.009G019600.1

Gorai.008G047700.1

Gorai.008G012600.1

Gorai.007G370900.2

Gorai.007G075400.2

Gorai.006G156900.1

Gorai.006G110800.1

Gorai.006G034200.1

Gorai.005G267200.1

Gorai.004G166000.2

Gorai.004G018700.1

Gorai.003G139300.1

Gorai.002G102000.2

Gorai.001G229700.1

Gorai.001G140200.1

Gorai.001G120600.1

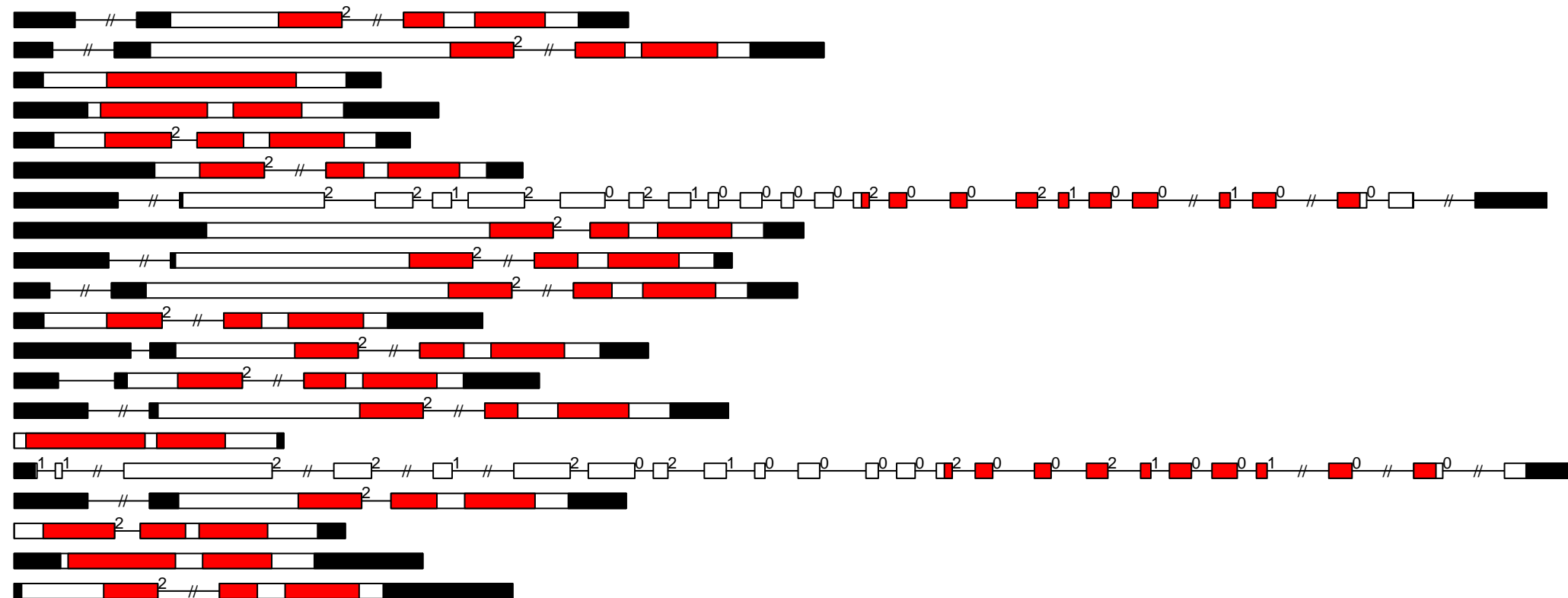

0

2000

4000

6000

G.ra AGC_RSK-2 exon-intron and domain diagram (part 2)

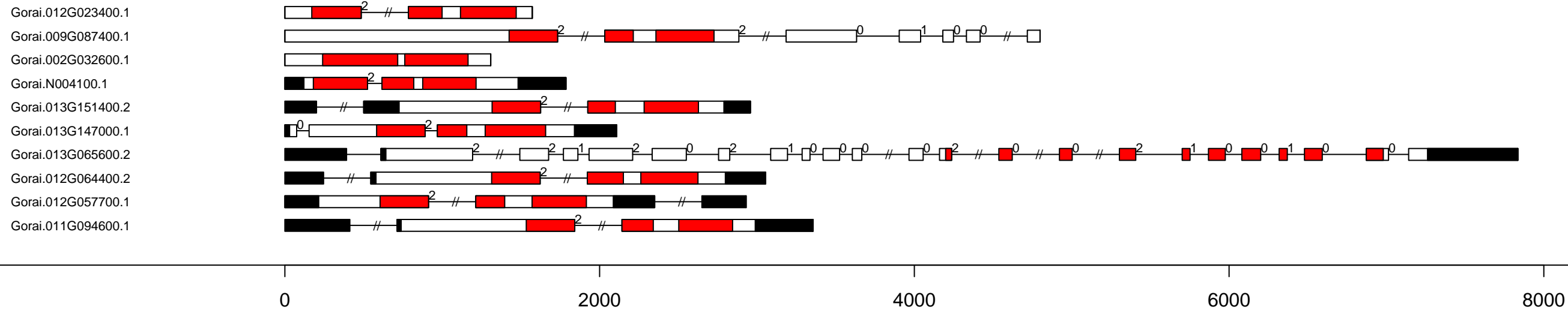

G.ra AGC-PI exon-intron and domain diagram (all)

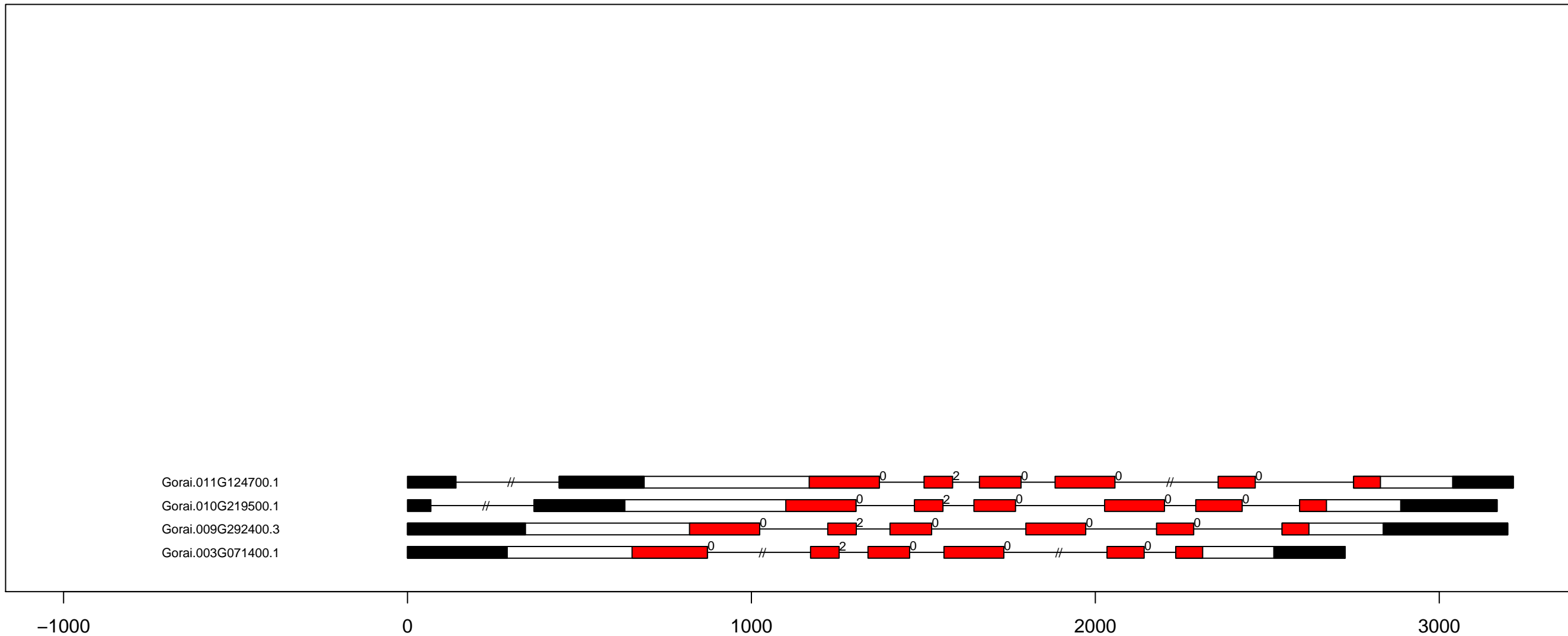

G.ra Aur exon-intron and domain diagram (all)

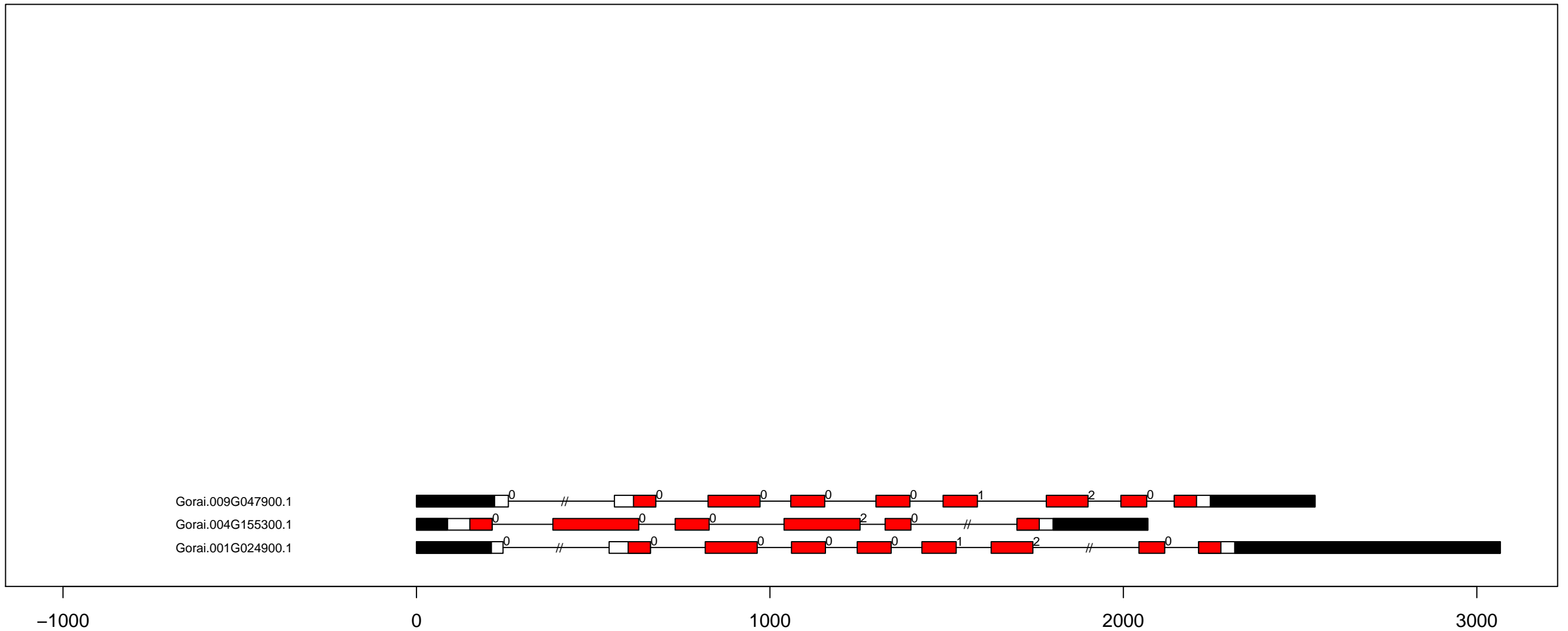

G.ra BUB exon-intron and domain diagram (all)

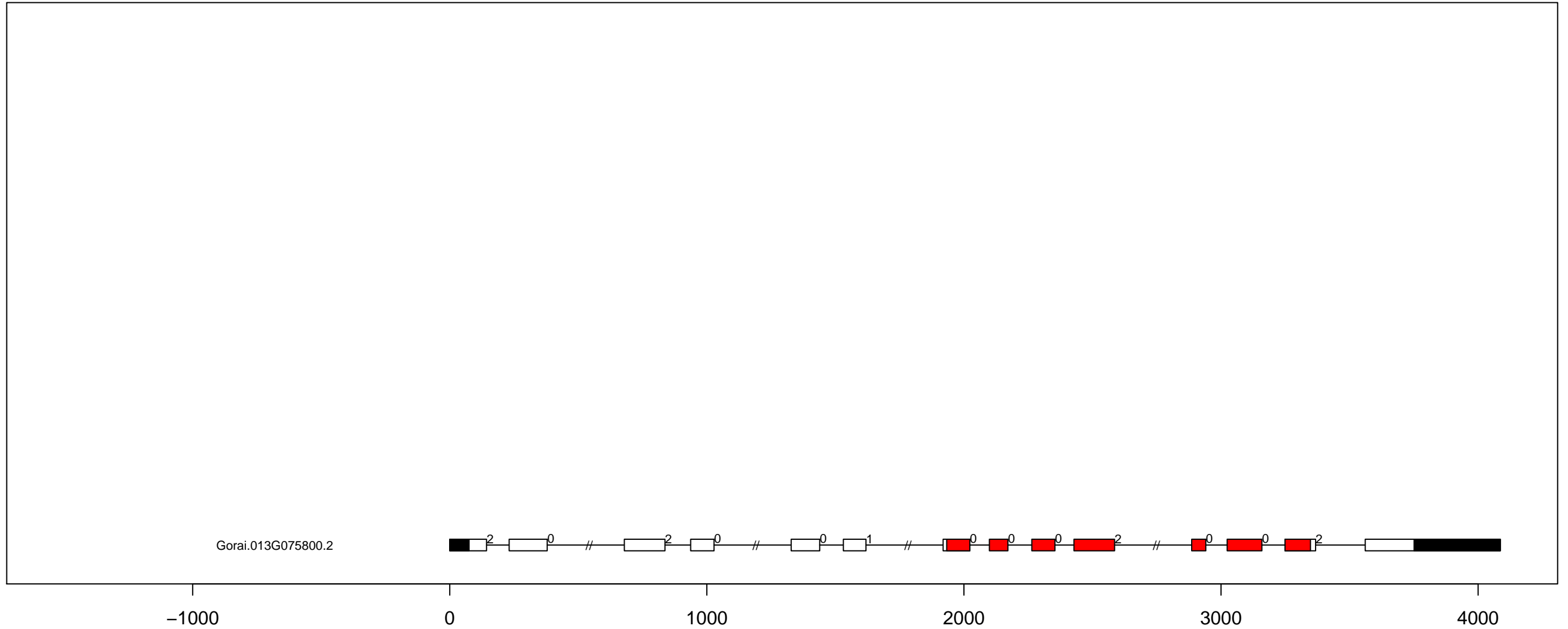

G.ra CAMK_AMPK exon-intron and domain diagram (all)

Gorai.007G011900.1
Gorai.007G080200.1
Gorai.006G013500.1
Gorai.001G241000.1

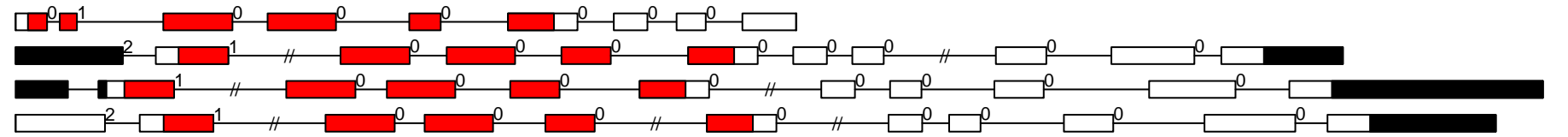

-1000

0

1000

2000

3000

4000

G.ra CAMK_CAMK1-DCAMKL exon-intron and domain diagram (all)

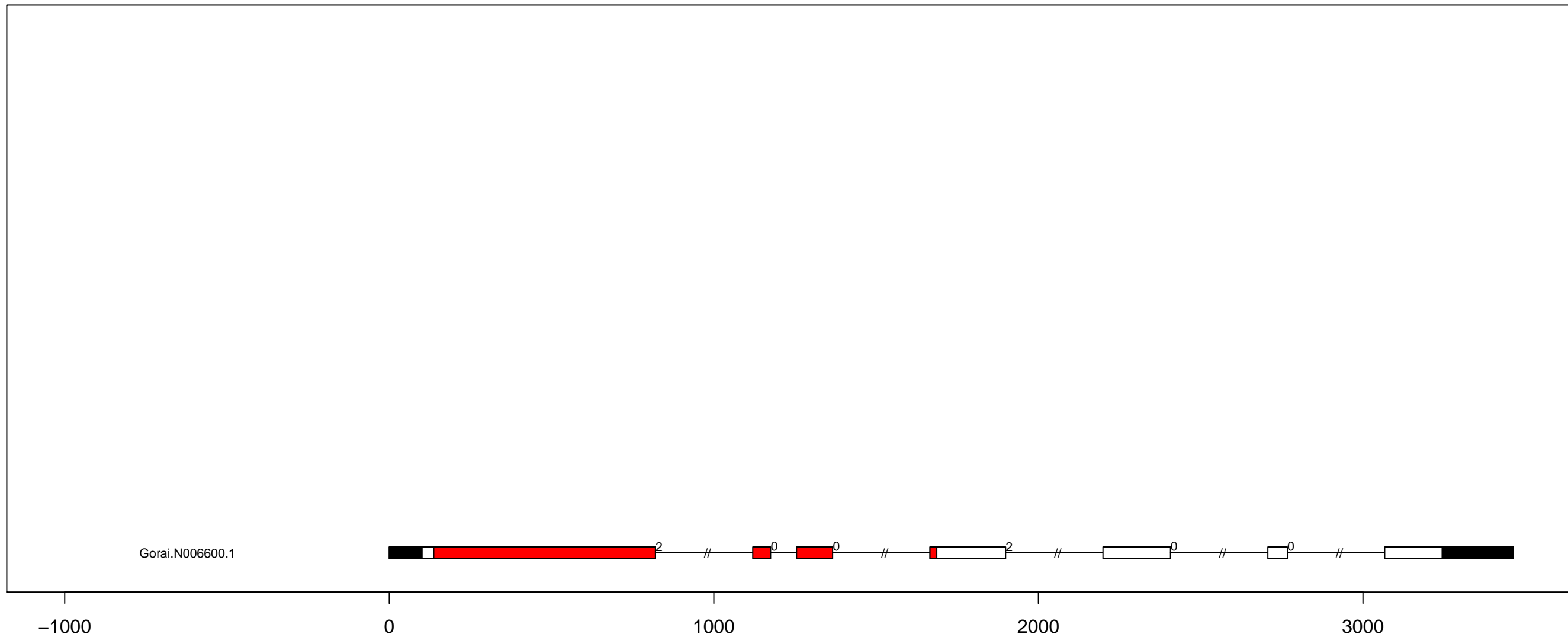

G.ra CAMK_CAMKL-CHK1 exon-intron and domain diagram (part 2)

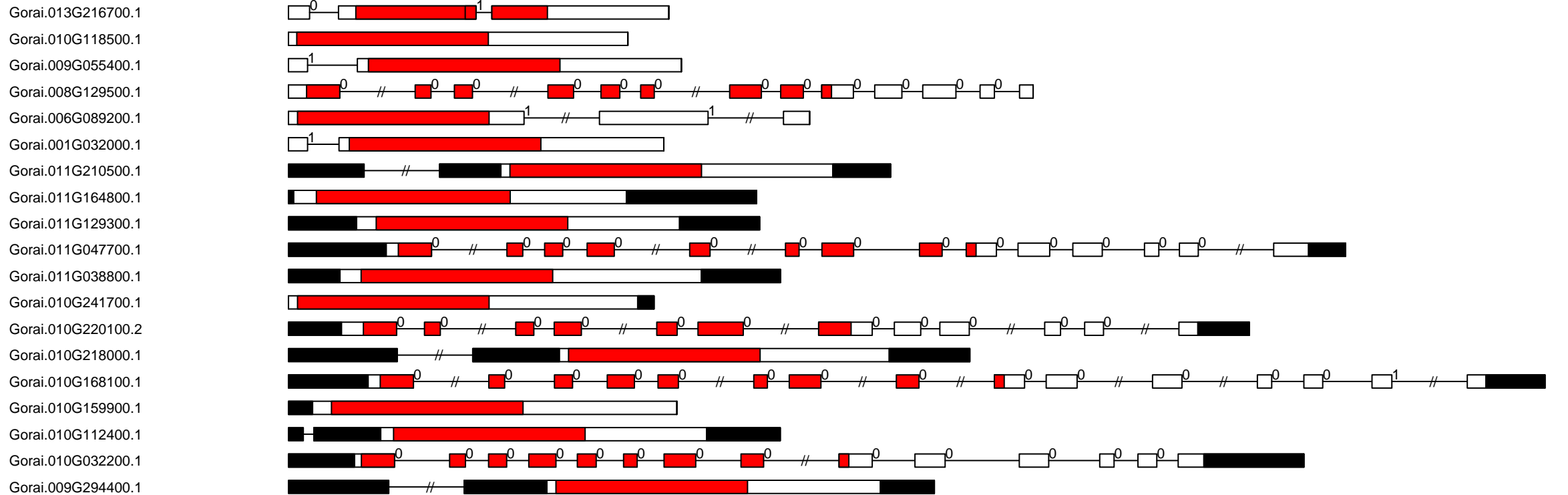

G.ra CAMK_CAMKL-LKB exon-intron and domain diagram (all)

Gorai.009G078200.1
Gorai.004G013200.1
Gorai.001G132000.1

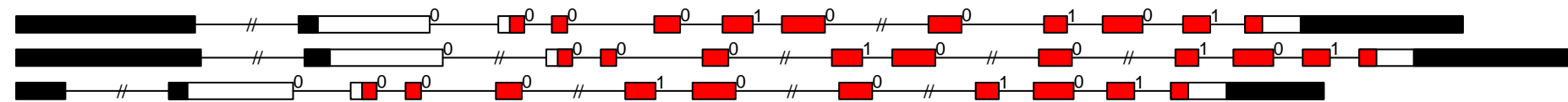

-1000

0

1000

2000

3000

4000

G.ra CAMK_CDPK exon-intron and domain diagram (part 1)

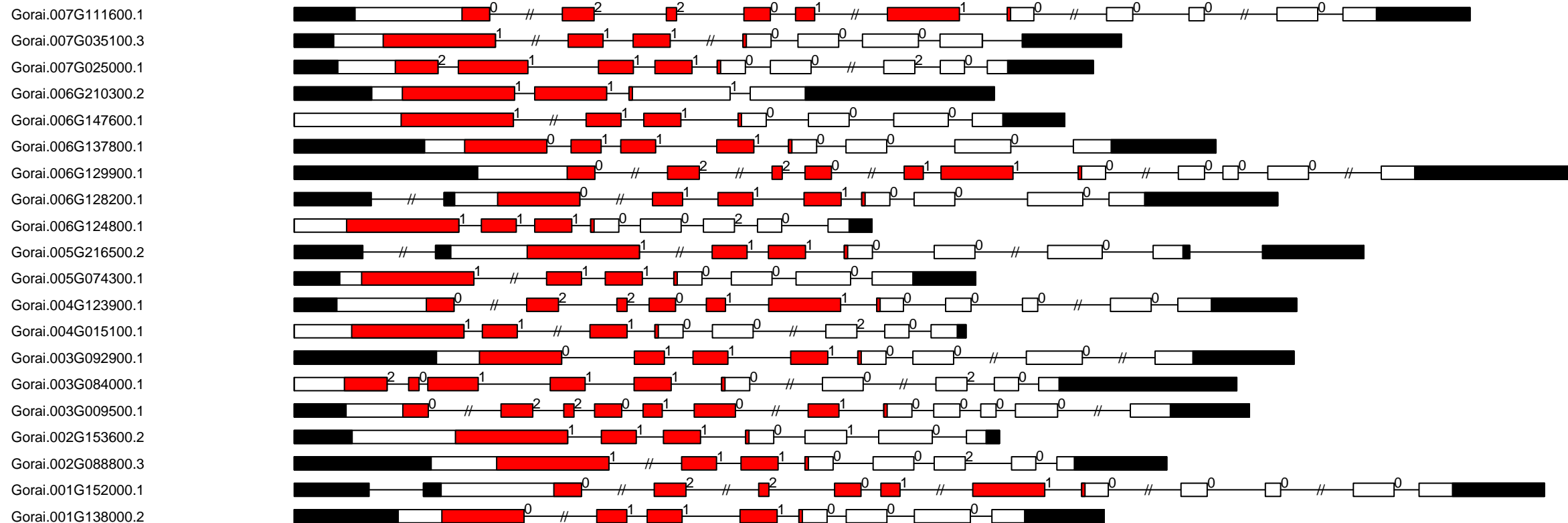

G.ra CAMK_CDPK exon-intron and domain diagram (part 2)

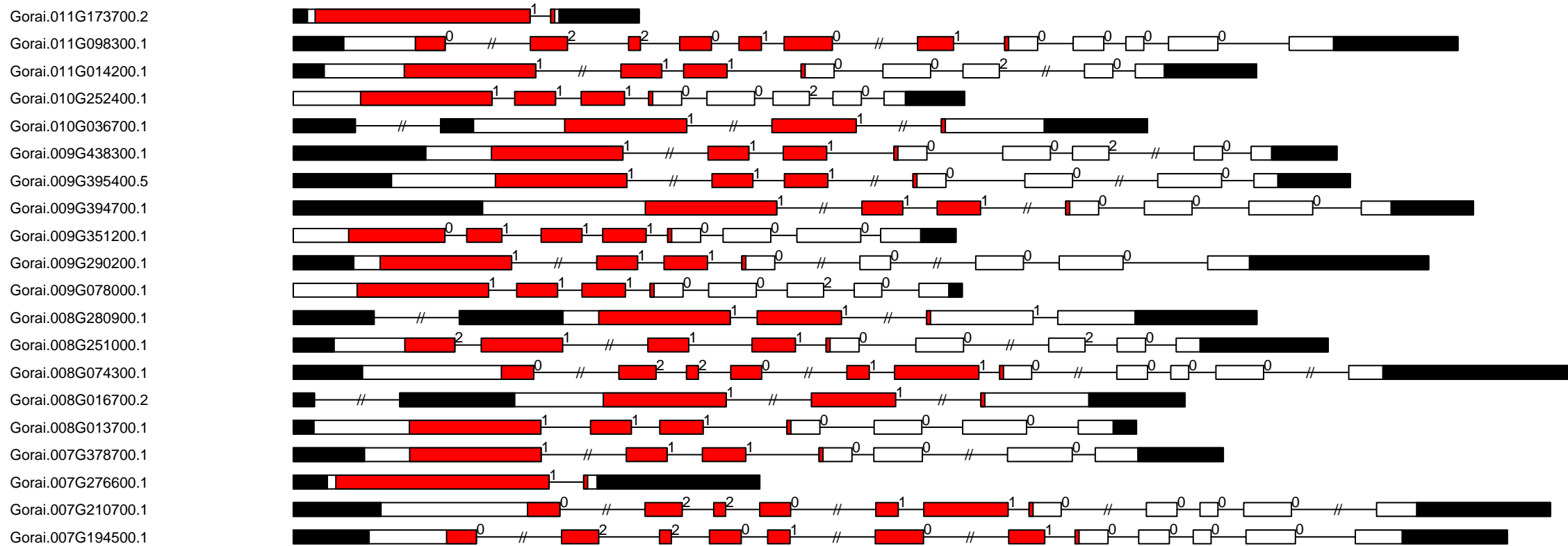

G.ra CAMK_OST1L exon-intron and domain diagram (all)

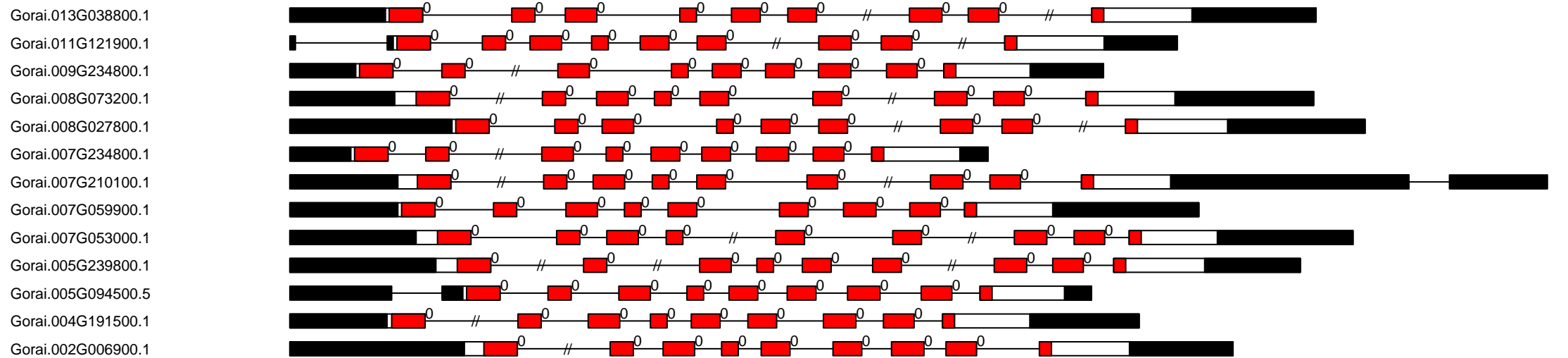

G.ra CK1_CK1 exon-intron and domain diagram (all)

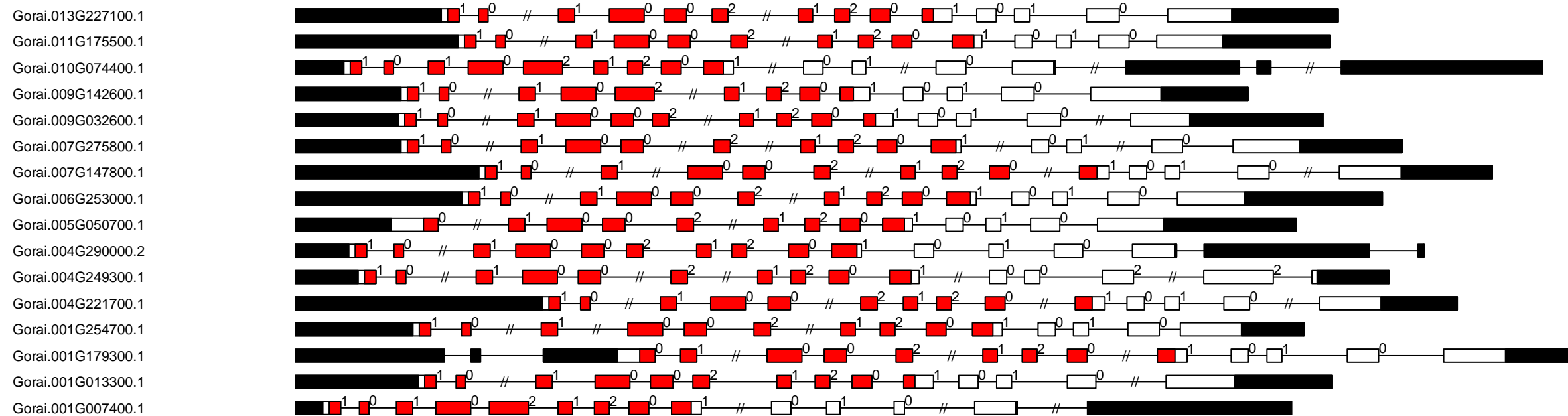

-1000

0

1000

2000

3000

4000

5000

G.ra CK1_CK1-PI exon-intron and domain diagram (all)

Gorai.013G219500.2
 Gorai.013G203000.1
 Gorai.013G175600.1
 Gorai.013G123300.1
 Gorai.011G072100.1
 Gorai.009G137100.1
 Gorai.009G024100.1
 Gorai.007G343500.1
 Gorai.007G289500.1
 Gorai.004G279600.2
 Gorai.004G018100.1
 Gorai.004G018000.1
 Gorai.001G026300.2

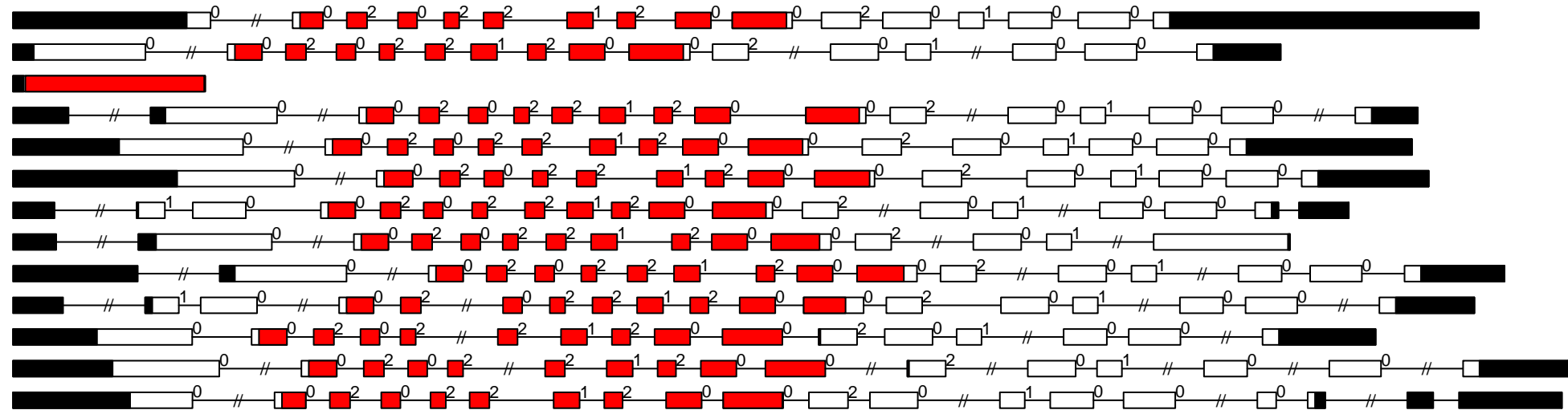

G.ra CMGC_CDK-CCRK exon-intron and domain diagram (all)

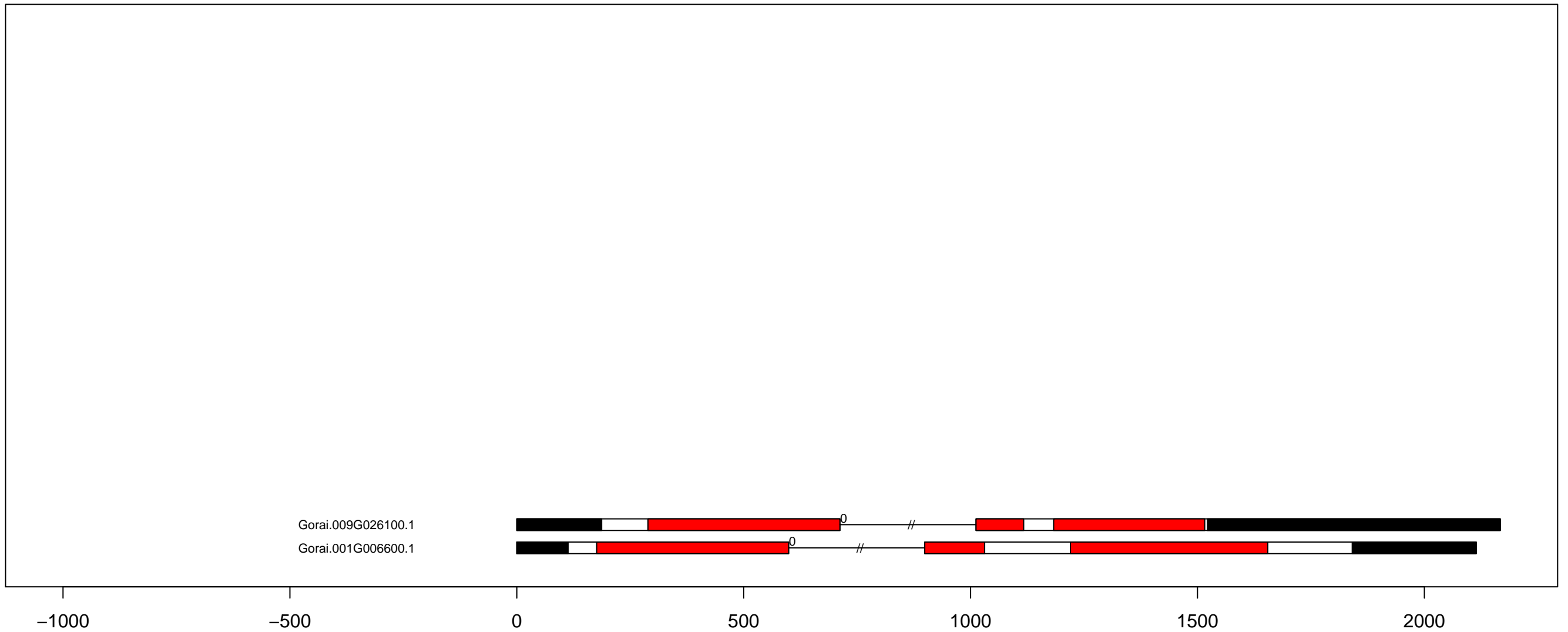

G.ra CMGC_CDK-CDK7 exon-intron and domain diagram (all)

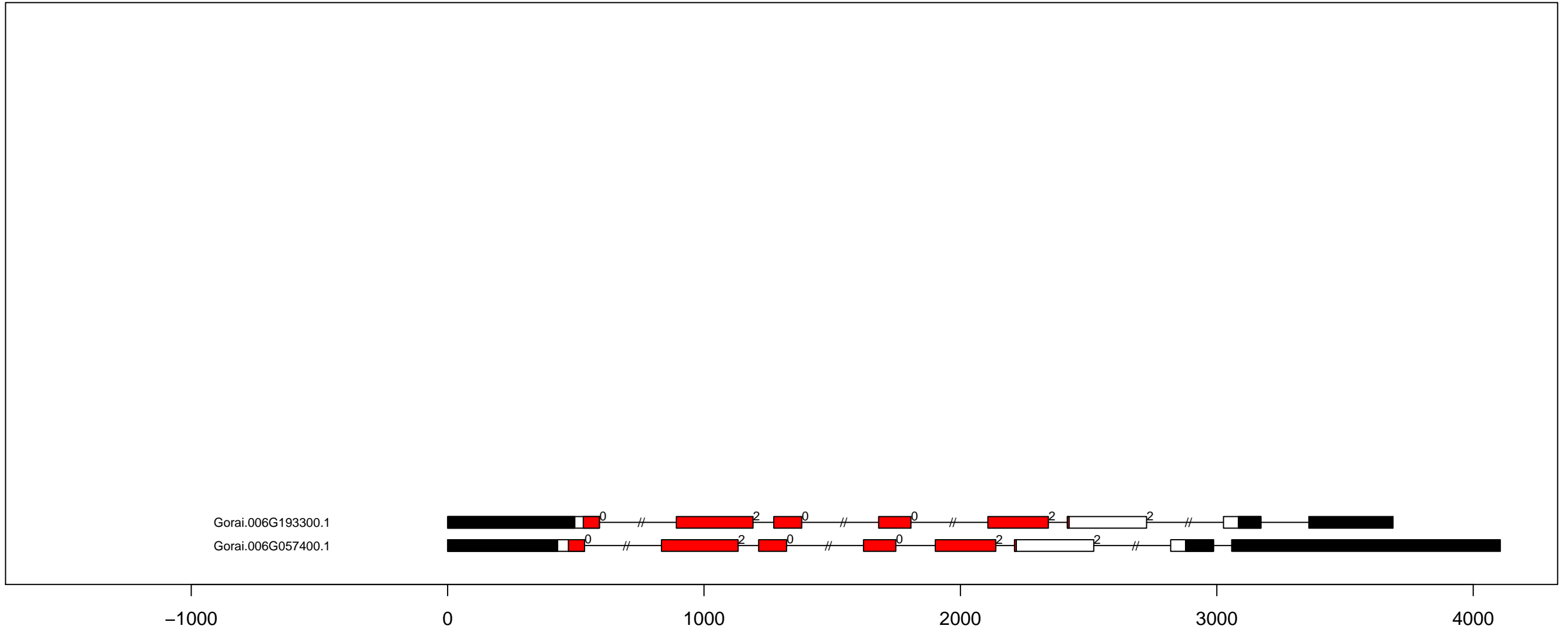

G.ra CMGC_CDK-CDK8 exon-intron and domain diagram (all)

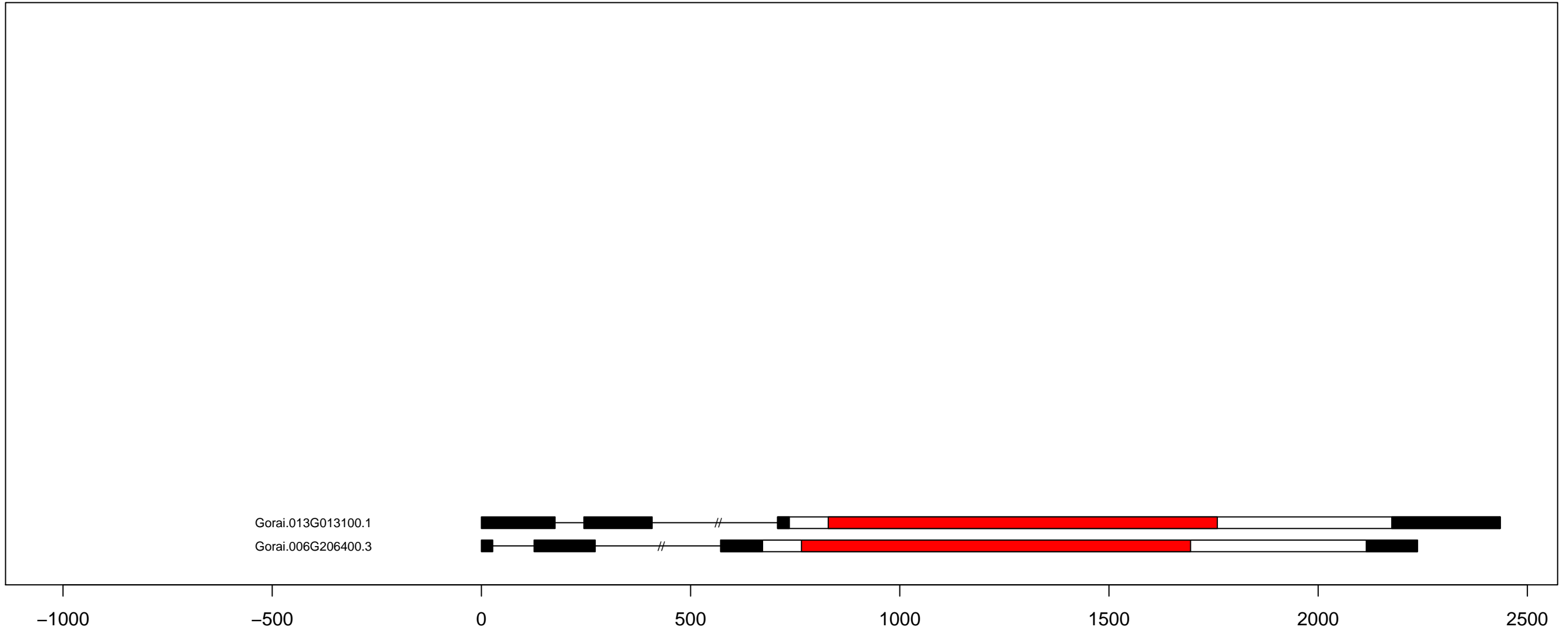

G.ra CMGC_CDK-CRK7-CDK9 exon-intron and domain diagram (part 1)

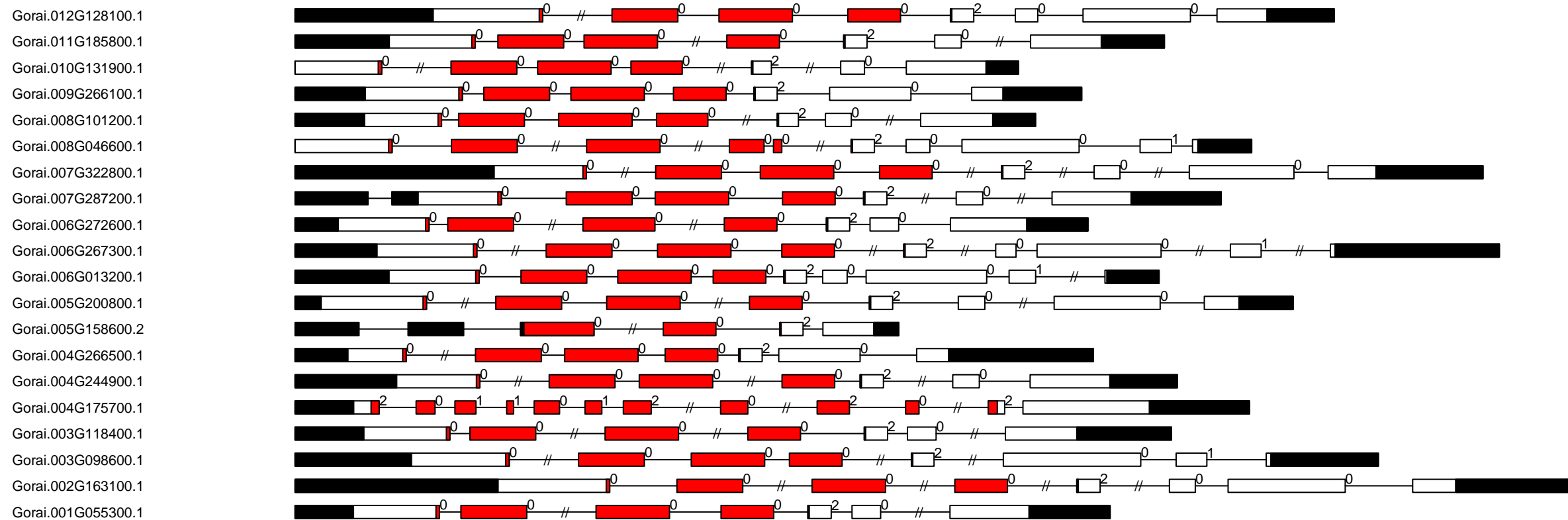

G.ra CMGC_CDK-CRK7-CDK9 exon-intron and domain diagram (part 2)

Gorai.013G134700.1
Gorai.012G170000.1
Gorai.013G202600.1
Gorai.013G168700.1

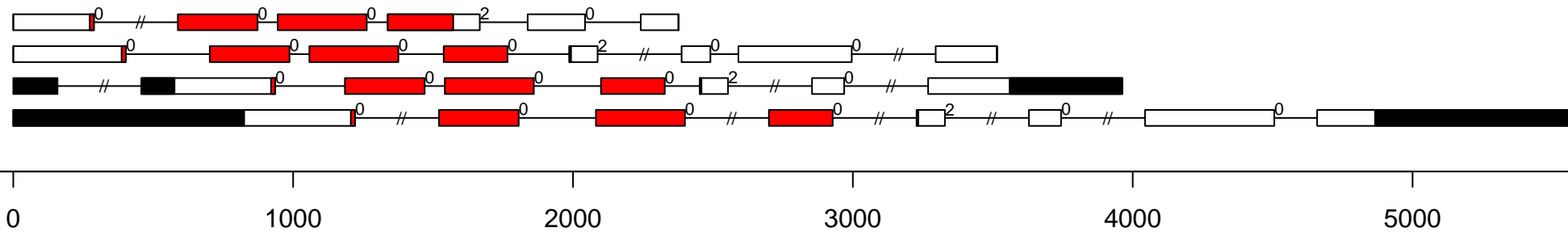

G.ra CMGC_CDK-PITSLRE exon-intron and domain diagram (all)

Gorai.008G205000.1
Gorai.012G174900.2
Gorai.005G170300.1
Gorai.001G060800.2

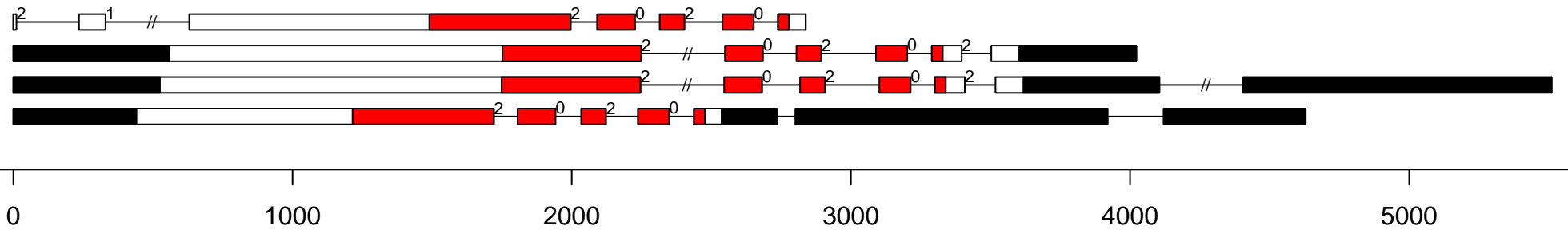

G.ra CMGC_CDK-PI exon-intron and domain diagram (all)

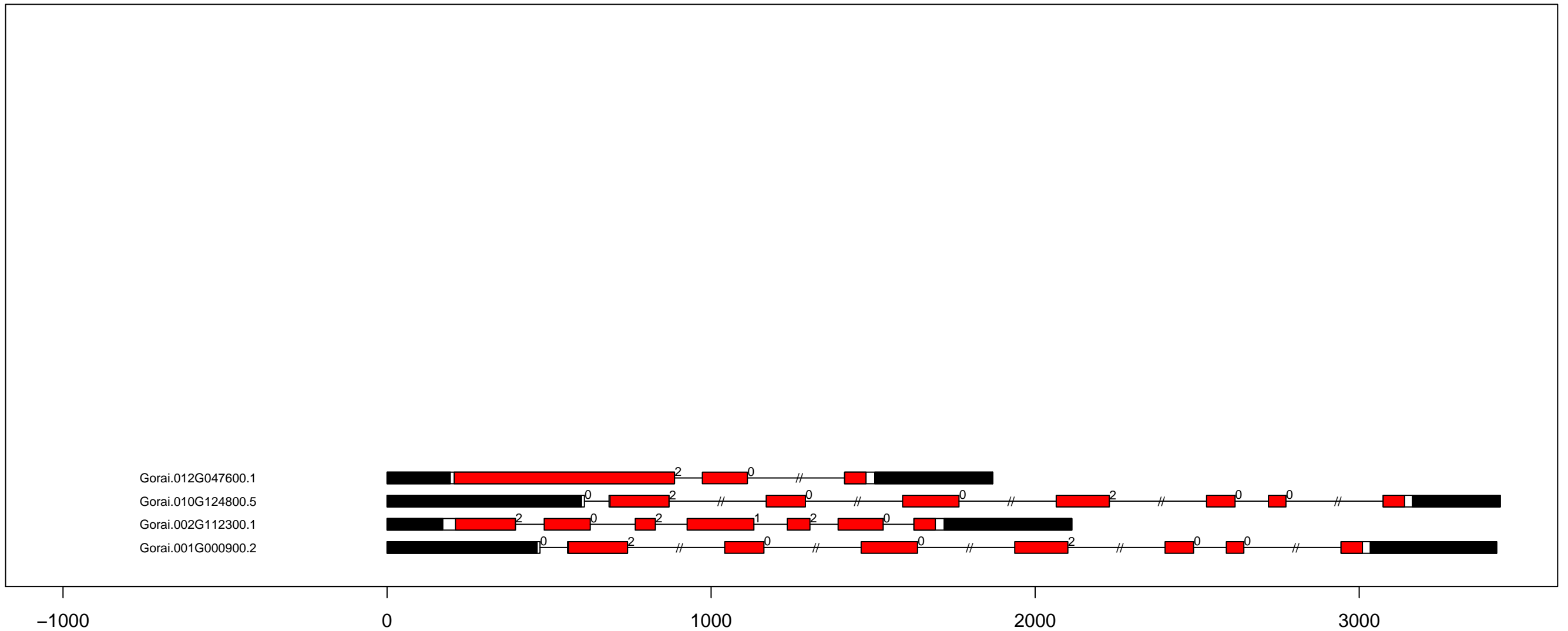

G.ra CMGC_CK2 exon-intron and domain diagram (all)

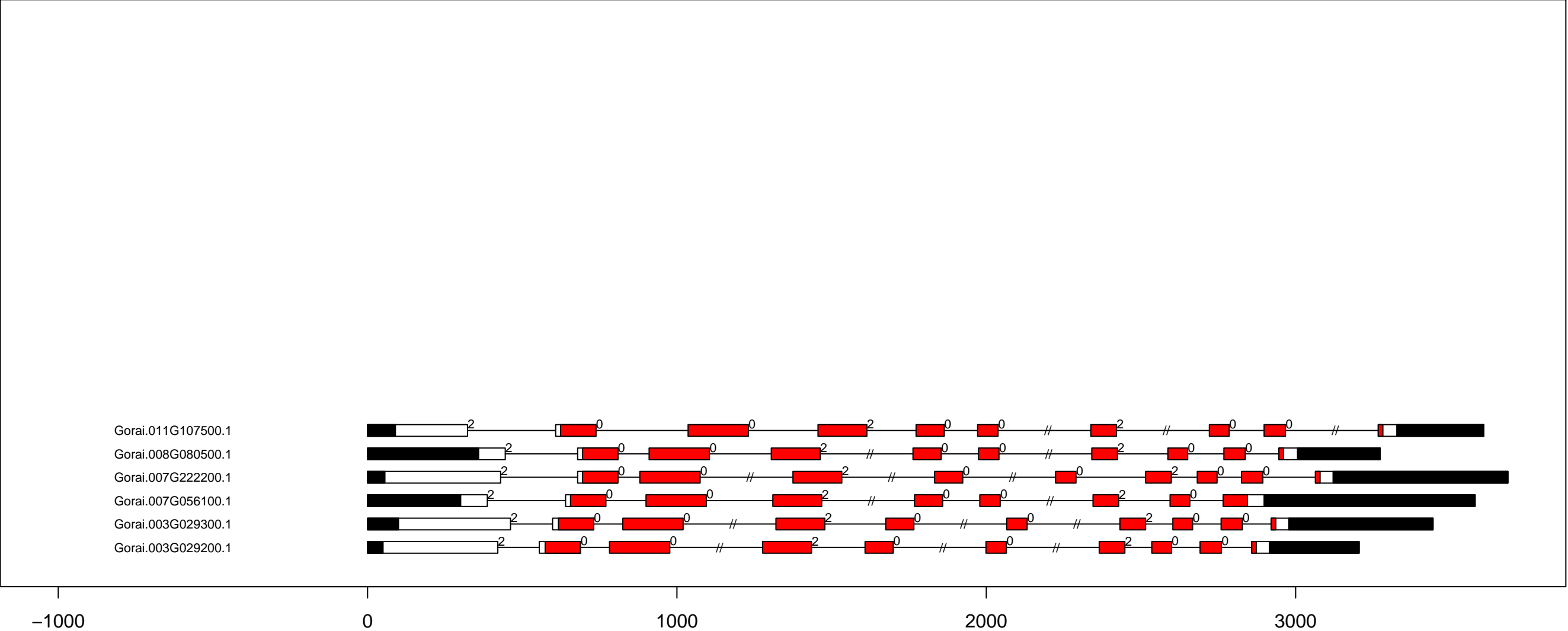

G.ra CMGC_CLK exon-intron and domain diagram (all)

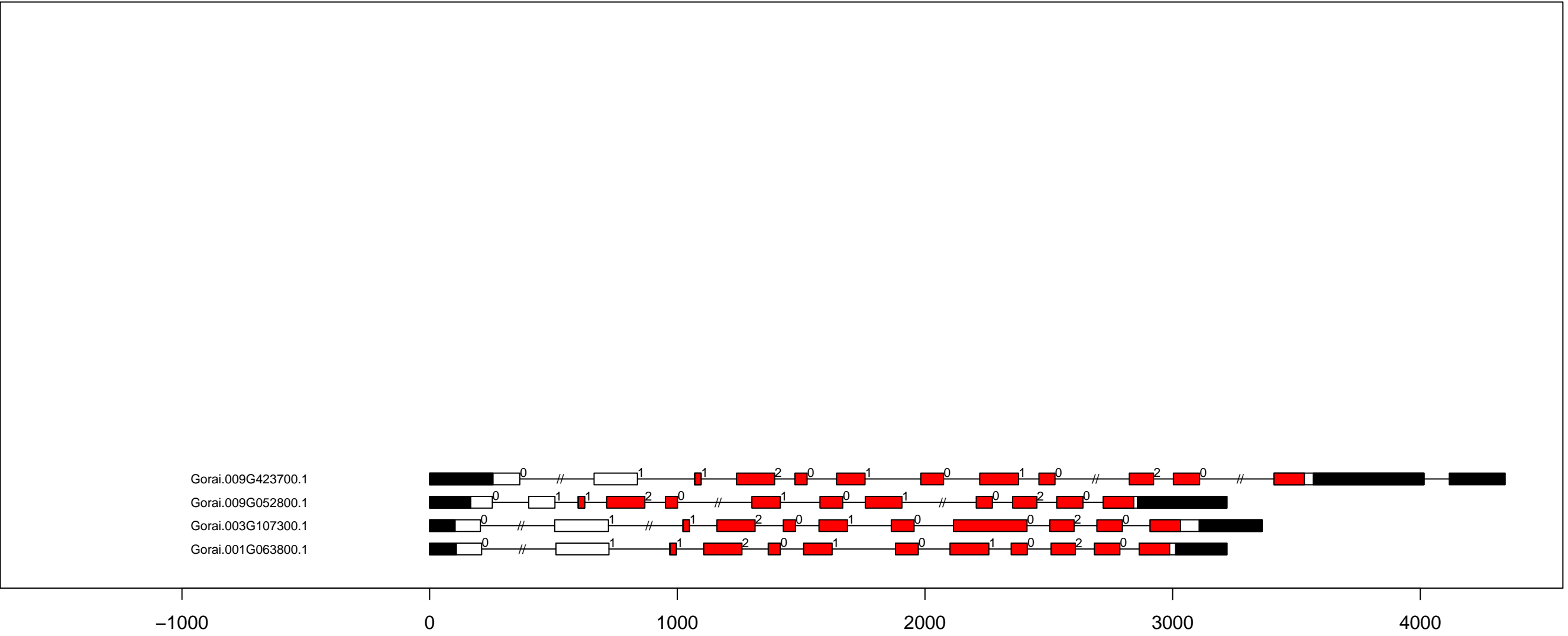

G.ra CMGC_DYRK-PRP4 exon-intron and domain diagram (all)

Gorai.013G081700.3

Gorai.011G288600.1

Gorai.007G002400.1

Gorai.005G135000.1

Gorai.001G069500.1

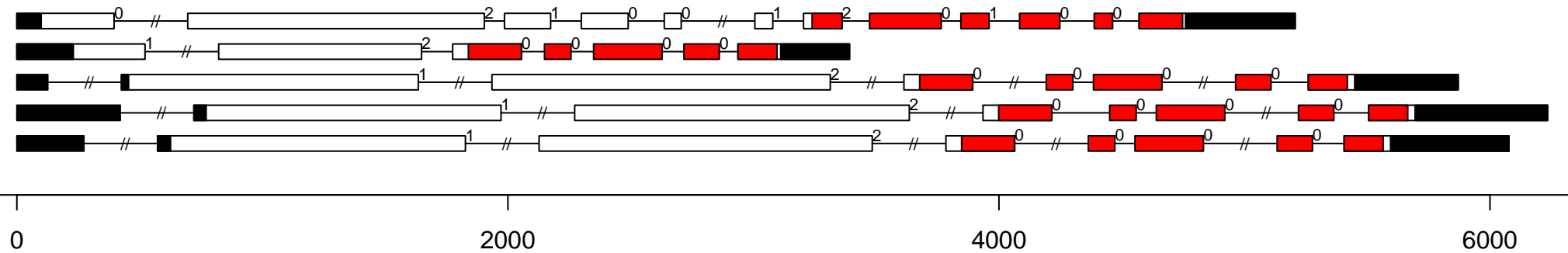

G.ra CMGC_DYRK-YAK exon-intron and domain diagram (all)

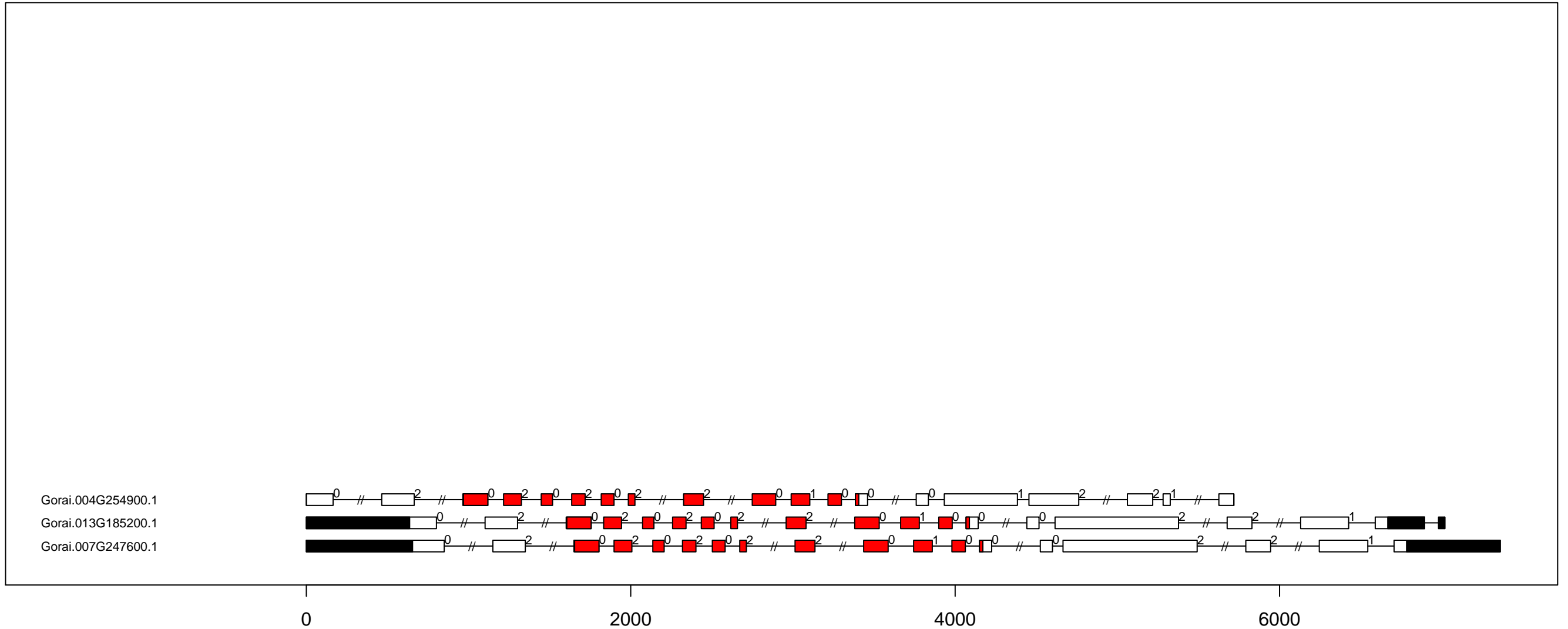

G.ra CMGC_GSKL exon-intron and domain diagram (all)

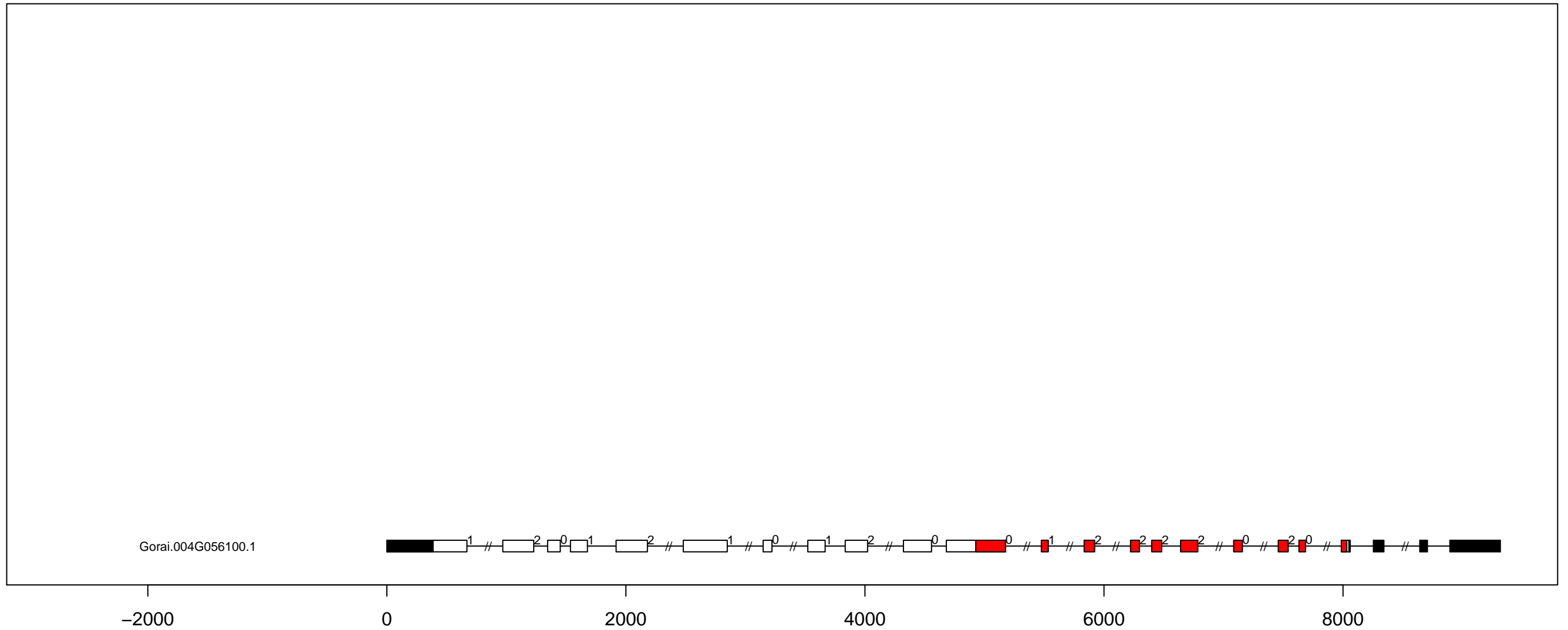

G.ra CMGC_GSK exon-intron and domain diagram (all)

Gorai.010G241600.1

Gorai.008G136600.1

Gorai.008G045800.1

Gorai.007G308500.3

Gorai.007G096100.1

Gorai.006G089400.1

Gorai.006G089300.1

Gorai.004G156700.1

Gorai.004G042400.1

Gorai.002G218100.1

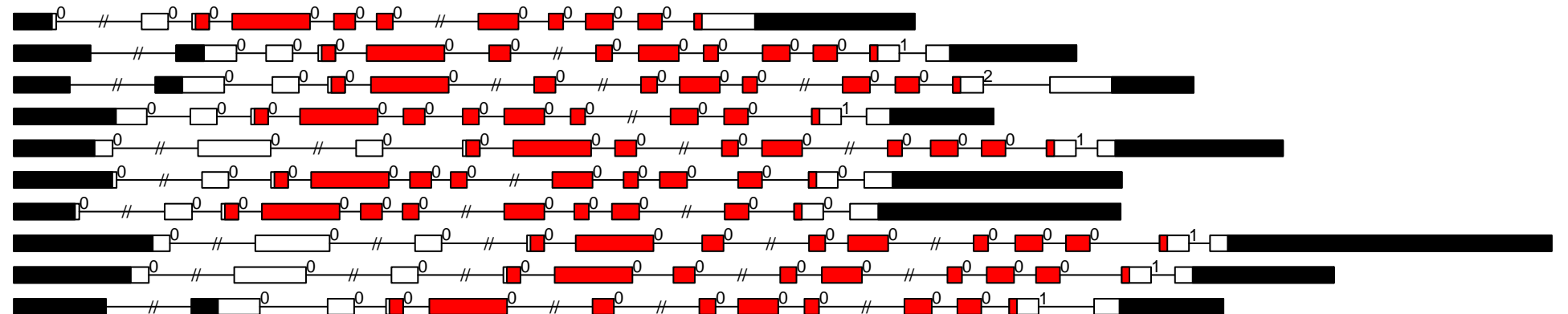

-1000

0

1000

2000

3000

4000

5000

G.ra CMGC_MAPK exon-intron and domain diagram (part 1)

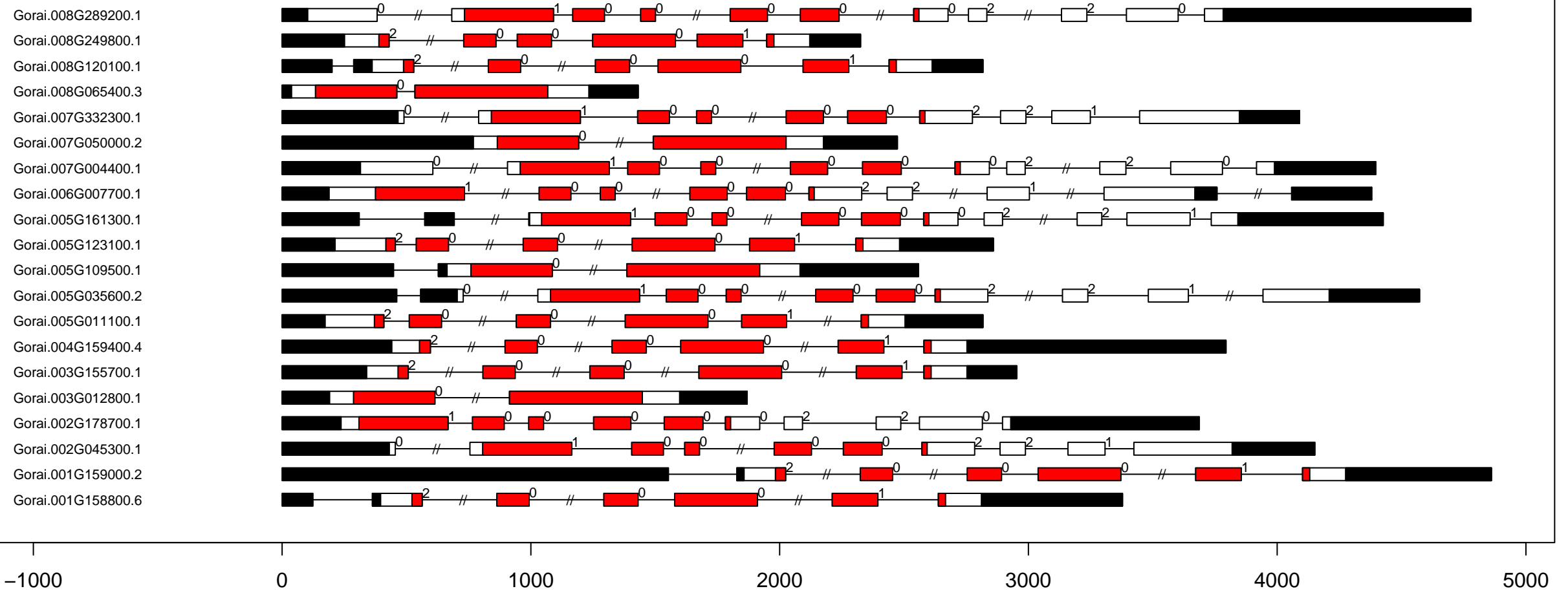

G.ra CMGC_MAPK exon-intron and domain diagram (part 2)

Gorai.012G041500.1
 Gorai.011G132800.1
 Gorai.011G100600.2
 Gorai.009G361300.1
 Gorai.009G199400.1
 Gorai.009G104600.1
 Gorai.009G103800.1

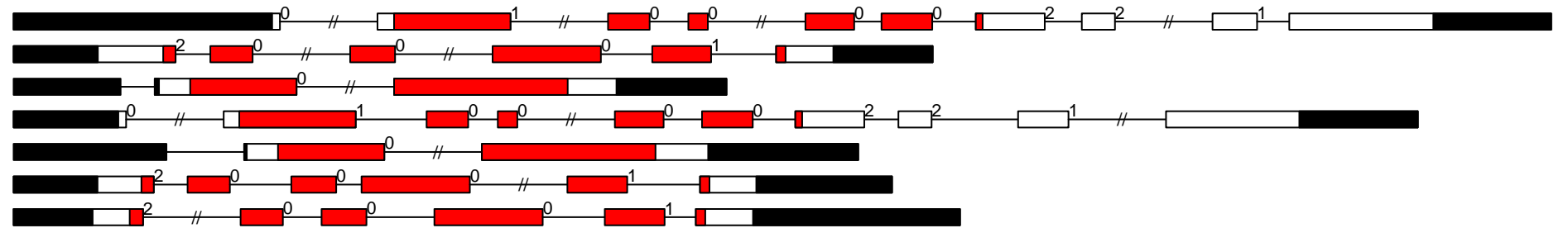

G.ra CMGC_PI-Tthe exon-intron and domain diagram (all)

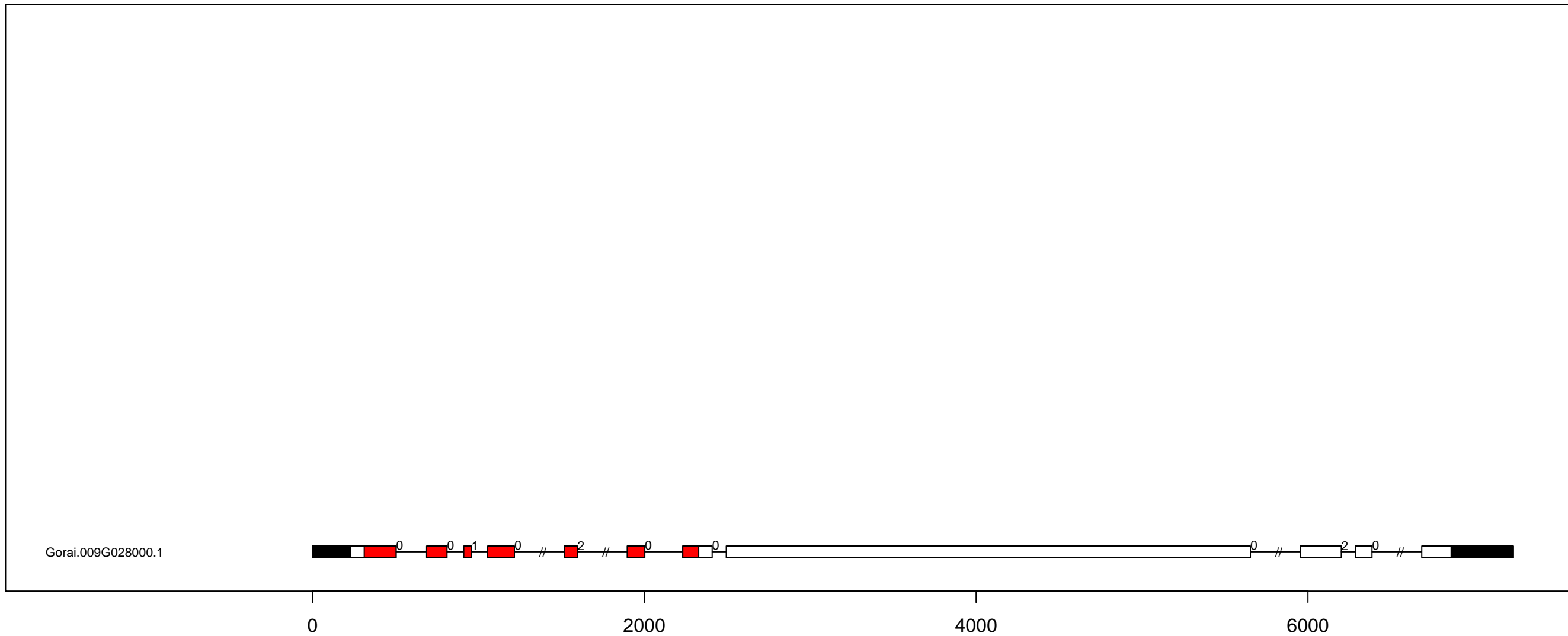

G.ra CMGC_RCK exon-intron and domain diagram (all)

Gorai.008G220700.1
Gorai.003G187100.1
Gorai.007G157300.1
Gorai.004G178800.1
Gorai.001G230900.1

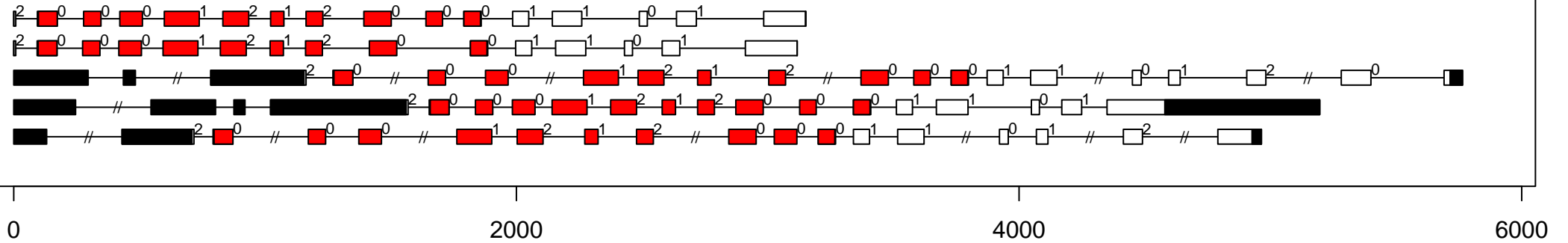

G.ra CMGC_SRPK exon-intron and domain diagram (all)

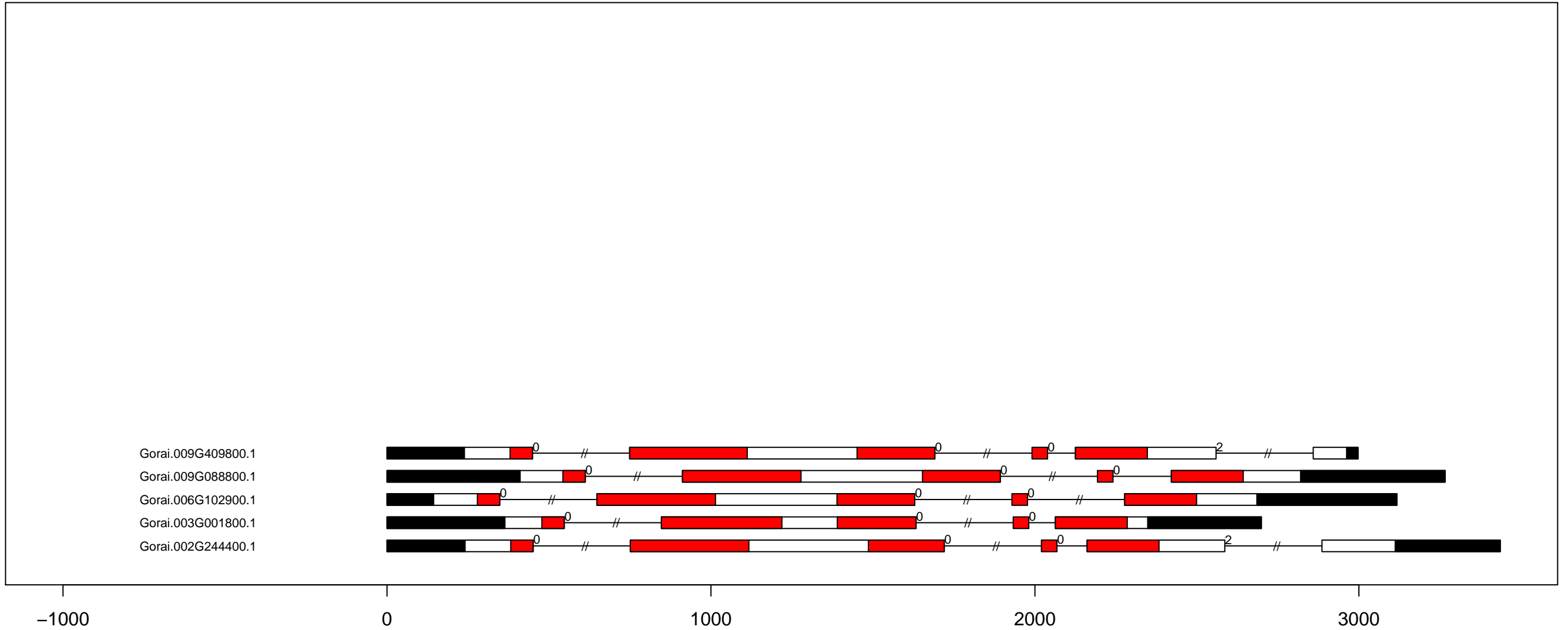

G.ra Group-PI-2 exon-intron and domain diagram (all)

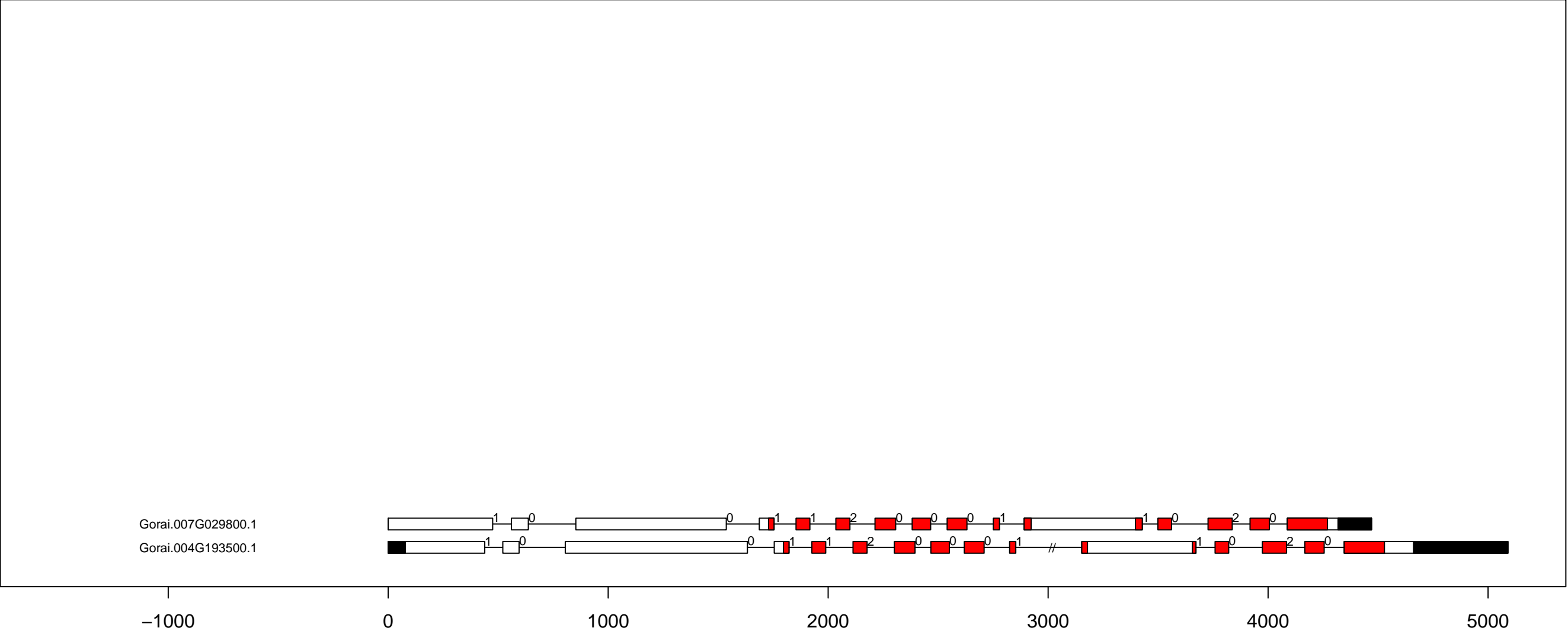

G.ra Group-PI-3 exon-intron and domain diagram (all)

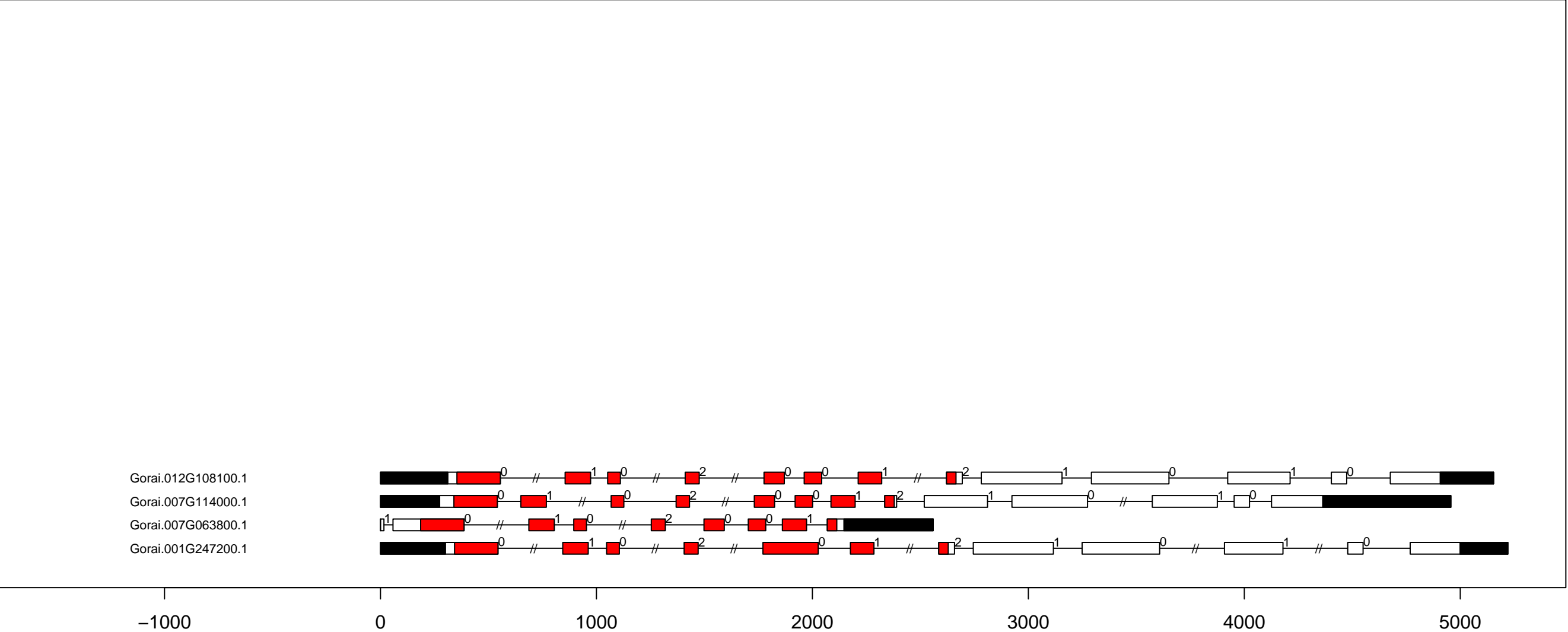

G.ra Group-PI-4 exon-intron and domain diagram (all)

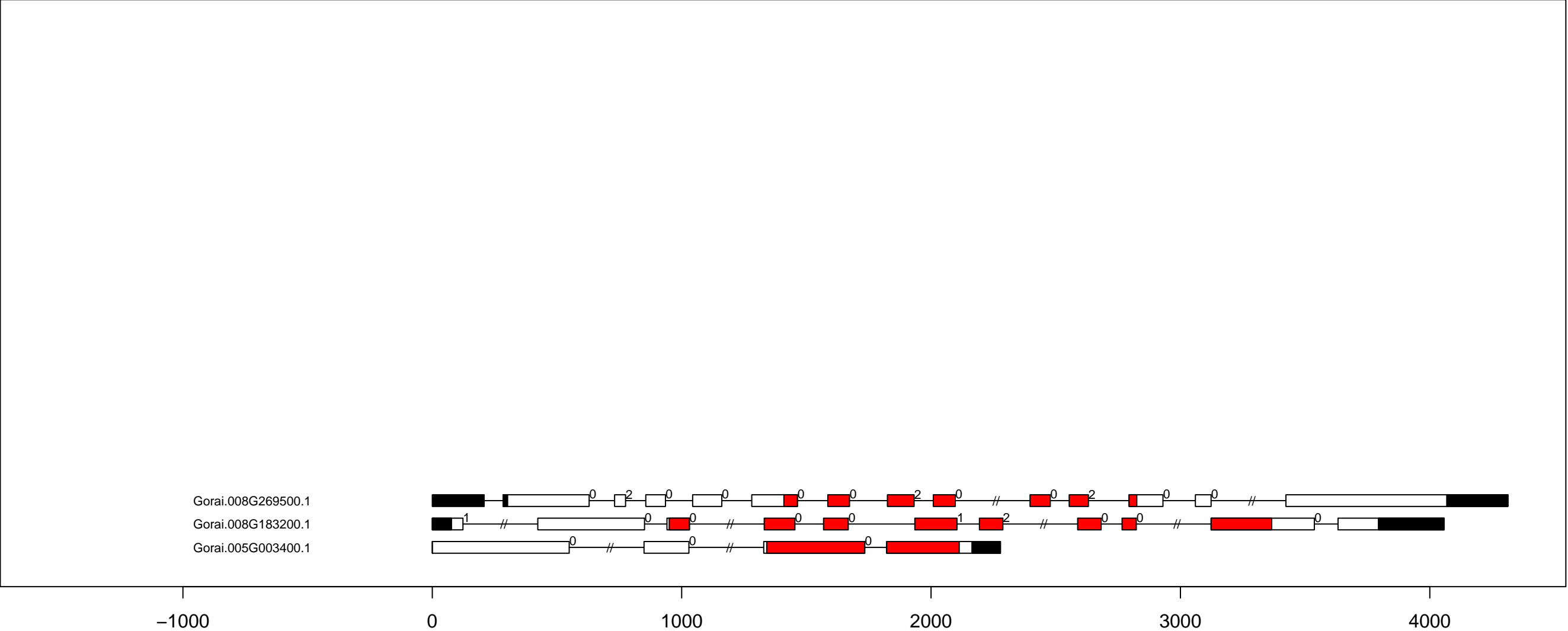

G.ra IRE1 exon-intron and domain diagram (all)

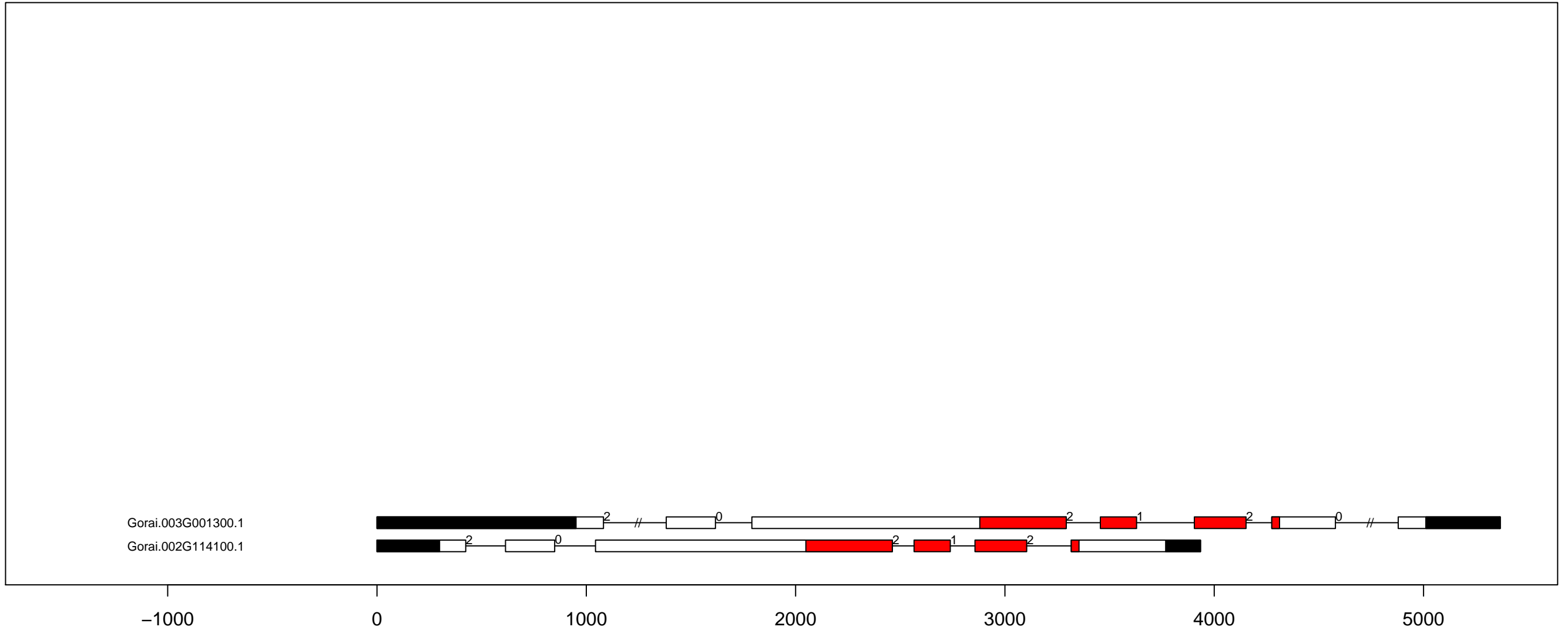

G.ra NAK exon-intron and domain diagram (all)

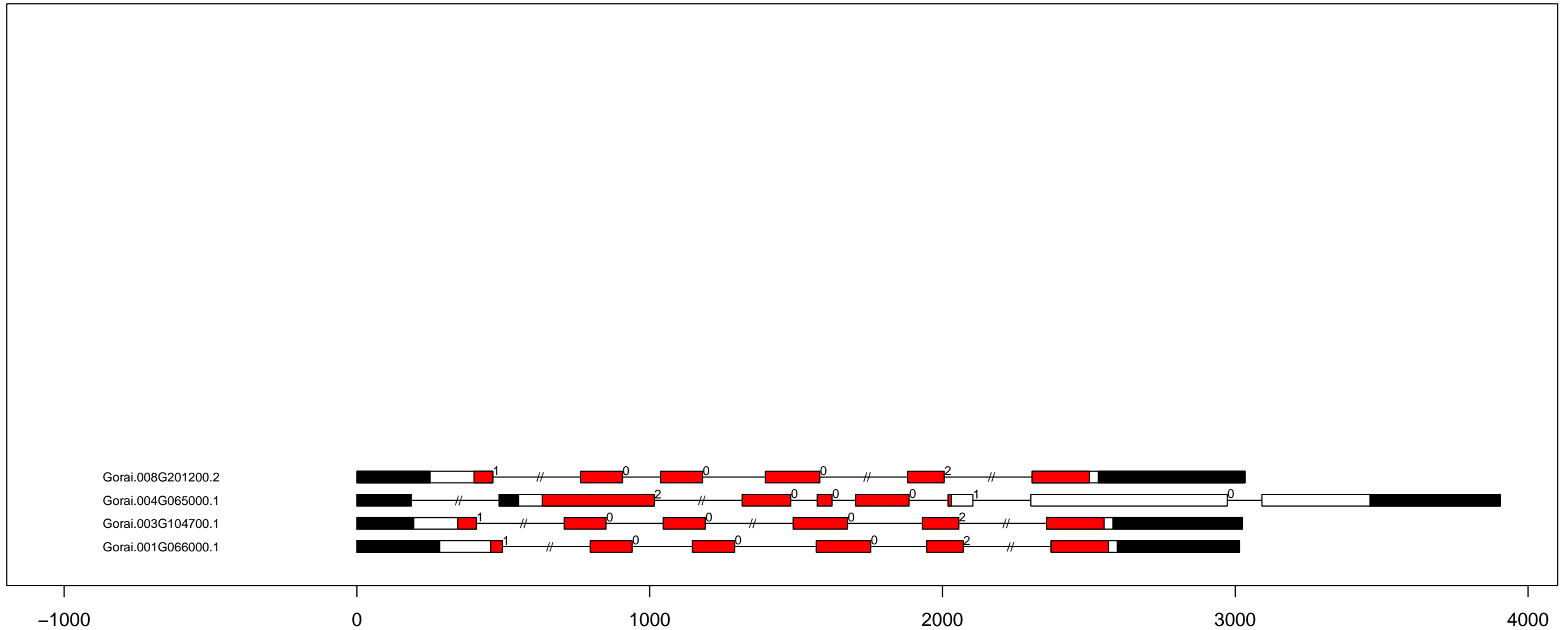

G.ra NEK exon-intron and domain diagram (all)

Gorai.013G256900.3

Gorai.013G201300.1

Gorai.009G082900.1

Gorai.008G002700.3

Gorai.007G283900.3

Gorai.006G139000.3

Gorai.006G114800.1

Gorai.004G077600.1

Gorai.004G018800.3

Gorai.002G229400.1

Gorai.001G124800.1

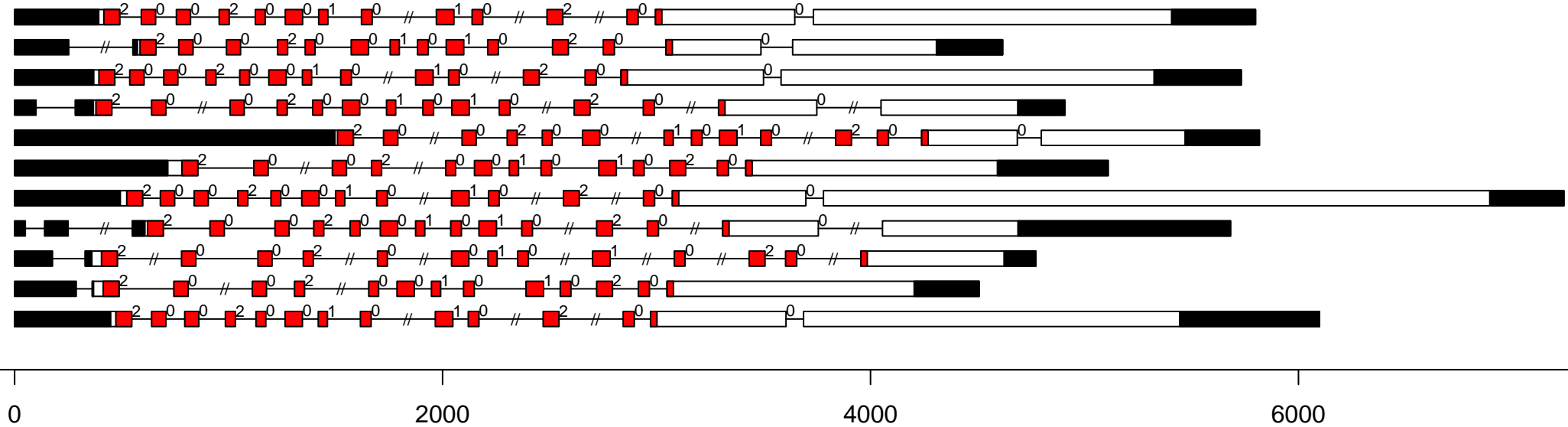

G.ra PEK_GCN2 exon-intron and domain diagram (all)

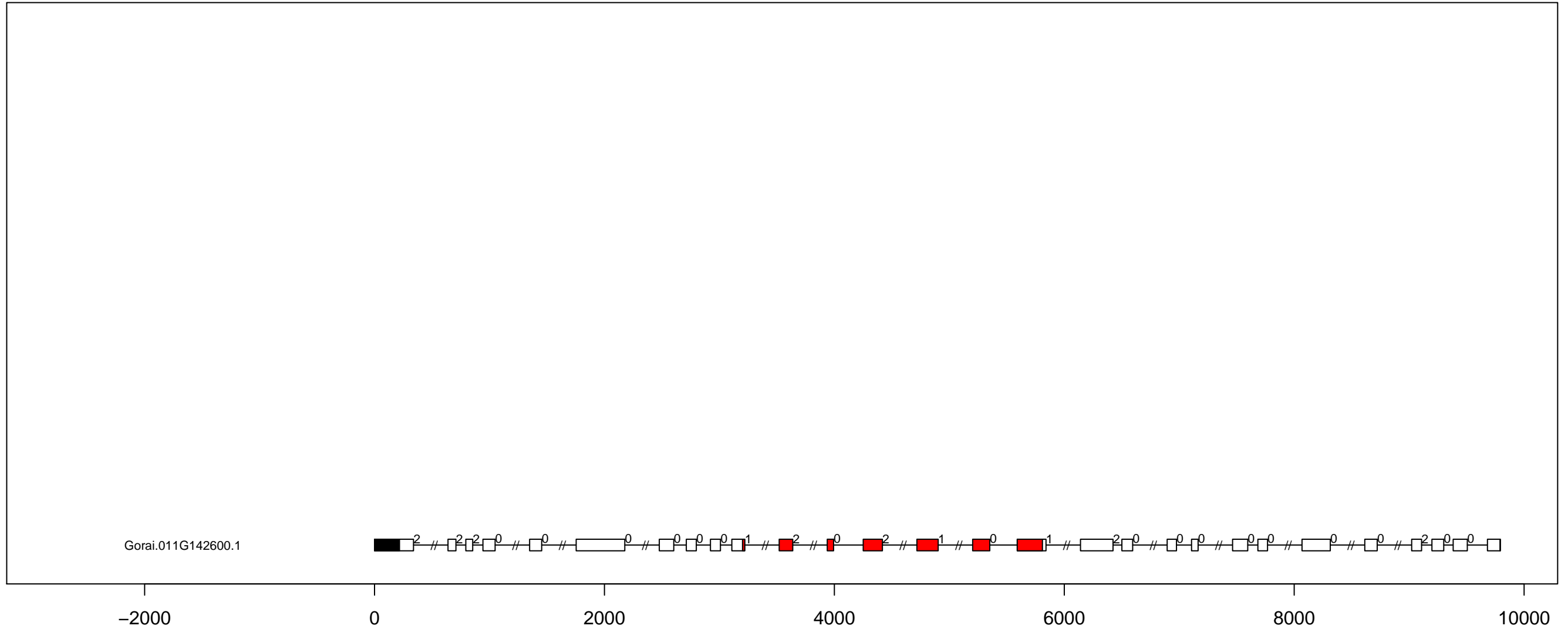

G.ra PEK_PEK exon-intron and domain diagram (all)

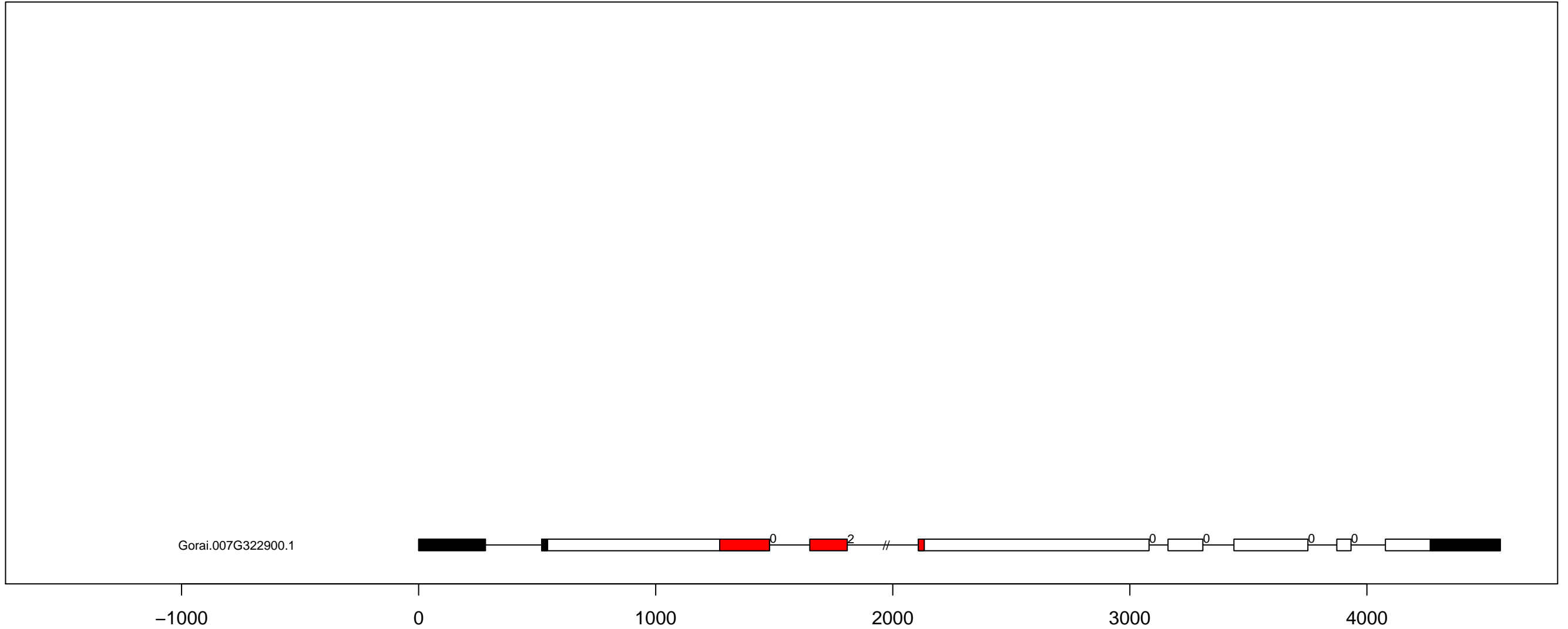

G.ra RLK-Pelle_C-LEC exon-intron and domain diagram (all)

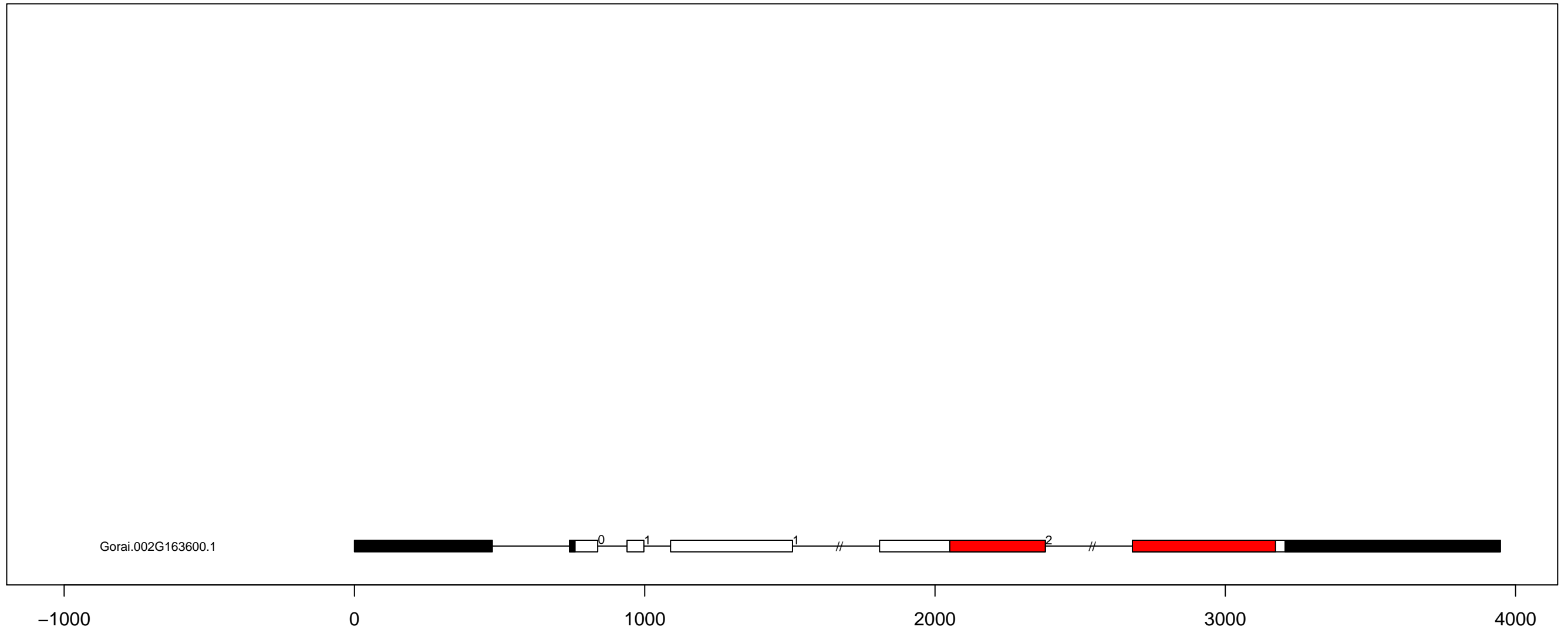

G.ra RLK-Pelle_CR4L exon-intron and domain diagram (all)

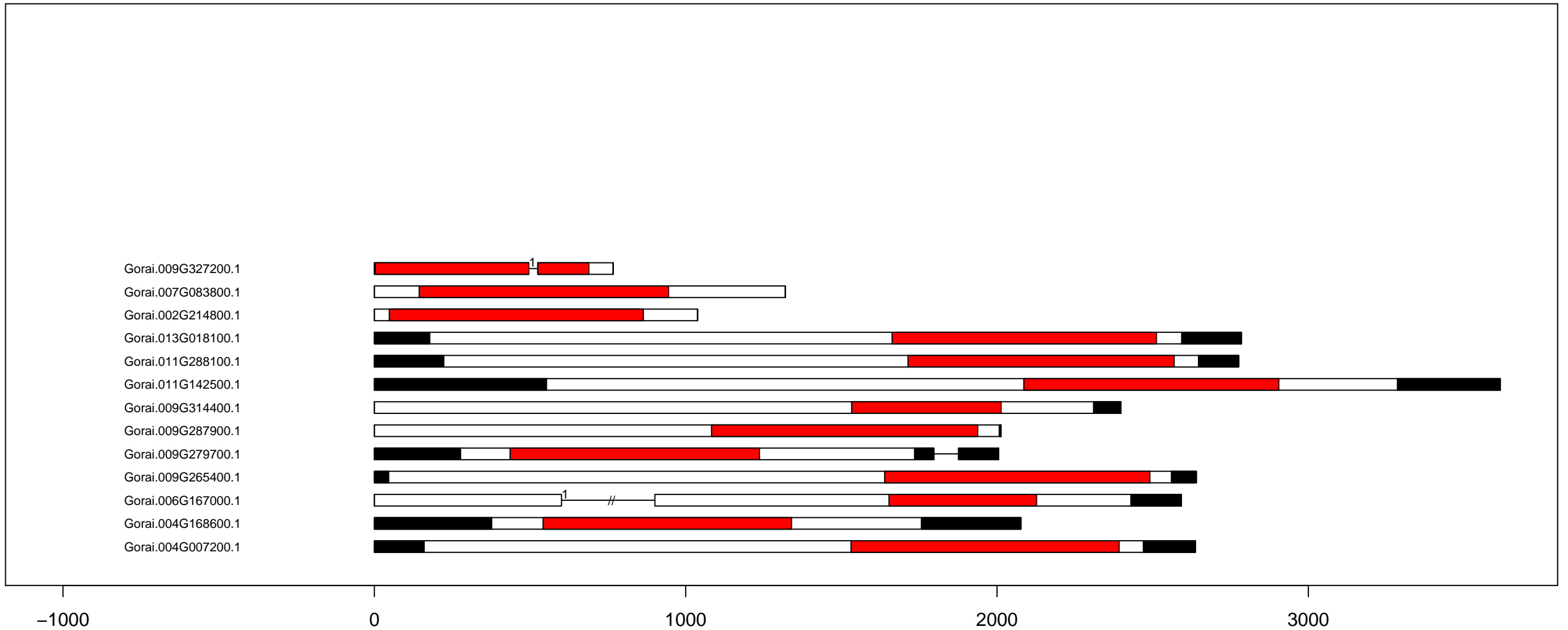

G.ra RLK-Pelle_CrRLK1L-1 exon-intron and domain diagram (part 1)

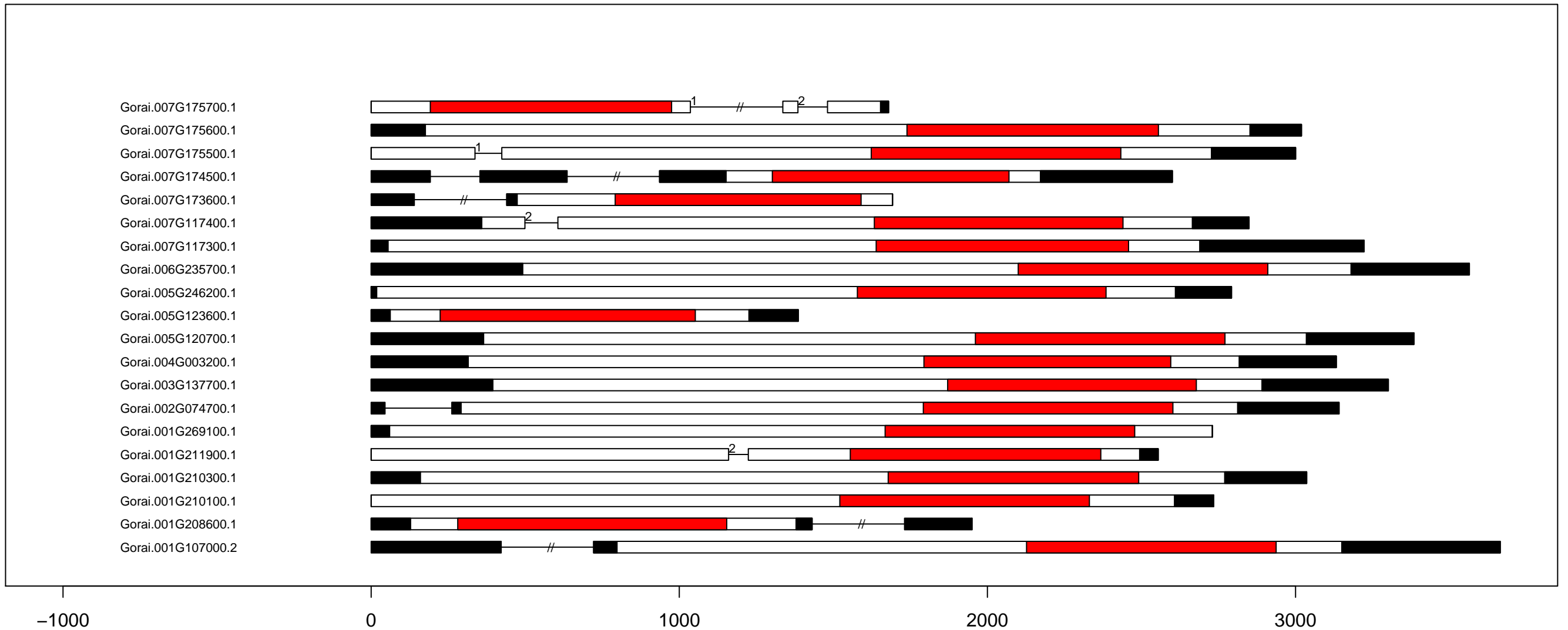

G.ra RLK-Pelle_CrRLK1L-1 exon-intron and domain diagram (part 2)

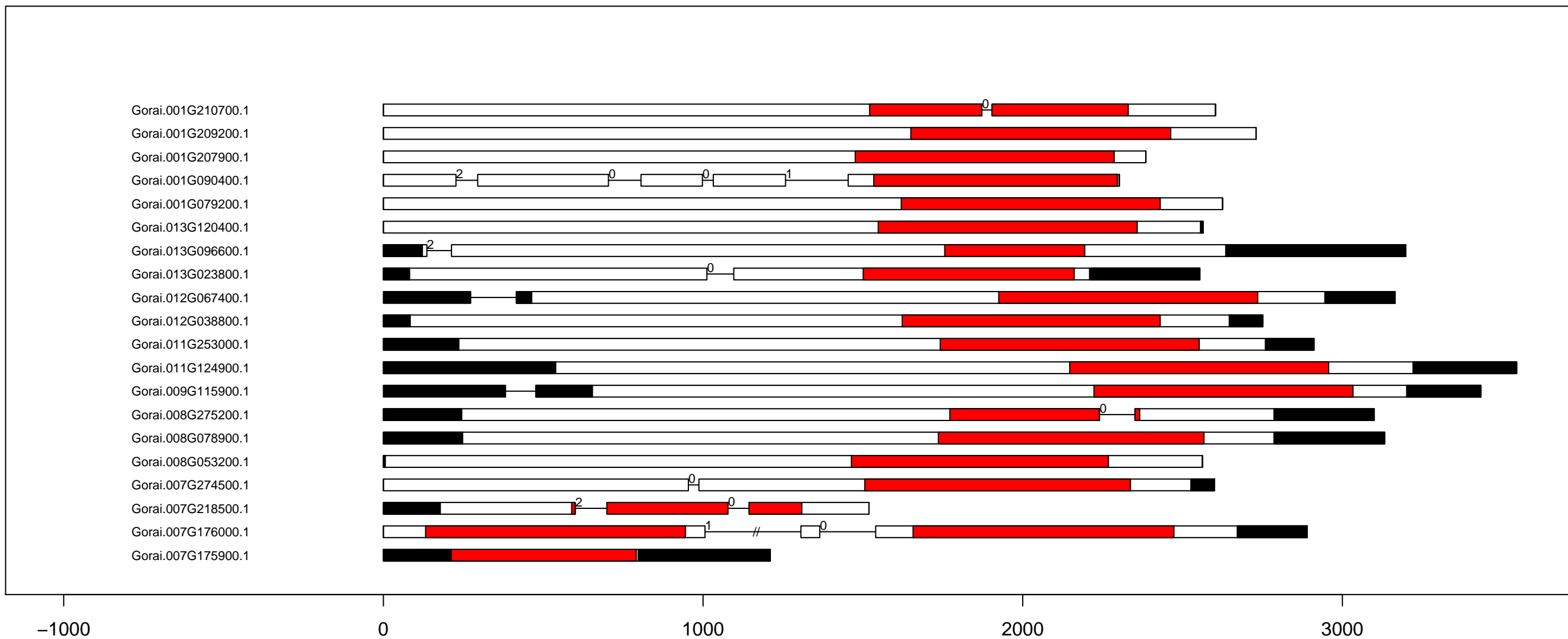

G.ra RLK-Pelle_CrRLK1L-1 exon-intron and domain diagram (part 3)

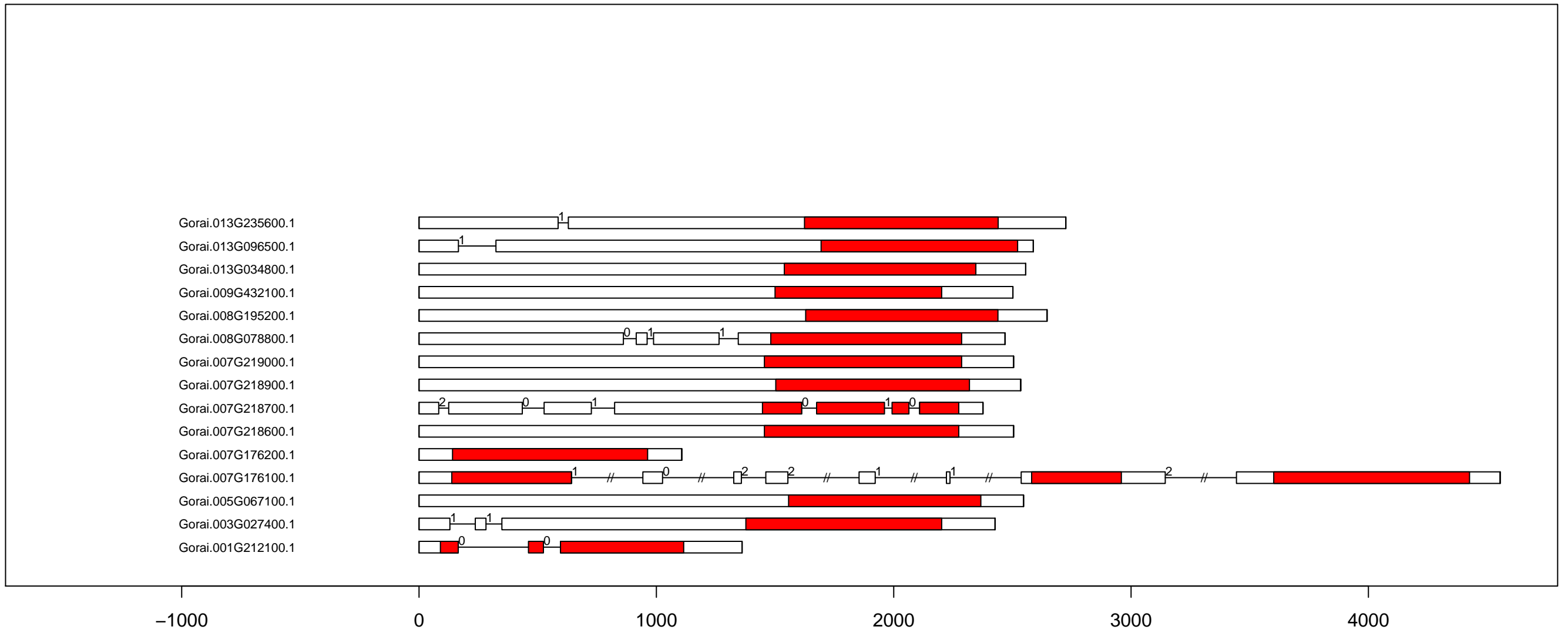

G.ra RLK-Pelle_DLSV exon-intron and domain diagram (part 1)

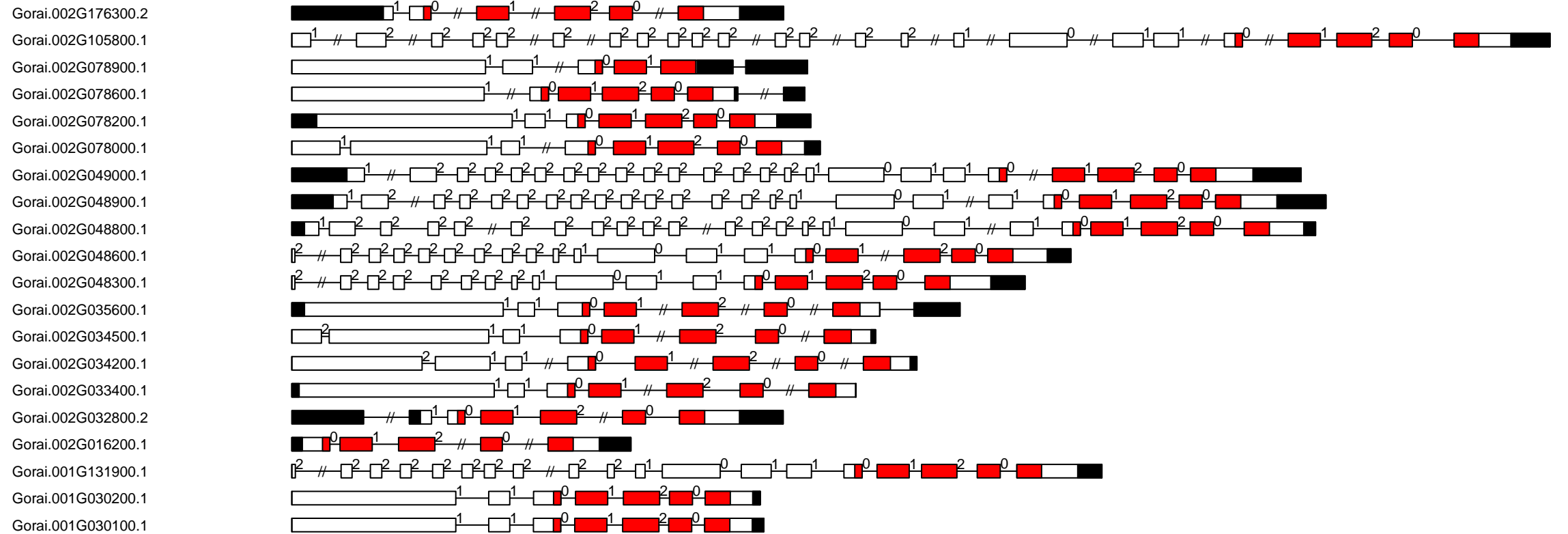

G.ra RLK-Pelle_DLSV exon-intron and domain diagram (part 2)

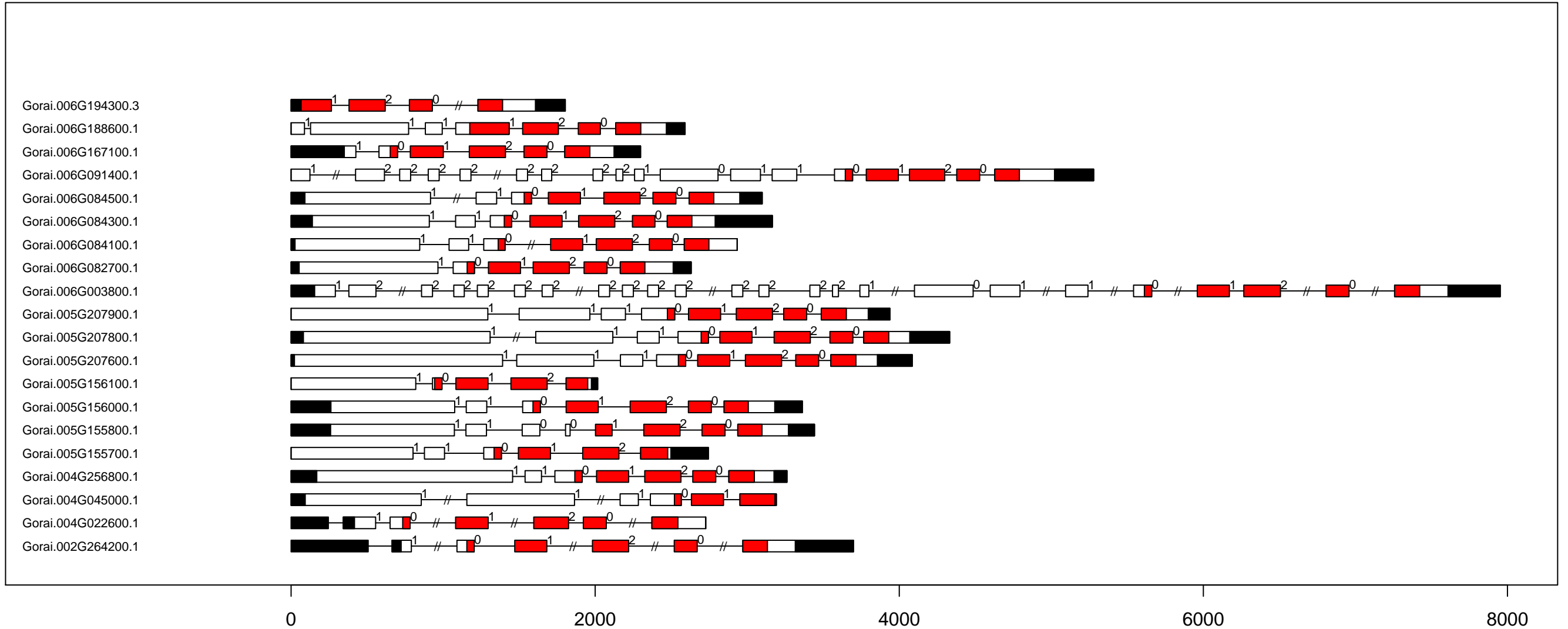

G.ra RLK-Pelle_DLSV exon-intron and domain diagram (part 3)

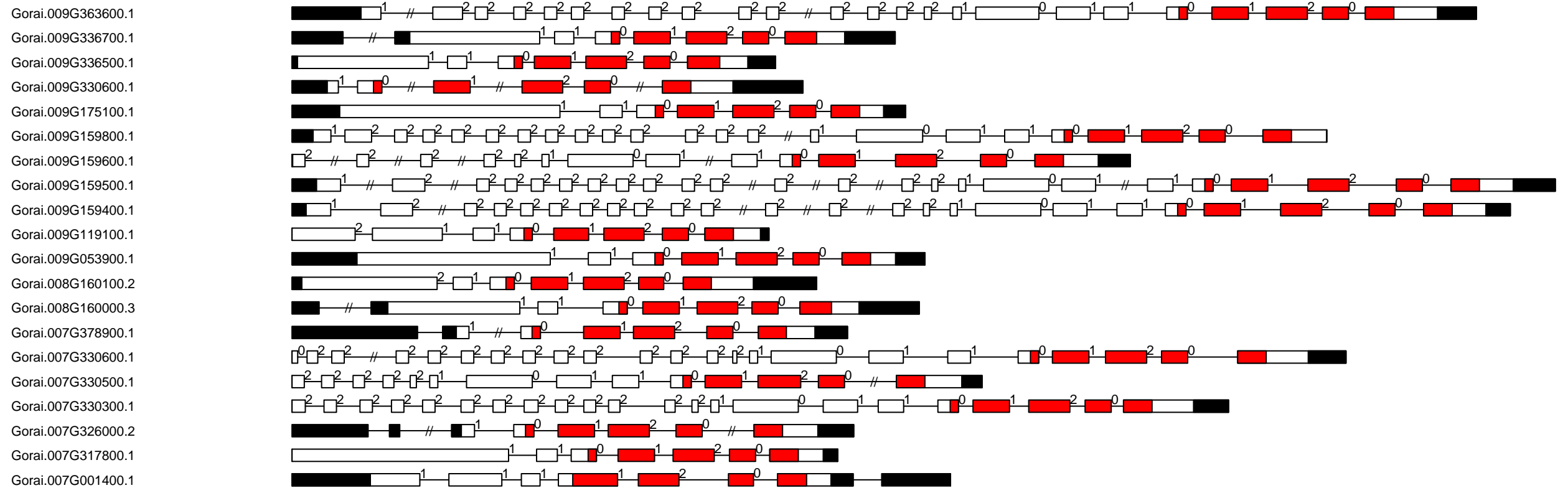

G.ra RLK-Pelle_DLSV exon-intron and domain diagram (part 4)

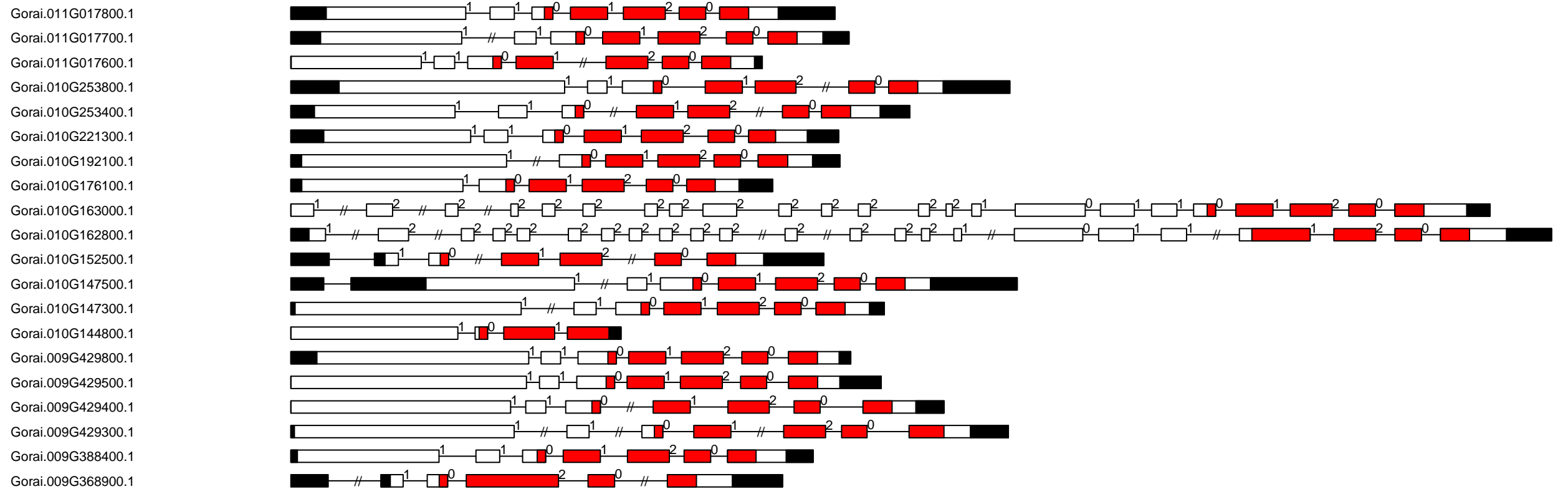

G.ra RLK-Pelle_DLSV exon-intron and domain diagram (part 5)

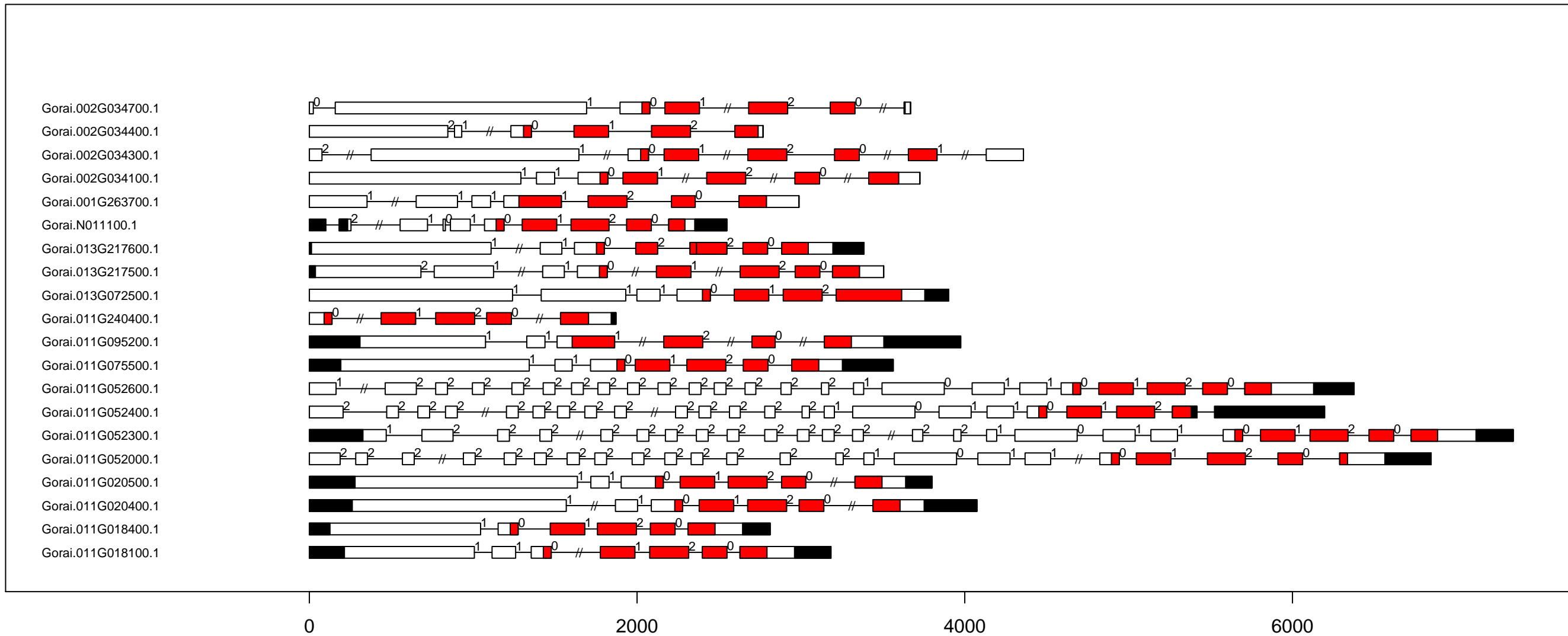

G.ra RLK-Pelle_DLSV exon-intron and domain diagram (part 6)

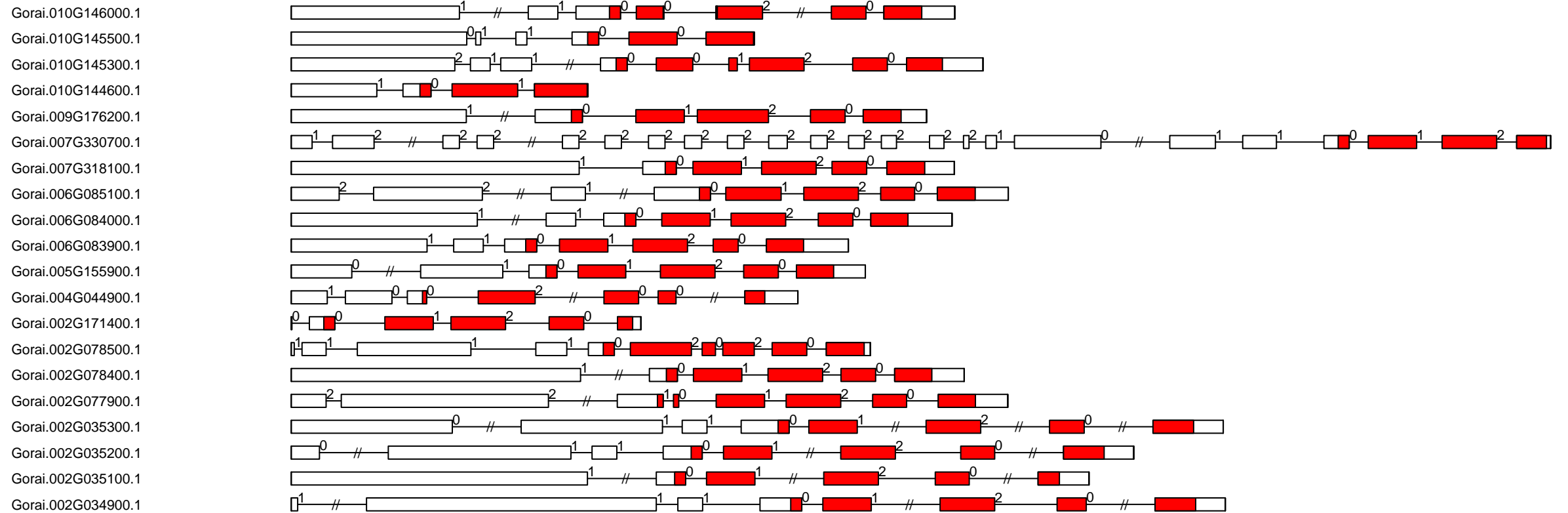

G.ra RLK-Pelle_DLSV exon-intron and domain diagram (part 7)

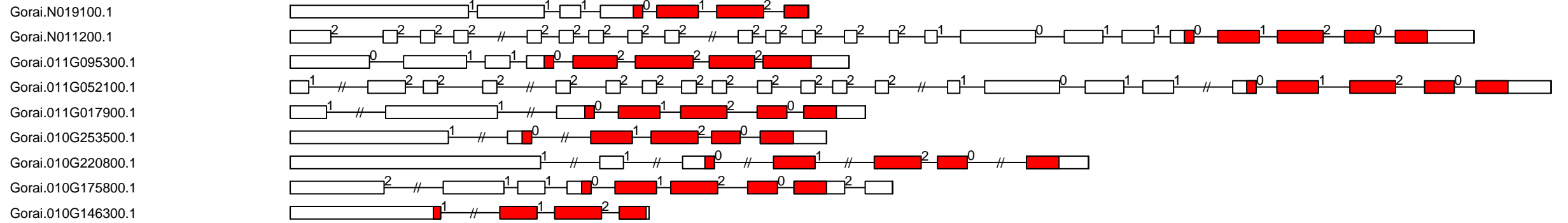

G.ra RLK-Pelle_Extensin exon-intron and domain diagram (all)



G.ra RLK-Pelle_L-LEC exon-intron and domain diagram (part 2)

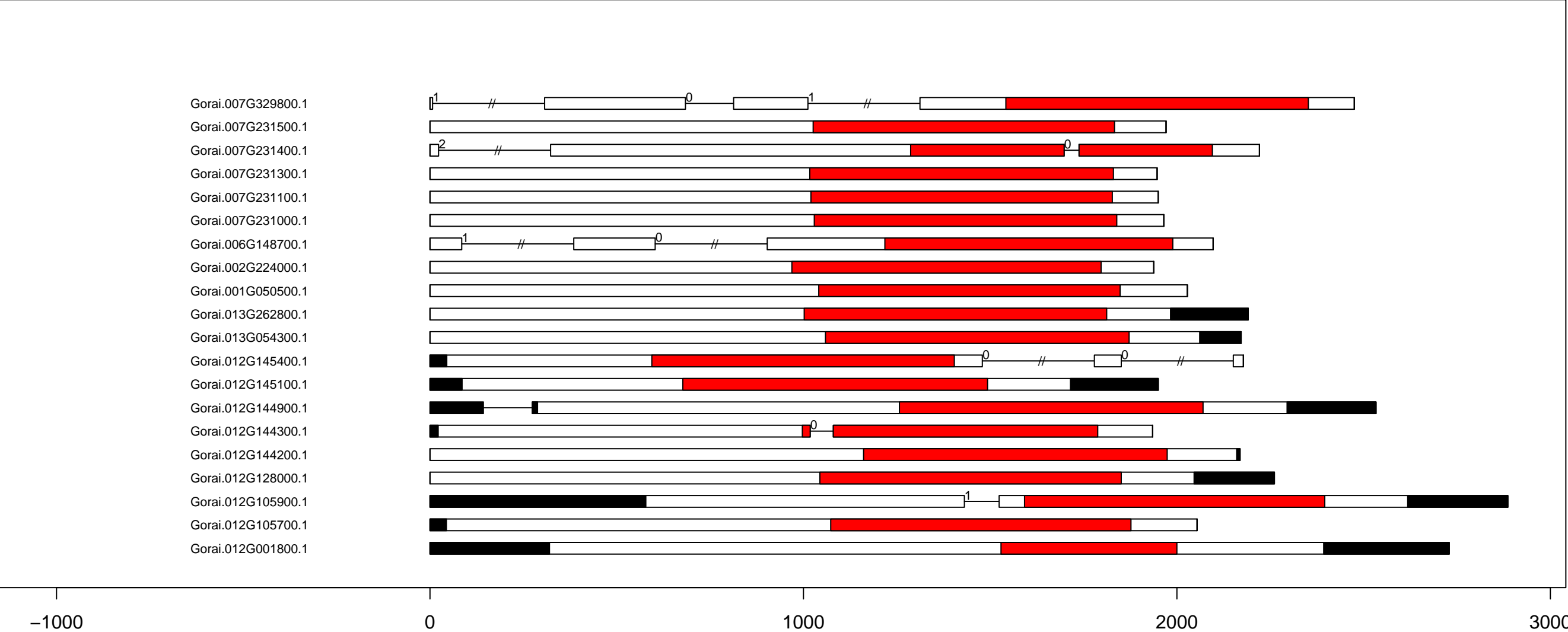

G.ra RLK-Pelle_L-LEC exon-intron and domain diagram (part 3)

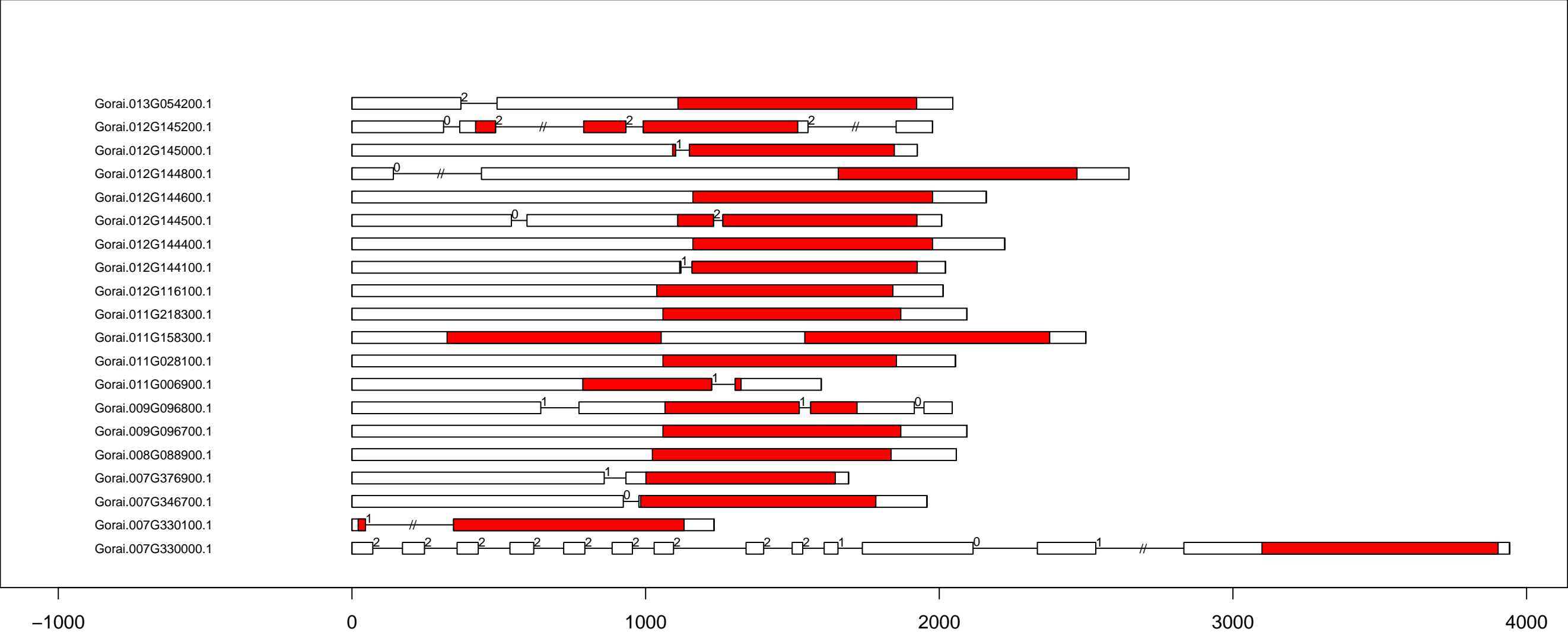

G.ra RLK-Pelle_L-LEC exon-intron and domain diagram (part 4)

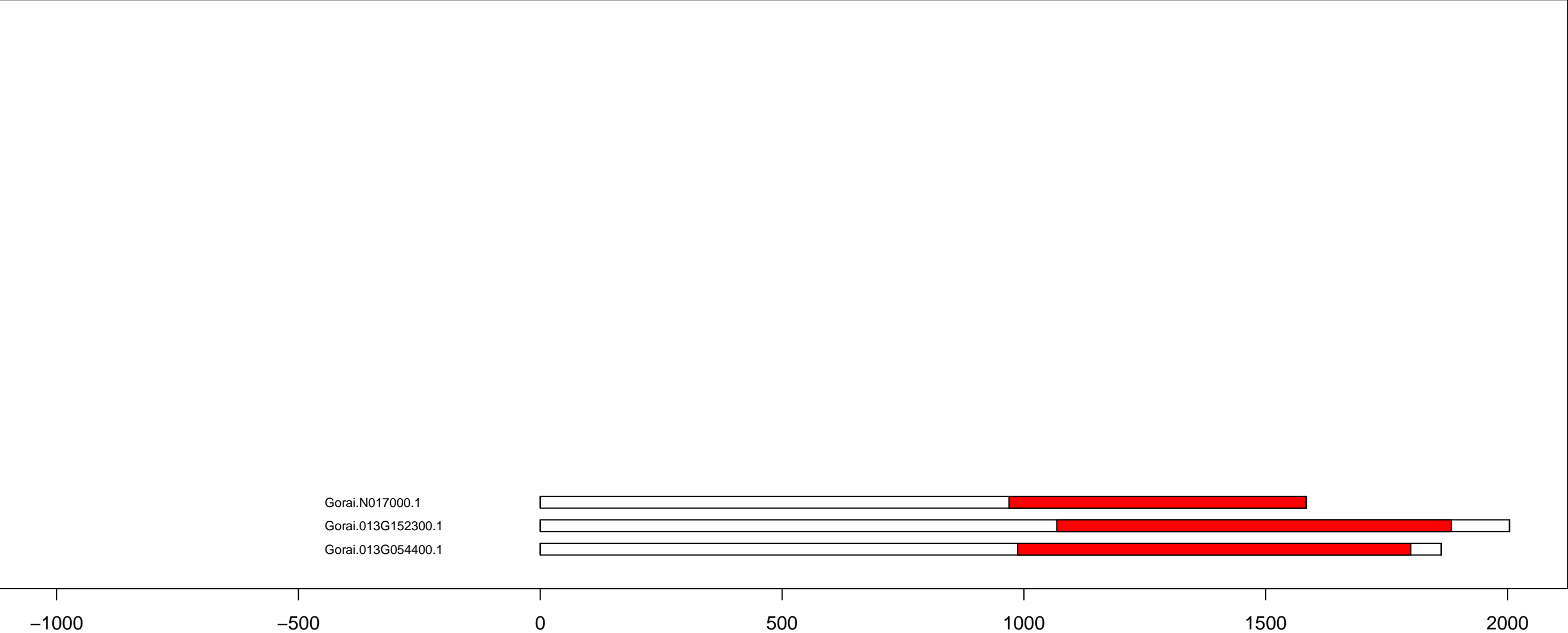

G.ra RLK-Pelle_LRK10L-2 exon-intron and domain diagram (part 2)

Gorai.007G183300.1
 Gorai.007G182500.1
 Gorai.006G059500.1
 Gorai.002G047800.1
 Gorai.002G042100.1
 Gorai.002G042000.1
 Gorai.002G041800.1
 Gorai.002G041500.1
 Gorai.002G041100.1
 Gorai.002G040100.1
 Gorai.013G013500.1
 Gorai.012G183300.1
 Gorai.012G003300.1
 Gorai.012G003200.1
 Gorai.010G091900.1
 Gorai.009G305500.1
 Gorai.009G305400.1
 Gorai.009G304800.1
 Gorai.007G335100.1
 Gorai.007G335000.1

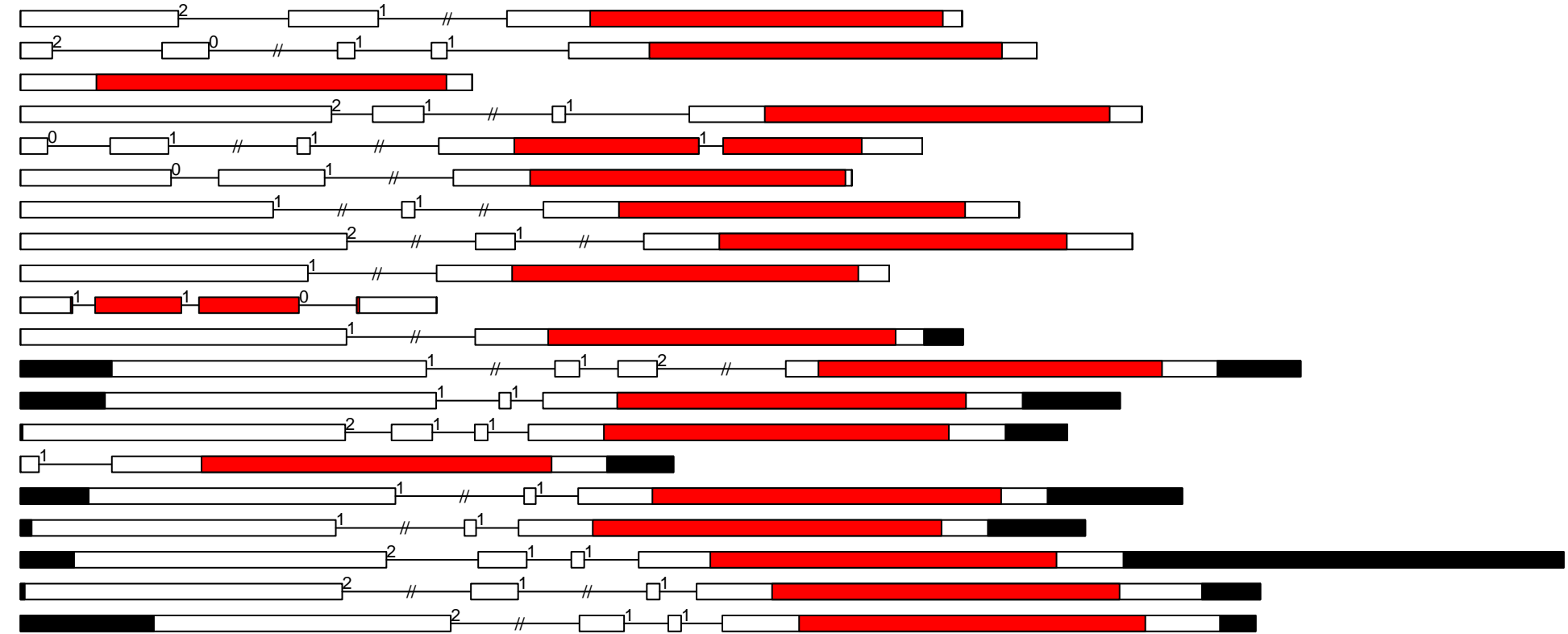

-1000

0

1000

2000

3000

G.ra RLK-Pelle_LRK10L-2 exon-intron and domain diagram (part 3)

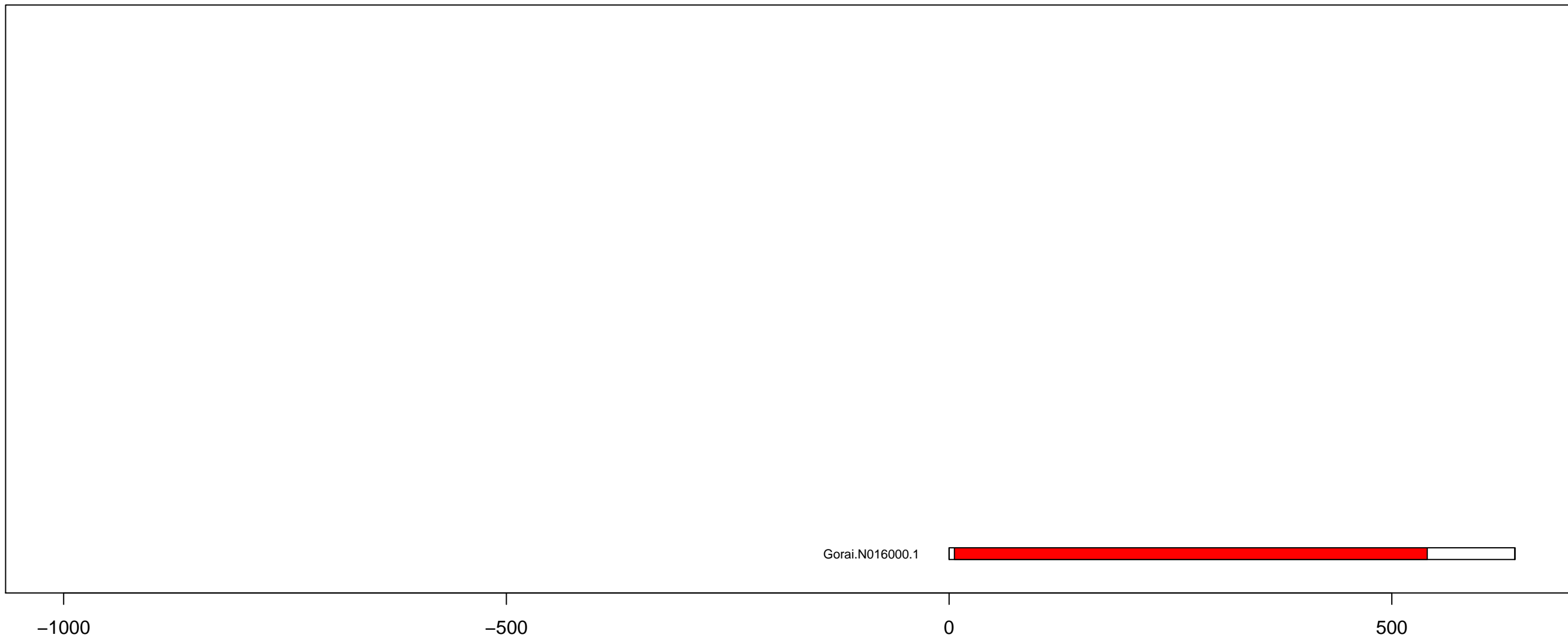

G.ra RLK-Pelle_LRR-I-1 exon-intron and domain diagram (all)

Gorai.003G006200.1
 Gorai.010G230800.1
 Gorai.008G088500.1
 Gorai.007G190800.1
 Gorai.006G169000.1
 Gorai.005G173400.1
 Gorai.004G225900.1
 Gorai.001G186800.1

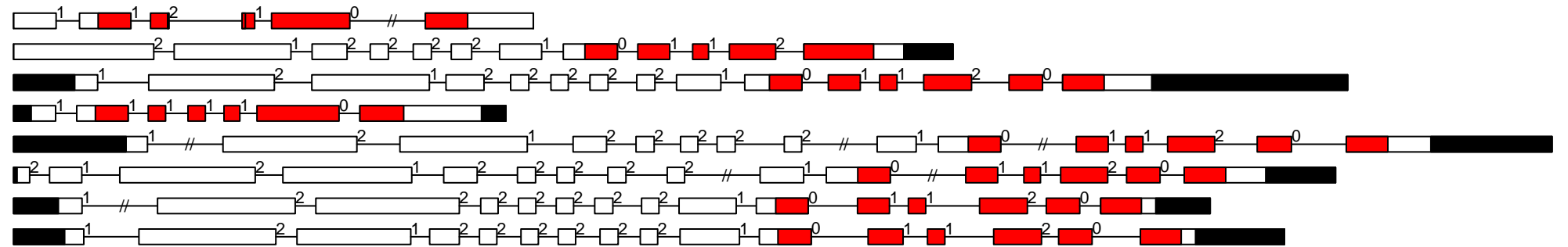

0

2000

4000

6000

G.ra RLK-Pelle_LRR-I-2 exon-intron and domain diagram (all)

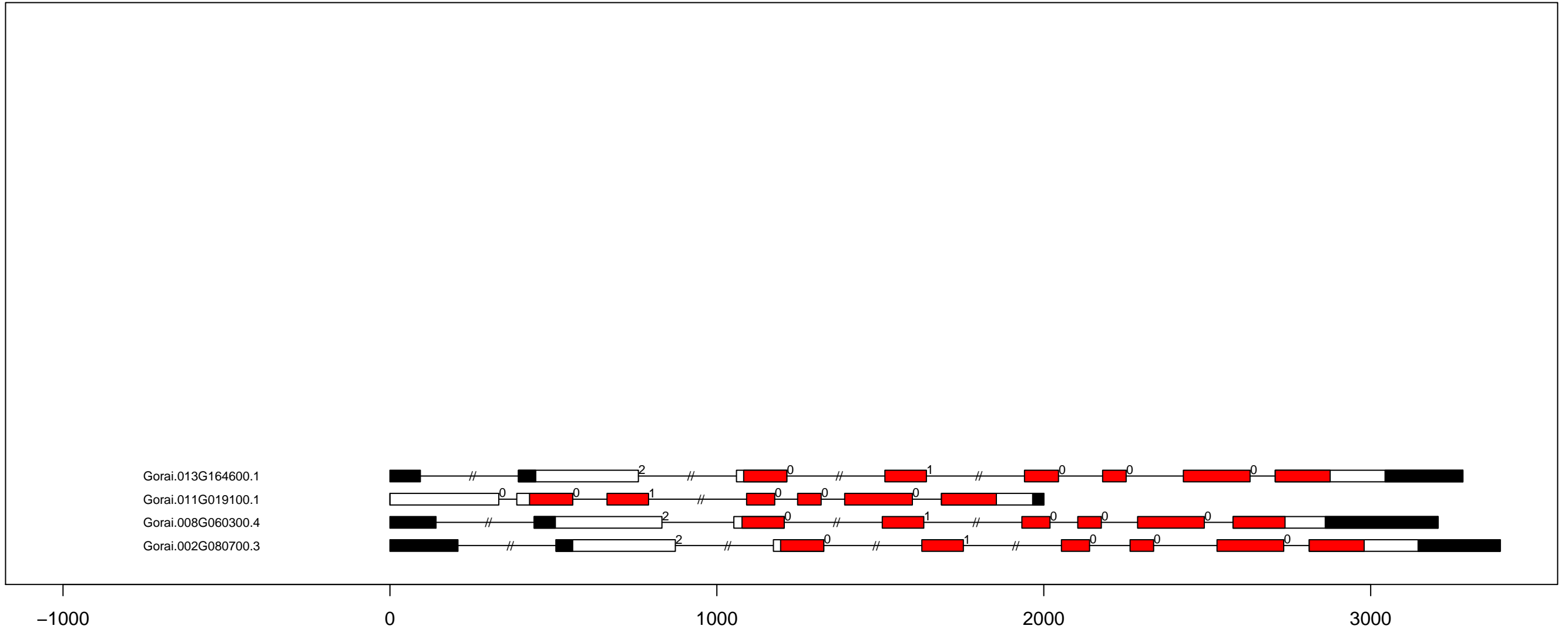

G.ra RLK-Pelle_LRR-III exon-intron and domain diagram (part 1)

Gorai.005G193500.1
Gorai.005G192800.1
Gorai.005G169100.1
Gorai.005G133200.1
Gorai.005G120900.1
Gorai.004G278900.1
Gorai.004G134300.1
Gorai.003G153000.3
Gorai.003G082600.1
Gorai.003G046400.1
Gorai.003G027300.1
Gorai.003G026300.1
Gorai.002G243600.1
Gorai.002G229000.1
Gorai.002G134400.1
Gorai.001G260600.1
Gorai.001G203900.1
Gorai.001G198100.1
Gorai.001G081900.1
Gorai.001G003200.1

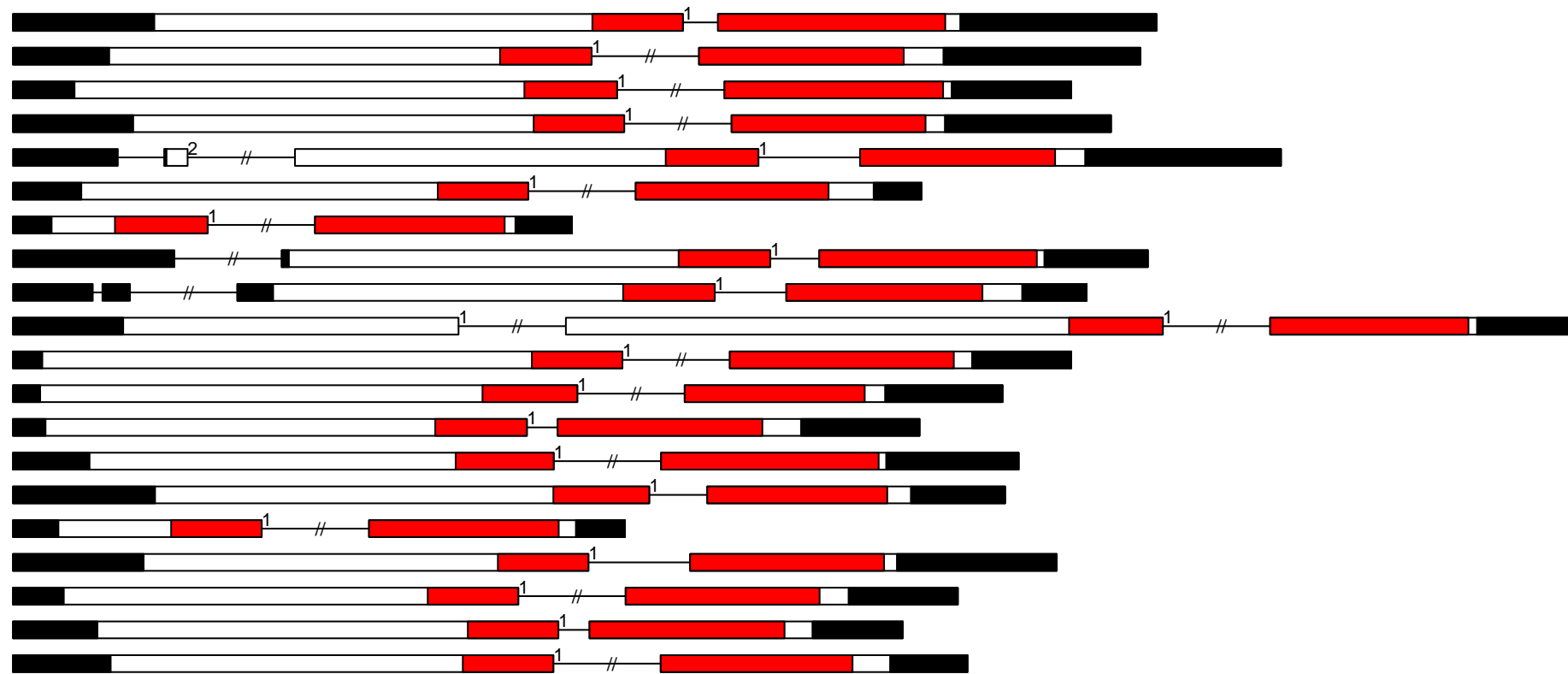

G.ra RLK-Pelle_LRR-III exon-intron and domain diagram (part 2)

Gorai.010G067400.1
 Gorai.009G348000.1
 Gorai.009G214700.1
 Gorai.009G120000.1
 Gorai.009G105200.1
 Gorai.009G036600.1
 Gorai.009G022300.1
 Gorai.009G001100.1
 Gorai.008G271600.4
 Gorai.008G214600.1
 Gorai.008G171200.1
 Gorai.008G078600.1
 Gorai.008G023200.2
 Gorai.007G244000.1
 Gorai.007G216500.1
 Gorai.007G186000.1
 Gorai.007G184800.1
 Gorai.007G152400.1
 Gorai.007G047200.1
 Gorai.005G239500.1

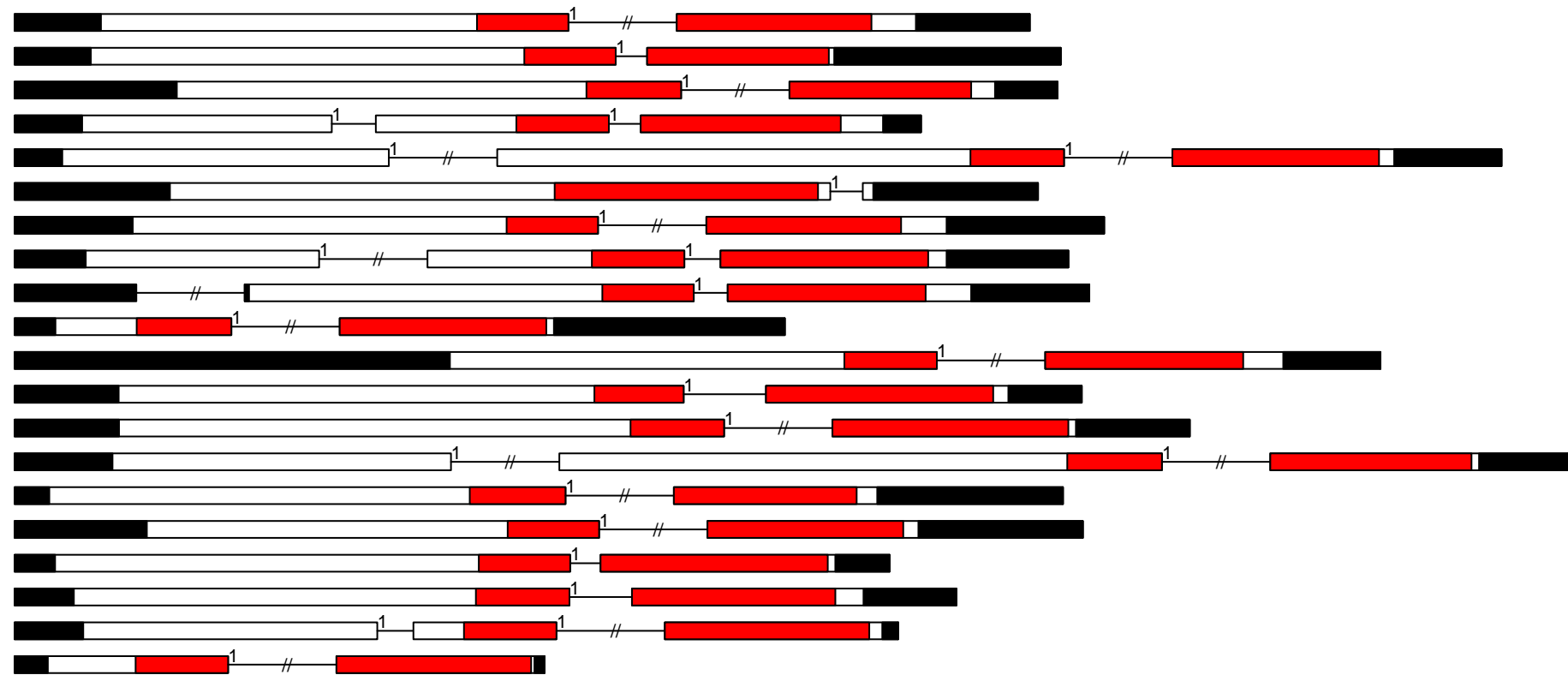

G.ra RLK-Pelle_LRR-III exon-intron and domain diagram (part 3)

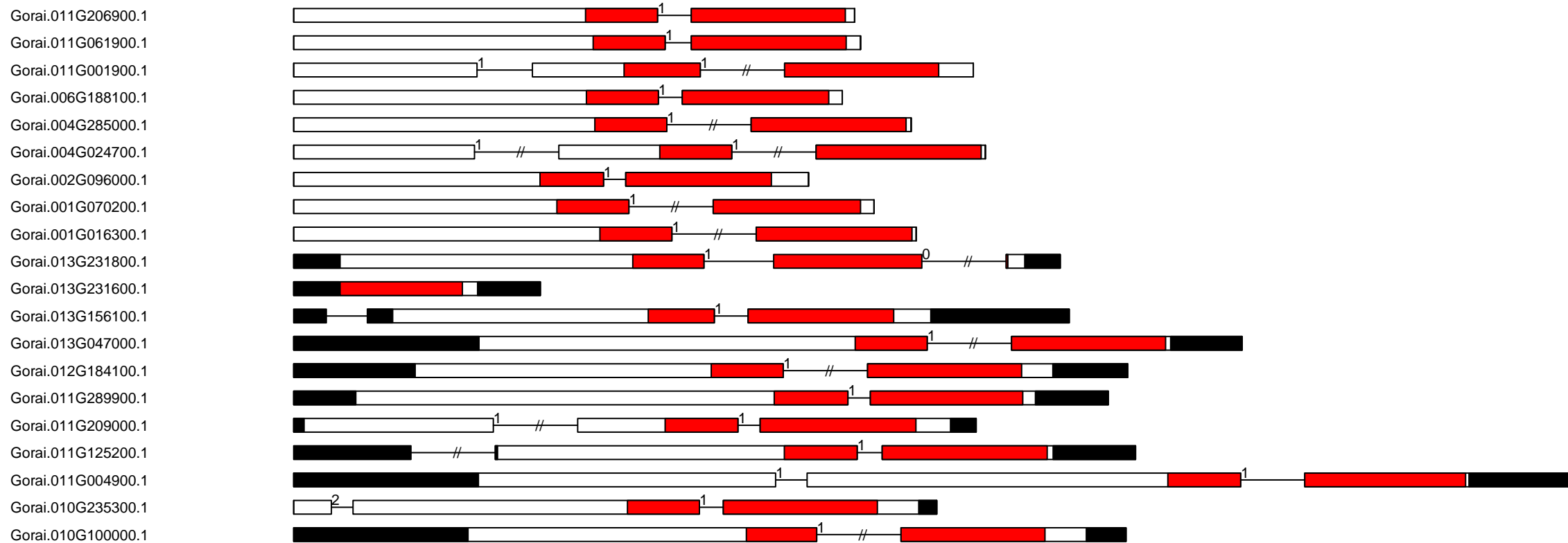

G.ra RLK-Pelle_LRR-III exon-intron and domain diagram (part 4)

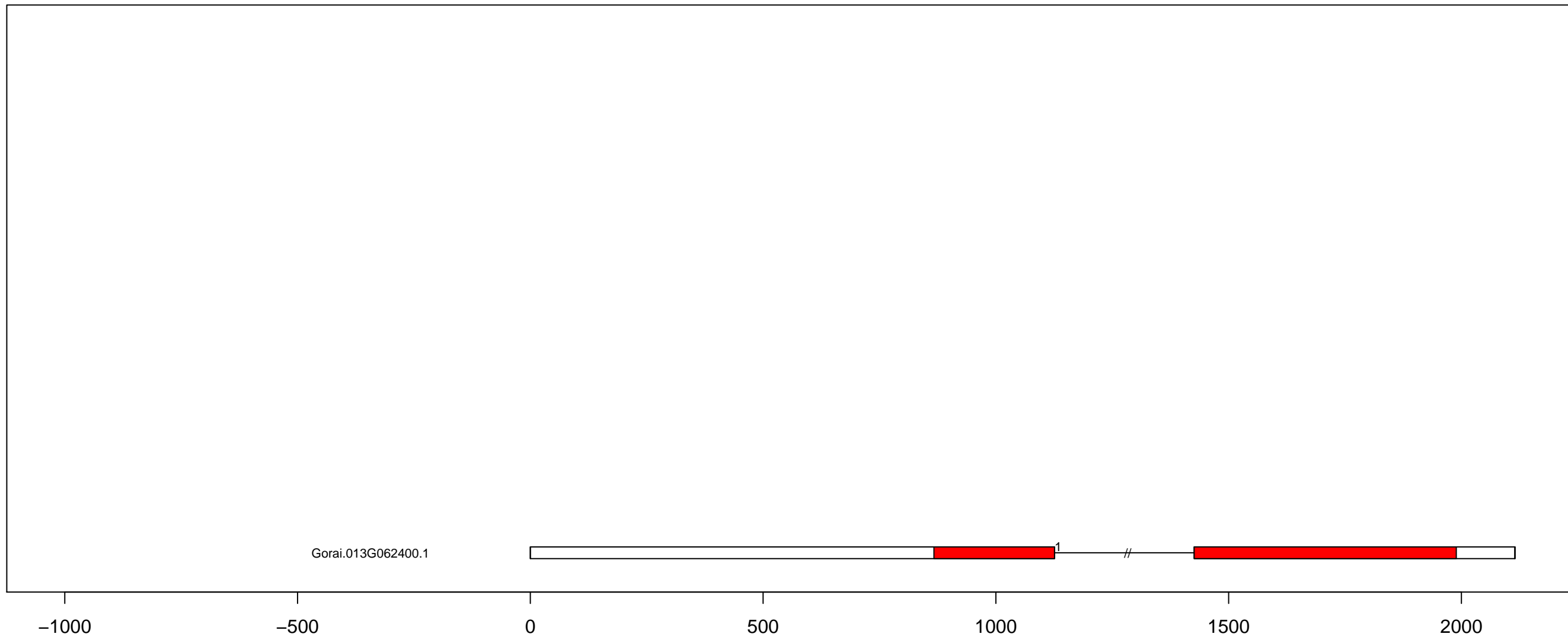

G.ra RLK-Pelle_LRR-II exon-intron and domain diagram (all)

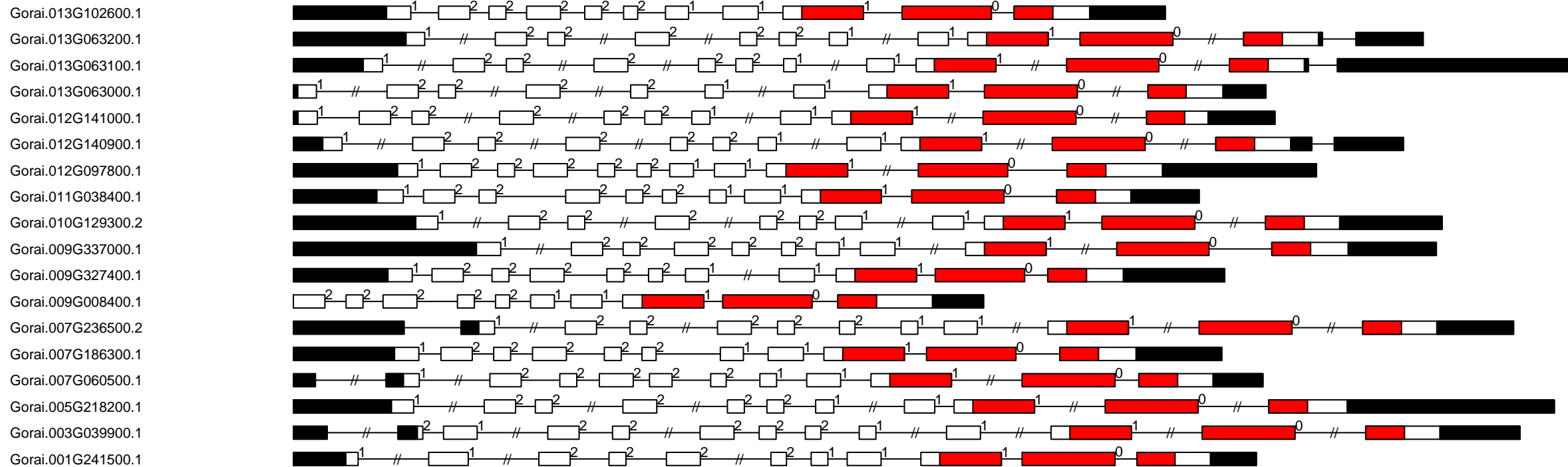

G.ra RLK-Pelle_LRR-IV exon-intron and domain diagram (all)

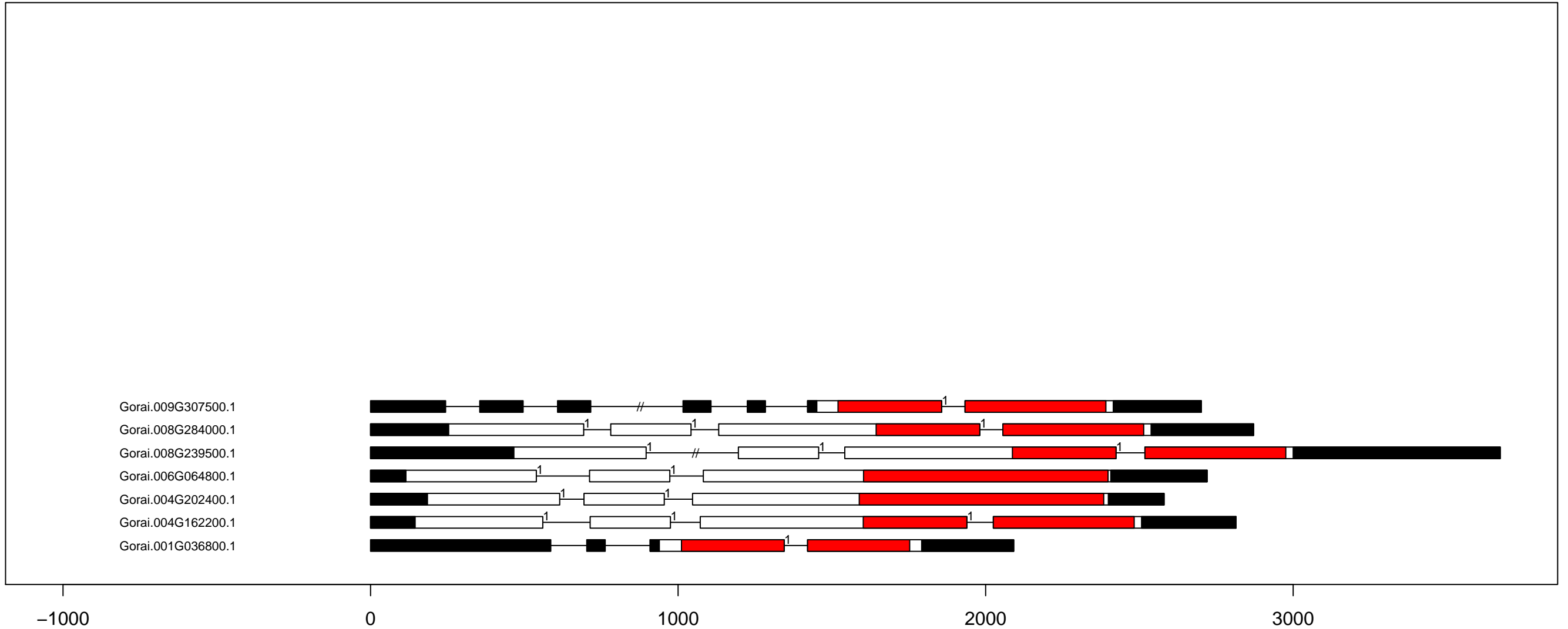

G.ra RLK-Pelle_LRR-IX exon-intron and domain diagram (all)

Gorai.006G224800.1
Gorai.013G030200.1
Gorai.011G151900.1
Gorai.008G170100.1
Gorai.007G187900.1
Gorai.006G149500.1
Gorai.006G115200.1
Gorai.005G026700.1
Gorai.002G235300.1
Gorai.001G125200.1

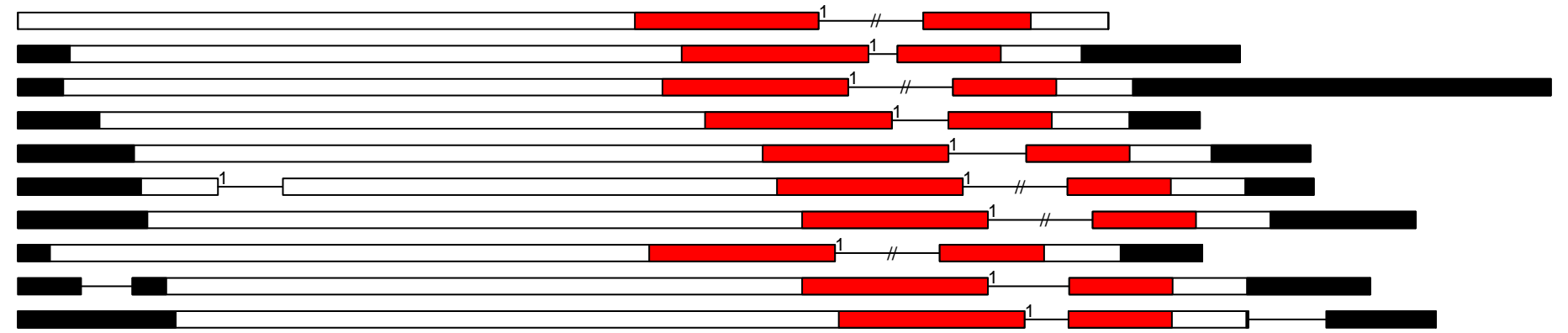

G.ra RLK-Pelle_LRR-VI-1 exon-intron and domain diagram (all)

Gorai.N006900.1
Gorai.013G195600.1
Gorai.012G088400.1
Gorai.008G205300.3
Gorai.007G256600.1
Gorai.005G139400.1
Gorai.001G269200.1
Gorai.001G060100.1

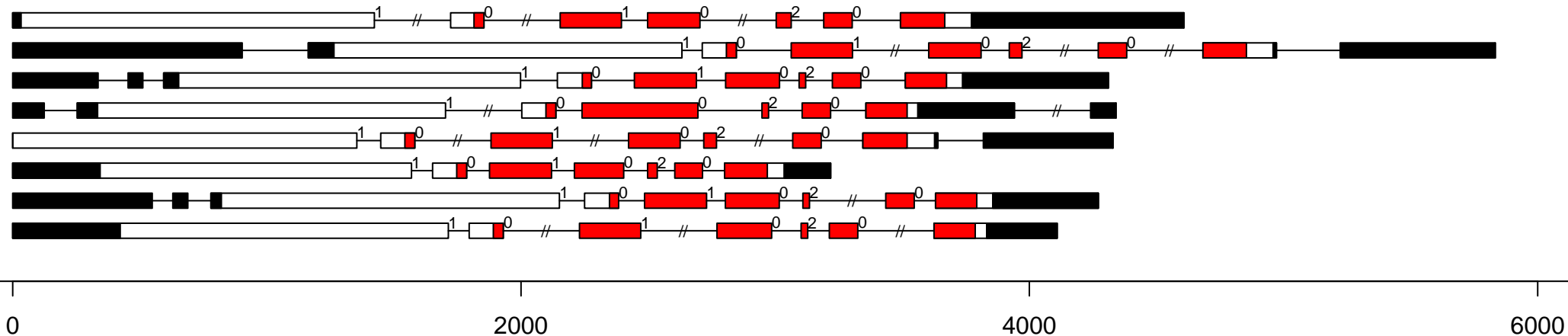

G.ra RLK-Pelle_LRR-VI-2 exon-intron and domain diagram (all)

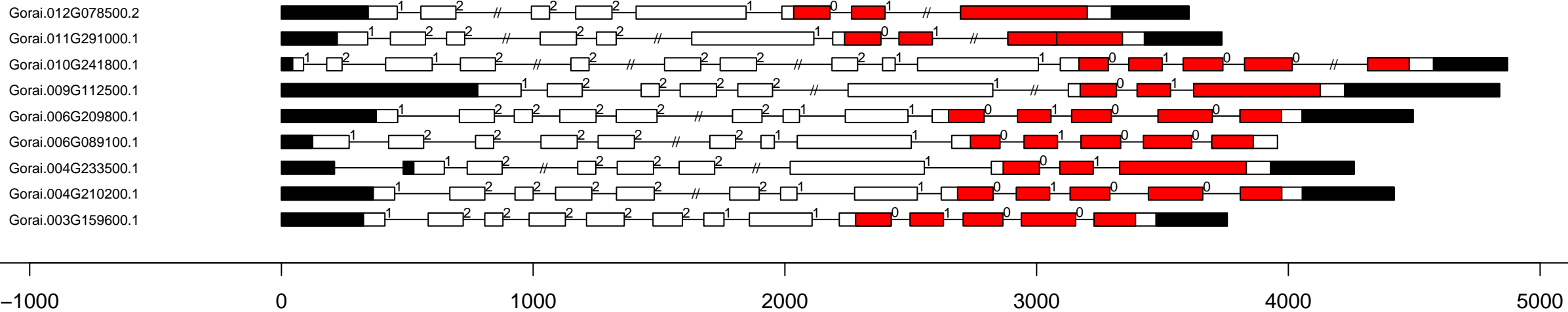

G.ra RLK-Pelle_LRR-VII-1 exon-intron and domain diagram (all)

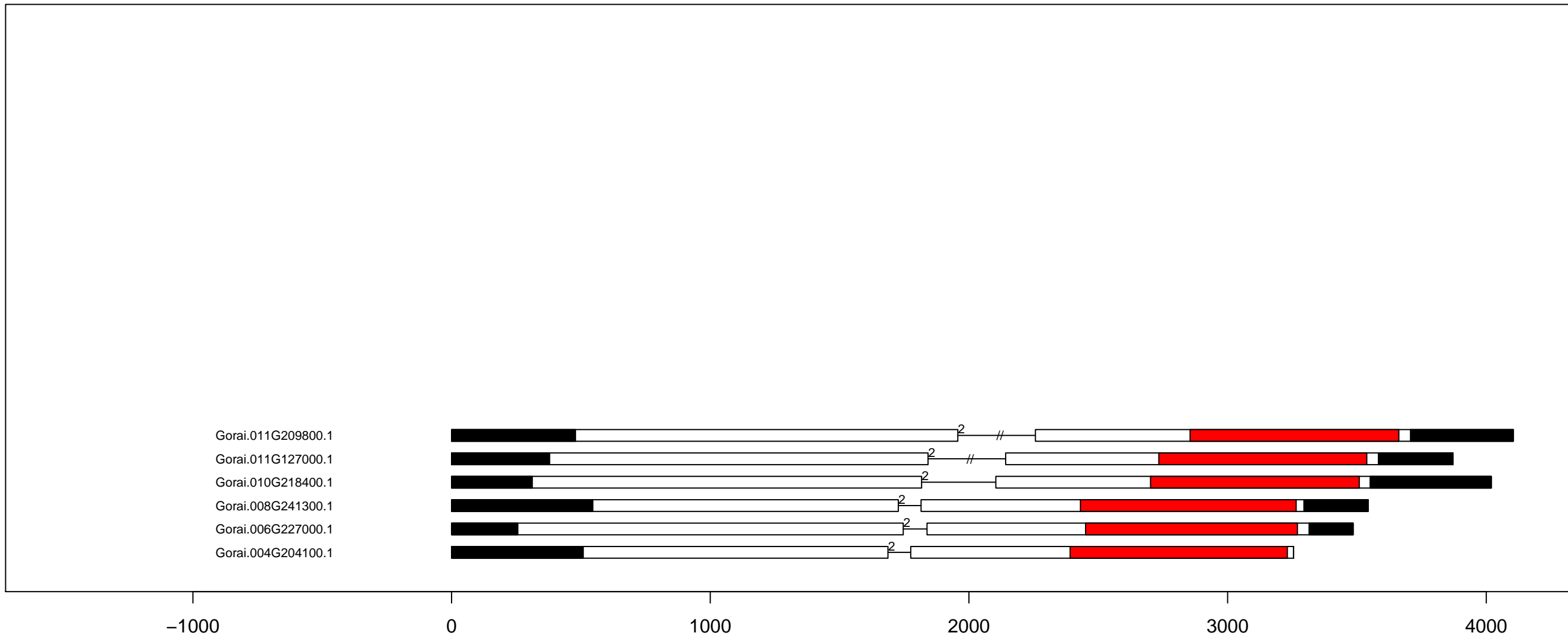

G.ra RLK-Pelle_LRR-VII-2 exon-intron and domain diagram (all)

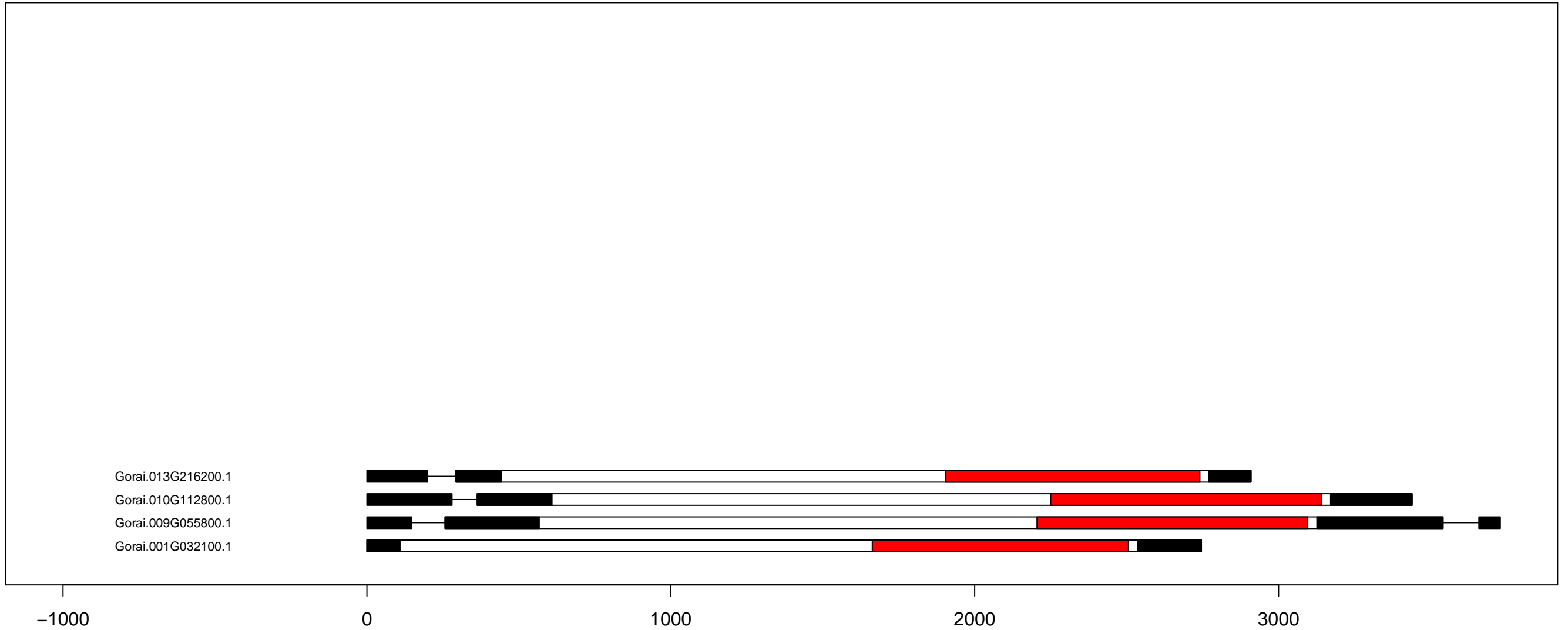

G.ra RLK-Pelle_LRR-VII-3 exon-intron and domain diagram (all)

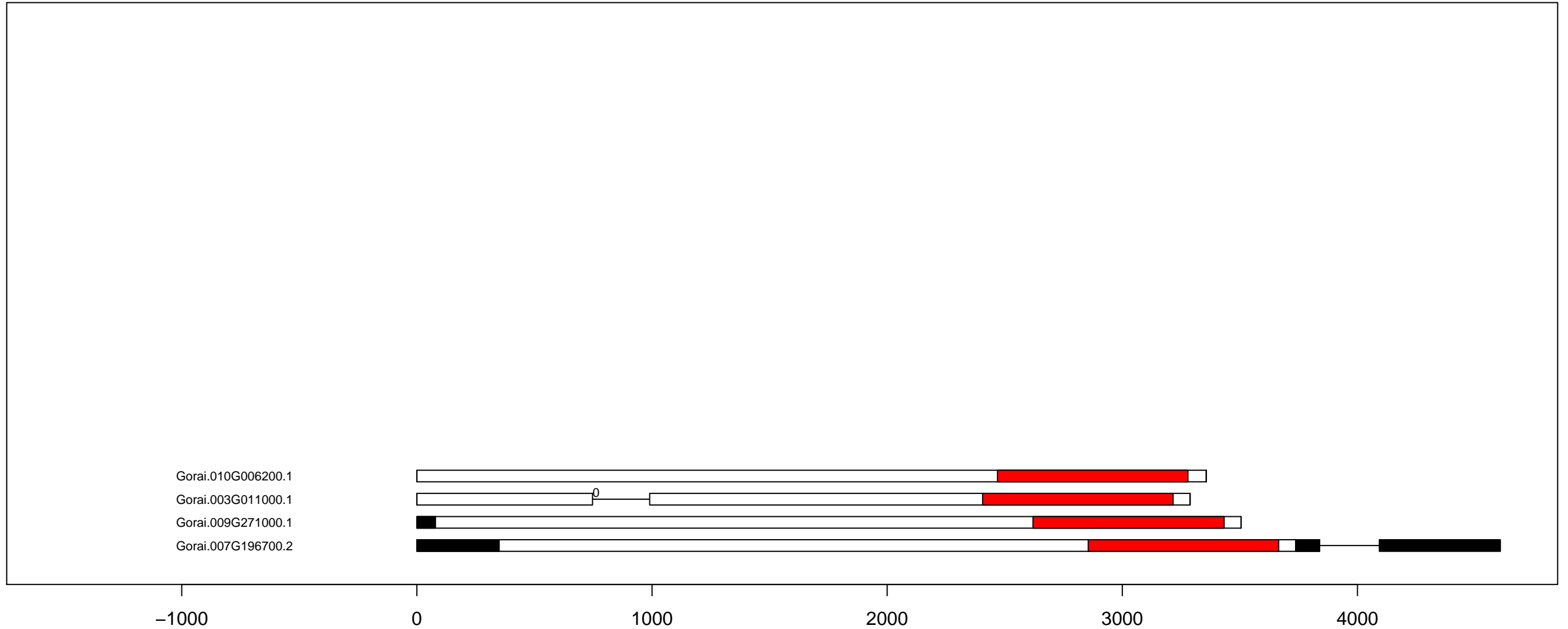

G.ra RLK-Pelle_LRR-VIII-1 exon-intron and domain diagram (all)

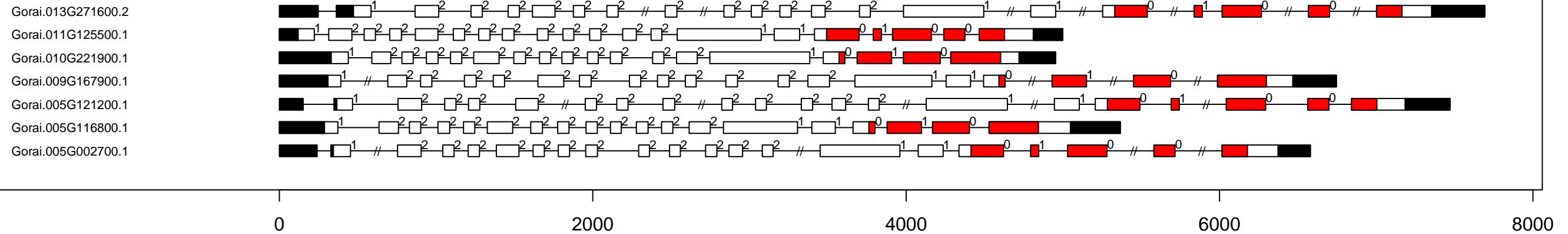

G.ra RLK-Pelle_LRR-V exon-intron and domain diagram (all)

Gorai.011G054100.1
 Gorai.006G141800.1
 Gorai.011G024500.1
 Gorai.011G011800.1
 Gorai.010G183400.1
 Gorai.010G172500.1
 Gorai.009G148500.1
 Gorai.009G120500.1
 Gorai.005G204500.2

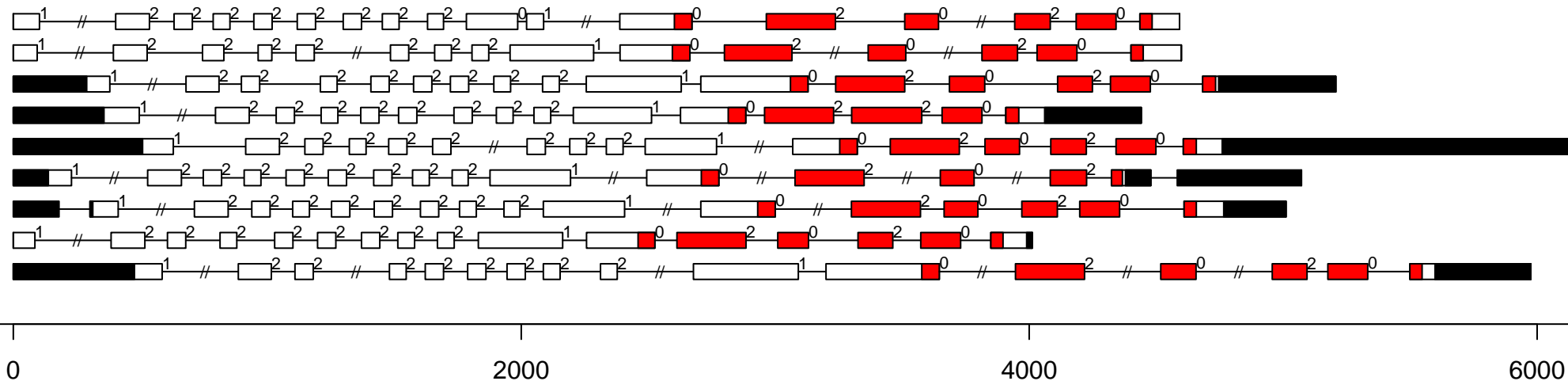

G.ra RLK-Pelle_LRR-Xa exon-intron and domain diagram (all)

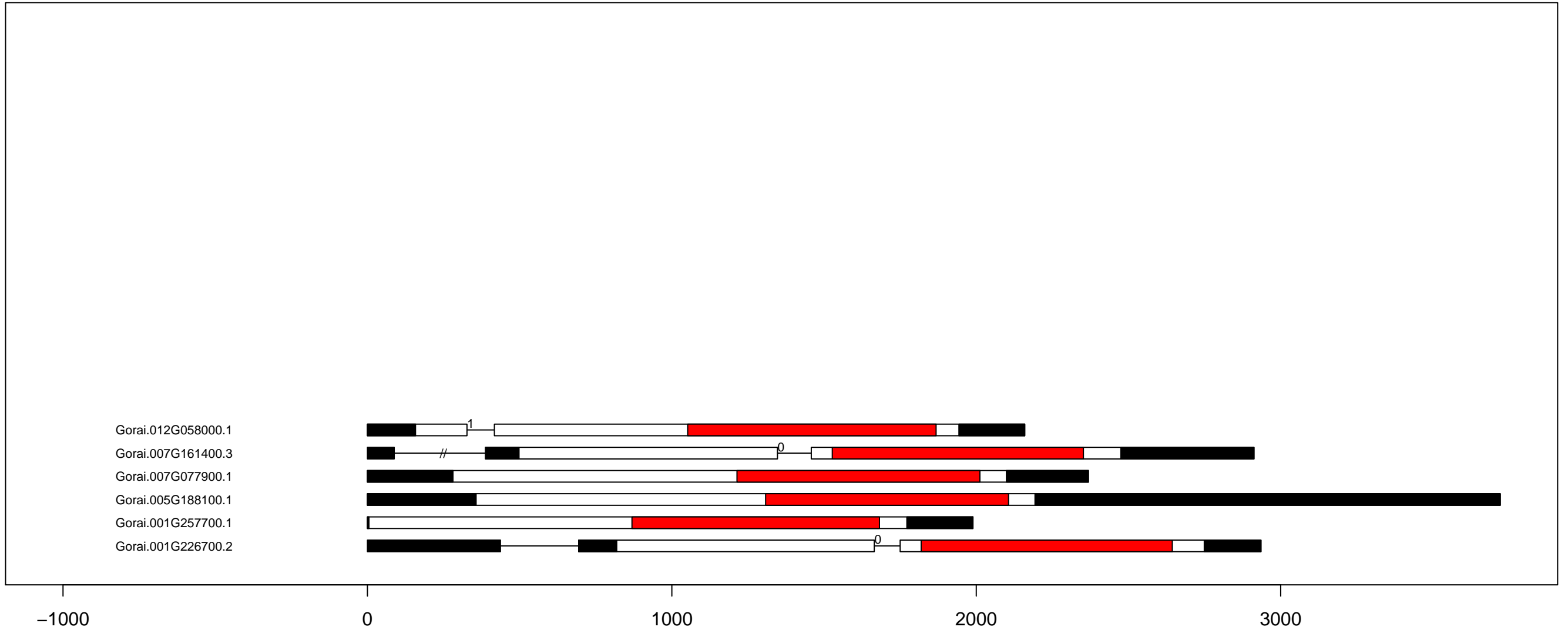

G.ra RLK-Pelle_LRR-Xb-1 exon-intron and domain diagram (all)

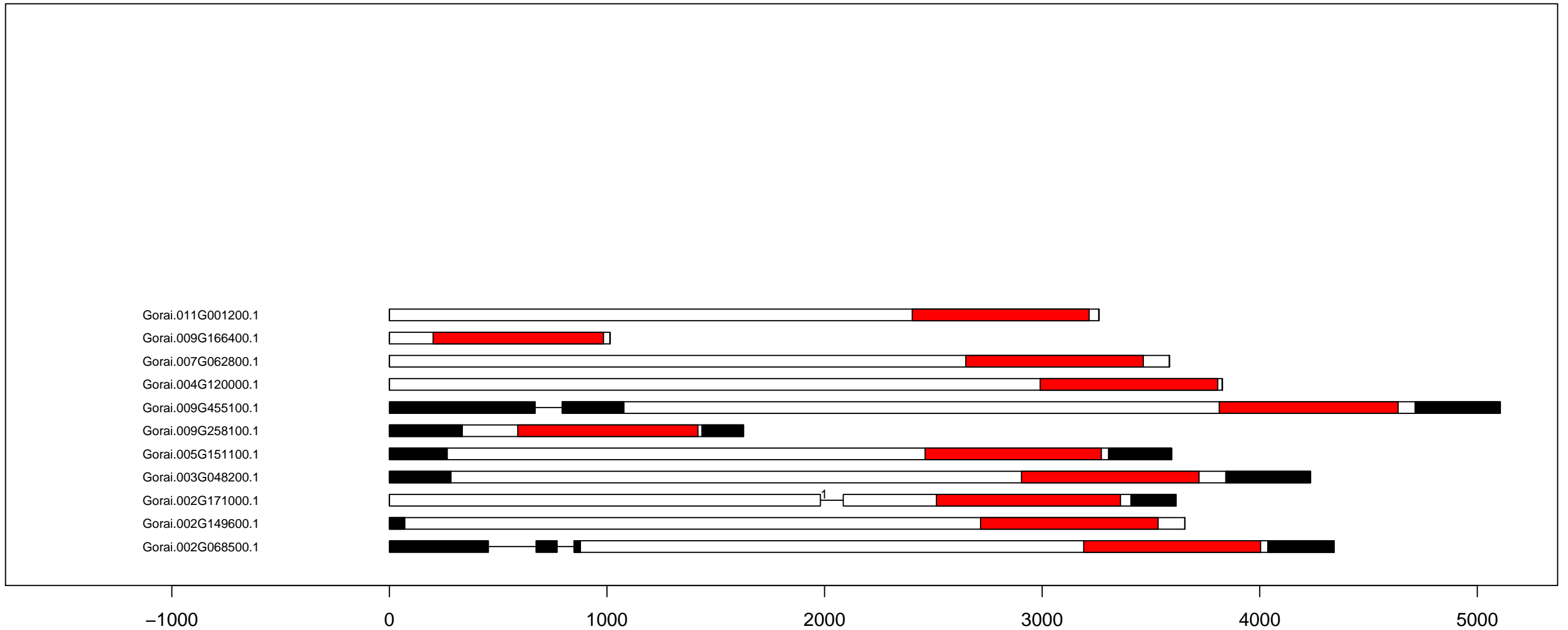

G.ra RLK-Pelle_LRR-Xb-2 exon-intron and domain diagram (all)

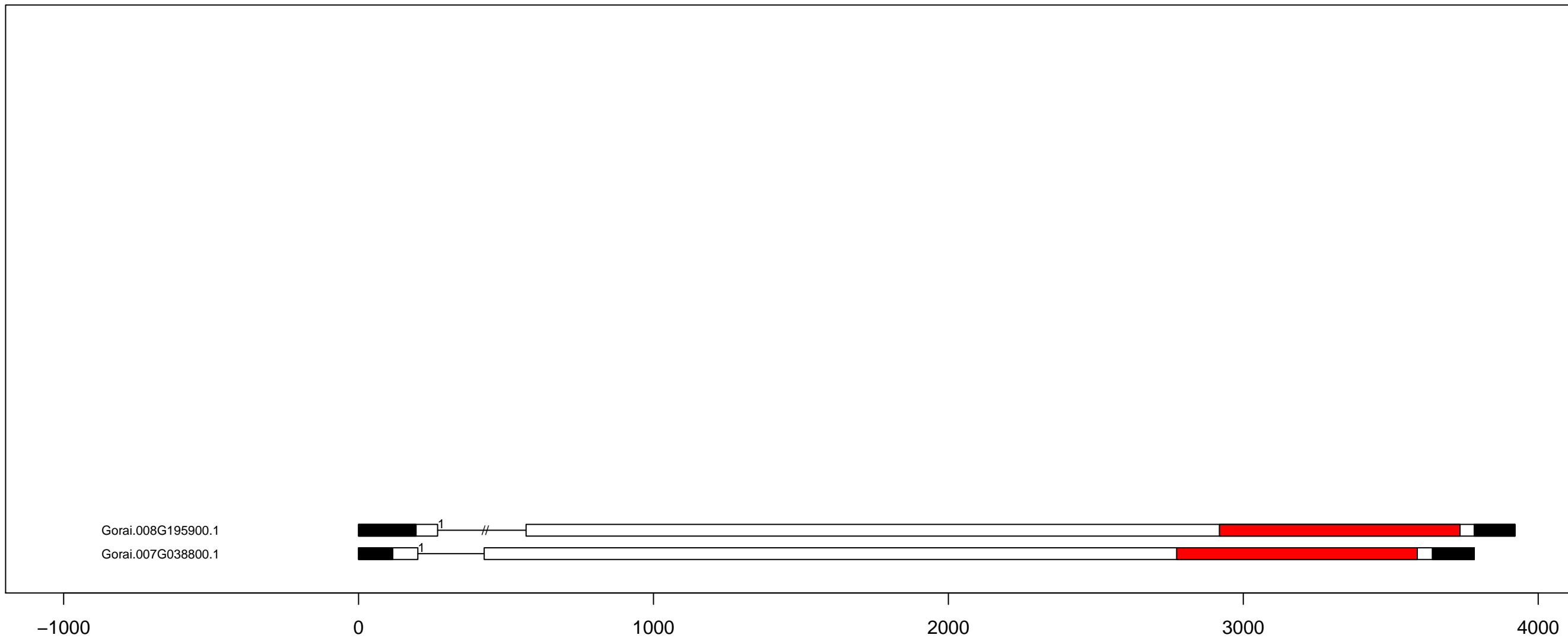

G.ra RLK-Pelle_LRR-XI-1 exon-intron and domain diagram (part 1)

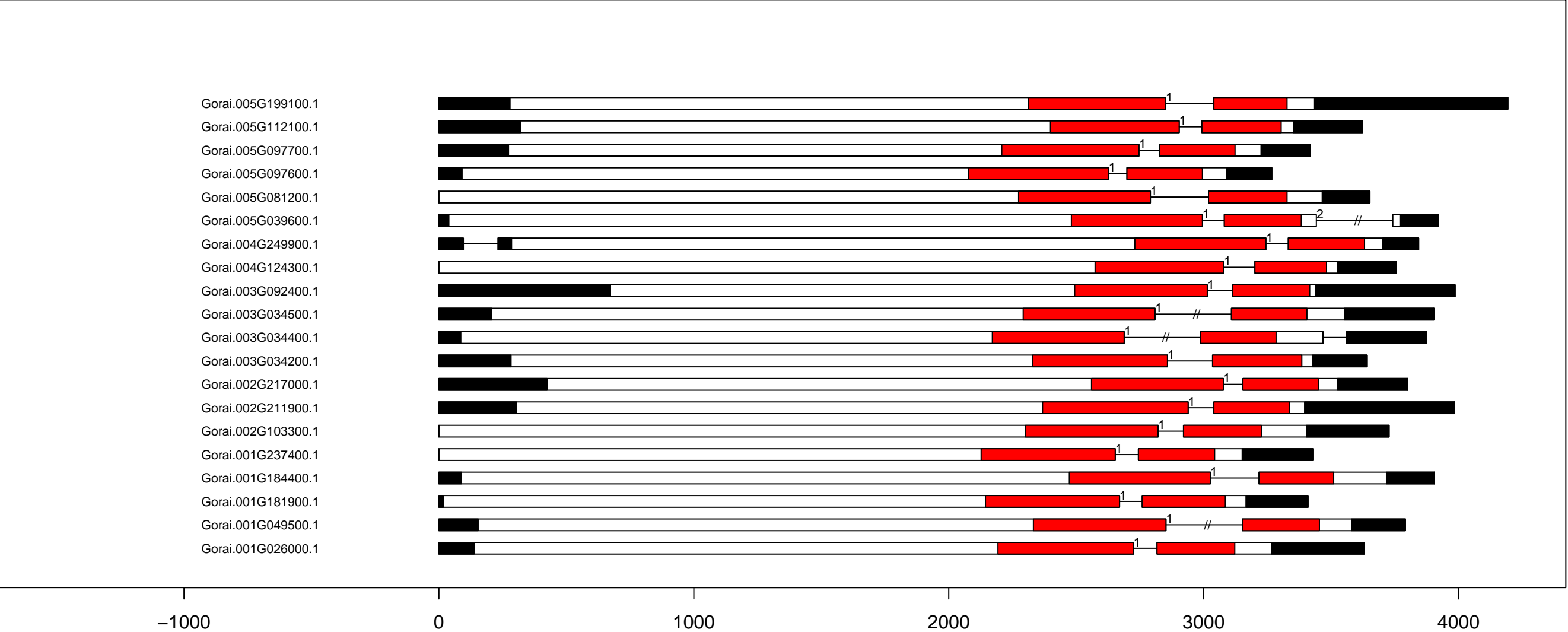

G.ra RLK-Pelle_LRR-XI-1 exon-intron and domain diagram (part 2)

Gorai.009G048200.1
 Gorai.009G027700.1
 Gorai.008G215400.1
 Gorai.008G087500.1
 Gorai.008G051700.1
 Gorai.007G273700.1
 Gorai.007G271300.2
 Gorai.007G228700.1
 Gorai.007G148900.1
 Gorai.006G219400.2
 Gorai.006G139200.1
 Gorai.006G137100.1
 Gorai.006G131800.1
 Gorai.006G022800.1
 Gorai.006G020800.1
 Gorai.006G020400.1
 Gorai.006G020100.1
 Gorai.006G020000.1
 Gorai.005G268400.1
 Gorai.005G265400.1

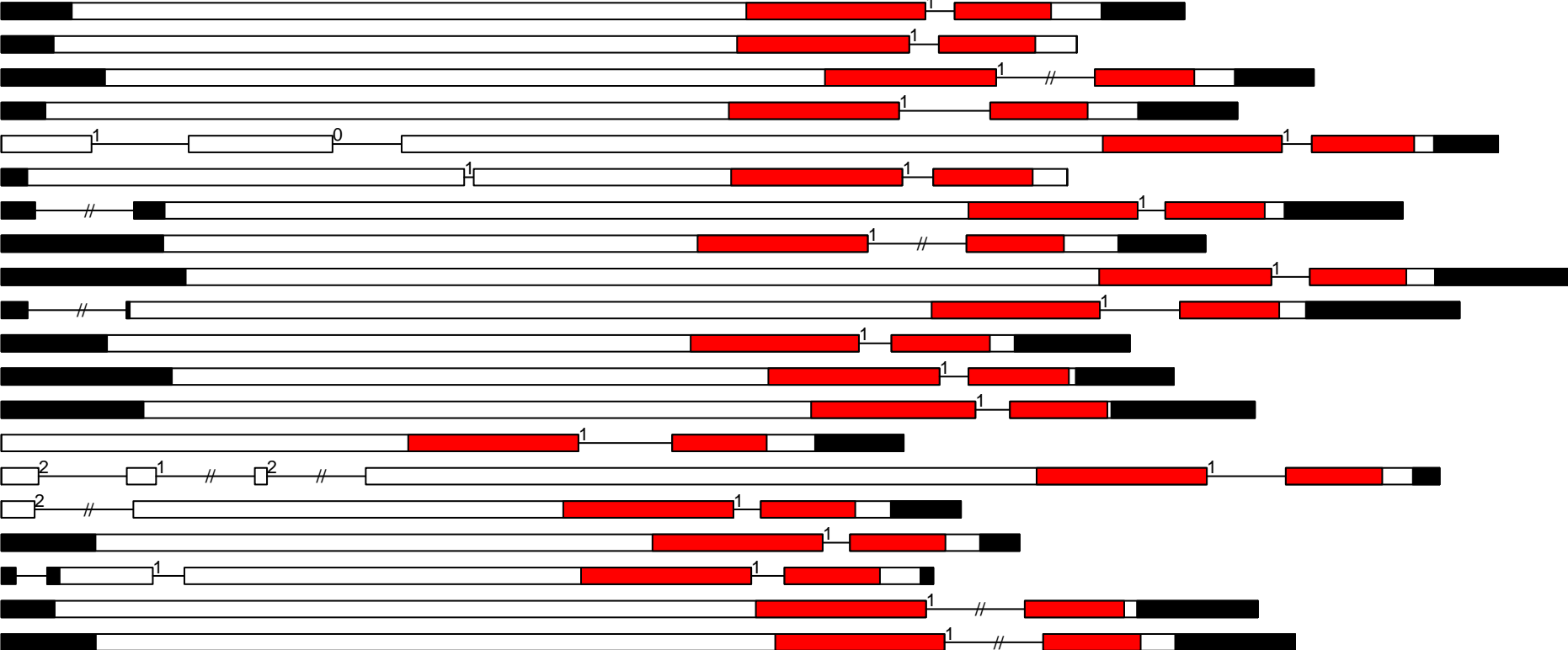

-1000

0

1000

2000

3000

4000

5000

G.ra RLK-Pelle_LRR-XI-1 exon-intron and domain diagram (part 3)

Gorai.011G217800.1
Gorai.011G217500.1
Gorai.011G162100.1
Gorai.011G030400.1
Gorai.011G008200.1
Gorai.010G110800.1
Gorai.010G104300.2
Gorai.010G040600.1
Gorai.010G030500.1
Gorai.009G452000.2
Gorai.009G287800.2
Gorai.009G286600.1
Gorai.009G278300.1
Gorai.009G265300.1
Gorai.009G237700.1
Gorai.009G225300.1
Gorai.009G225100.1
Gorai.009G193600.1
Gorai.009G166500.1
Gorai.009G053200.1

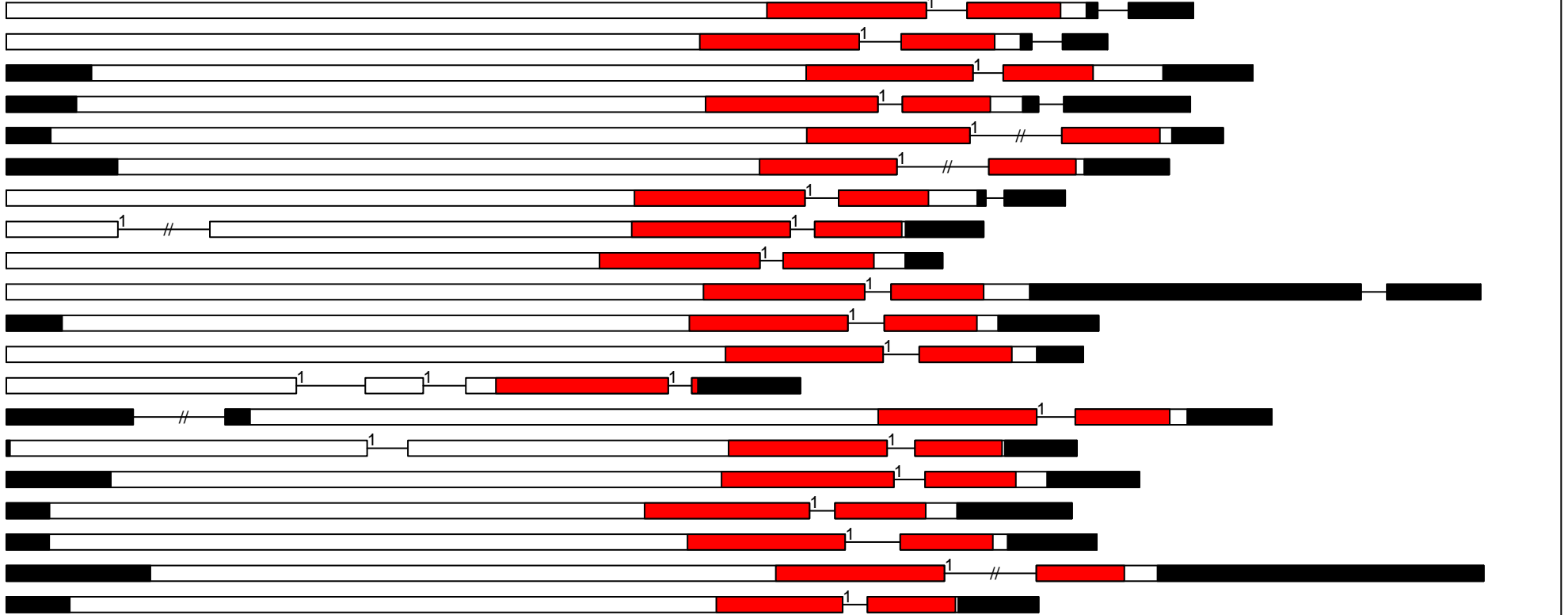

G.ra RLK-Pelle_LRR-XI-1 exon-intron and domain diagram (part 4)

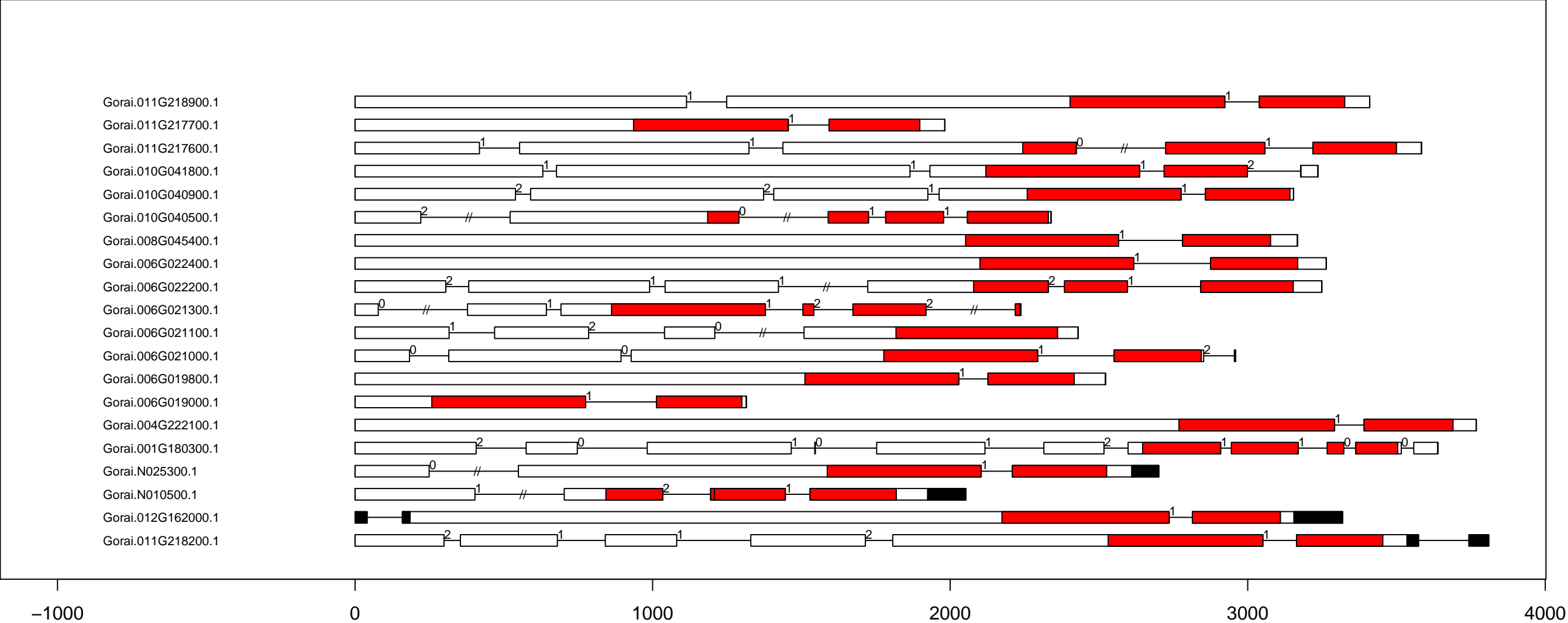

G.ra RLK-Pelle_LRR-XI-1 exon-intron and domain diagram (part 5)

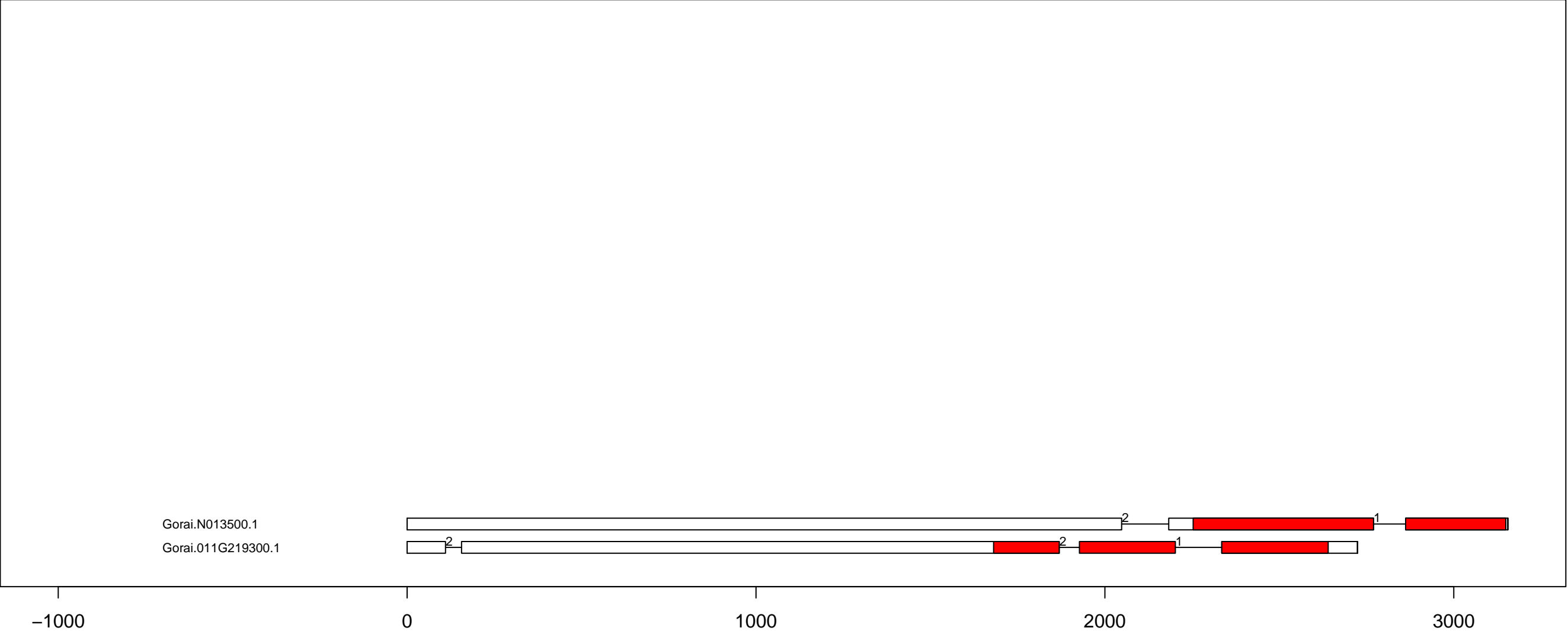

G.ra RLK-Pelle_LRR-XI-2 exon-intron and domain diagram (all)

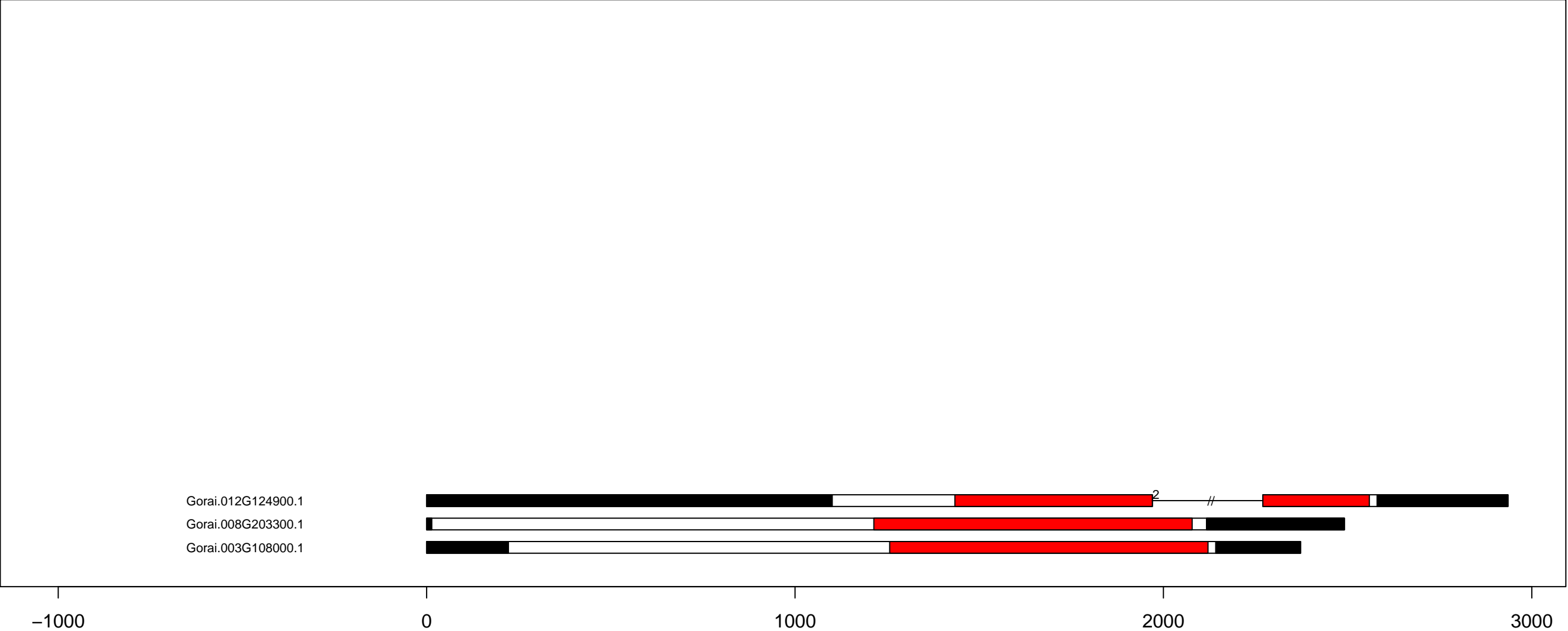

G.ra RLK-Pelle_LRR-XII-1 exon-intron and domain diagram (part 1)

Gorai.011G000900.1
Gorai.010G165300.1
Gorai.010G136200.1
Gorai.009G436300.1
Gorai.009G436200.1
Gorai.009G371100.1
Gorai.009G370000.1
Gorai.009G369800.1
Gorai.009G340400.1
Gorai.008G290200.1
Gorai.007G181000.1
Gorai.007G045900.1
Gorai.004G027800.1
Gorai.002G260200.1
Gorai.002G133000.1
Gorai.002G131000.1
Gorai.002G064300.1
Gorai.002G051900.1
Gorai.002G051300.1
Gorai.002G049400.1

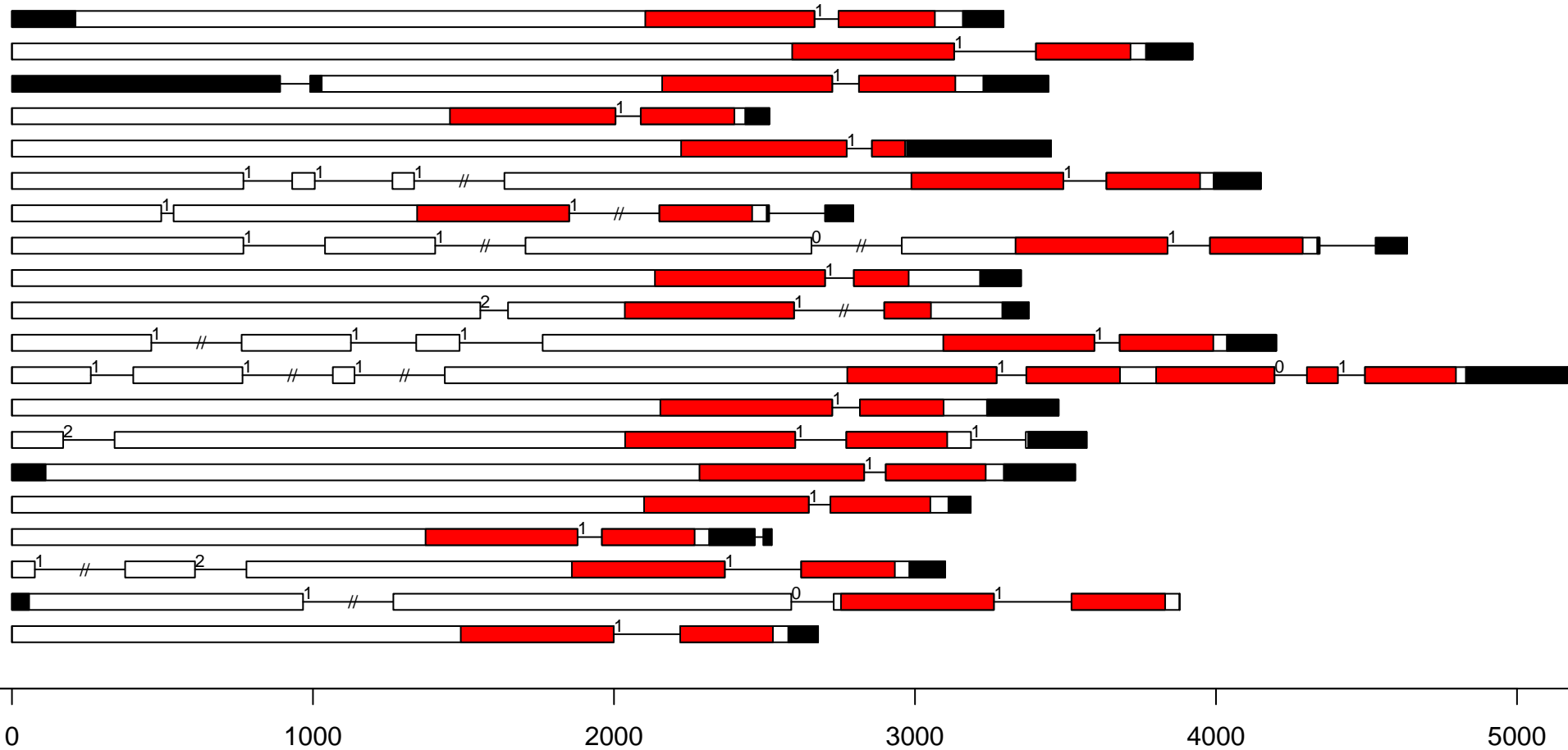

G.ra RLK-Pelle_LRR-XII-1 exon-intron and domain diagram (part 2)

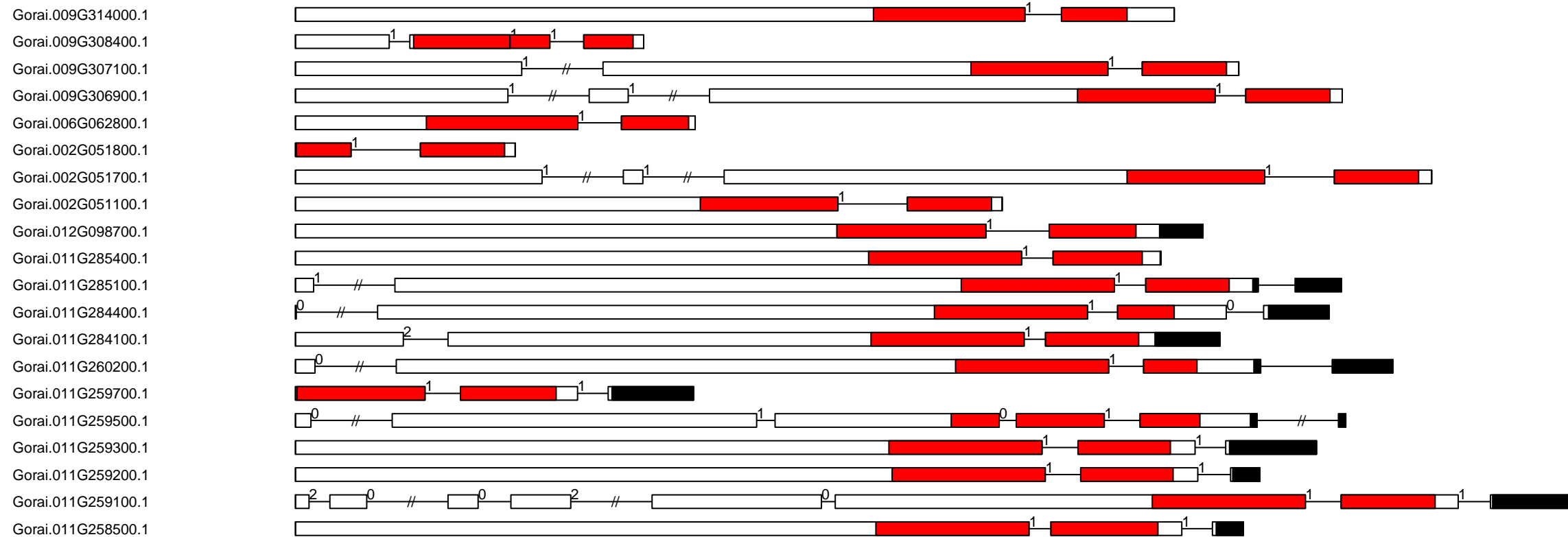

G.ra RLK-Pelle_LRR-XII-1 exon-intron and domain diagram (part 4)

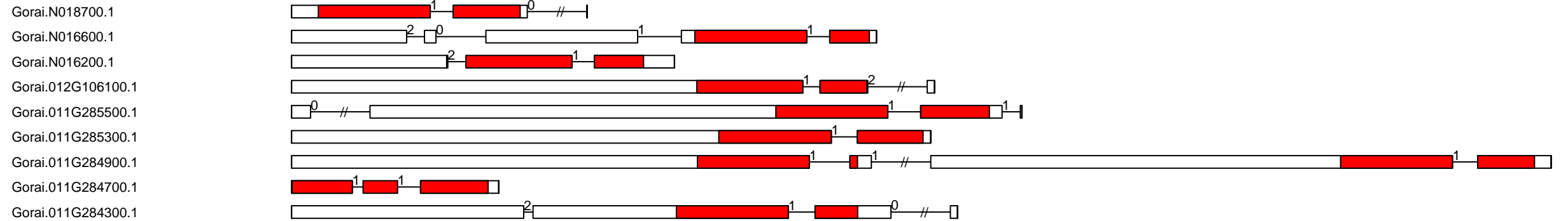

G.ra RLK-Pelle_LRR-XIIIa exon-intron and domain diagram (all)

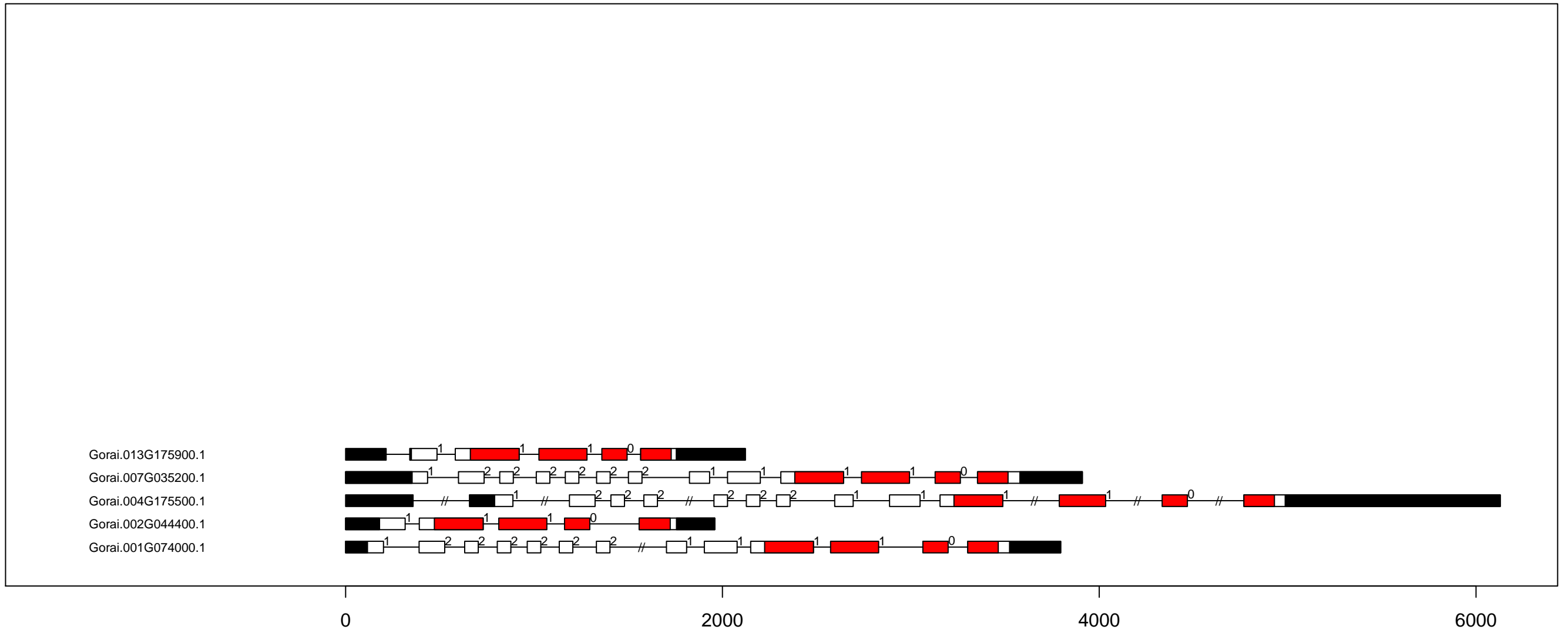

G.ra RLK-Pelle_LRR-XIIIb exon-intron and domain diagram (all)

Gorai.010G096300.1
Gorai.007G009000.2
Gorai.001G019800.1

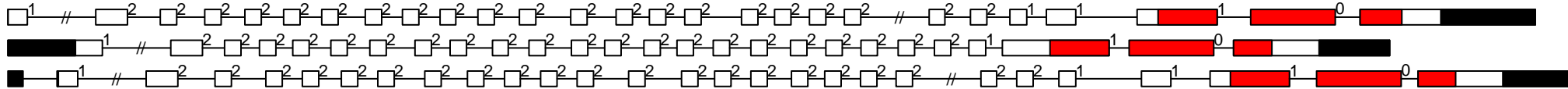

0

2000

4000

6000

G.ra RLK-Pelle_LRR-XIV exon-intron and domain diagram (all)

Gorai.013G036900.1
Gorai.010G010100.2
Gorai.008G029000.1
Gorai.005G243800.1
Gorai.002G127700.4

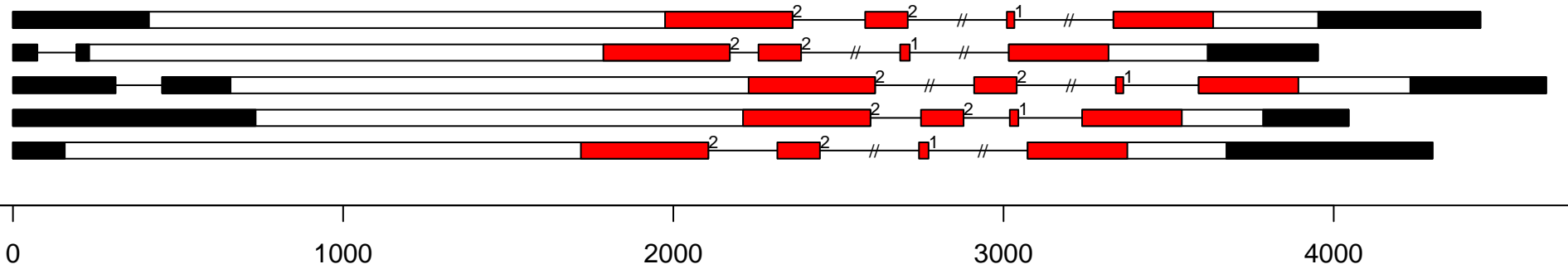

G.ra RLK-Pelle_LRR-XV exon-intron and domain diagram (all)

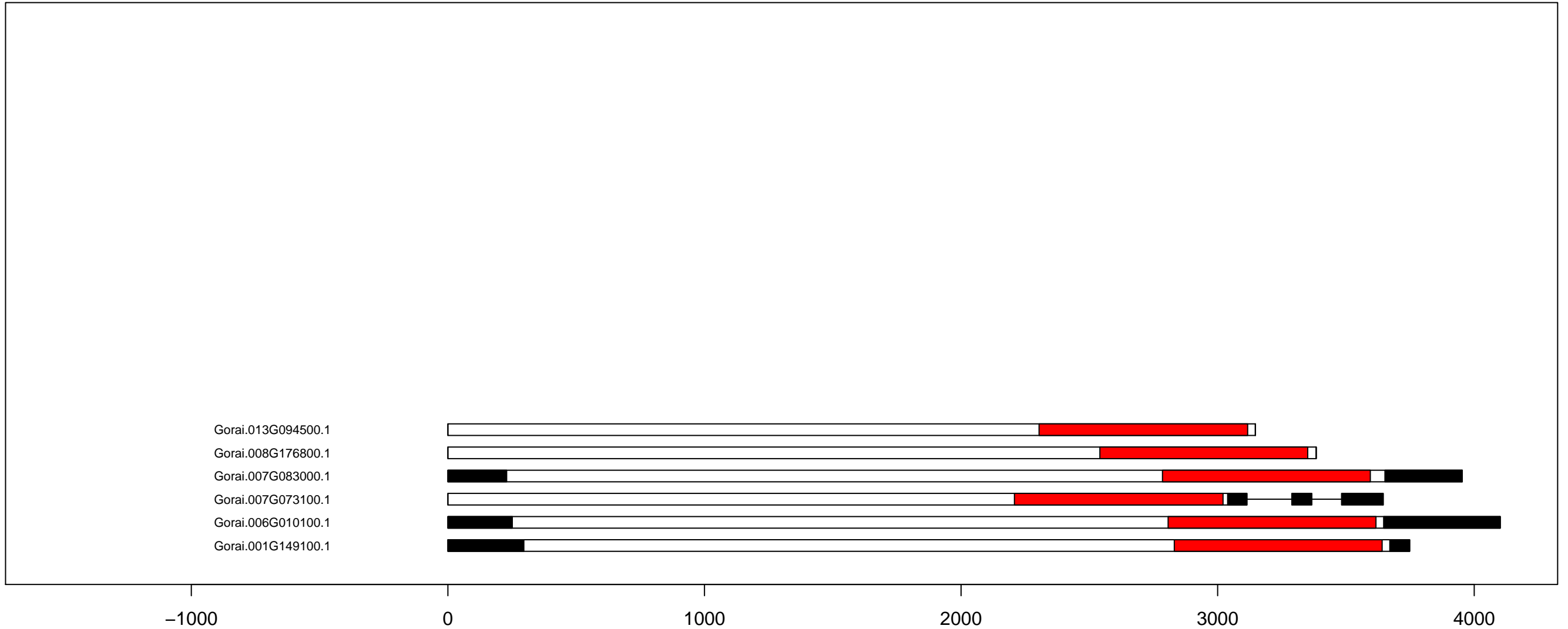

G.ra RLK-Pelle_LysM exon-intron and domain diagram (all)

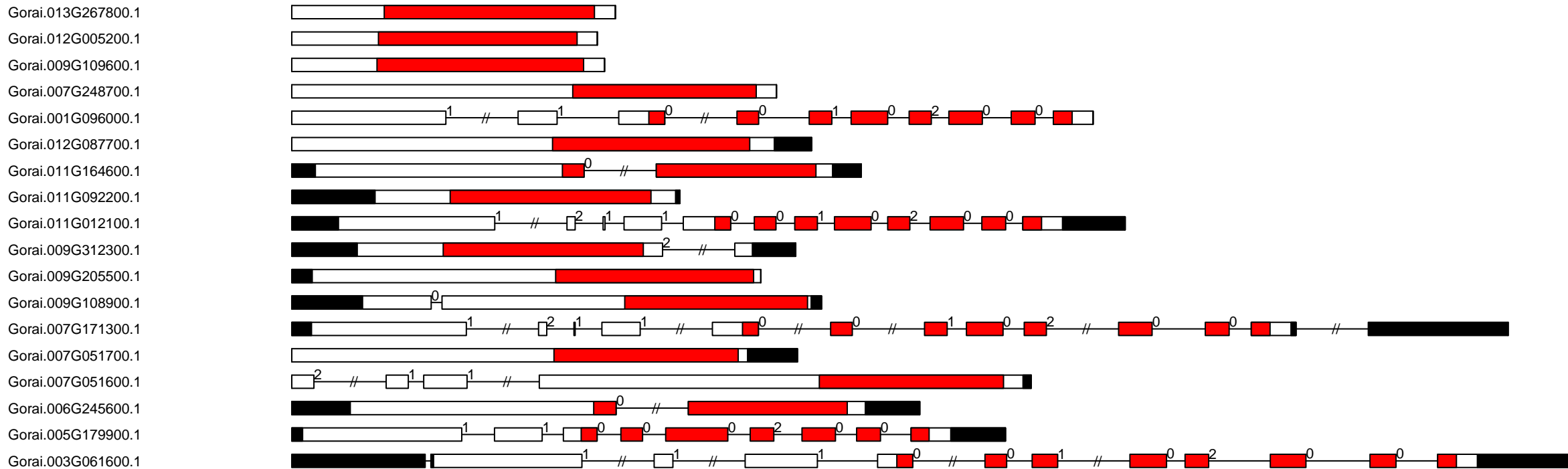

G.ra RLK-Pelle_PERK-1 exon-intron and domain diagram (all)

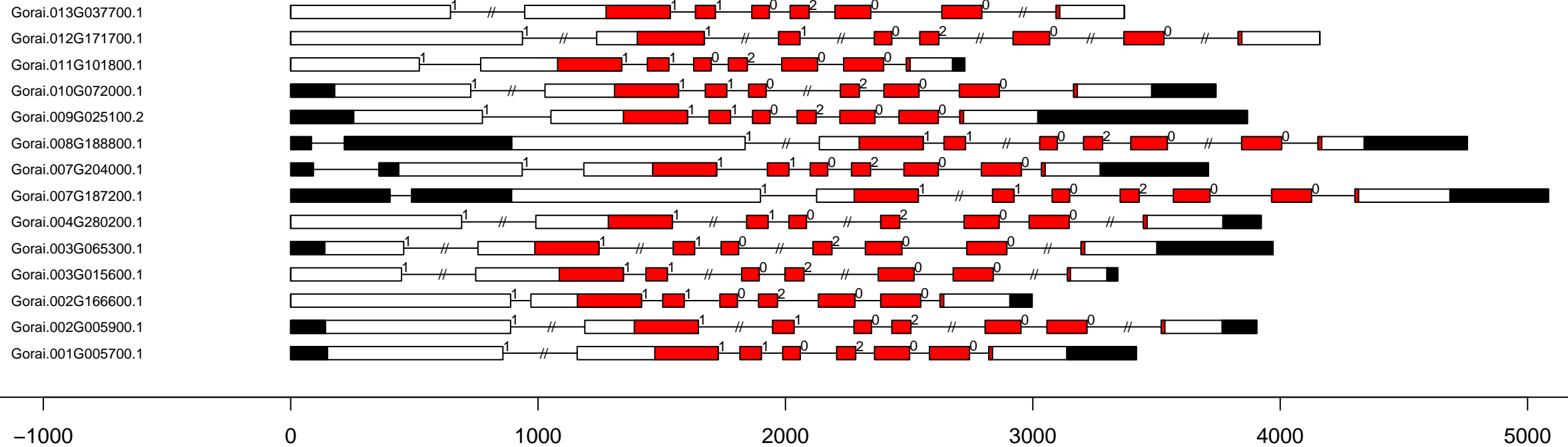

G.ra RLK-Pelle_PERK-2 exon-intron and domain diagram (all)

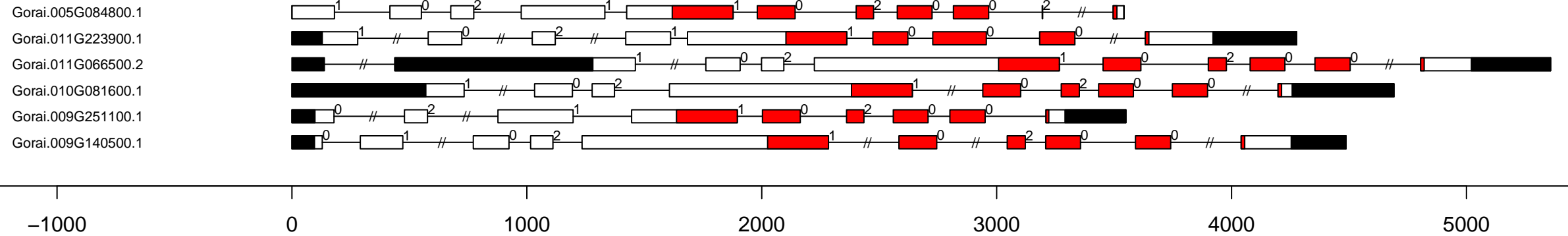

G.ra RLK-Pelle_RKF3 exon-intron and domain diagram (all)

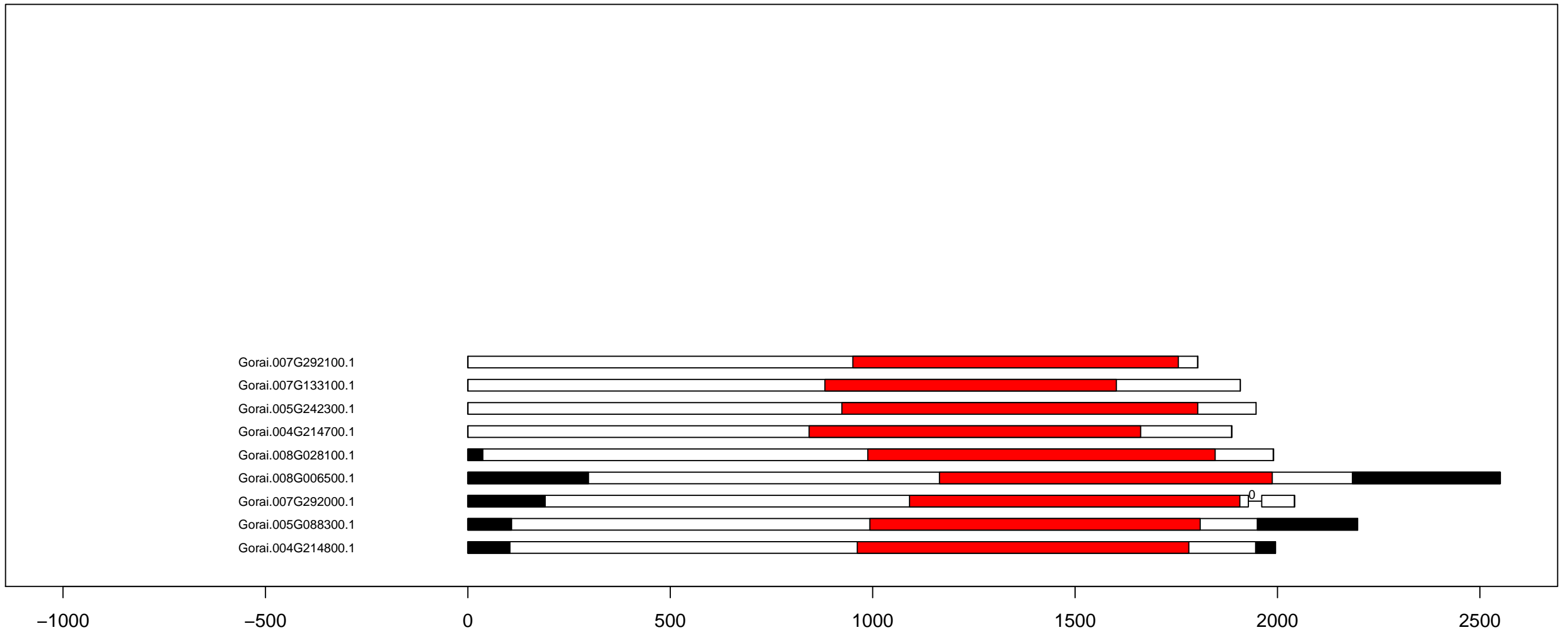

G.ra RLK-Pelle_RLCK-II exon-intron and domain diagram (all)

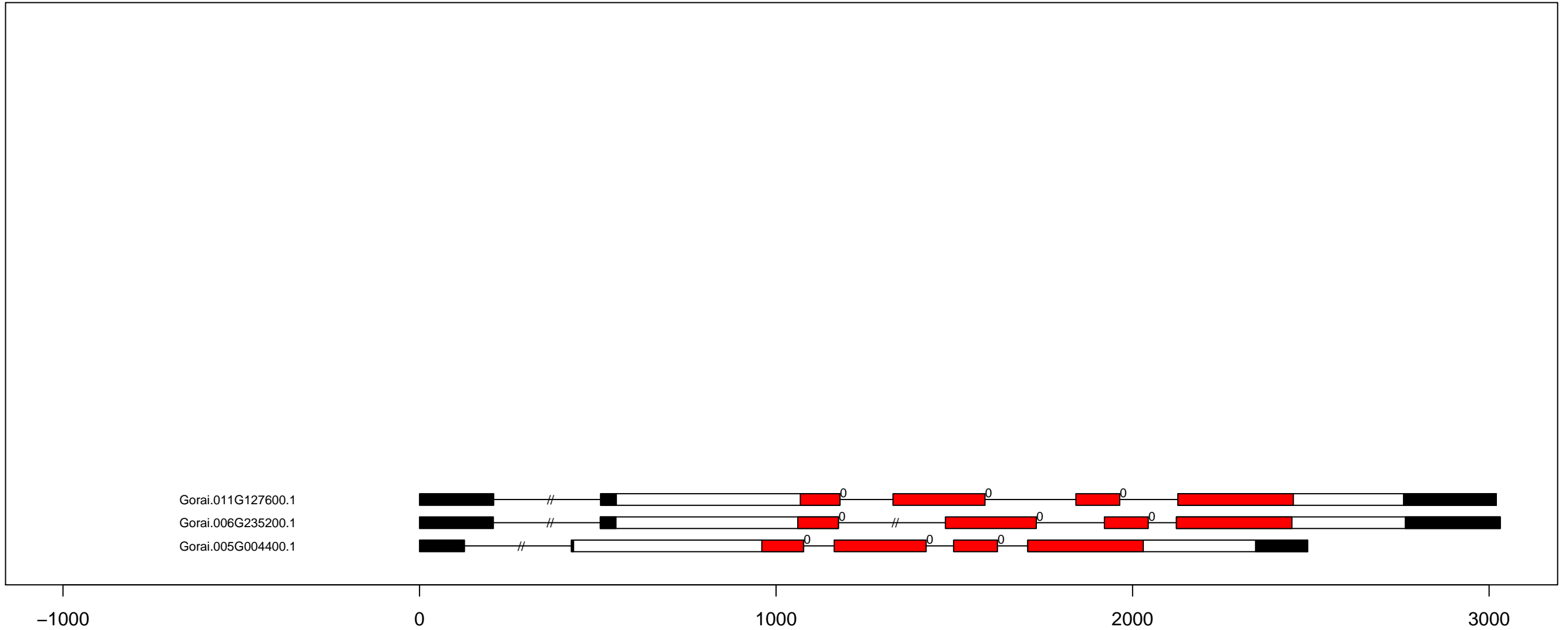

G.ra RLK-Pelle_RLCK-IXa exon-intron and domain diagram (all)

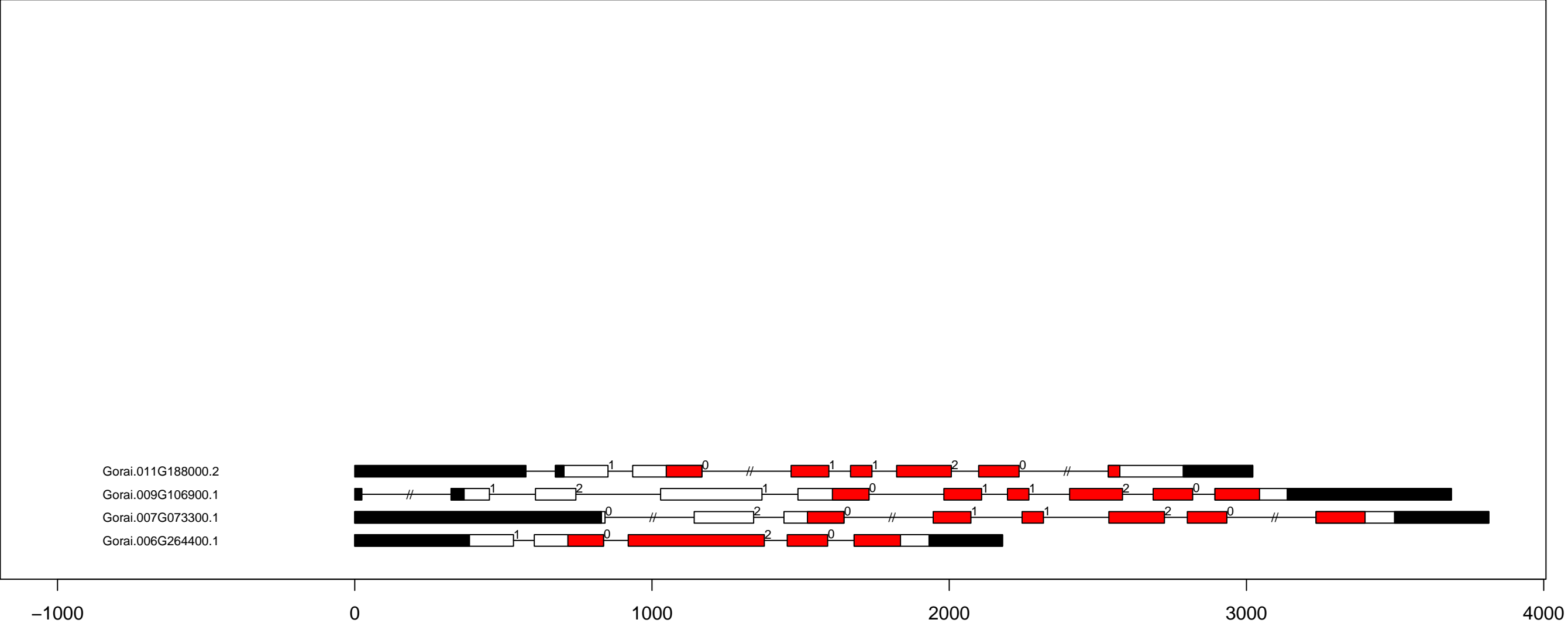

G.ra RLK-Pelle_RLCK-IXb exon-intron and domain diagram (all)

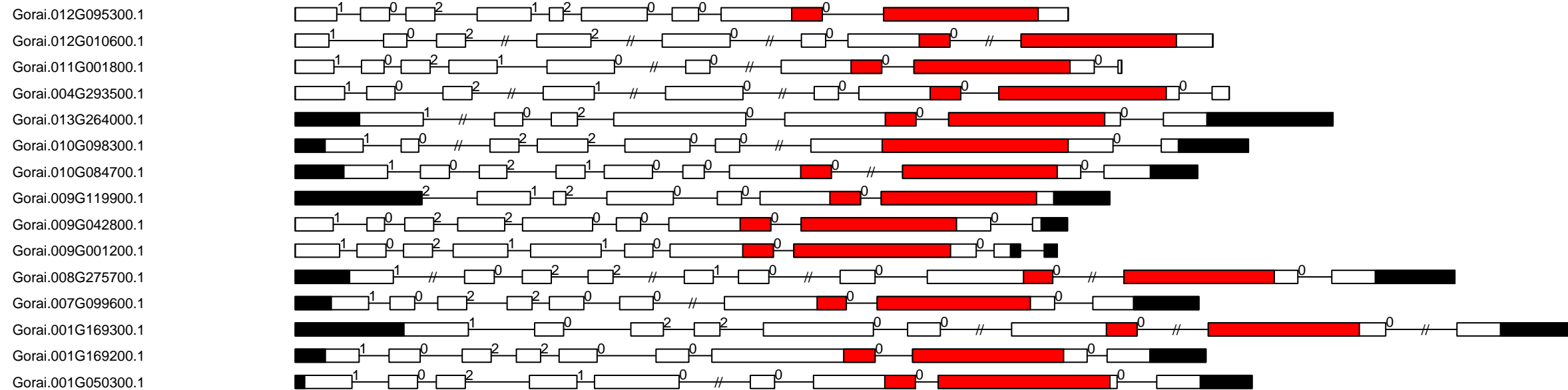

G.ra RLK-Pelle_RLCK-Os exon-intron and domain diagram (all)

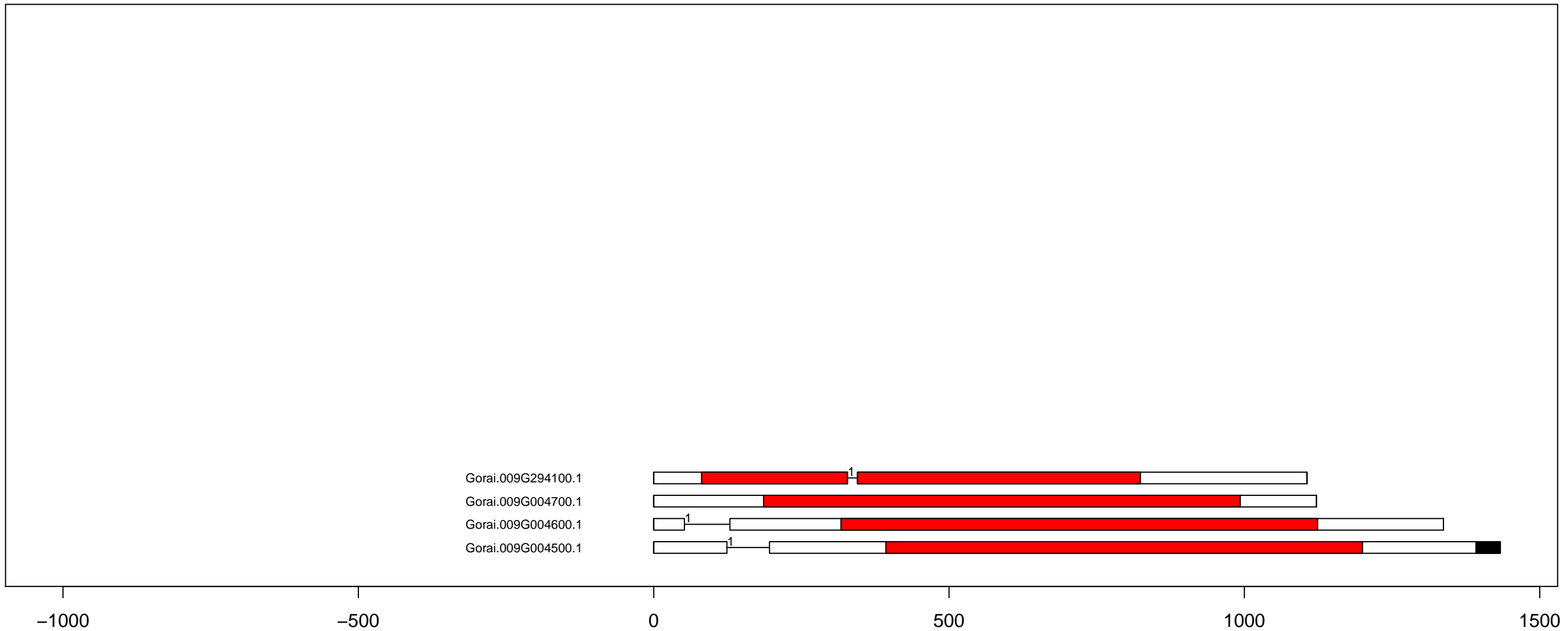

G.ra RLK-Pelle_RLCK-VIIa-1 exon-intron and domain diagram (part 1)

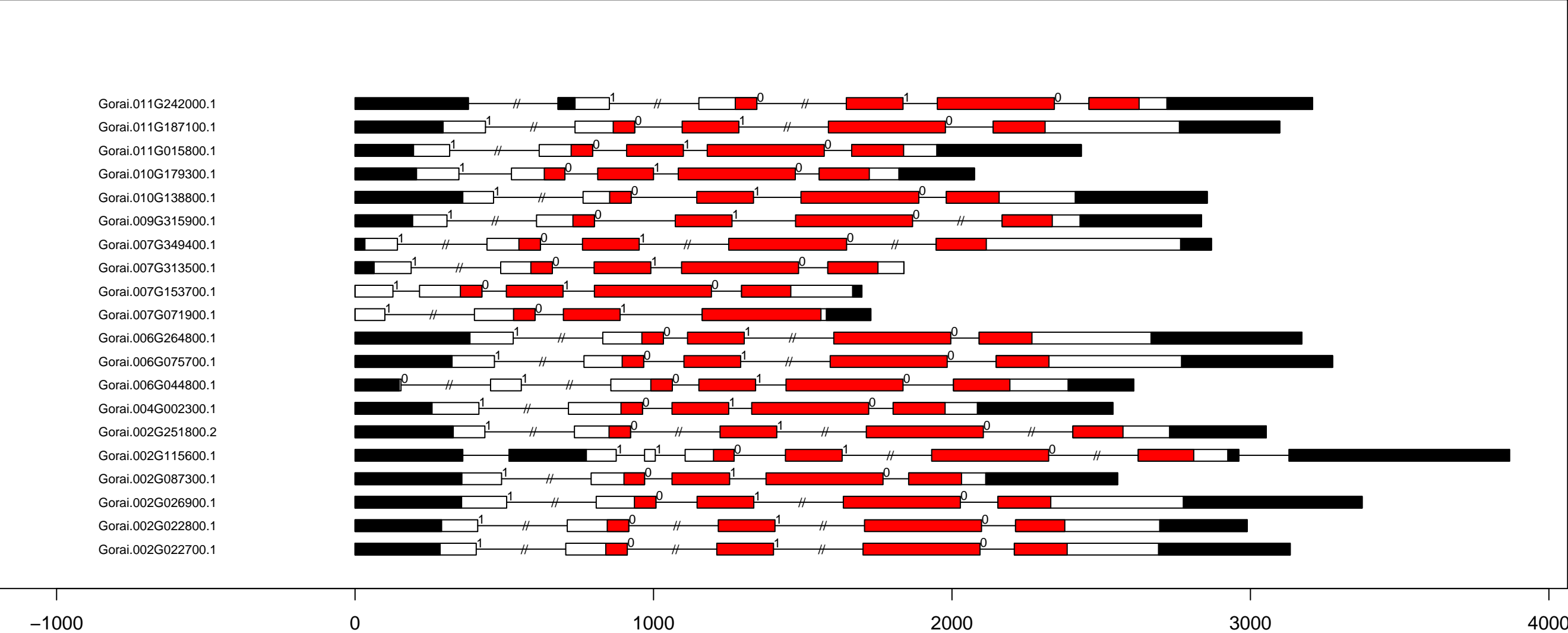

G.ra RLK-Pelle_RLCK-VIIa-1 exon-intron and domain diagram (part 2)

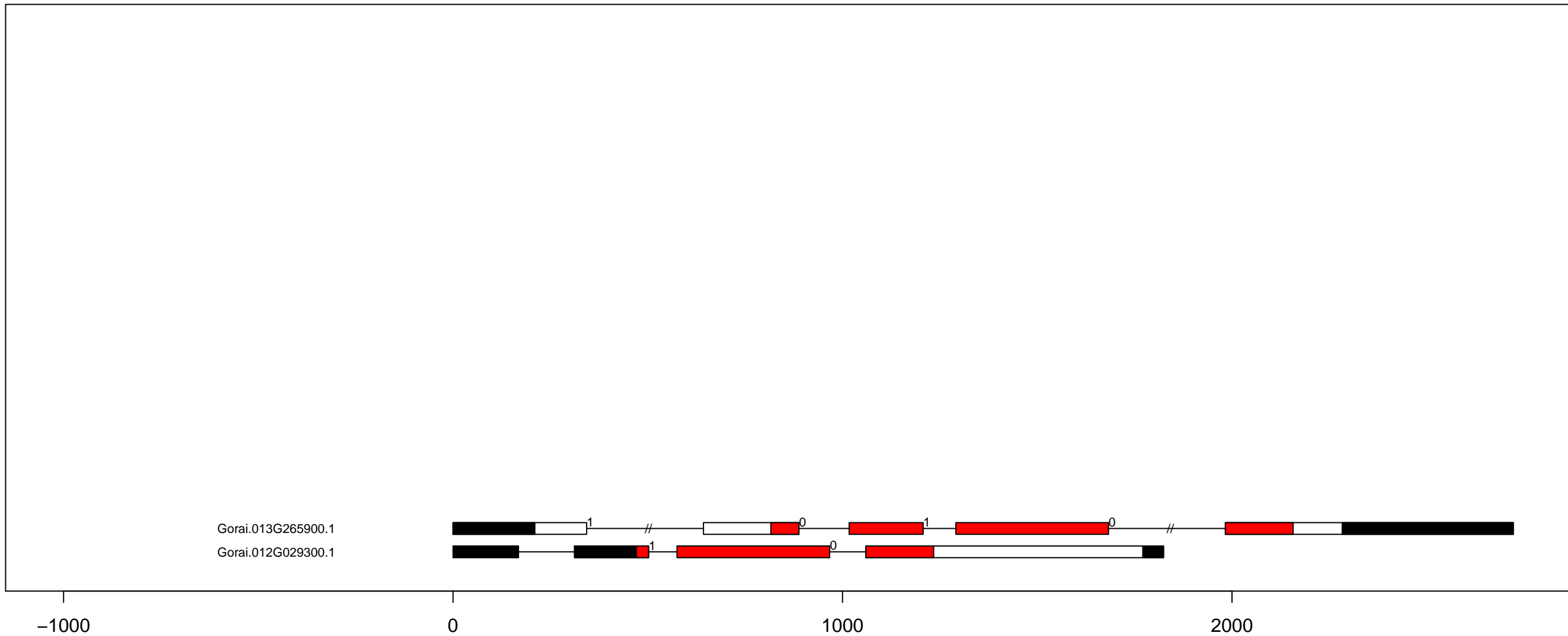

G.ra RLK-Pelle_RLCK-VIIa-2 exon-intron and domain diagram (part 1)

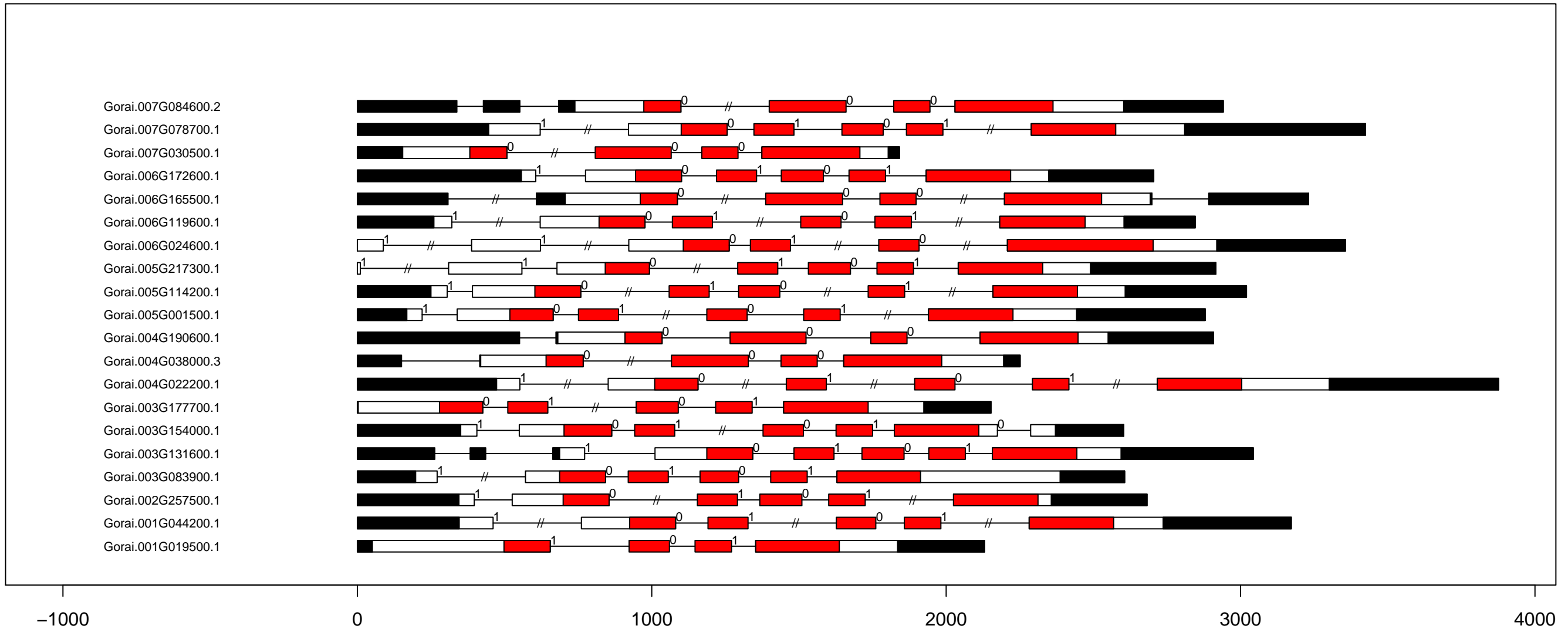

G.ra RLK-Pelle_RLCK-VIIa-2 exon-intron and domain diagram (part 2)

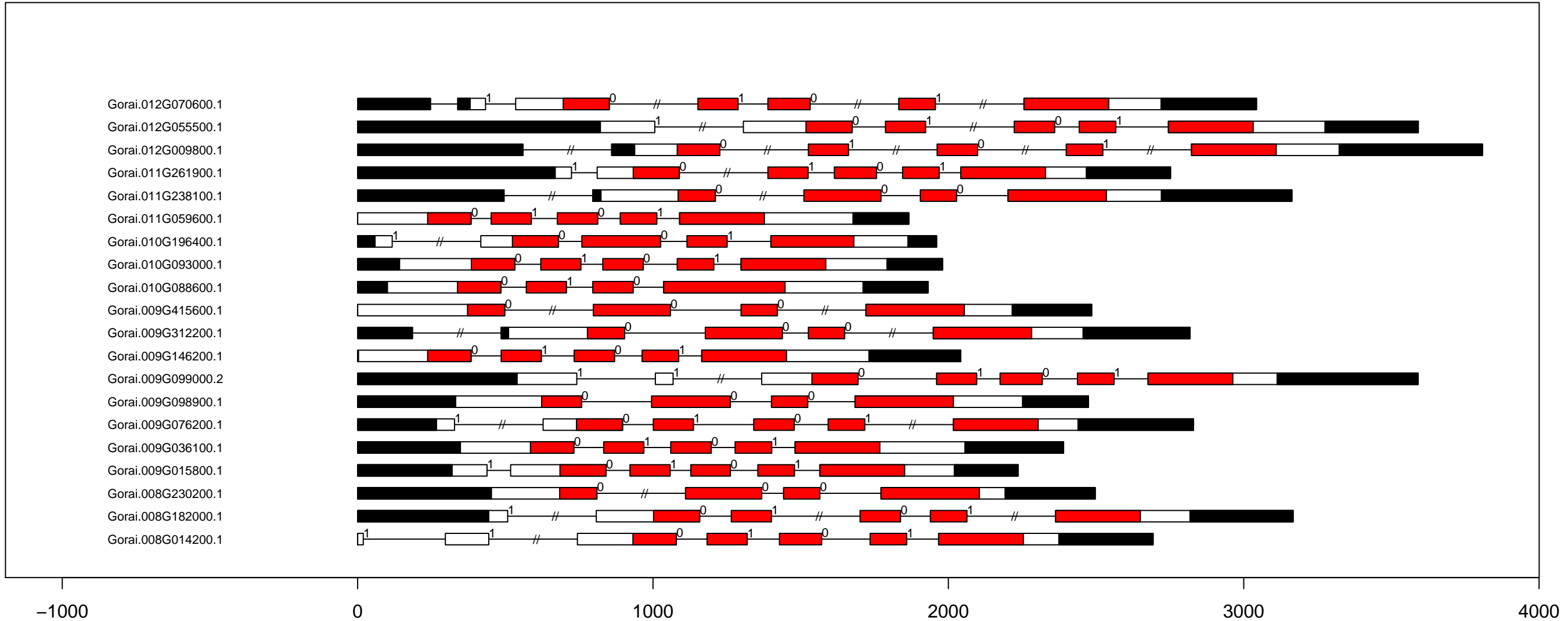

G.ra RLK-Pelle_RLCK-VIIa-2 exon-intron and domain diagram (part 3)

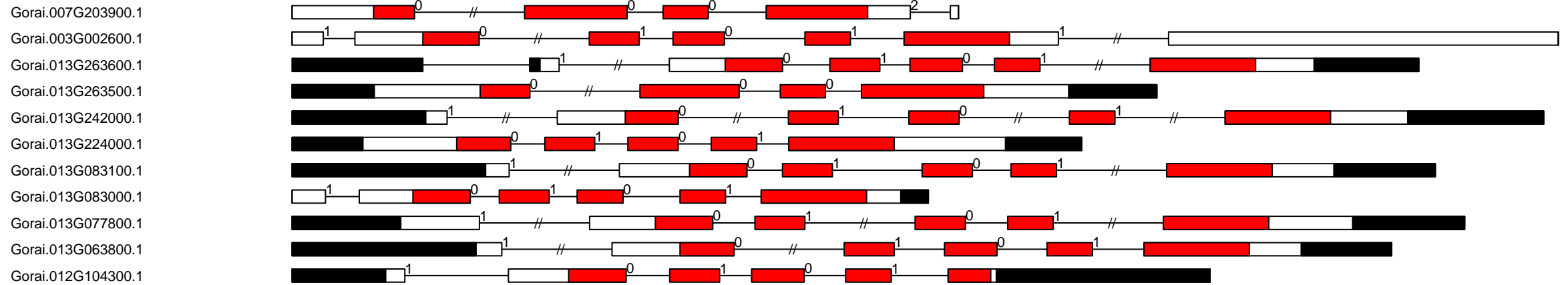

-1000

0

1000

2000

3000

G.ra RLK-Pelle_RLCK-VIIb exon-intron and domain diagram (all)

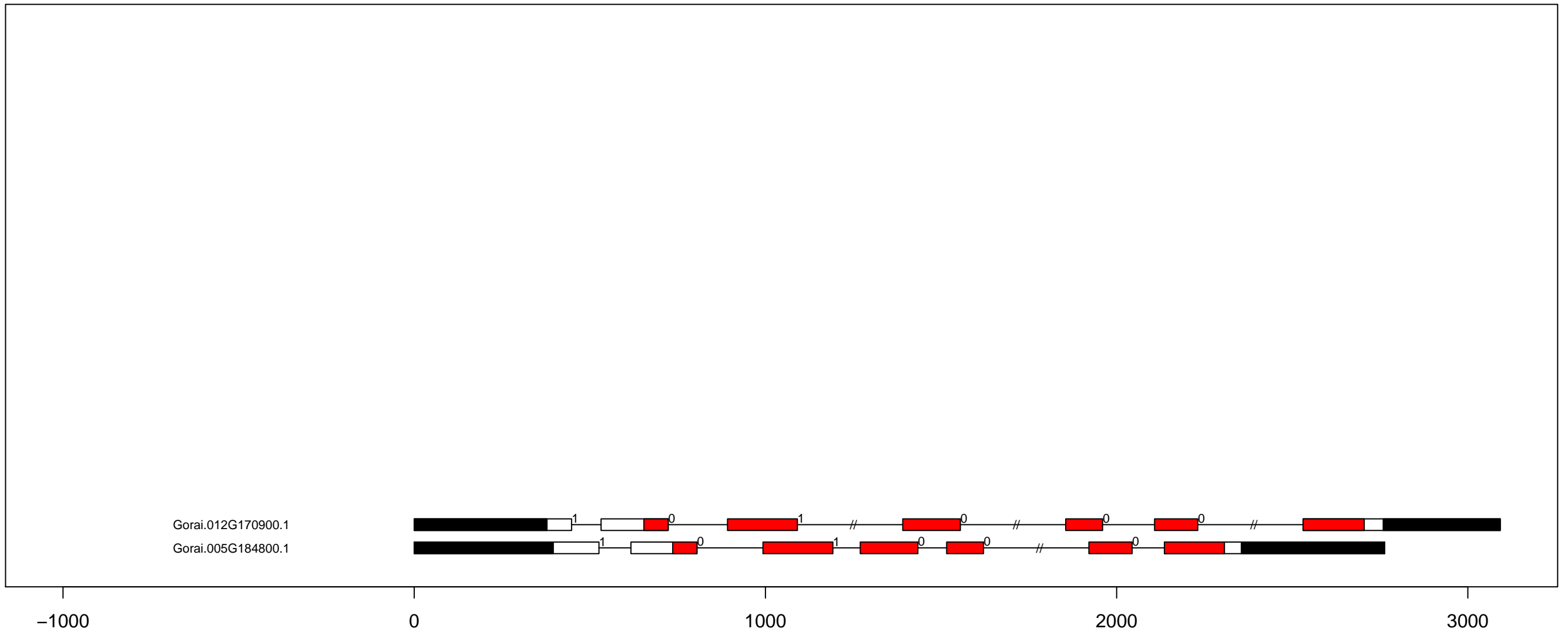

G.ra RLK-Pelle_RLCK-VI exon-intron and domain diagram (part 1)

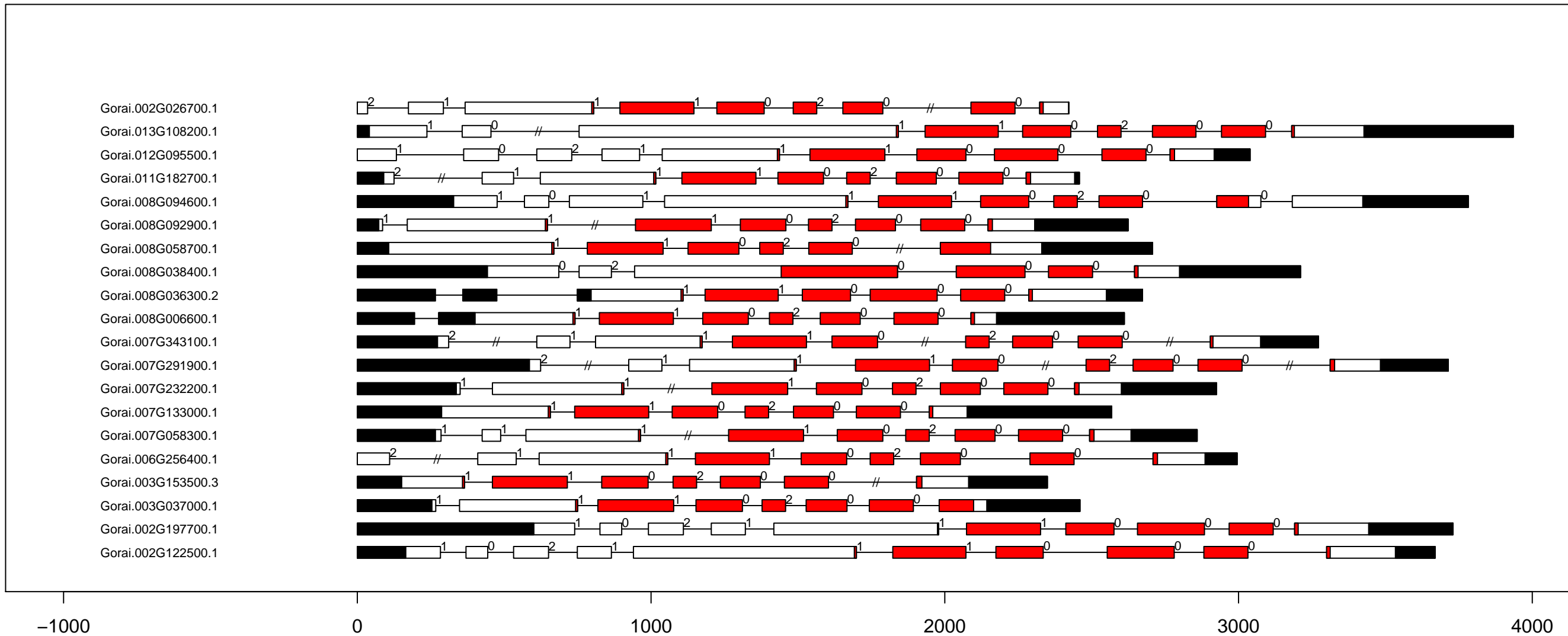

G.ra RLK-Pelle_RLCK-VI exon-intron and domain diagram (part 2)

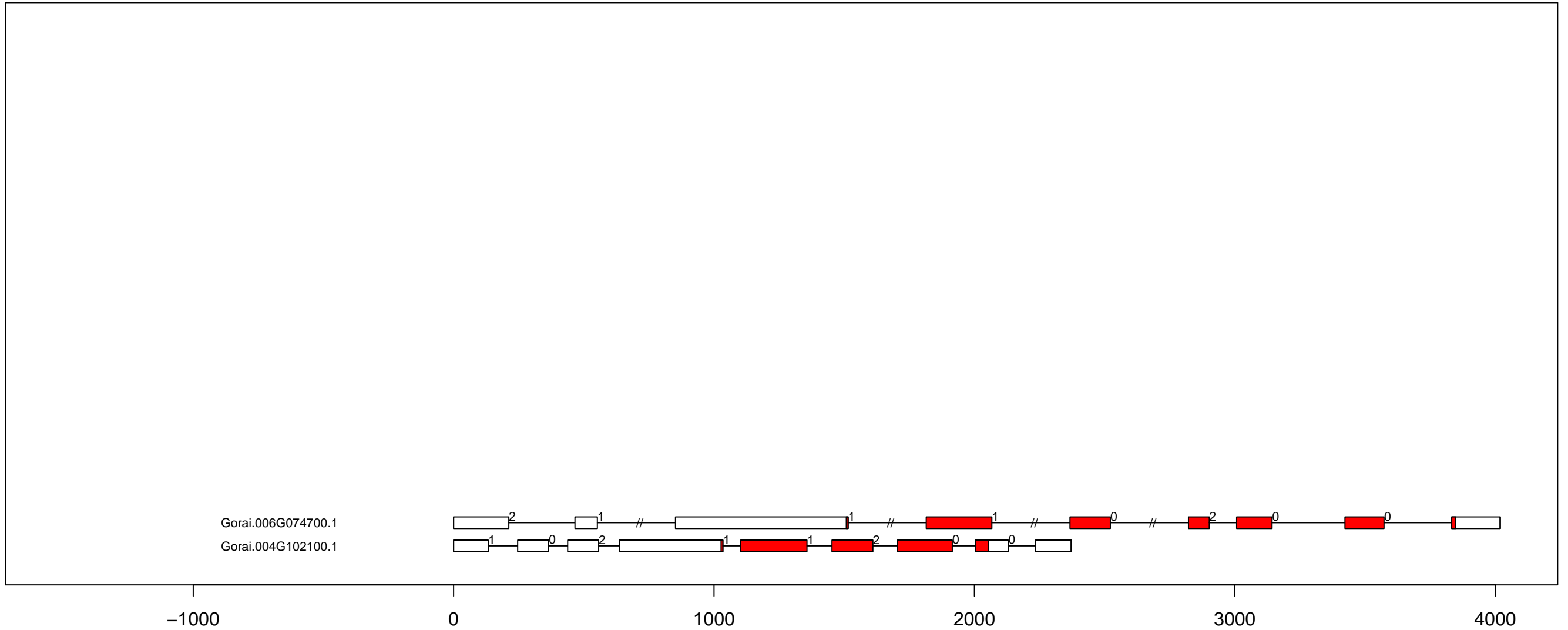

G.ra RLK-Pelle_RLCK-V exon-intron and domain diagram (all)

Gorai.012G040400.2
 Gorai.009G276000.2
 Gorai.009G213700.2
 Gorai.008G119900.1
 Gorai.008G028600.1
 Gorai.007G308900.1
 Gorai.007G214500.1
 Gorai.007G102400.1
 Gorai.006G266500.1
 Gorai.005G243300.1
 Gorai.005G071600.4
 Gorai.004G117200.1
 Gorai.002G031900.2
 Gorai.001G158500.2

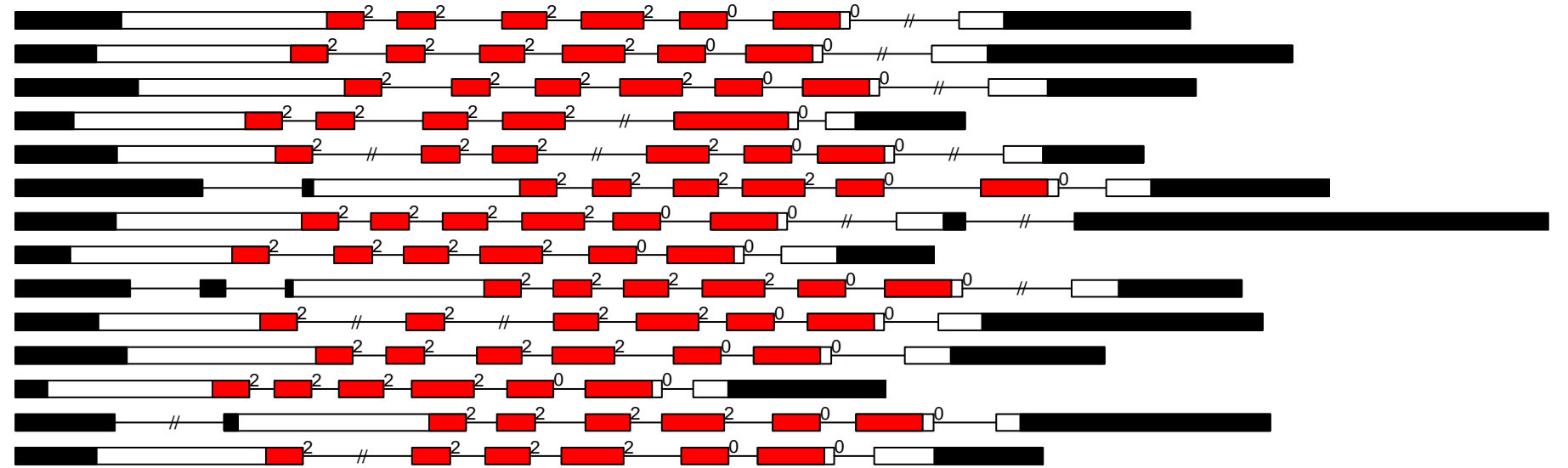

G.ra RLK-Pelle_RLCK-XII-1 exon-intron and domain diagram (all)

Gorai.011G295900.1
Gorai.009G188600.1
Gorai.009G094800.1
Gorai.008G246800.4
Gorai.008G122000.1
Gorai.008G040100.1
Gorai.006G209500.1
Gorai.006G179500.1
Gorai.005G113100.1
Gorai.003G126600.1
Gorai.002G259200.1
Gorai.002G205100.1
Gorai.001G114400.1

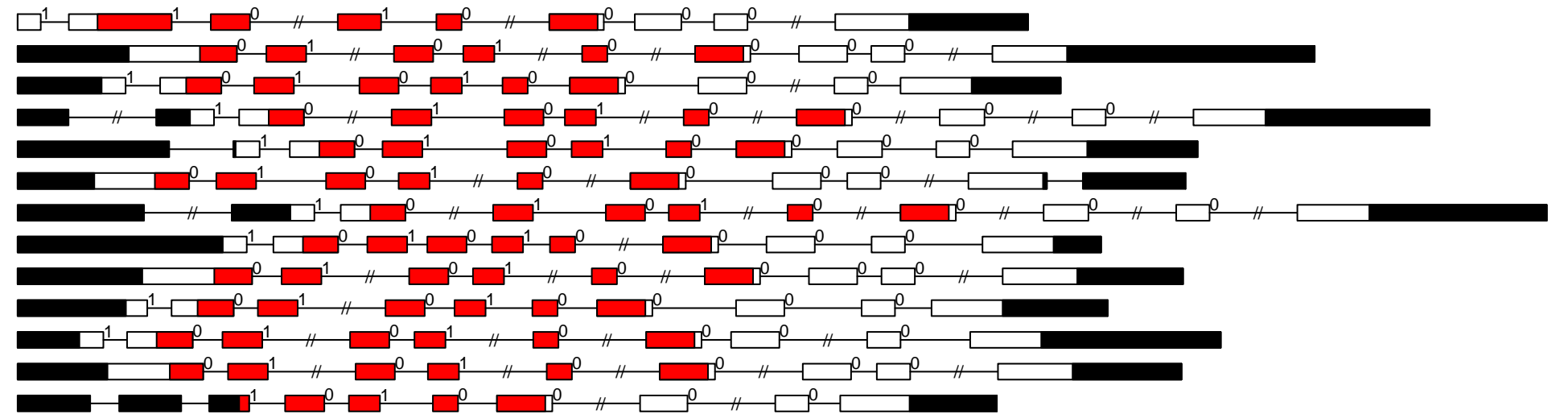

-1000

0

1000

2000

3000

4000

5000

G.ra RLK-Pelle_RLCK-XIII exon-intron and domain diagram (all)

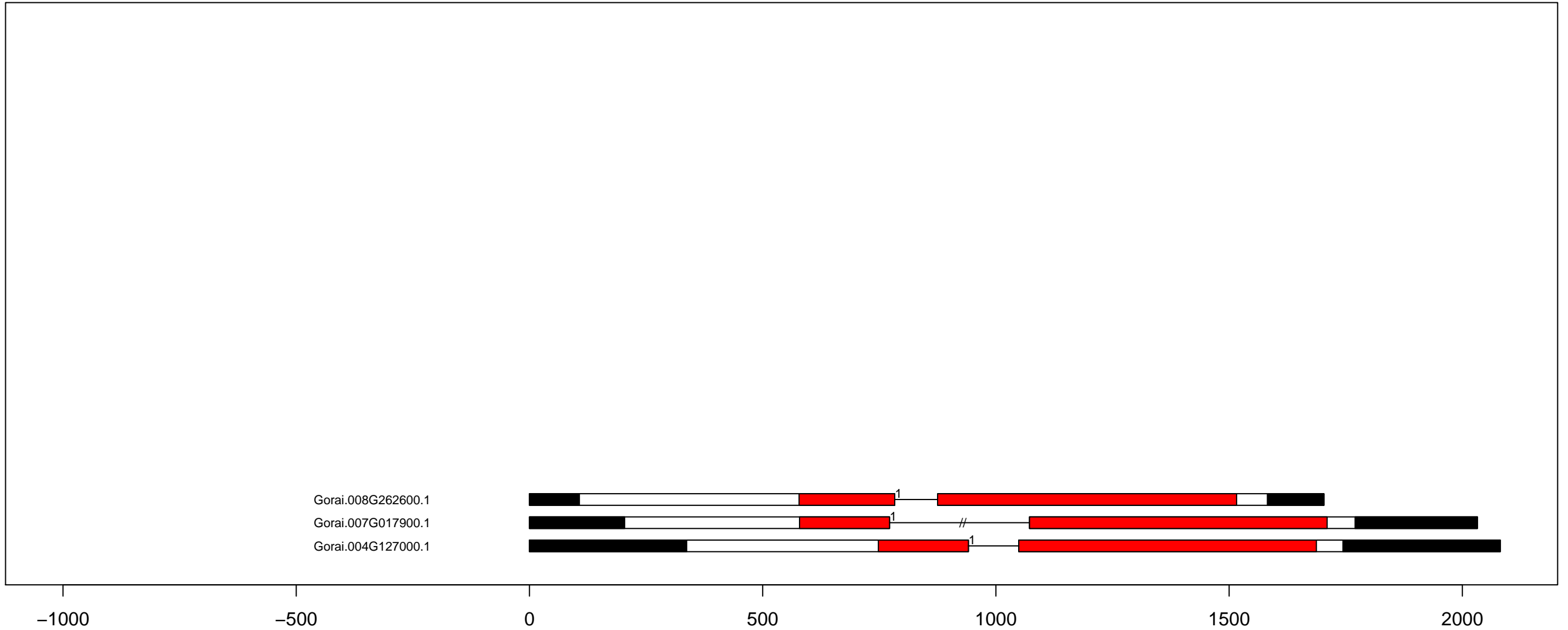

G.ra RLK-Pelle_RLCK-XI exon-intron and domain diagram (all)

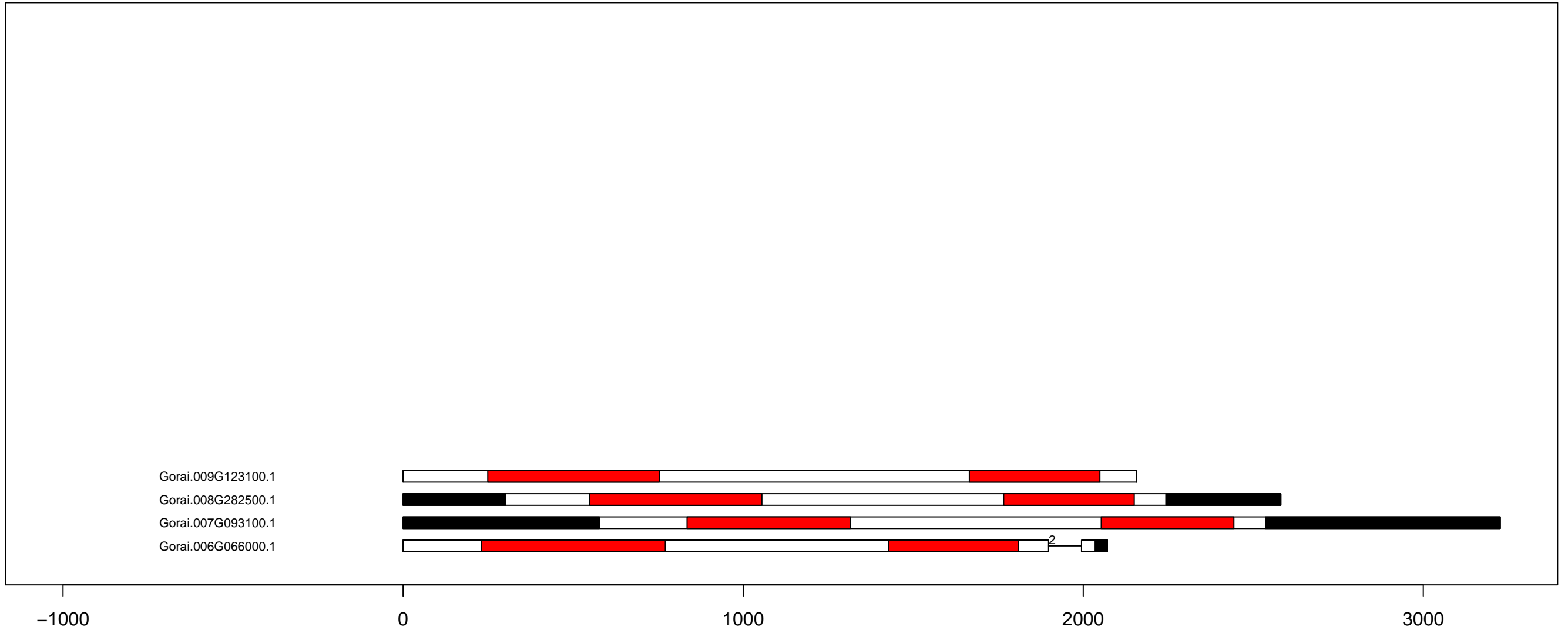

G.ra RLK-Pelle_RLCK-XVI exon-intron and domain diagram (all)

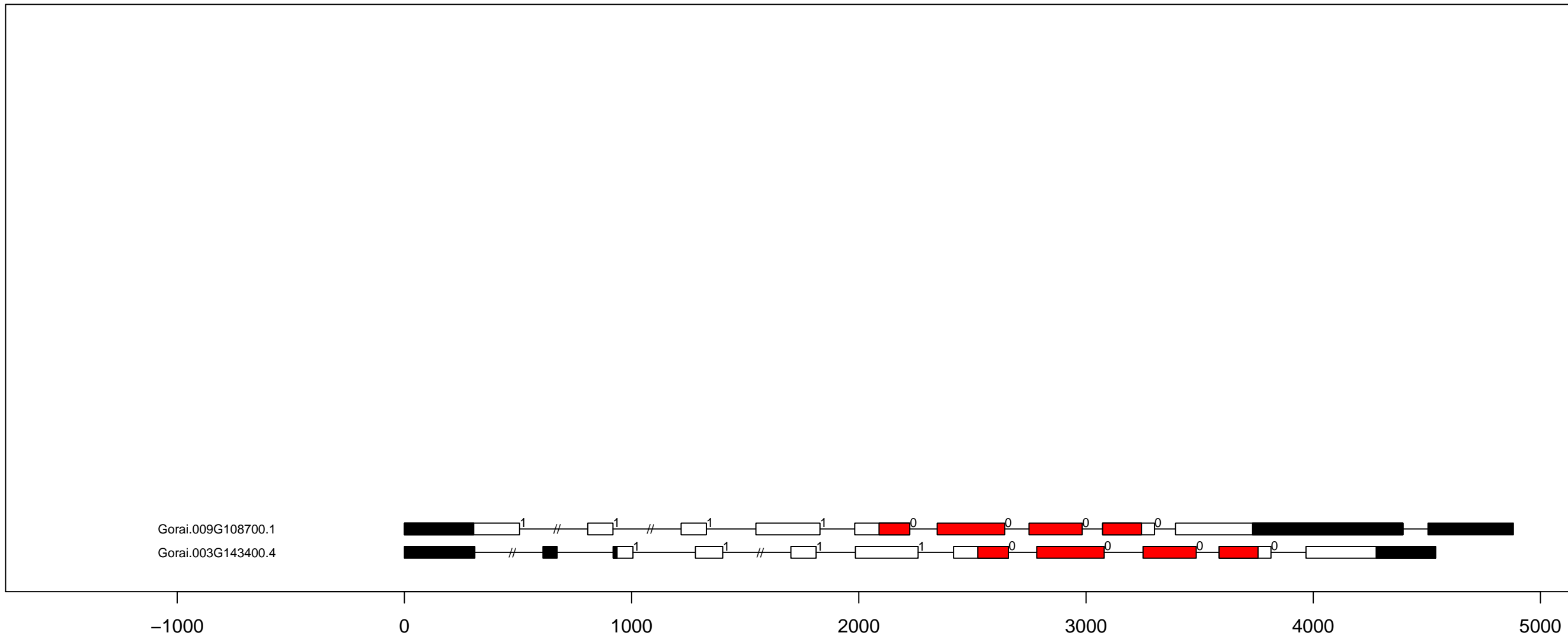

G.ra RLK-Pelle_RLCK-XV exon-intron and domain diagram (all)

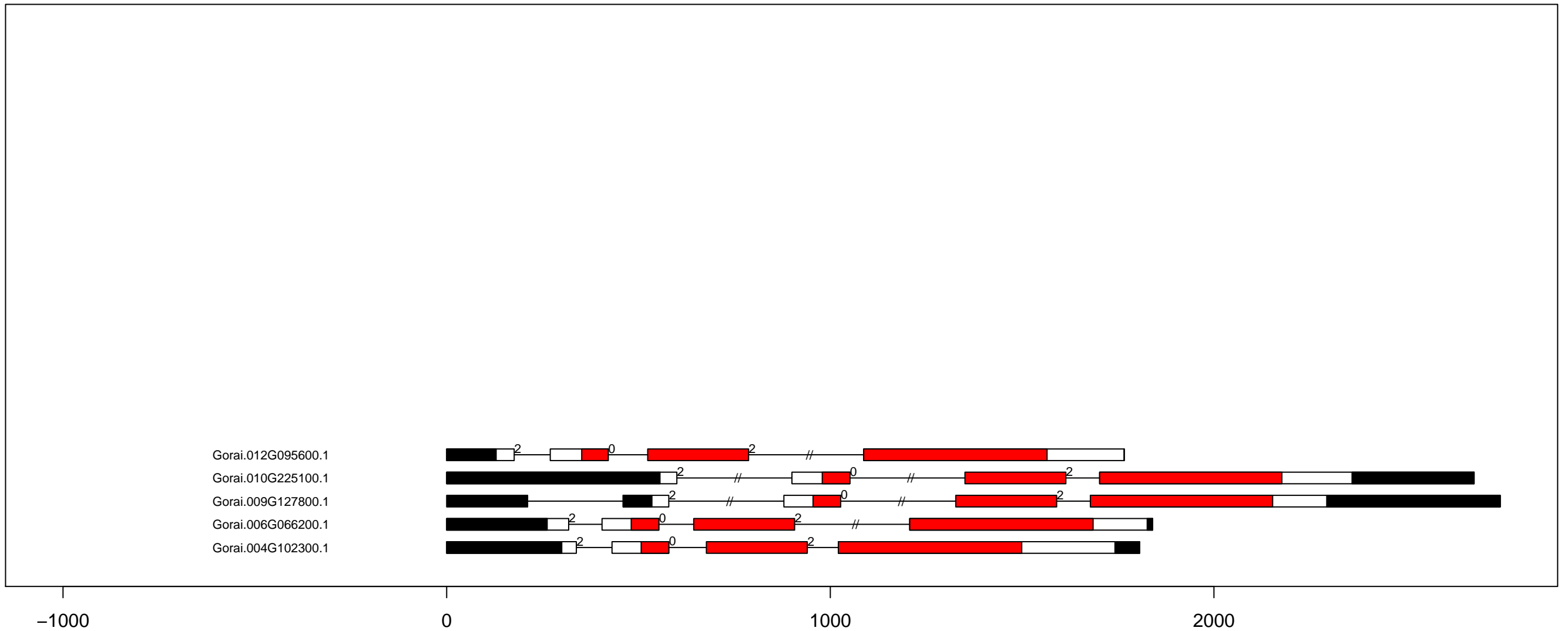

G.ra RLK-Pelle_SD-2b exon-intron and domain diagram (part 1)

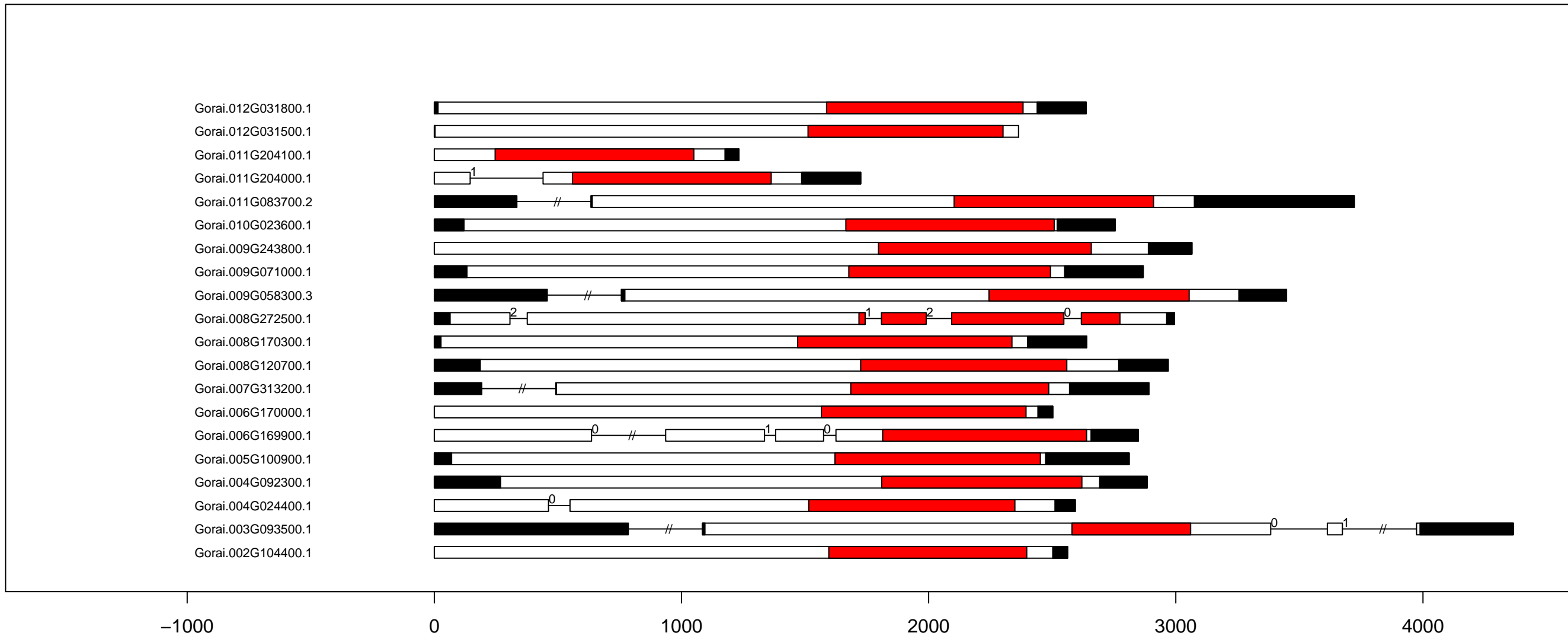

G.ra RLK-Pelle_SD-2b exon-intron and domain diagram (part 3)

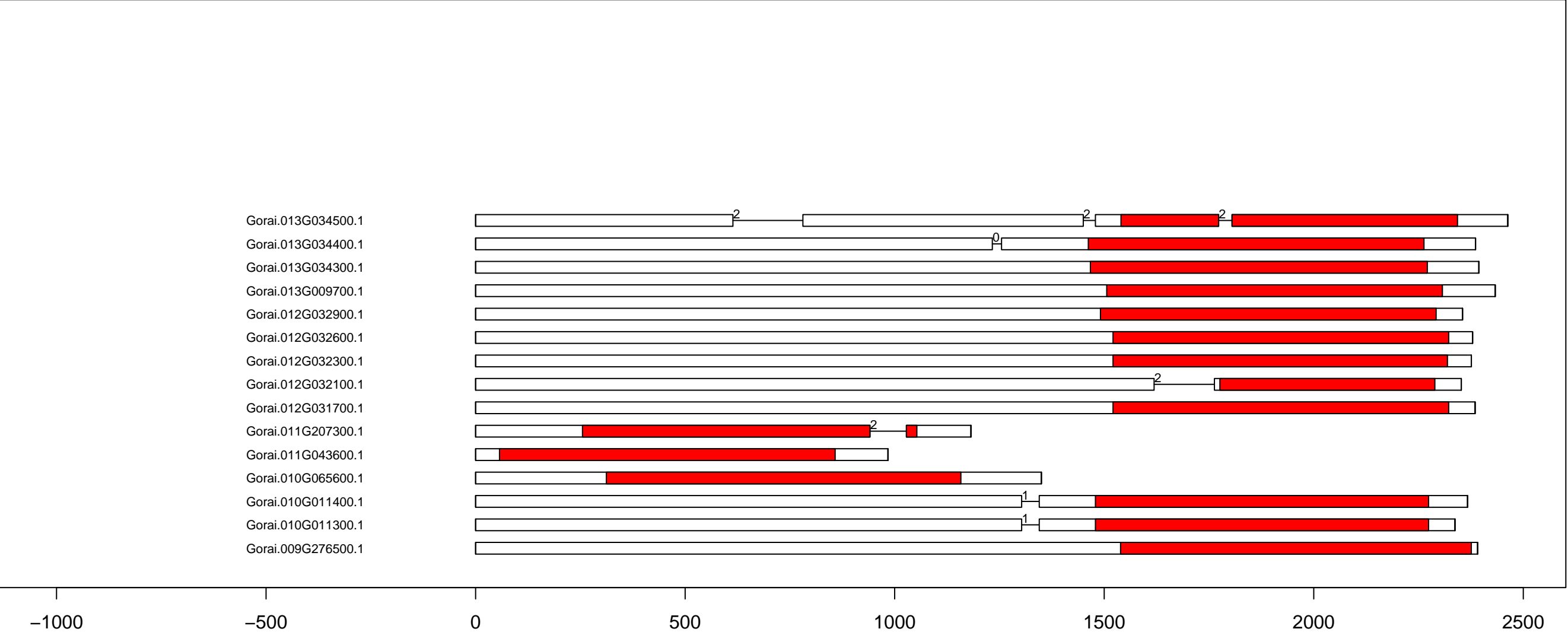

G.ra RLK-Pelle_Singleton exon-intron and domain diagram (all)

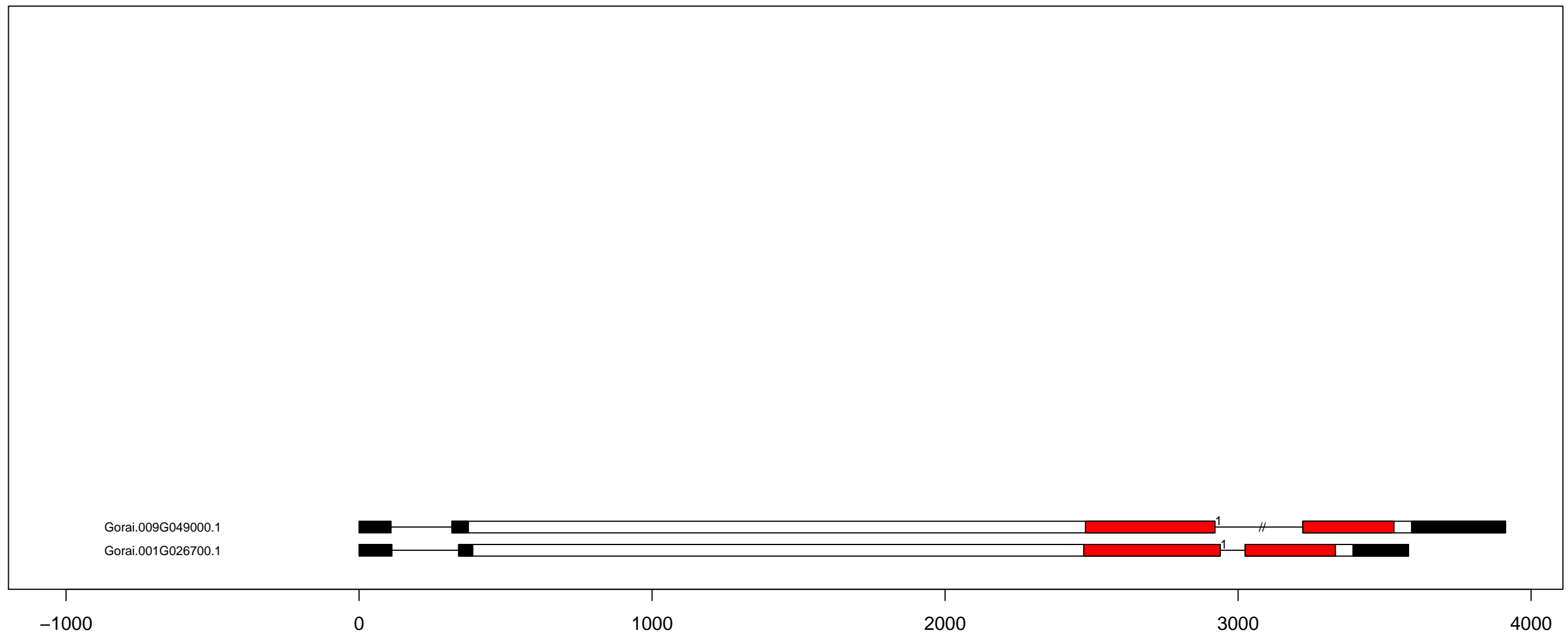

G.ra RLK-Pelle_URK-1 exon-intron and domain diagram (all)

Gorai.013G044800.1
Gorai.008G024300.1
Gorai.001G126300.1

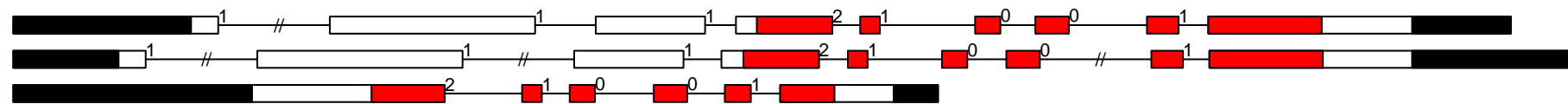

G.ra RLK-Pelle_URK-3 exon-intron and domain diagram (all)

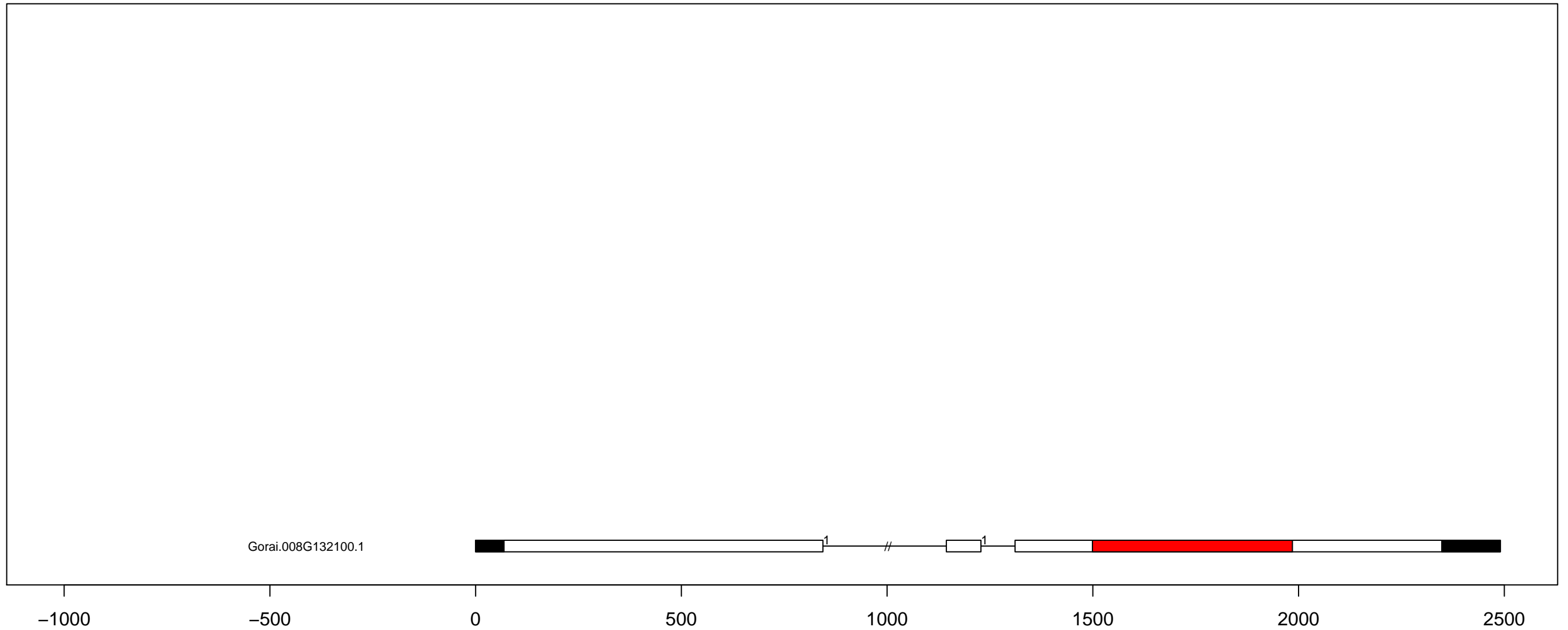

G.ra RLK-Pelle_WAK_LRK10L-1 exon-intron and domain diagram (all)

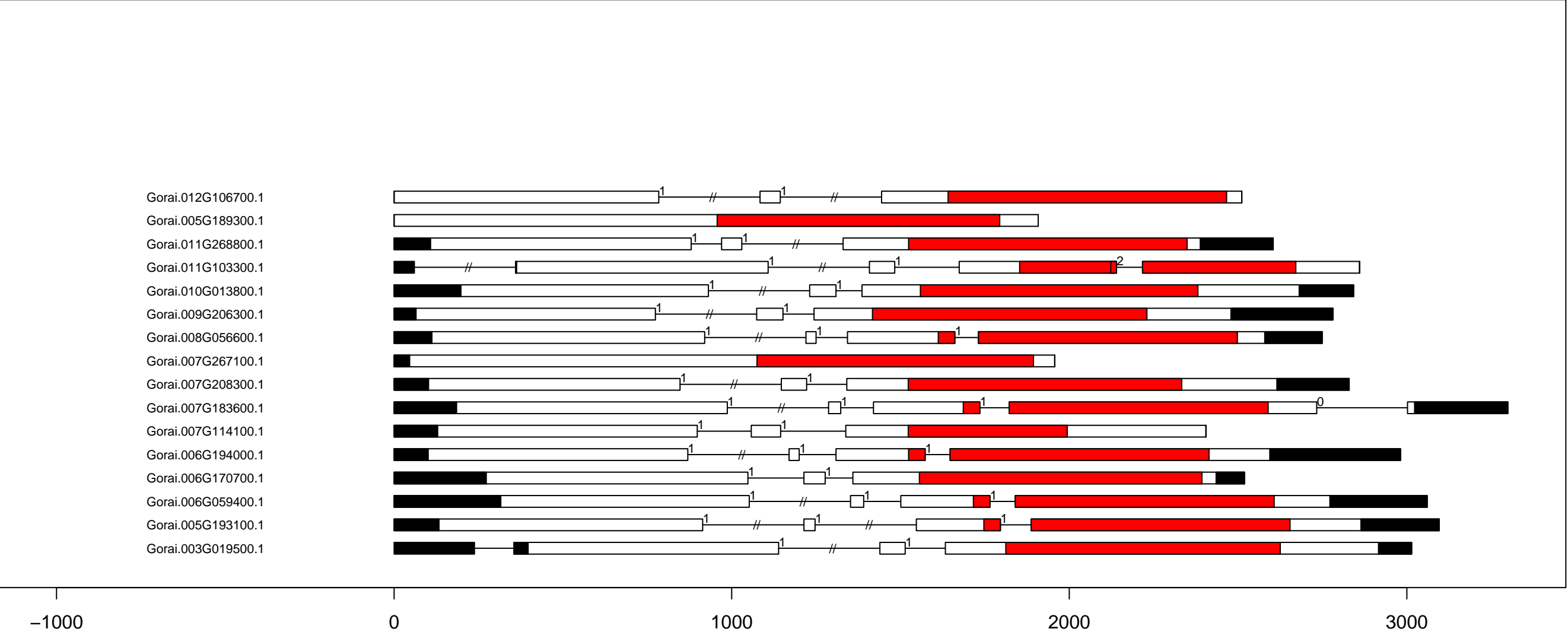

G.ra RLK-Pelle_WAK exon-intron and domain diagram (part 2)

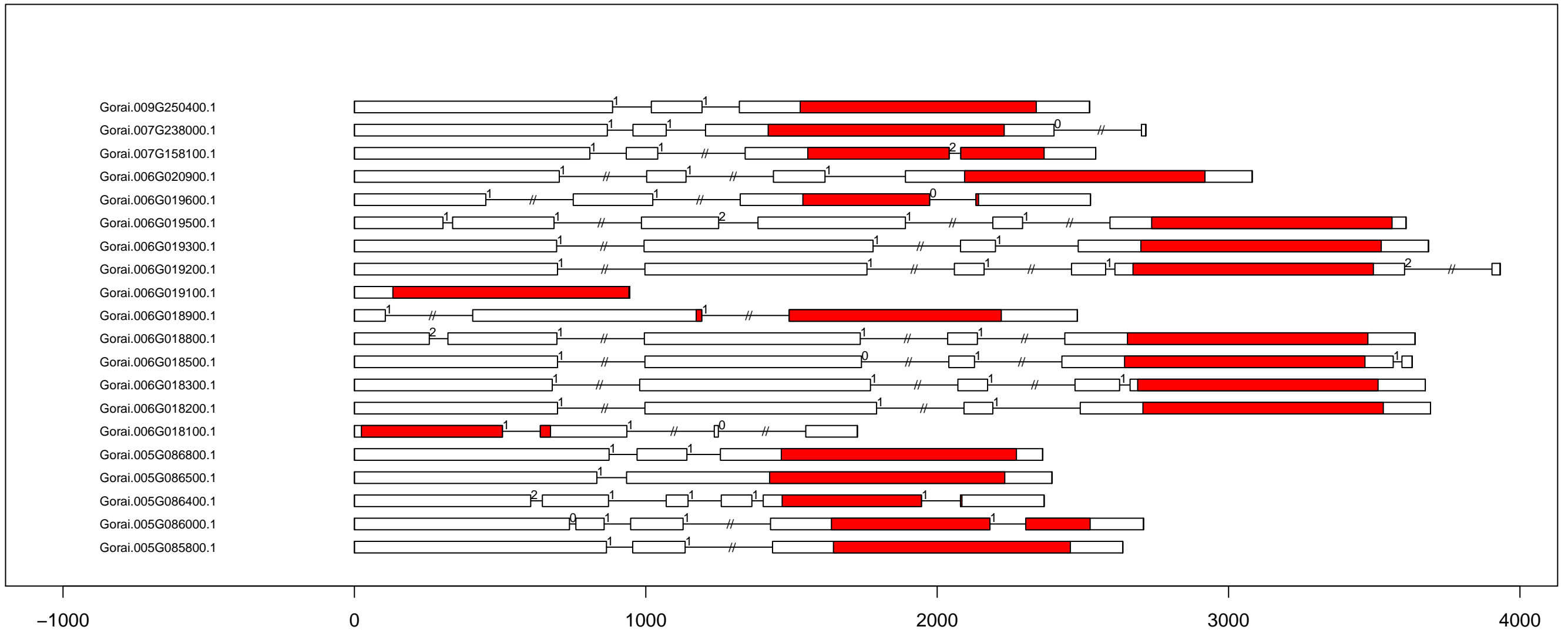

G.ra RLK-Pelle_WAK exon-intron and domain diagram (part 3)

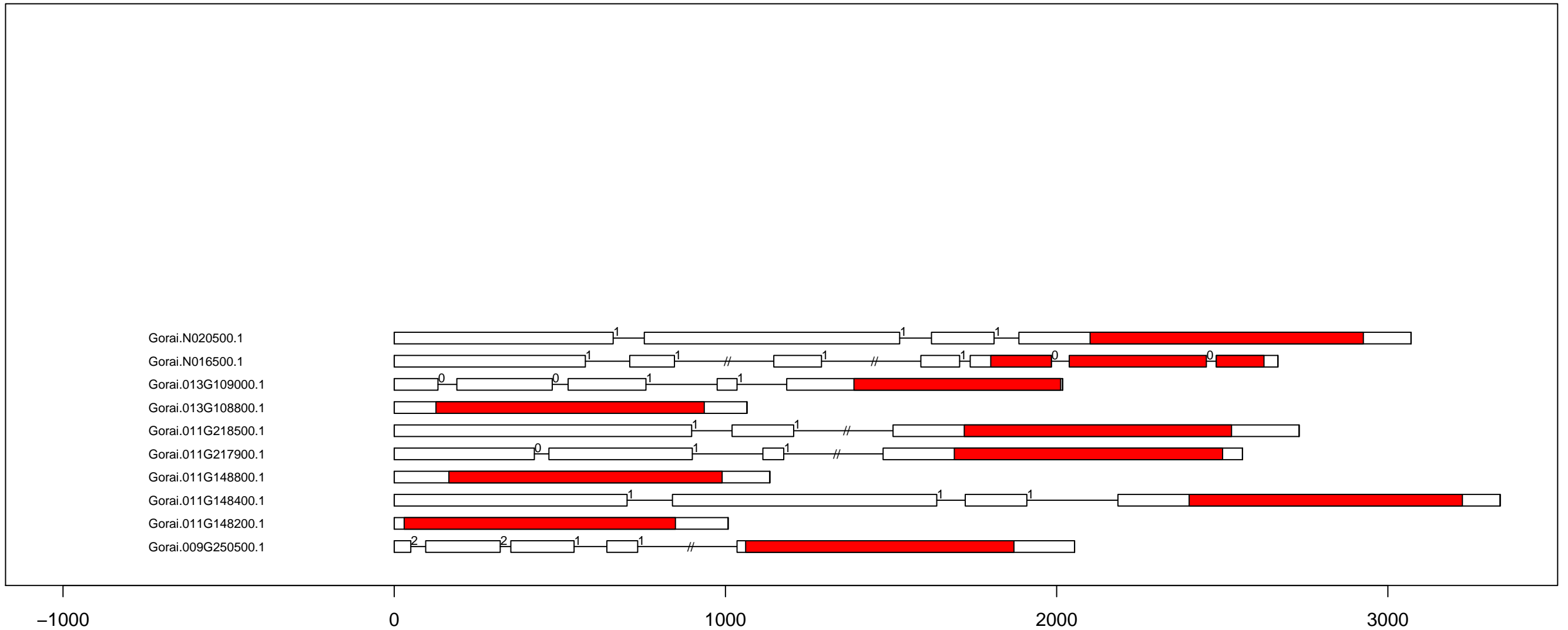

G.ra SCY1_SCYL1 exon-intron and domain diagram (all)

Gorai.010G219100.1

Gorai.009G292700.2

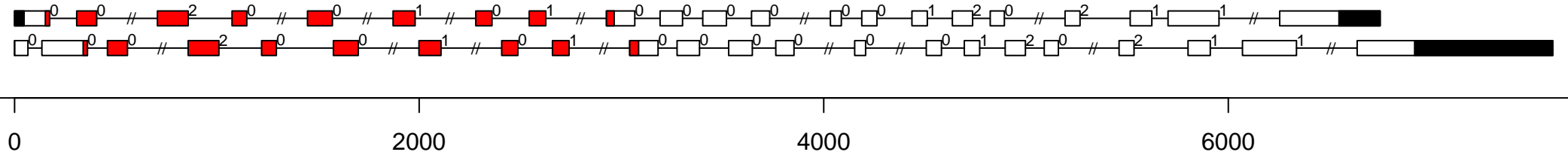

G.ra SCY1_SCYL2 exon-intron and domain diagram (all)

Gorai.009G290500.1

Gorai.009G262900.1

Gorai.004G267700.1

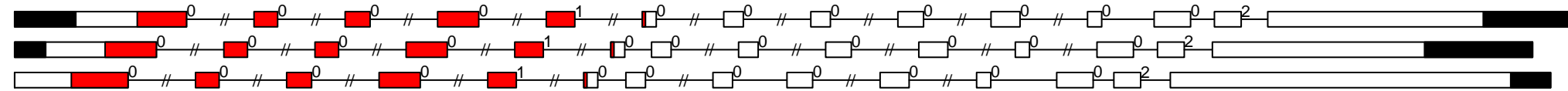

0

2000

4000

6000

G.ra STE_STE11 exon-intron and domain diagram (part 1)

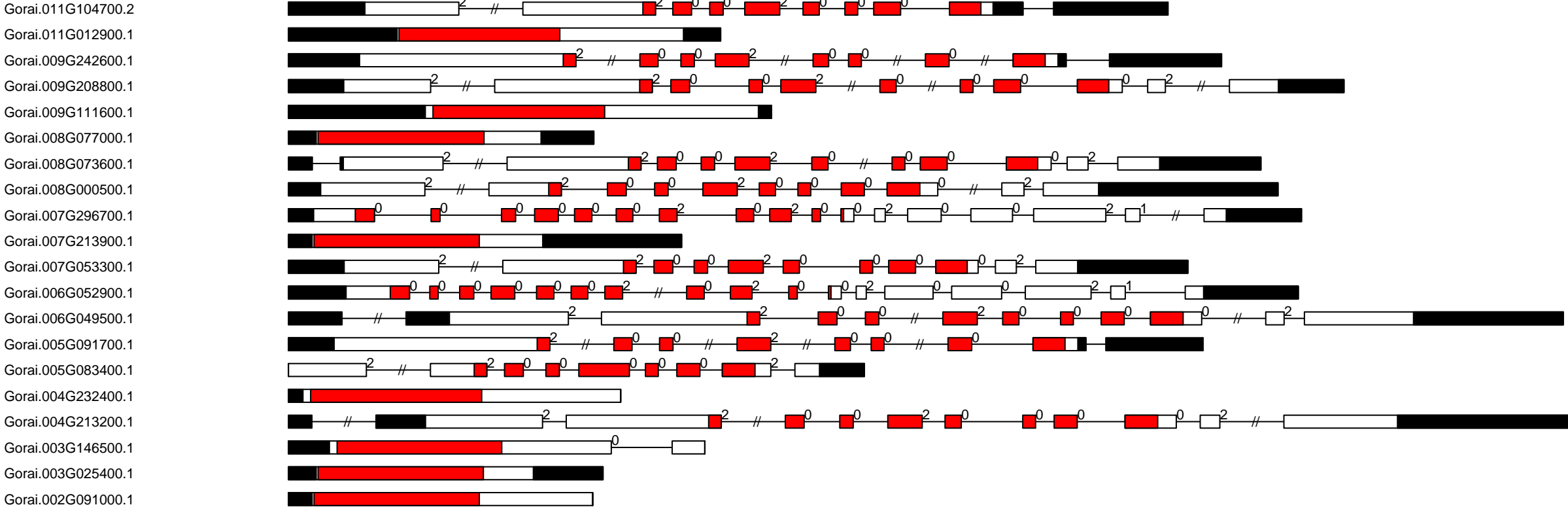

G.ra STE_STE20-Fray exon-intron and domain diagram (all)

Gorai.013G174600.1

Gorai.011G155300.1

Gorai.011G155200.1

Gorai.011G154500.1

Gorai.011G154300.1

Gorai.011G095700.3

Gorai.011G053300.2

Gorai.009G149600.1

Gorai.008G258000.1

Gorai.007G076300.1

Gorai.007G020100.1

Gorai.006G247600.1

Gorai.006G030400.4

Gorai.004G130000.1

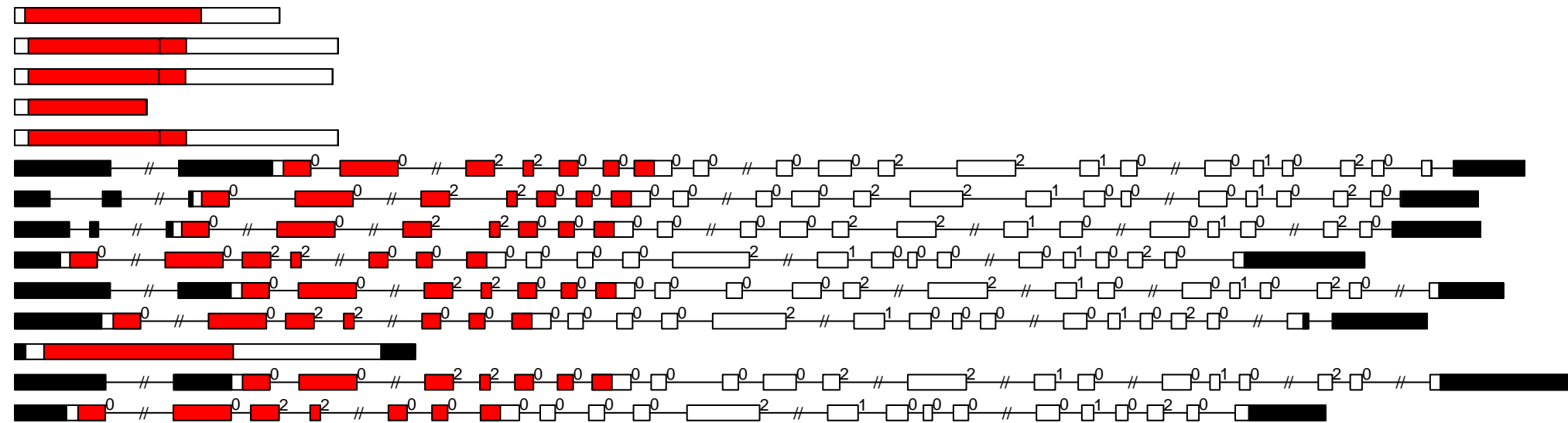

0

2000

4000

6000

G.ra STE_STE20-PI exon-intron and domain diagram (all)

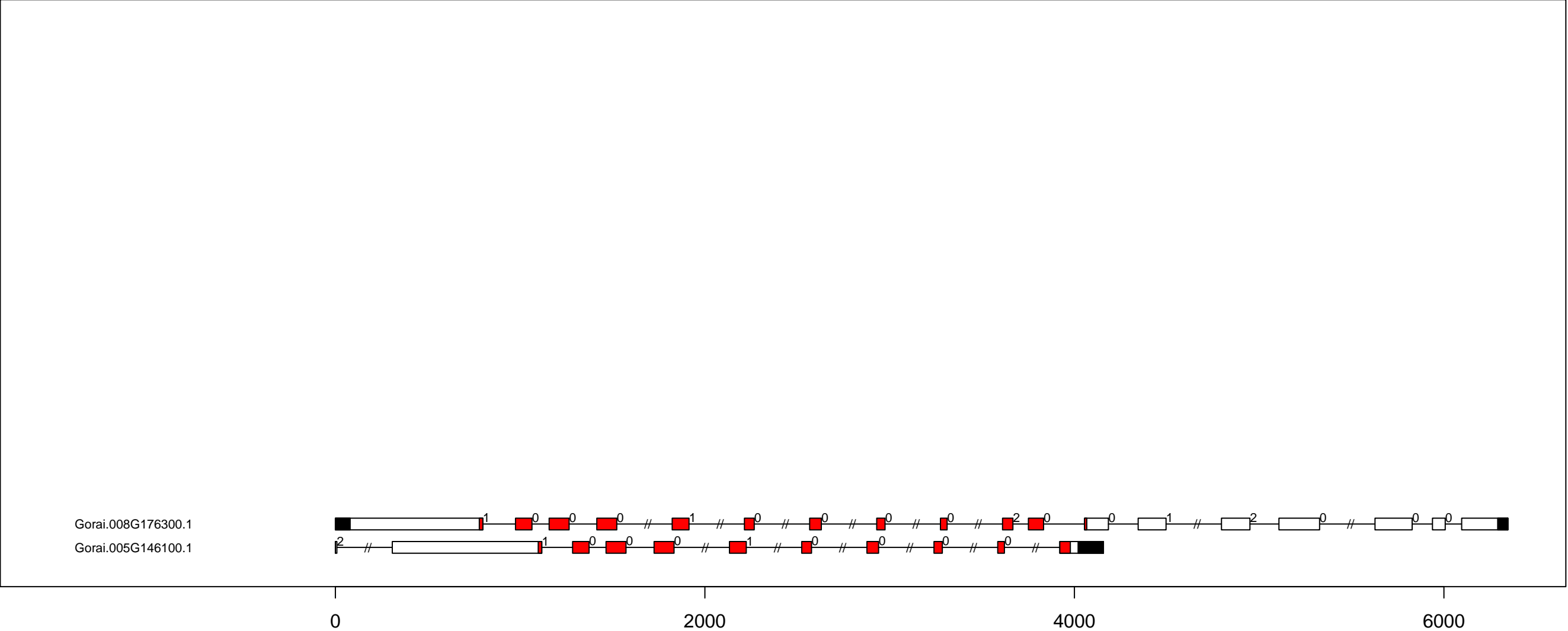

G.ra STE_STE20-YSK exon-intron and domain diagram (all)

Gorai.013G169600.1
Gorai.009G376100.1
Gorai.002G067900.1

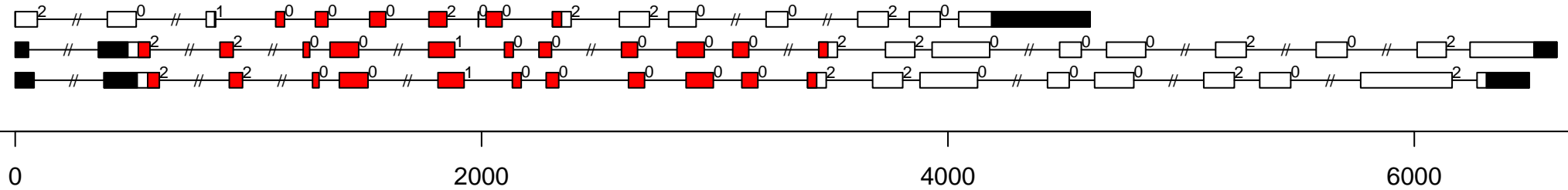

G.ra STE_STE7 exon-intron and domain diagram (all)

Gorai.010G221800.1
 Gorai.008G291800.1
 Gorai.008G291700.1
 Gorai.002G188500.1
 Gorai.013G229600.1
 Gorai.010G085300.1
 Gorai.009G033800.2
 Gorai.008G225100.1
 Gorai.007G075600.3
 Gorai.003G184000.1
 Gorai.001G013600.1
 Gorai.001G009700.1

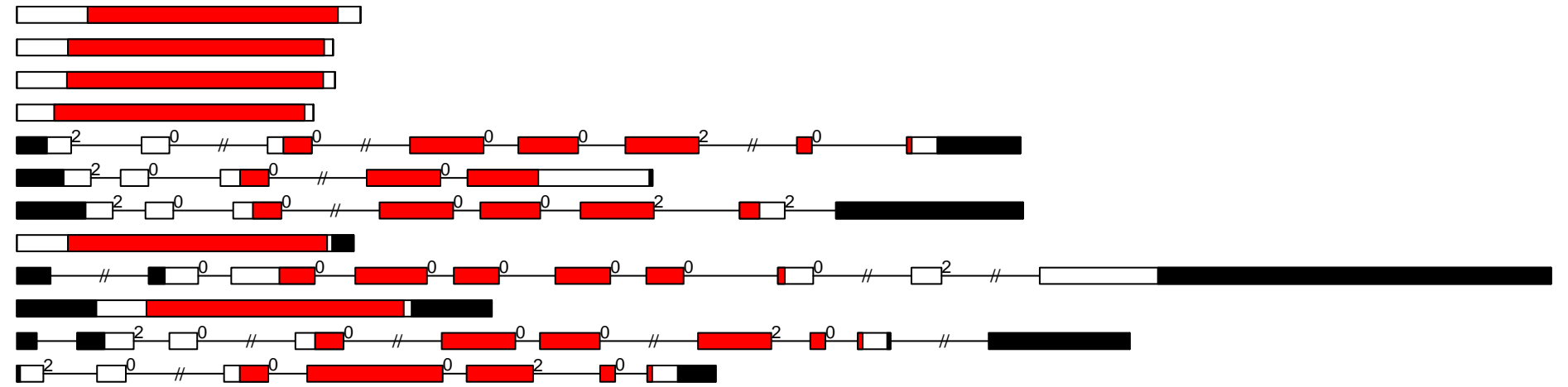

-1000

0

1000

2000

3000

4000

G.ra STE_STE-PI exon-intron and domain diagram (all)

Gorai.008G149400.1

Gorai.005G210100.1

Gorai.002G016000.1

-2000

0

2000

4000

6000

8000

10000

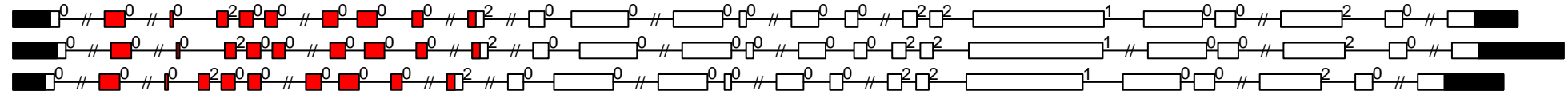

G.ra TKL_CTR1-DRK-1 exon-intron and domain diagram (all)

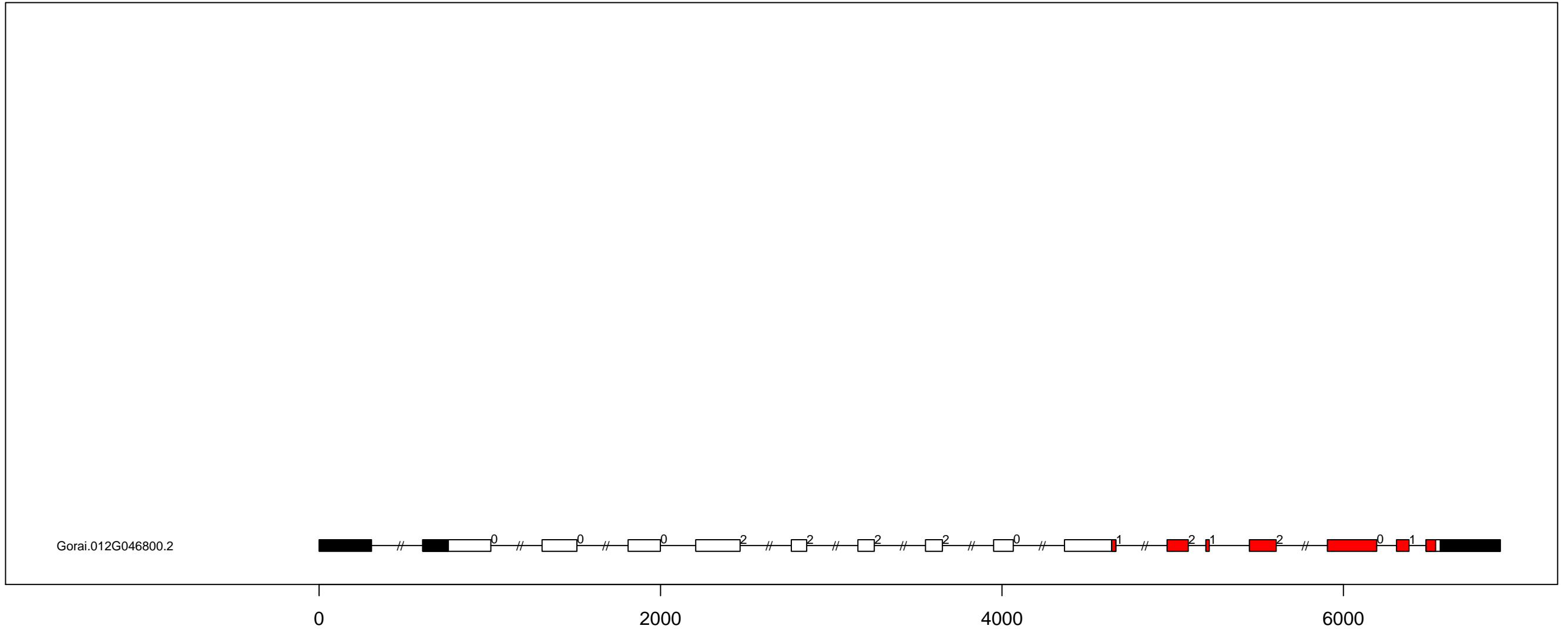

G.ra TKL_CTR1-DRK-2 exon-intron and domain diagram (all)

Gorai.011G200300.1

Gorai.010G033900.1

Gorai.009G408200.3

Gorai.009G304300.1

Gorai.009G228800.2

Gorai.009G045200.1

Gorai.008G289300.1

Gorai.007G286200.1

Gorai.006G258400.1

Gorai.006G158200.1

Gorai.006G080100.1

Gorai.006G056600.1

Gorai.005G067400.1

Gorai.005G067300.1

Gorai.004G245400.2

Gorai.003G162100.1

Gorai.002G159900.1

Gorai.001G022800.1

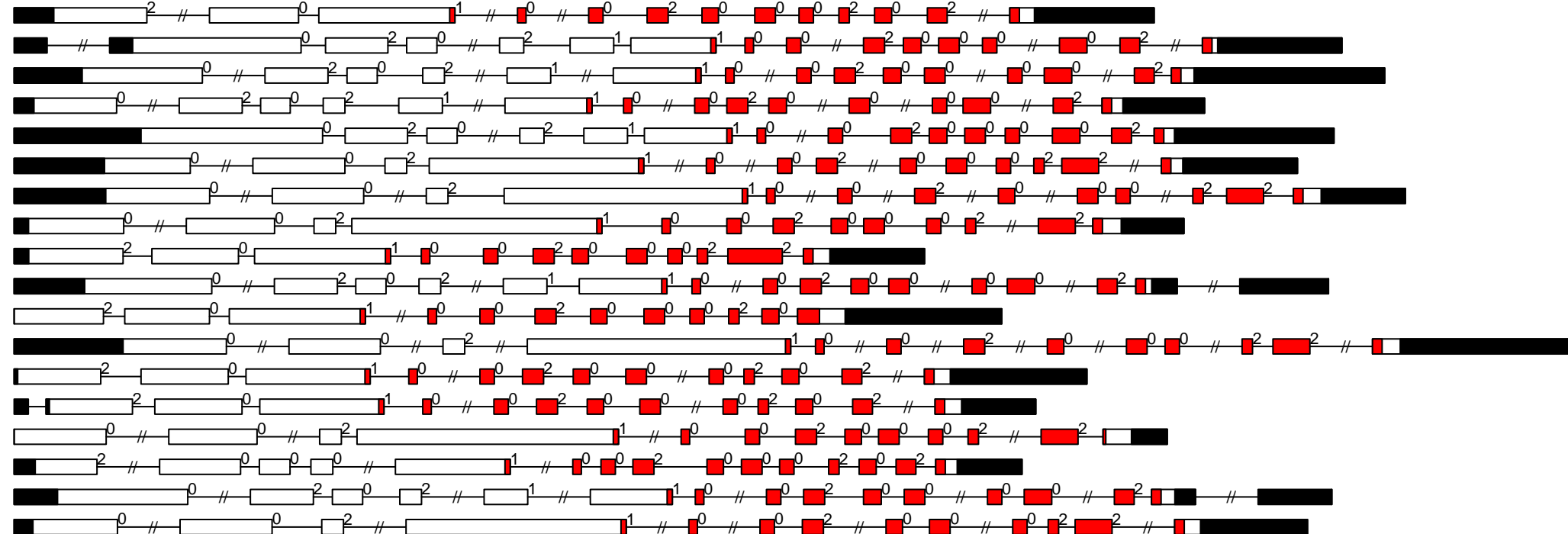

0

2000

4000

6000

G.ra TKL_Gdt exon-intron and domain diagram (all)

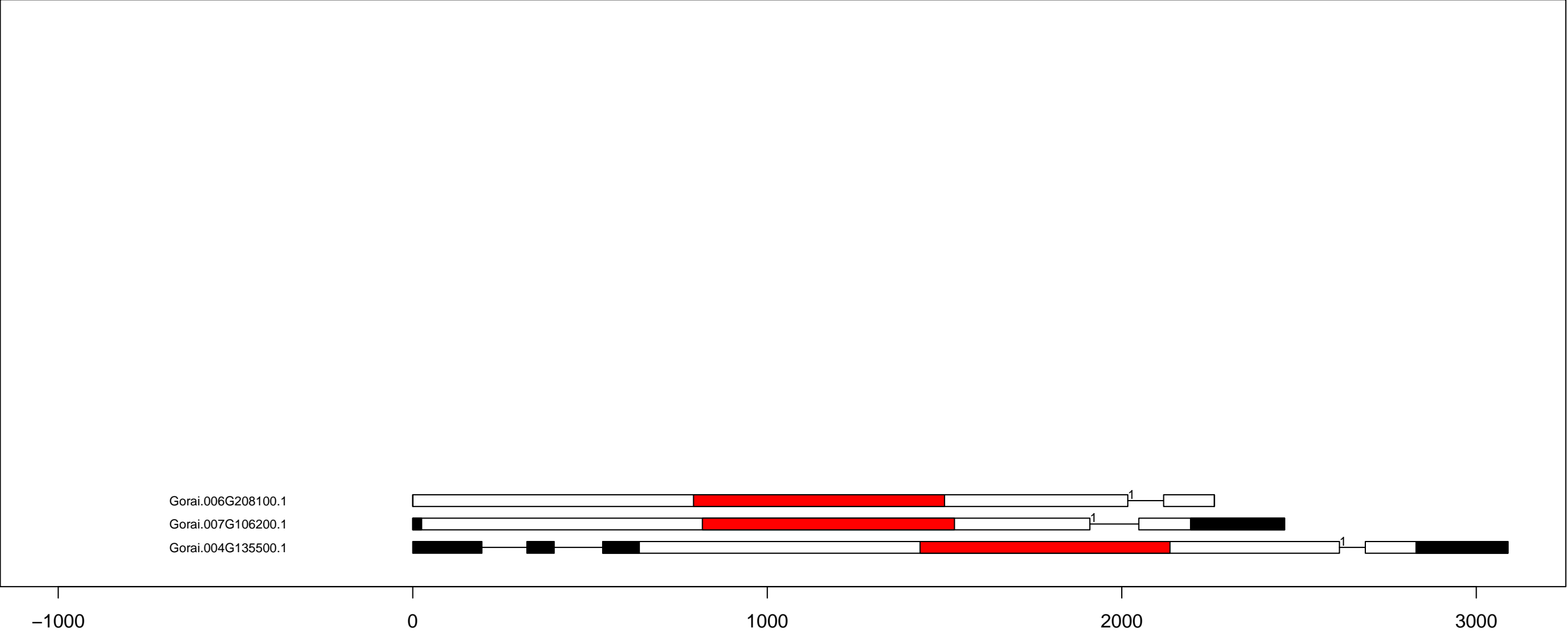

G.ra TKL-PI-1 exon-intron and domain diagram (all)

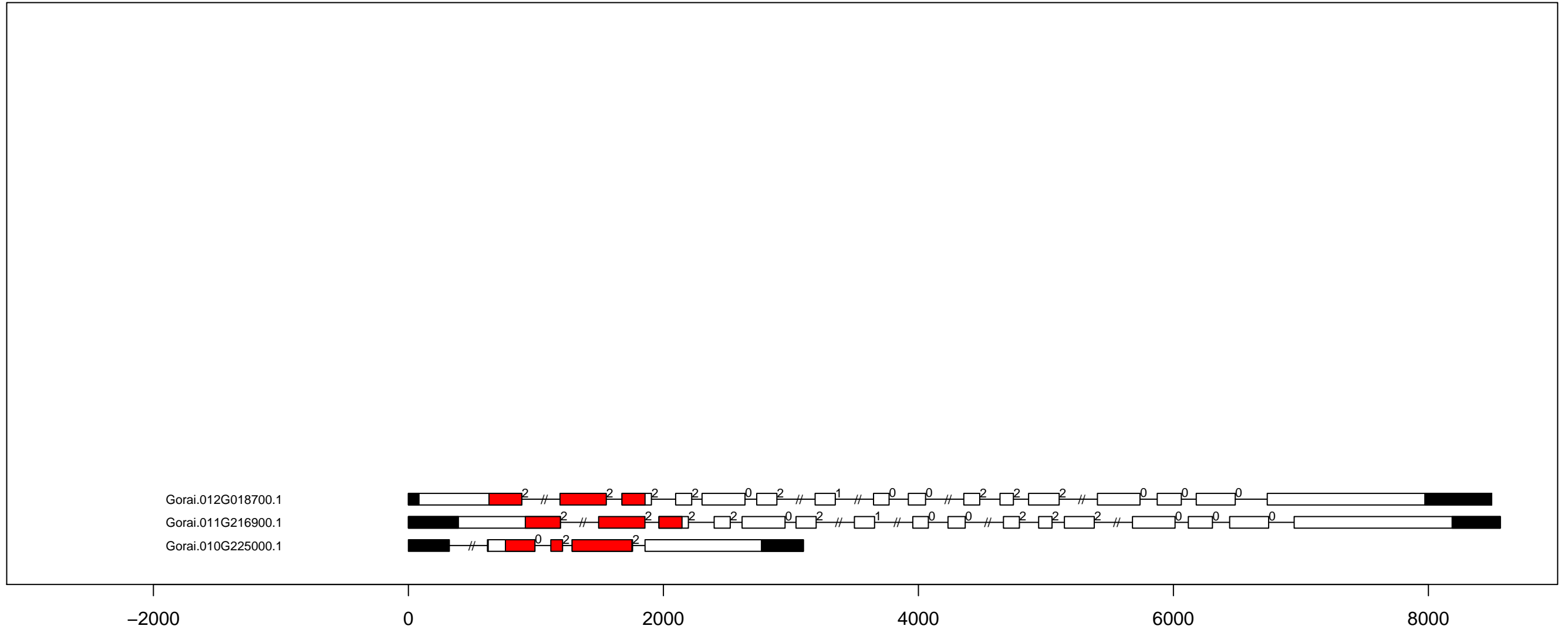

G.ra TKL-PI-2 exon-intron and domain diagram (all)

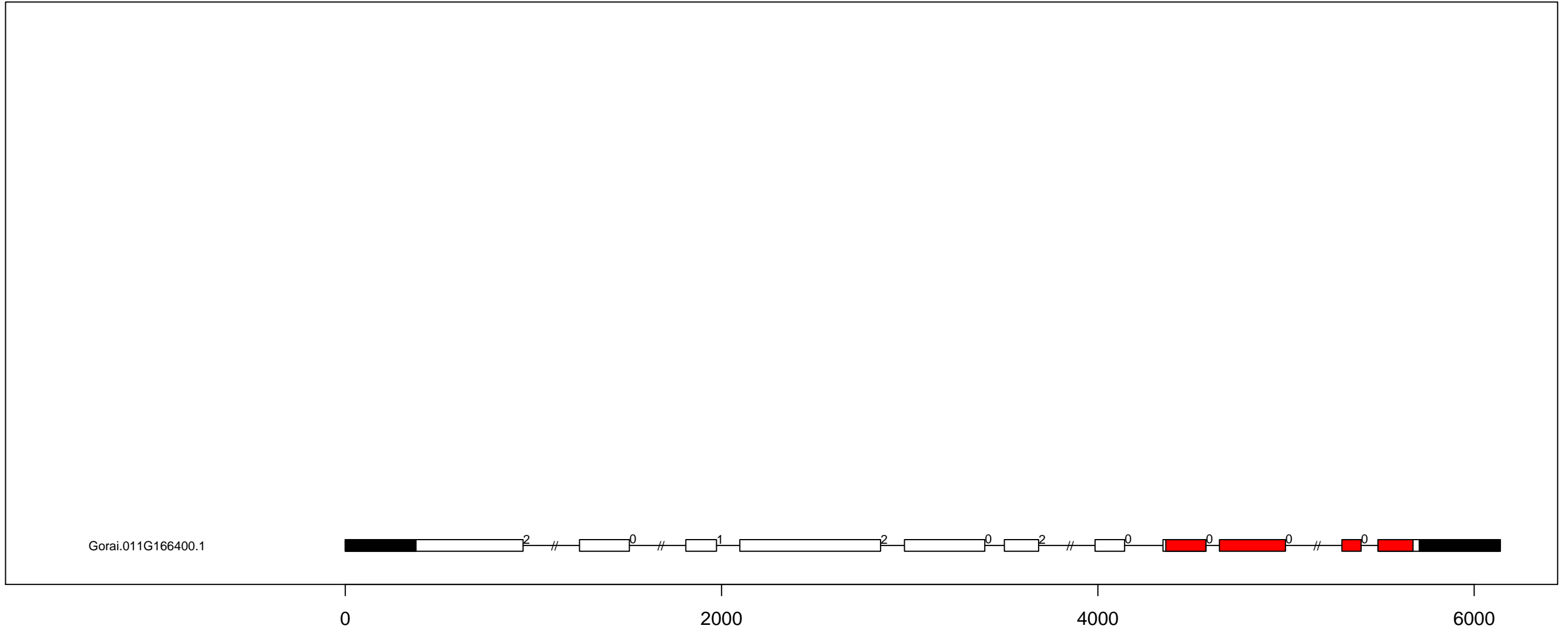

G.ra TKL-PI-3 exon-intron and domain diagram (all)

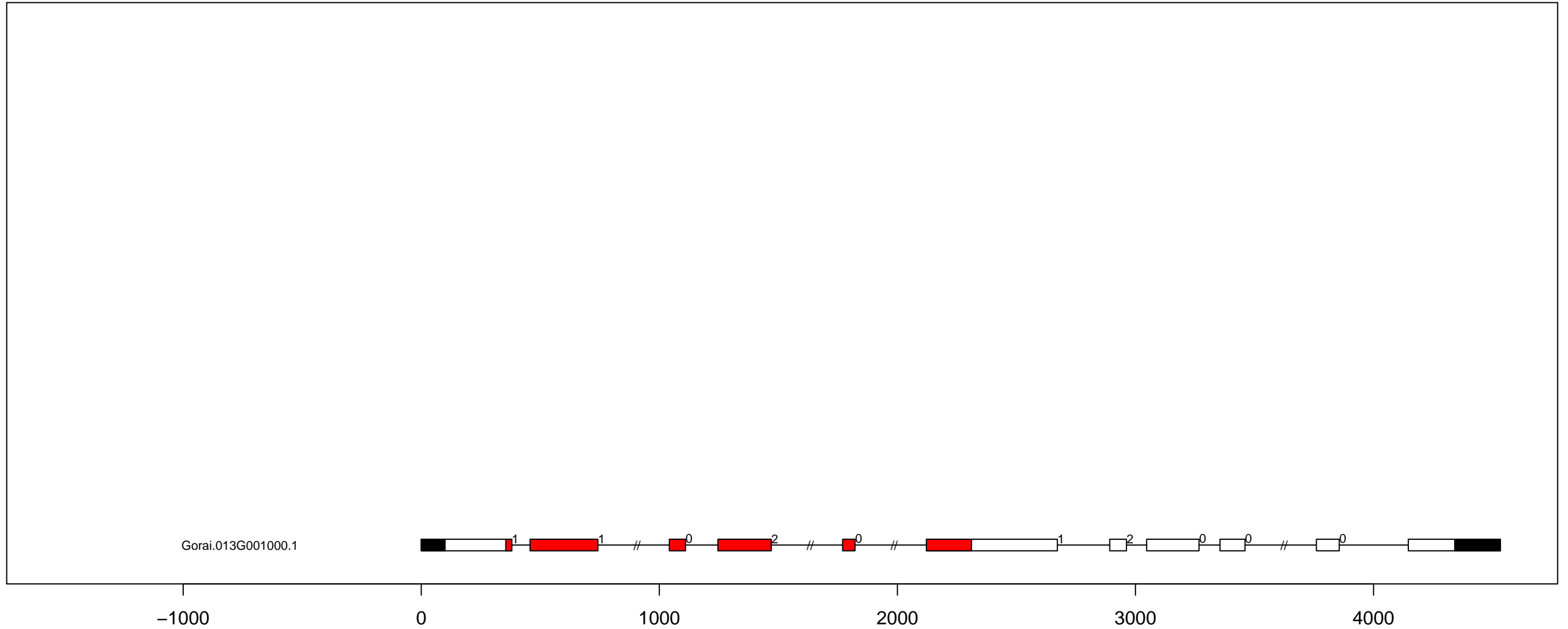

G.ra TKL-PI-4 exon-intron and domain diagram (part 1)

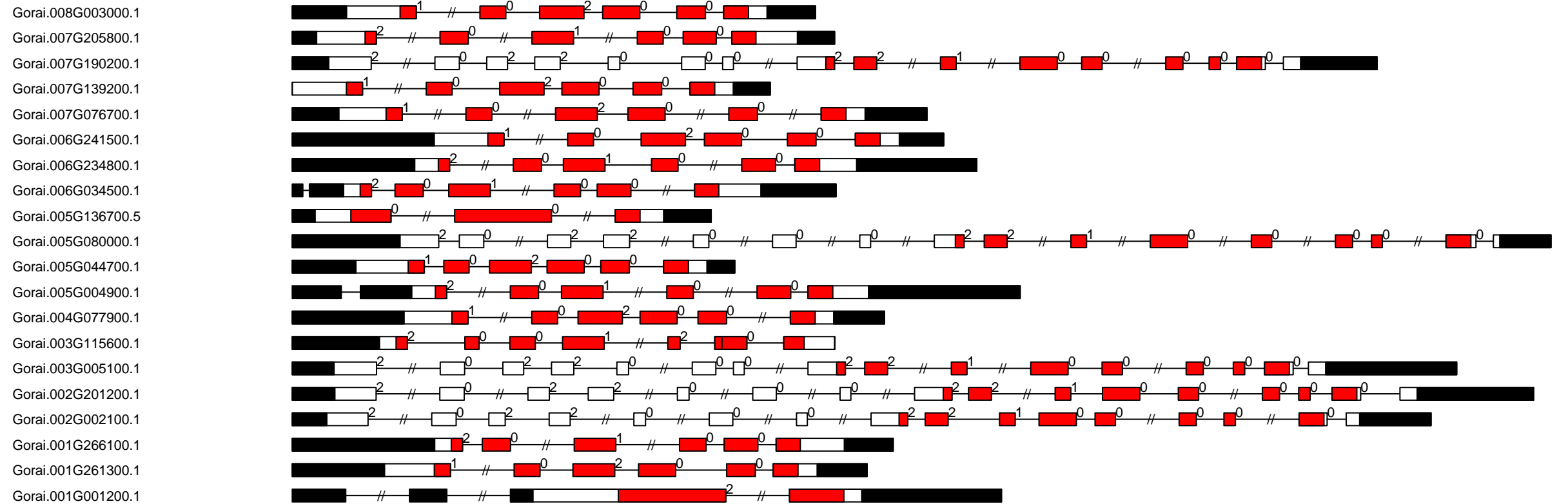

G.ra TKL-PI-4 exon-intron and domain diagram (part 2)

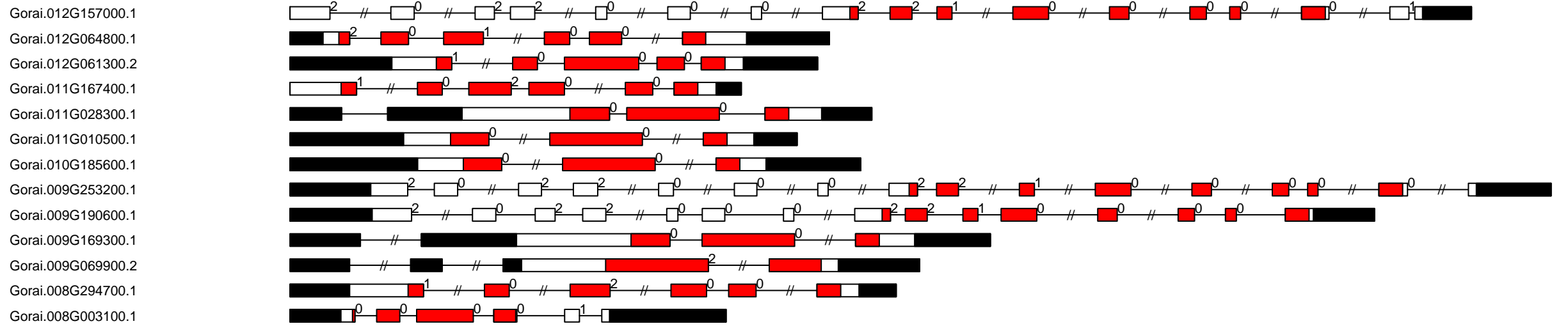

G.ra TKL-PI-5 exon-intron and domain diagram (all)

Gorai.013G089100.2
Gorai.012G042800.1
Gorai.011G131000.1
Gorai.011G035600.1
Gorai.008G179300.3
Gorai.008G121800.1
Gorai.006G233100.1
Gorai.005G142900.1
Gorai.005G007700.1

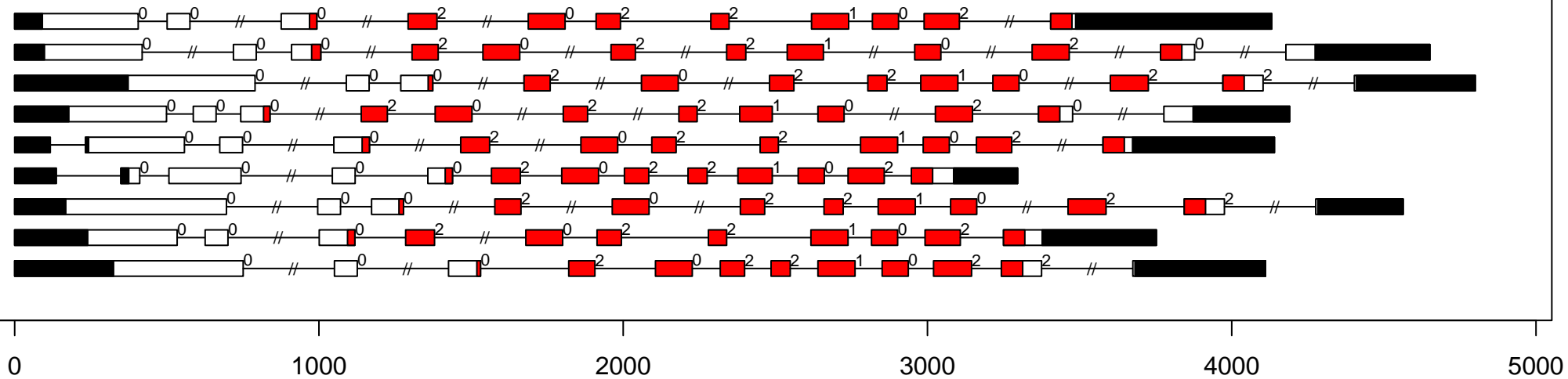

G.ra TKL-PI-6 exon-intron and domain diagram (all)

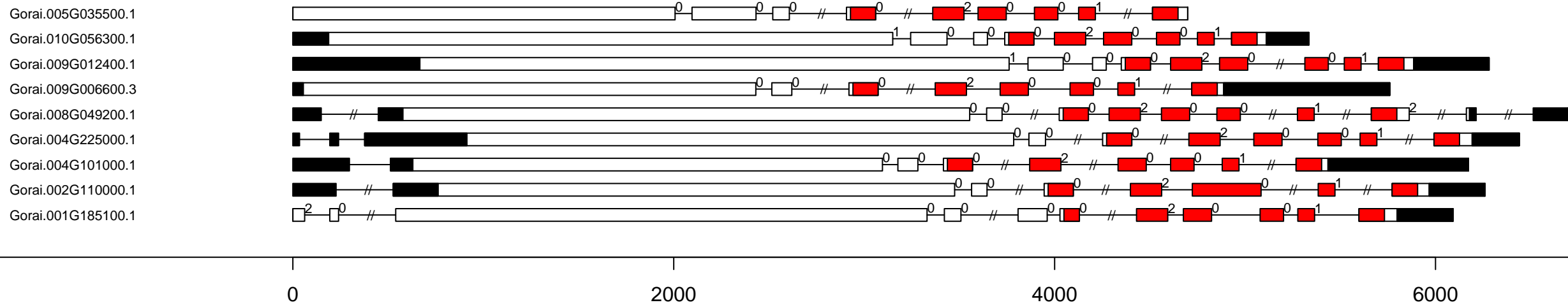

G.ra TKL-PI-7 exon-intron and domain diagram (all)

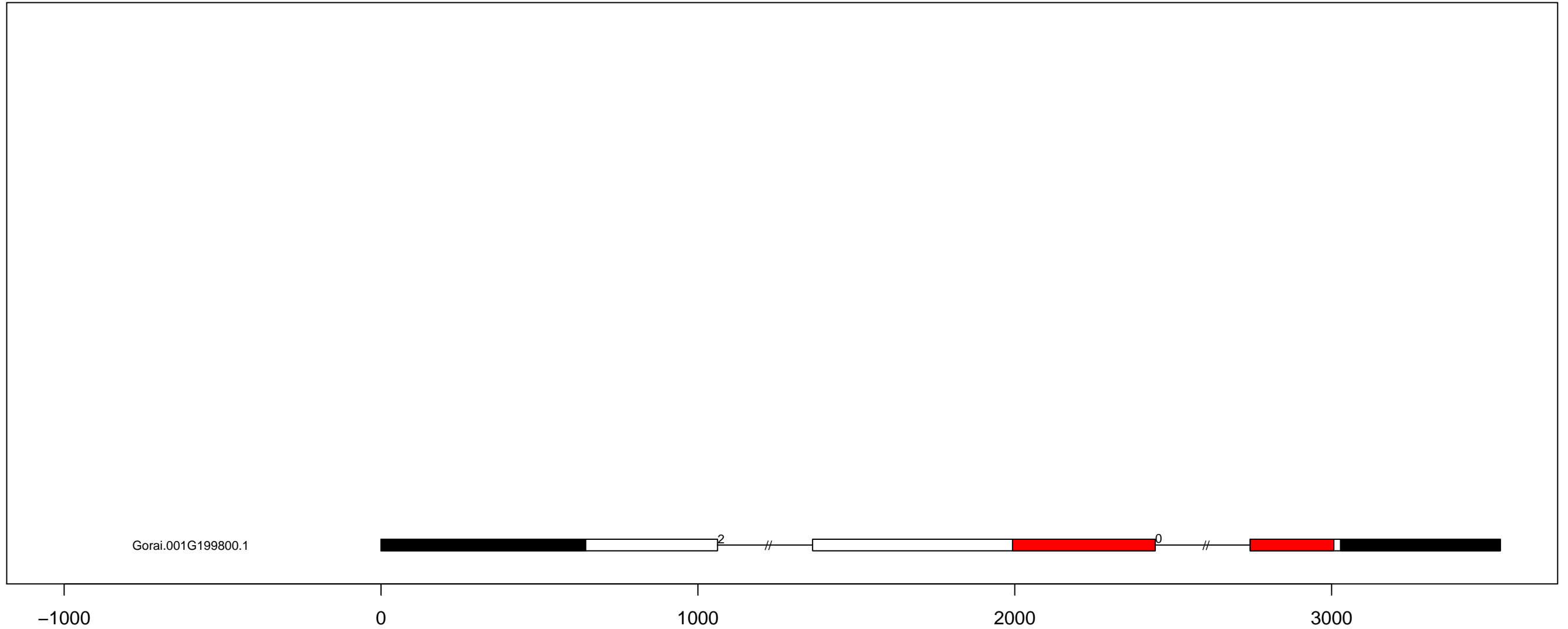

G.ra TKL-PI-8 exon-intron and domain diagram (all)

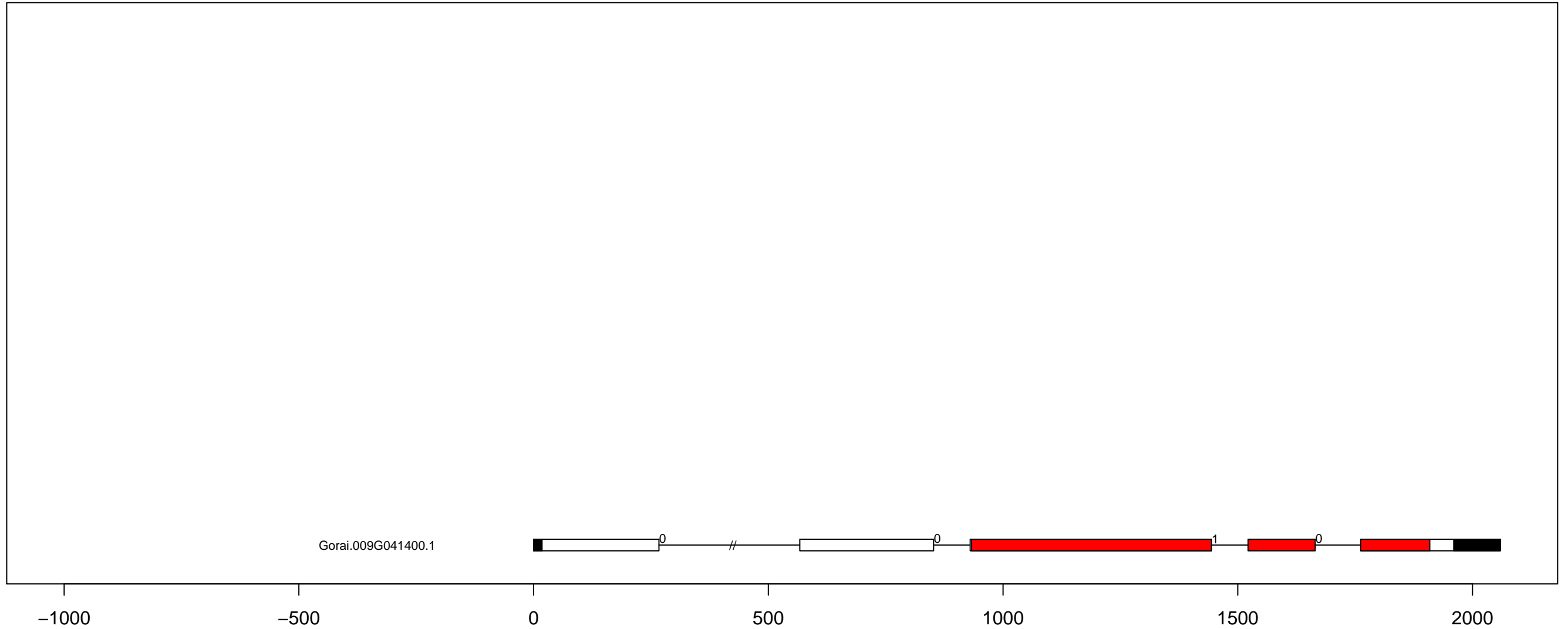

G.ra TLK exon-intron and domain diagram (all)

Gorai.013G256500.1

Gorai.001G127300.1

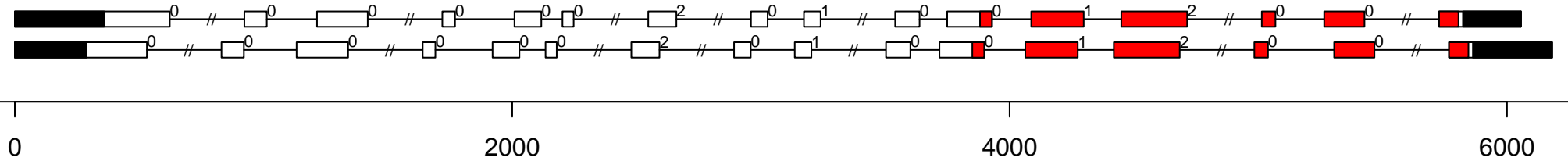

G.ra TTK exon-intron and domain diagram (all)

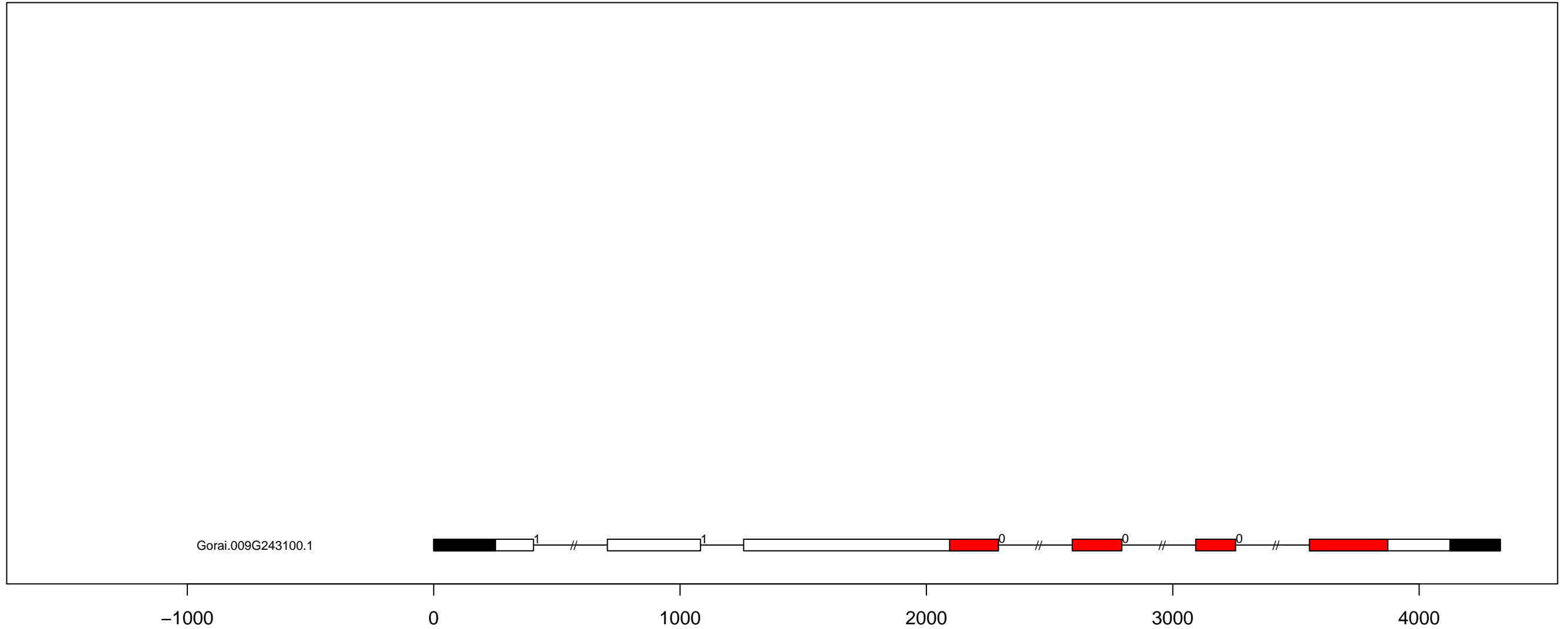

G.ra ULK_Fused exon-intron and domain diagram (all)

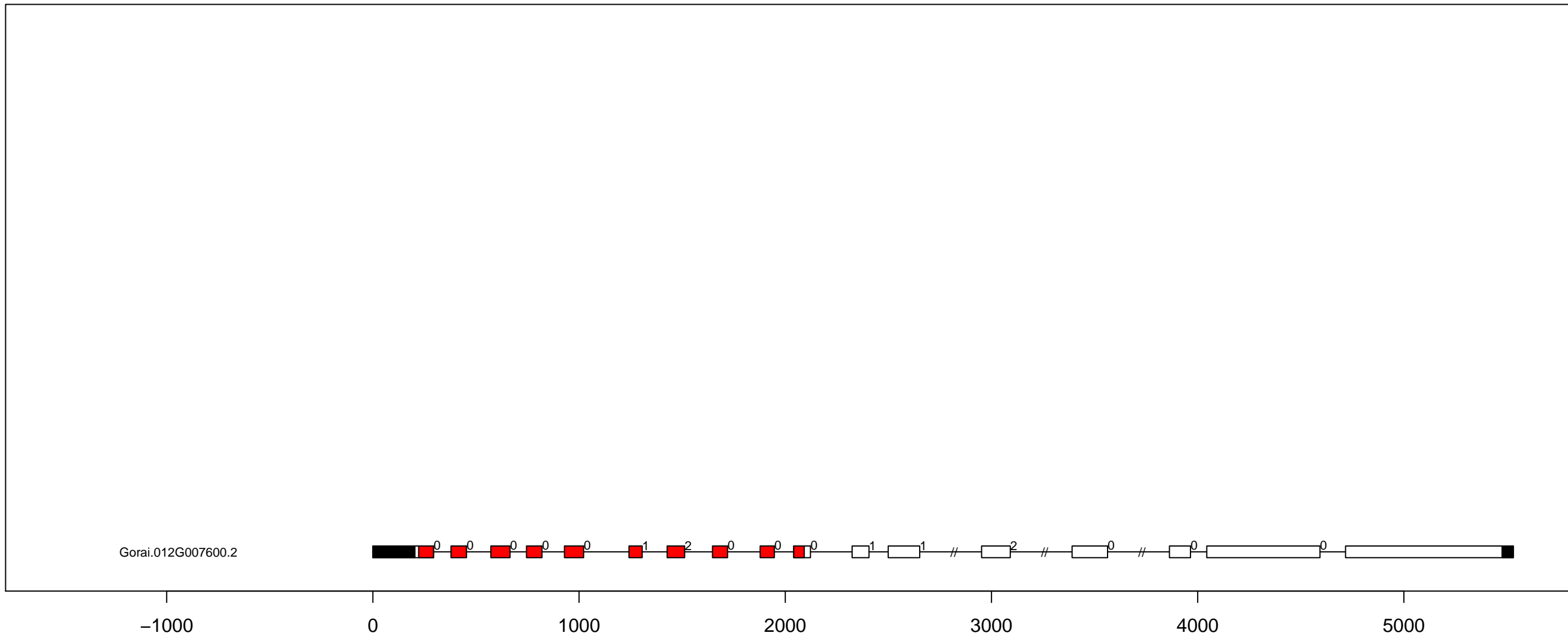

G.ra ULK_ULK4 exon-intron and domain diagram (all)

Gorai.011G185300.1

Gorai.005G057000.1

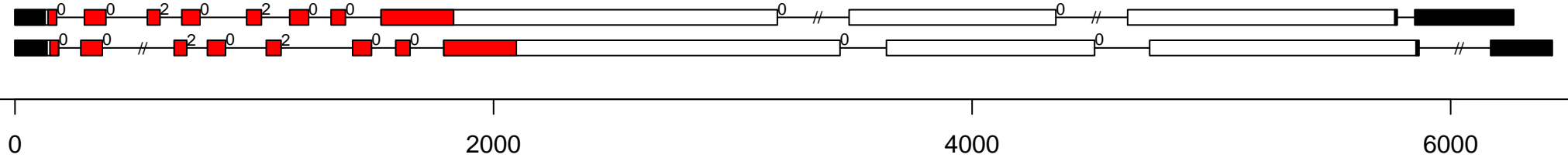

G.ra WEE exon-intron and domain diagram (all)

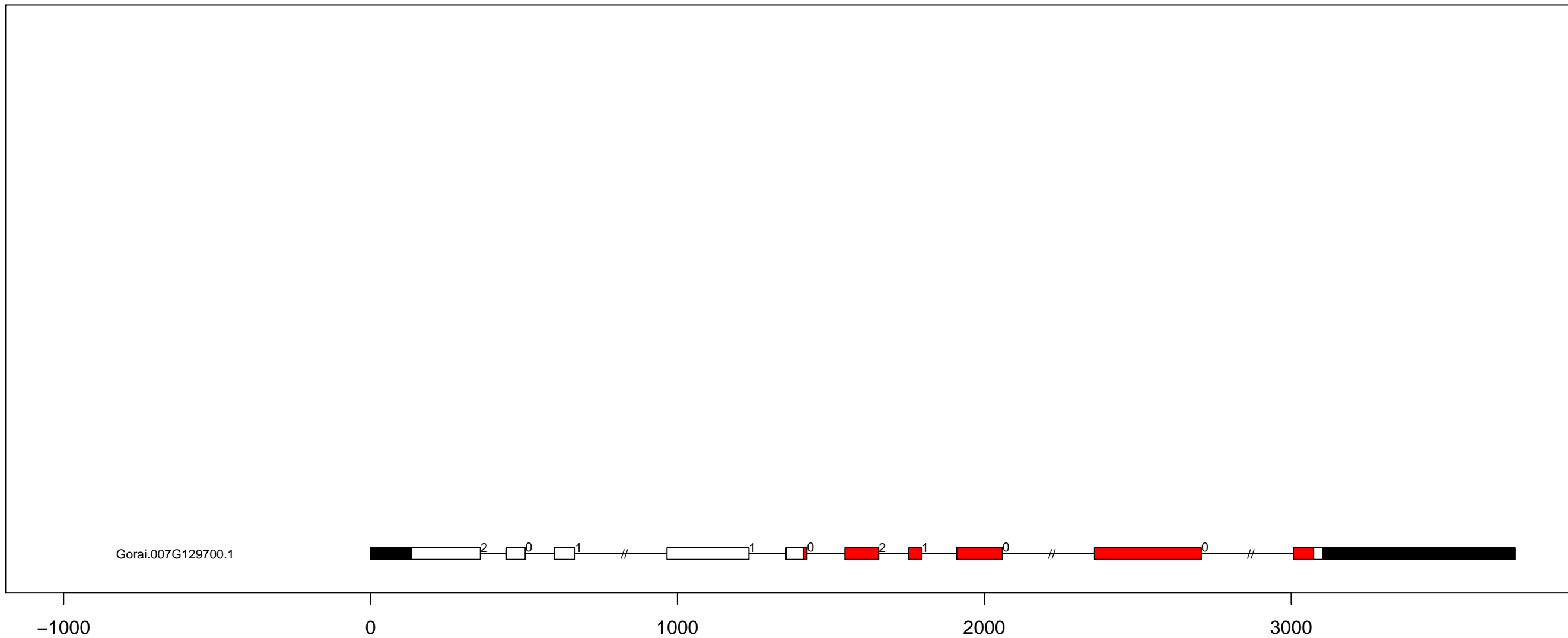

G.ra WNK_NRBP exon-intron and domain diagram (all)

Gorai.003G075600.1
 Gorai.013G272100.1
 Gorai.013G156000.1
 Gorai.012G033500.1
 Gorai.011G128900.1
 Gorai.008G257300.1
 Gorai.007G285300.1
 Gorai.007G167300.1
 Gorai.006G269500.1
 Gorai.005G042400.1
 Gorai.004G150400.1
 Gorai.003G069600.1
 Gorai.002G096100.1
 Gorai.001G064400.1

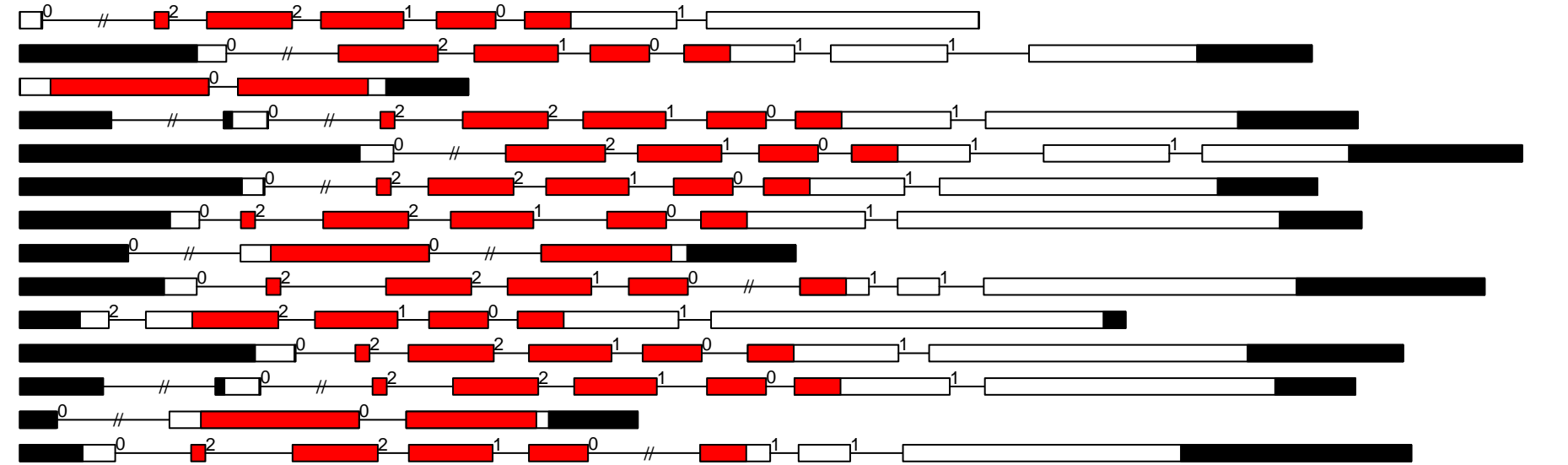

A.th AGC_MAST exon-intron and kinase domain diagram (all)

Ath_AT5G62310.1
Ath_AT3G17850.1
Ath_AT1G48490.1
Ath_AT1G45160.2

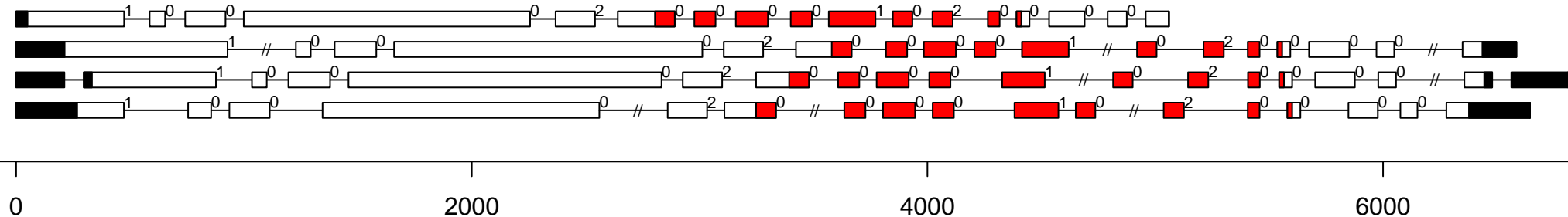

A.th AGC_NDR exon-intron and kinase domain diagram (all)

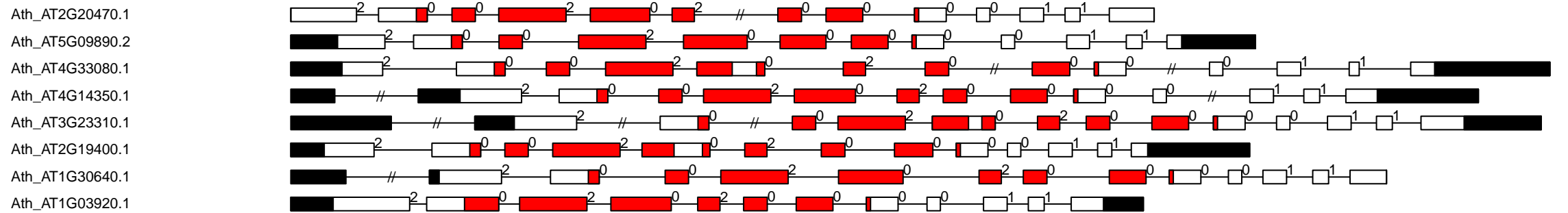

-1000

0

1000

2000

3000

4000

A.th AGC_PDK1 exon-intron and kinase domain diagram (all)

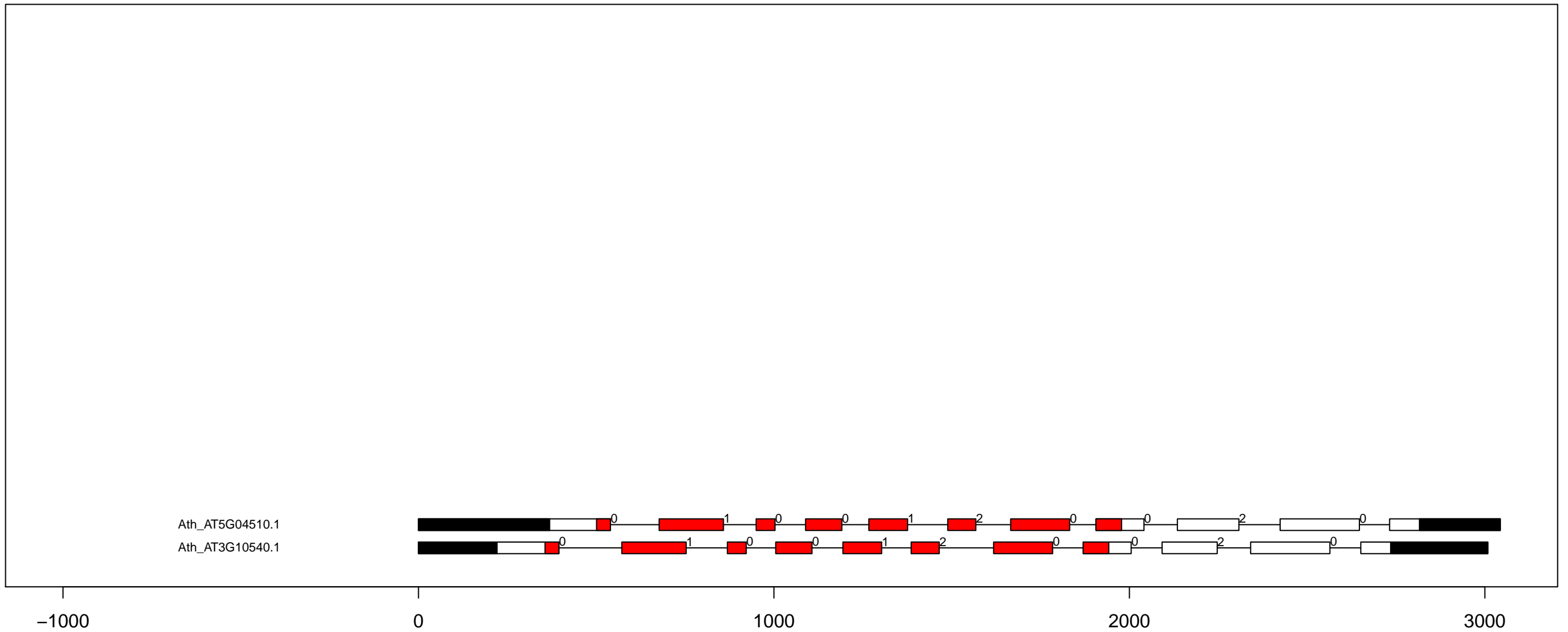

A.th AGC_PKA-PKG exon-intron and kinase domain diagram (all)

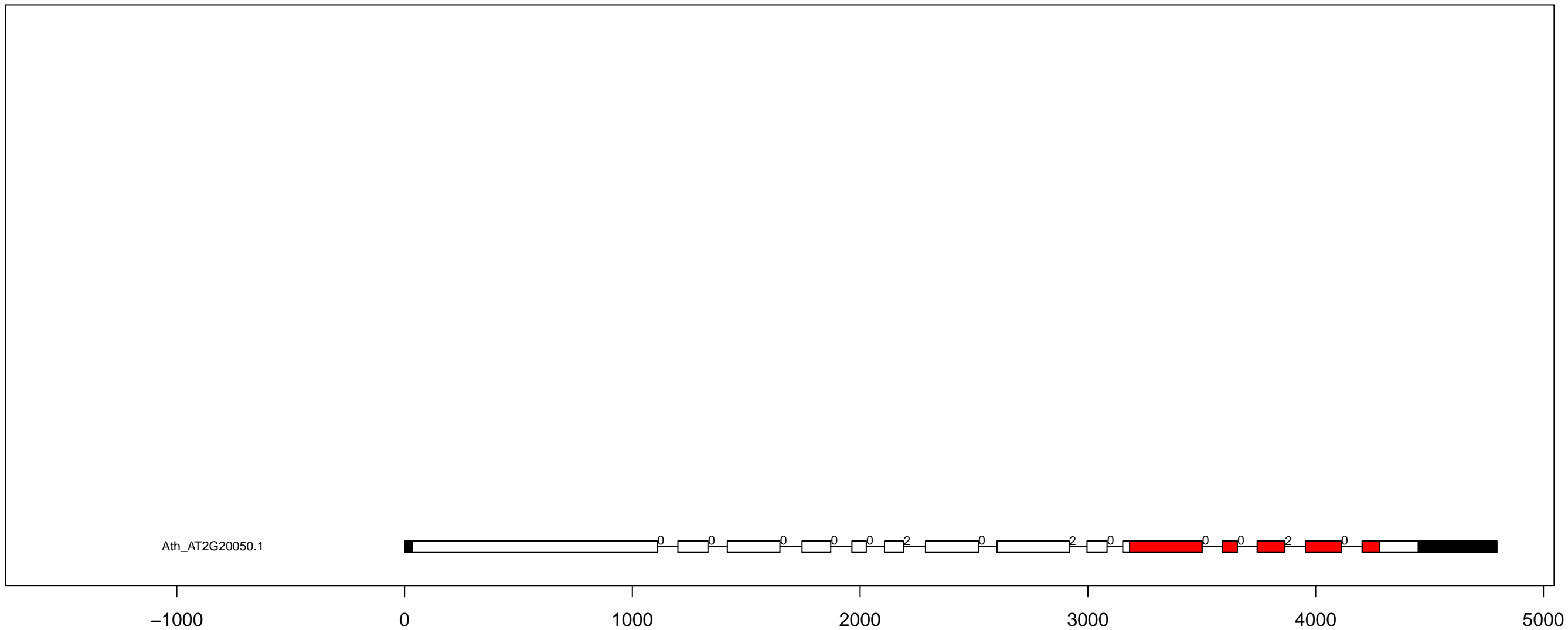

A.th AGC_RSK-2 exon-intron and kinase domain diagram (part 2)

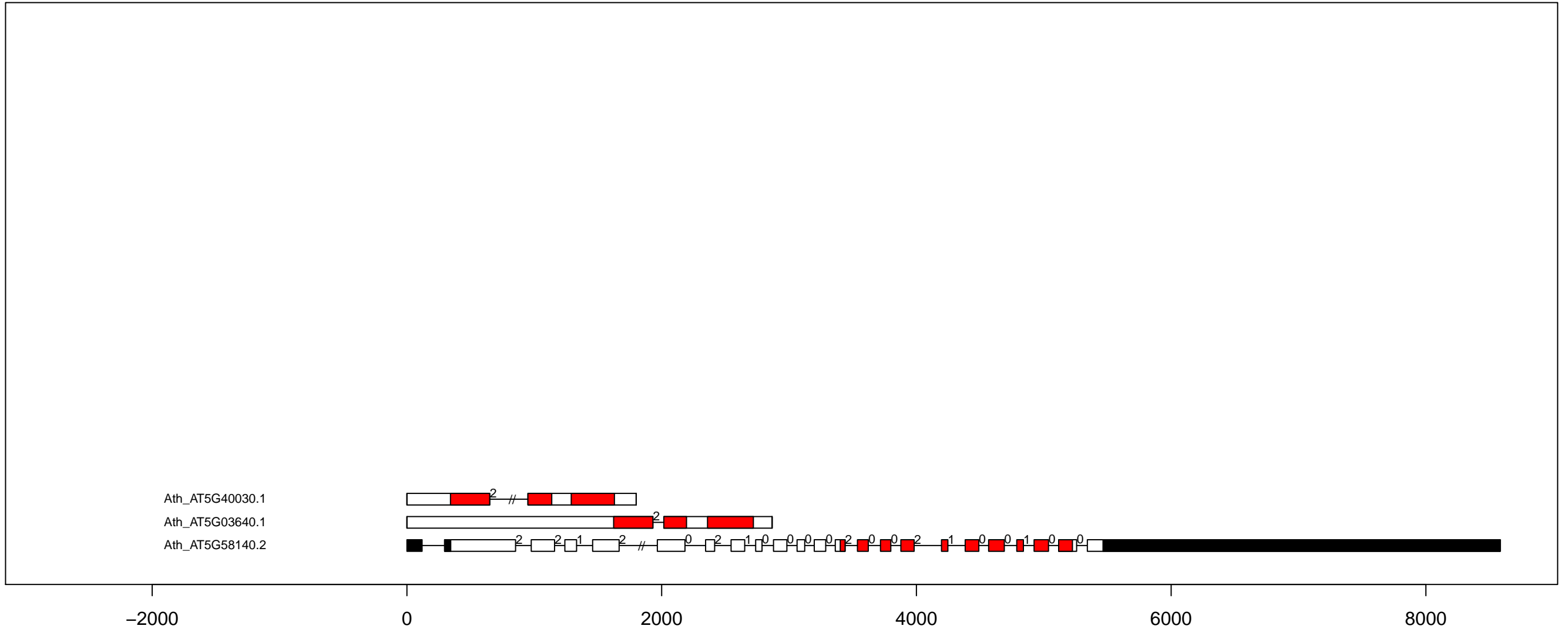

A.th AGC-PI exon-intron and kinase domain diagram (all)

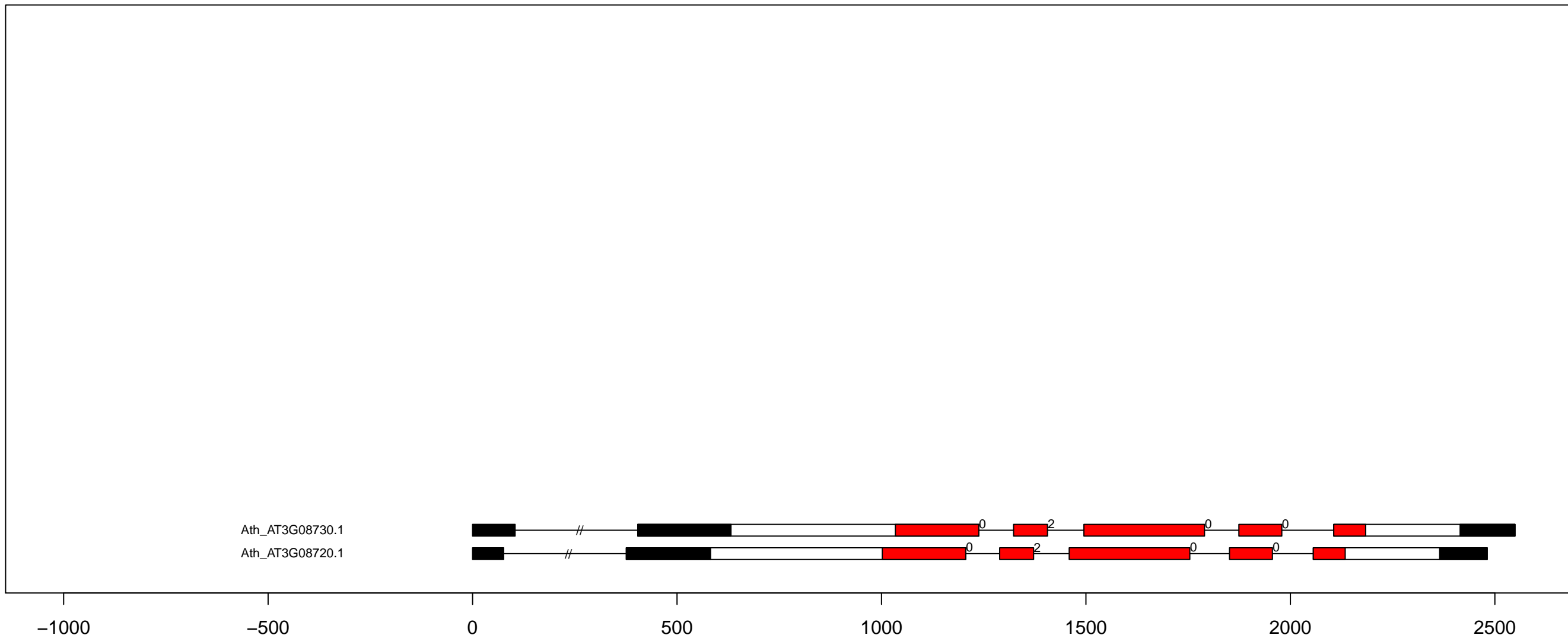

A.th CAMK_AMPK exon-intron and kinase domain diagram (all)

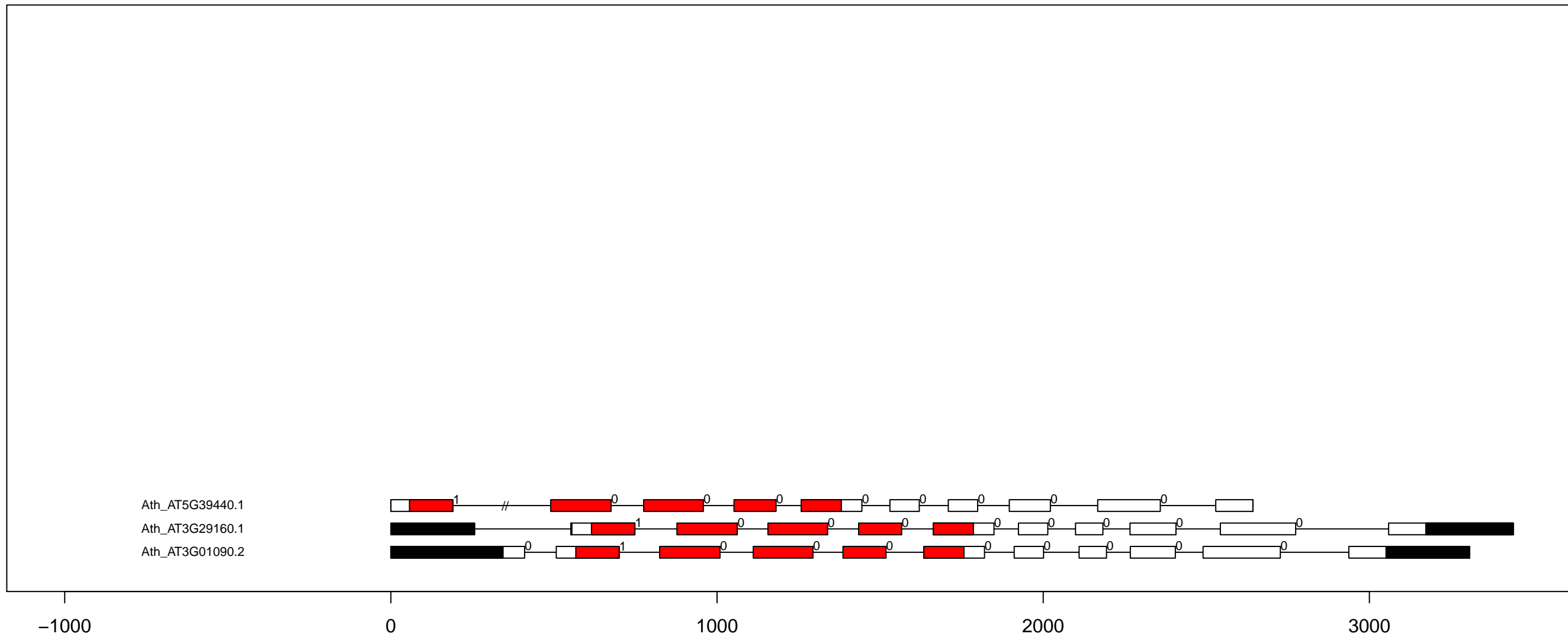

A.th CAMK_CAMKL-CHK1 exon-intron and kinase domain diagram (part 1)

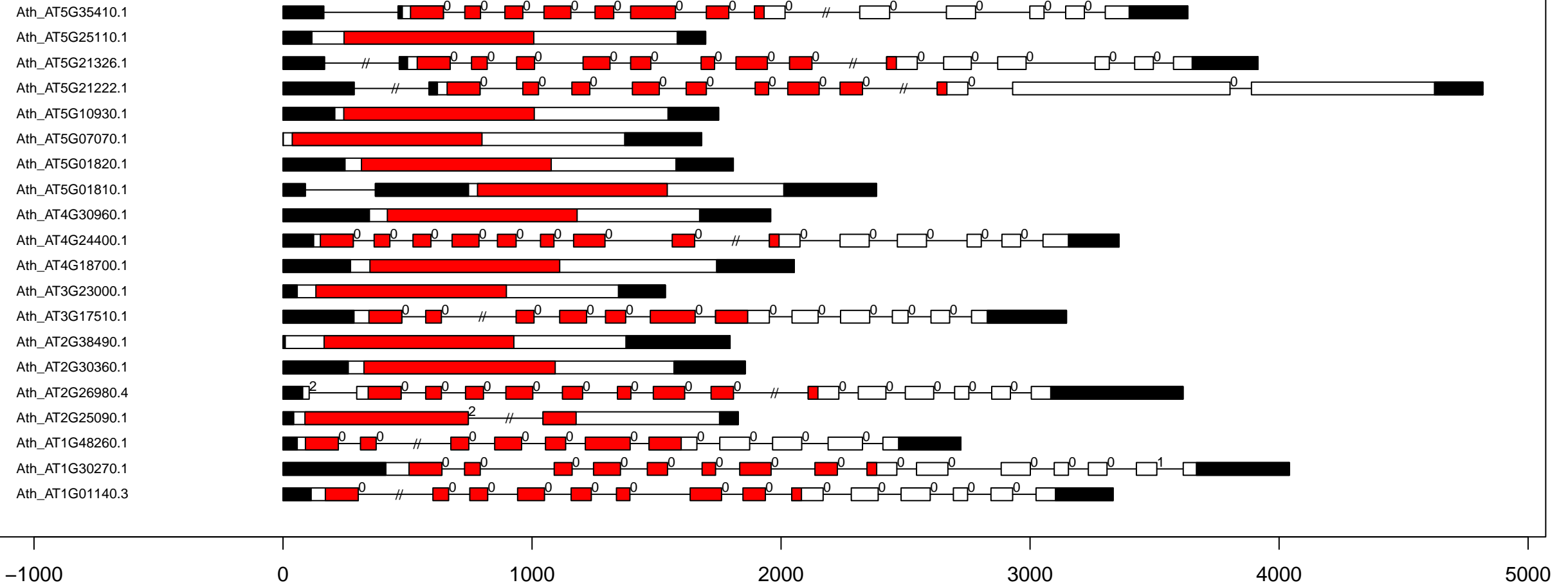

A.th CAMK_CAMKL-LKB exon-intron and kinase domain diagram (all)

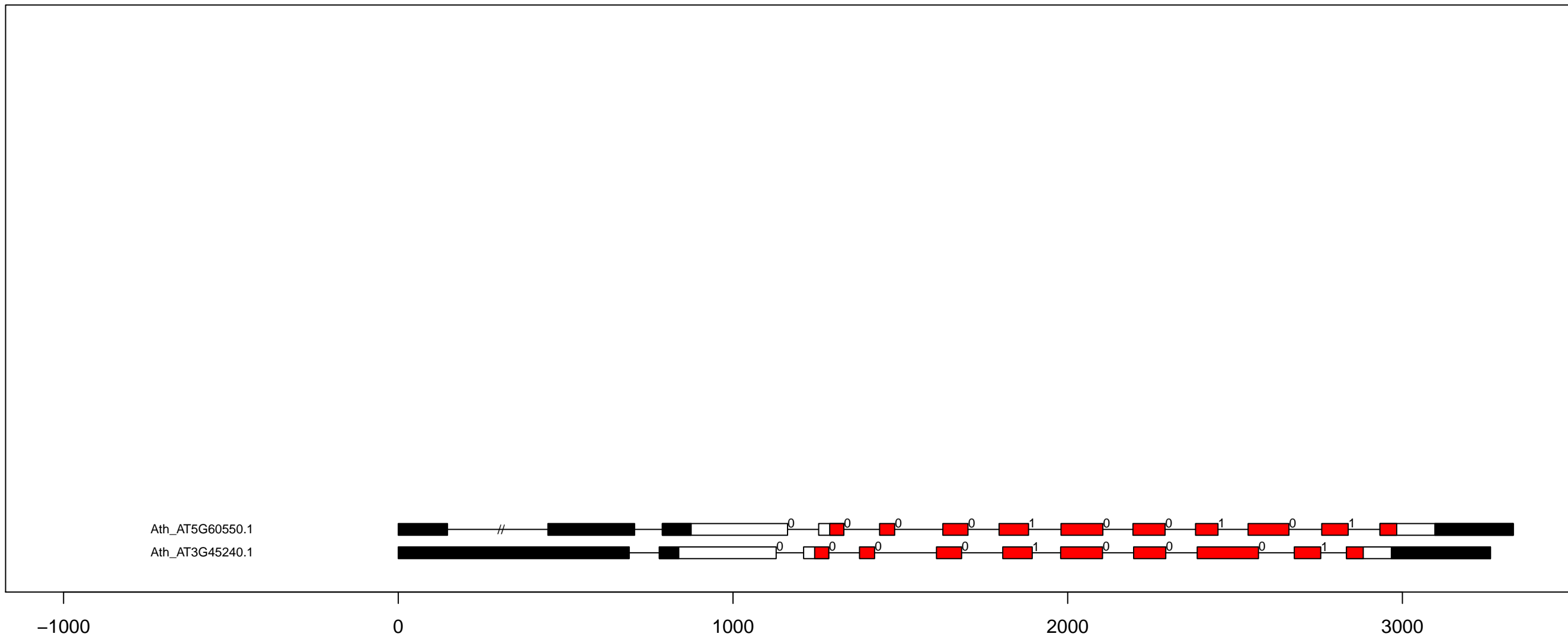

A.th CAMK_CDPK exon-intron and kinase domain diagram (part 1)

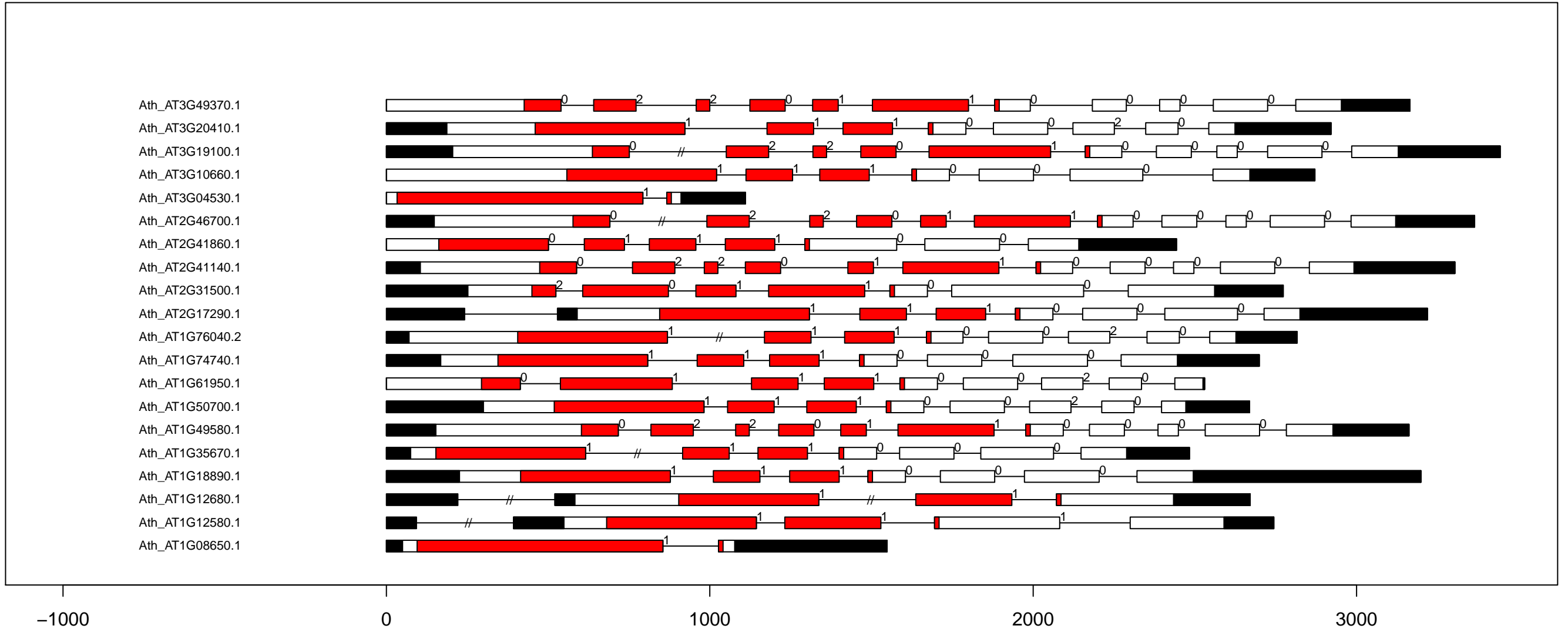

A.th CAMK_CDPK exon-intron and kinase domain diagram (part 2)

Ath_AT2G17890.1
 Ath_AT5G66210.2
 Ath_AT5G24430.1
 Ath_AT5G23580.1
 Ath_AT5G19450.1
 Ath_AT5G12480.1
 Ath_AT5G12180.1
 Ath_AT5G04870.1
 Ath_AT4G38230.2
 Ath_AT4G36070.2
 Ath_AT4G35310.1
 Ath_AT4G23650.1
 Ath_AT4G21940.2
 Ath_AT4G09570.1
 Ath_AT4G04740.2
 Ath_AT4G04720.1
 Ath_AT3G57530.1
 Ath_AT3G56760.1
 Ath_AT3G51850.1
 Ath_AT3G50530.2

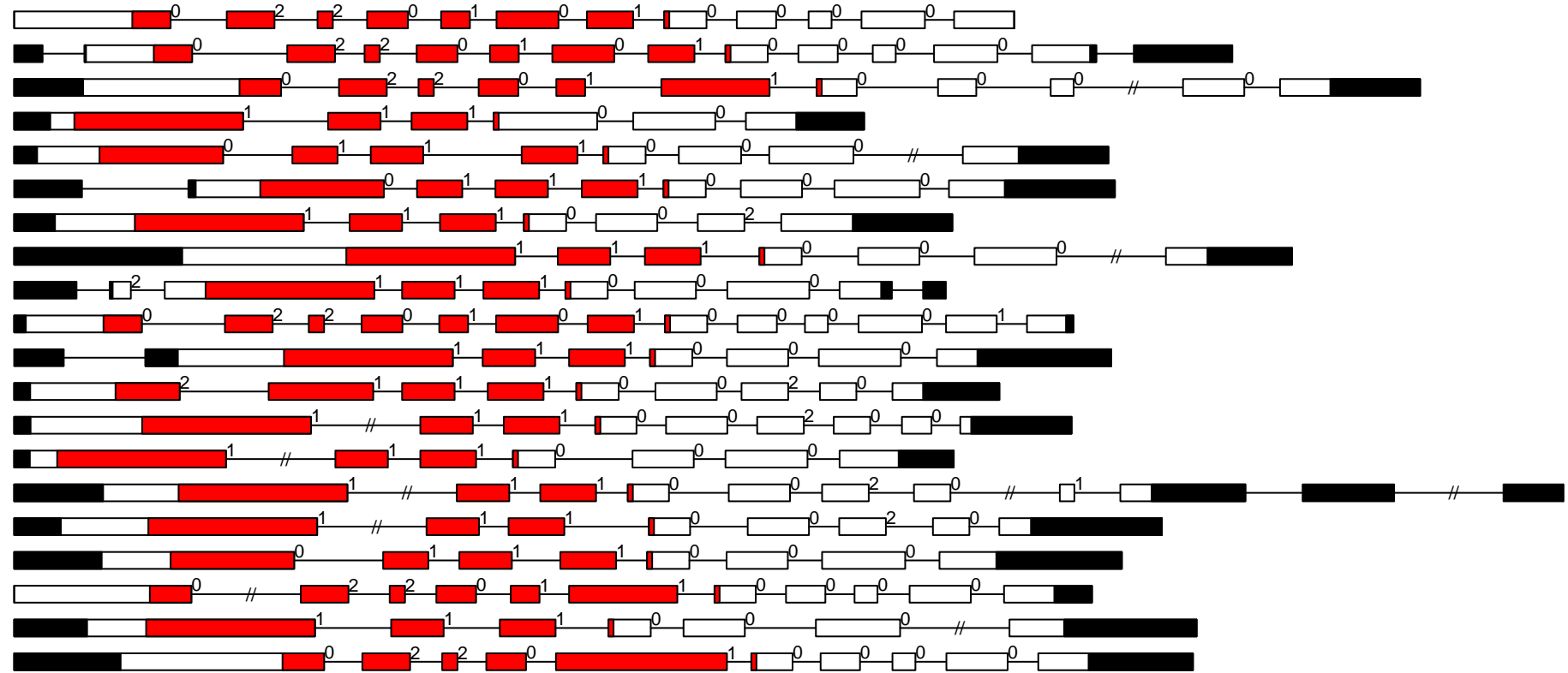

A.th CK1_CK1 exon-intron and kinase domain diagram (all)

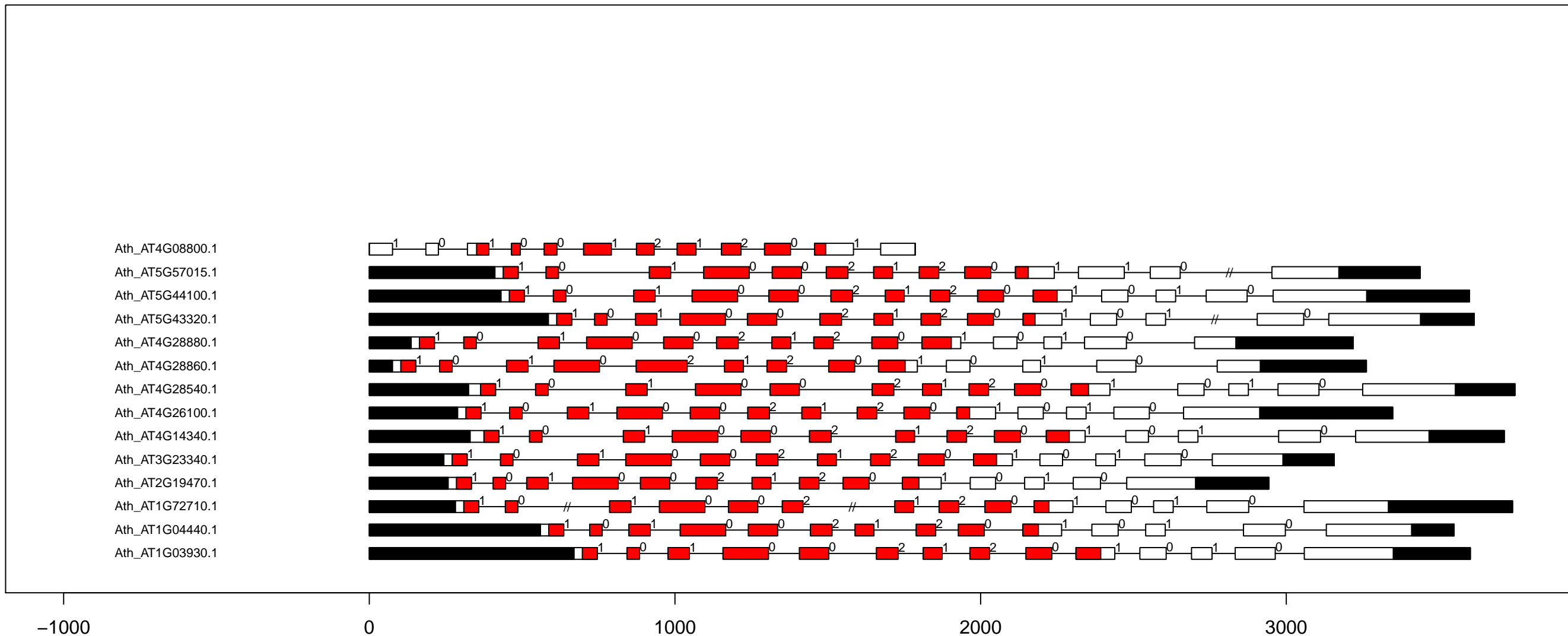

A.th CK1_CK1-PI exon-intron and kinase domain diagram (all)

Ath_AT5G18190.1
Ath_AT3G13670.1
Ath_AT3G03940.1
Ath_AT2G25760.2

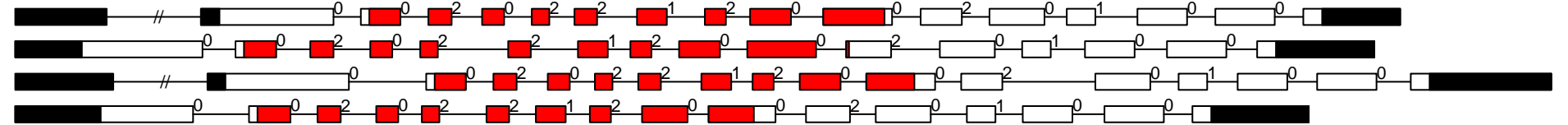

-1000

0

1000

2000

3000

4000

5000

A.th CMGC_CDK-CCRK exon-intron and kinase domain diagram (all)

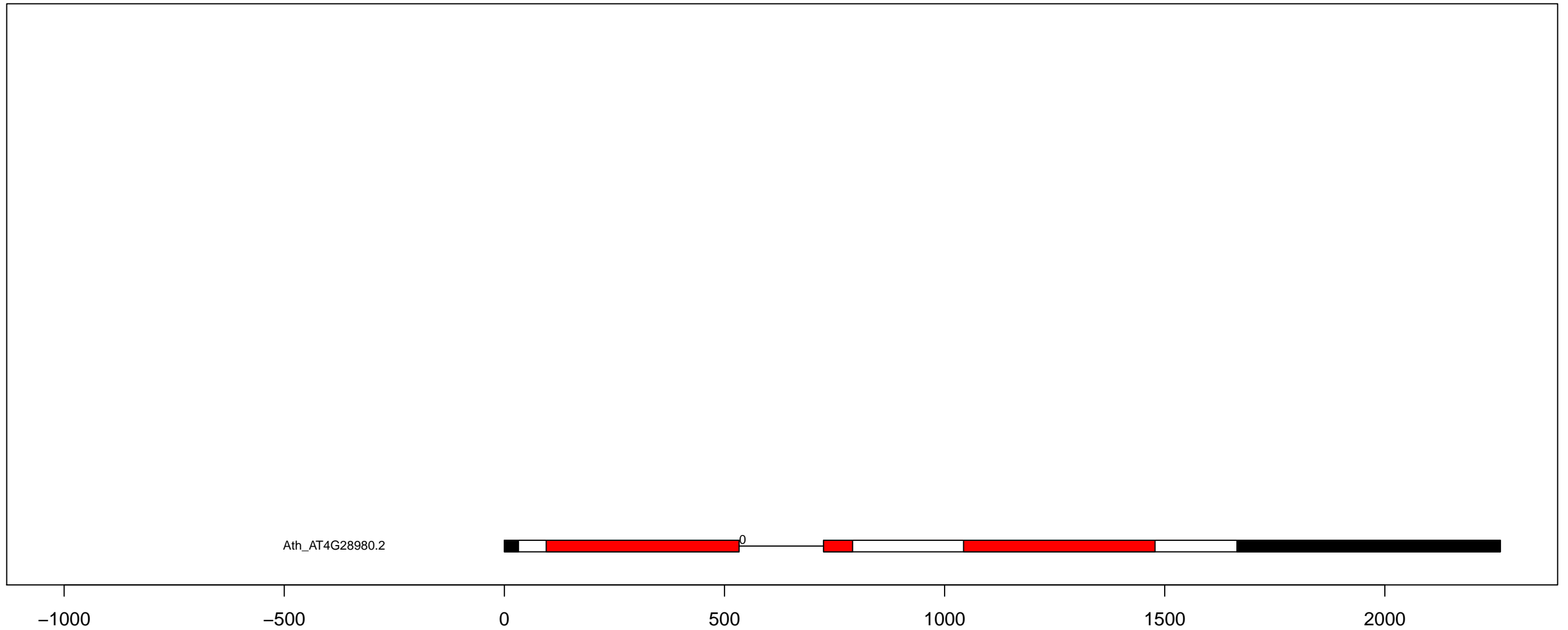

A.th CMGC_CDK-CDK7 exon-intron and kinase domain diagram (all)

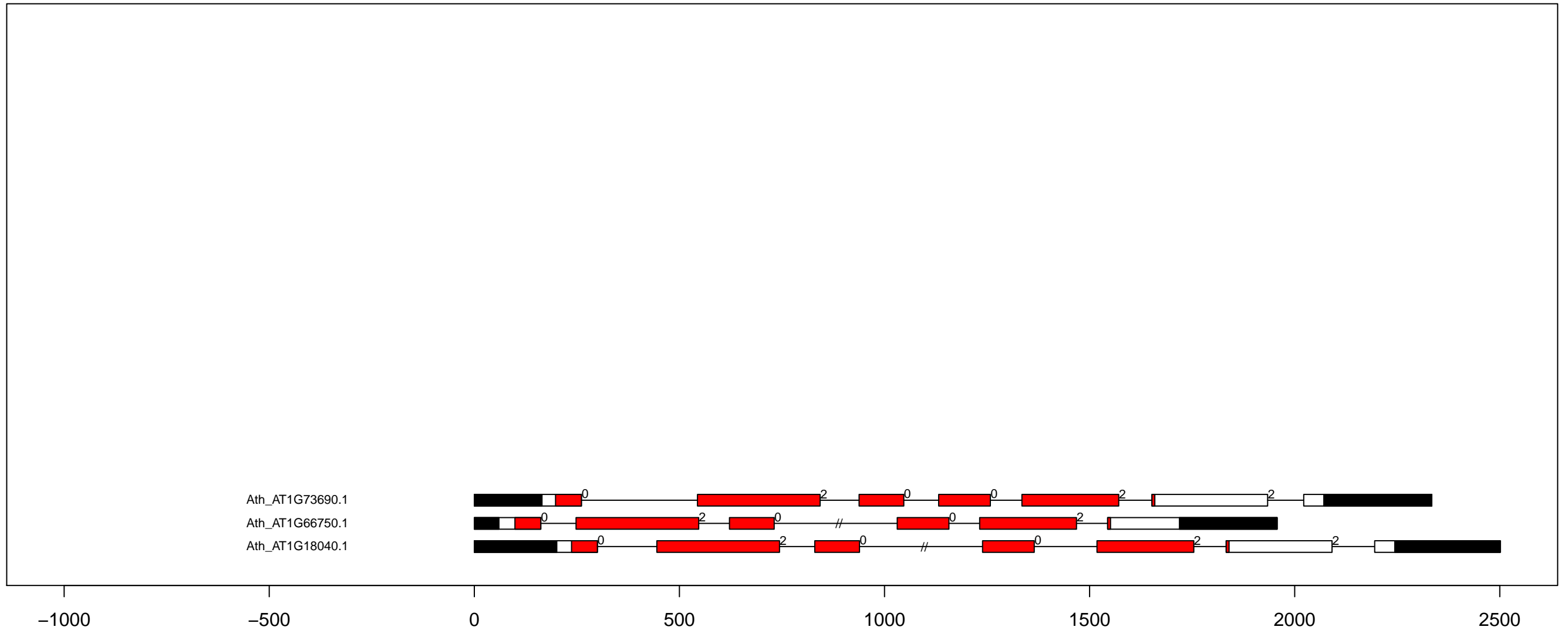

A.th CMGC_CDK-CDK8 exon-intron and kinase domain diagram (all)

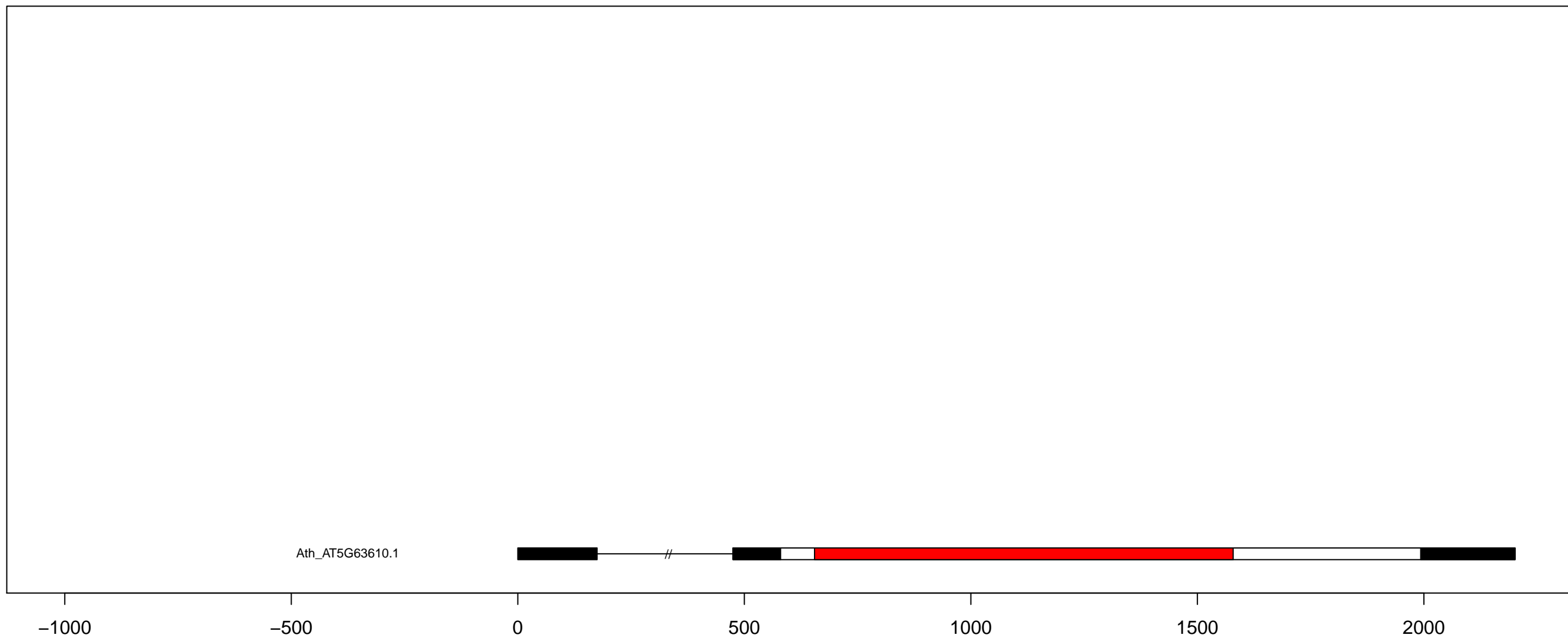

A.th CMGC_CDK-CRK7-CDK9 exon-intron and kinase domain diagram (all)

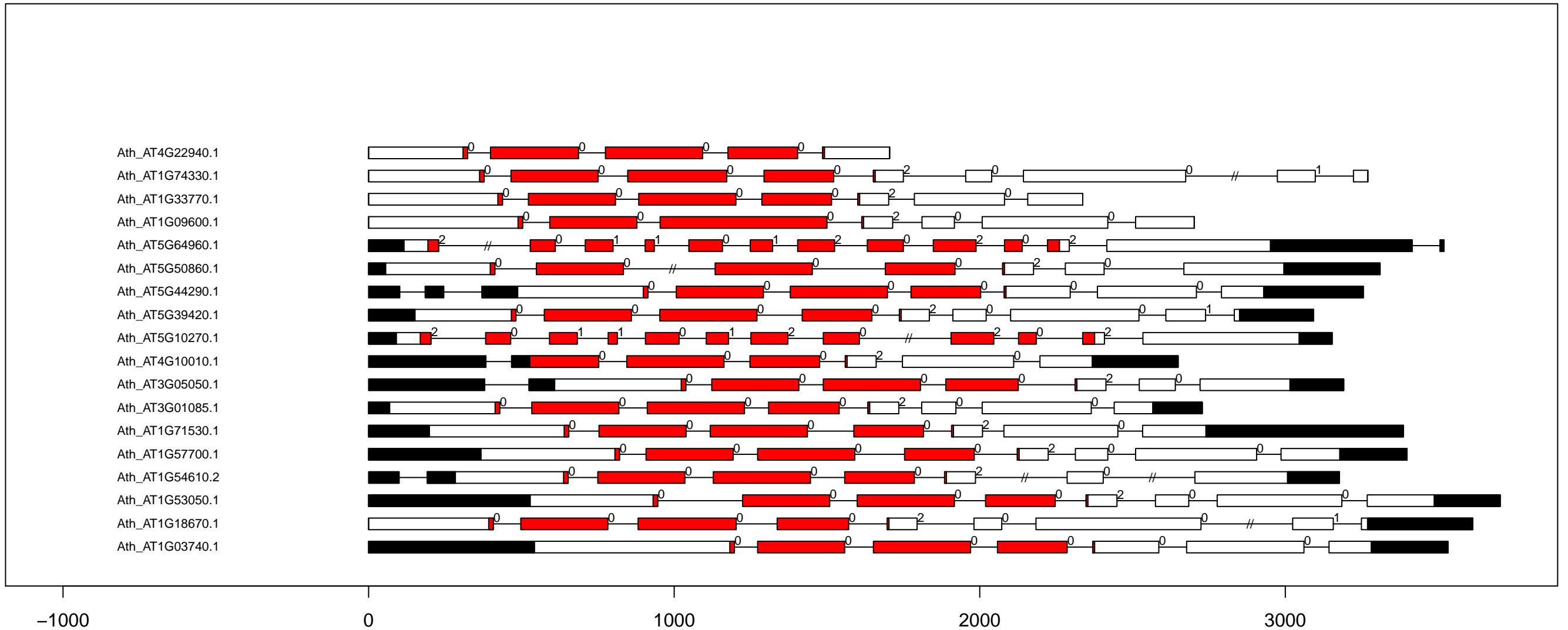

A.th CMGC_CDK-PITSLRE exon-intron and kinase domain diagram (all)

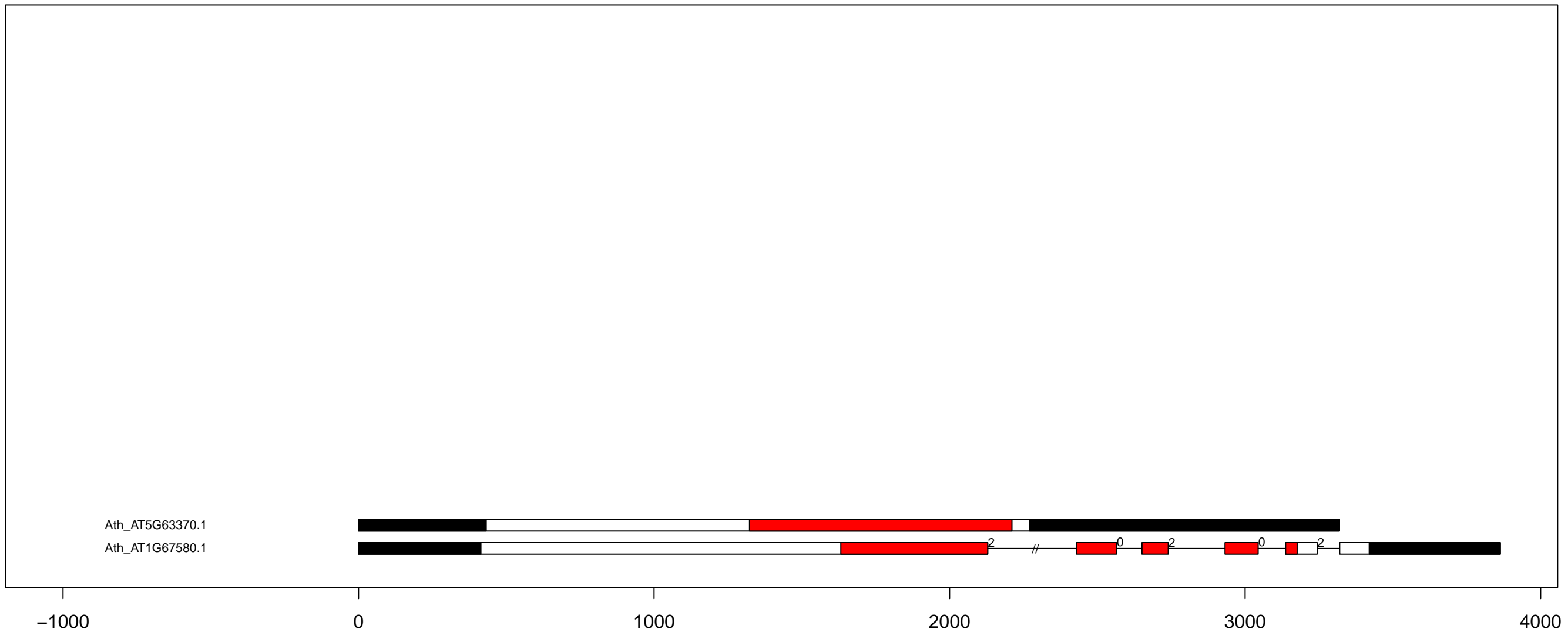

A.th CMGC_CDK-PI exon-intron and kinase domain diagram (all)

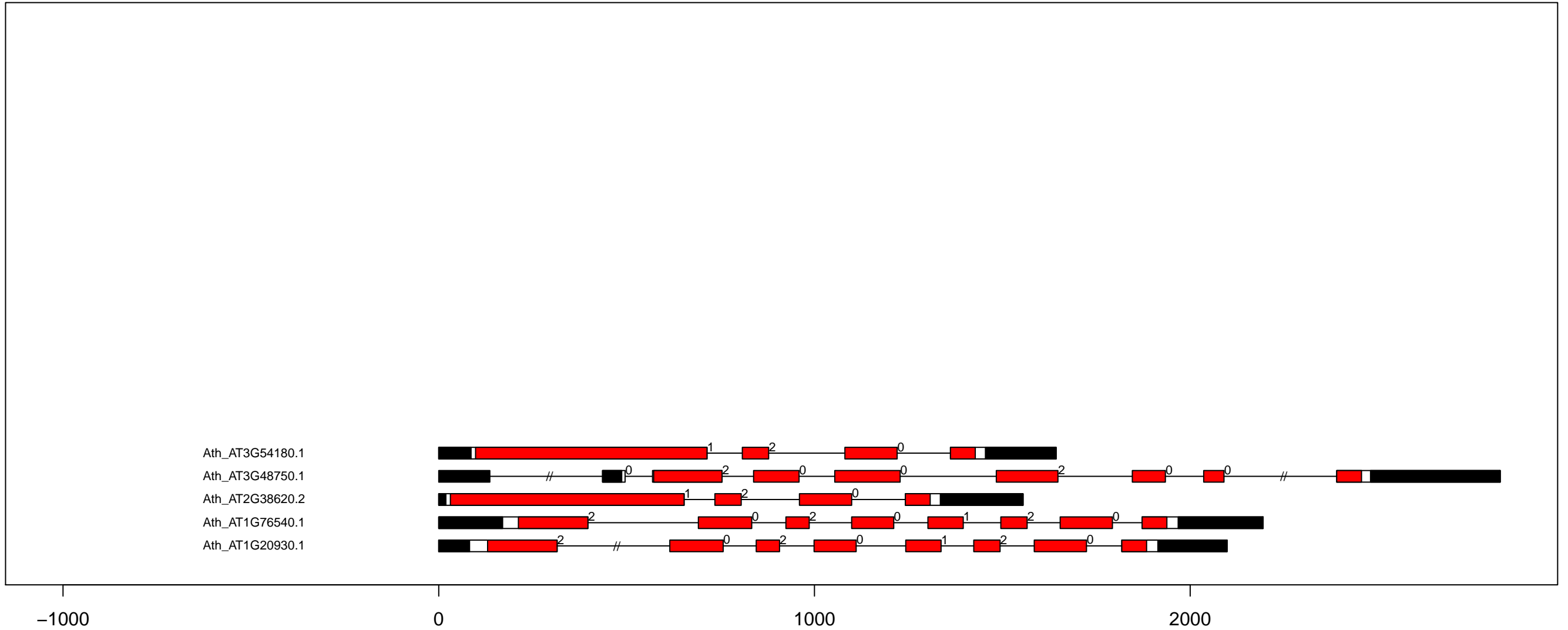

A.th CMGC_CK2 exon-intron and kinase domain diagram (all)

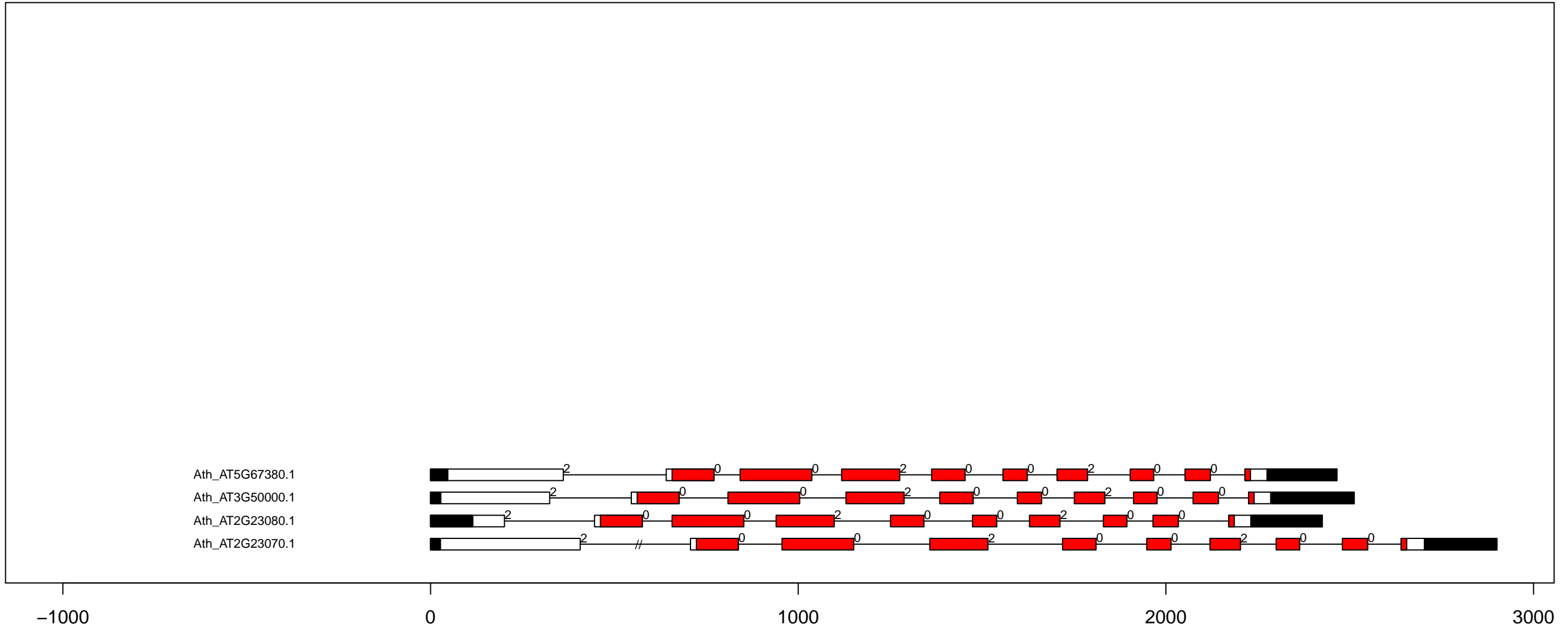

A.th CMGC_CLK exon-intron and kinase domain diagram (all)

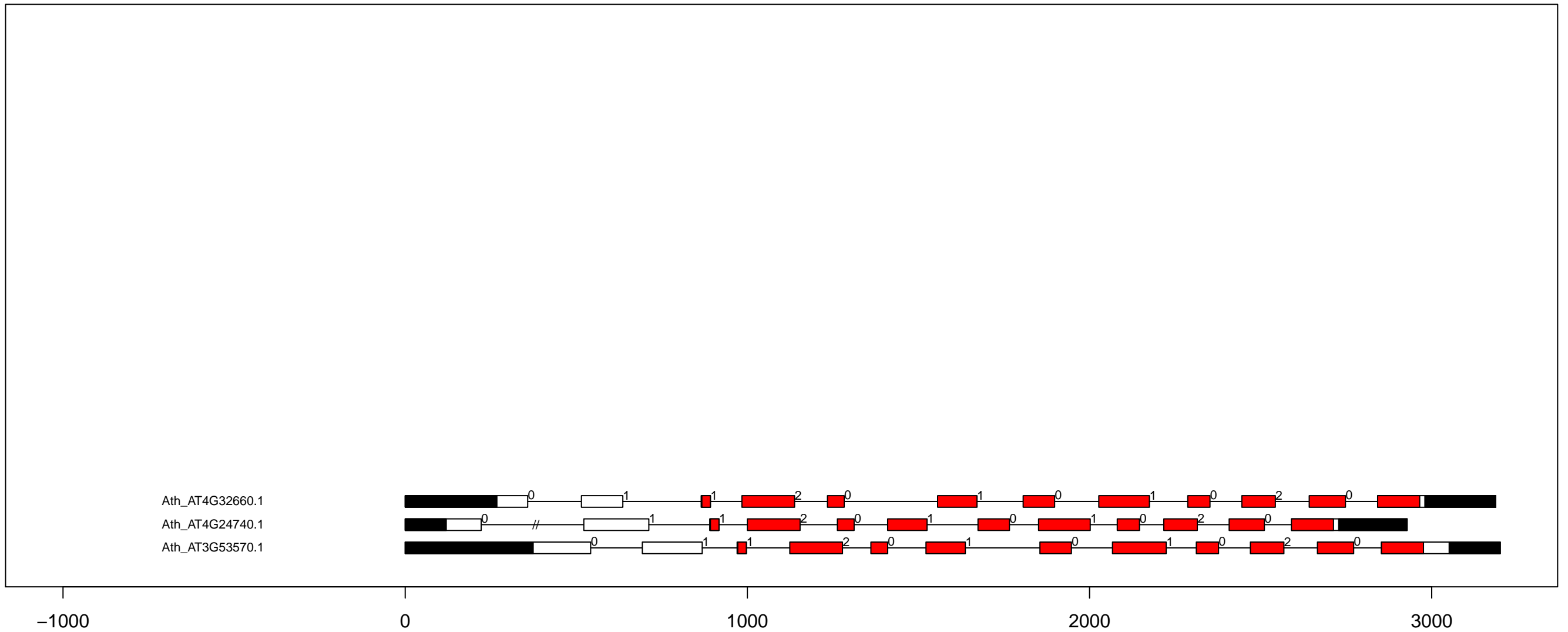

A.th CMGC_DYRK-PRP4 exon-intron and kinase domain diagram (all)

Ath_AT3G53640.1
 Ath_AT3G25840.1
 Ath_AT3G17750.1
 Ath_AT2G40120.1
 Ath_AT1G73460.1
 Ath_AT1G73450.1
 Ath_AT1G13350.2

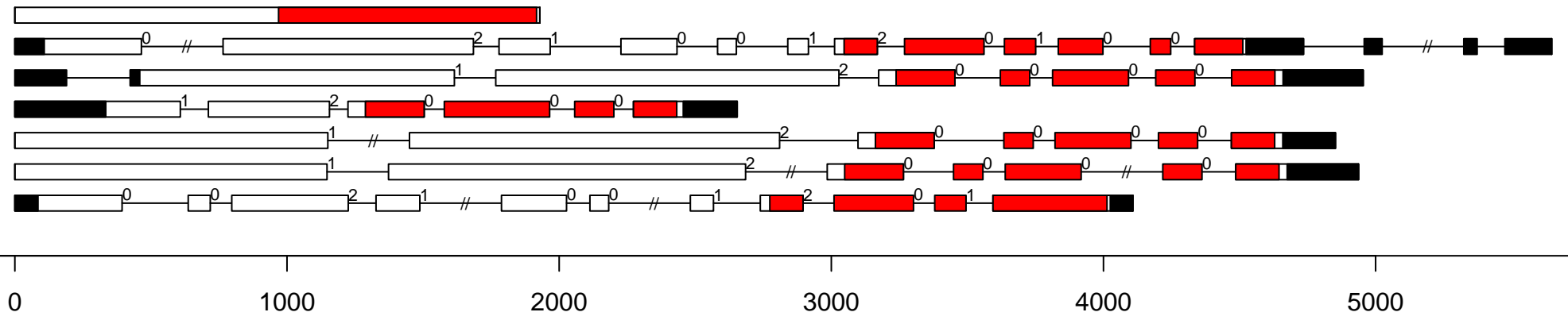

A.th CMGC_DYRK-YAK exon-intron and kinase domain diagram (all)

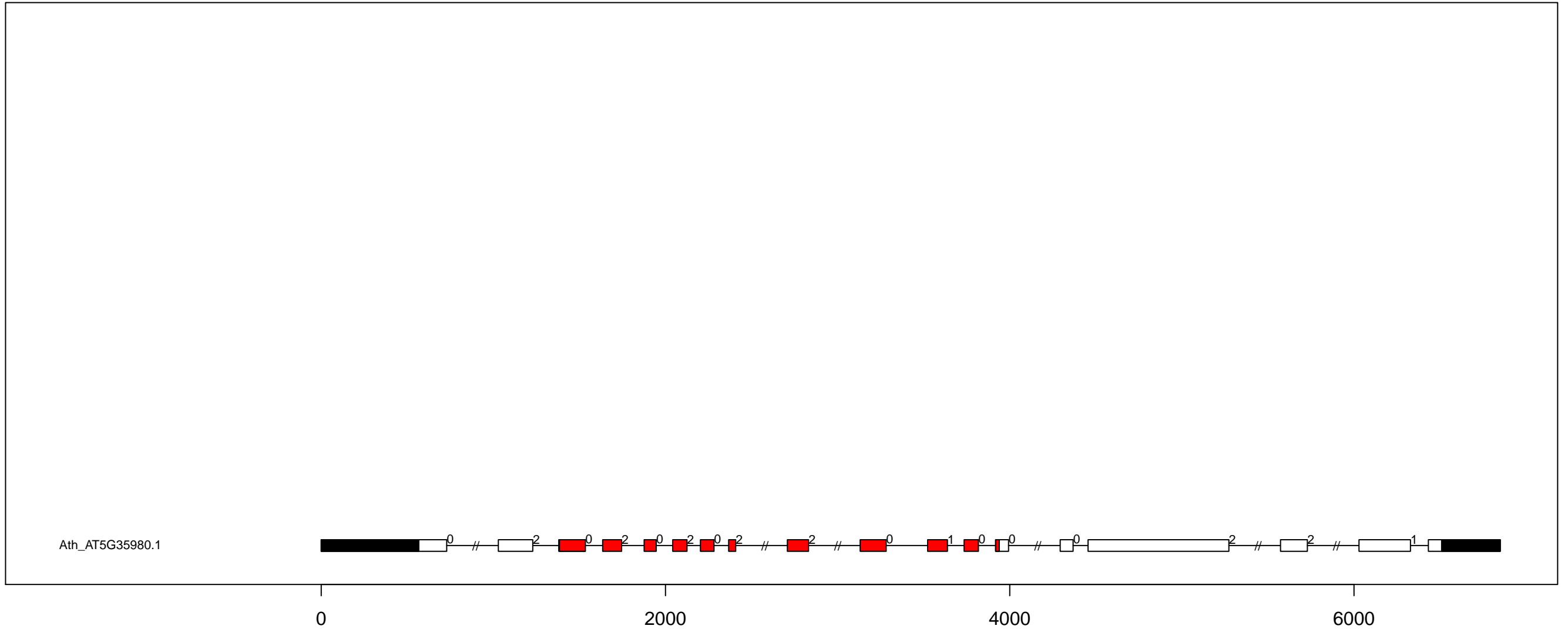

A.th CMGC_GSKL exon-intron and kinase domain diagram (all)

Ath_AT3G63340.2

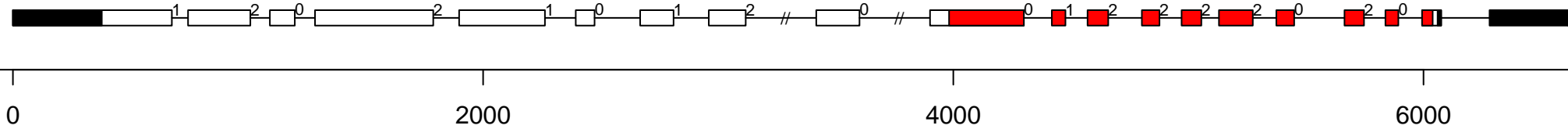

A.th CMGC_GSK exon-intron and kinase domain diagram (all)

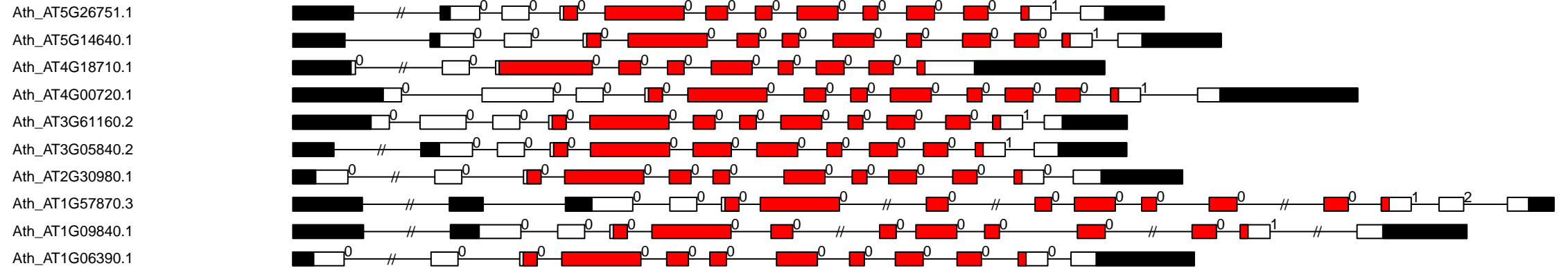

A.th CMGC_MAPK exon-intron and kinase domain diagram (all)

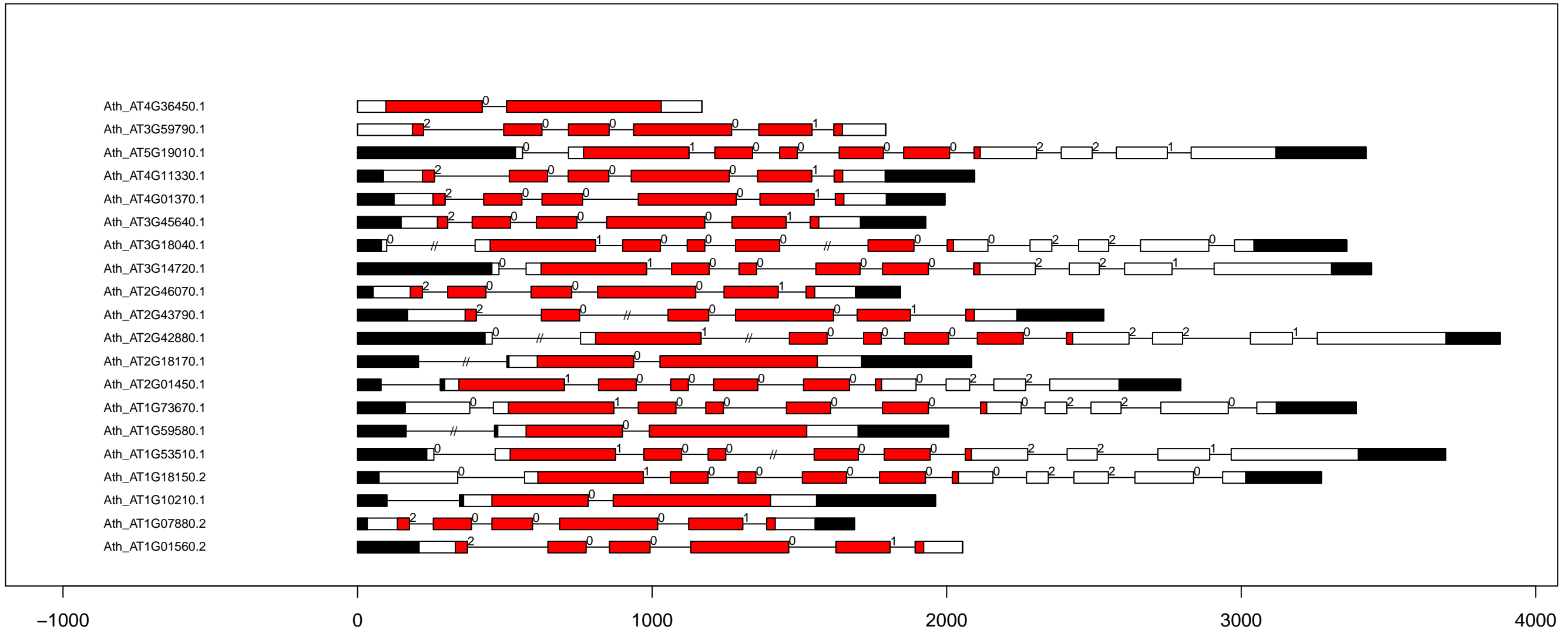

A.th CMGC_PI-Tthe exon-intron and kinase domain diagram (all)

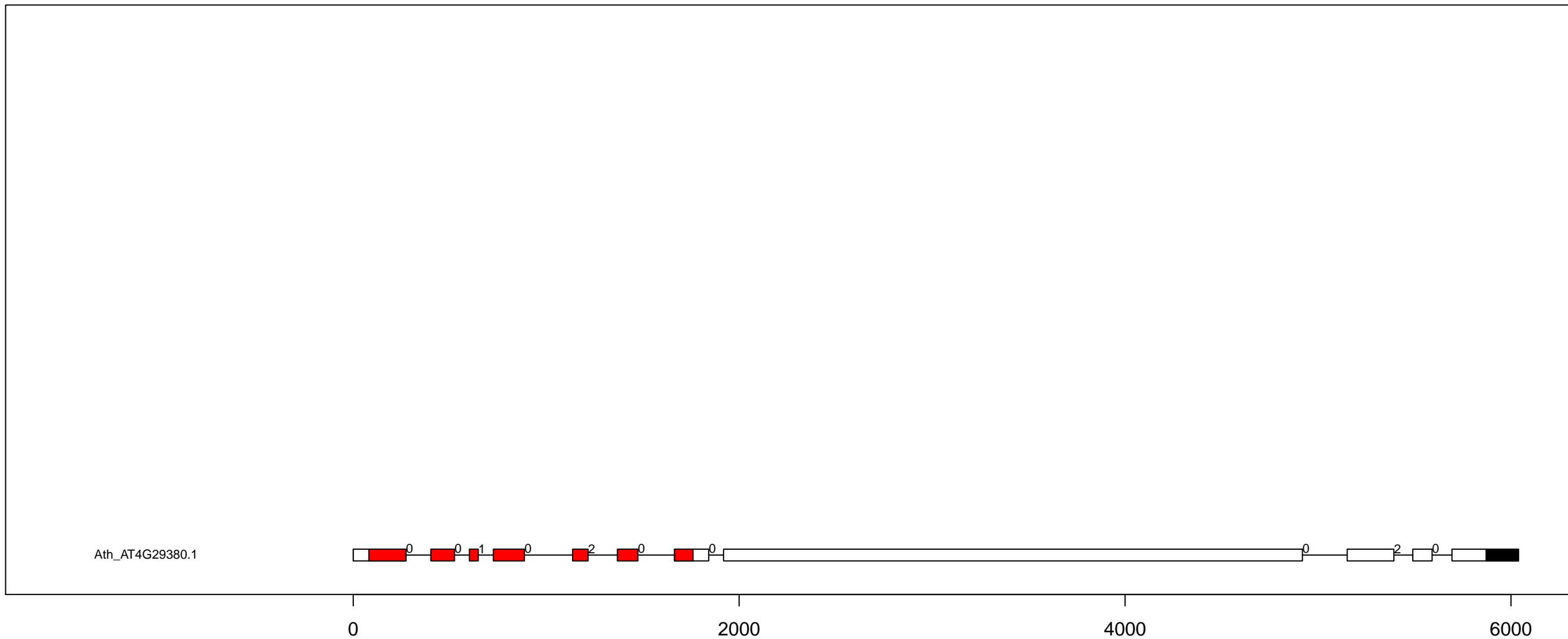

A.th CMGC_RCK exon-intron and kinase domain diagram (all)

Ath_AT5G45430.1
Ath_AT4G19110.2
Ath_AT4G13020.3

-1000

0

1000

2000

3000

4000

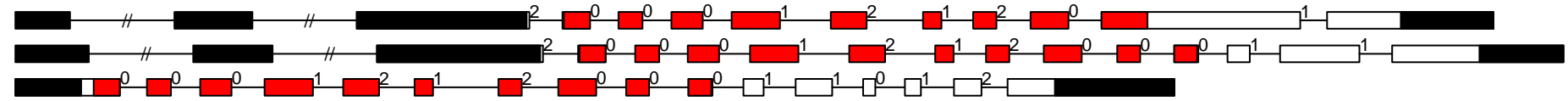

A.th CMGC_SRPK exon-intron and kinase domain diagram (all)

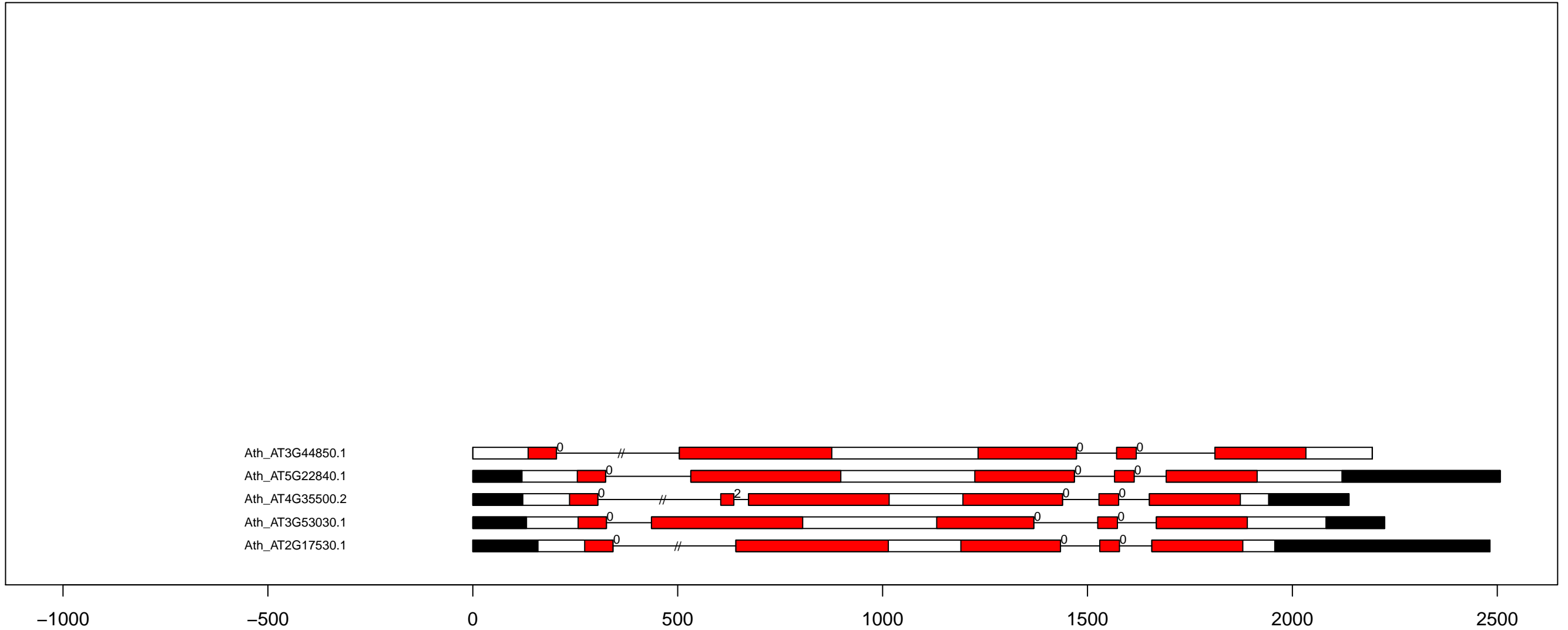

A.th Group-PI-2 exon-intron and kinase domain diagram (all)

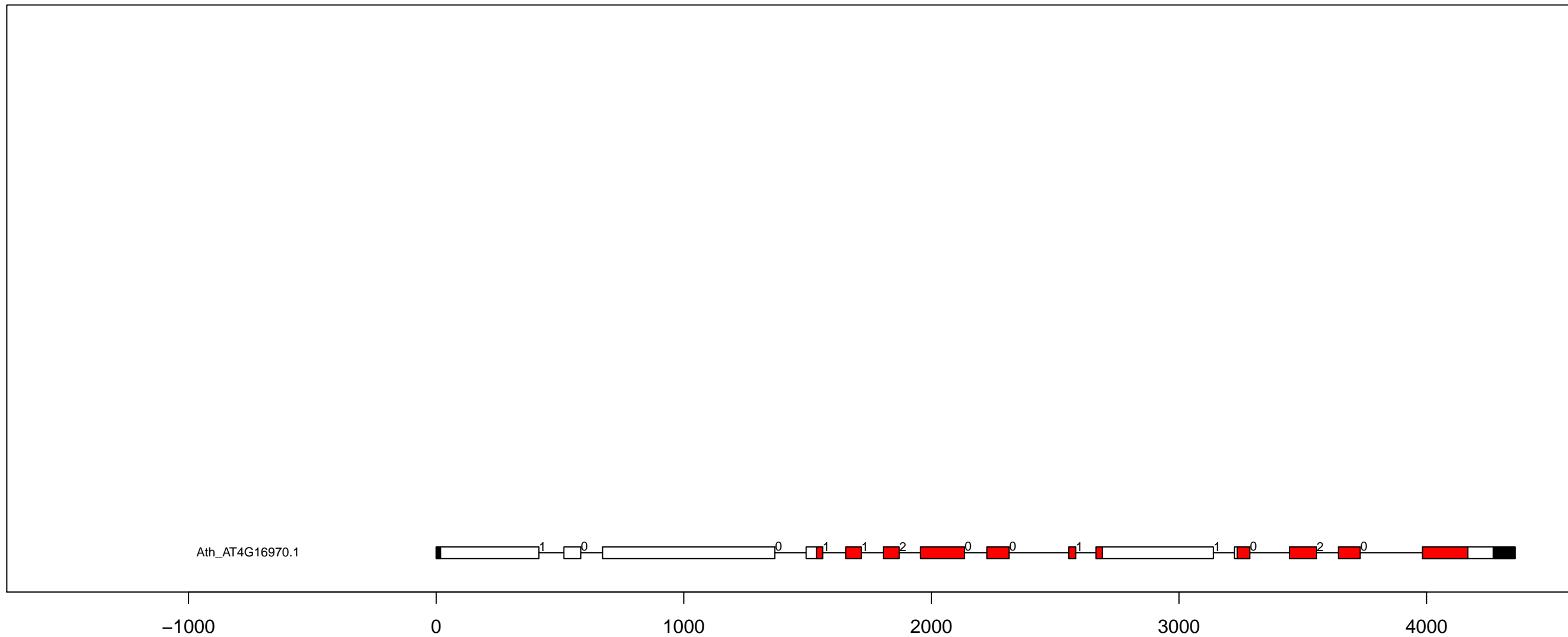

A.th Group-PI-3 exon-intron and kinase domain diagram (all)

Ath_AT3G61960.1
Ath_AT3G53930.2
Ath_AT2G37840.1
Ath_AT1G49180.1

-1000

0

1000

2000

3000

4000

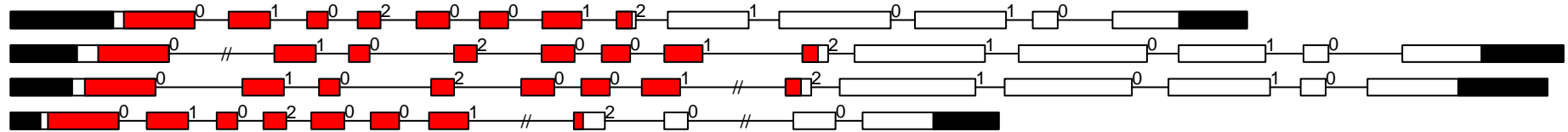

A.th Group-PI-4 exon-intron and kinase domain diagram (all)

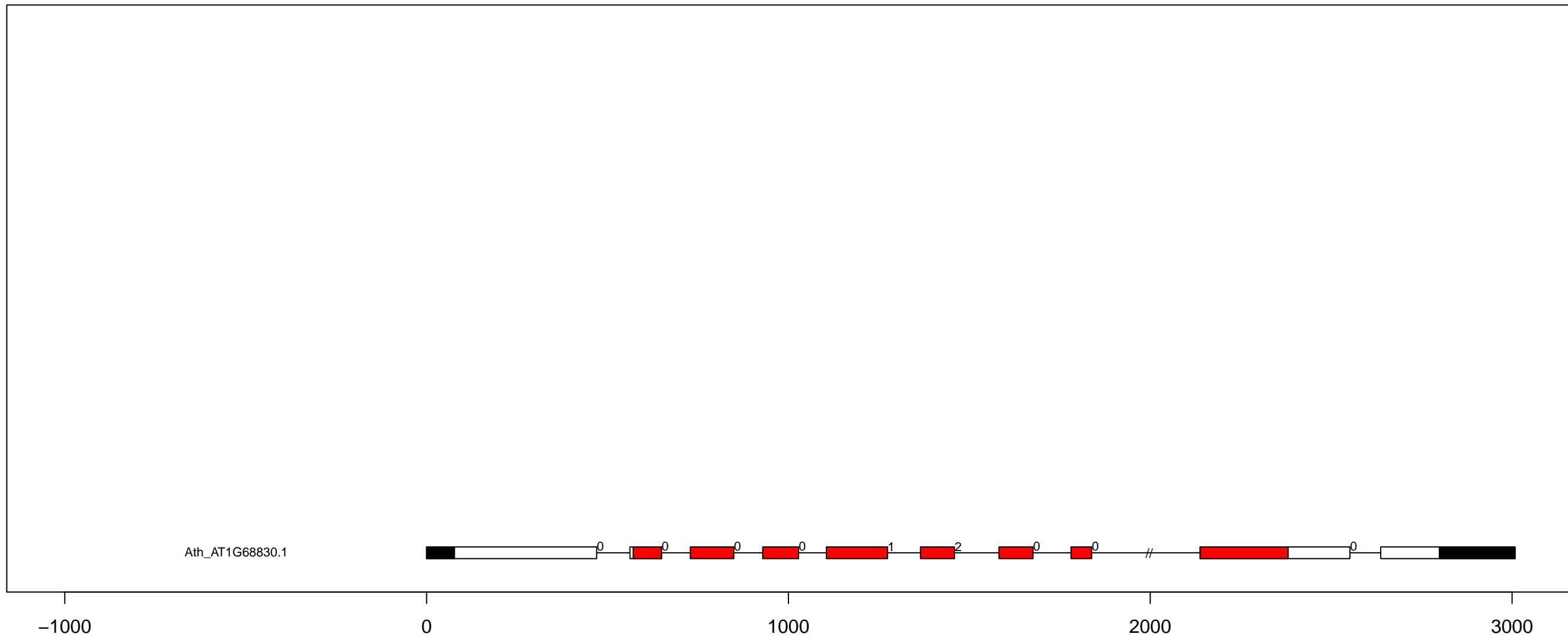

A.th NAK exon-intron and kinase domain diagram (all)

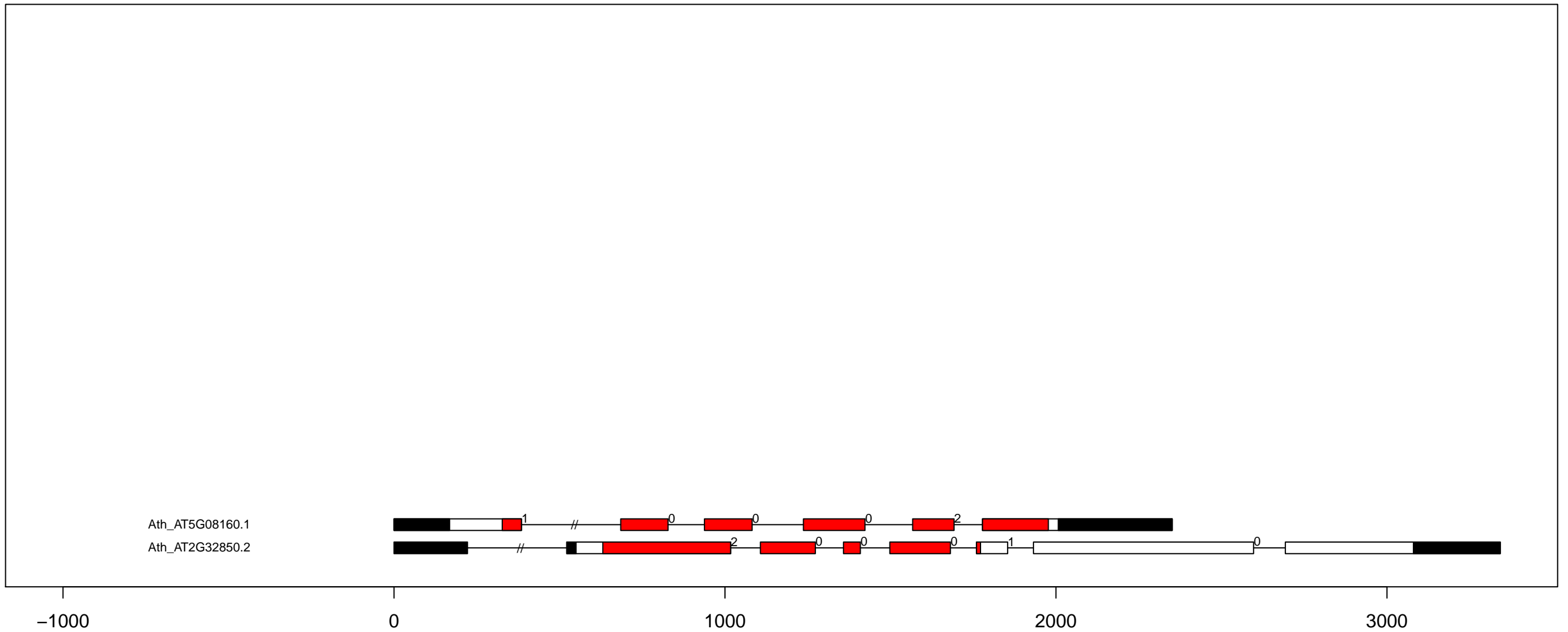

A.th NEK exon-intron and kinase domain diagram (all)

Ath_AT3G20860.1
Ath_AT5G28290.1
Ath_AT3G63280.1
Ath_AT3G44200.1
Ath_AT3G12200.2
Ath_AT3G04810.1
Ath_AT1G54510.1

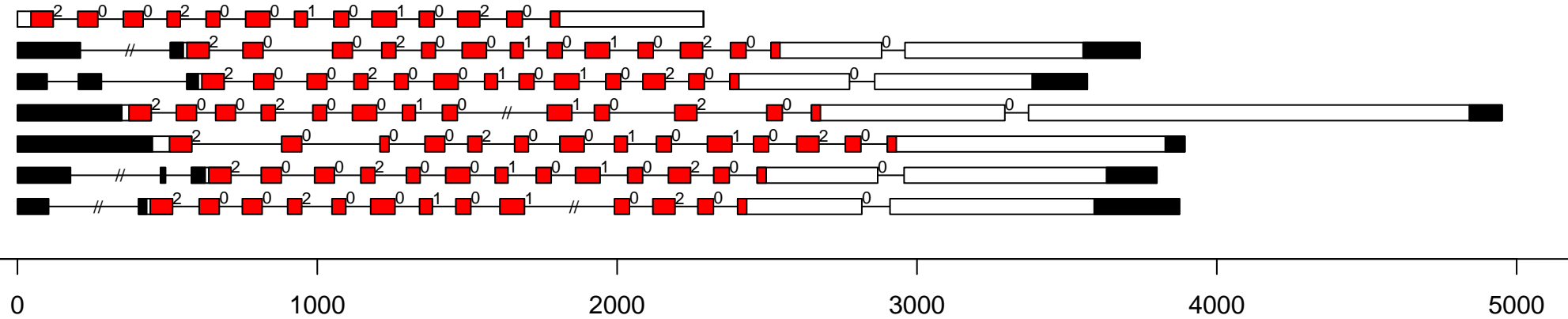

A.th PEK_GCN2 exon-intron and kinase domain diagram (all)

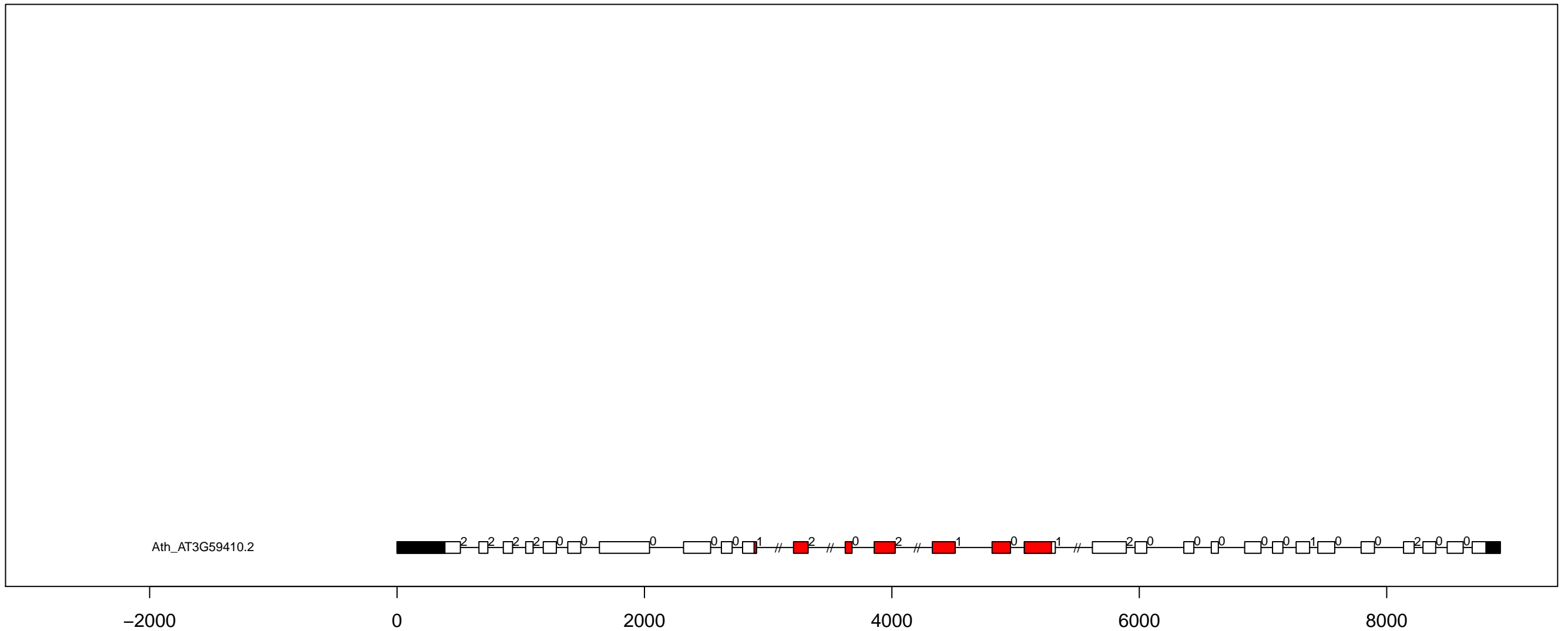

A.th RLK-Pelle_C-LEC exon-intron and kinase domain diagram (all)

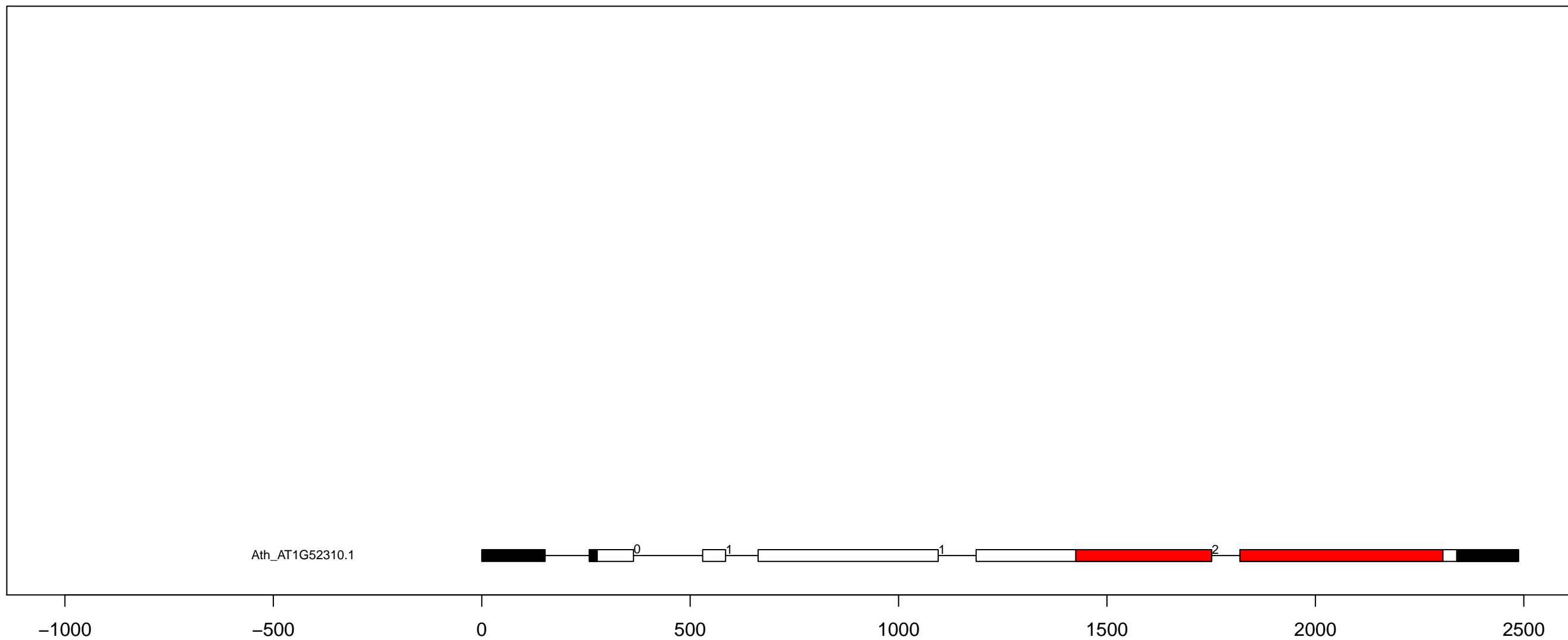

A.th RLK-Pelle_CR4L exon-intron and kinase domain diagram (all)

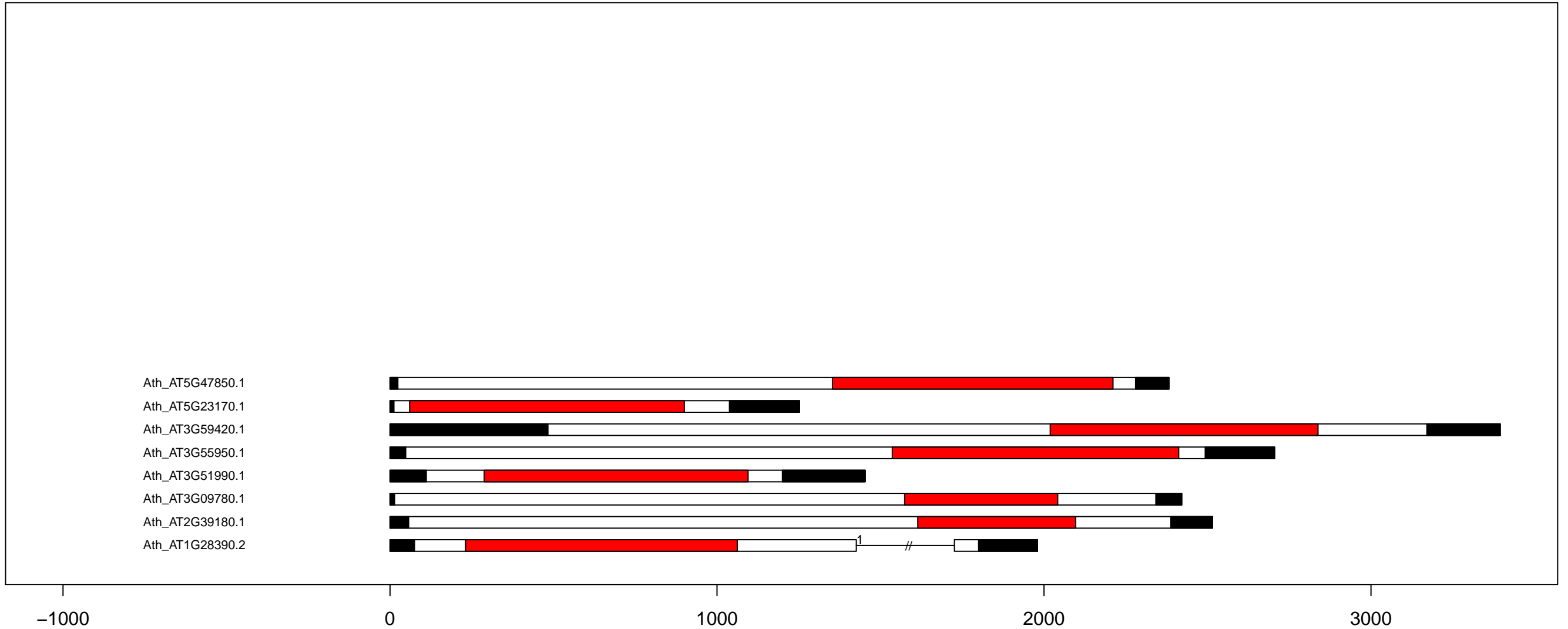

A.th RLK-Pelle_CrRLK1L-1 exon-intron and kinase domain diagram (all)

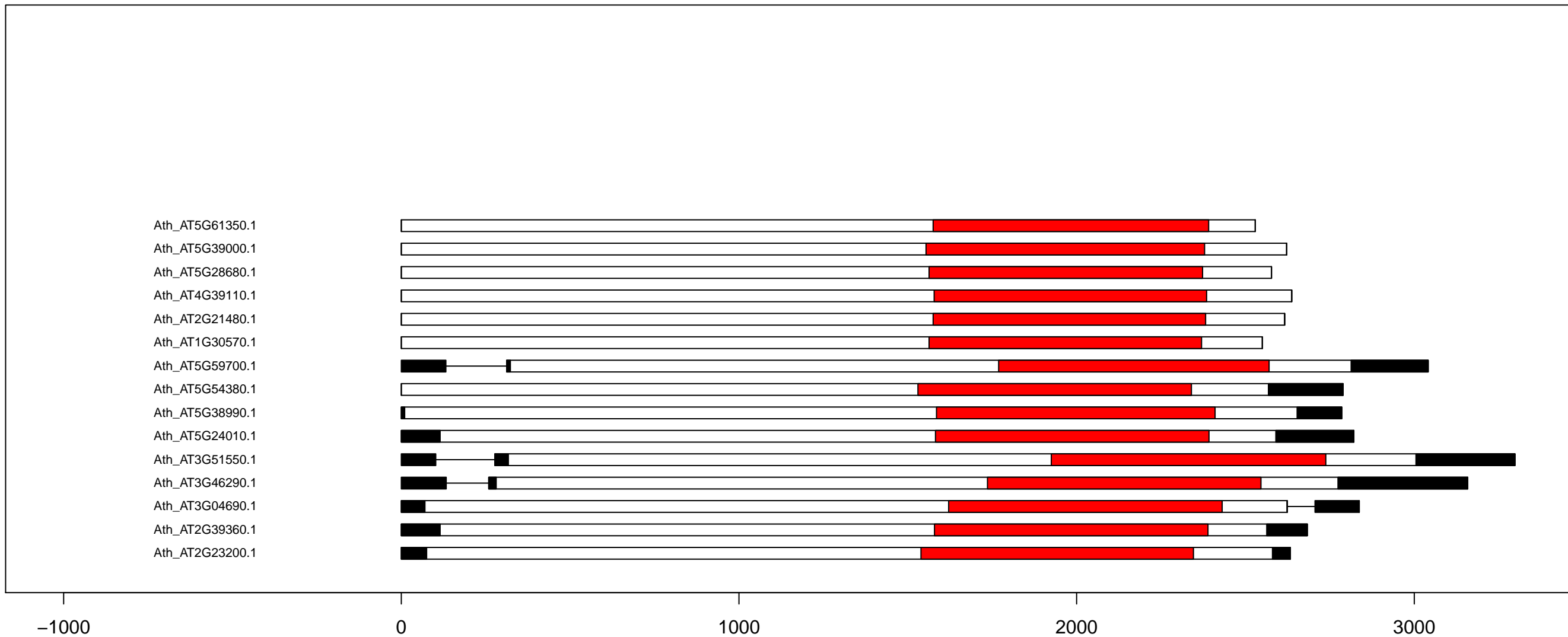

A.th RLK-Pelle_DLSV exon-intron and kinase domain diagram (part 1)

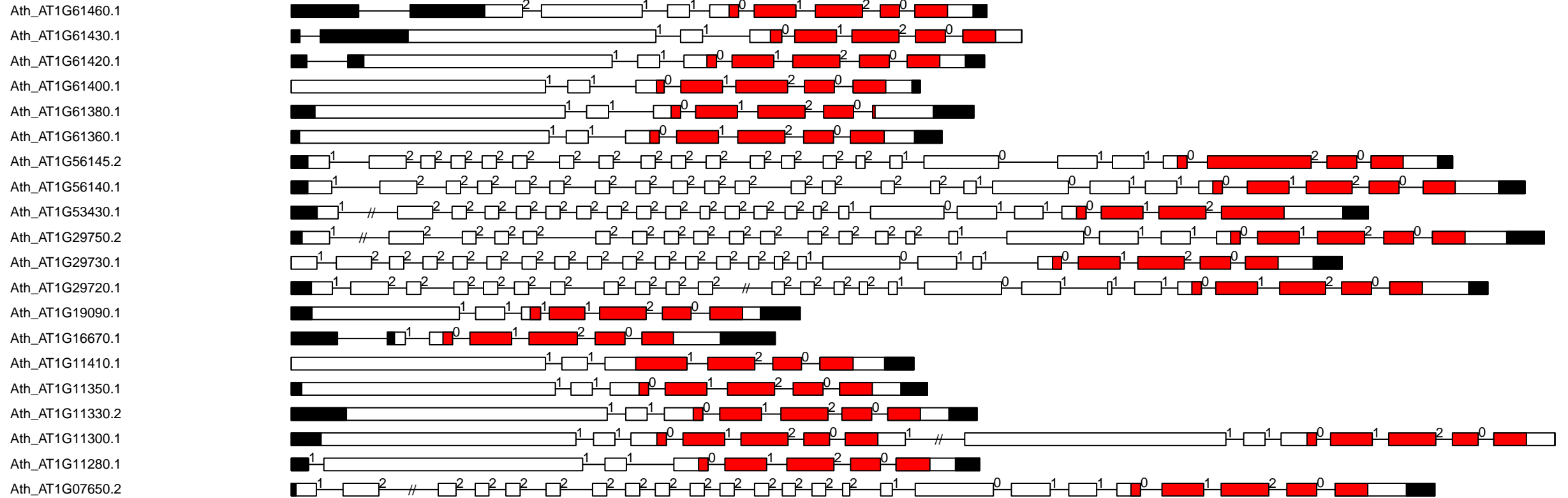

0 2000 4000 6000

A.th RLK-Pelle_DLSV exon-intron and kinase domain diagram (part 2)

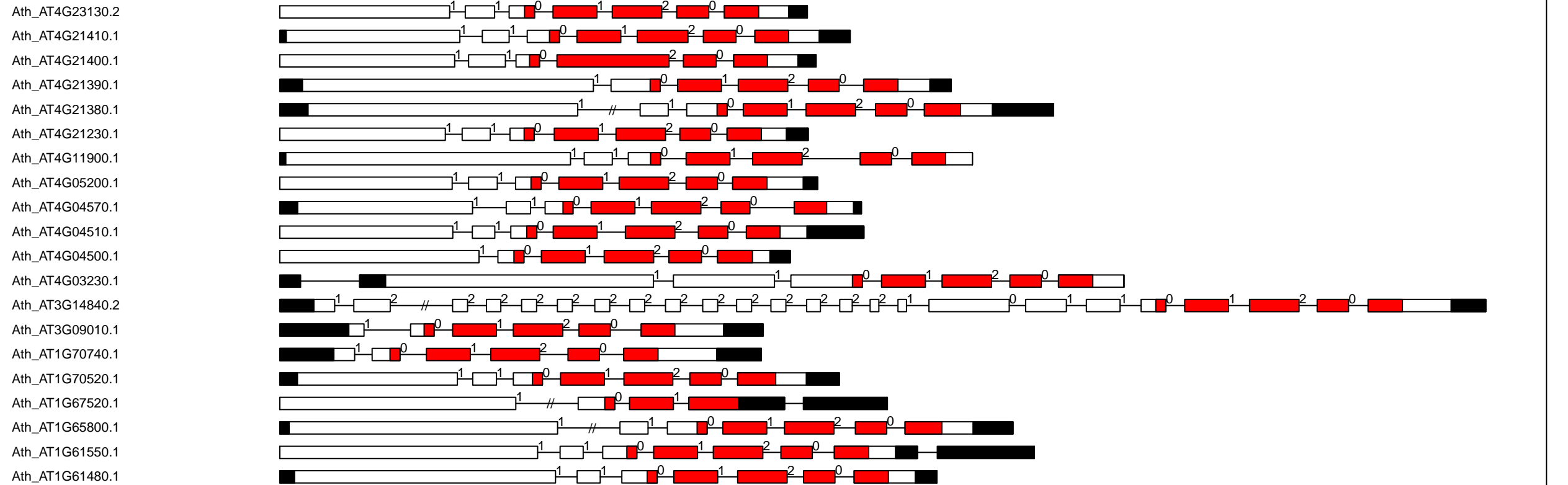

A.th RLK-Pelle_DLSV exon-intron and kinase domain diagram (part 3)

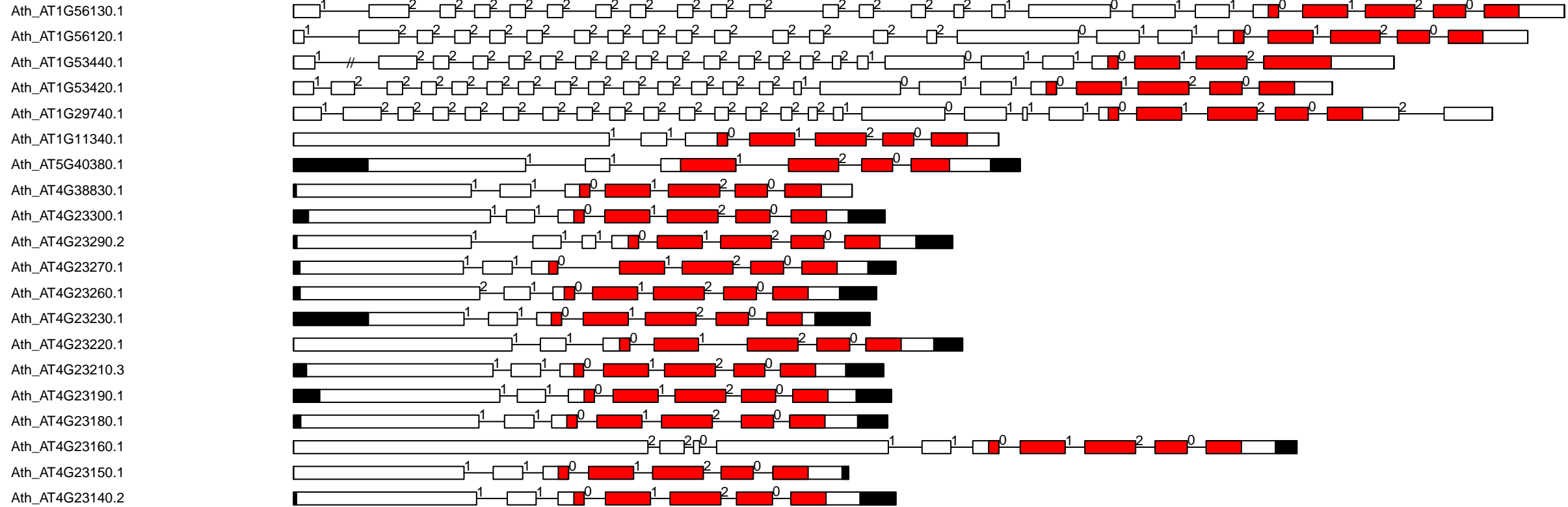

A.th RLK-Pelle_DSLV exon-intron and kinase domain diagram (all)

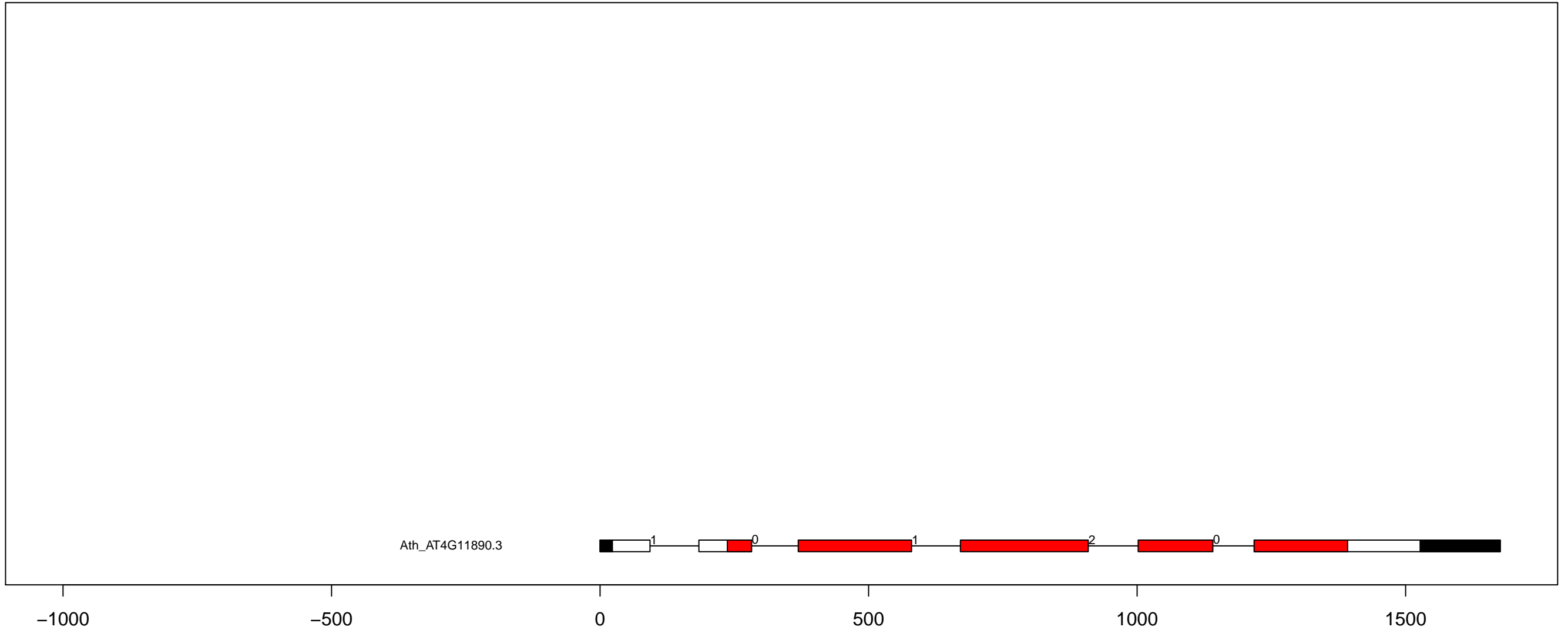

A.th RLK-Pelle_Extensin exon-intron and kinase domain diagram (all)

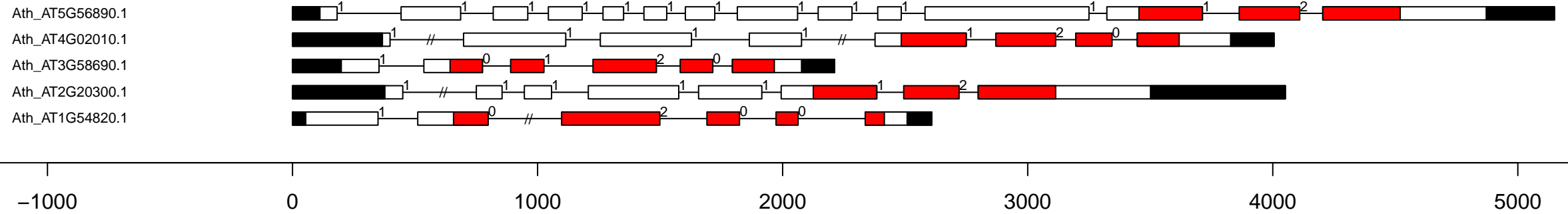

A.th RLK-Pelle_L-LEC exon-intron and kinase domain diagram (part 2)

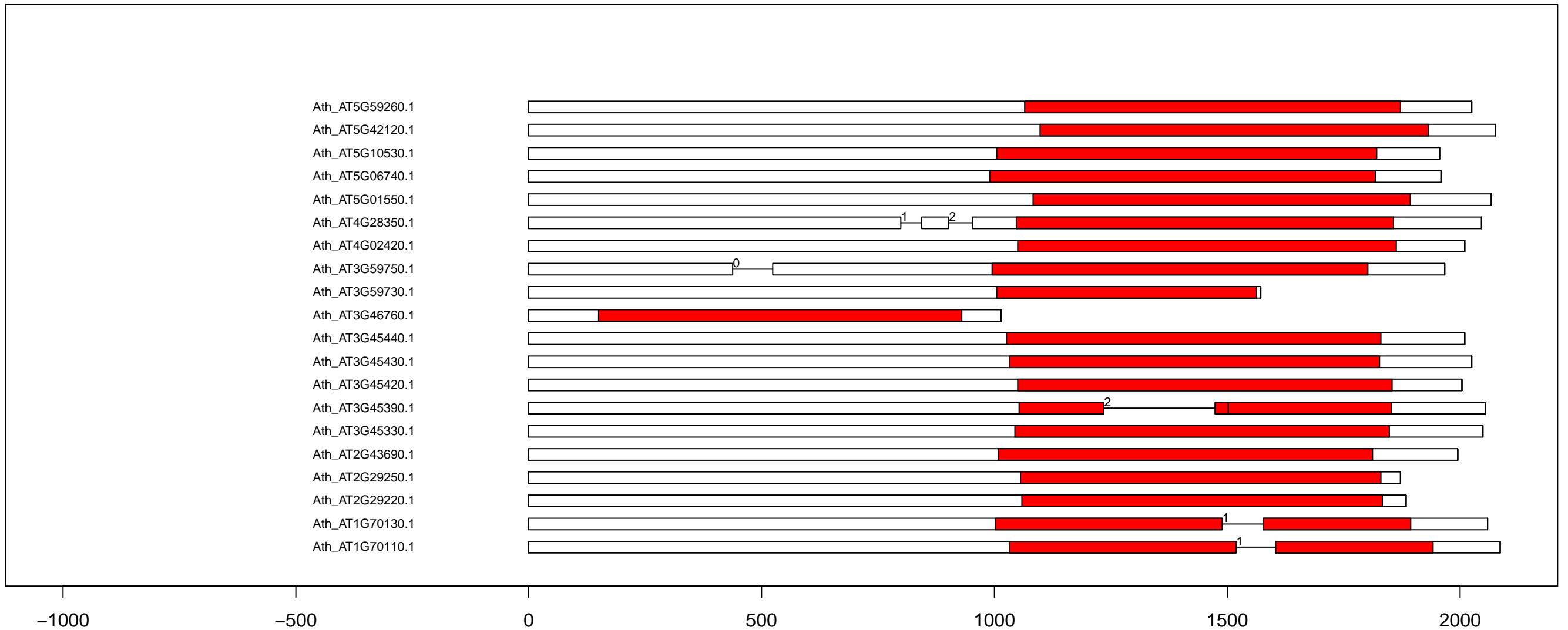

A.th RLK-Pelle_L-LEC exon-intron and kinase domain diagram (part 3)

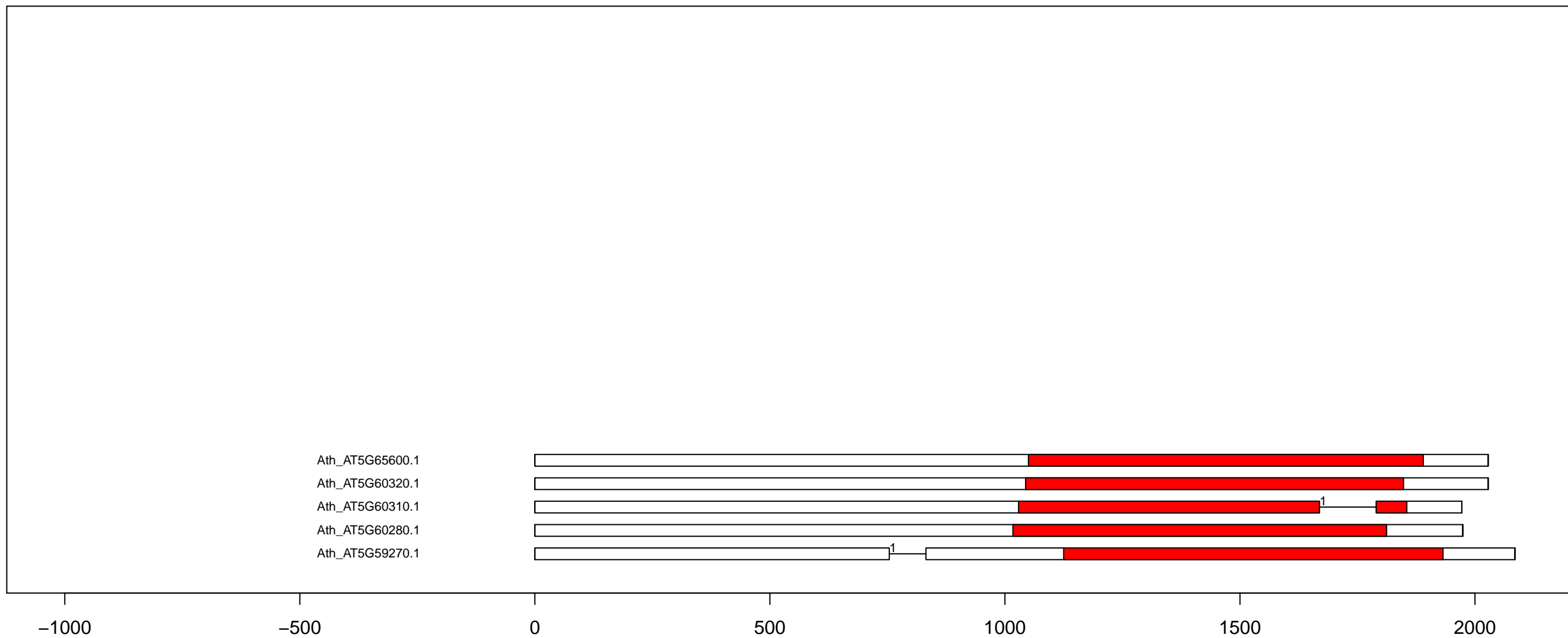

A.th RLK-Pelle_LRK10L-2 exon-intron and kinase domain diagram (all)

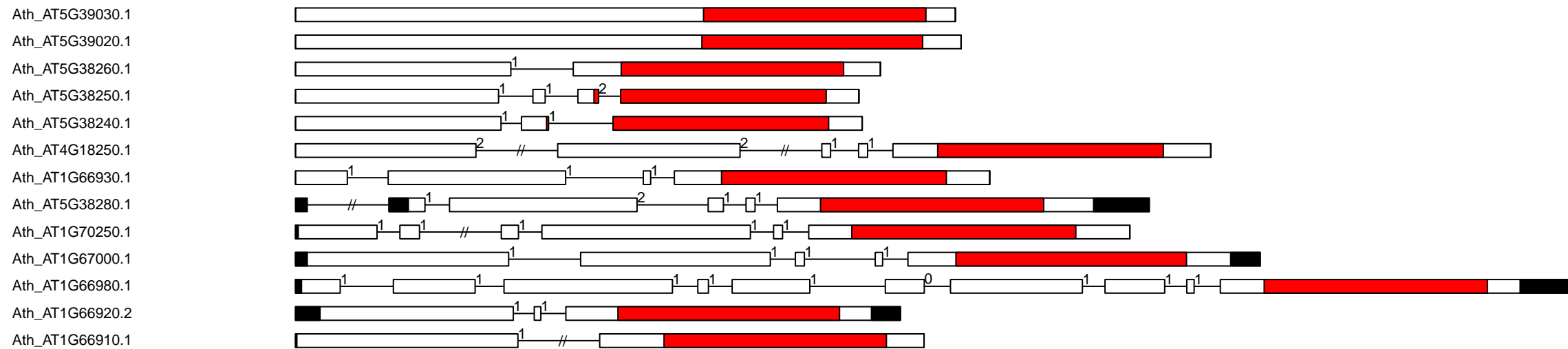

A.th RLK-Pelle_LRR-I-1 exon-intron and kinase domain diagram (part 1)

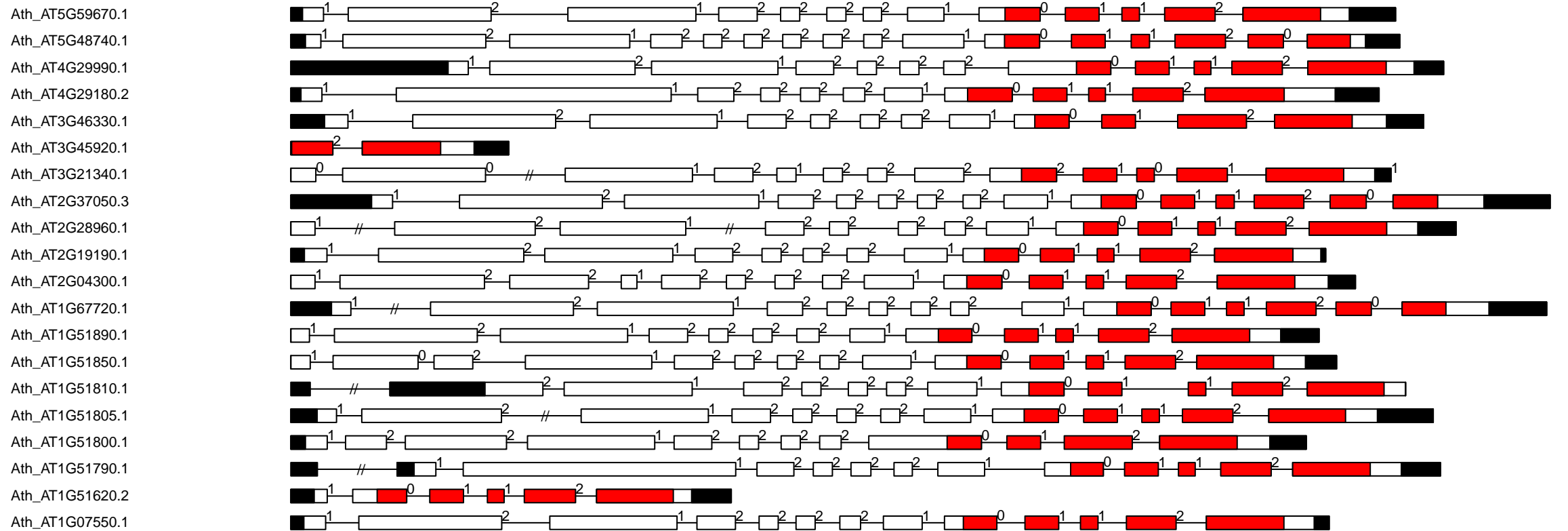

-1000

0

1000

2000

3000

4000

A.th RLK-Pelle_LRR-I-1 exon-intron and kinase domain diagram (part 2)

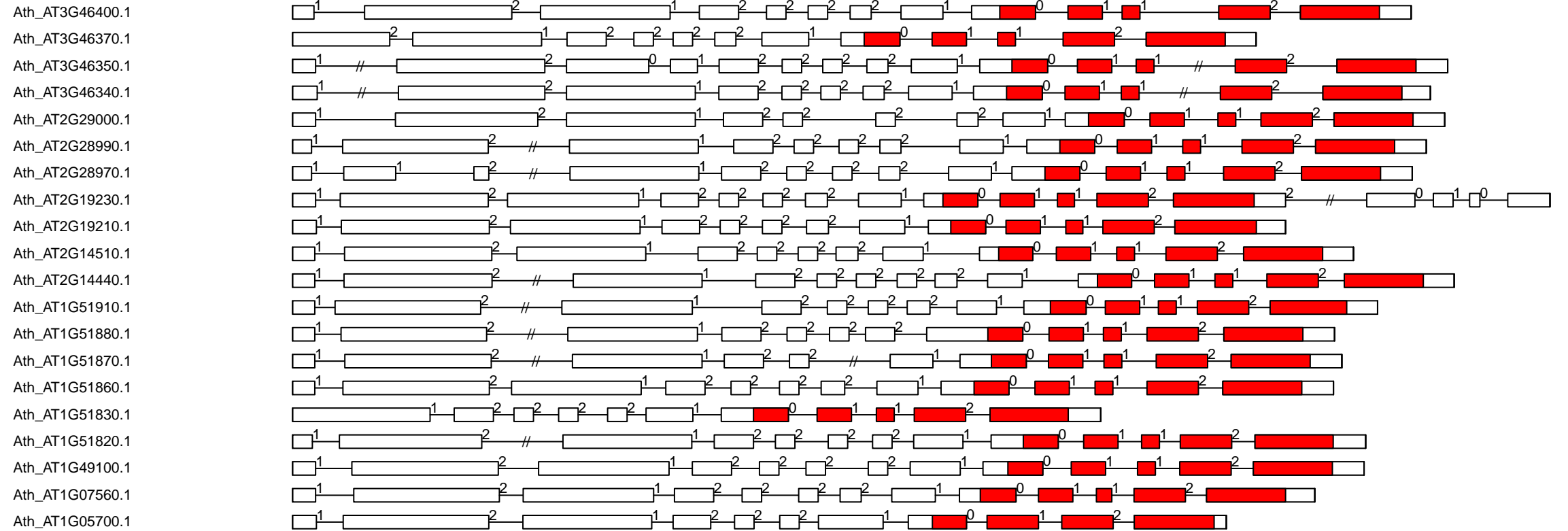

A.th RLK-Pelle_LRR-I-1 exon-intron and kinase domain diagram (part 3)

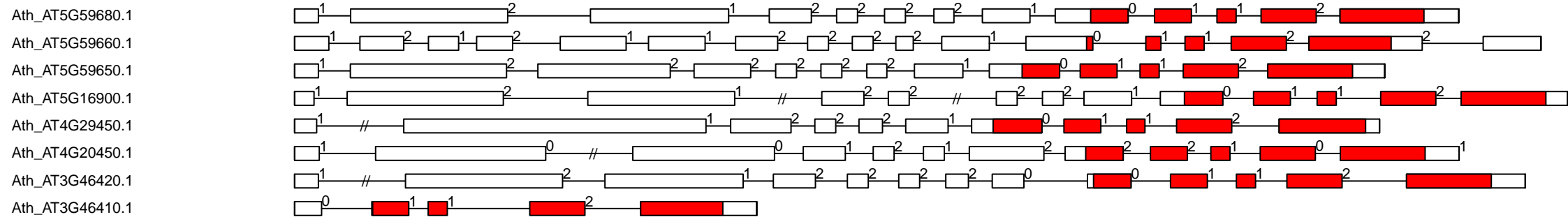

A.th RLK-Pelle_LRR-I-2 exon-intron and kinase domain diagram (all)

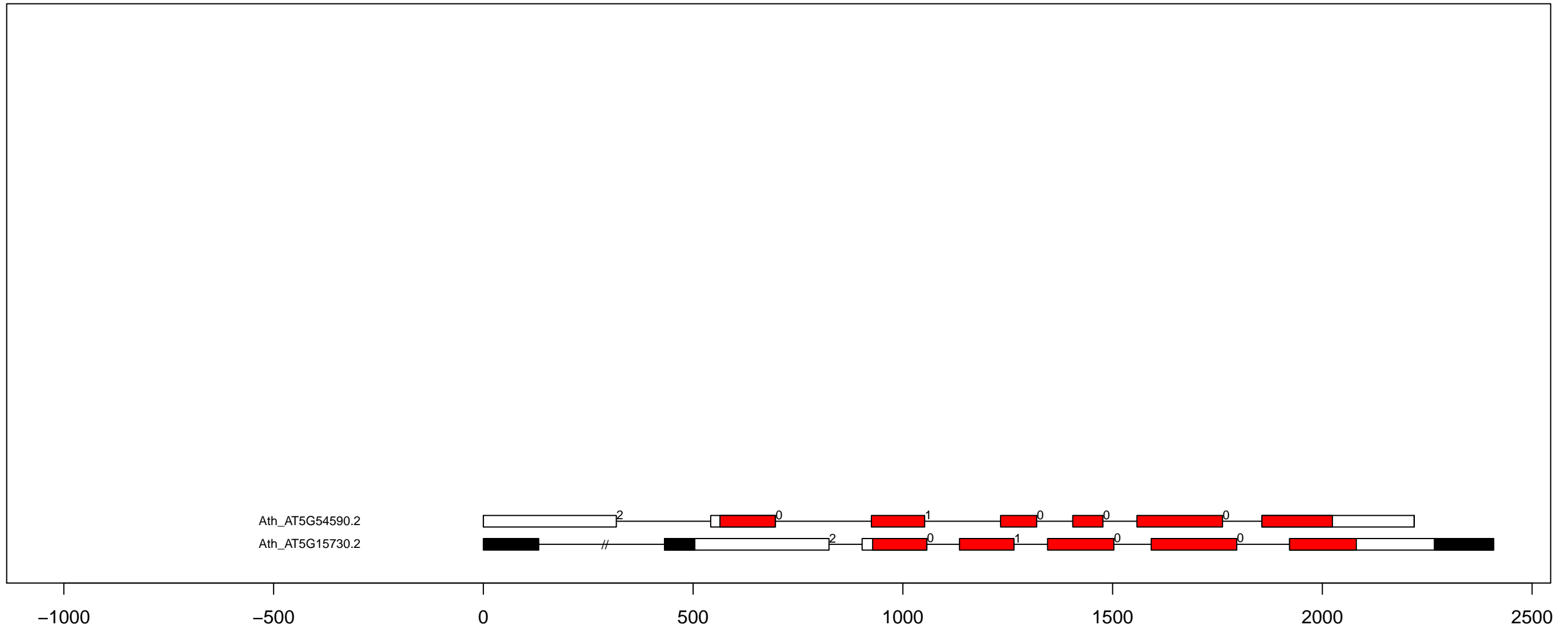

A.th RLK-Pelle_LRR-III exon-intron and kinase domain diagram (part 1)

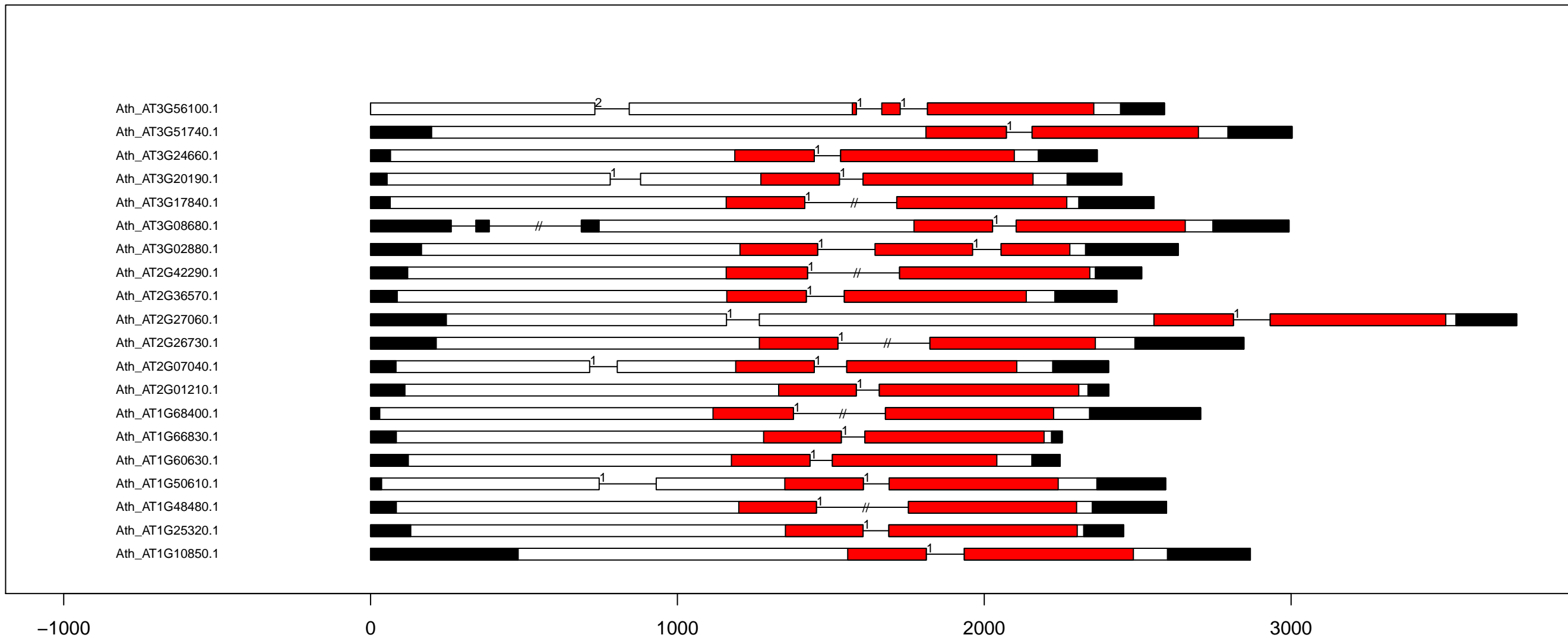

A.th RLK-Pelle_LRR-III exon-intron and kinase domain diagram (part 2)

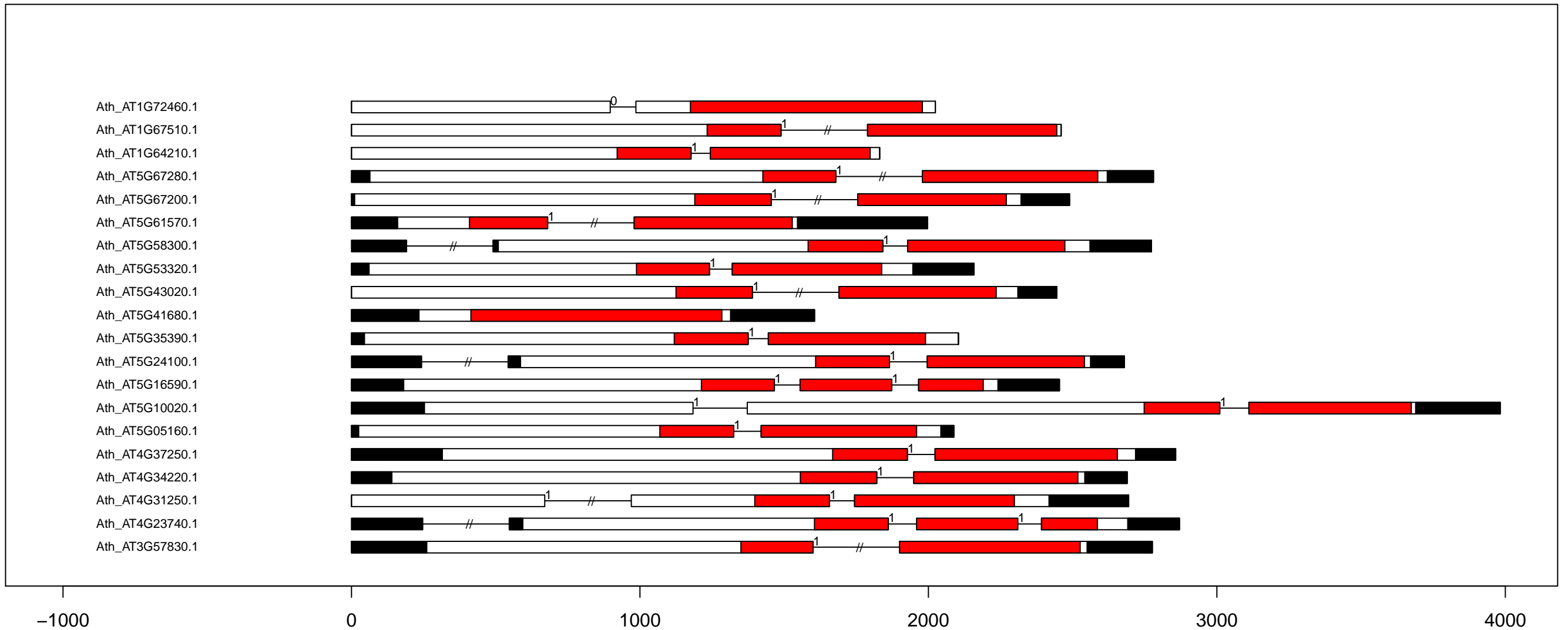

A.th RLK-Pelle_LRR-III exon-intron and kinase domain diagram (part 3)

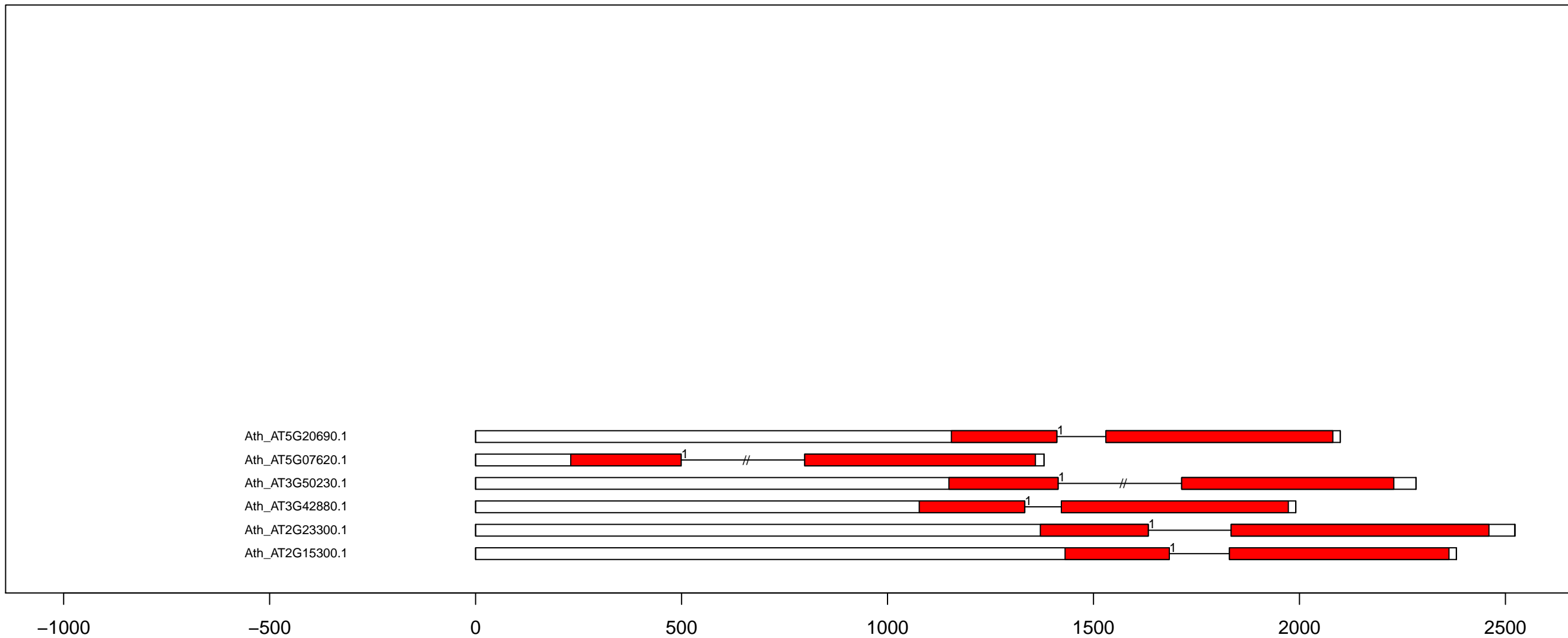

A.th RLK-Pelle_LRR-II exon-intron and kinase domain diagram (all)

Ath_AT5G65240.2

Ath_AT5G63710.1

Ath_AT5G45780.1

Ath_AT5G16000.1

Ath_AT5G10290.1

Ath_AT4G33430.2

Ath_AT4G30520.1

Ath_AT3G25560.3

Ath_AT2G23950.1

Ath_AT2G13800.1

Ath_AT2G13790.1

Ath_AT1G71830.1

Ath_AT1G60800.1

Ath_AT1G34210.1

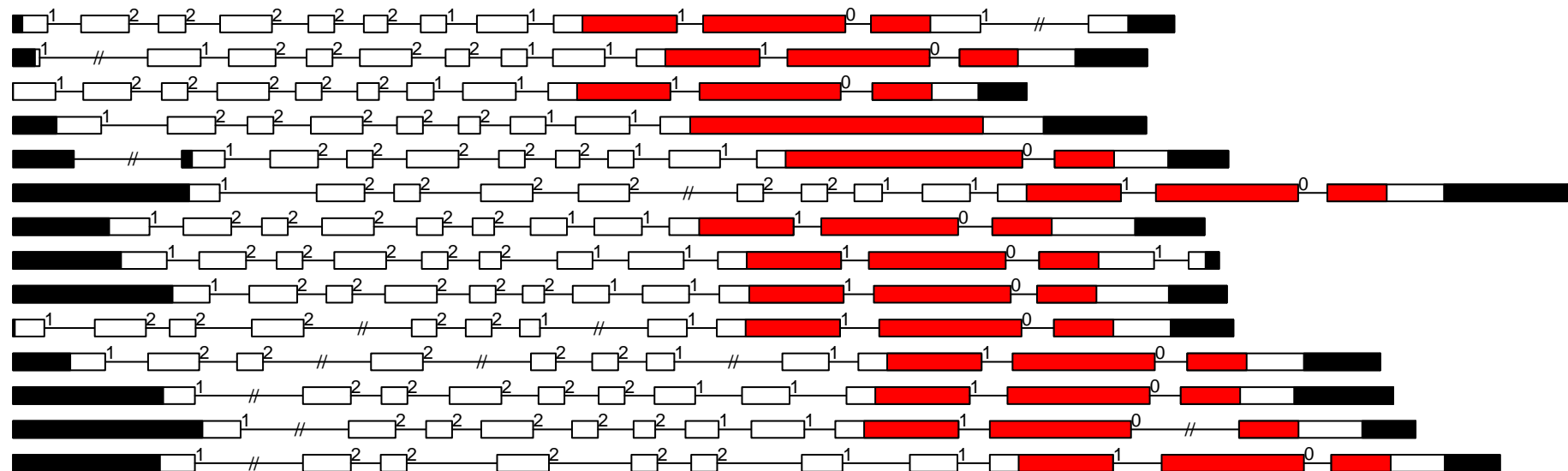

-1000

0

1000

2000

3000

4000

A.th RLK-Pelle_LRR-IV exon-intron and kinase domain diagram (all)

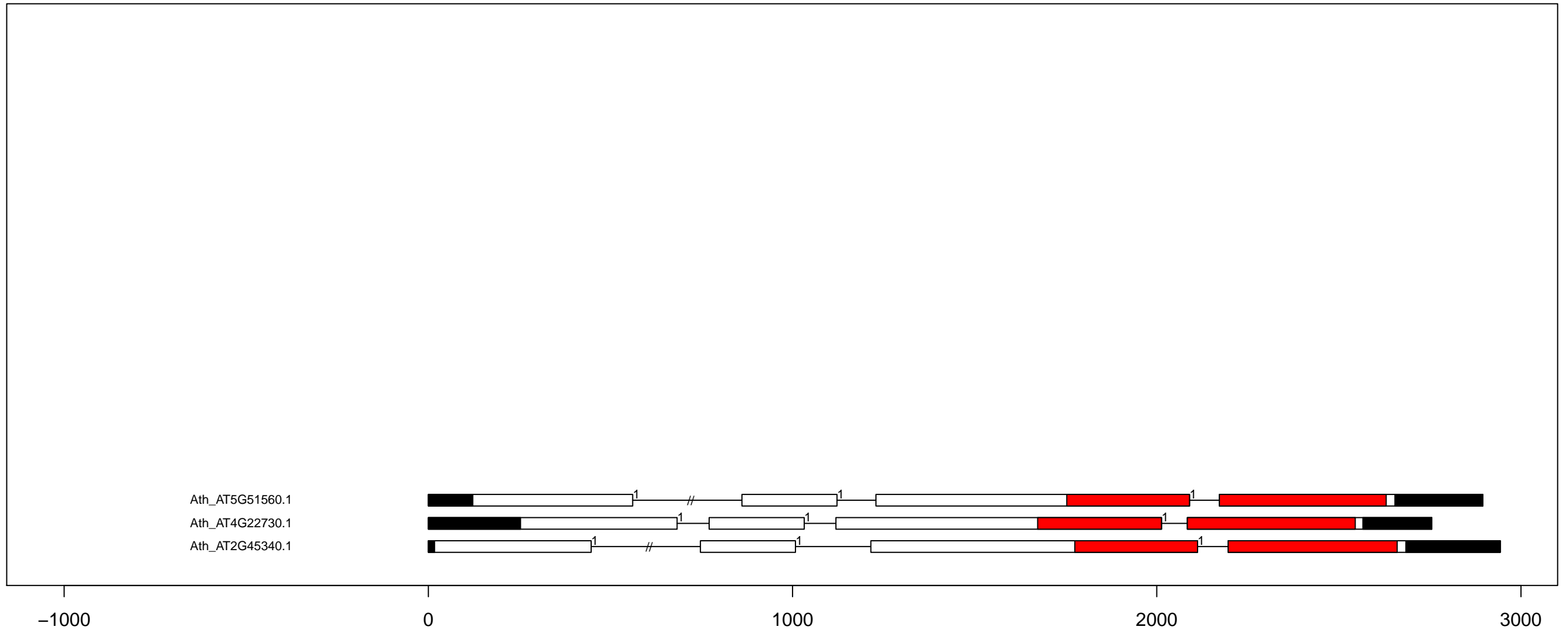

A.th RLK-Pelle_LRR-IX exon-intron and kinase domain diagram (all)

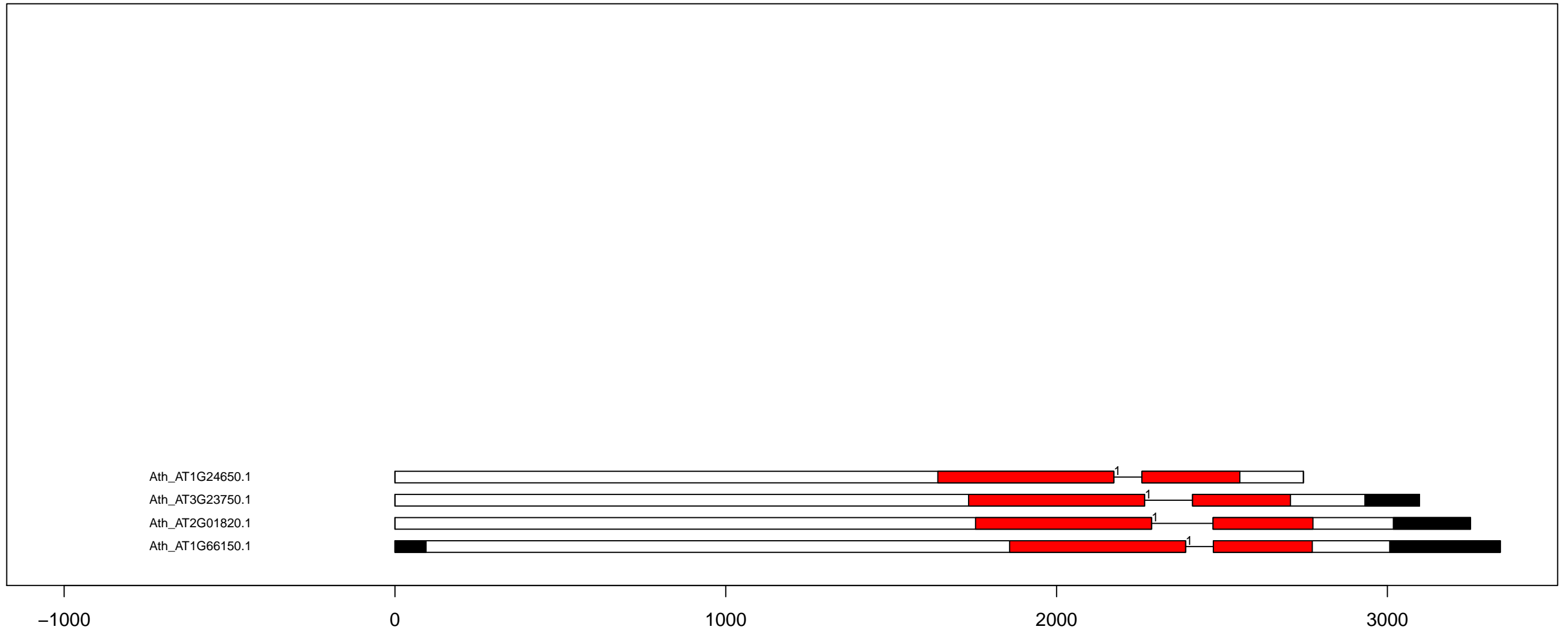

A.th RLK-Pelle_LRR-VI-1 exon-intron and kinase domain diagram (all)

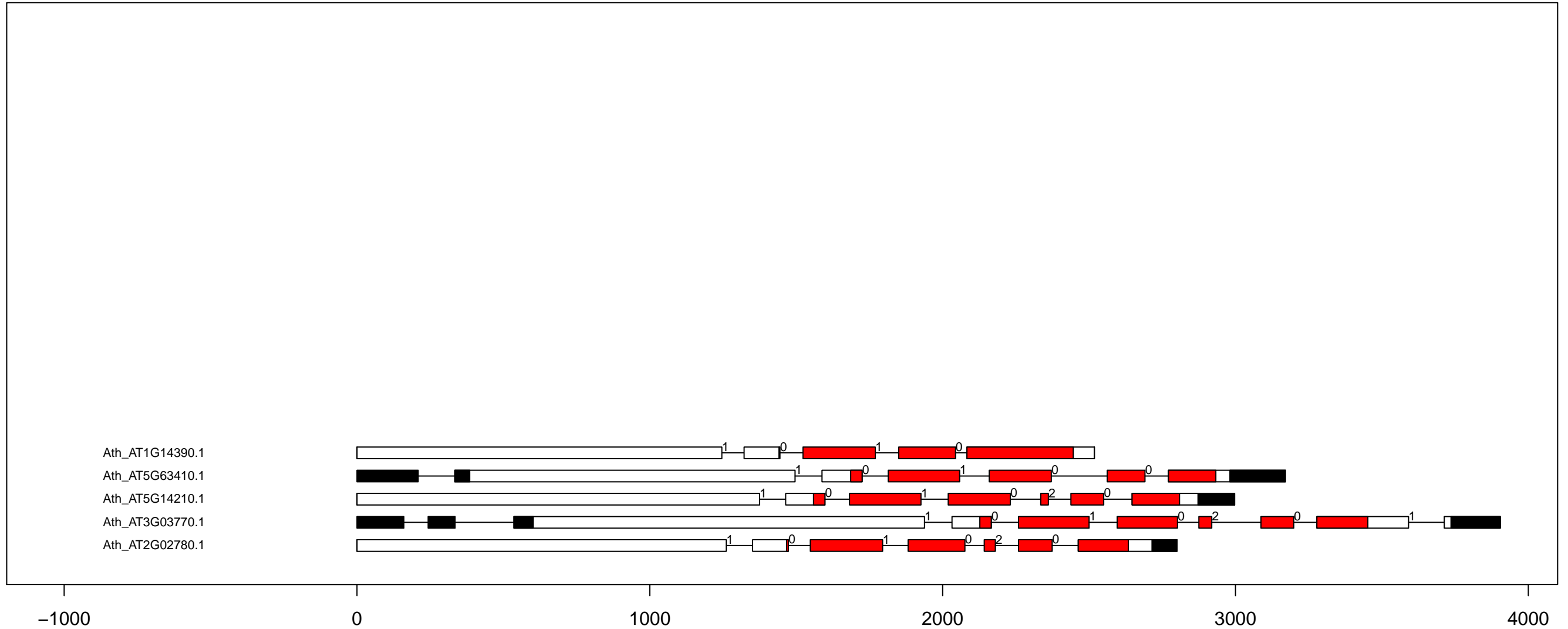

A.th RLK-Pelle_LRR-VI-2 exon-intron and kinase domain diagram (all)

Ath_AT5G07150.1
 Ath_AT5G58540.1
 Ath_AT5G45840.2
 Ath_AT5G41180.1
 Ath_AT4G18640.1
 Ath_AT3G56050.1
 Ath_AT2G40270.1
 Ath_AT1G63430.2

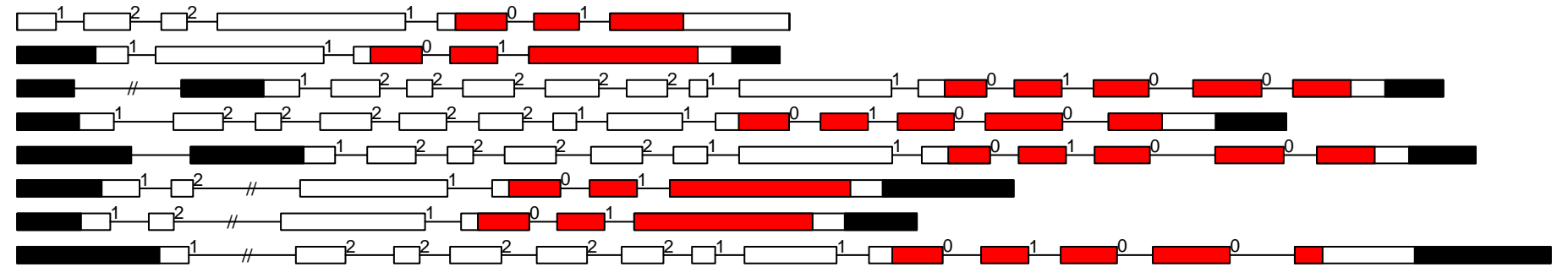

-1000

0

1000

2000

3000

4000

A.th RLK-Pelle_LRR-VII-1 exon-intron and kinase domain diagram (all)

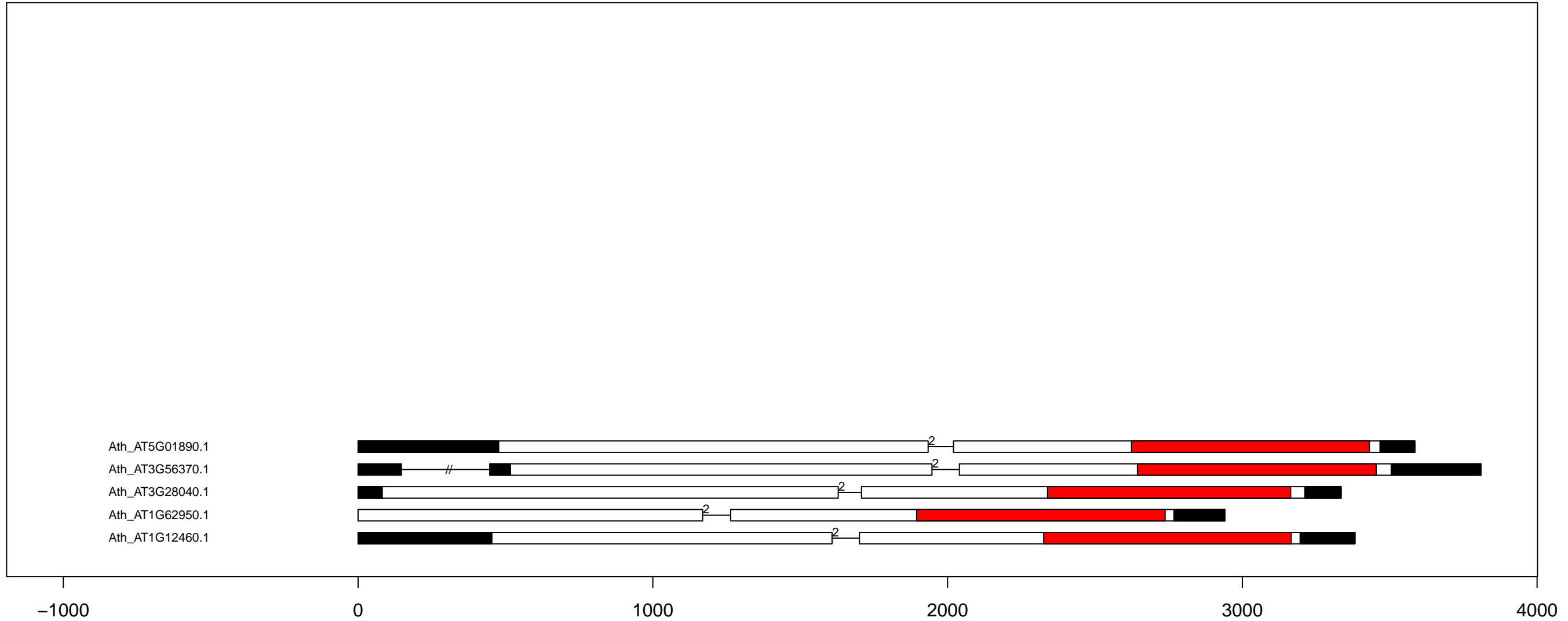

A.th RLK-Pelle_LRR-VII-2 exon-intron and kinase domain diagram (all)

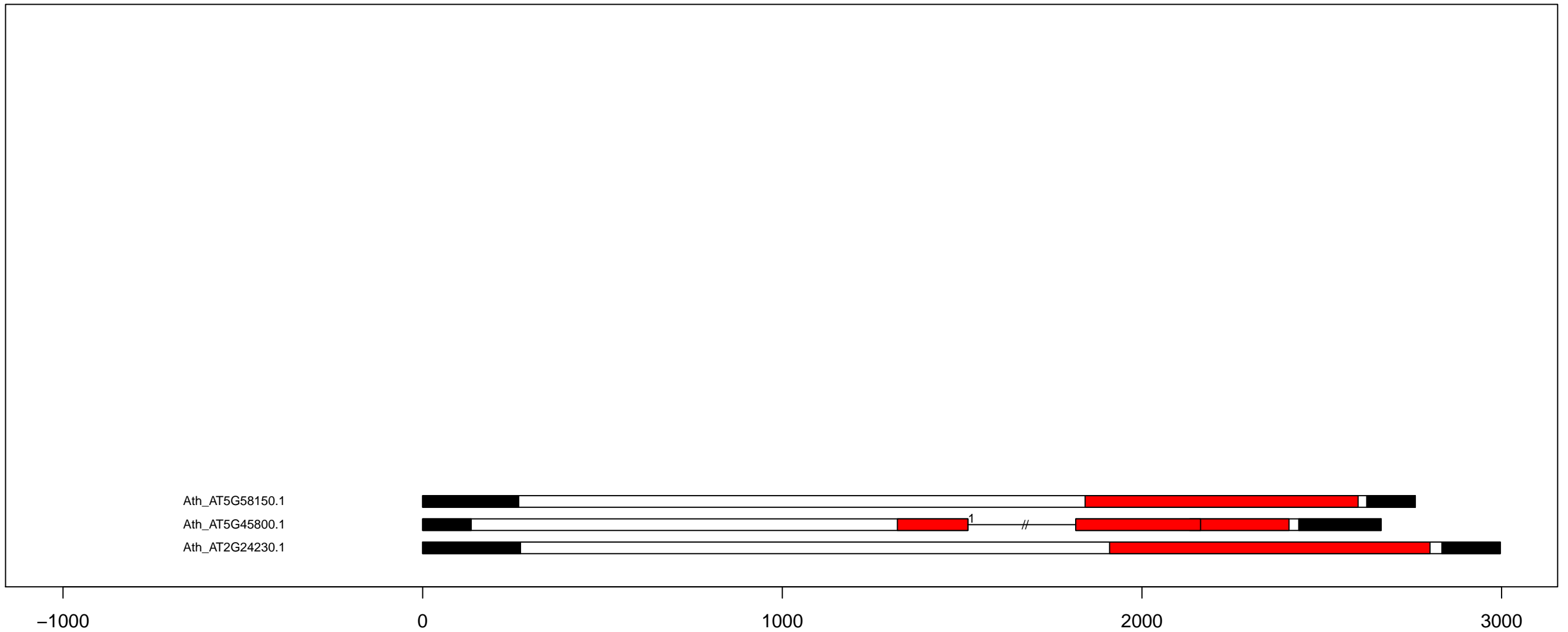

A.th RLK-Pelle_LRR-VII-3 exon-intron and kinase domain diagram (all)

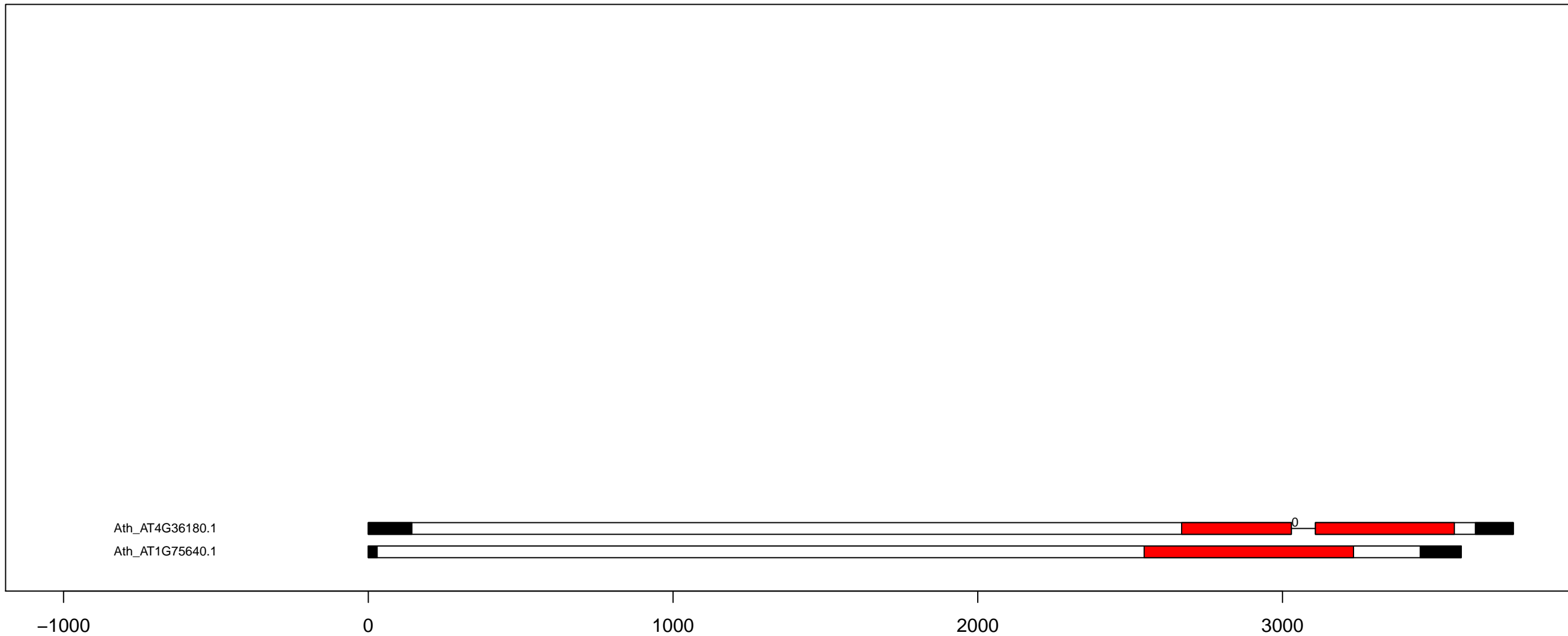

A.th RLK-Pelle_LRR-VIII-1 exon-intron and kinase domain diagram (all)

Ath_AT5G37450.1
Ath_AT3G53590.1
Ath_AT5G49780.1
Ath_AT5G49770.1
Ath_AT5G49760.1
Ath_AT5G01950.1
Ath_AT1G79620.1
Ath_AT1G06840.1

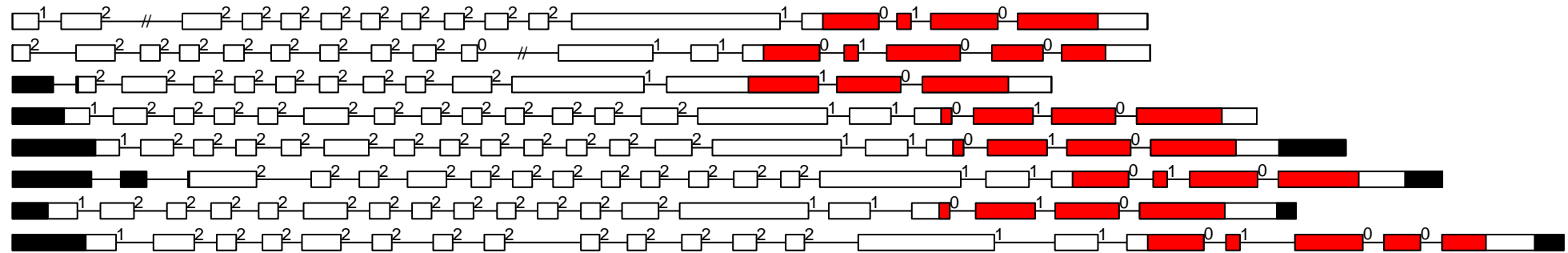

0

2000

4000

6000

A.th RLK-Pelle_LRR-V exon-intron and kinase domain diagram (all)

Ath_AT5G06820.1
 Ath_AT4G22130.1
 Ath_AT4G03390.1
 Ath_AT3G14350.1
 Ath_AT3G13065.1
 Ath_AT2G20850.1
 Ath_AT1G78980.1
 Ath_AT1G53730.2
 Ath_AT1G11130.1

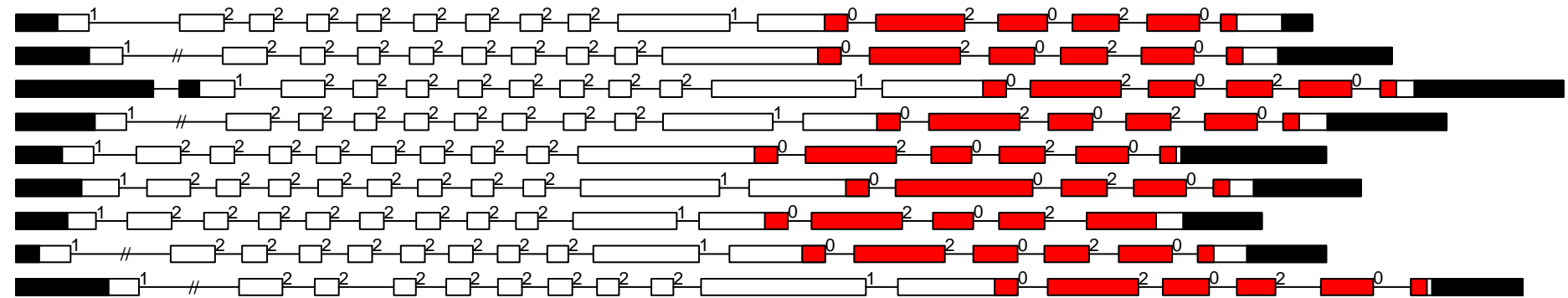

-1000

0

1000

2000

3000

4000

A.th RLK-Pelle_LRR-Xa exon-intron and kinase domain diagram (all)

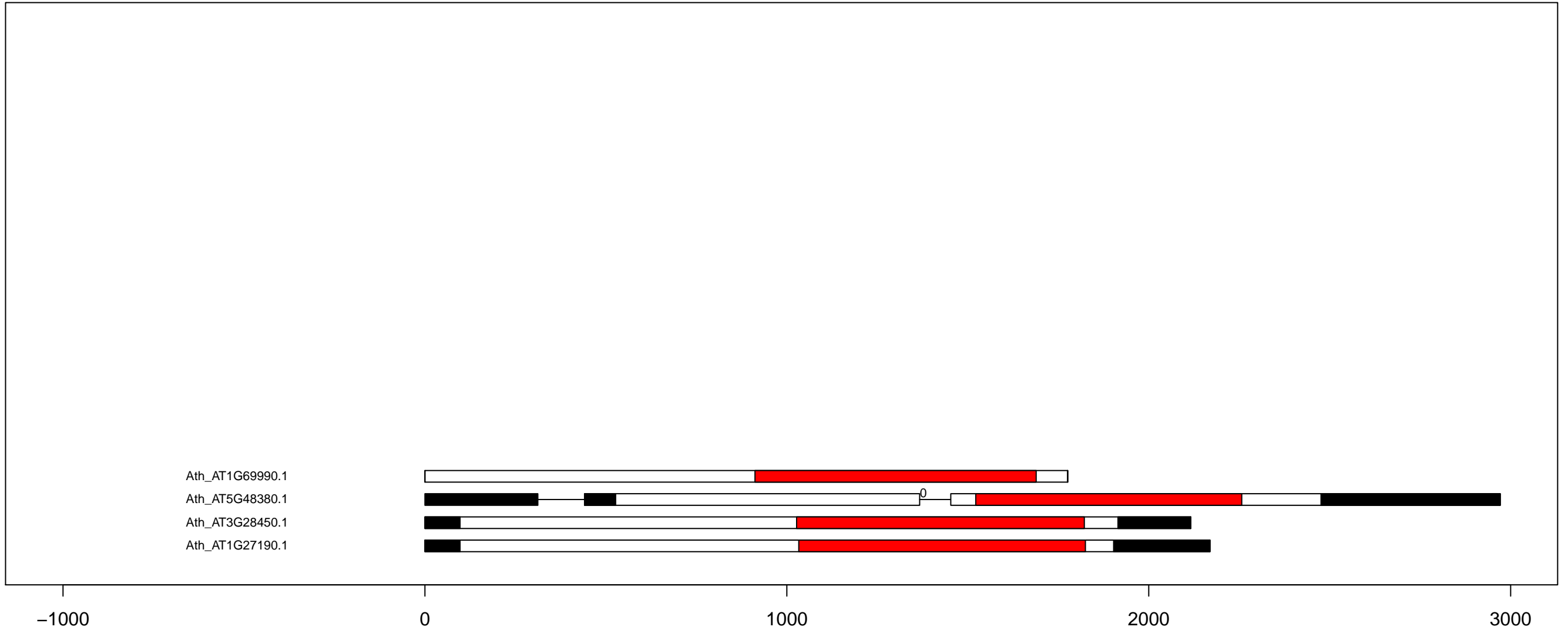

A.th RLK-Pelle_LRR-Xb-2 exon-intron and kinase domain diagram (all)

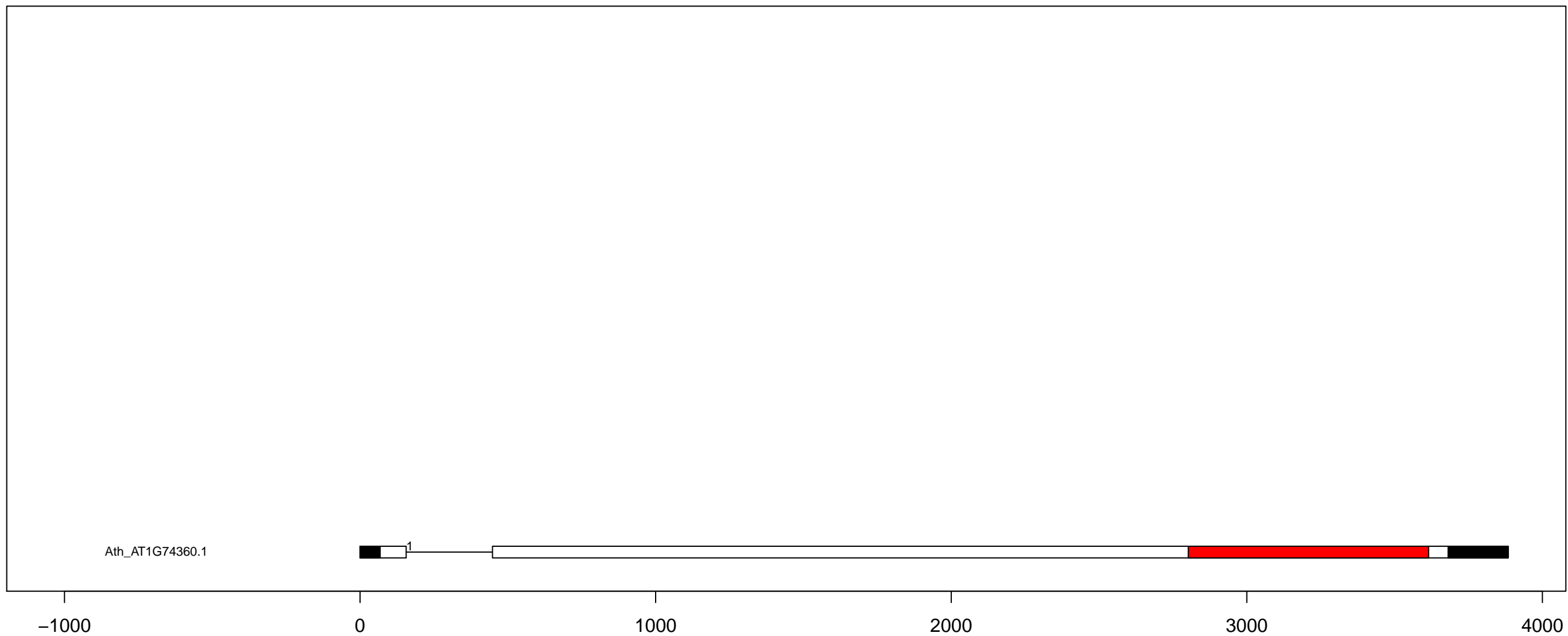

A.th RLK-Pelle_LRR-XI-1 exon-intron and kinase domain diagram (part 1)

Ath_AT4G28490.1
 Ath_AT4G26540.1
 Ath_AT4G20270.1
 Ath_AT4G20140.1
 Ath_AT4G08850.1
 Ath_AT3G49670.1
 Ath_AT3G24240.1
 Ath_AT3G19700.1
 Ath_AT2G41820.1
 Ath_AT2G33170.1
 Ath_AT1G75820.1
 Ath_AT1G73080.1
 Ath_AT1G72180.1
 Ath_AT1G35710.1
 Ath_AT1G34110.1
 Ath_AT1G28440.1
 Ath_AT1G17750.1
 Ath_AT1G17230.1
 Ath_AT1G09970.2
 Ath_AT1G08590.1

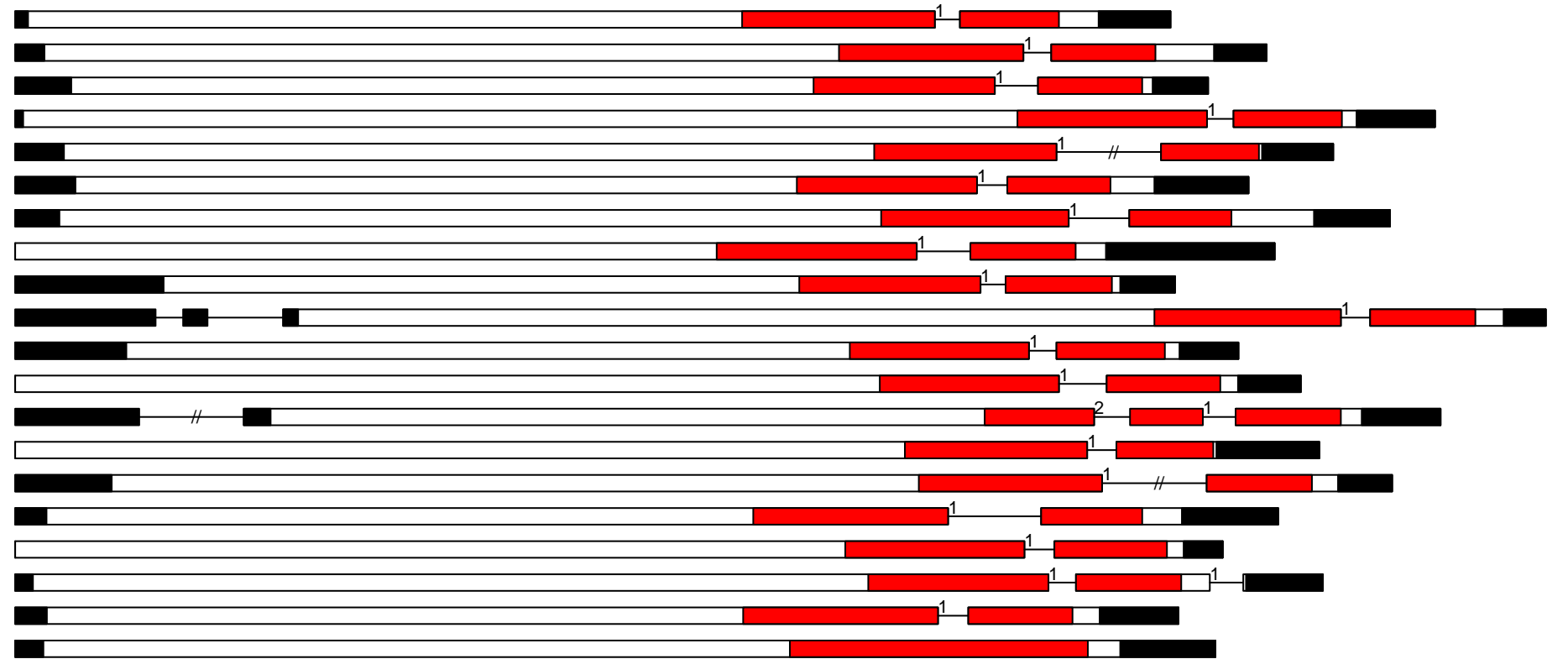

A.th RLK-Pelle_LRR-XI-1 exon-intron and kinase domain diagram (part 2)

Ath_AT5G65710.1
Ath_AT5G61480.1
Ath_AT5G06940.1
Ath_AT1G34420.1
Ath_AT5G65700.1
Ath_AT5G63930.1
Ath_AT5G56040.2
Ath_AT5G51350.1
Ath_AT5G49660.1
Ath_AT5G48940.1
Ath_AT5G44700.1
Ath_AT5G25930.1
Ath_AT4G28650.1

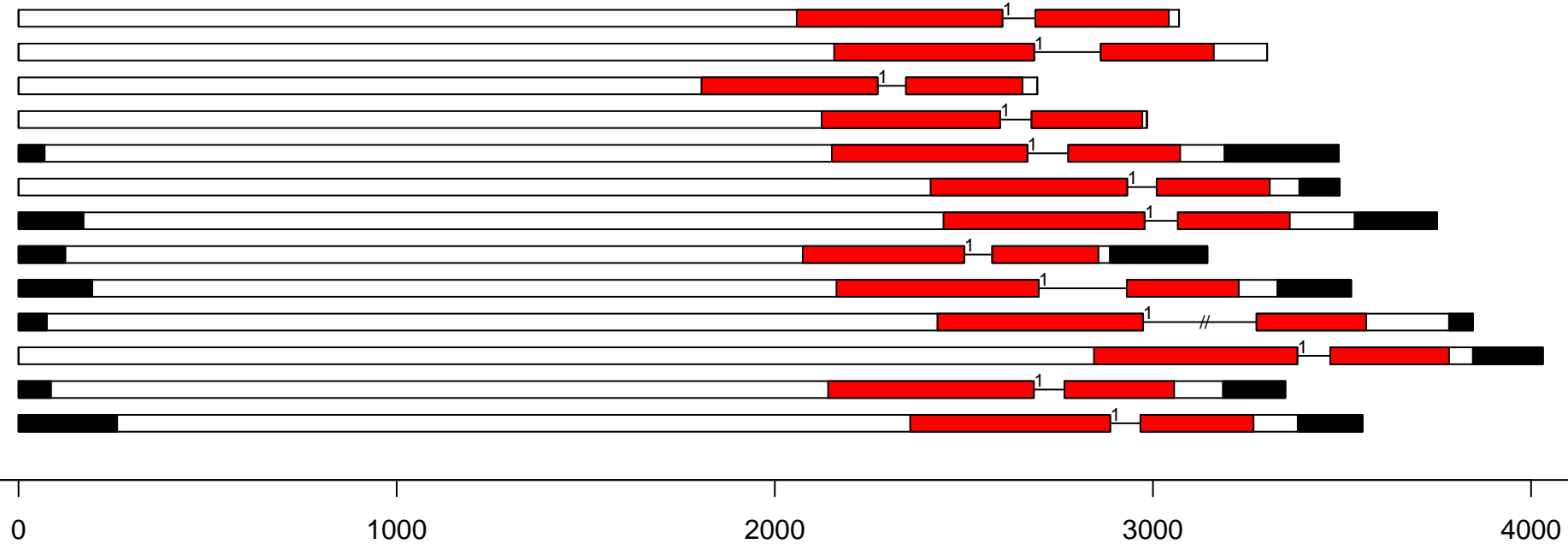

A.th RLK-Pelle_LRR-XI-2 exon-intron and kinase domain diagram (all)

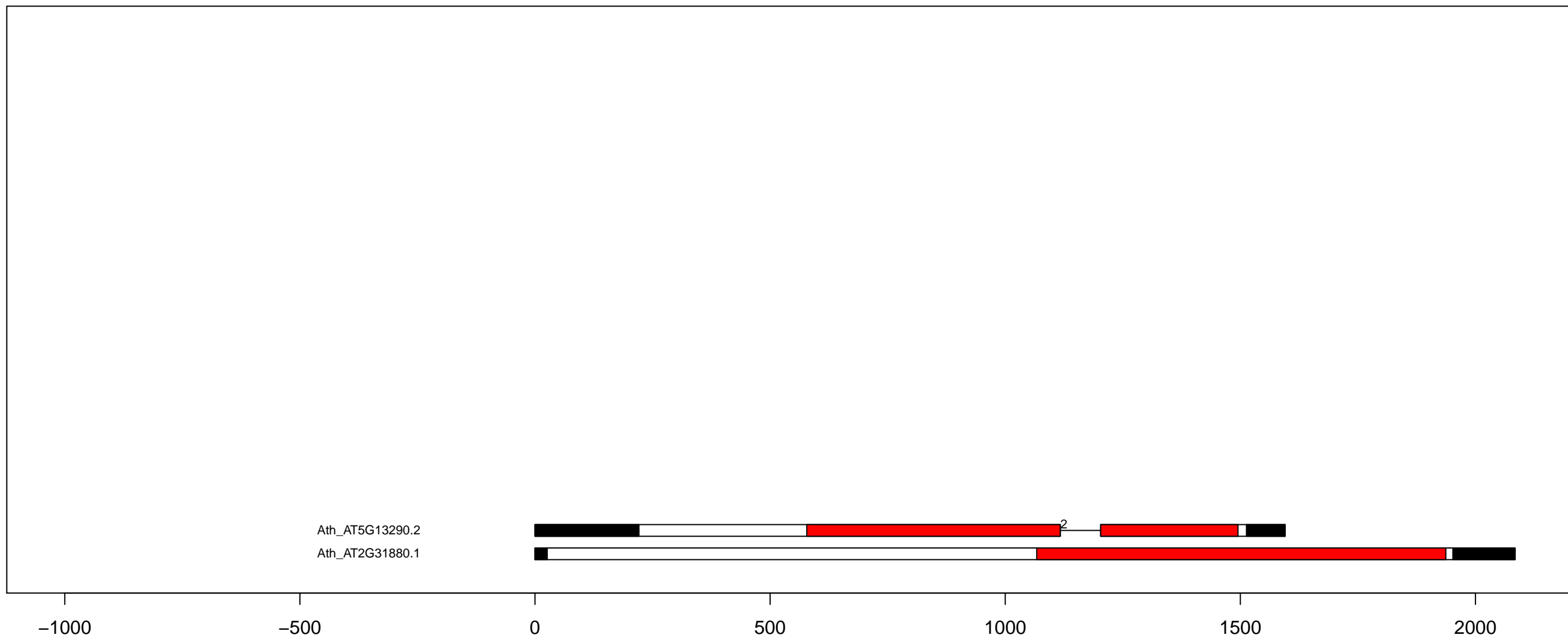

A.th RLK-Pelle_LRR-XIIIb exon-intron and kinase domain diagram (all)

Ath_AT5G62230.1

Ath_AT5G07180.1

Ath_AT2G26330.1

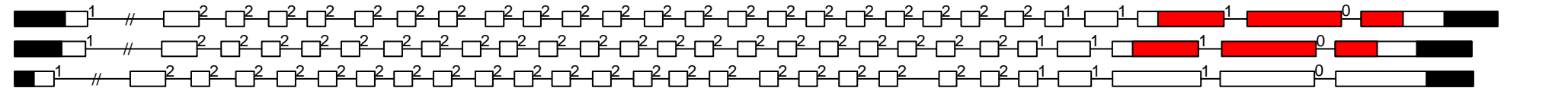

0

2000

4000

6000

A.th RLK-Pelle_LRR-XIV exon-intron and kinase domain diagram (all)

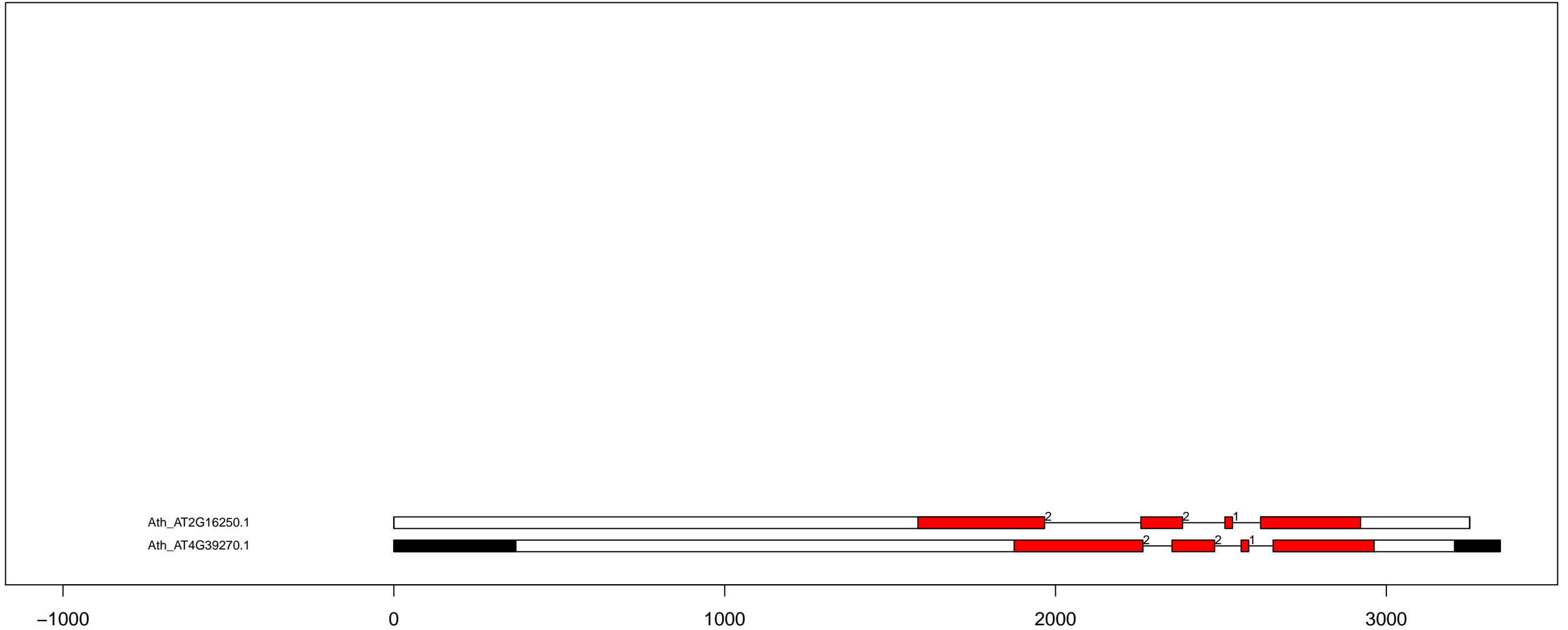

A.th RLK-Pelle_LRR-XV exon-intron and kinase domain diagram (all)

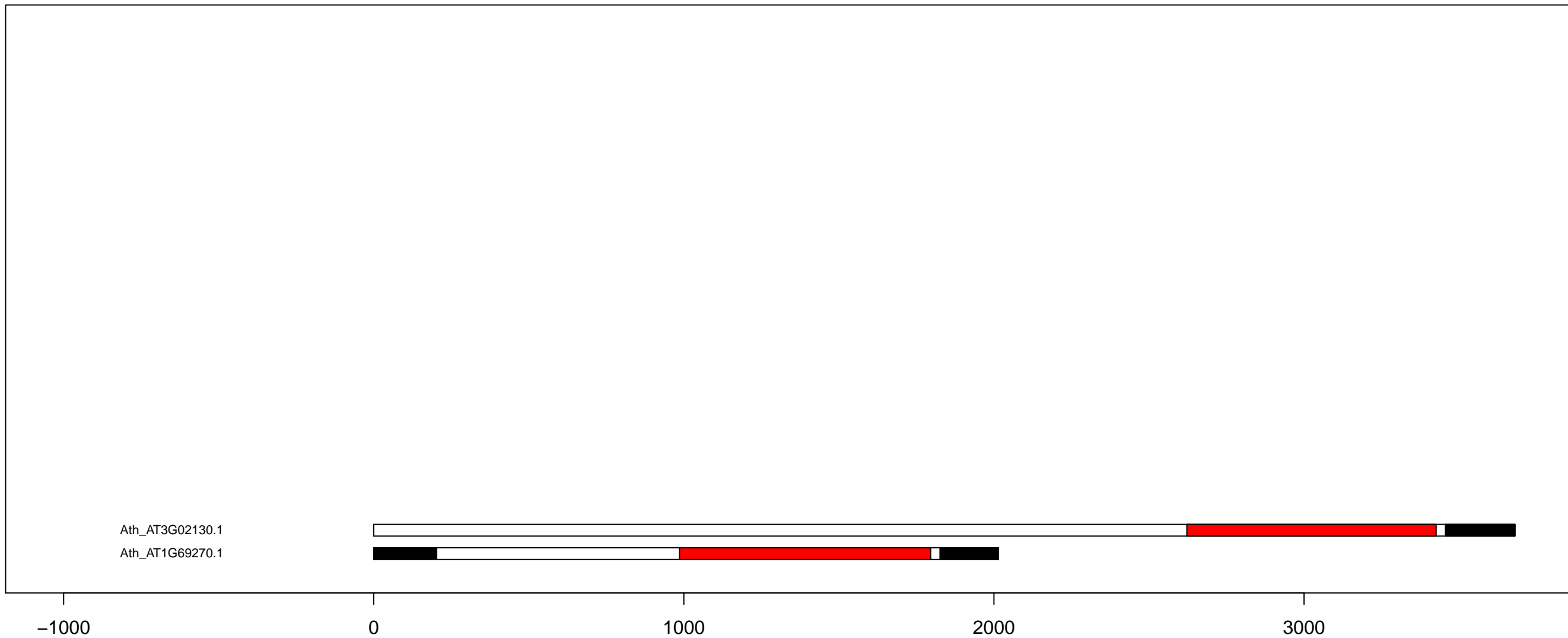

A.th RLK-Pelle_LysM exon-intron and kinase domain diagram (all)



A.th RLK-Pelle_PERK-1 exon-intron and kinase domain diagram (all)

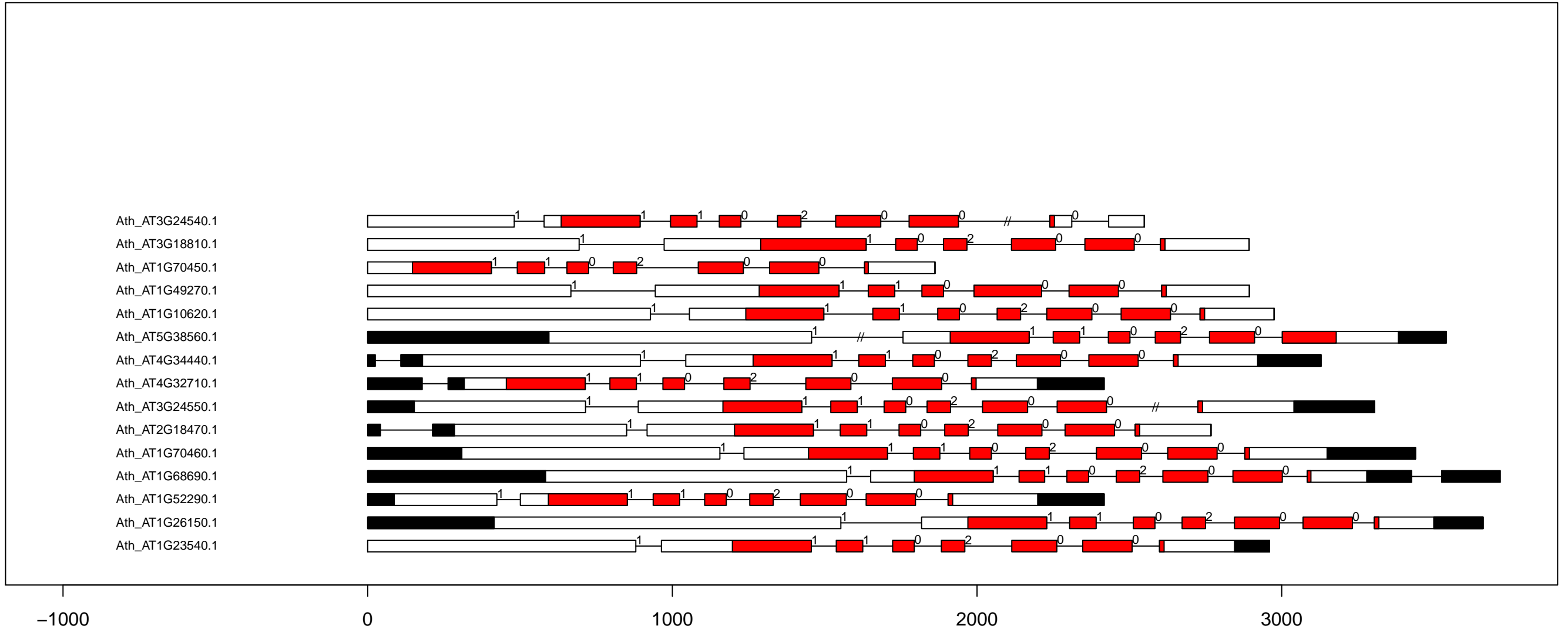

A.th RLK-Pelle_RKF3 exon-intron and kinase domain diagram (all)

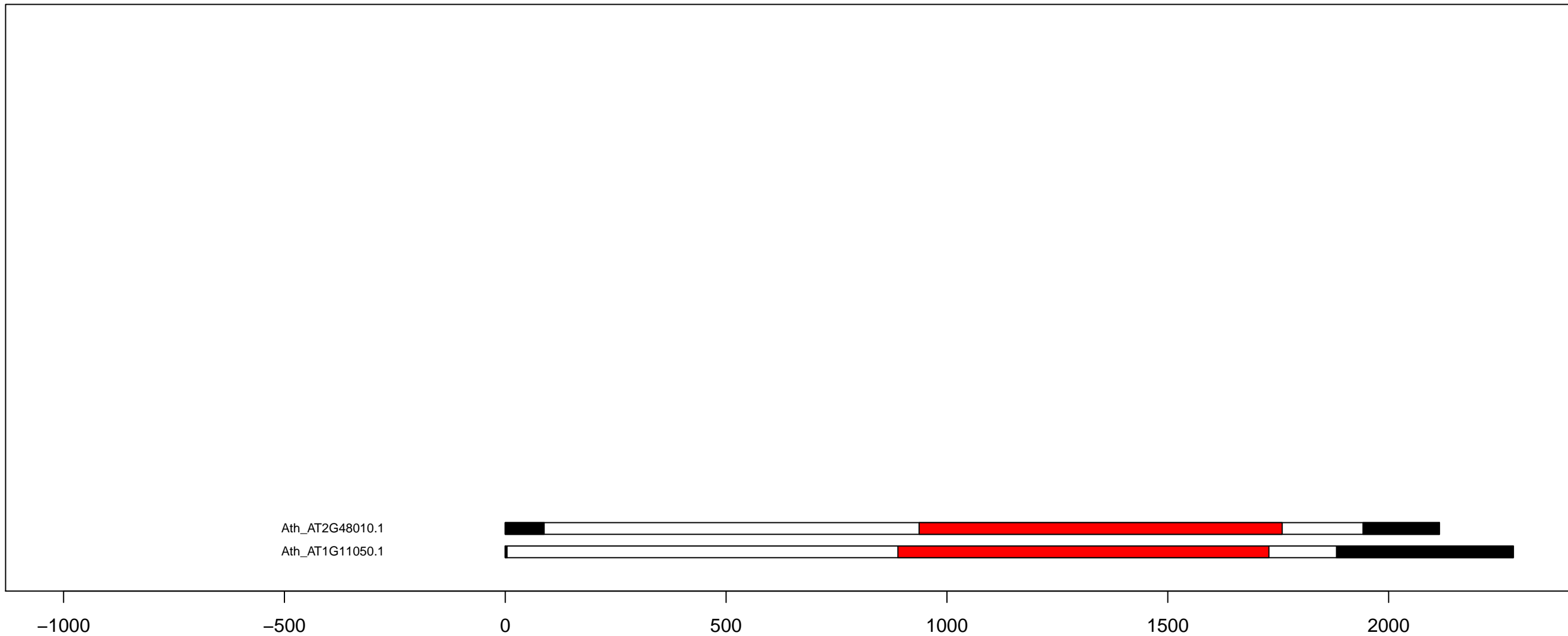

A.th RLK-Pelle_RLCK-II exon-intron and kinase domain diagram (all)

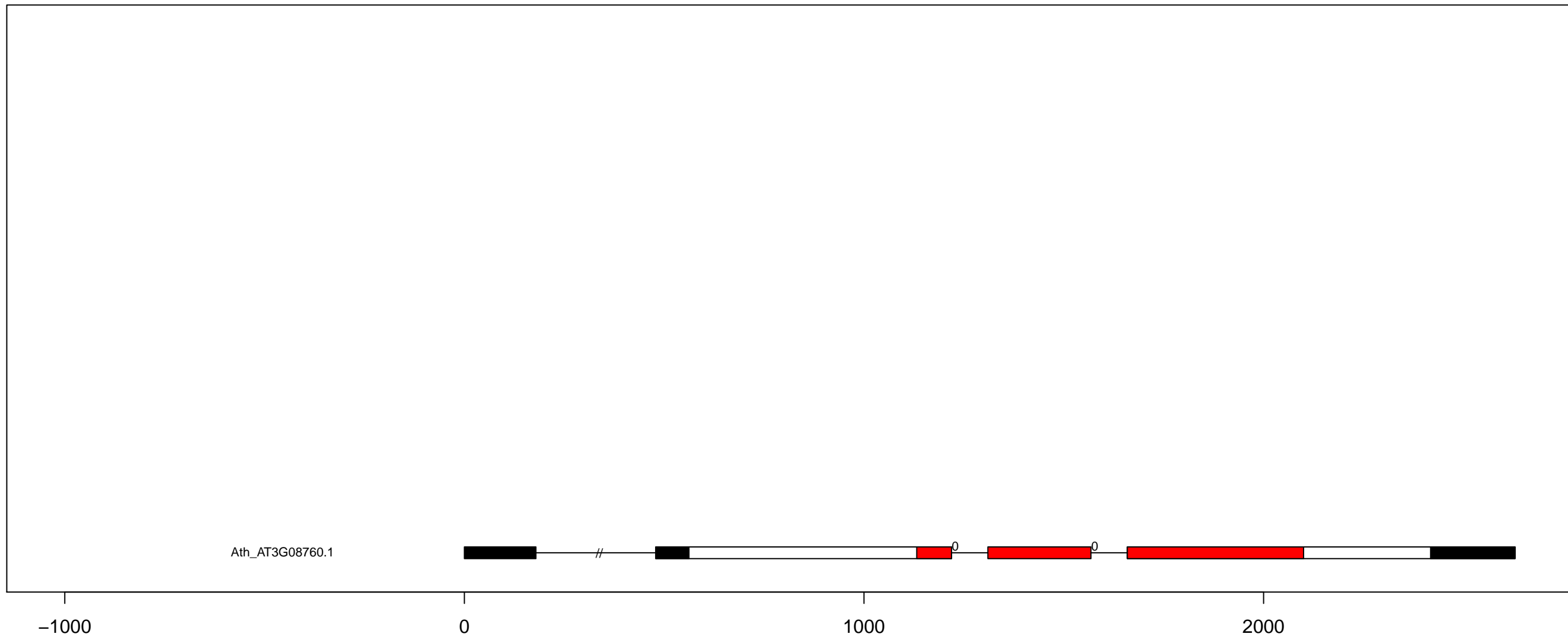

A.th RLK-Pelle_RLCK-IV exon-intron and kinase domain diagram (all)

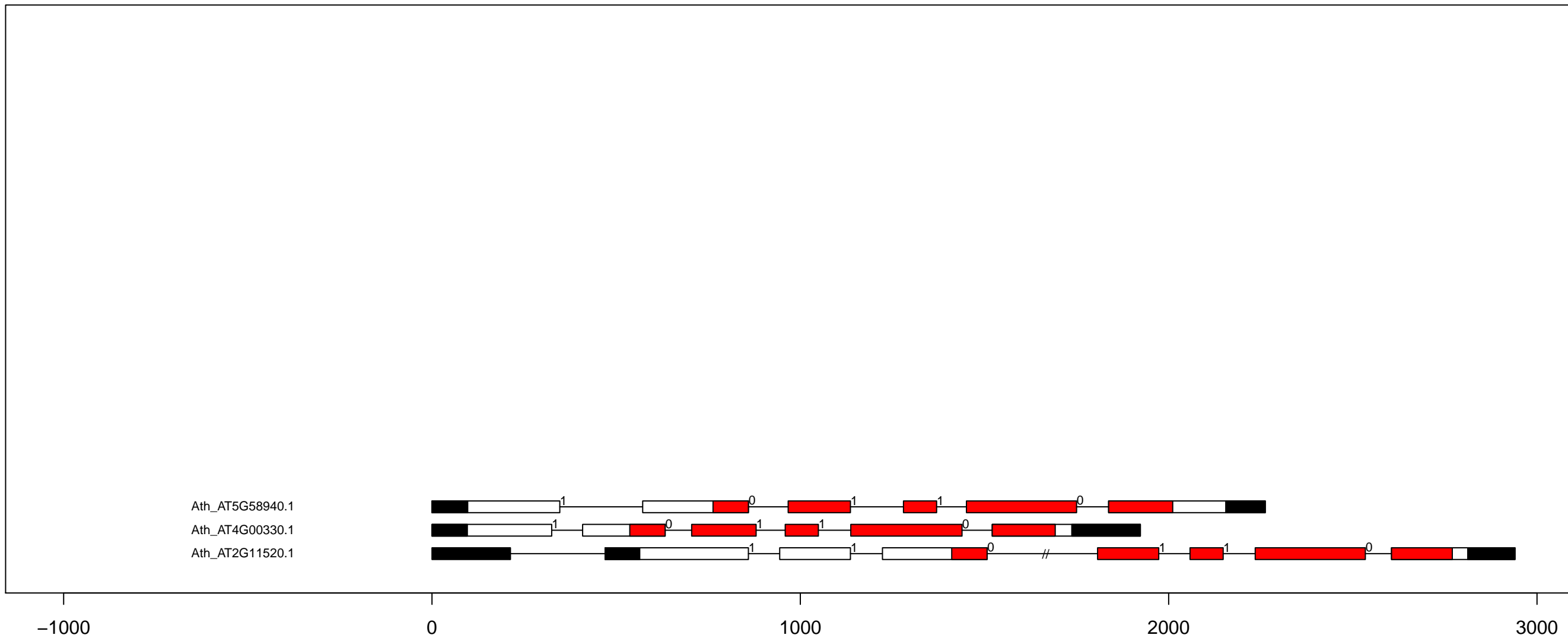

A.th RLK-Pelle_RLCK-IXa exon-intron and kinase domain diagram (all)

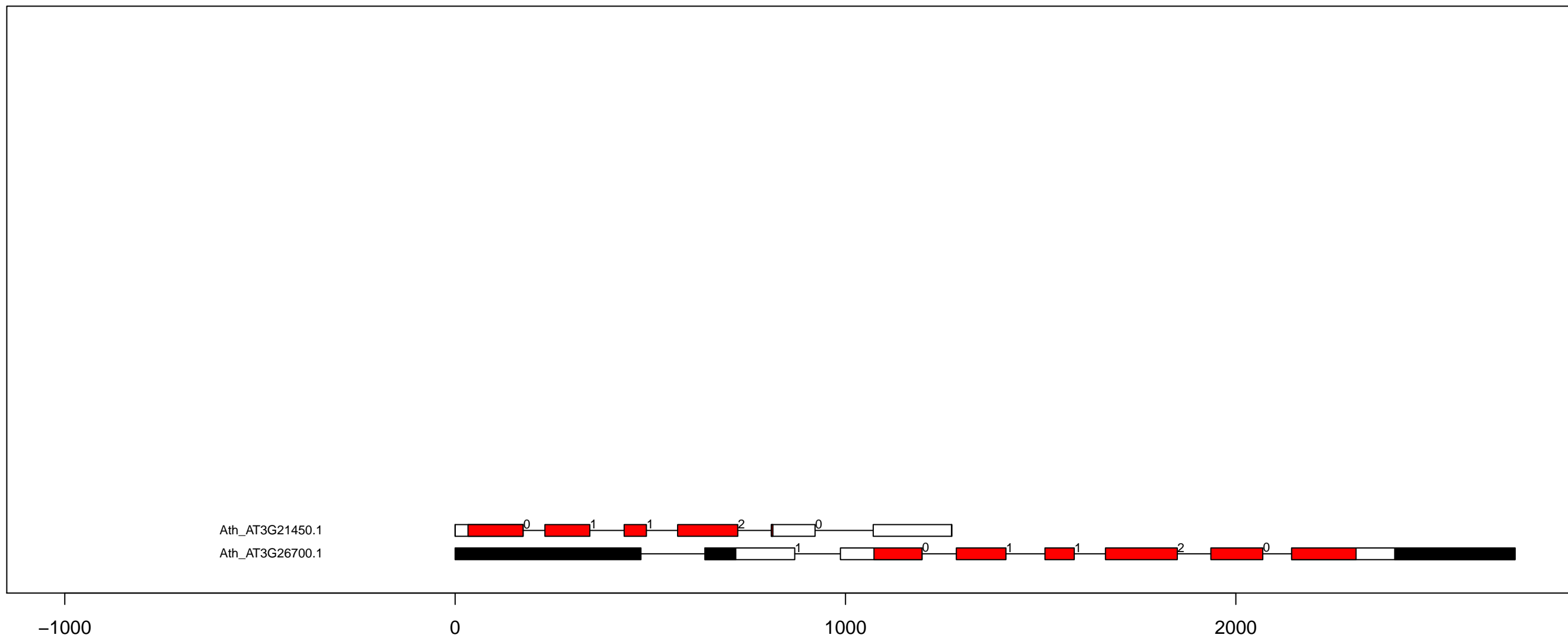

A.th RLK-Pelle_RLCK-VIIa-1 exon-intron and kinase domain diagram (all)

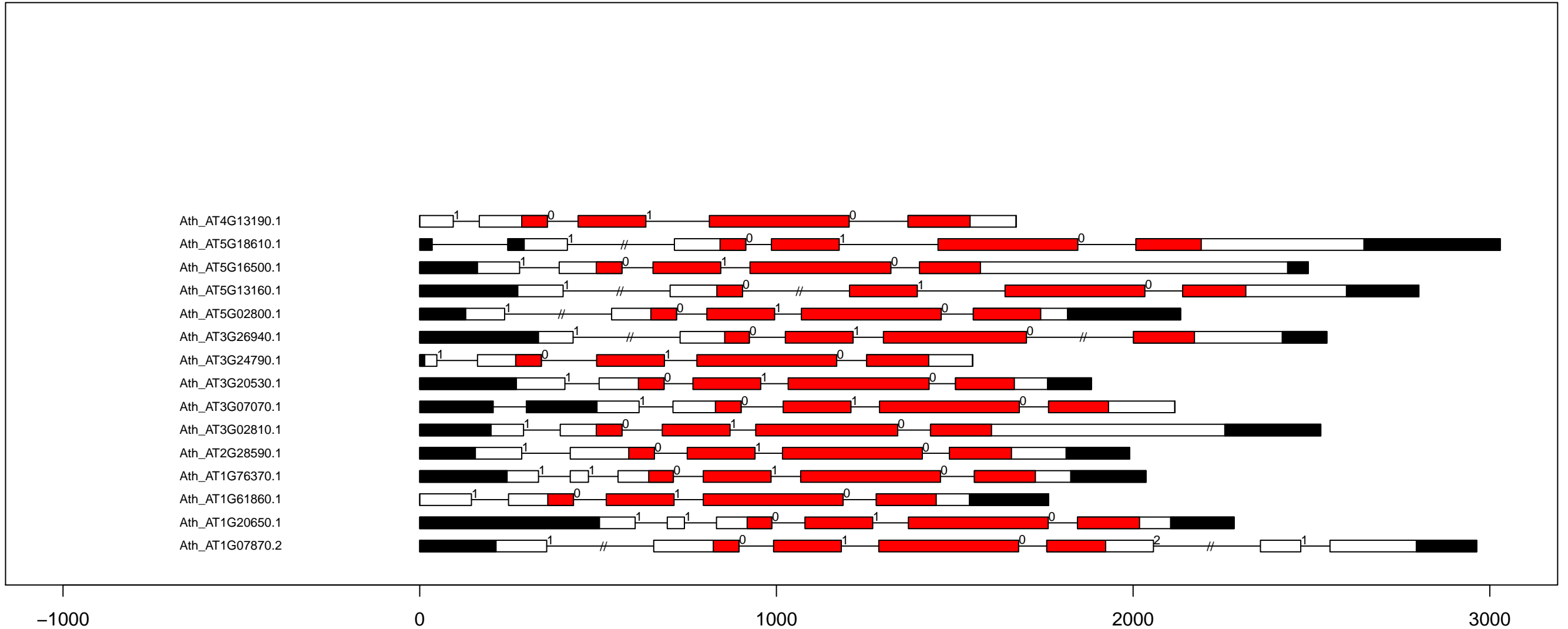

A.th RLK-Pelle_RLCK-VIIa-2 exon-intron and kinase domain diagram (part 1)

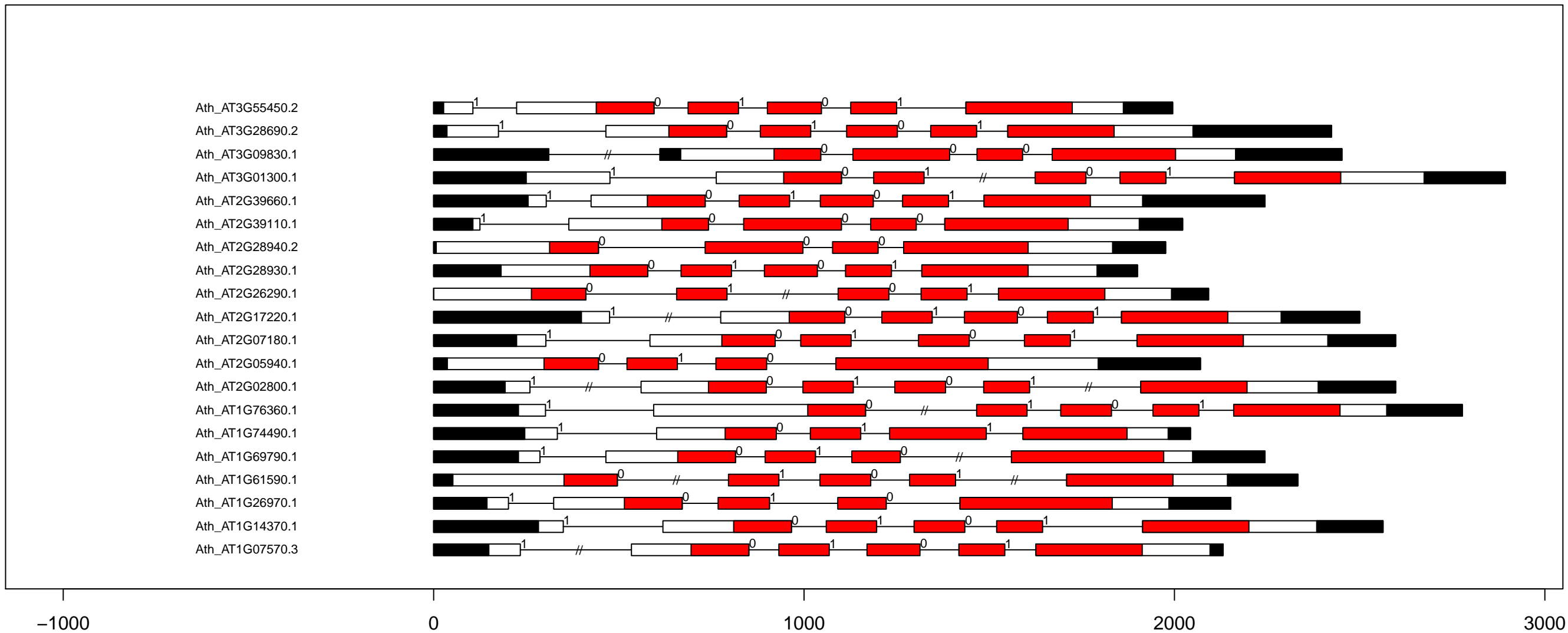

A.th RLK-Pelle_RLCK-VIIa-2 exon-intron and kinase domain diagram (part 2)

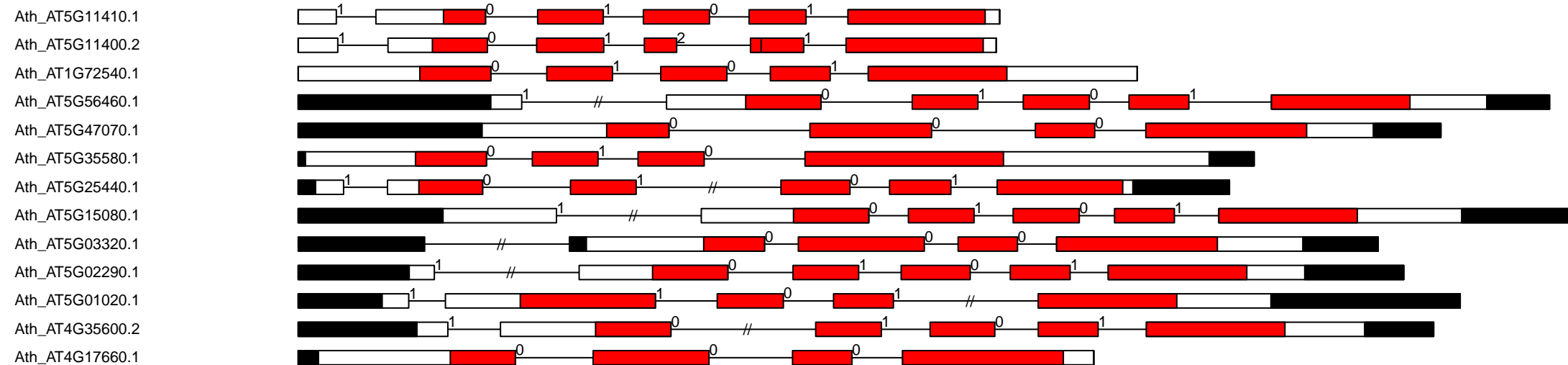

-1000

0

1000

2000

A.th RLK-Pelle_RLCK-VIIb exon-intron and kinase domain diagram (all)

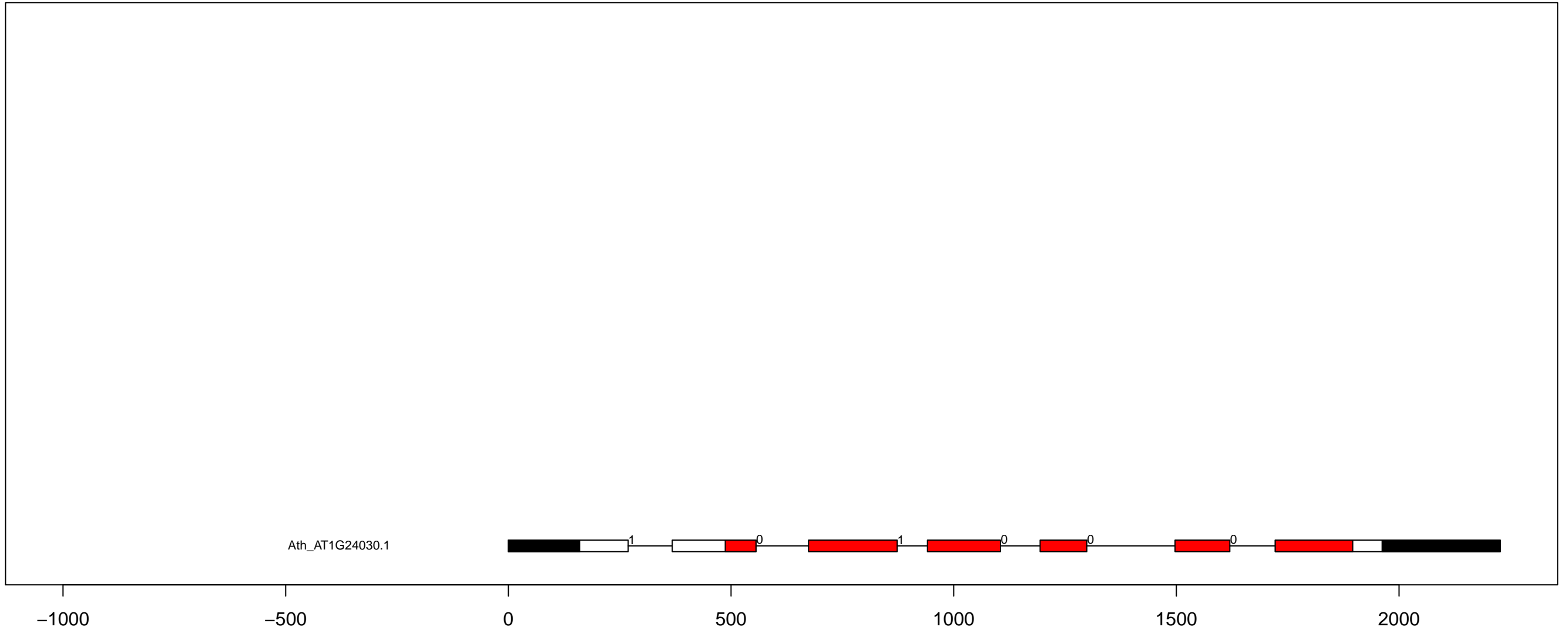

A.th RLK-Pelle_RLCK-VIII exon-intron and kinase domain diagram (all)

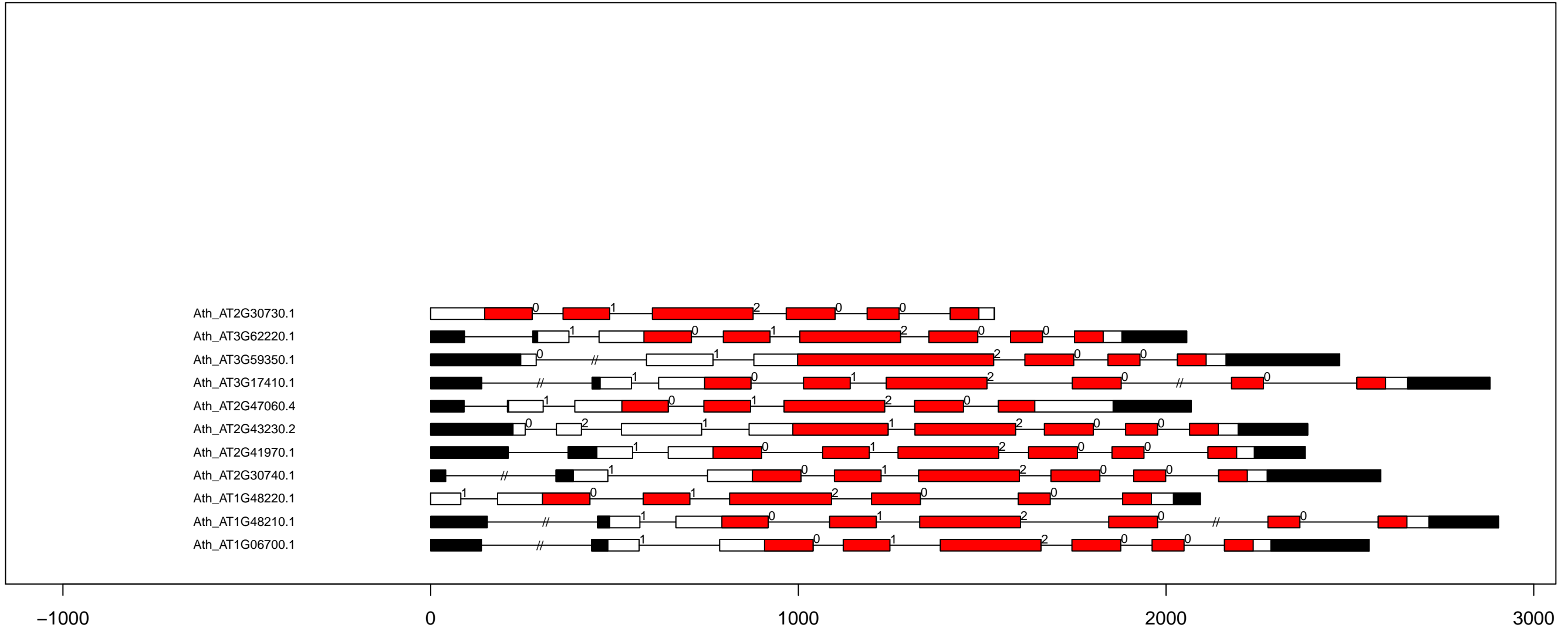

A.th RLK-Pelle_RLCK-VI exon-intron and kinase domain diagram (all)

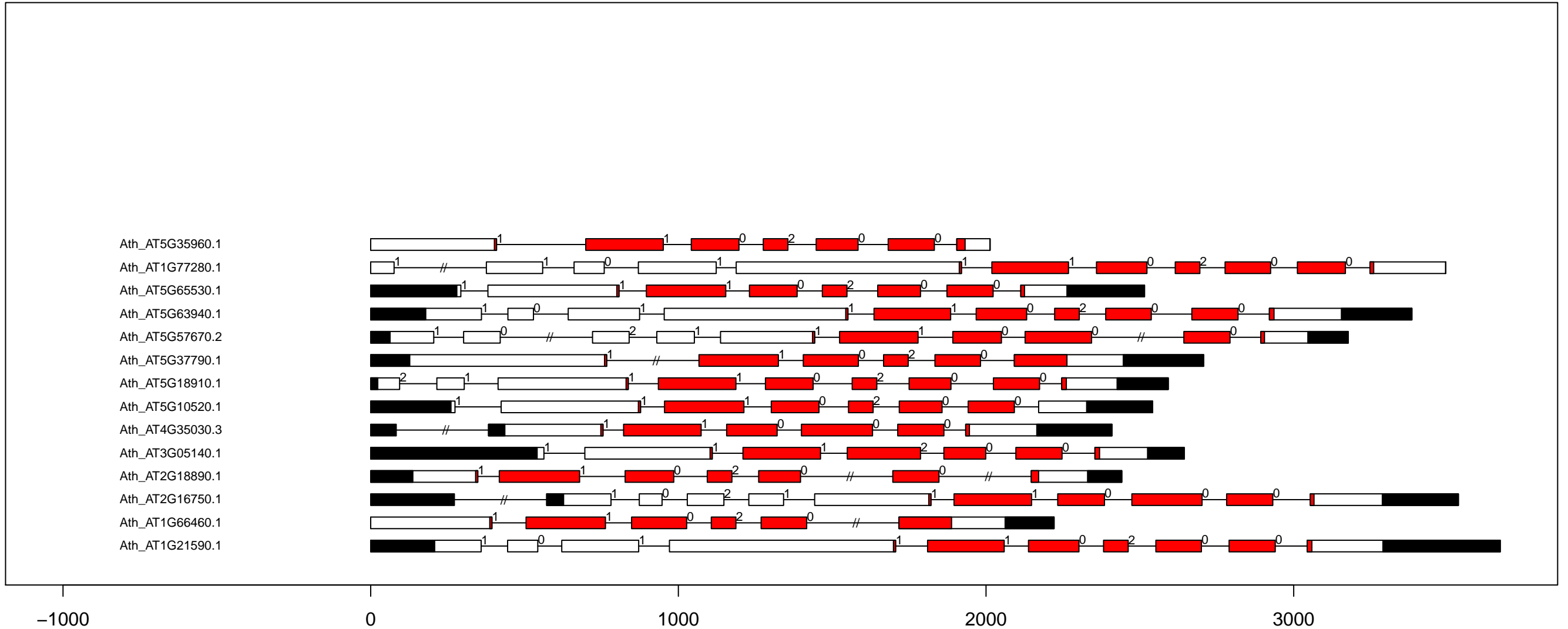

A.th RLK-Pelle_RLCK-V exon-intron and kinase domain diagram (all)

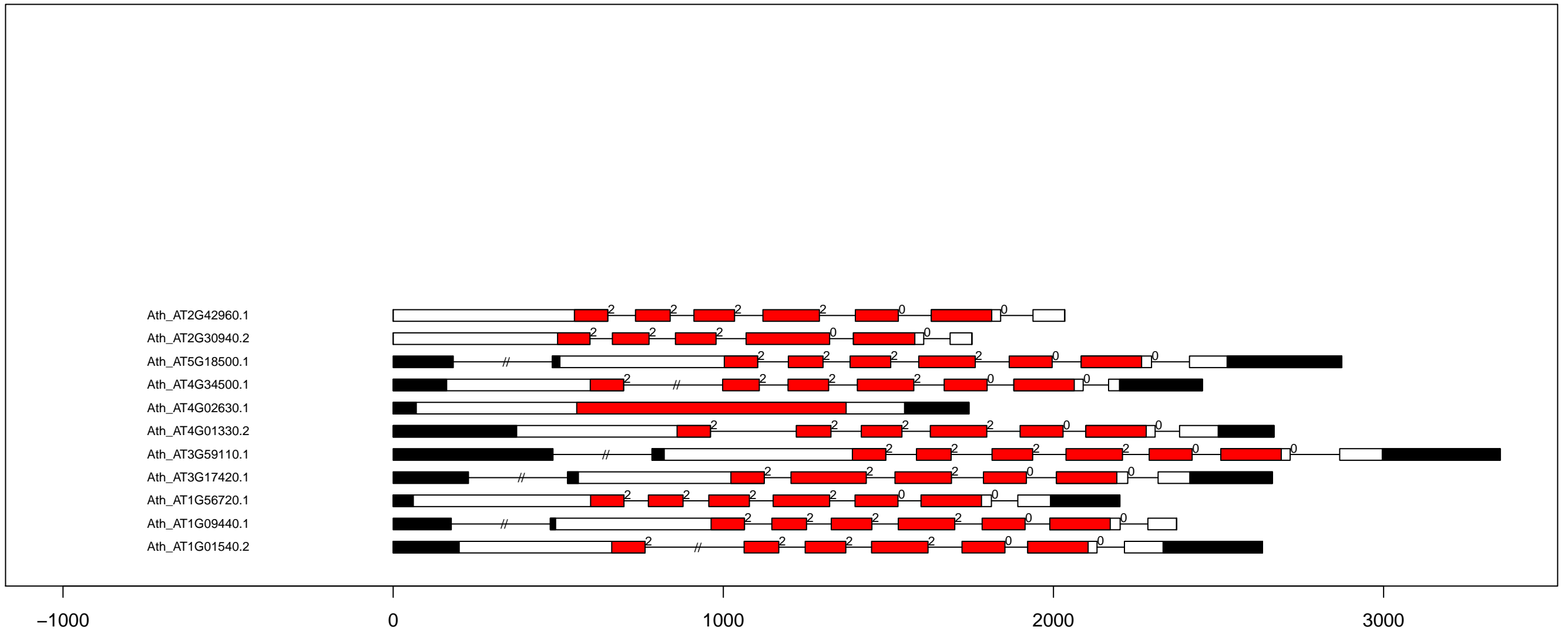

A.th RLK-Pelle_RLCK-XII-1 exon-intron and kinase domain diagram (all)

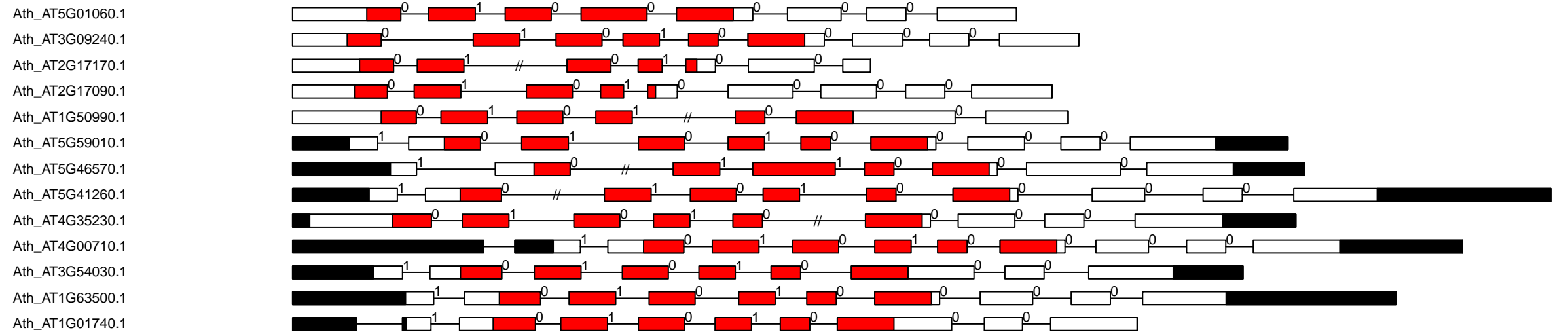

-1000

0

1000

2000

3000

A.th RLK-Pelle_RLCK-XII-2 exon-intron and kinase domain diagram (all)

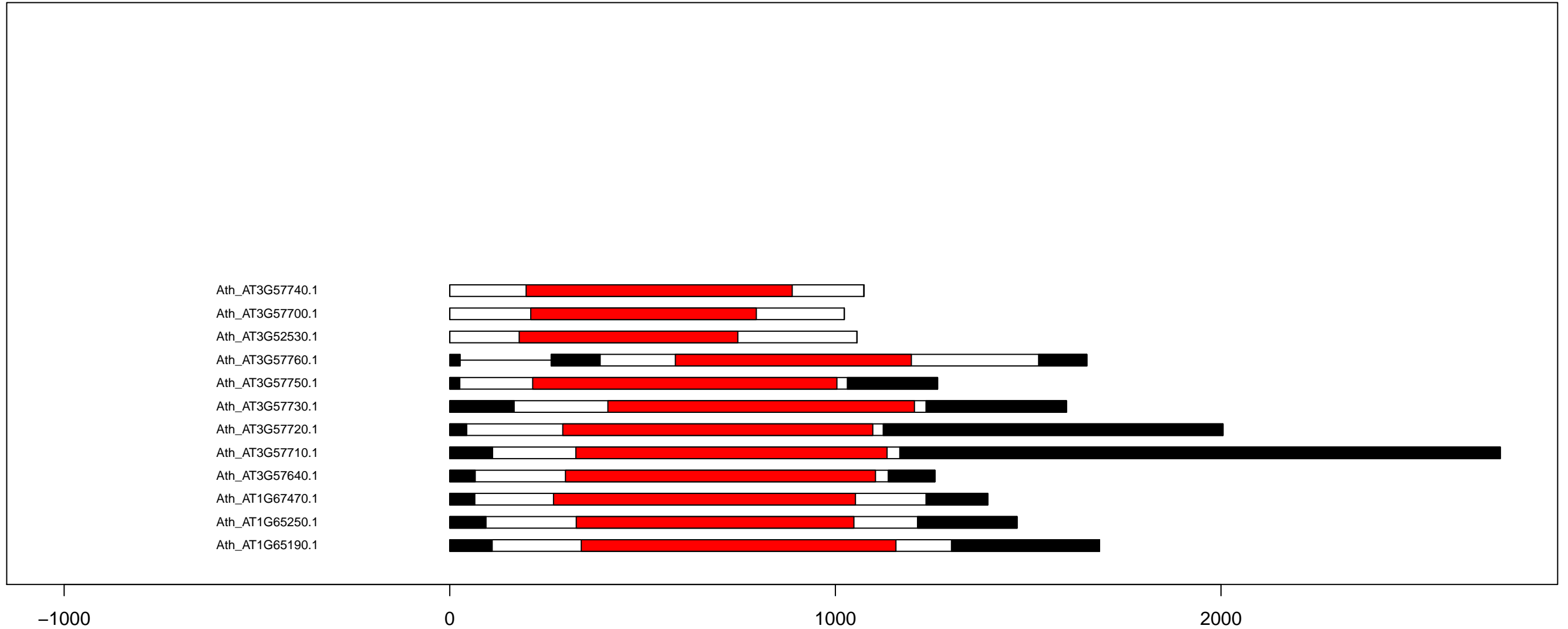

A.th RLK-Pelle_RLCK-XIII exon-intron and kinase domain diagram (all)

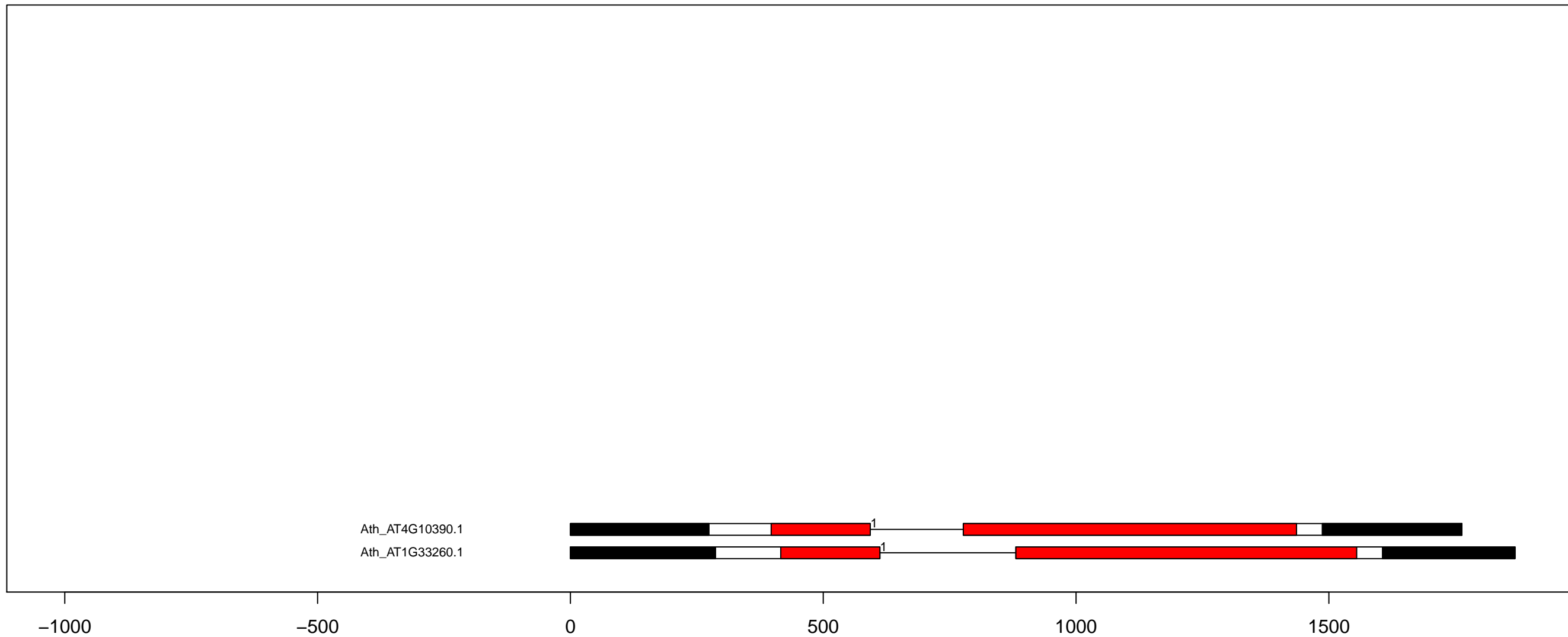

A.th RLK-Pelle_RLCK-XI exon-intron and kinase domain diagram (all)

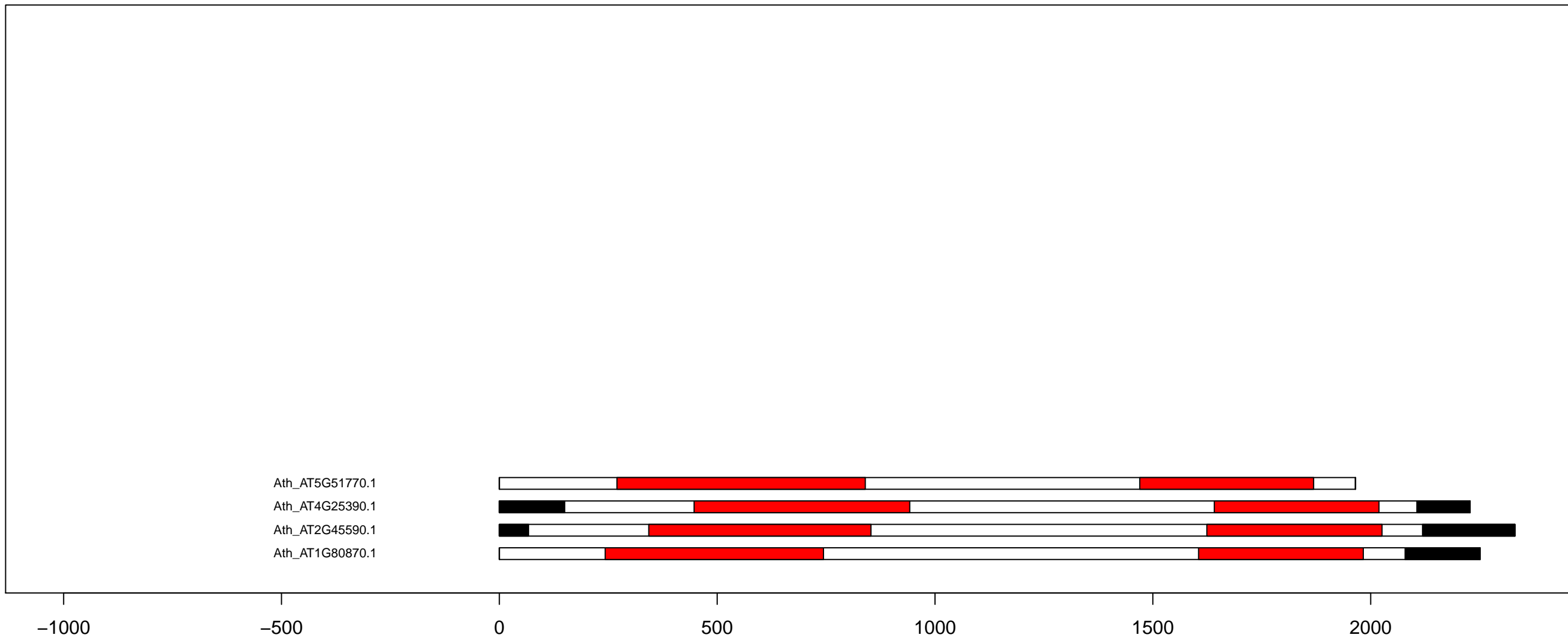

A.th RLK-Pelle_RLCK-X exon-intron and kinase domain diagram (all)

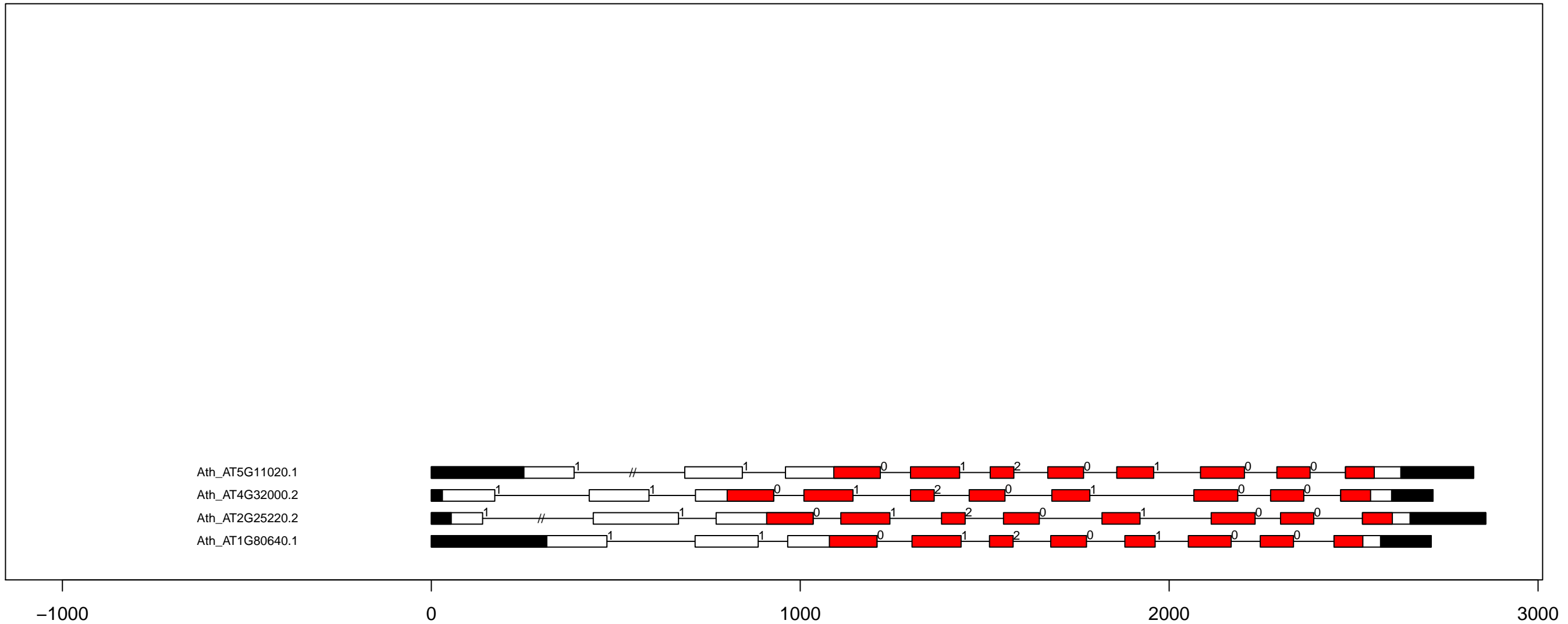

A.th RLK-Pelle_RLCK-XVII exon-intron and kinase domain diagram (all)

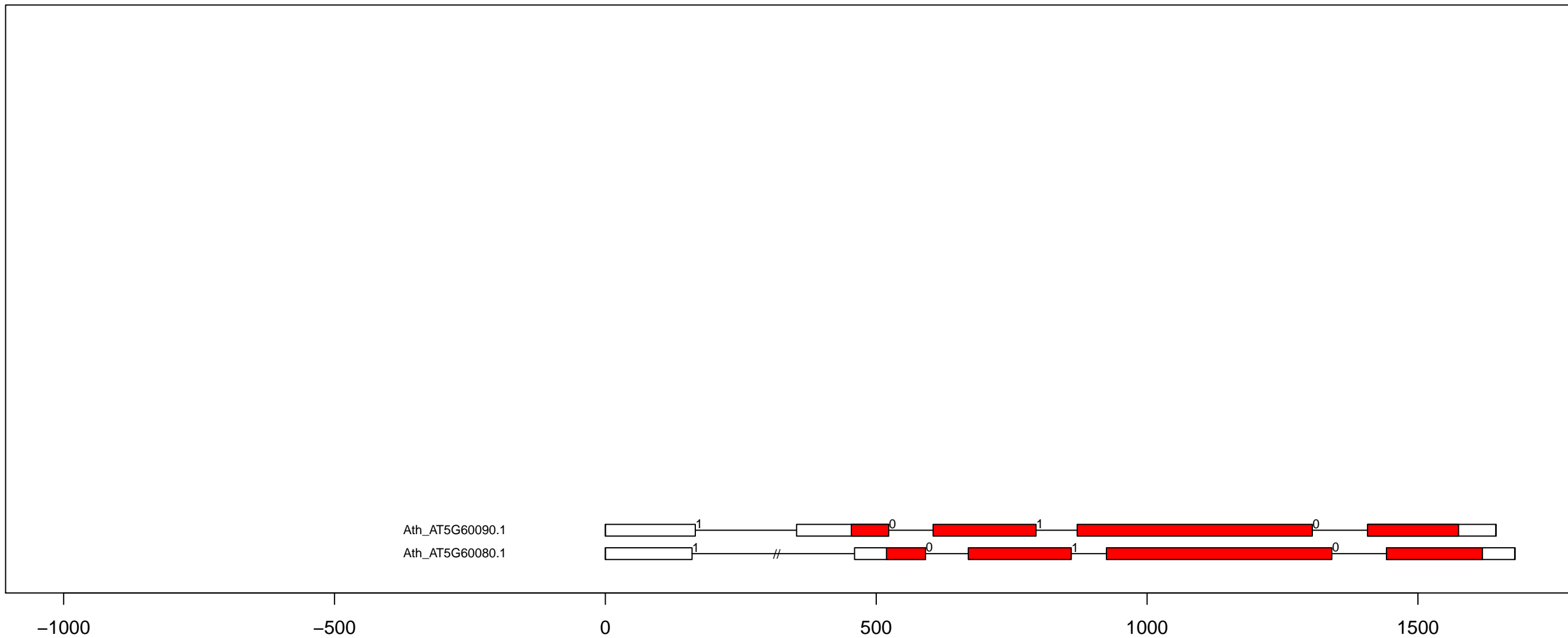

A.th RLK-Pelle_RLCK-XVI exon-intron and kinase domain diagram (all)

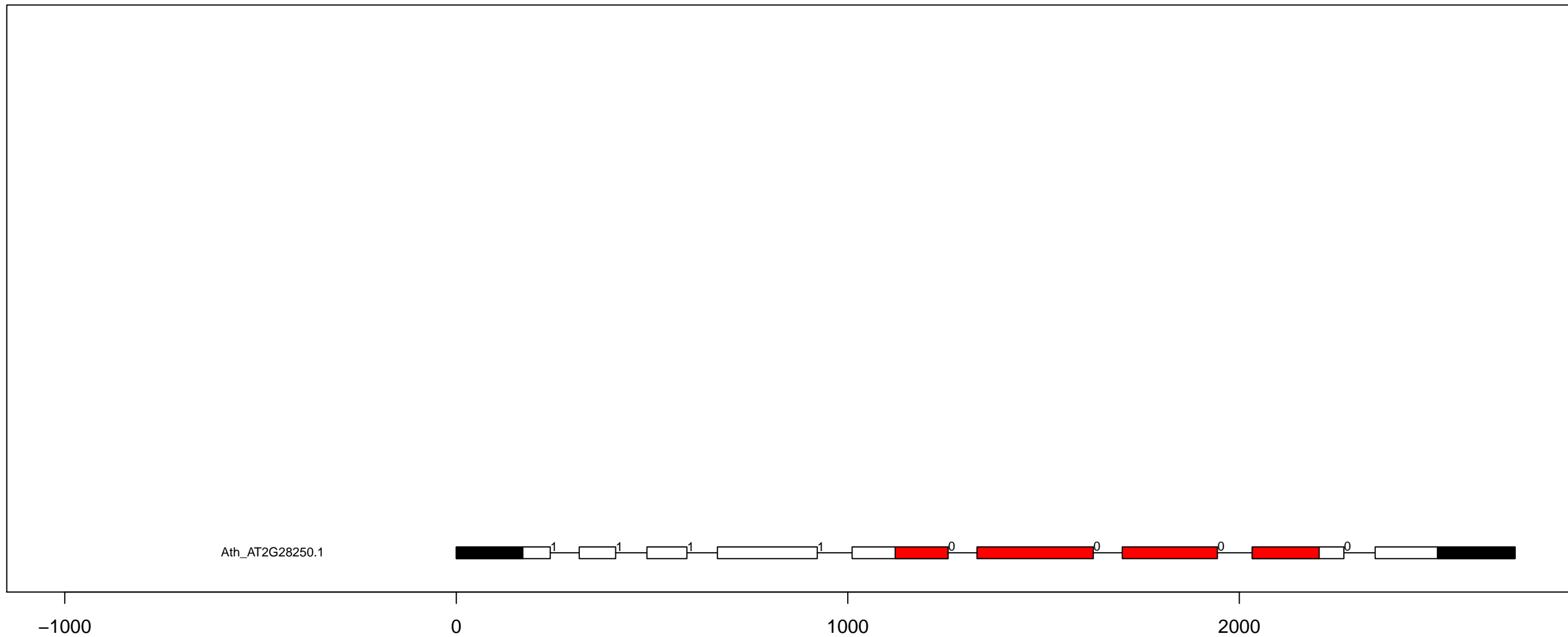

A.th RLK-Pelle_RLCK-XV exon-intron and kinase domain diagram (all)

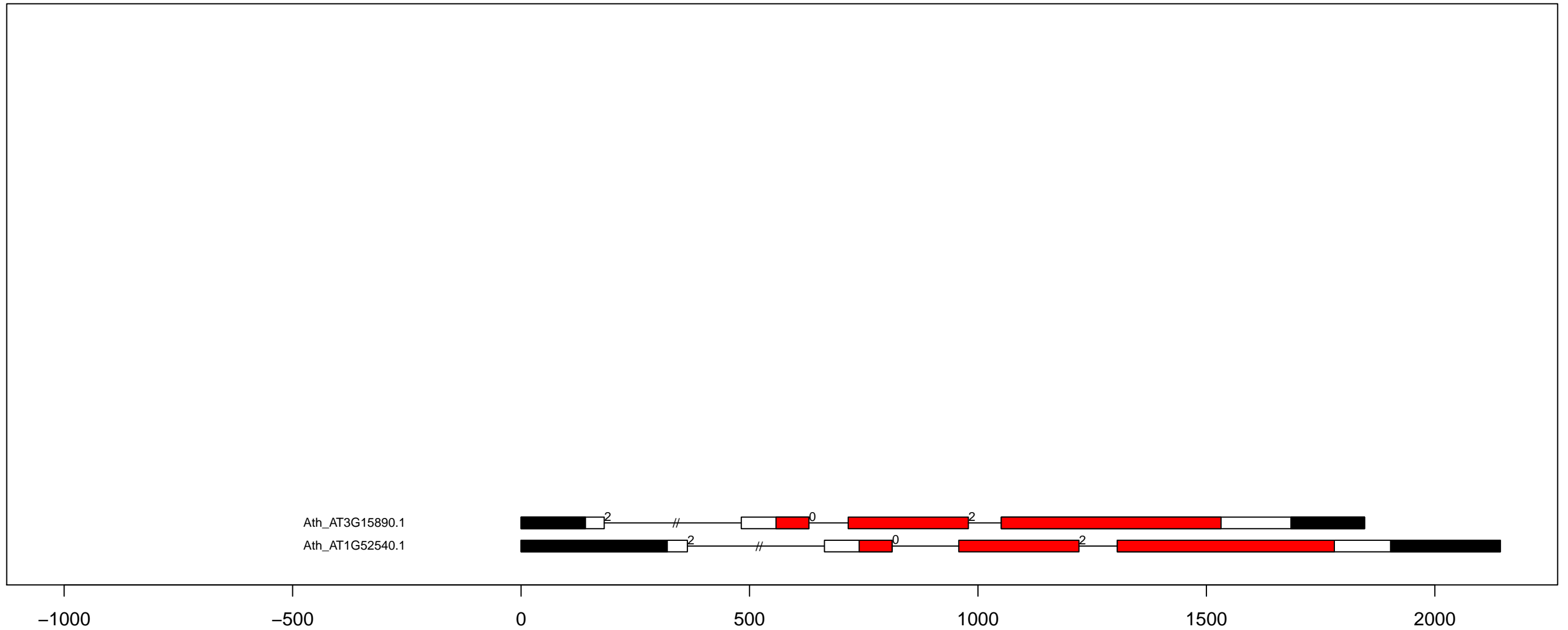

A.th RLK-Pelle_SD-2b exon-intron and kinase domain diagram (all)

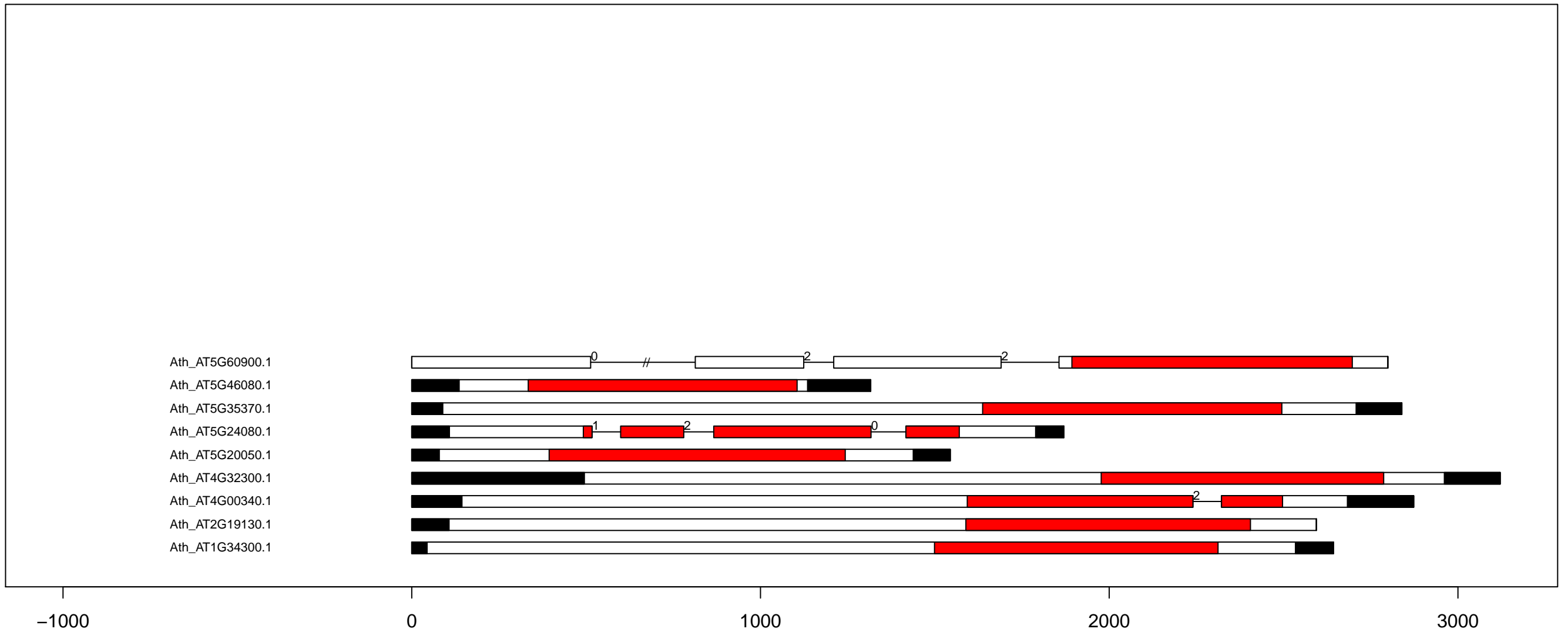

A.th RLK-Pelle_Singleton exon-intron and kinase domain diagram (all)

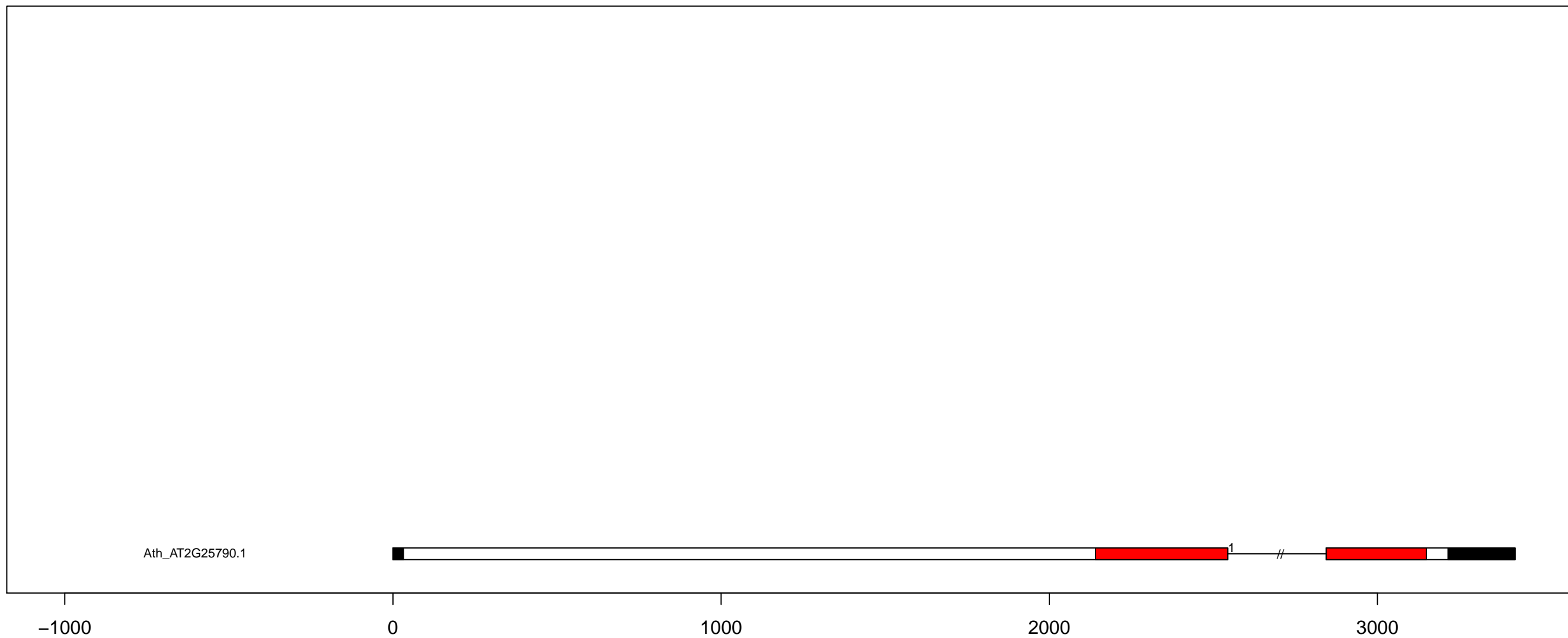

A.th RLK-Pelle_URK-1 exon-intron and kinase domain diagram (all)

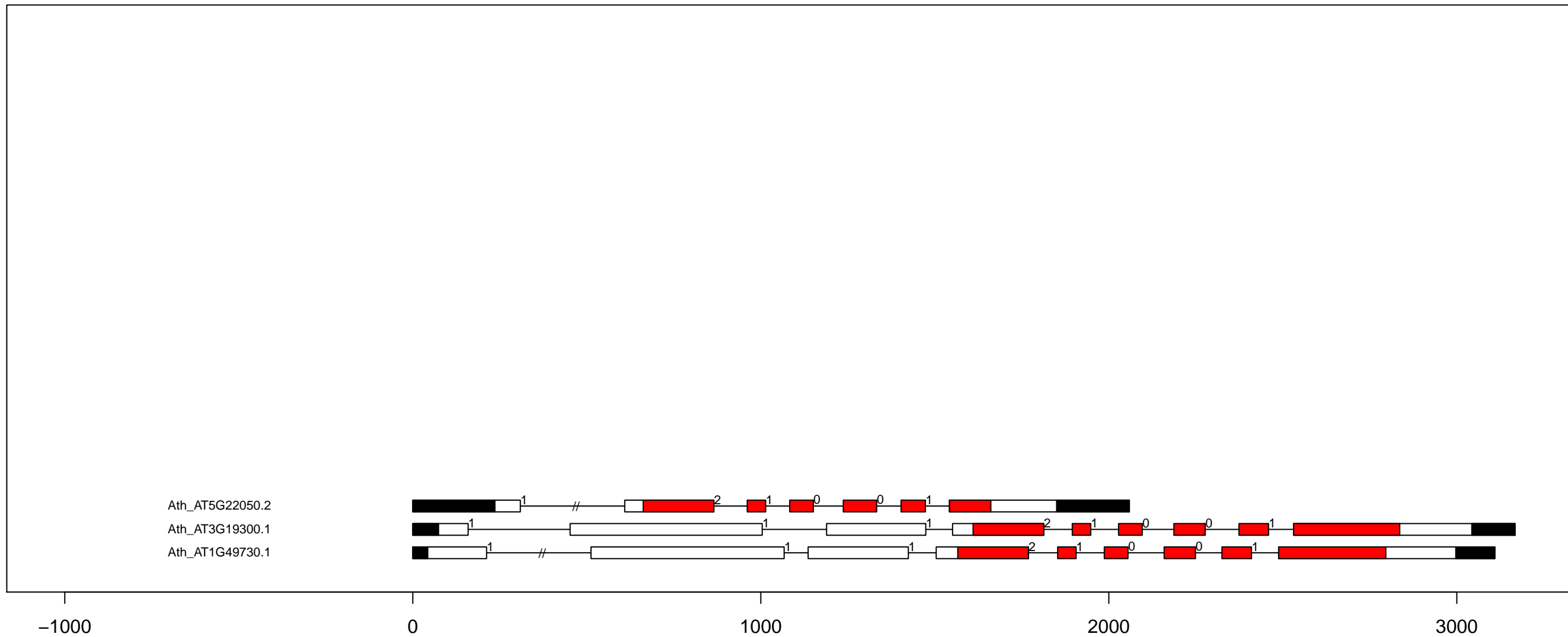

A.th RLK-Pelle_URK-3 exon-intron and kinase domain diagram (all)

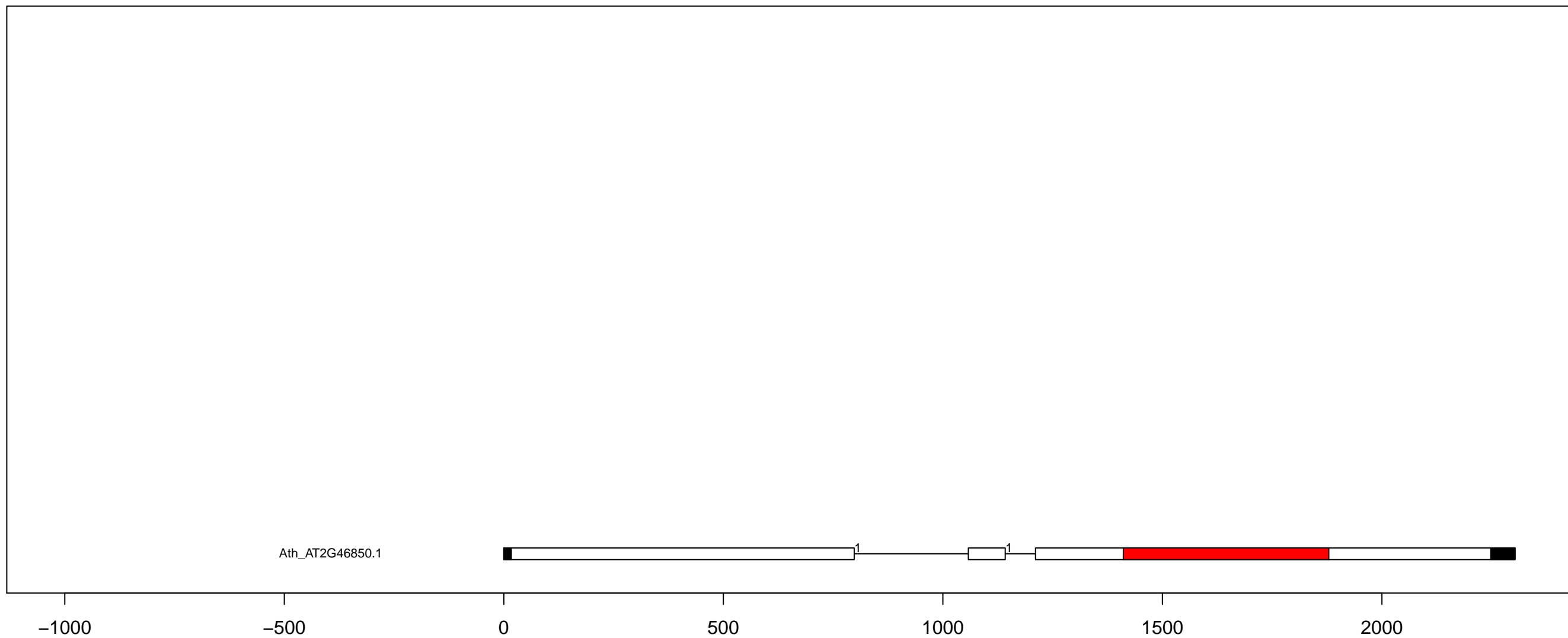

A.th RLK-Pelle_WAK_LRK10L-1 exon-intron and kinase domain diagram (all)

Ath_AT5G02070.1
 Ath_AT3G53840.1
 Ath_AT5G66790.1
 Ath_AT5G38210.1
 Ath_AT2G23450.2
 Ath_AT1G69910.1
 Ath_AT1G66880.1
 Ath_AT1G25390.1
 Ath_AT1G18390.2

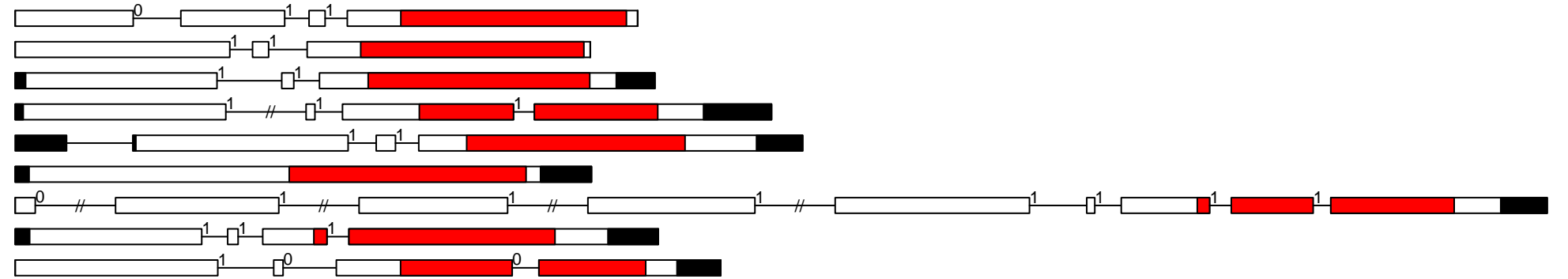

0

2000

4000

6000

A.th RLK-Pelle_WAK exon-intron and kinase domain diagram (all)

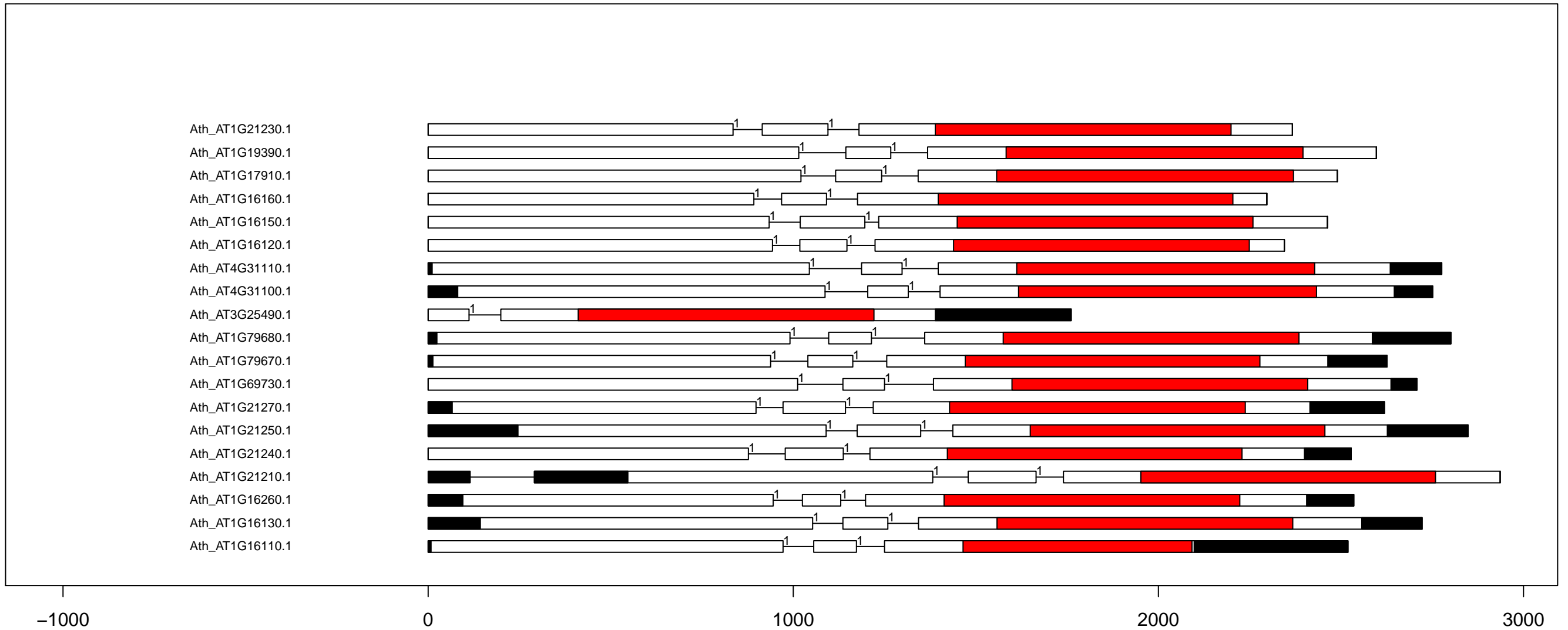

A.th SCY1_SCYL1 exon-intron and kinase domain diagram (all)

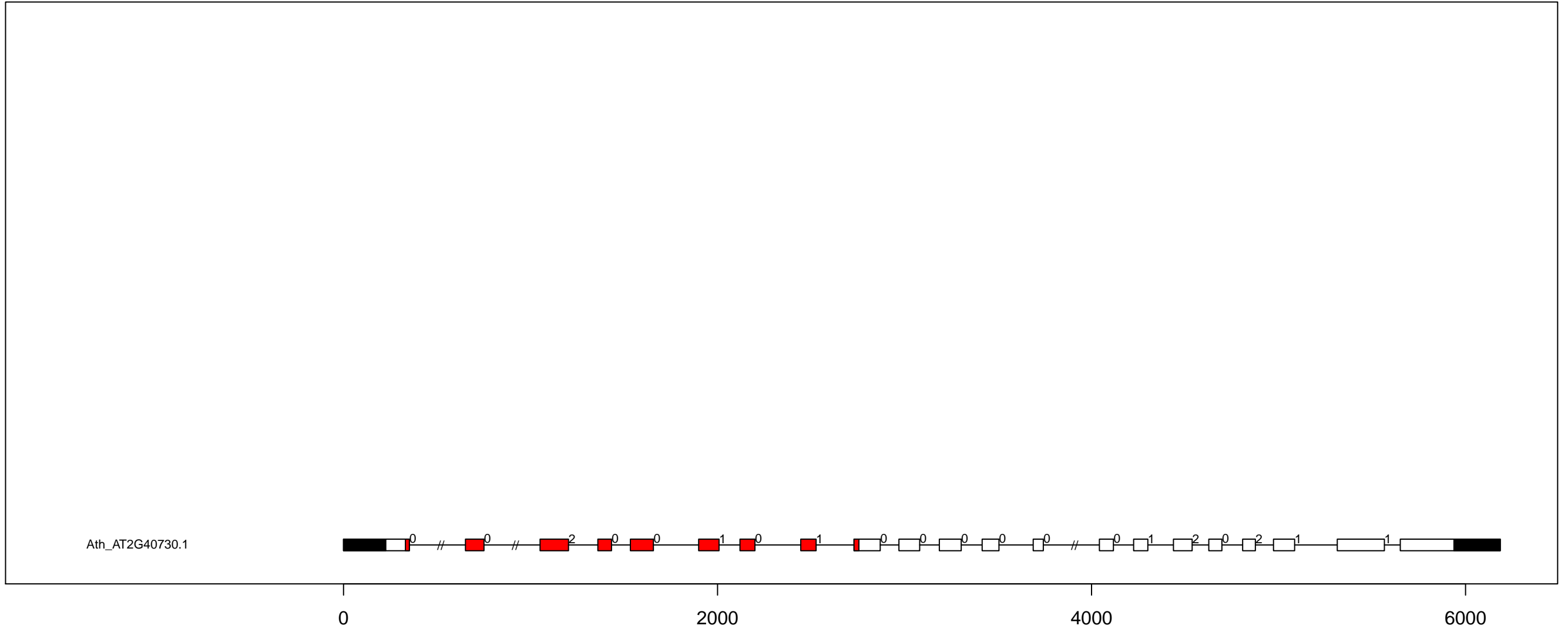

A.th SCY1_SCYL2 exon-intron and kinase domain diagram (all)

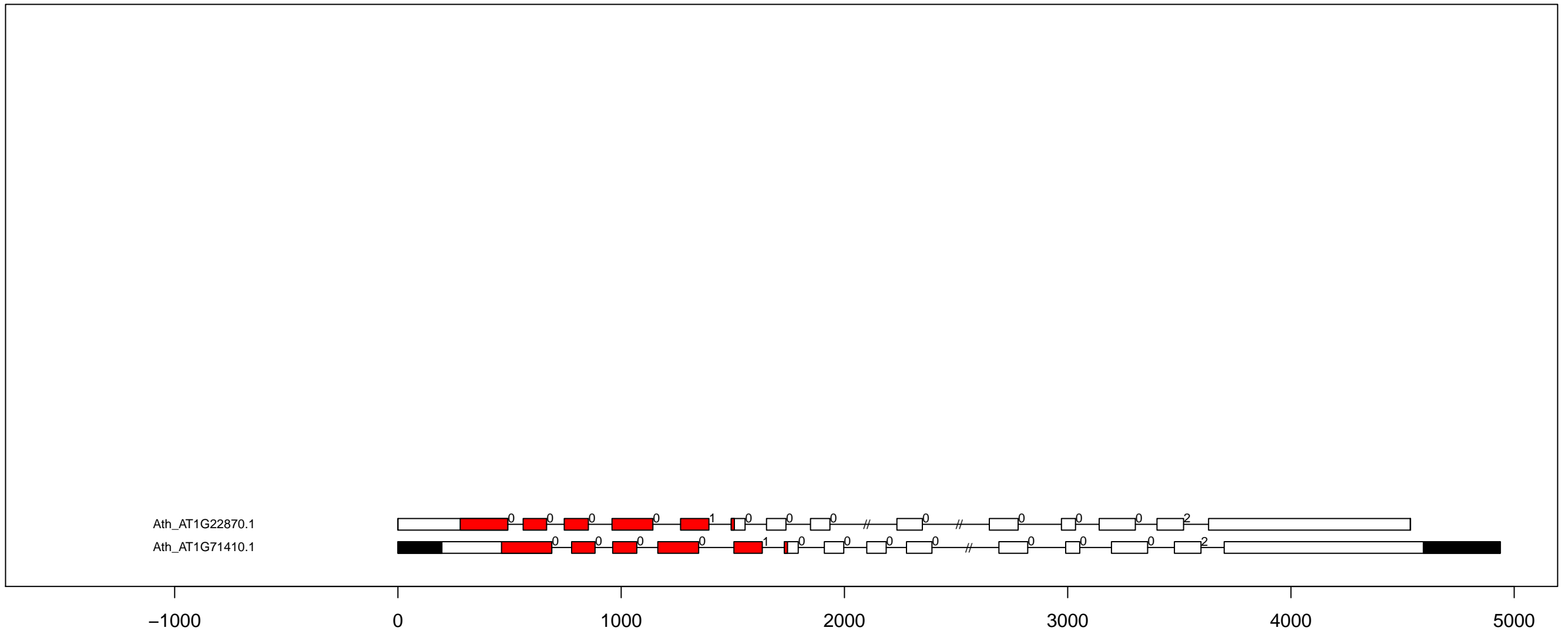

A.th STE_STE11 exon-intron and kinase domain diagram (part 1)

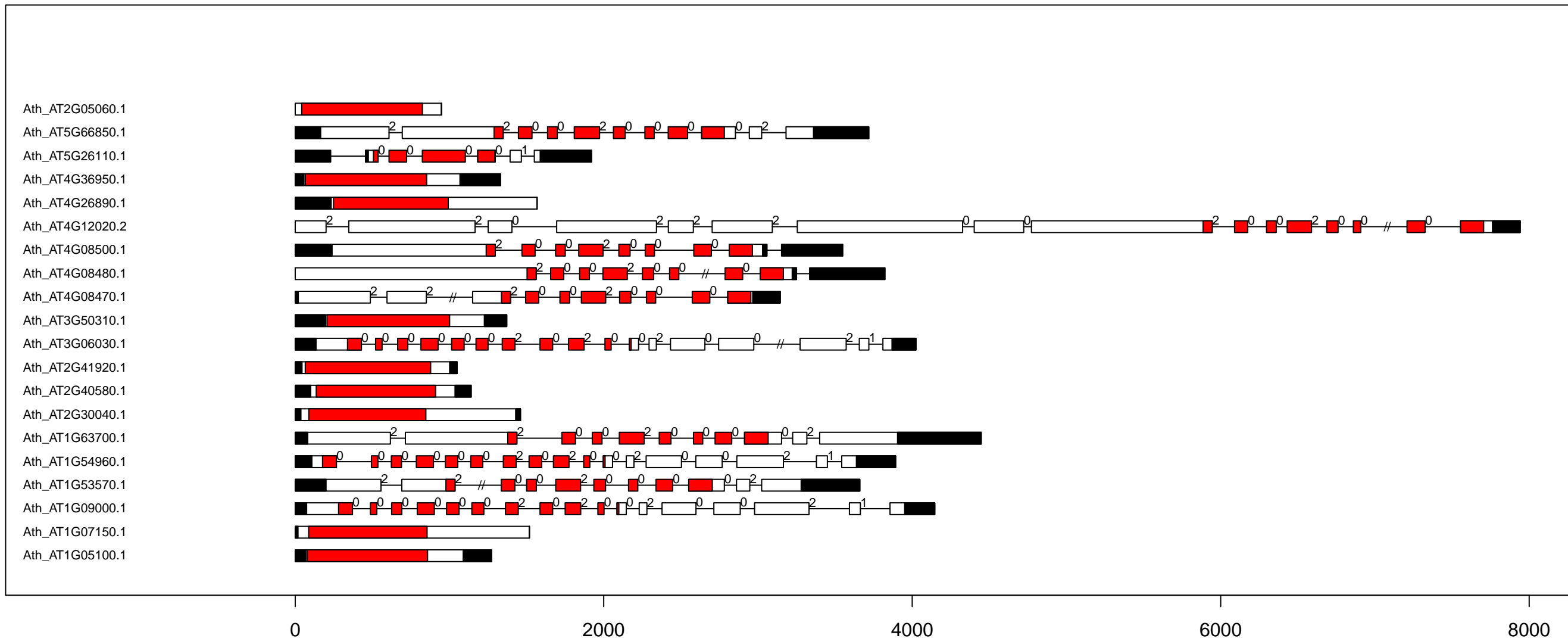

A.th STE_STE11 exon-intron and kinase domain diagram (part 2)

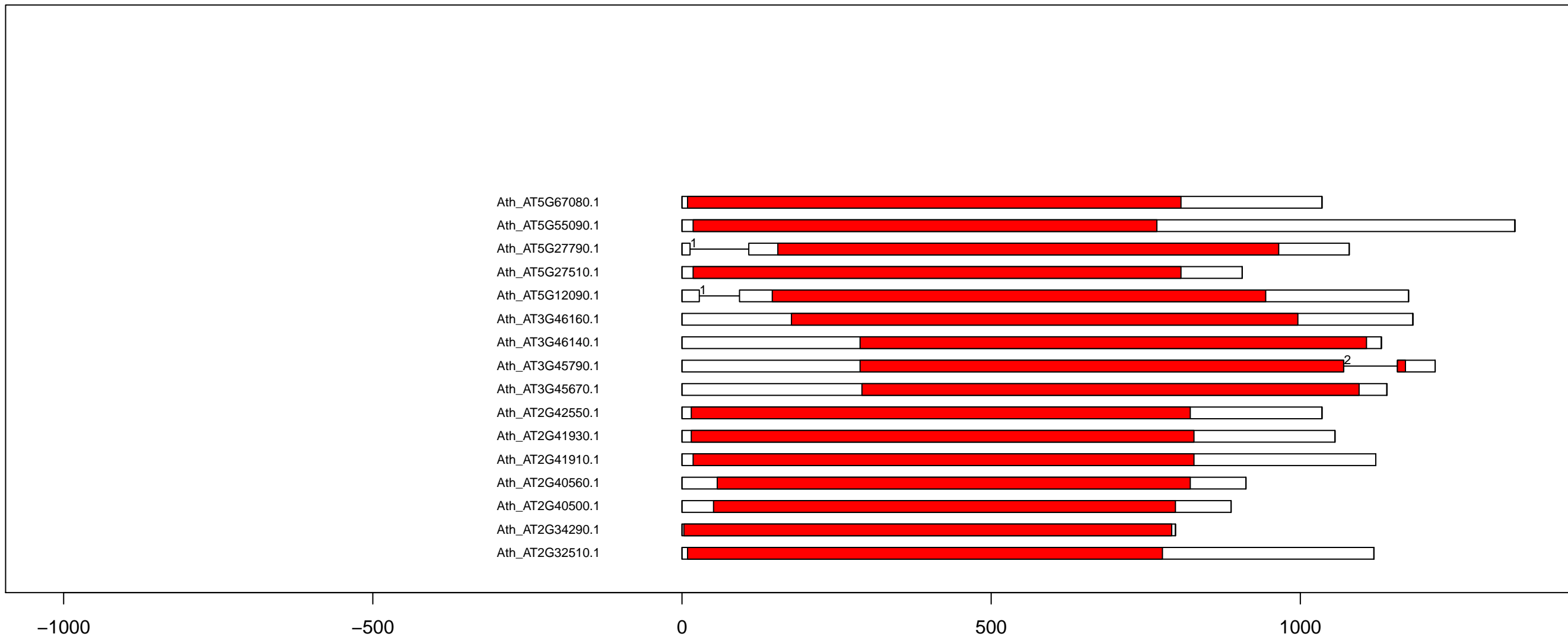

A.th STE_STE20-Fray exon-intron and kinase domain diagram (all)

Ath_AT4G14480.1

Ath_AT1G23700.1

Ath_AT5G14720.1

Ath_AT4G24100.1

Ath_AT4G10730.1

Ath_AT1G79640.1

Ath_AT1G70430.1

-1000

0

1000

2000

3000

4000

5000

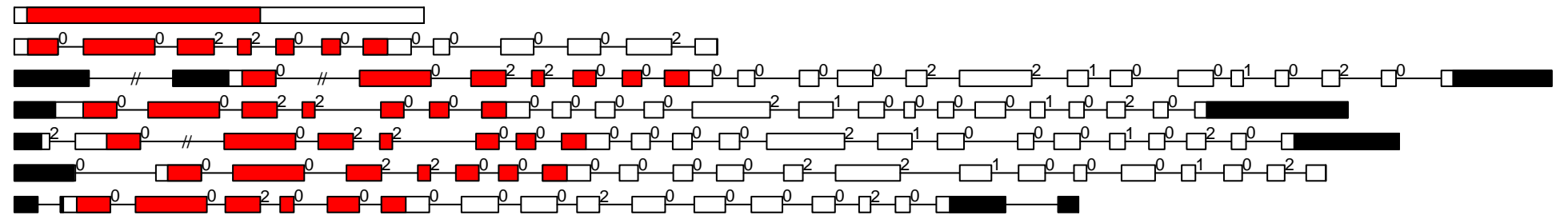

A.th STE_STE20-PI exon-intron and kinase domain diagram (all)

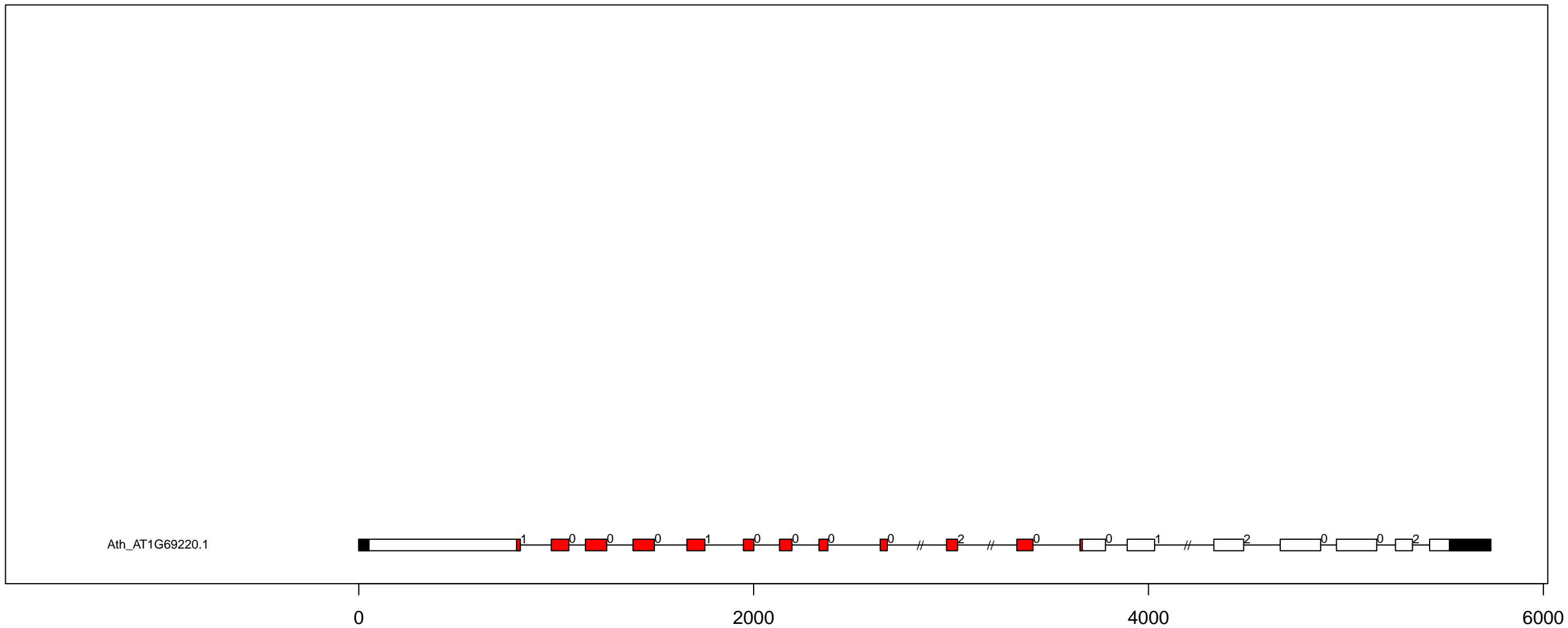

A.th STE_STE20-YSK exon-intron and kinase domain diagram (all)

Ath_AT3G15220.1

Ath_AT1G53165.3

-1000

0

1000

2000

3000

4000

5000

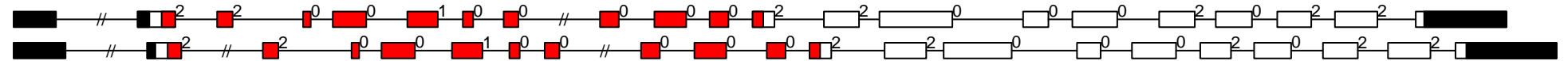

A.th STE_STE7 exon-intron and kinase domain diagram (all)

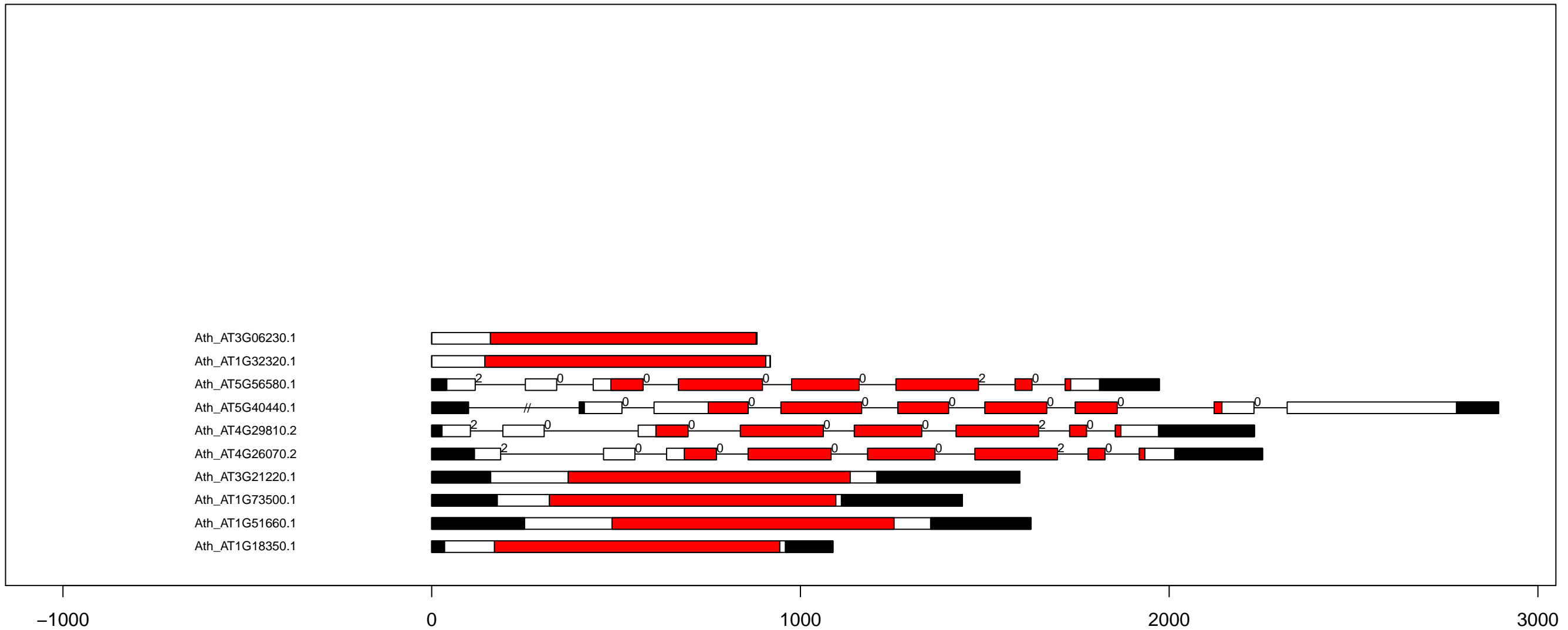

A.th STE_STE-PI exon-intron and kinase domain diagram (all)

Ath_AT3G13530.1

Ath_AT3G07980.1

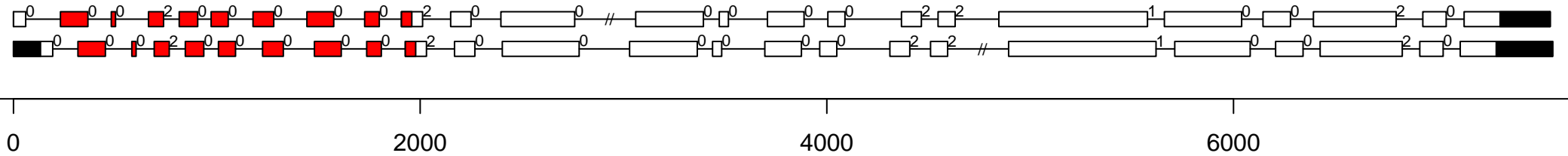

A.th TKL_CTRL-DRK-1 exon-intron and kinase domain diagram (all)

Ath_AT3G58640.1
Ath_AT2G42640.1
Ath_AT2G31010.1

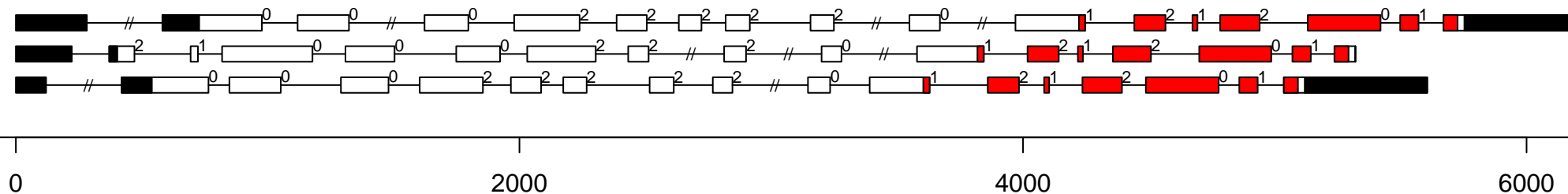

A.th TKL_CTR1-DRK-2 exon-intron and kinase domain diagram (all)

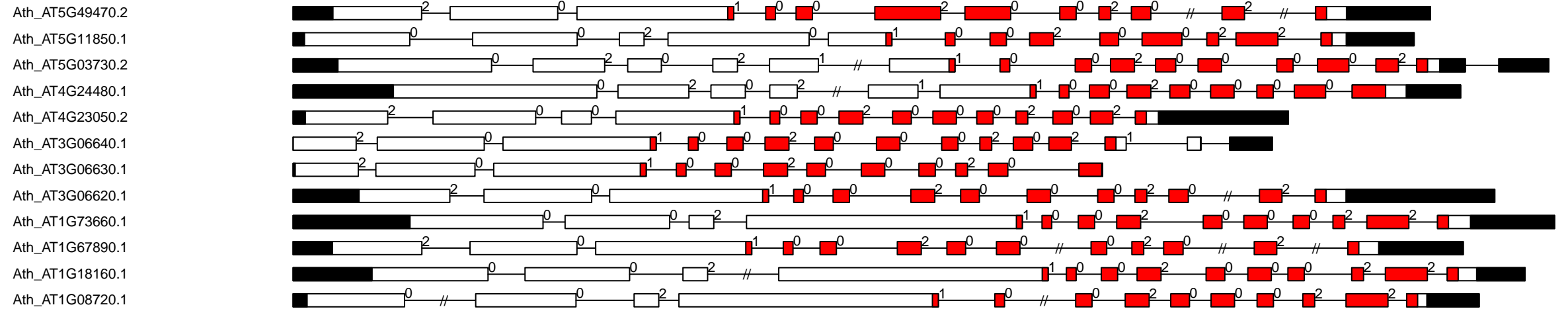

-1000

0

1000

2000

3000

4000

5000

A.th TKL_Gdt exon-intron and kinase domain diagram (all)

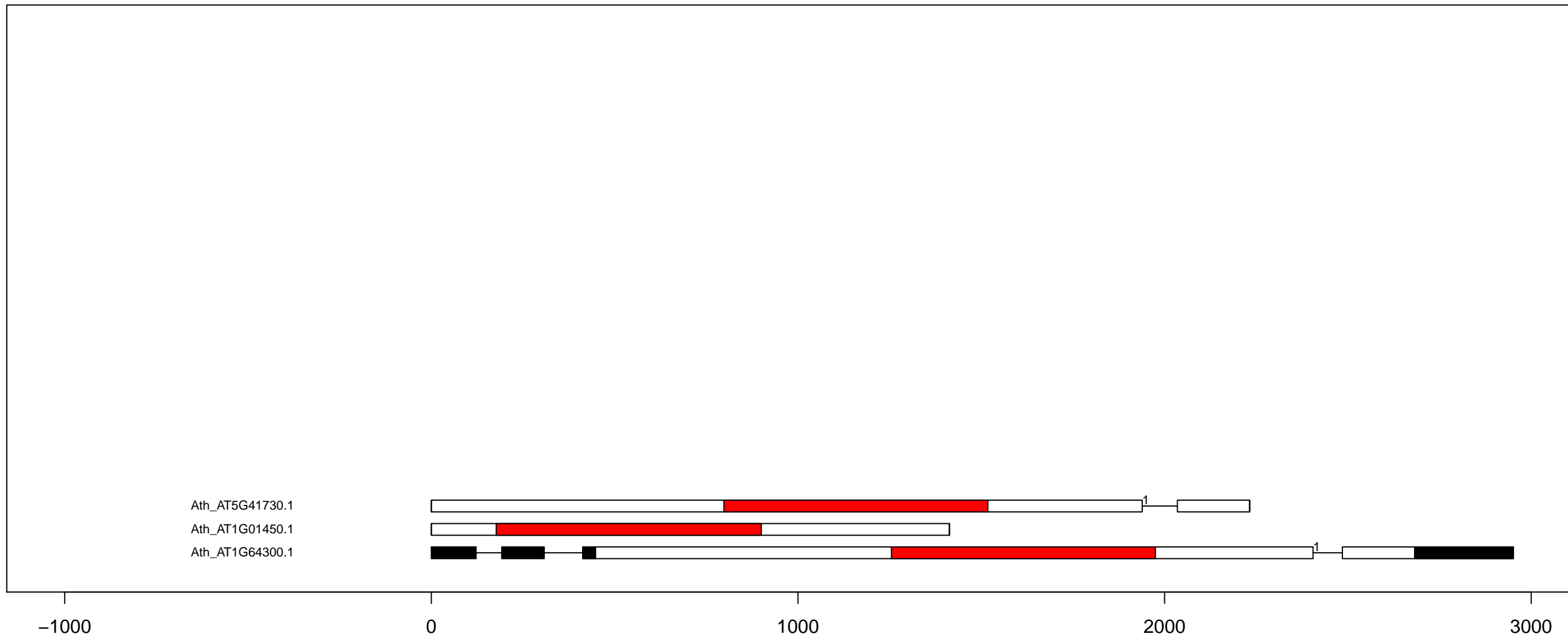

A.th TKL-PI-1 exon-intron and kinase domain diagram (all)

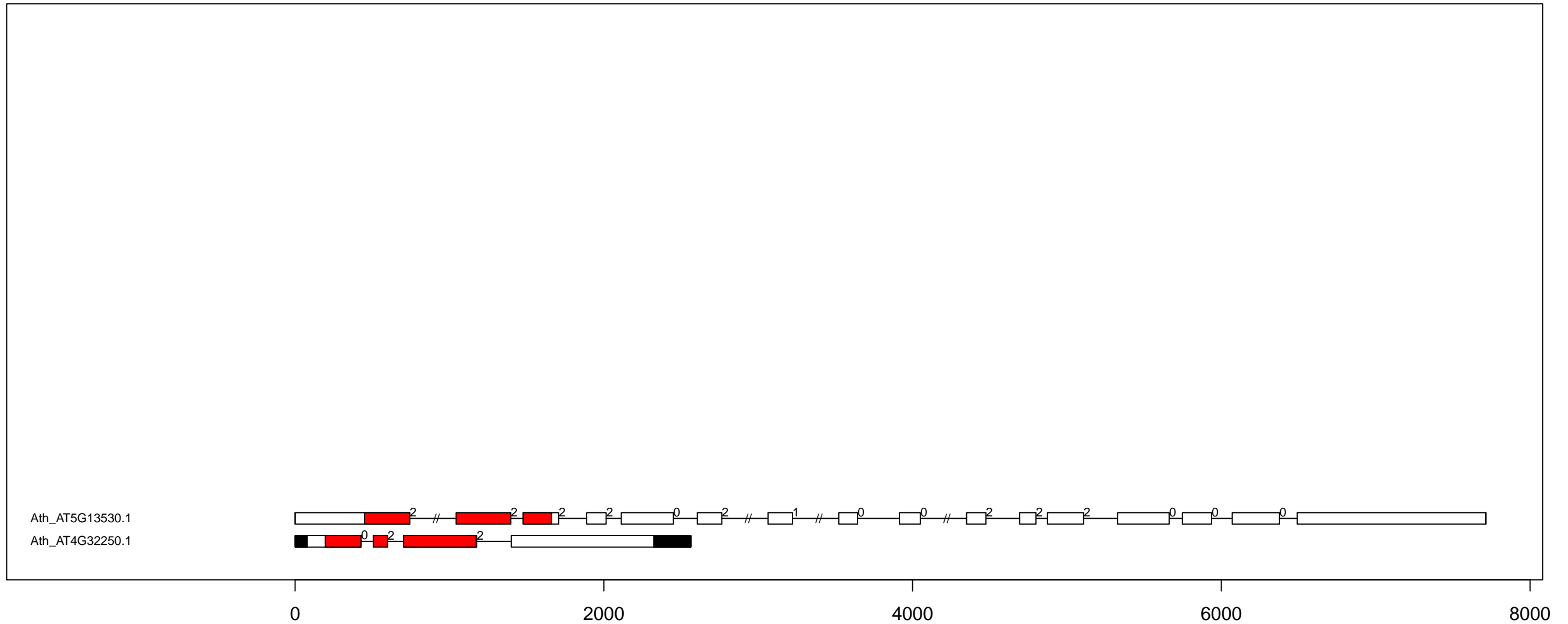

A.th TKL-PI-2 exon-intron and kinase domain diagram (all)

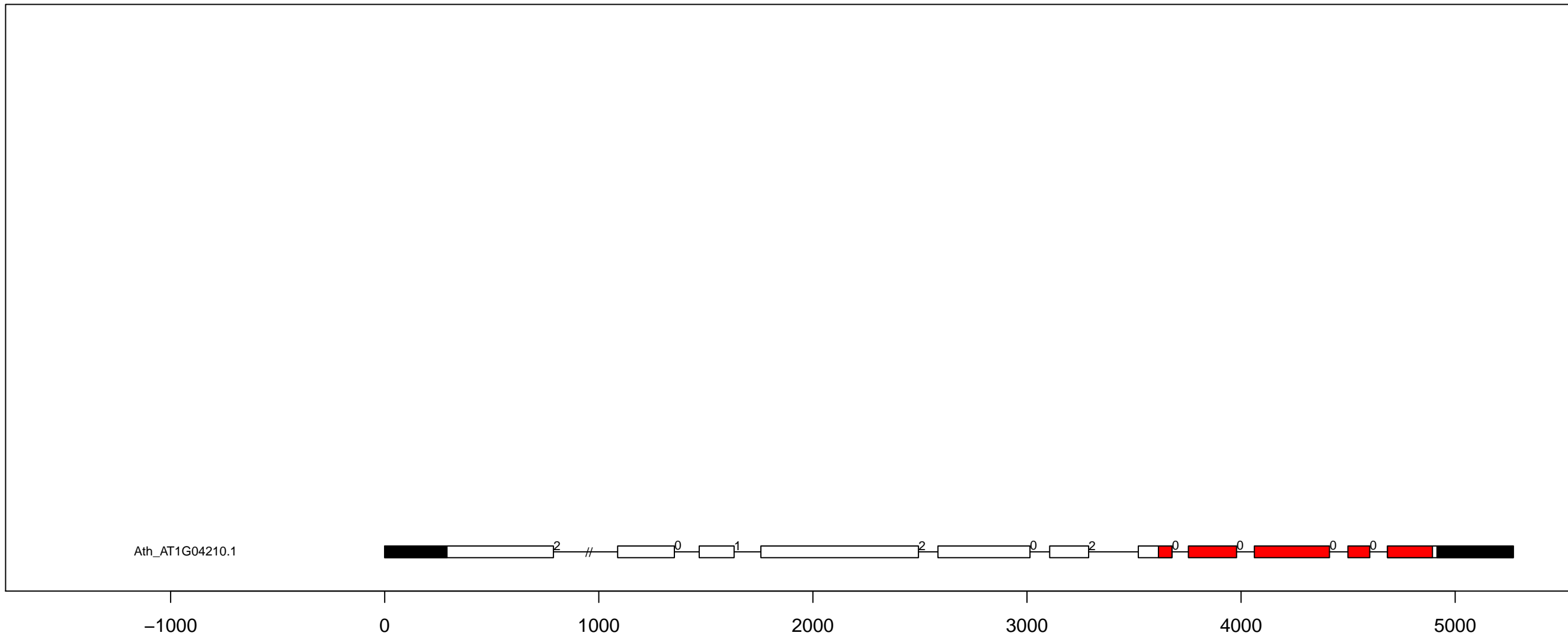

A.th TKL-PI-3 exon-intron and kinase domain diagram (all)

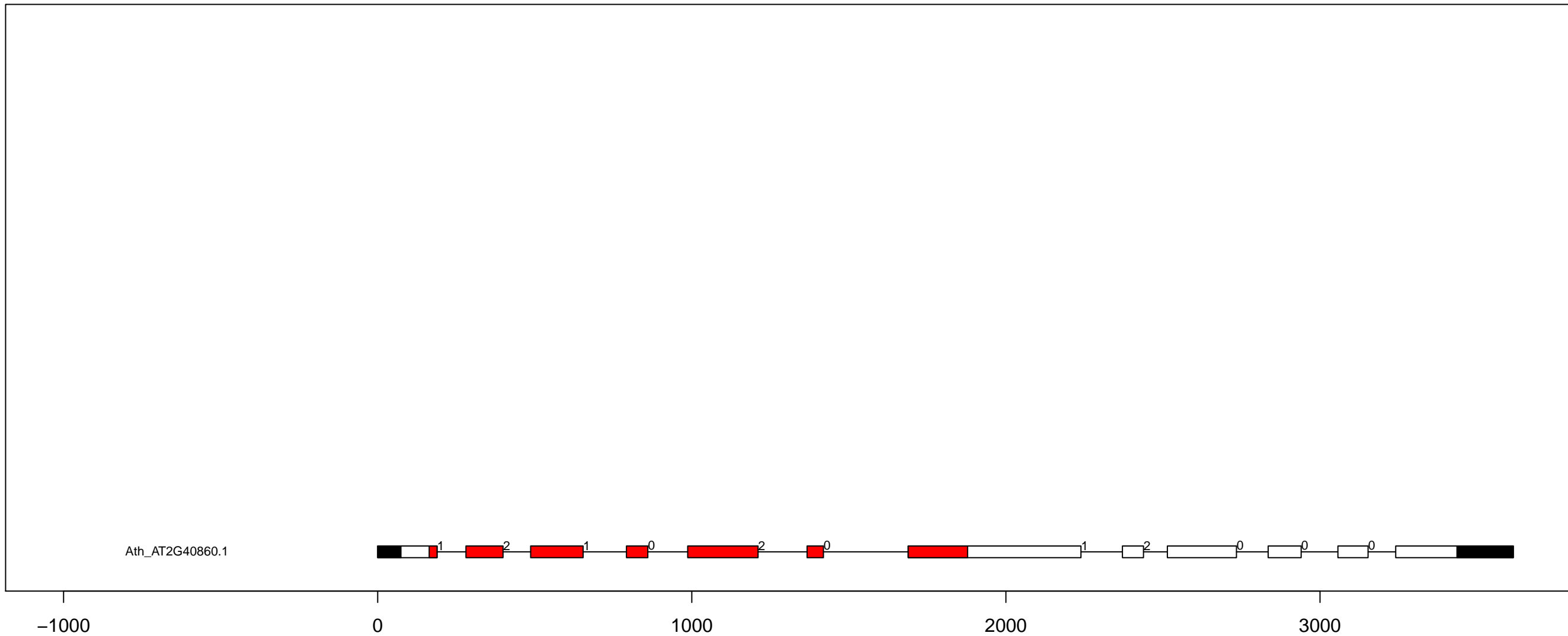

A.th TKL-PI-4 exon-intron and kinase domain diagram (all)

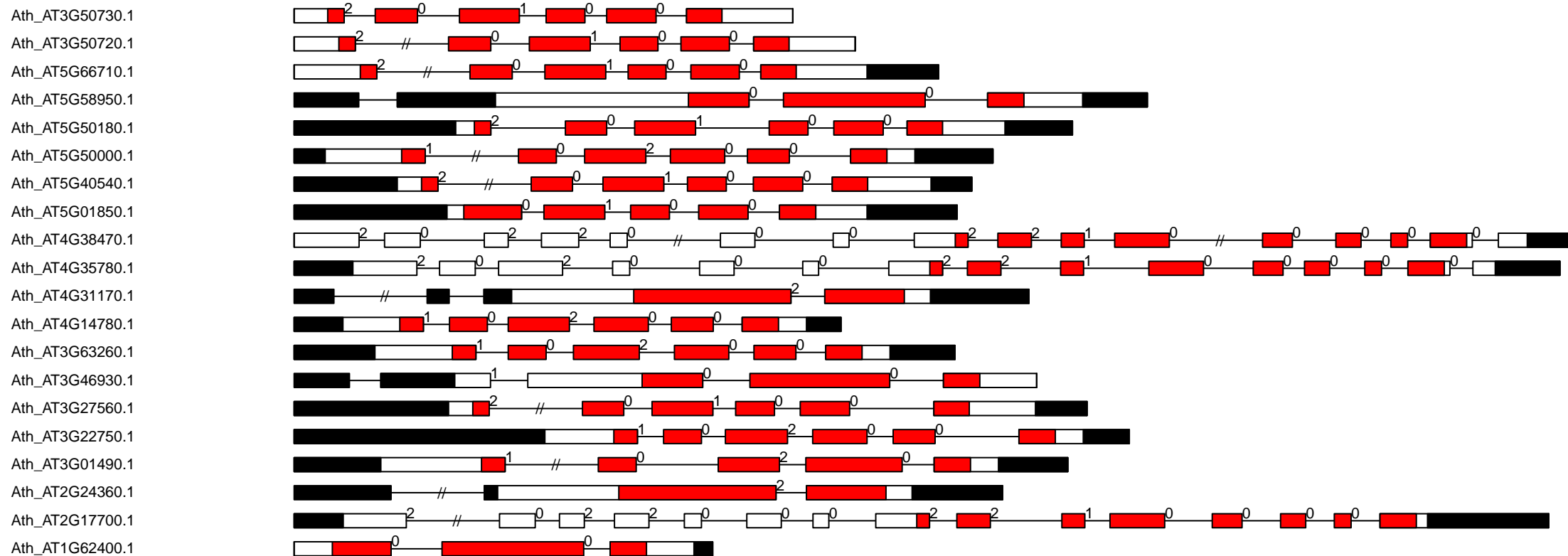

A.th TKL-PI-5 exon-intron and kinase domain diagram (all)

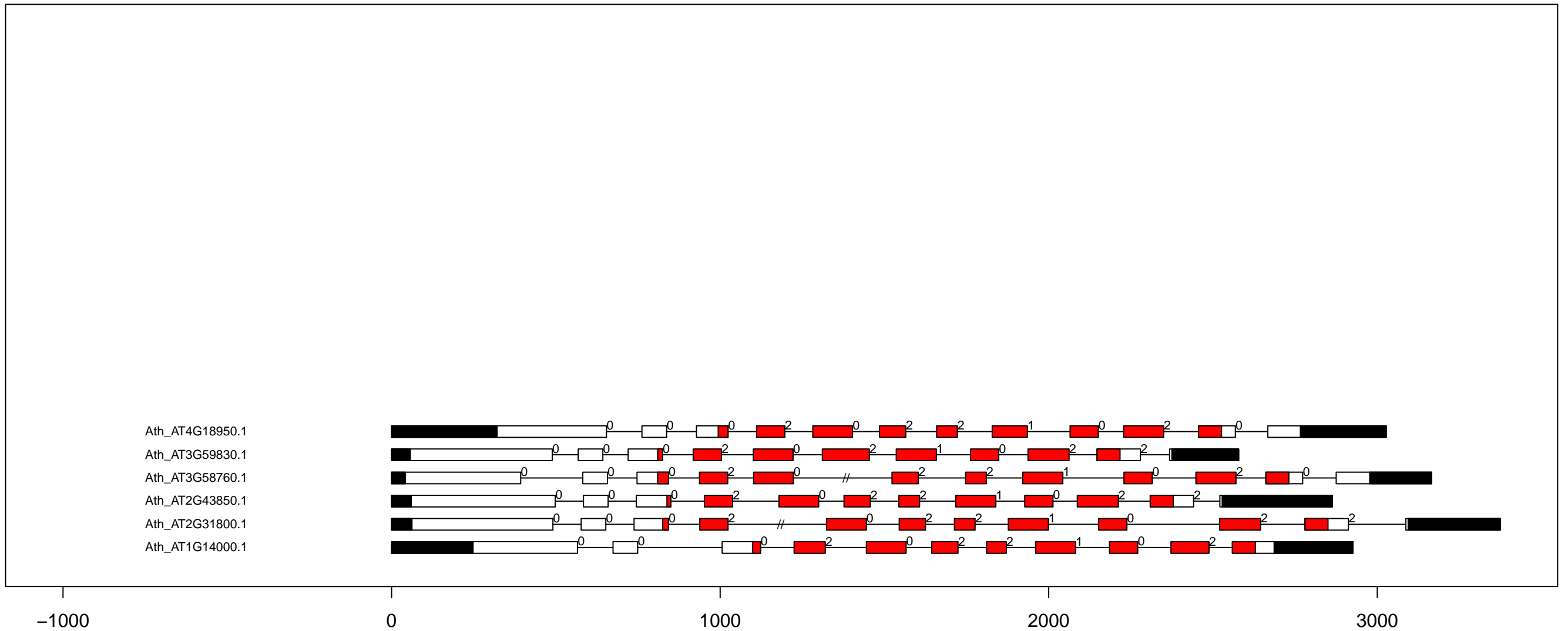

A.th TKL-PI-6 exon-intron and kinase domain diagram (all)

Ath_AT3G46920.1
 Ath_AT3G24715.1
 Ath_AT5G57610.1
 Ath_AT2G35050.1
 Ath_AT1G79570.1
 Ath_AT1G16270.1
 Ath_AT1G04700.1

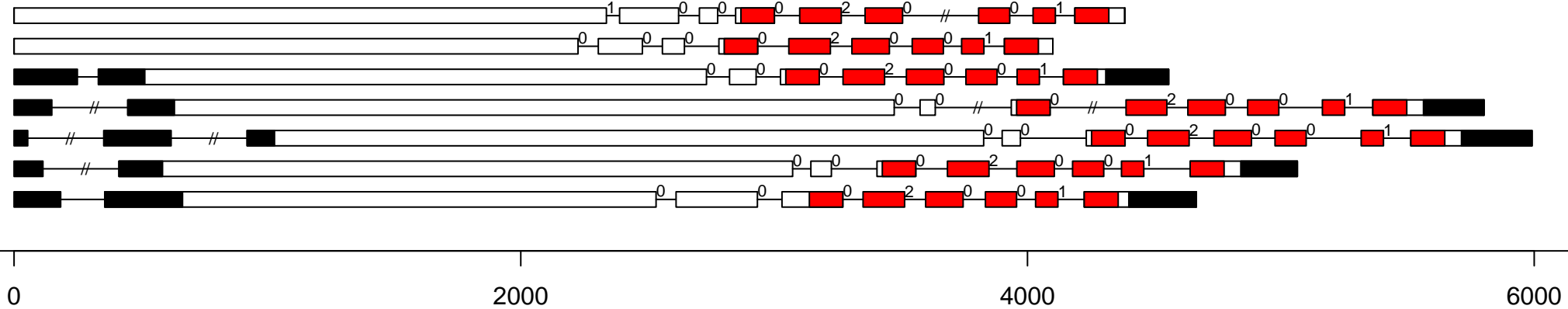

A.th TKL-PI-7 exon-intron and kinase domain diagram (all)

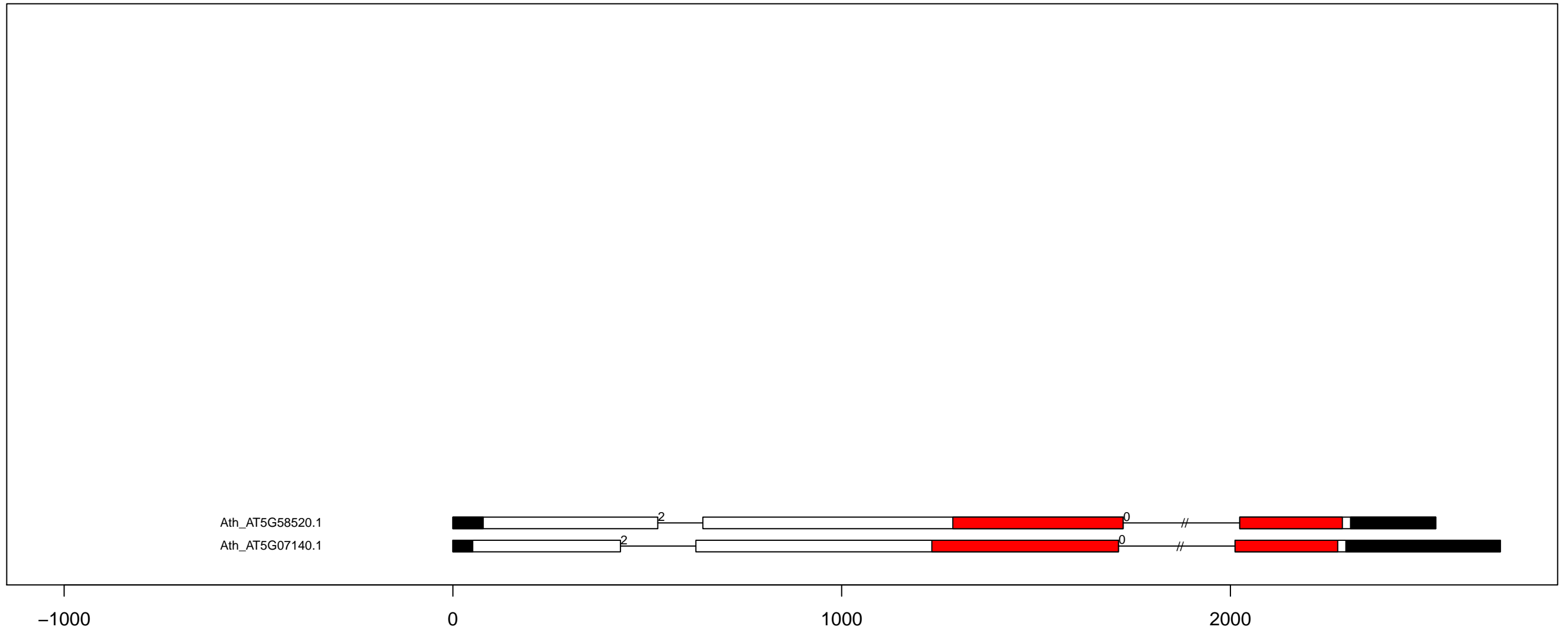

A.th TLK exon-intron and kinase domain diagram (all)

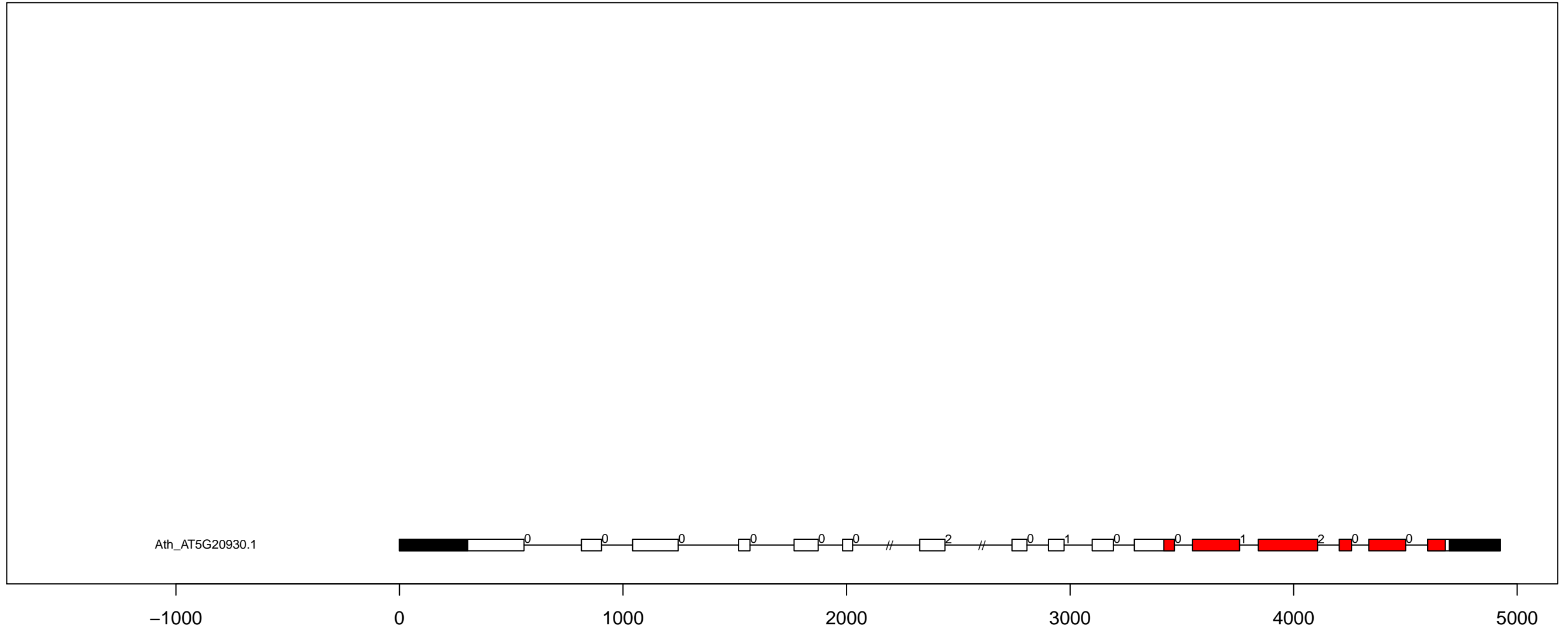

A.th TTK exon-intron and kinase domain diagram (all)

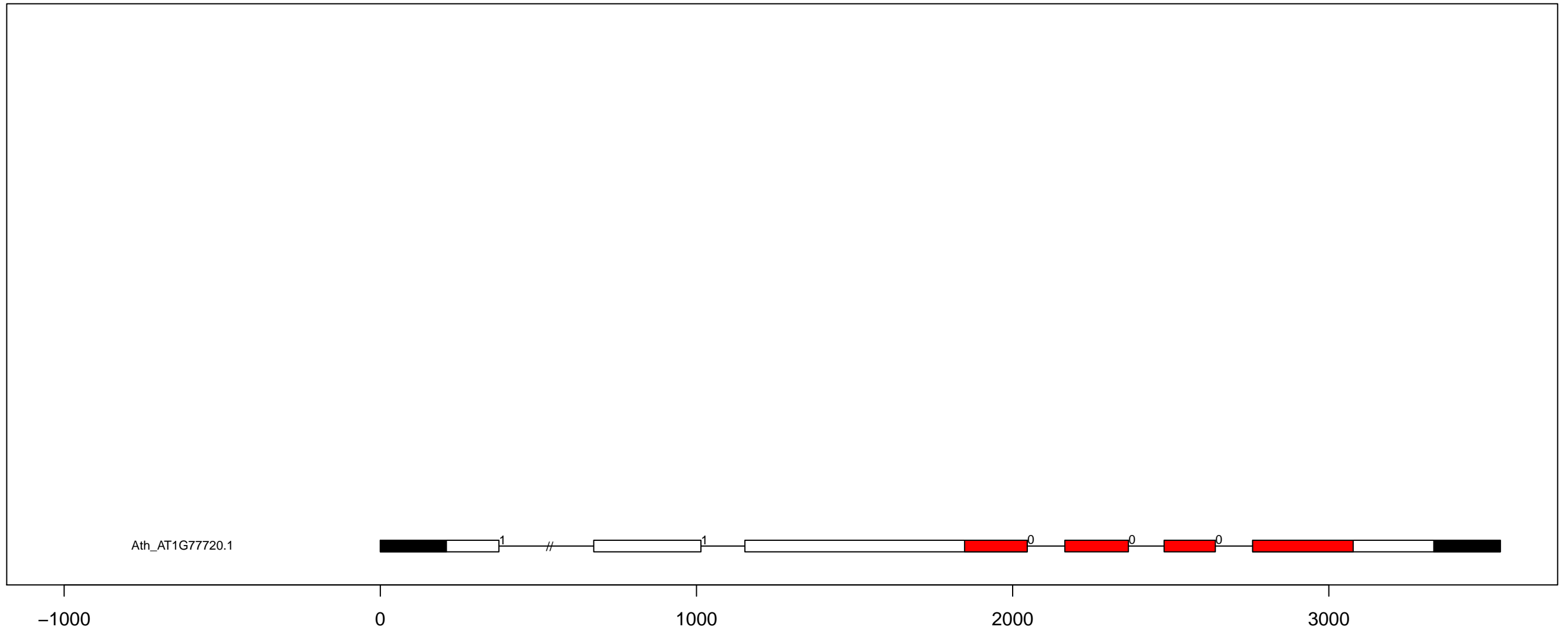

A.th ULK_Fused exon-intron and kinase domain diagram (all)

Ath_AT1G50240.2

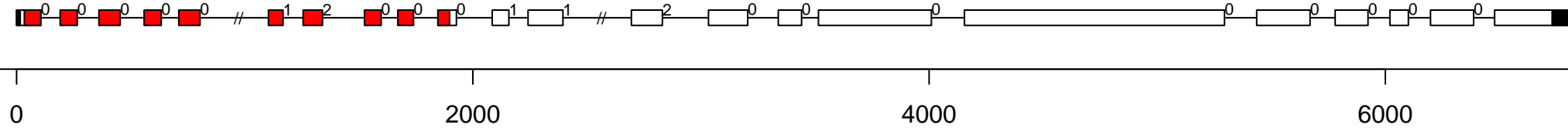

A.th ULK_ULK4 exon-intron and kinase domain diagram (all)

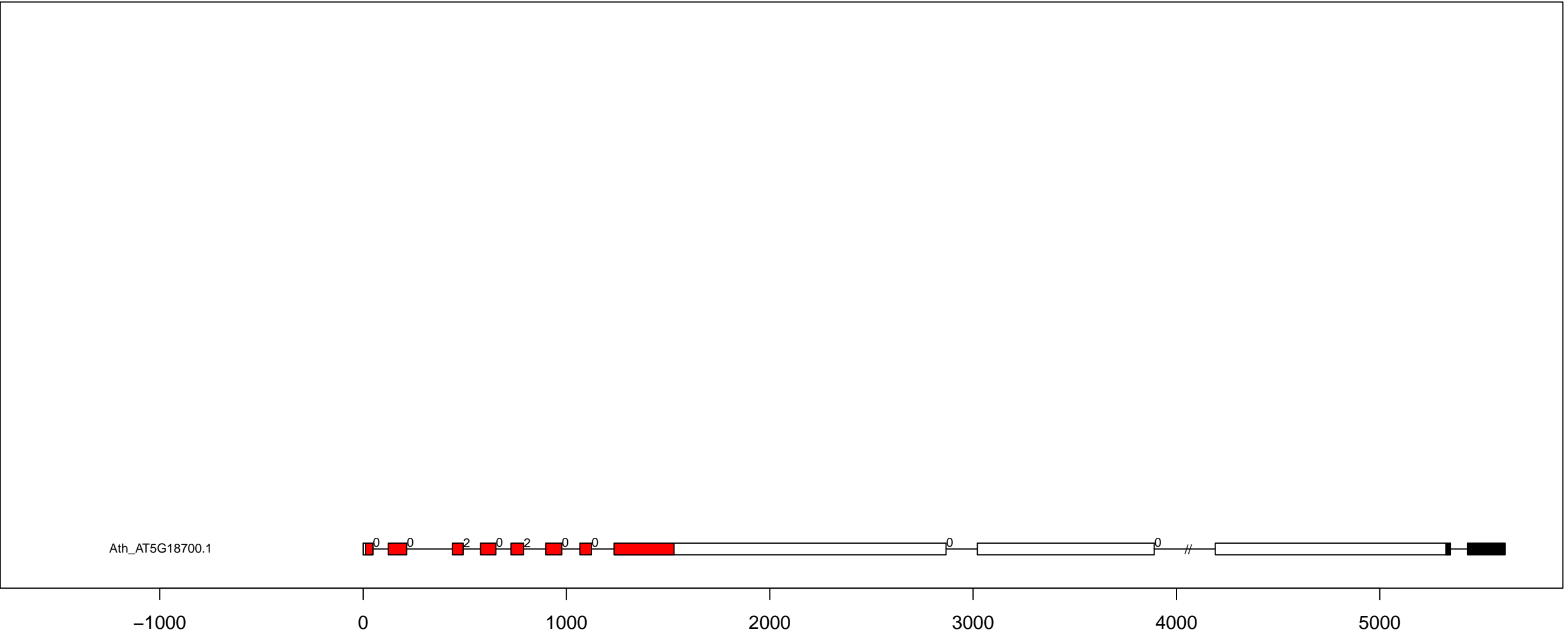

A.th WEE exon-intron and kinase domain diagram (all)

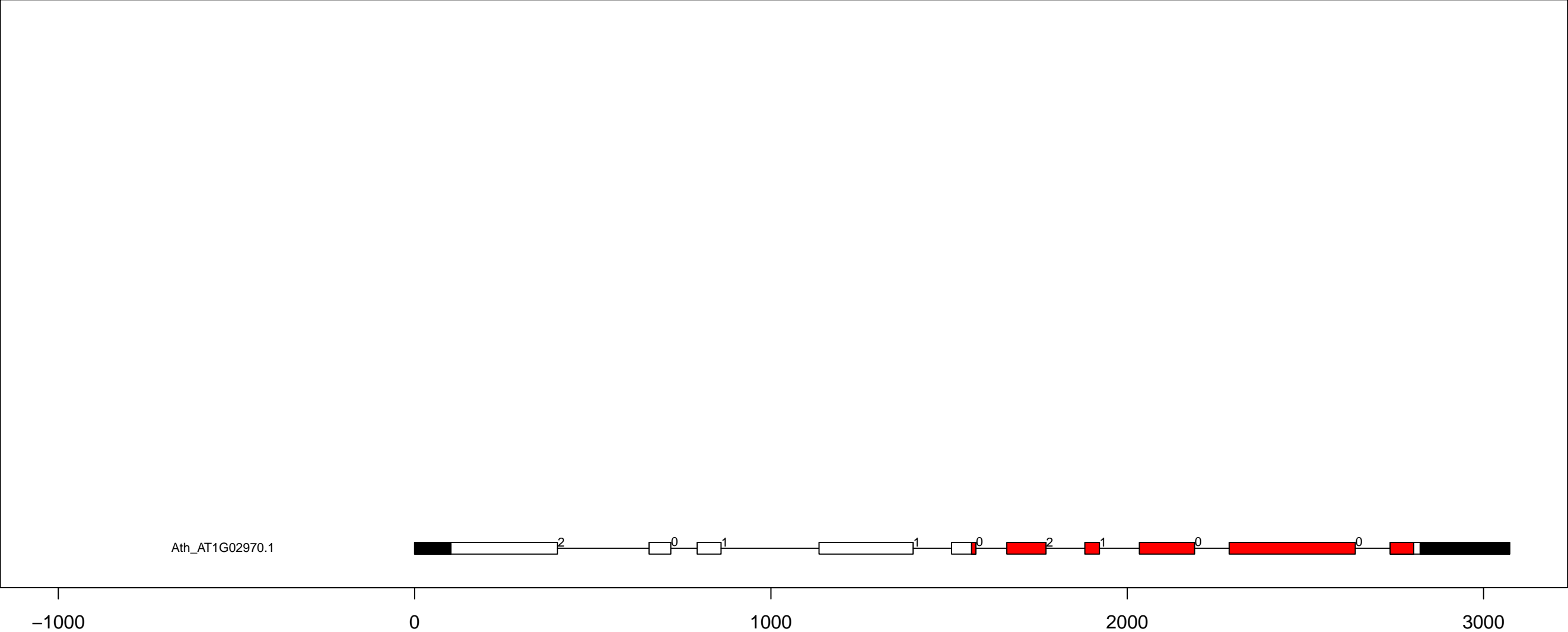

V.vi AGC_MAST exon-intron and domain diagram (all)

Vvi_GSVIVT01018574001

Vvi_GSVIVT01008473001

Vvi_GSVIVT01009685001

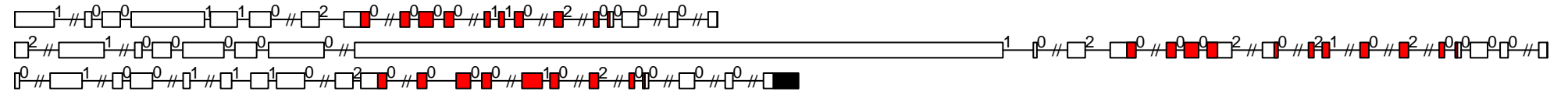

0

5000

10000

15000

V.vi AGC_NDR exon-intron and domain diagram (all)

Vvi_GSVIVT01035418001
Vvi_GSVIVT01028361001
Vvi_GSVIVT01027833001
Vvi_GSVIVT01021759001
Vvi_GSVIVT01015159001
Vvi_GSVIVT01009489001

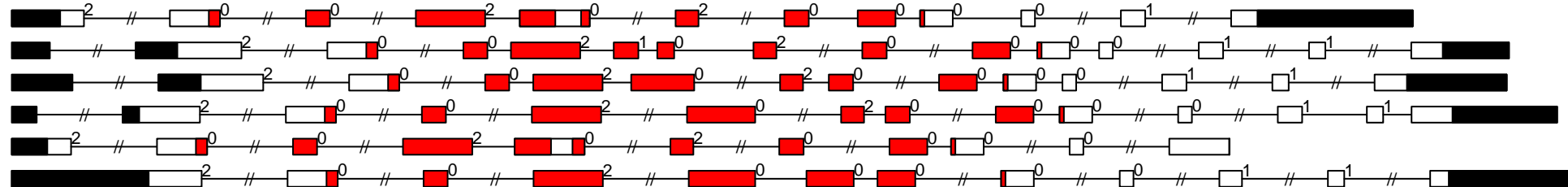

-1000

0

1000

2000

3000

4000

5000

V.vi AGC_PDK1 exon-intron and domain diagram (all)

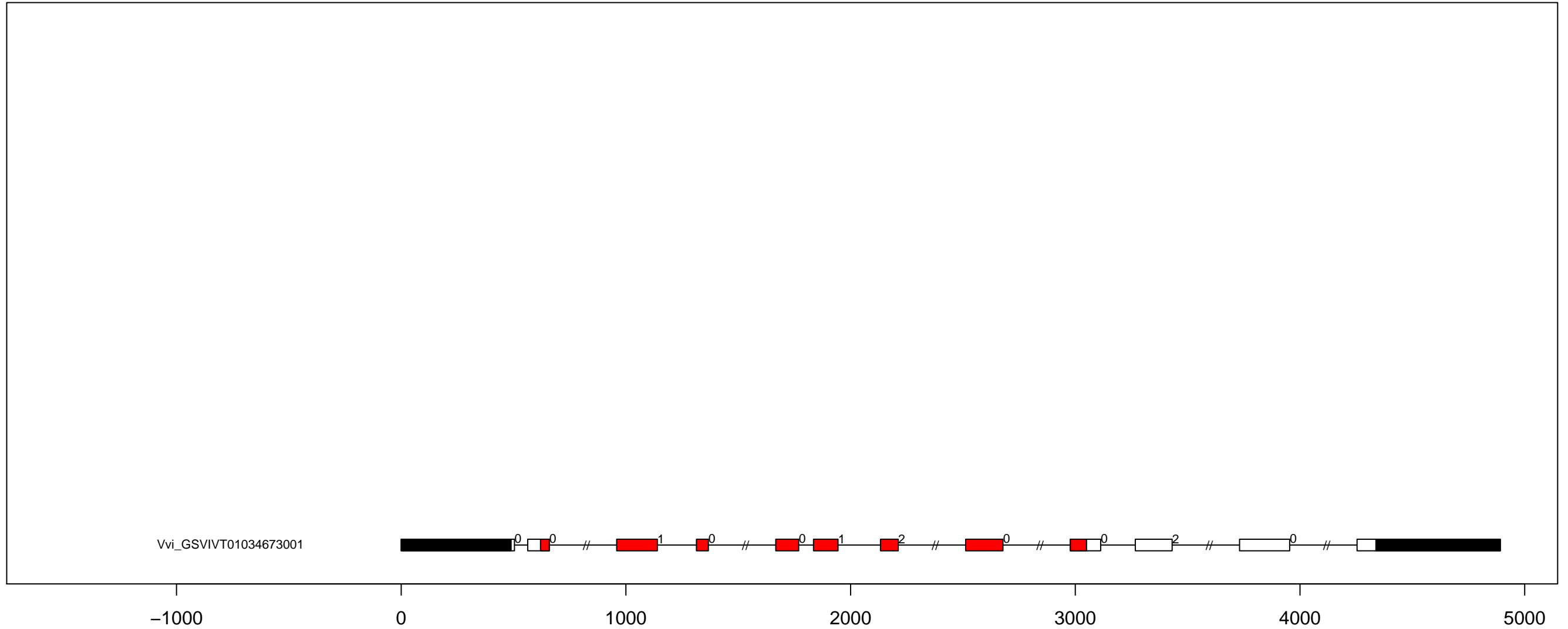

V.vi AGC_PKA-PKG exon-intron and domain diagram (all)

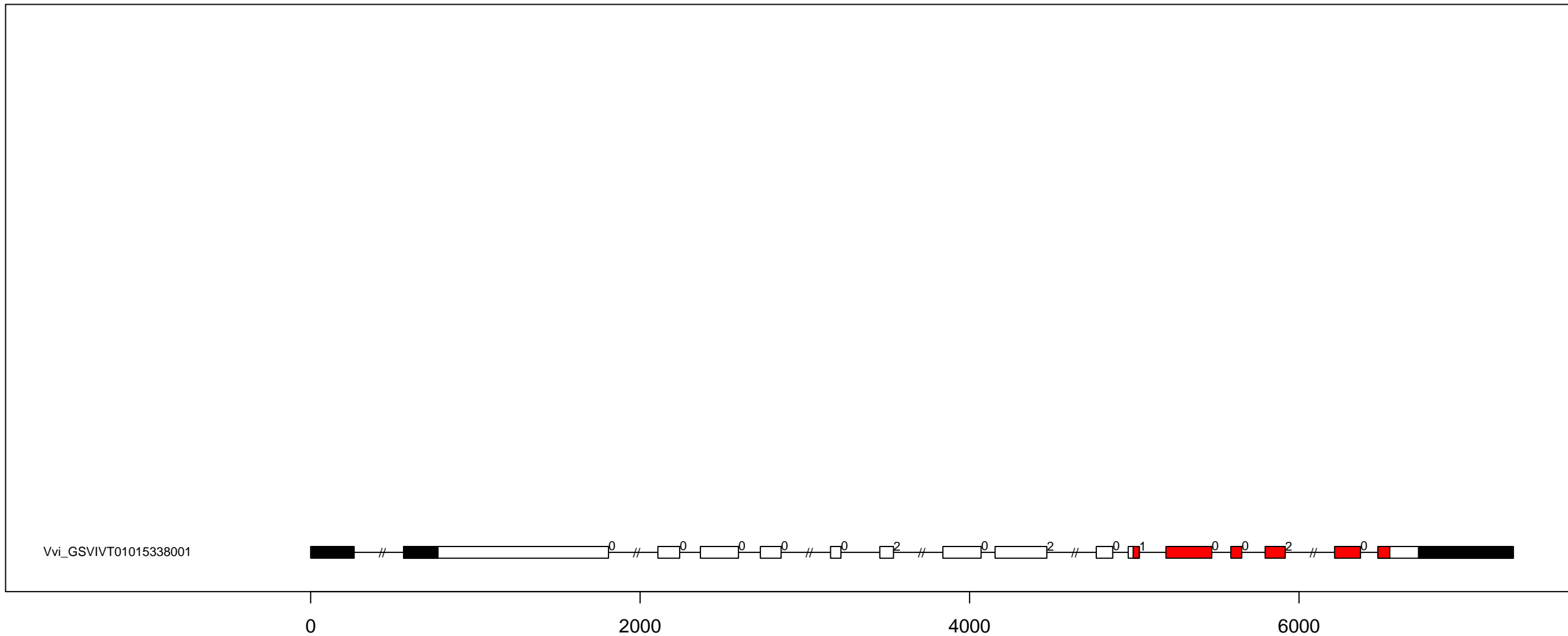

V.vi AGC_RSK-2 exon-intron and domain diagram (all)

Vvi_GSVIVT01036690001
 Vvi_GSVIVT01032561001
 Vvi_GSVIVT01025309001
 Vvi_GSVIVT01021582001
 Vvi_GSVIVT01020511001
 Vvi_GSVIVT01015496001
 Vvi_GSVIVT01034755001
 Vvi_GSVIVT01033816001
 Vvi_GSVIVT01032399001
 Vvi_GSVIVT01031372001
 Vvi_GSVIVT01031370001
 Vvi_GSVIVT01025082001
 Vvi_GSVIVT01023842001
 Vvi_GSVIVT01018278001
 Vvi_GSVIVT01002205001

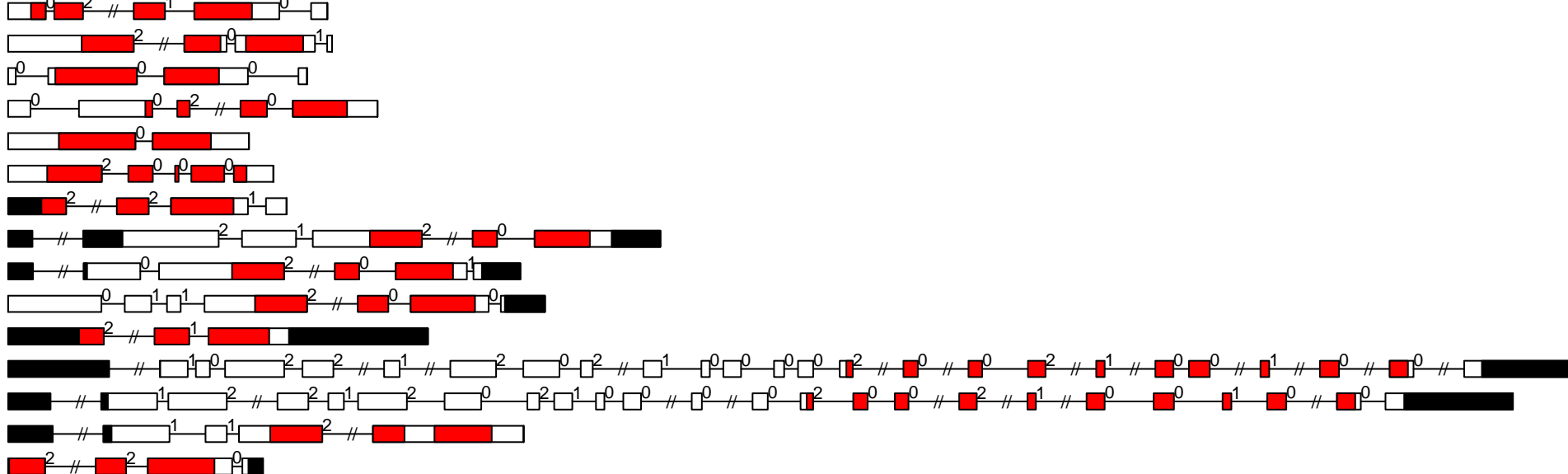

V.vi AGC-PI exon-intron and domain diagram (all)

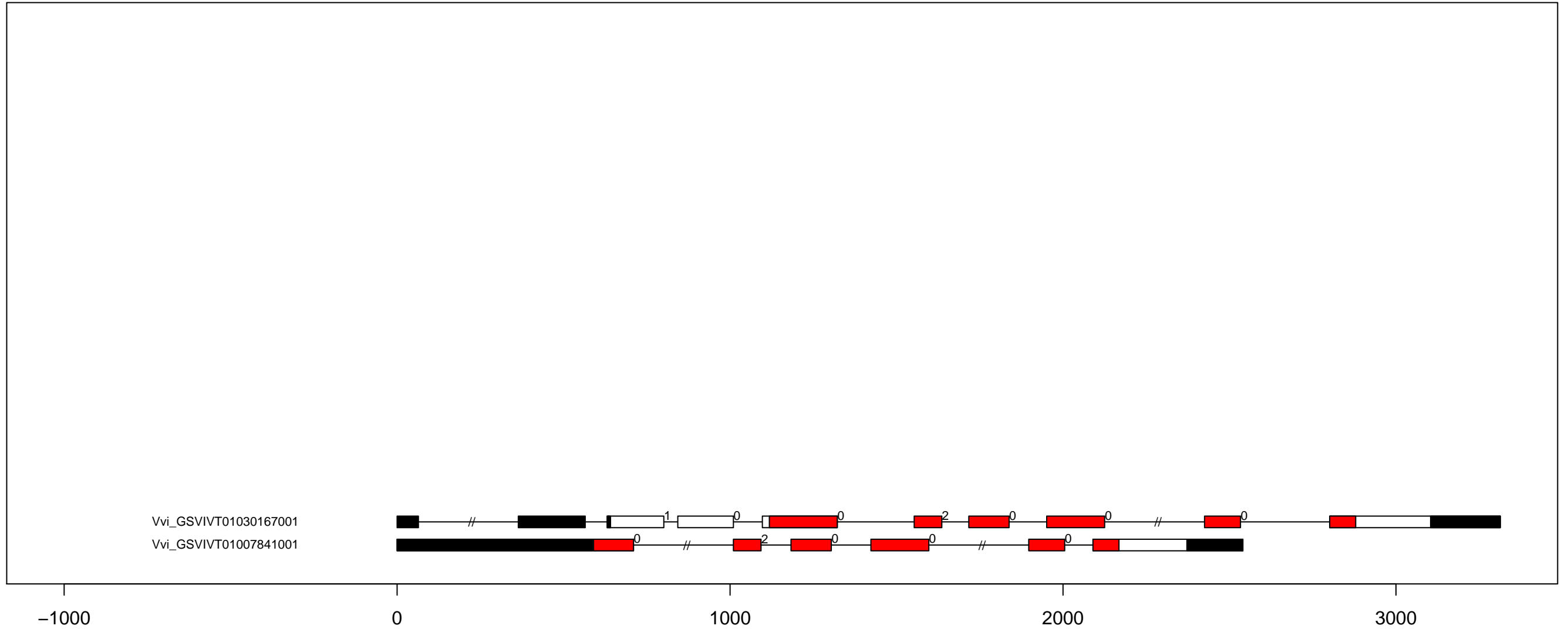

V.vi Aur exon-intron and domain diagram (all)

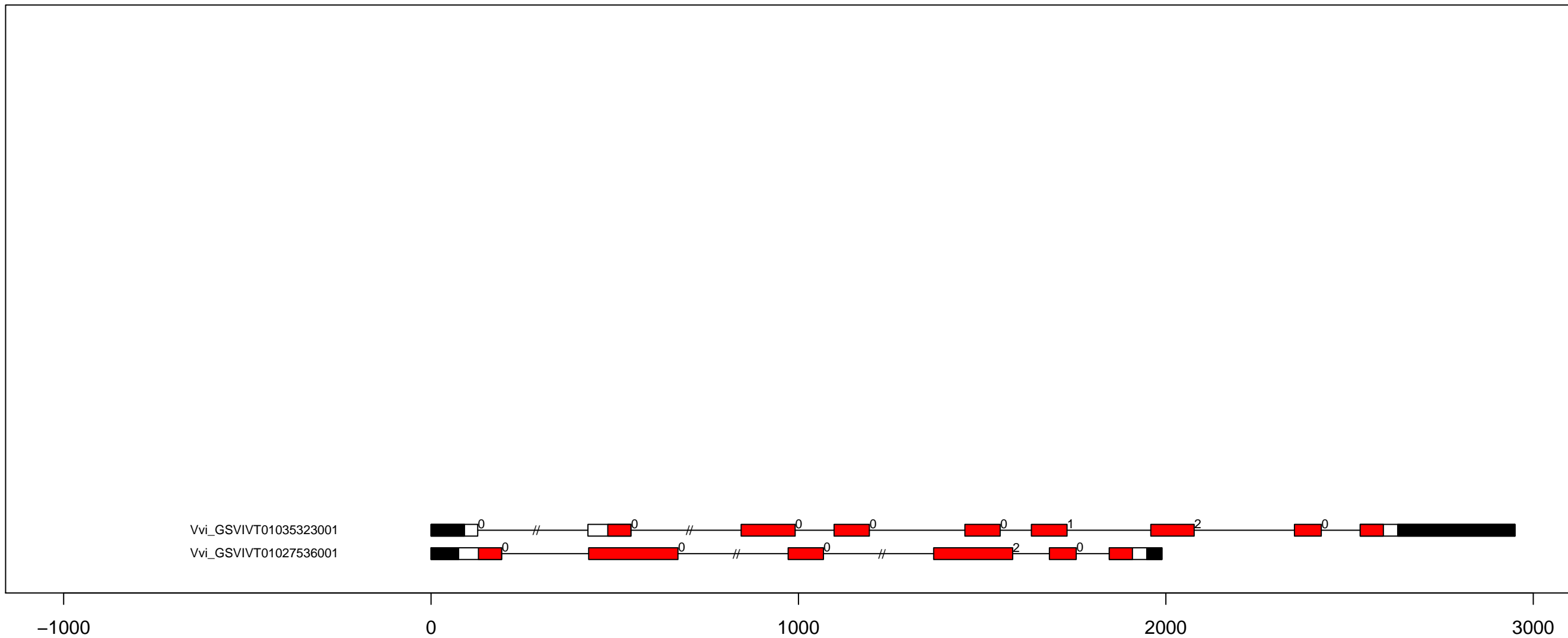

V.vi CAMK_AMPK exon-intron and domain diagram (all)

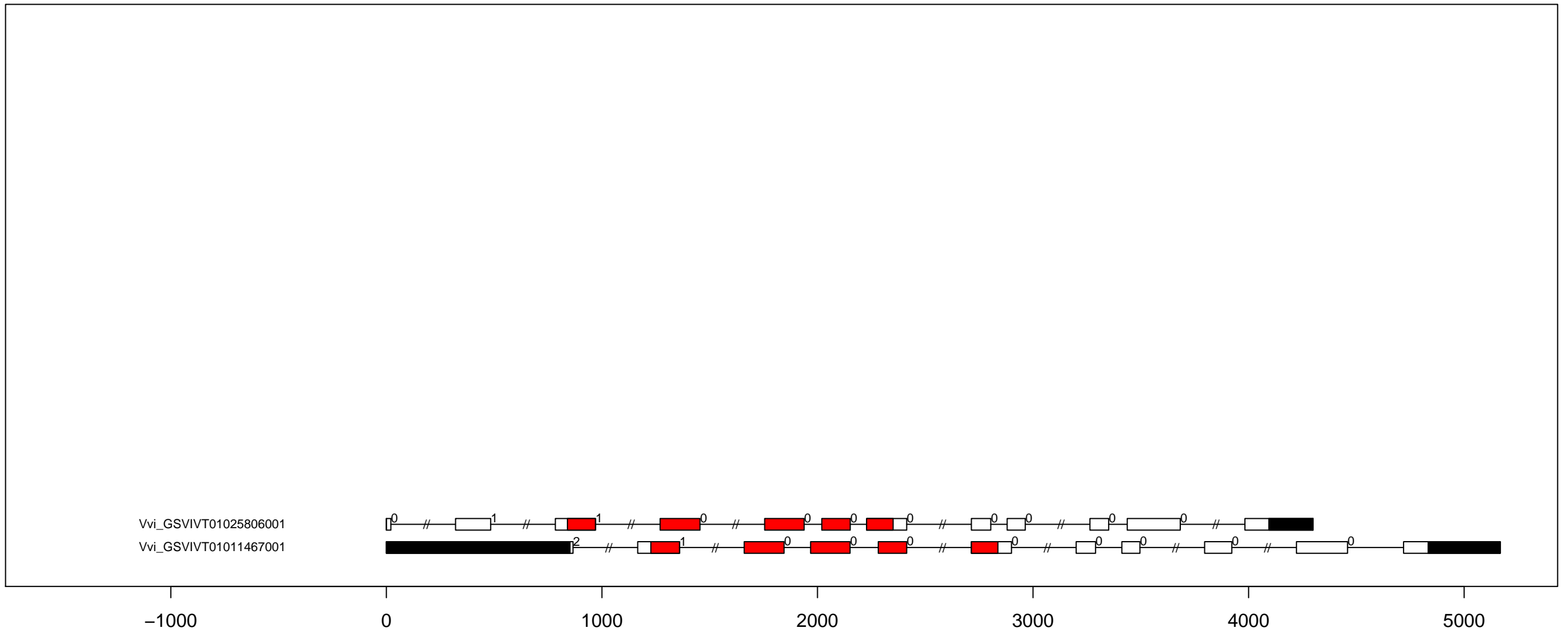

V.vi CAMK_CAMK1-DCAMKL exon-intron and domain diagram (all)

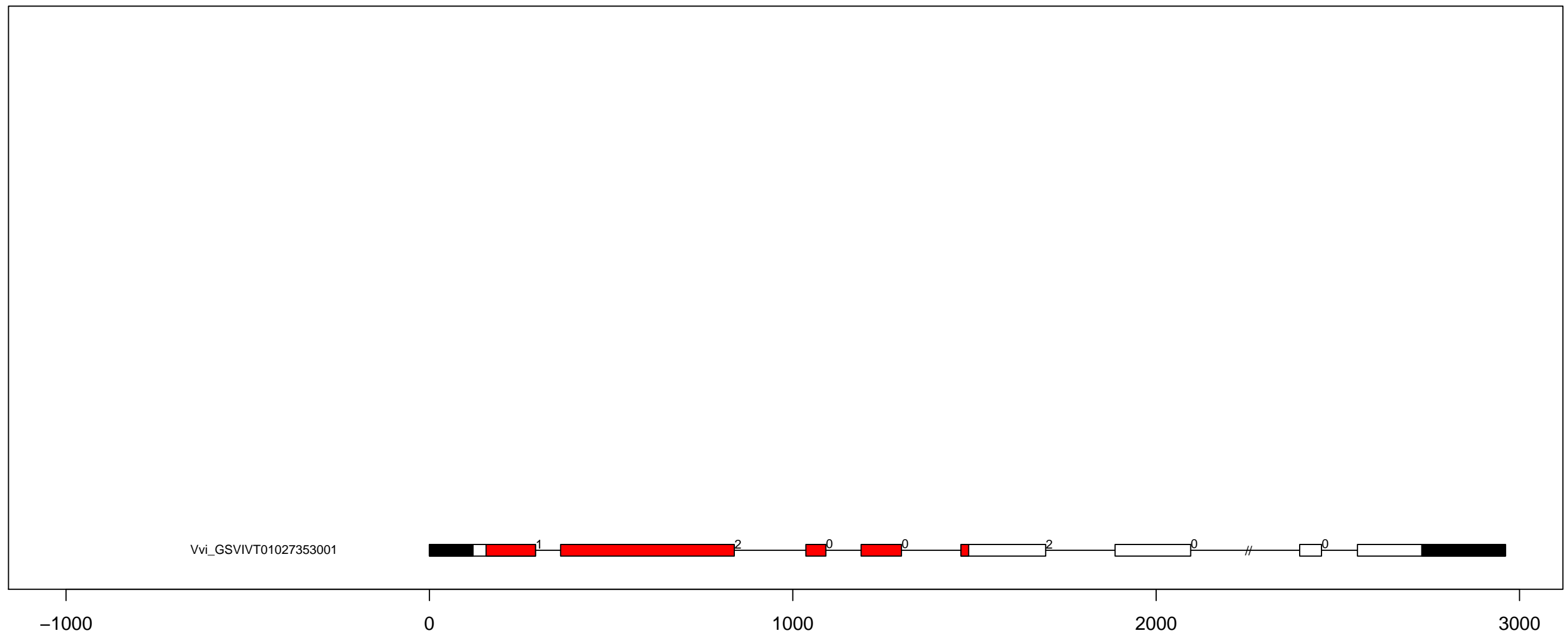

V.vi CAMK_CAMKL-CHK1 exon-intron and domain diagram (all)

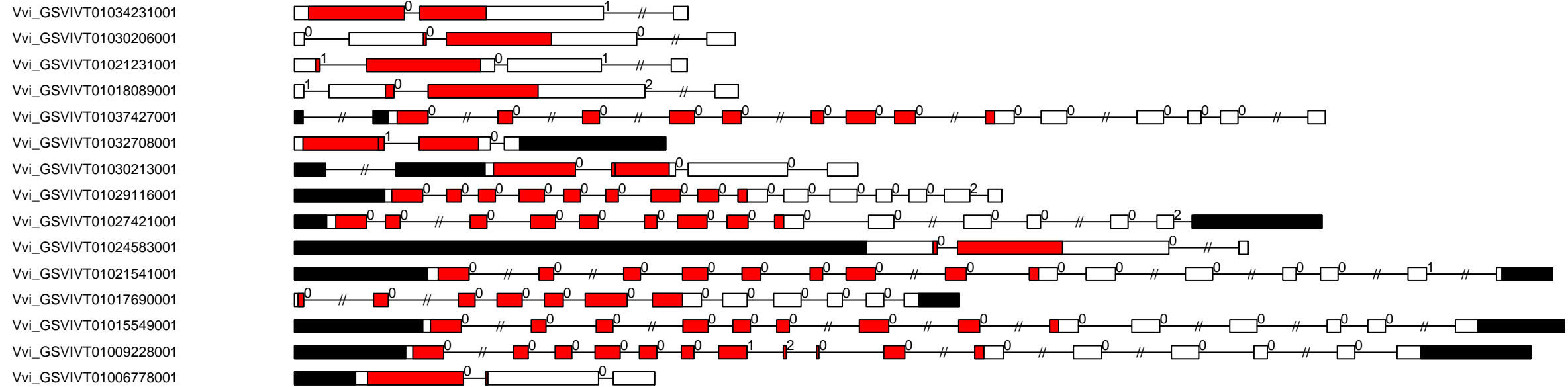

V.vi CAMK_CAMKL-LKB exon-intron and domain diagram (all)

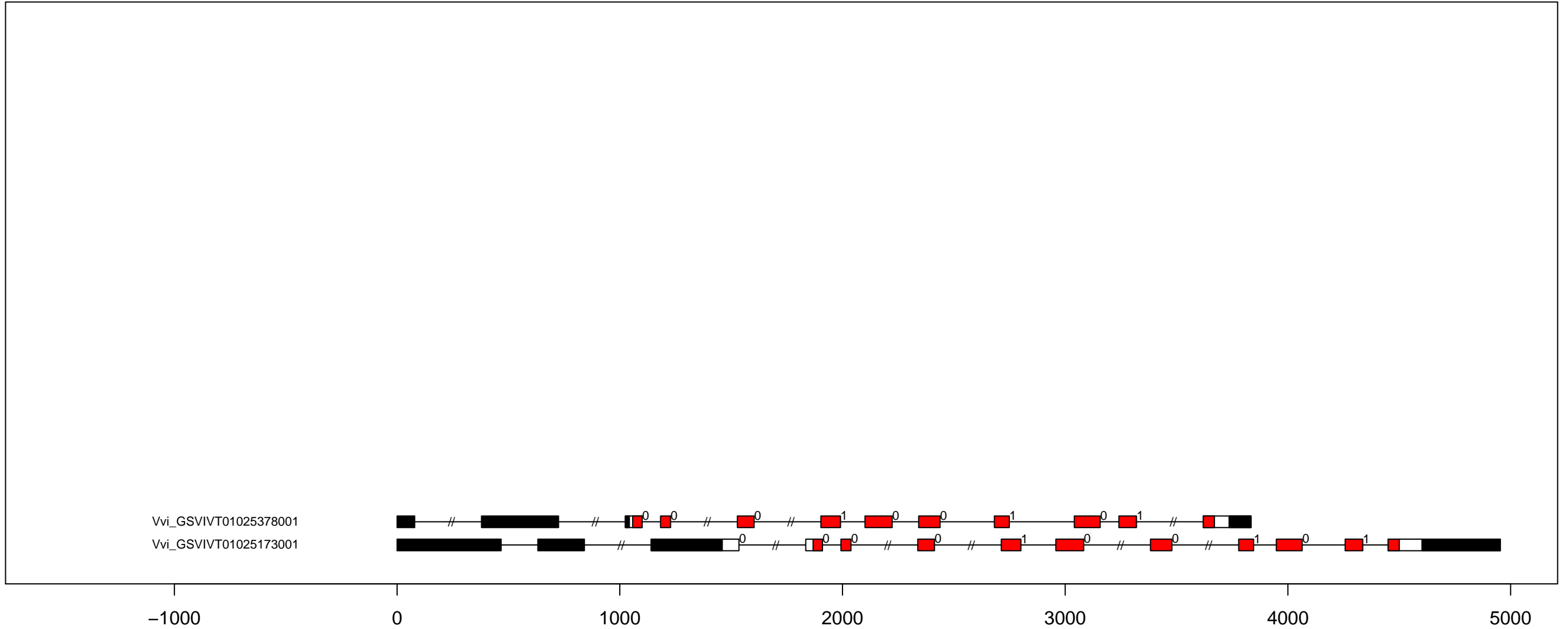

V.vi CAMK_CDPK exon-intron and domain diagram (part 1)

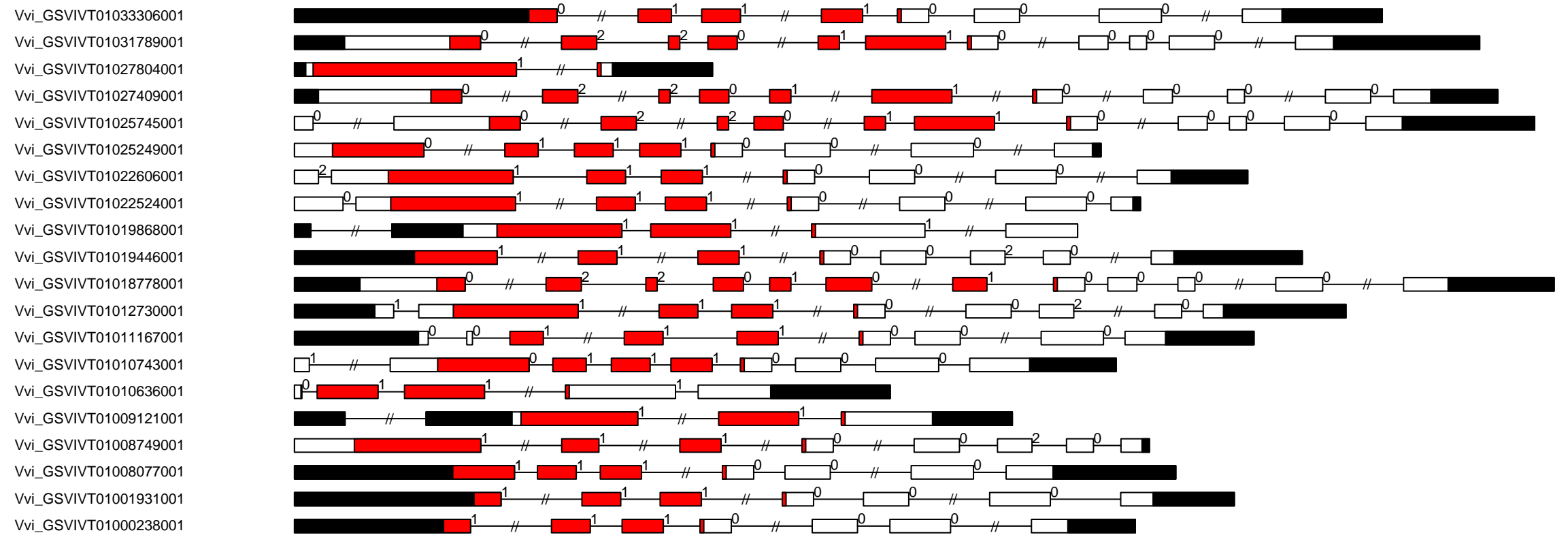

V.vi CAMK_OST1L exon-intron and domain diagram (all)

Vvi_GSVIVT01031806001
Vvi_GSVIVT01023339001
Vvi_GSVIVT01022427001
Vvi_GSVIVT01009074001
Vvi_GSVIVT01004839001
Vvi_GSVIVT01003554001
Vvi_GSVIVT01003419001
Vvi_GSVIVT01002389001

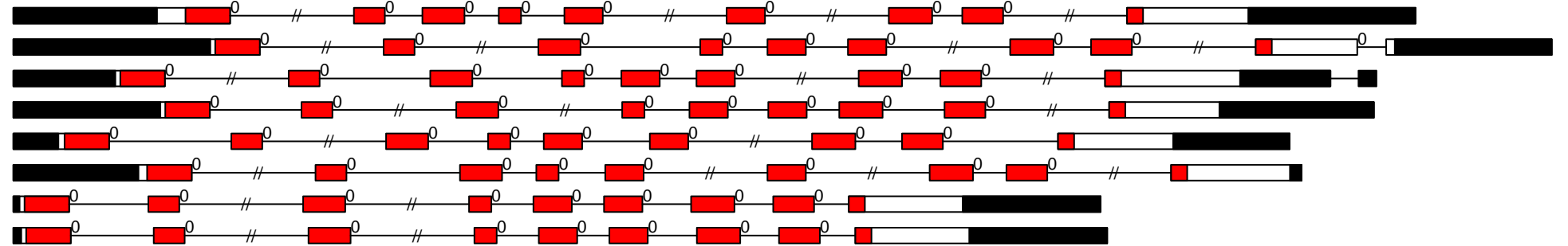

-1000

0

1000

2000

3000

V.vi CK1_CK1 exon-intron and domain diagram (all)

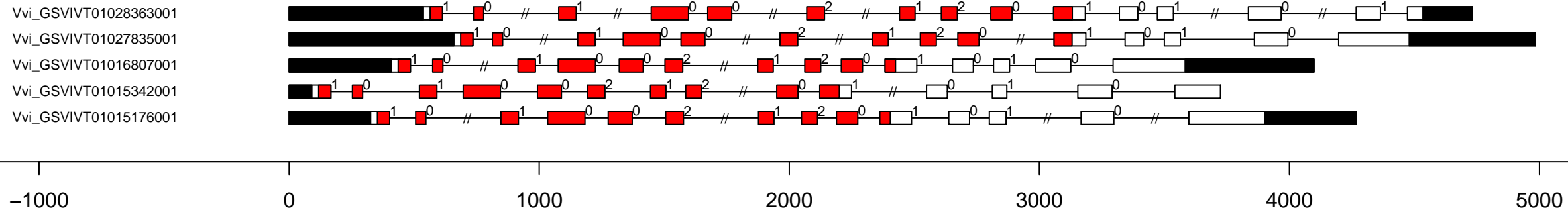

V.vi CK1-CK1-PI exon-intron and domain diagram (all)

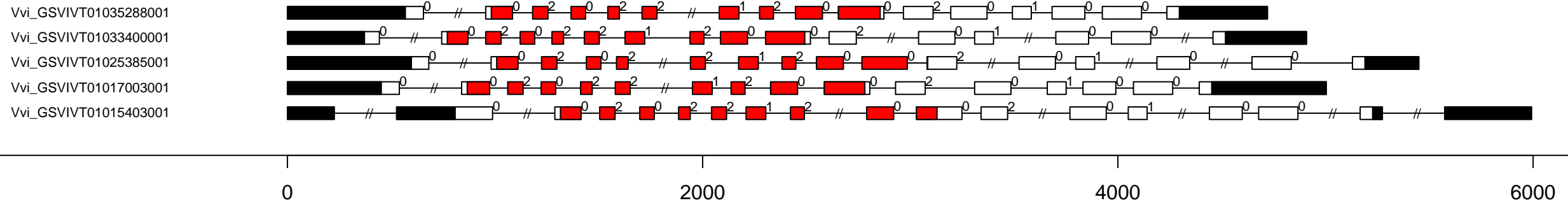

V.vi CMGC_CDK-CDK7 exon-intron and domain diagram (all)

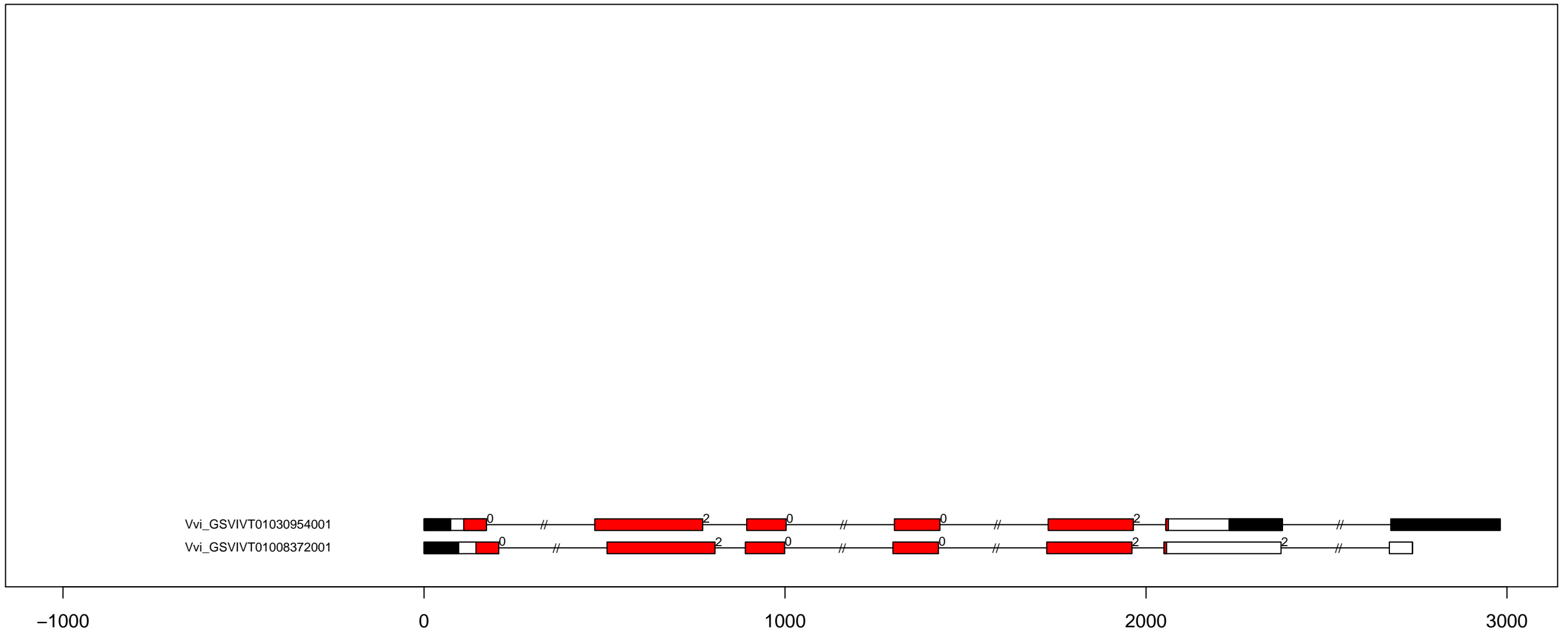

V.vi CMGC_CDK-CDK8 exon-intron and domain diagram (all)

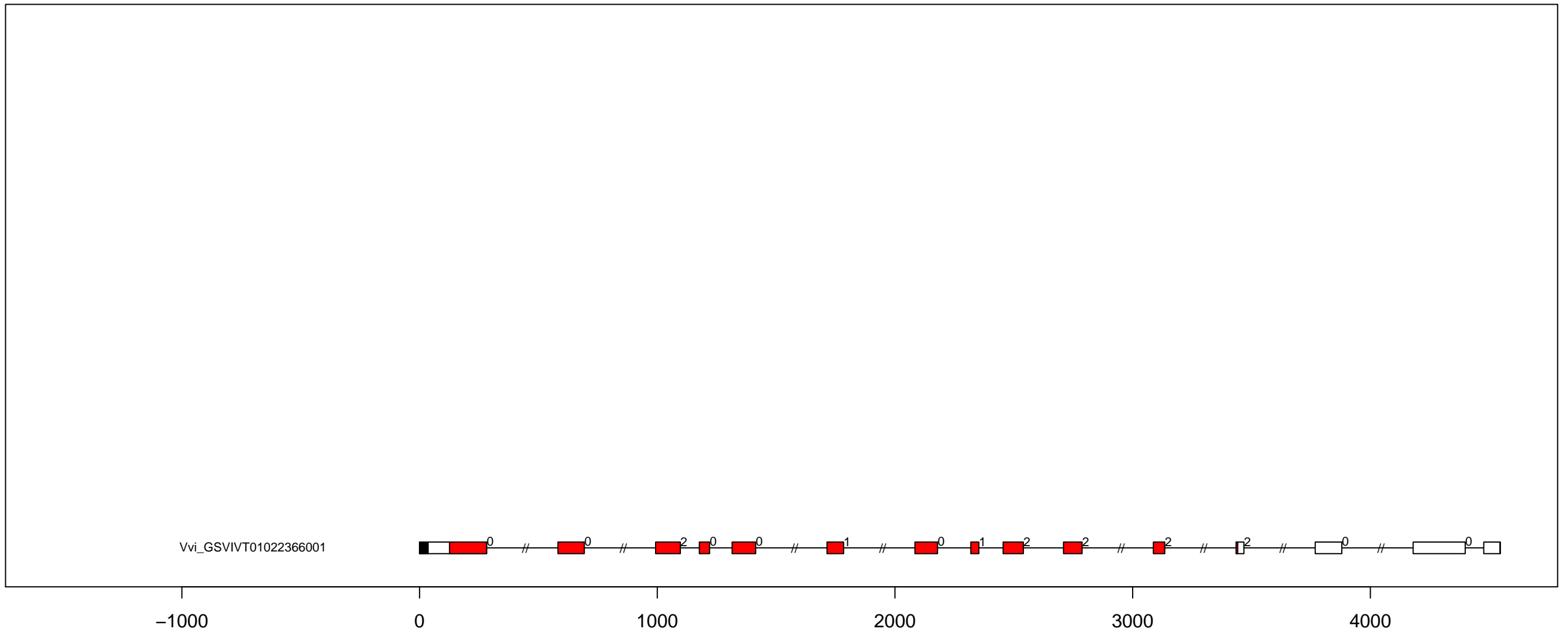

V.vi CMGC_CDK-CRK7-CDK9 exon-intron and domain diagram (all)

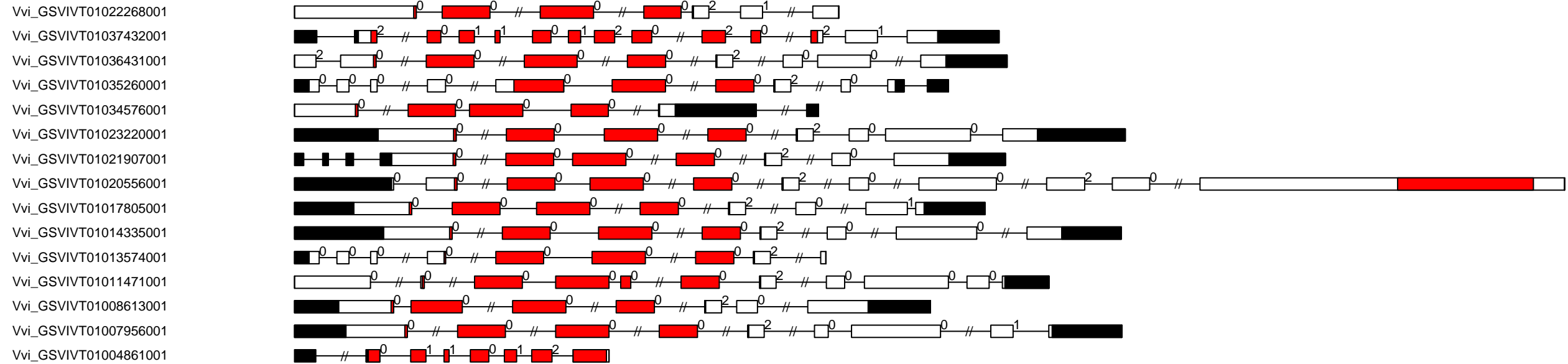

0

2000

4000

6000

V.vi CMGC_CDK-PITSLRE exon-intron and domain diagram (all)

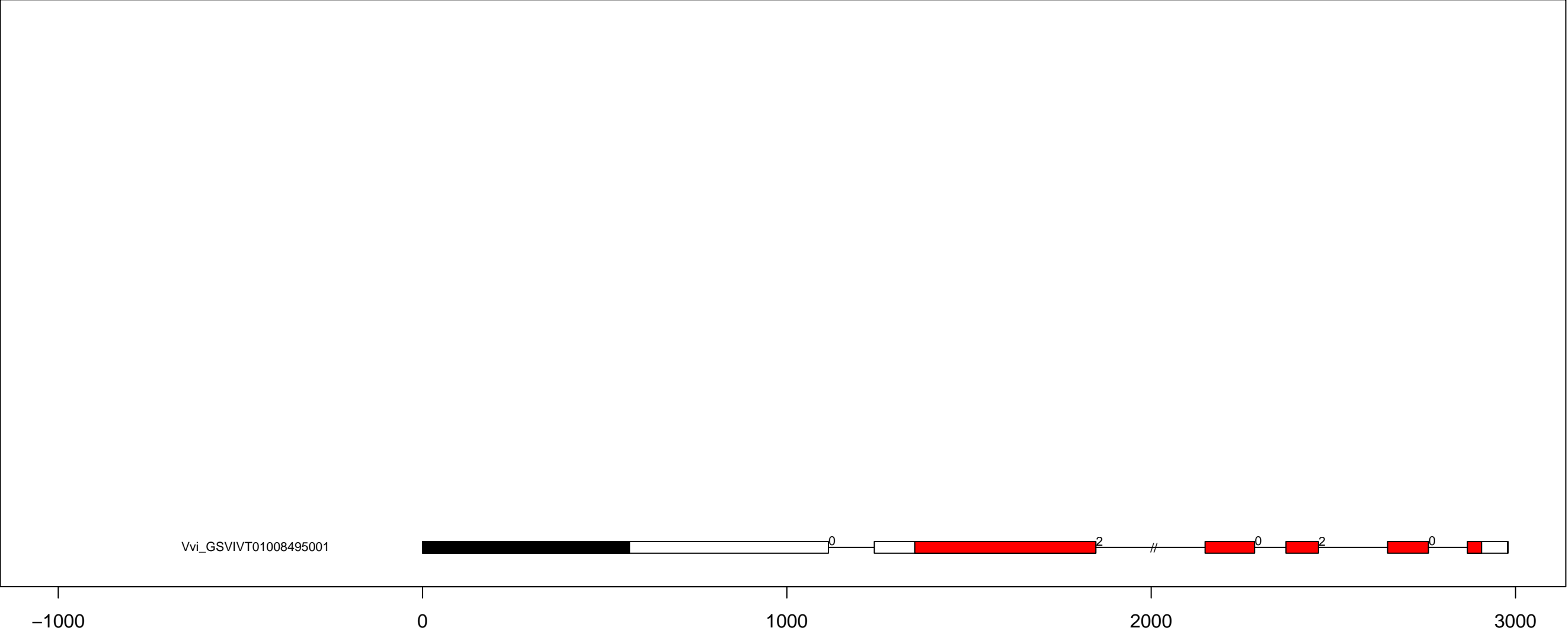

V.vi CMGC_CK2 exon-intron and domain diagram (all)

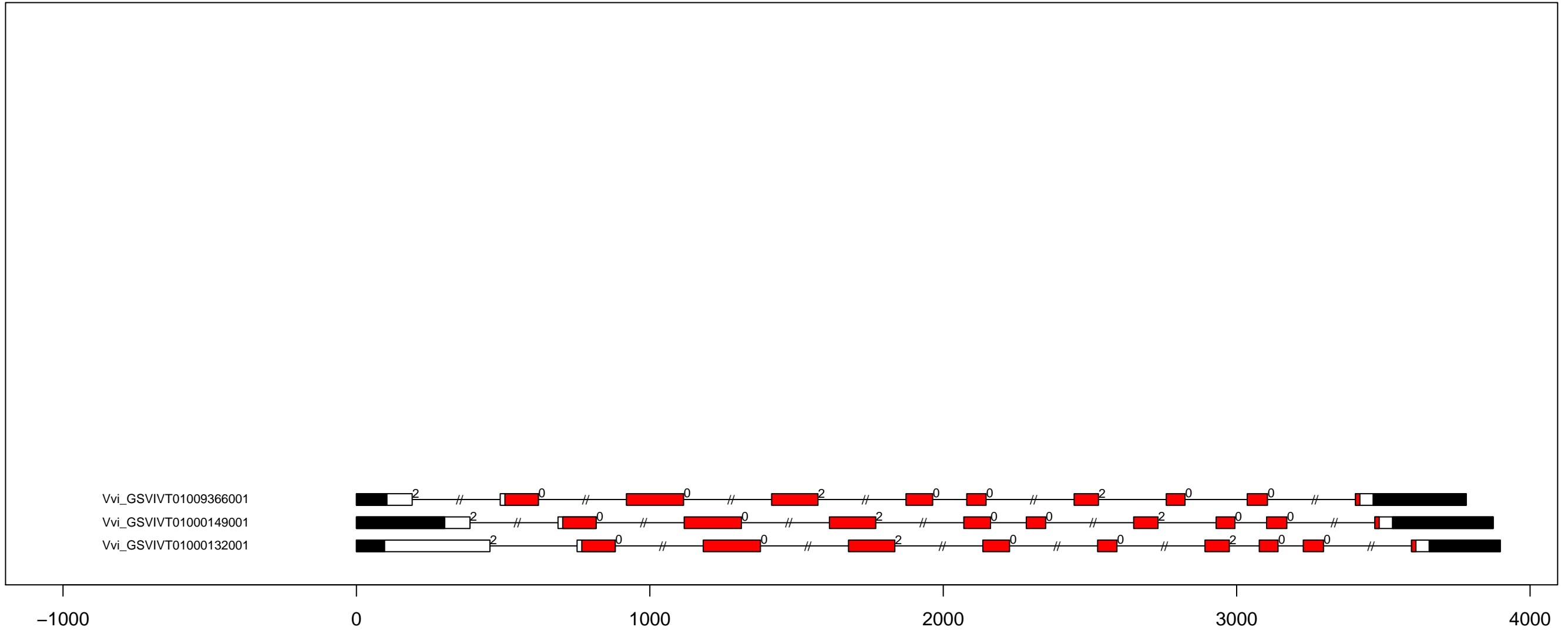

V.vi CMGC_DYRK-PRP4 exon-intron and domain diagram (all)

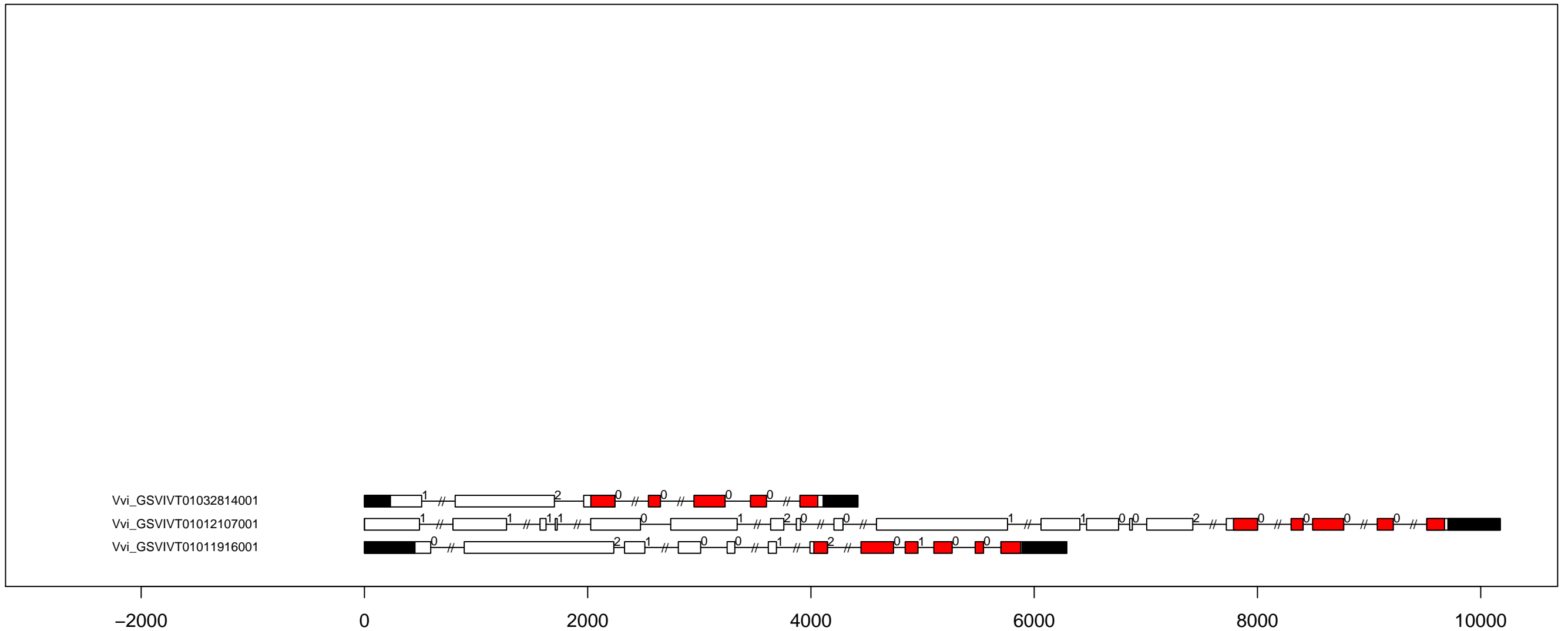

V.vi CMGC_DYRK-YAK exon-intron and domain diagram (all)

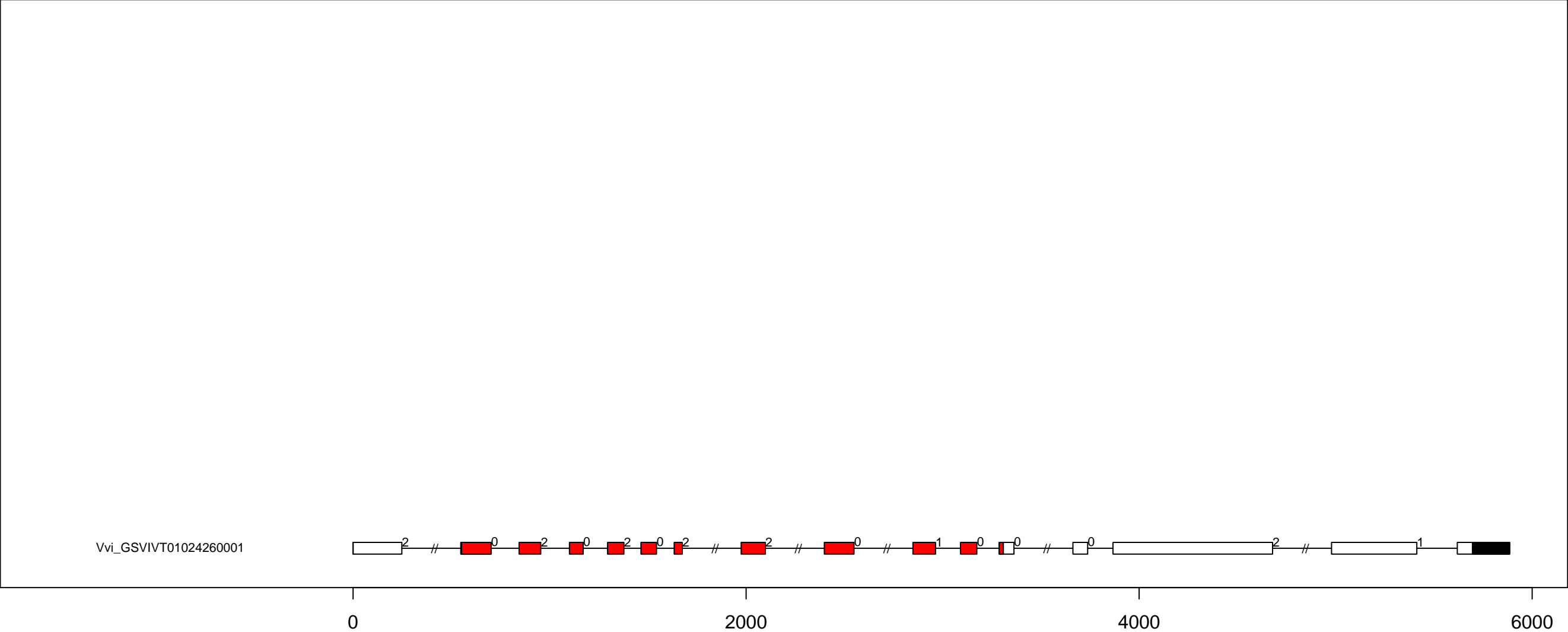

V.vi CMGC_GSK exon-intron and domain diagram (all)

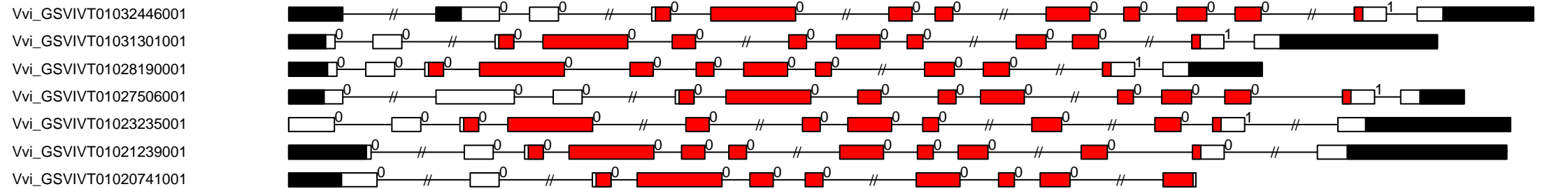

V.vi CMGC_MAPK exon-intron and domain diagram (all)

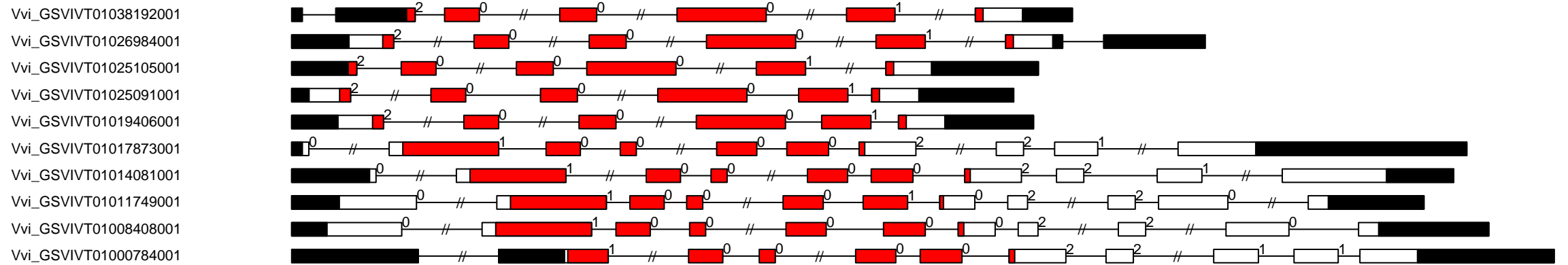

-1000

0

1000

2000

3000

4000

V.vi CMGC_PI-Tthe exon-intron and domain diagram (all)

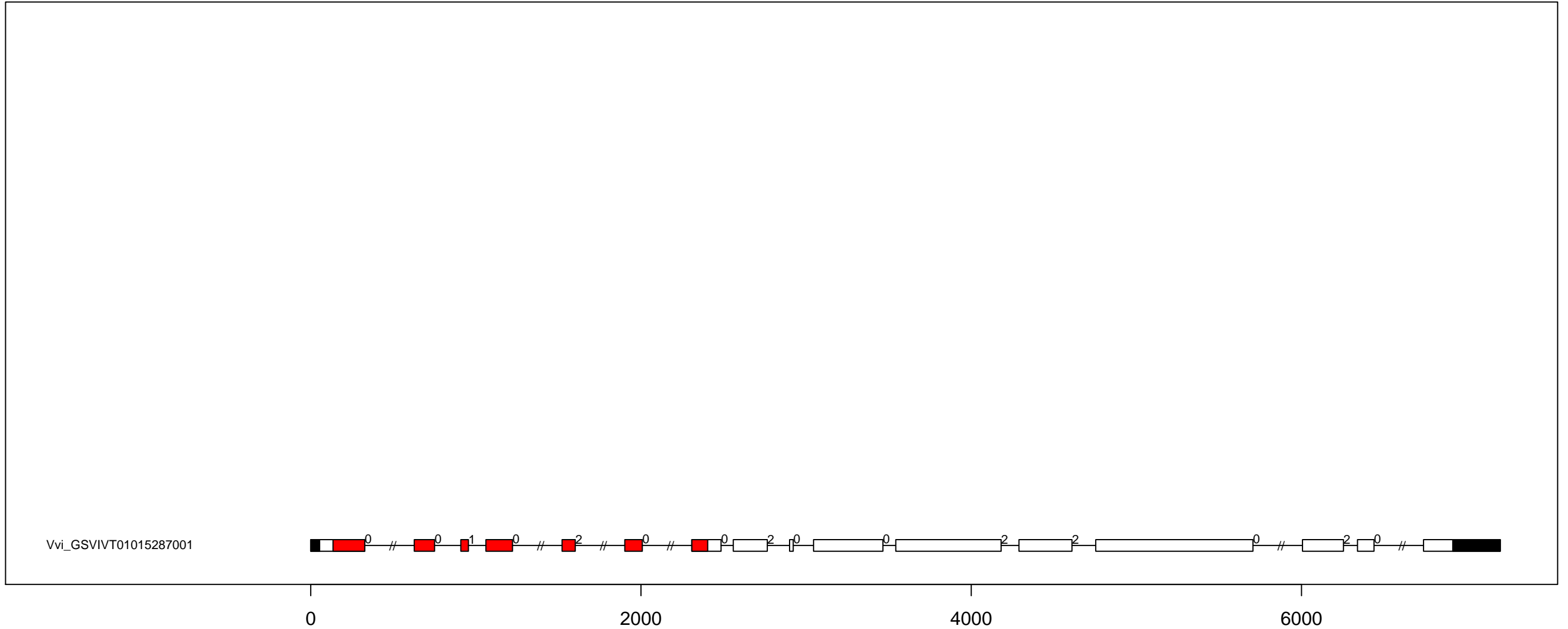

V.vi CMGC_RCK exon-intron and domain diagram (all)

Vvi_GSVIVT01022771001

Vvi_GSVIVT01005924001

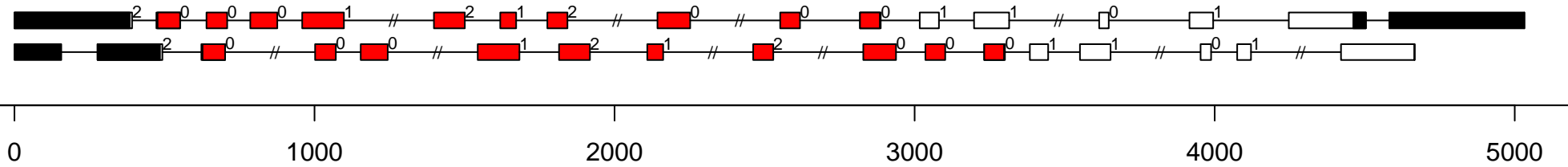

V.vi CMGC_SRPK exon-intron and domain diagram (all)

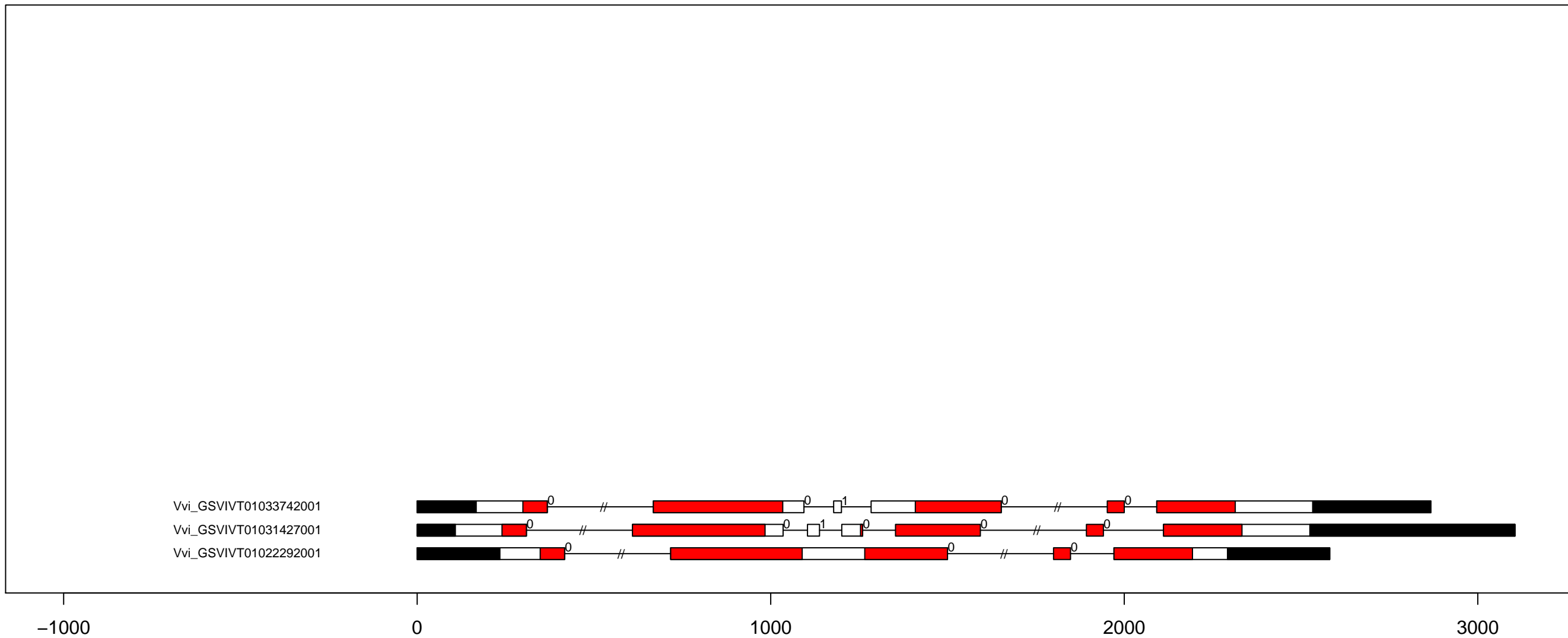

V.vi Group-PI-2 exon-intron and domain diagram (all)

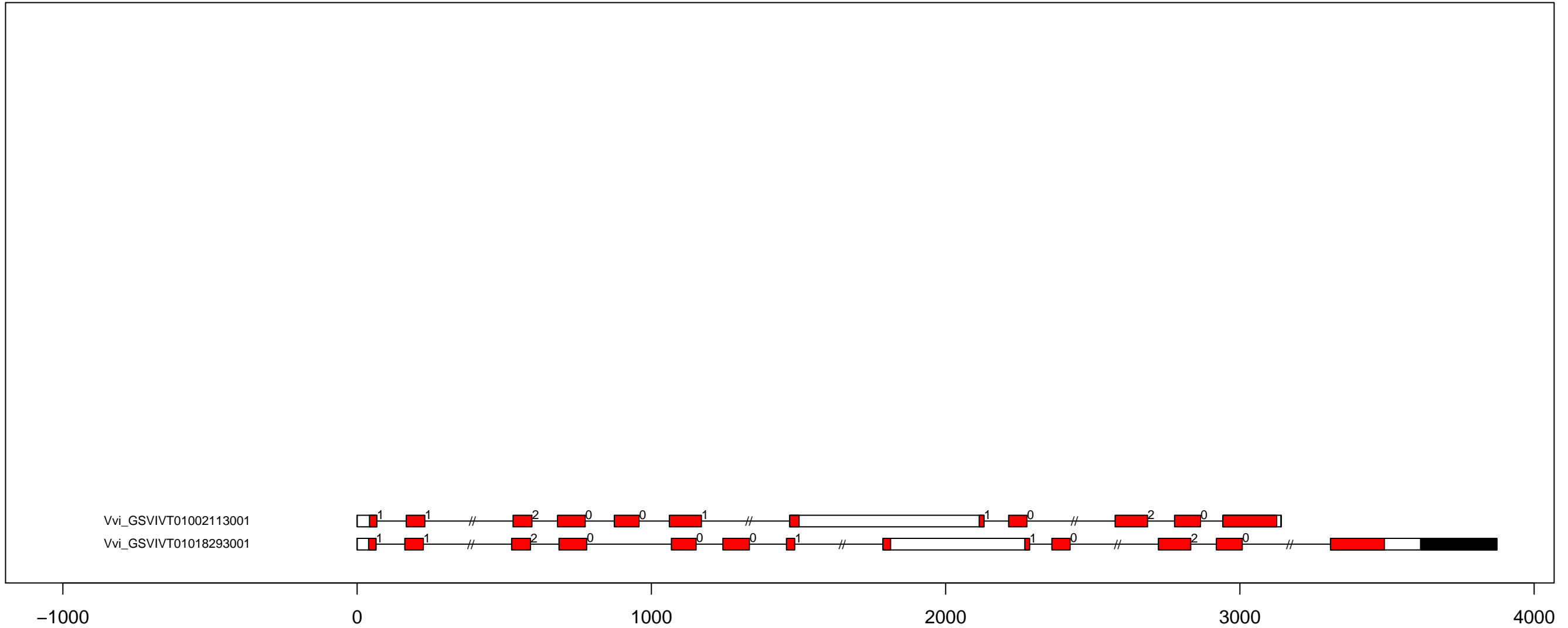

V.vi Group-PI-3 exon-intron and domain diagram (all)

Vvi_GSVIVT01034089001
Vvi_GSVIVT01027458001
Vvi_GSVIVT01026573001

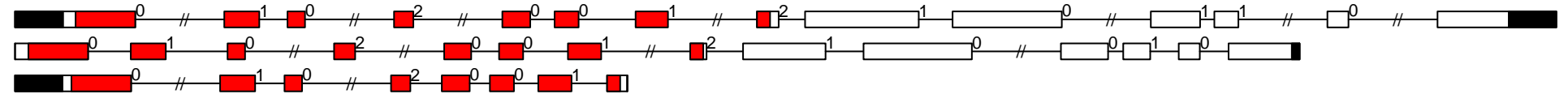

-1000

0

1000

2000

3000

4000

5000

V.vi Group-PI-4 exon-intron and domain diagram (all)

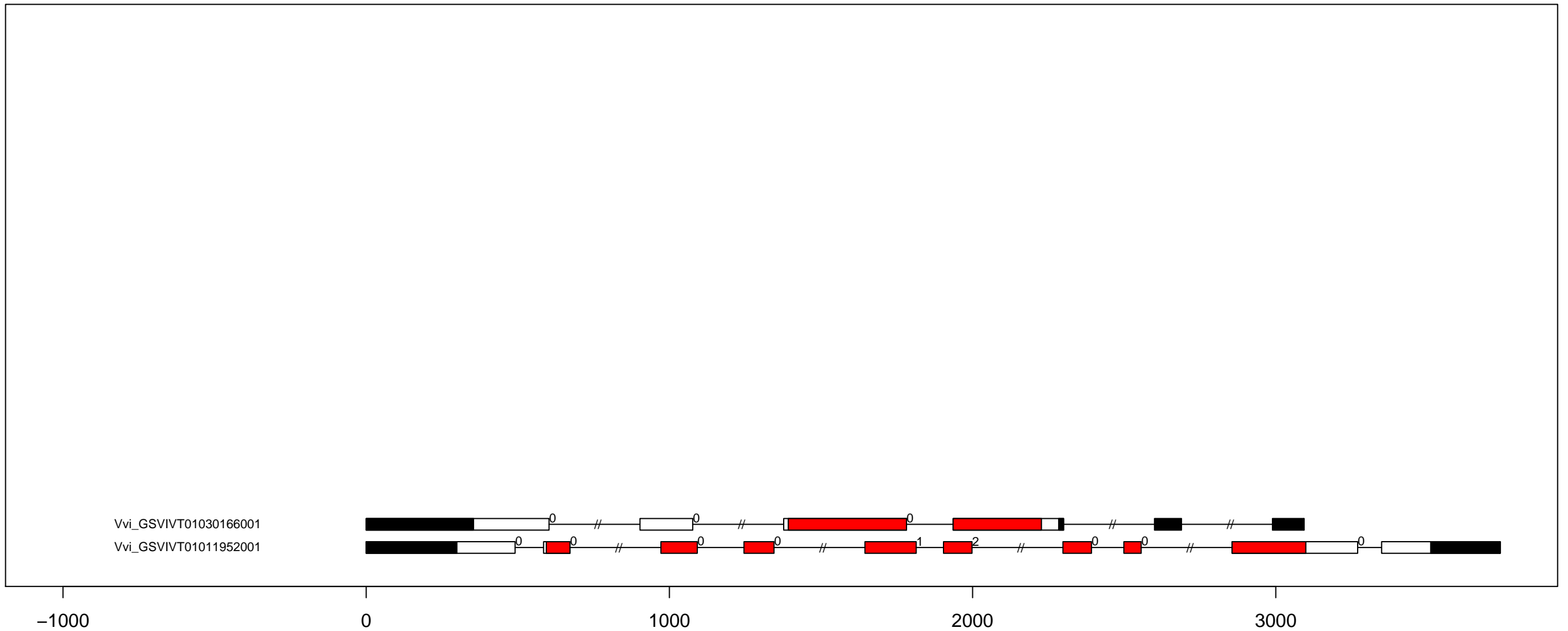

V.vi IRE1 exon-intron and domain diagram (all)

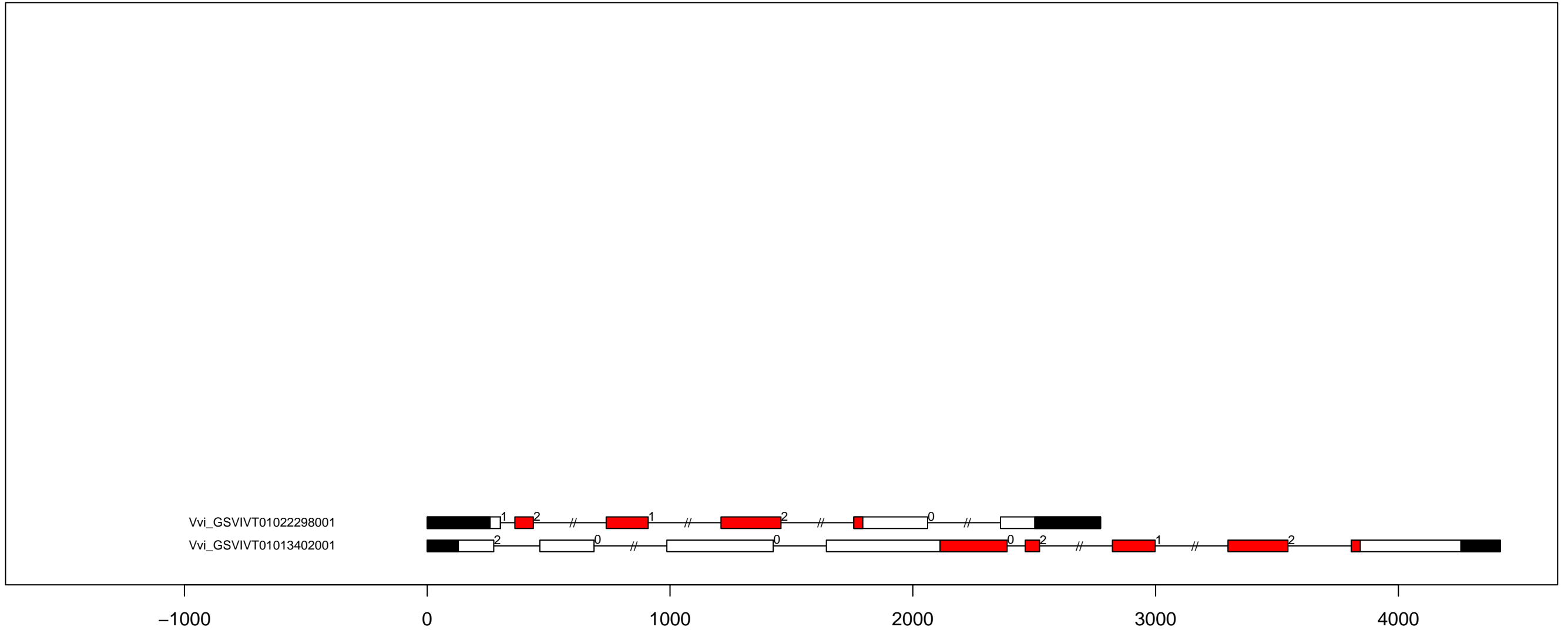

V.vi NAK exon-intron and domain diagram (all)

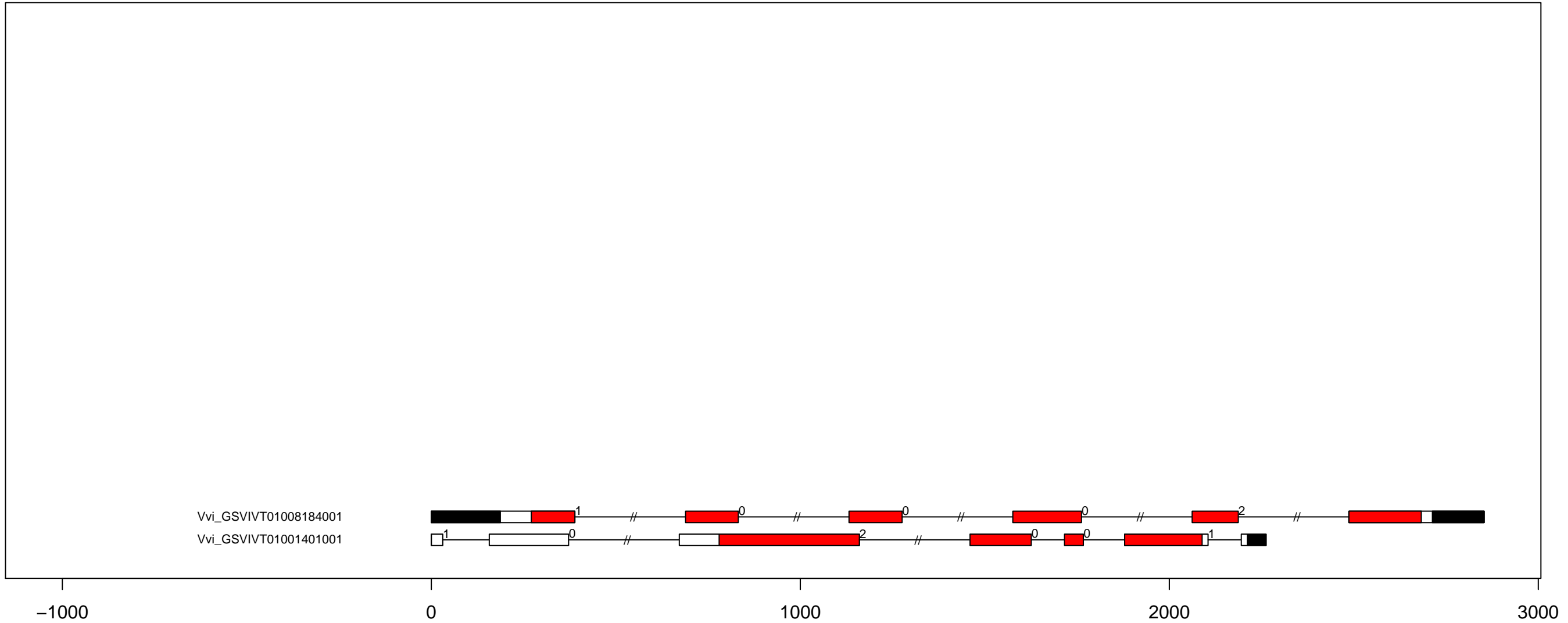

V.vi NEK exon-intron and domain diagram (all)

Vvi_GSVIVT01033338001
Vvi_GSVIVT01037558001
Vvi_GSVIVT01025304001
Vvi_GSVIVT01021831001
Vvi_GSVIVT01001199001

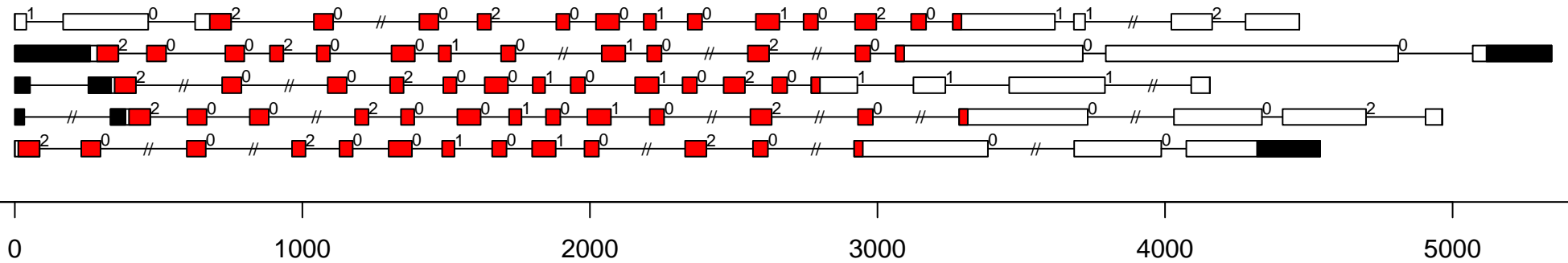

V.vi PEK_GCIN2 exon-intron and domain diagram (all)

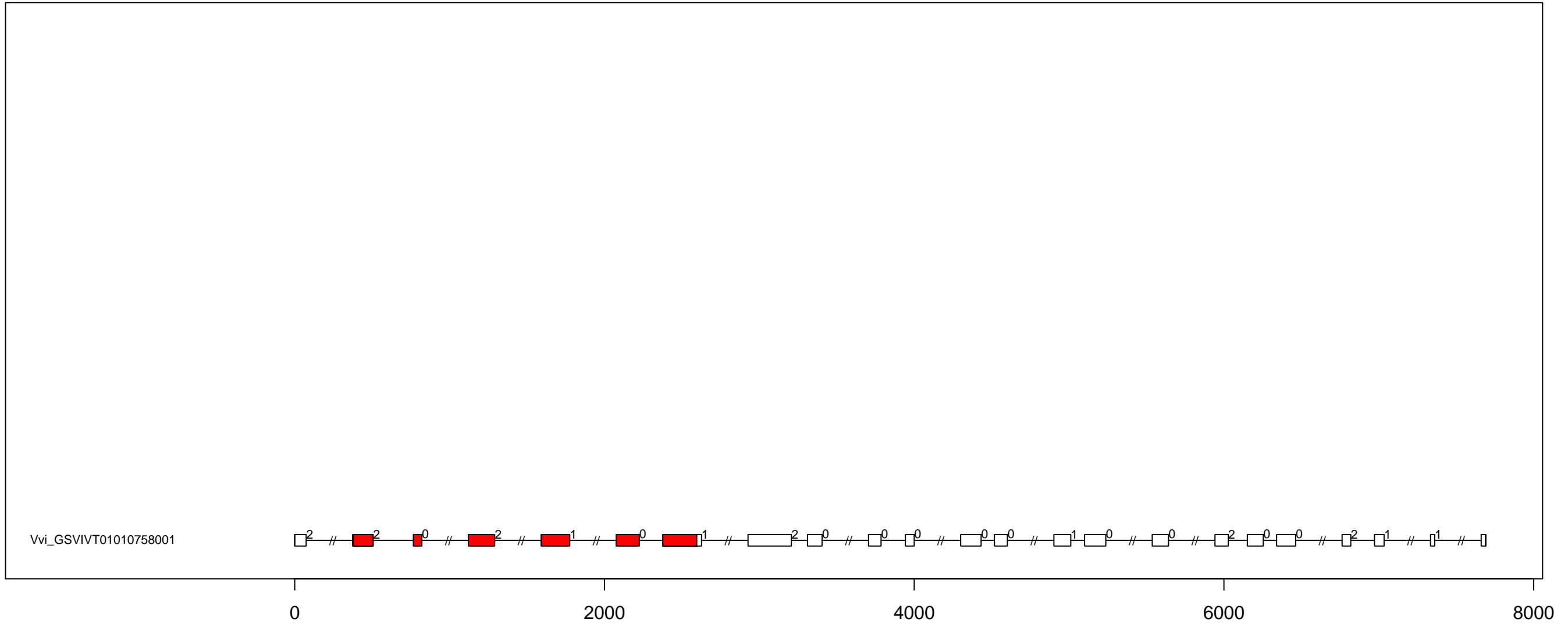

V.vi RLK-Pelle_C-LEC exon-intron and domain diagram (all)

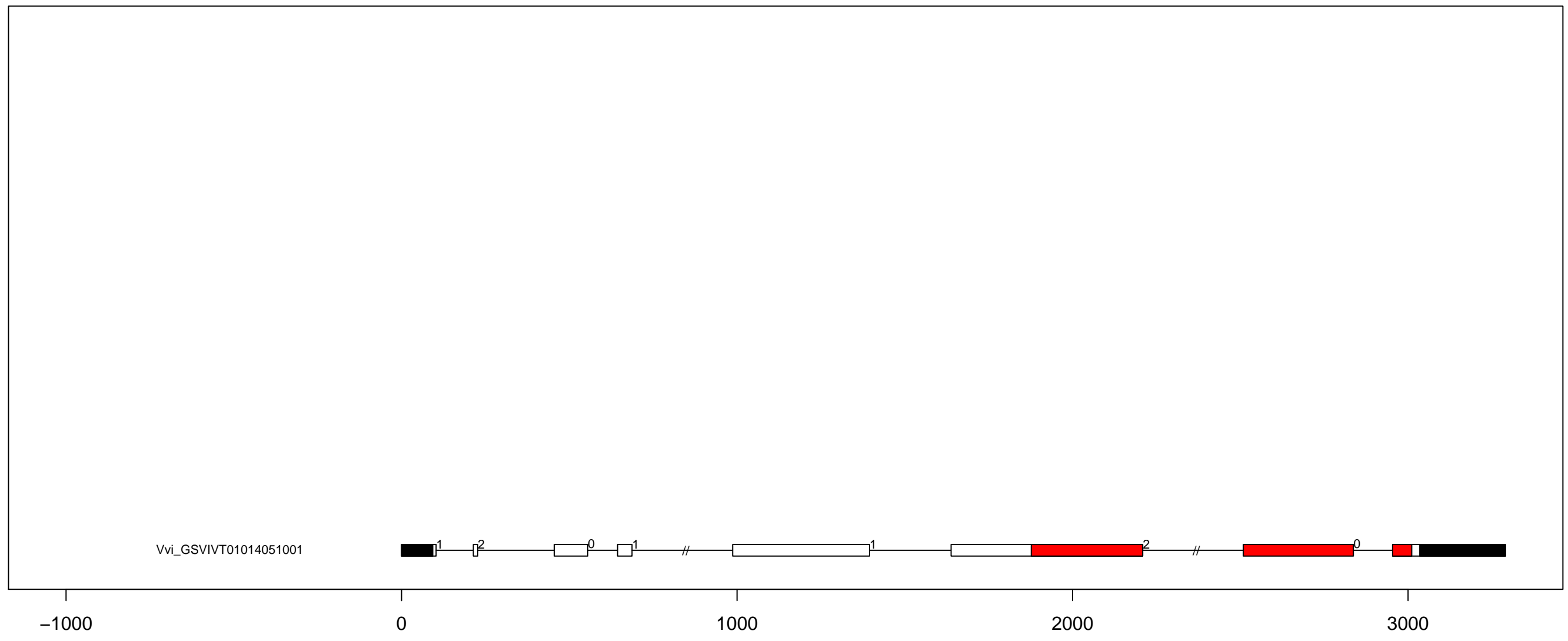

V.vi RLK-Pelle_CR4L exon-intron and domain diagram (all)

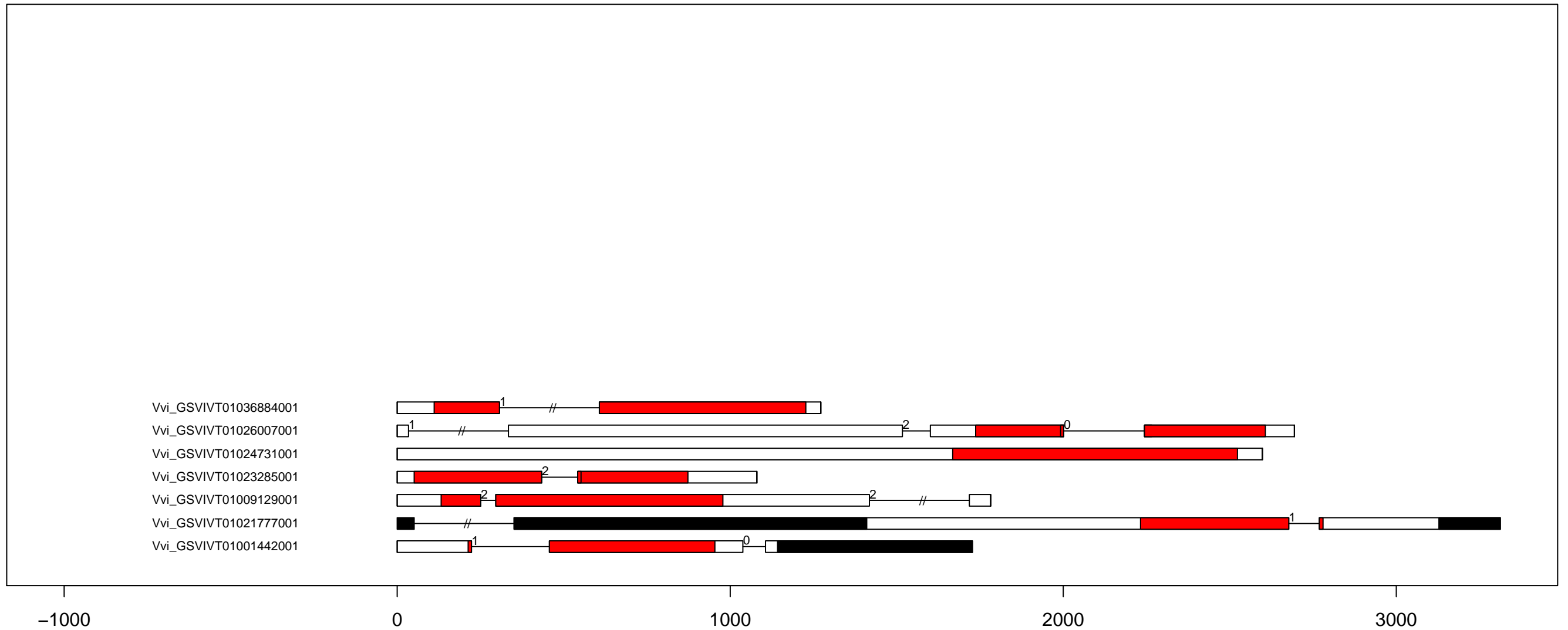

V.vi RLK-Pelle_CrRLK1L-1 exon-intron and domain diagram (all)

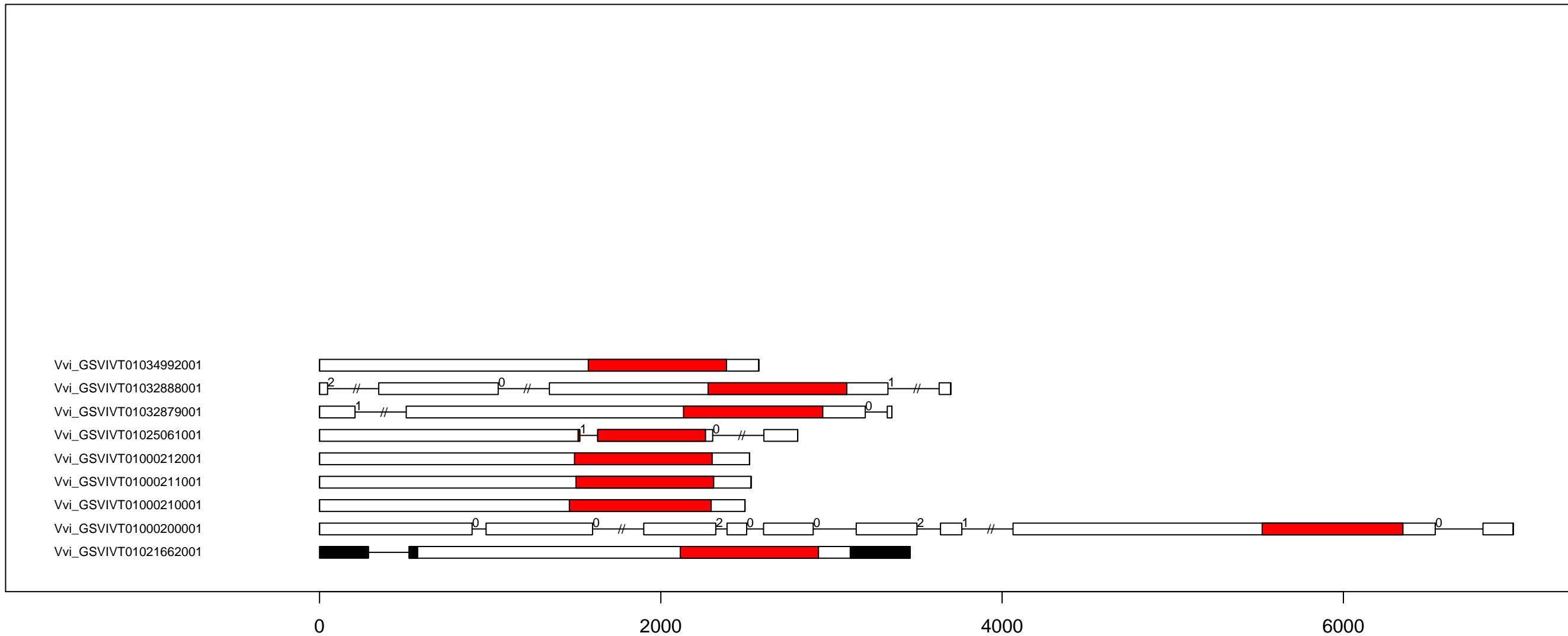

V.vi RLK-Pelle_DLSV exon-intron and domain diagram (part 1)

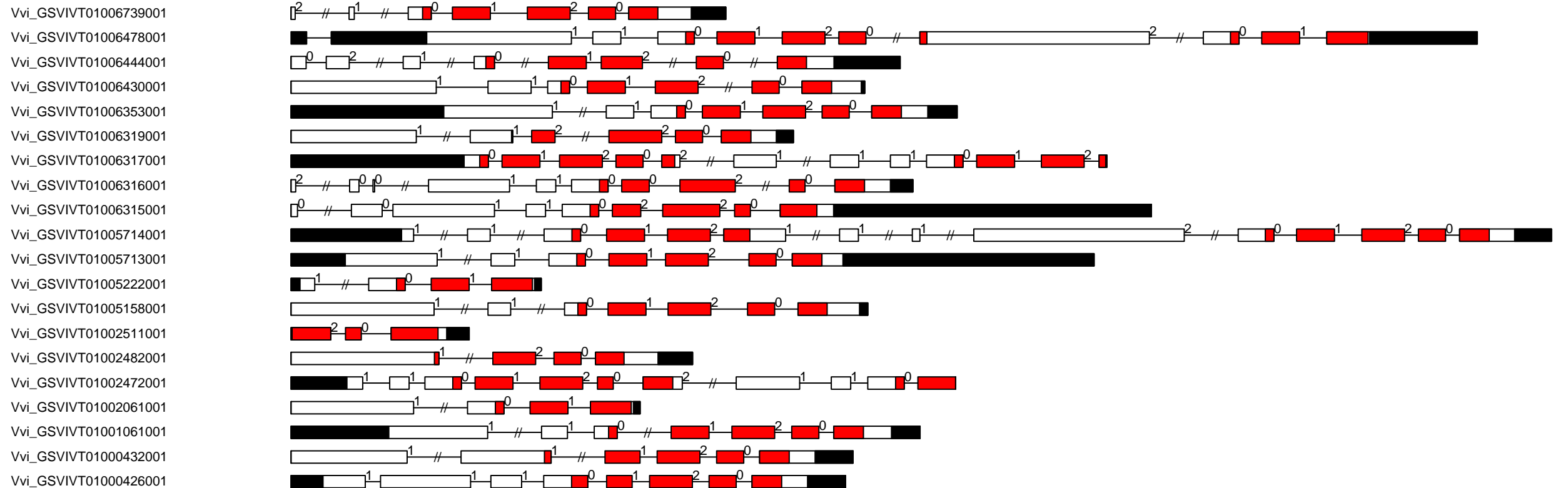

V.vi RLK-Pelle_DLSV exon-intron and domain diagram (part 2)

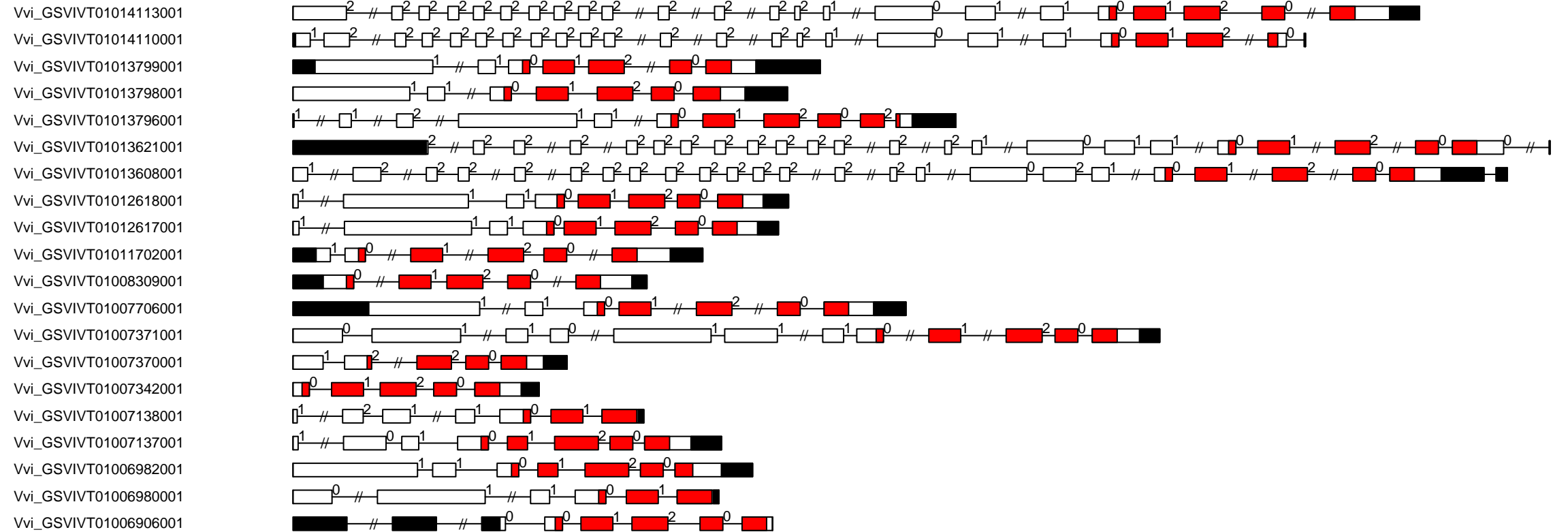

V.vi RLK-Pelle_DLSV exon-intron and domain diagram (part 3)

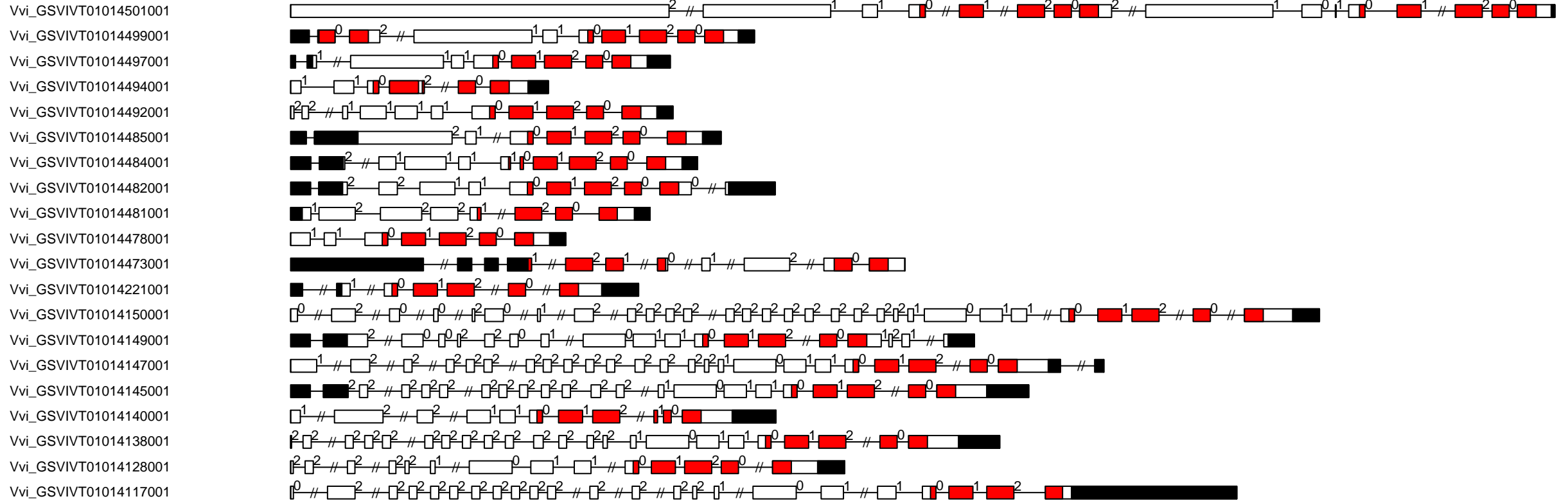

V.vi RLK-Pelle_DLSV exon-intron and domain diagram (part 4)

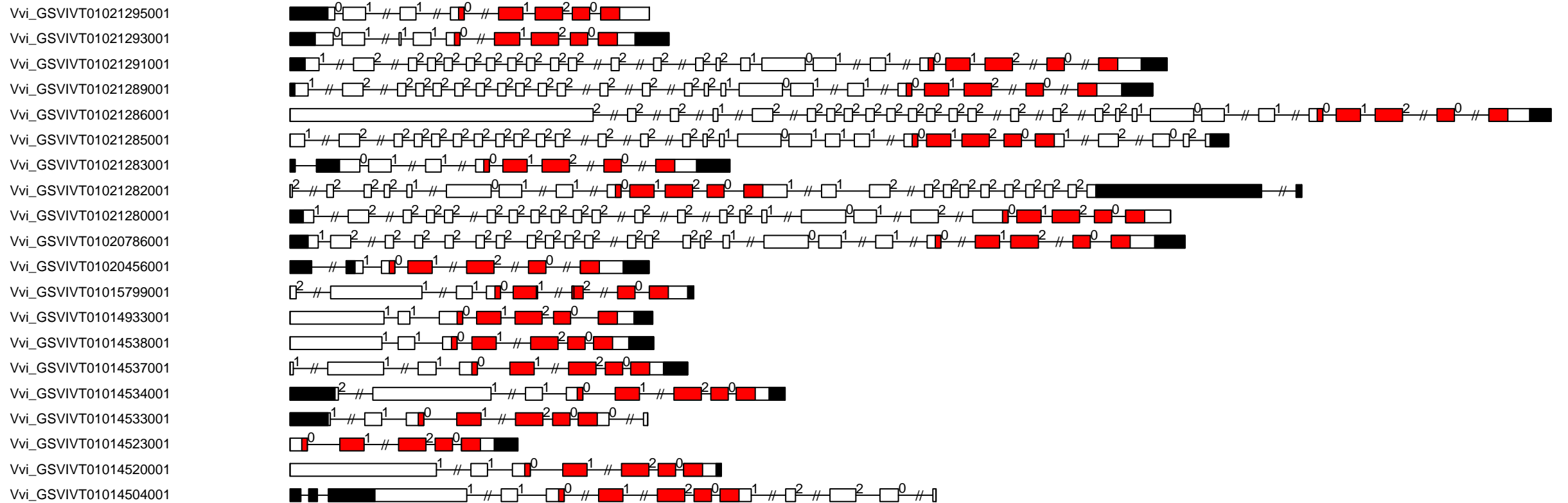

V.vi RLK-Pelle_DLSV exon-intron and domain diagram (part 5)

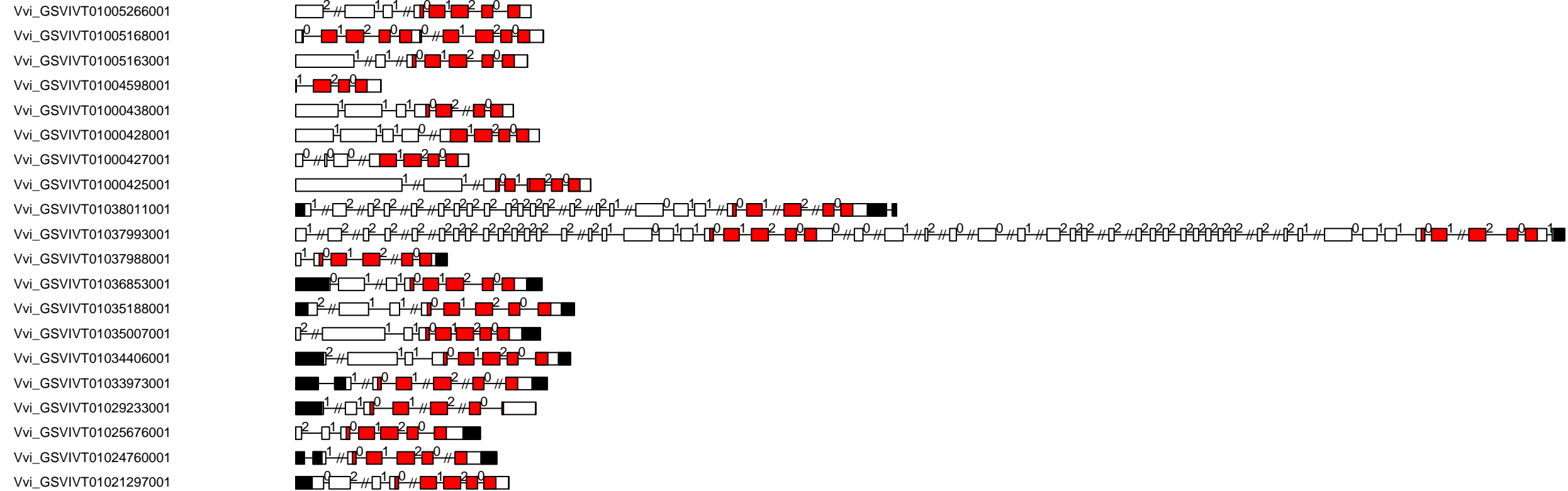

V.vi RLK-Pelle_DLSV exon-intron and domain diagram (part 6)

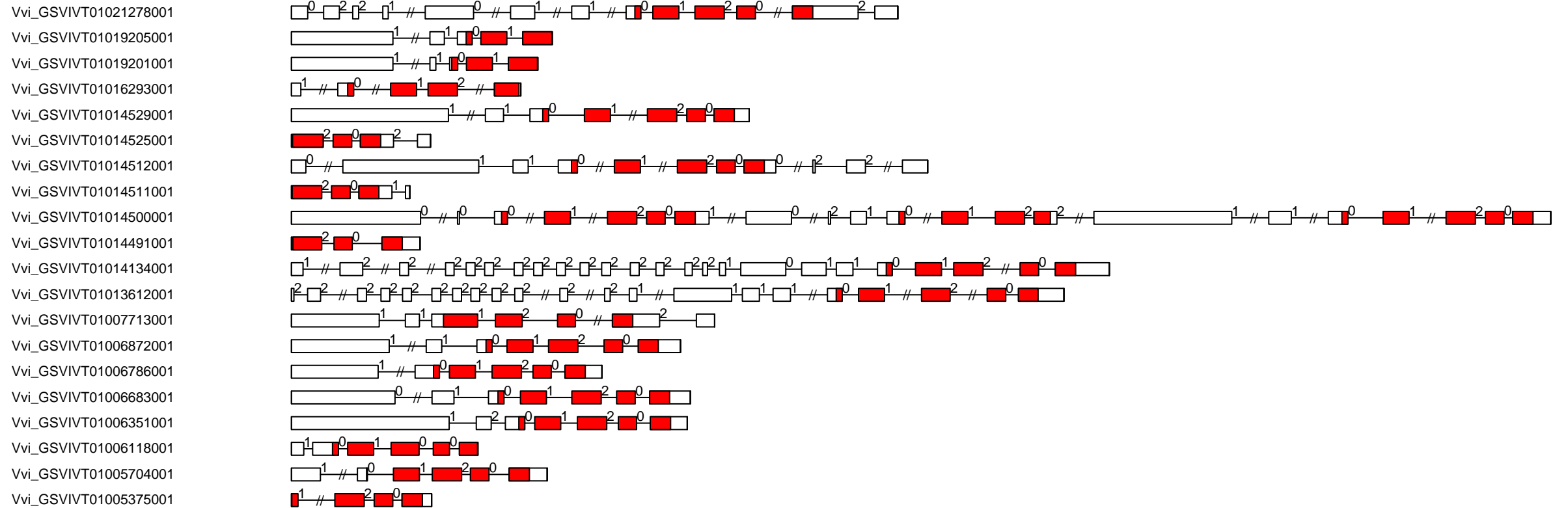

V.vi RLK-Pelle_DLSV exon-intron and domain diagram (part 7)

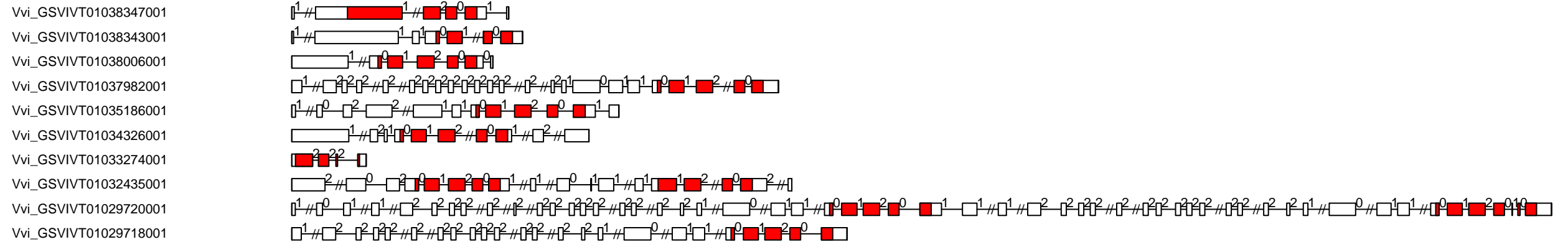

V.vi RLK-Pelle_Extensin exon-intron and domain diagram (all)

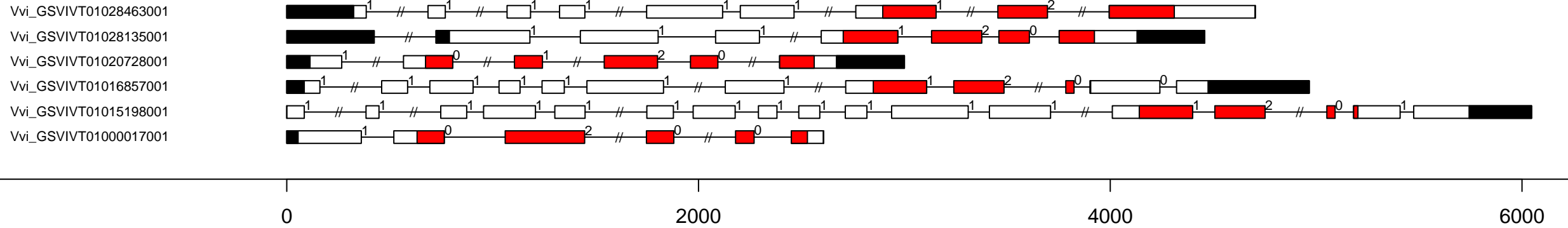

V.vi RLK-Pelle_LRR-I-1 exon-intron and domain diagram (all)

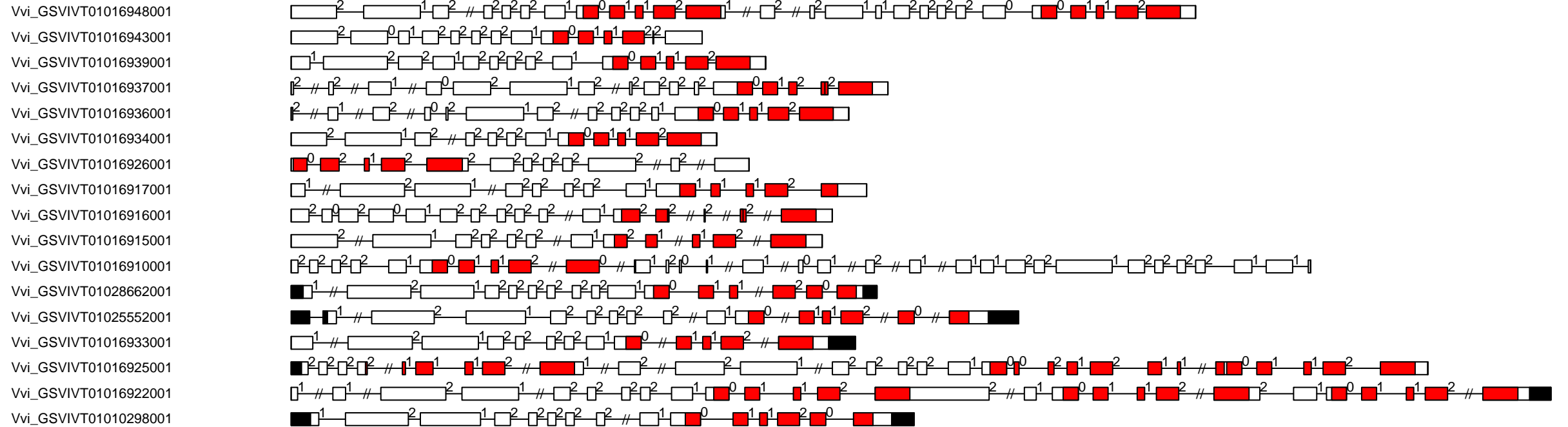

V.vi RLK-Pelle_LRR-I-2 exon-intron and domain diagram (all)

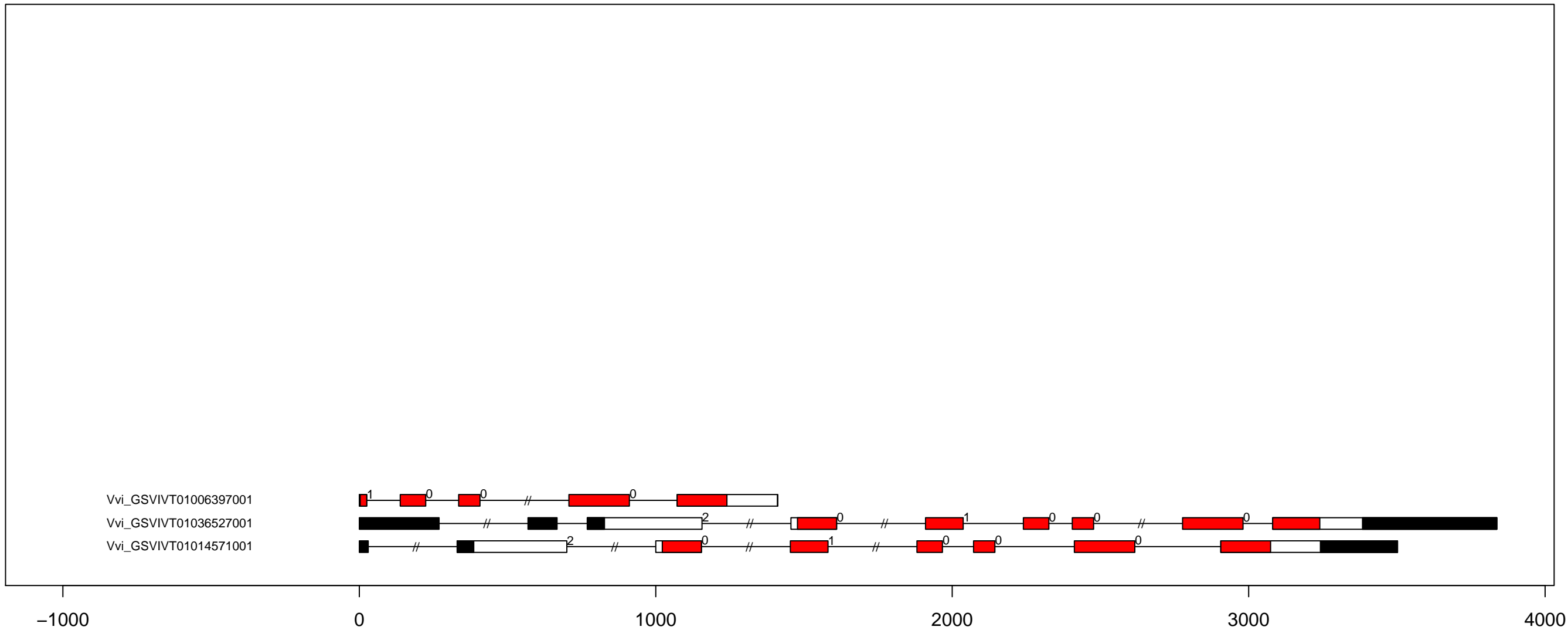

V.vi RLK-Pelle_LRR-III exon-intron and domain diagram (part 1)

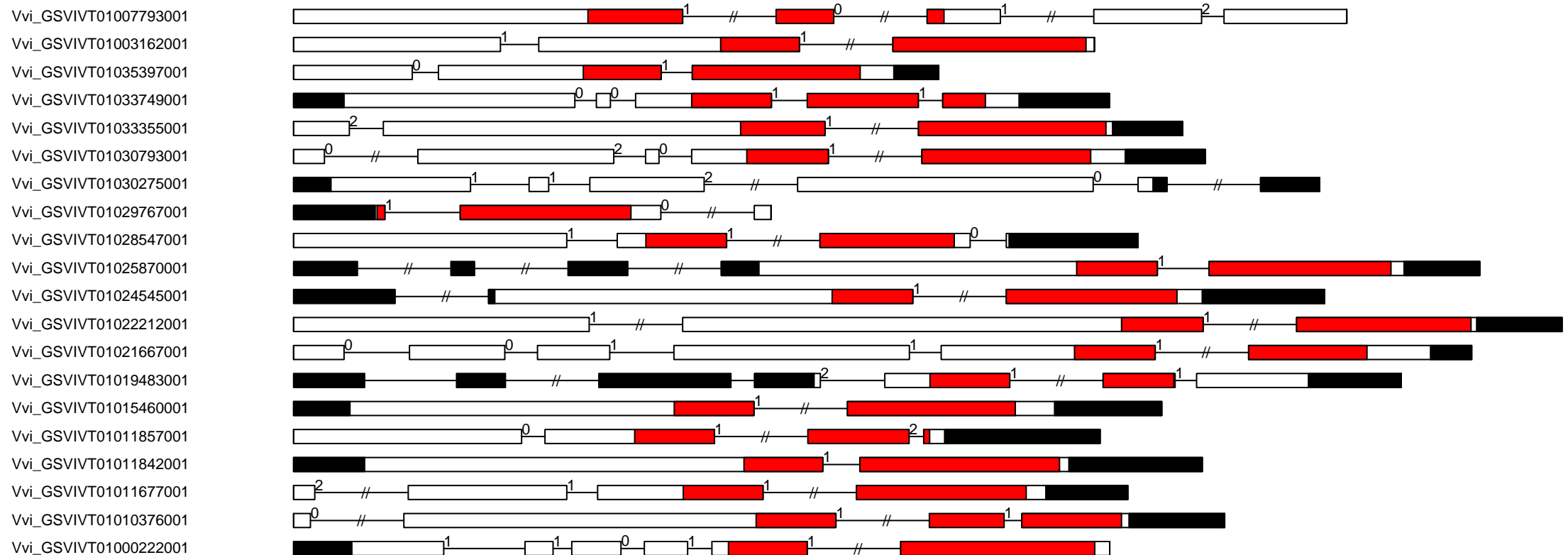

V.vi RLK-Pelle_LRR-III exon-intron and domain diagram (part 2)

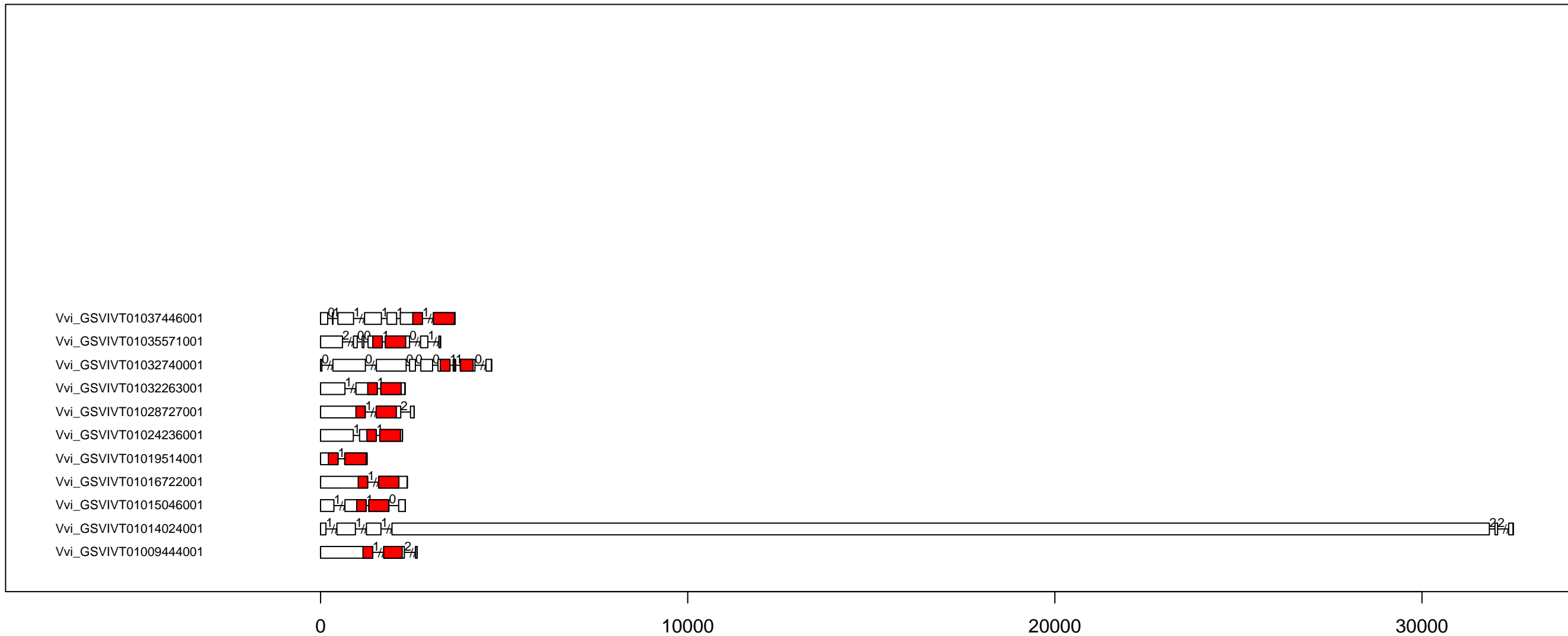

V.vi RLK-Pelle_LRR-II exon-intron and domain diagram (all)

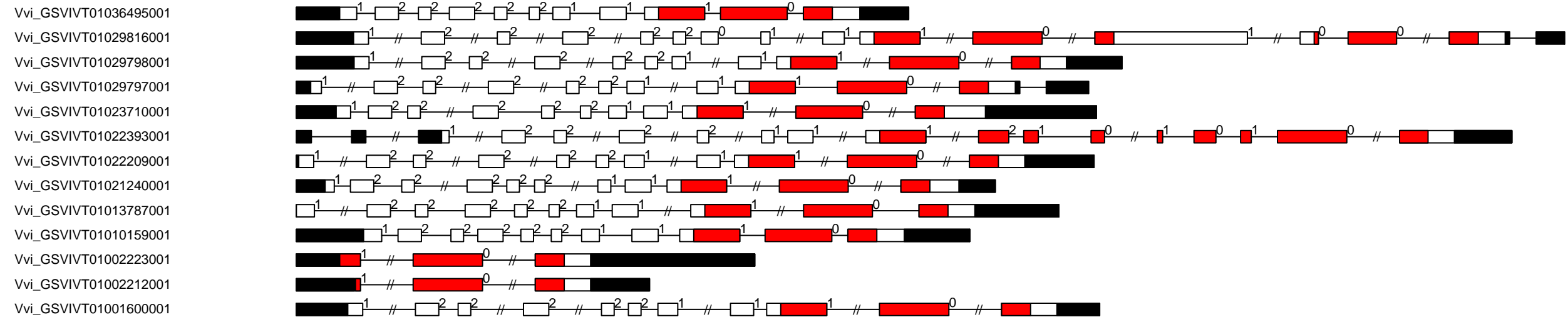

0

2000

4000

6000

V.vi RLK-Pelle_LRR-IV exon-intron and domain diagram (all)

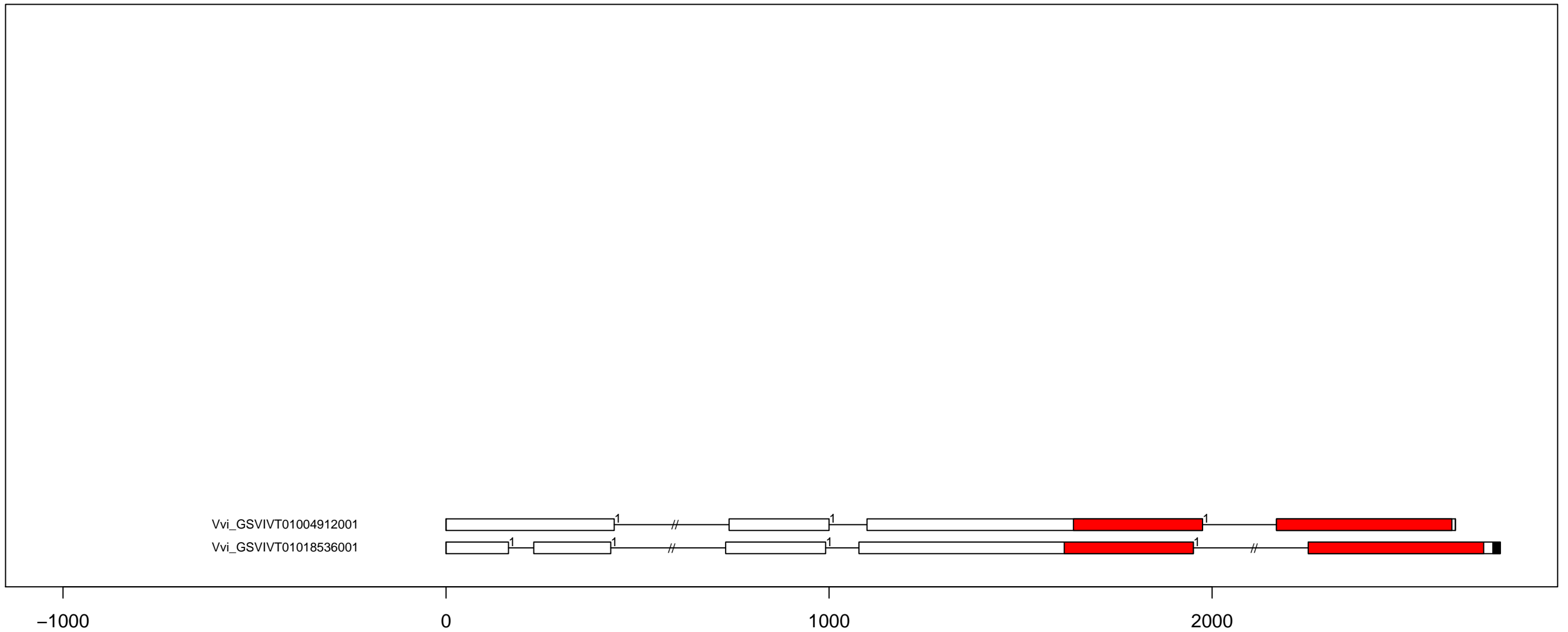

V.vi RLK-Pelle_LRR-IX exon-intron and domain diagram (all)

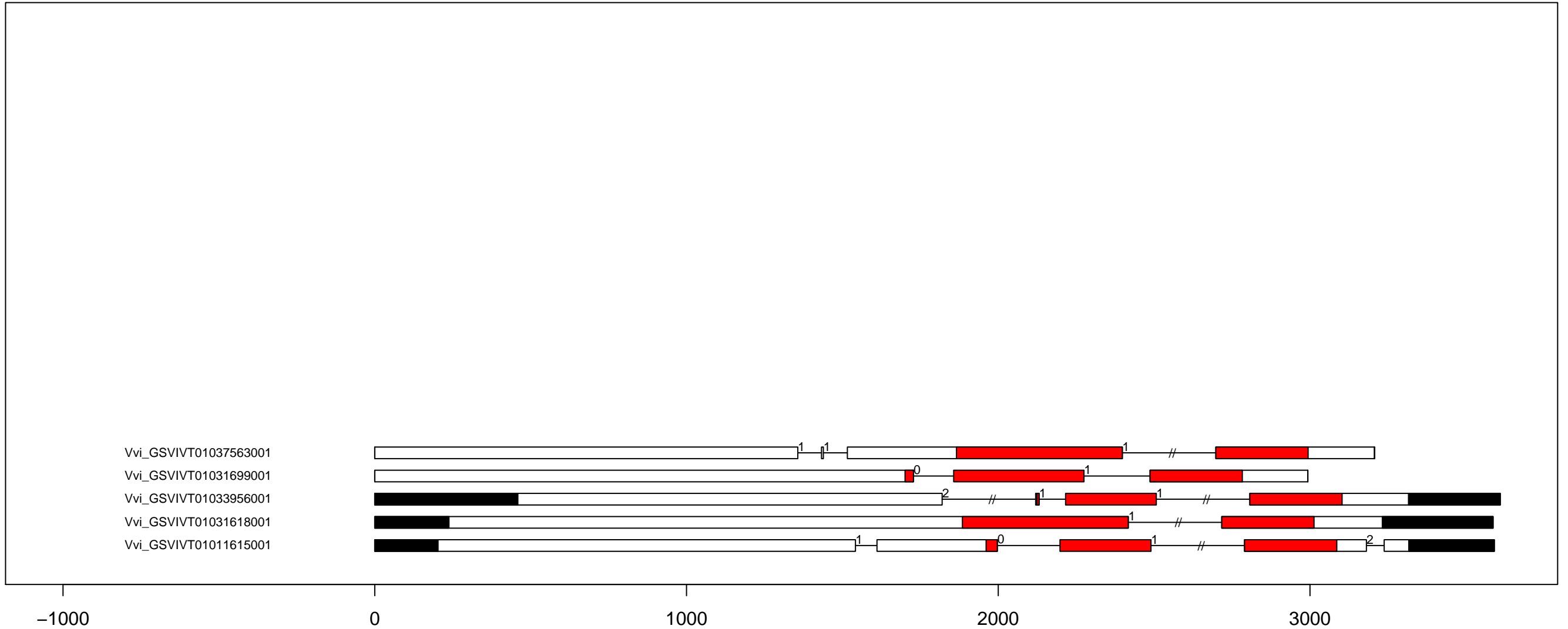

V.vi RLK-Pelle_LRR-VI-1 exon-intron and domain diagram (all)

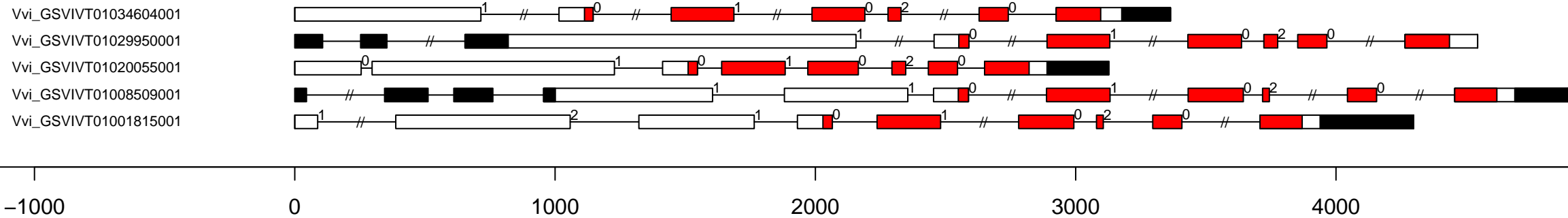

V.vi RLK-Pelle_LRR-VI-2 exon-intron and domain diagram (all)

Vvi_GSVIVT01014189001

Vvi_GSVIVT01032772001

Vvi_GSVIVT01024684001

Vvi_GSVIVT01021228001

Vvi_GSVIVT01019778001

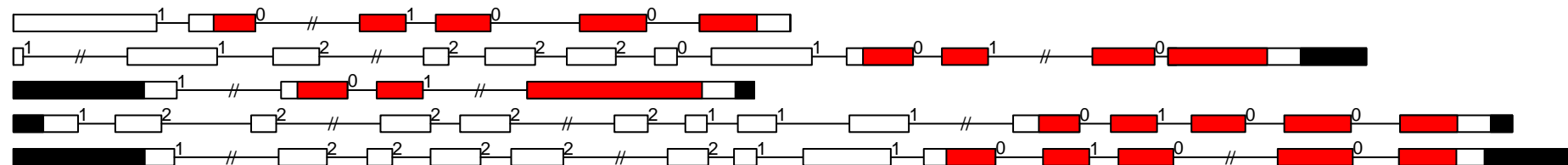

-1000

0

1000

2000

3000

4000

V.vi RLK-Pelle_LRR-VII-1 exon-intron and domain diagram (all)

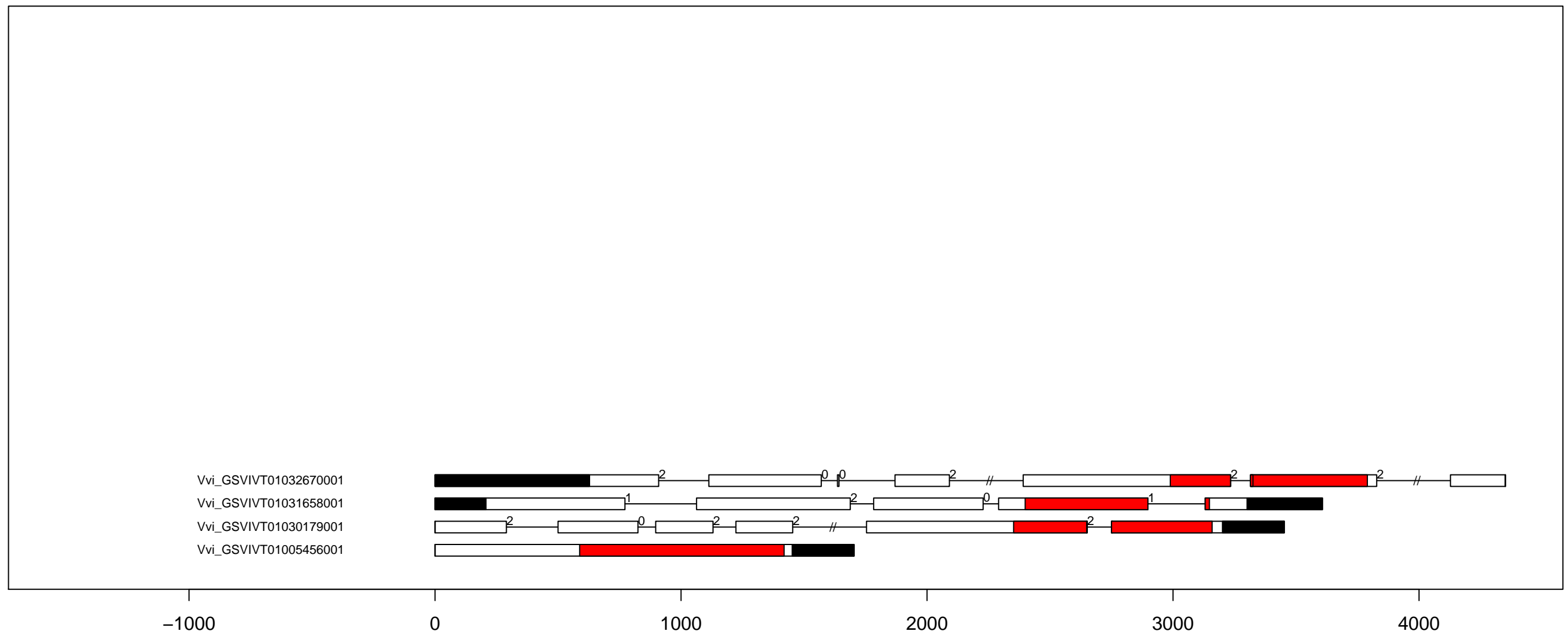

V.vi RLK-Pelle_LRR-VII-2 exon-intron and domain diagram (all)

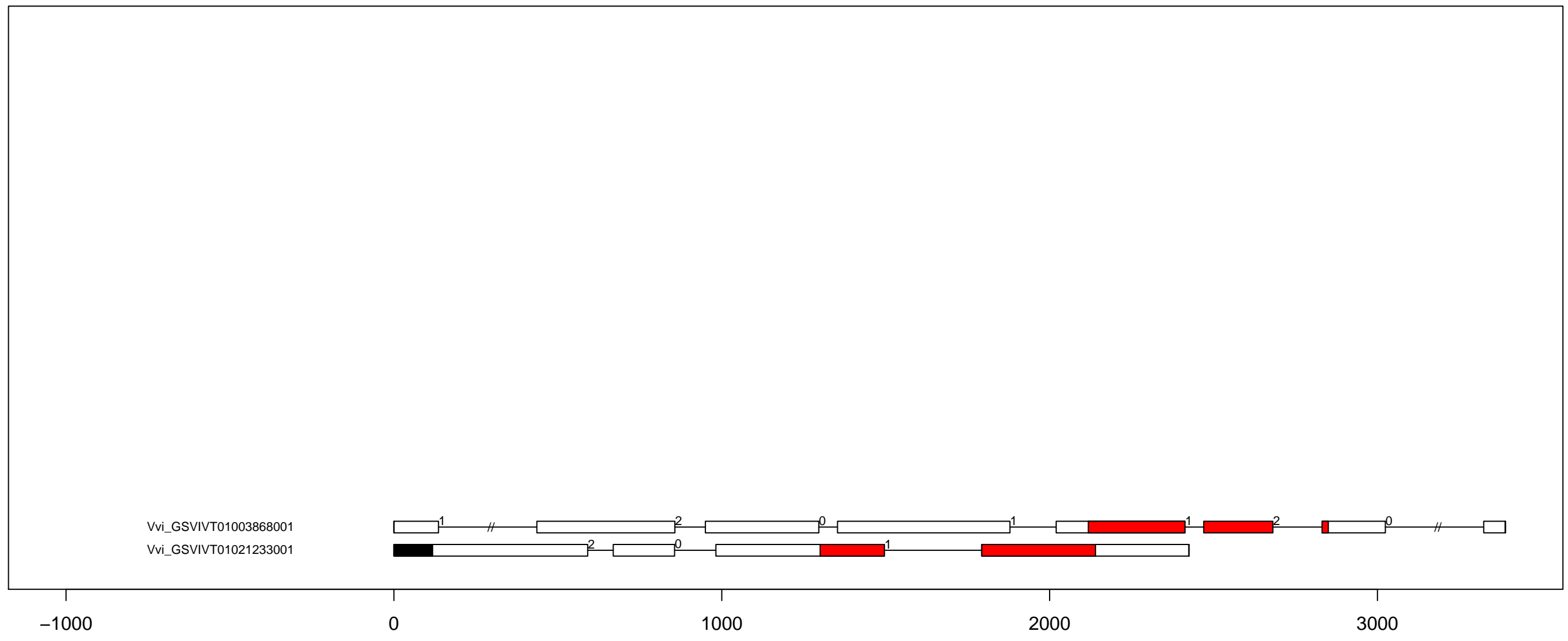

V.vi RLK-Pelle_LRR-VII-3 exon-intron and domain diagram (all)

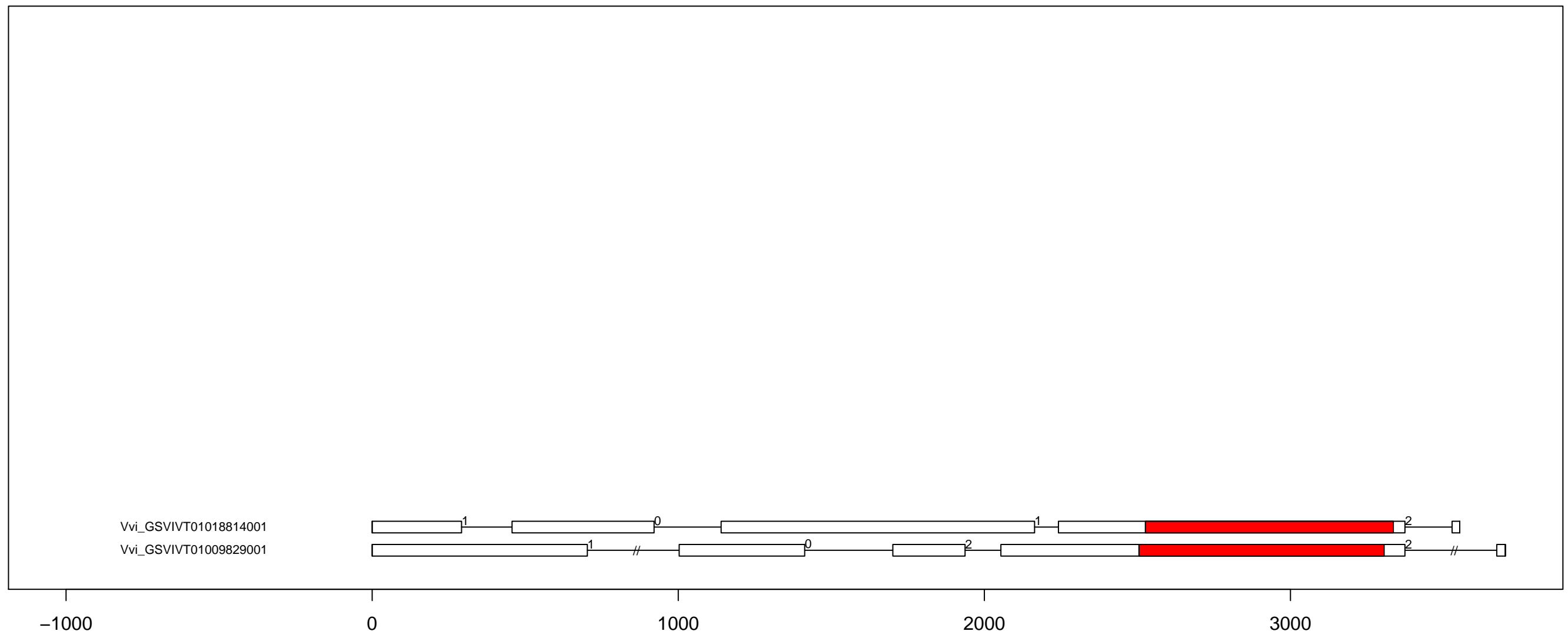

V.vi RLK-Pelle_LRR-VIII-1 exon-intron and domain diagram (all)

Vvi_GSVIVT01029870001
Vvi_GSVIVT01029829001
Vvi_GSVIVT01024538001
Vvi_GSVIVT01023113001

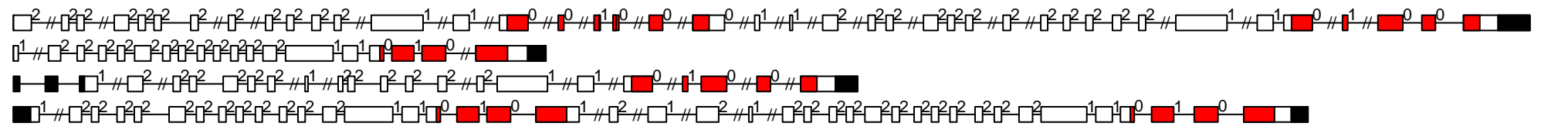

0

5000

10000

15000

V.vi RLK-Pelle_LRR-V exon-intron and domain diagram (all)

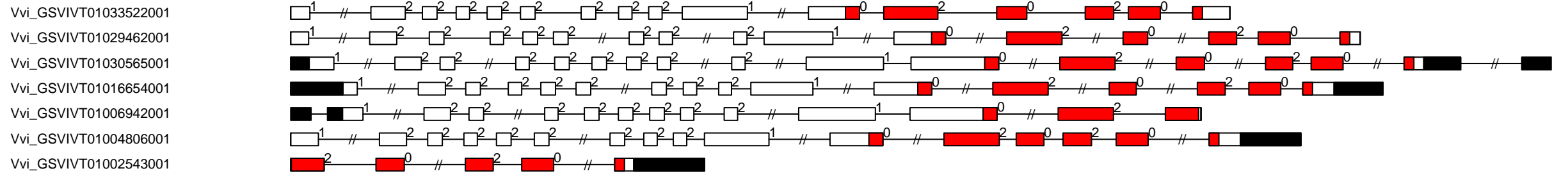

0

2000

4000

6000

V.vi RLK-Pelle_LRR-Xa exon-intron and domain diagram (all)

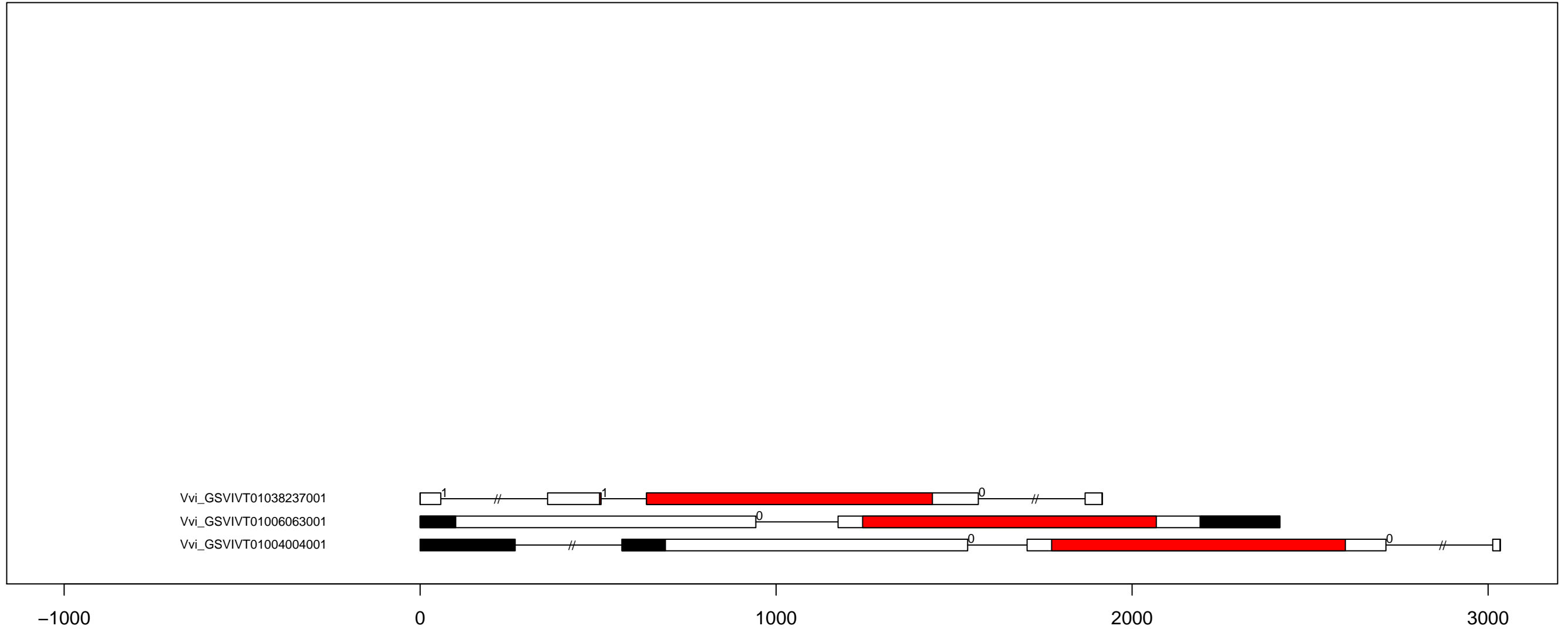

V.vi RLK-Pelle_LRR-Xb-1 exon-intron and domain diagram (all)

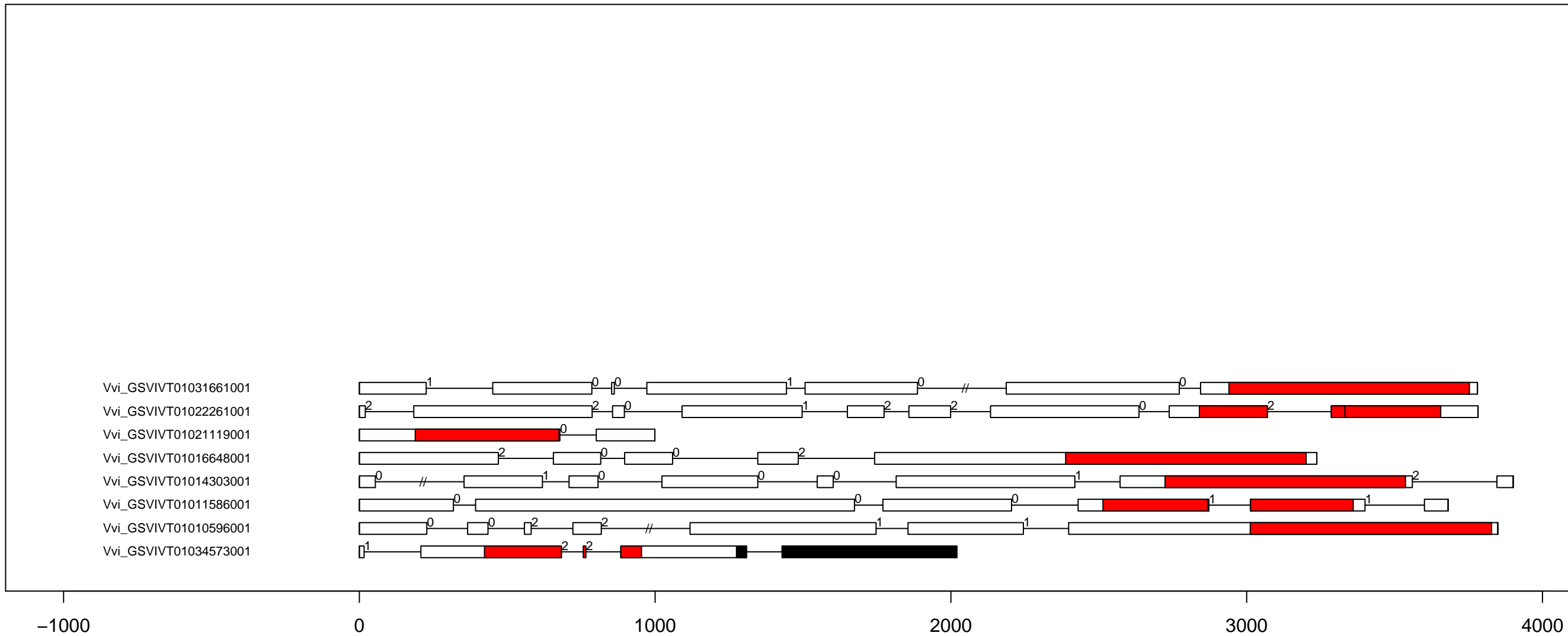

V.vi RLK-Pelle_LRR-XI-1 exon-intron and domain diagram (part 1)

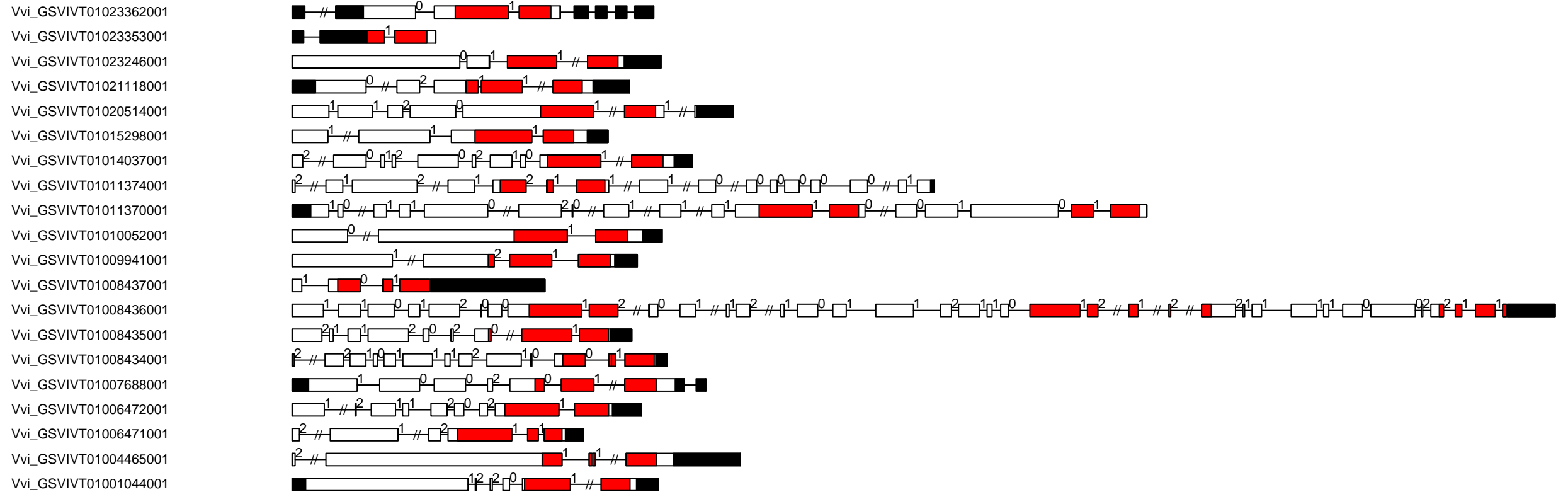

V.vi RLK-Pelle_LRR-XI-1 exon-intron and domain diagram (part 2)

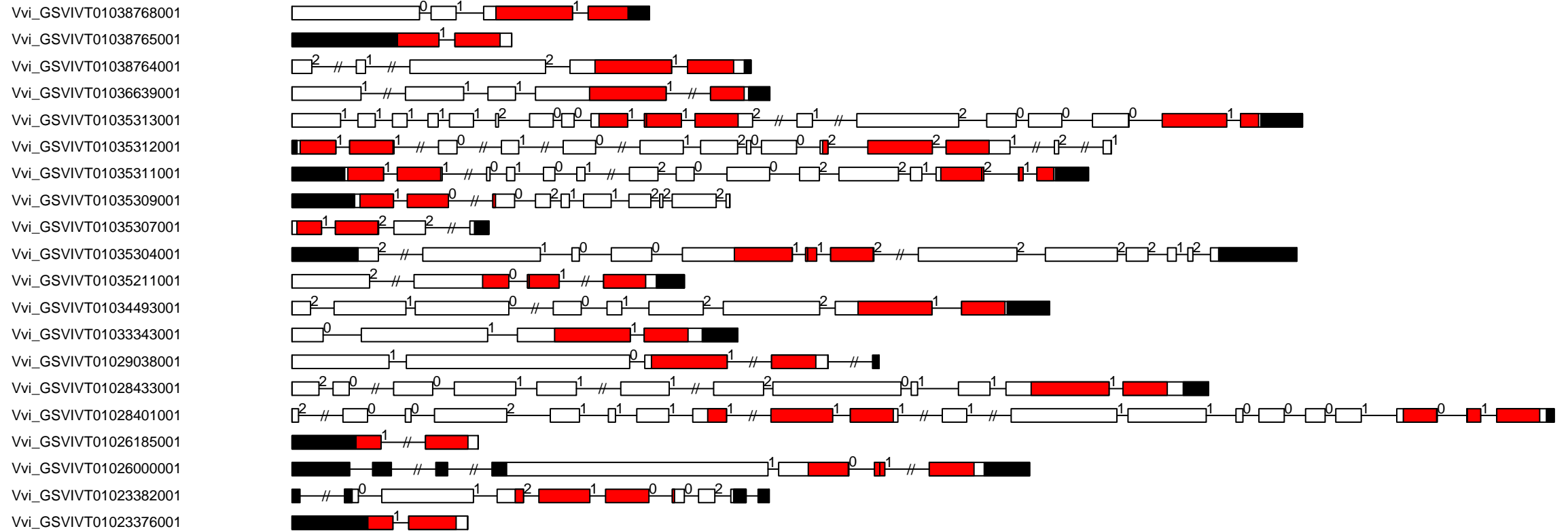

V.vi RLK-Pelle_LRR-XI-1 exon-intron and domain diagram (part 3)

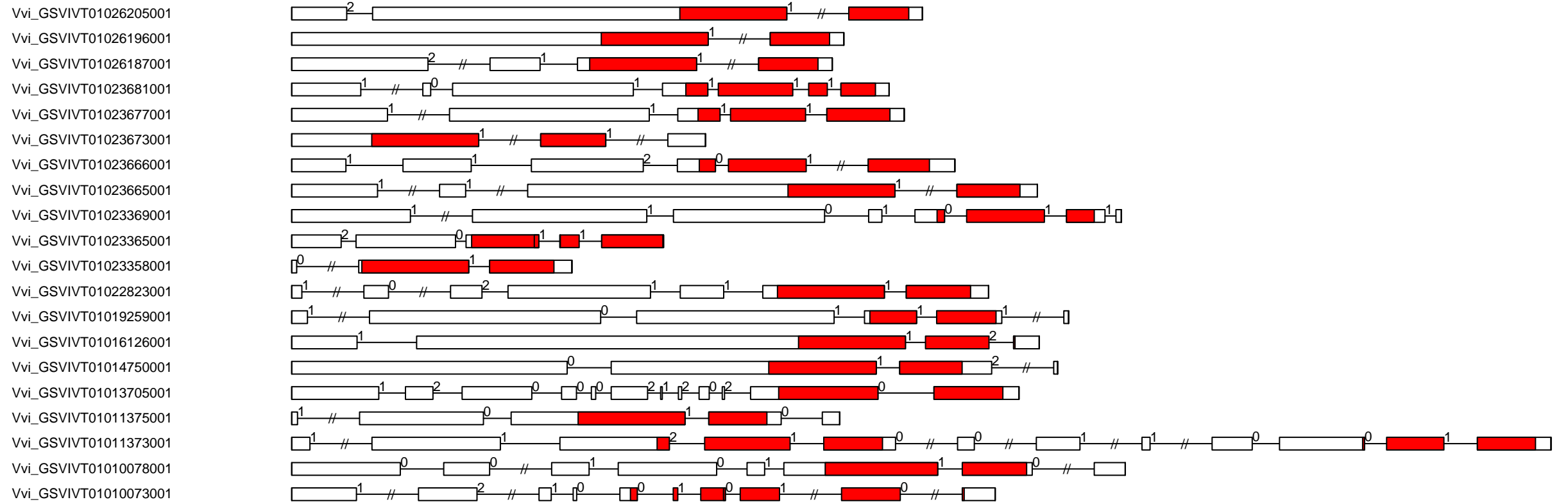

V.vi RLK-Pelle_LRR-XI-1 exon-intron and domain diagram (part 4)

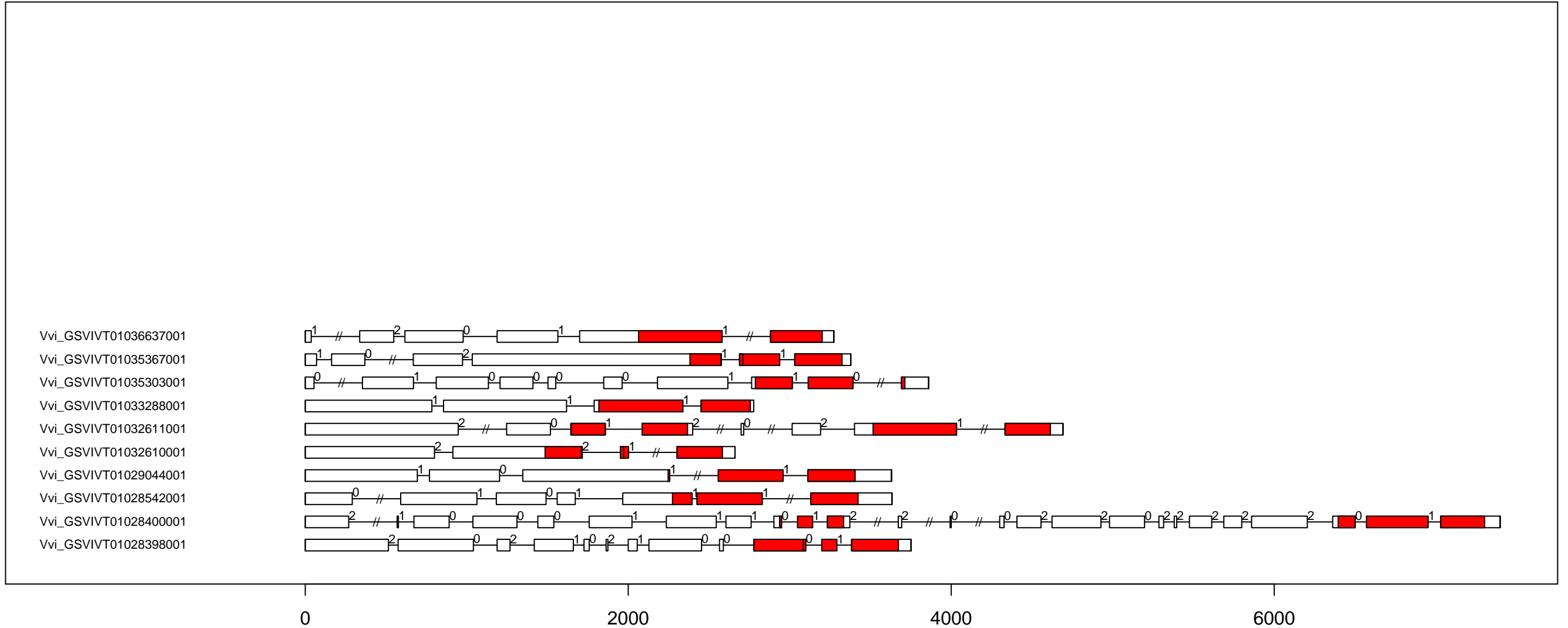

V.vi RLK-Pelle_LRR-XI-2 exon-intron and domain diagram (all)

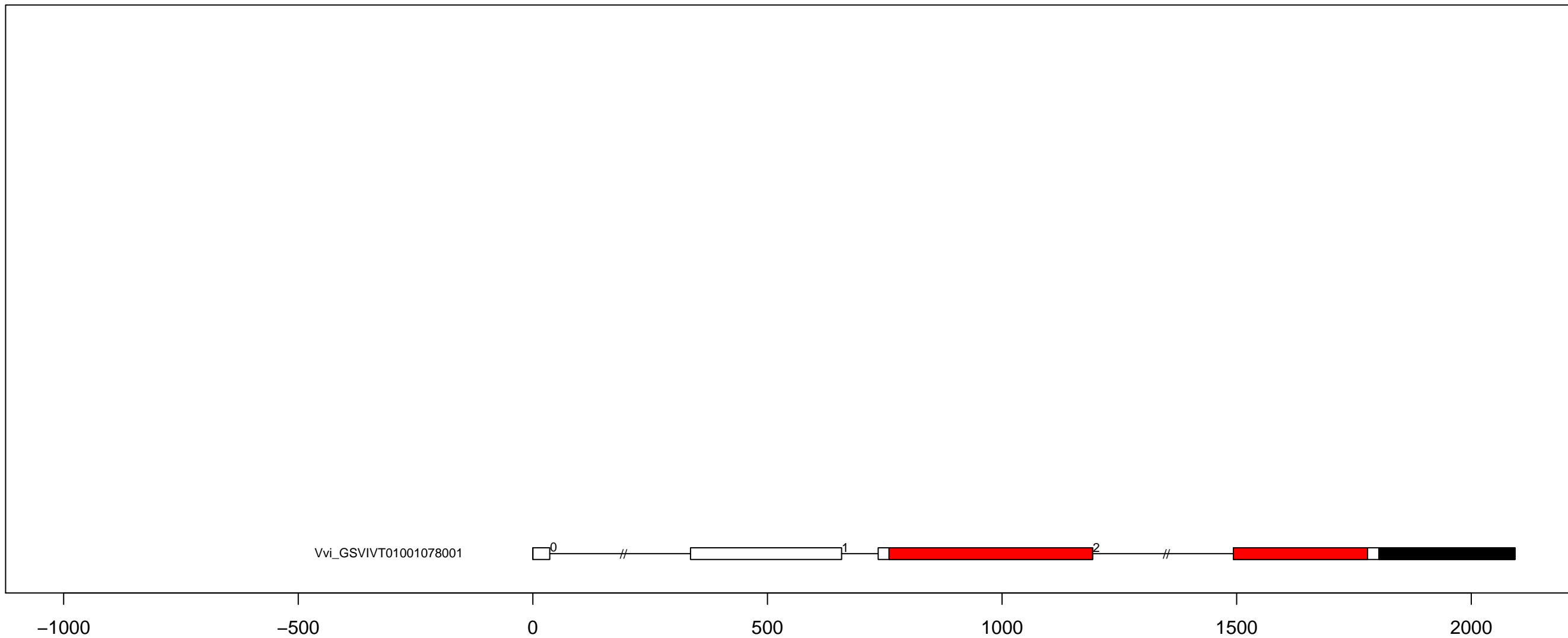

V.vi RLK-Pelle_LRR-XII-1 exon-intron and domain diagram (part 1)

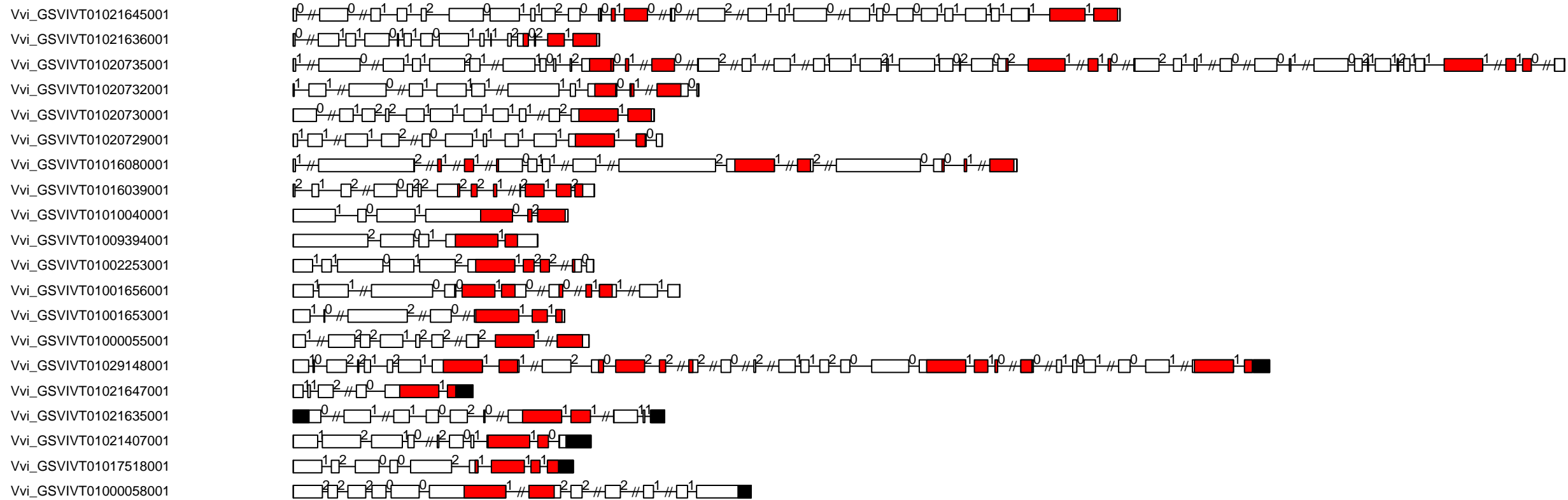

0

5000

10000

15000

V.vi RLK-Pelle_LRR-XII-1 exon-intron and domain diagram (part 2)

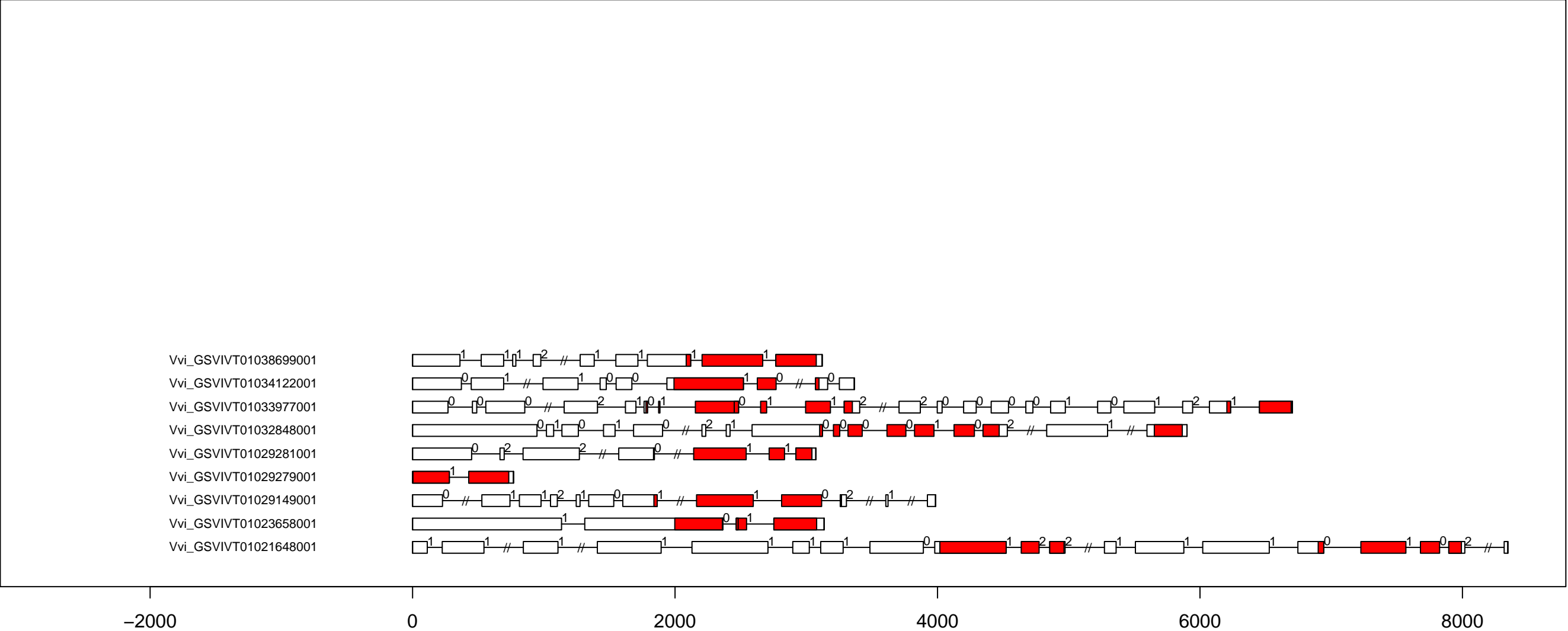

V.vi RLK-Pelle_LRR-XIIIa exon-intron and domain diagram (all)

Vvi_GSVIVT01020857001
 Vvi_GSVIVT01036936001
 Vvi_GSVIVT01014070001
 Vvi_GSVIVT01008070001

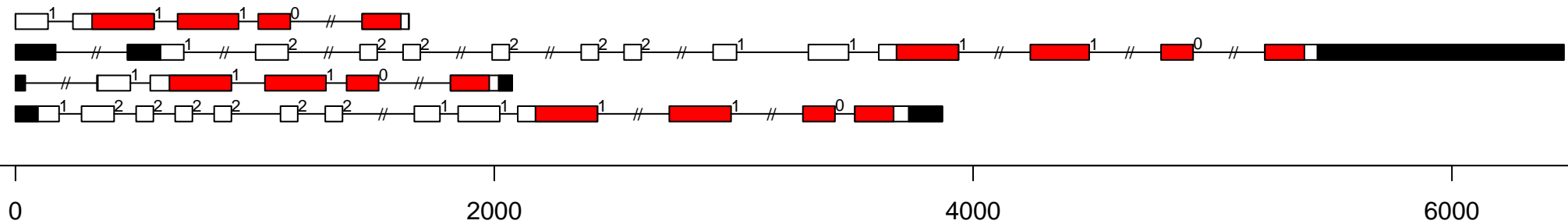

V.vi RLK-Pelle_LRR-XIIIb exon-intron and domain diagram (all)

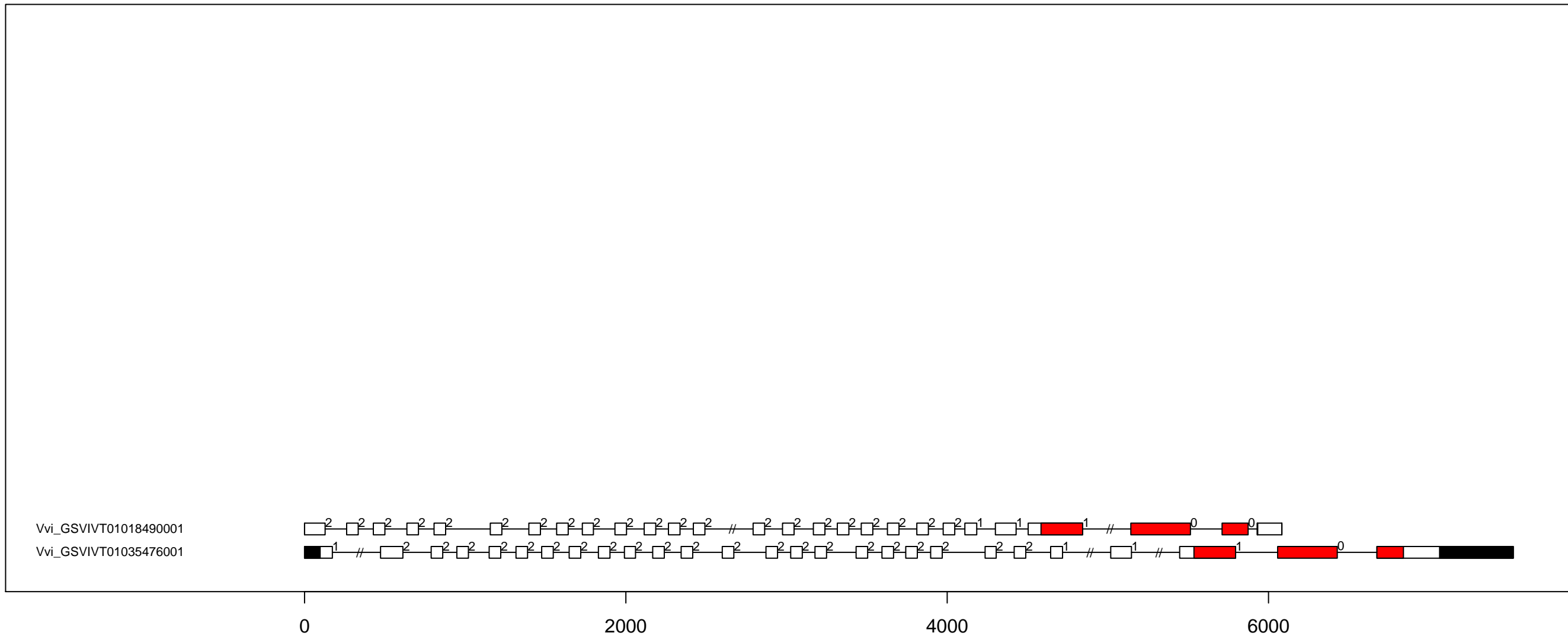

V.vi RLK-Pelle_LRR-XIV exon-intron and domain diagram (all)

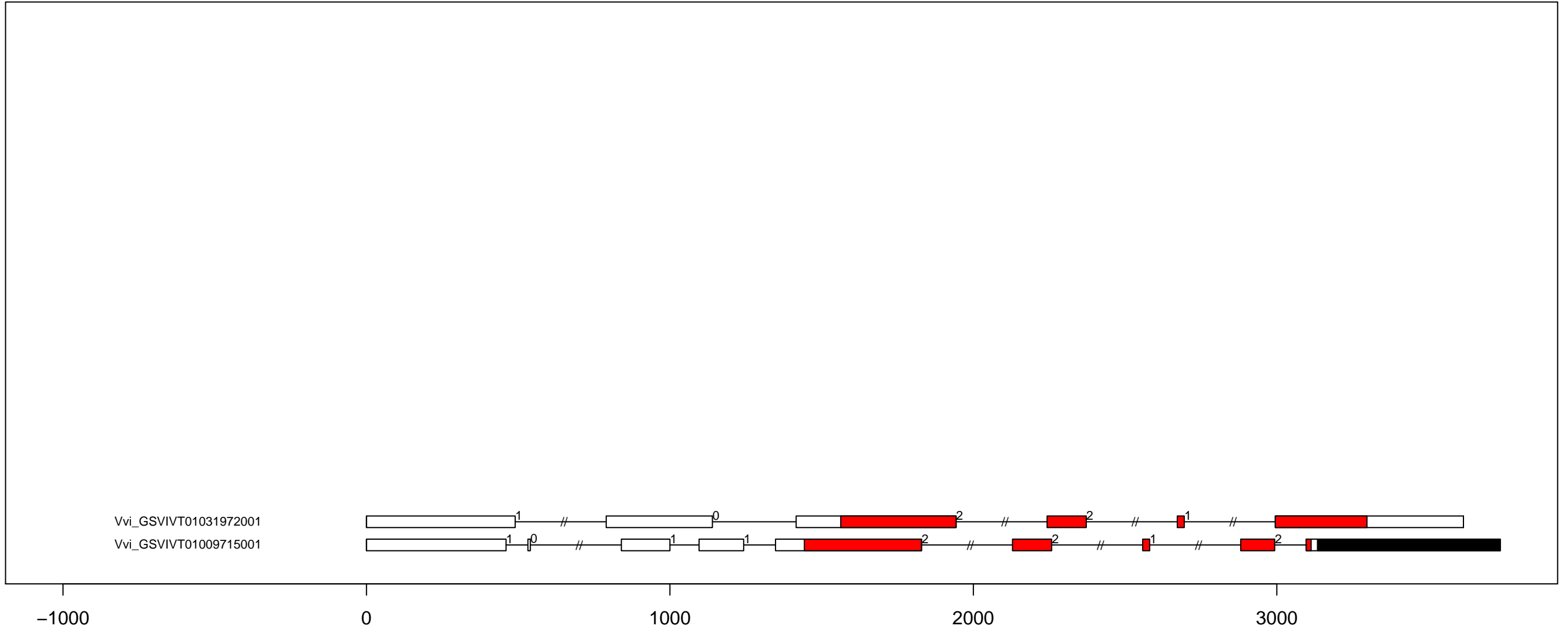

V.vi RLK-Pelle_LysM exon-intron and domain diagram (all)

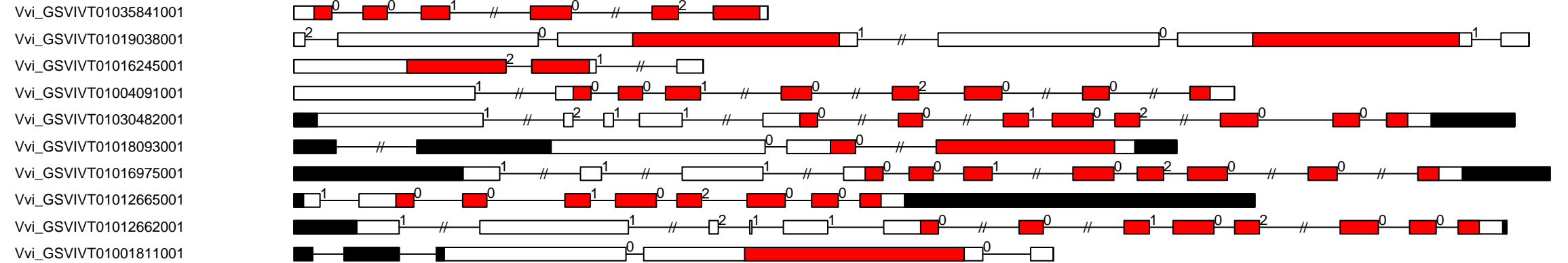

V.vi RLK-Pelle_PERK-1 exon-intron and domain diagram (all)

Vvi_GSVIVT01013741001
 Vvi_GSVIVT01036465001
 Vvi_GSVIVT01031954001
 Vvi_GSVIVT01018982001
 Vvi_GSVIVT01017060001
 Vvi_GSVIVT01015383001
 Vvi_GSVIVT01012008001
 Vvi_GSVIVT01003848001

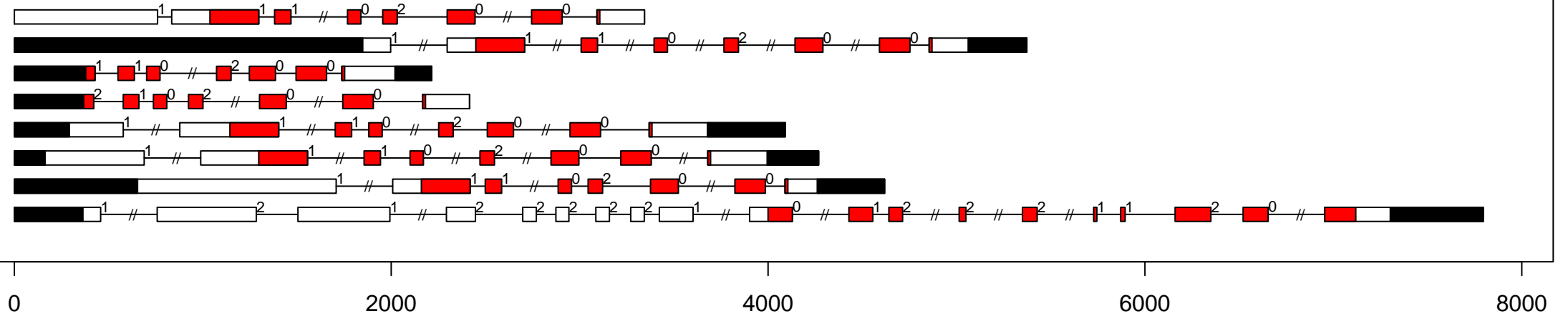

V.vi RLK-Pelle_PERK-2 exon-intron and domain diagram (all)

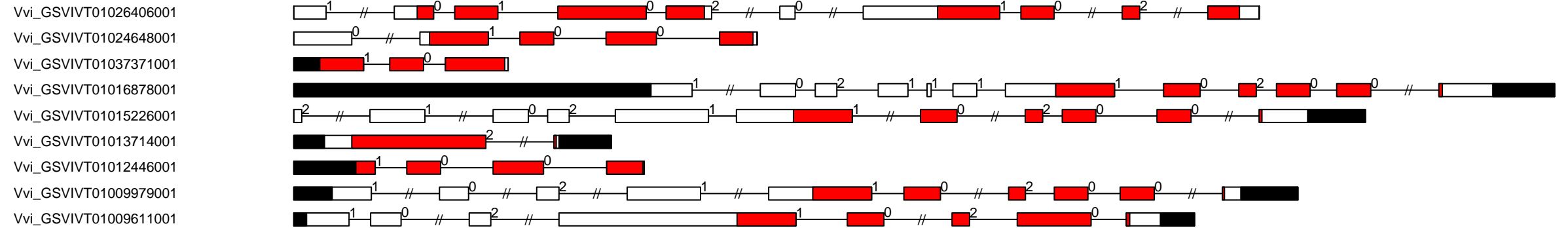

-1000

0

1000

2000

3000

4000

5000

V.vi RLK-Pelle_RKF3 exon-intron and domain diagram (all)

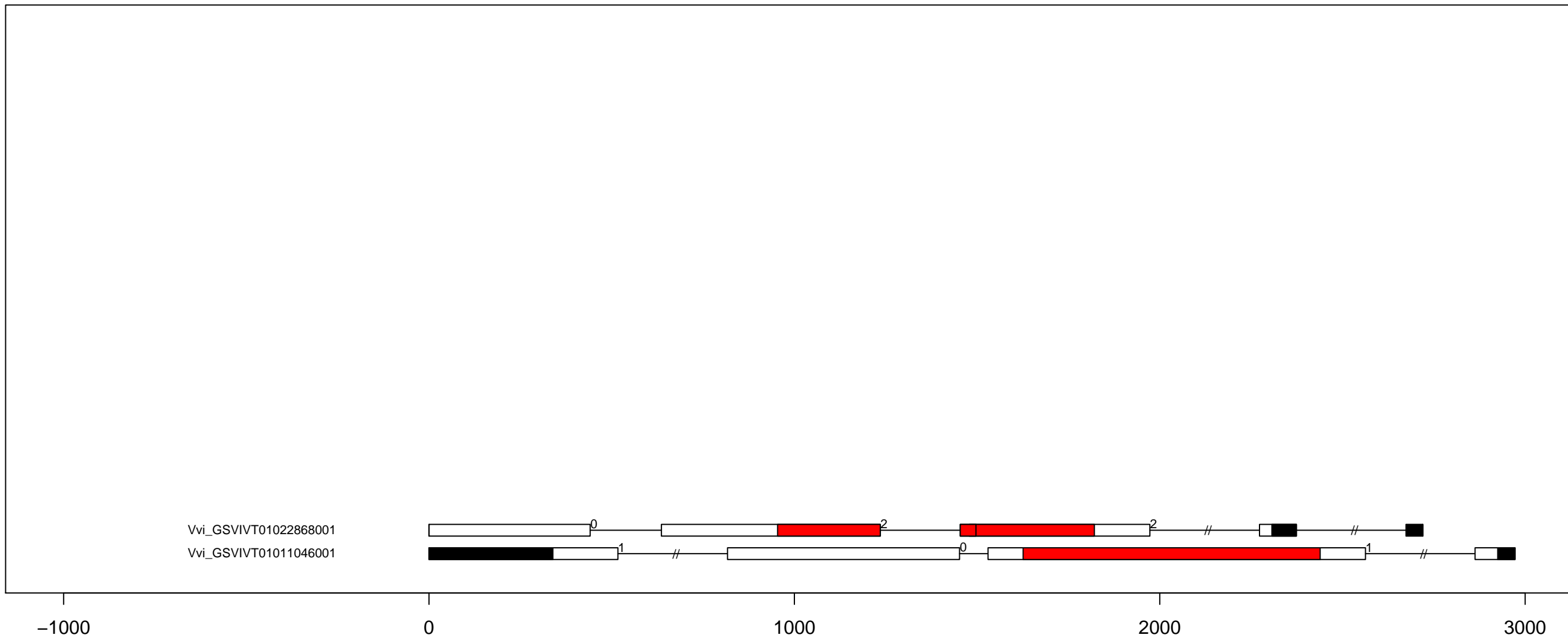

V.vi RLK-Pelle_RLCK-II exon-intron and domain diagram (all)

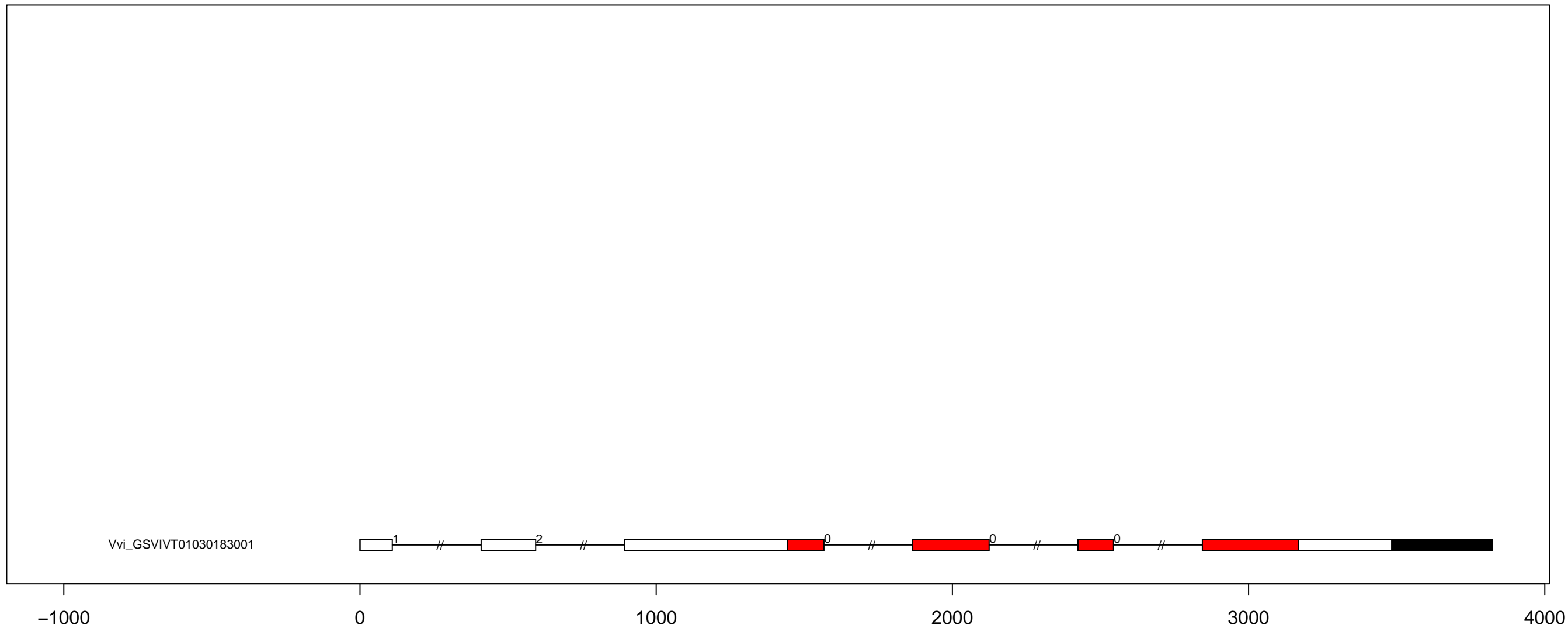

V.vi RLK-Pelle_RLCK-IV exon-intron and domain diagram (all)

Vvi_GSVIVT01027001001
Vvi_GSVIVT01024803001
Vvi_GSVIVT01012827001

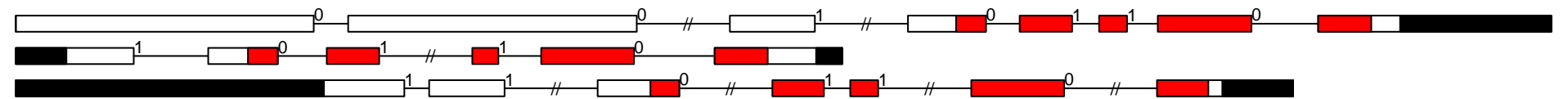

-1000

0

1000

2000

3000

4000

5000

V.vi RLK-Pelle_RLCK-IXa exon-intron and domain diagram (all)

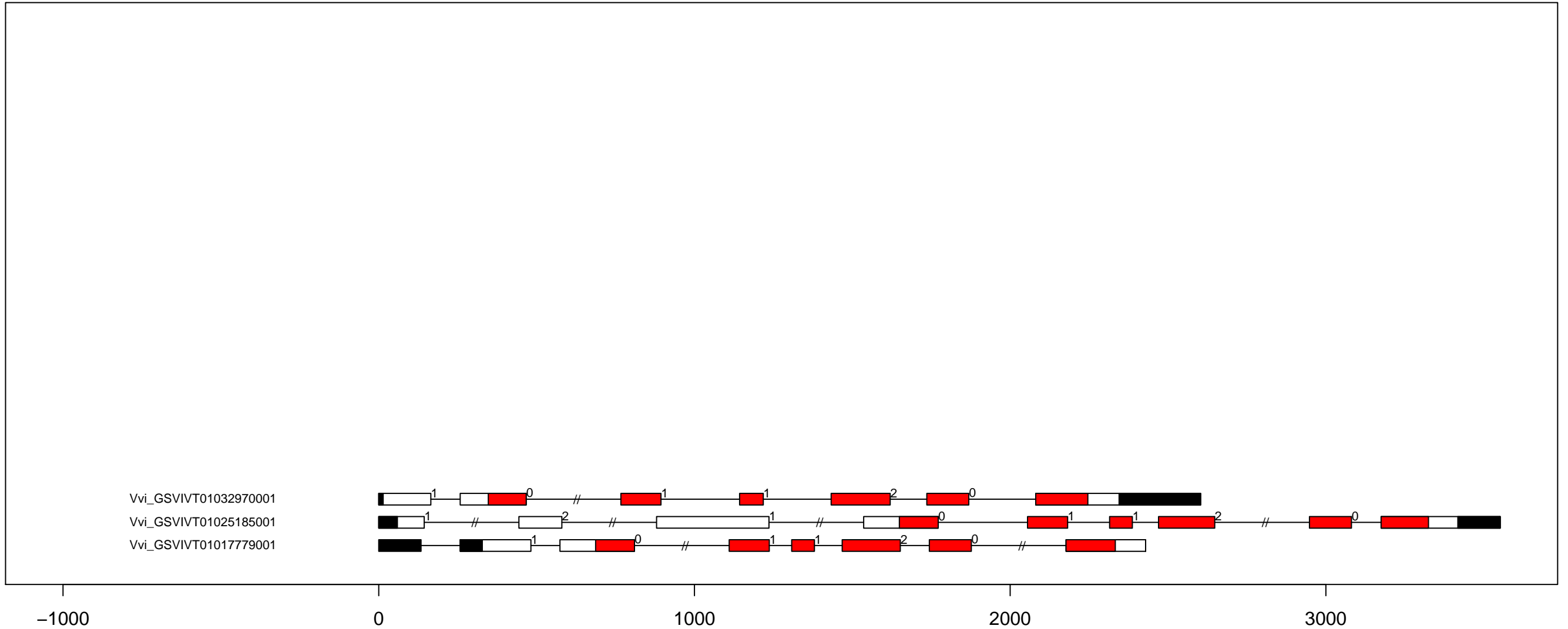

V.vi RLK-Pelle_RLCK-IXb exon-intron and domain diagram (all)

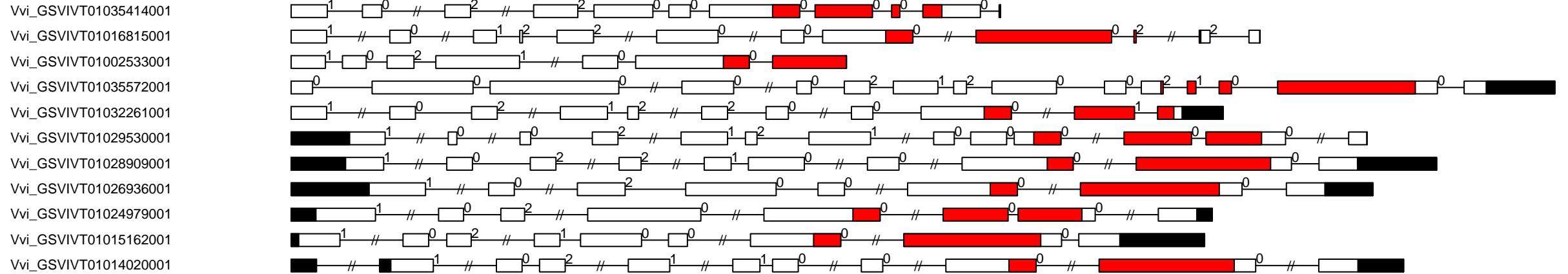

V.vi RLK-Pelle_RLCK-ViIa-1 exon-intron and domain diagram (all)

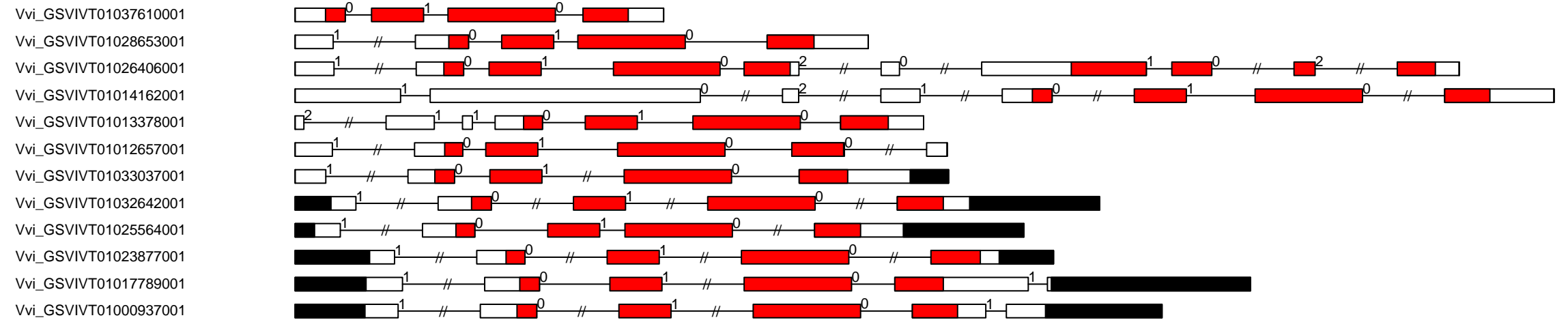

V.vi RLK-Pelle_RLCK-ViIa-2 exon-intron and domain diagram (part 1)

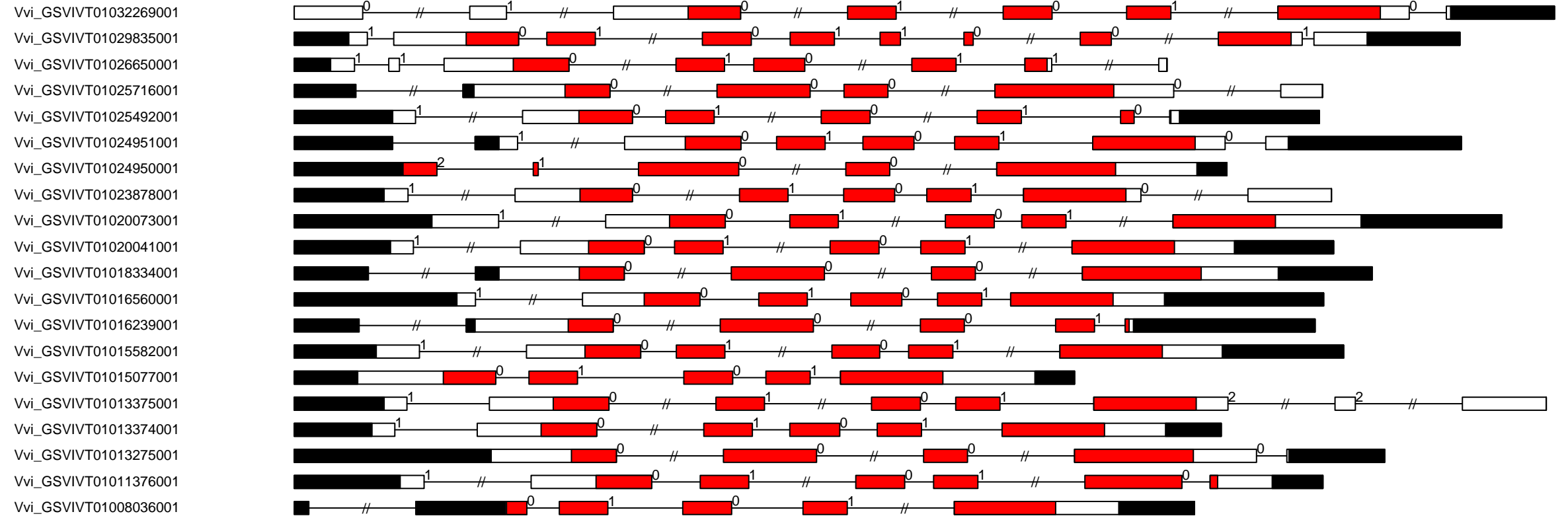

-1000

0

1000

2000

3000

V.vi RLK-Pelle_RLCK-VIIa-2 exon-intron and domain diagram (part 2)

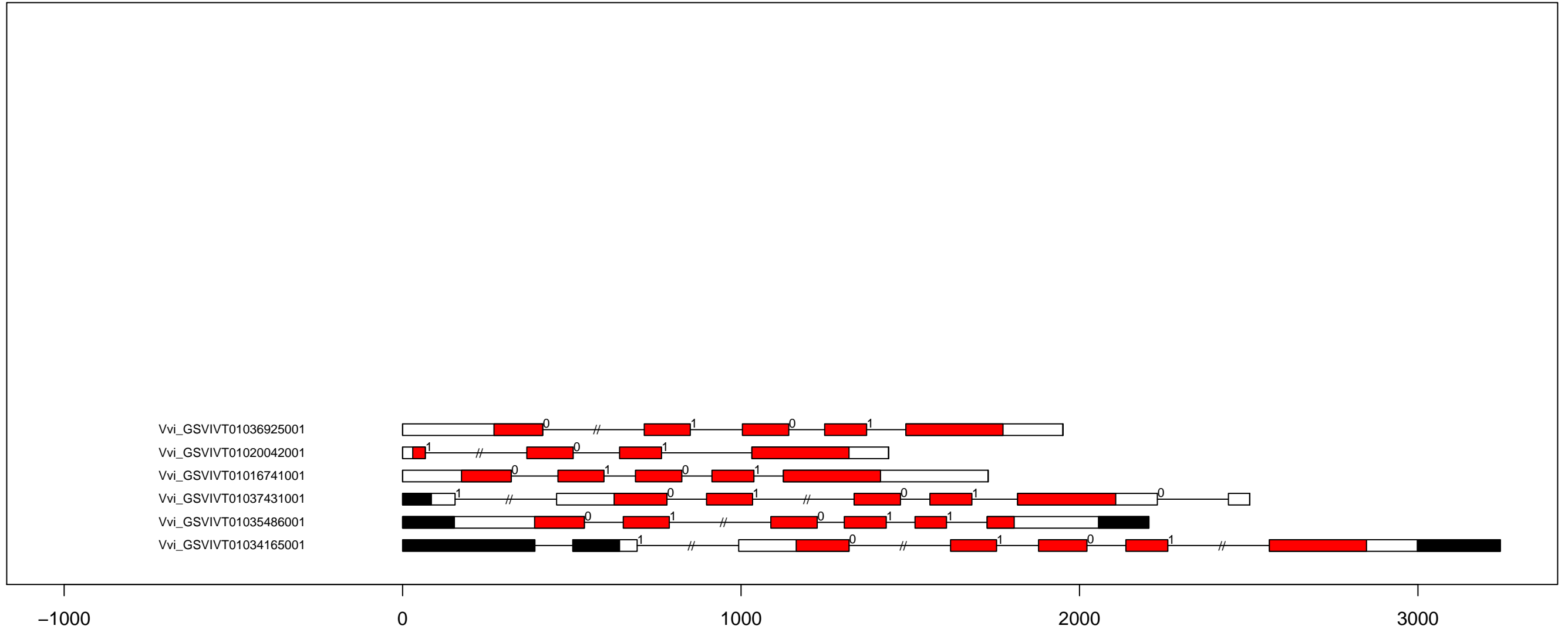

V.vi RLK-Pelle_RLCK-VIIb exon-intron and domain diagram (all)

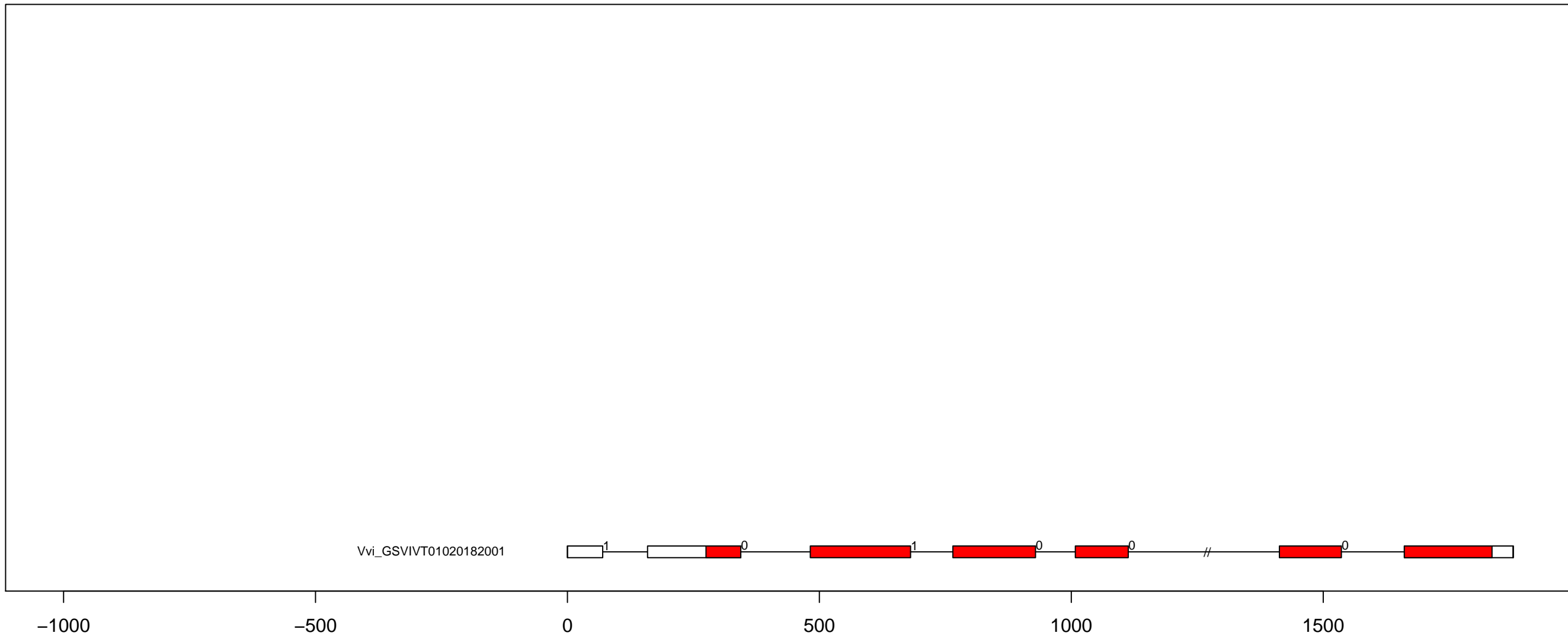

V.vi RLK–Pelle_RLCK–VIII exon–intron and domain diagram (all)

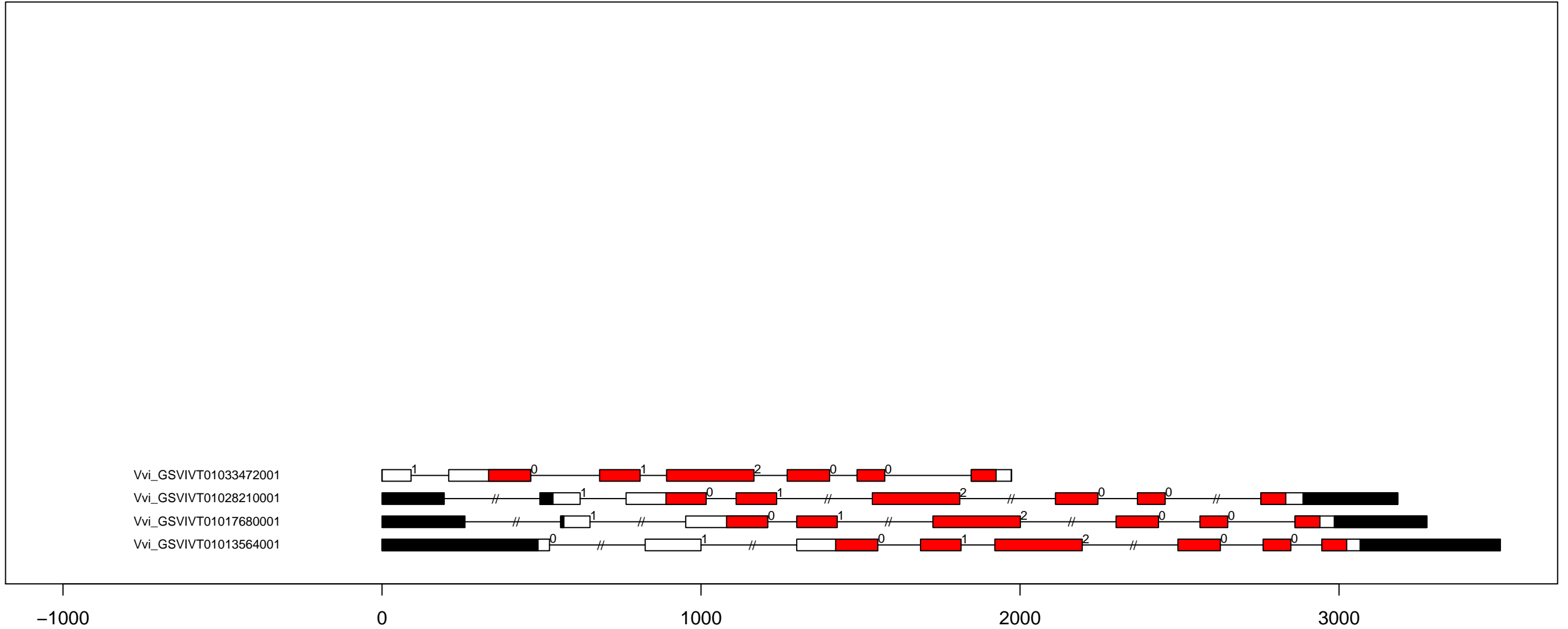

V.vi RLK-Pelle_RLCK-VI exon-intron and domain diagram (all)

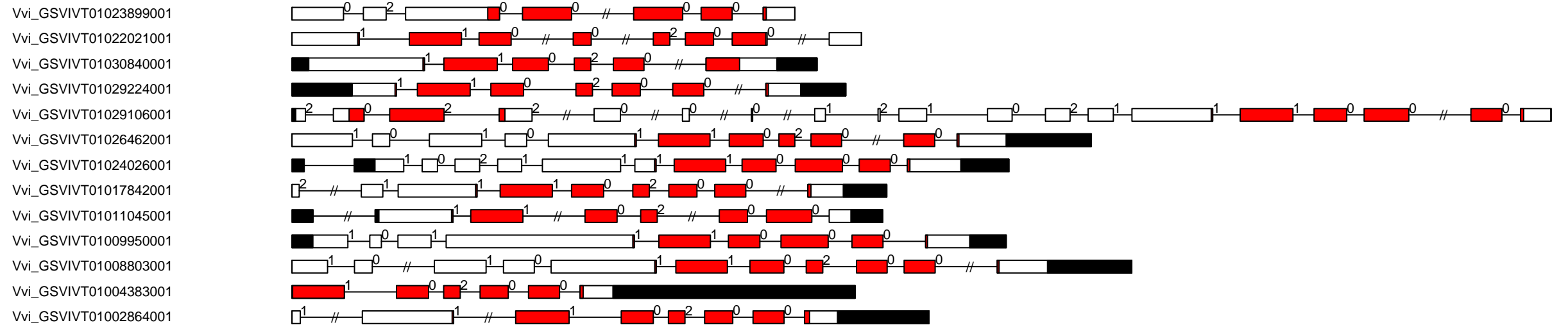

V.vi RLK-Pelle_RLCK-V exon-intron and domain diagram (all)

Vvi_GSVIVT01028858001
Vvi_GSVIVT01031962001
Vvi_GSVIVT01031315001
Vvi_GSVIVT01026982001
Vvi_GSVIVT01022114001
Vvi_GSVIVT01020860001
Vvi_GSVIVT01017681001
Vvi_GSVIVT01009470001

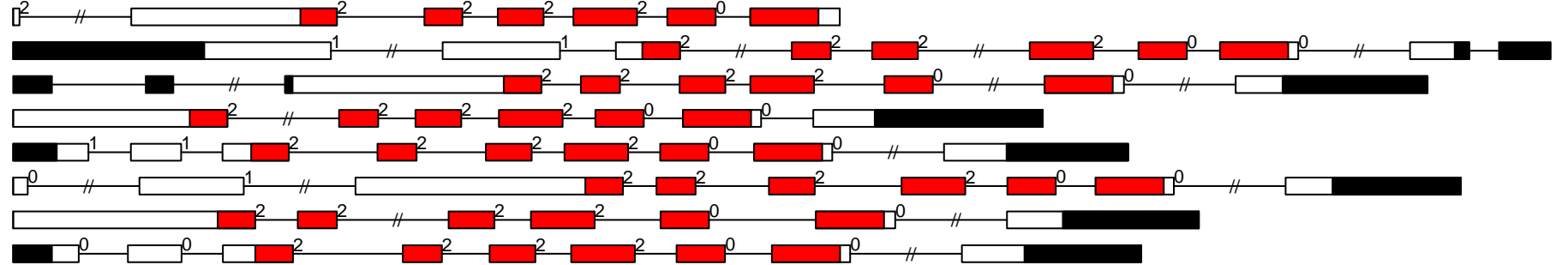

-1000

0

1000

2000

3000

4000

V.vi RLK-Pelle_RLCK-XII-1 exon-intron and domain diagram (all)

Vvi_GSVIVT01034043001
Vvi_GSVIVT01026892001
Vvi_GSVIVT01024833001
Vvi_GSVIVT01023930001
Vvi_GSVIVT01019759001
Vvi_GSVIVT01013173001
Vvi_GSVIVT01008685001

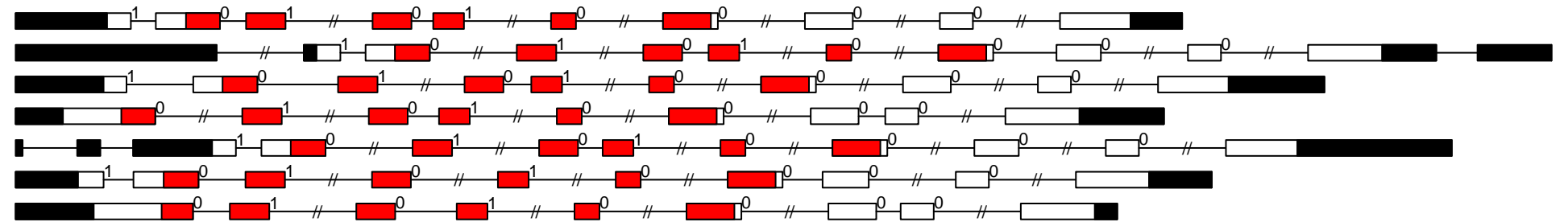

-1000

0

1000

2000

3000

4000

5000

V.vi RLK-Pelle_RLCK-XII-2 exon-intron and domain diagram (all)

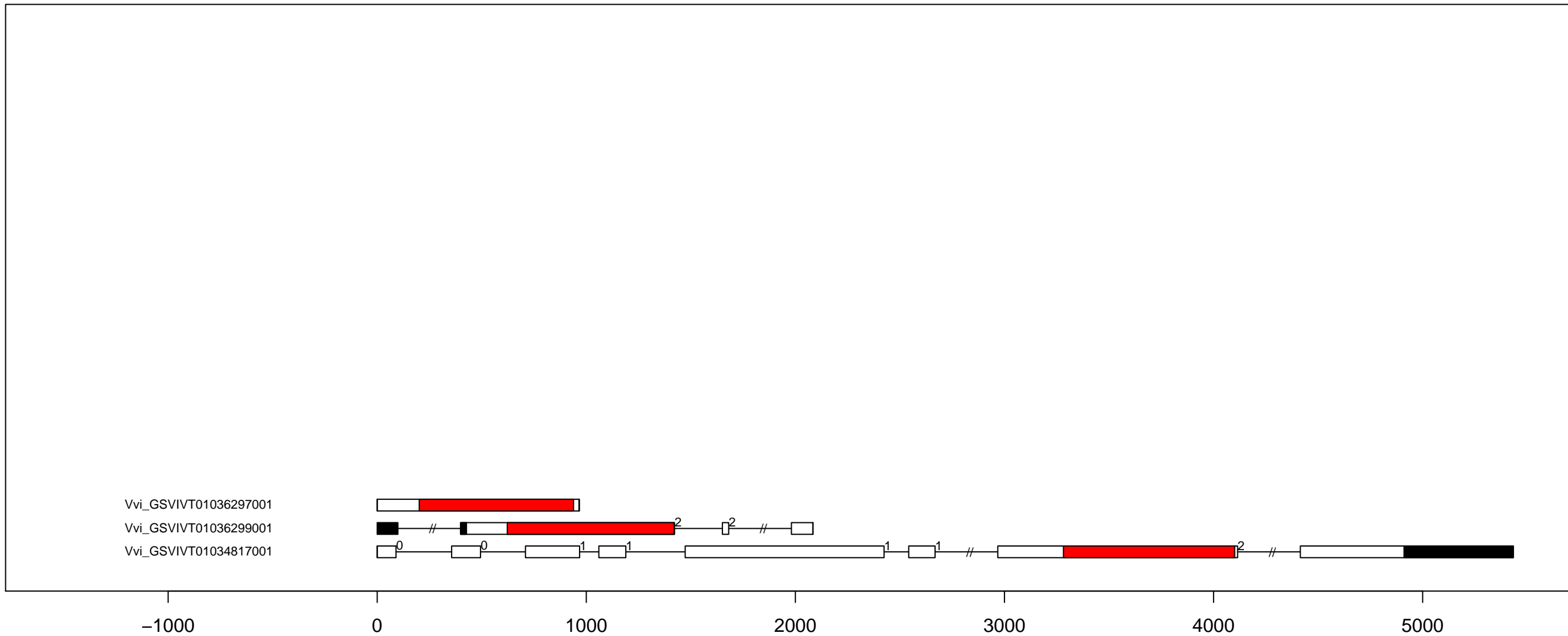

V.vi RLK-Pelle_RLCK-XIII exon-intron and domain diagram (all)

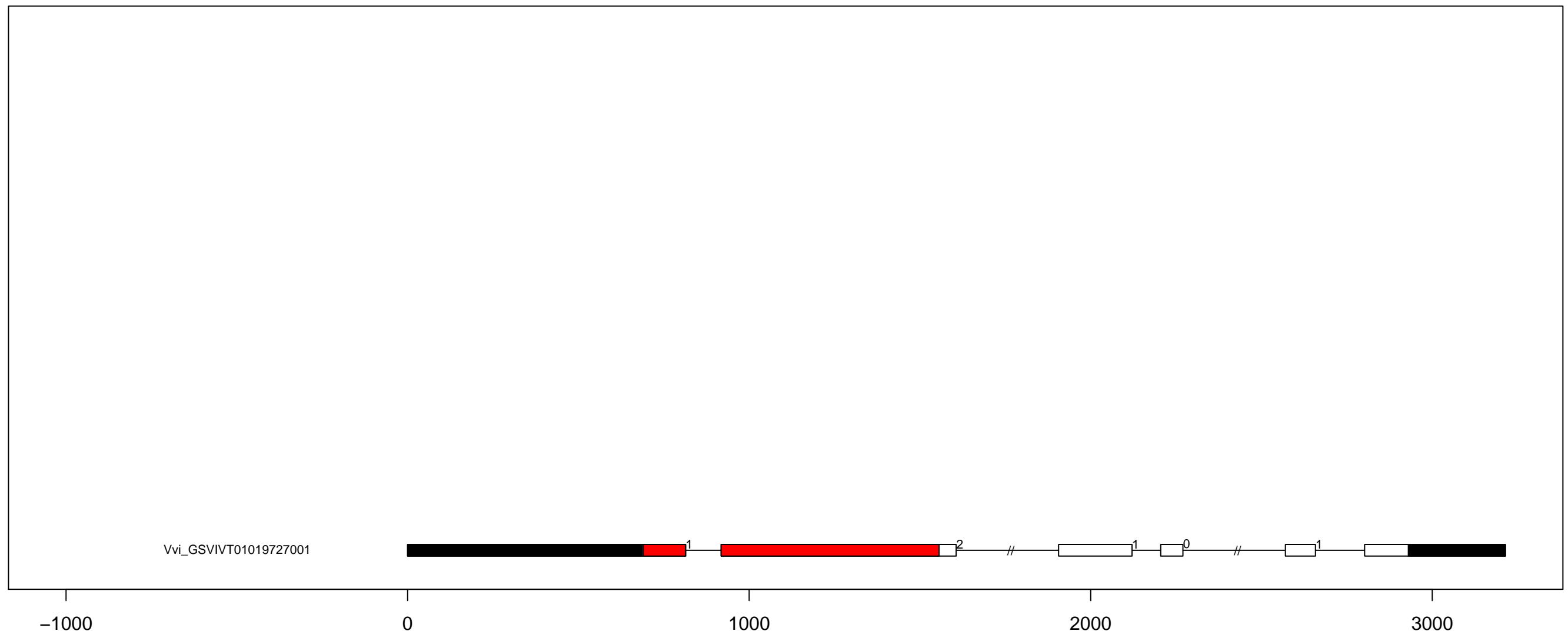

V.vi RLK-Pelle_RLCK-XI exon-intron and domain diagram (all)

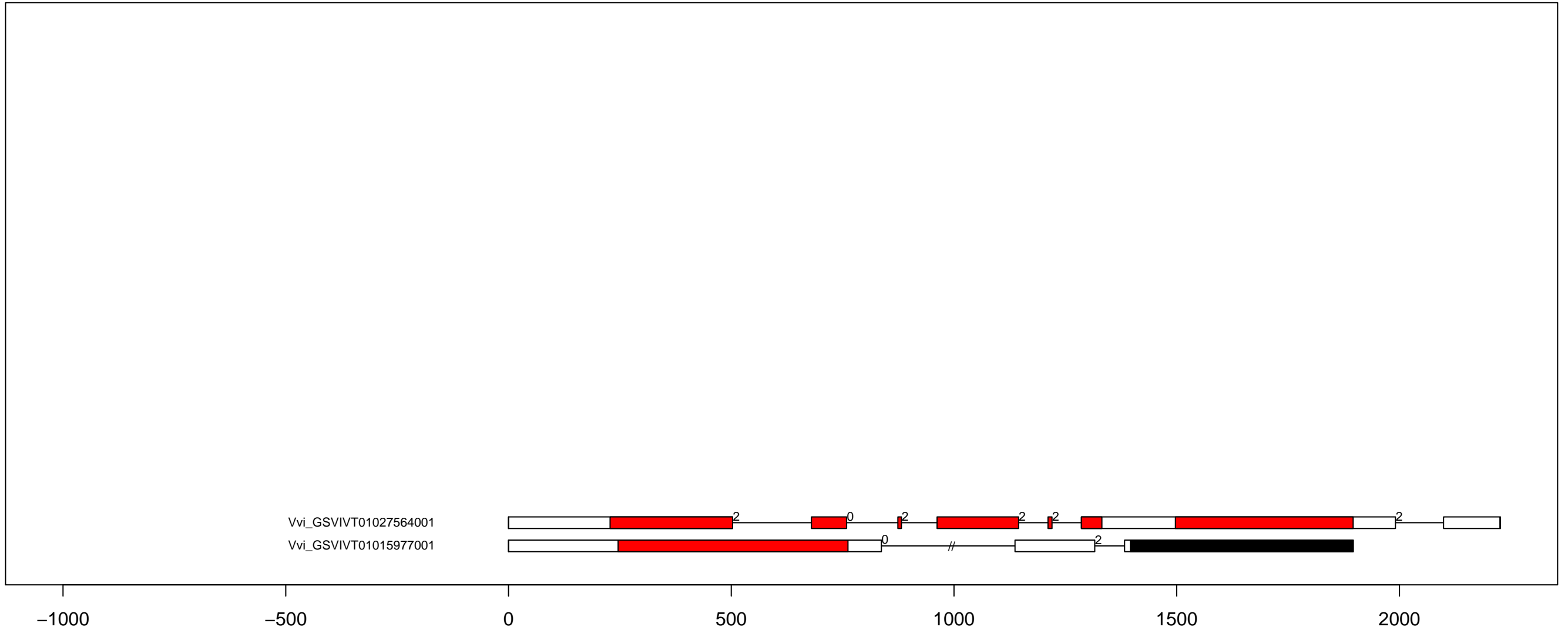

V.vi RLK-Pelle_RLCK-X exon-intron and domain diagram (all)

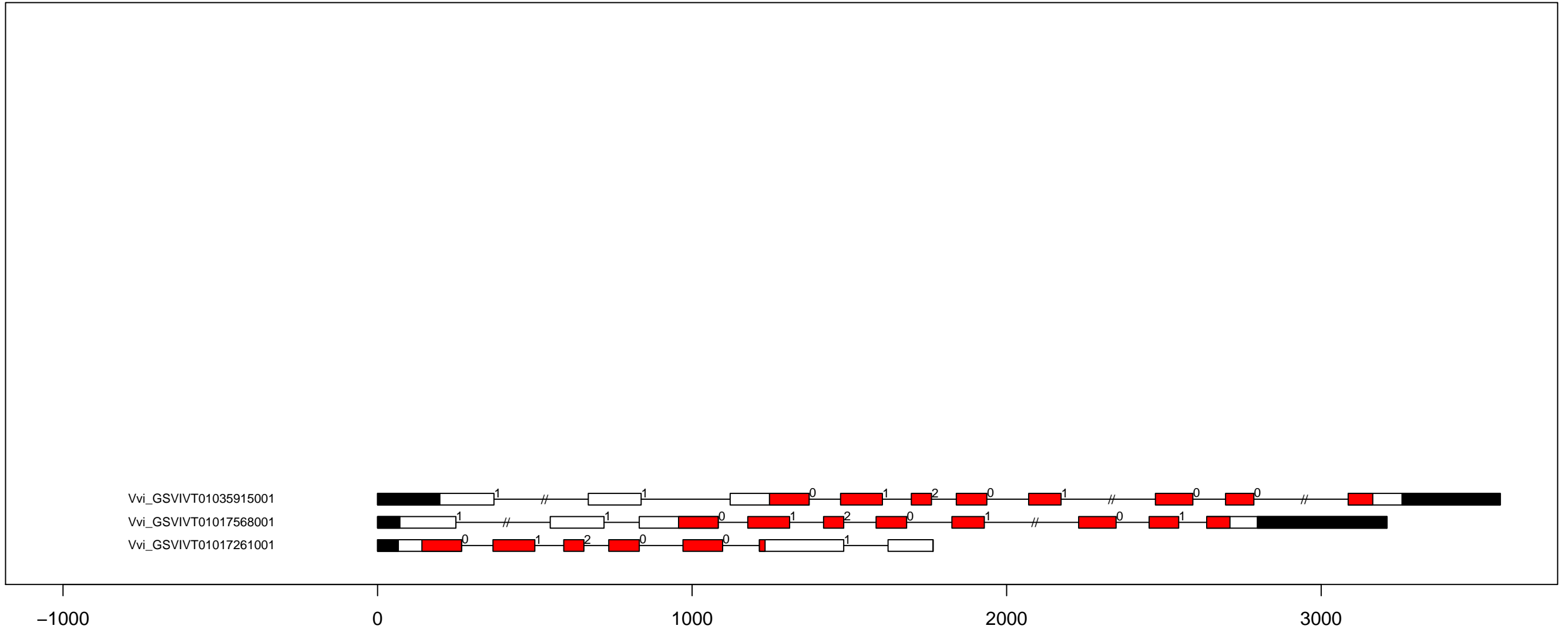

V.vi RLK-Pelle_RLCK-XVI exon-intron and domain diagram (all)

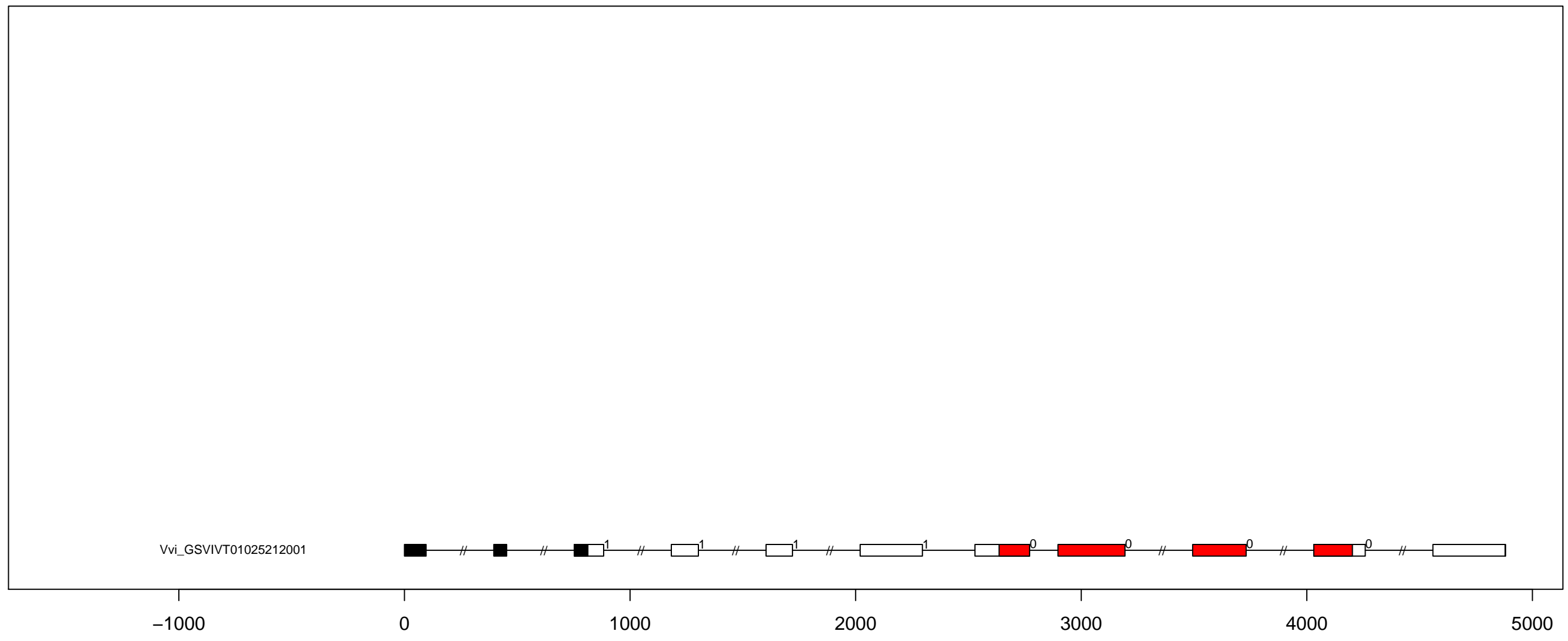

V.vi RLK-Pelle_RLCK-XV exon-intron and domain diagram (all)

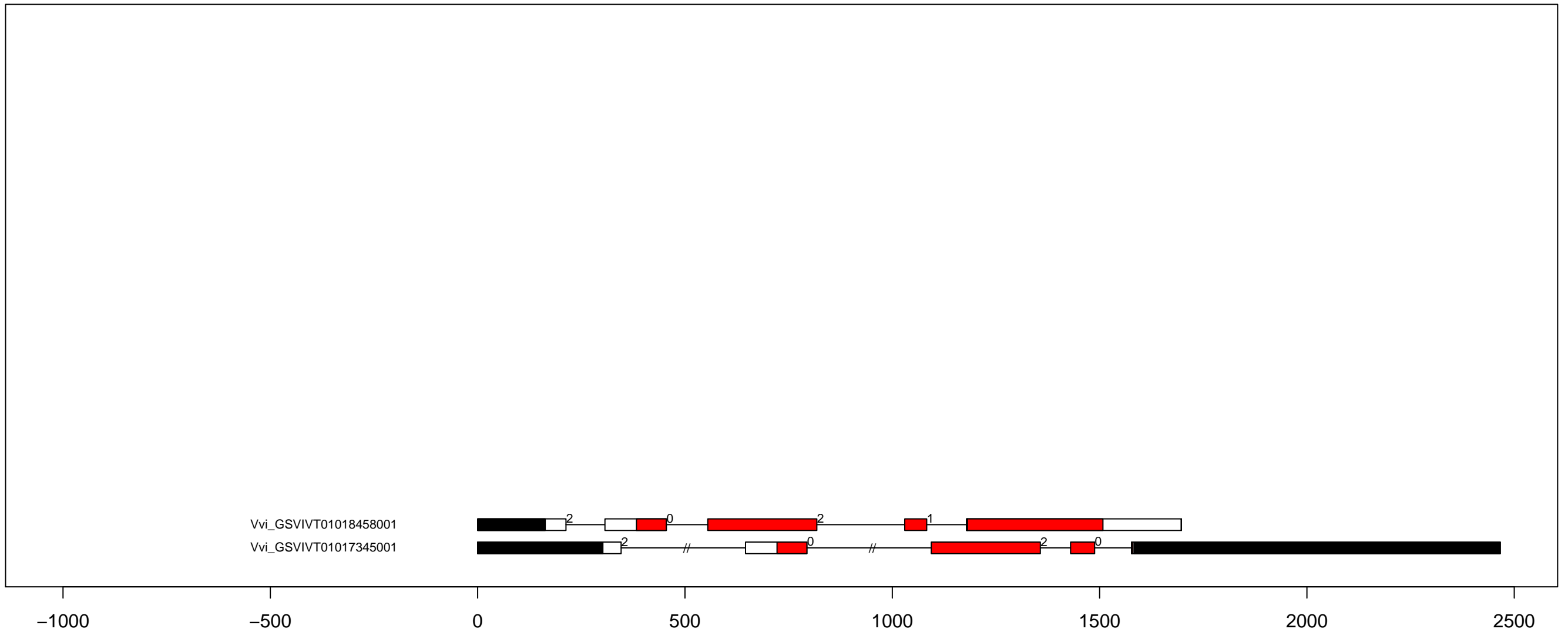

V.vi RLK-Pelle_SD-2b exon-intron and domain diagram (part 1)

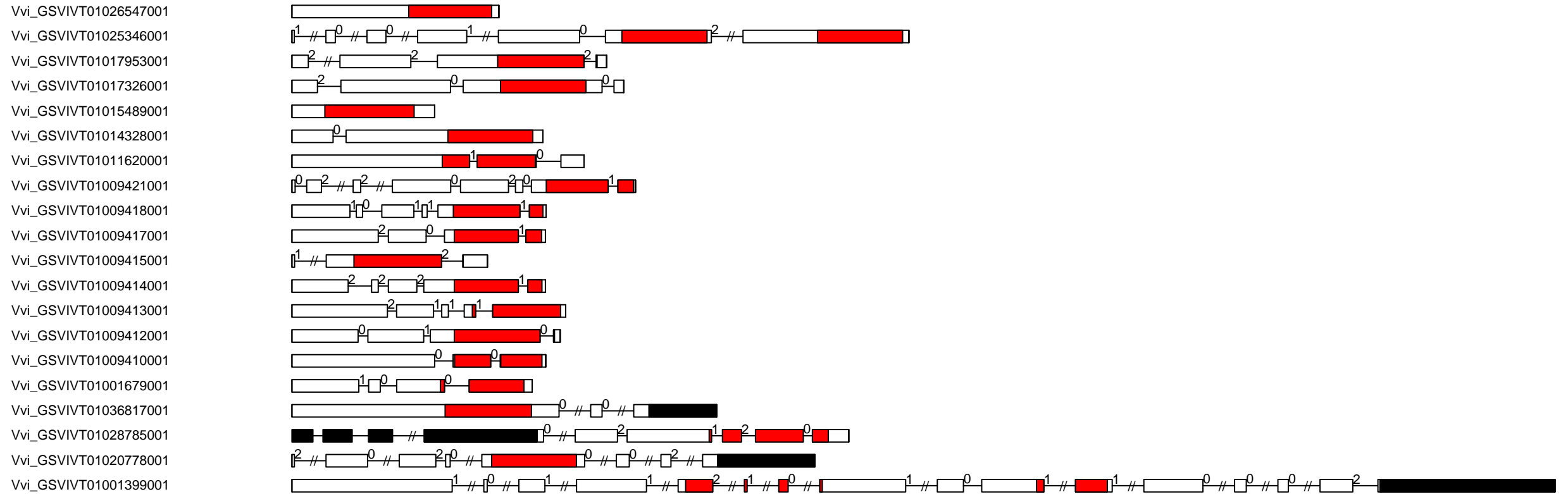

V.vi RLK-Pelle_SD-2b exon-intron and domain diagram (part 2)

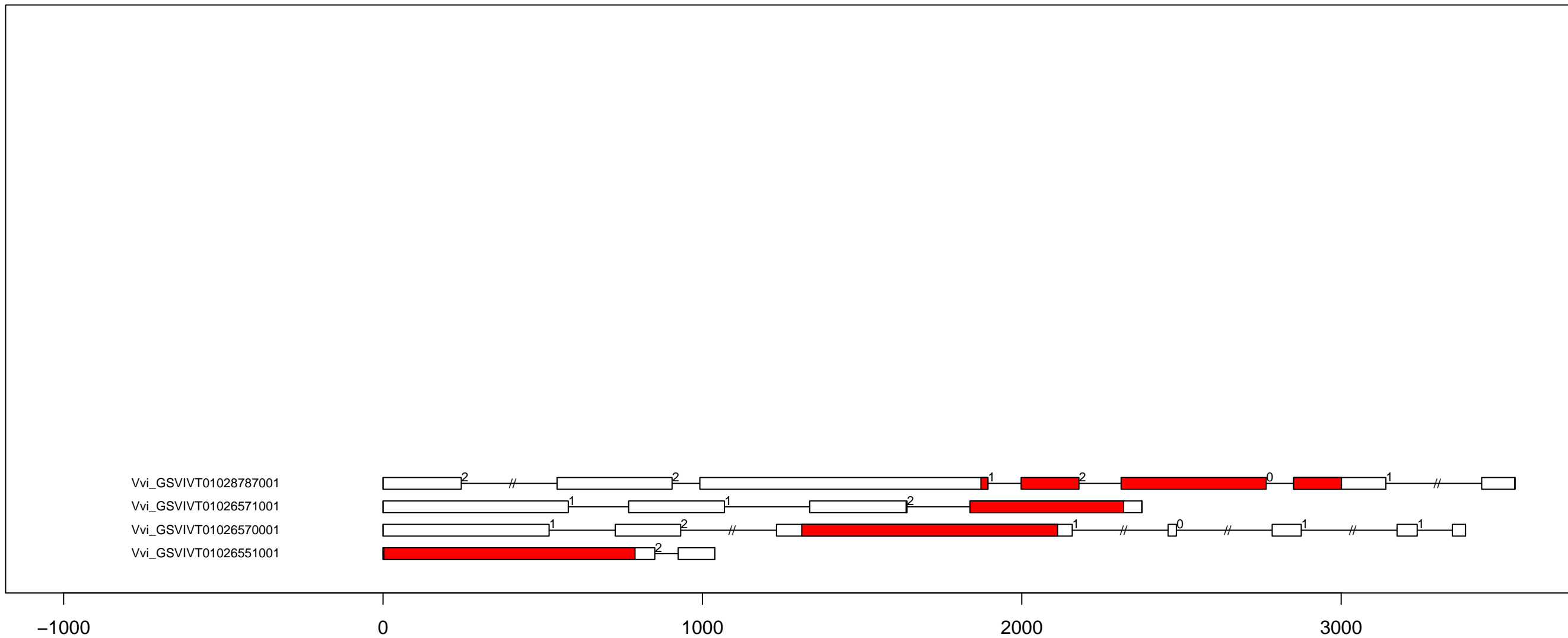

V.vi RLK-Pelle_Singleton exon-intron and domain diagram (all)

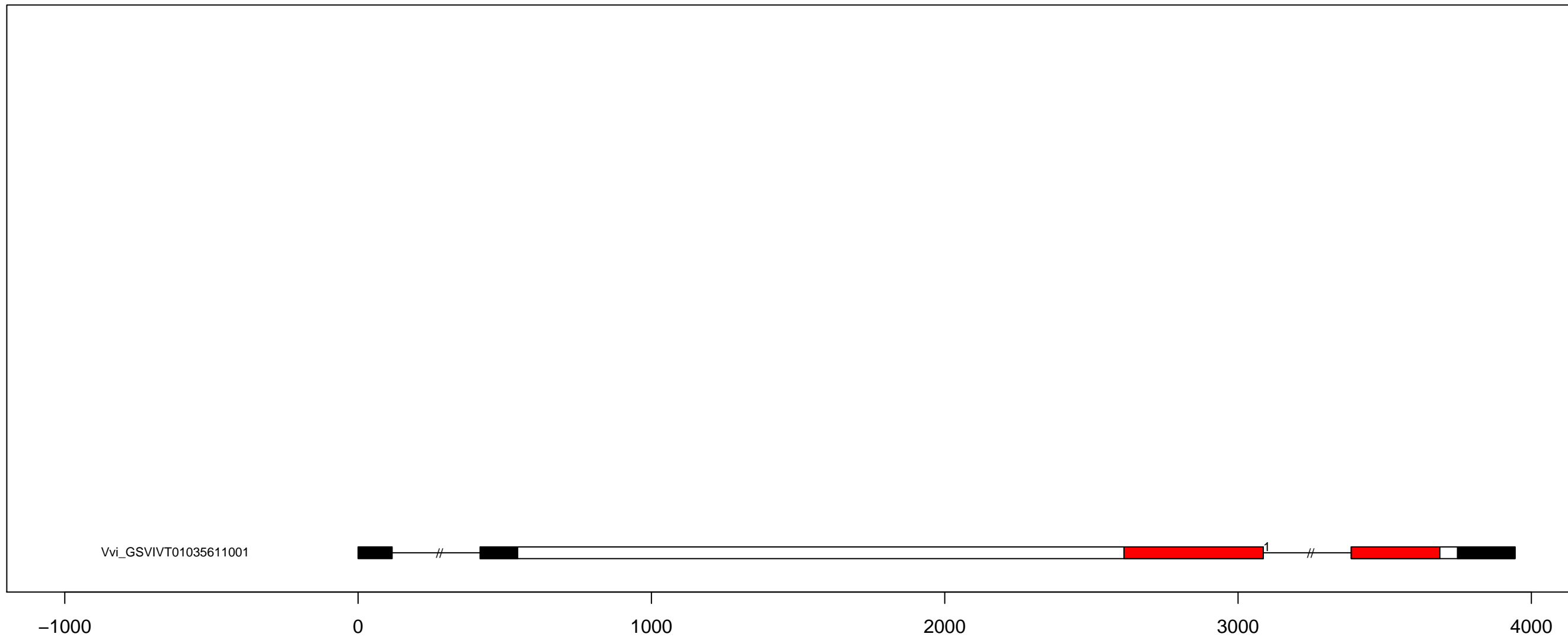

V.vi RLK-Pelle_URK-1 exon-intron and domain diagram (all)

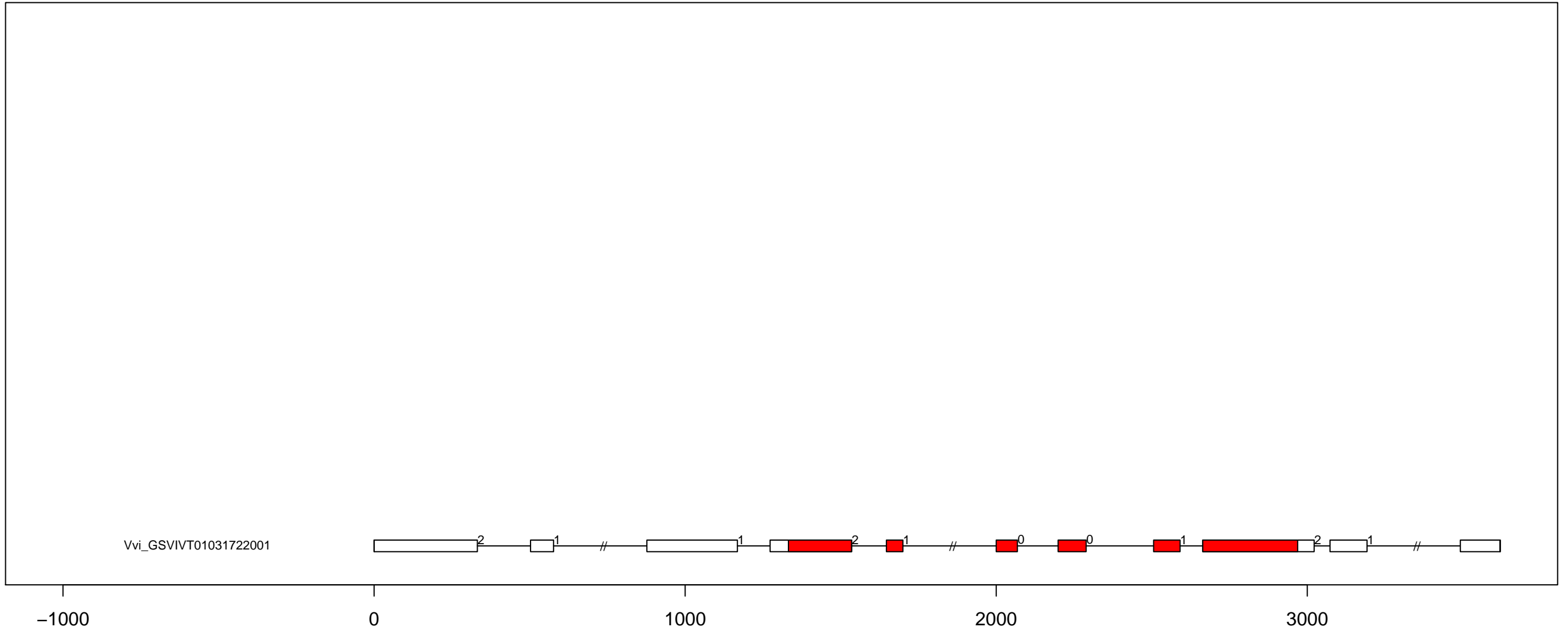

V.vi RLK-Pelle_URK-2 exon-intron and domain diagram (all)

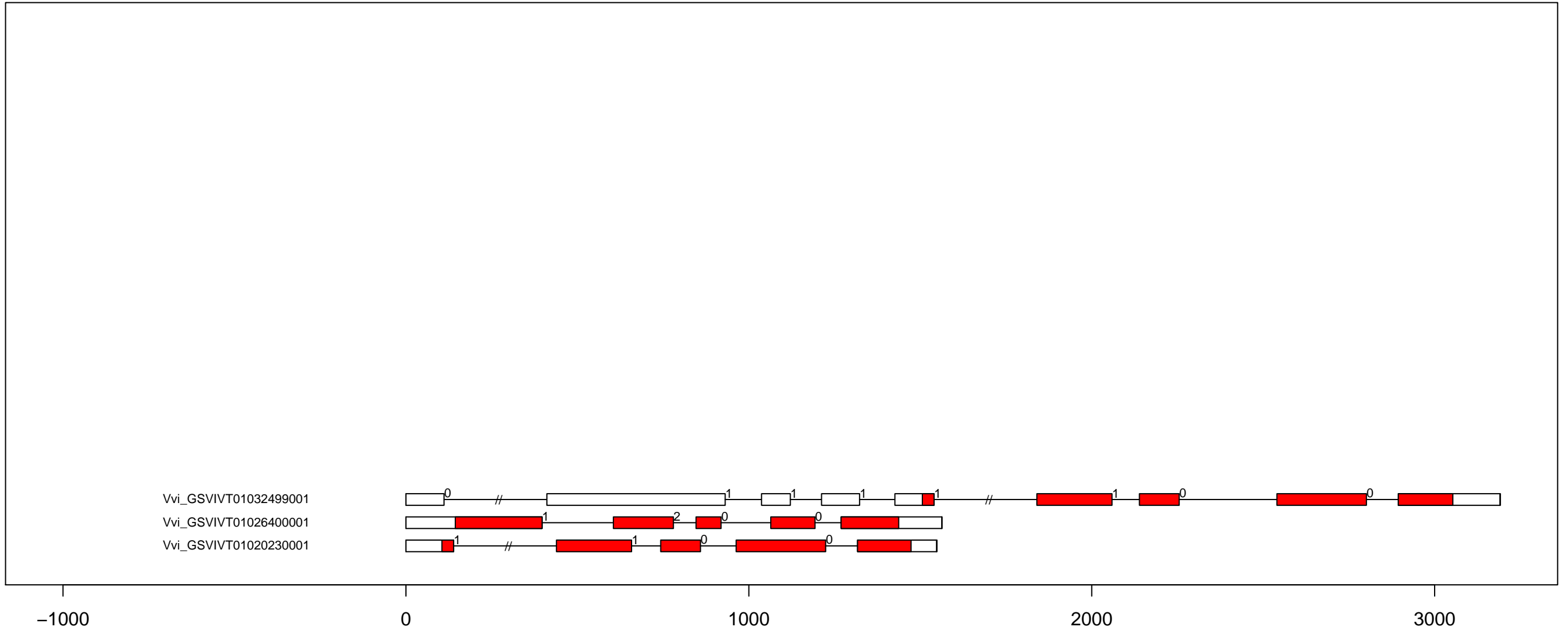

V.vi RLK-Pelle_URK-3 exon-intron and domain diagram (all)

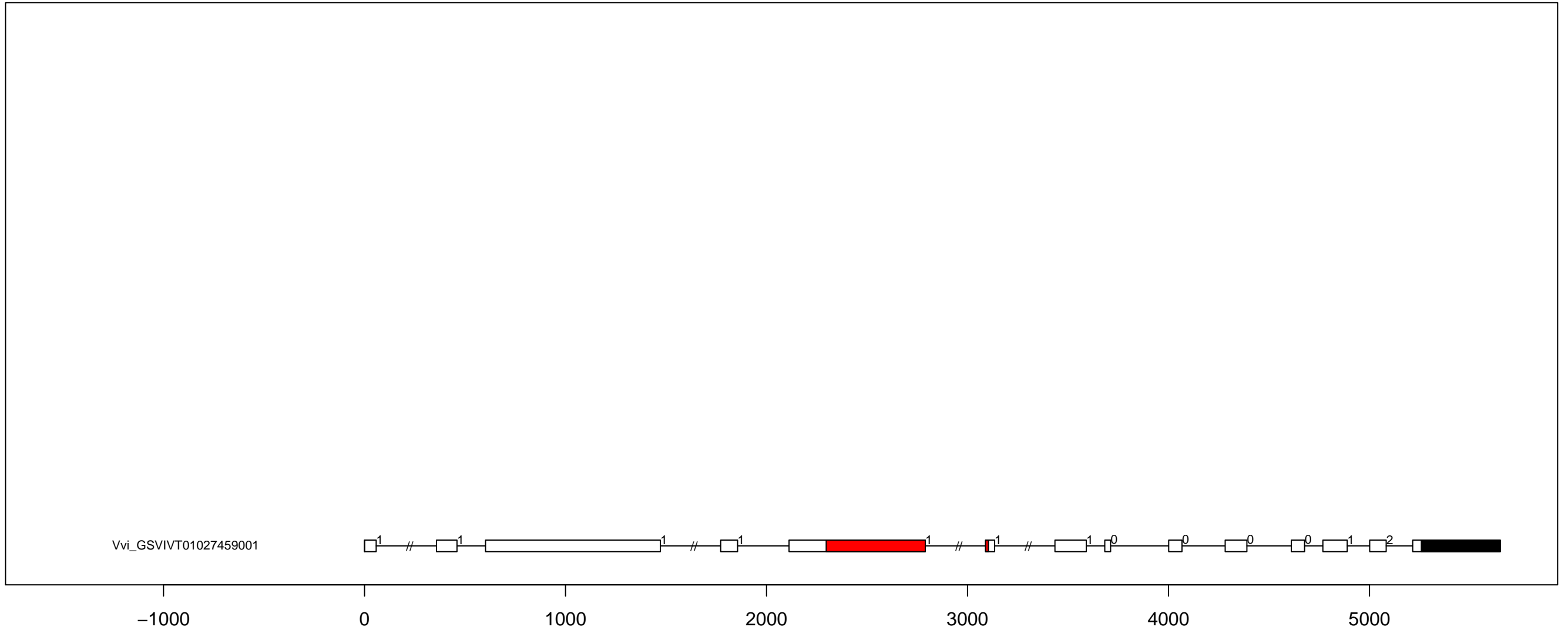

V.vi RLK-Pelle_WAK_LRK10L-1 exon-intron and domain diagram (all)

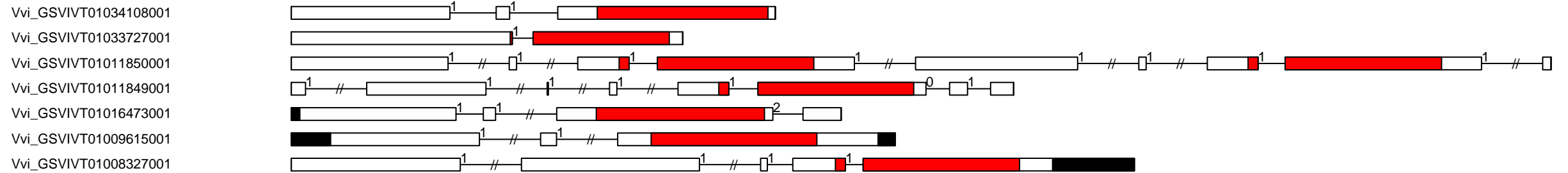

V.vi RLK-Pelle_WAK exon-intron and domain diagram (all)

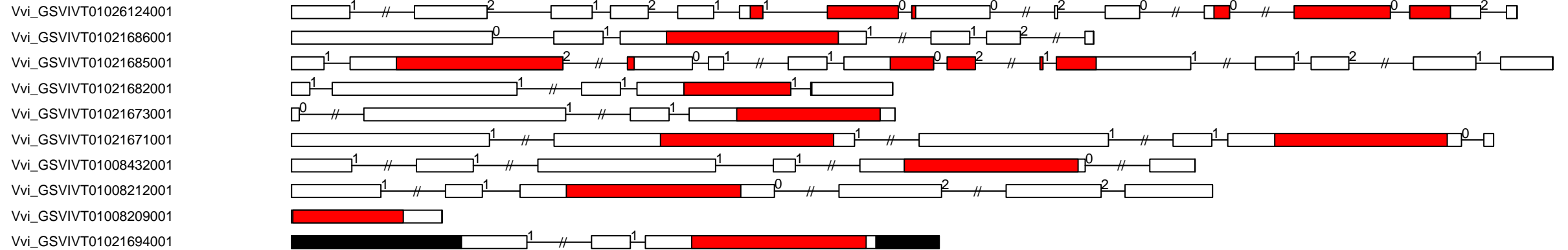

0

2000

4000

6000

V.vi SCY1_SCYL1 exon-intron and domain diagram (all)

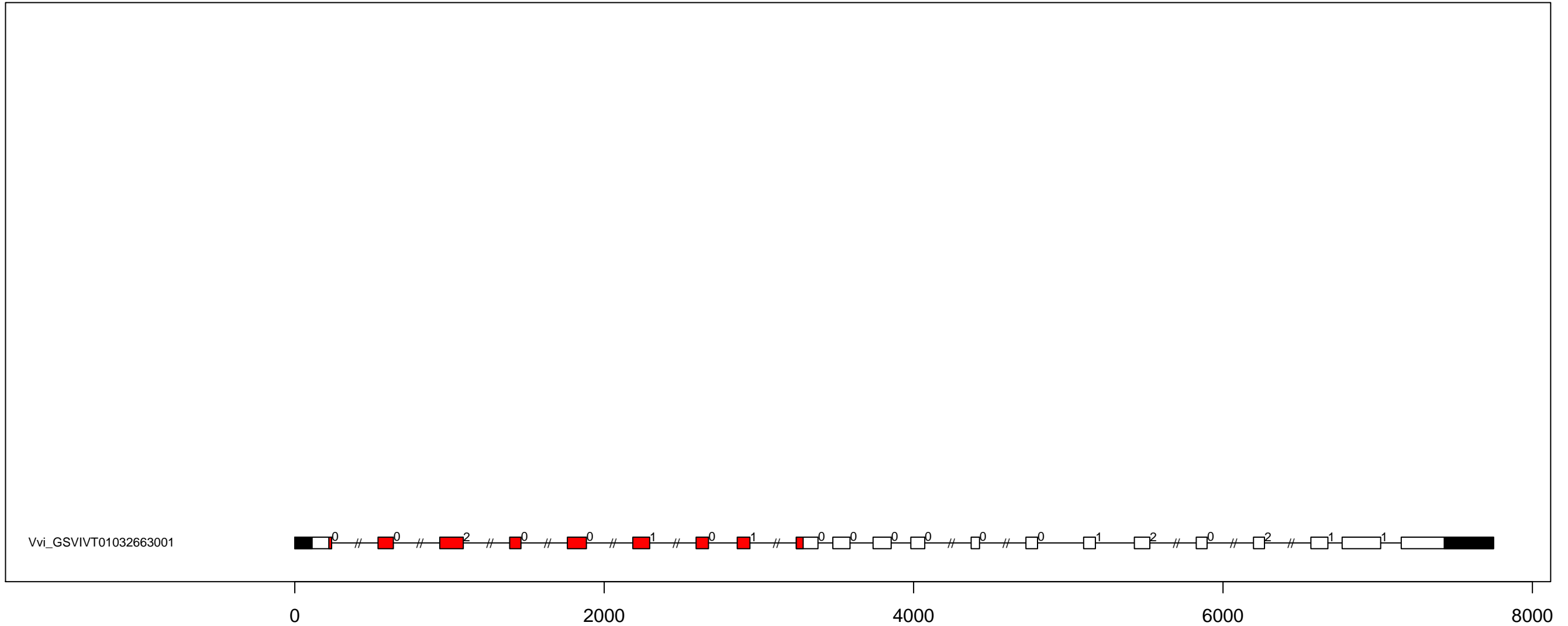

V.vi SCY1_SCYL2 exon-intron and domain diagram (all)

Vvi_GSVIVT01037227001

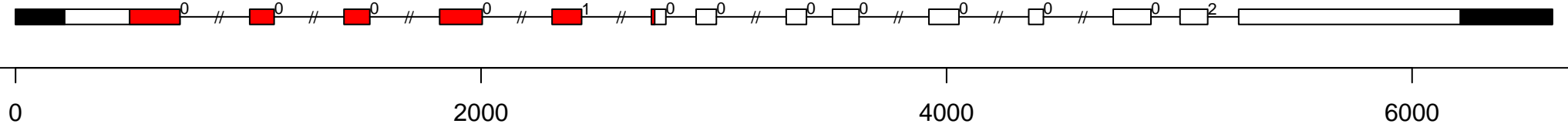

V.vi STE_STE11 exon-intron and domain diagram (part 1)

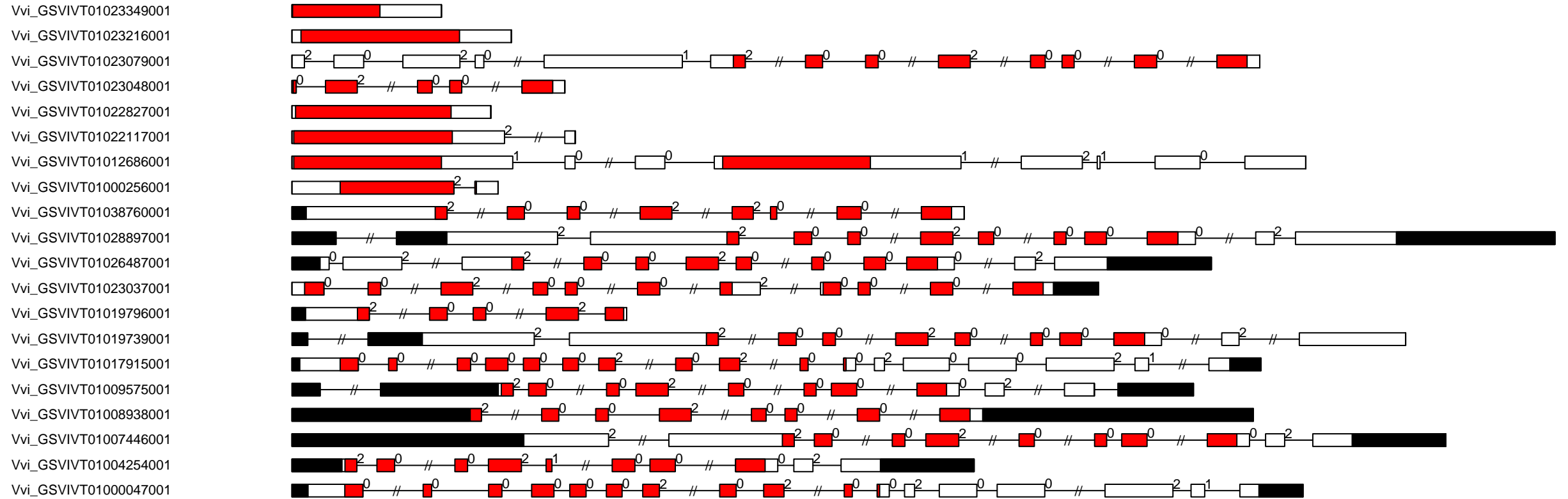

V.vi STE_STE11 exon-intron and domain diagram (part 2)

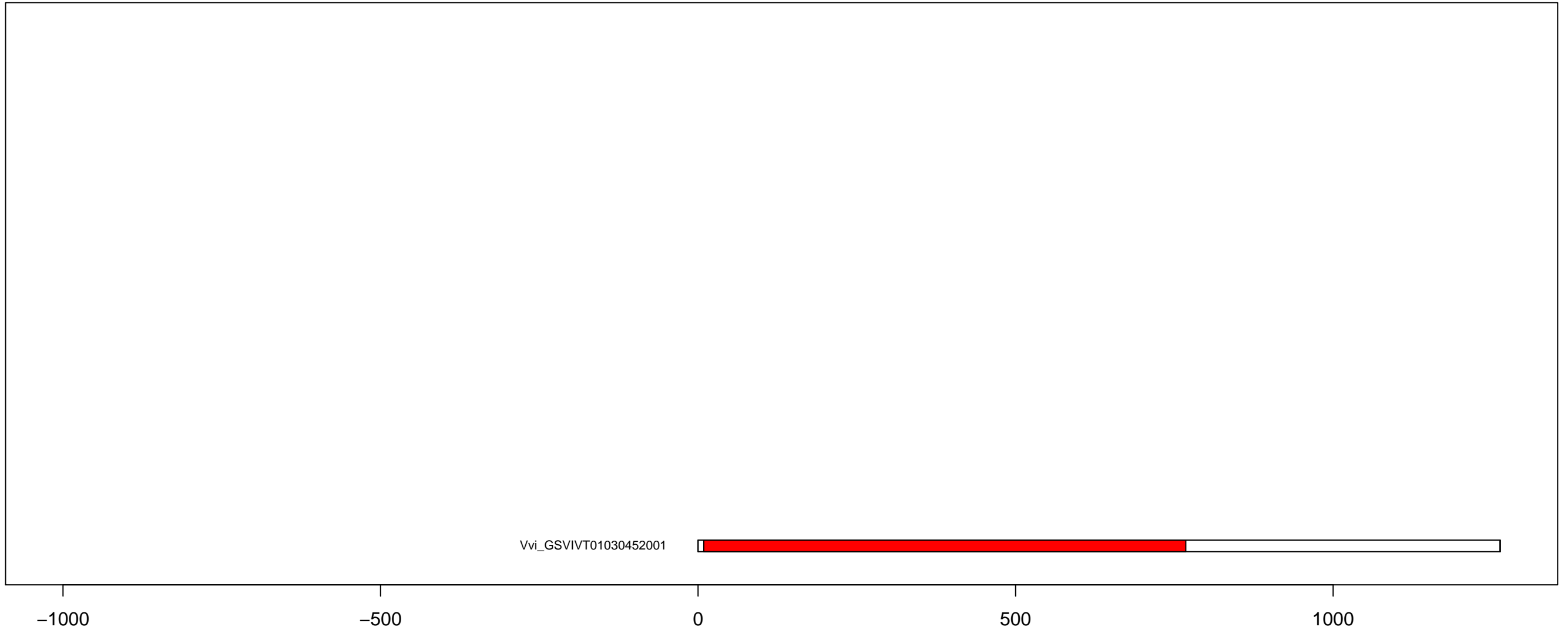

V.vi STE_STE20-Fray exon-intron and domain diagram (all)

Vvi_GSVIVT01027718001

Vvi_GSVIVT01032461001

Vvi_GSVIVT01019643001

Vvi_GSVIVT01016074001

Vvi_GSVIVT01013739001

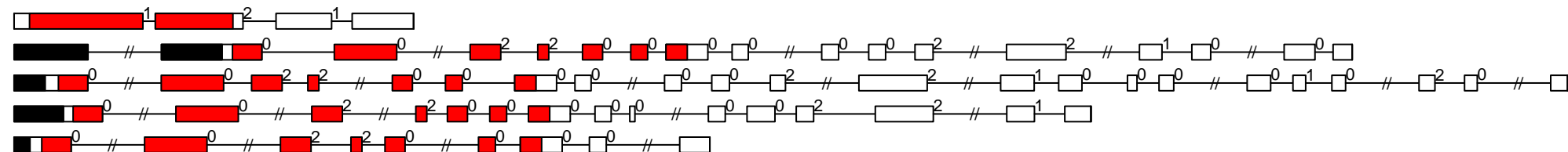

0

2000

4000

6000

V.vi STE_STE20-PI exon-intron and domain diagram (all)

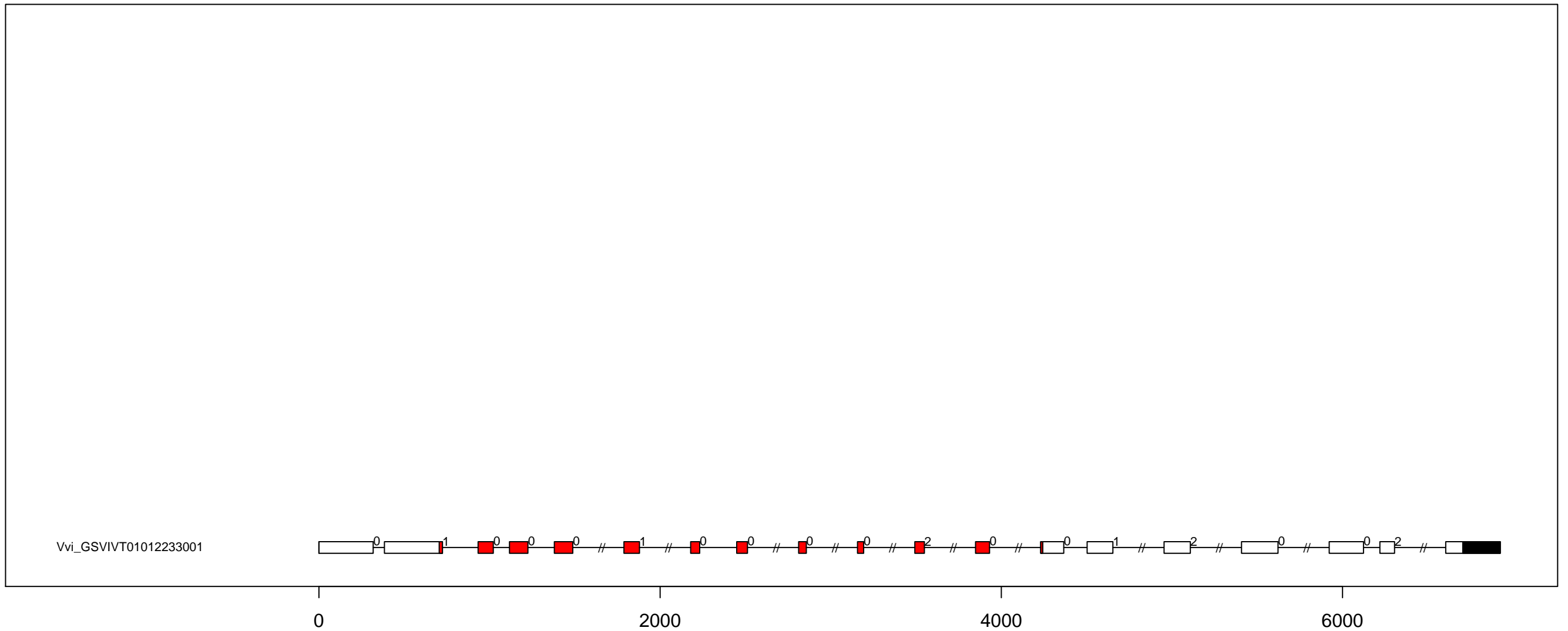

V.vi STE_STE20-YSK exon-intron and domain diagram (all)

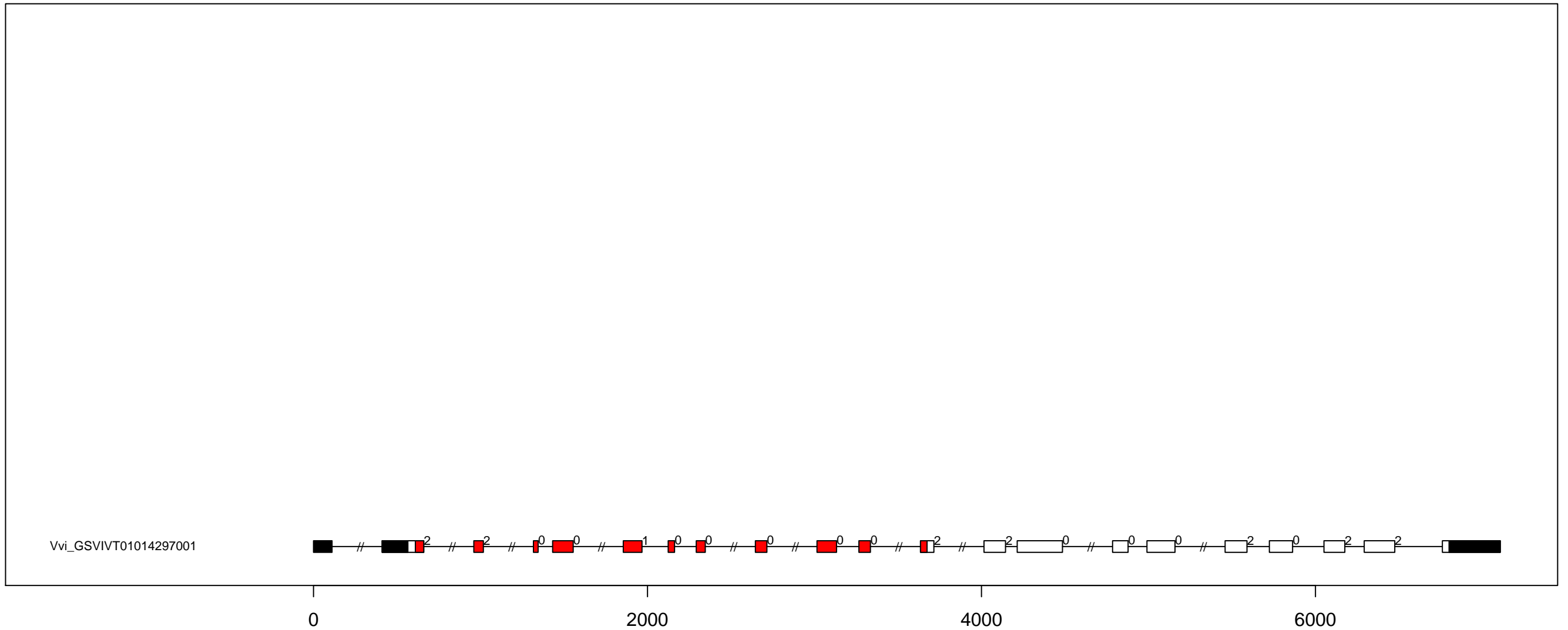

V.vi STE_STE7 exon-intron and domain diagram (all)

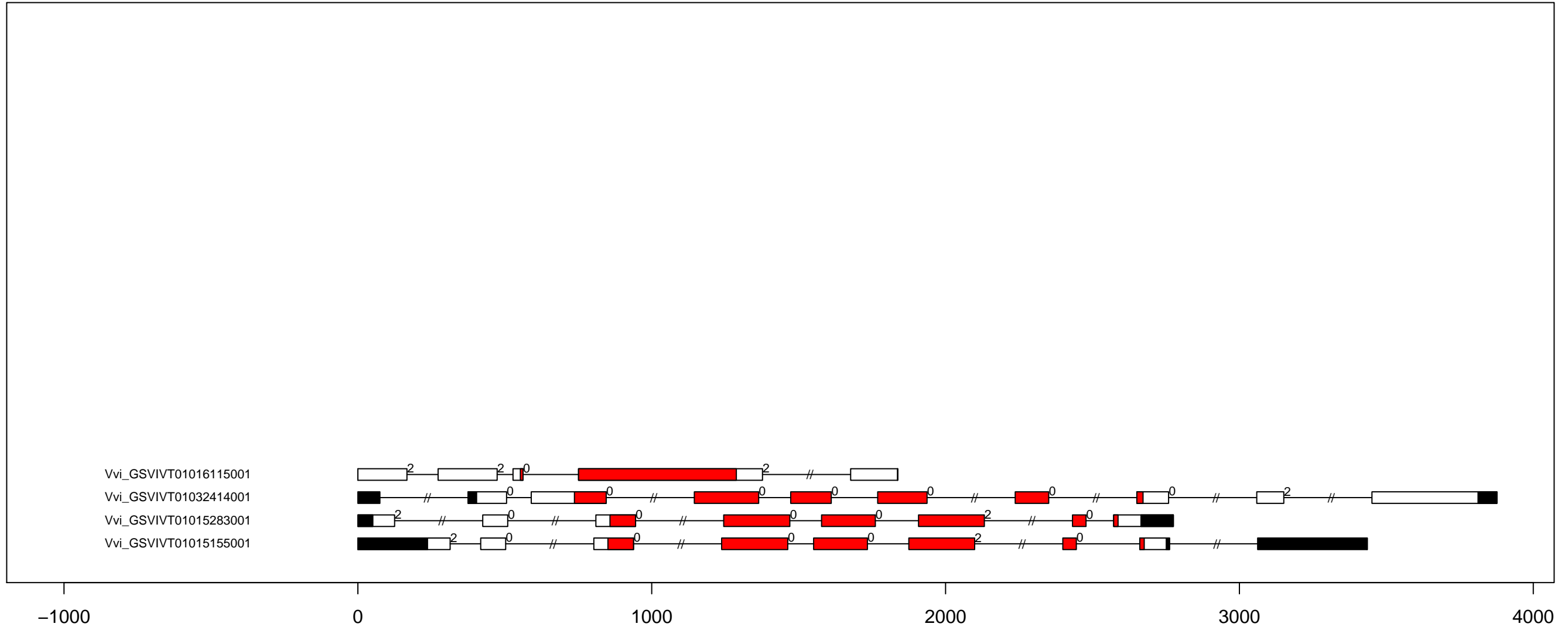

V.vi STE_STE-PI exon-intron and domain diagram (all)

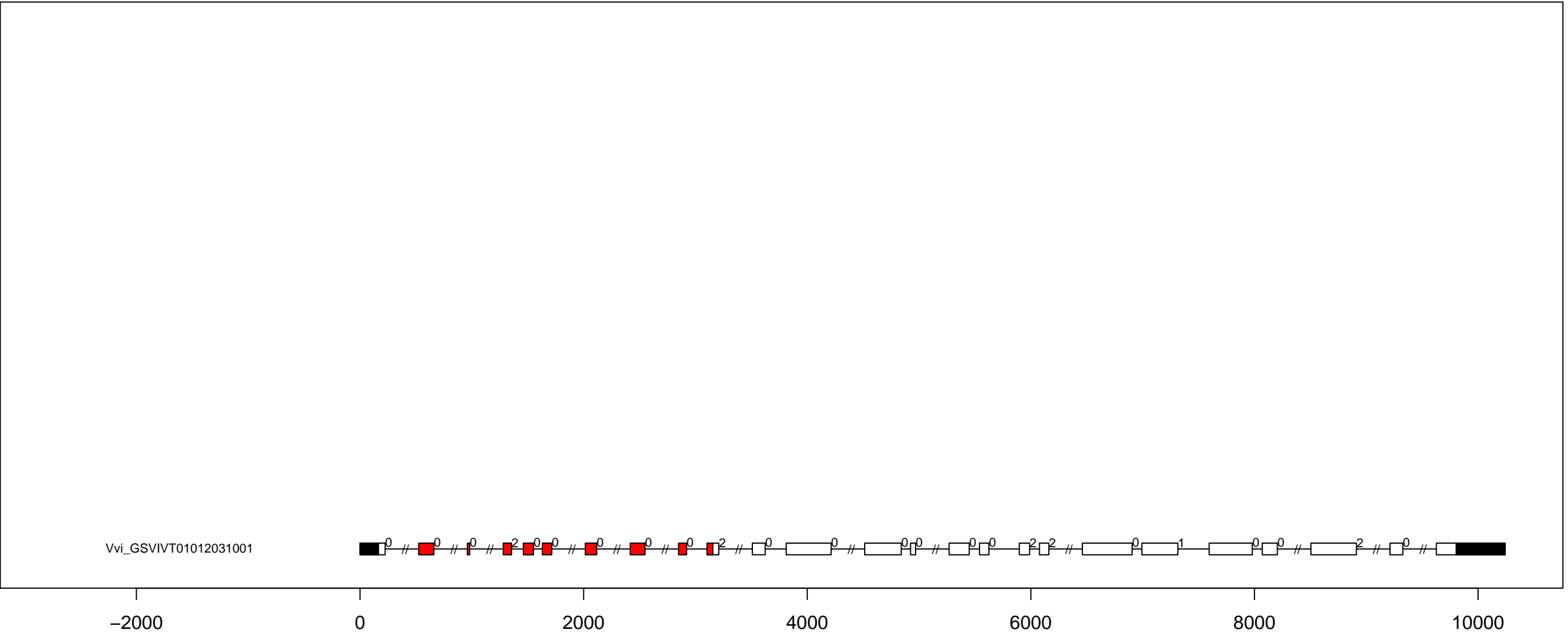

V.vi TKL_CTR1-DRK-1 exon-intron and domain diagram (all)

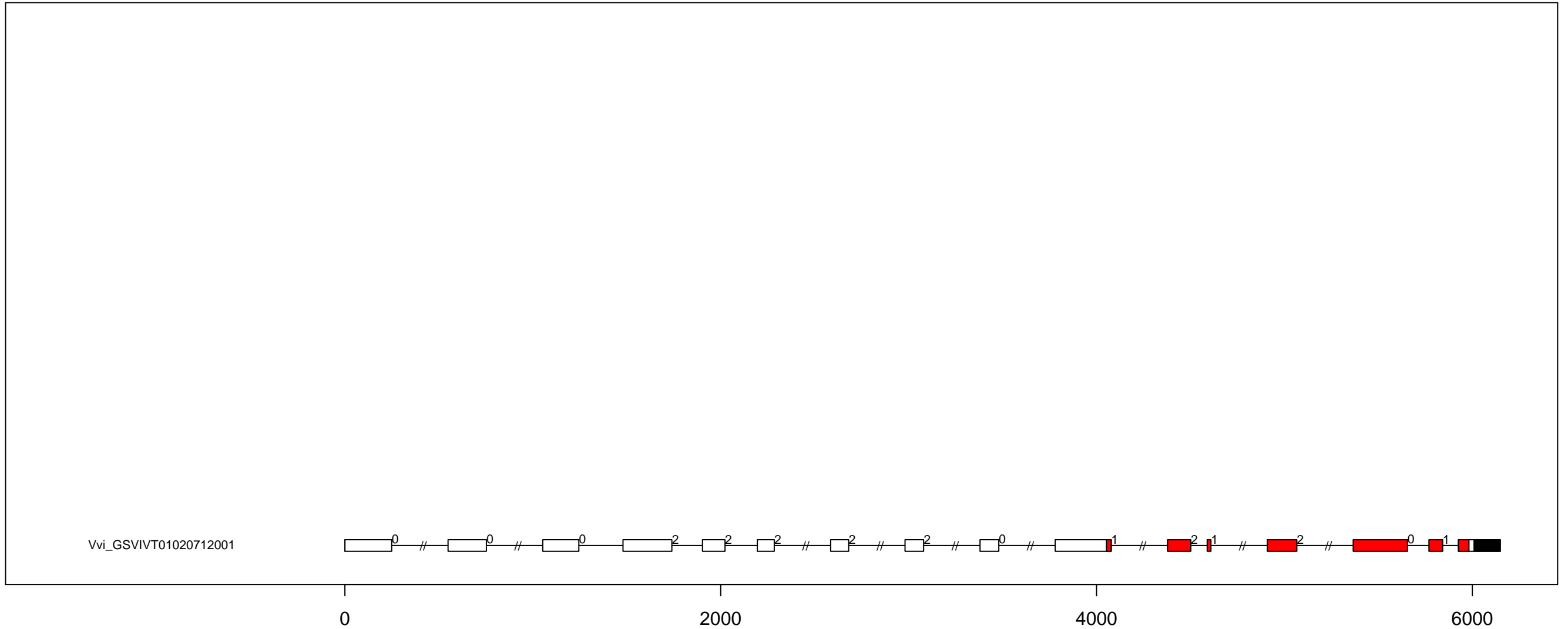

V.vi TKL_CTRL1-DRK-2 exon-intron and domain diagram (all)

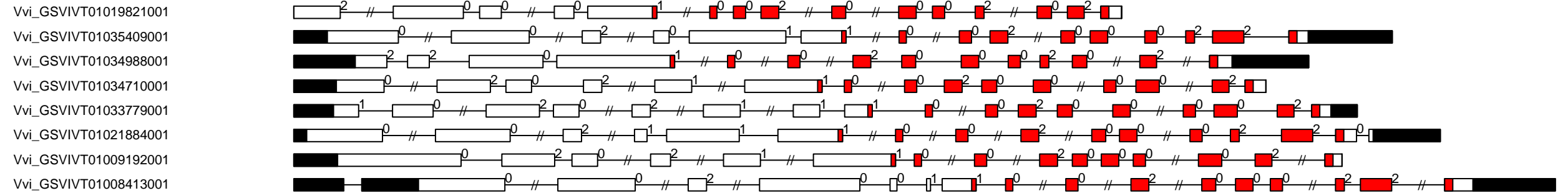

0

2000

4000

6000

V.vi TKL_Gdt exon-intron and domain diagram (all)

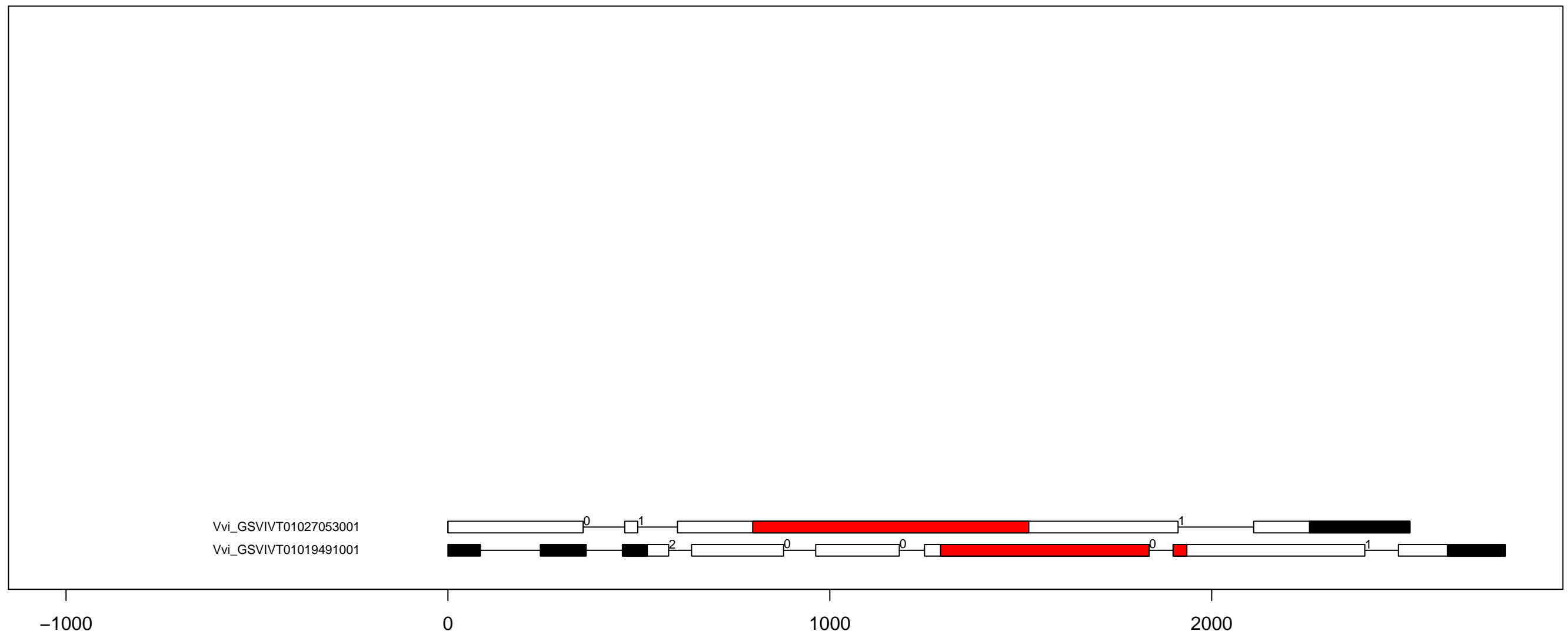

V.vi TKL-PI-1 exon-intron and domain diagram (all)

Vvi_GSVIVT01017348001

Vvi_GSVIVT01036651001

Vvi_GSVIVT01035870001

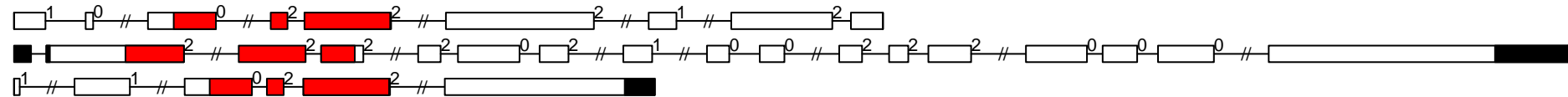

-2000

0

2000

4000

6000

8000

V.vi TKL-PI-2 exon-intron and domain diagram (all)

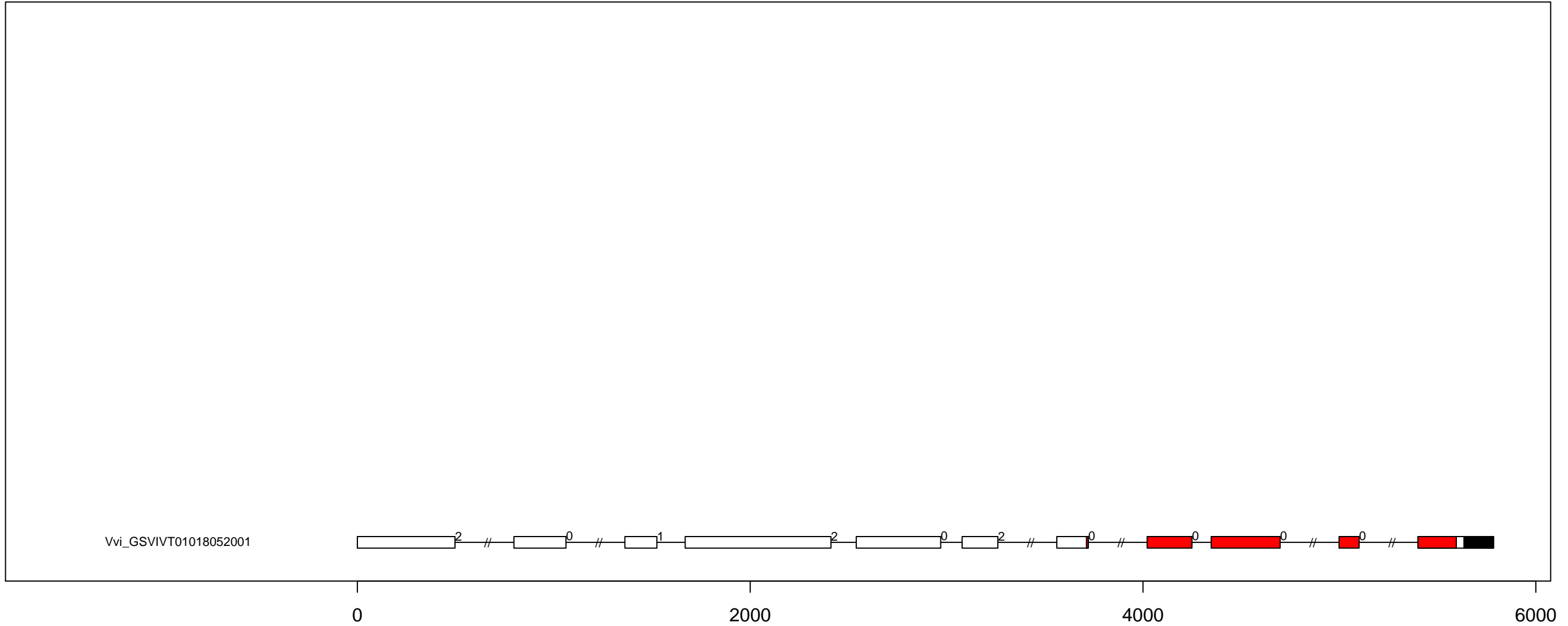

V.vi TKL-PI-3 exon-intron and domain diagram (all)

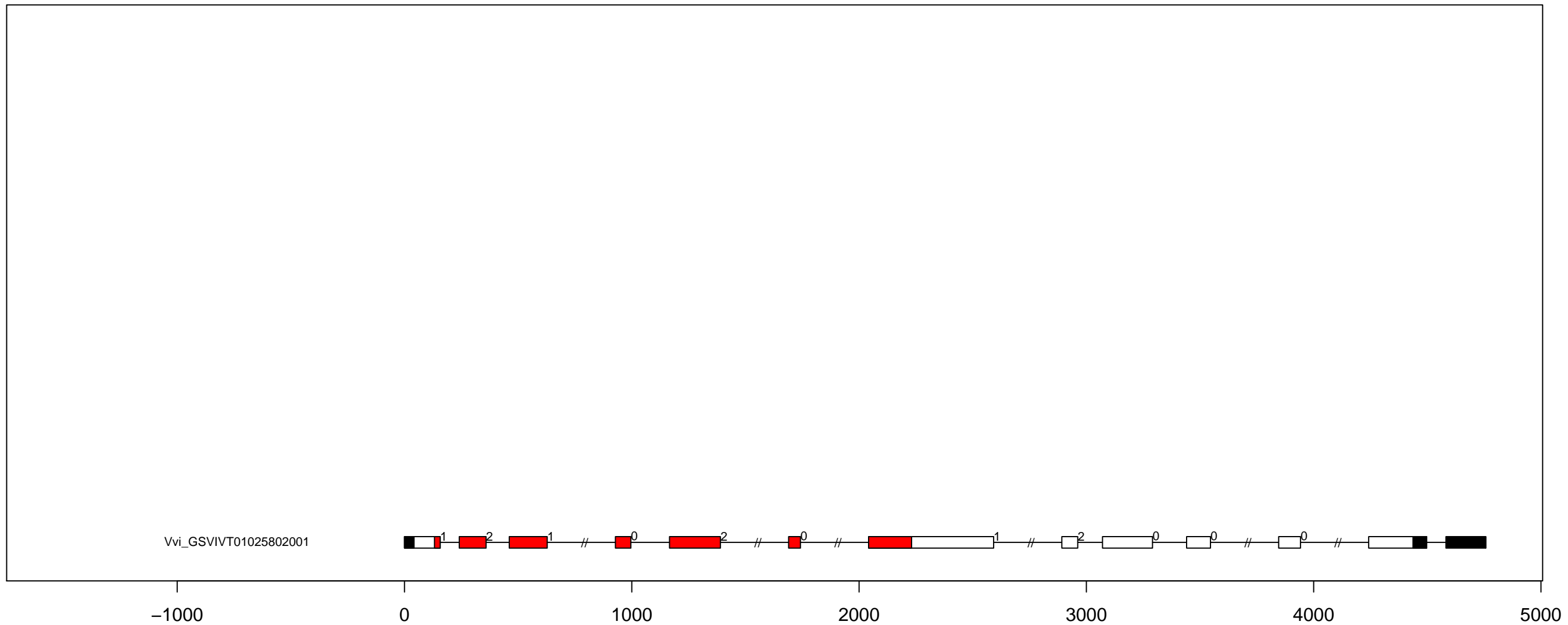

V.vi TKL-PI-4 exon-intron and domain diagram (all)

Vvi_GSVIVT01019010001
 Vvi_GSVIVT01032487001
 Vvi_GSVIVT01032389001
 Vvi_GSVIVT01030194001
 Vvi_GSVIVT01023958001
 Vvi_GSVIVT01018020001
 Vvi_GSVIVT01008728001
 Vvi_GSVIVT01007775001
 Vvi_GSVIVT01007762001
 Vvi_GSVIVT01007646001
 Vvi_GSVIVT01002332001
 Vvi_GSVIVT01001690001
 Vvi_GSVIVT01001193001

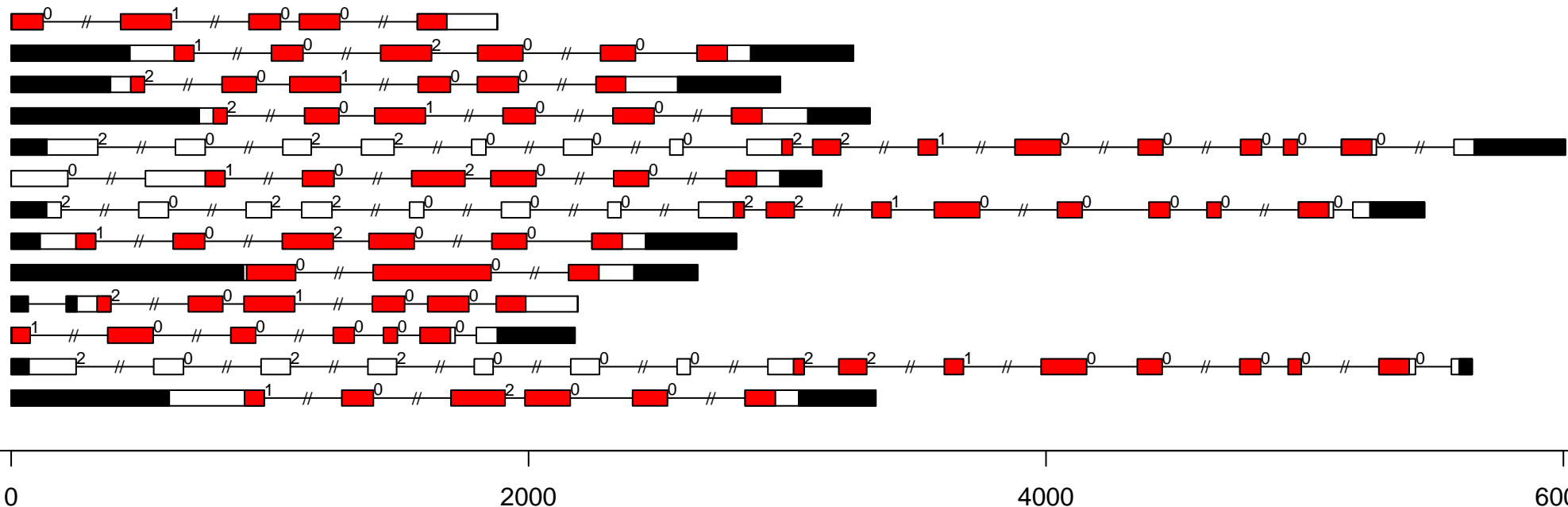

V.vi TKL-PI-5 exon-intron and domain diagram (all)

Vvi_GSVIVT01026899001
 Vvi_GSVIVT01026898001
 Vvi_GSVIVT01038213001
 Vvi_GSVIVT01021301001
 Vvi_GSVIVT01003214001

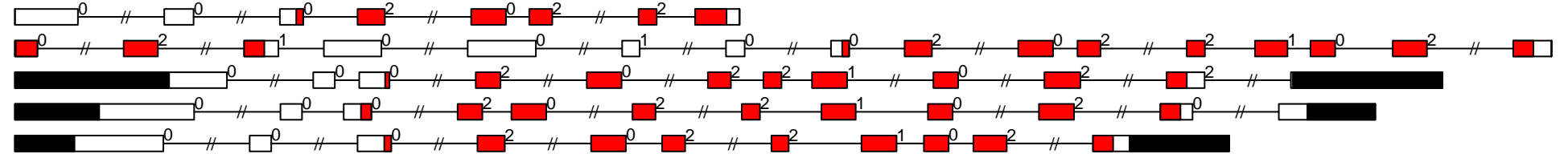

-1000

0

1000

2000

3000

4000

5000

V.vi TKL-PI-6 exon-intron and domain diagram (all)

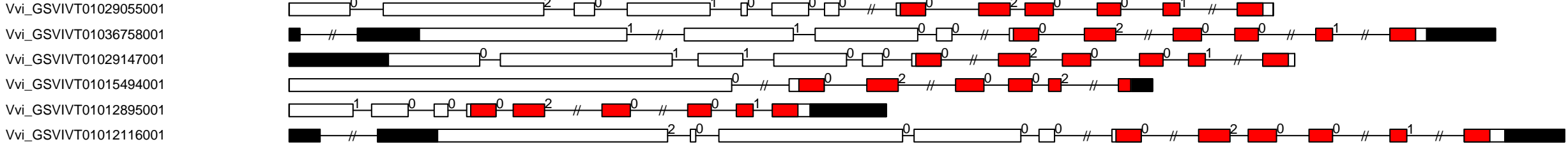

V.vi TKL-PI-7 exon-intron and domain diagram (all)

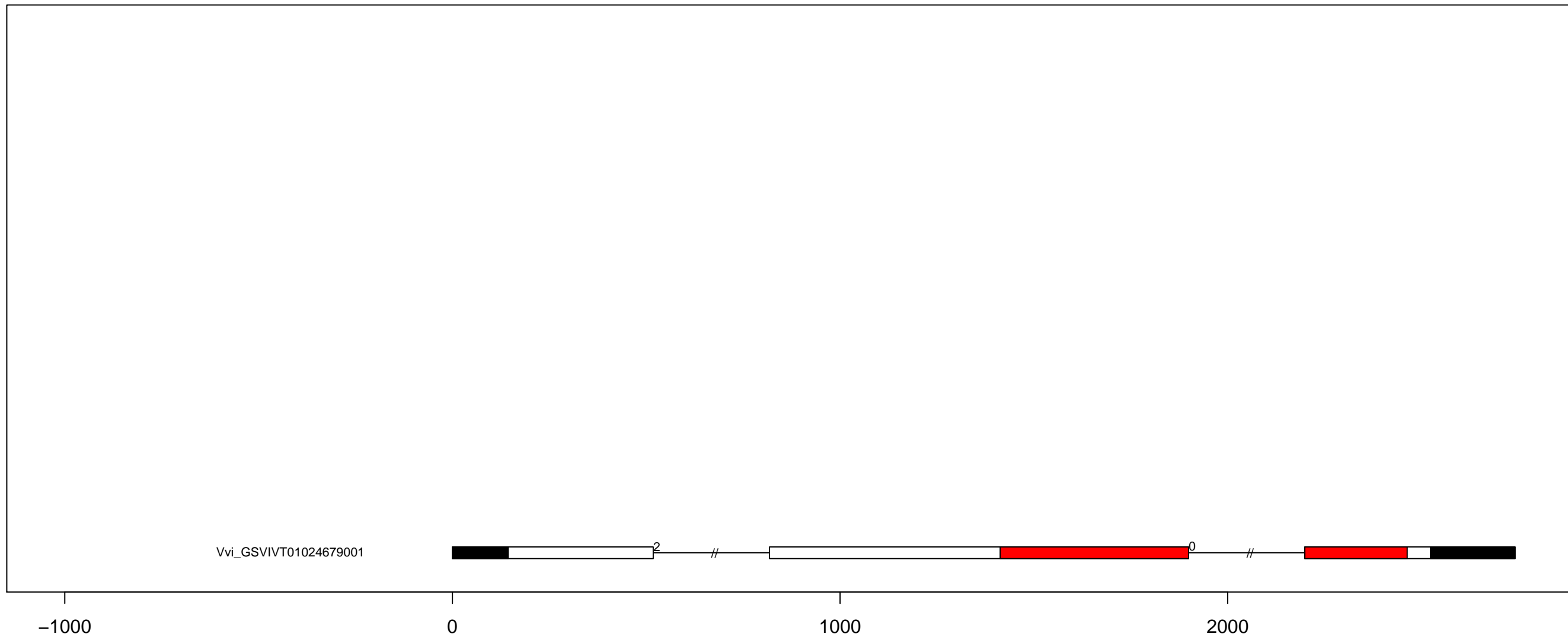

V.vi TKL-PI-8 exon-intron and domain diagram (all)

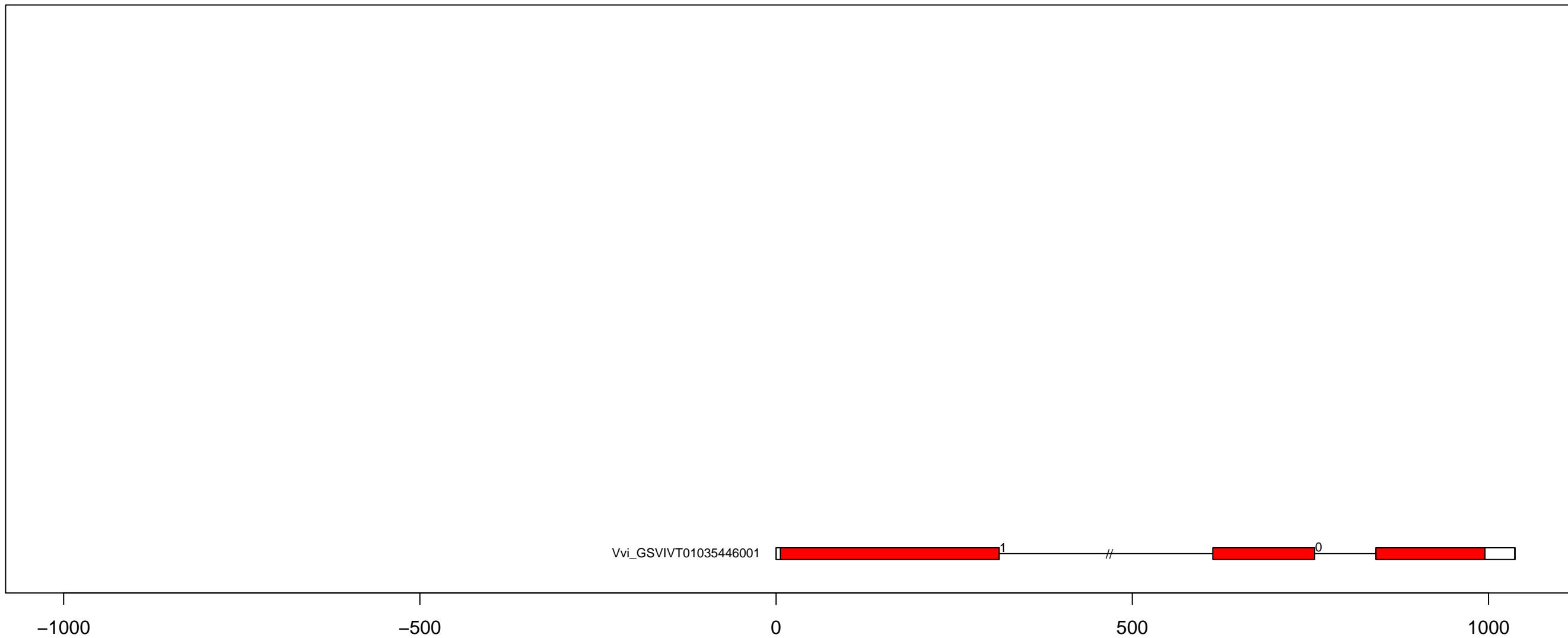

V.vi TLK exon-intron and domain diagram (all)

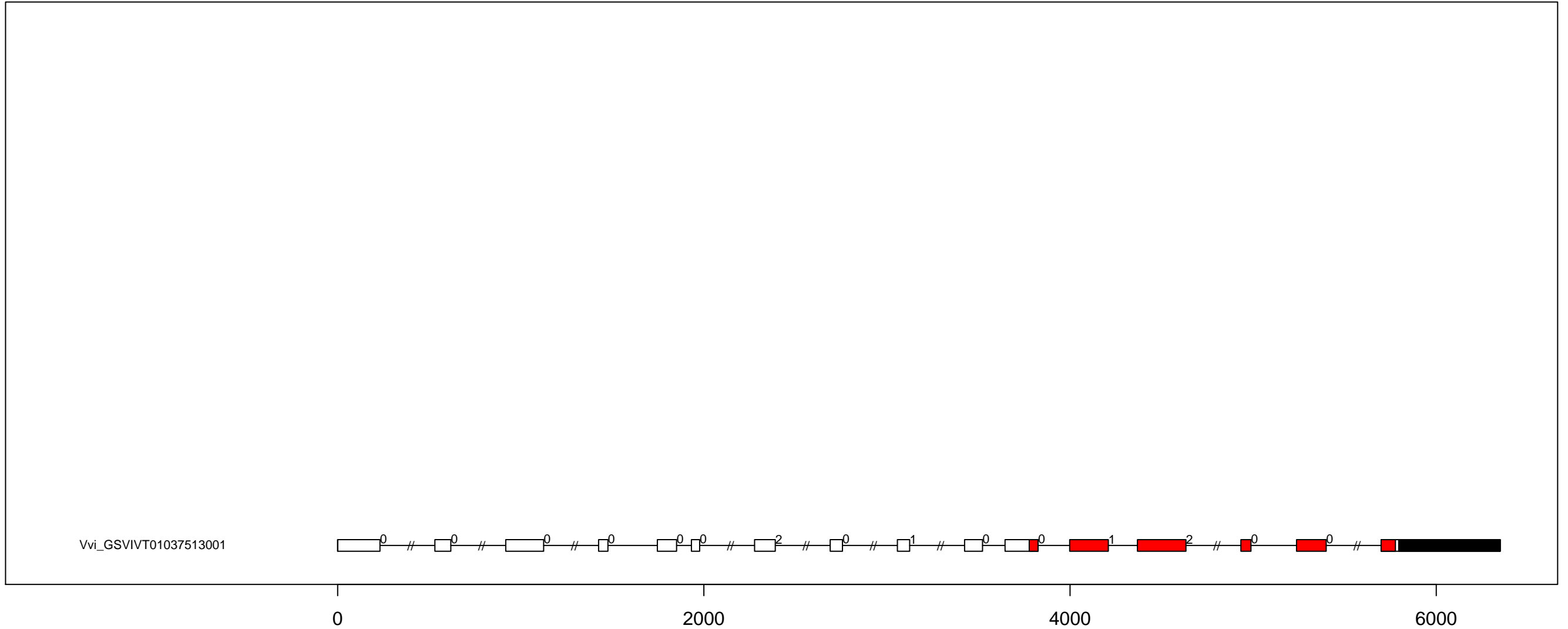

V.vi TTK exon-intron and domain diagram (all)

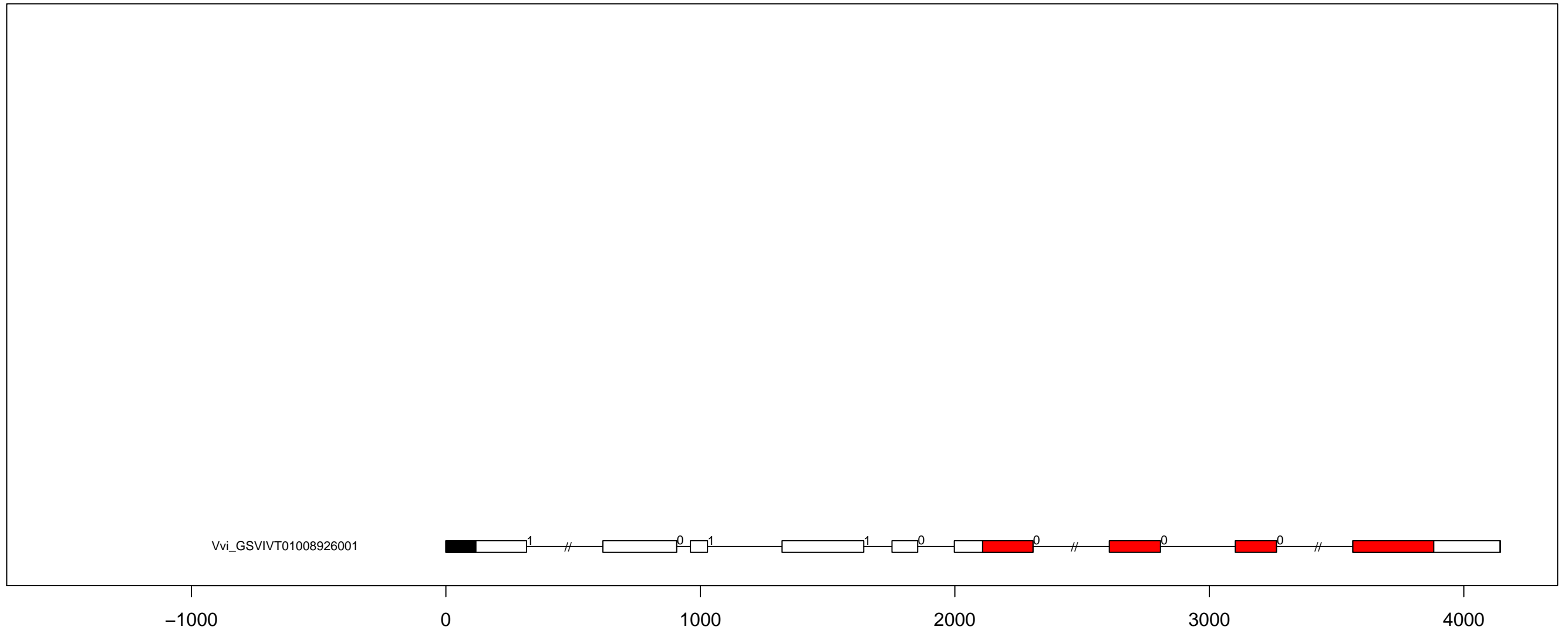

V.vi ULK_Fused exon-intron and domain diagram (all)

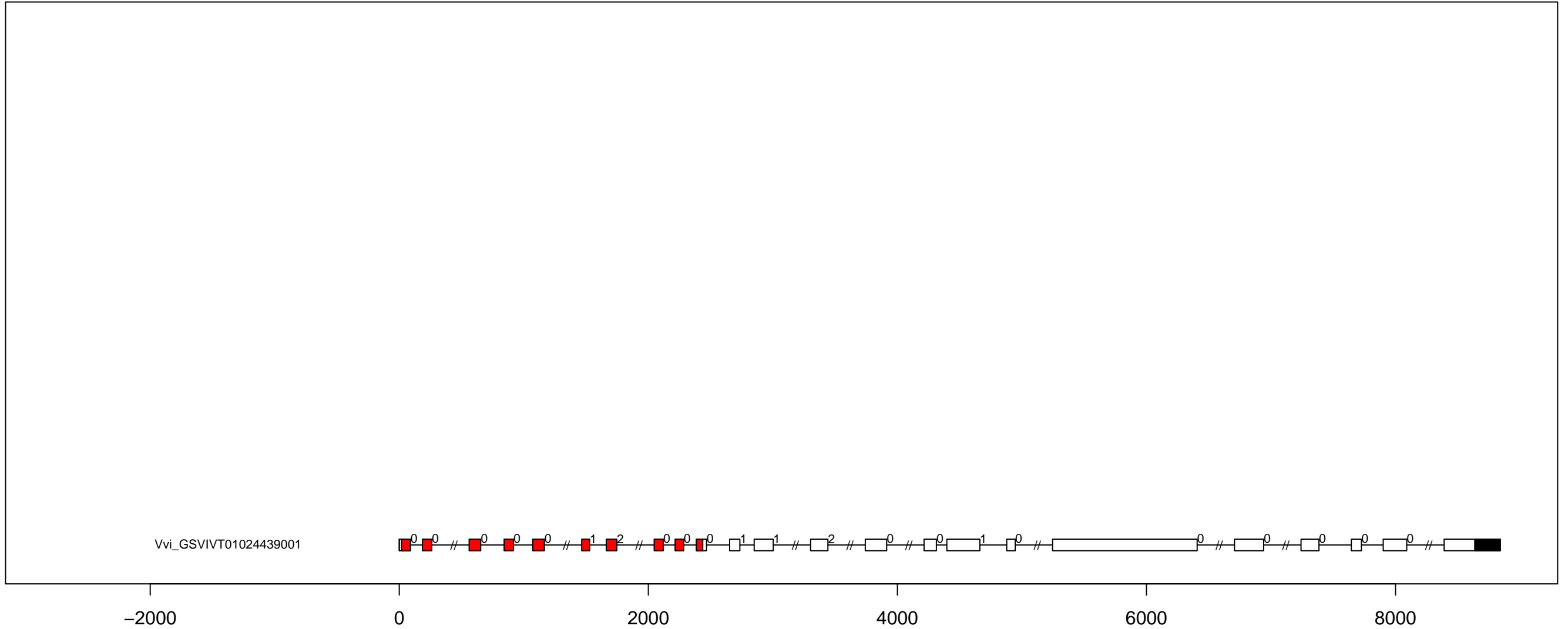

V.vi ULK_ULK4 exon-intron and domain diagram (all)

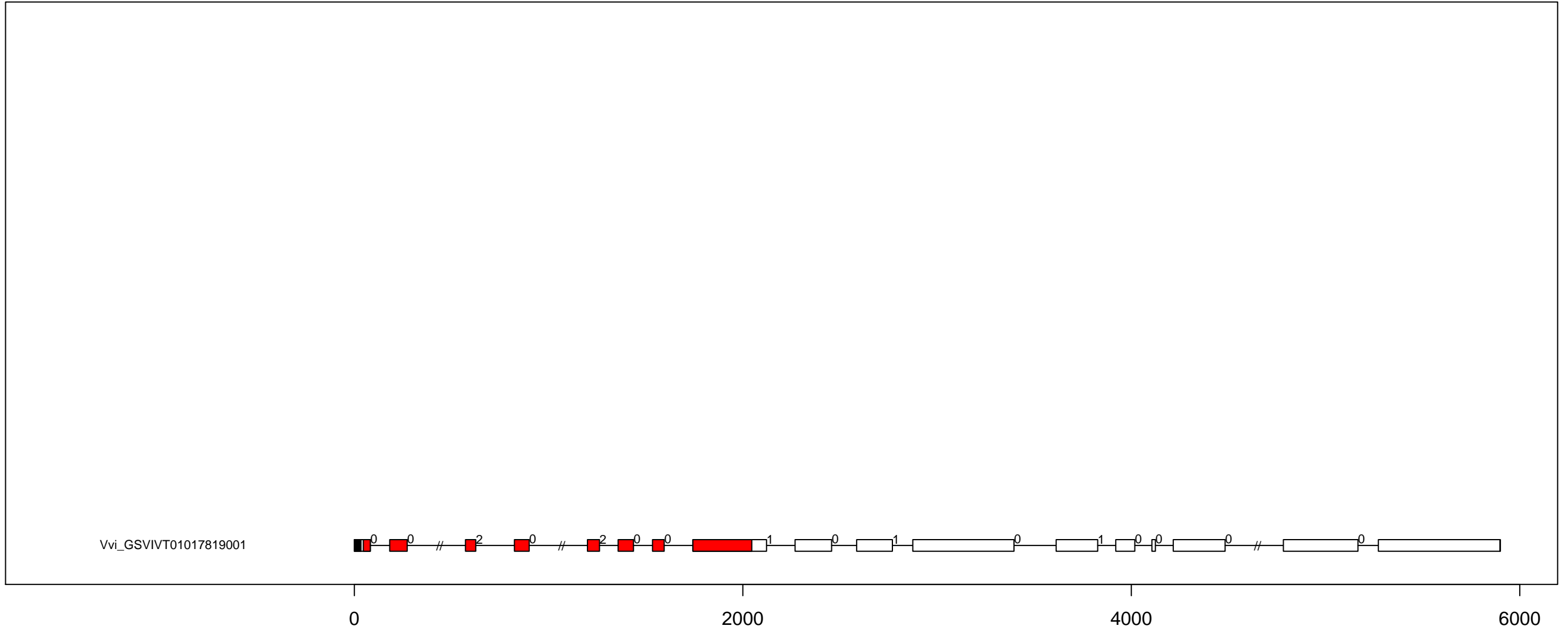

V.vi WEE exon-intron and domain diagram (all)

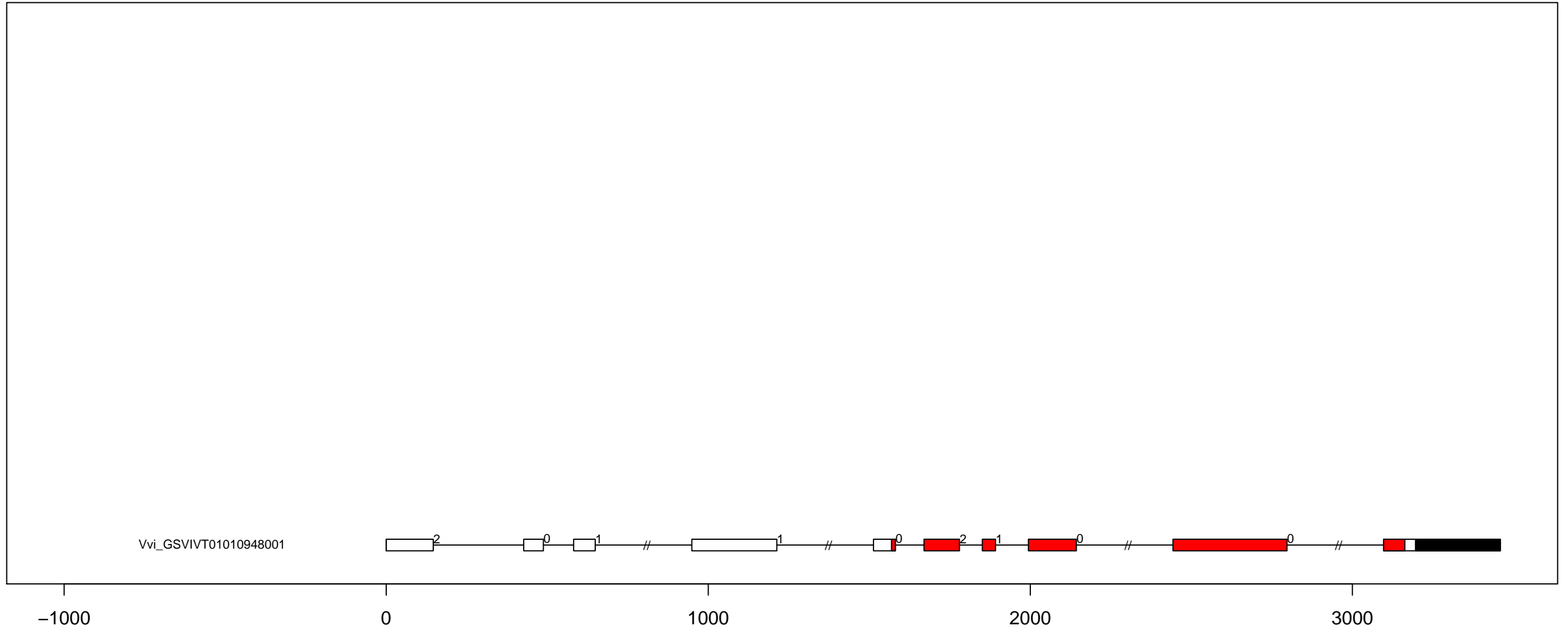

V.vi WNK_NRBP exon-intron and domain diagram (all)

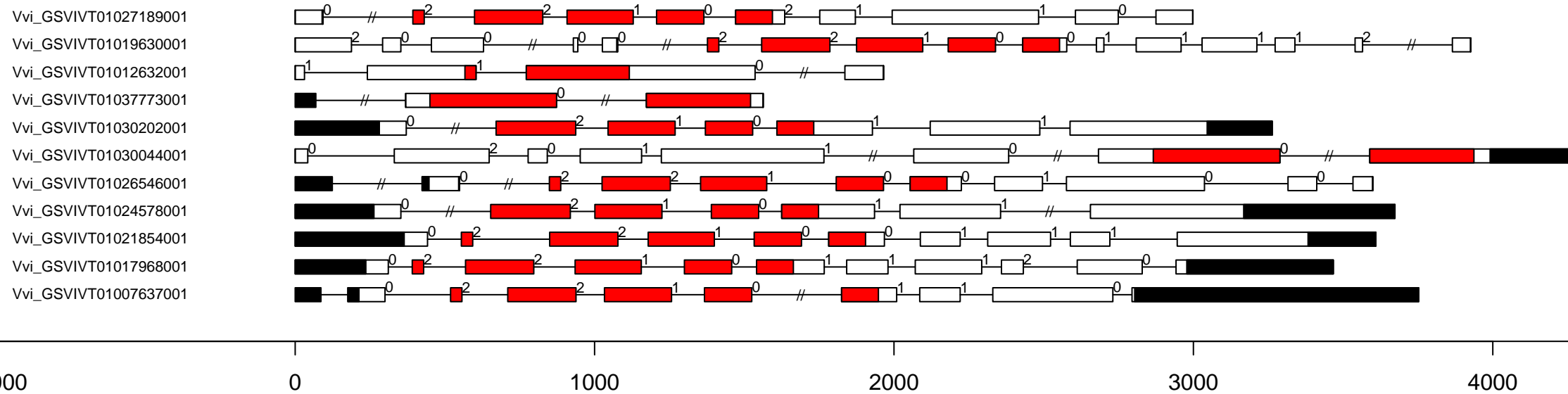

O.sa AGC_MAST exon-intron and kinase domain diagram (all)

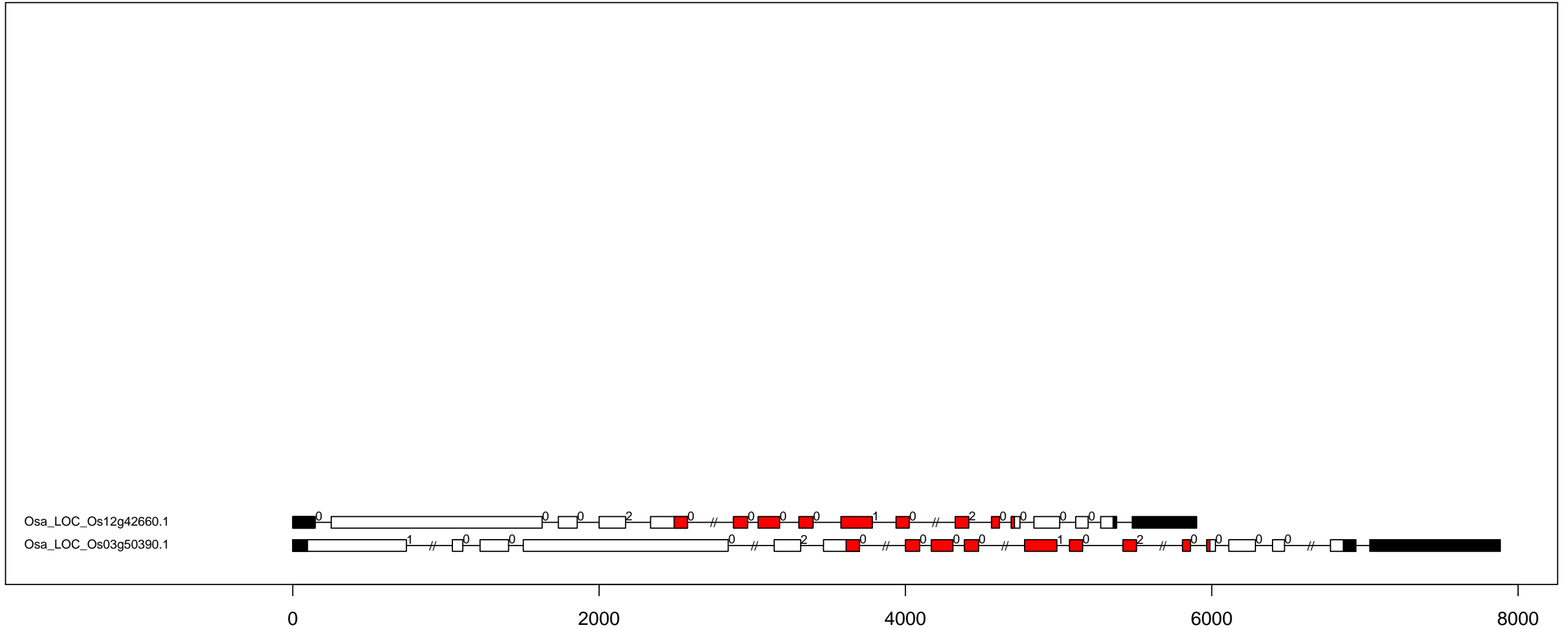

O.sa AGC_NDR exon-intron and kinase domain diagram (all)

Osa_LOC_Os10g33640.1
Osa_LOC_Os12g19290.1
Osa_LOC_Os05g43570.2
Osa_LOC_Os01g09200.1

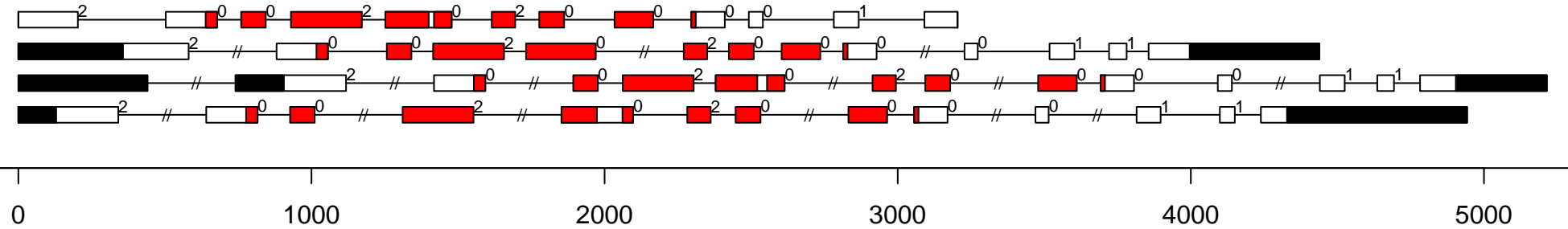

O.sa AGC_PDK1 exon-intron and kinase domain diagram (all)

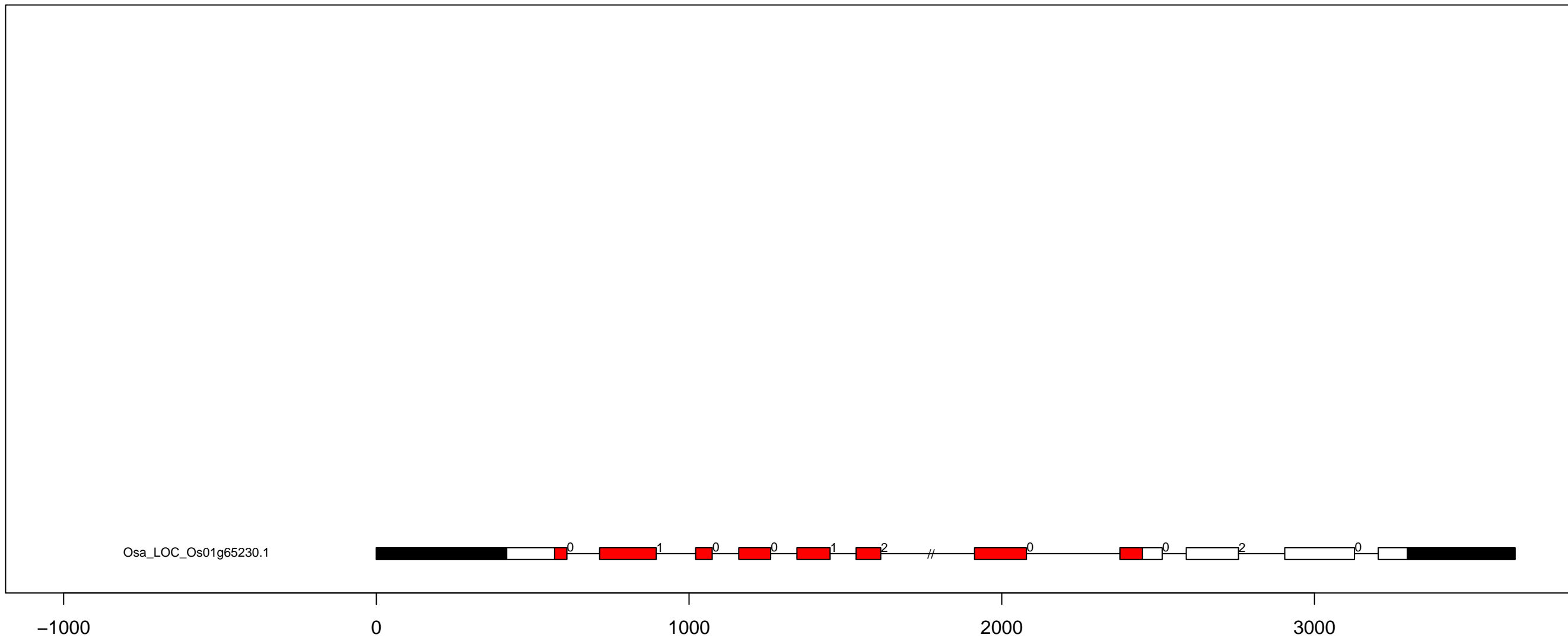

O.sa AGC_PKA-PKG exon-intron and kinase domain diagram (all)

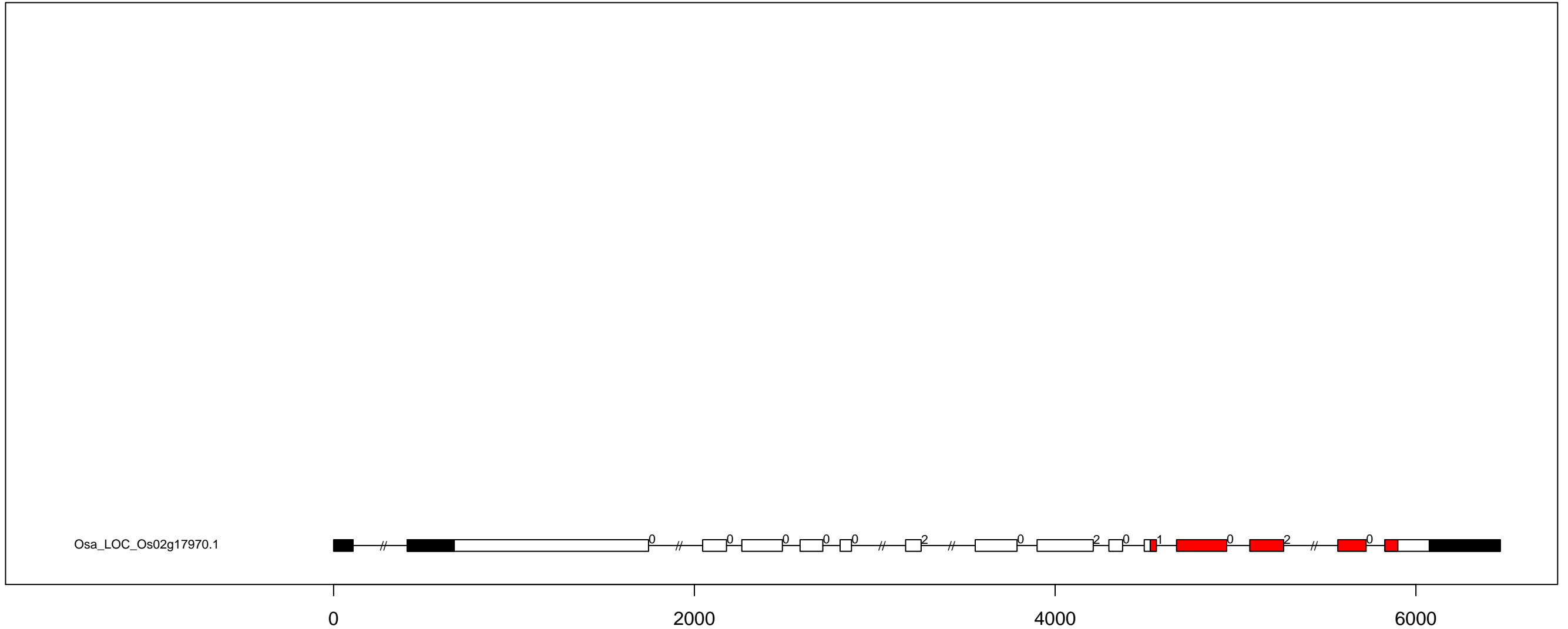

O.sa AGC_RSK-2 exon-intron and kinase domain diagram (part 1)

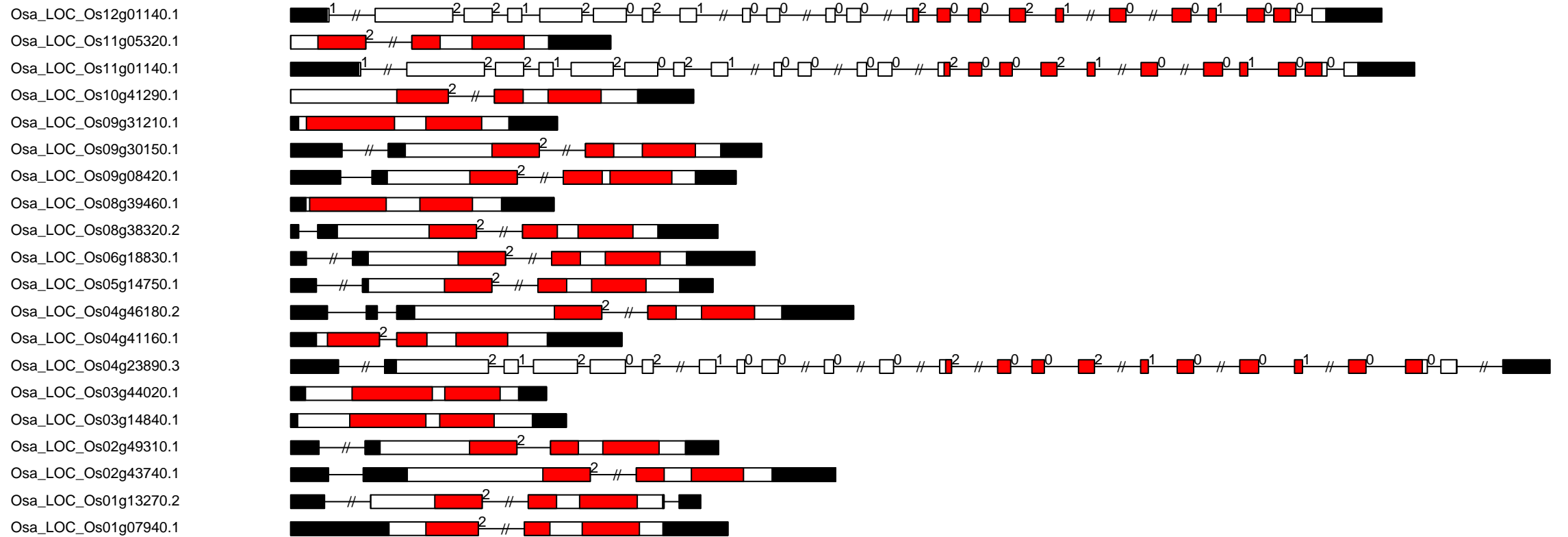

-2000

0

2000

4000

6000

8000

O.sa AGC_RSK-2 exon-intron and kinase domain diagram (part 2)

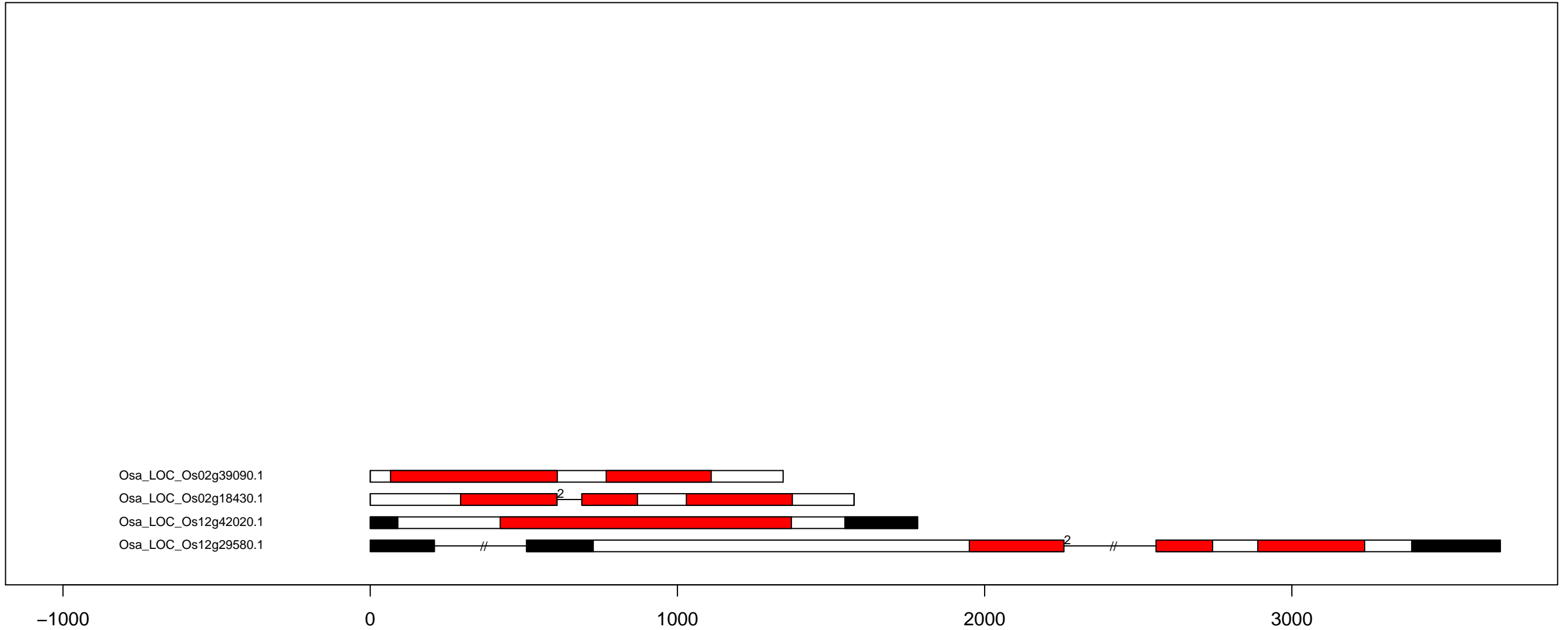

O.sa AGC-PI exon-intron and kinase domain diagram (all)

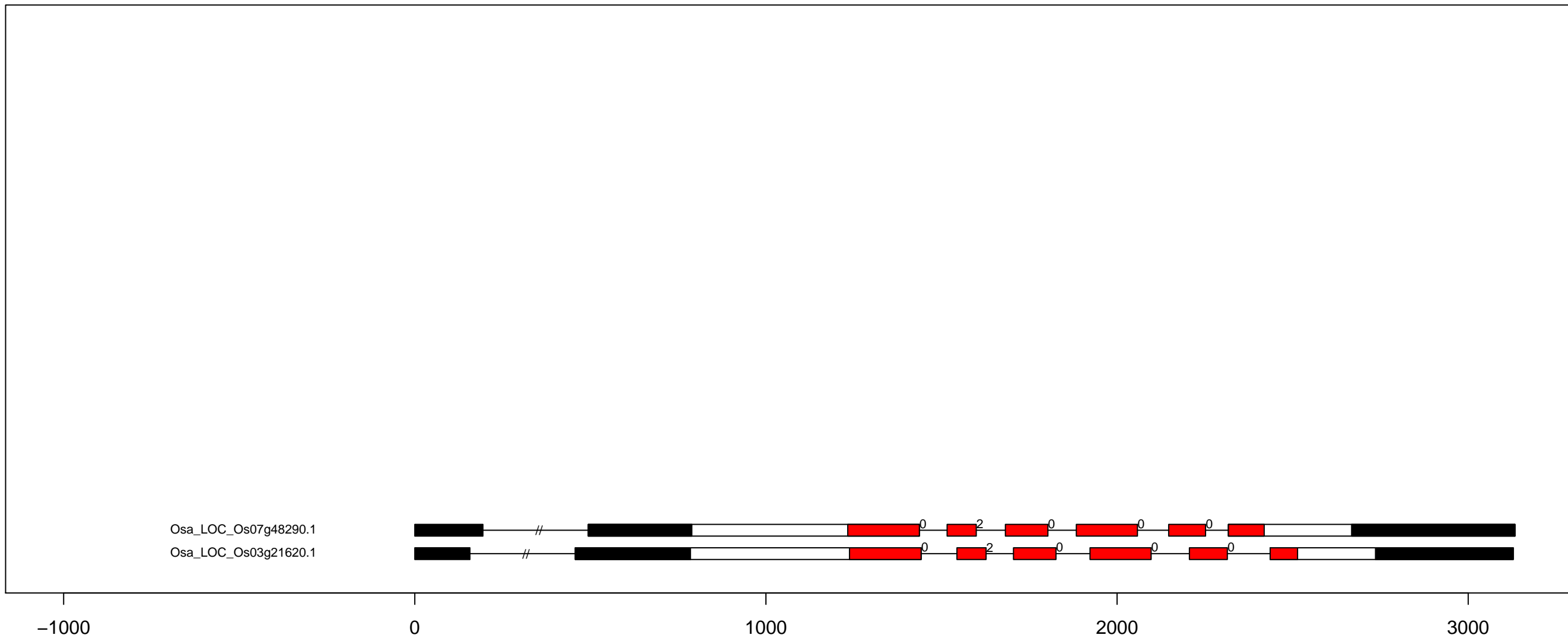

O.sa Aur exon-intron and kinase domain diagram (all)

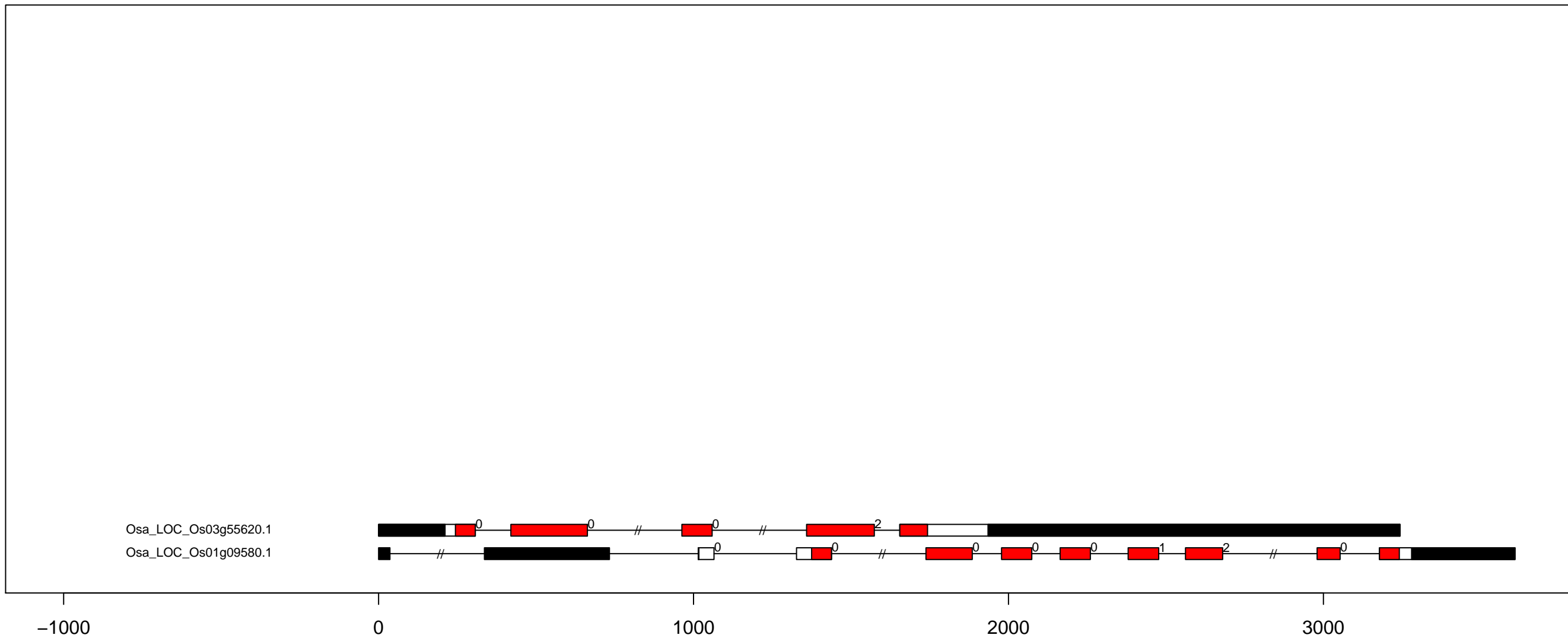

O.sa BUB exon-intron and kinase domain diagram (all)

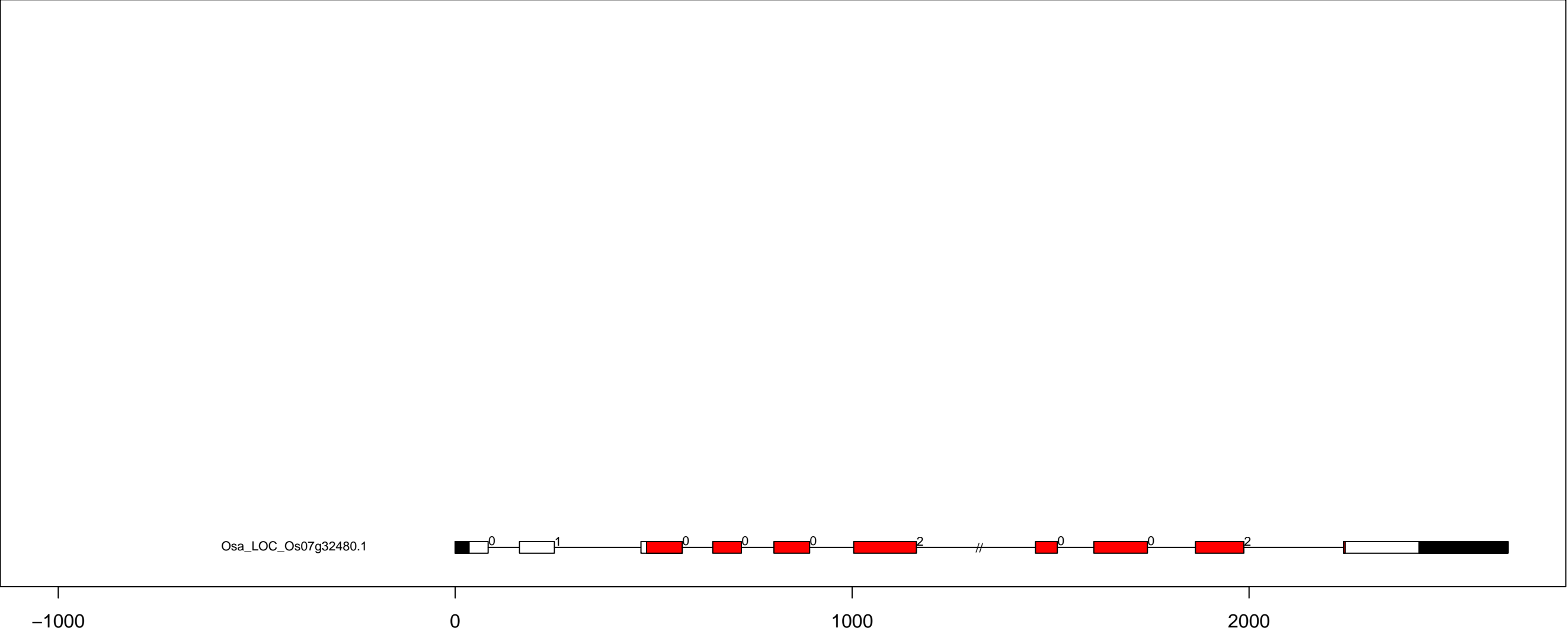

O.sa CAMK_AMPK exon-intron and kinase domain diagram (all)

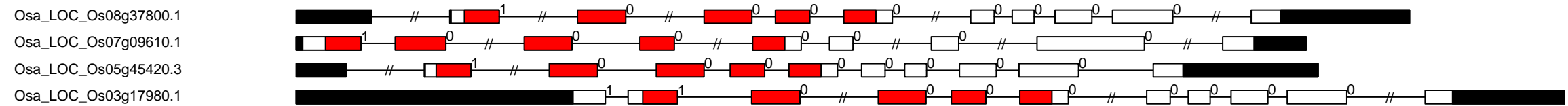

O.sa CAMK_CAMK1-DCAMKL exon-intron and kinase domain diagram (all)

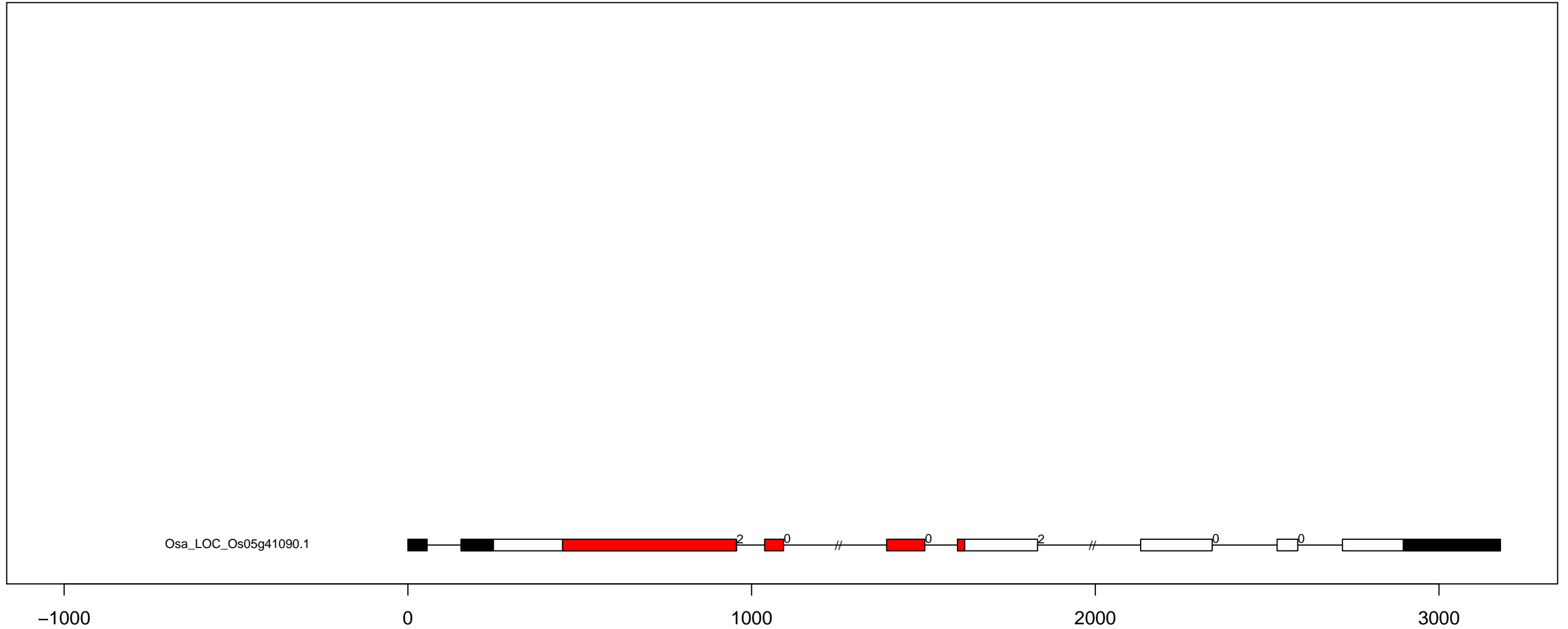

O.sa CAMK_CAMKL-CHK1 exon-intron and kinase domain diagram (part 1)

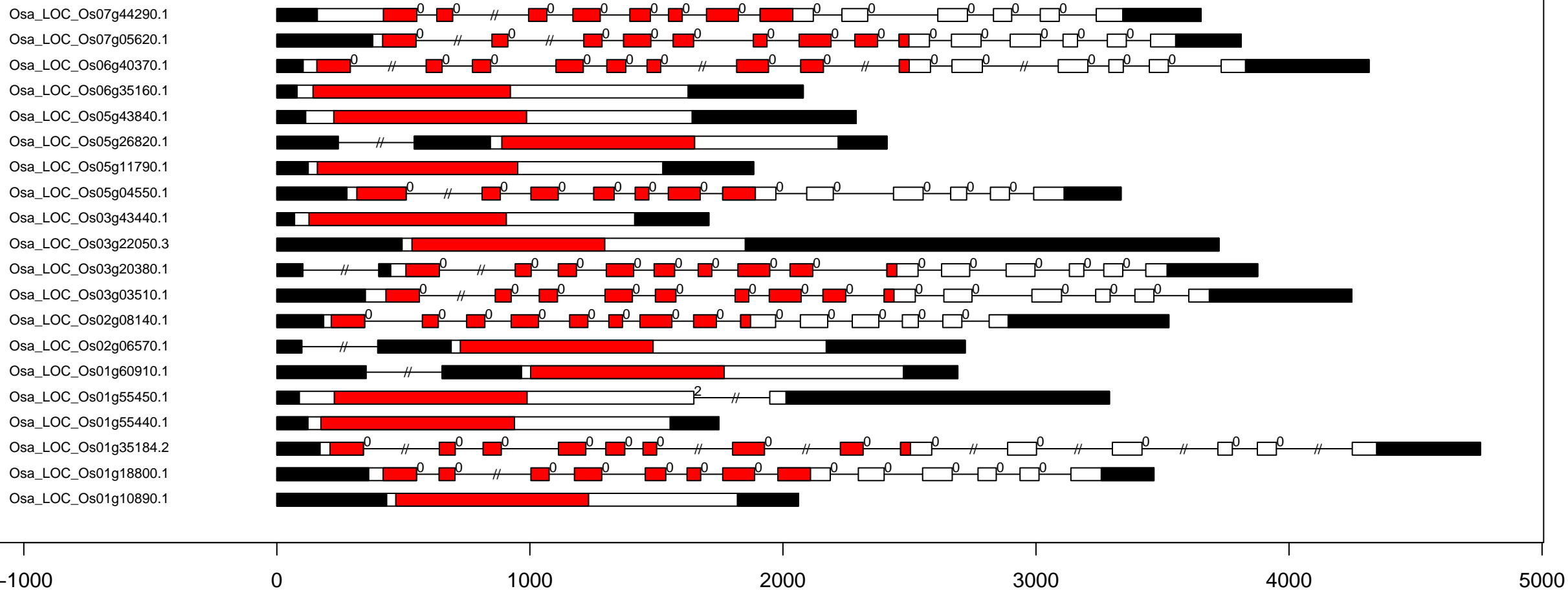

O.sa CAMK_CAMKL-CHK1 exon-intron and kinase domain diagram (part 2)

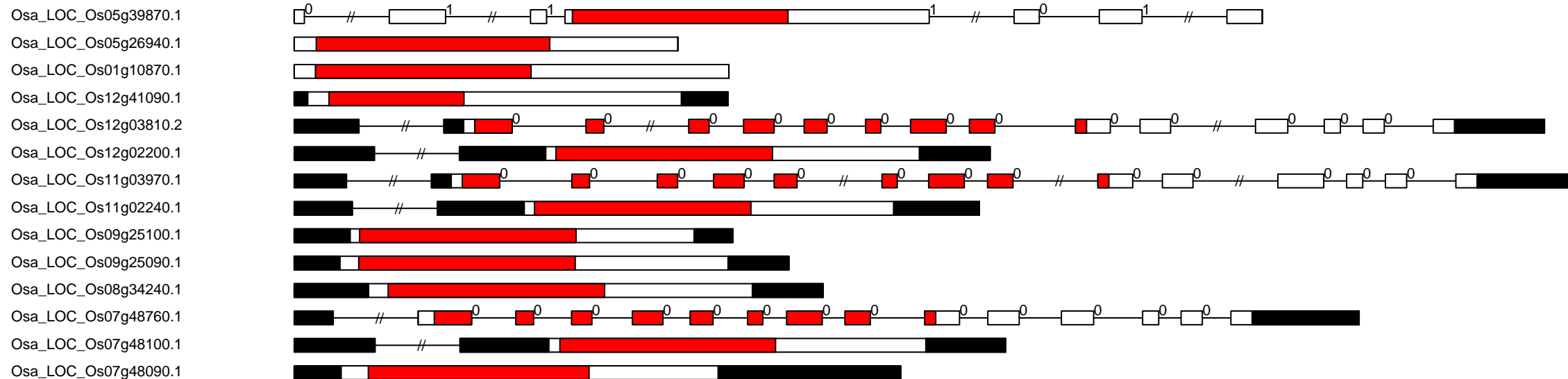

-1000

0

1000

2000

3000

4000

O.sa CAMK_CAMKL-LKB exon-intron and kinase domain diagram (all)

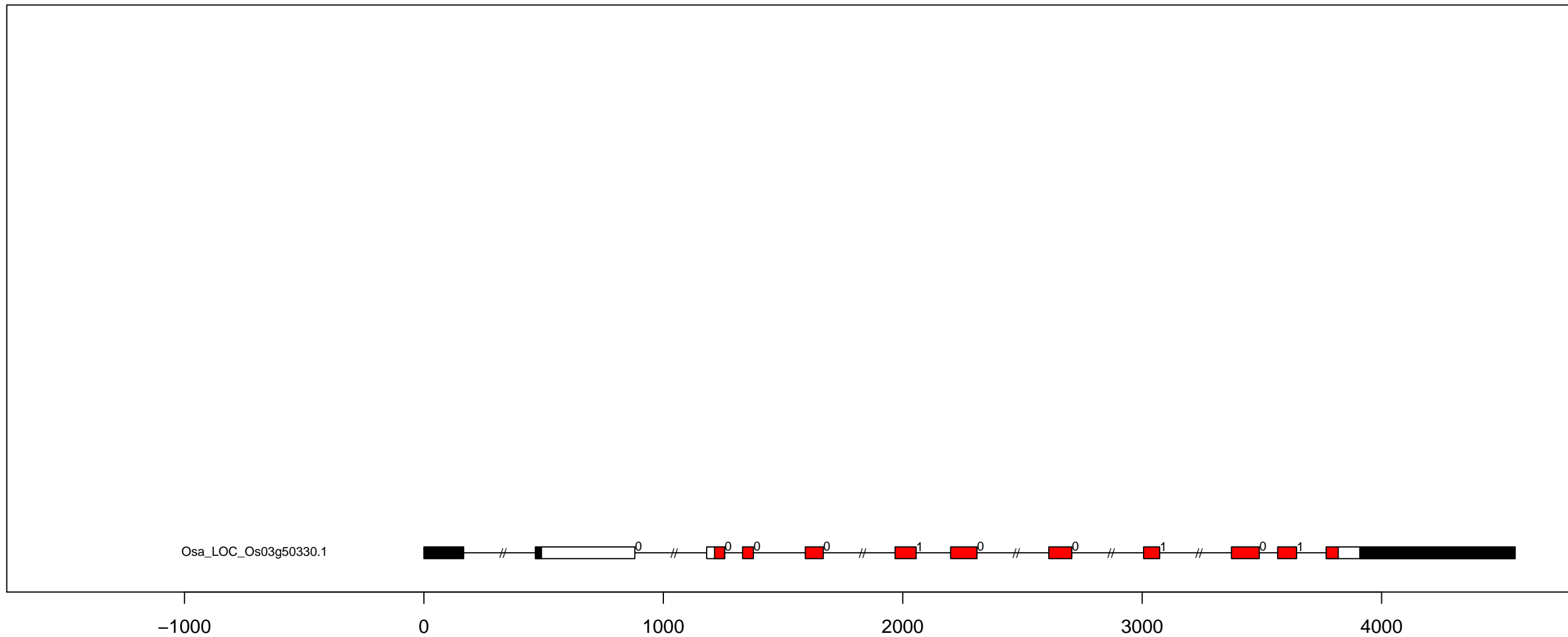

O.sa CAMK_CDPK exon-intron and kinase domain diagram (part 1)

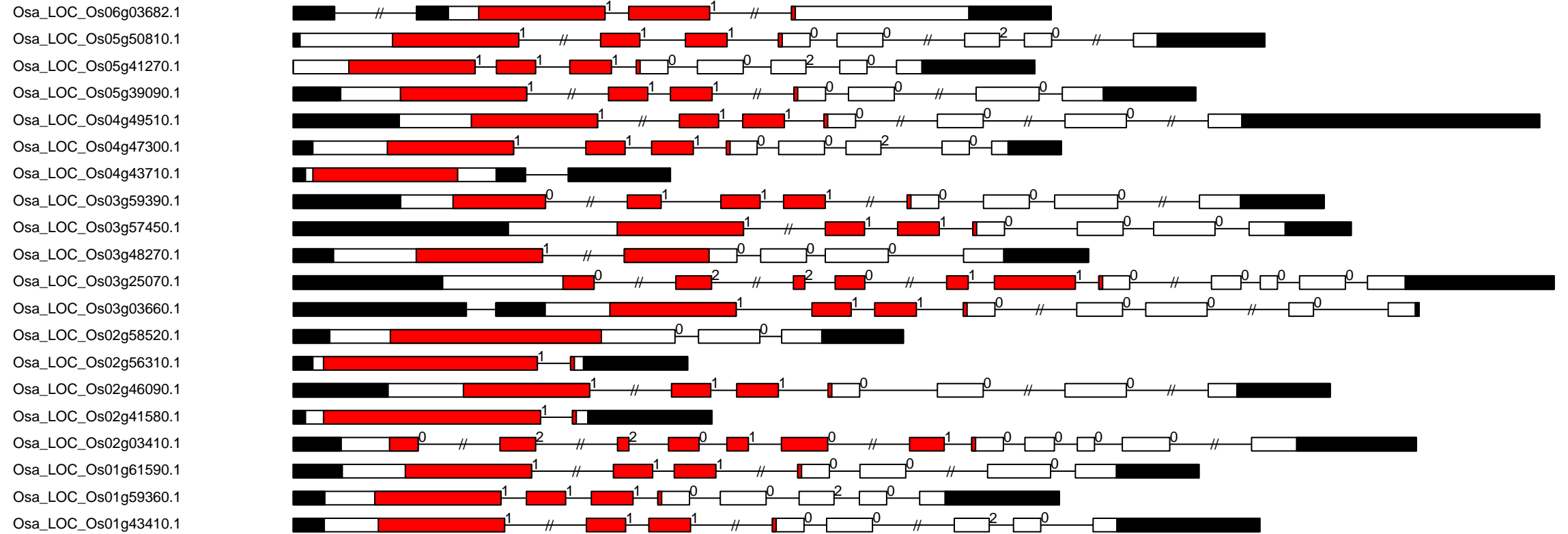

O.sa CAMK_CDPK exon-intron and kinase domain diagram (part 2)

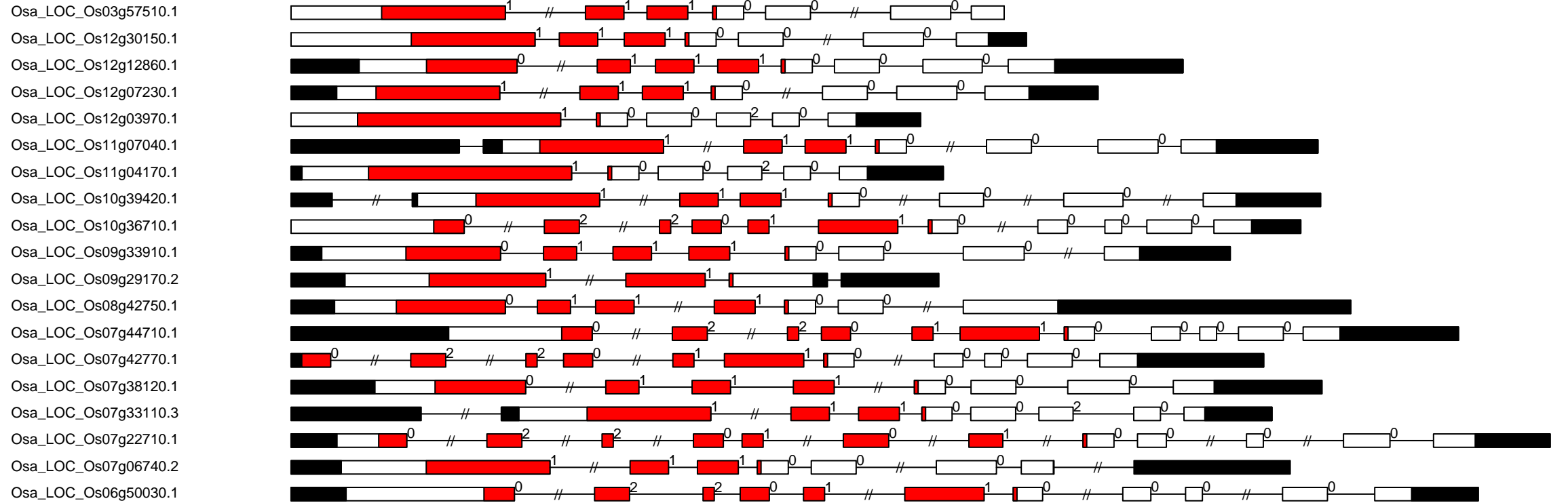

-1000

0

1000

2000

3000

4000

O.sa CAMK_OST1L exon-intron and kinase domain diagram (all)

Osa_LOC_Os05g35770.1
Osa_LOC_Os12g39630.1
Osa_LOC_Os10g41490.1
Osa_LOC_Os07g42940.1
Osa_LOC_Os04g59450.1
Osa_LOC_Os04g35240.1
Osa_LOC_Os03g55600.1
Osa_LOC_Os03g41460.1
Osa_LOC_Os03g27280.1
Osa_LOC_Os02g34600.1
Osa_LOC_Os01g64970.1

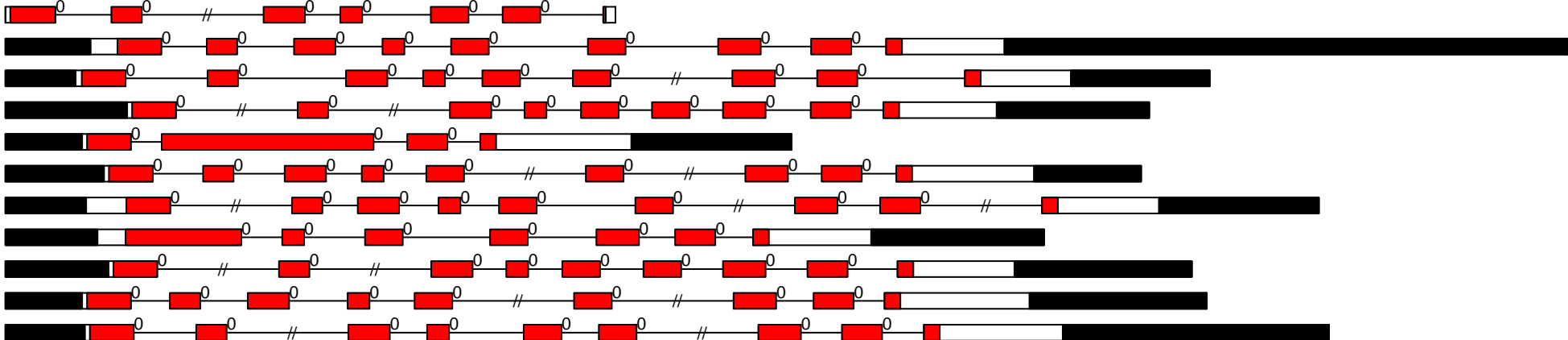

-1000

0

1000

2000

3000

4000

O.sa CK1_CK1 exon-intron and kinase domain diagram (all)

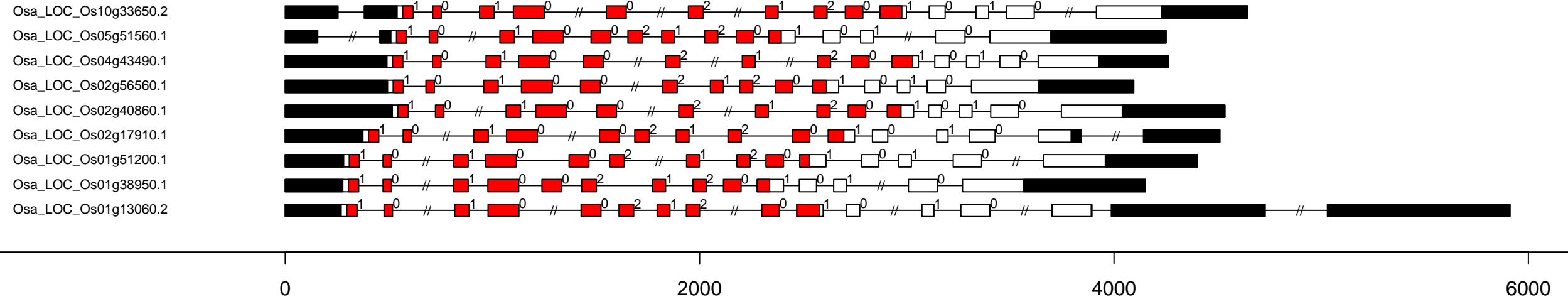

O.sa CK1_CK1-PI exon-intron and kinase domain diagram (all)

Osa_LOC_Os07g07560.2
Osa_LOC_Os05g11140.1
Osa_LOC_Os03g57940.1
Osa_LOC_Os01g56580.2
Osa_LOC_Os01g54100.1
Osa_LOC_Os01g10150.1

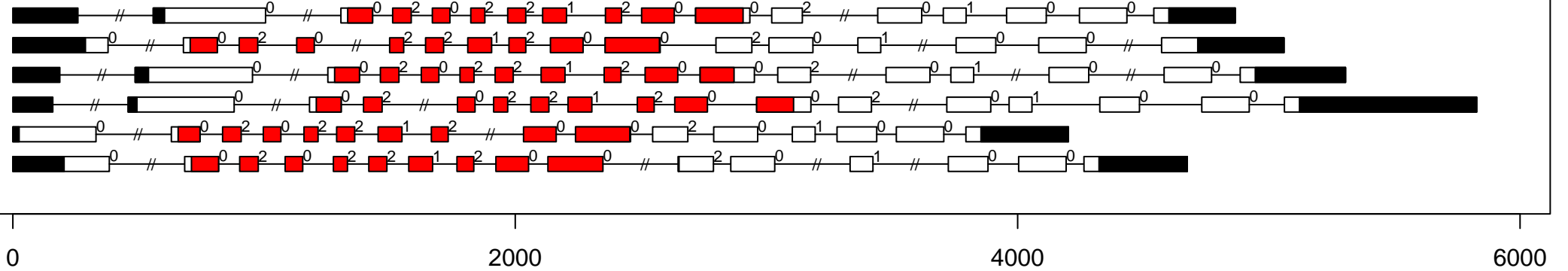

O.sa CMGC_CDK-CCRK exon-intron and kinase domain diagram (all)

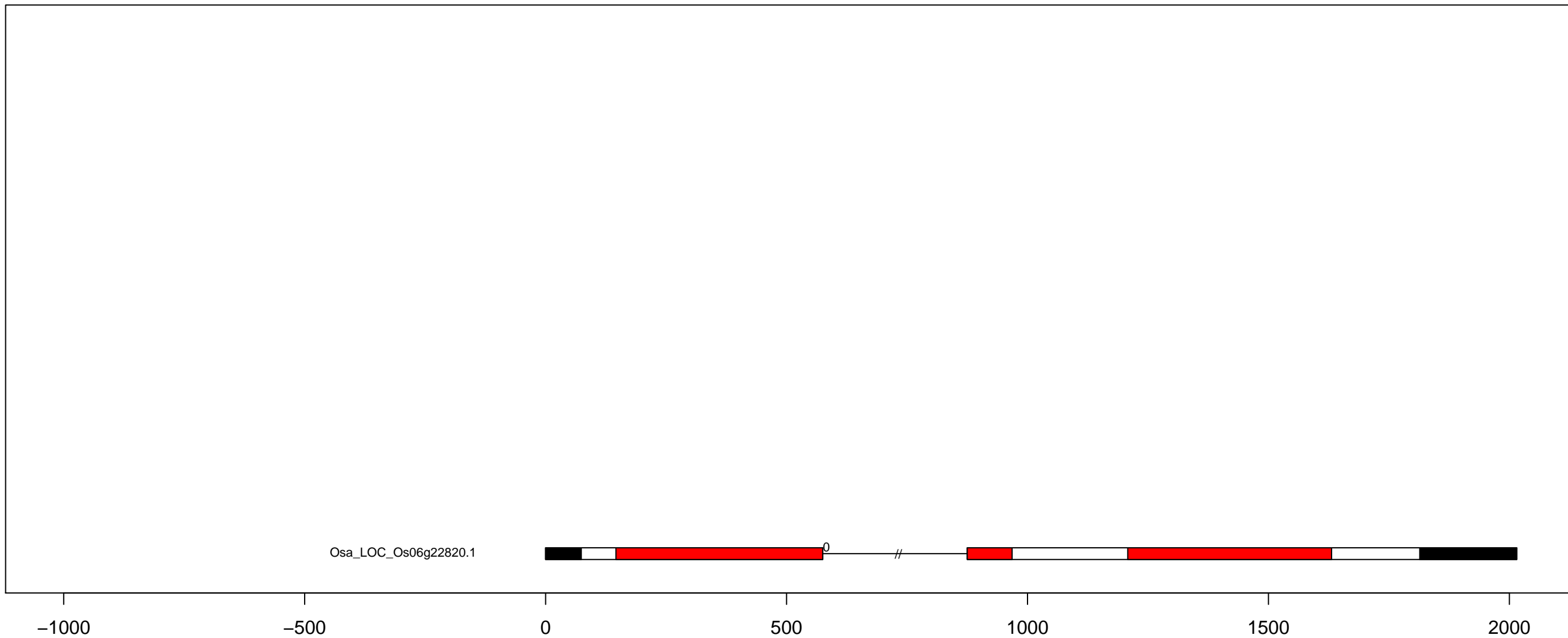

O.sa CMGC_CDK-CDK7 exon-intron and kinase domain diagram (all)

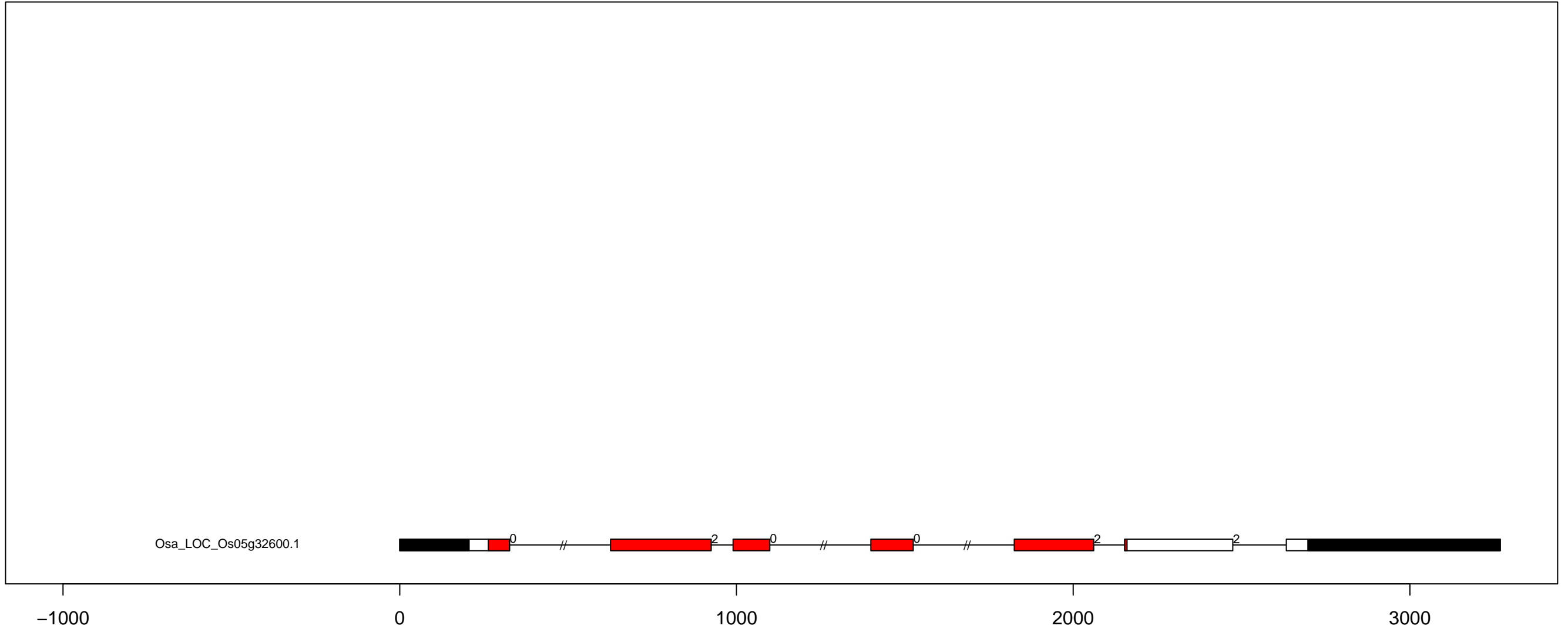

O.sa CMGC_CDK-CDK8 exon-intron and kinase domain diagram (all)

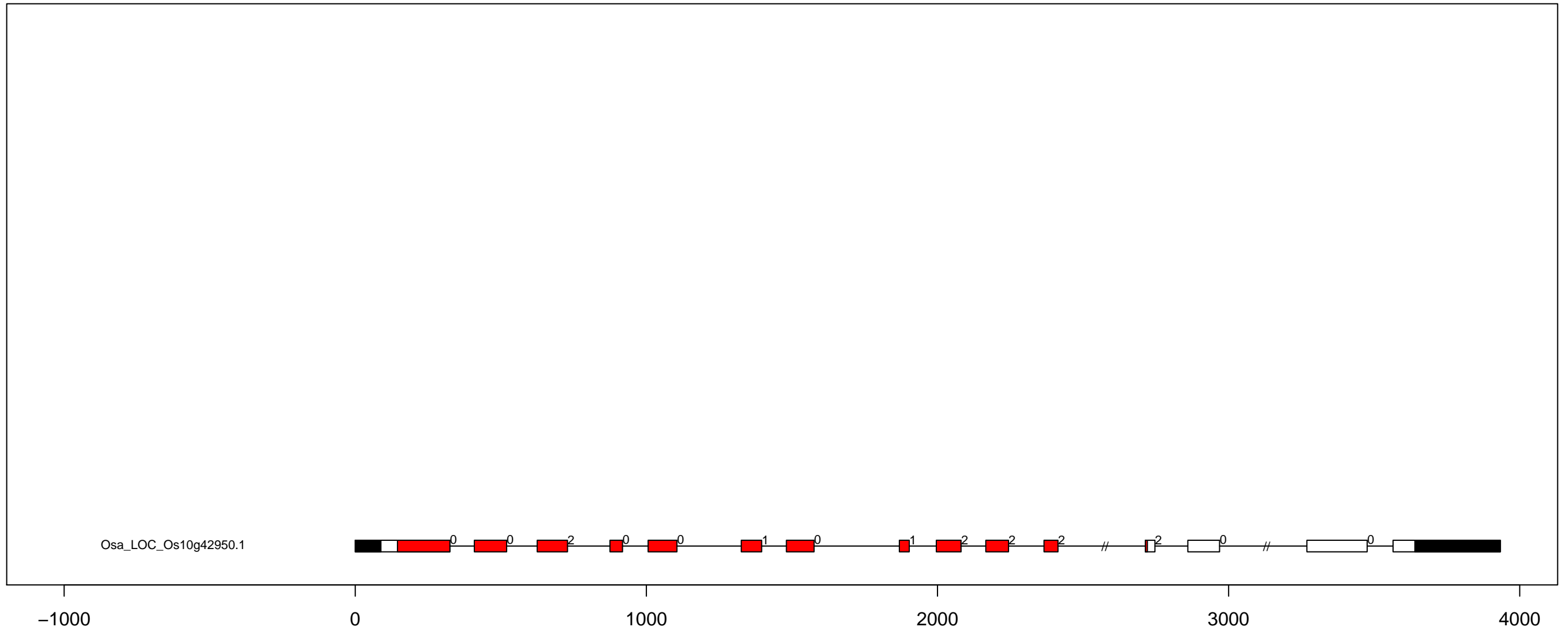

O.sa CMGC_CDK-CRK7-CDK9 exon-intron and kinase domain diagram (all)

Osa_LOC_Os02g20140.1
Osa_LOC_Os08g35220.1
Osa_LOC_Os08g02050.1
Osa_LOC_Os07g40550.1
Osa_LOC_Os05g32360.1
Osa_LOC_Os01g72790.1
Osa_LOC_Os01g70130.1
Osa_LOC_Os01g10430.1

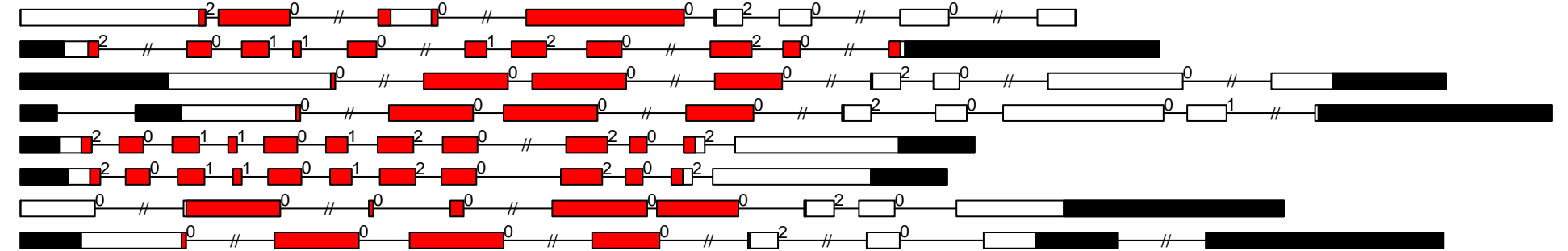

-1000

0

1000

2000

3000

4000

5000

O.sa CMGC_CDKL-Os exon-intron and kinase domain diagram (all)

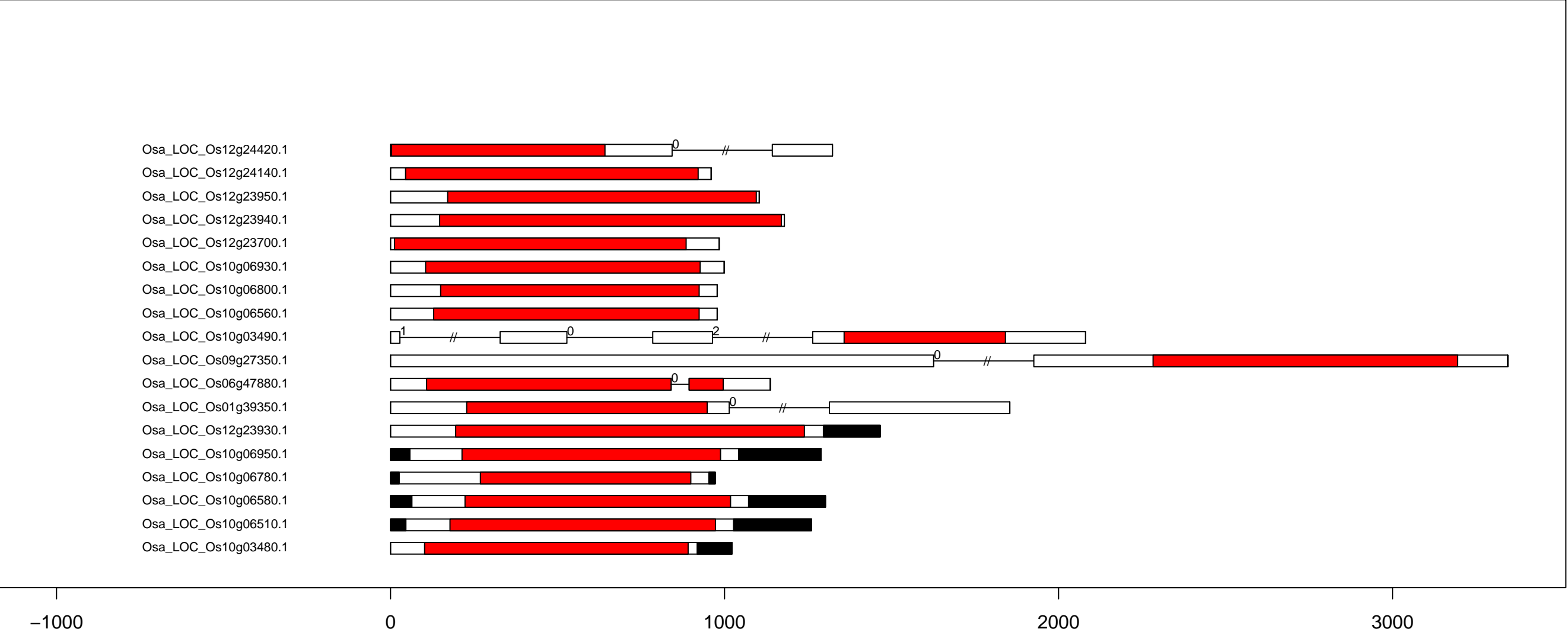

O.sa CMGC_CDK-PITSLRE exon-intron and kinase domain diagram (all)

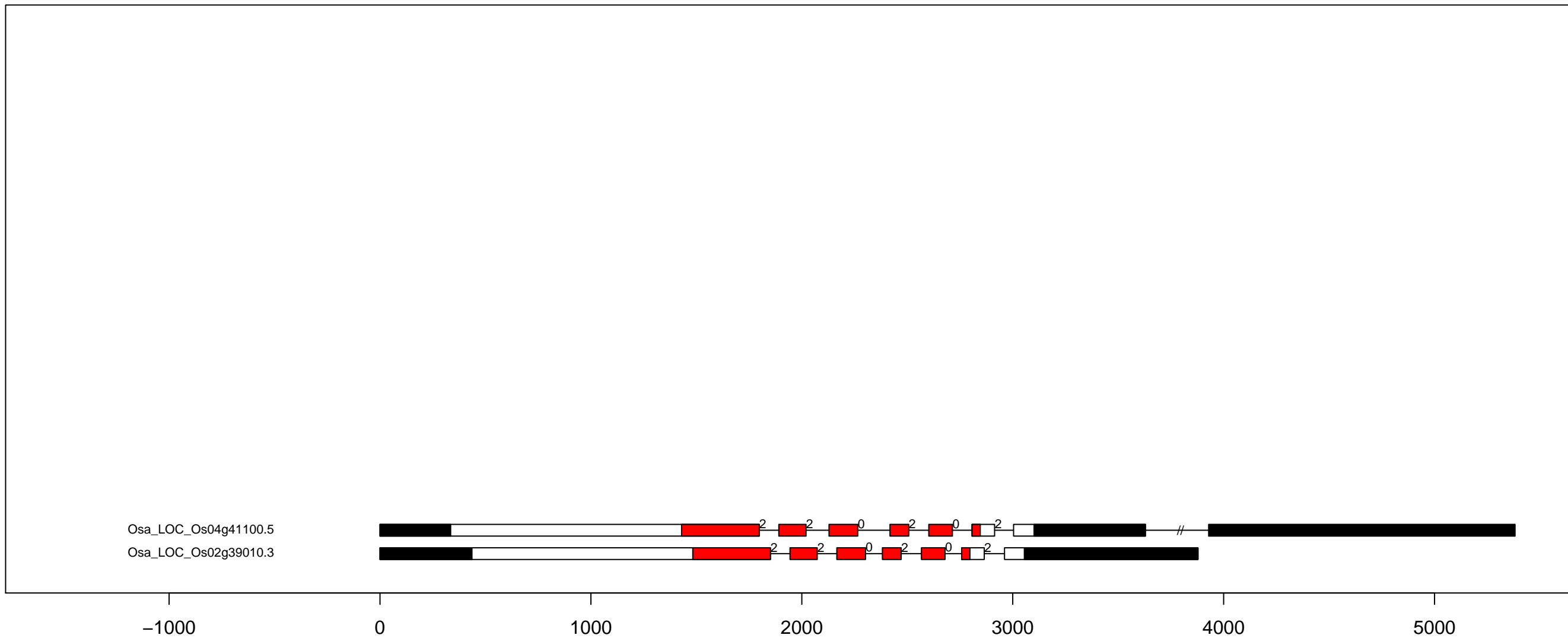

O.sa CMGC_CDK-PI exon-intron and kinase domain diagram (all)

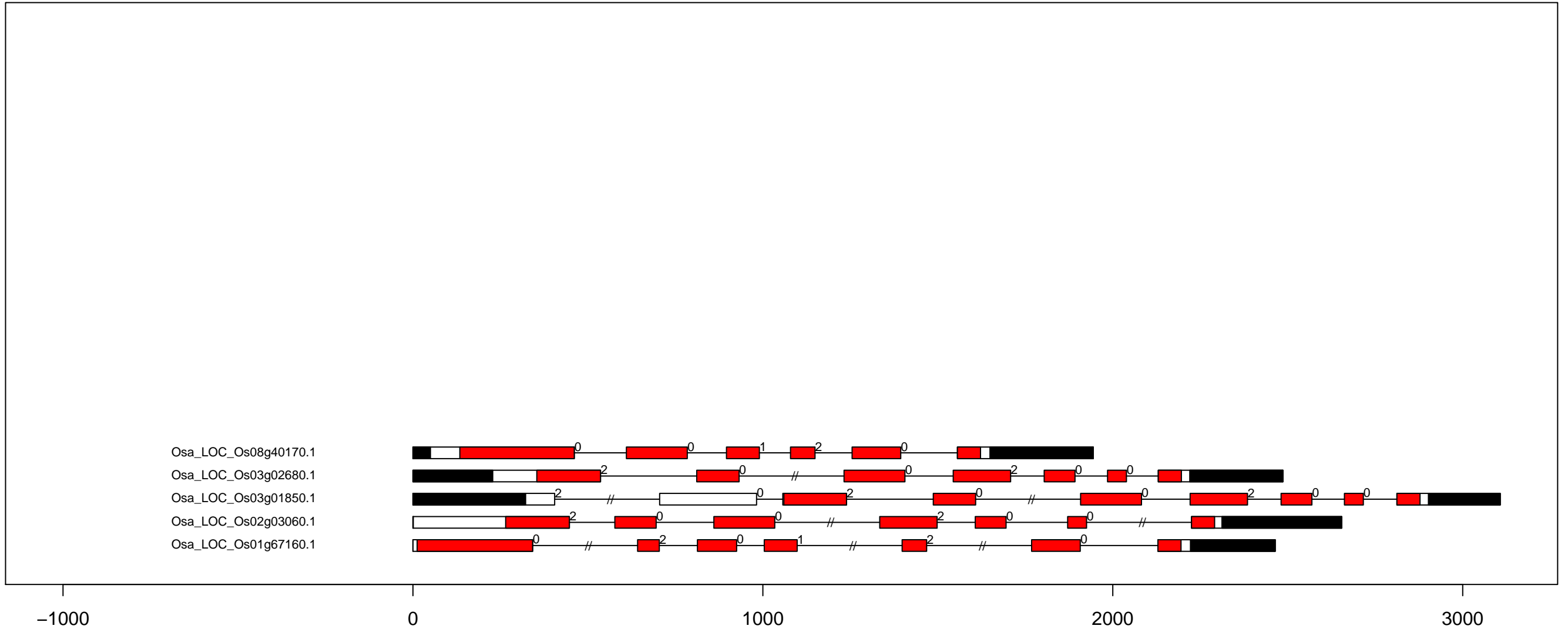

O.sa CMGC_CK2 exon-intron and kinase domain diagram (all)

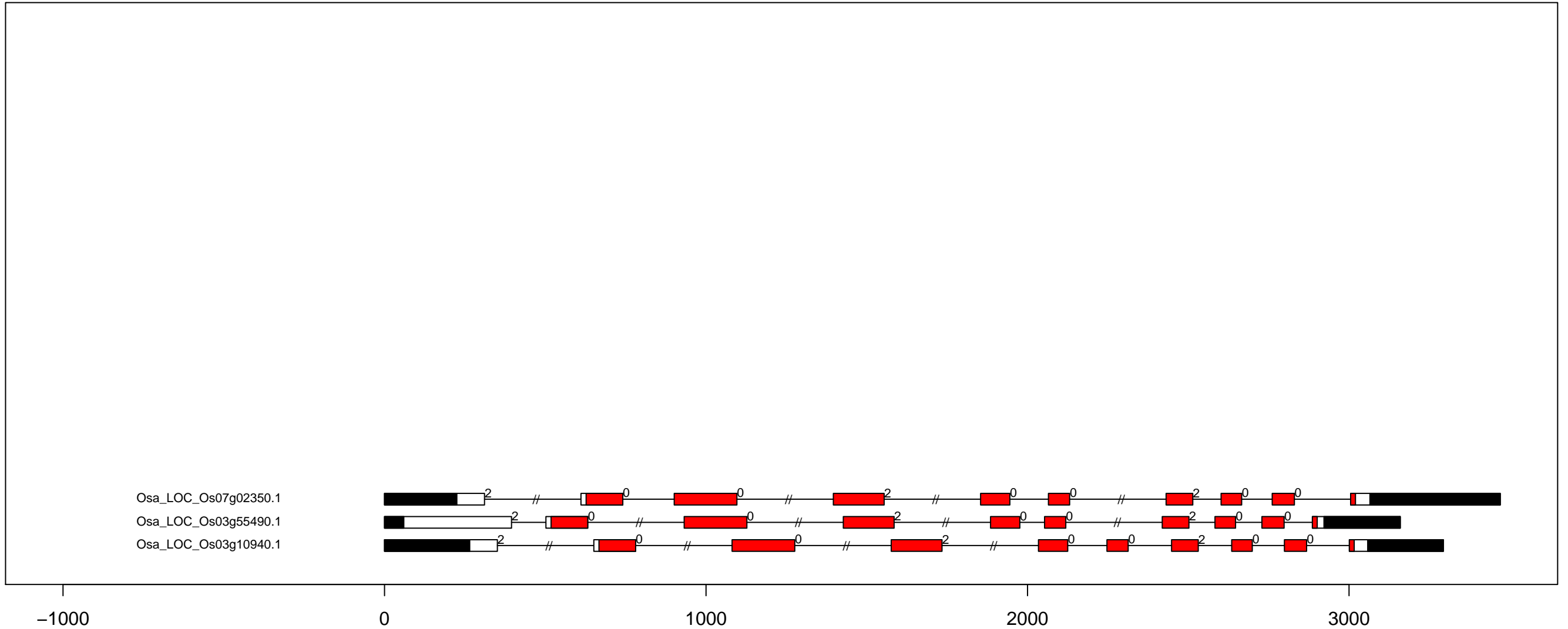

O.sa CMGC_CLK exon-intron and kinase domain diagram (all)

Osa_LOC_Os12g27520.1
Osa_LOC_Os01g62080.2
Osa_LOC_Os01g40840.1

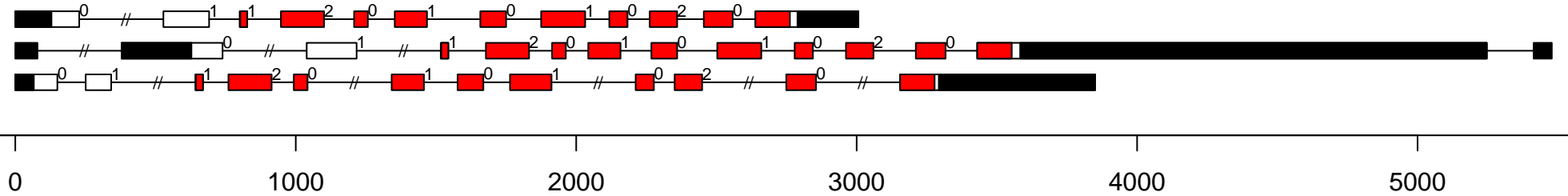

O.sa CMGC_DYRK-PRP4 exon-intron and kinase domain diagram (all)

Osa_LOC_Os12g44330.1
Osa_LOC_Os05g39080.1
Osa_LOC_Os03g51020.1
Osa_LOC_Os03g50230.1
Osa_LOC_Os01g61620.1

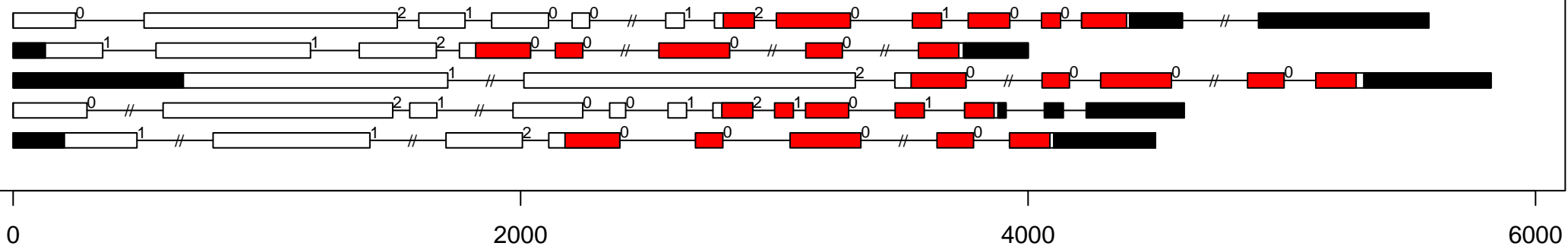

O.sa CMGC_DYRK-YAK exon-intron and kinase domain diagram (all)

Osa_LOC_Os04g51370.1

Osa_LOC_Os02g47410.1

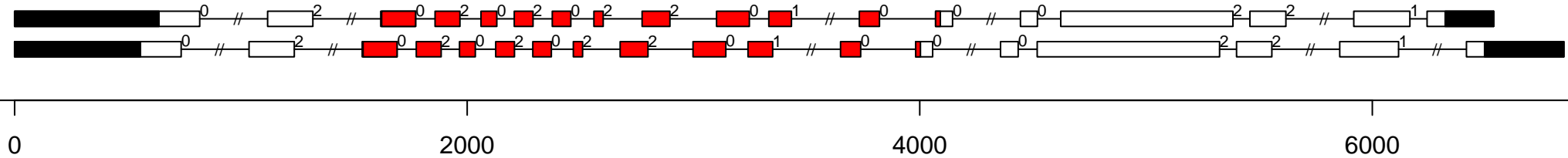

O.sa CMGC_GSK exon-intron and kinase domain diagram (all)

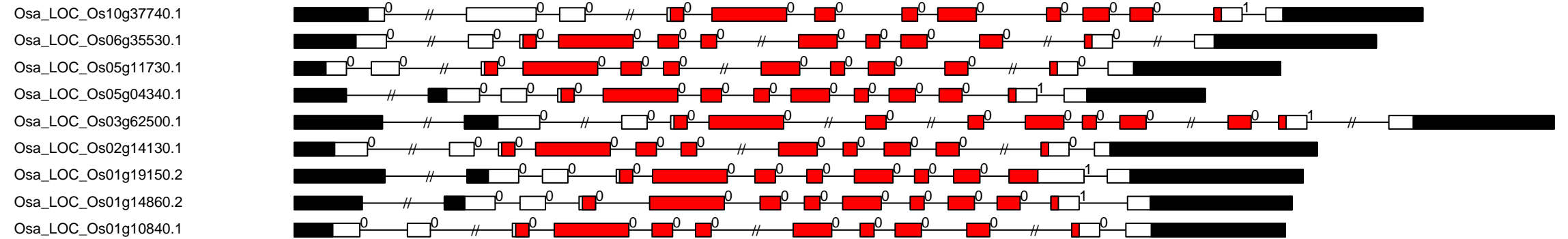

-1000

0

1000

2000

3000

4000

O.sa CMGC_MAPK exon-intron and kinase domain diagram (all)

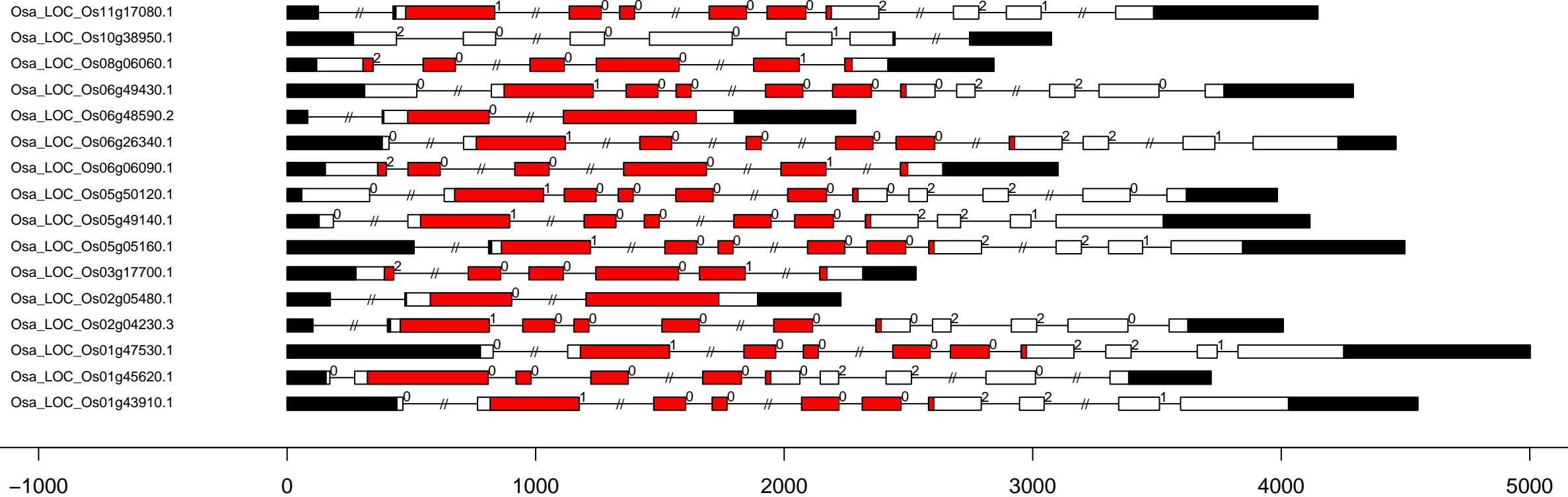

O.sa CMGC_PI-Tthe exon-intron and kinase domain diagram (all)

Osa_LOC_Os02g55340.1

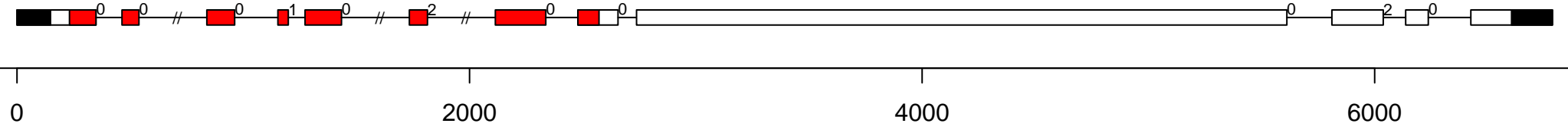

O.sa CMGC_RCK exon-intron and kinase domain diagram (all)

Osa_LOC_Os06g02550.2

Osa_LOC_Os03g63020.1

Osa_LOC_Os02g47220.1

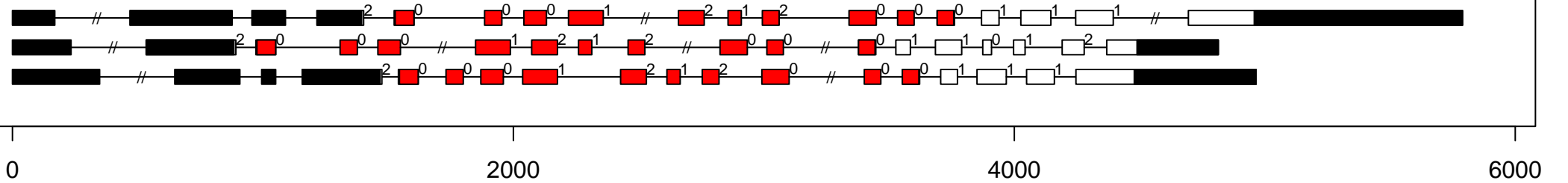

O.sa CMGC_SRPK exon-intron and kinase domain diagram (all)

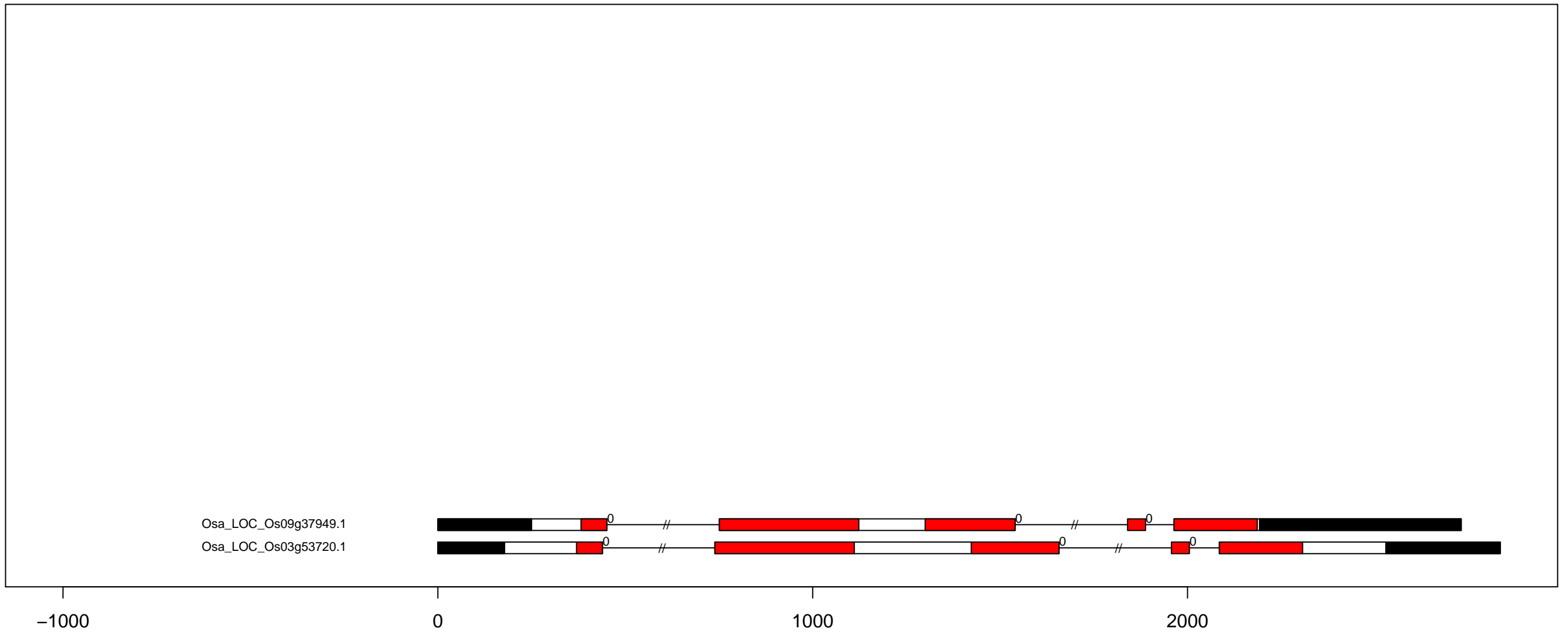

O.sa Group-PI-2 exon-intron and kinase domain diagram (all)

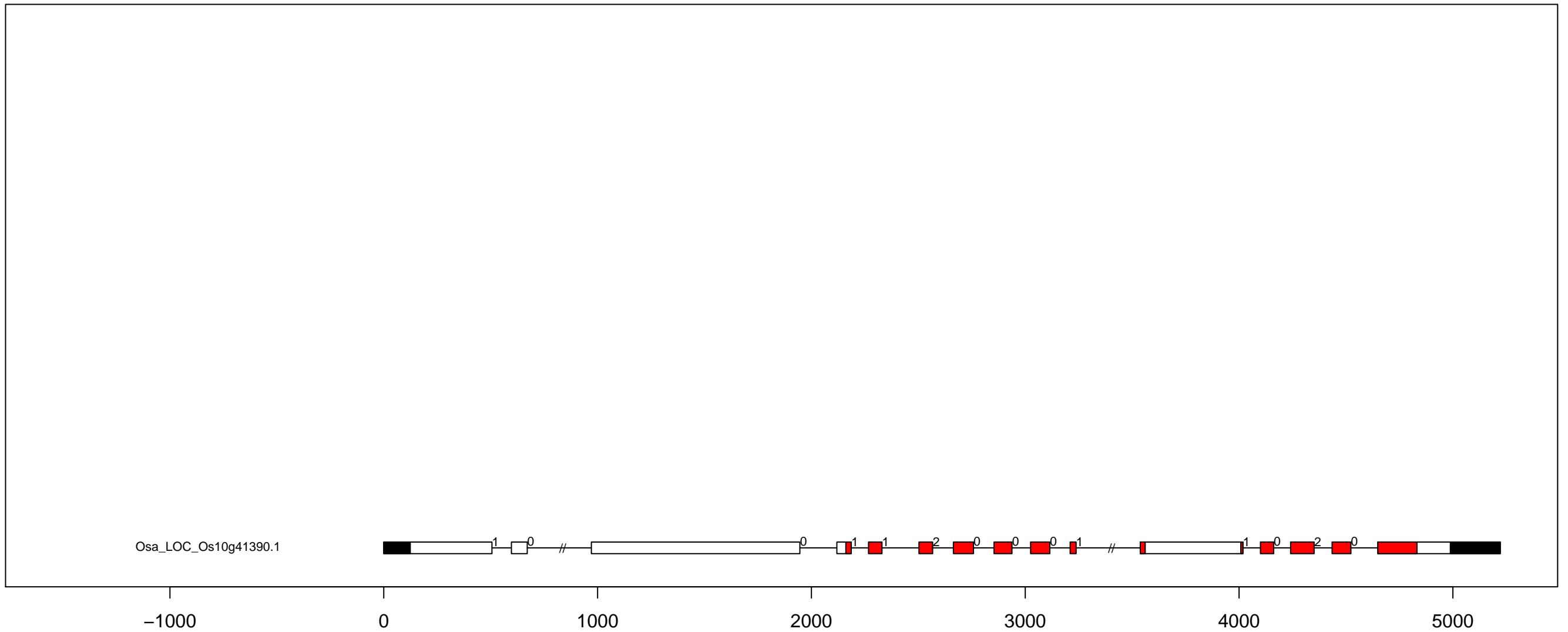

O.sa Group-PI-3 exon-intron and kinase domain diagram (all)

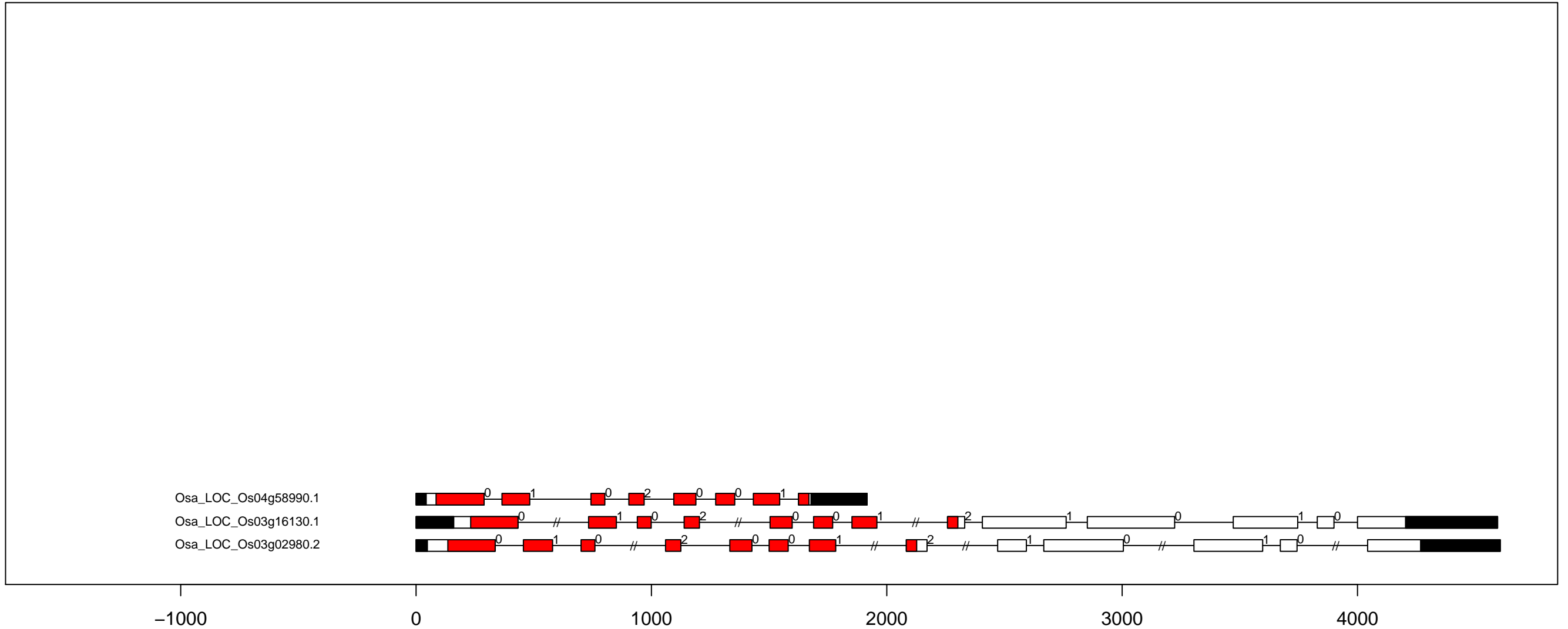

O.sa Group-PI-4 exon-intron and kinase domain diagram (all)

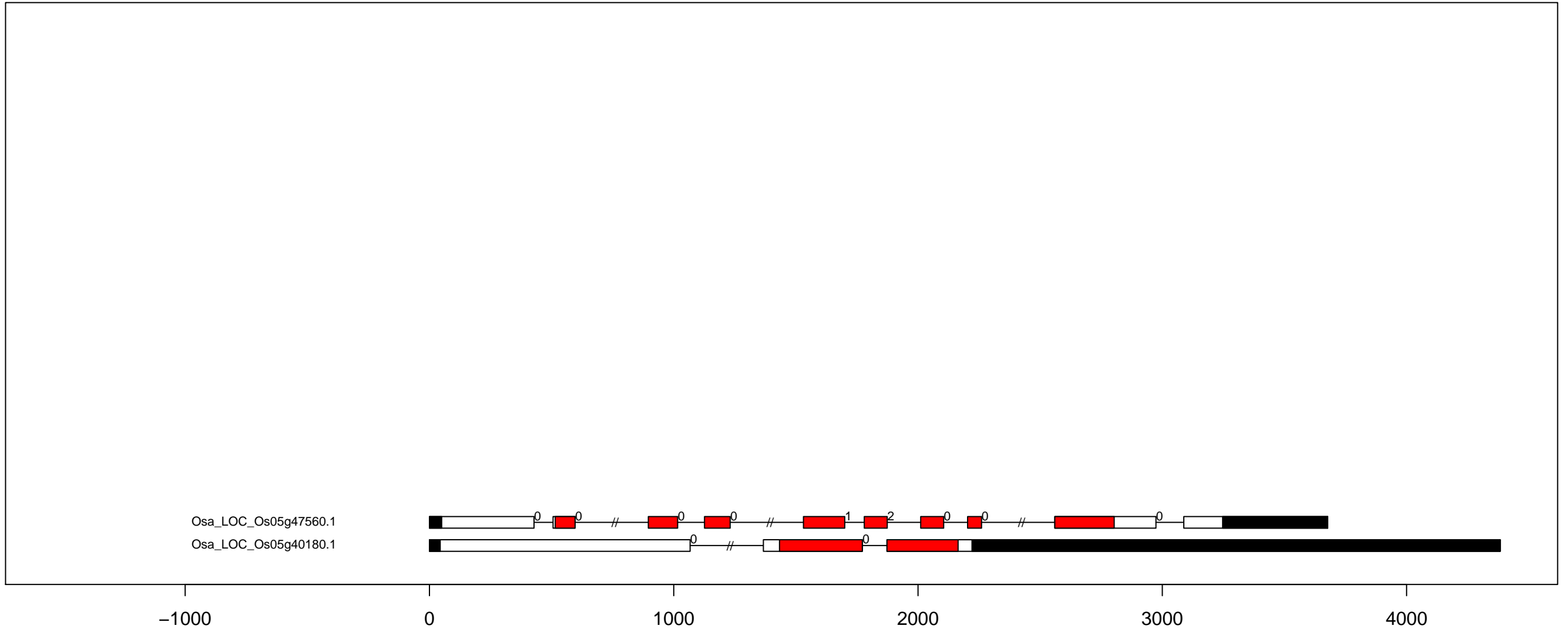

O.sa IRE1 exon-intron and kinase domain diagram (all)

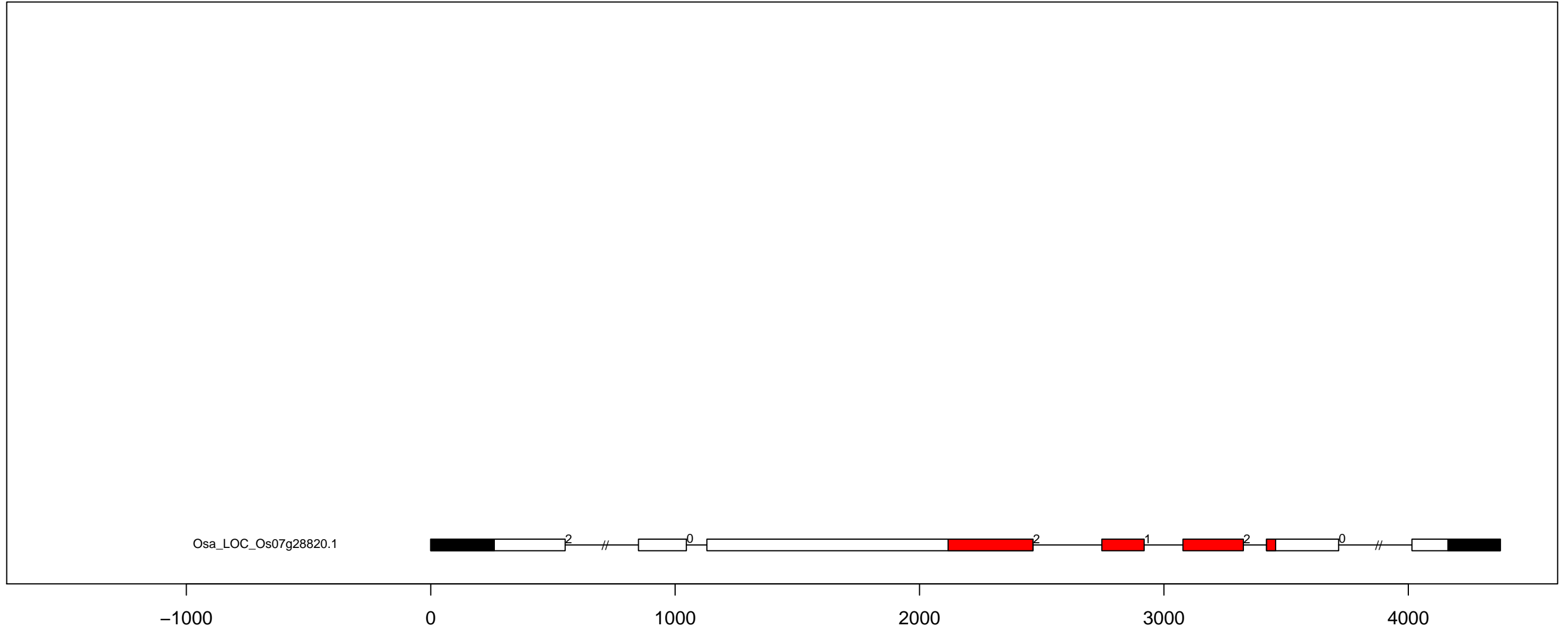

O.sa NAK exon-intron and kinase domain diagram (all)

Osa_LOC_Os09g20640.1
Osa_LOC_Os09g10720.1
Osa_LOC_Os09g06230.1
Osa_LOC_Os02g37880.3

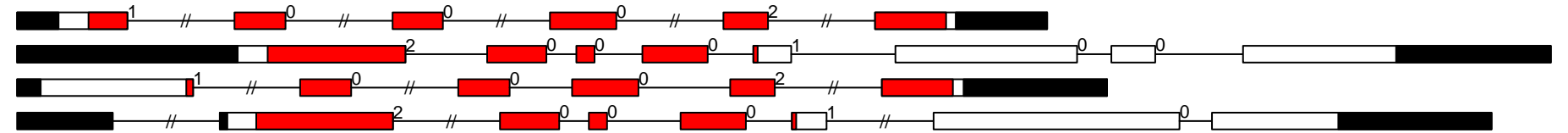

-1000

0

1000

2000

3000

4000

O.sa NEK exon-intron and kinase domain diagram (all)

Osa_LOC_Os12g41180.1
Osa_LOC_Os07g08000.1
Osa_LOC_Os05g36960.1
Osa_LOC_Os03g43590.1
Osa_LOC_Os02g37830.1
Osa_LOC_Os01g64490.1

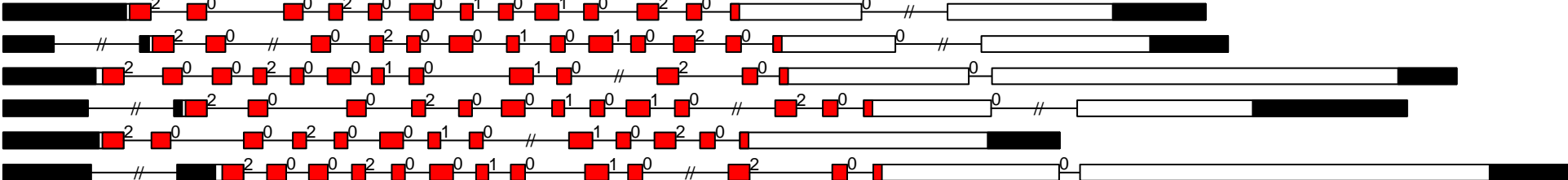

-1000

0

1000

2000

3000

4000

5000

O.sa PEK_GCN2 exon-intron and kinase domain diagram (all)

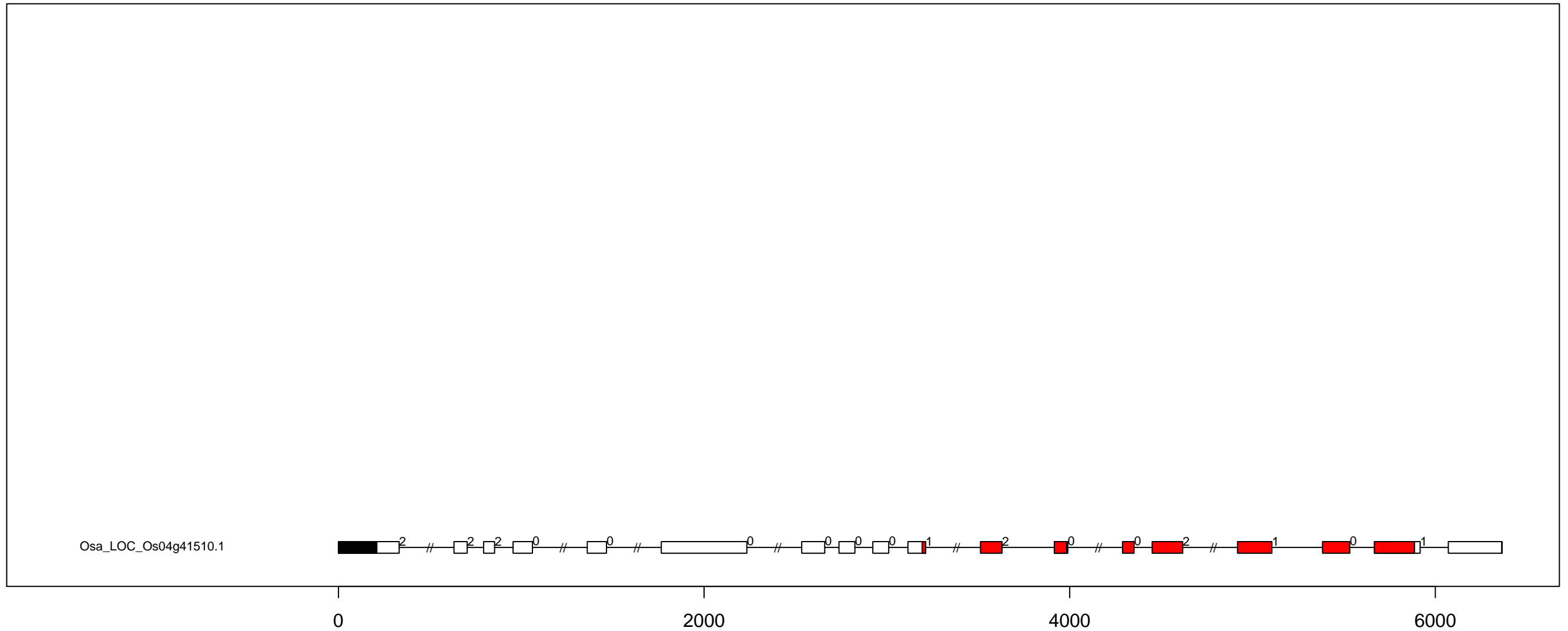

O.sa RLK-Pelle_C-LEC exon-intron and kinase domain diagram (all)

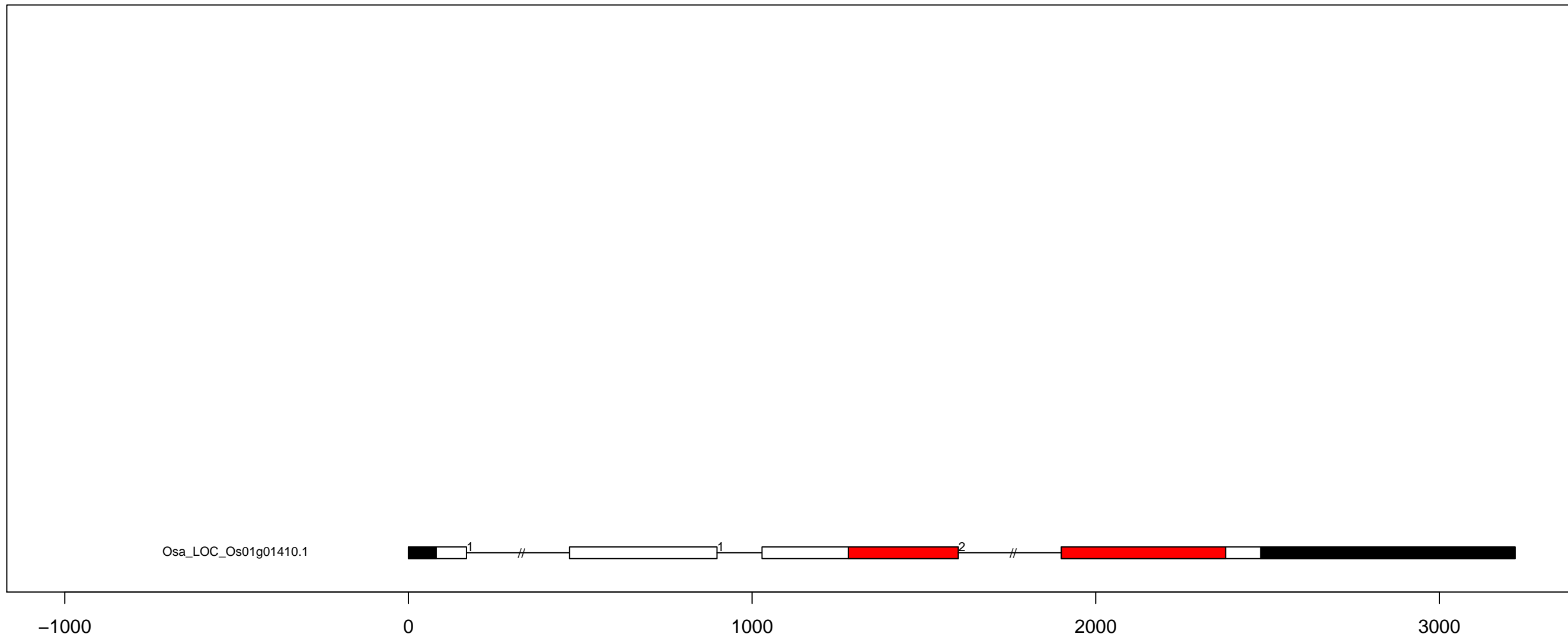

O.sa RLK-Pelle_CR4L exon-intron and kinase domain diagram (all)

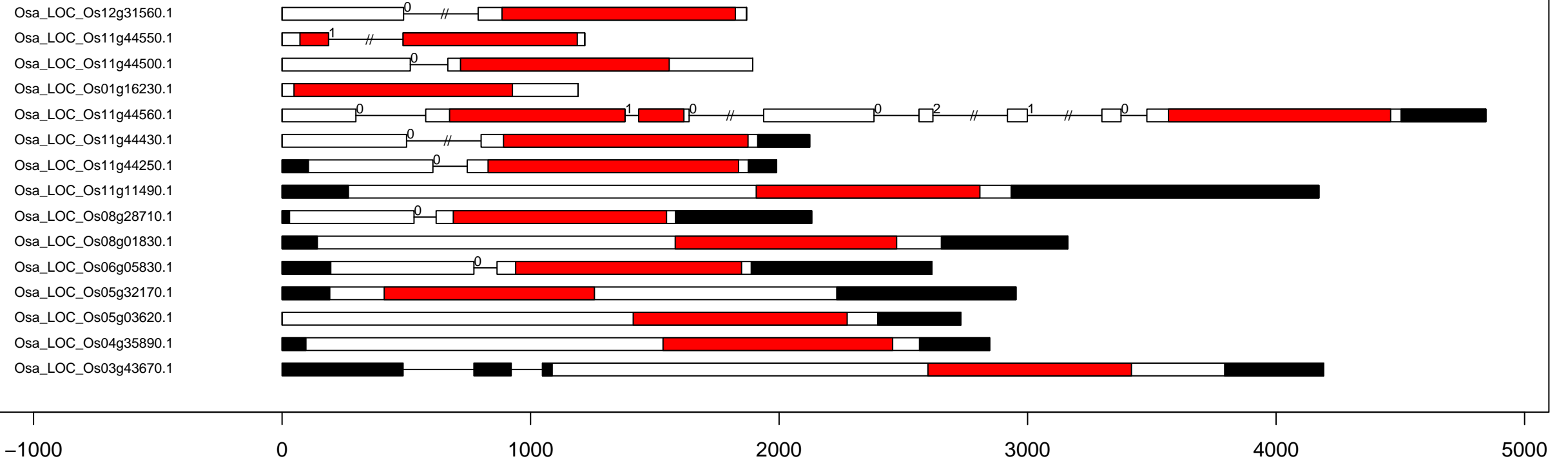

O.sa RLK-Pelle_CrRLK1L-1 exon-intron and kinase domain diagram (all)

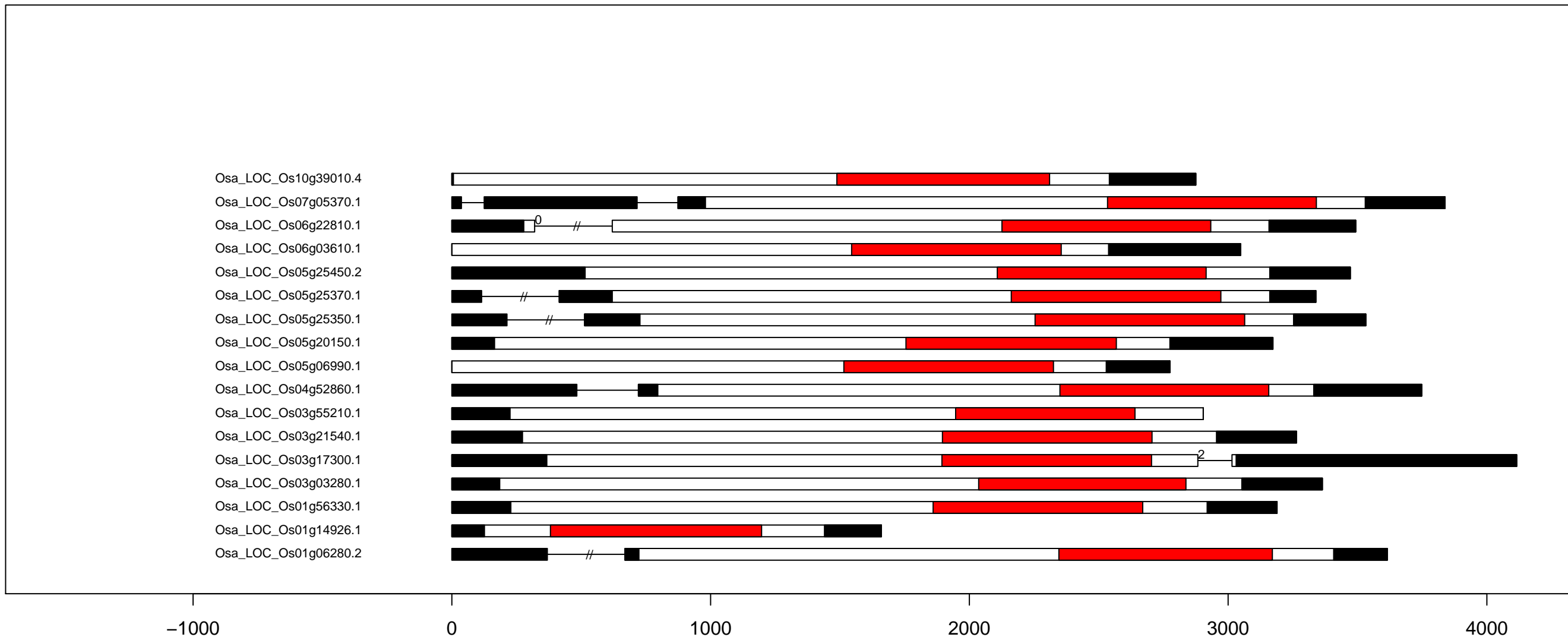

O.sa RLK-Pelle_DLSV exon-intron and kinase domain diagram (part 1)

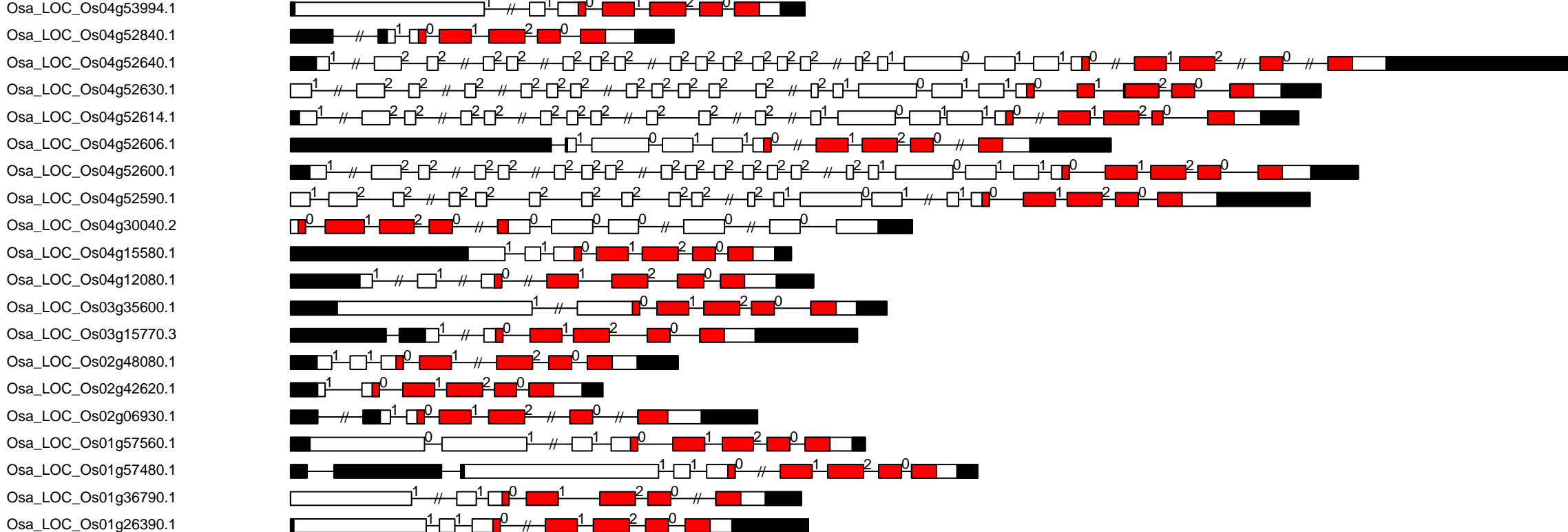

-2000

0

2000

4000

6000

8000

O.sa RLK-Pelle_DLSV exon-intron and kinase domain diagram (part 2)

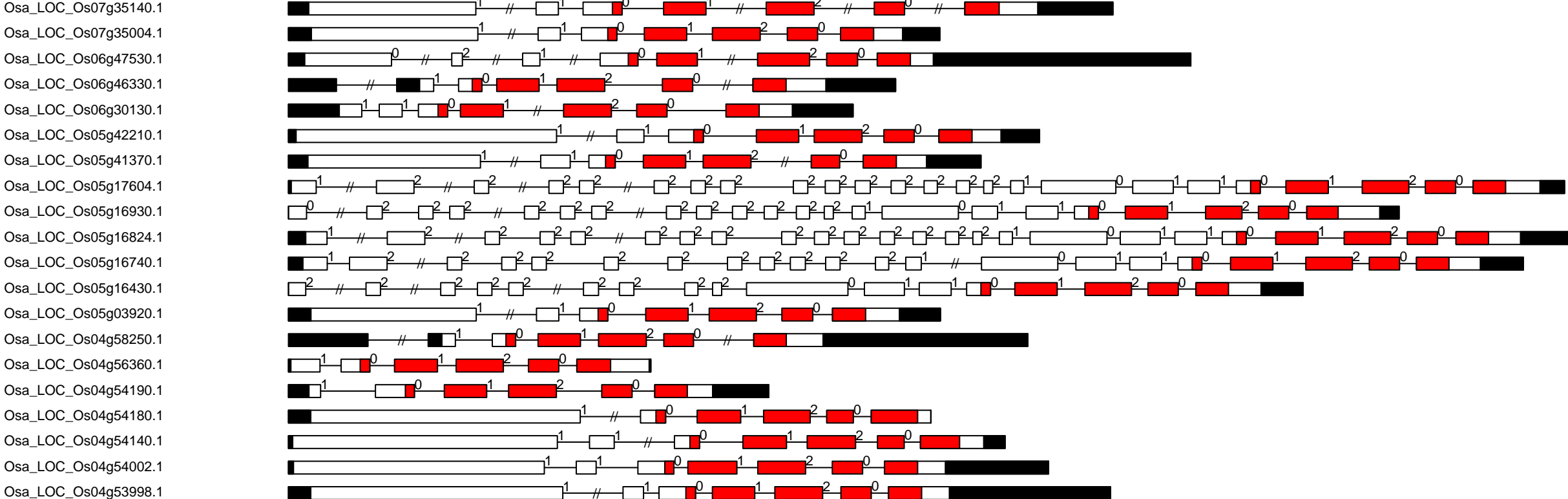

0

2000

4000

6000

O.sa RLK-Pelle_DLSV exon-intron and kinase domain diagram (part 3)

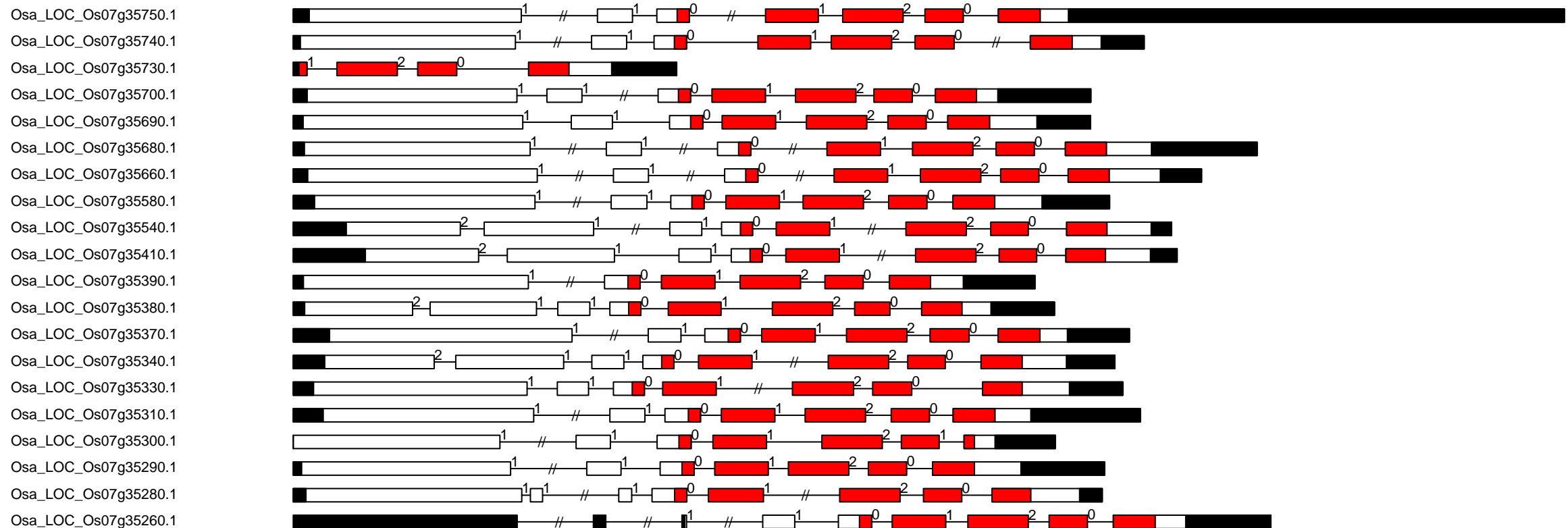

O.sa RLK-Pelle_DLSV exon-intron and kinase domain diagram (part 4)

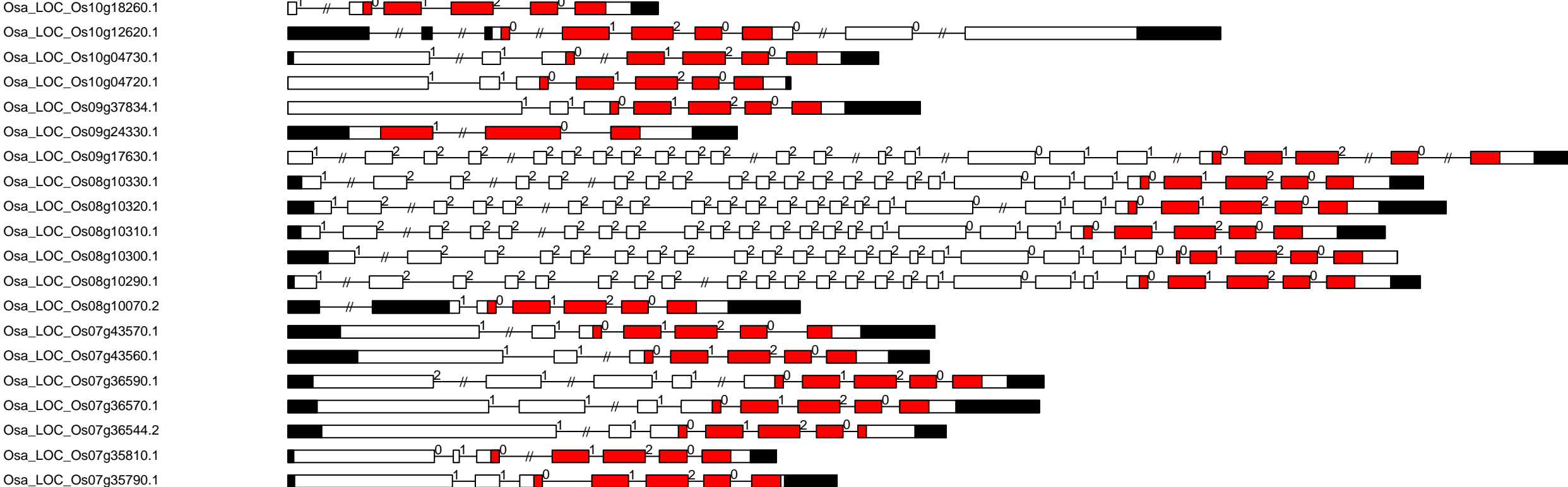

0

2000

4000

6000

O.sa RLK-Pelle_DLSV exon-intron and kinase domain diagram (part 5)

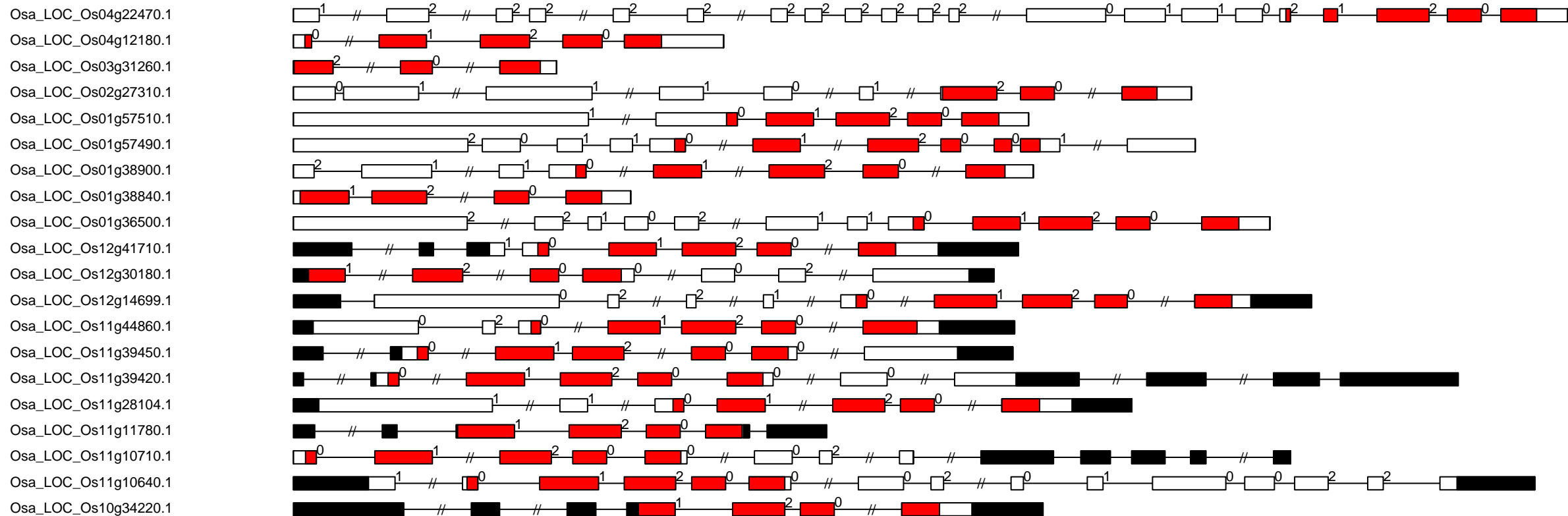

O.sa RLK-Pelle_DLSV exon-intron and kinase domain diagram (part 6)

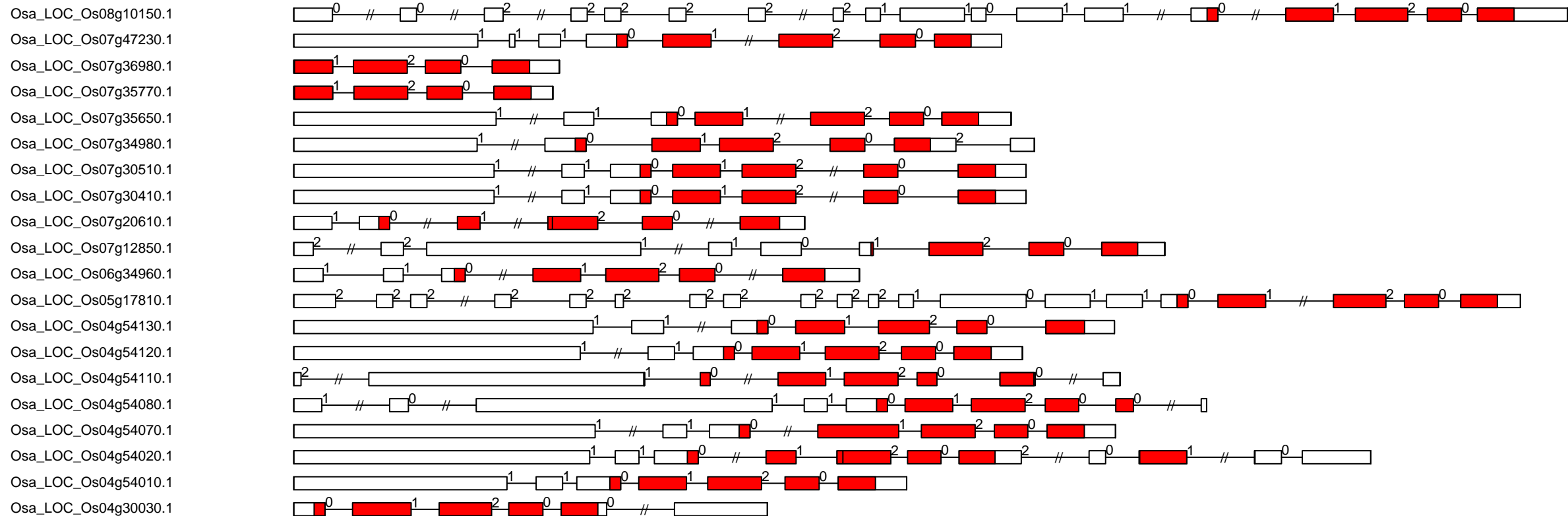

O.sa RLK-Pelle_DLSV exon-intron and kinase domain diagram (part 7)

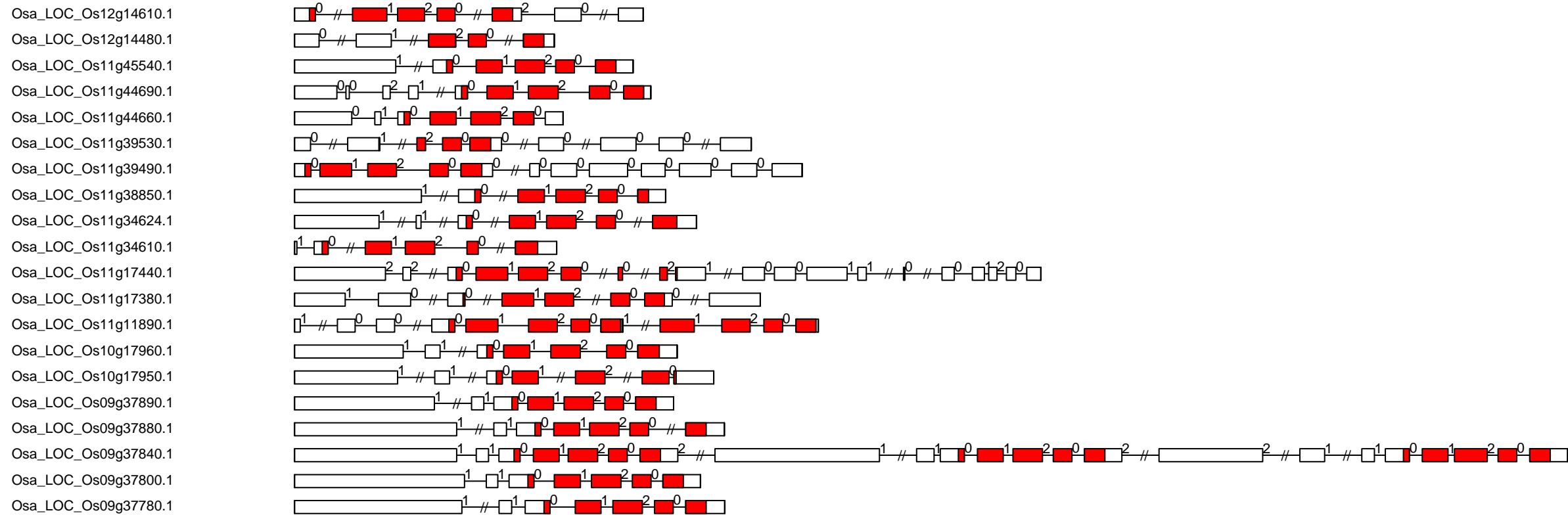

O.sa RLK-Pelle_Extensin exon-intron and kinase domain diagram (all)

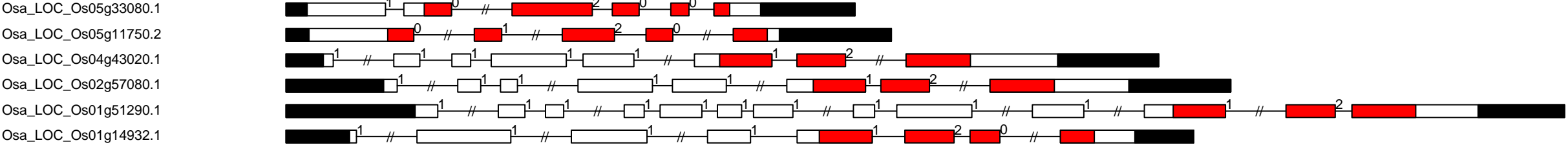

0

2000

4000

6000

O.sa RLK-Pelle_L-LEC exon-intron and kinase domain diagram (part 1)

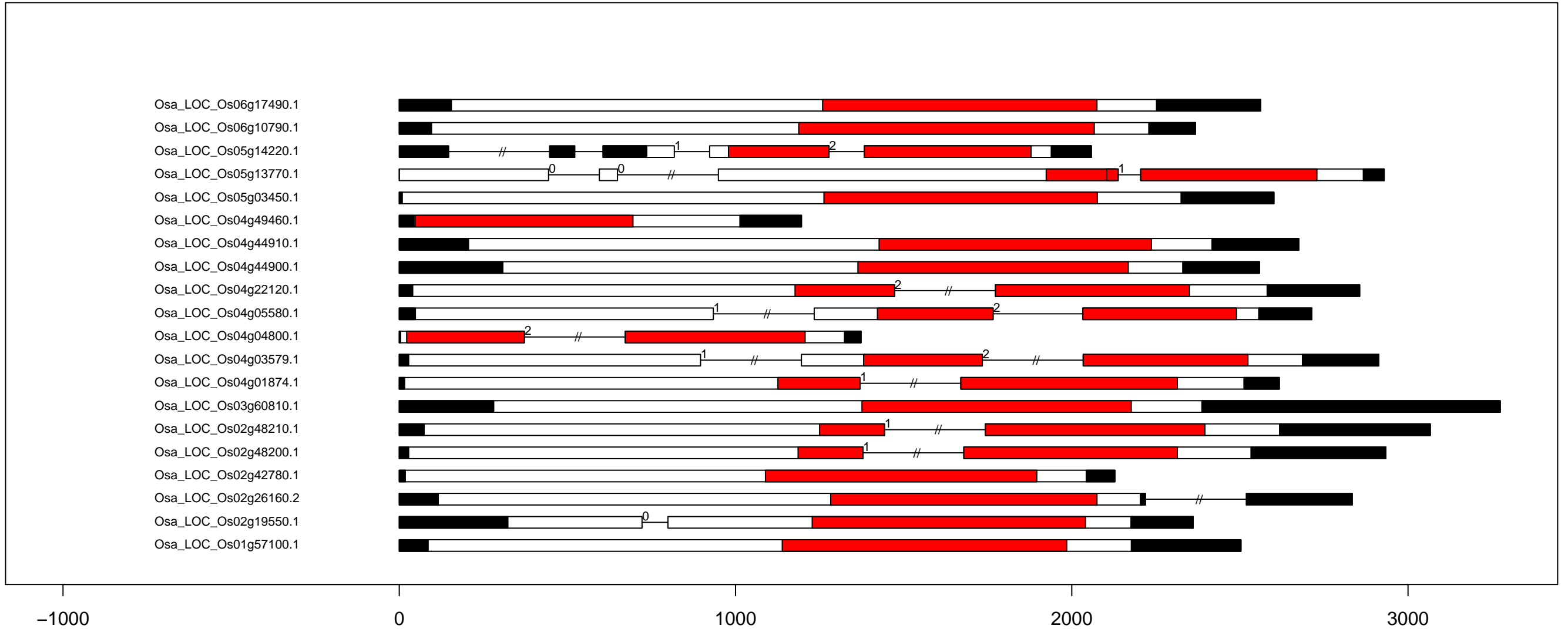

O.sa RLK-Pelle_L-LEC exon-intron and kinase domain diagram (part 2)

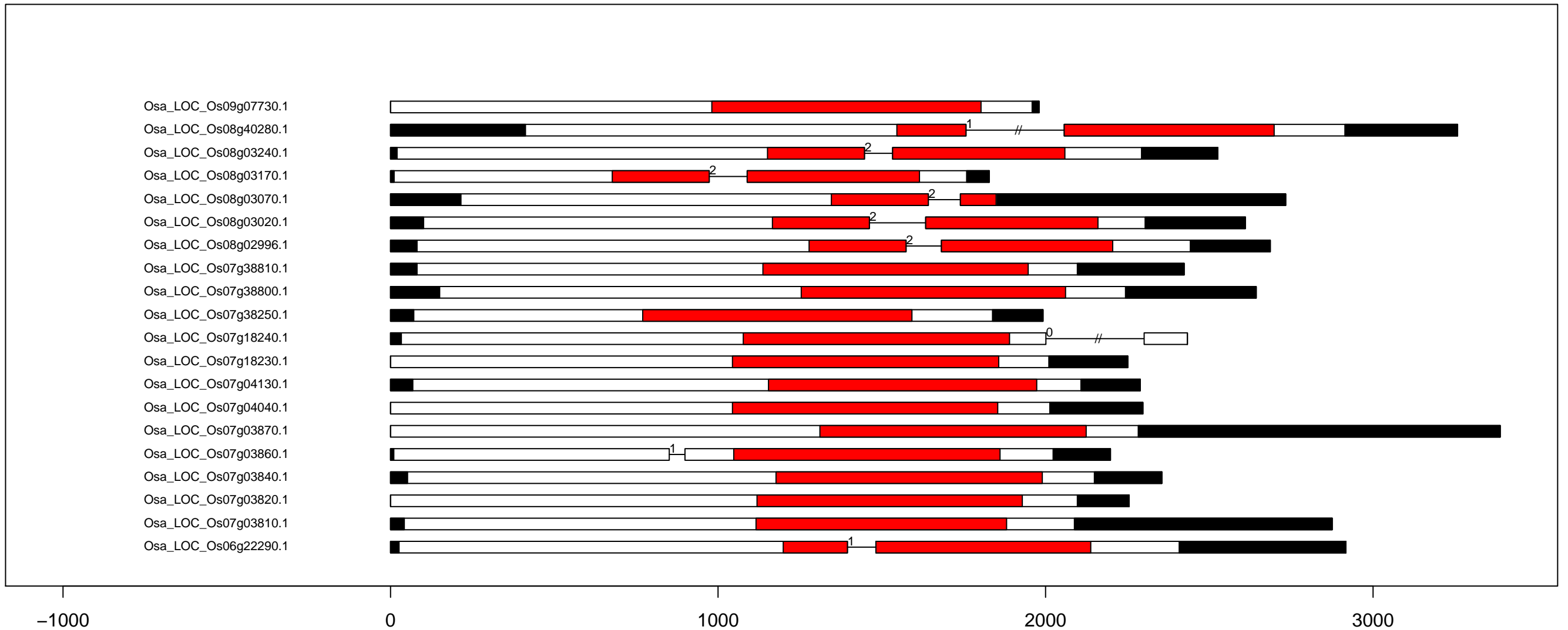

O.sa RLK-Pelle_L-LEC exon-intron and kinase domain diagram (part 3)

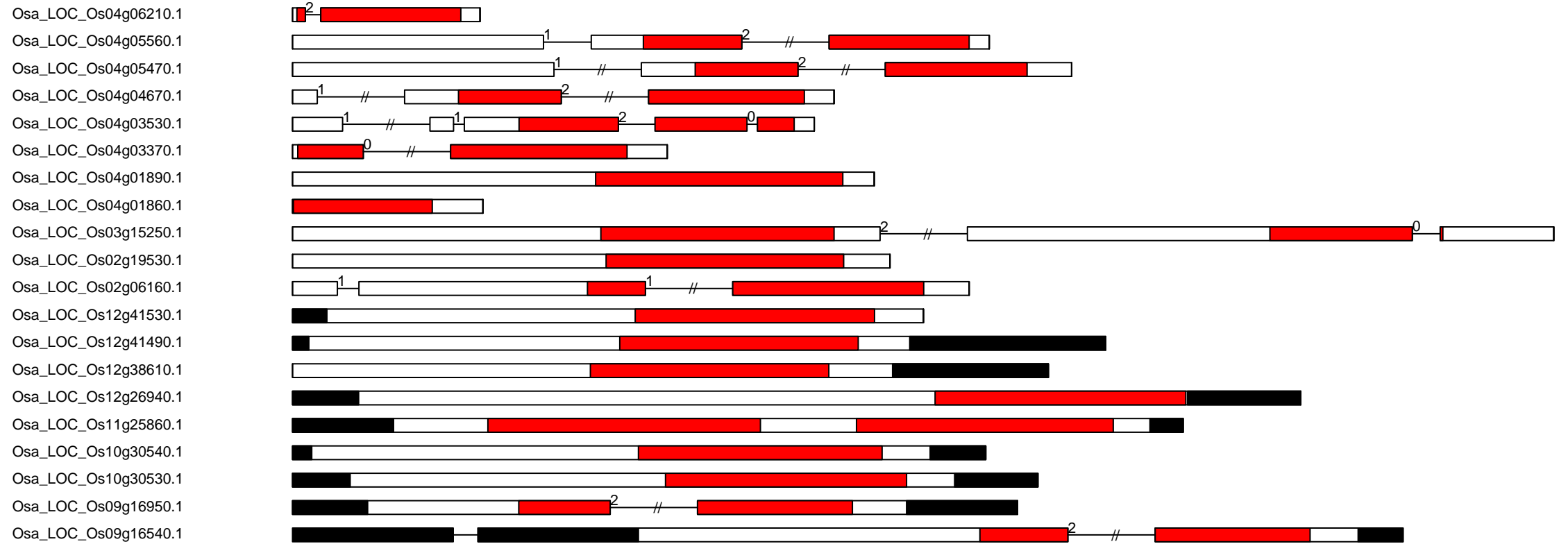

O.sa RLK-Pelle_L-LEC exon-intron and kinase domain diagram (part 4)

Osa_LOC_Os08g03150.1
 Osa_LOC_Os08g03100.1
 Osa_LOC_Os08g03090.1
 Osa_LOC_Os08g03040.1
 Osa_LOC_Os07g38820.1
 Osa_LOC_Os07g15930.1
 Osa_LOC_Os07g04010.1
 Osa_LOC_Os07g04000.1
 Osa_LOC_Os07g03970.1
 Osa_LOC_Os07g03950.1
 Osa_LOC_Os07g03930.1
 Osa_LOC_Os07g03920.1
 Osa_LOC_Os07g03900.1
 Osa_LOC_Os07g03890.1
 Osa_LOC_Os07g03880.1
 Osa_LOC_Os07g03830.1
 Osa_LOC_Os07g03790.1
 Osa_LOC_Os07g03780.1
 Osa_LOC_Os06g14260.1
 Osa_LOC_Os04g06244.1

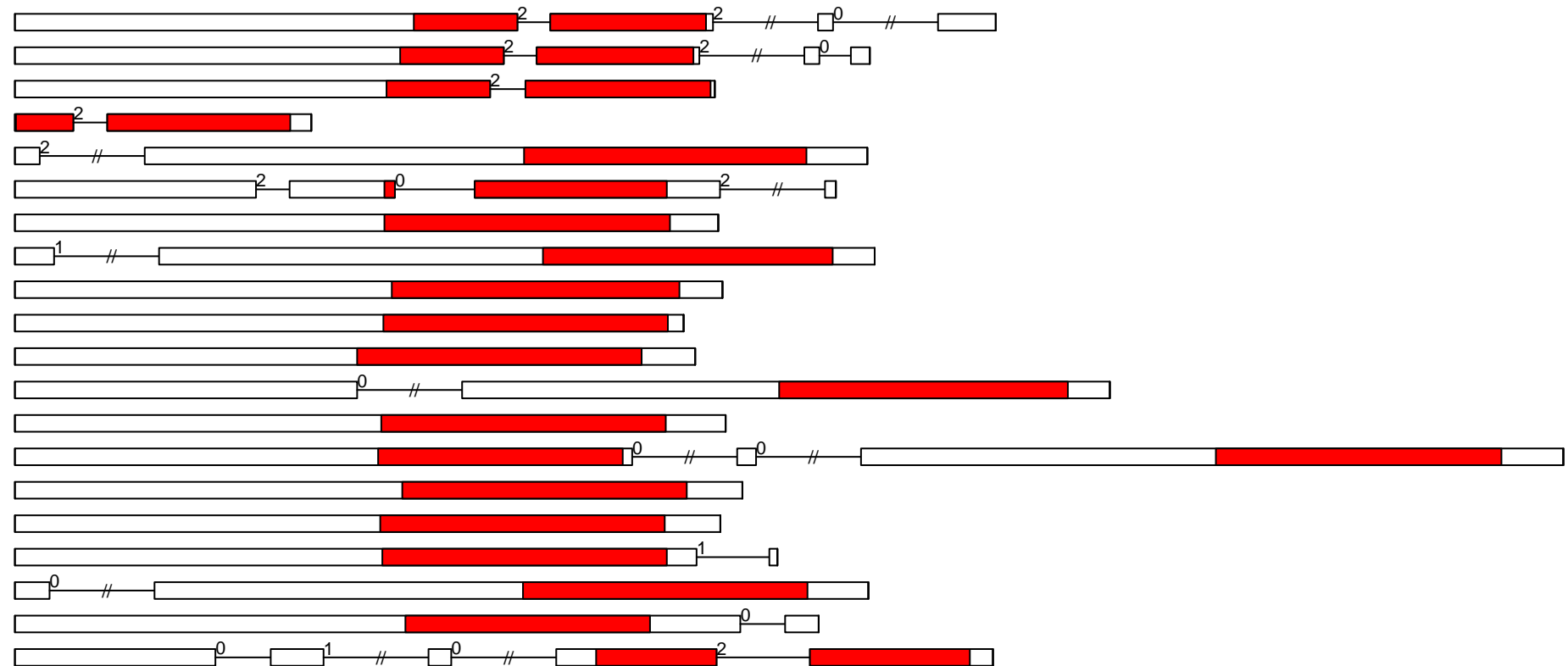

-1000

0

1000

2000

3000

4000

O.sa RLK-Pelle_L-LEC exon-intron and kinase domain diagram (part 5)

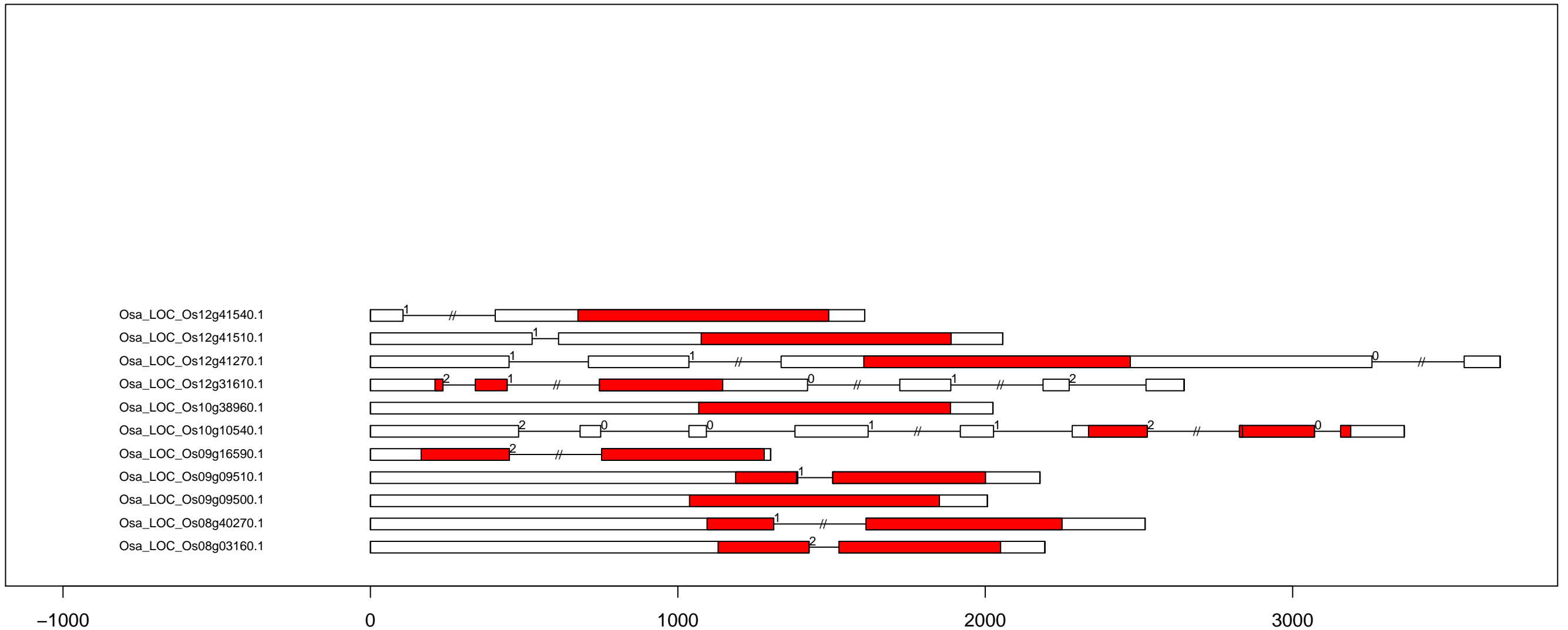

O.sa RLK-Pelle_LRK10L-2 exon-intron and kinase domain diagram (part 1)

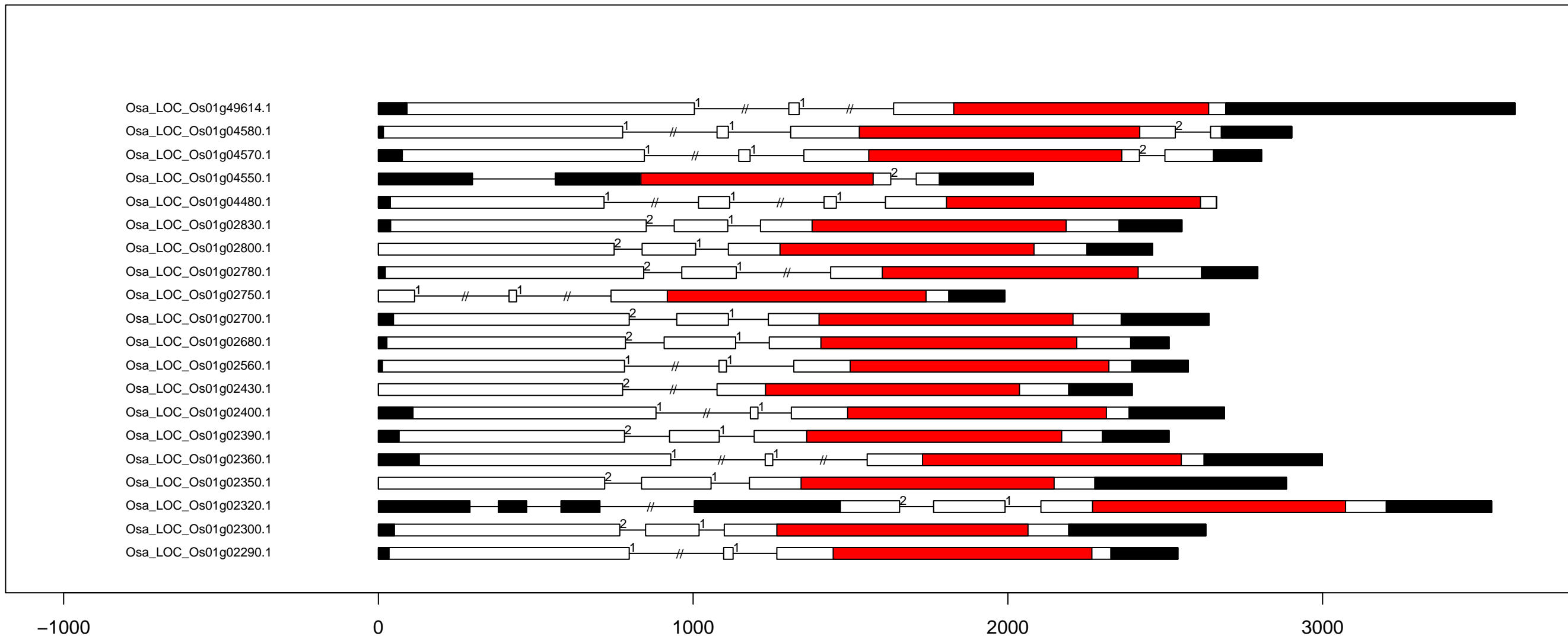

O.sa RLK-Pelle_LRK10L-2 exon-intron and kinase domain diagram (part 2)

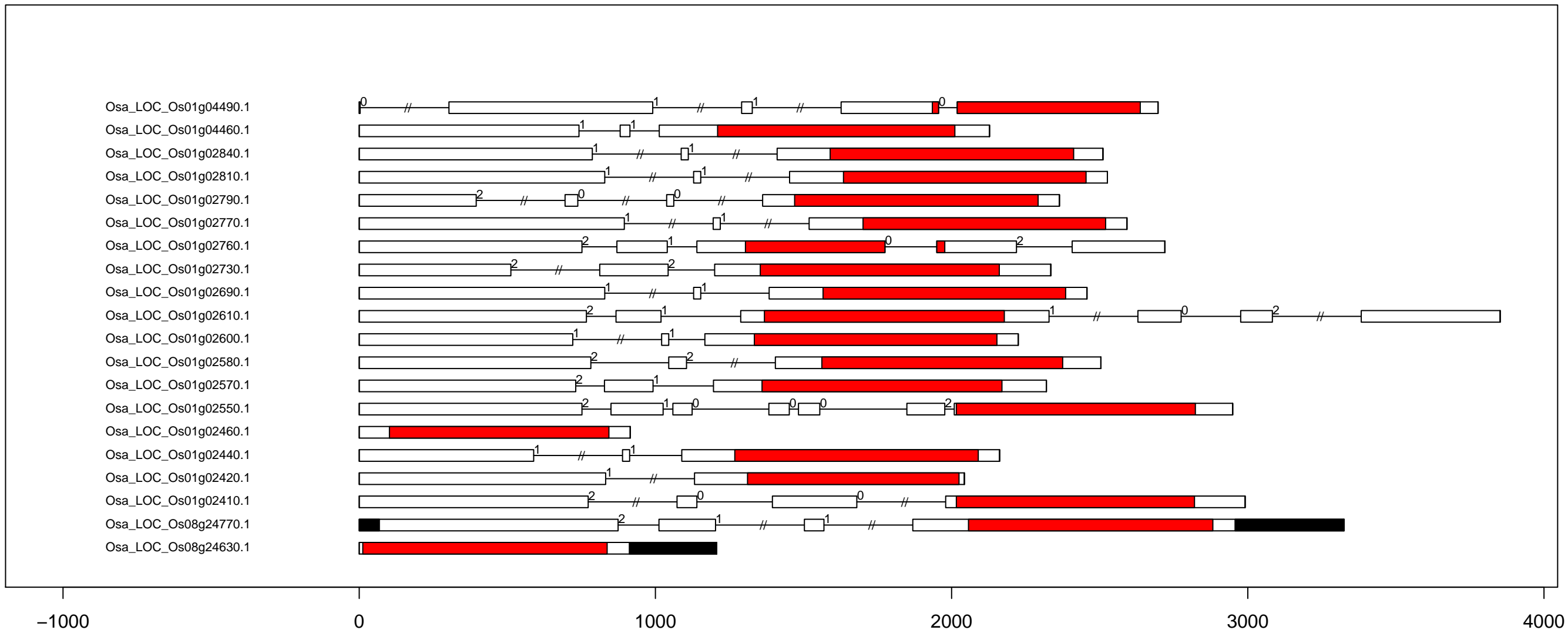

O.sa RLK-Pelle_LRR-I-1 exon-intron and kinase domain diagram (part 1)

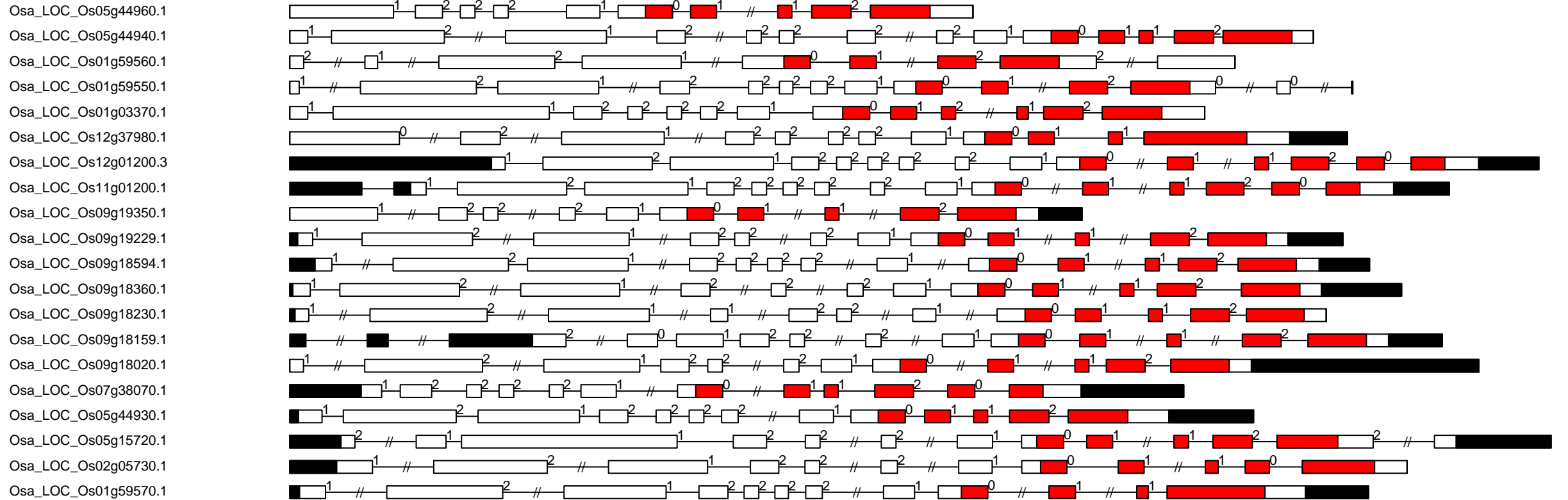

0

2000

4000

6000

O.sa RLK-Pelle_LRR-I-1 exon-intron and kinase domain diagram (part 2)

Osa_LOC_Os09g19510.1
Osa_LOC_Os09g19380.1
Osa_LOC_Os09g19160.1
Osa_LOC_Os09g19140.1
Osa_LOC_Os09g18530.1
Osa_LOC_Os09g18260.1
Osa_LOC_Os09g18010.1
Osa_LOC_Os09g17970.1
Osa_LOC_Os09g17910.1
Osa_LOC_Os09g09220.1
Osa_LOC_Os08g40650.1
Osa_LOC_Os05g44990.1
Osa_LOC_Os05g44970.1

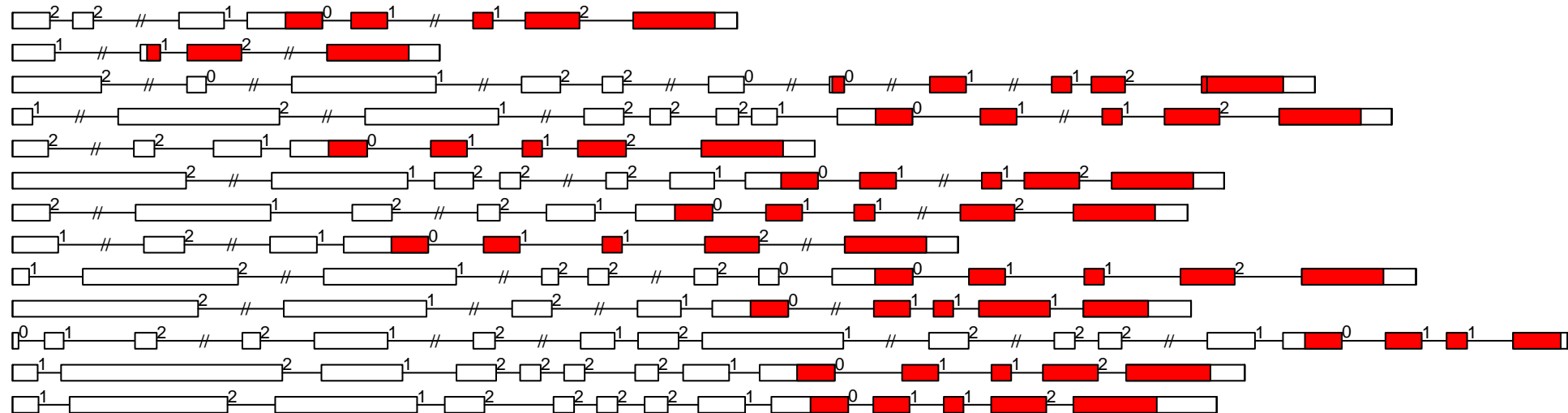

-1000

0

1000

2000

3000

4000

5000

O.sa RLK-Pelle_LRR-I-2 exon-intron and kinase domain diagram (all)

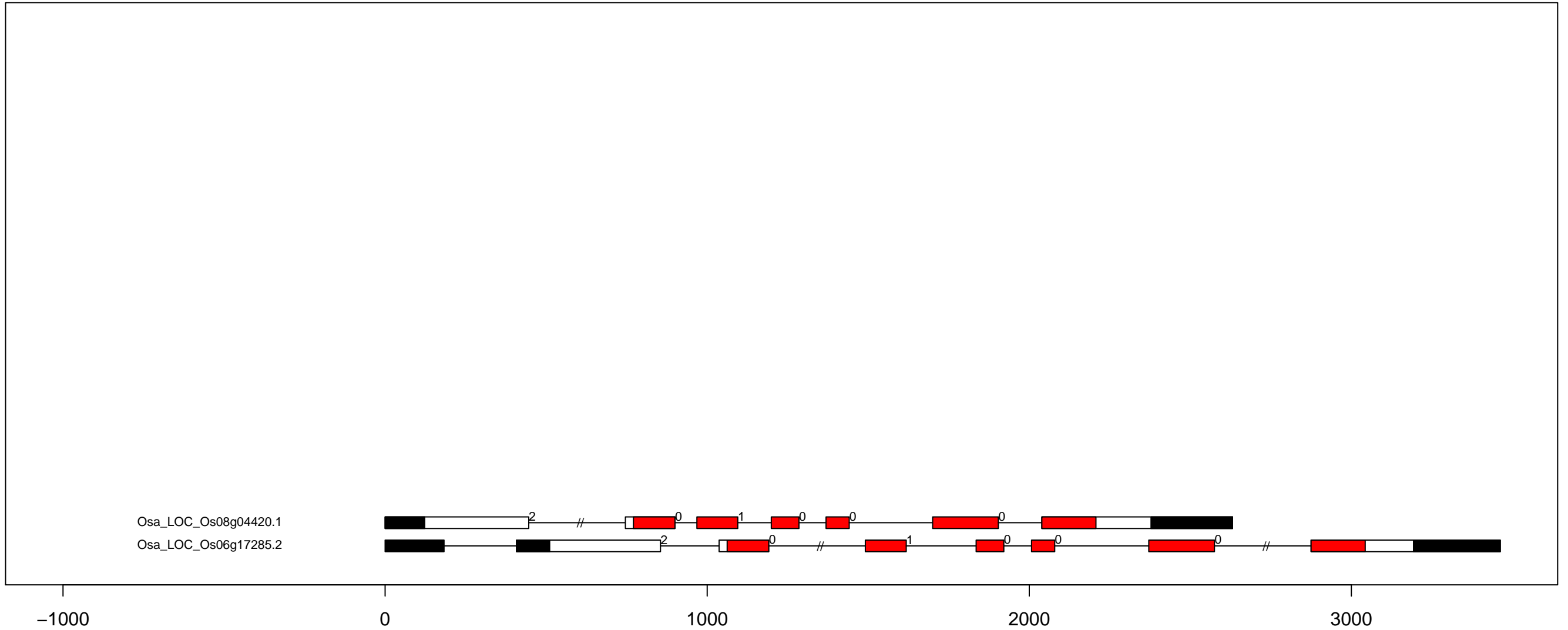

O.sa RLK-Pelle_LRR-III exon-intron and kinase domain diagram (part 1)

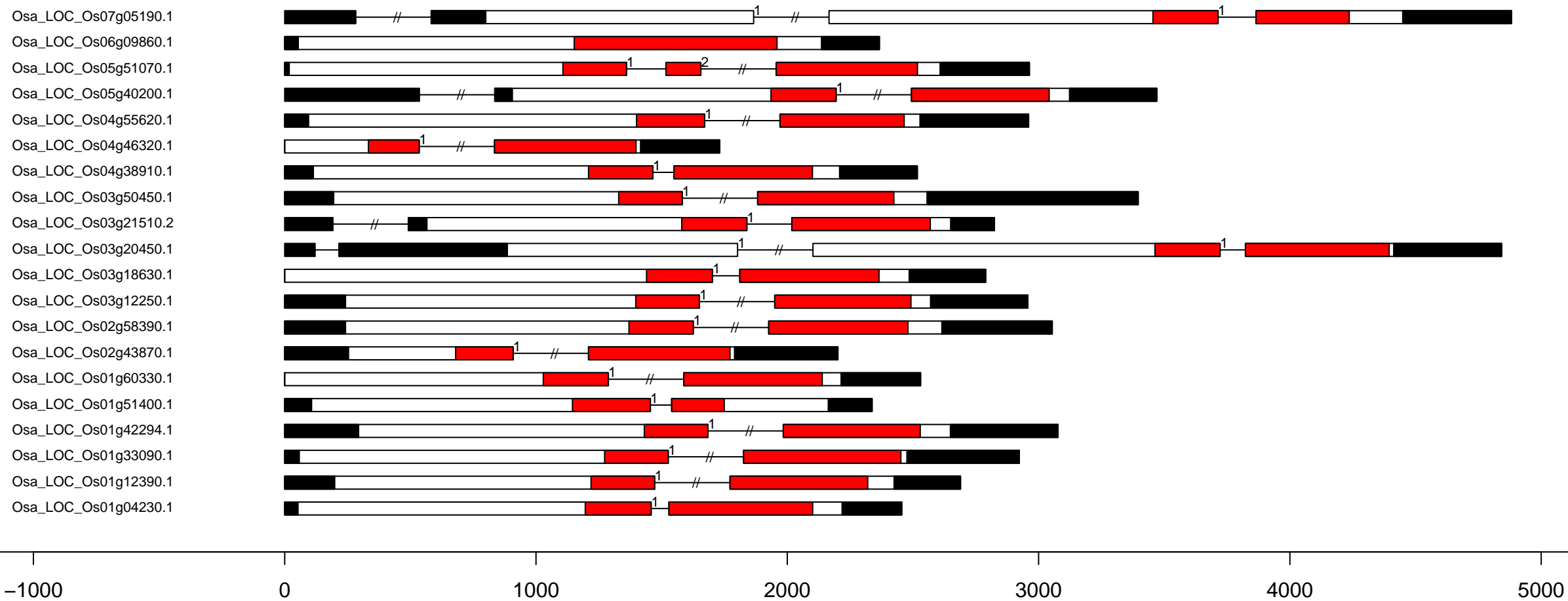

O.sa RLK-Pelle_LRR-II exon-intron and kinase domain diagram (all)

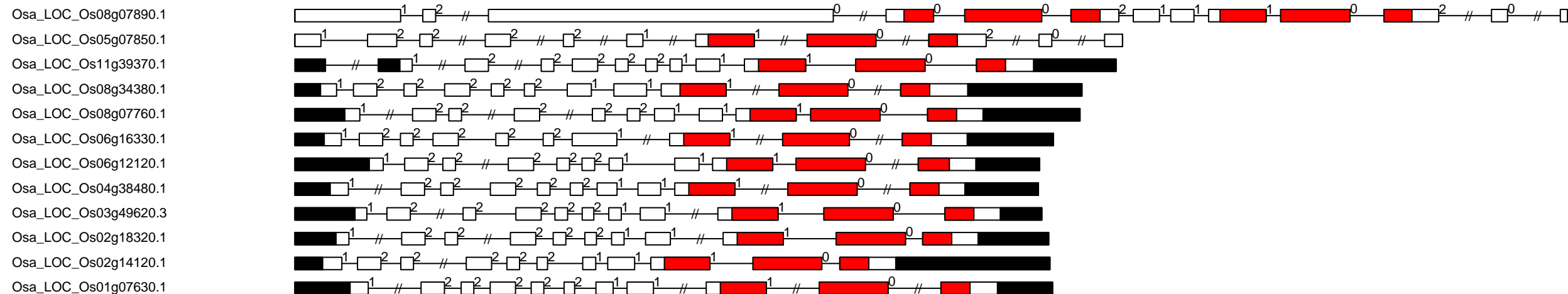

0

2000

4000

6000

O.sa RLK-Pelle_LRR-IV exon-intron and kinase domain diagram (all)

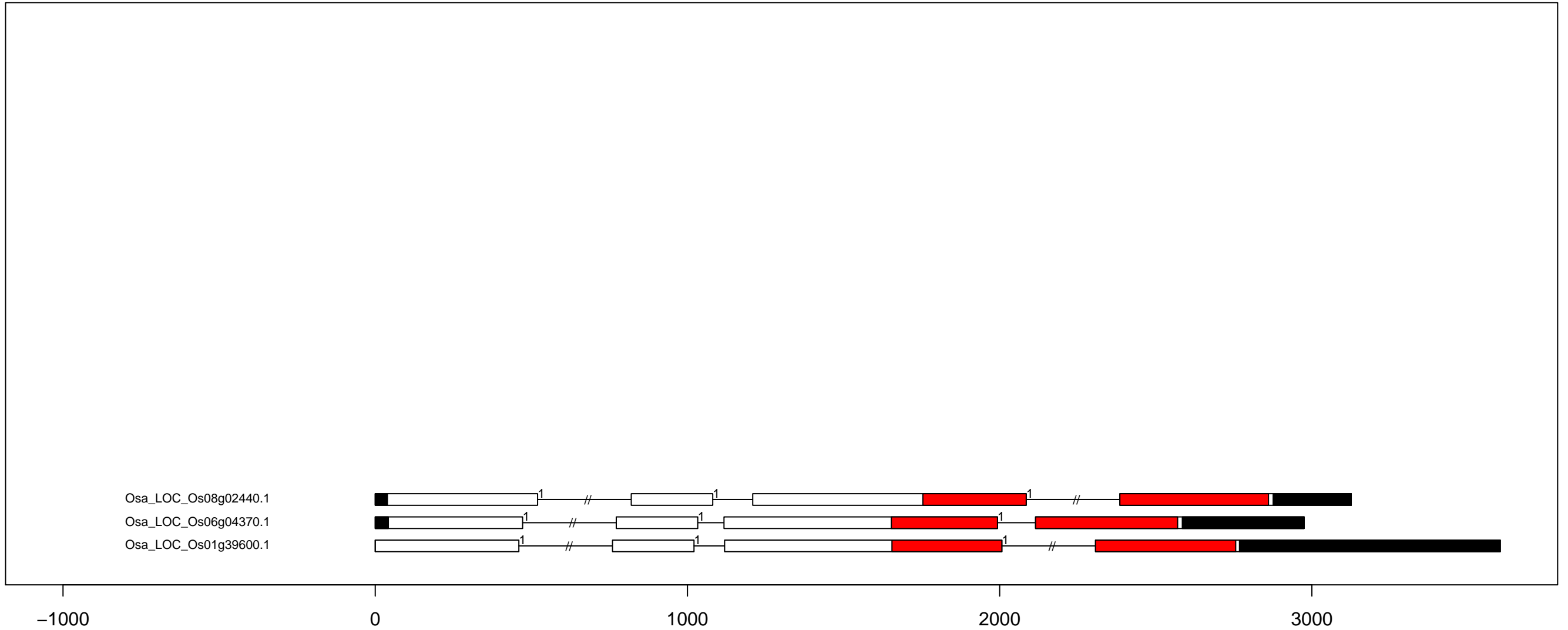

O.sa RLK-Pelle_LRR-IX exon-intron and kinase domain diagram (all)

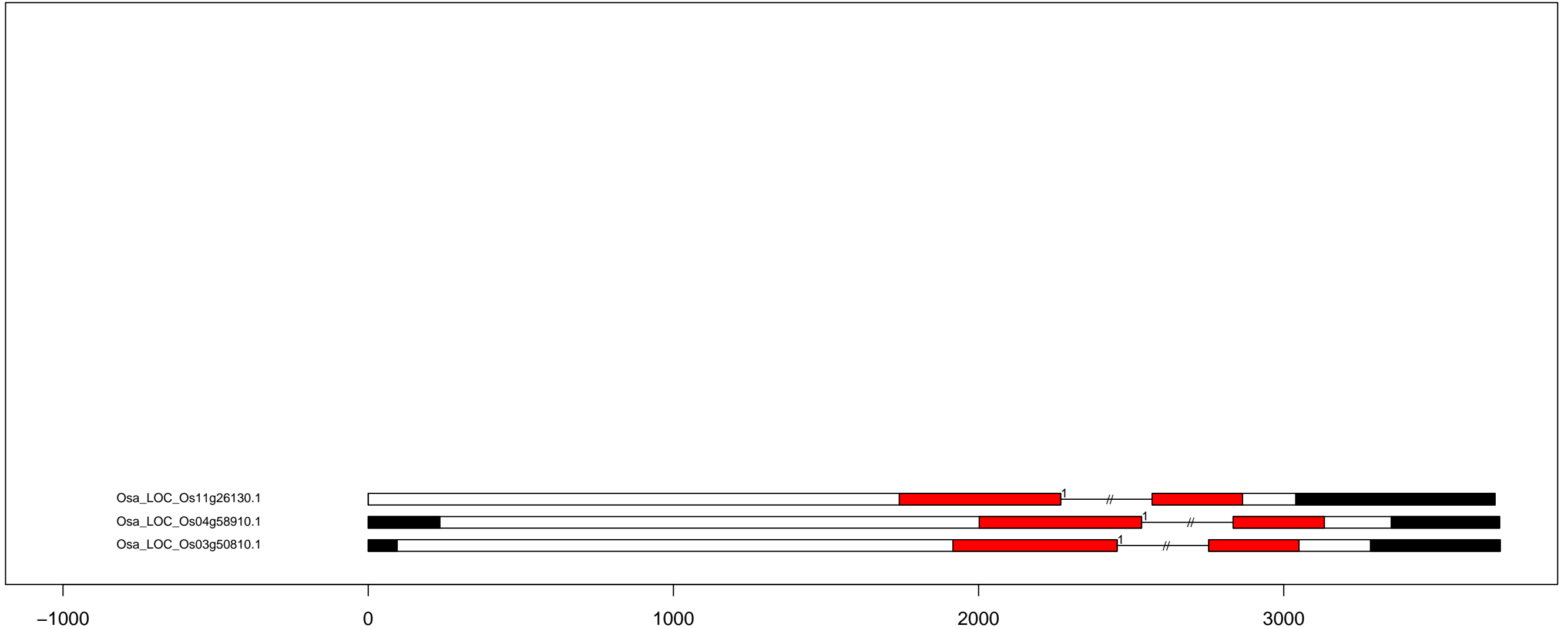

O.sa RLK-Pelle_LRR-VI-1 exon-intron and kinase domain diagram (all)

Osa_LOC_Os11g20360.2
Osa_LOC_Os07g07230.2
Osa_LOC_Os06g38970.1
Osa_LOC_Os03g57780.1

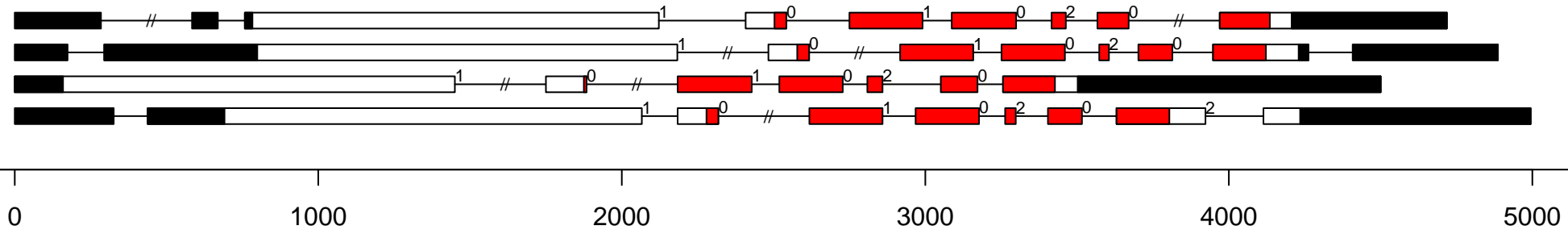

O.sa RLK-Pelle_LRR-VI-2 exon-intron and kinase domain diagram (all)

Osa_LOC_Os12g01510.1
 Osa_LOC_Os07g49240.1
 Osa_LOC_Os05g48660.2
 Osa_LOC_Os05g39410.1
 Osa_LOC_Os05g28520.1
 Osa_LOC_Os04g58700.1
 Osa_LOC_Os03g18370.1
 Osa_LOC_Os01g48390.2
 Osa_LOC_Os01g10900.1



-1000

0

1000

2000

3000

4000

5000

O.sa RLK-Pelle_LRR-VII-1 exon-intron and kinase domain diagram (all)

Osa_LOC_Os10g38800.1

Osa_LOC_Os05g40050.1

Osa_LOC_Os03g21730.1

Osa_LOC_Os03g03570.2

Osa_LOC_Os01g72700.1

Osa_LOC_Os01g60670.1

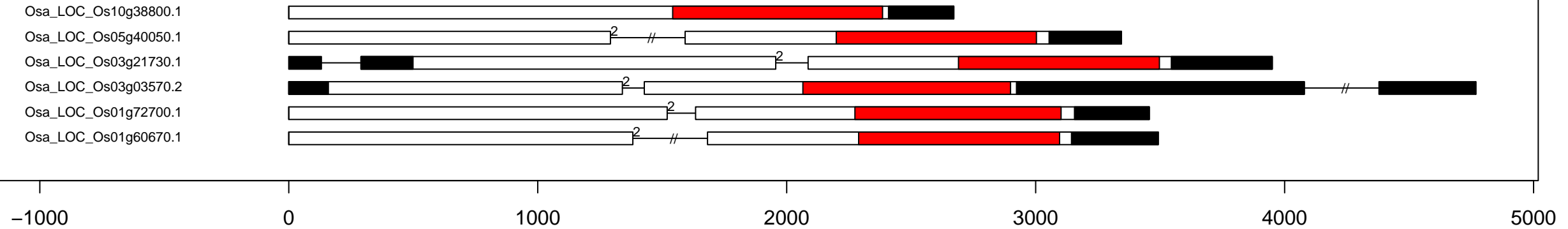

O.sa RLK-Pelle_LRR-VII-2 exon-intron and kinase domain diagram (all)

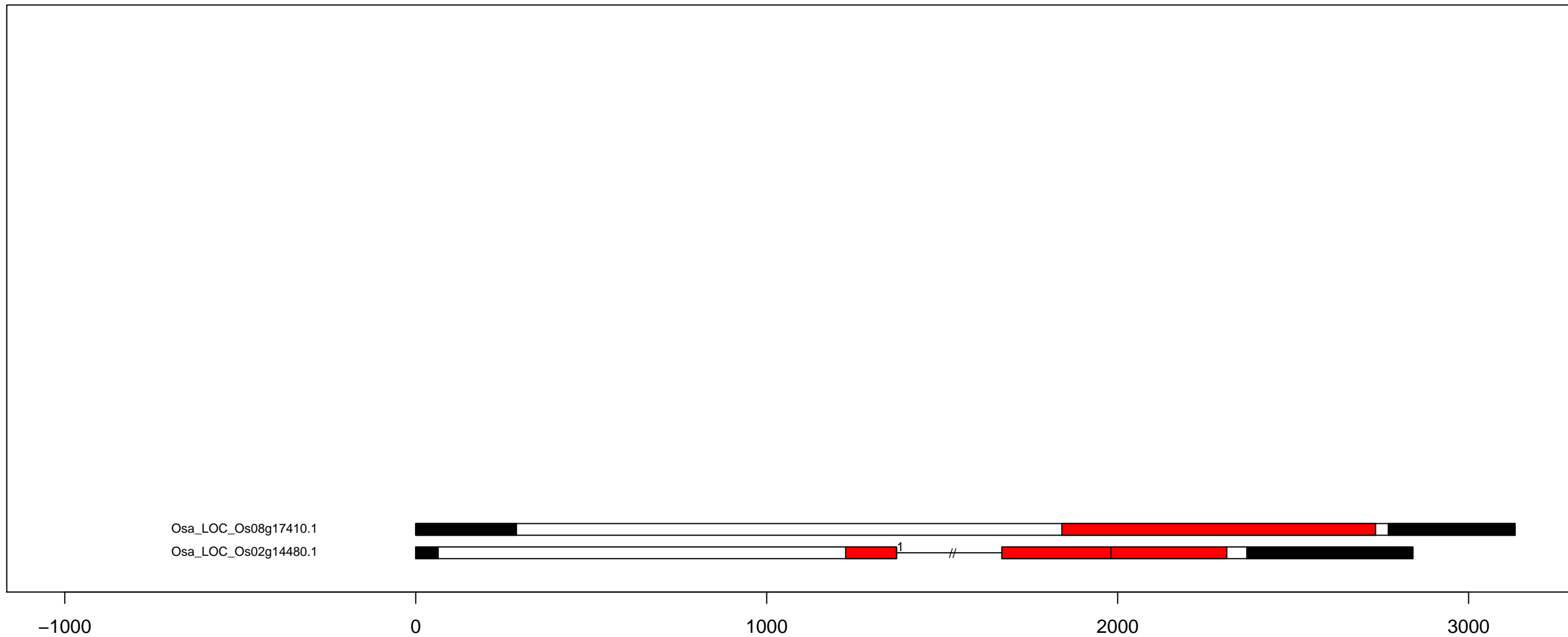

O.sa RLK-Pelle_LRR-VII-3 exon-intron and kinase domain diagram (all)

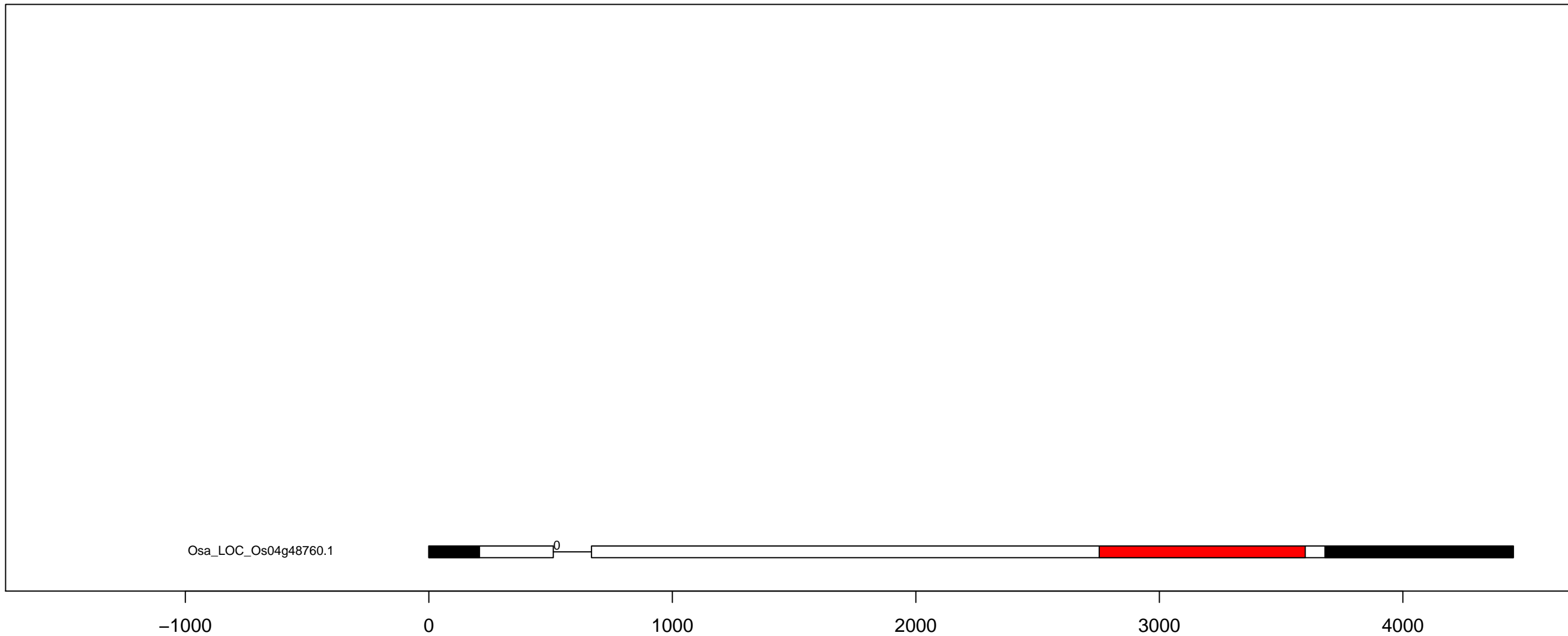

O.sa RLK-Pelle_LRR-VIII-1 exon-intron and kinase domain diagram (all)

Osa_LOC_Os12g10740.1
 Osa_LOC_Os11g14050.1
 Osa_LOC_Os05g40770.1
 Osa_LOC_Os05g40270.5
 Osa_LOC_Os05g24010.1
 Osa_LOC_Os03g21230.1
 Osa_LOC_Os01g72990.2
 Osa_LOC_Os01g60280.1
 Osa_LOC_Os01g60060.1

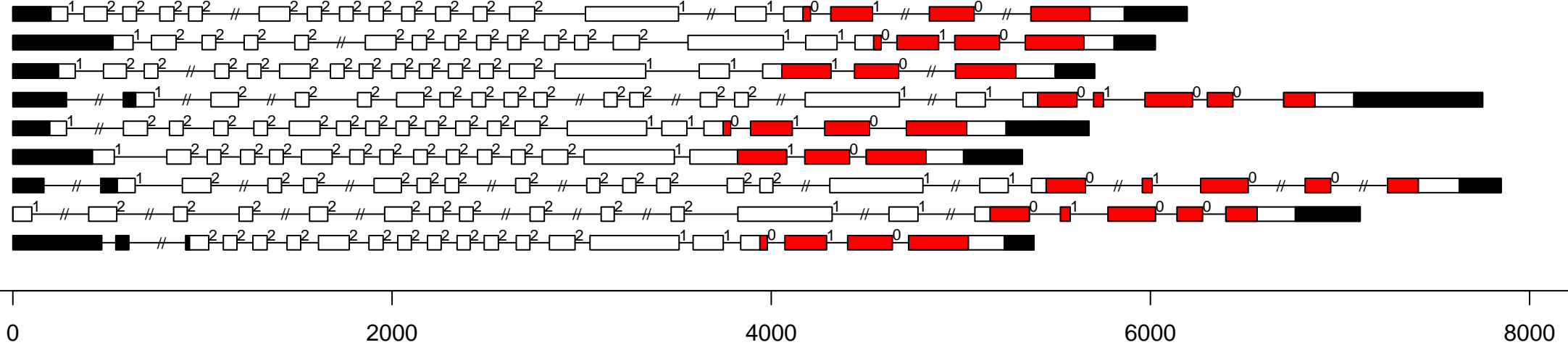

O.sa RLK-Pelle_LRR-V exon-intron and kinase domain diagram (all)

Osa_LOC_Os10g25090.1
Osa_LOC_Os09g38700.1
Osa_LOC_Os07g42626.1
Osa_LOC_Os07g37810.1
Osa_LOC_Os06g45020.1
Osa_LOC_Os06g42800.1
Osa_LOC_Os03g27990.1
Osa_LOC_Os03g08550.1
Osa_LOC_Os02g10110.1
Osa_LOC_Os02g09740.1
Osa_LOC_Os02g07960.4
Osa_LOC_Os02g04430.1

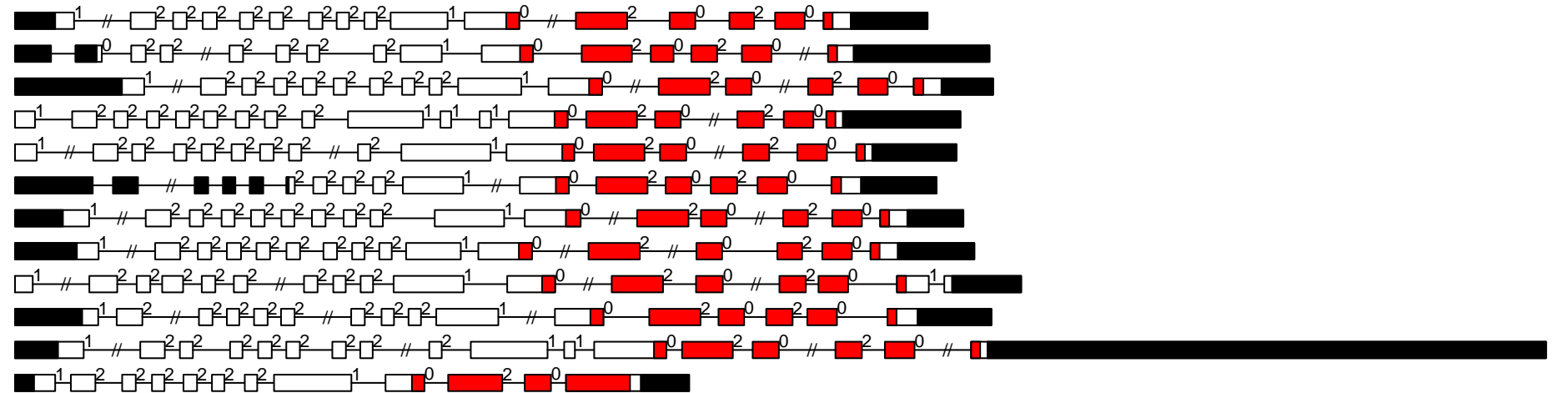

O.sa RLK-Pelle_LRR-Xa exon-intron and kinase domain diagram (all)

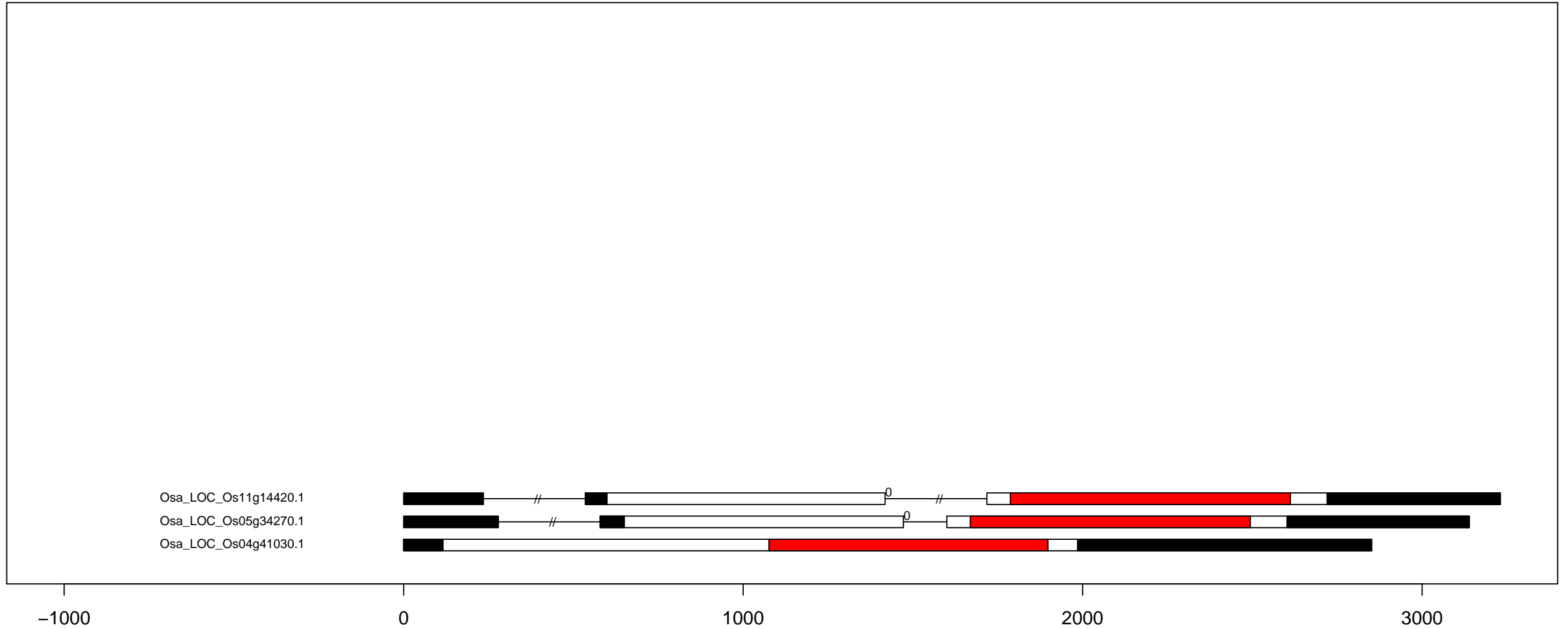

O.sa RLK-Pelle_LRR-Xb-1 exon-intron and kinase domain diagram (part 1)

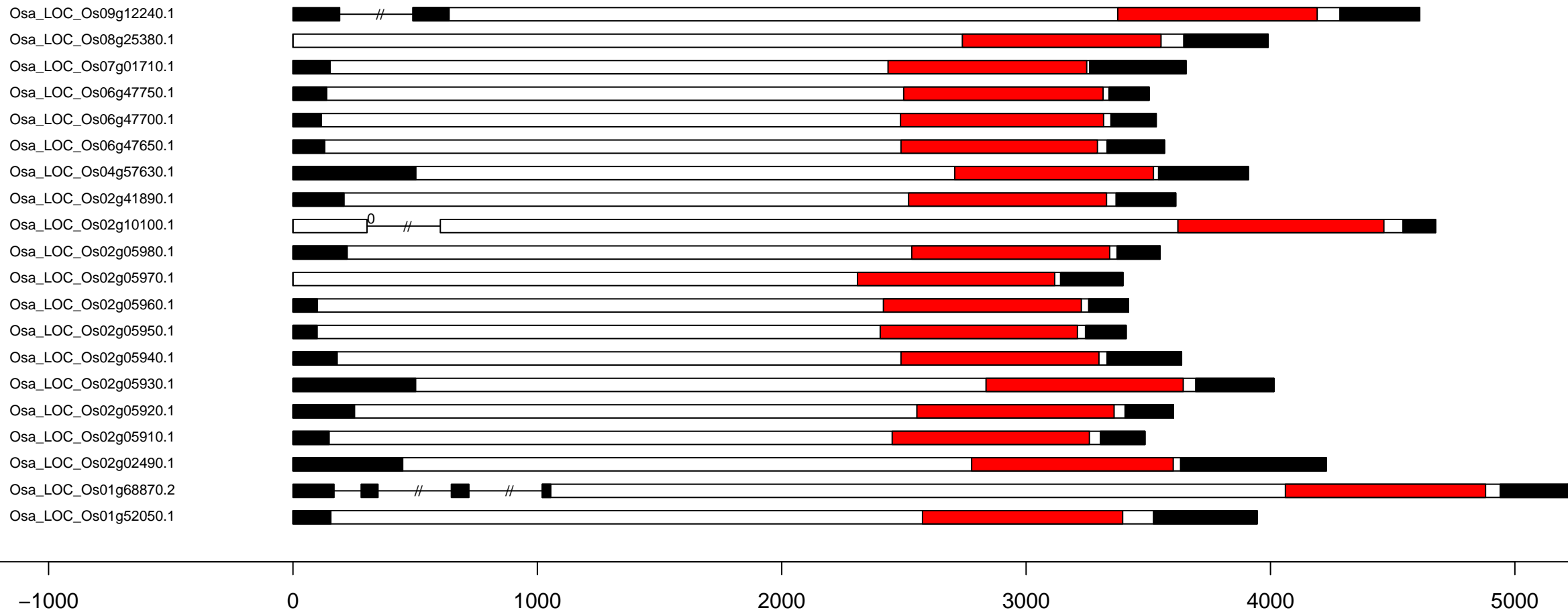

O.sa RLK-Pelle_LRR-Xb-1 exon-intron and kinase domain diagram (part 2)

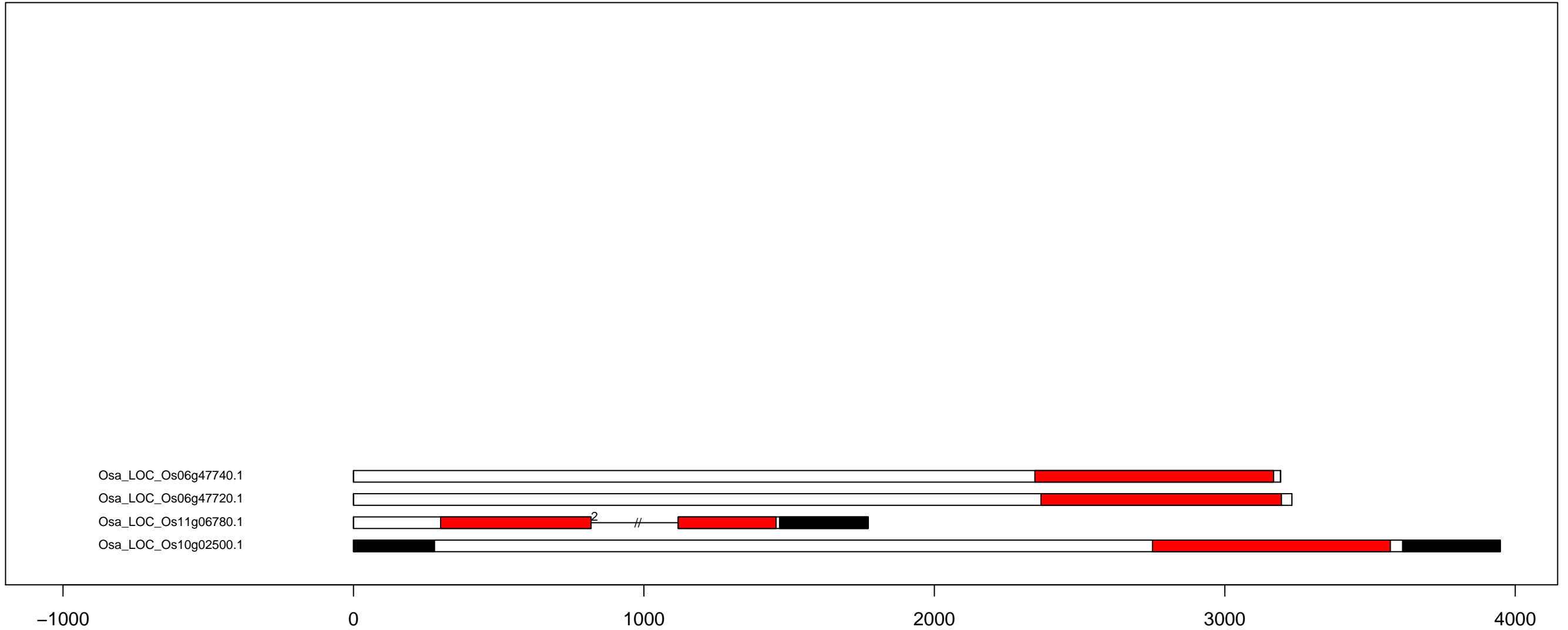

O.sa RLK-Pelle_LRR-Xb-2 exon-intron and kinase domain diagram (all)

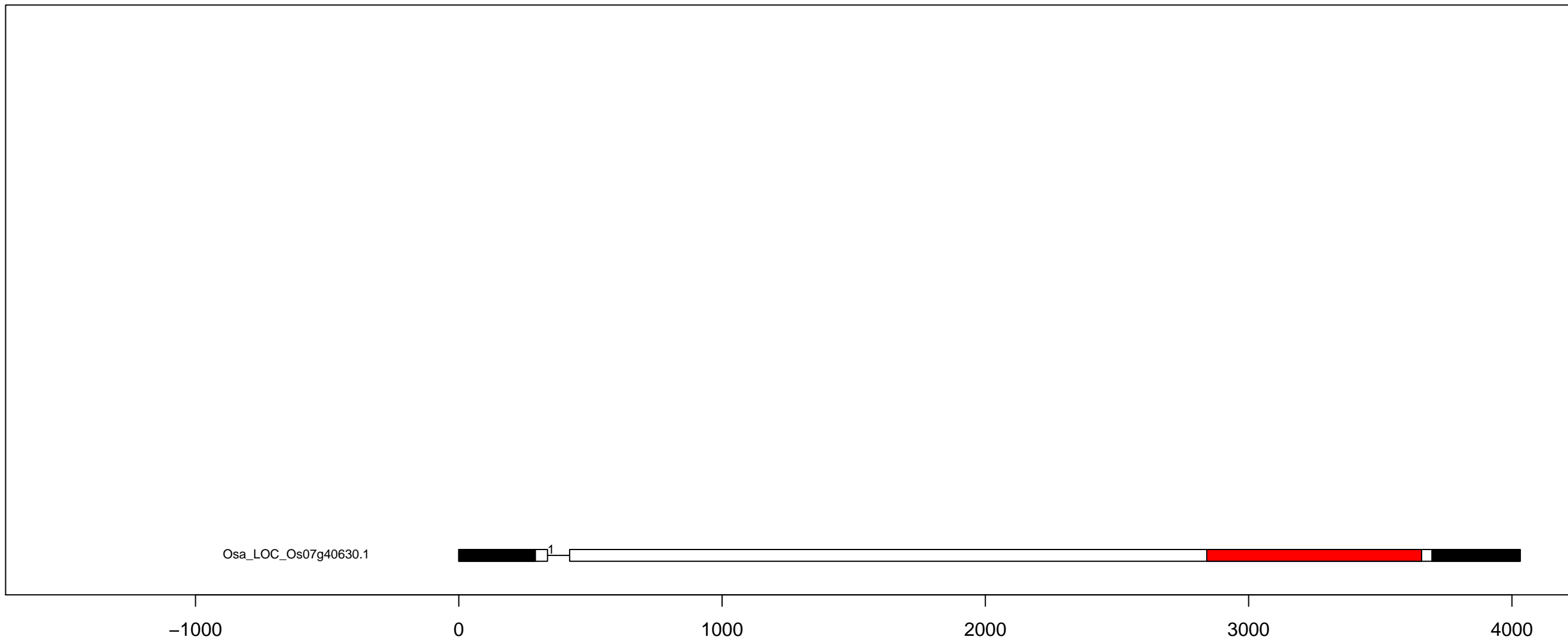

O.sa RLK-Pelle_LRR-XI-1 exon-intron and kinase domain diagram (part 1)

Osa_LOC_Os06g36270.2
 Osa_LOC_Os05g51740.1
 Osa_LOC_Os05g44770.1
 Osa_LOC_Os05g07740.1
 Osa_LOC_Os04g42700.1
 Osa_LOC_Os04g39650.1
 Osa_LOC_Os04g04330.2
 Osa_LOC_Os03g56270.2
 Osa_LOC_Os03g12730.1
 Osa_LOC_Os02g34790.1
 Osa_LOC_Os02g34750.2
 Osa_LOC_Os02g13510.1
 Osa_LOC_Os02g13430.1
 Osa_LOC_Os02g02140.1
 Osa_LOC_Os01g65650.1
 Osa_LOC_Os01g53920.1
 Osa_LOC_Os01g33110.1
 Osa_LOC_Os01g19160.2
 Osa_LOC_Os01g13800.1
 Osa_LOC_Os01g07560.1

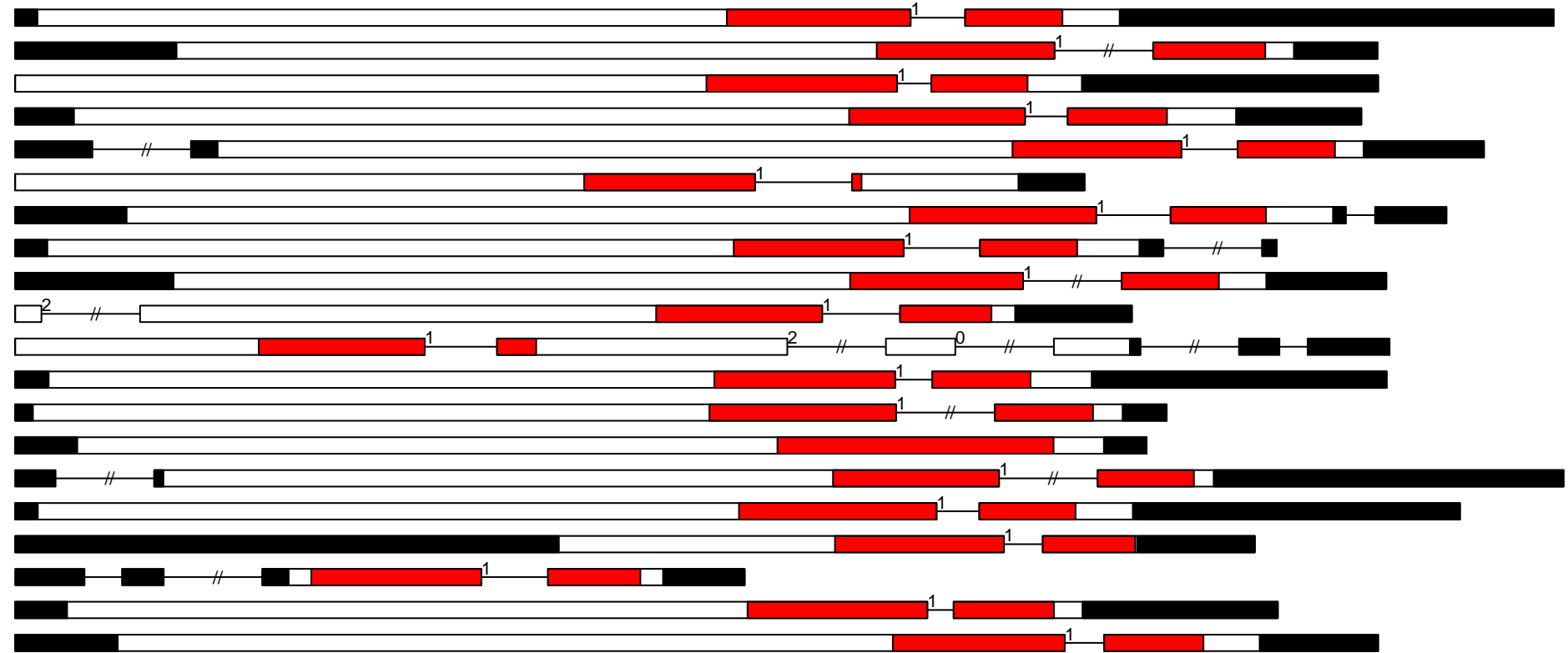

-1000

0

1000

2000

3000

4000

O.sa RLK-Pelle_LRR-XI-1 exon-intron and kinase domain diagram (part 2)

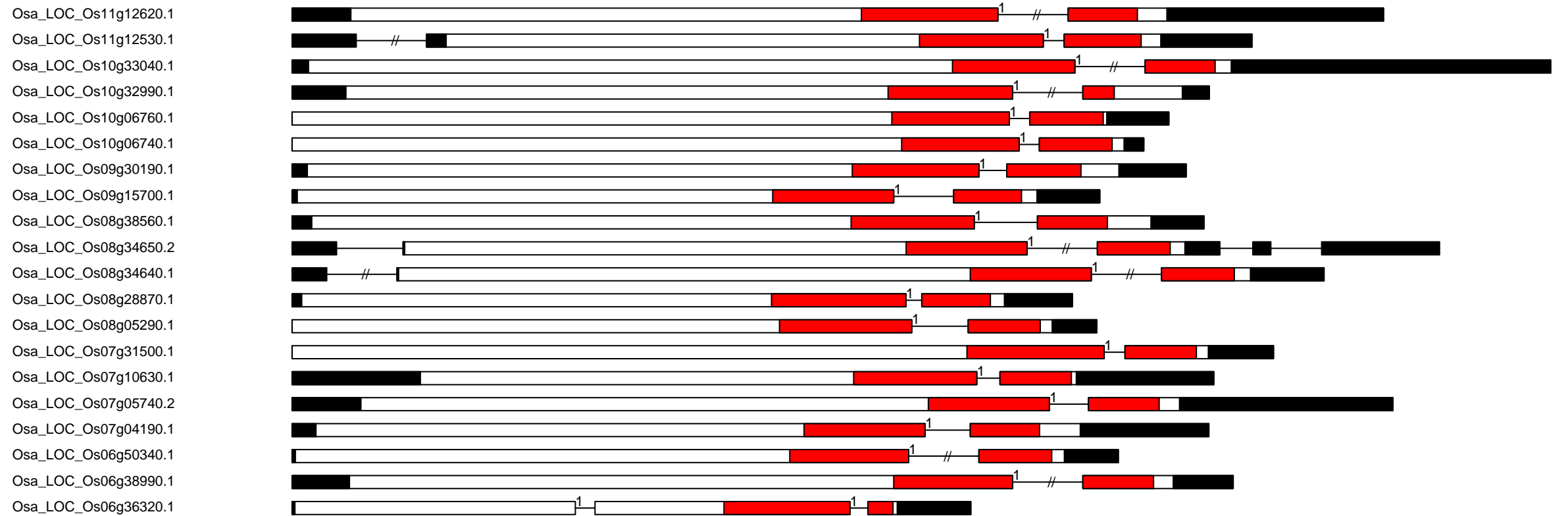

O.sa RLK-Pelle_LRR-XI-1 exon-intron and kinase domain diagram (part 3)

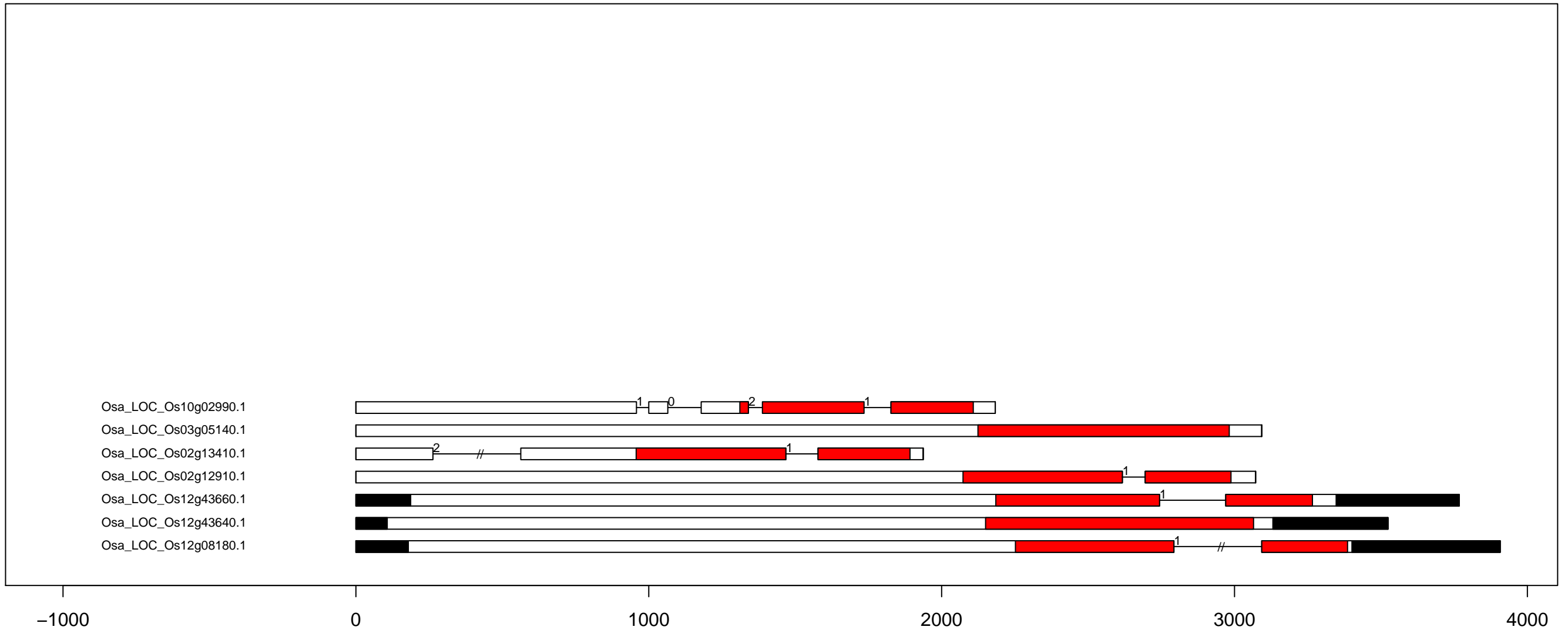

O.sa RLK-Pelle_LRR-XI-2 exon-intron and kinase domain diagram (all)

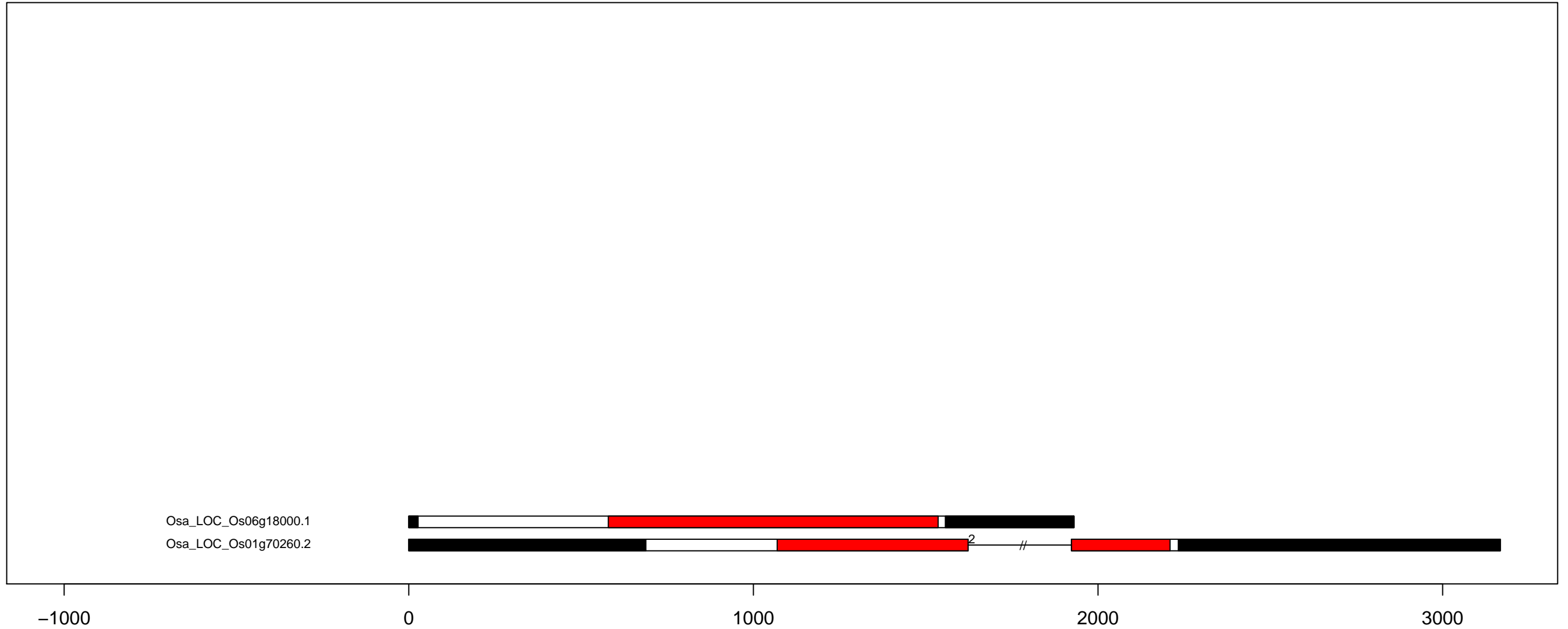

O.sa RLK-Pelle_LRR-XII-1 exon-intron and kinase domain diagram (part 1)

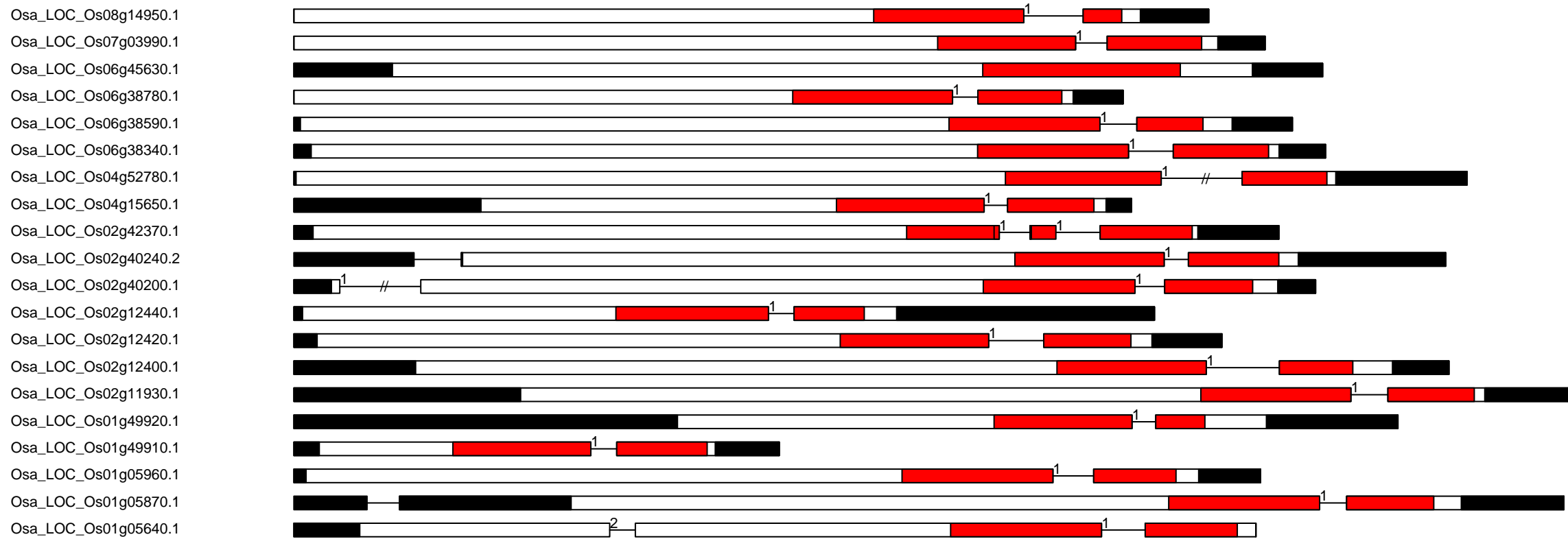

-1000

0

1000

2000

3000

4000

O.sa RLK-Pelle_LRR-XII-1 exon-intron and kinase domain diagram (part 2)

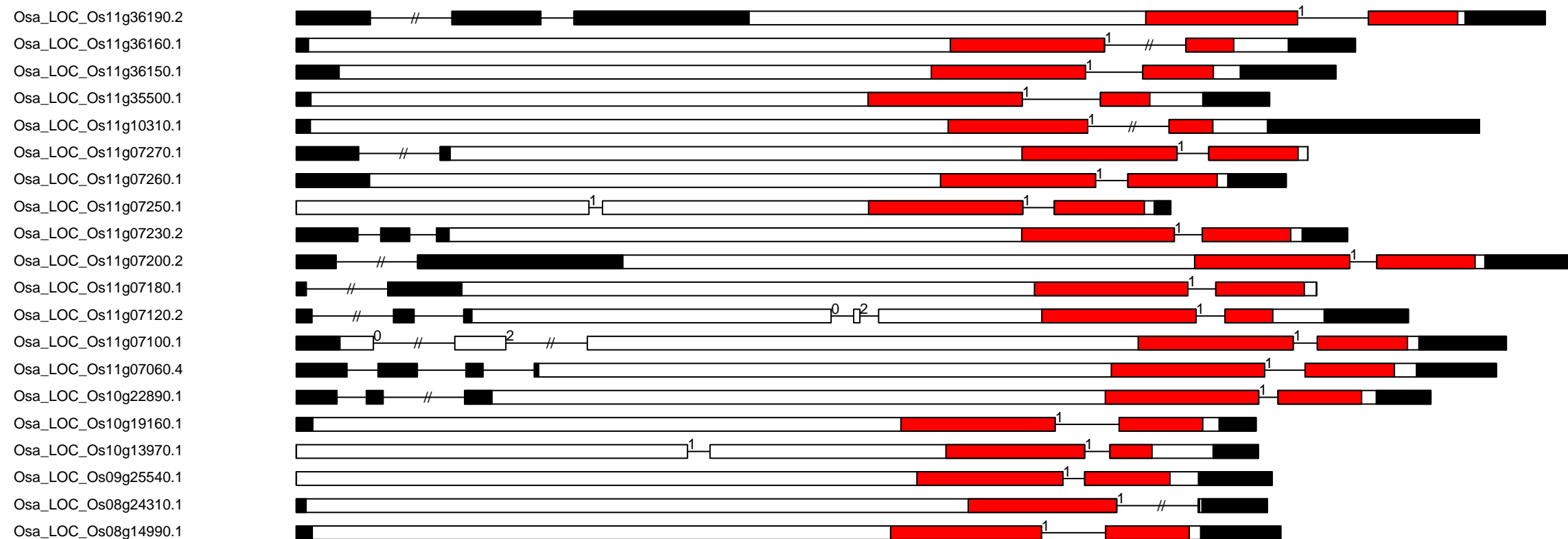

O.sa RLK-Pelle_LRR-XII-1 exon-intron and kinase domain diagram (part 3)

Osa_LOC_Os06g08690.1
Osa_LOC_Os04g15660.1
Osa_LOC_Os04g15630.1
Osa_LOC_Os04g13640.1
Osa_LOC_Os04g03210.1
Osa_LOC_Os02g40180.1
Osa_LOC_Os02g30540.1
Osa_LOC_Os02g13780.1
Osa_LOC_Os02g12450.1
Osa_LOC_Os02g12030.1
Osa_LOC_Os02g11980.1
Osa_LOC_Os02g01800.1
Osa_LOC_Os01g33950.1
Osa_LOC_Os01g12790.1
Osa_LOC_Os01g05980.1
Osa_LOC_Os01g05940.1
Osa_LOC_Os11g47310.1
Osa_LOC_Os11g47240.1
Osa_LOC_Os11g40970.1
Osa_LOC_Os11g40890.1

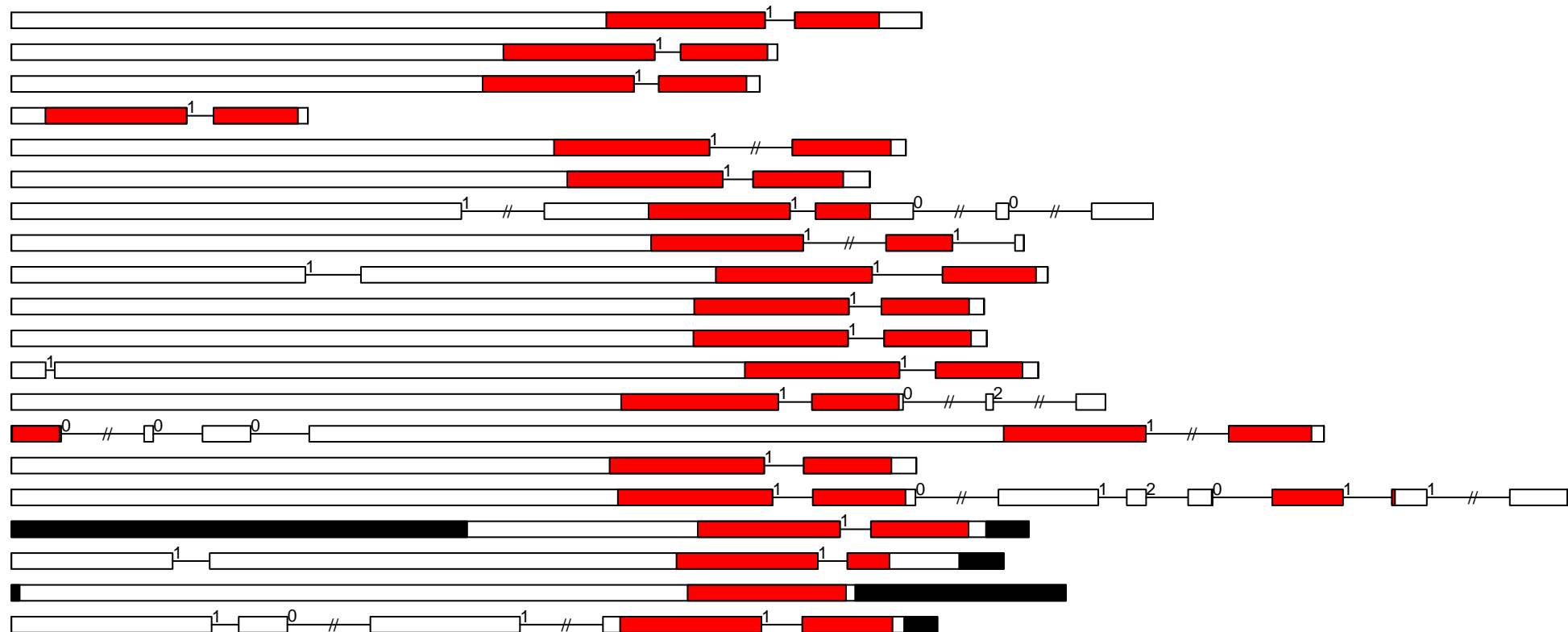

-1000

0

1000

2000

3000

4000

5000

O.sa RLK-Pelle_LRR-XII-1 exon-intron and kinase domain diagram (part 4)

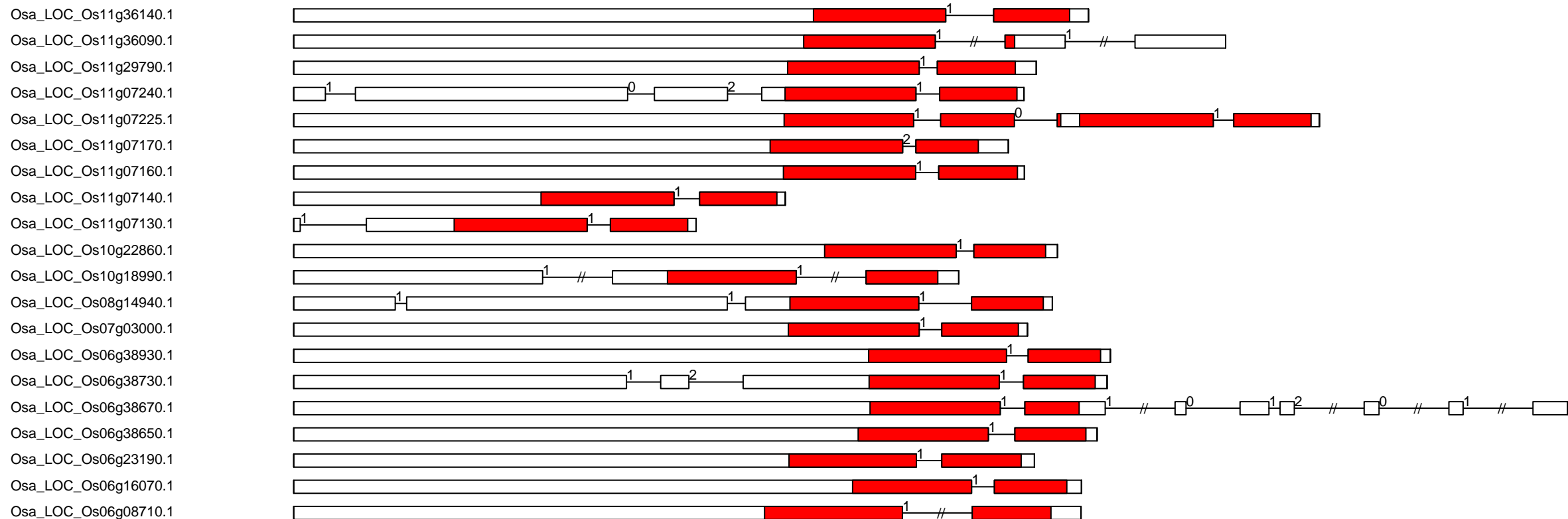

O.sa RLK-Pelle_LRR-XII-1 exon-intron and kinase domain diagram (part 5)

Osa_LOC_Os12g42520.1
 Osa_LOC_Os11g47300.1
 Osa_LOC_Os11g47290.1
 Osa_LOC_Os11g47210.1
 Osa_LOC_Os11g47180.1
 Osa_LOC_Os11g47030.1
 Osa_LOC_Os11g47000.1
 Osa_LOC_Os11g46980.1
 Osa_LOC_Os11g46970.1
 Osa_LOC_Os11g41100.1
 Osa_LOC_Os11g40810.1
 Osa_LOC_Os11g36180.1

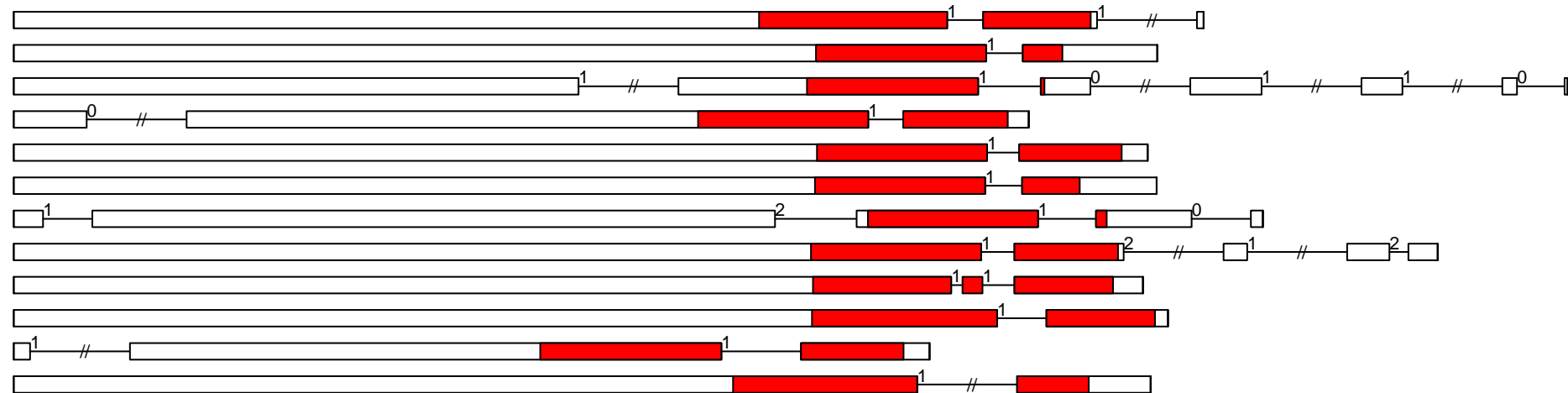

-1000

0

1000

2000

3000

4000

O.sa RLK-Pelle_LRR-XIIIa exon-intron and kinase domain diagram (all)

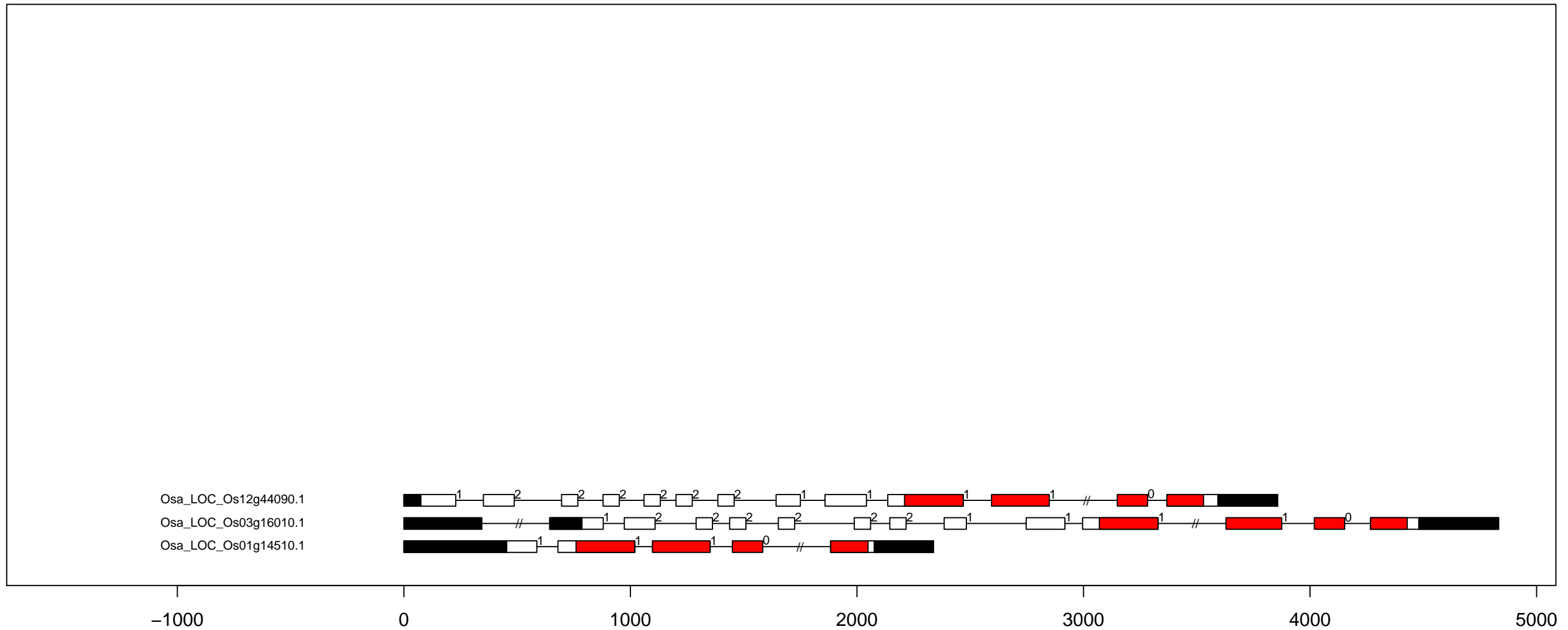

O.sa RLK-Pelle_LRR-XIIIb exon-intron and kinase domain diagram (all)

Osa_LOC_Os06g10230.1

Osa_LOC_Os06g03970.1

Osa_LOC_Os02g53720.2

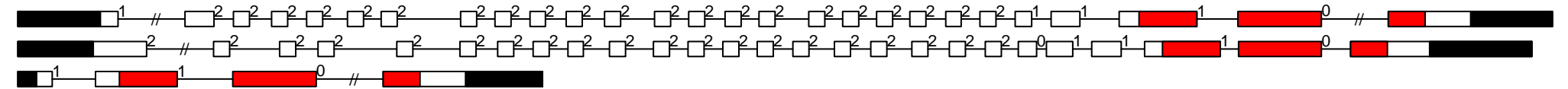

0

2000

4000

6000

O.sa RLK-Pelle_LRR-XIV exon-intron and kinase domain diagram (all)

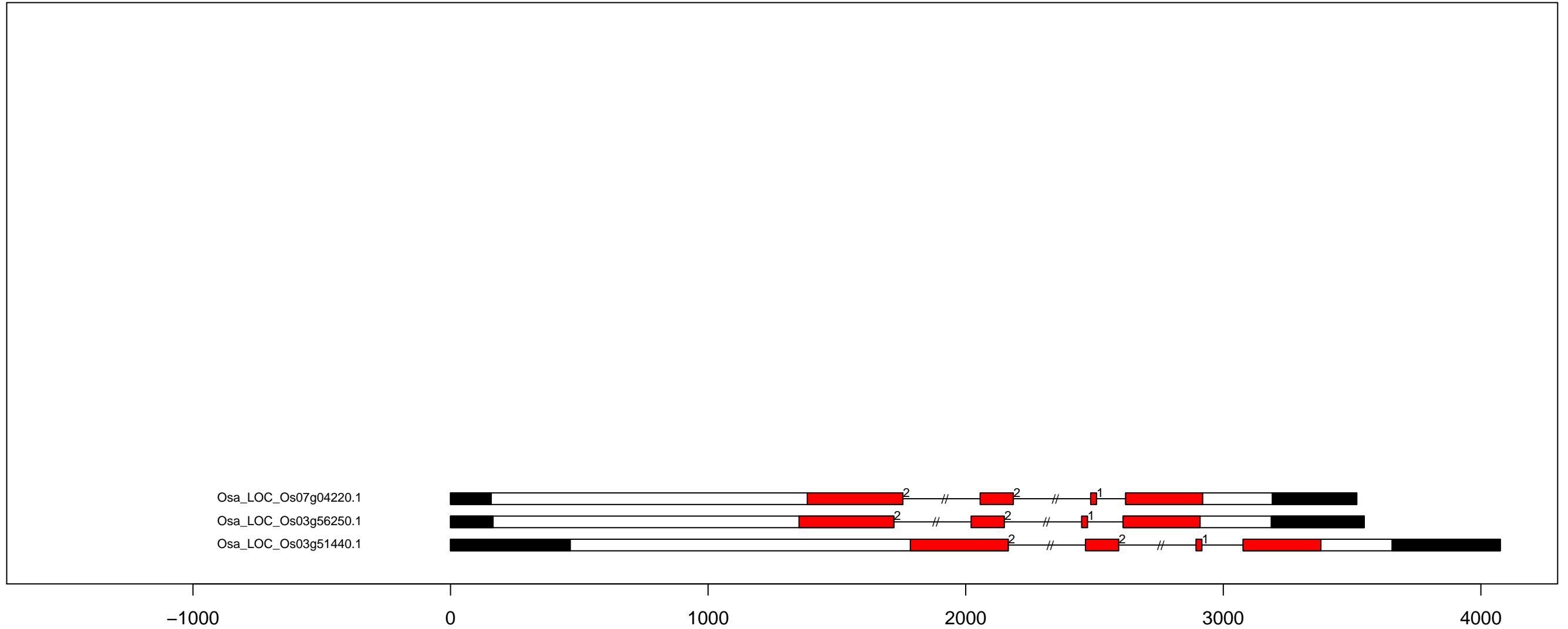

O.sa RLK-Pelle_LRR-XV exon-intron and kinase domain diagram (all)

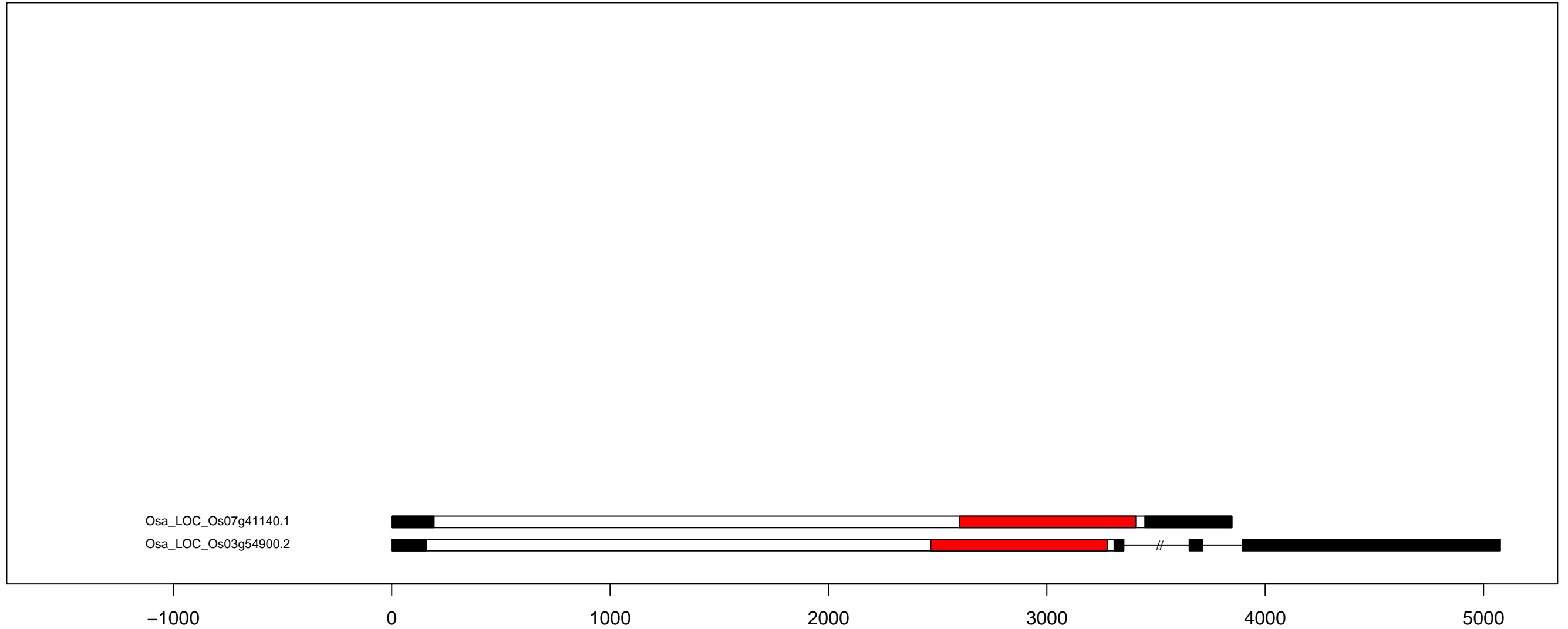

O.sa RLK-Pelle_LysM exon-intron and kinase domain diagram (all)

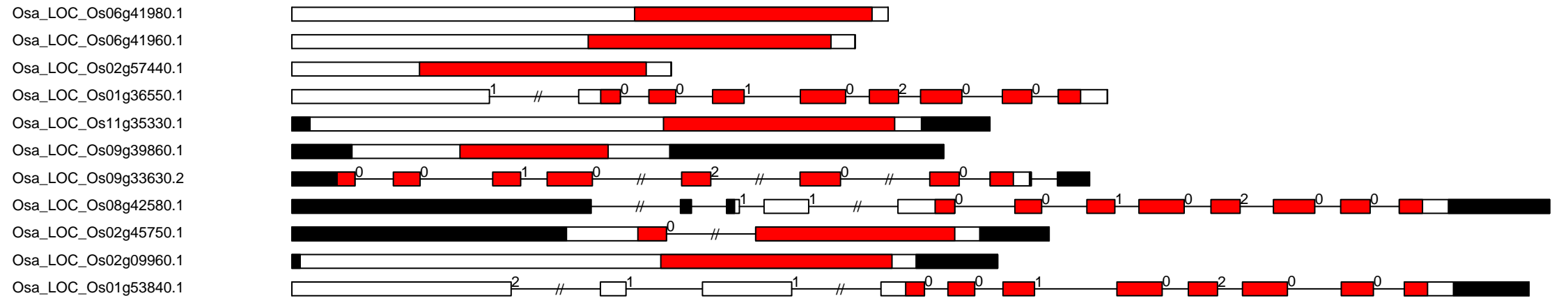

O.sa RLK-Pelle_PERK-1 exon-intron and kinase domain diagram (all)

Osa_LOC_Os09g14580.1



Osa_LOC_Os05g44030.1

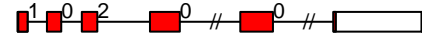

Osa_LOC_Os03g38710.1



Osa_LOC_Os10g01560.1



Osa_LOC_Os07g04520.1



Osa_LOC_Os06g29080.1

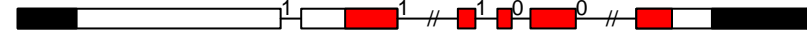

Osa_LOC_Os05g01040.3



Osa_LOC_Os03g56470.1



Osa_LOC_Os03g16260.1



Osa_LOC_Os03g12570.1

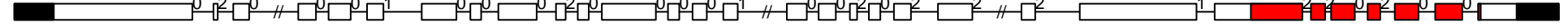

Osa_LOC_Os01g12720.1



-2000

0

2000

4000

6000

8000

O.sa RLK-Pelle_PERK-2 exon-intron and kinase domain diagram (all)

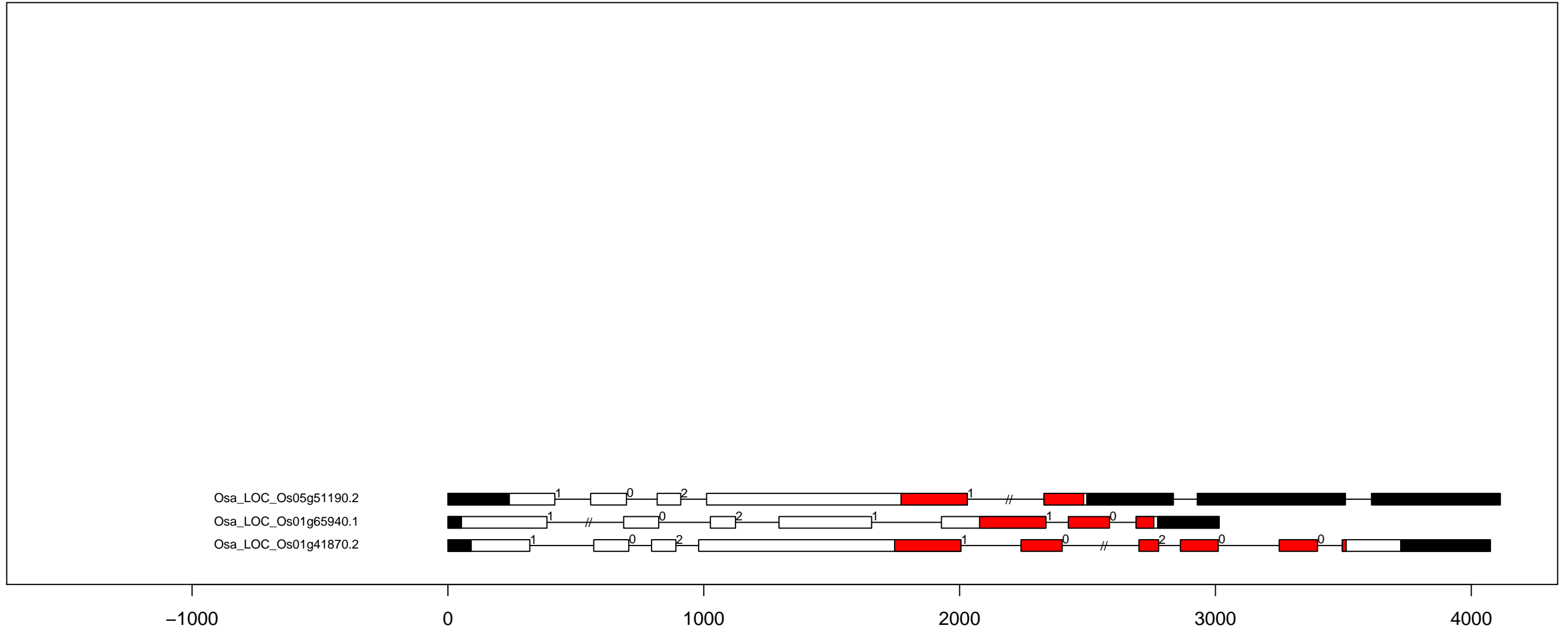

O.sa RLK-Pelle_RKF3 exon-intron and kinase domain diagram (all)

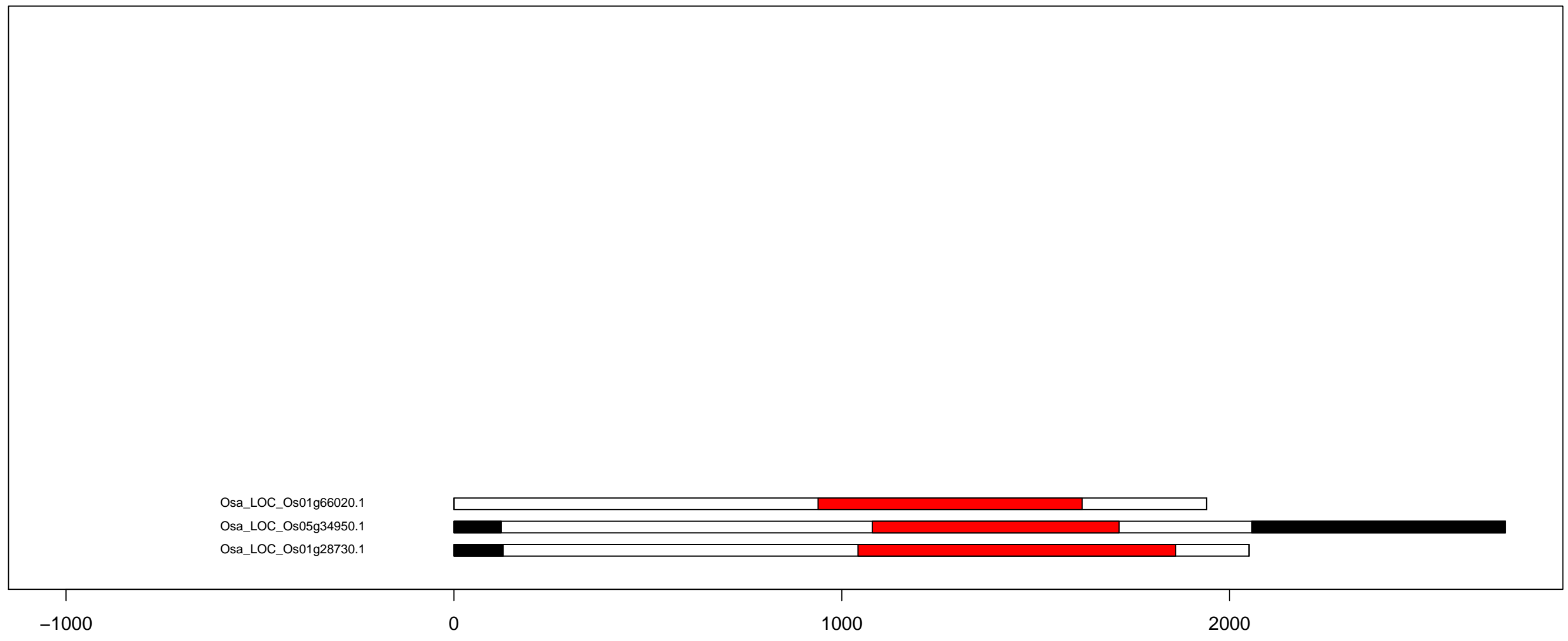

O.sa RLK-Pelle_RLCK-II exon-intron and kinase domain diagram (all)

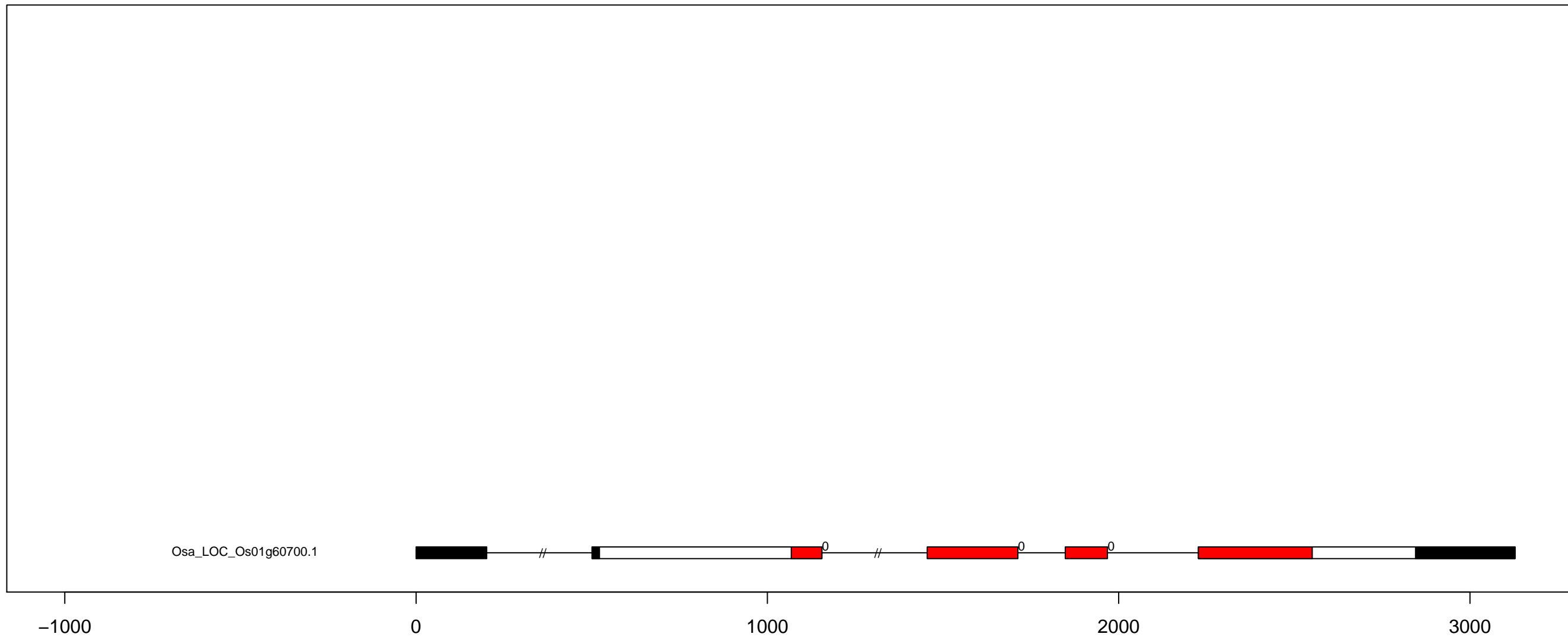

O.sa RLK-Pelle_RLCK-IV exon-intron and kinase domain diagram (all)

Osa_LOC_Os09g03620.1
Osa_LOC_Os04g42480.1
Osa_LOC_Os03g61060.1
Osa_LOC_Os03g05470.1
Osa_LOC_Os02g57560.1
Osa_LOC_Os01g63280.2

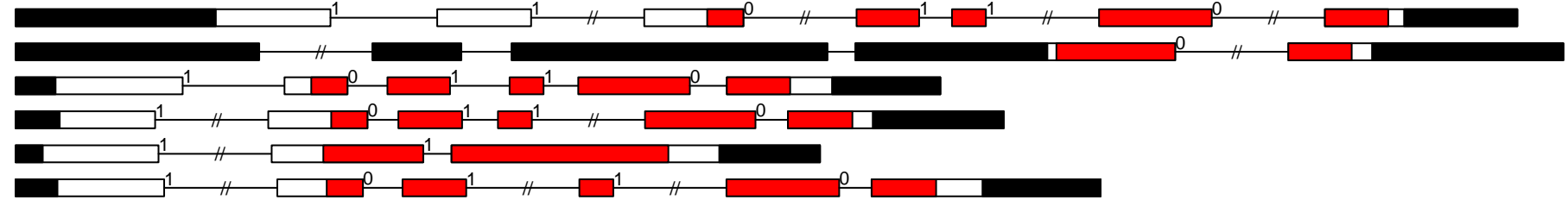

-1000

0

1000

2000

3000

4000

O.sa RLK-Pelle_RLCK-IXa exon-intron and kinase domain diagram (all)

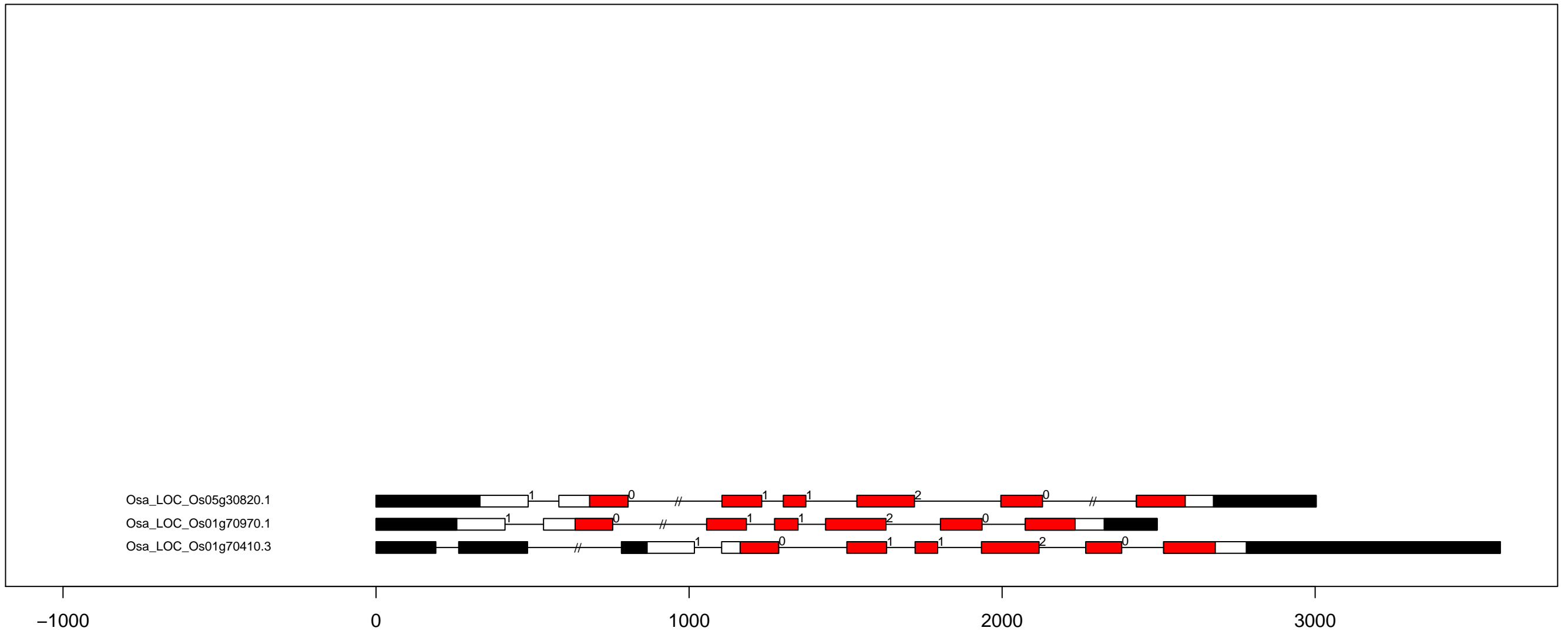

O.sa RLK-Pelle_RLCK-IXb exon-intron and kinase domain diagram (part 1)

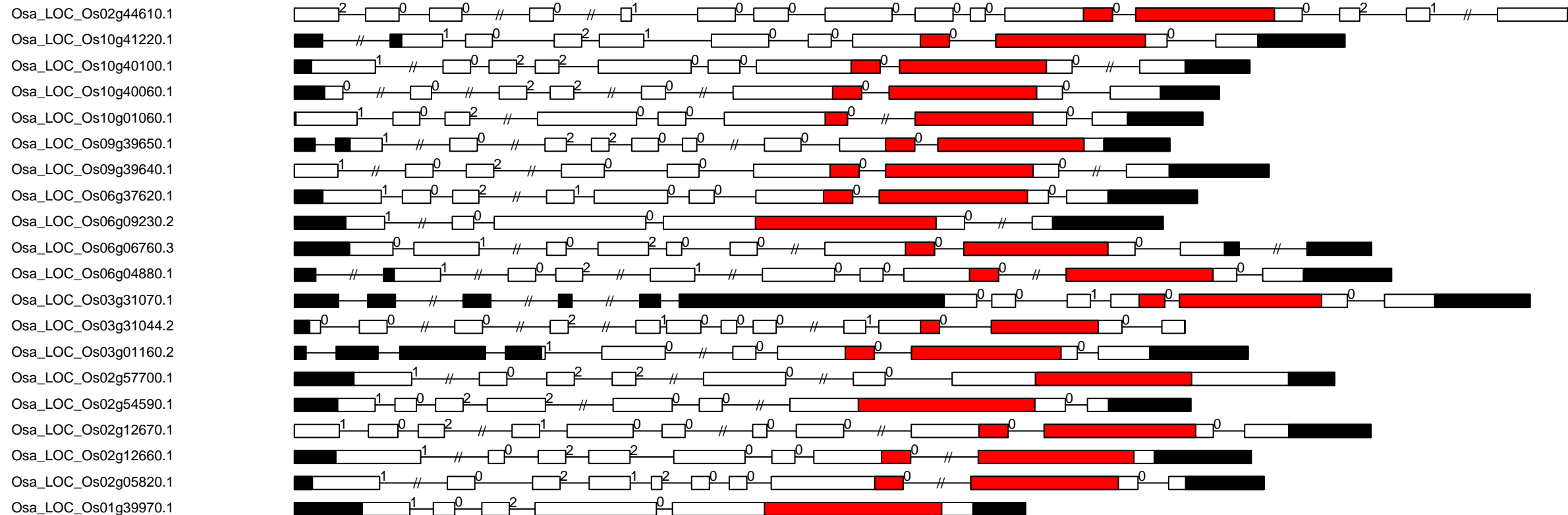

-1000

0

1000

2000

3000

4000

5000

O.sa RLK-Pelle_RLCK-IXb exon-intron and kinase domain diagram (part 2)

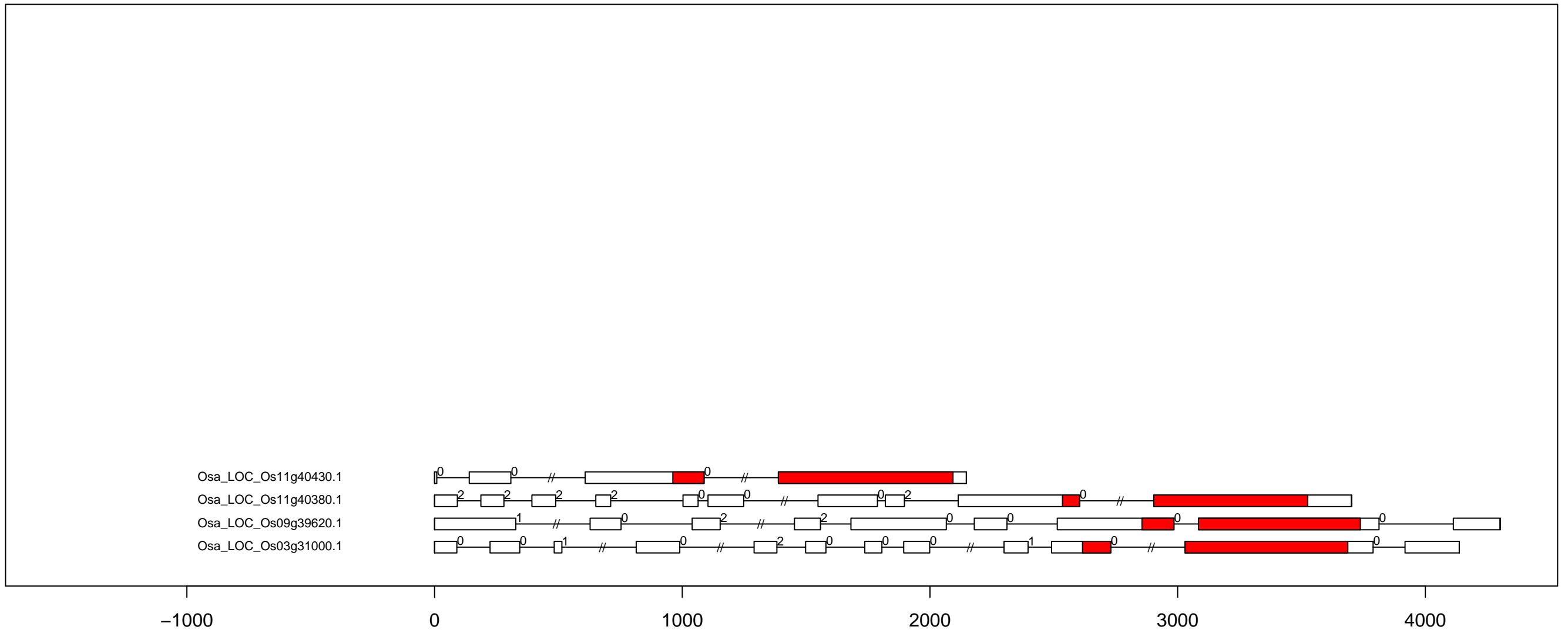

O.sa RLK-Pelle_RLCK-Os exon-intron and kinase domain diagram (all)

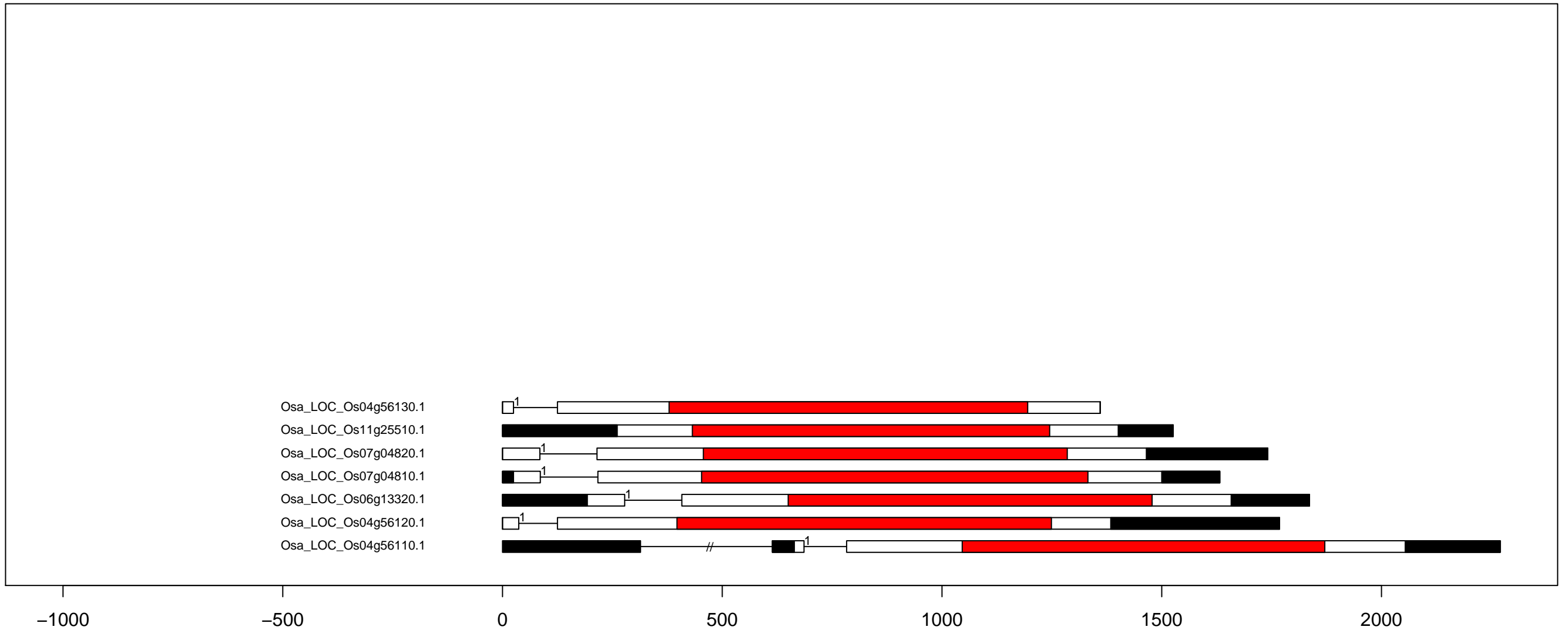

O.sa RLK-Pelle_RLCK-VIIa-1 exon-intron and kinase domain diagram (all)

Osa_LOC_Os05g03460.1
 Osa_LOC_Os09g39930.1
 Osa_LOC_Os07g49470.1
 Osa_LOC_Os07g47270.1
 Osa_LOC_Os05g41950.1
 Osa_LOC_Os05g38770.1
 Osa_LOC_Os05g30870.1
 Osa_LOC_Os04g32310.1
 Osa_LOC_Os03g17550.1
 Osa_LOC_Os03g03880.1
 Osa_LOC_Os02g58610.1
 Osa_LOC_Os02g30900.1
 Osa_LOC_Os01g71000.1
 Osa_LOC_Os01g57940.1
 Osa_LOC_Os01g15470.1

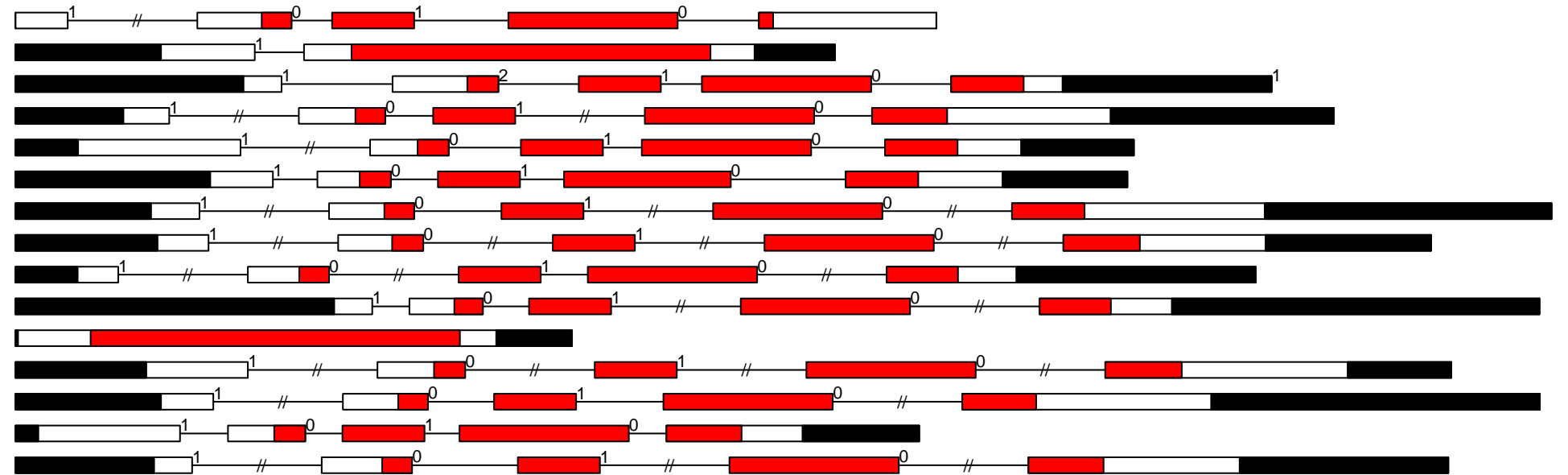

-1000

0

1000

2000

3000

O.sa RLK-Pelle_RLCK-VIIa-2 exon-intron and kinase domain diagram (part 1)

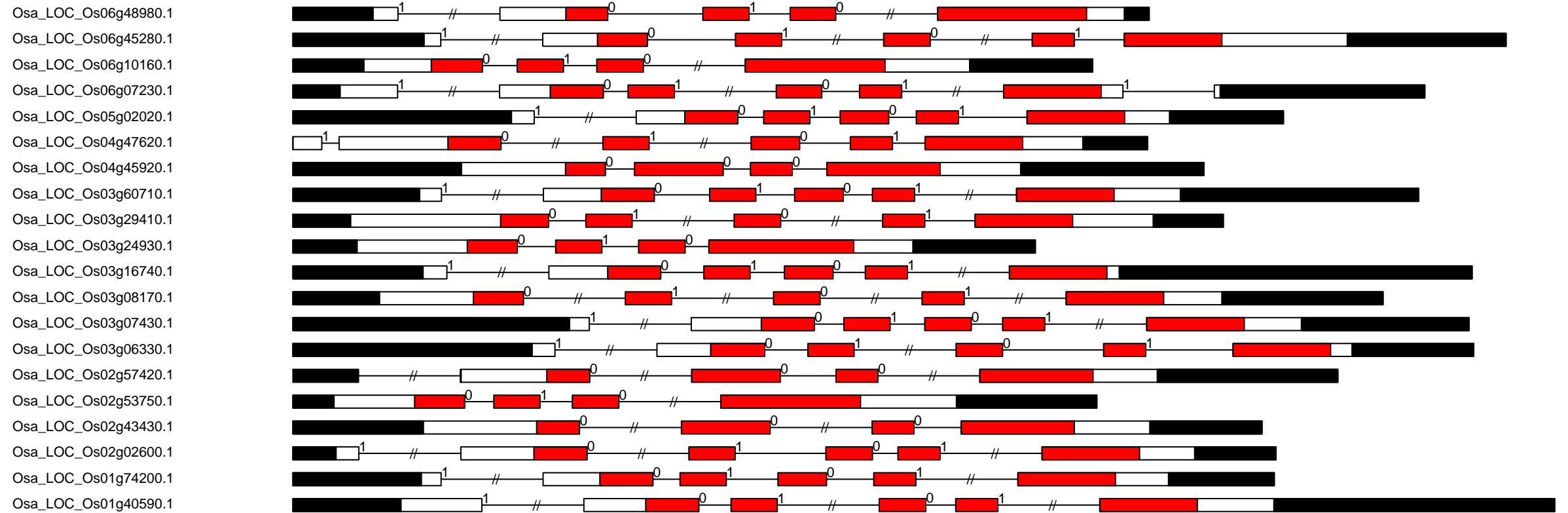

-1000

0

1000

2000

3000

O.sa RLK-Pelle_RLCK-VIIa-2 exon-intron and kinase domain diagram (part 2)

Osa_LOC_Os07g31290.1
 Osa_LOC_Os05g51400.1
 Osa_LOC_Os03g03890.1
 Osa_LOC_Os02g44920.1
 Osa_LOC_Os12g02810.1
 Osa_LOC_Os11g02830.1
 Osa_LOC_Os10g30600.1
 Osa_LOC_Os10g29620.1
 Osa_LOC_Os10g26520.1
 Osa_LOC_Os10g25550.1
 Osa_LOC_Os09g36320.1
 Osa_LOC_Os09g27010.1
 Osa_LOC_Os09g19700.1
 Osa_LOC_Os08g35600.1
 Osa_LOC_Os07g48730.1
 Osa_LOC_Os07g42200.1
 Osa_LOC_Os06g51170.1
 Osa_LOC_Os06g50100.1

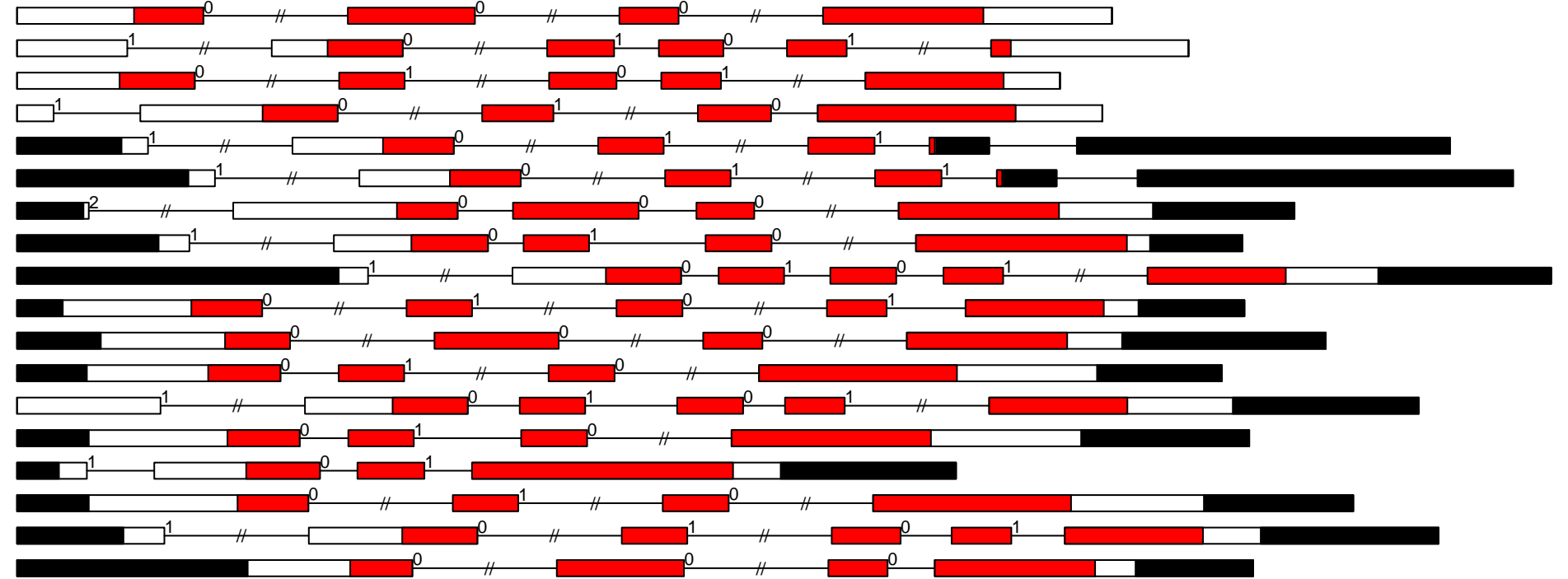

-1000

0

1000

2000

3000

O.sa RLK-Pelle_RLCK-VIIb exon-intron and kinase domain diagram (all)

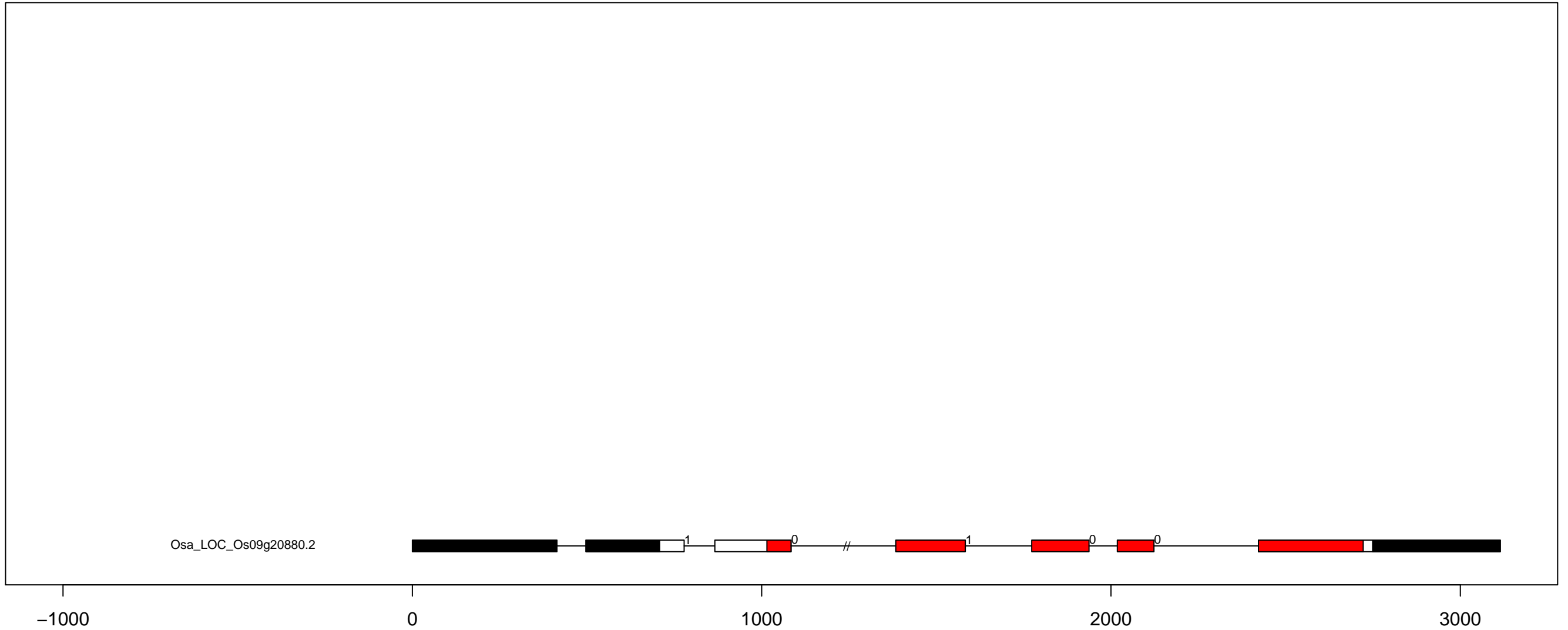

O.sa RLK-Pelle_RLCK-VI exon-intron and kinase domain diagram (all)

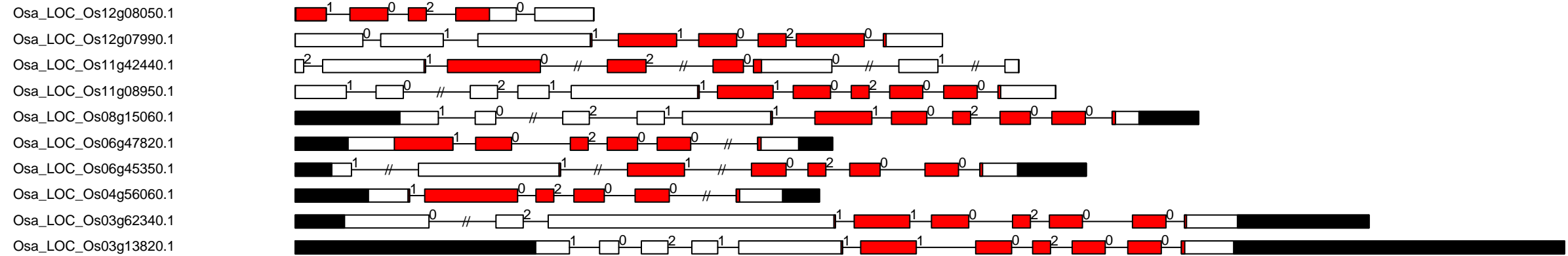

-1000

0

1000

2000

3000

4000

5000

O.sa RLK-Pelle_RLCK-V exon-intron and kinase domain diagram (all)

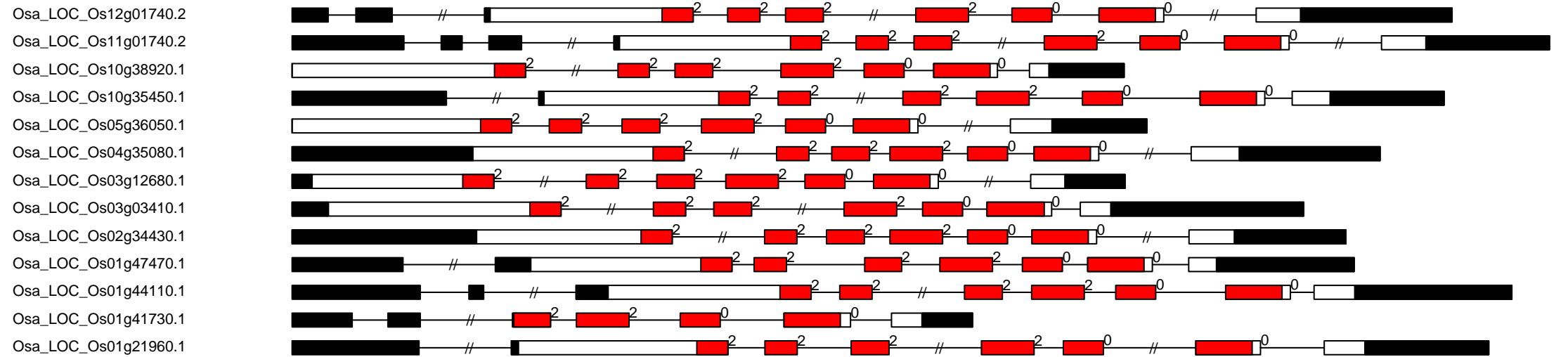

-1000

0

1000

2000

3000

4000

O.sa RLK-Pelle_RLCK-XII-1 exon-intron and kinase domain diagram (all)

Osa_LOC_Os10g42110.1

Osa_LOC_Os10g39670.1

Osa_LOC_Os04g58750.1

Osa_LOC_Os03g61010.1

Osa_LOC_Os03g04050.1

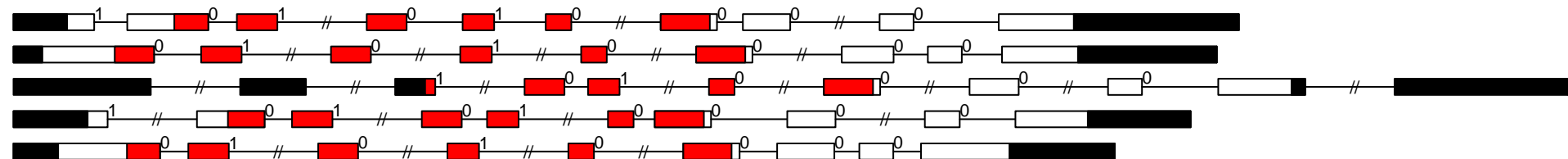

-1000

0

1000

2000

3000

4000

5000

O.sa RLK-Pelle_RLCK-XIII exon-intron and kinase domain diagram (all)

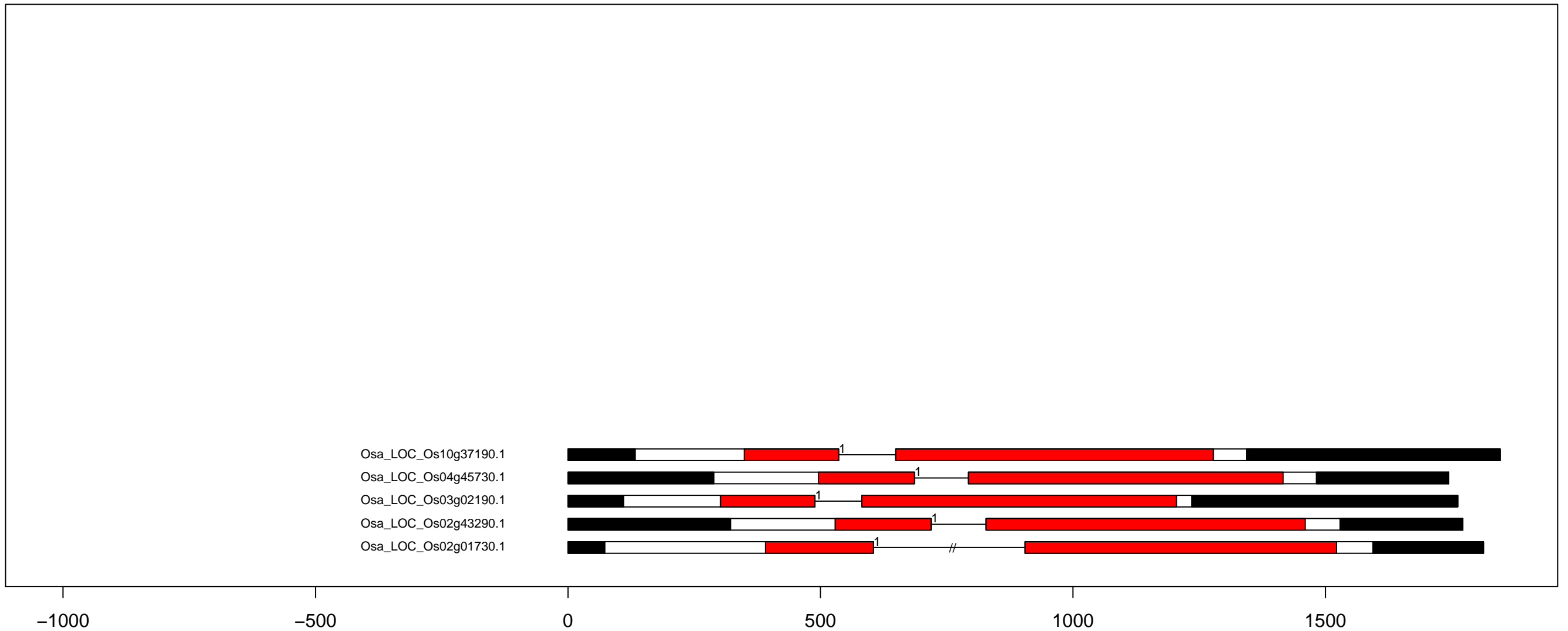

O.sa RLK-Pelle_RLCK-X exon-intron and kinase domain diagram (all)

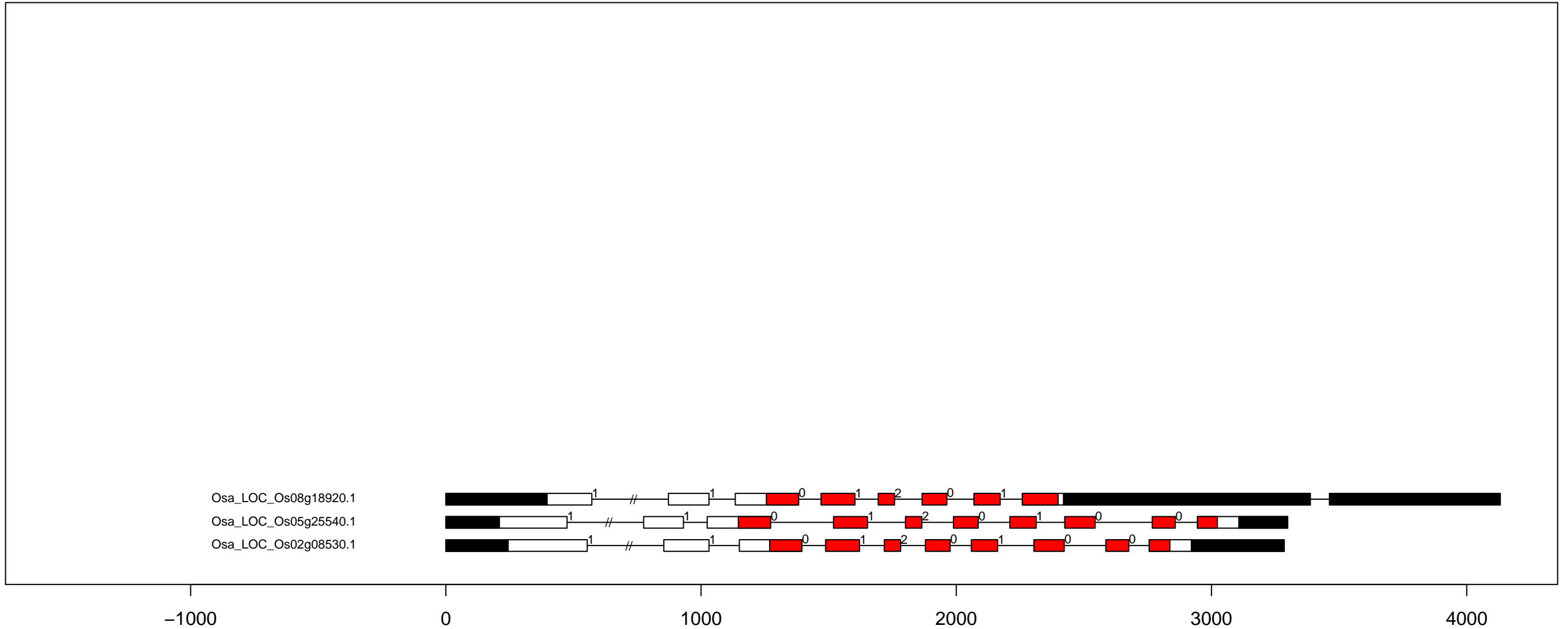

O.sa RLK-Pelle_RLCK-XVI exon-intron and kinase domain diagram (all)

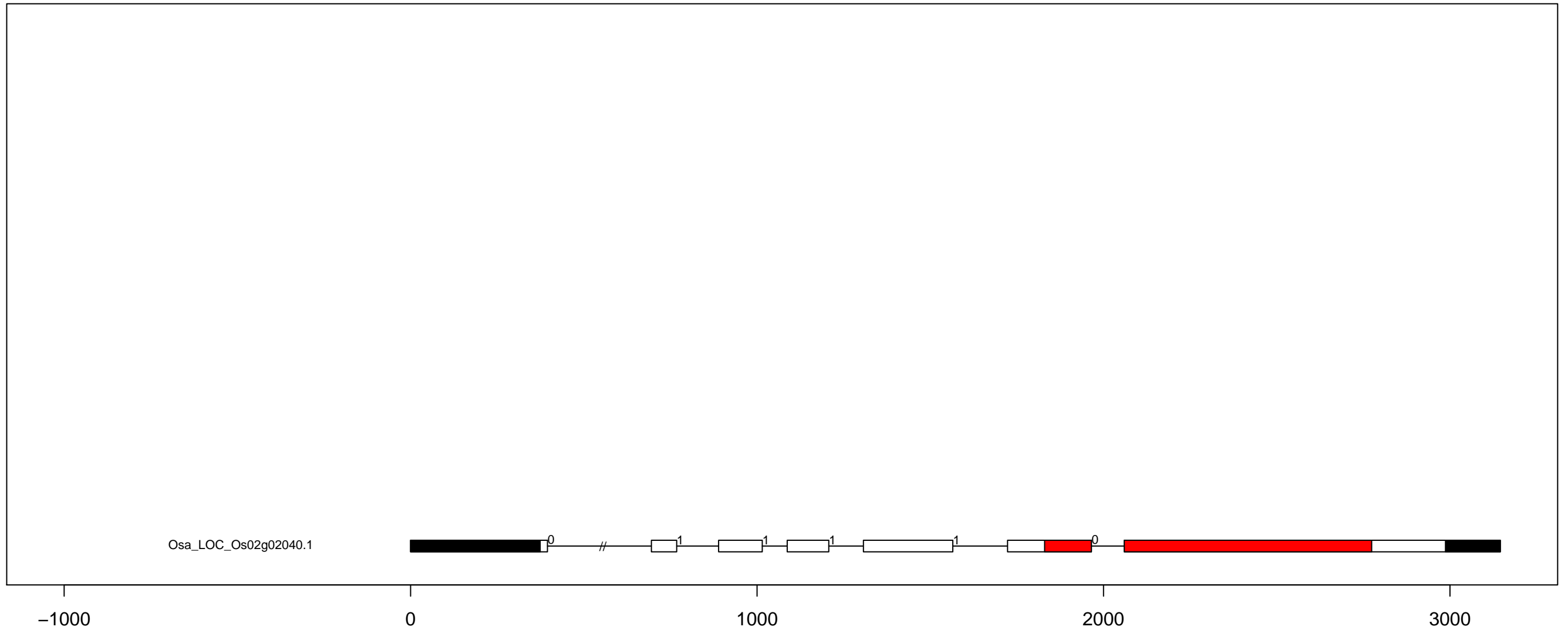

O.sa RLK-Pelle_RLCK-XV exon-intron and kinase domain diagram (all)

Osa_LOC_Os09g36180.1
 Osa_LOC_Os06g44430.1
 Osa_LOC_Os06g07070.1
 Osa_LOC_Os02g09359.1

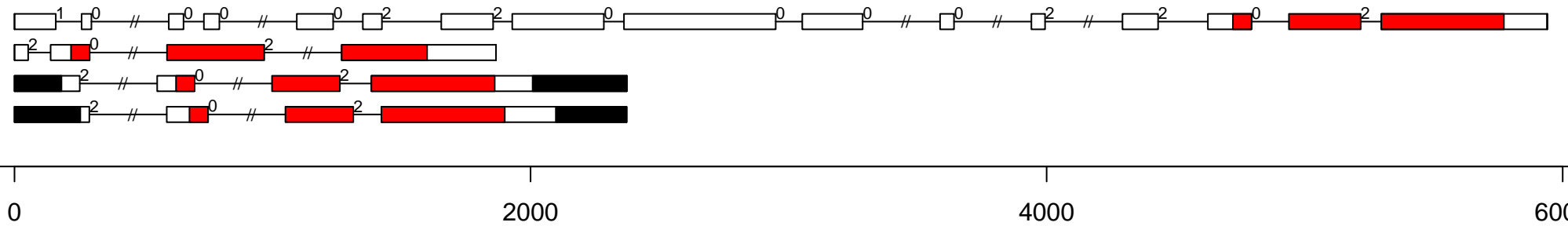

O.sa RLK-Pelle_SD-2b exon-intron and kinase domain diagram (part 1)

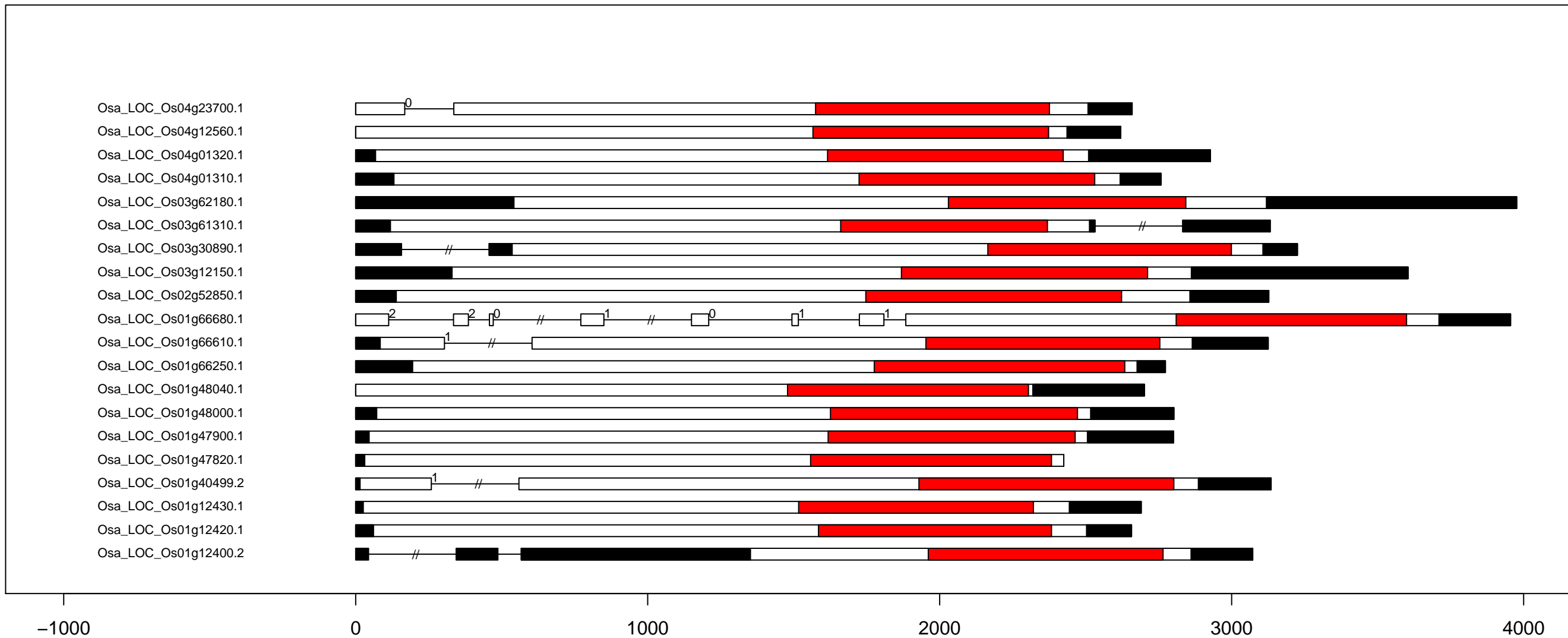

O.sa RLK-Pelle_SD-2b exon-intron and kinase domain diagram (part 2)

Osa_LOC_Os10g20160.1
Osa_LOC_Os10g01100.1
Osa_LOC_Os09g28180.1
Osa_LOC_Os07g36780.1
Osa_LOC_Os06g41560.1
Osa_LOC_Os06g40030.1
Osa_LOC_Os06g37750.1
Osa_LOC_Os06g37670.1
Osa_LOC_Os06g35850.2
Osa_LOC_Os06g29810.3
Osa_LOC_Os06g06960.1
Osa_LOC_Os06g06940.1
Osa_LOC_Os06g05070.1
Osa_LOC_Os05g07420.1
Osa_LOC_Os05g07300.1
Osa_LOC_Os04g34370.1
Osa_LOC_Os04g34360.1
Osa_LOC_Os04g34270.1
Osa_LOC_Os04g34250.1
Osa_LOC_Os04g28780.1

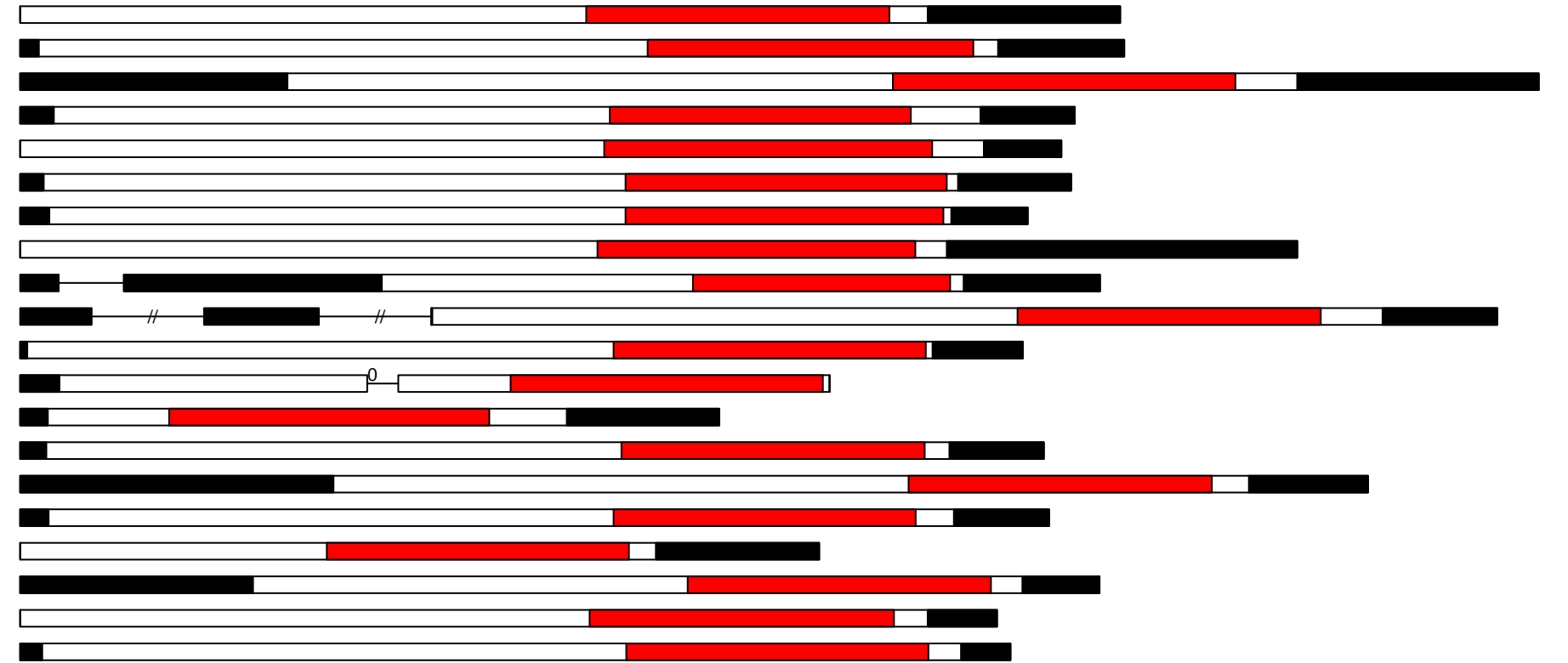

O.sa RLK-Pelle_SD-2b exon-intron and kinase domain diagram (part 3)

Osa_LOC_Os01g65060.1
 Osa_LOC_Os01g65010.1
 Osa_LOC_Os01g48020.1
 Osa_LOC_Os01g47840.1
 Osa_LOC_Os01g47810.1
 Osa_LOC_Os01g46030.1
 Osa_LOC_Os01g45520.1
 Osa_LOC_Os01g12410.1
 Osa_LOC_Os01g12290.1
 Osa_LOC_Os01g10710.1
 Osa_LOC_Os01g10700.1
 Osa_LOC_Os01g06240.1
 Osa_LOC_Os01g02310.1
 Osa_LOC_Os12g44320.1
 Osa_LOC_Os12g34320.1
 Osa_LOC_Os12g07800.1
 Osa_LOC_Os12g03640.1
 Osa_LOC_Os11g03880.1
 Osa_LOC_Os11g03840.1
 Osa_LOC_Os11g03820.1

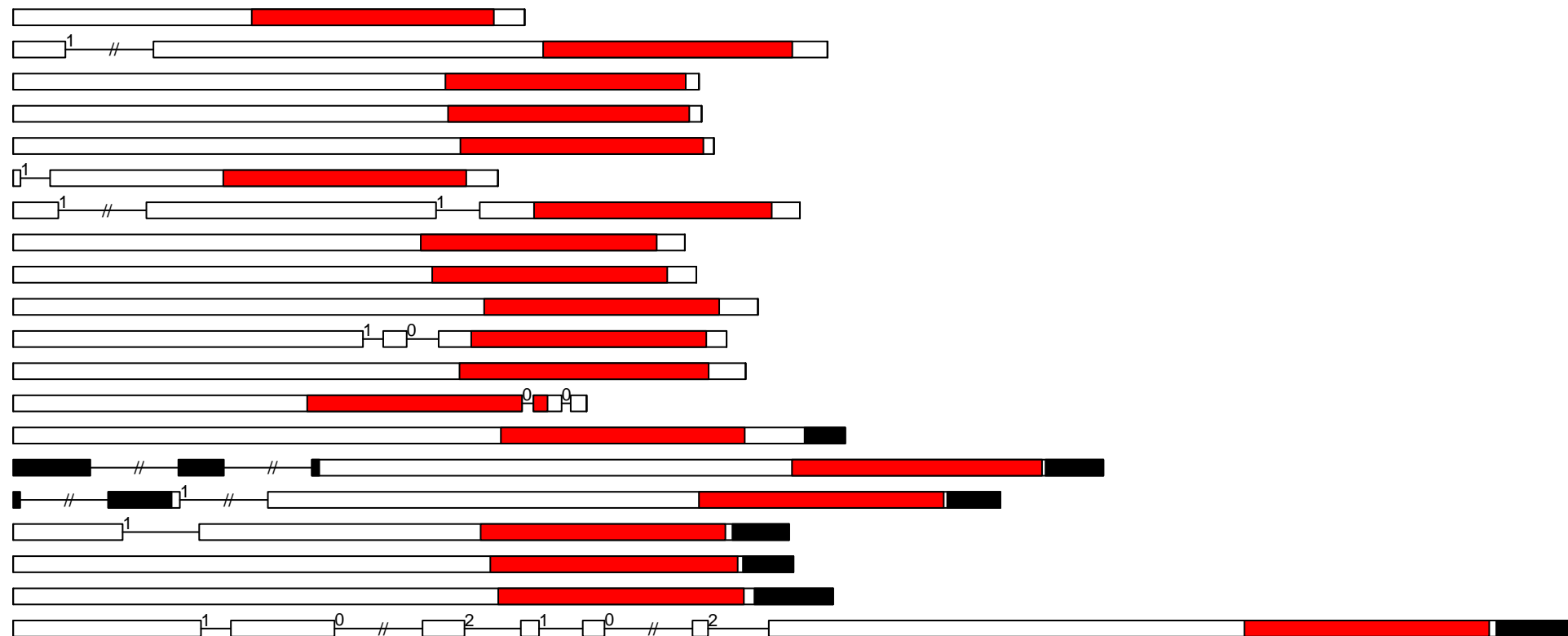

O.sa RLK-Pelle_SD-2b exon-intron and kinase domain diagram (part 4)

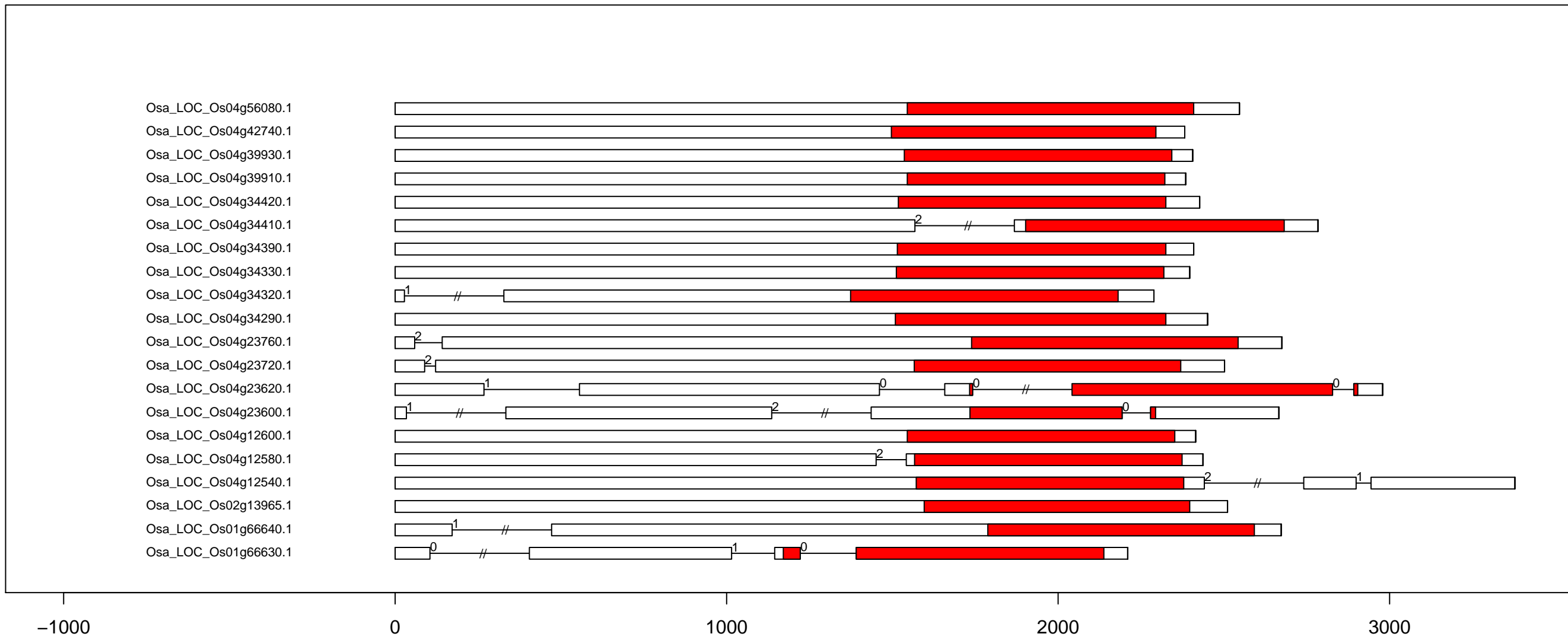

O.sa RLK-Pelle_URK-1 exon-intron and kinase domain diagram (all)

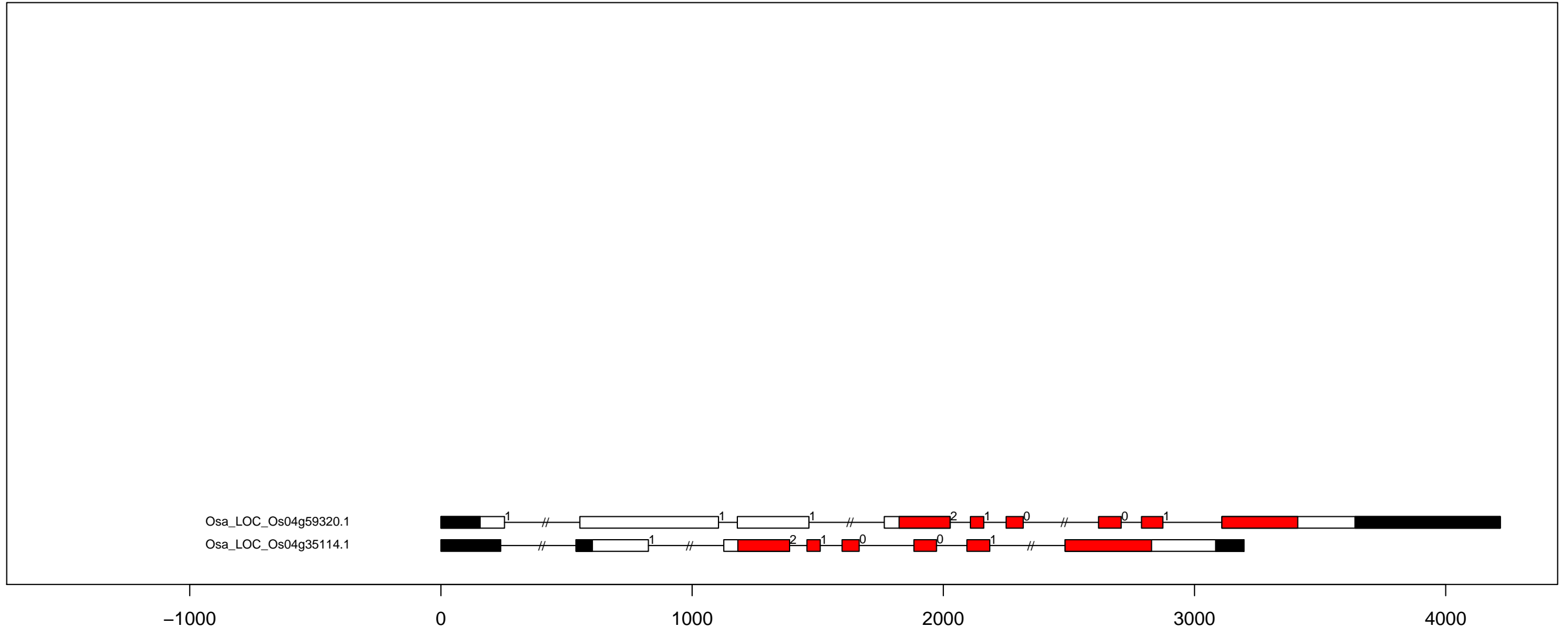

O.sa RLK-Pelle_URK-2 exon-intron and kinase domain diagram (all)

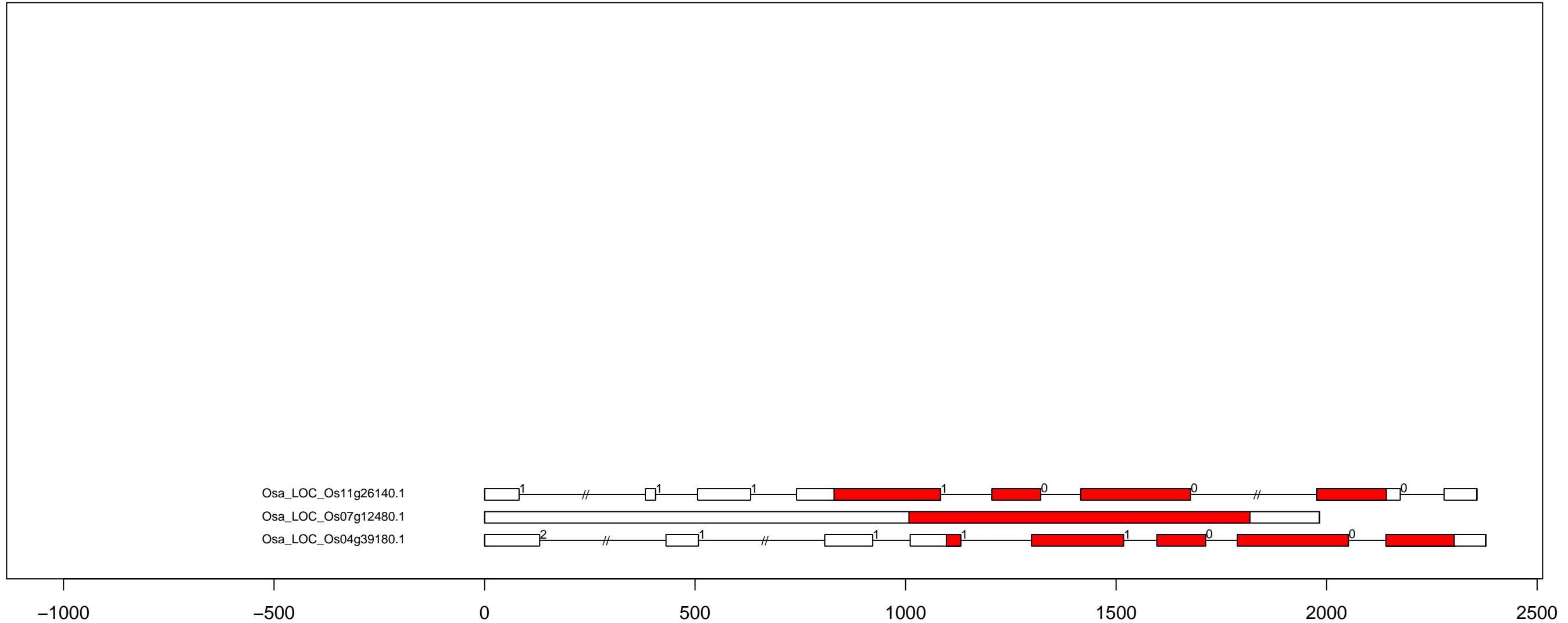

O.sa RLK-Pelle_URK-3 exon-intron and kinase domain diagram (all)

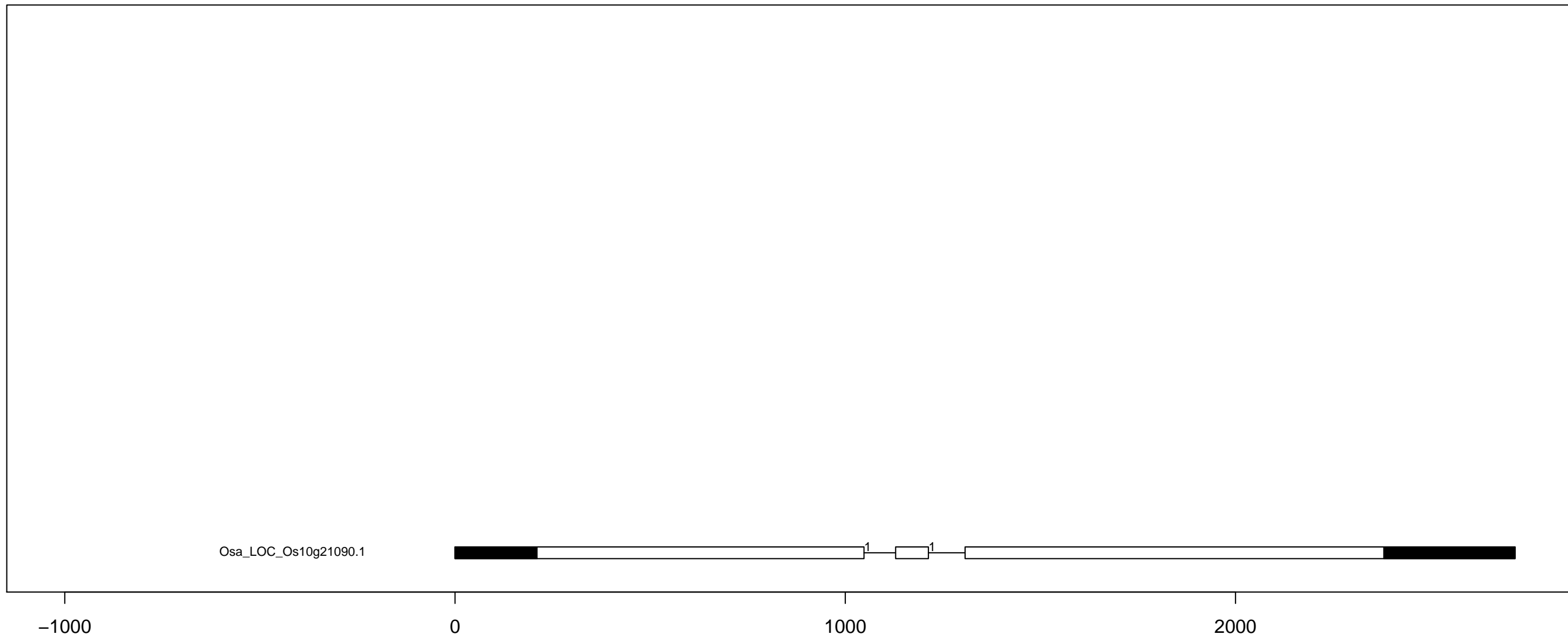

O.sa RLK-Pelle_WAK_LRK10L-1 exon-intron and kinase domain diagram (all)

Osa_LOC_Os12g40419.1
Osa_LOC_Os05g47770.1
Osa_LOC_Os05g25390.1
Osa_LOC_Os03g58750.1
Osa_LOC_Os03g12470.1
Osa_LOC_Os01g49529.1
Osa_LOC_Os01g04450.1
Osa_LOC_Os01g04409.1

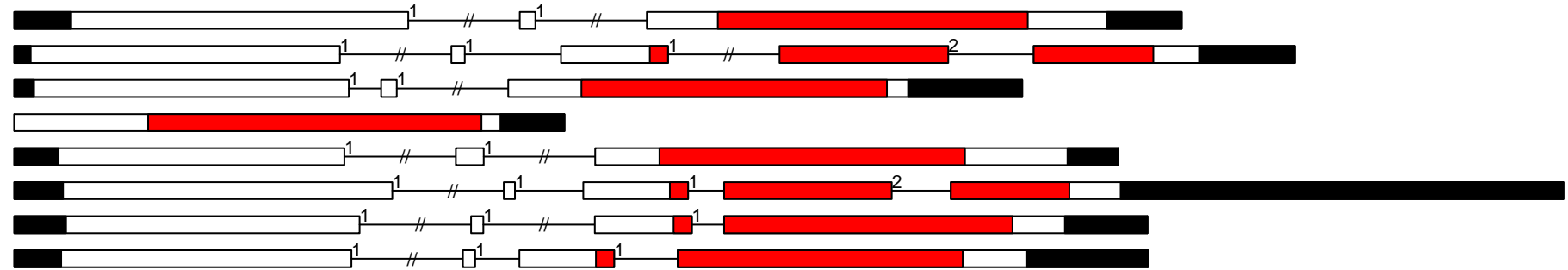

-1000

0

1000

2000

3000

4000

O.sa RLK-Pelle_WAK exon-intron and kinase domain diagram (part 1)

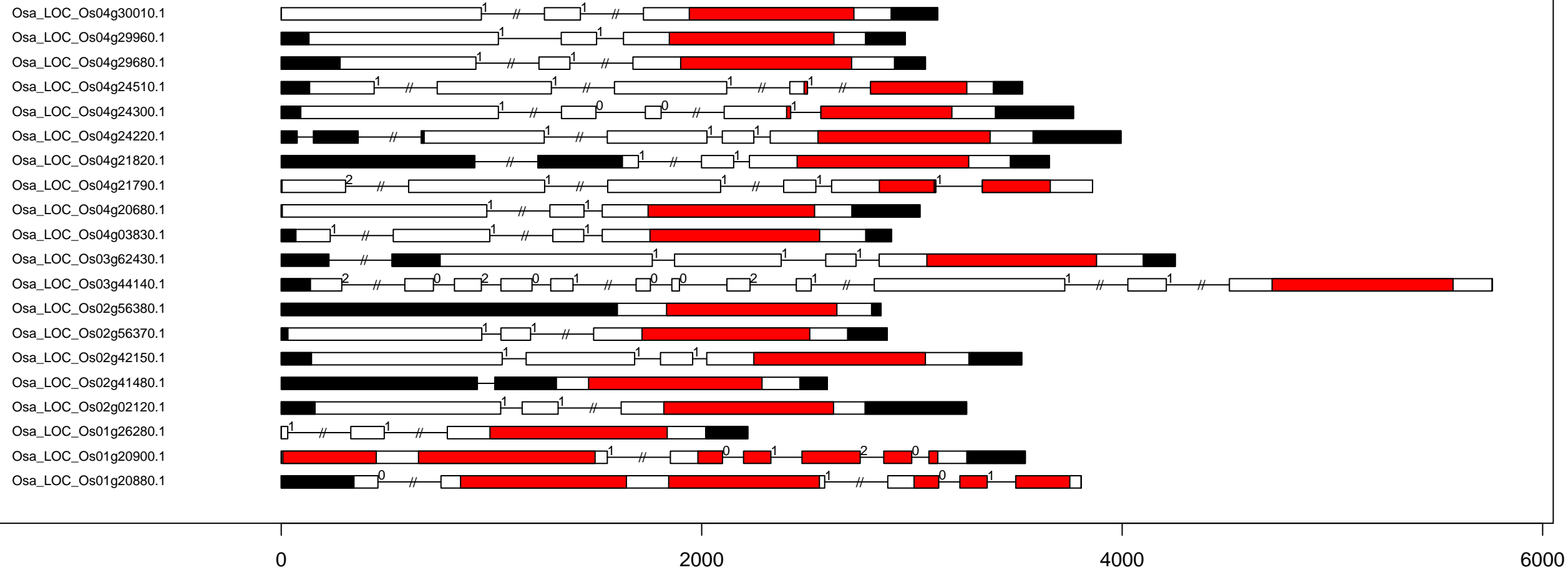

O.sa RLK-Pelle_WAK exon-intron and kinase domain diagram (part 2)

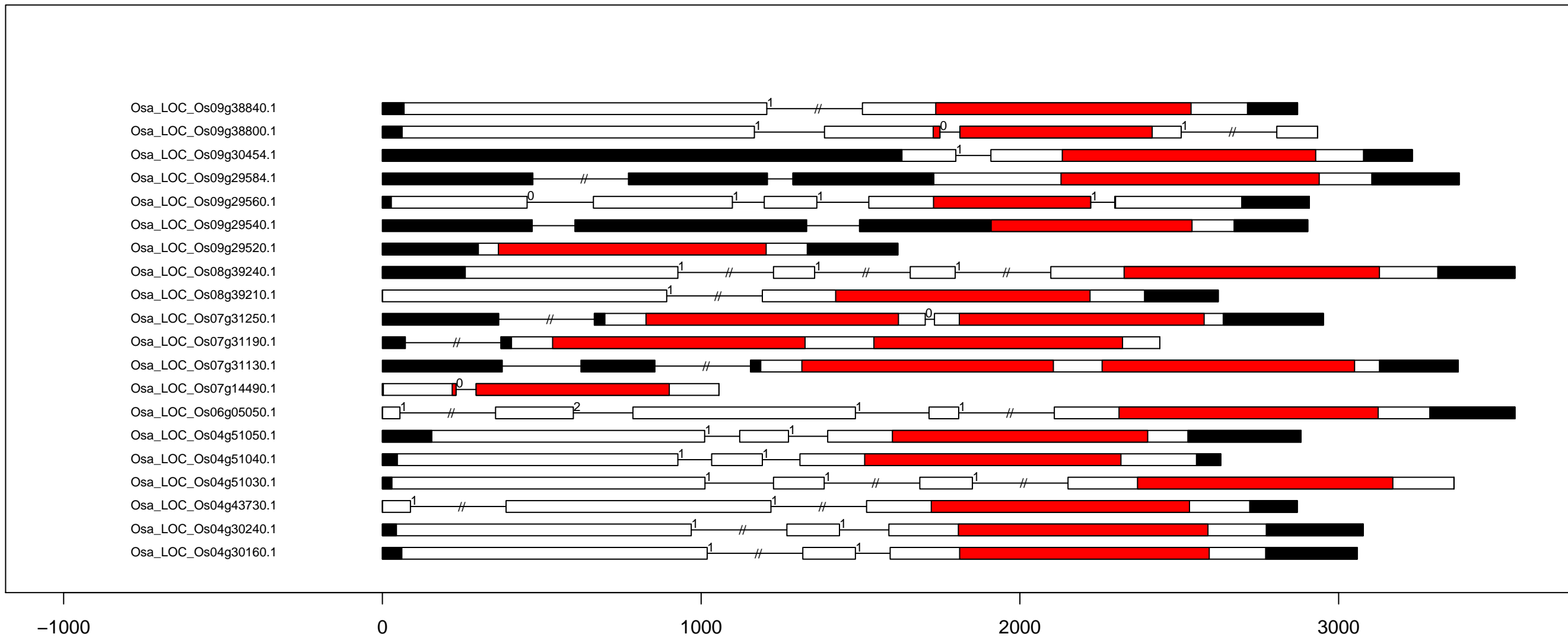

O.sa RLK-Pelle_WAK exon-intron and kinase domain diagram (part 3)

Osa_LOC_Os01g26300.1
 Osa_LOC_Os01g26210.1
 Osa_LOC_Os01g26174.1
 Osa_LOC_Os12g42070.1
 Osa_LOC_Os12g42060.1
 Osa_LOC_Os12g16520.1
 Osa_LOC_Os11g47140.1
 Osa_LOC_Os11g46950.1
 Osa_LOC_Os11g46860.1
 Osa_LOC_Os11g35274.1
 Osa_LOC_Os11g35220.1
 Osa_LOC_Os10g10130.1
 Osa_LOC_Os10g10030.1
 Osa_LOC_Os10g07556.1
 Osa_LOC_Os10g06140.1
 Osa_LOC_Os10g05250.1
 Osa_LOC_Os10g02720.1
 Osa_LOC_Os10g02360.1
 Osa_LOC_Os09g38910.1
 Osa_LOC_Os09g38850.1

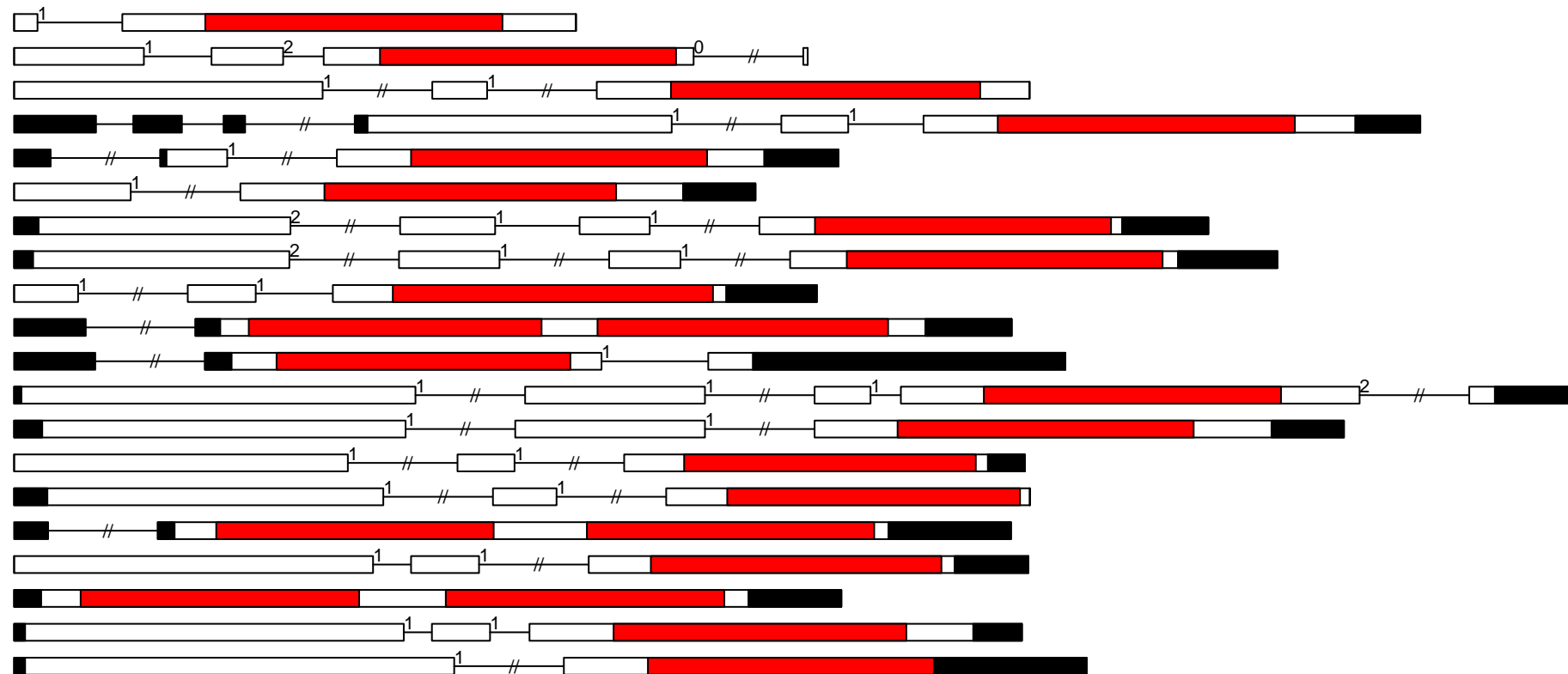

-1000

0

1000

2000

3000

4000

O.sa RLK-Pelle_WAK exon-intron and kinase domain diagram (part 4)

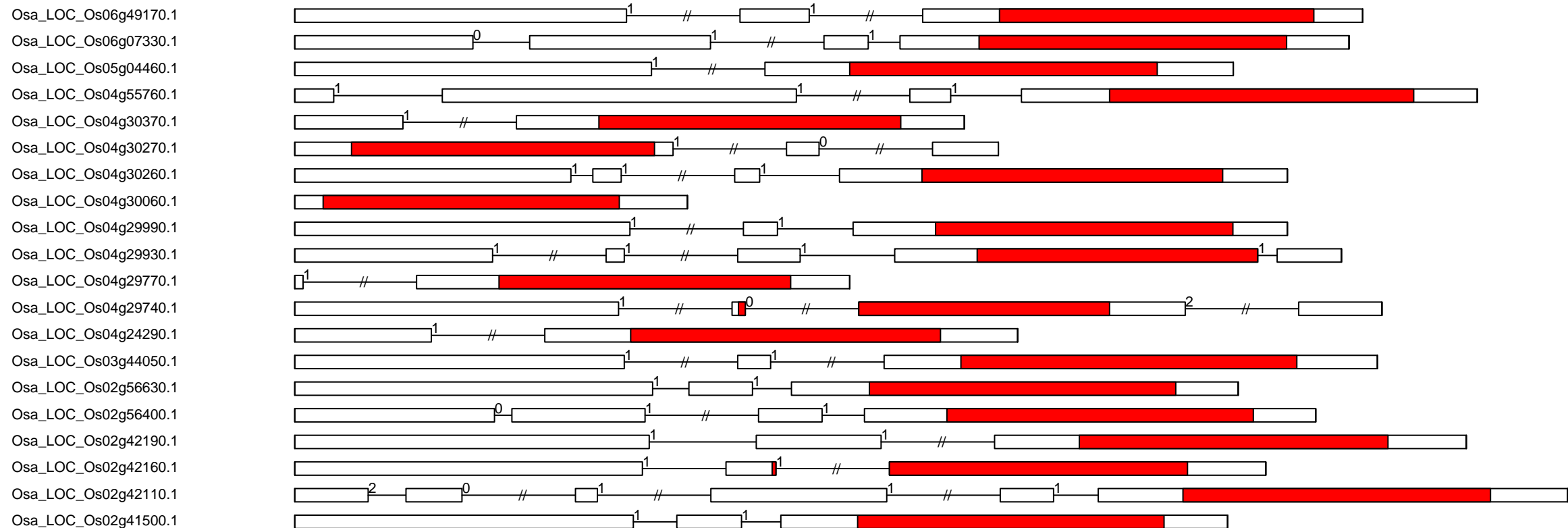

-1000

0

1000

2000

3000

O.sa RLK-Pelle_WAK exon-intron and kinase domain diagram (part 5)

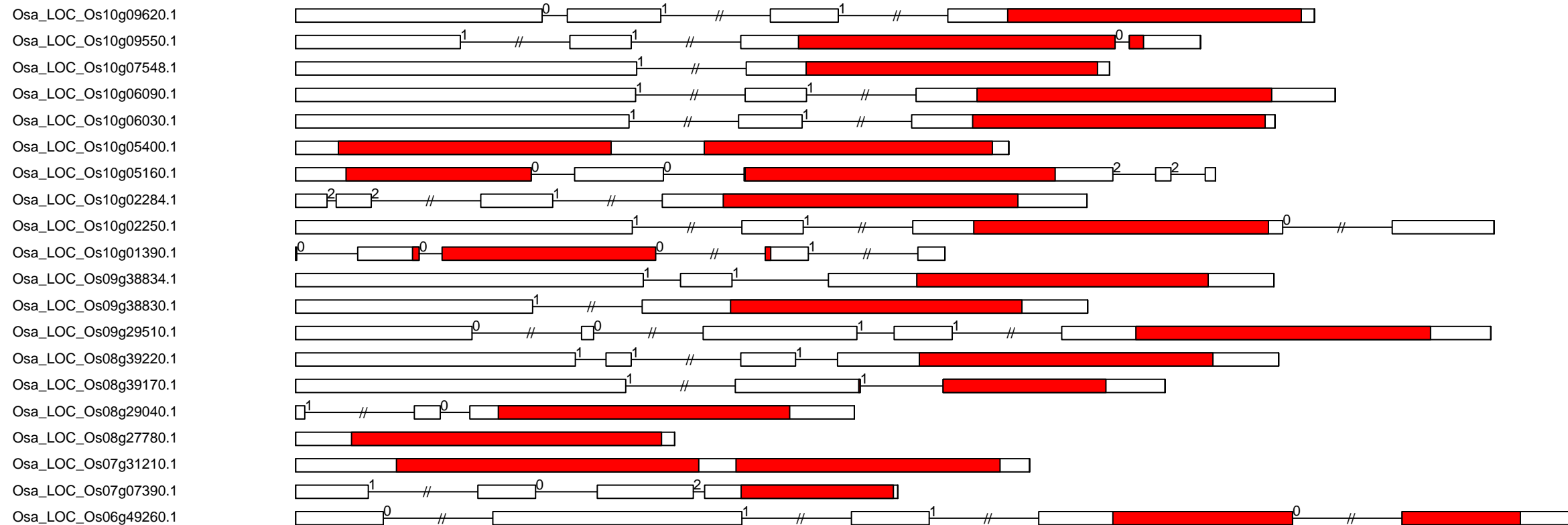

-1000

0

1000

2000

3000

O.sa RLK-Pelle_WAK exon-intron and kinase domain diagram (part 6)

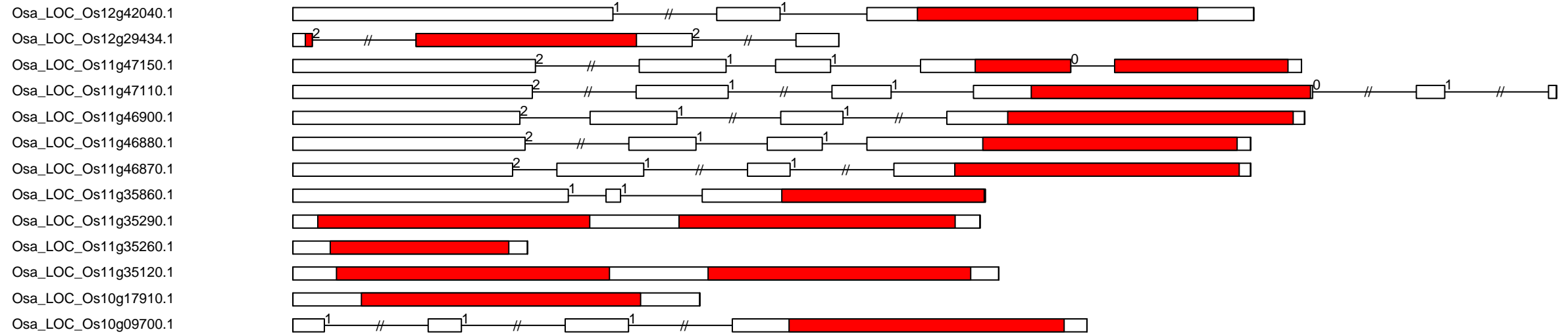

-1000

0

1000

2000

3000

O.sa SCY1_SCYL1 exon-intron and kinase domain diagram (all)

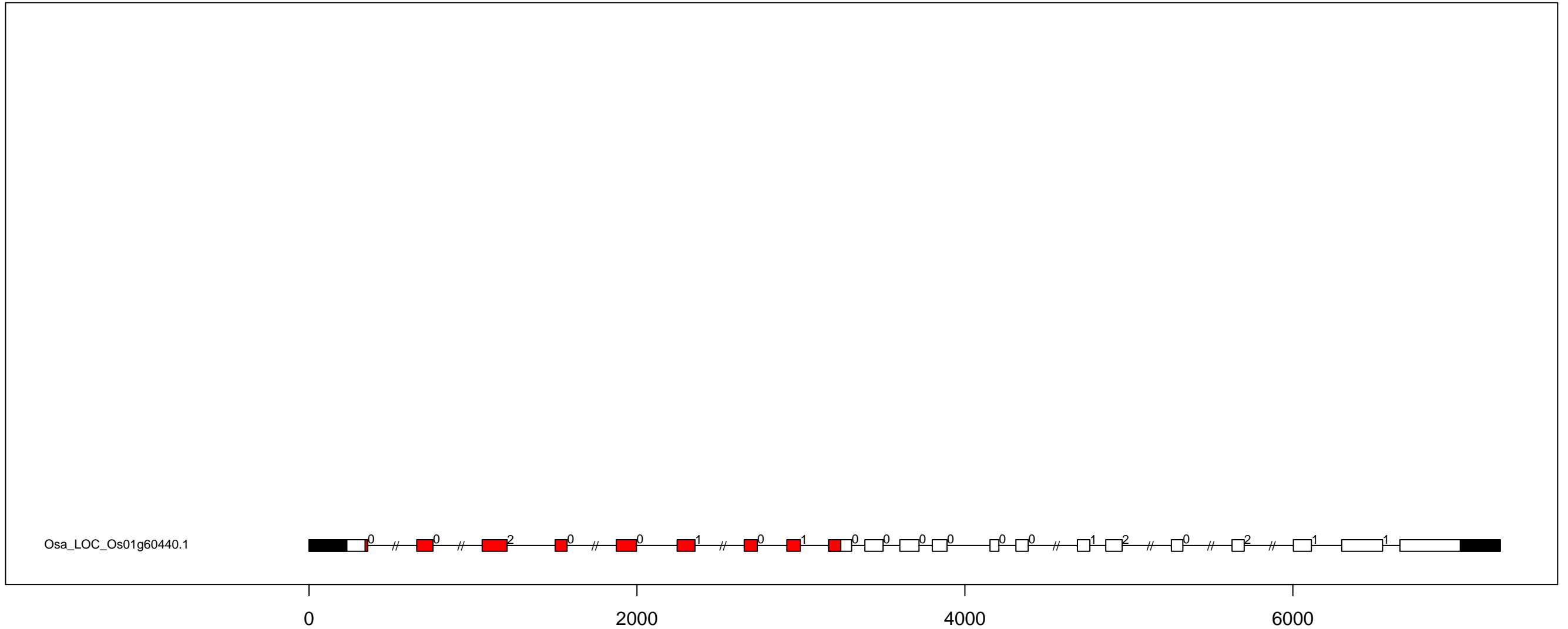

O.sa SCY1_SCYL2 exon-intron and kinase domain diagram (all)

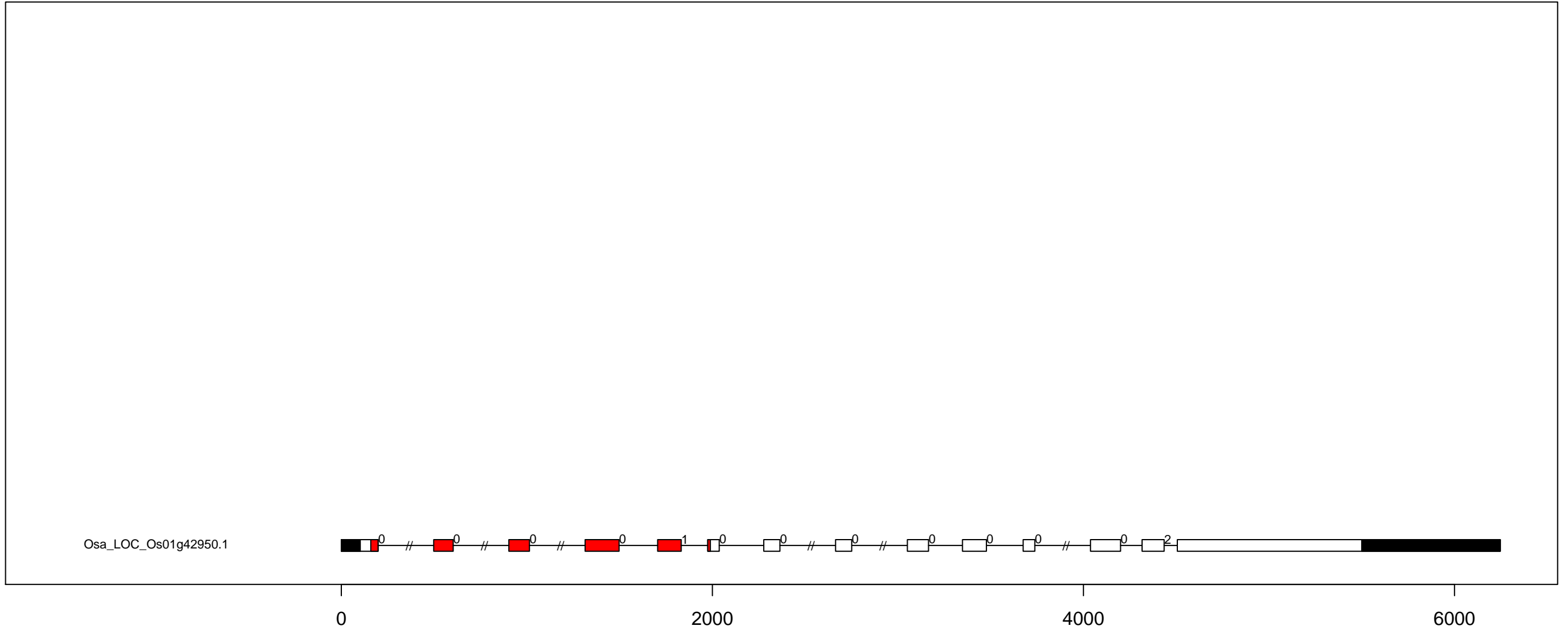

O.sa STE_STE11 exon-intron and kinase domain diagram (part 1)

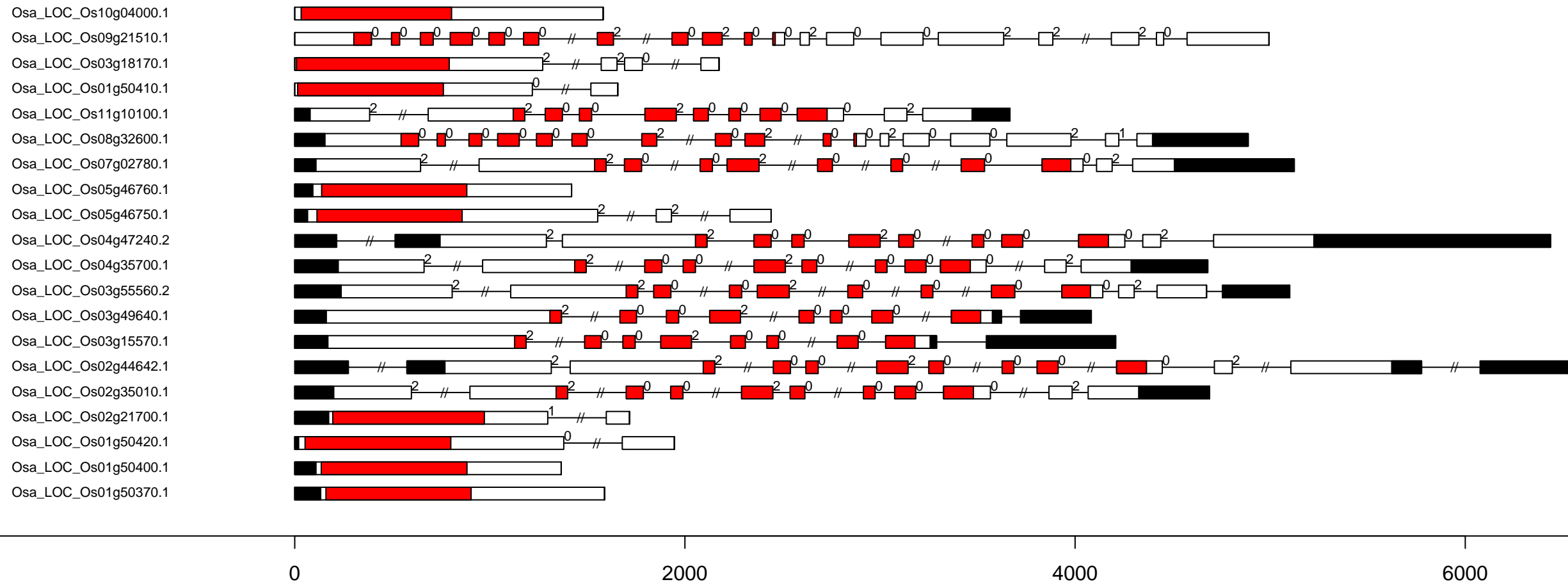

O.sa STE_STE11 exon-intron and kinase domain diagram (part 2)

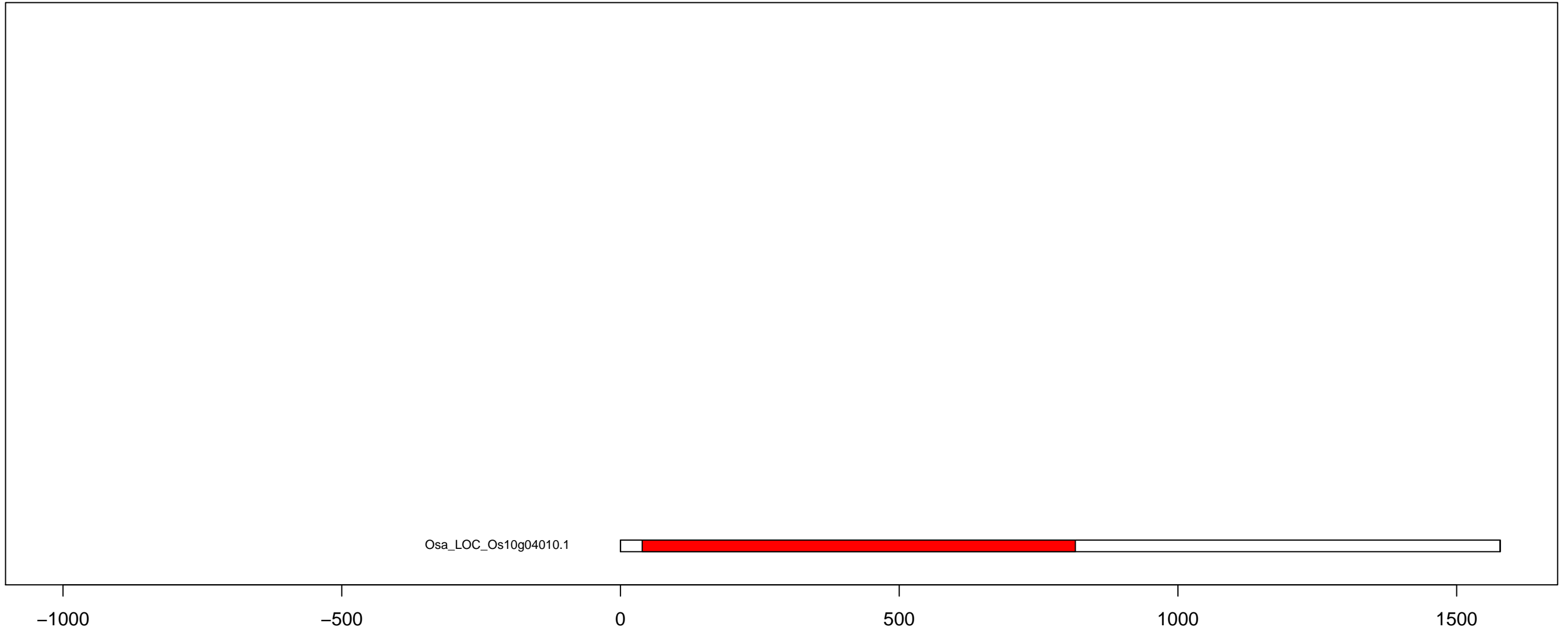

O.sa STE_STE20-Fray exon-intron and kinase domain diagram (all)

Osa_LOC_Os03g47470.1
 Osa_LOC_Os02g08240.1
 Osa_LOC_Os10g37480.1
 Osa_LOC_Os06g29120.2
 Osa_LOC_Os03g02320.1
 Osa_LOC_Os02g54900.1

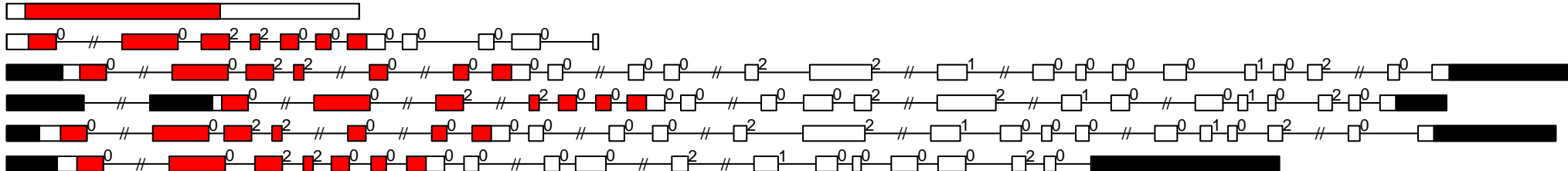

0

2000

4000

6000

O.sa STE_STE20-PI exon-intron and kinase domain diagram (all)

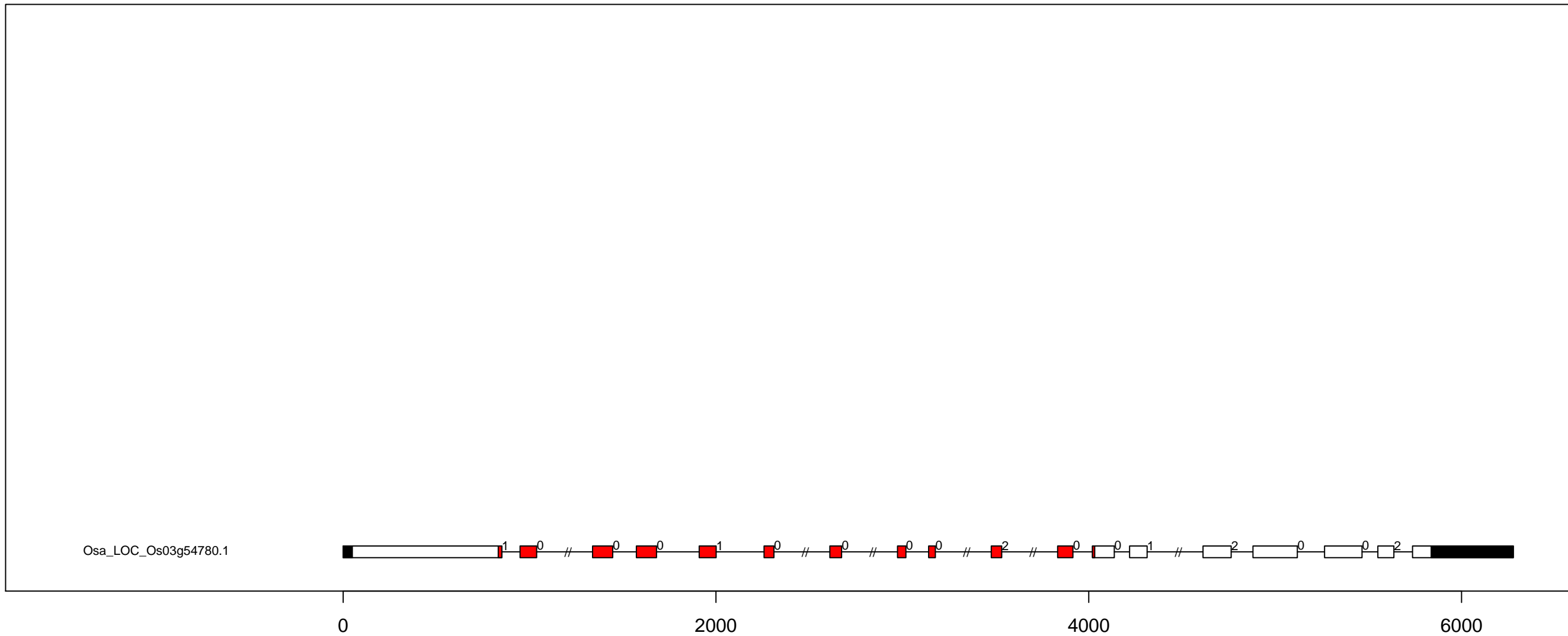

O.sa STE_STE20-YSK exon-intron and kinase domain diagram (all)

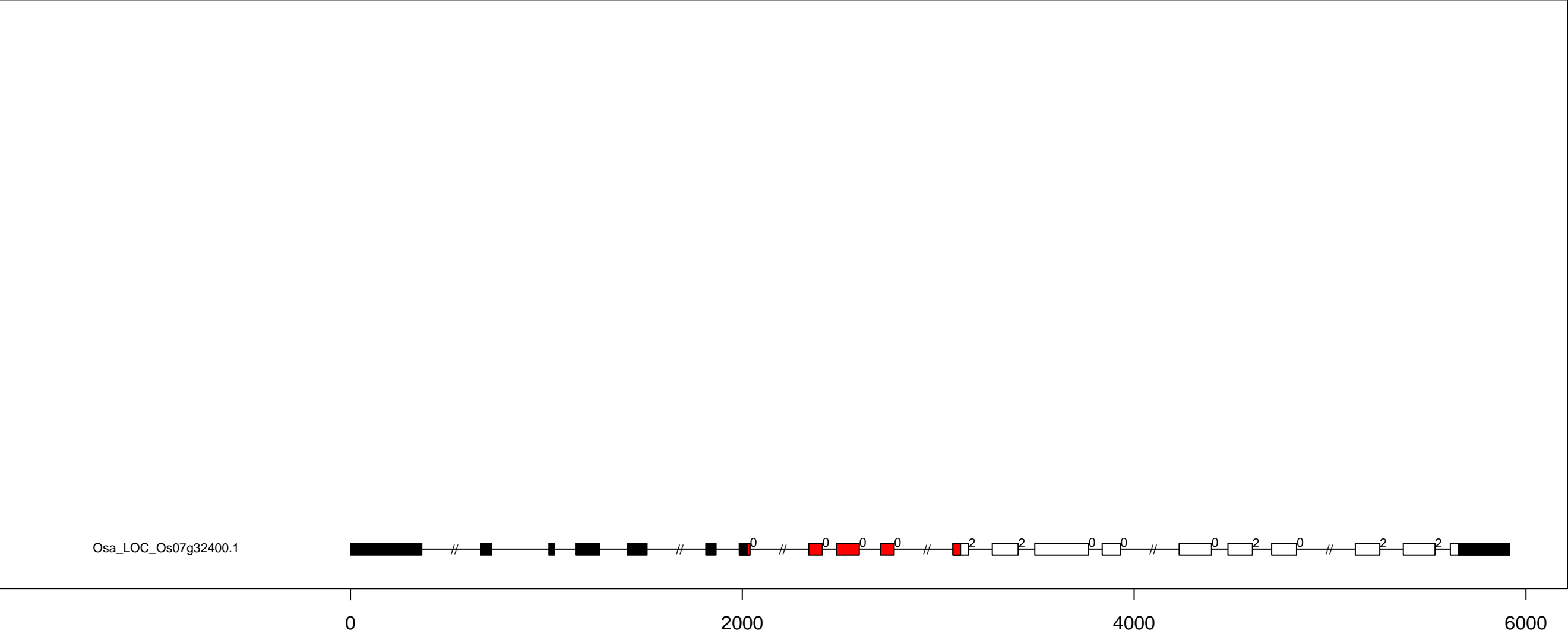

O.sa STE_STE7 exon-intron and kinase domain diagram (all)

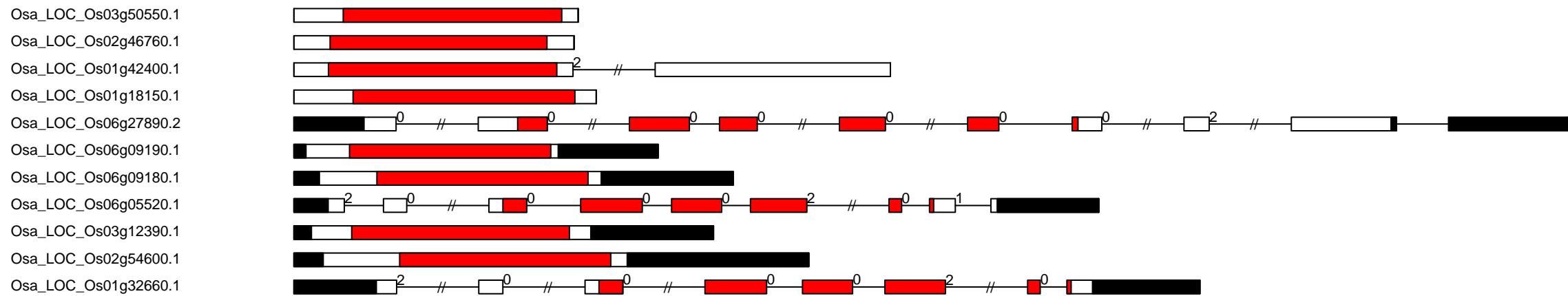

O.sa STE_STE-PI exon-intron and kinase domain diagram (all)

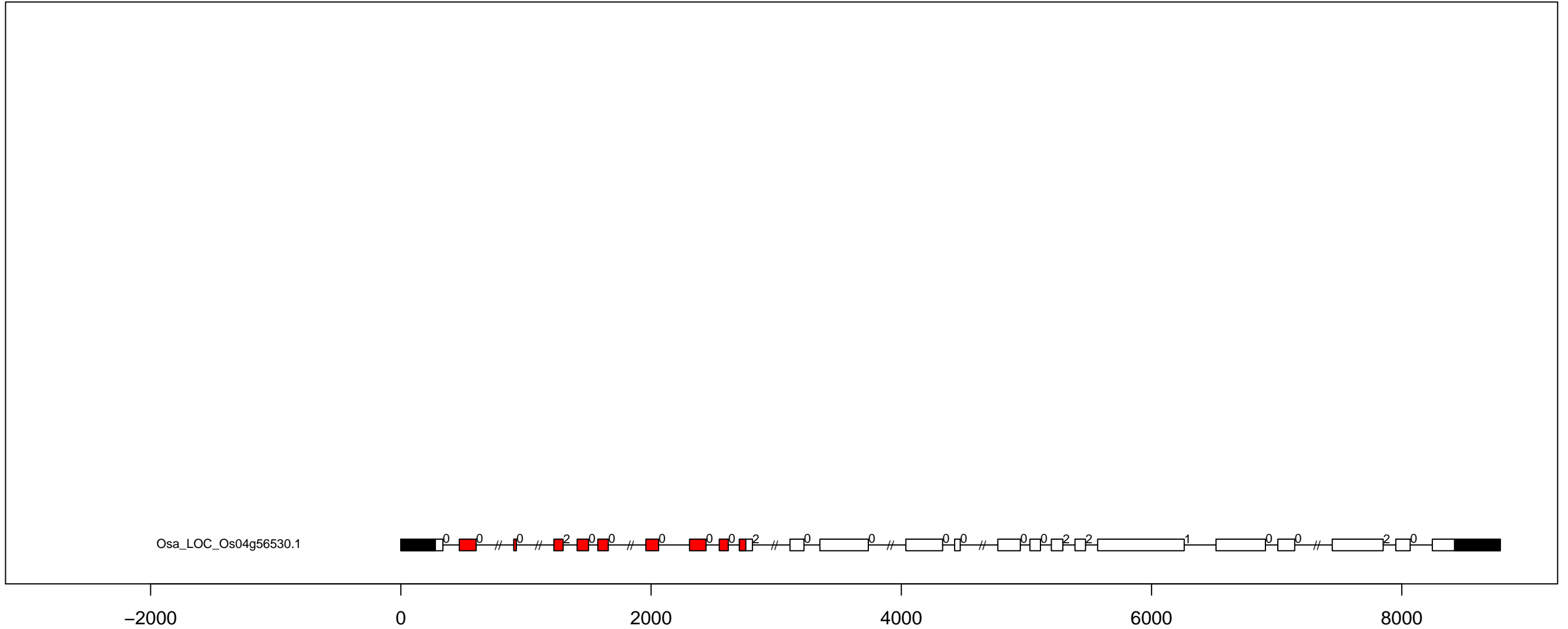

O.sa TKL_CTR1-DRK-1 exon-intron and kinase domain diagram (all)

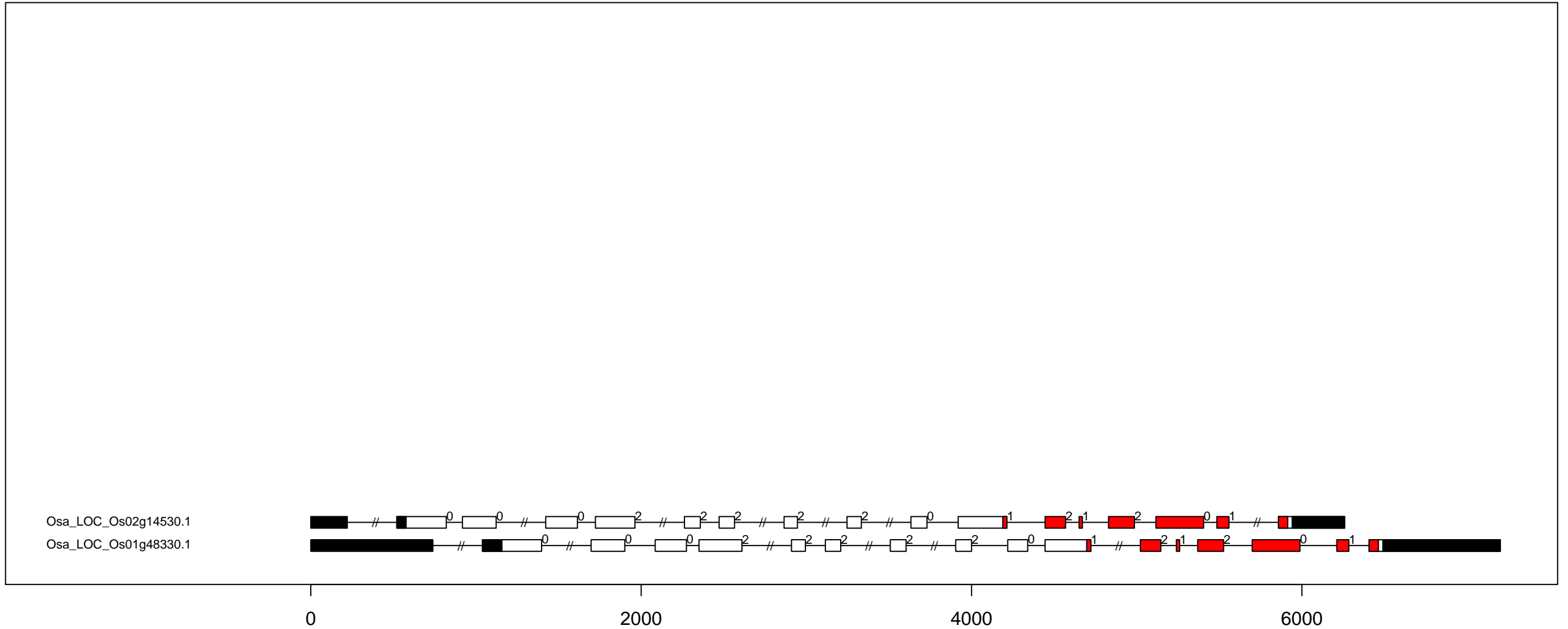

O.sa TKL_CTR1-DRK-2 exon-intron and kinase domain diagram (all)

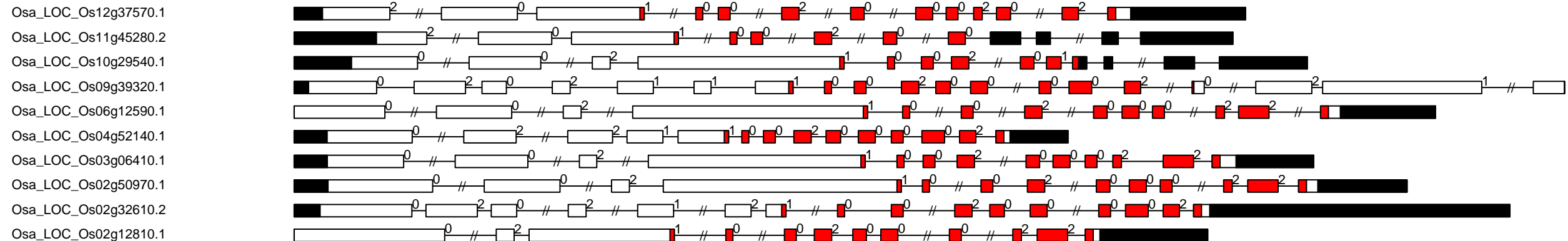

0

2000

4000

6000

O.sa TKL_Gdt exon-intron and kinase domain diagram (all)

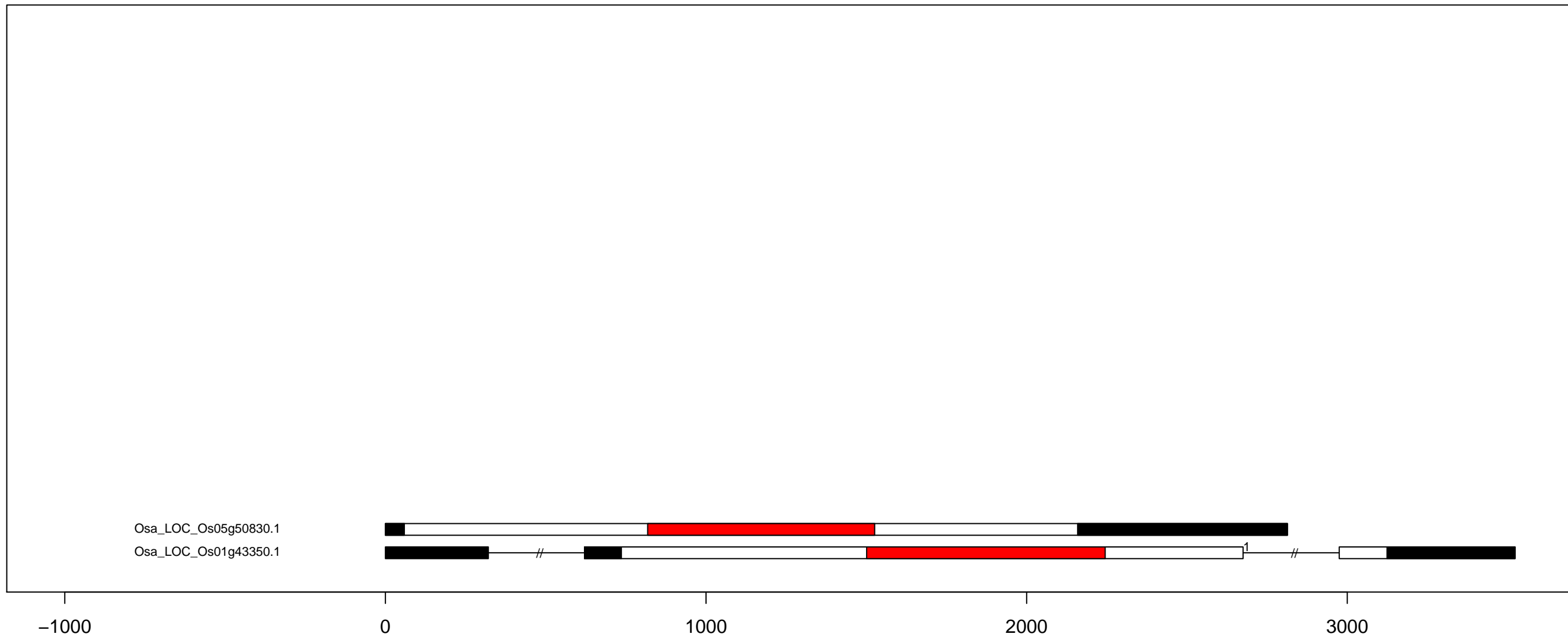

O.sa TKL-PI-1 exon-intron and kinase domain diagram (all)

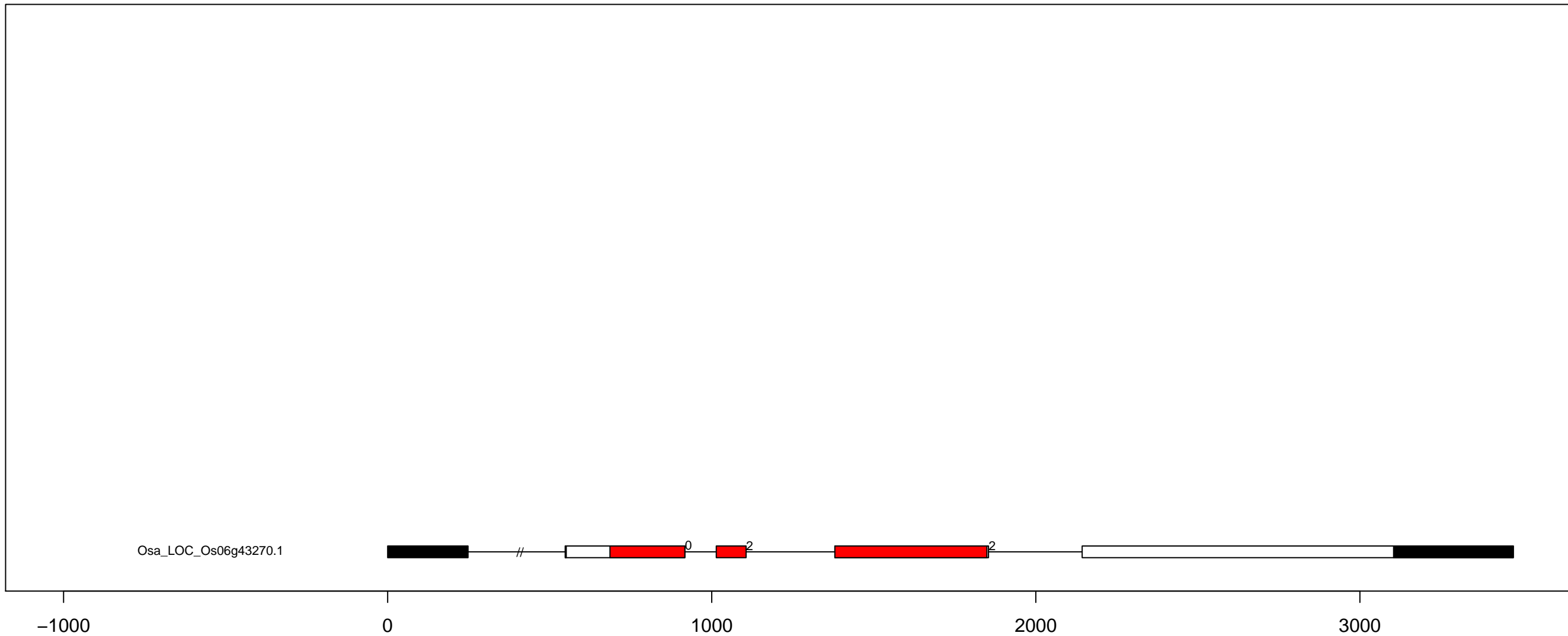

O.sa TKL-PI-2 exon-intron and kinase domain diagram (all)

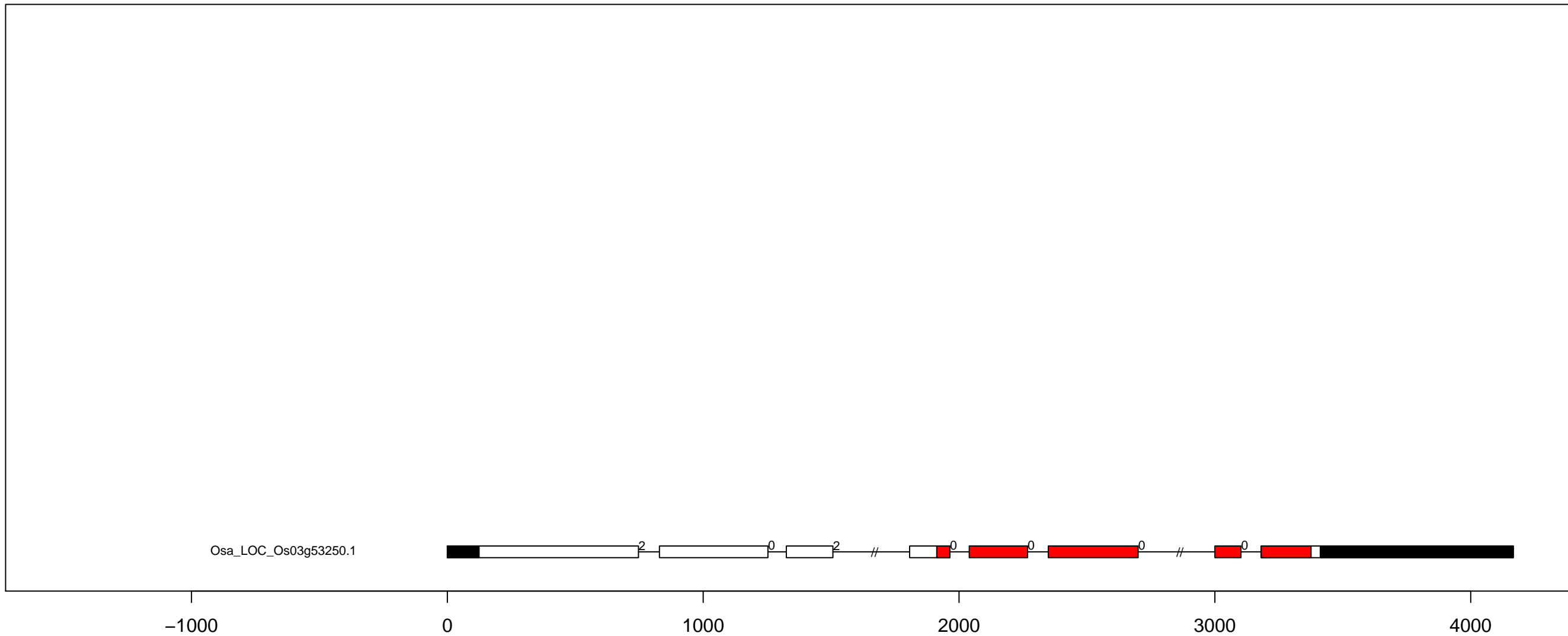

O.sa TKL-PI-4 exon-intron and kinase domain diagram (part 1)

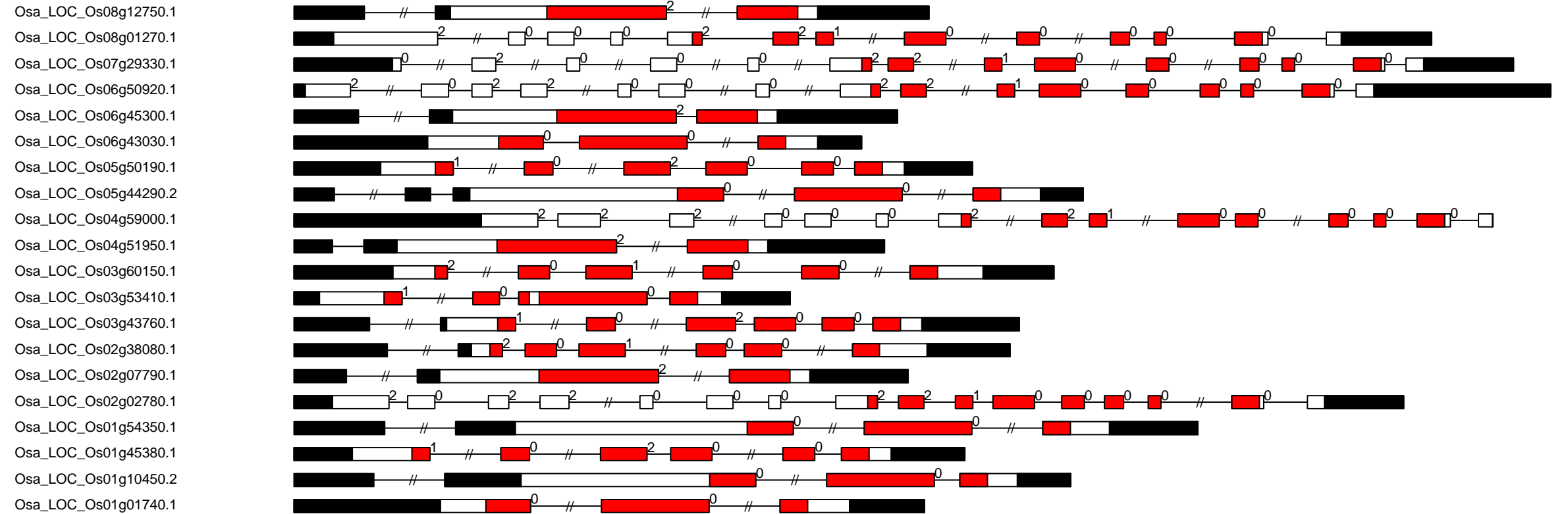

O.sa TKL-PI-4 exon-intron and kinase domain diagram (part 2)

Osa_LOC_Os12g30570.1

Osa_LOC_Os07g10400.1

Osa_LOC_Os03g39150.1

Osa_LOC_Os12g41260.1

Osa_LOC_Os12g06670.1

Osa_LOC_Os09g37230.1

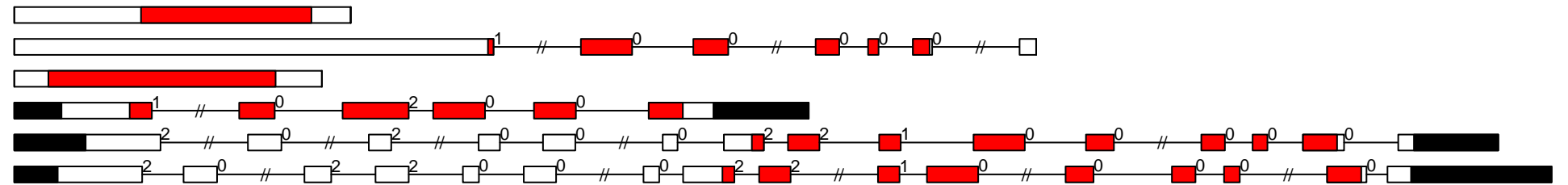

-1000

0

1000

2000

3000

4000

5000

O.sa TKL-PI-5 exon-intron and kinase domain diagram (all)

Osa_LOC_Os07g43900.1
 Osa_LOC_Os02g39560.1
 Osa_LOC_Os01g66860.2
 Osa_LOC_Os01g54480.1

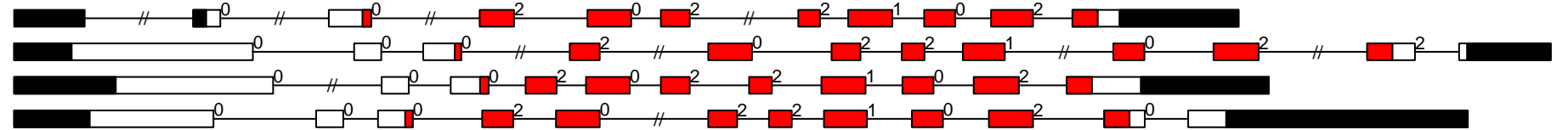

-1000

0

1000

2000

3000

4000

O.sa TKL-PI-6 exon-intron and kinase domain diagram (all)

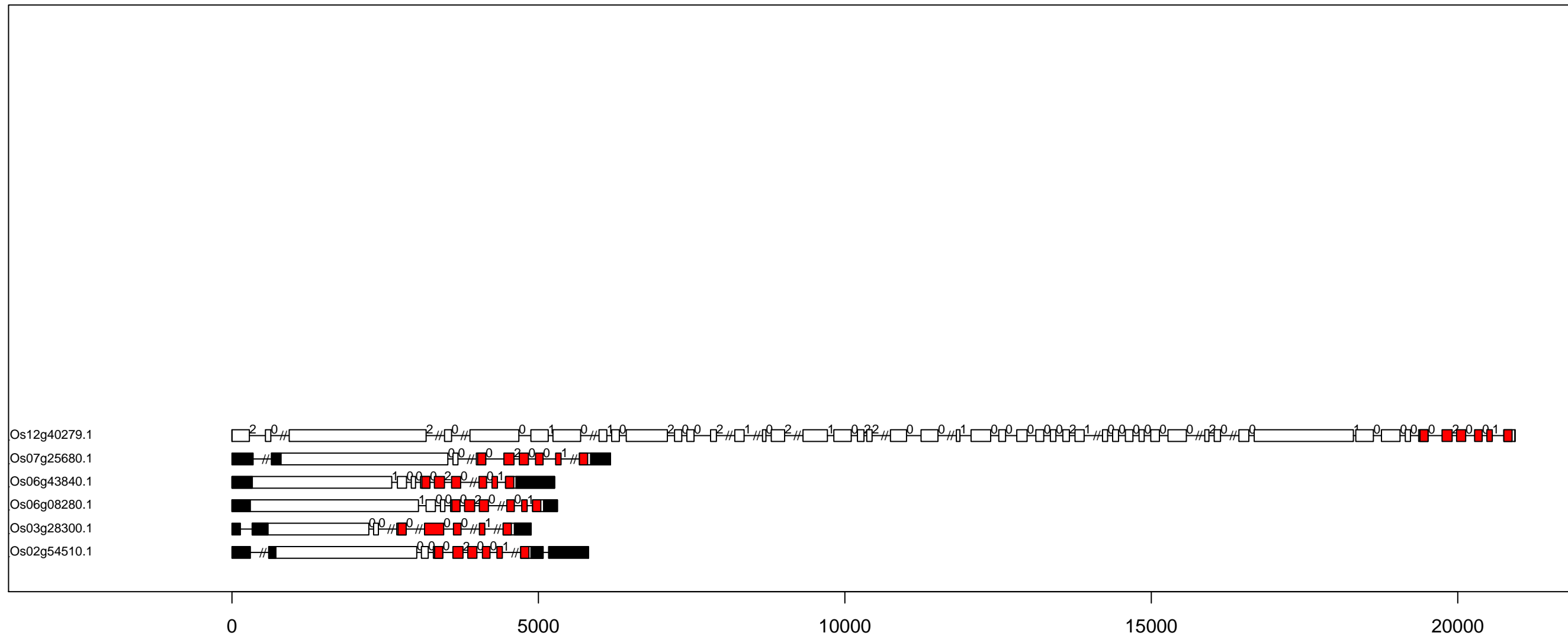

O.sa TKL-PI-7 exon-intron and kinase domain diagram (all)

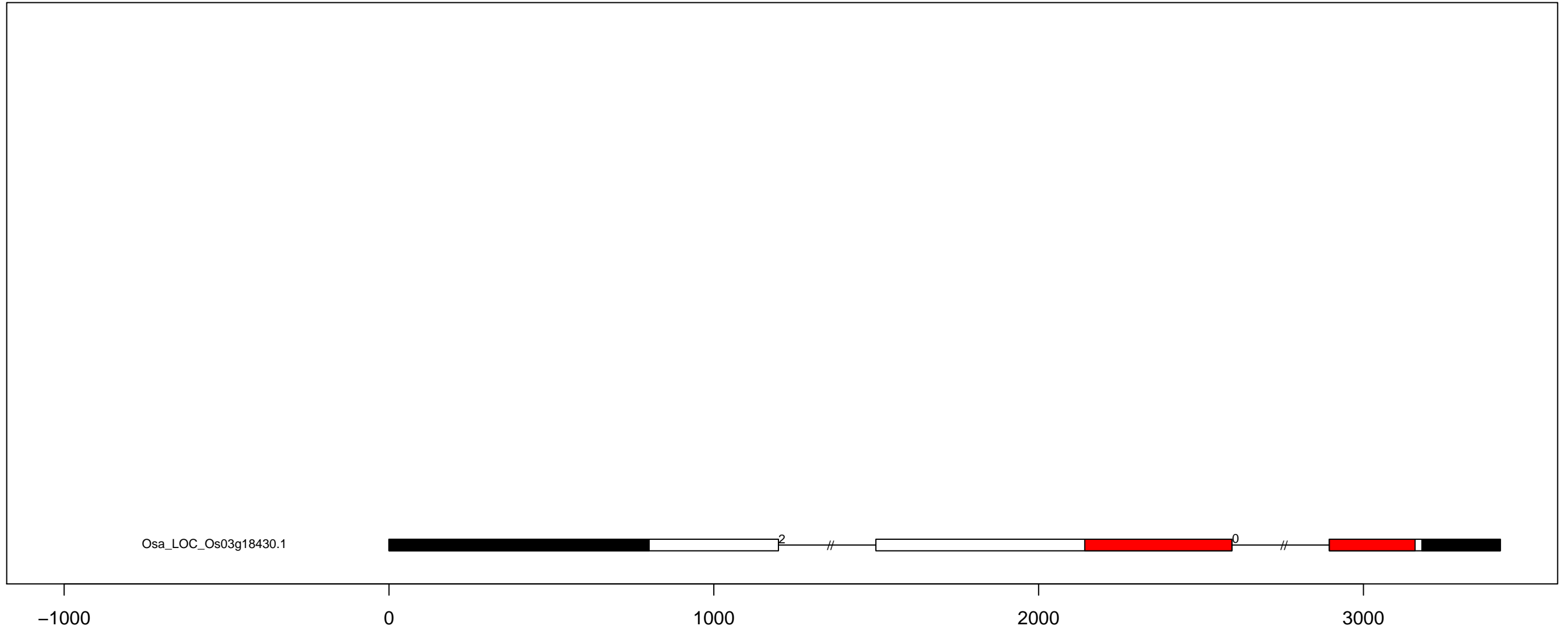

O.sa TKL-PI-8 exon-intron and kinase domain diagram (all)

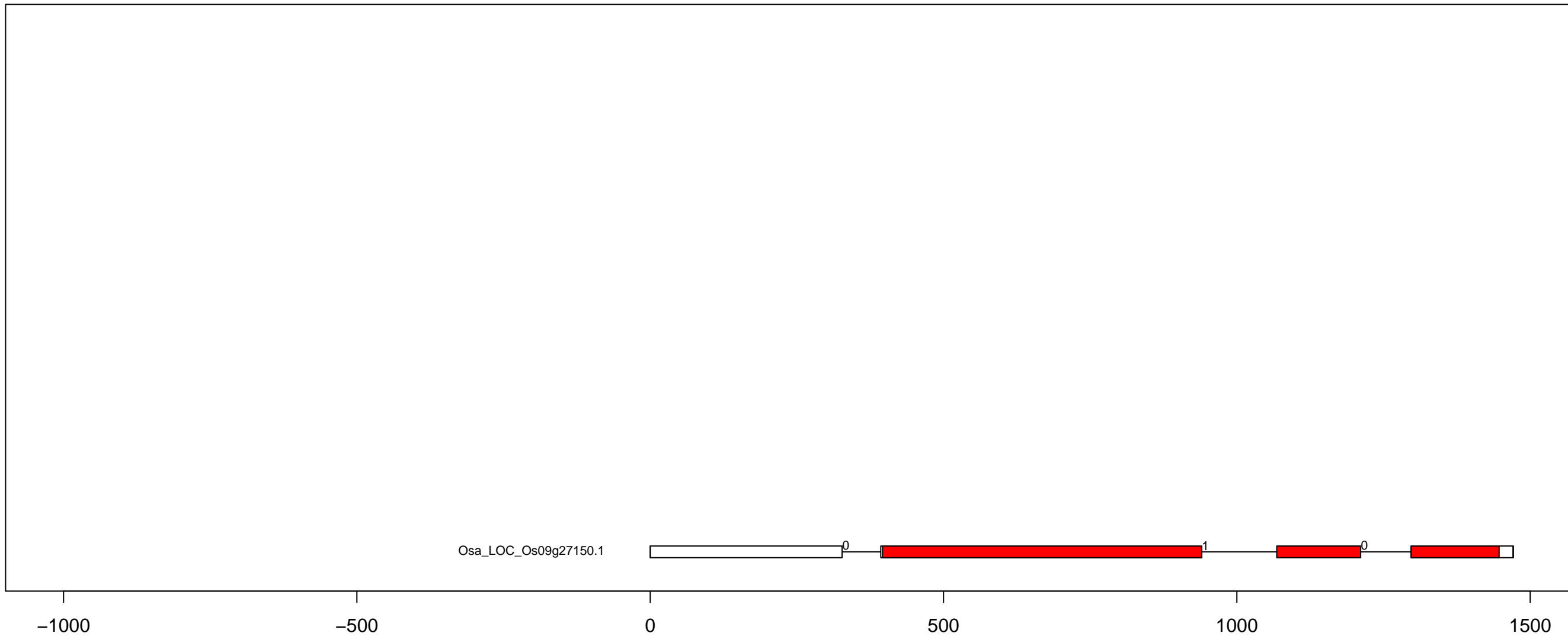

O.sa TLK exon-intron and kinase domain diagram (all)

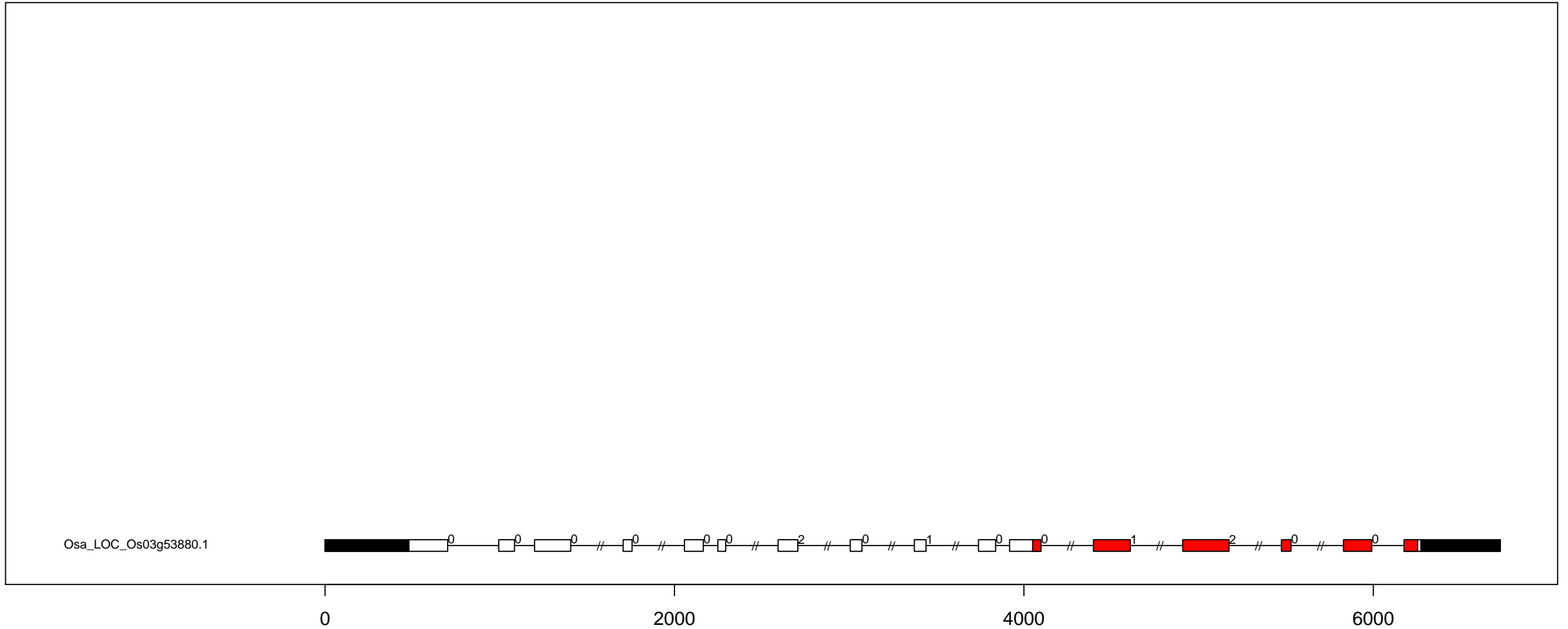

O.sa TTK exon-intron and kinase domain diagram (all)

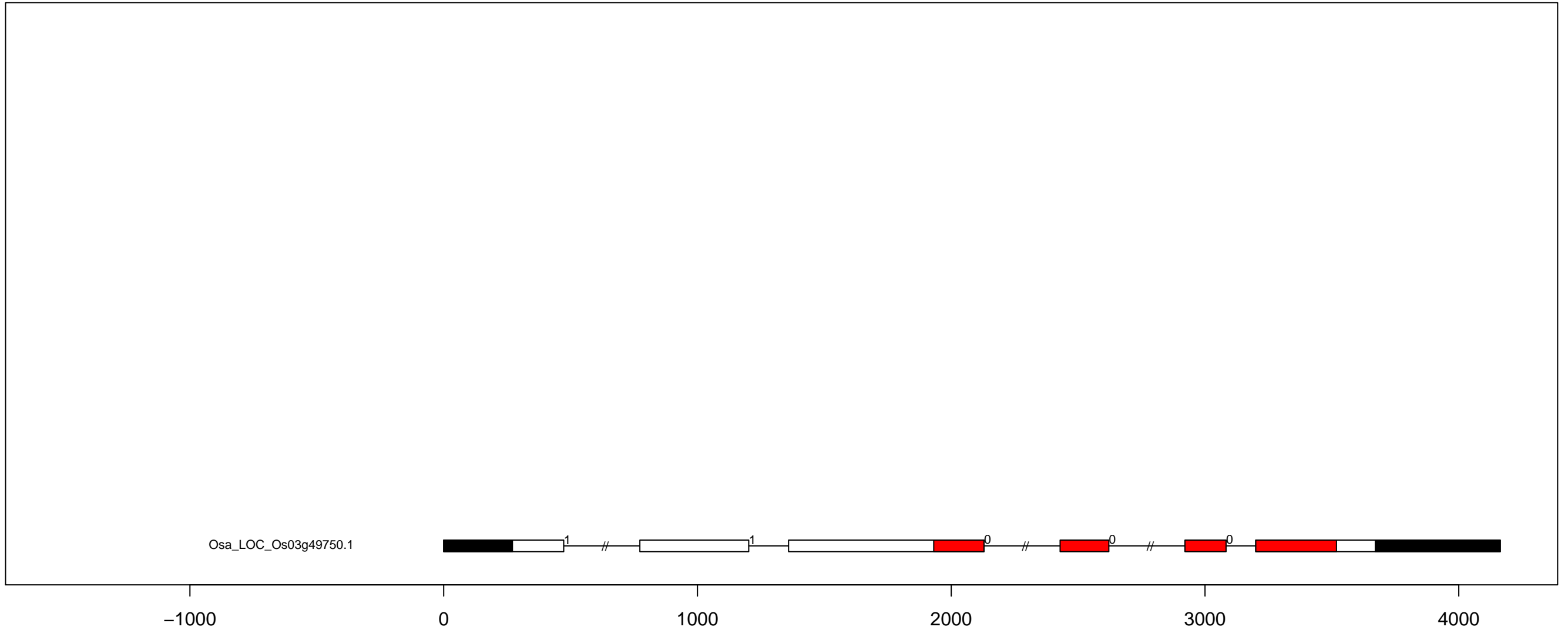

O.sa ULK_Fused exon-intron and kinase domain diagram (all)

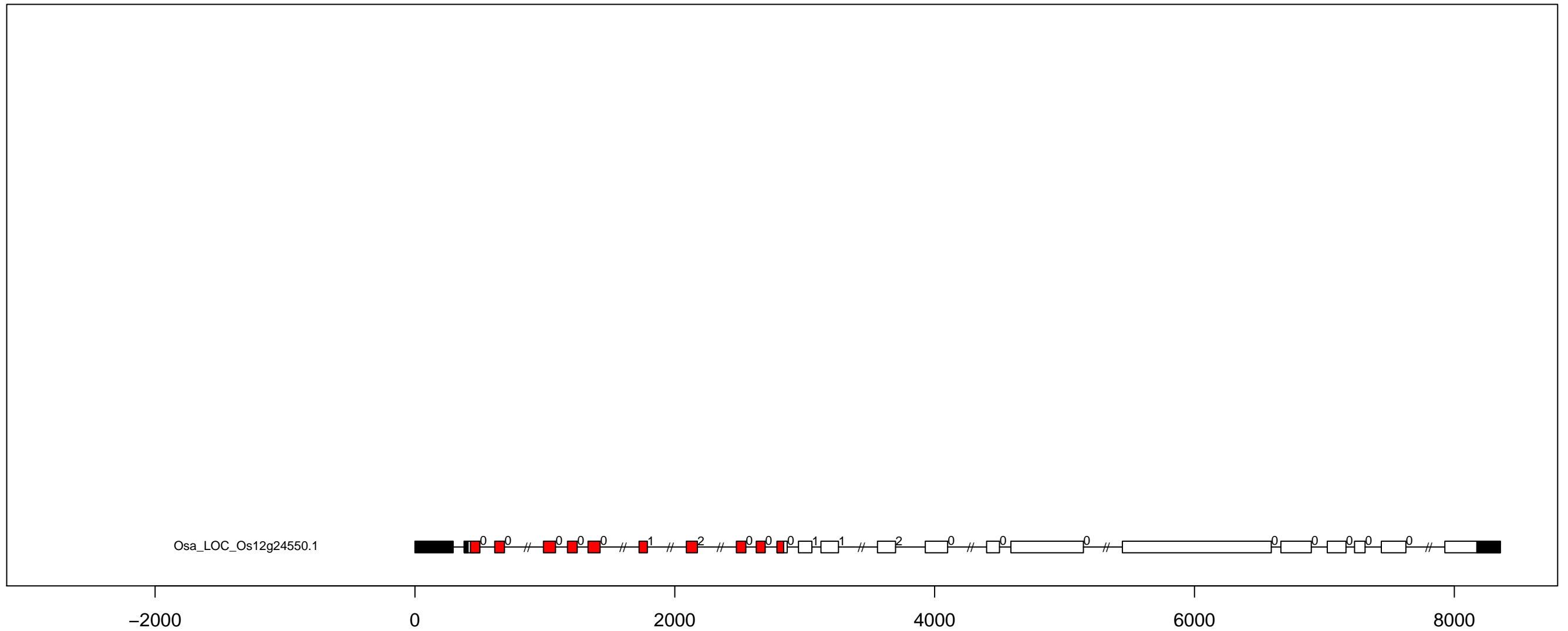

O.sa ULK_ULK4 exon-intron and kinase domain diagram (all)

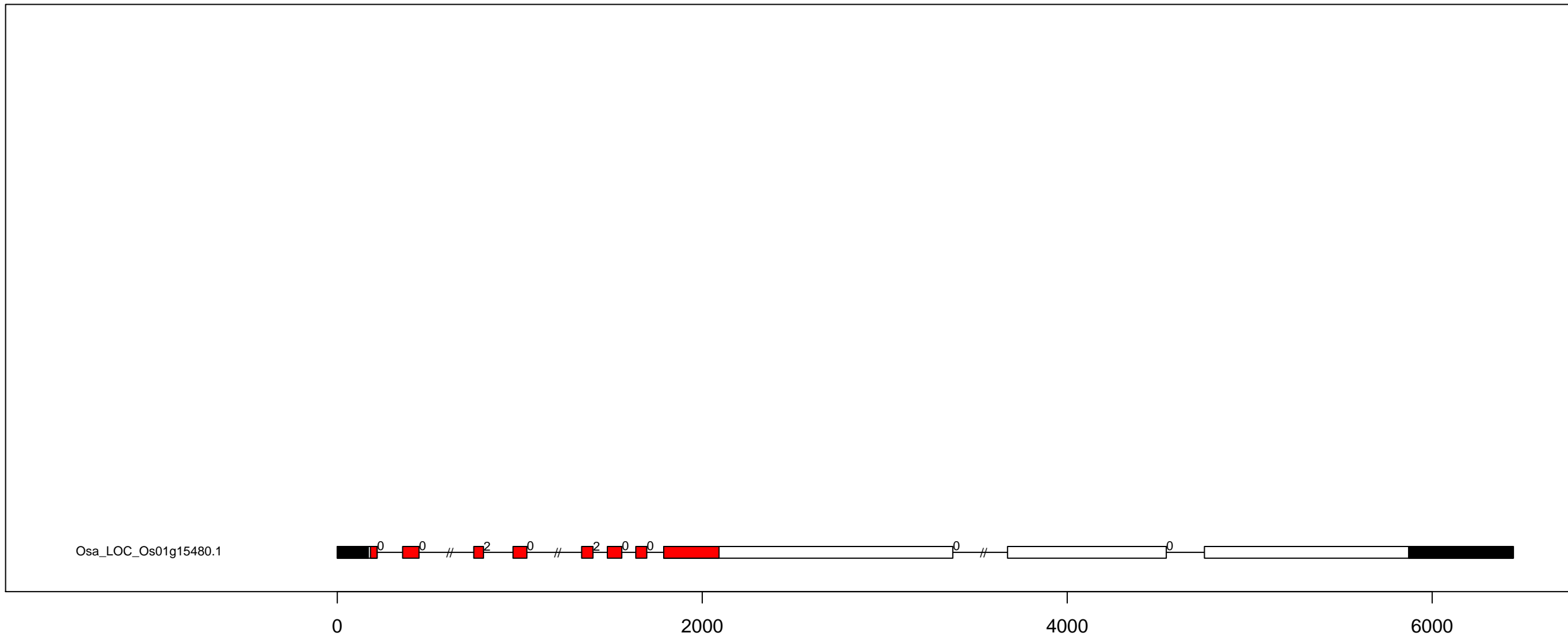

O.sa WEE exon-intron and kinase domain diagram (all)

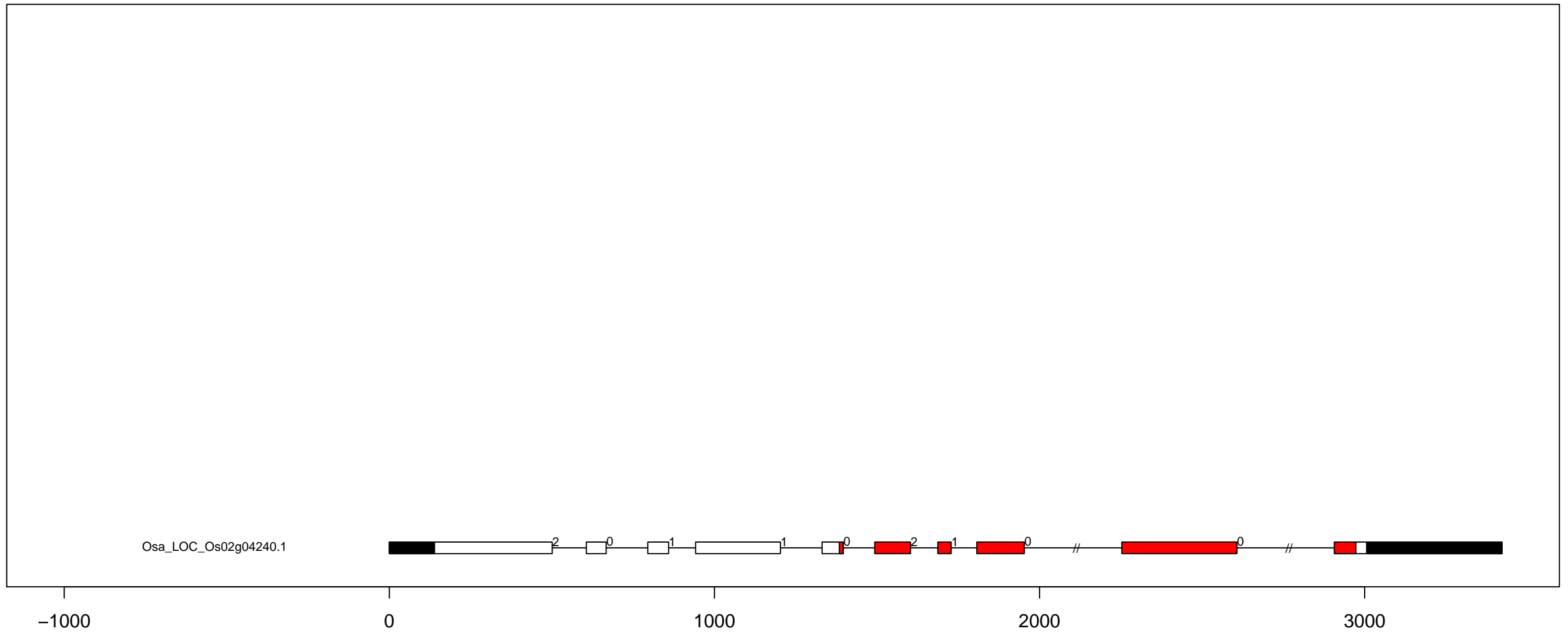

O.sa WNK_NRBP exon-intron and kinase domain diagram (all)

Osa_LOC_Os11g02305.1
 Osa_LOC_Os12g06490.1
 Osa_LOC_Os12g02250.1
 Osa_LOC_Os11g06140.1
 Osa_LOC_Os07g39520.1
 Osa_LOC_Os07g38530.1
 Osa_LOC_Os07g08750.1
 Osa_LOC_Os05g01780.1
 Osa_LOC_Os02g45130.1

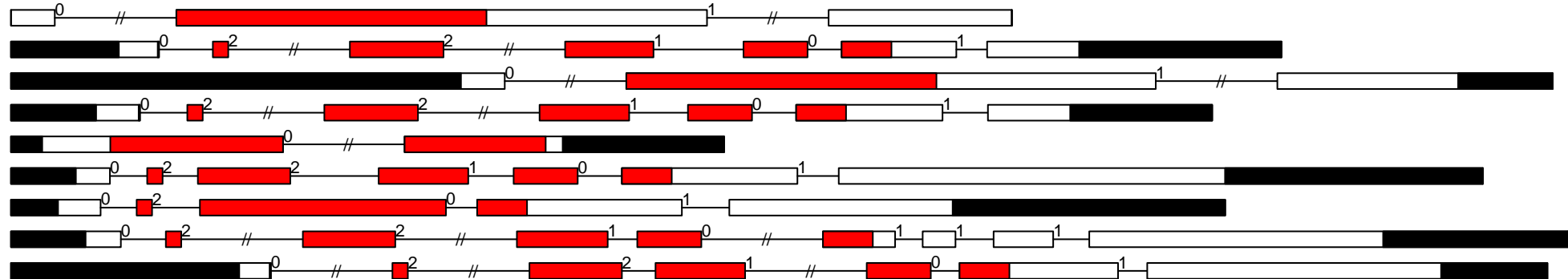

-1000

0

1000

2000

3000

4000

S.mo AGC_MAST exon-intron and kinase domain diagram (all)

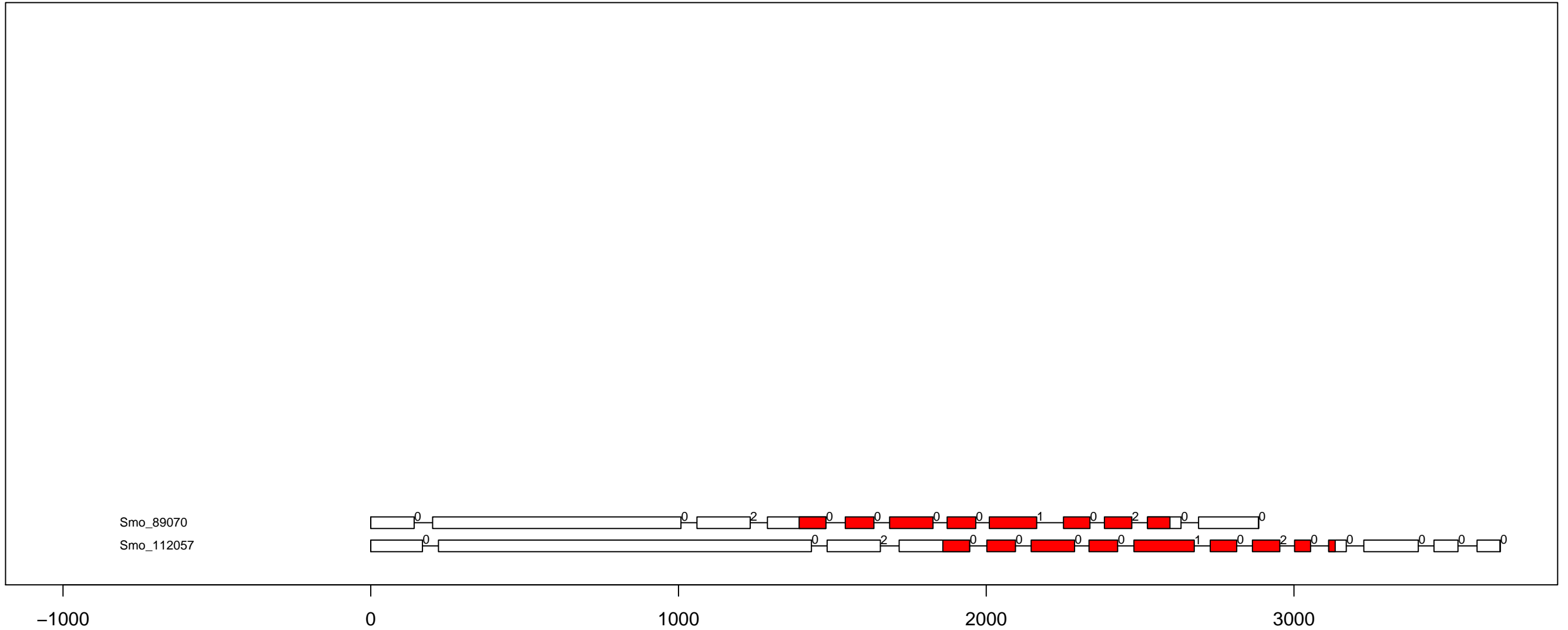

S.mo AGC_NDR exon-intron and kinase domain diagram (all)

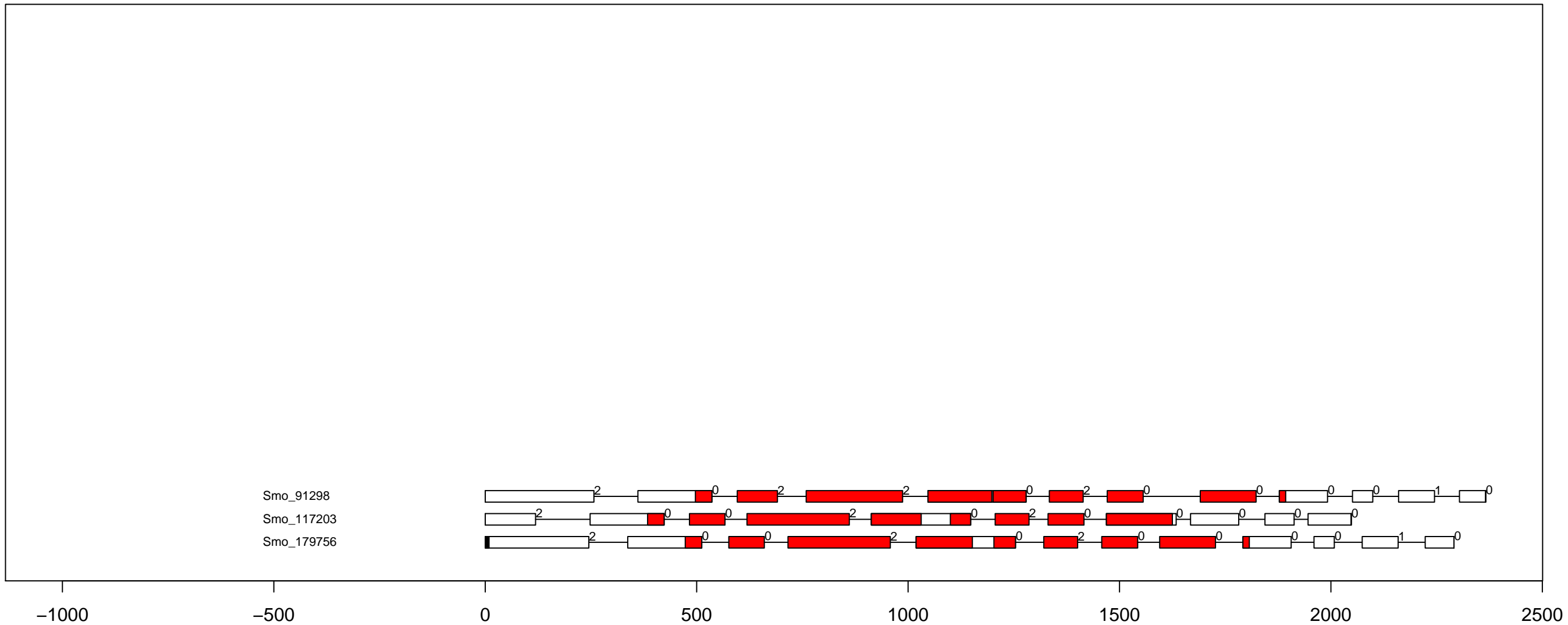

S.mo AGC_PDK1 exon-intron and kinase domain diagram (all)

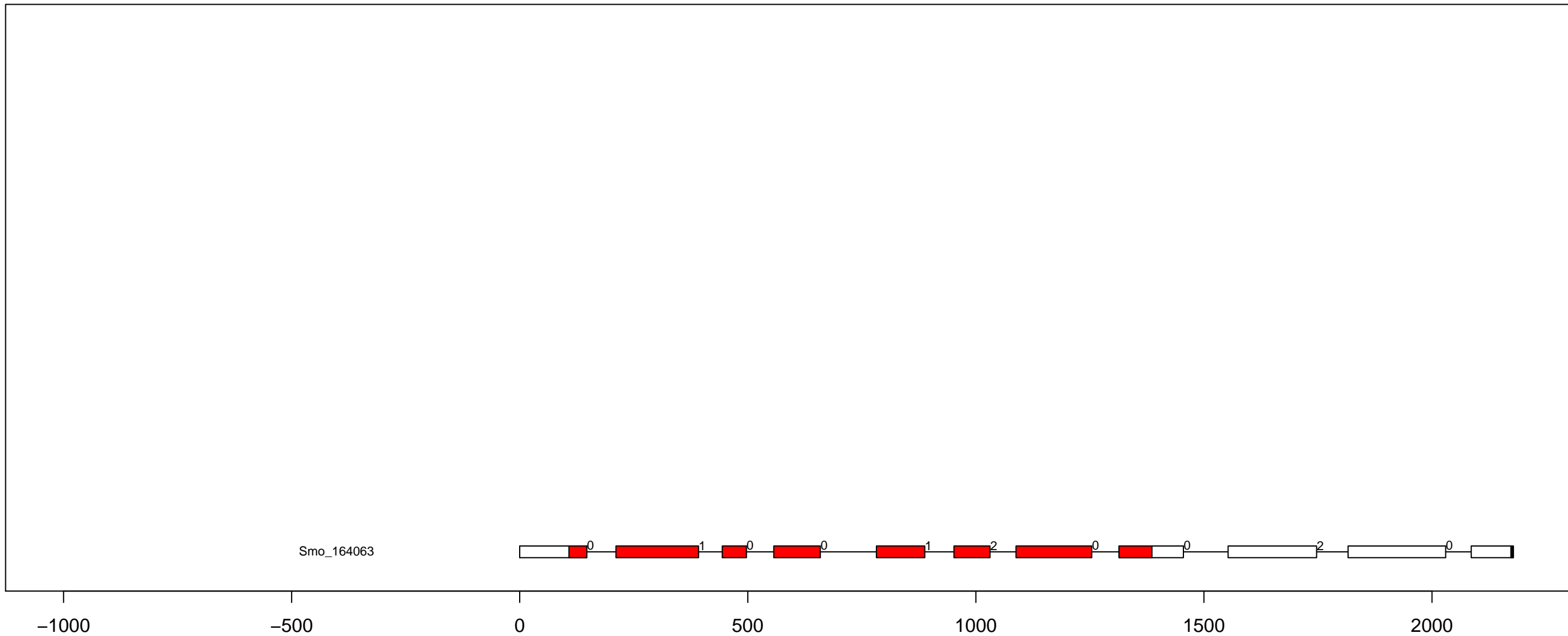

S.mo AGC_PKA-PKG exon-intron and kinase domain diagram (all)

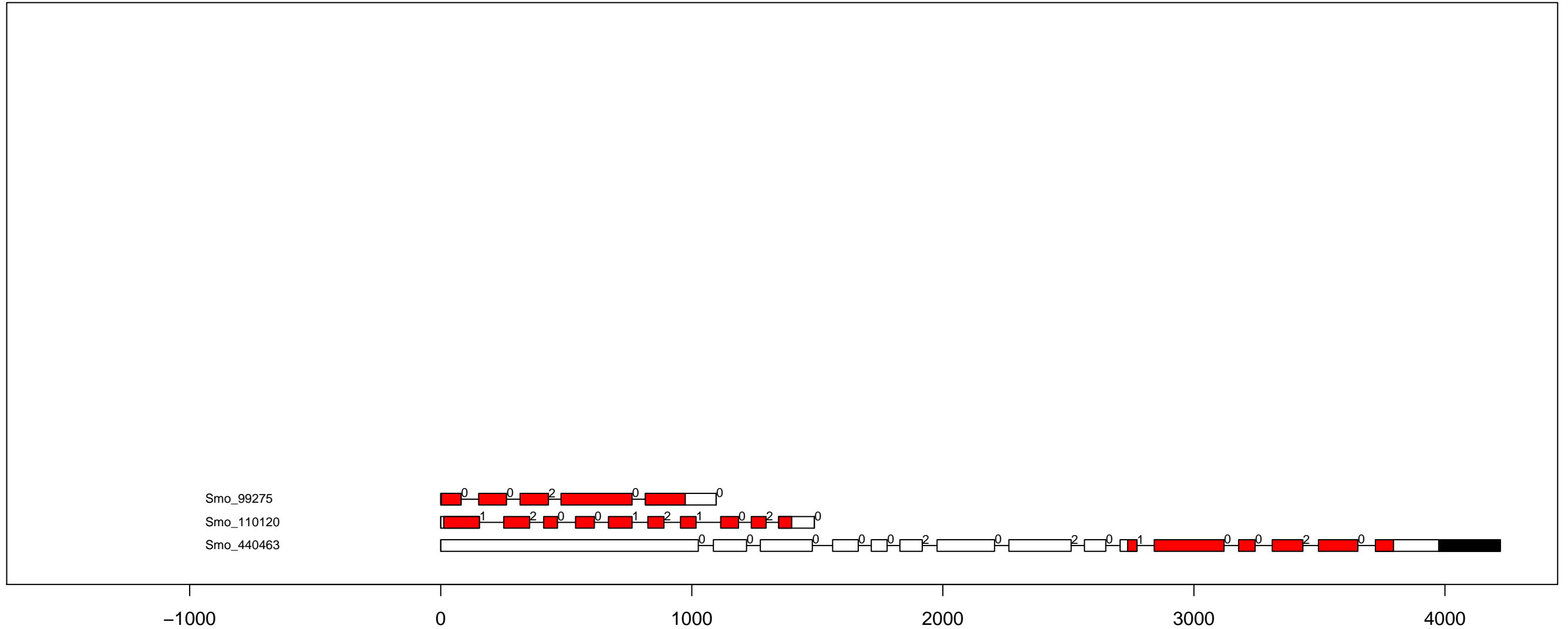

S.mo AGC_RSK-2 exon-intron and kinase domain diagram (all)

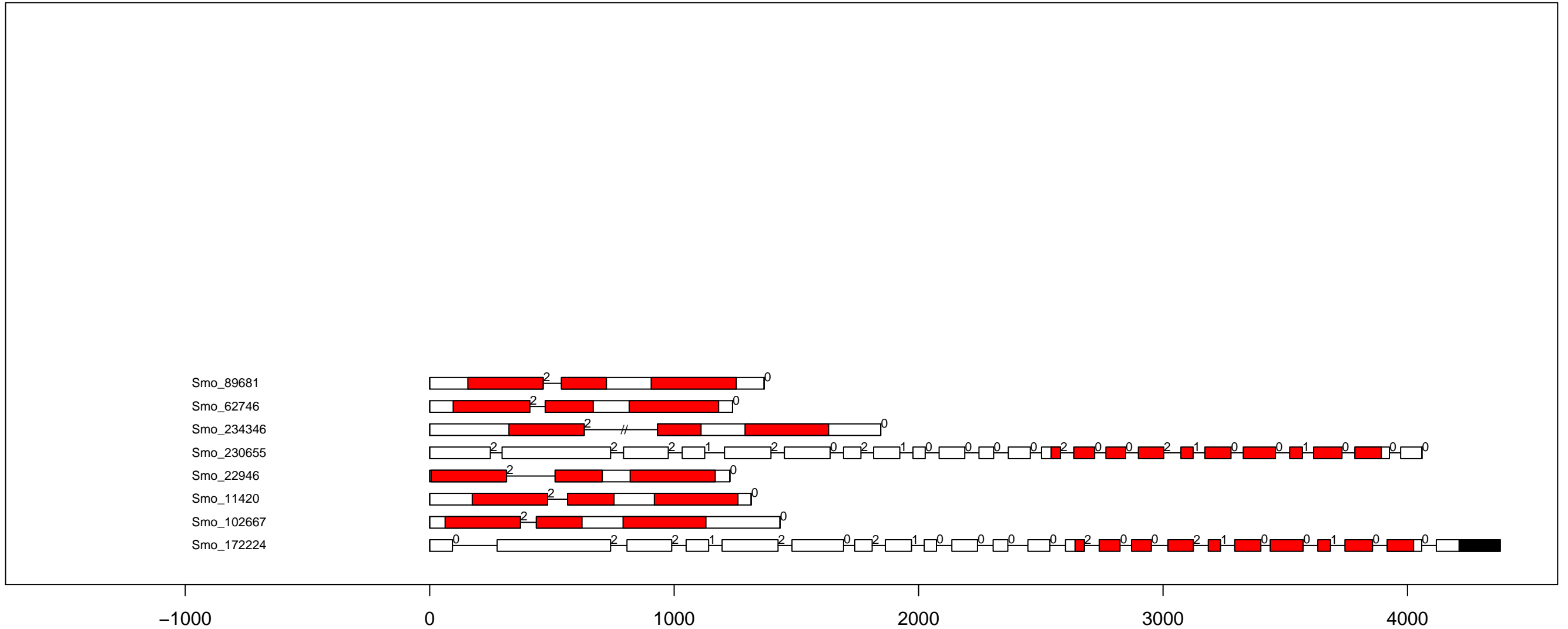

S.mo AGC-PI exon-intron and kinase domain diagram (all)

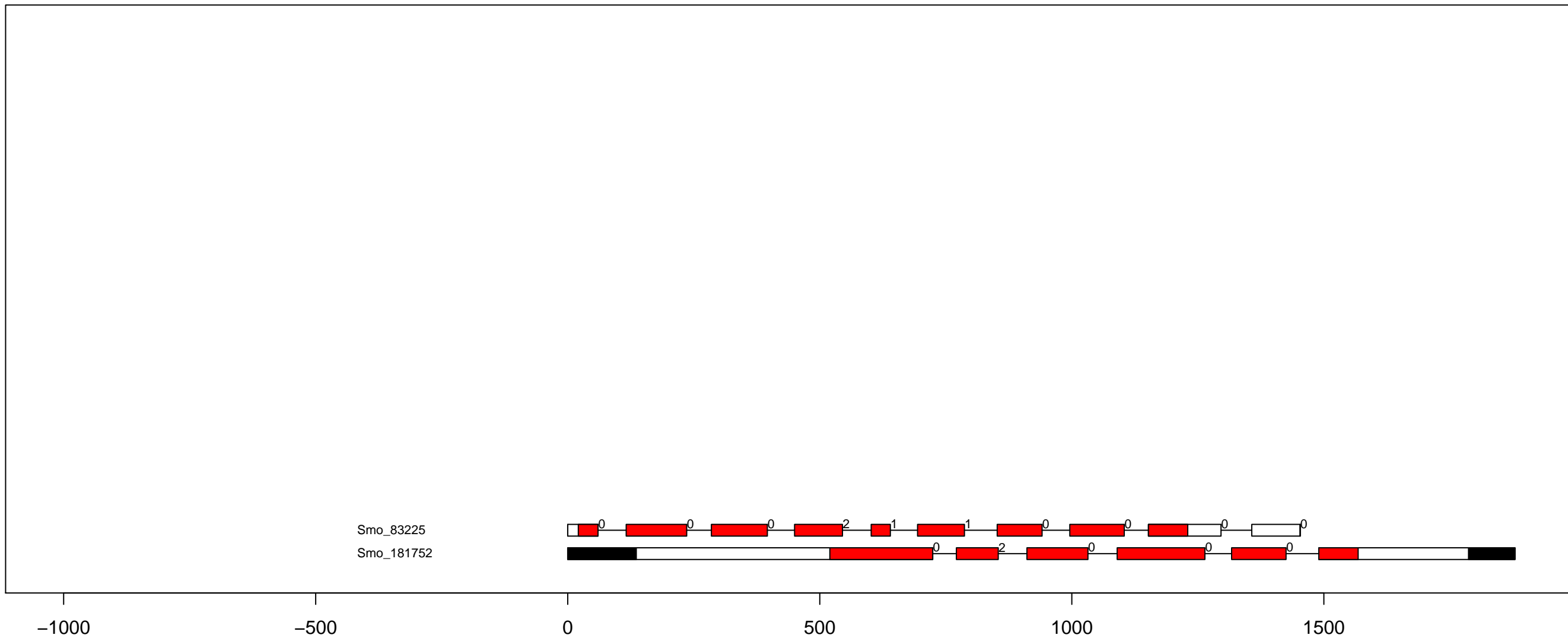

S.mo AurL-Cr-1 exon-intron and kinase domain diagram (all)

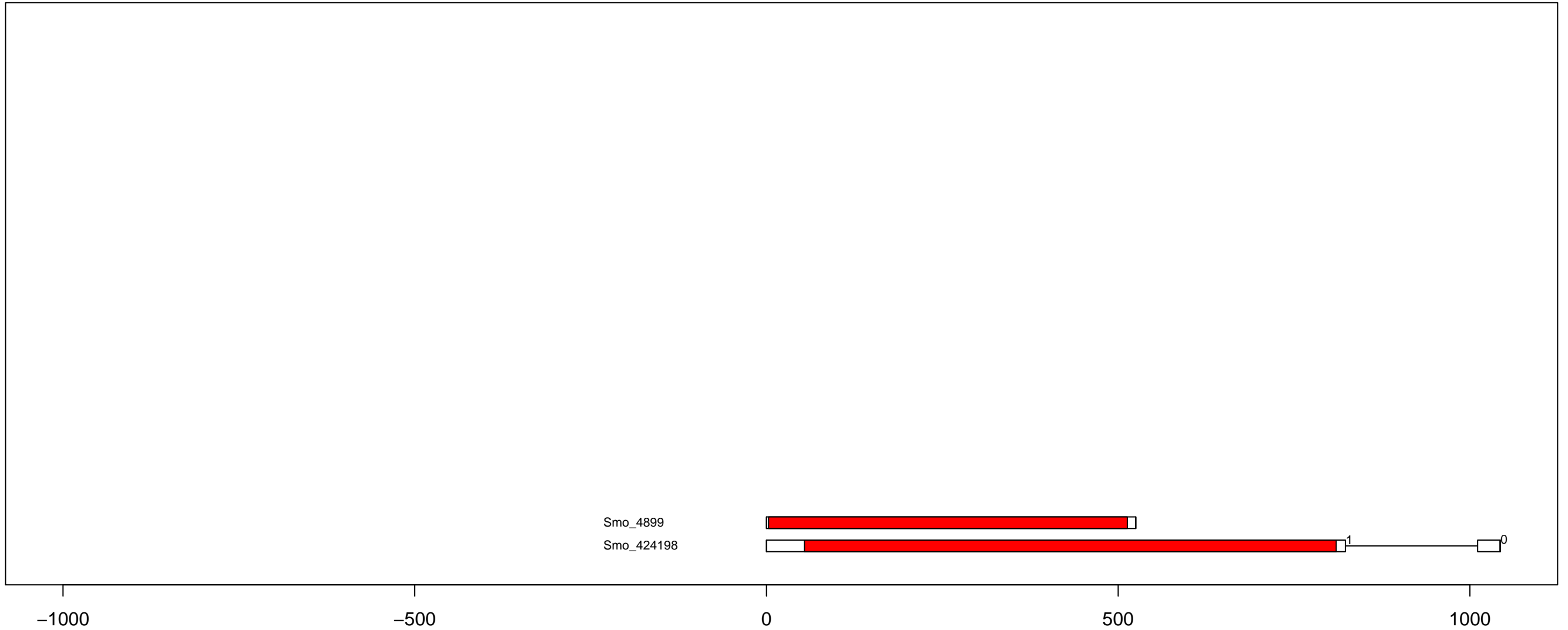

S.mo Aur exon-intron and kinase domain diagram (all)

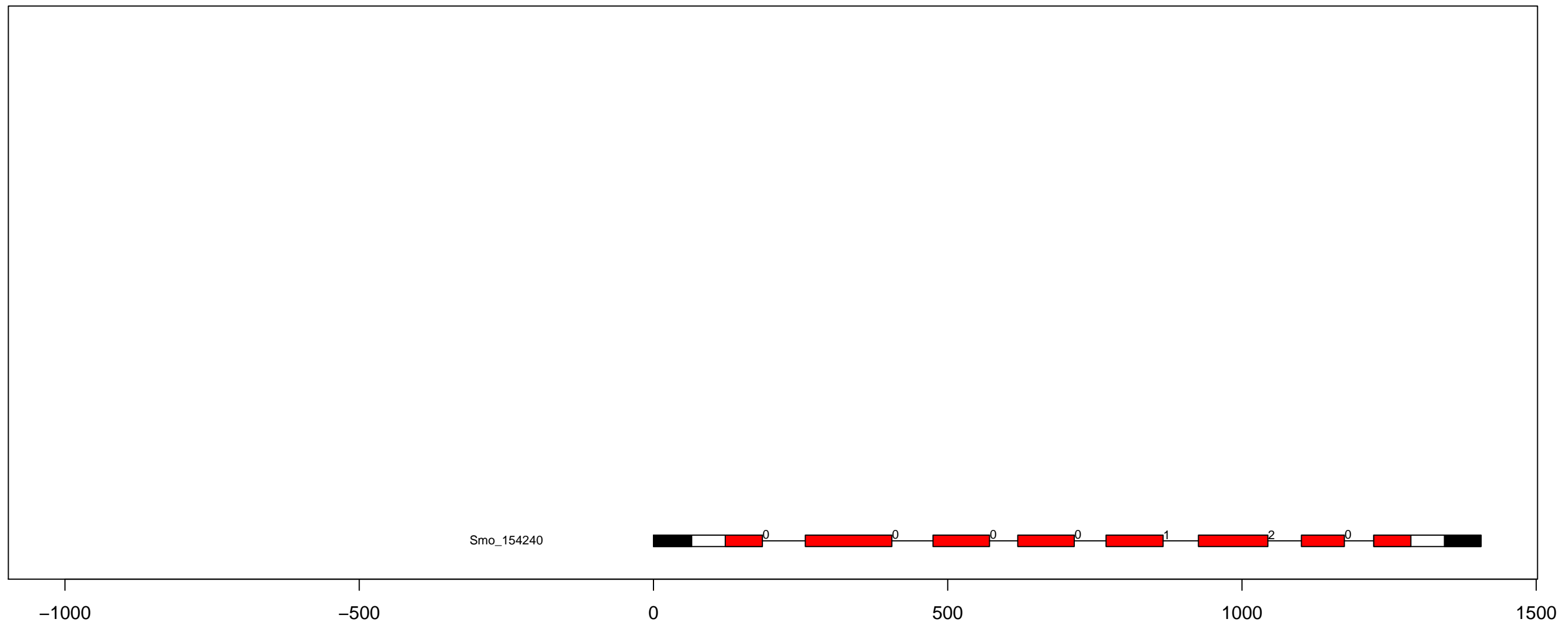

S.mo CAMK_AMPK exon-intron and kinase domain diagram (all)

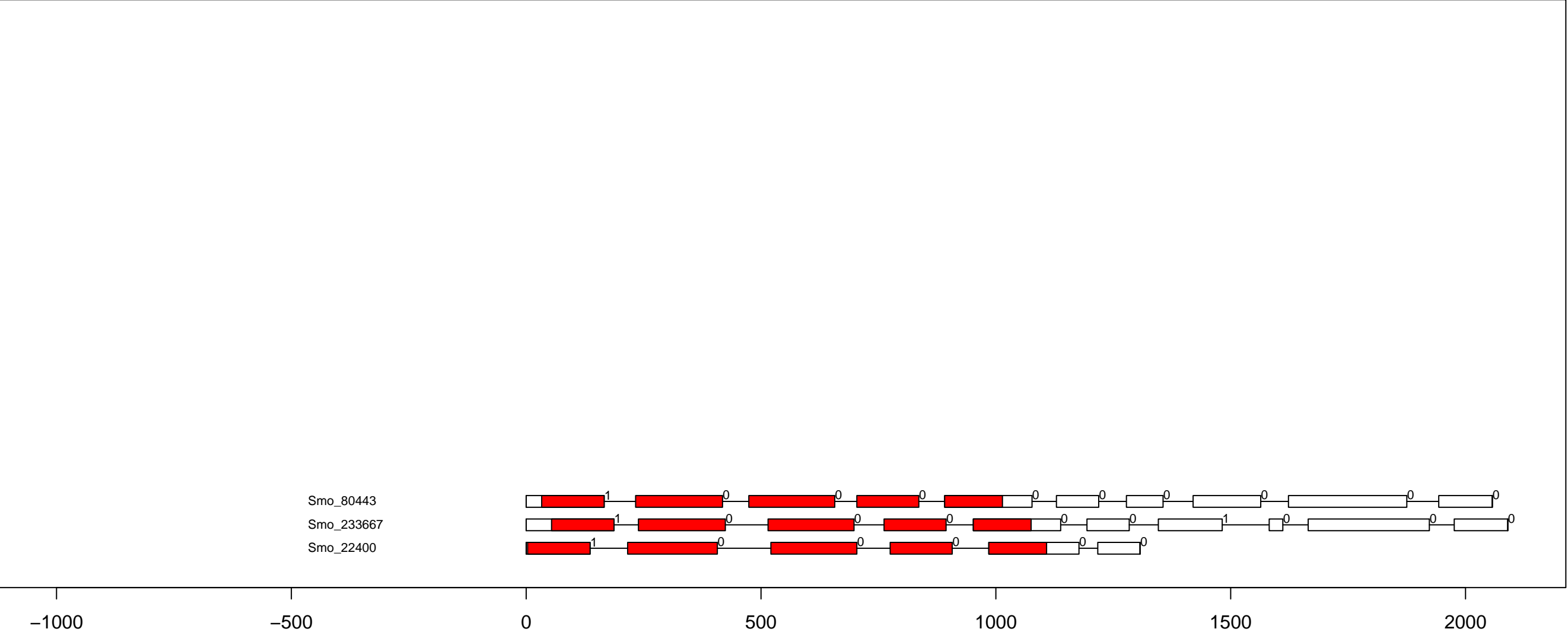

S.mo CAMK_CAMK1-DCAMKL exon-intron and kinase domain diagram (all)

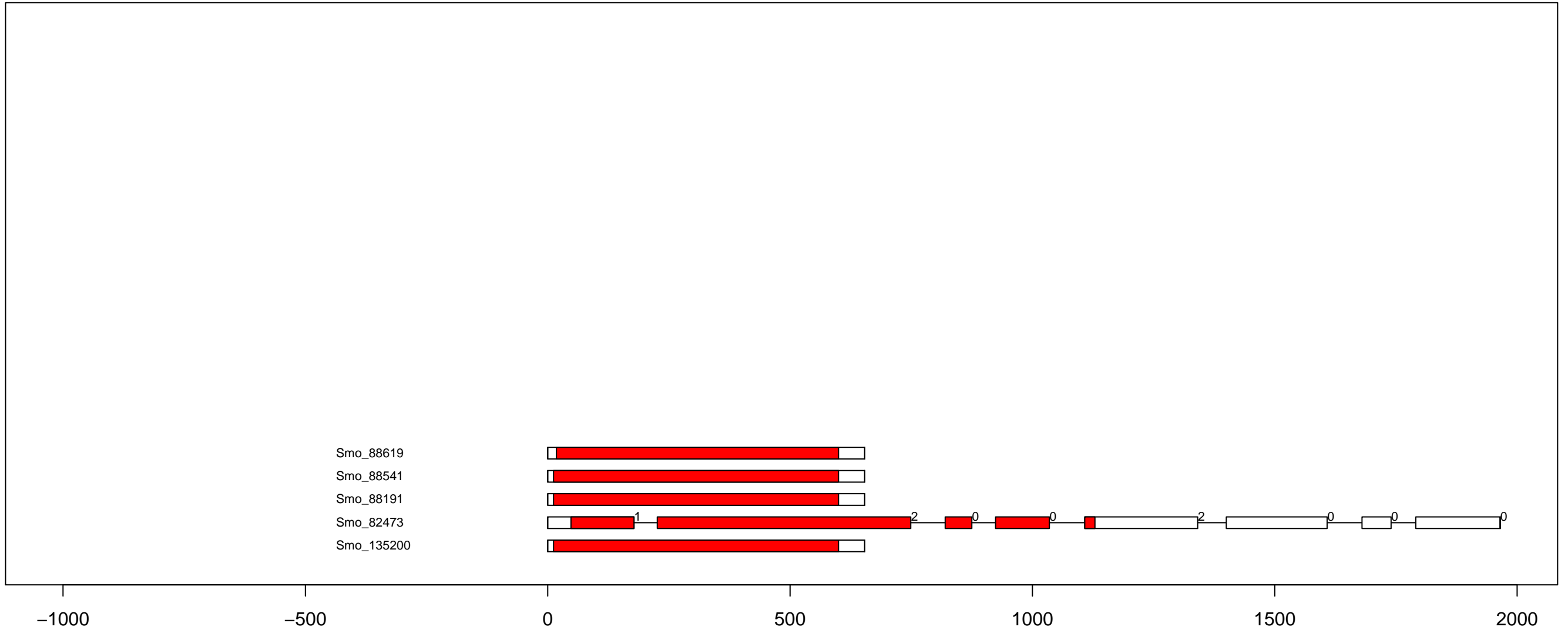

S.mo CAMK_CAMK1-Tthe exon-intron and kinase domain diagram (all)

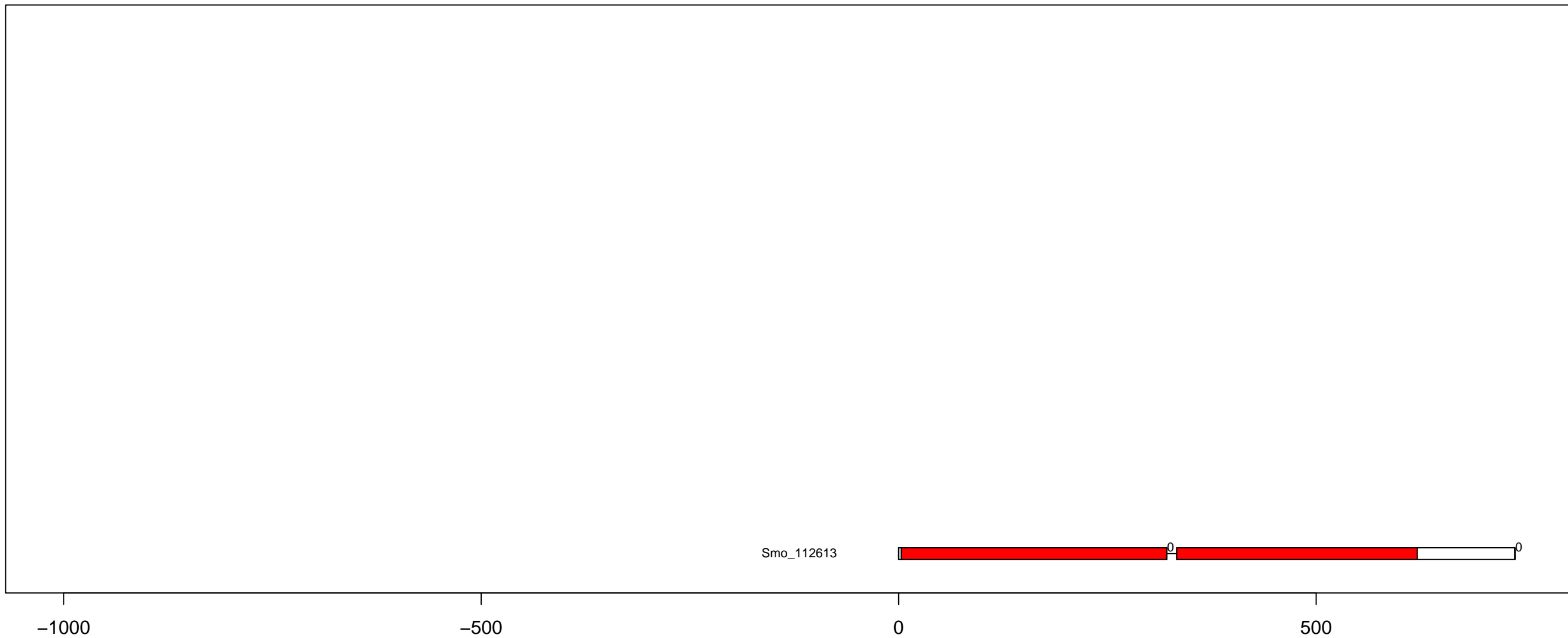

S.mo CAMK_CAMKL-CHK1 exon-intron and kinase domain diagram (all)

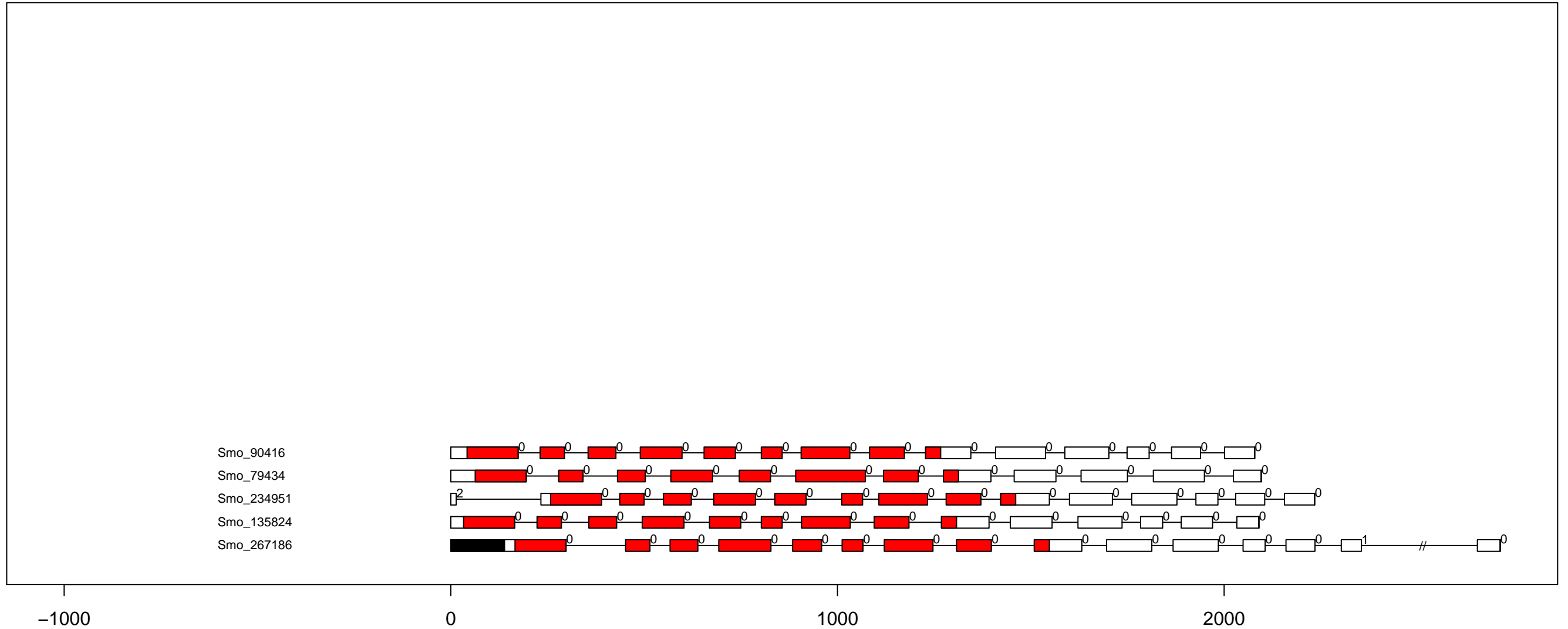

S.mo CAMK_CAMKL-LKB exon-intron and kinase domain diagram (all)

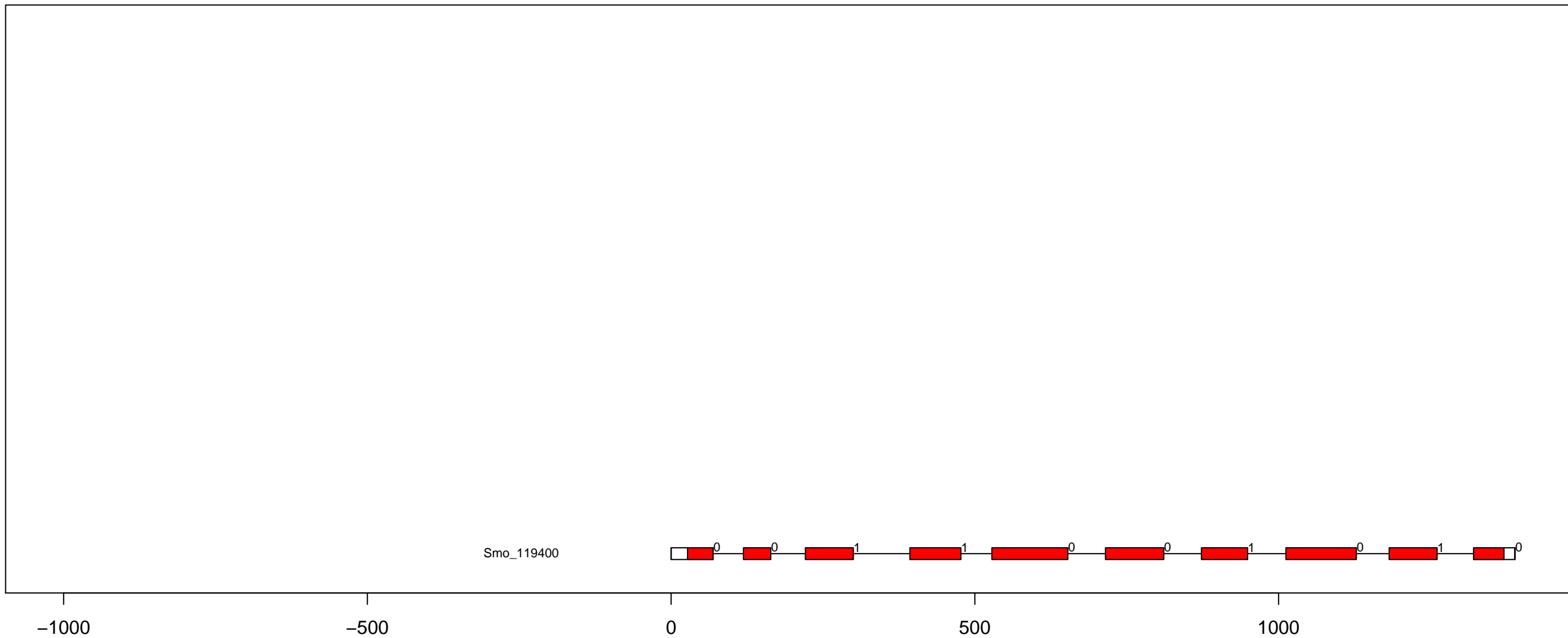

S.mo CAMK_CDPK exon-intron and kinase domain diagram (part 1)

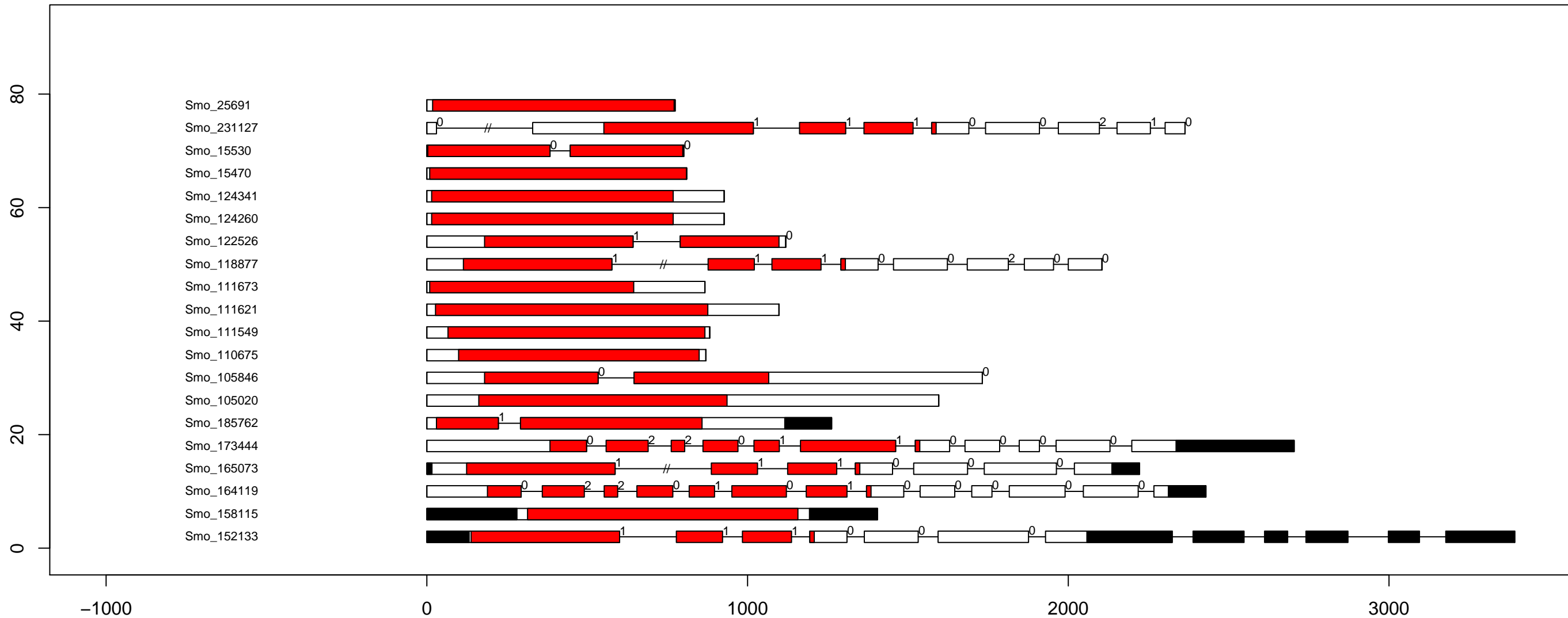

S.mo CAMK_CDPK exon-intron and kinase domain diagram (part 2)

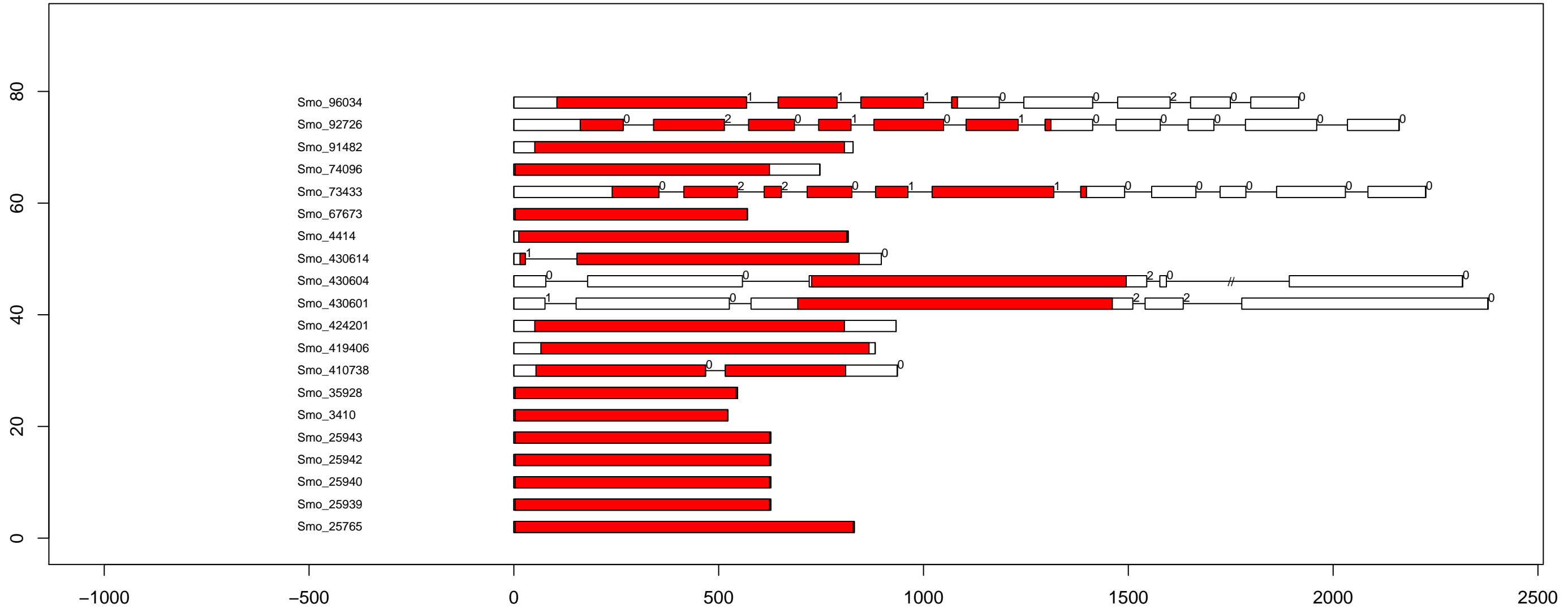

S.mo CAMK_OST1L exon-intron and kinase domain diagram (all)

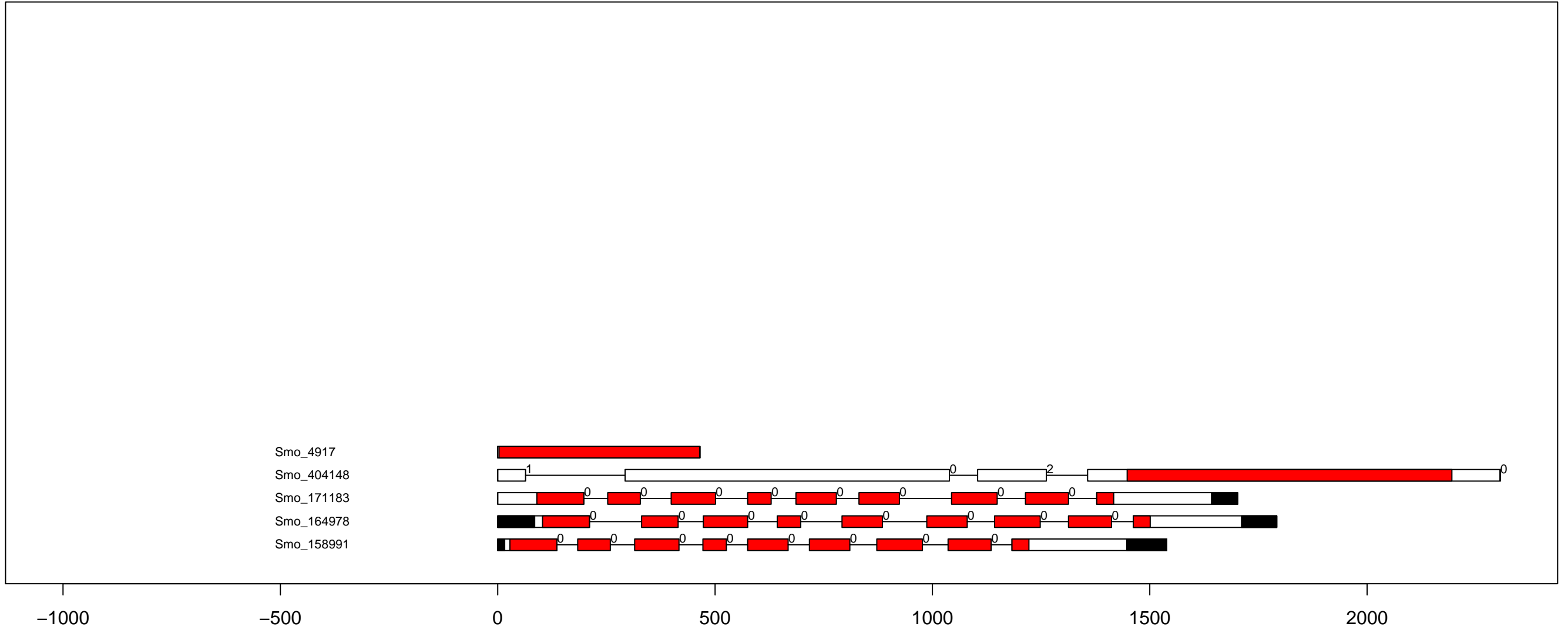

S.mo CK1_CK1-PI exon-intron and kinase domain diagram (all)

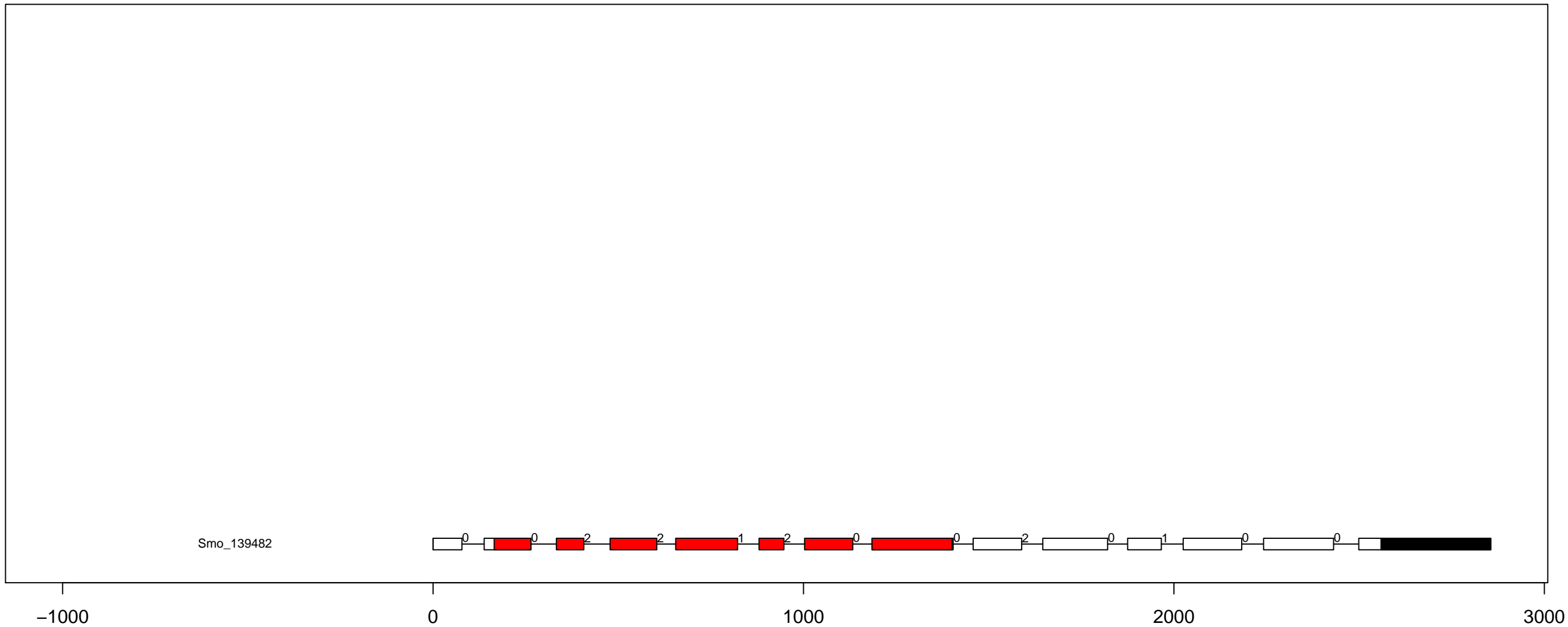

S.mo CMGC_CDK-CCRK exon-intron and kinase domain diagram (all)

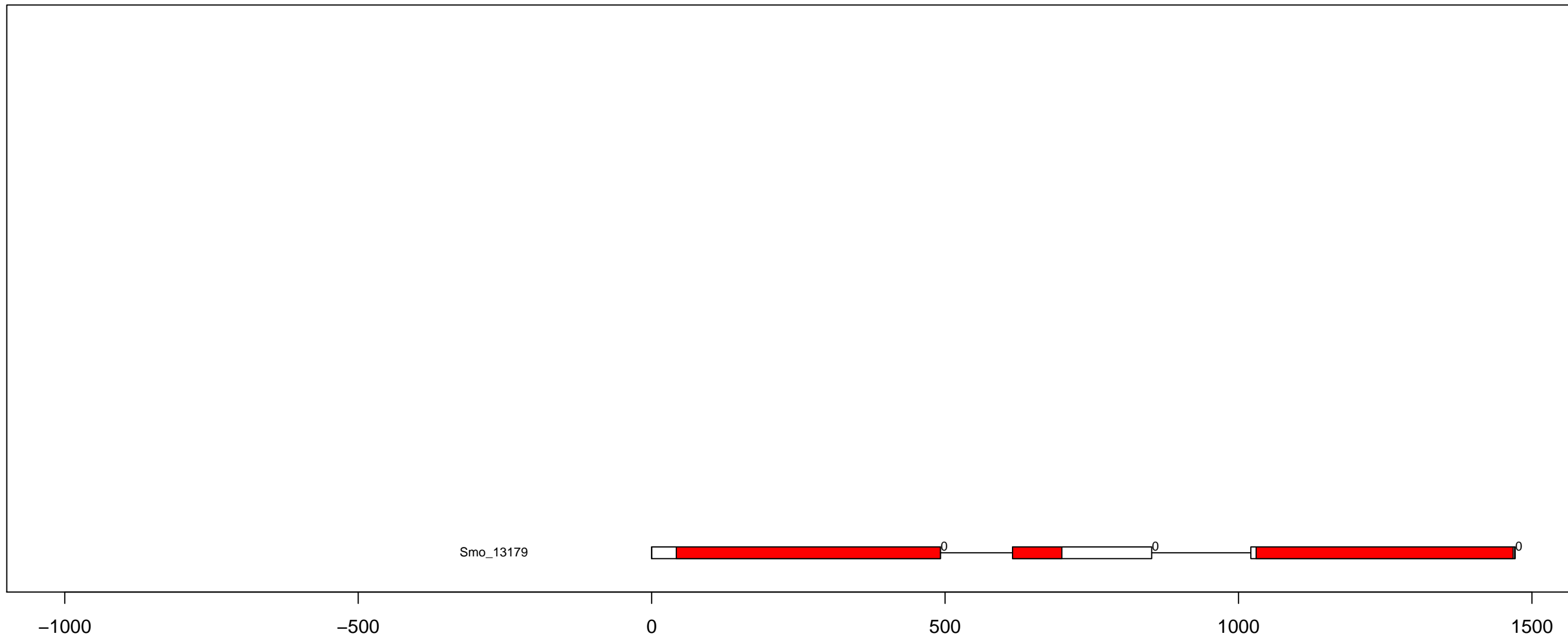

S.mo CMGC_CDK-CDK7 exon-intron and kinase domain diagram (all)

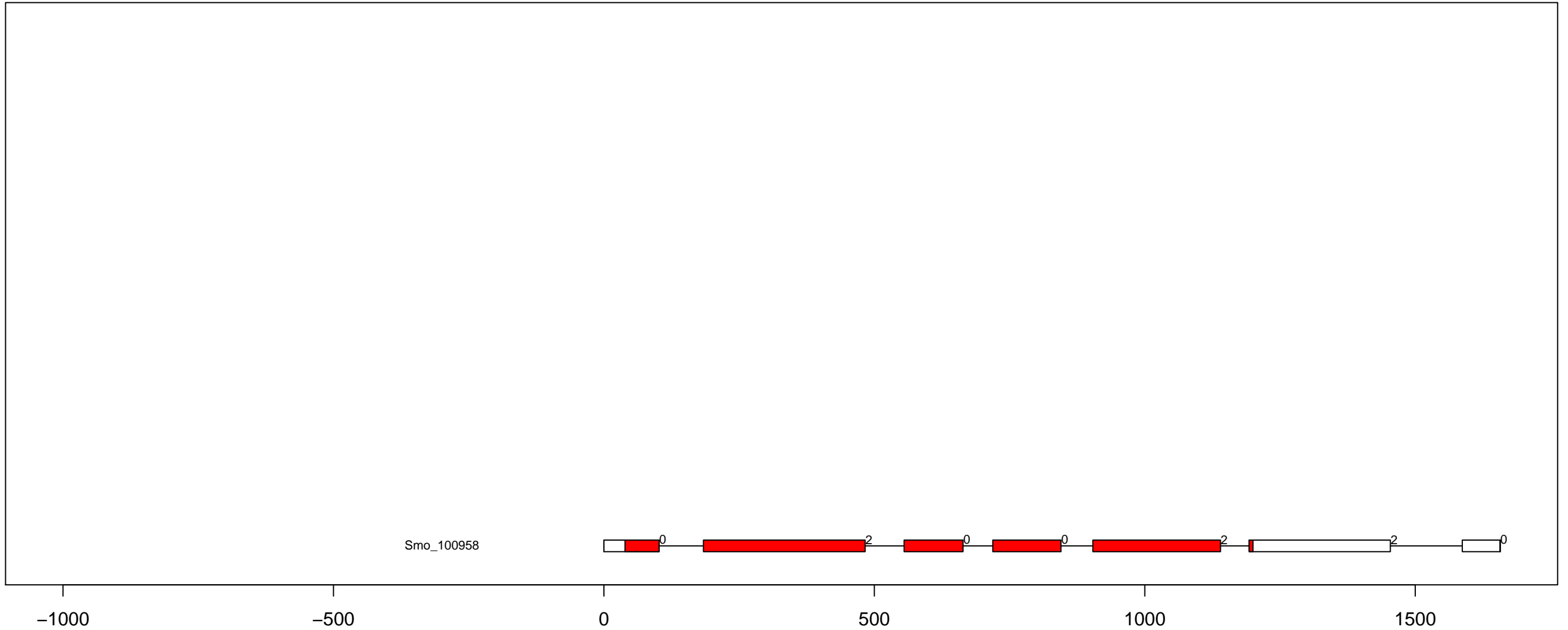

S.mo CMGC_CDK-CDK8 exon-intron and kinase domain diagram (all)

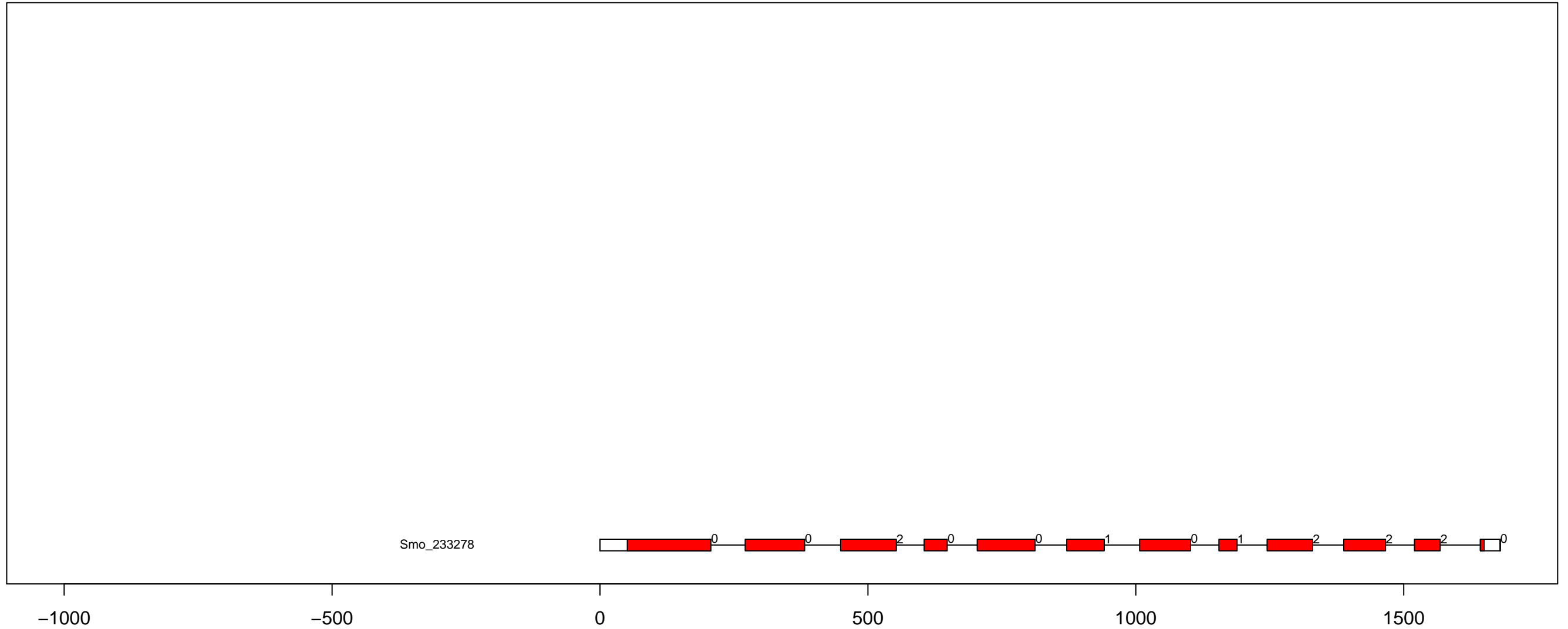

S.mo CMGC_CDK-CRK7-CDK9 exon-intron and kinase domain diagram (all)

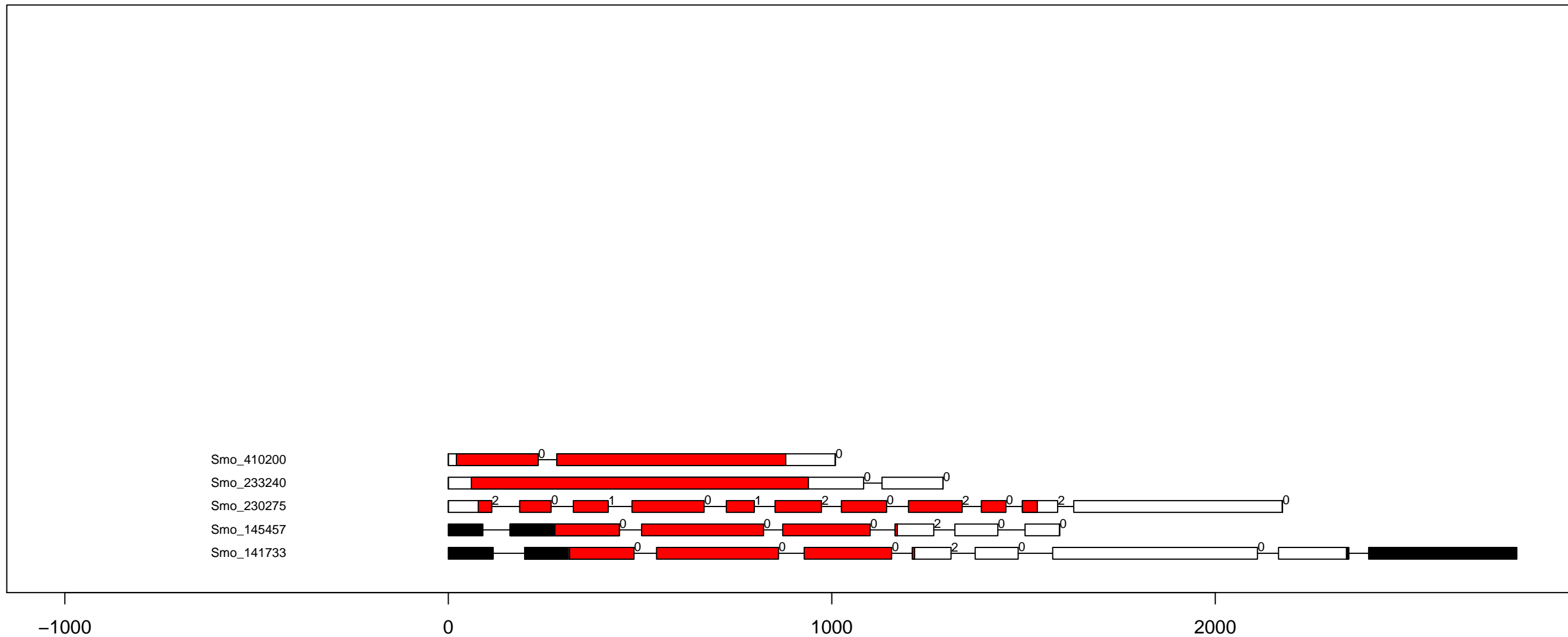

S.mo CMGC_CDKL-Cr exon-intron and kinase domain diagram (all)

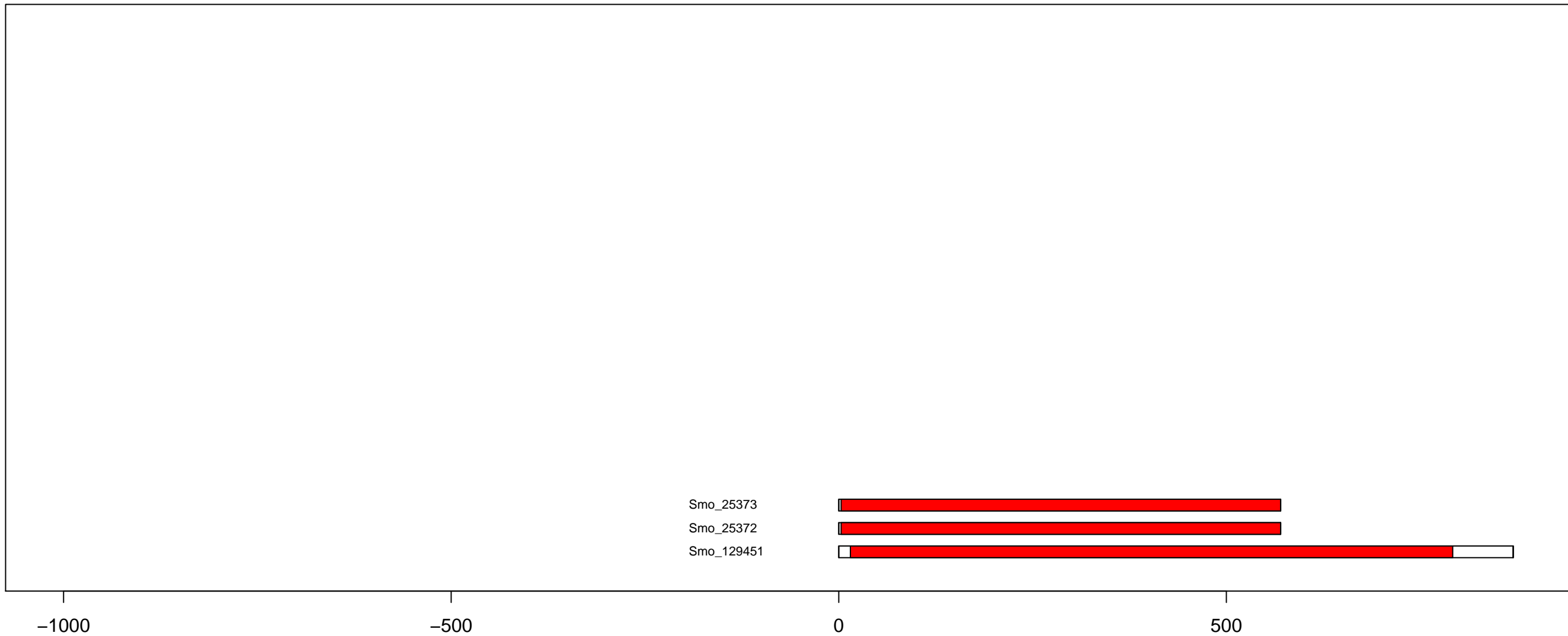

S.mo CMGC_CDK-PITSLRE exon-intron and kinase domain diagram (all)

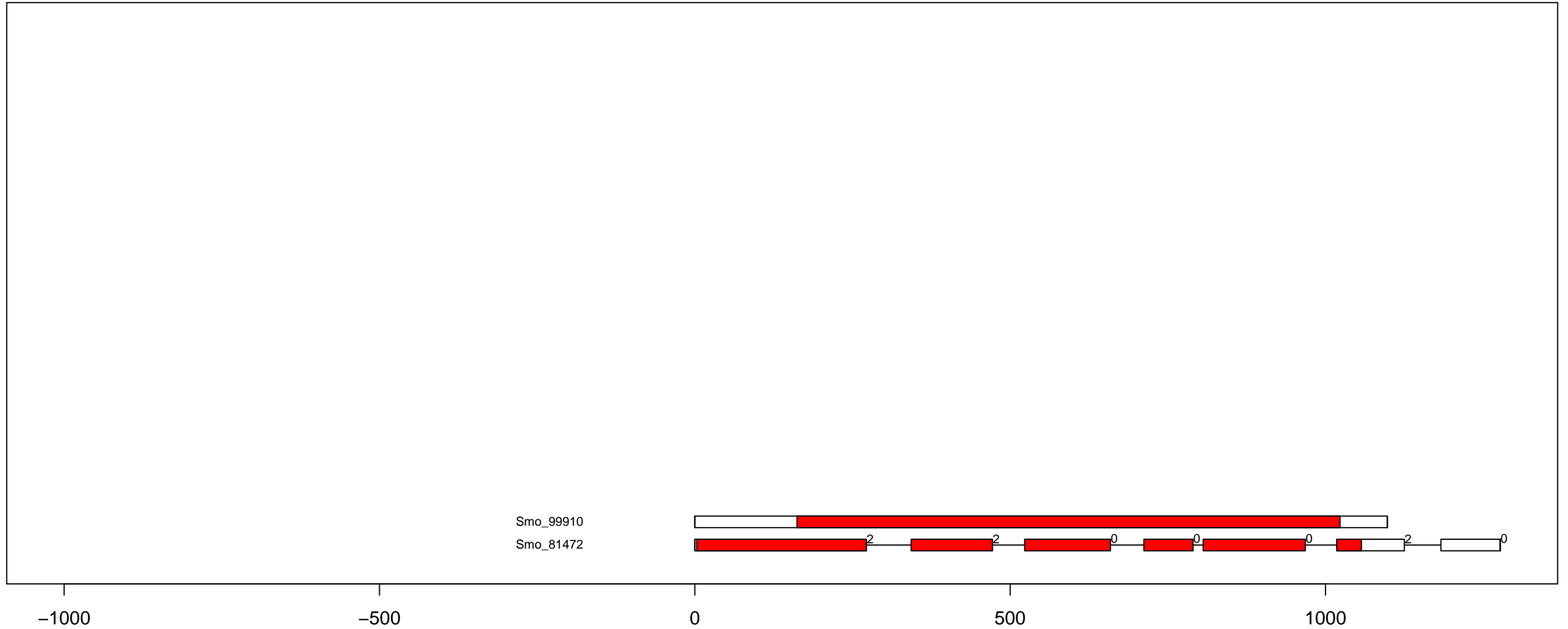

S.mo CMGC_CDK-PI exon-intron and kinase domain diagram (all)

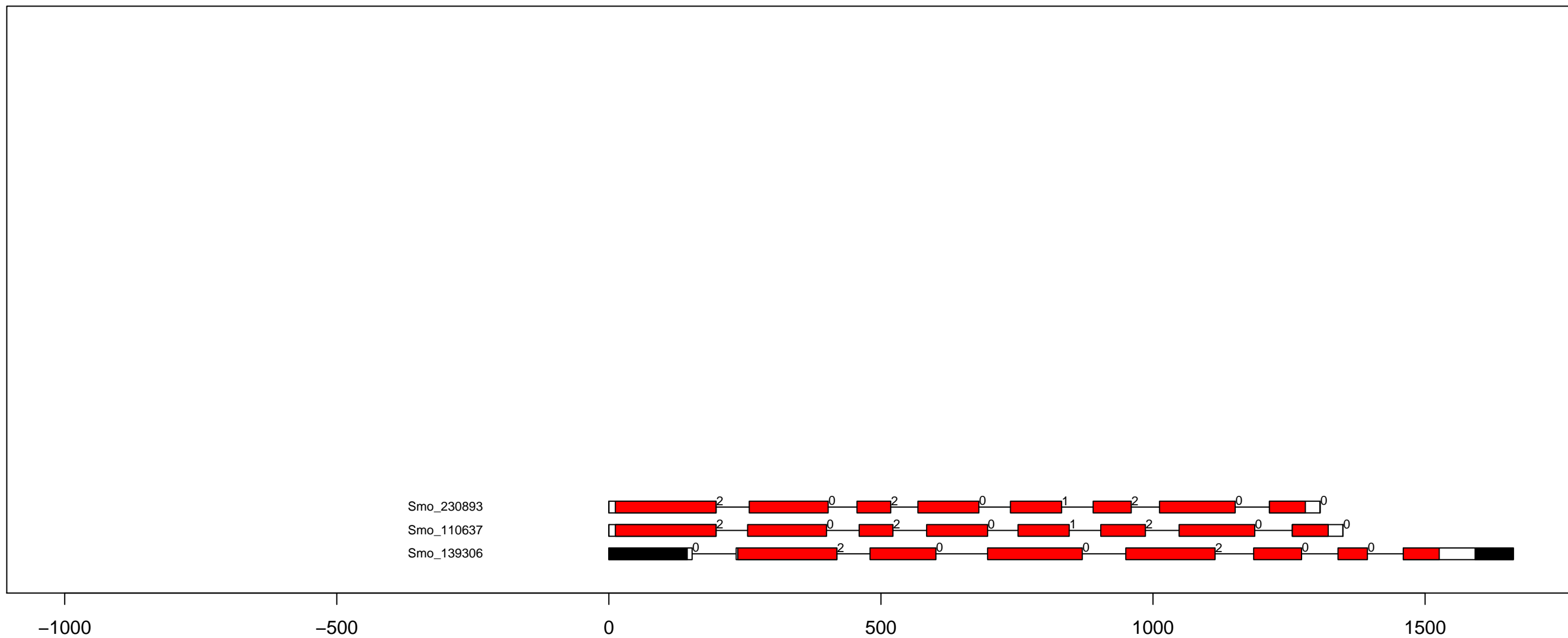

S.mo CMGC_CK2 exon-intron and kinase domain diagram (all)

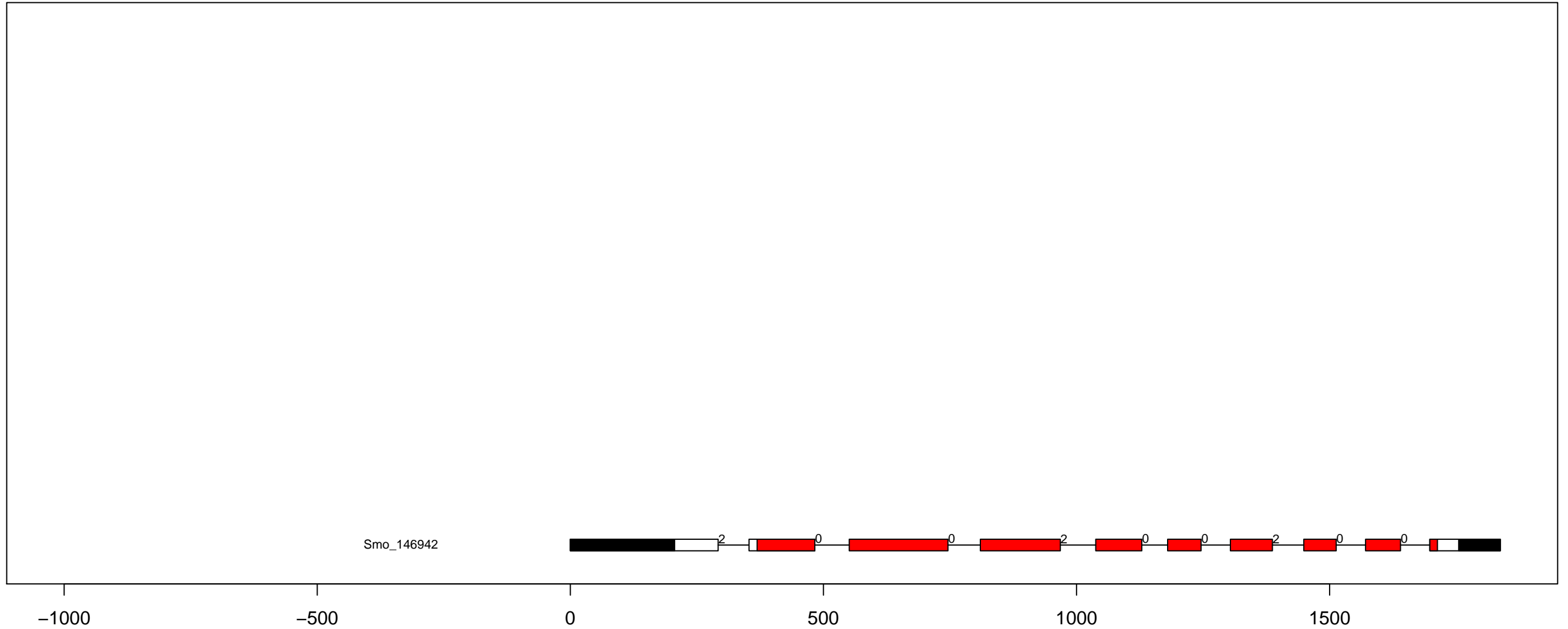

S.mo CMGC_CLK exon-intron and kinase domain diagram (all)

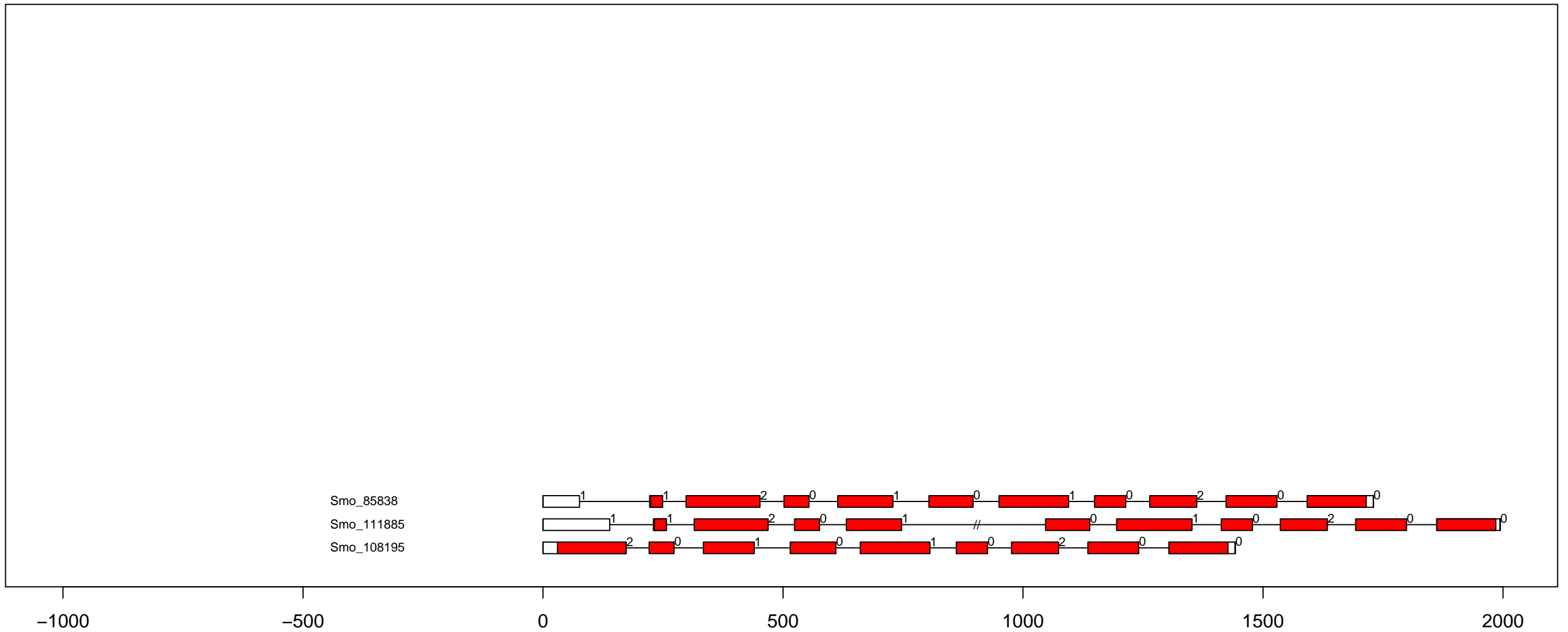

S.mo CMGC_DYRK-DRYK2 exon-intron and kinase domain diagram (all)

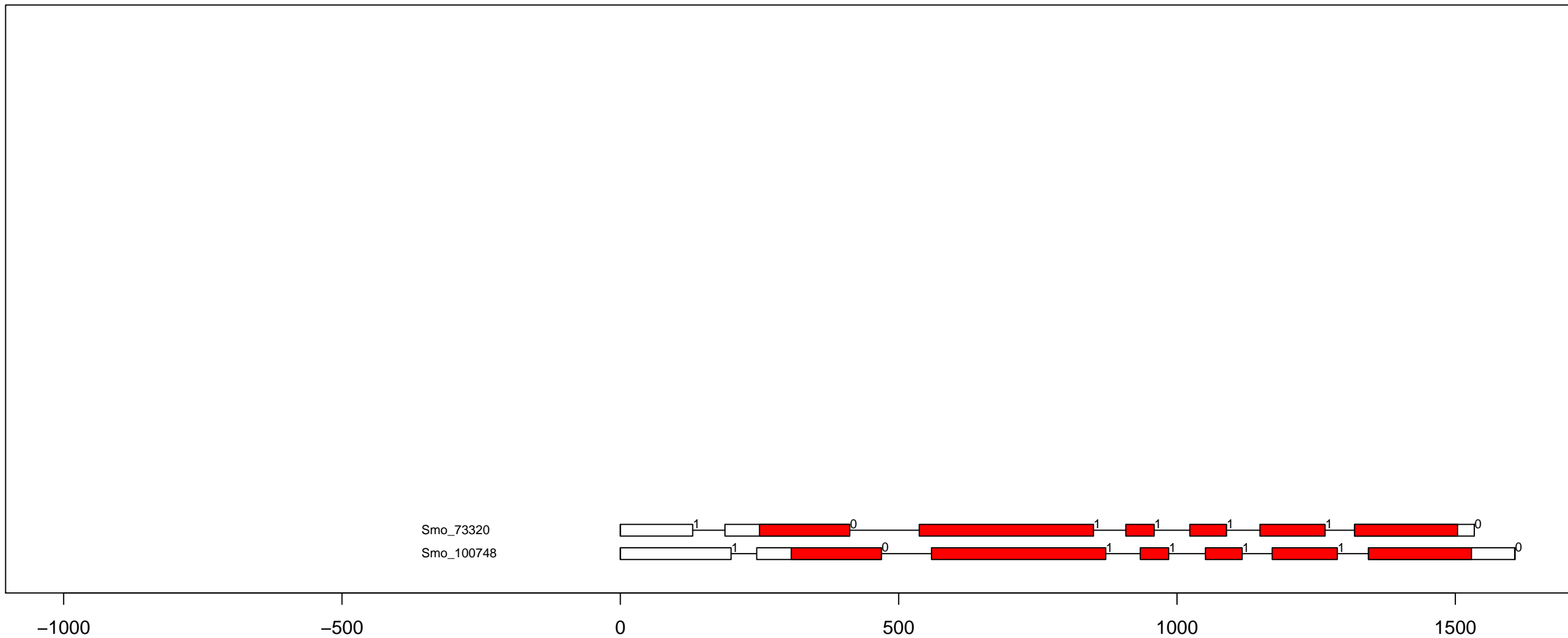

S.mo CMGC_DYRK-YAK exon-intron and kinase domain diagram (all)

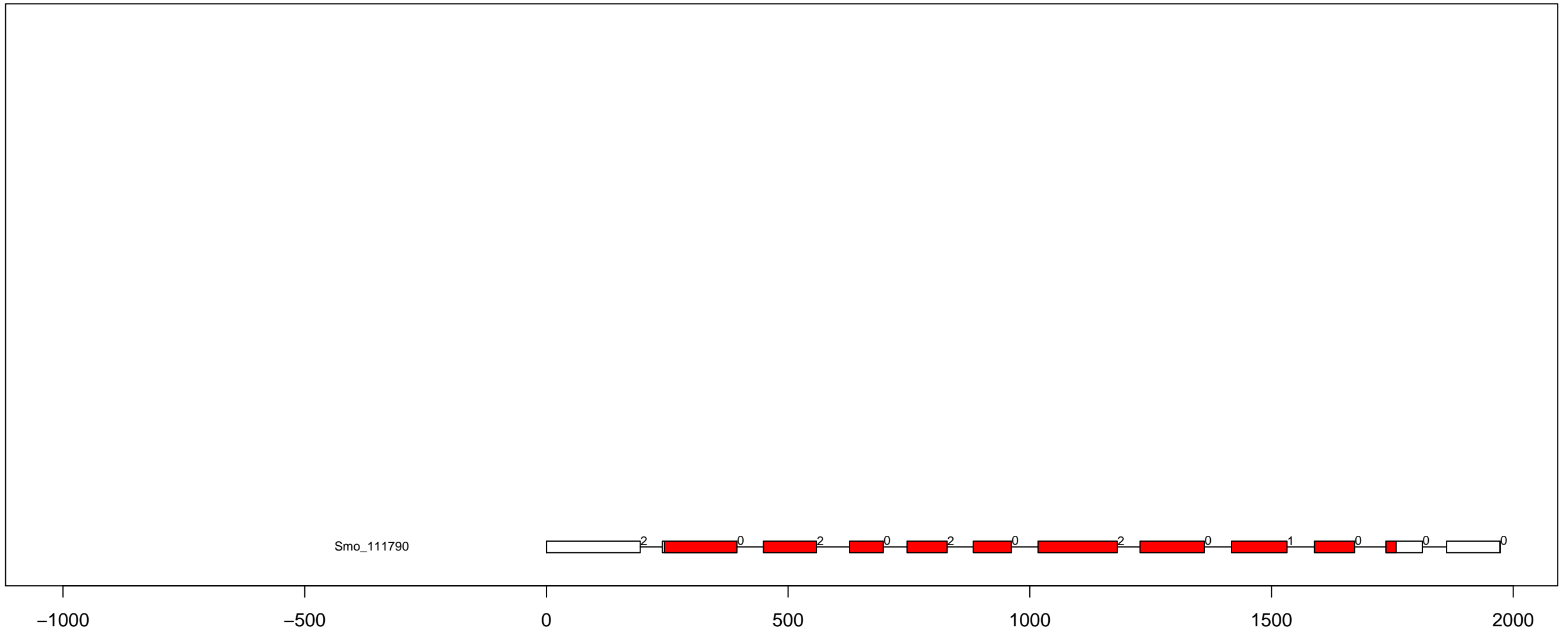

S.mo CMGC_GSKL exon-intron and kinase domain diagram (all)

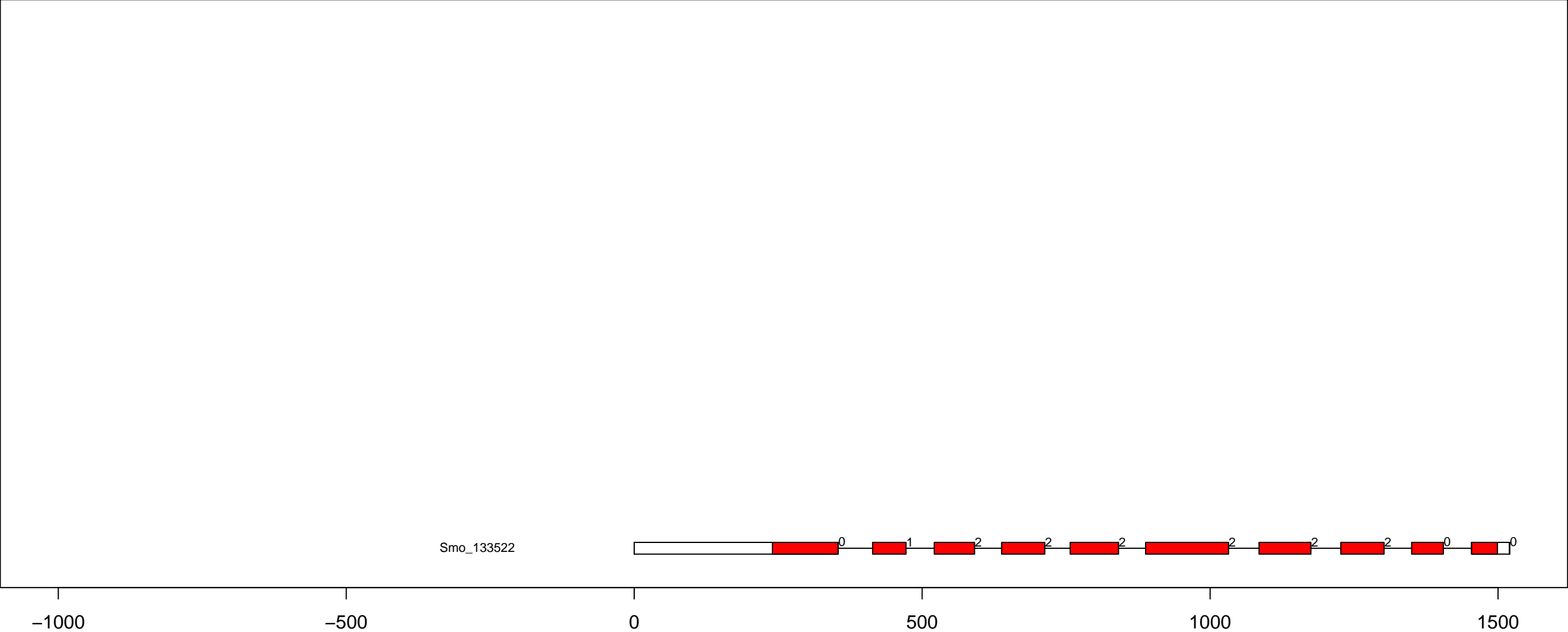

S.mo CMGC_GSK exon-intron and kinase domain diagram (all)

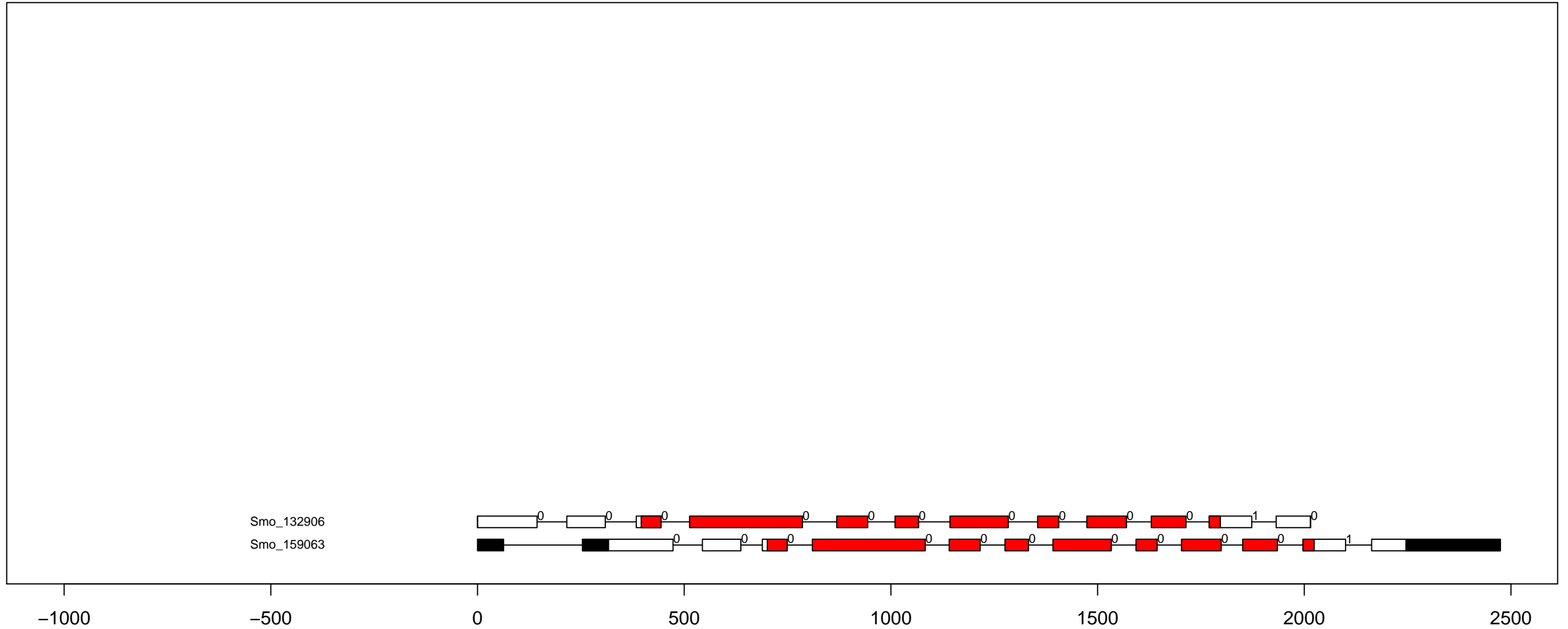

S.mo CMGC_MAPK exon-intron and kinase domain diagram (all)

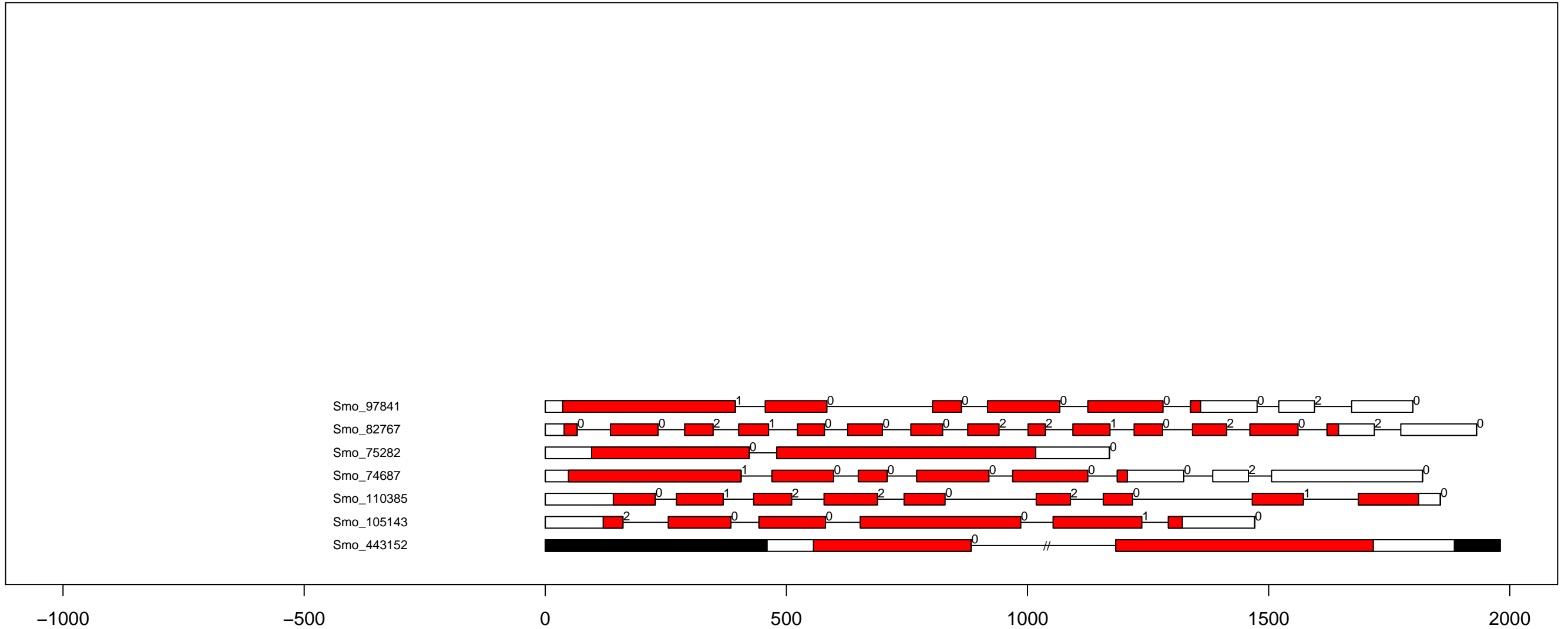

S.mo CMGC_RCK exon-intron and kinase domain diagram (all)

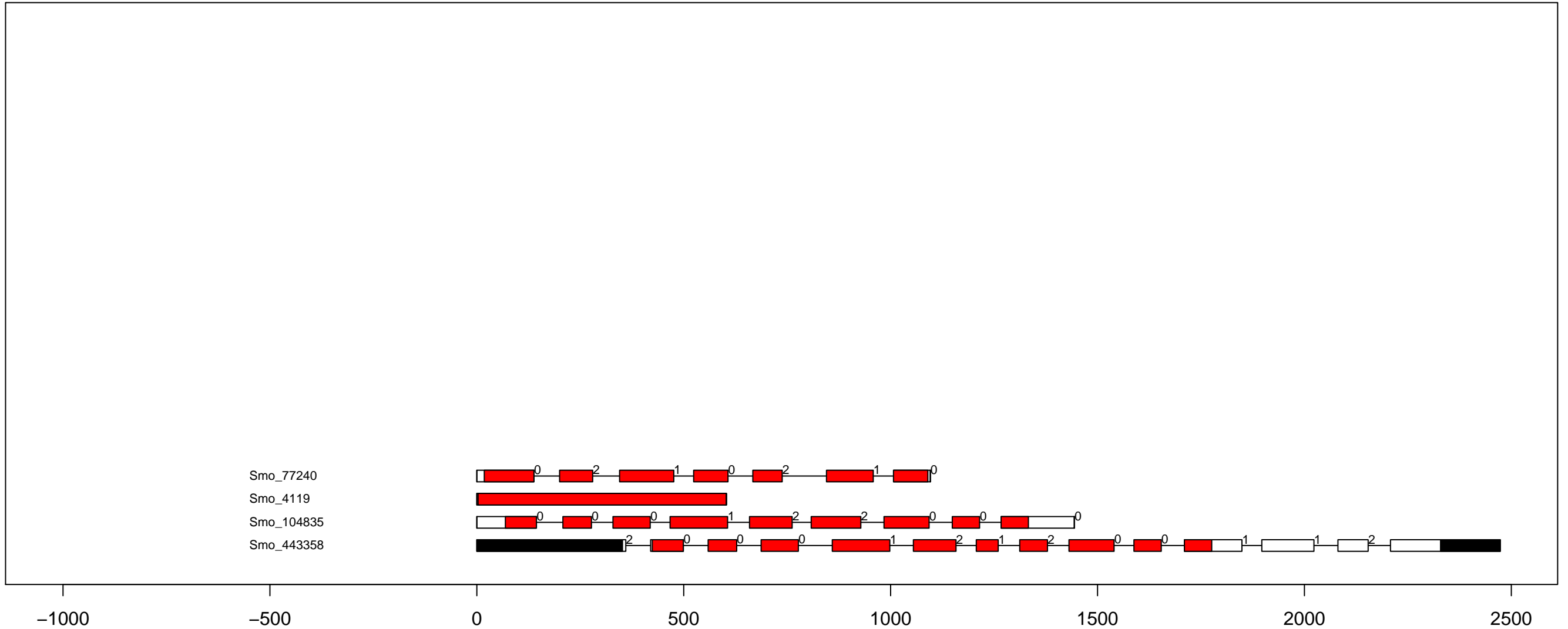

S.mo CMGC_SRPK exon-intron and kinase domain diagram (all)

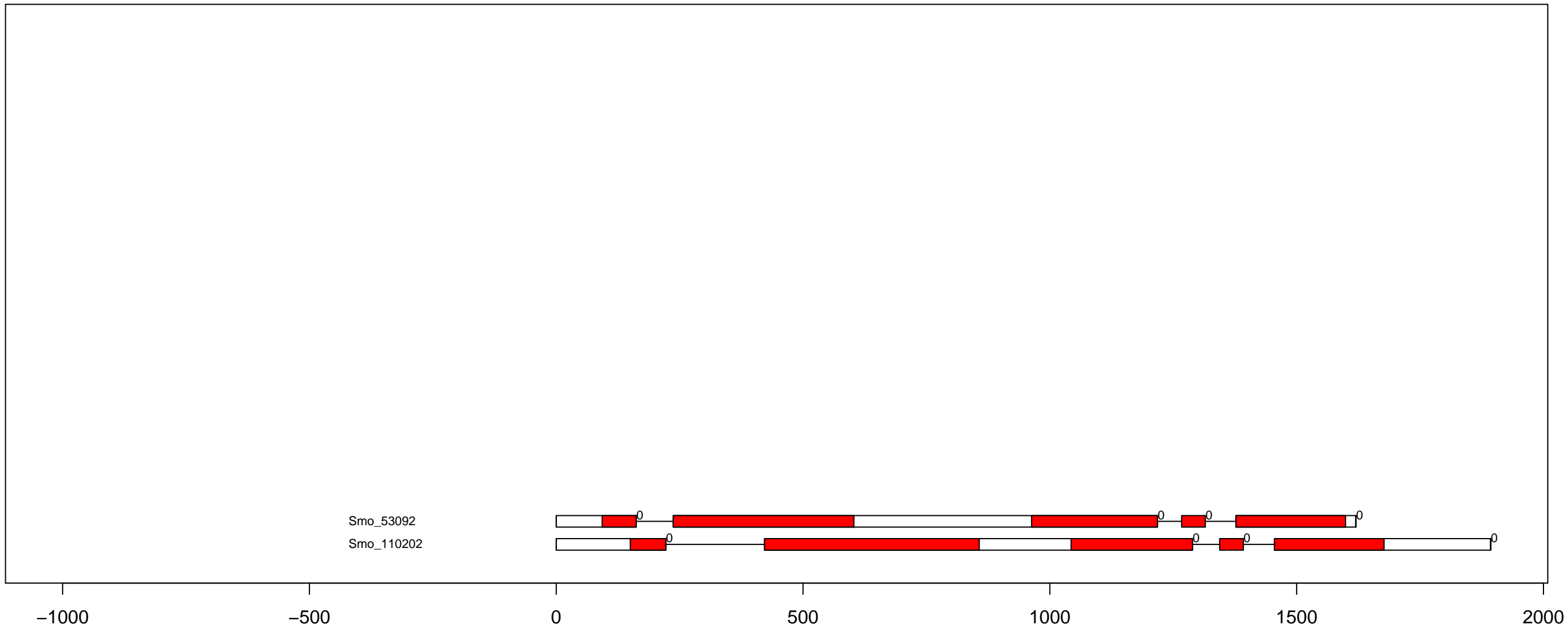

S.mo Group-Cr-1 exon-intron and kinase domain diagram (all)

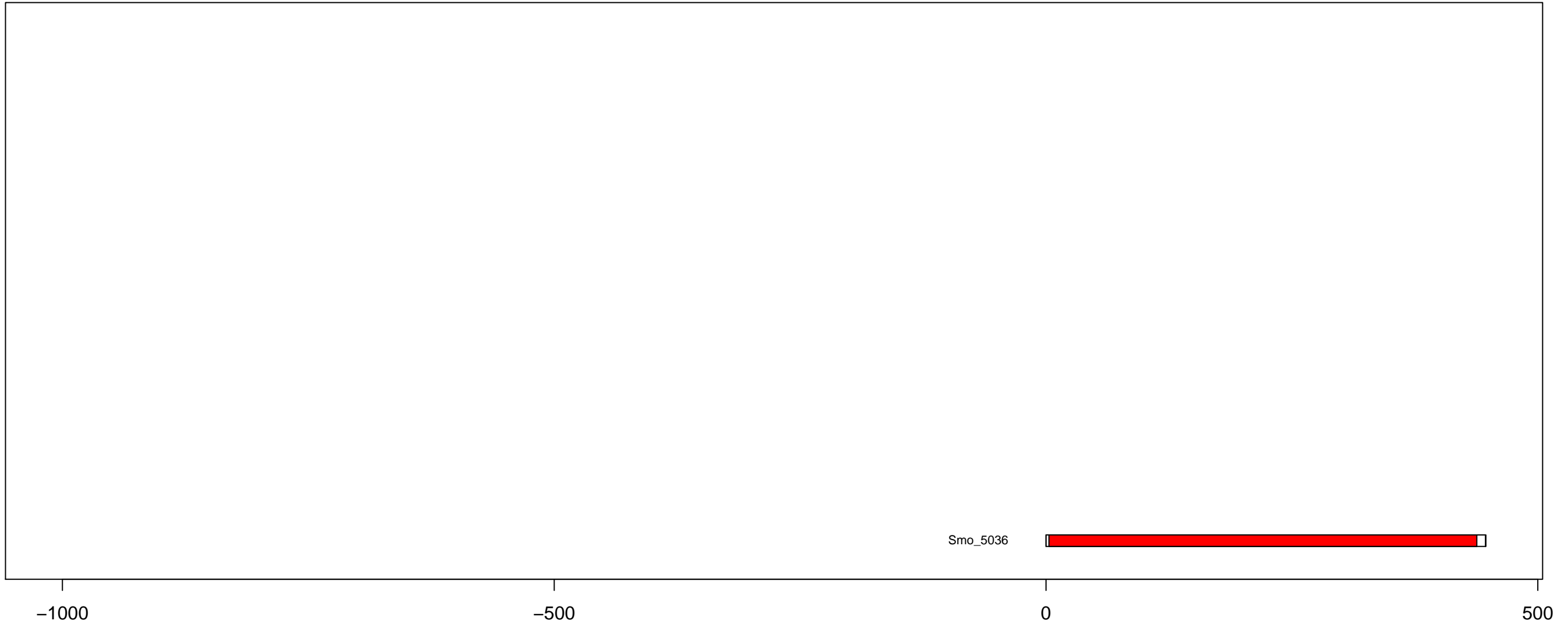

S.mo Group-PI-1 exon-intron and kinase domain diagram (all)

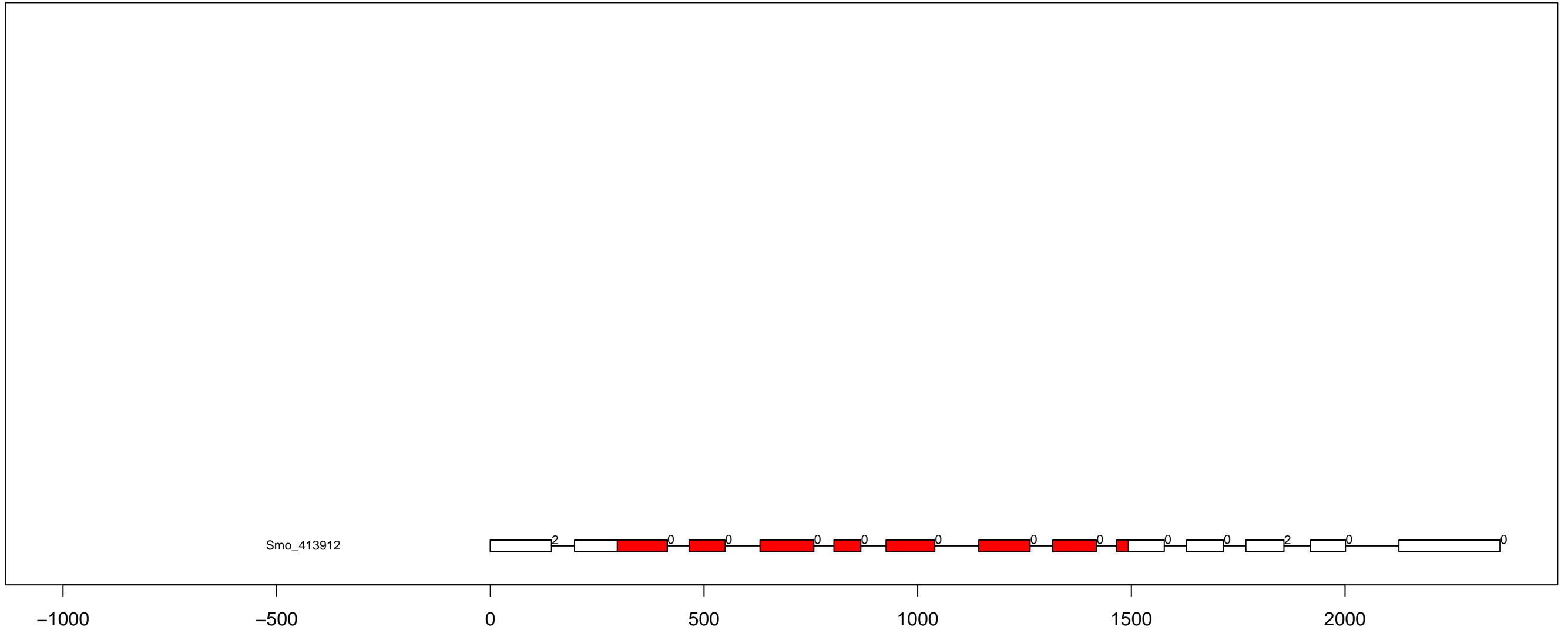

S.mo Group-PI-3 exon-intron and kinase domain diagram (all)

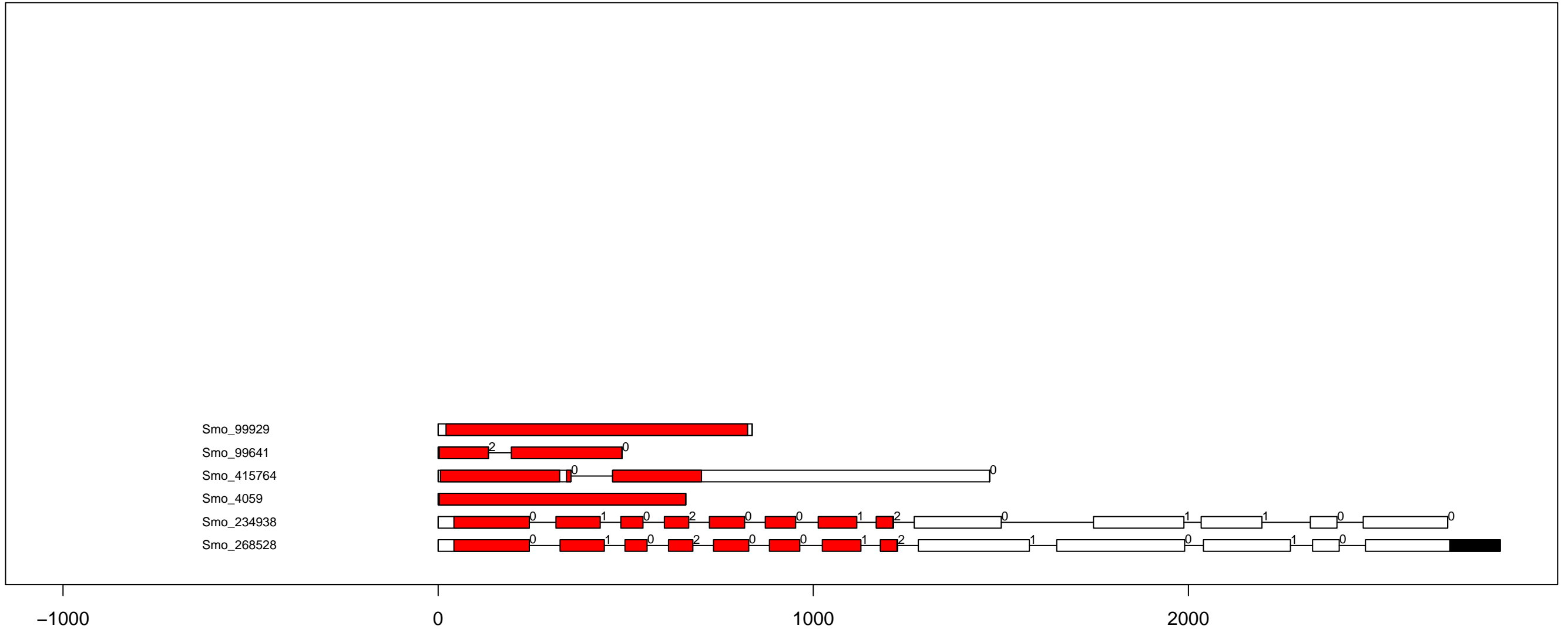

S.mo Group-PI-4 exon-intron and kinase domain diagram (all)

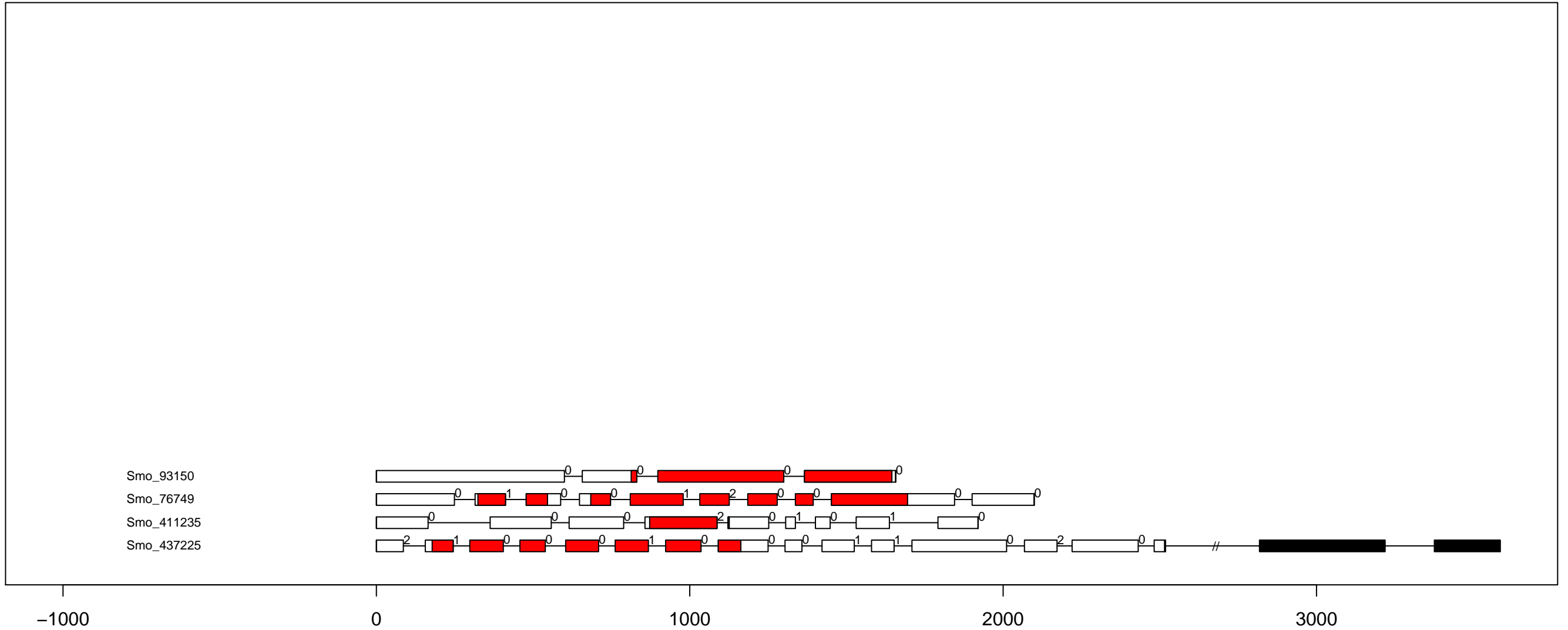

S.mo NAK exon-intron and kinase domain diagram (all)

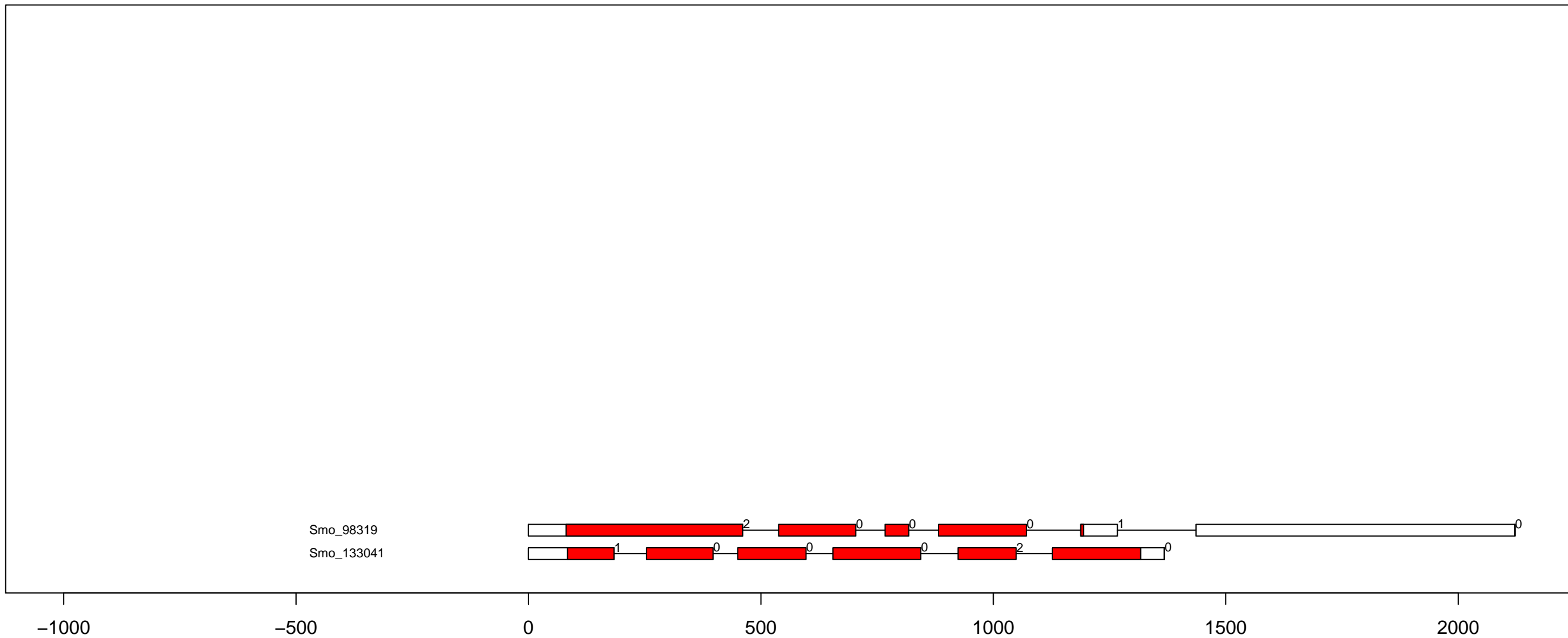

S.mo PEK_GCIN2 exon-intron and kinase domain diagram (all)

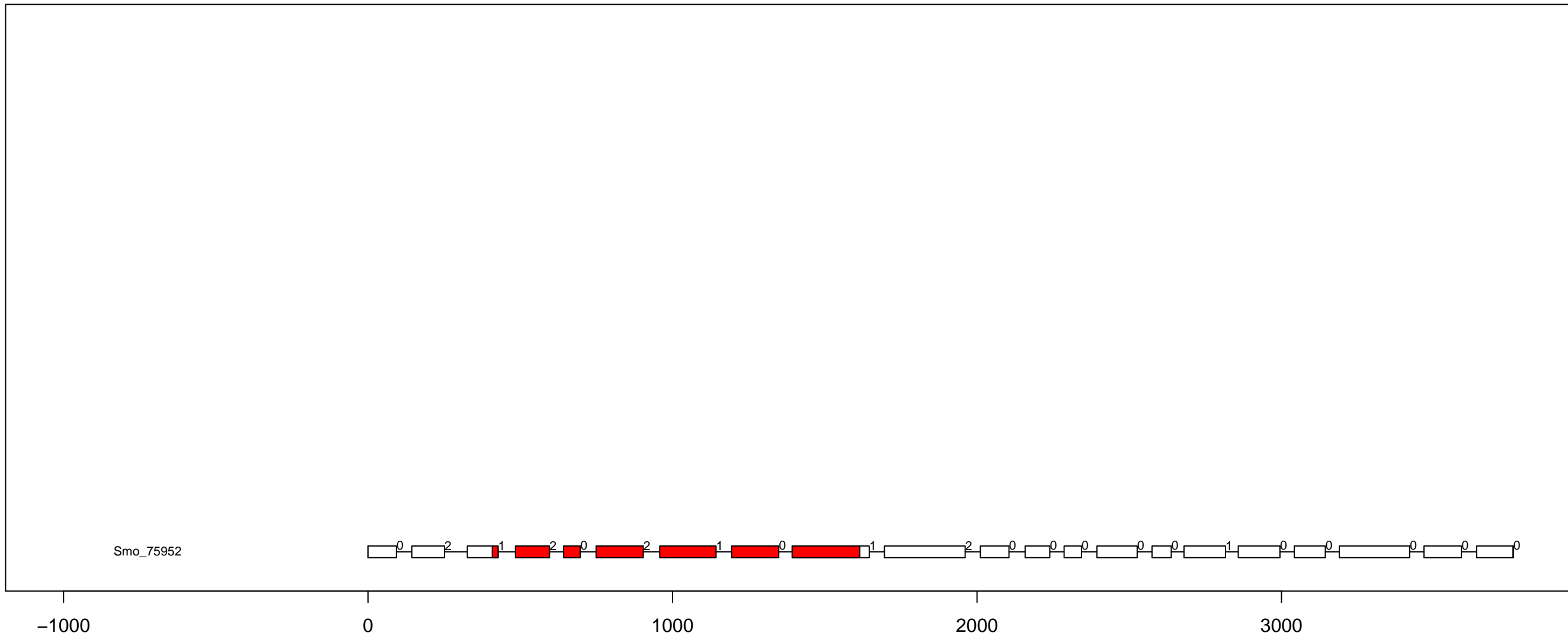

S.mo PEK_PEK exon-intron and kinase domain diagram (all)

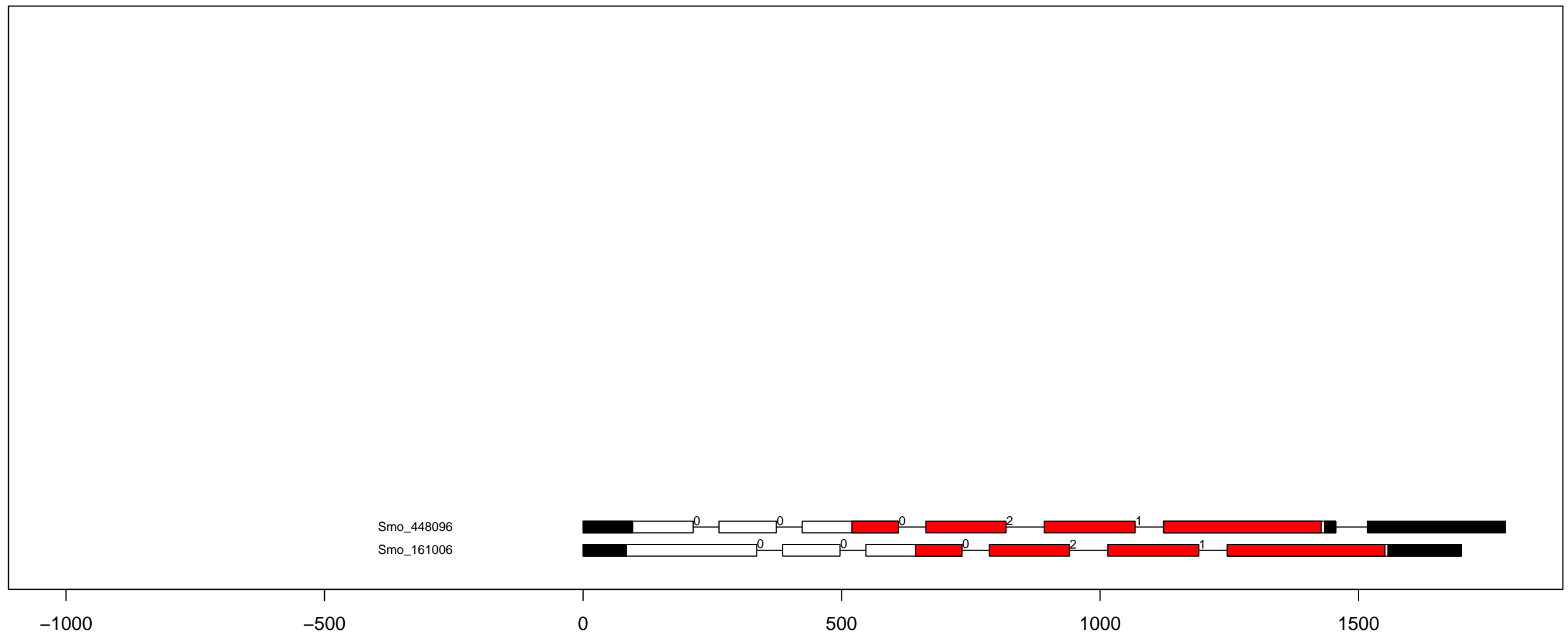

S.mo RLK-Pelle_C-LEC exon-intron and kinase domain diagram (all)

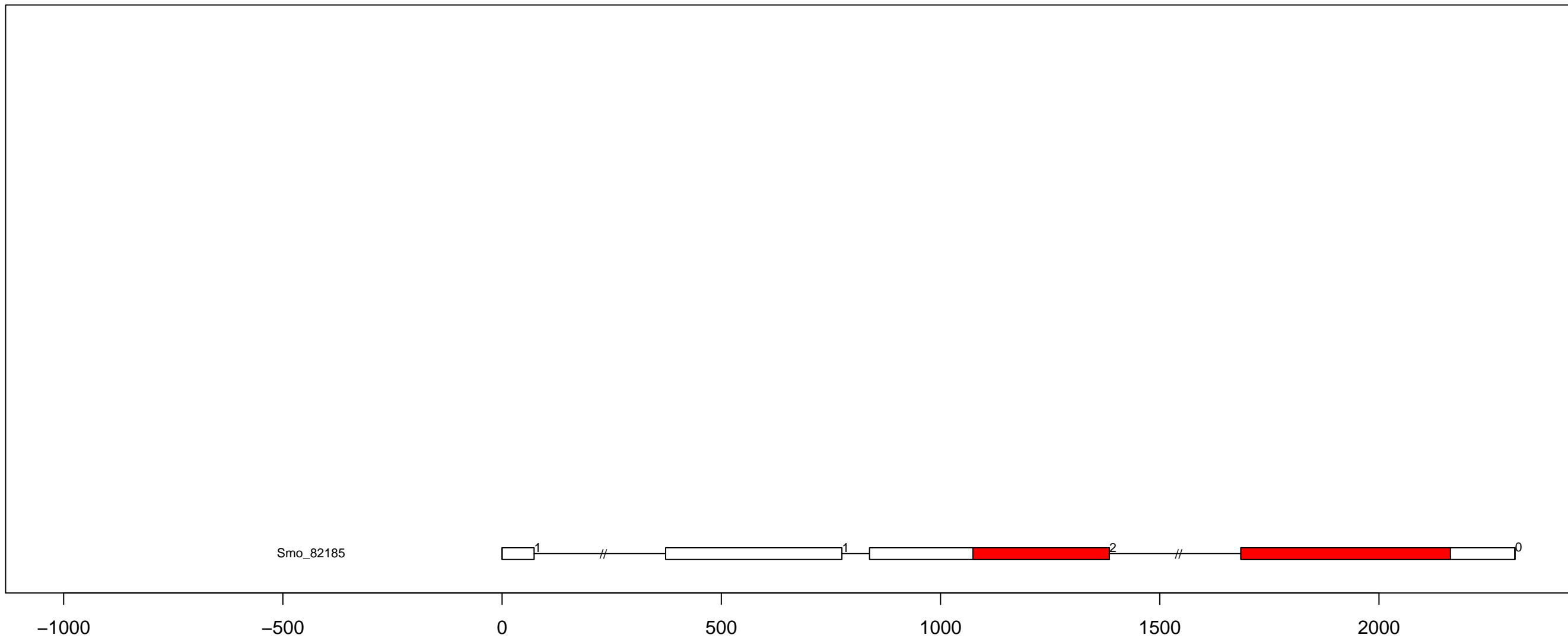

S.mo RLK-Pelle_CR4L exon-intron and kinase domain diagram (all)

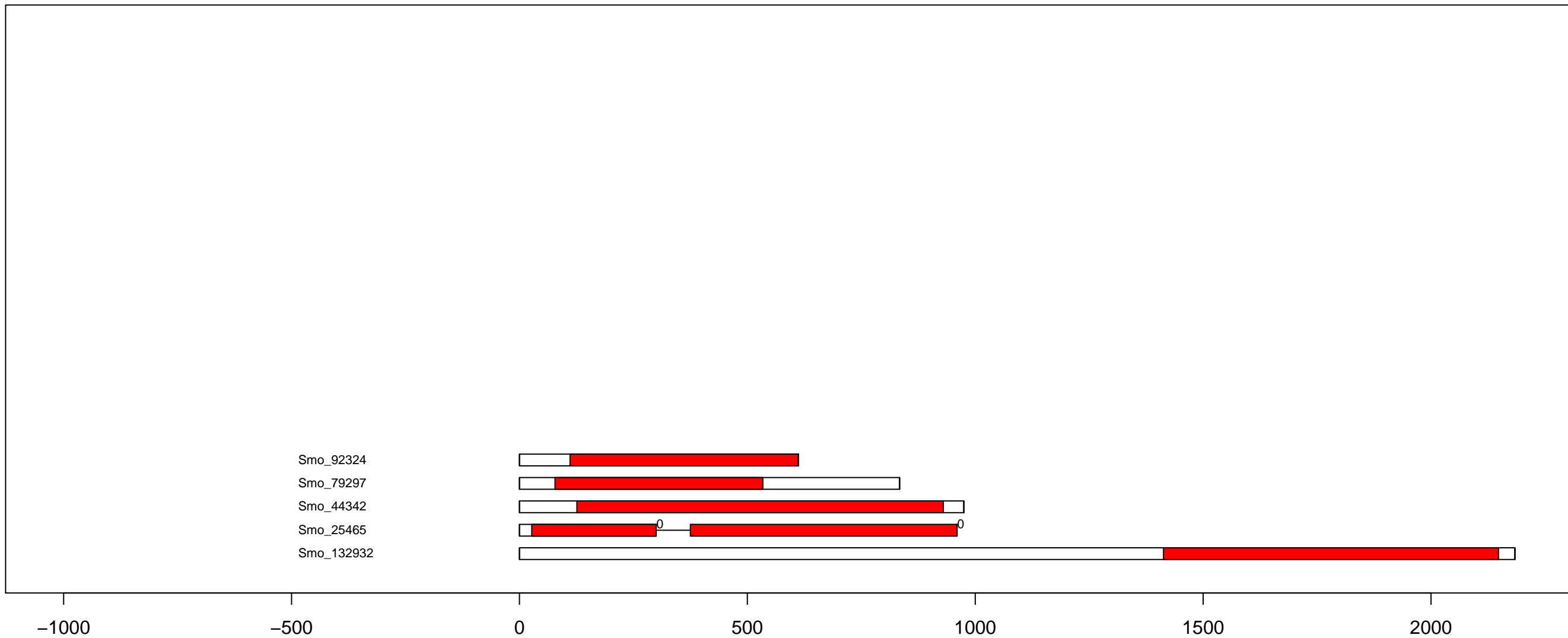

S.mo RLK-Pelle_CrRLK1L-1 exon-intron and kinase domain diagram (all)

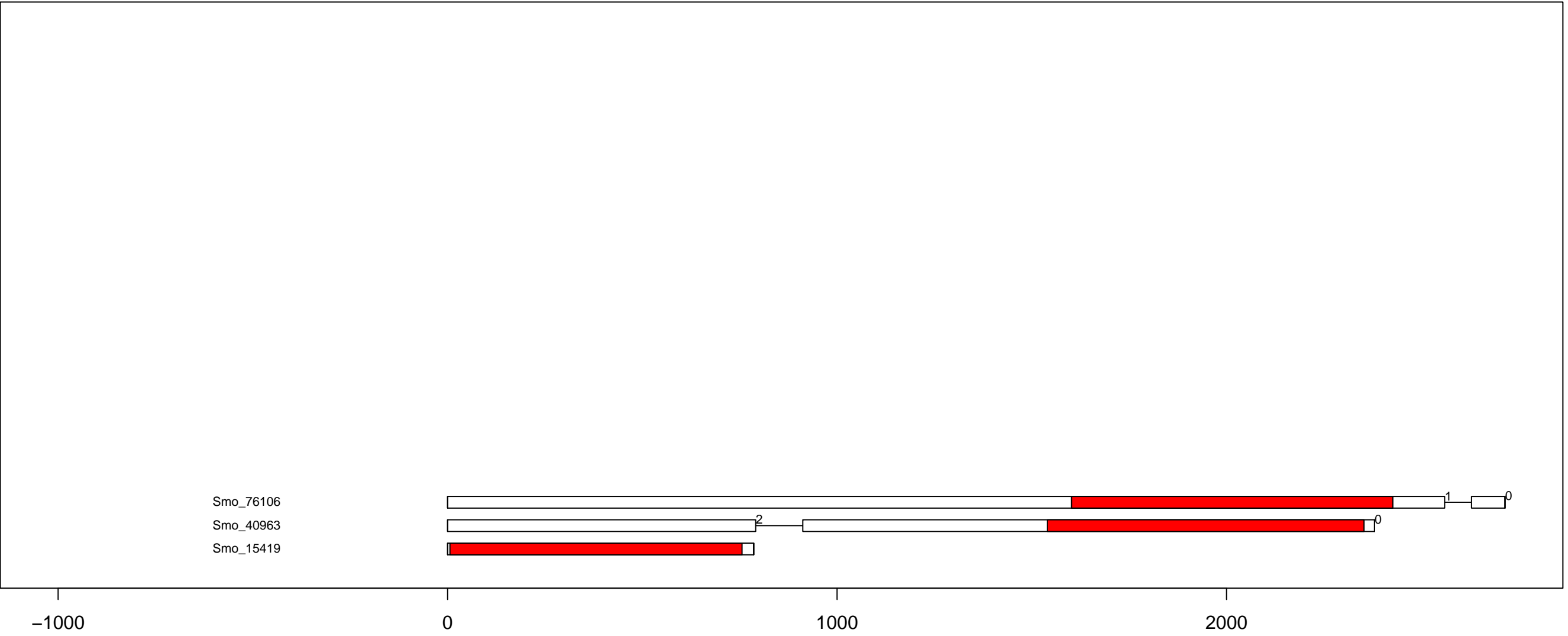

S.mo RLK-Pelle_DLSV exon-intron and kinase domain diagram (all)

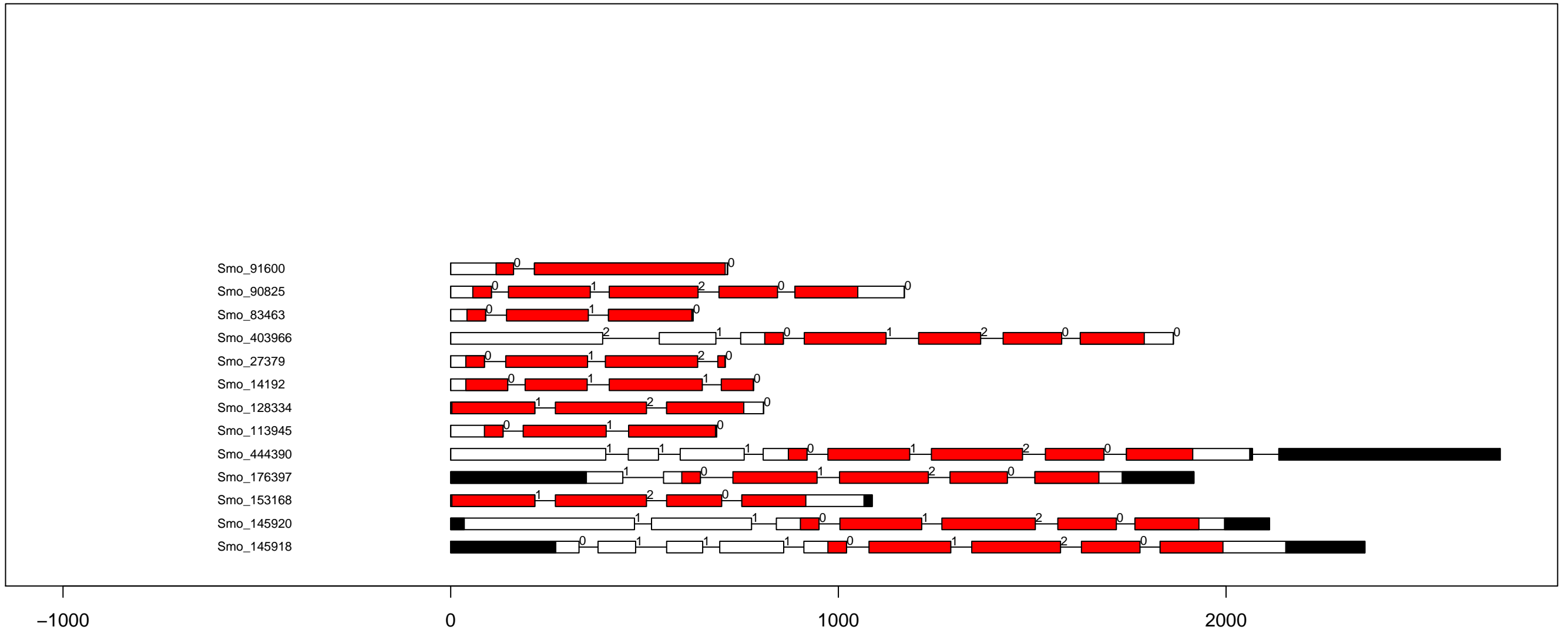

S.mo RLK-Pelle_Extensin exon-intron and kinase domain diagram (all)

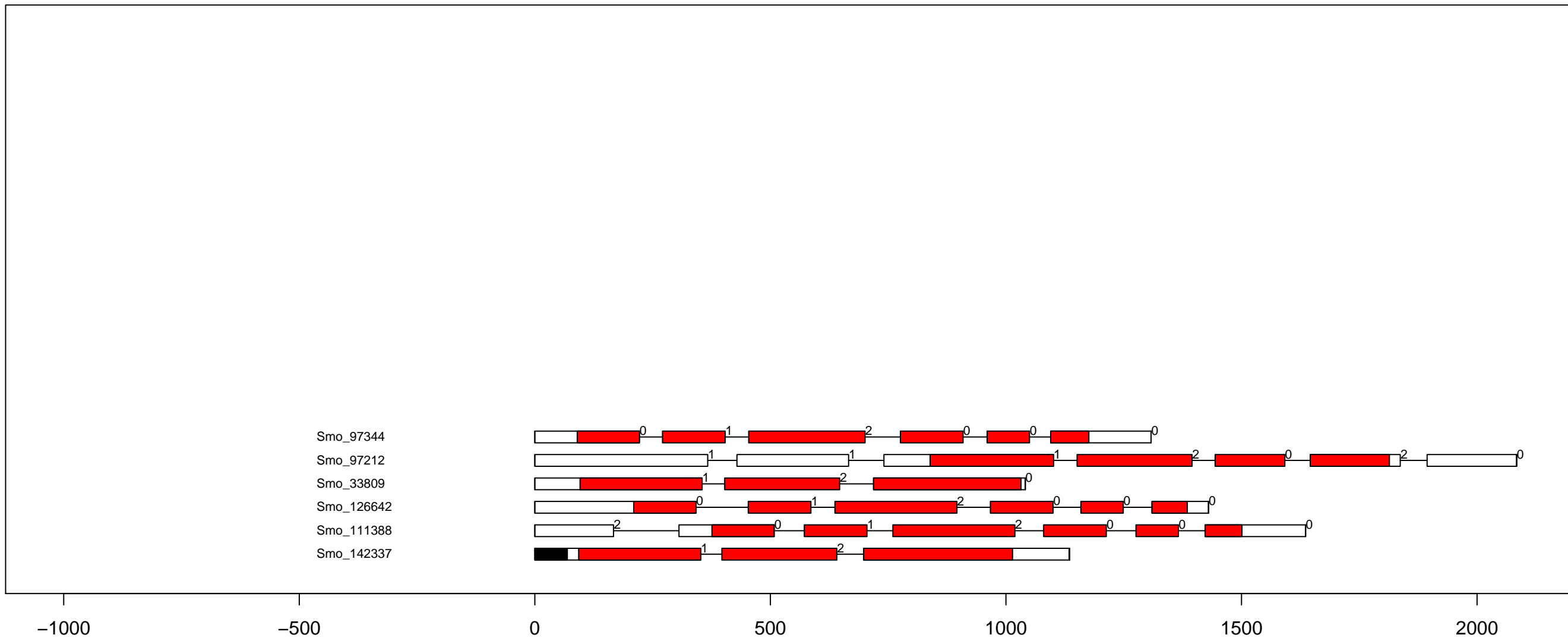

S.mo RLK-Pelle_L-LEC exon-intron and kinase domain diagram (all)

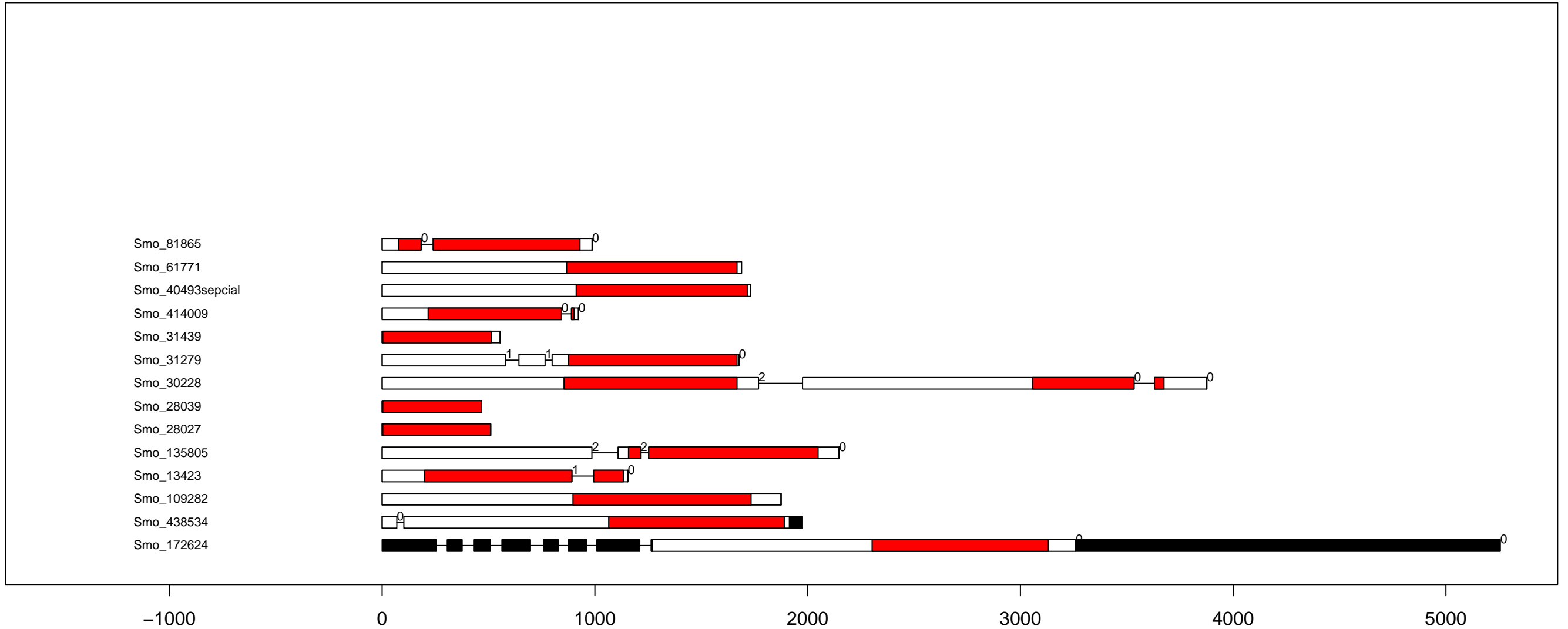

S.mo RLK-Pelle_LRR-I-2 exon-intron and kinase domain diagram (all)

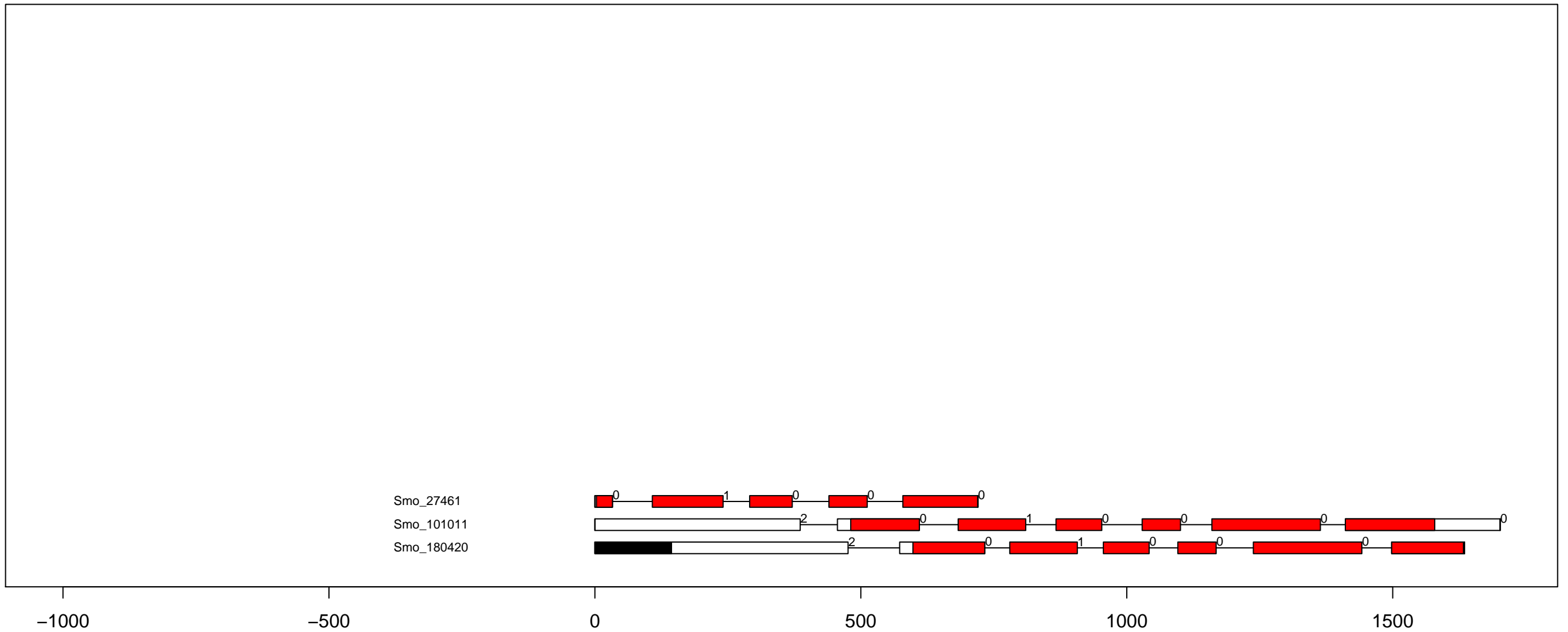

S.mo RLK-Pelle_LRR-III exon-intron and kinase domain diagram (all)

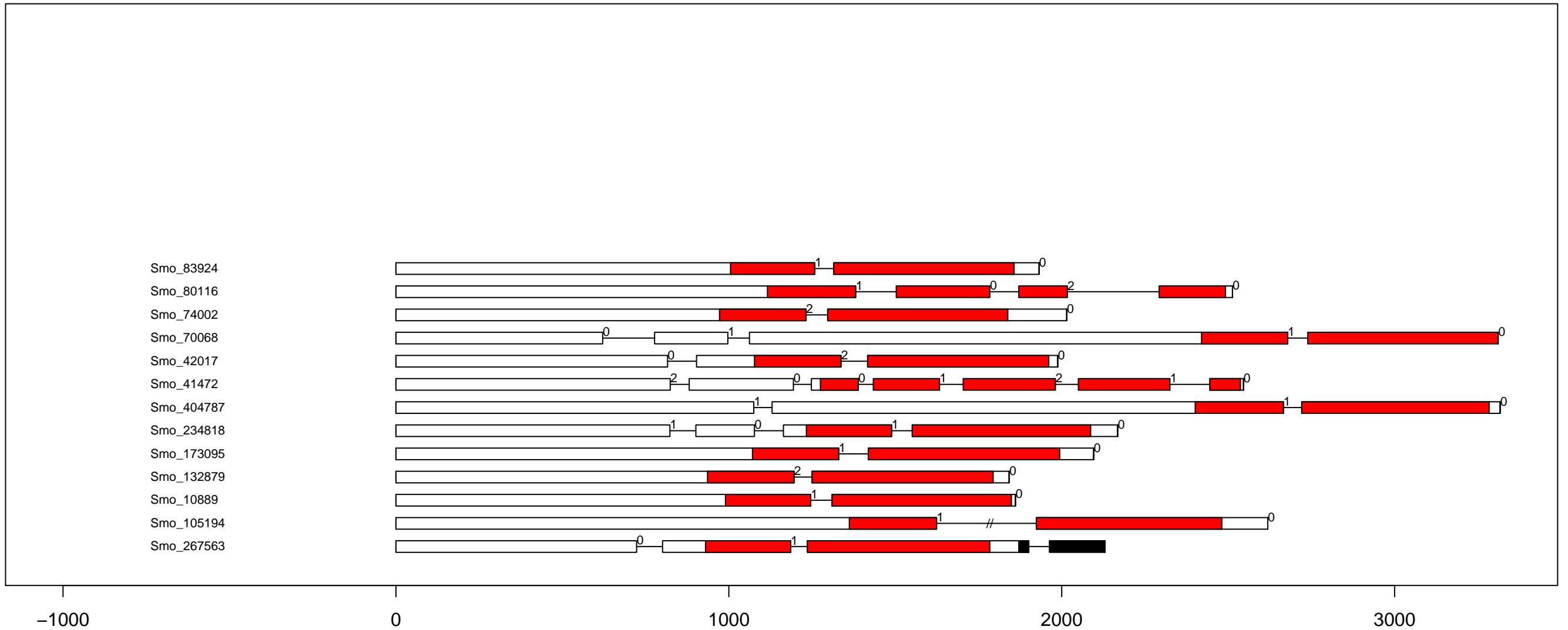

S.mo RLK-Pelle_LRR-IV exon-intron and kinase domain diagram (all)

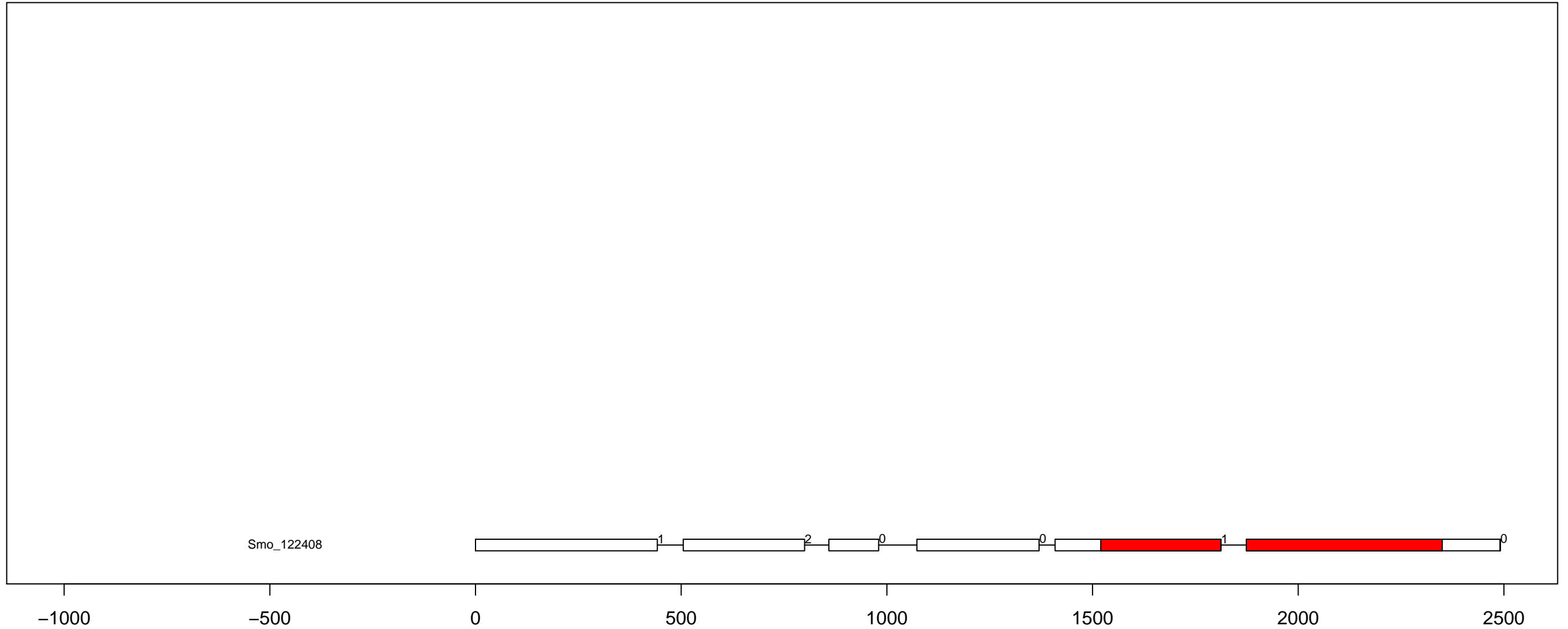

S.mo RLK-Pelle_LRR-IX exon-intron and kinase domain diagram (all)

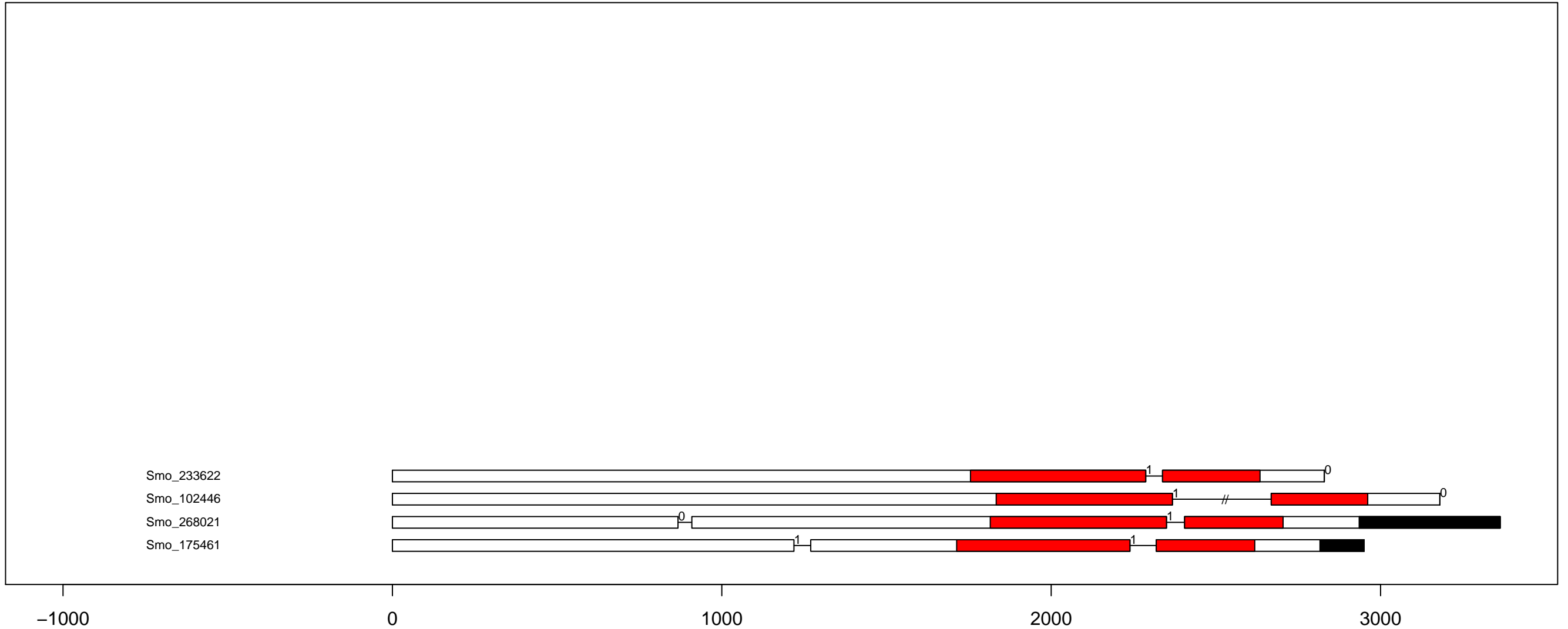

S.mo RLK-Pelle_LRR-VI-1 exon-intron and kinase domain diagram (all)



S.mo RLK-Pelle_LRR-VI-2 exon-intron and kinase domain diagram (all)

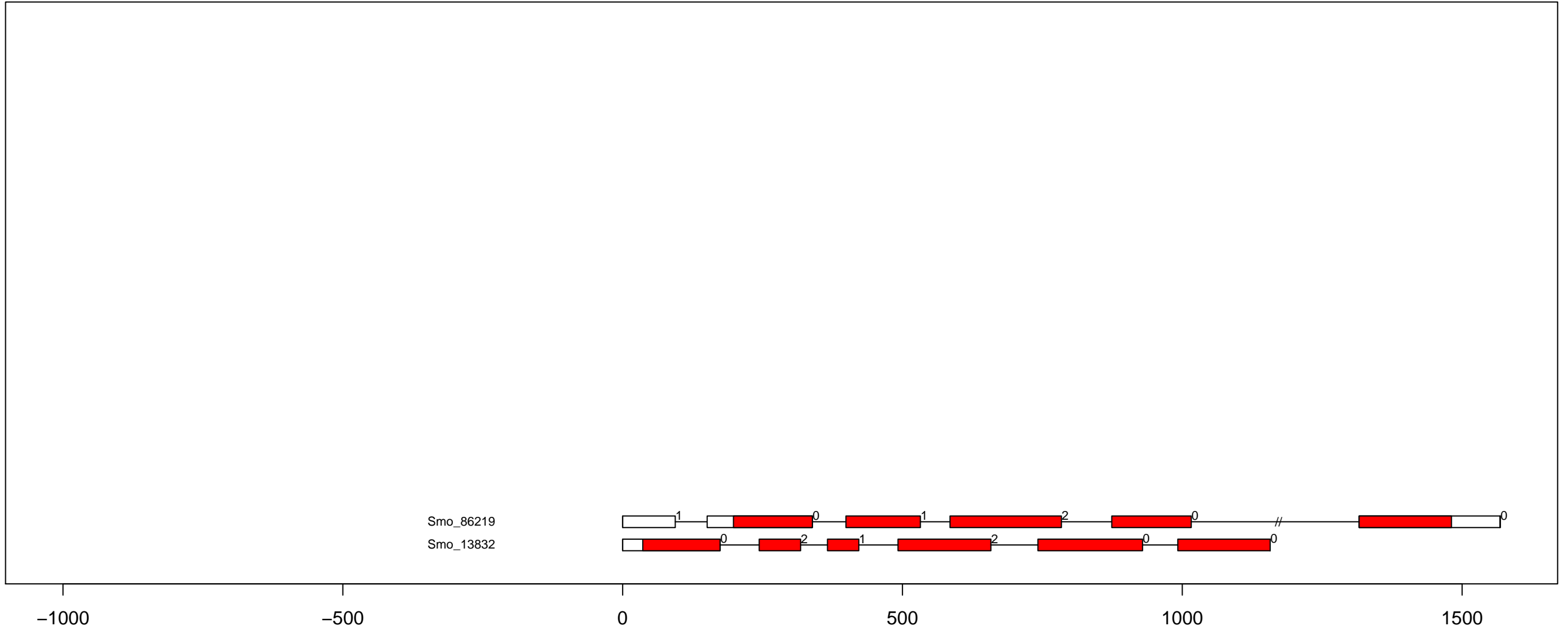

S.mo RLK-Pelle_LRR-VII-1 exon-intron and kinase domain diagram (all)

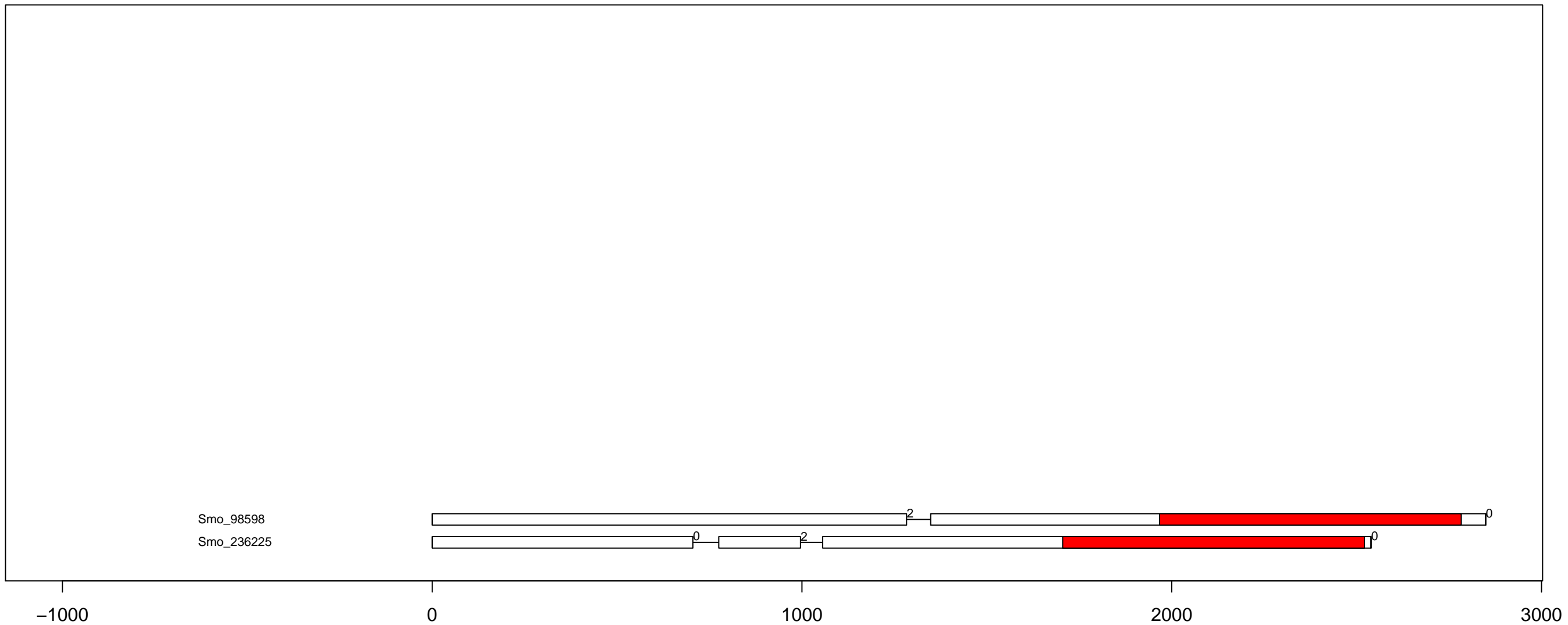

S.mo RLK-Pelle_LRR-VII-2 exon-intron and kinase domain diagram (all)

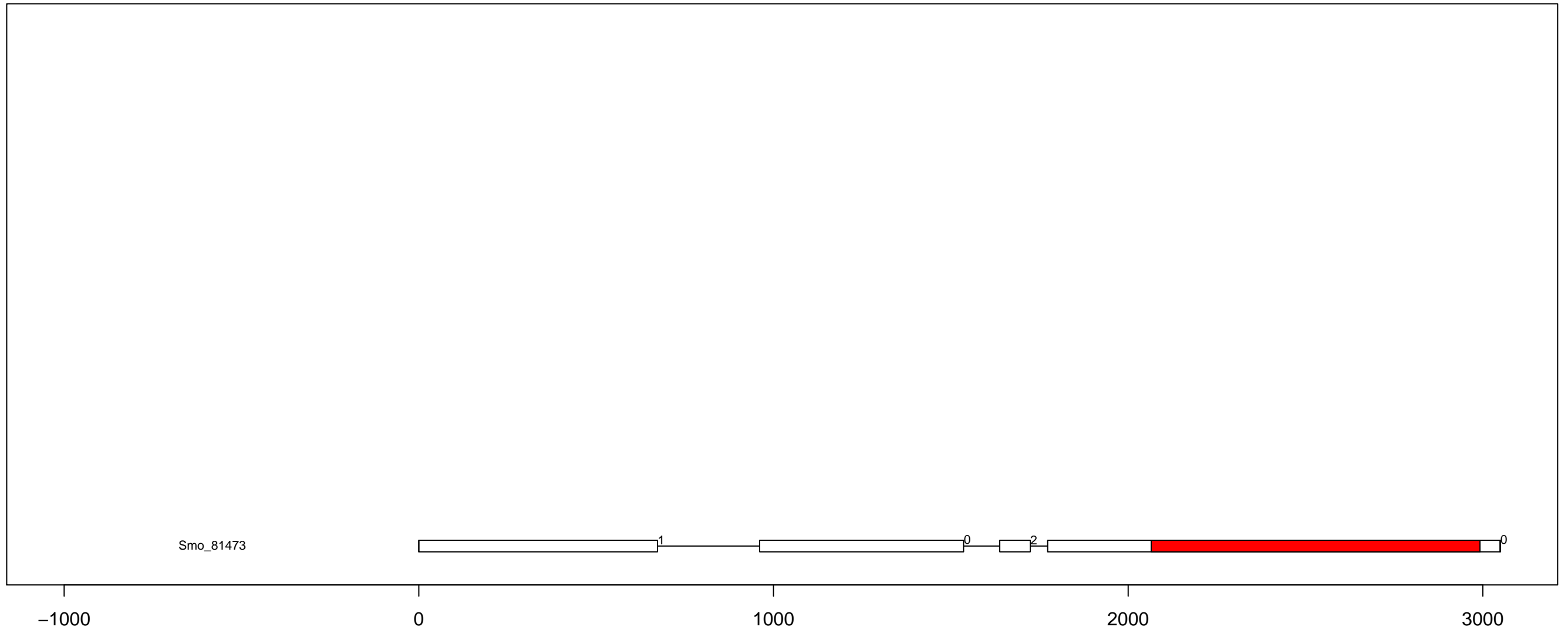

S.mo RLK-Pelle_LRR-VII-3 exon-intron and kinase domain diagram (all)



S.mo RLK-Pelle_LRR-VIII-1 exon-intron and kinase domain diagram (all)

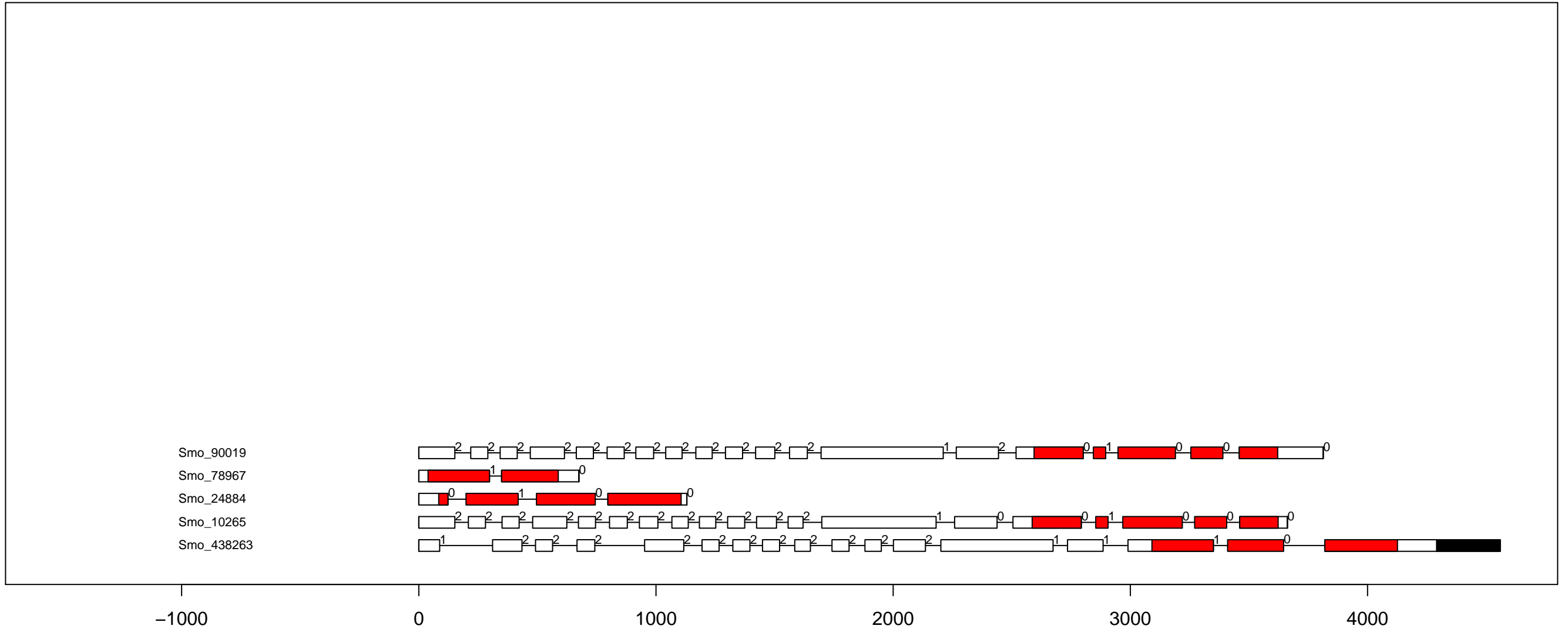

S.mo RLK-Pelle_LRR-V exon-intron and kinase domain diagram (all)

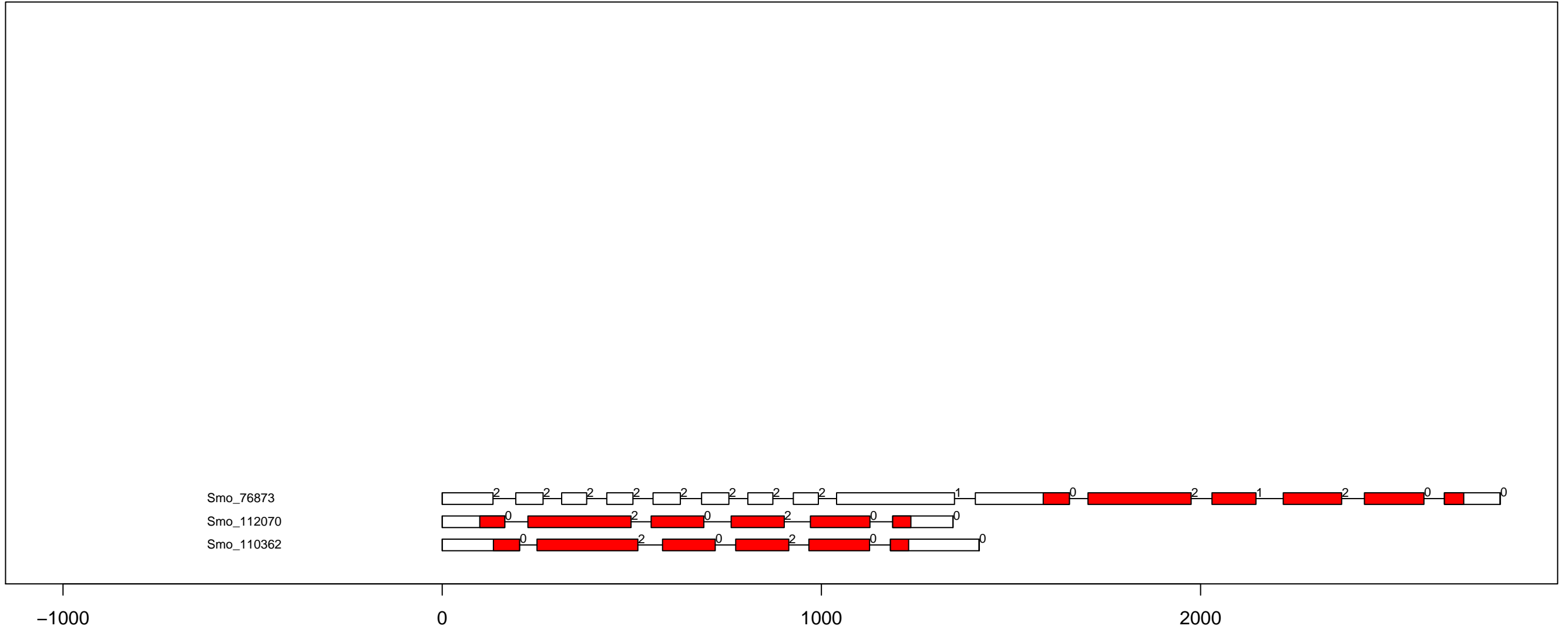

S.mo RLK-Pelle_LRR-Xa exon-intron and kinase domain diagram (all)

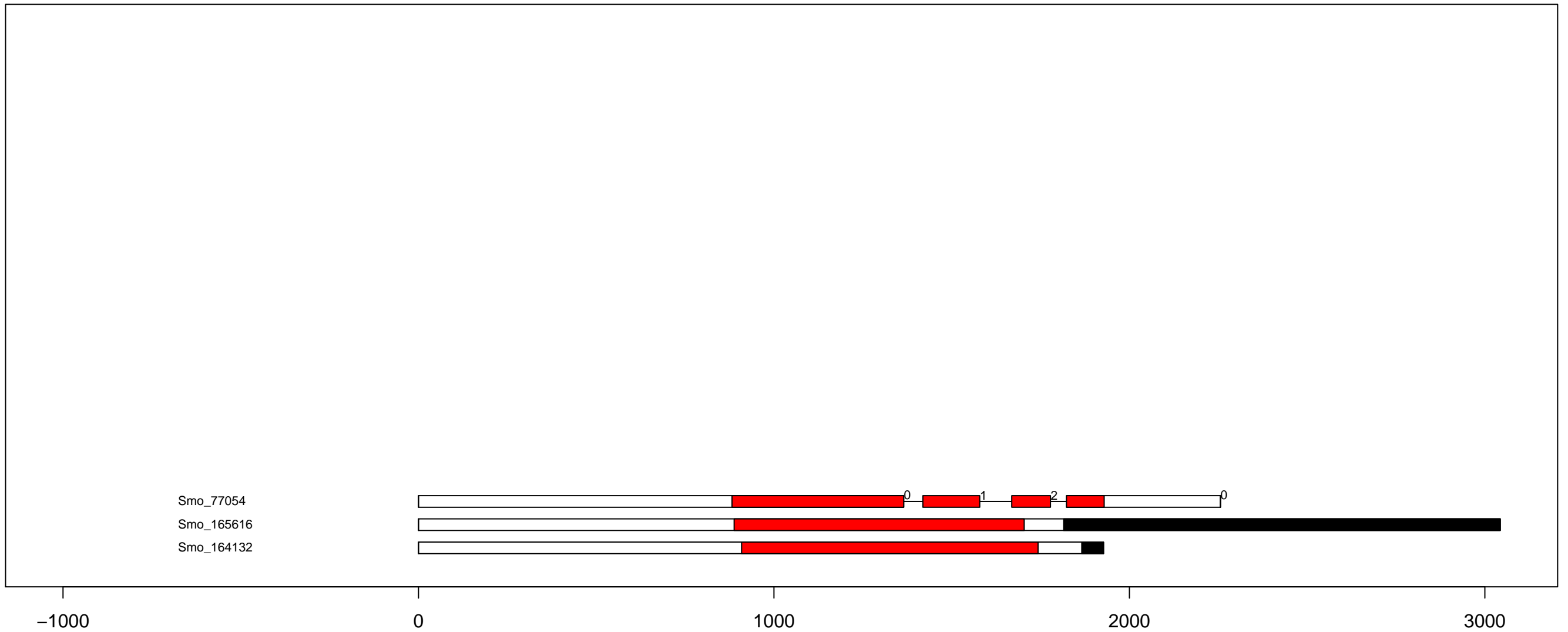

S.mo RLK-Pelle_LRR-Xb-1 exon-intron and kinase domain diagram (all)

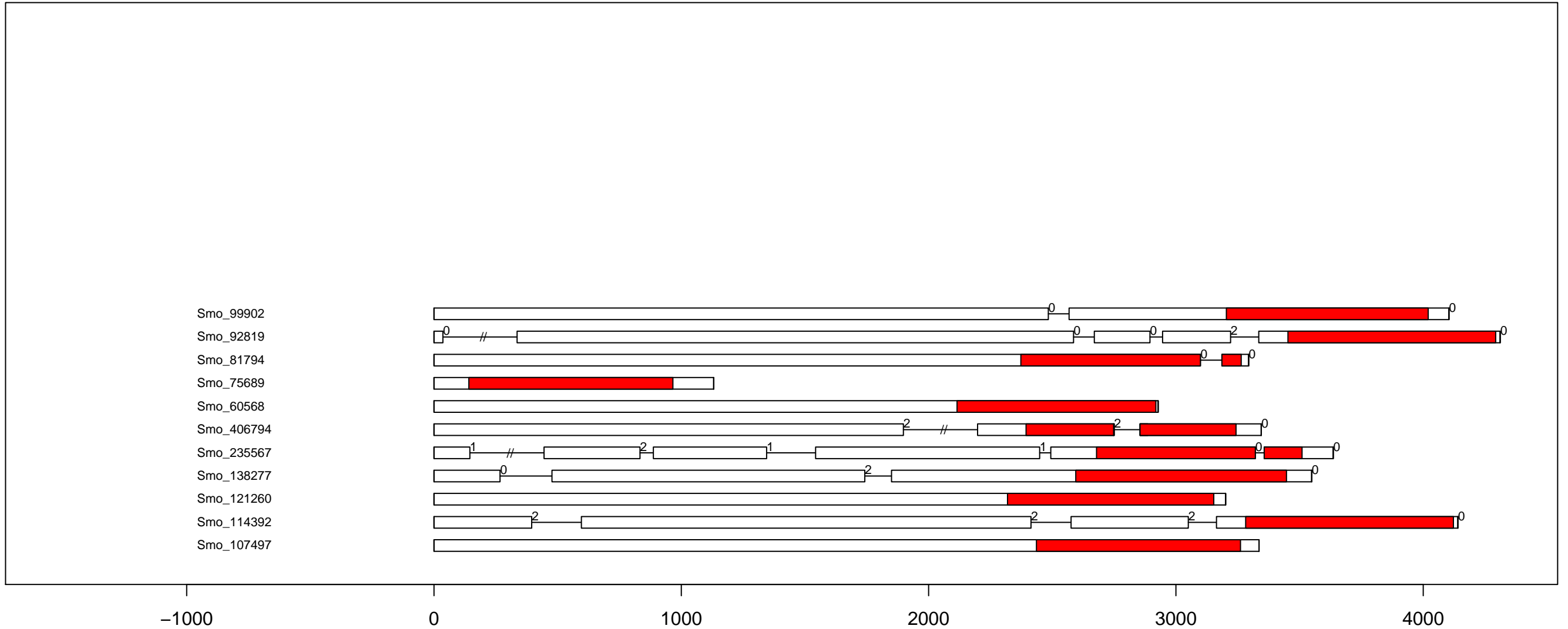

S.mo RLK-Pelle_LRR-XI-2 exon-intron and kinase domain diagram (all)

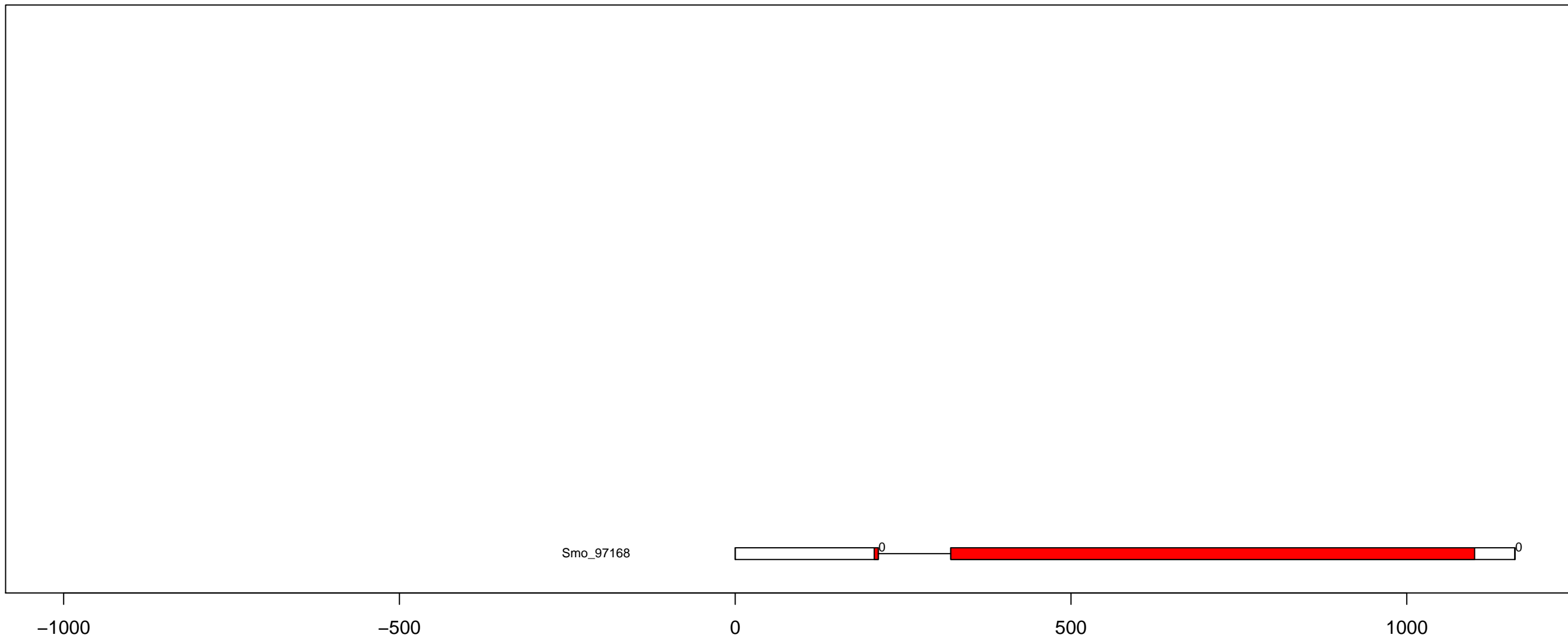

S.mo RLK-Pelle_LRR-XIIIa exon-intron and kinase domain diagram (all)

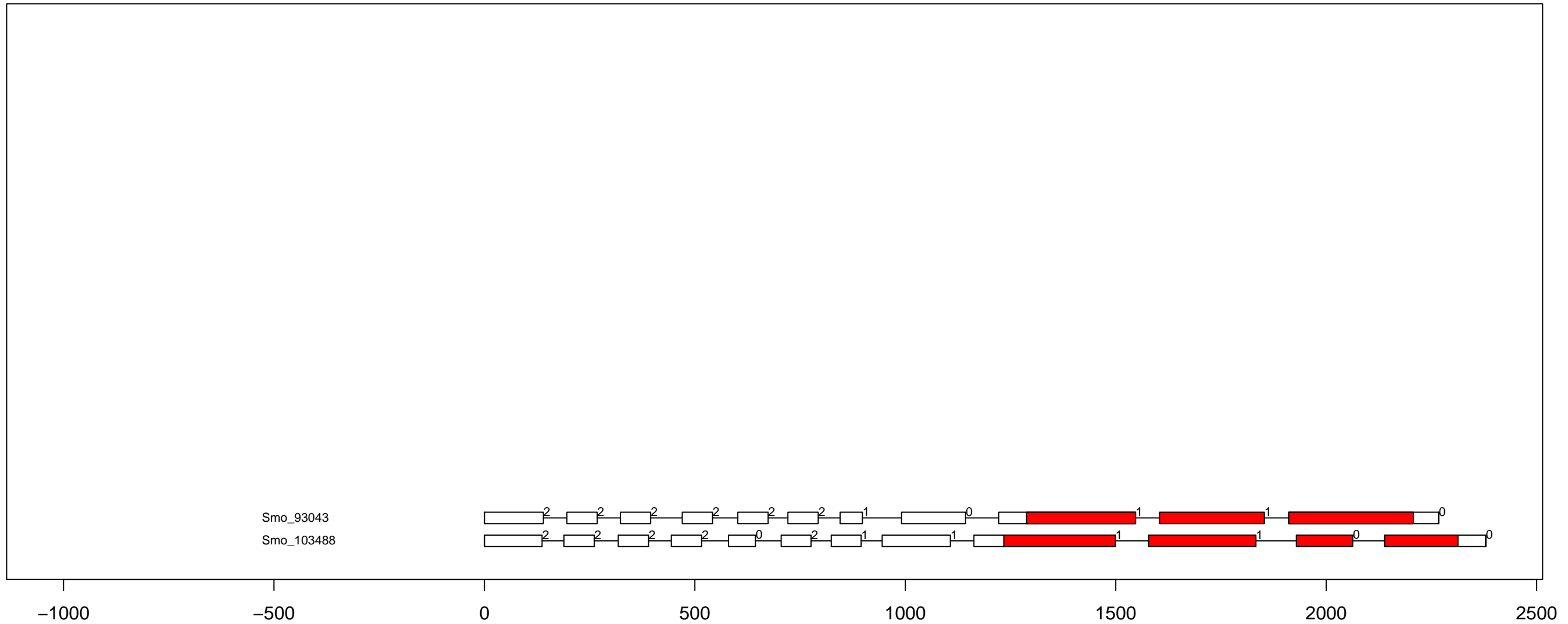

S.mo RLK-Pelle_LRR-XIIIb exon-intron and kinase domain diagram (all)

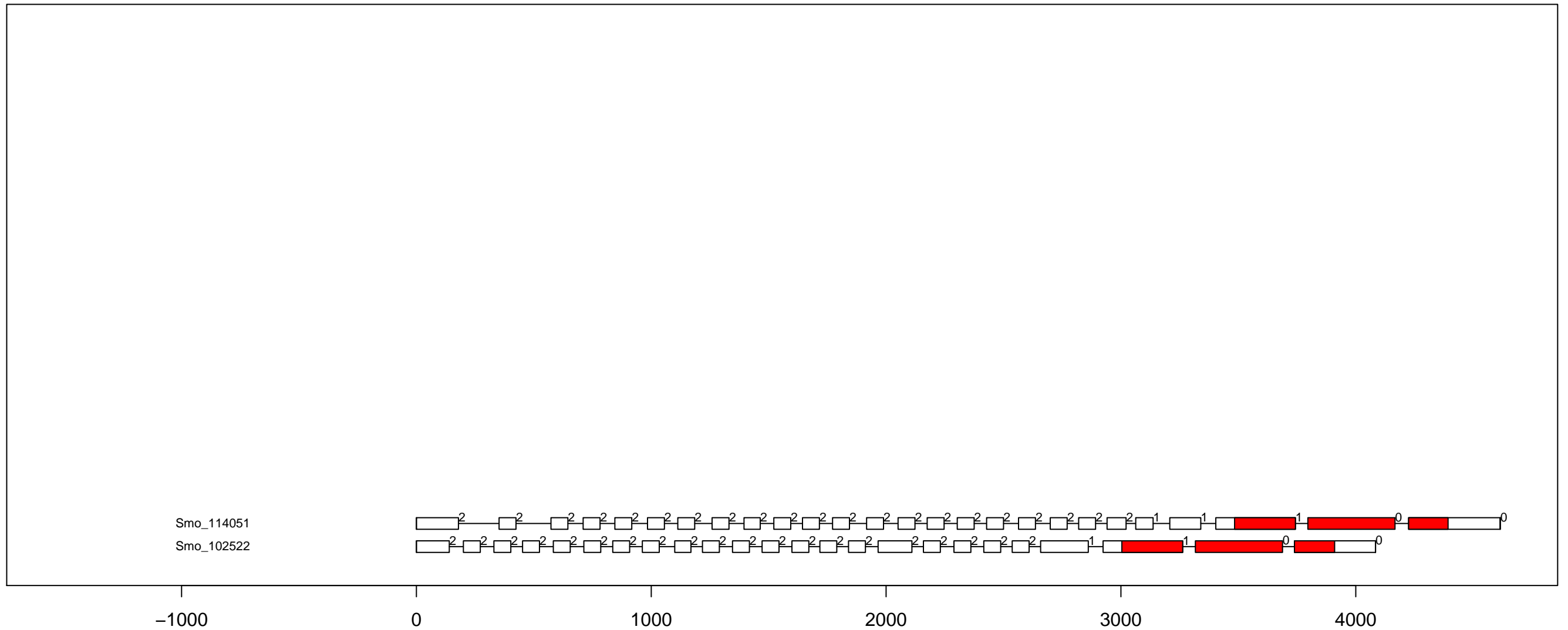

S.mo RLK-Pelle_LRR-XIV exon-intron and kinase domain diagram (all)

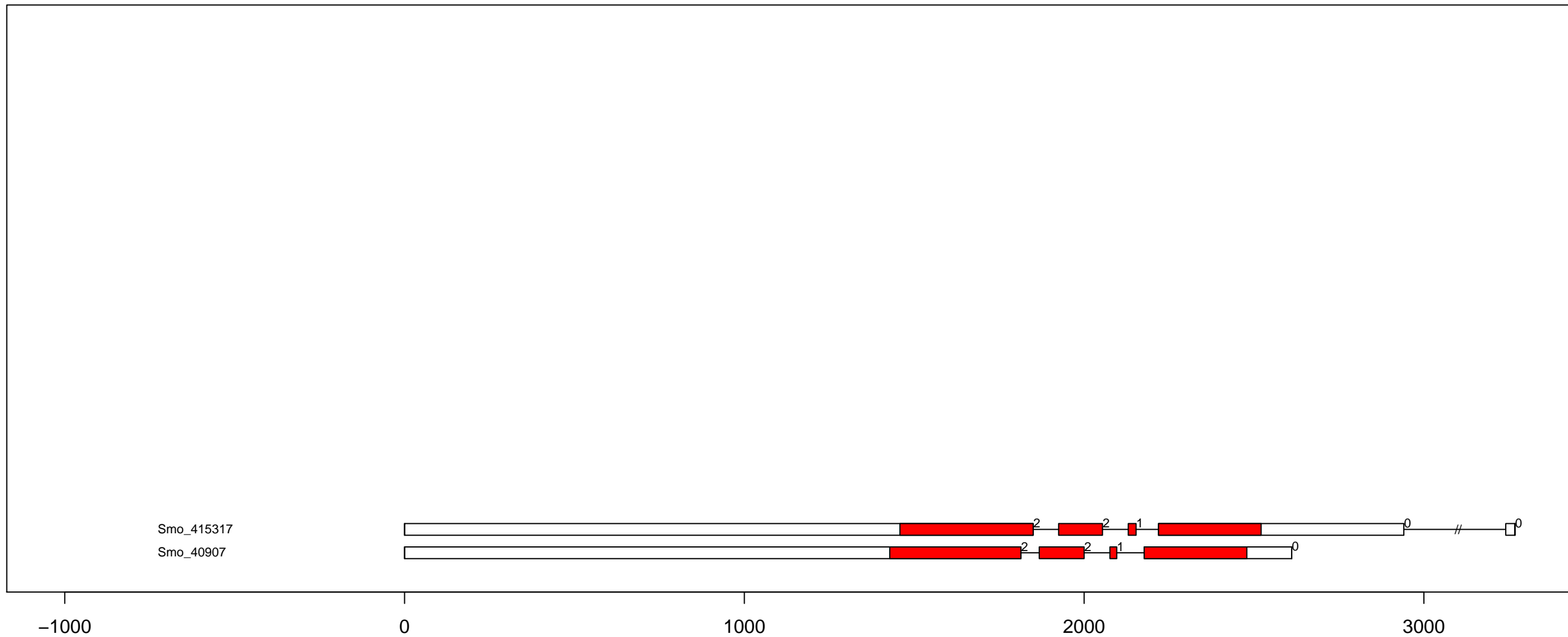

S.mo RLK-Pelle_LRR-XV exon-intron and kinase domain diagram (all)

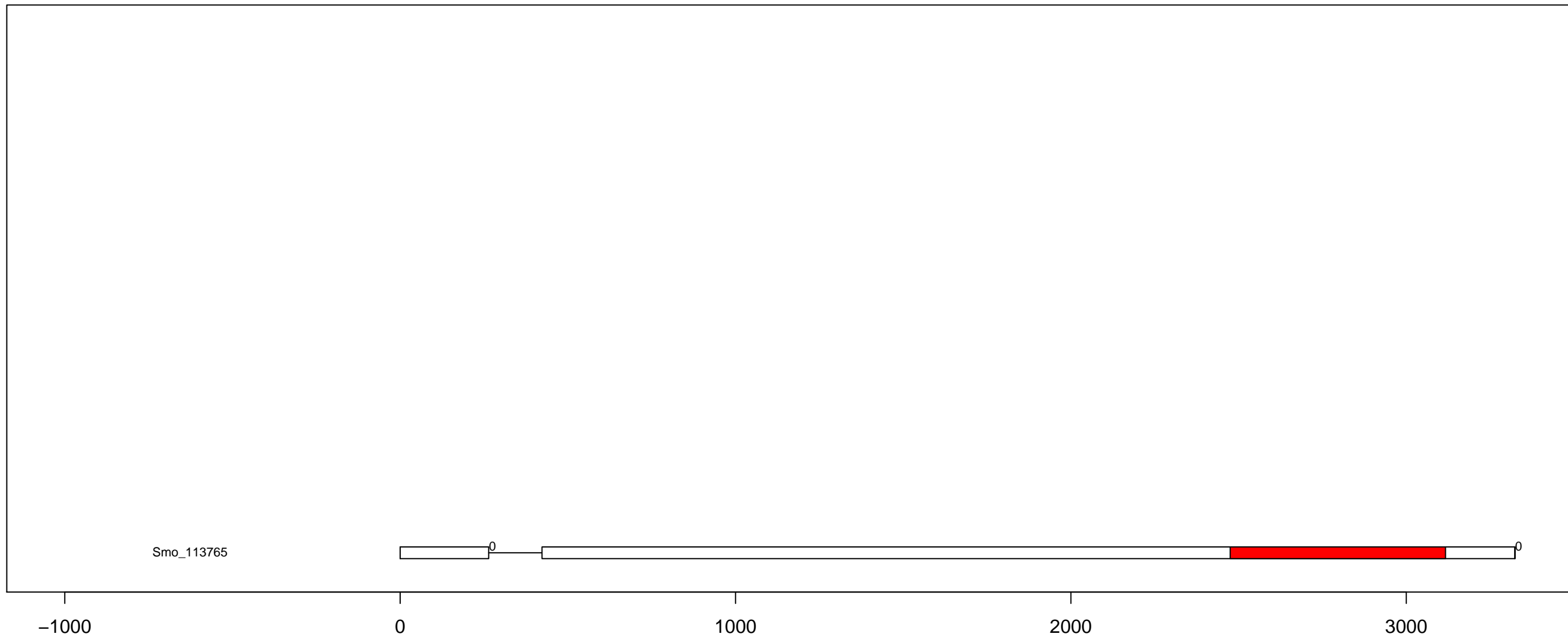

S.mo RLK-Pelle_LysM exon-intron and kinase domain diagram (all)

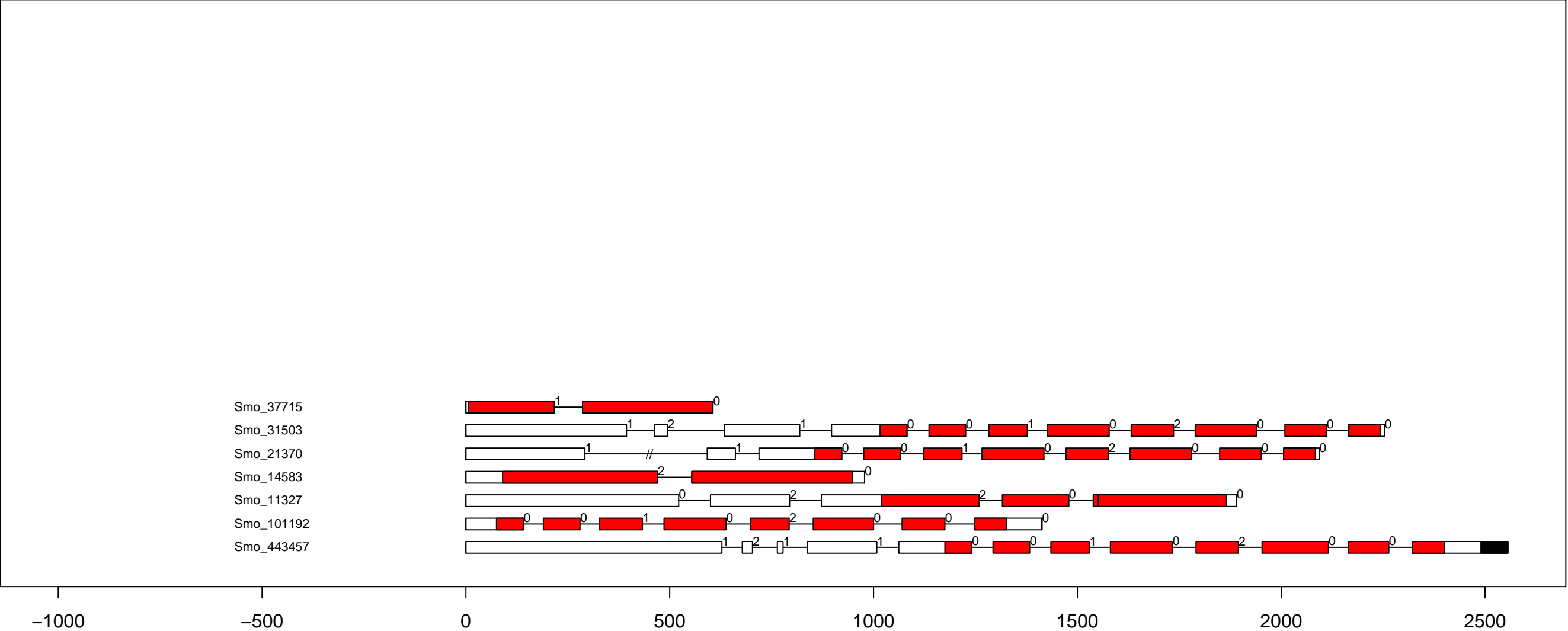

S.mo RLK-Pelle_PERK-2 exon-intron and kinase domain diagram (all)

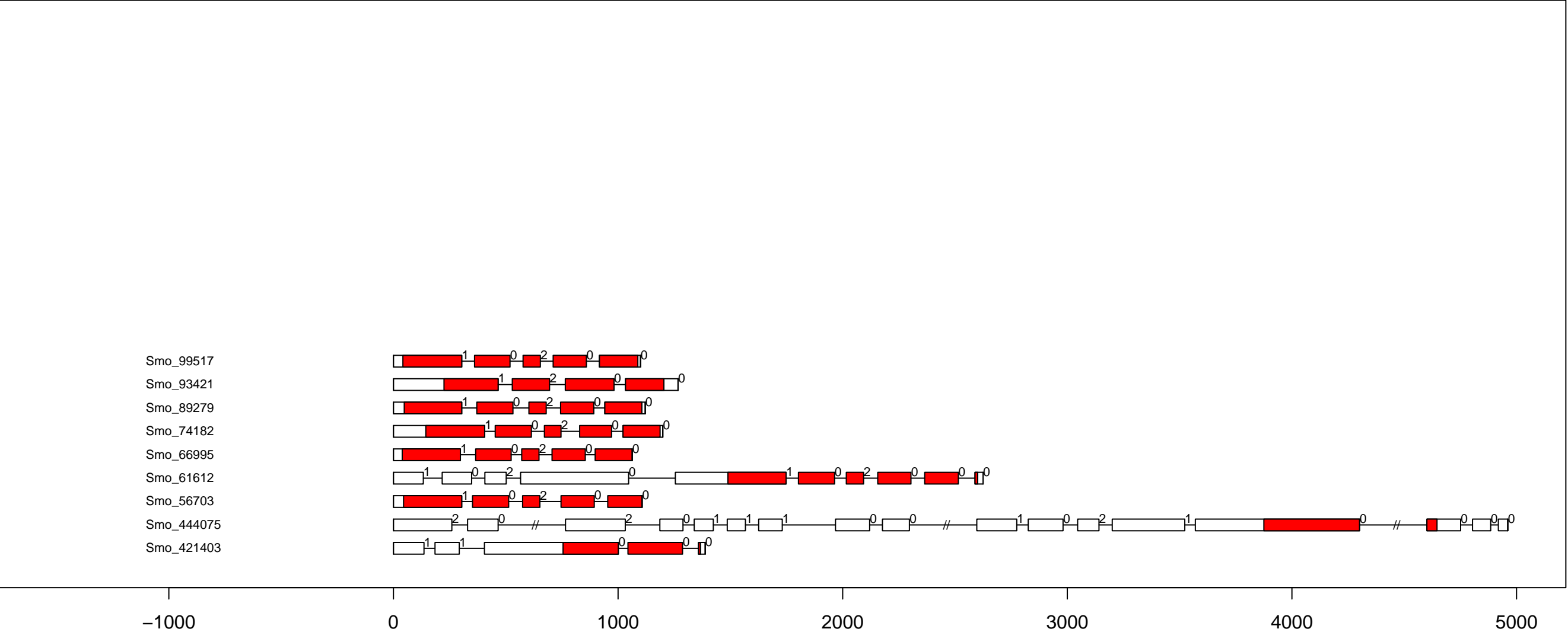

S.mo RLK-Pelle_RKF3 exon-intron and kinase domain diagram (all)

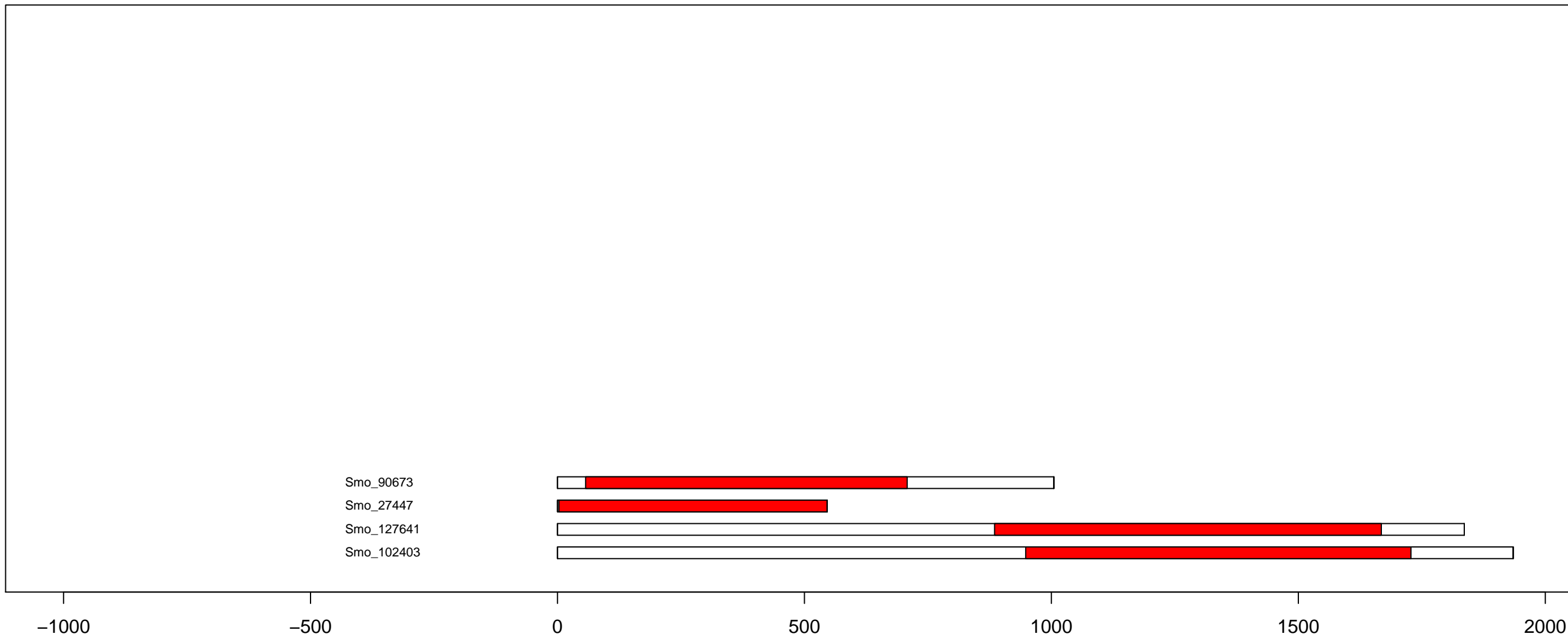

S.mo RLK-Pelle_RLCK-II exon-intron and kinase domain diagram (all)

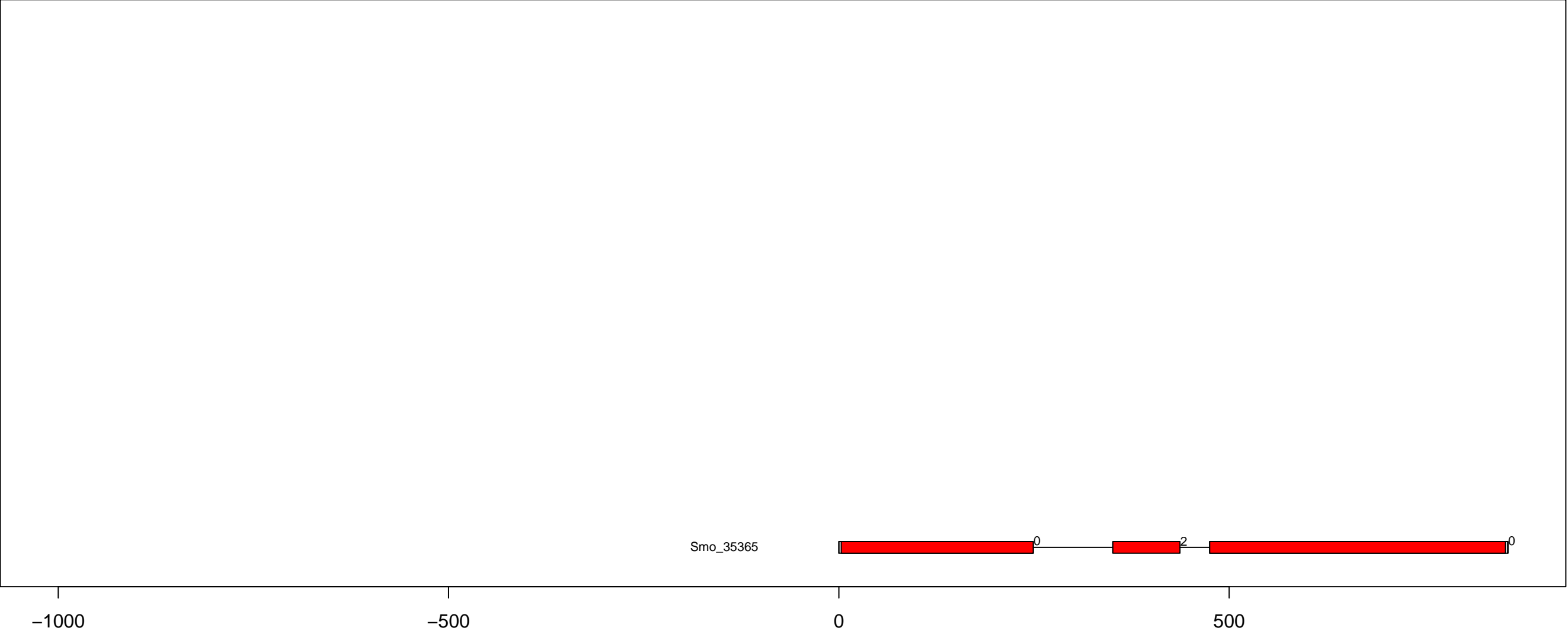

S.mo RLK-Pelle_RLCK-IV exon-intron and kinase domain diagram (all)

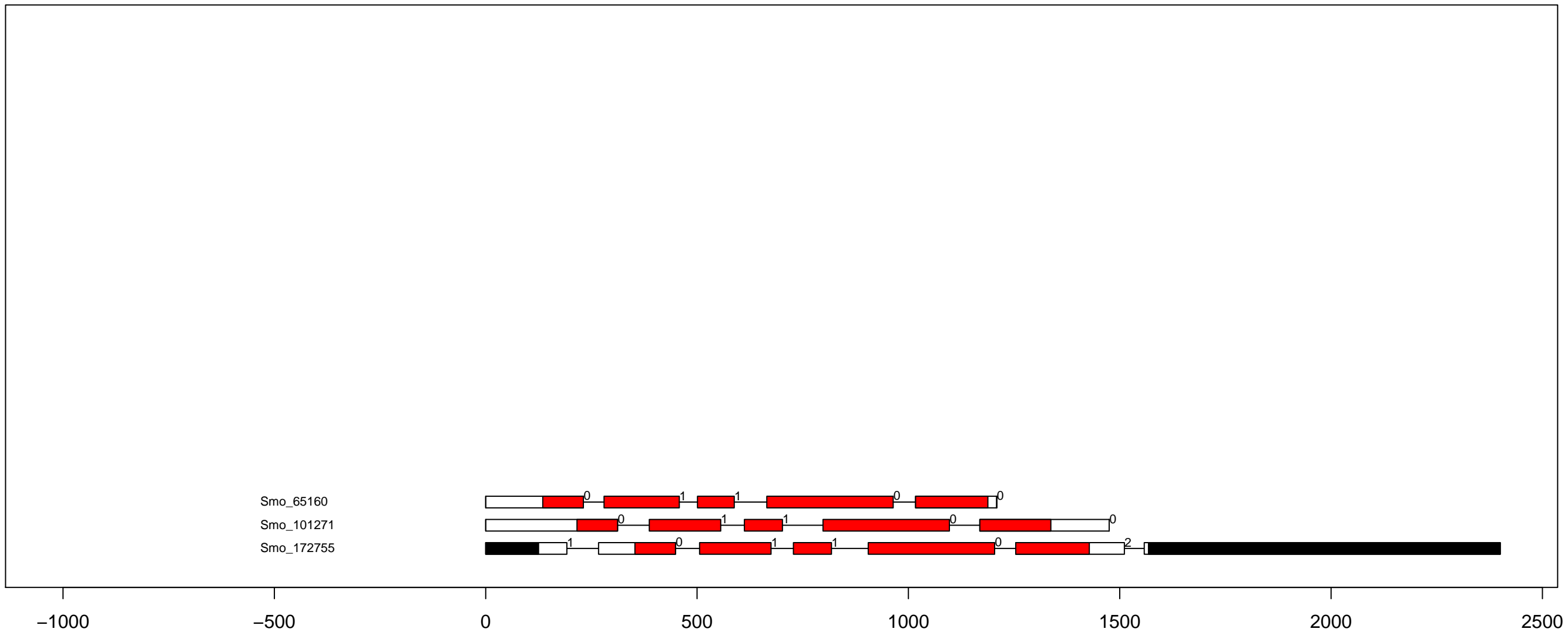

S.mo RLK-Pelle_RLCK-IXa exon-intron and kinase domain diagram (all)

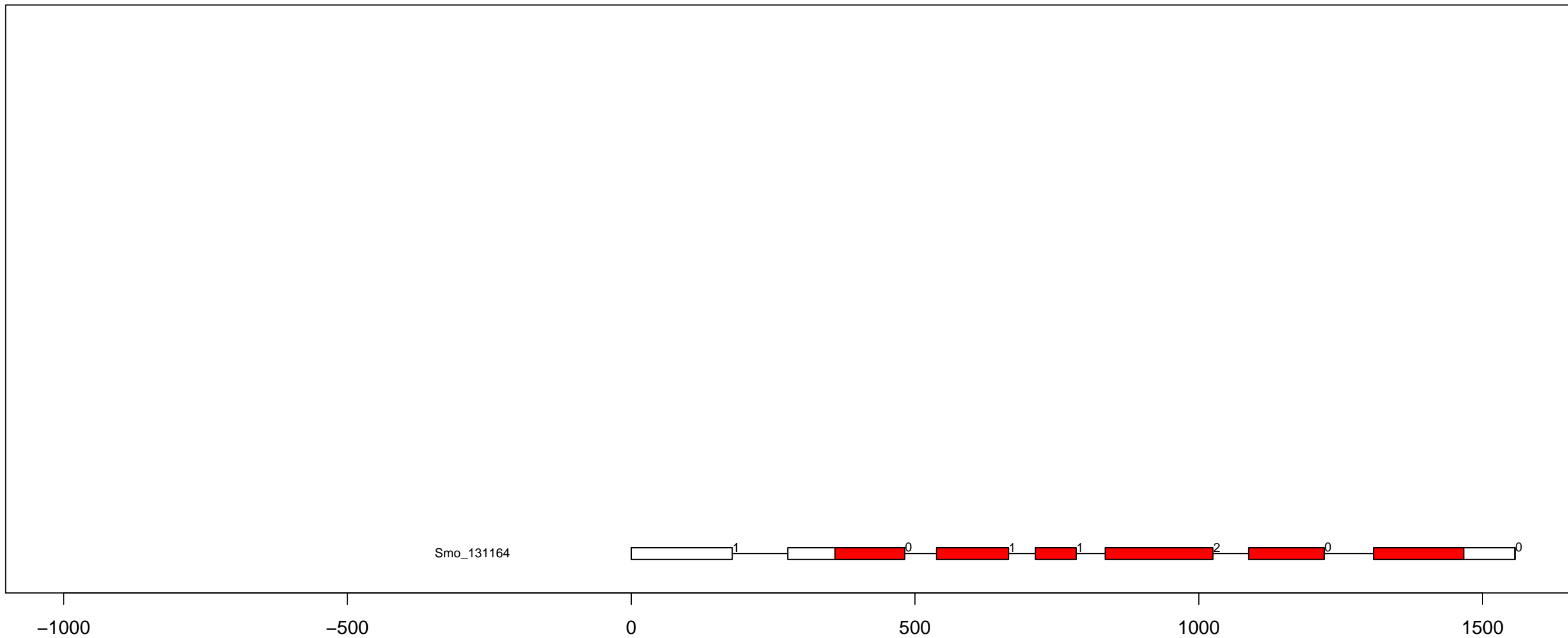

S.mo RLK-Pelle_RLCK-IXb exon-intron and kinase domain diagram (all)

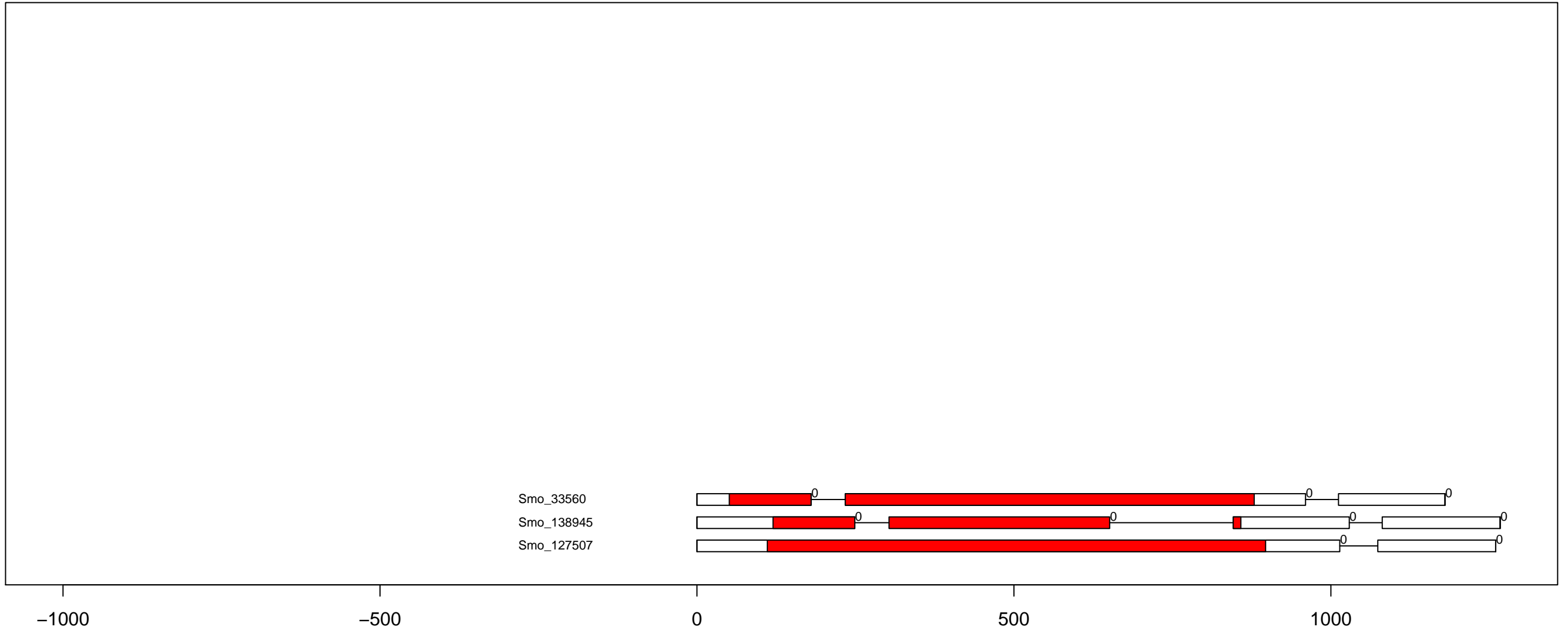

S.mo RLK-Pelle_RLCK-VIIa-1 exon-intron and kinase domain diagram (all)

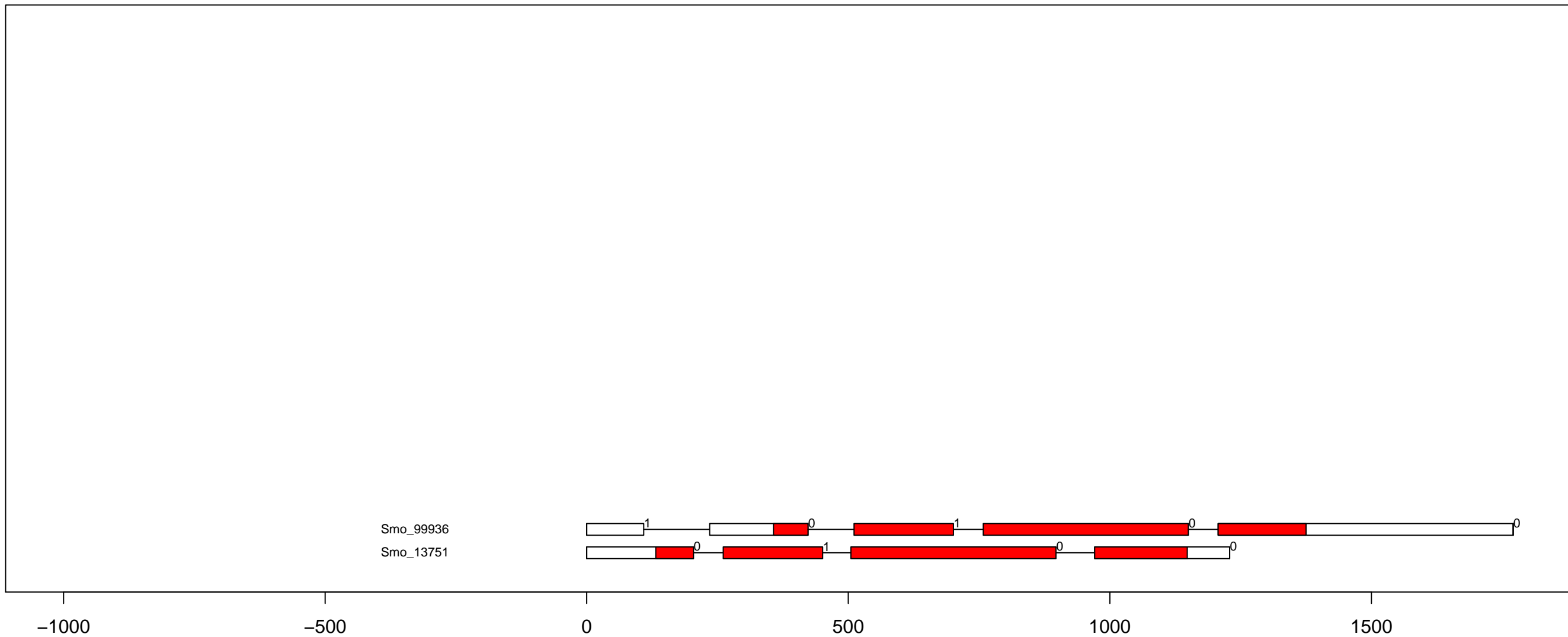

S.mo RLK-Pelle_RLCK-VIIa-2 exon-intron and kinase domain diagram (all)

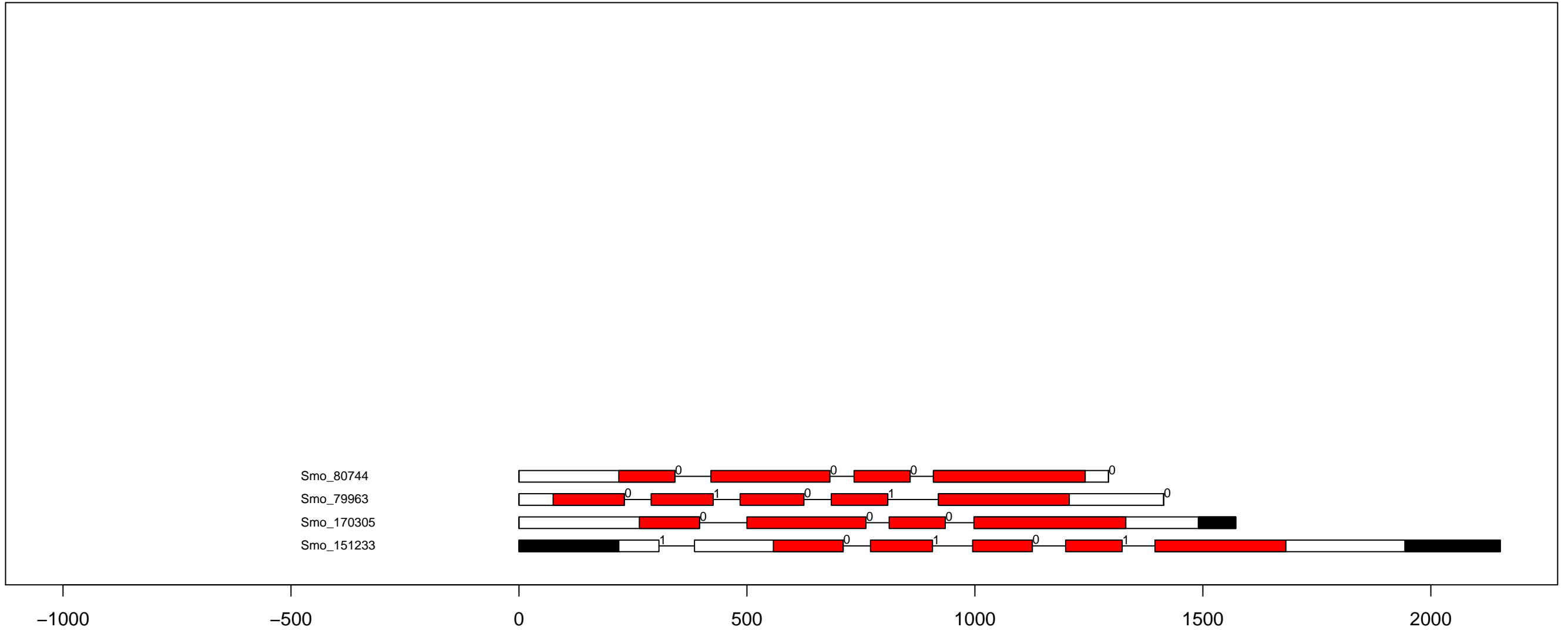

S.mo RLK-Pelle_RLCK-VIIb exon-intron and kinase domain diagram (all)

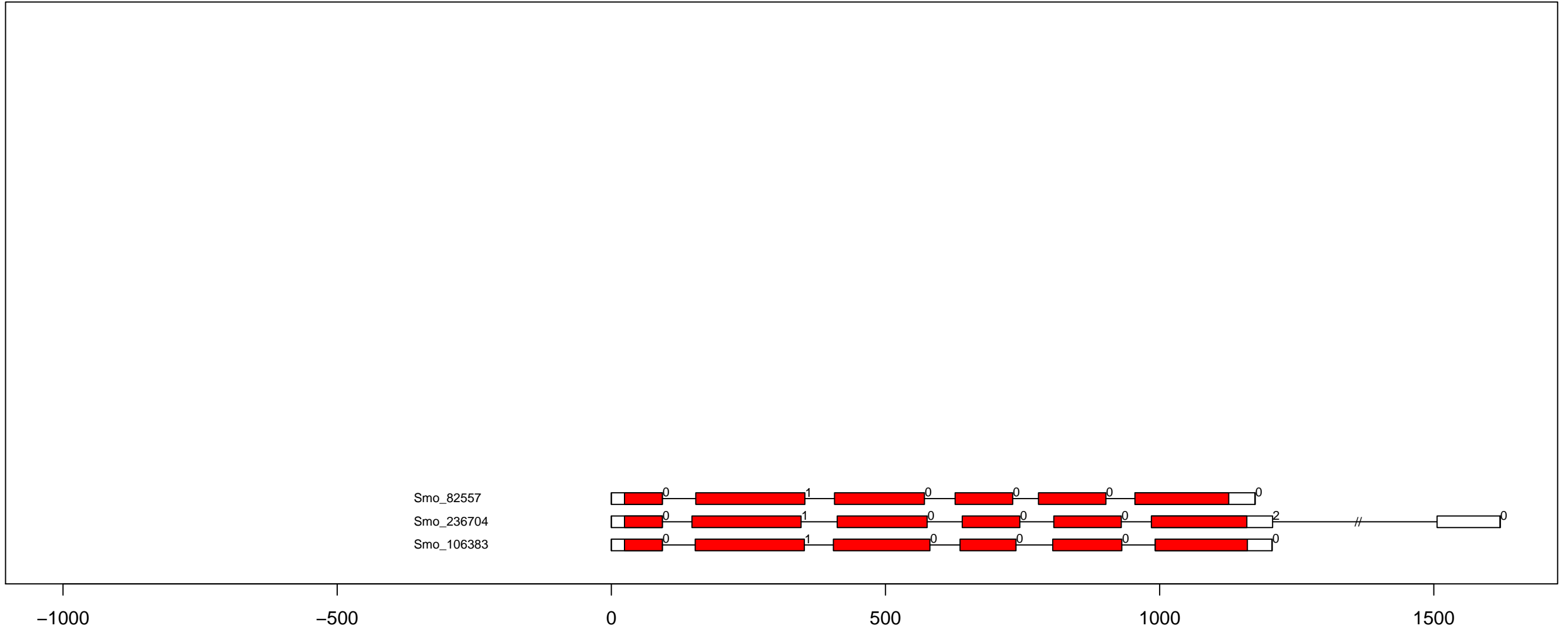

S.mo RLK-Pelle_RLCK-VIII exon-intron and kinase domain diagram (all)

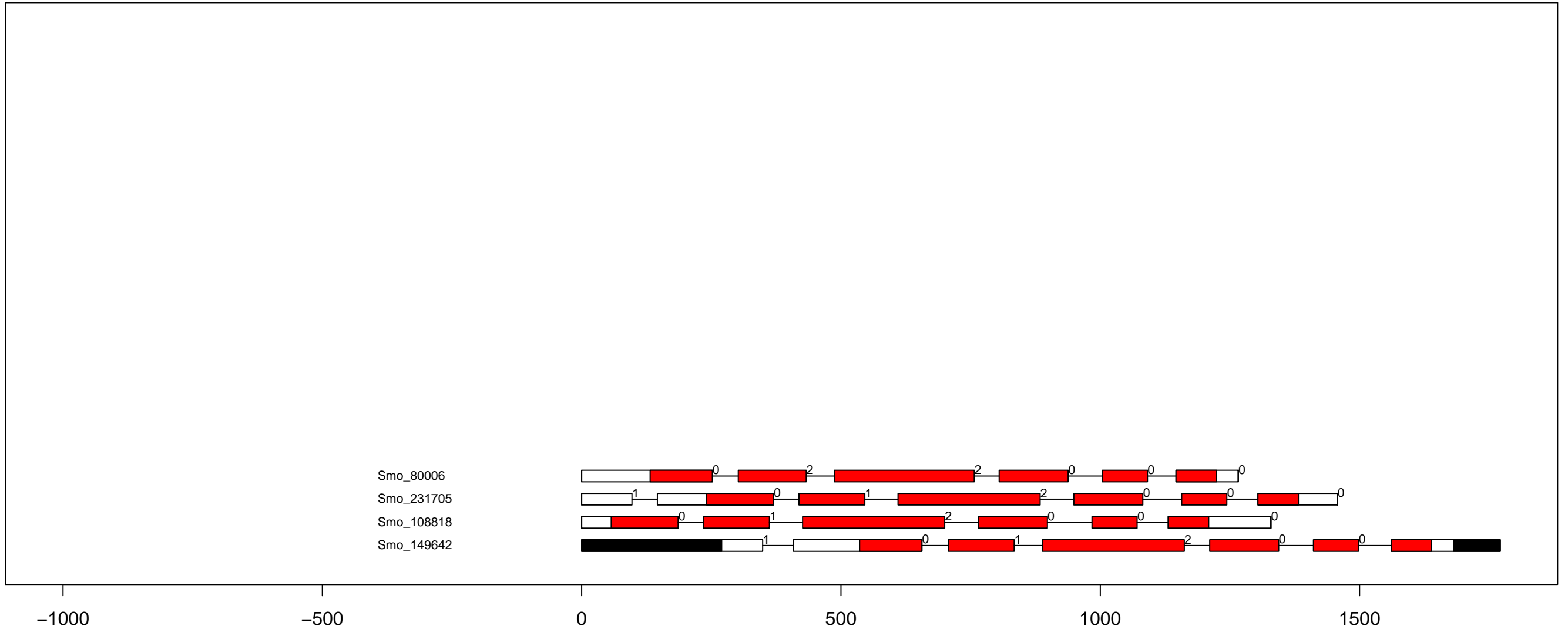

S.mo RLK-Pelle_RLCK-VI exon-intron and kinase domain diagram (all)

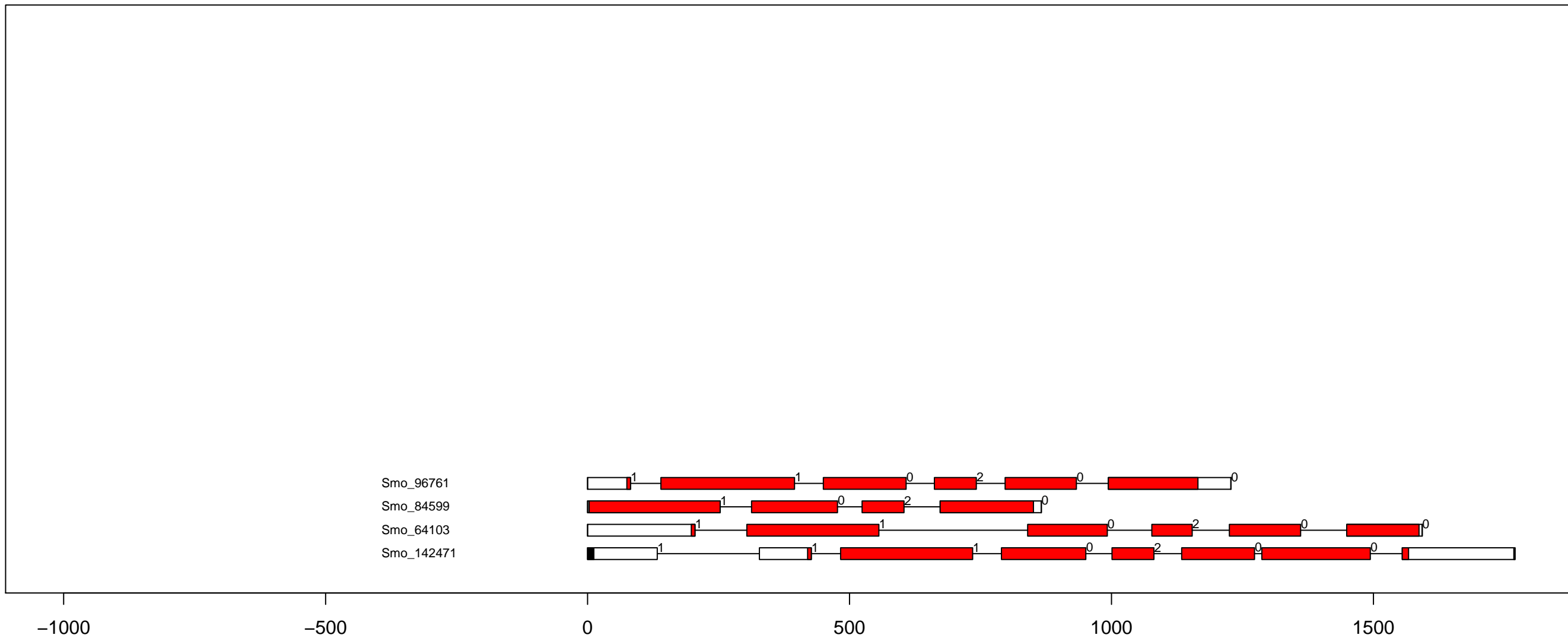

S.mo RLK-Pelle_RLCK-V exon-intron and kinase domain diagram (all)

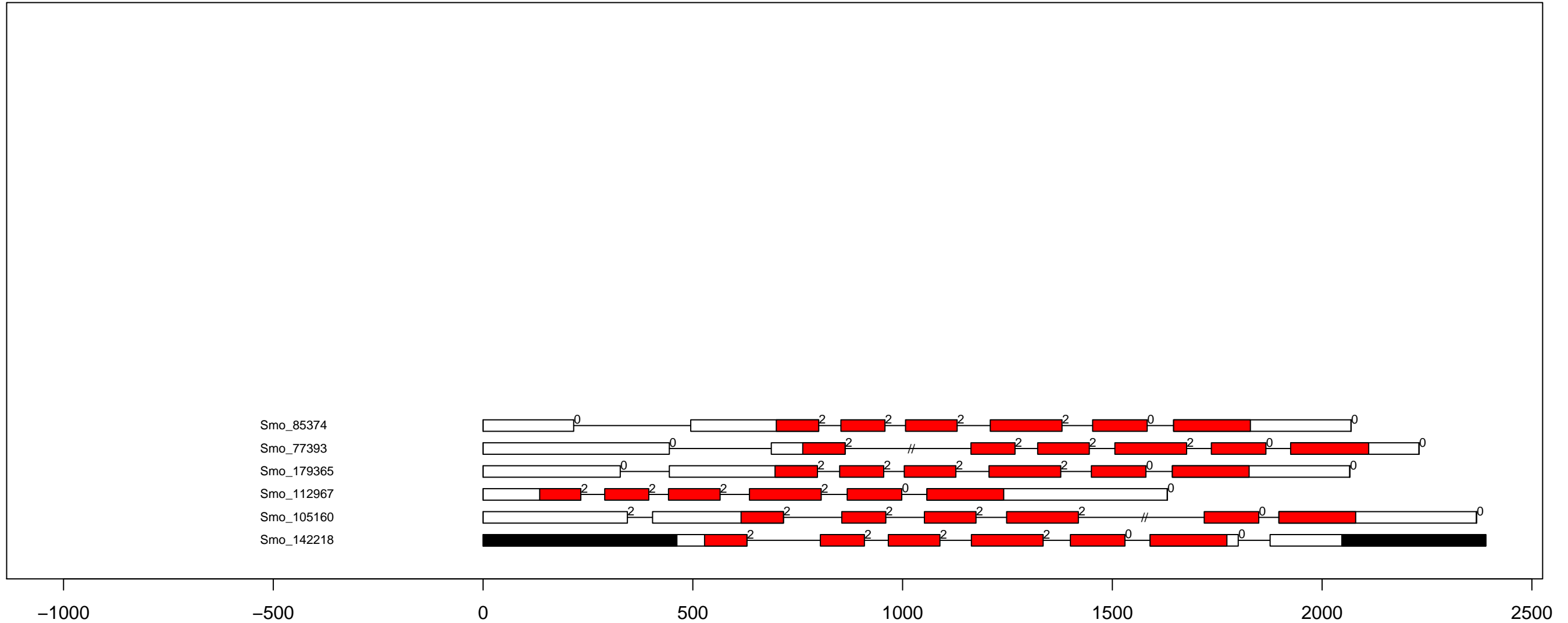

S.mo RLK-Pelle_RLCK-XII-1 exon-intron and kinase domain diagram (all)

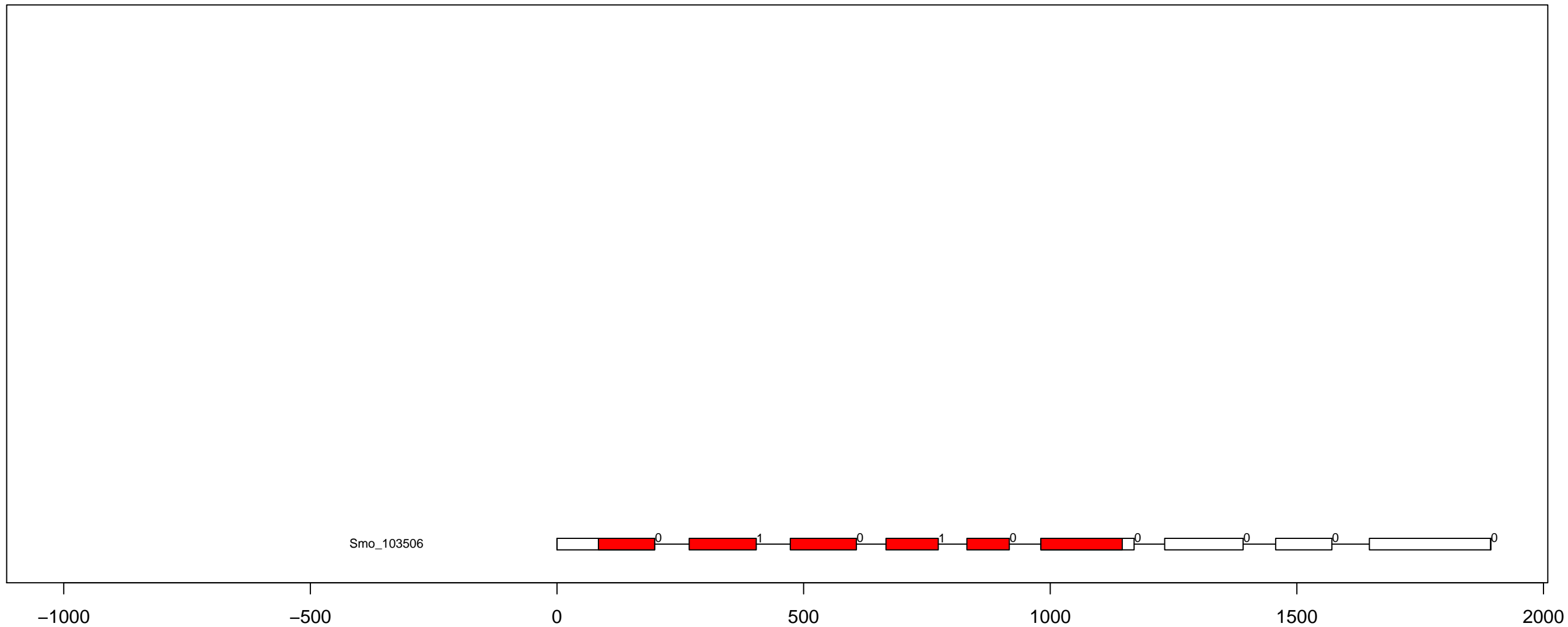

S.mo RLK-Pelle_RLCK-XI exon-intron and kinase domain diagram (all)

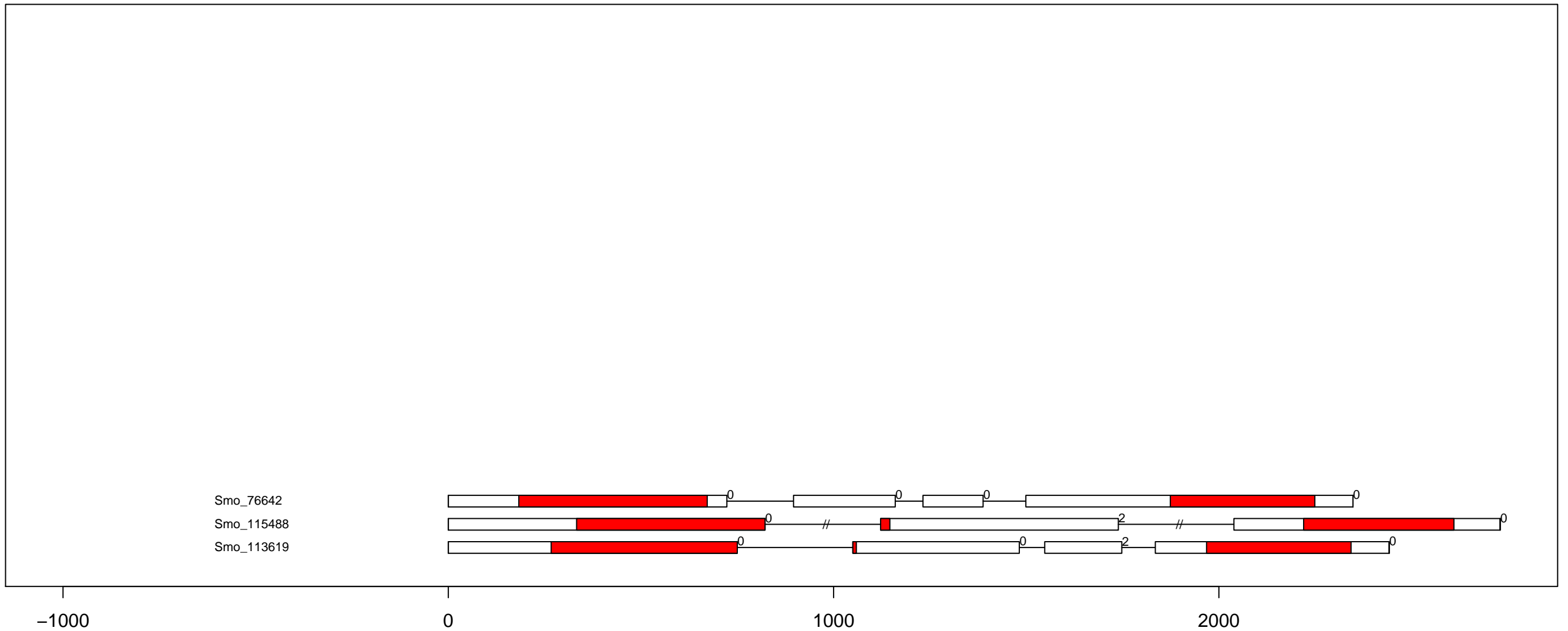

S.mo RLK-Pelle_RLCK-X exon-intron and kinase domain diagram (all)

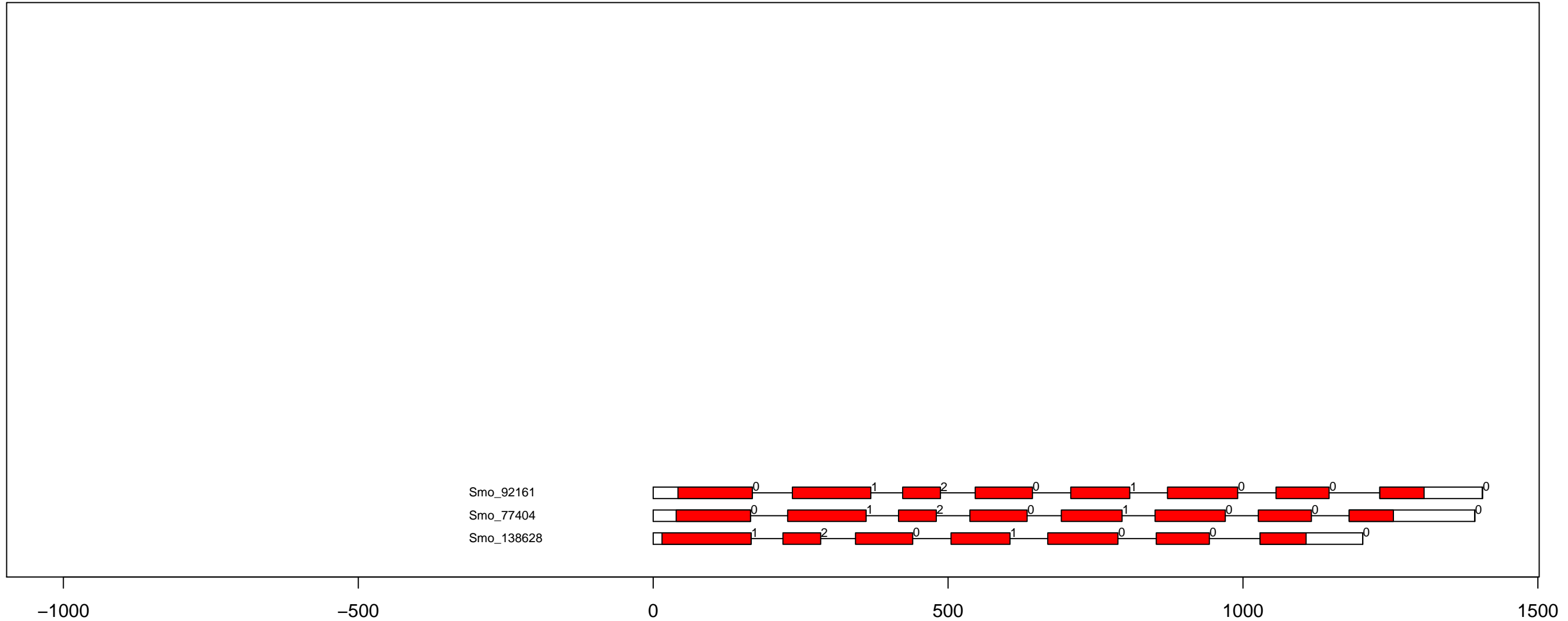

S.mo RLK-Pelle_SD-2b exon-intron and kinase domain diagram (part 1)

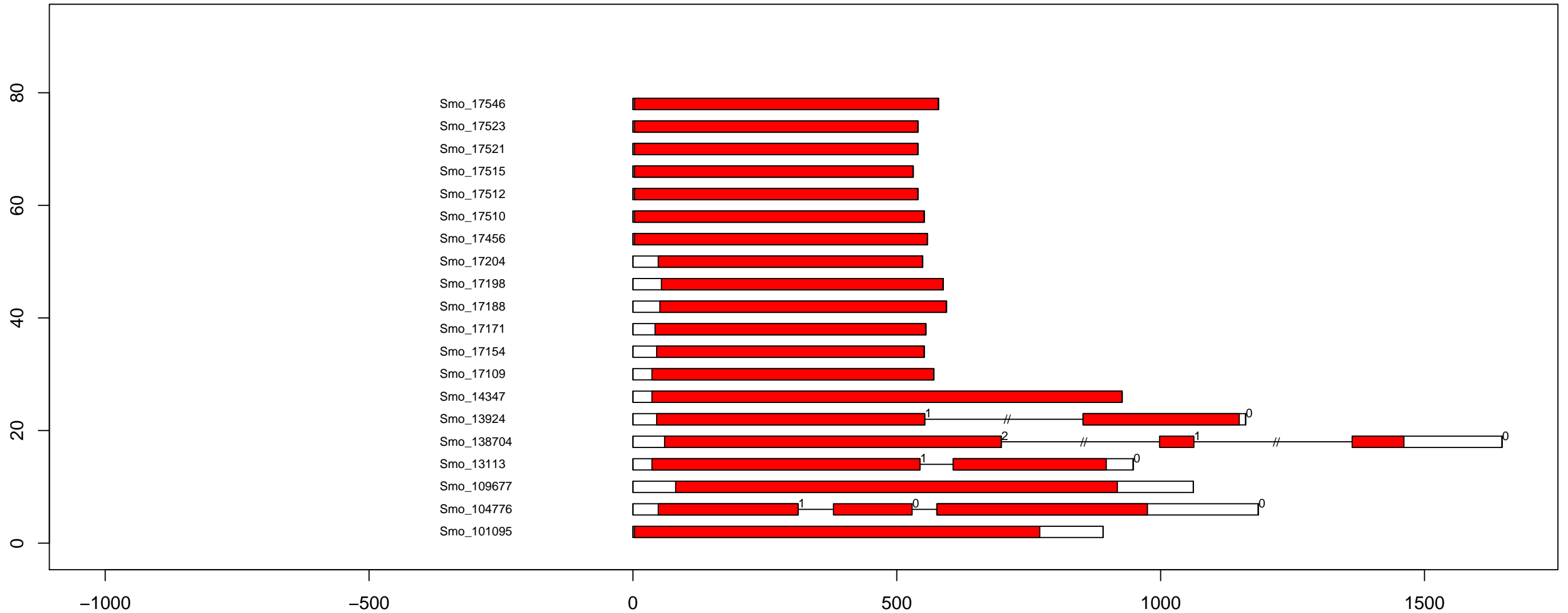

S.mo RLK-Pelle_SD-2b exon-intron and kinase domain diagram (part 2)

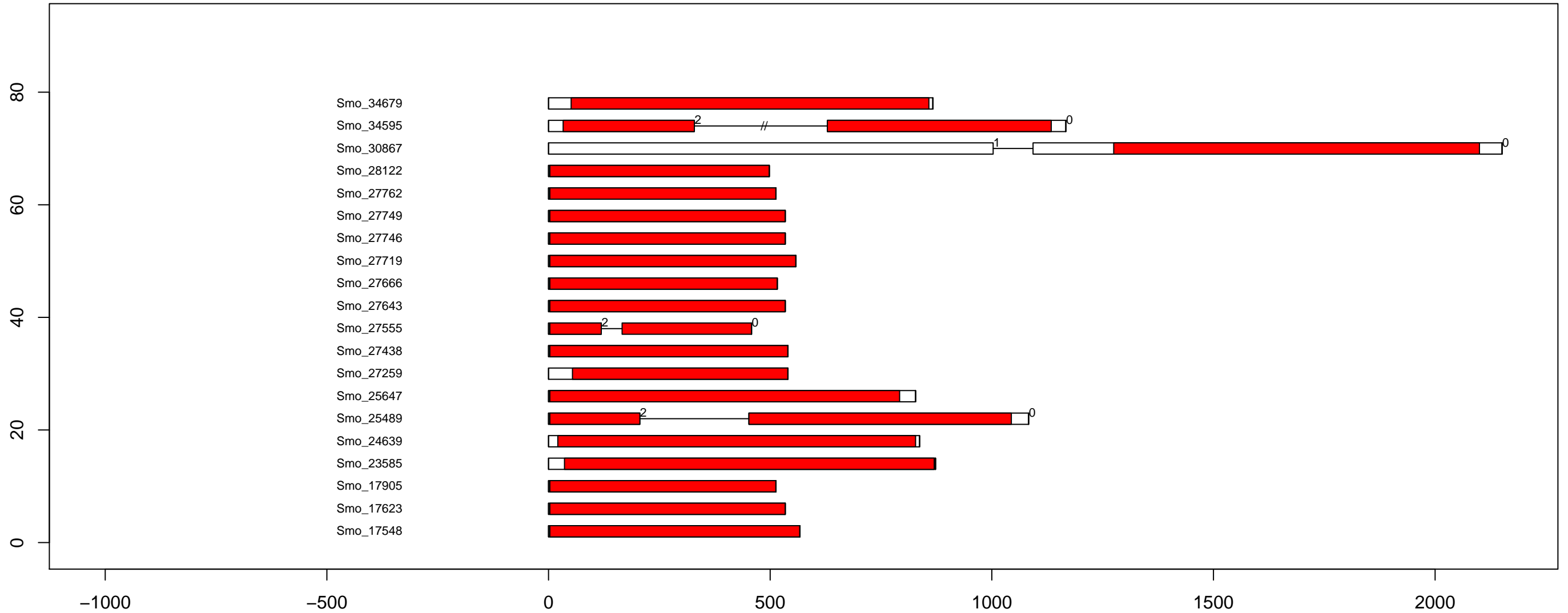

S.mo RLK-Pelle_SD-2b exon-intron and kinase domain diagram (part 4)

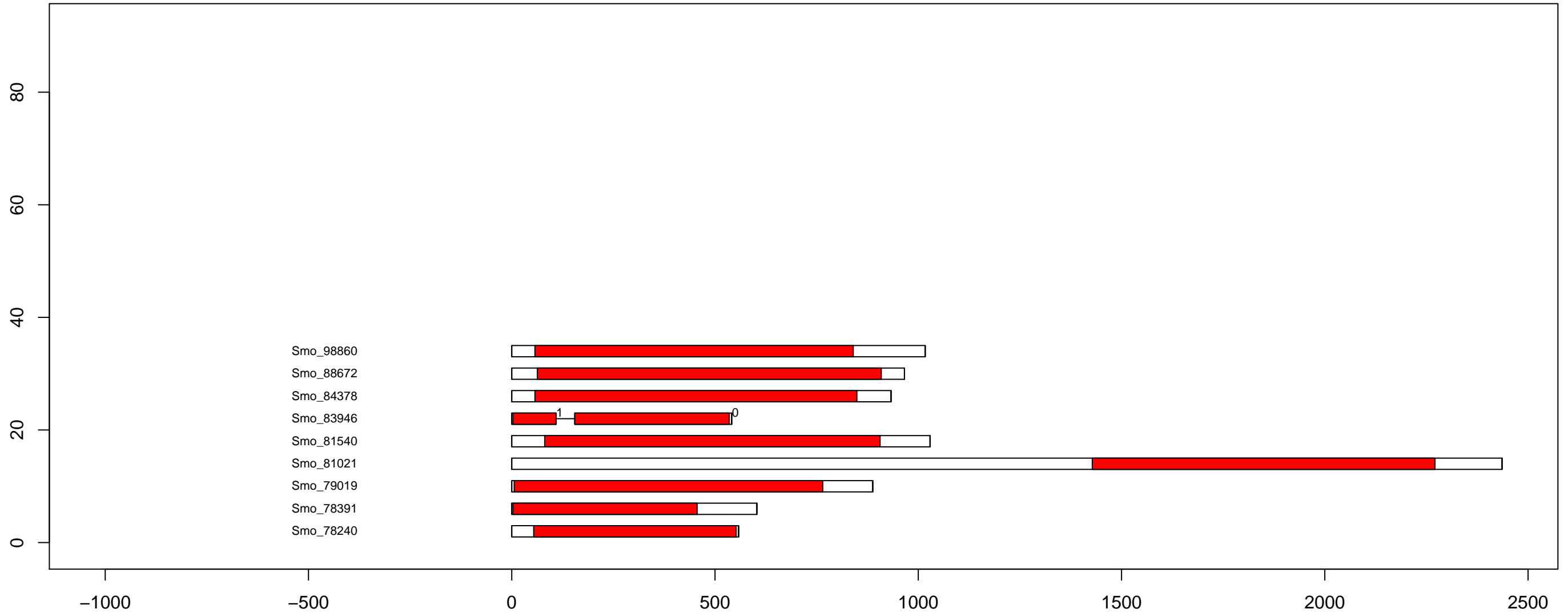

S.mo RLK-Pelle_URK-1 exon-intron and kinase domain diagram (all)

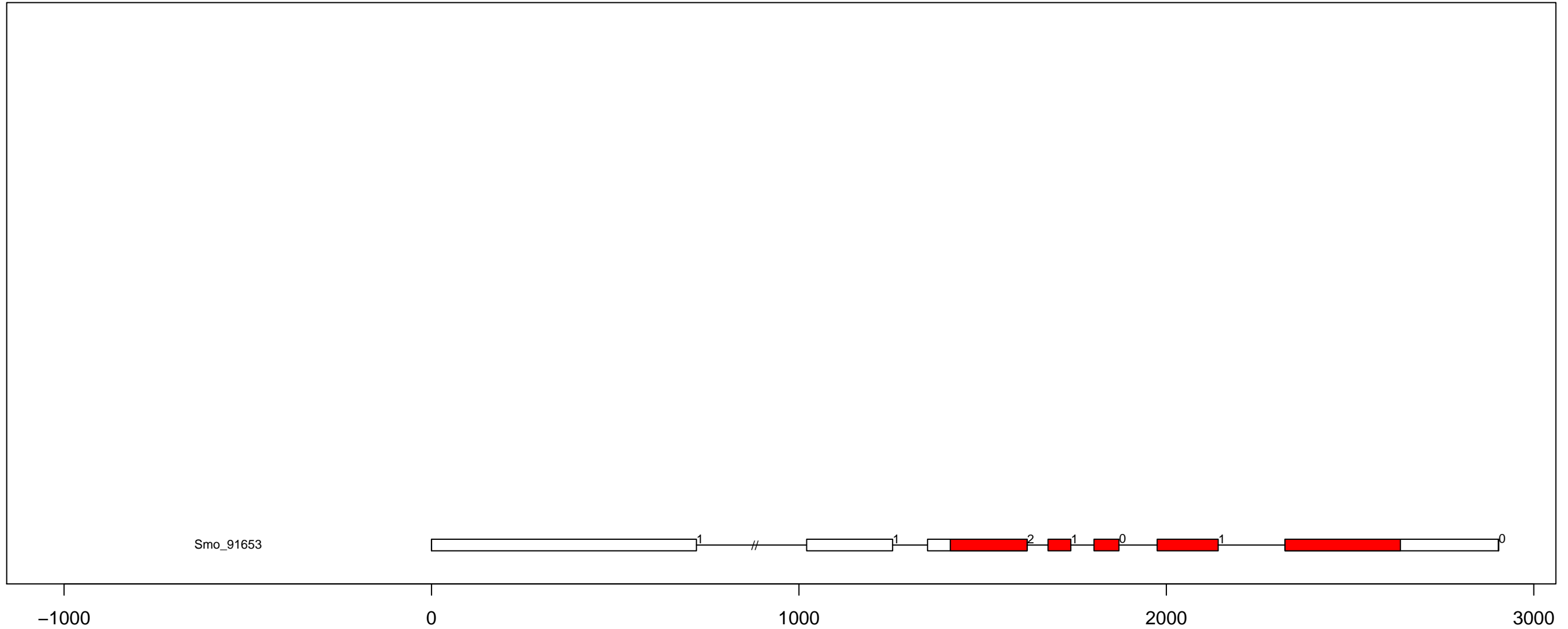

S.mo RLK-Pelle_URK-2 exon-intron and kinase domain diagram (all)

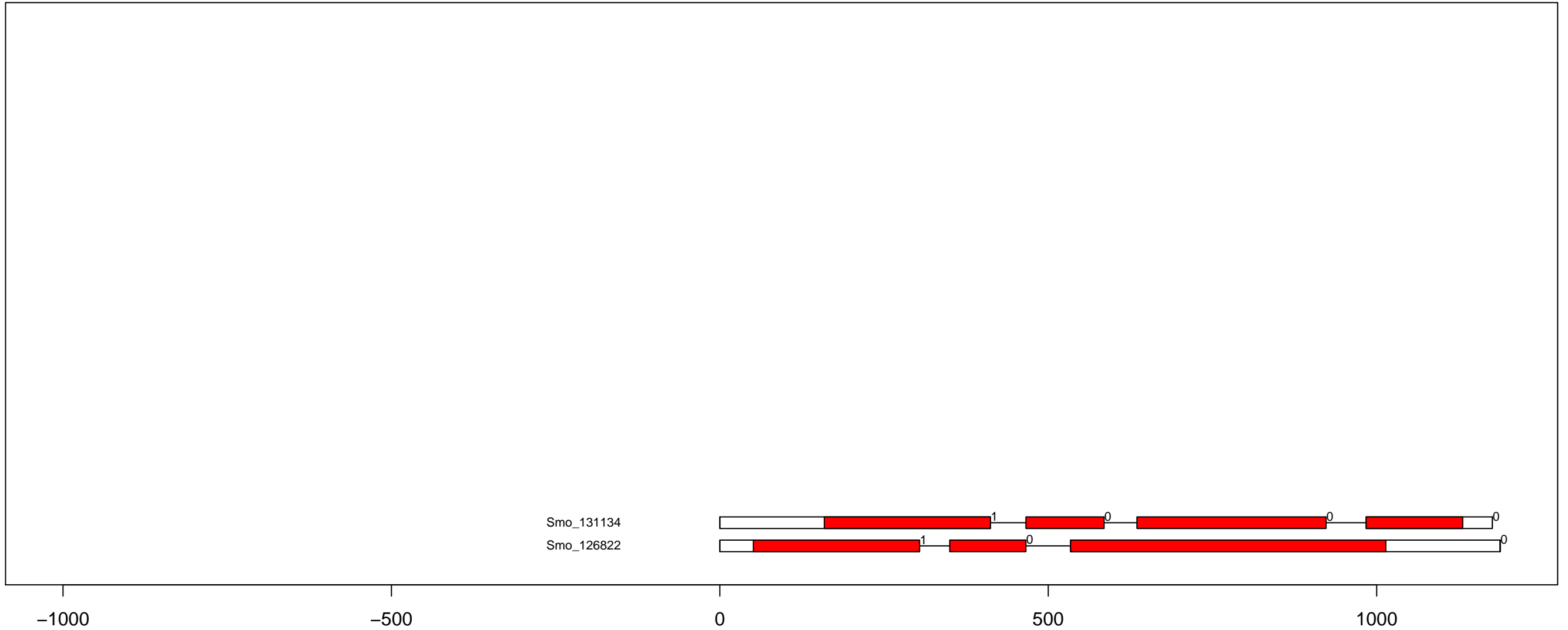

S.mo RLK-Pelle_URK-Pp-1 exon-intron and kinase domain diagram (all)

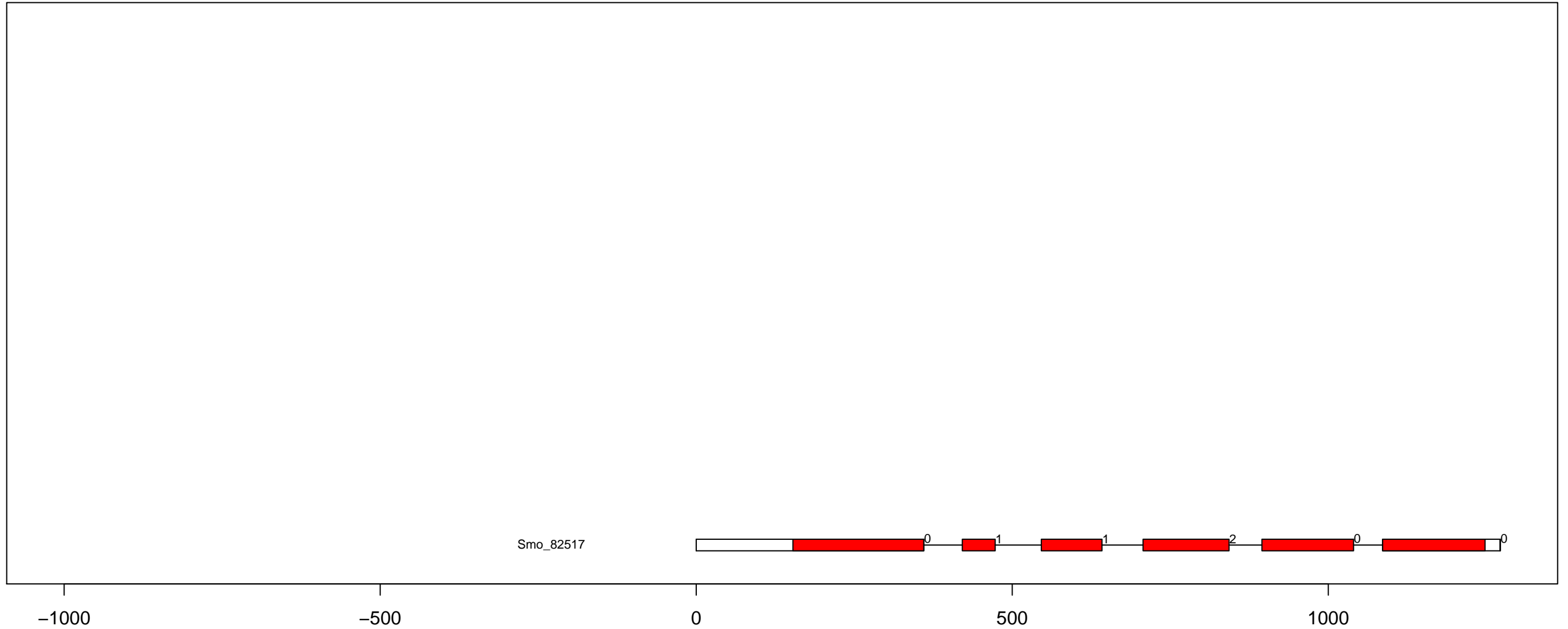

S.mo RLK-Pelle_WAK_LRK10L-1 exon-intron and kinase domain diagram (all)

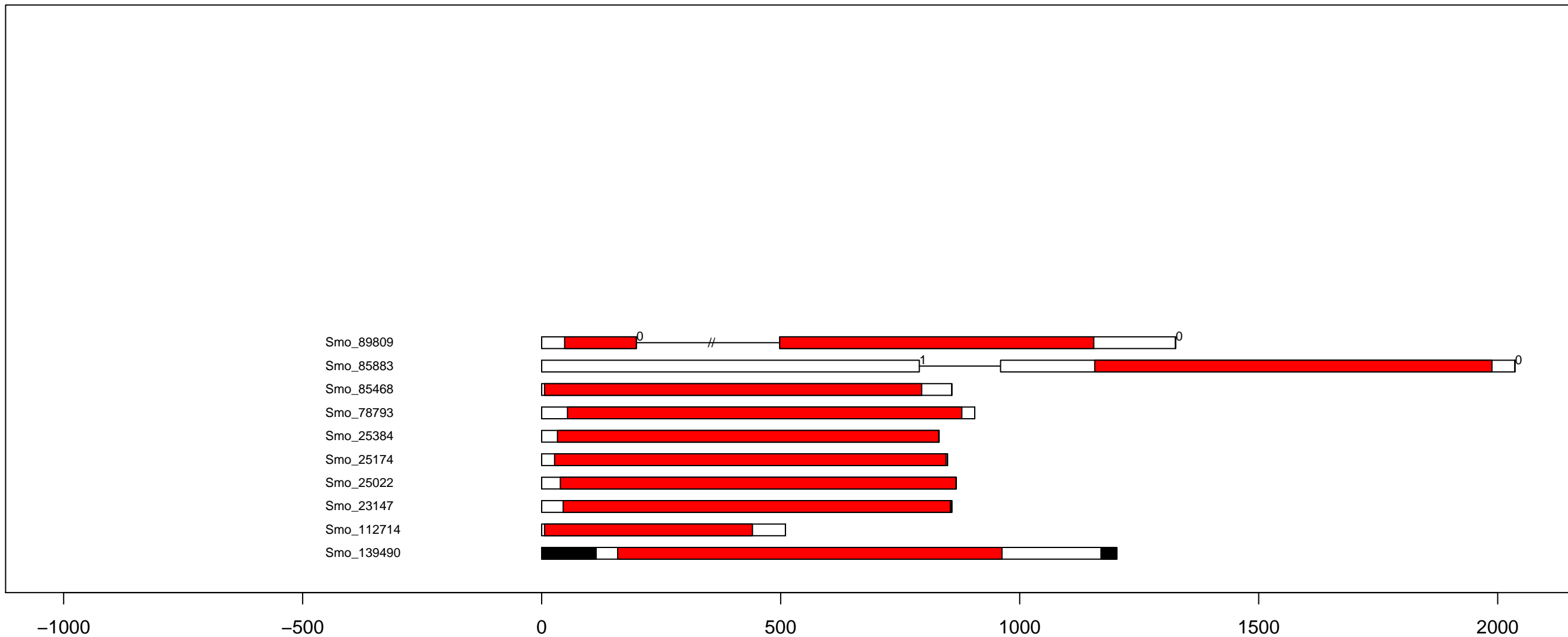

S.mo RLK-Pelle_WAK exon-intron and kinase domain diagram (all)

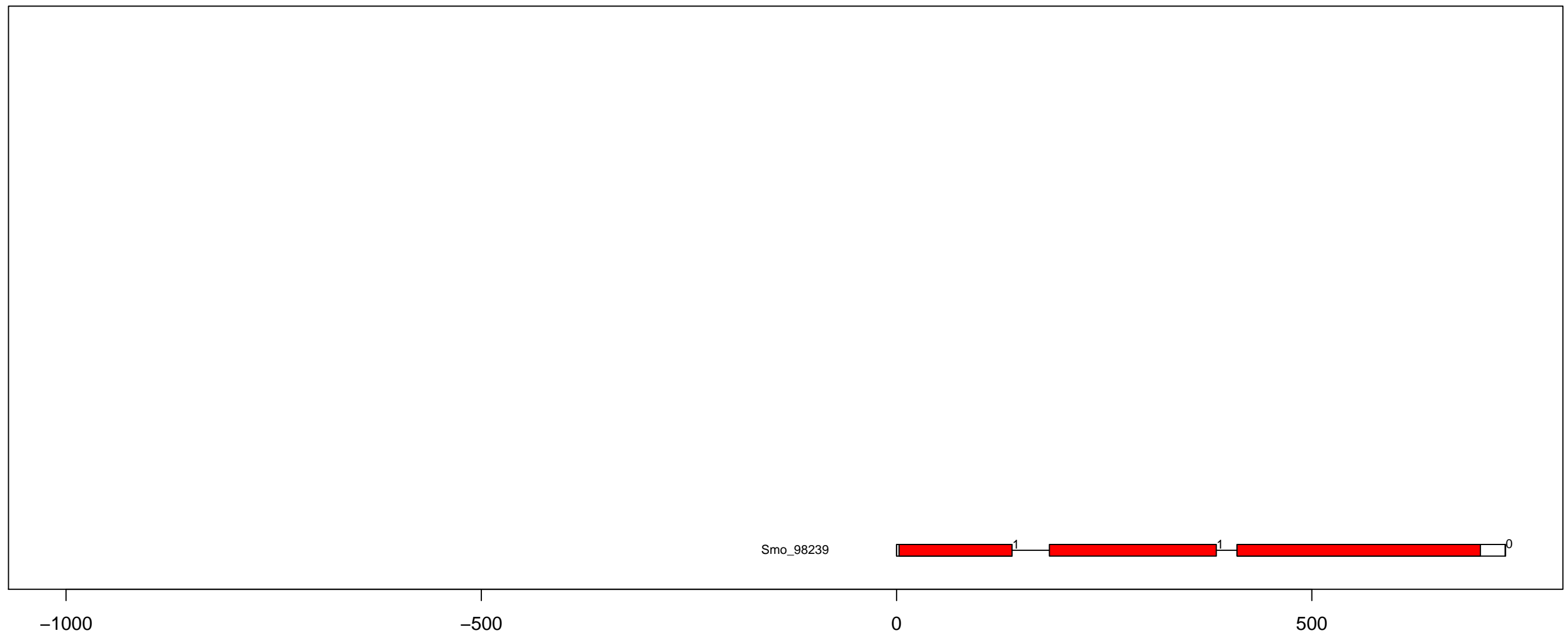

S.mo SCY1_SCYL1 exon-intron and kinase domain diagram (all)

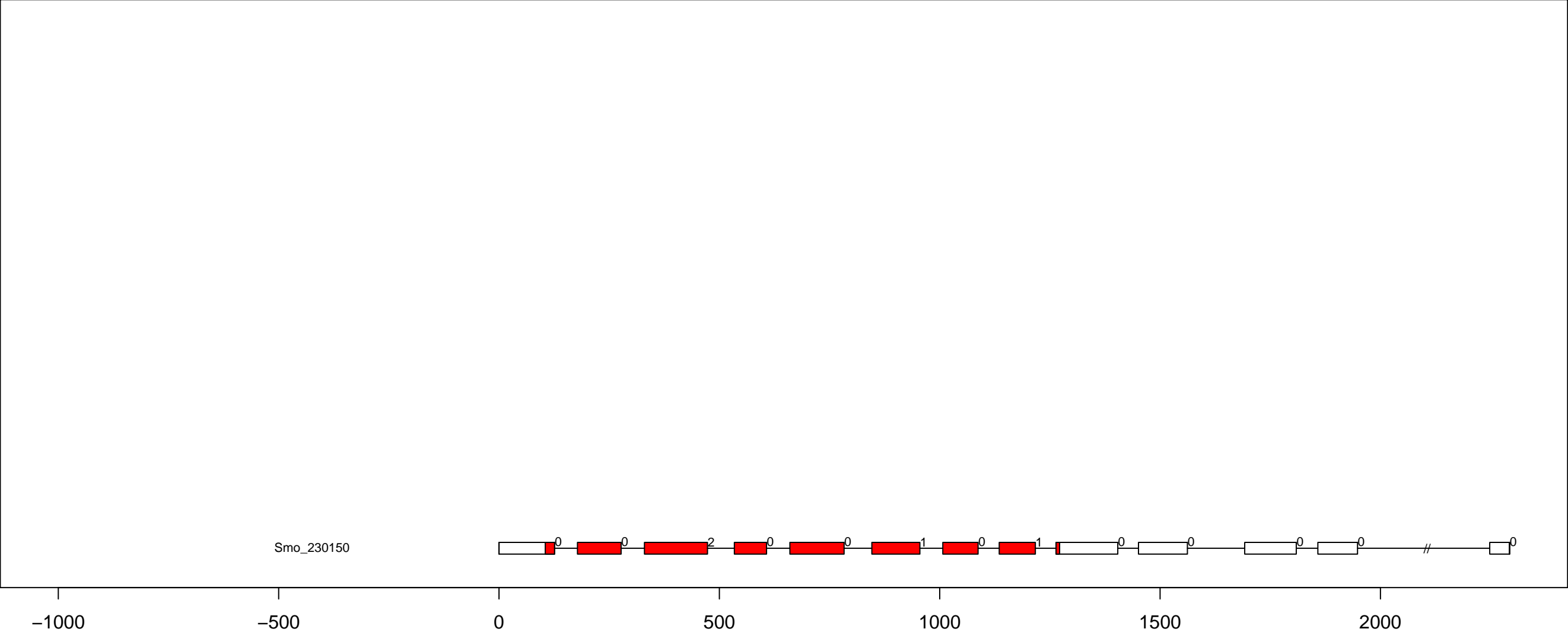

S.mo SCY1_SCYL2 exon-intron and kinase domain diagram (all)

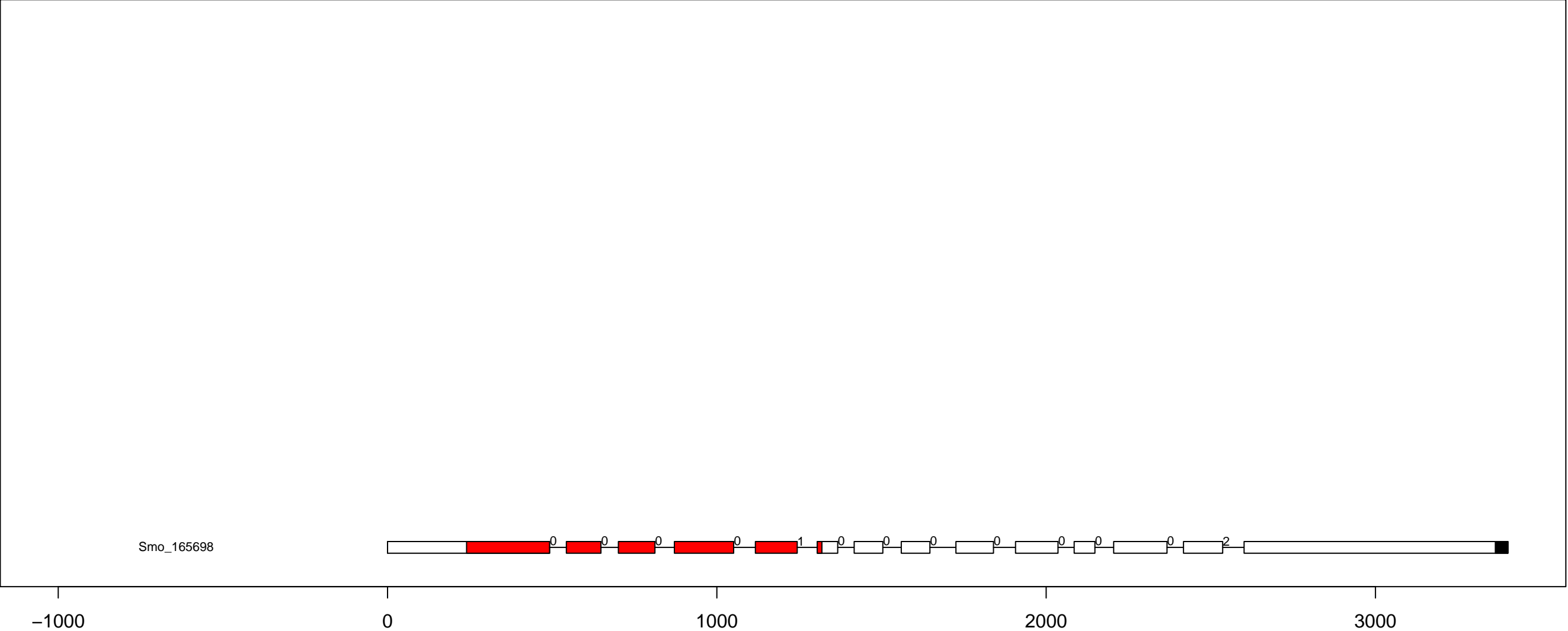

S.mo STE_STE11 exon-intron and kinase domain diagram (all)

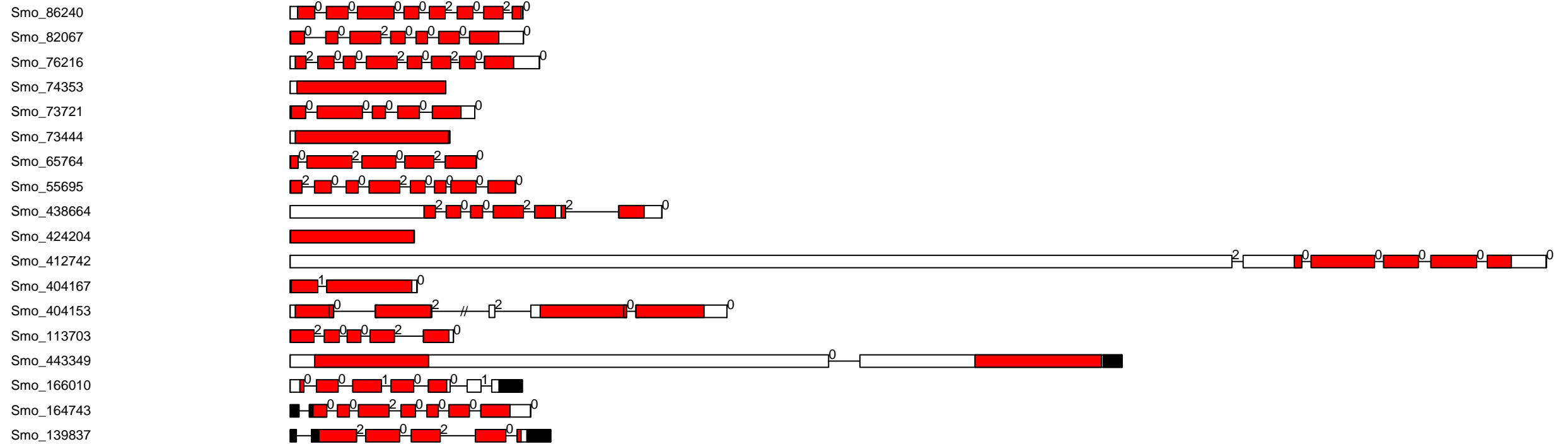

S.mo STE_STE20-PI exon-intron and kinase domain diagram (all)

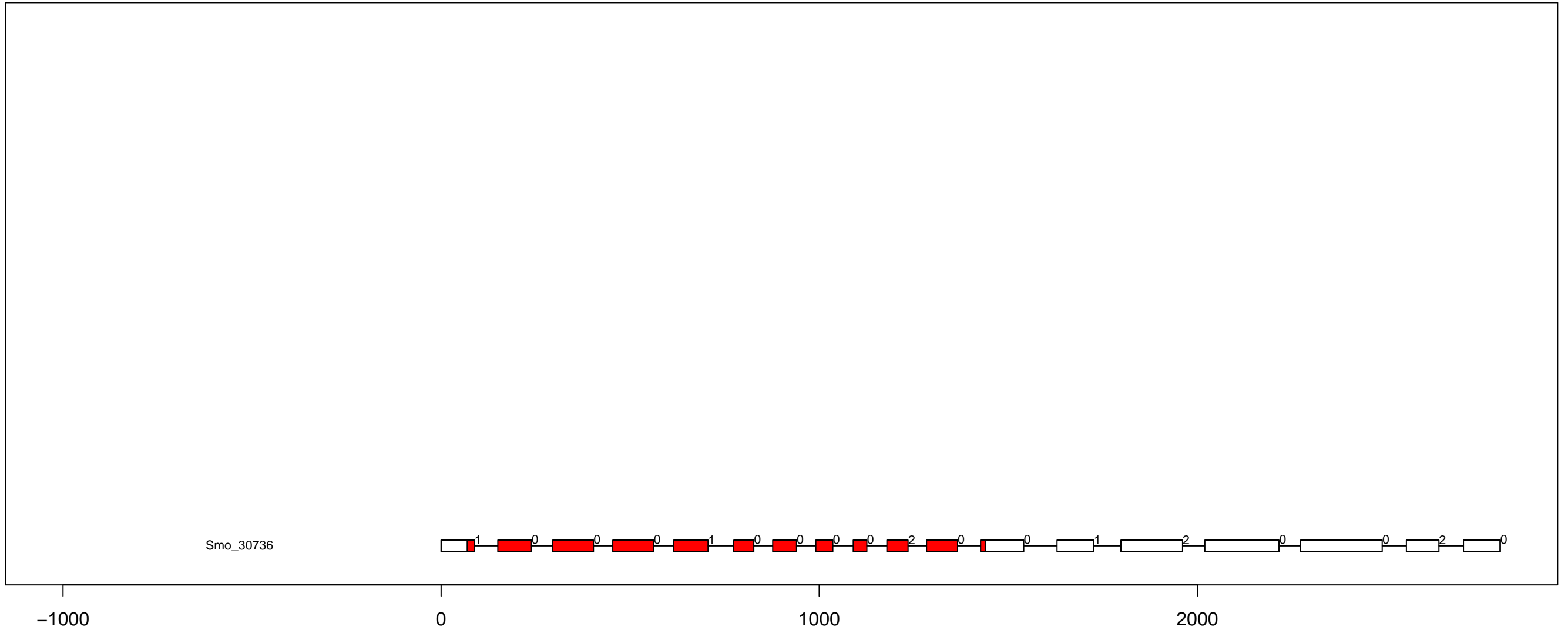

S.mo STE_STE20-YSK exon-intron and kinase domain diagram (all)

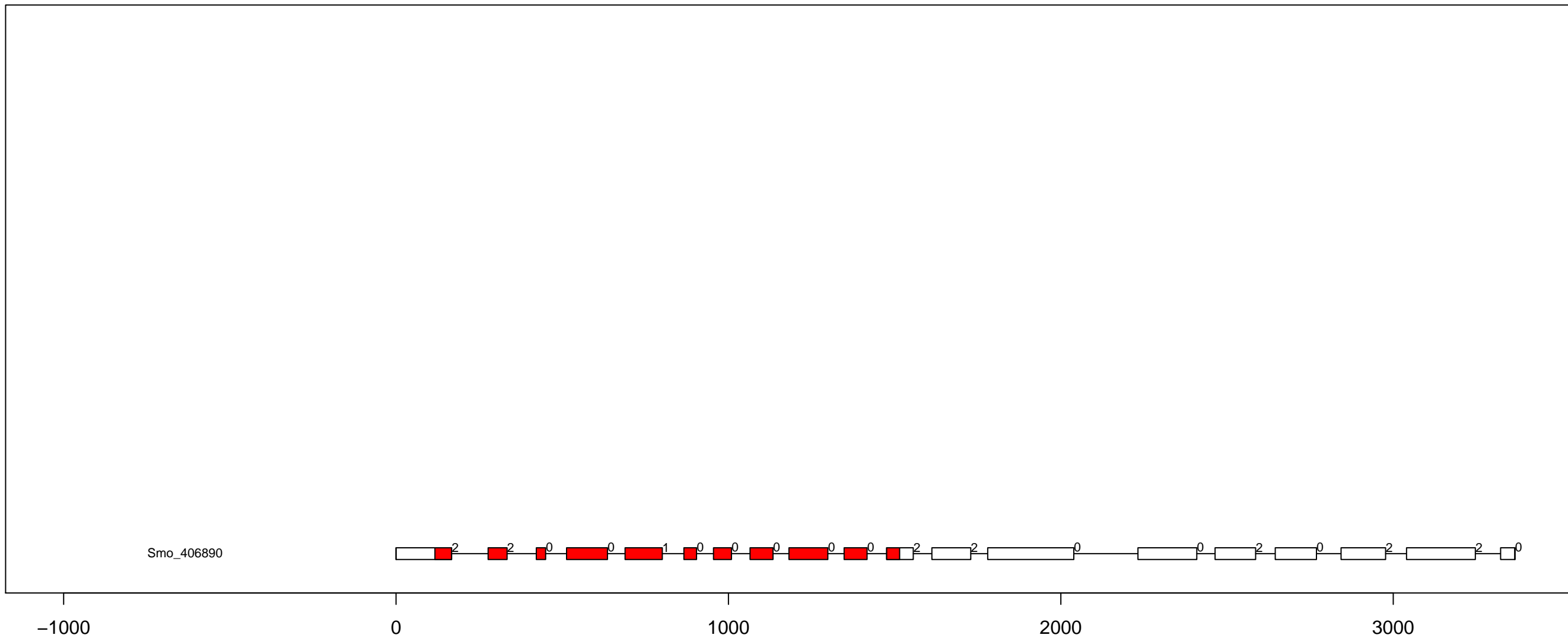

S.mo STE_STE7 exon-intron and kinase domain diagram (all)

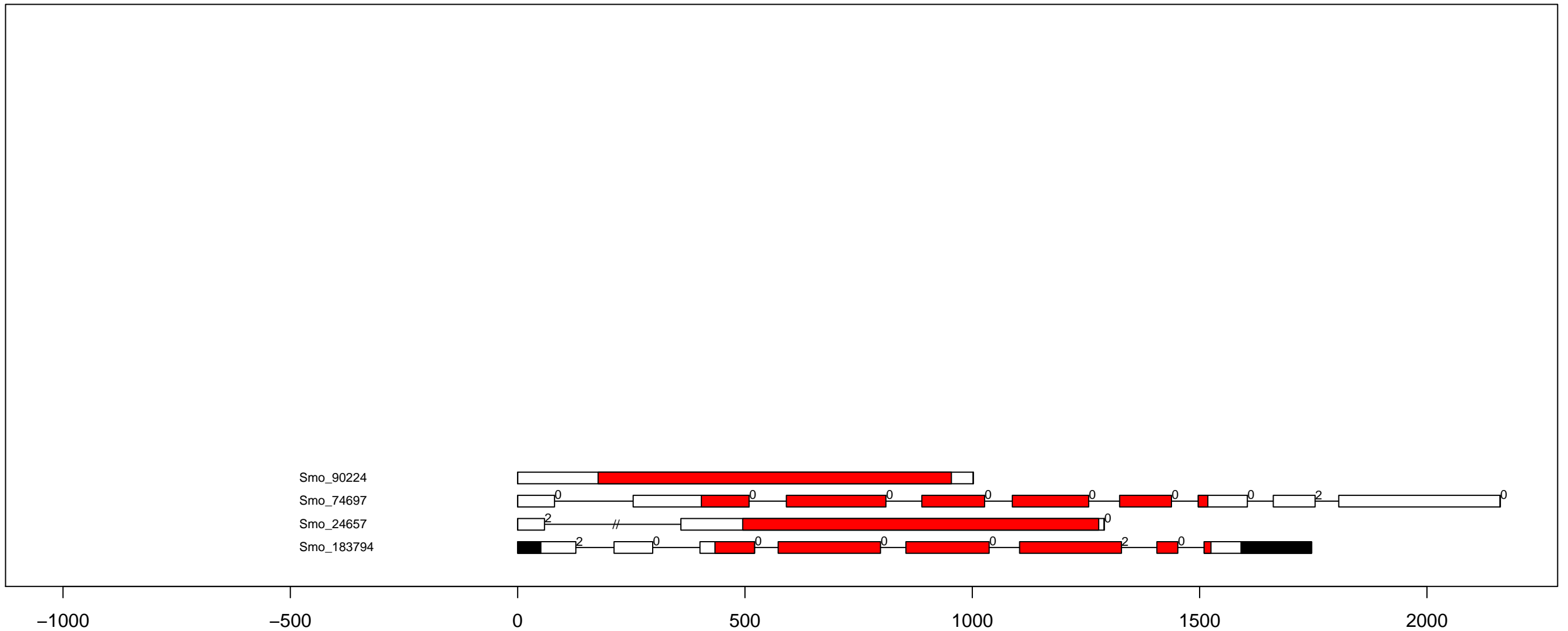

S.mo STE_STE-PI exon-intron and kinase domain diagram (all)

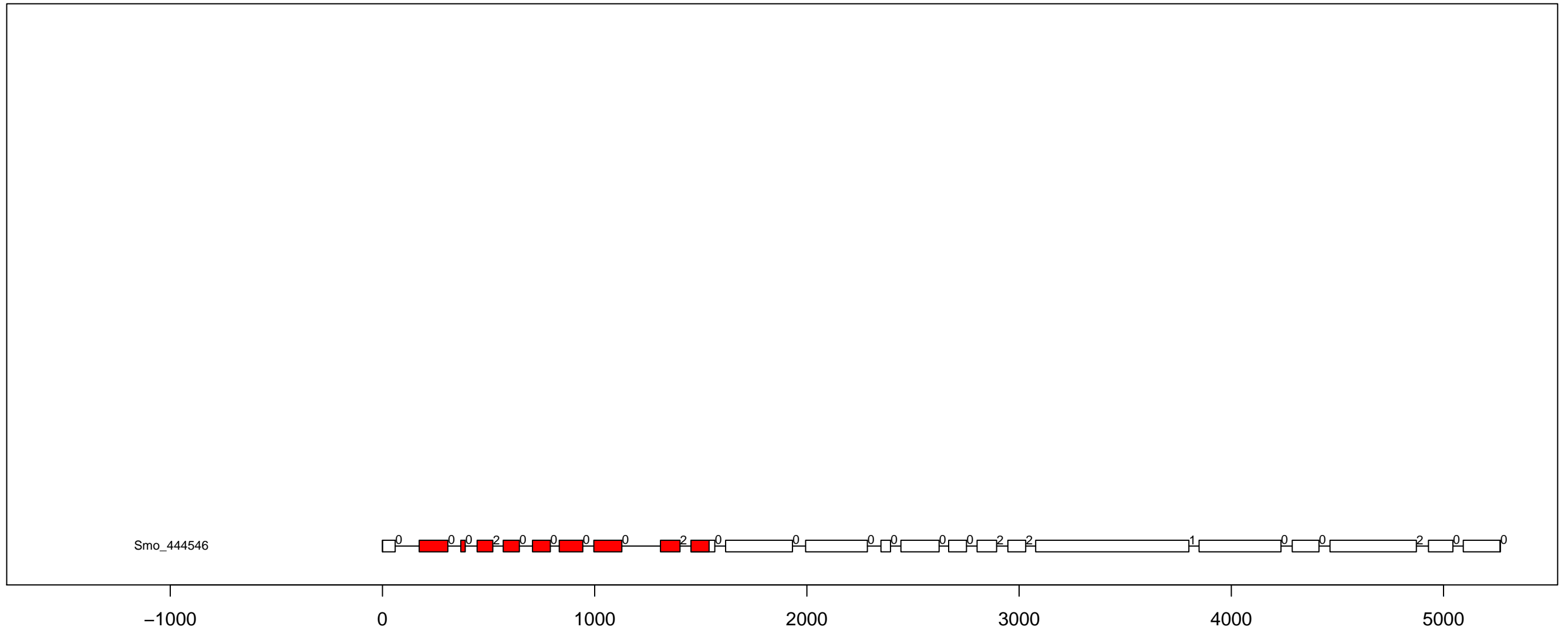

S.mo TKL_CTR1-DRK-1 exon-intron and kinase domain diagram (all)

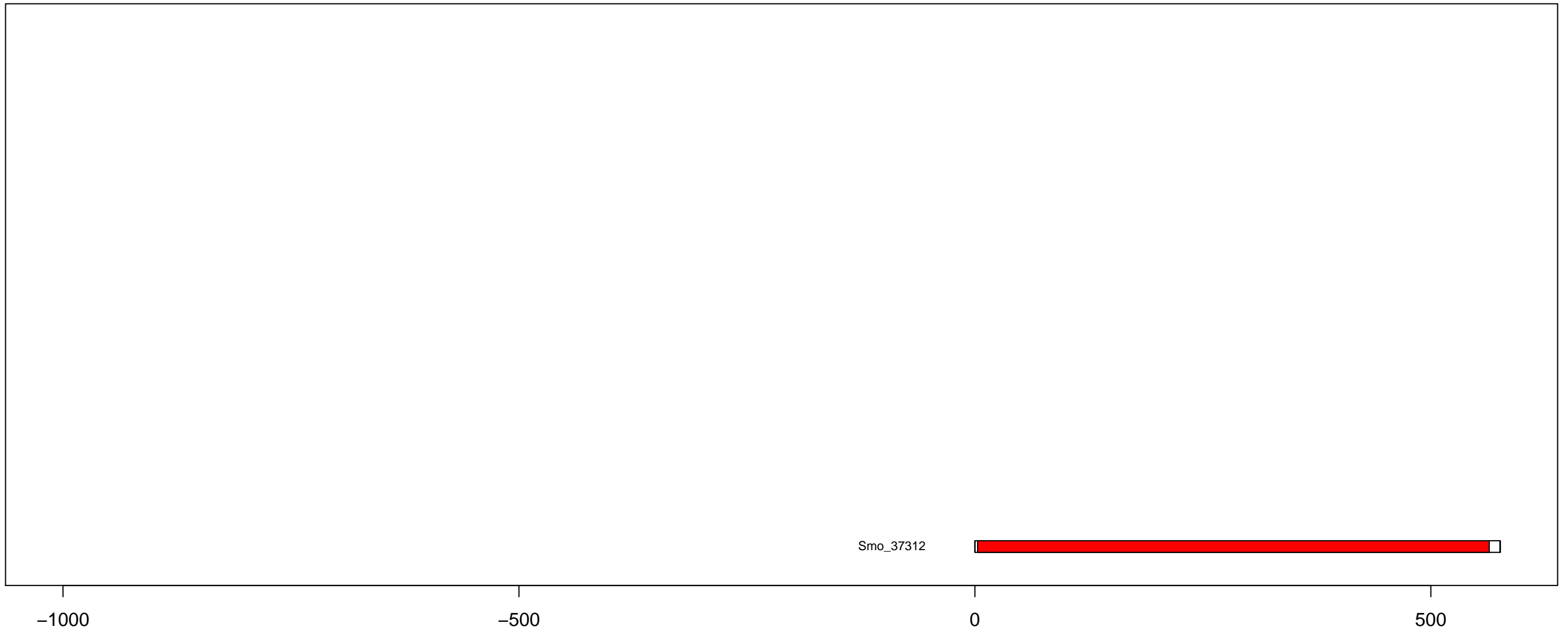

S.mo TKL_CTR1-DRK-2 exon-intron and kinase domain diagram (all)

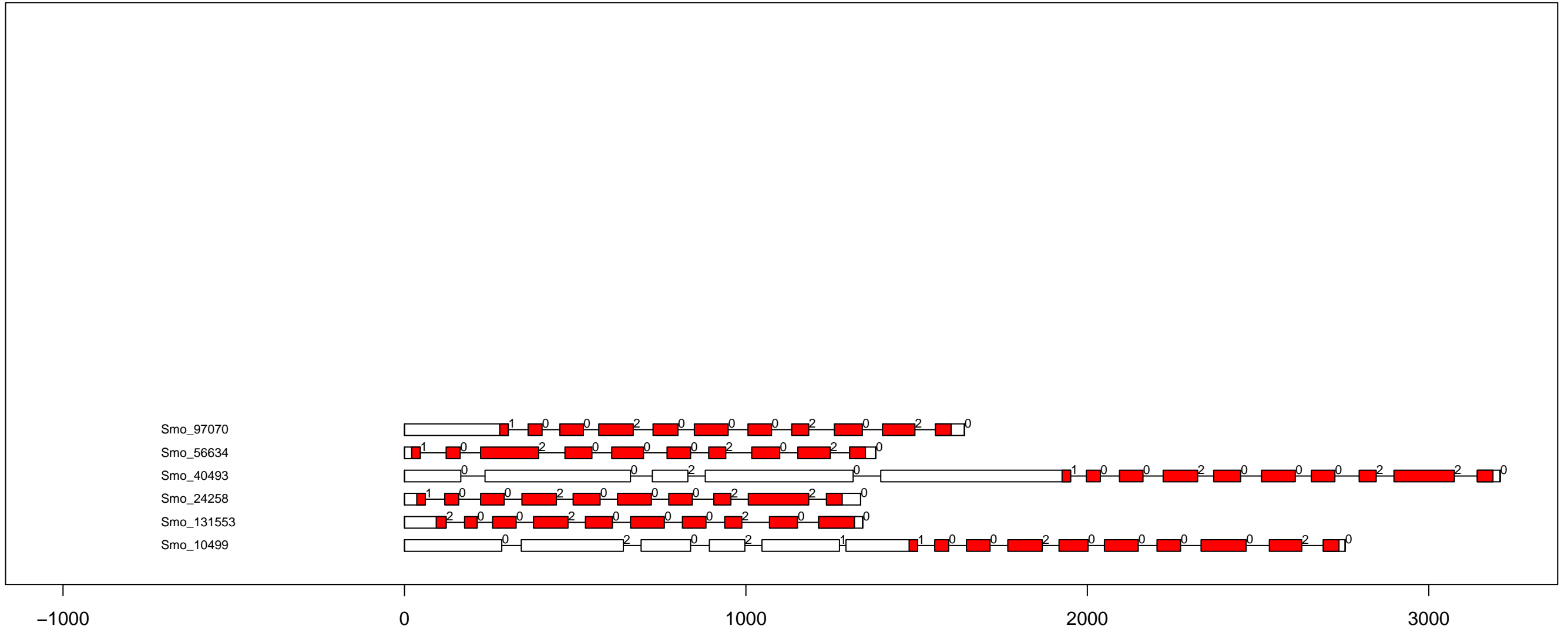

S.mo TKL_Gdt exon-intron and kinase domain diagram (all)

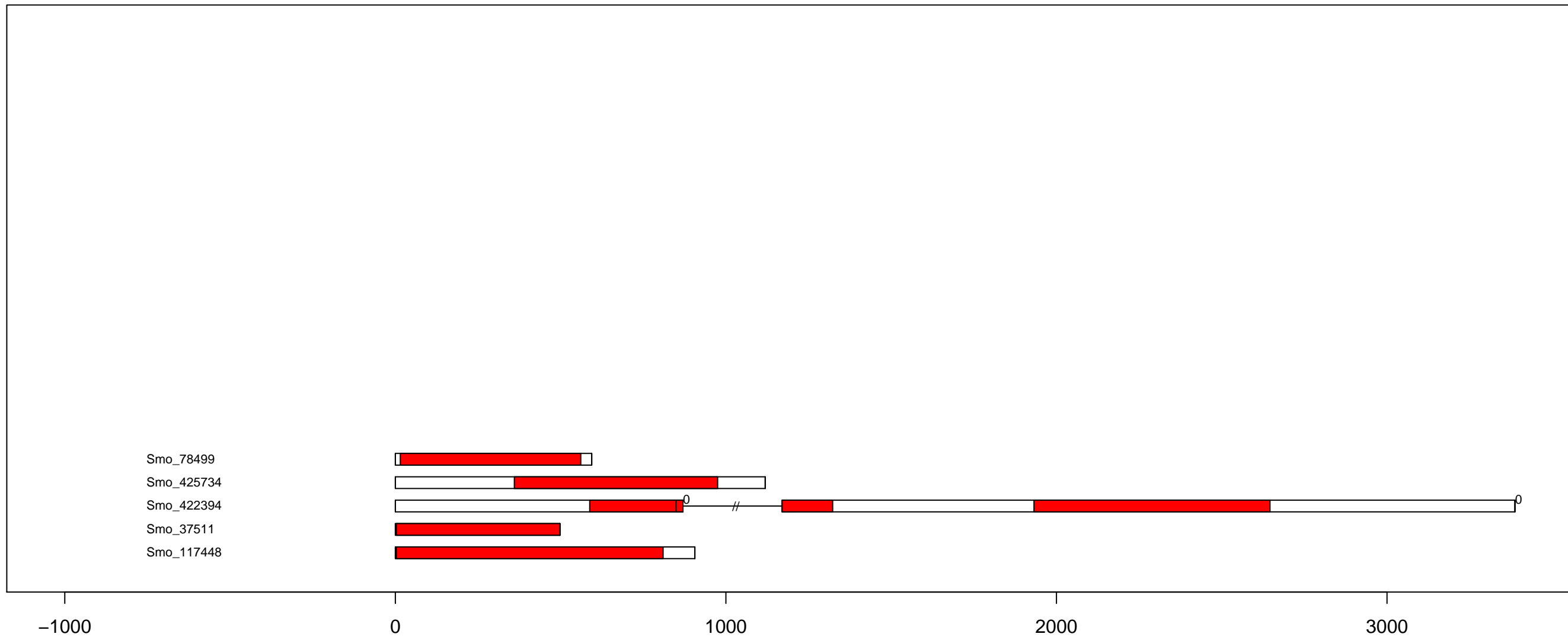

S.mo TKL-Cr-3 exon-intron and kinase domain diagram (all)

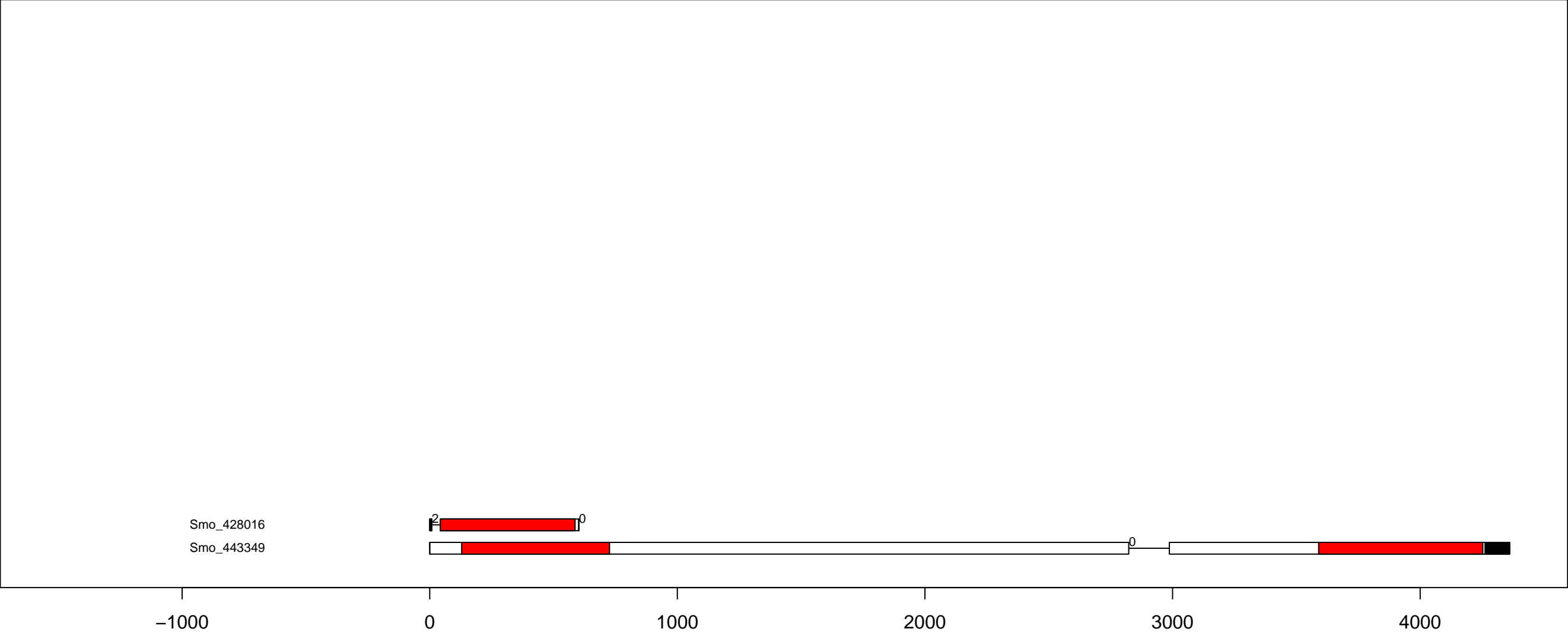

S.mo TKL-PI-1 exon-intron and kinase domain diagram (all)

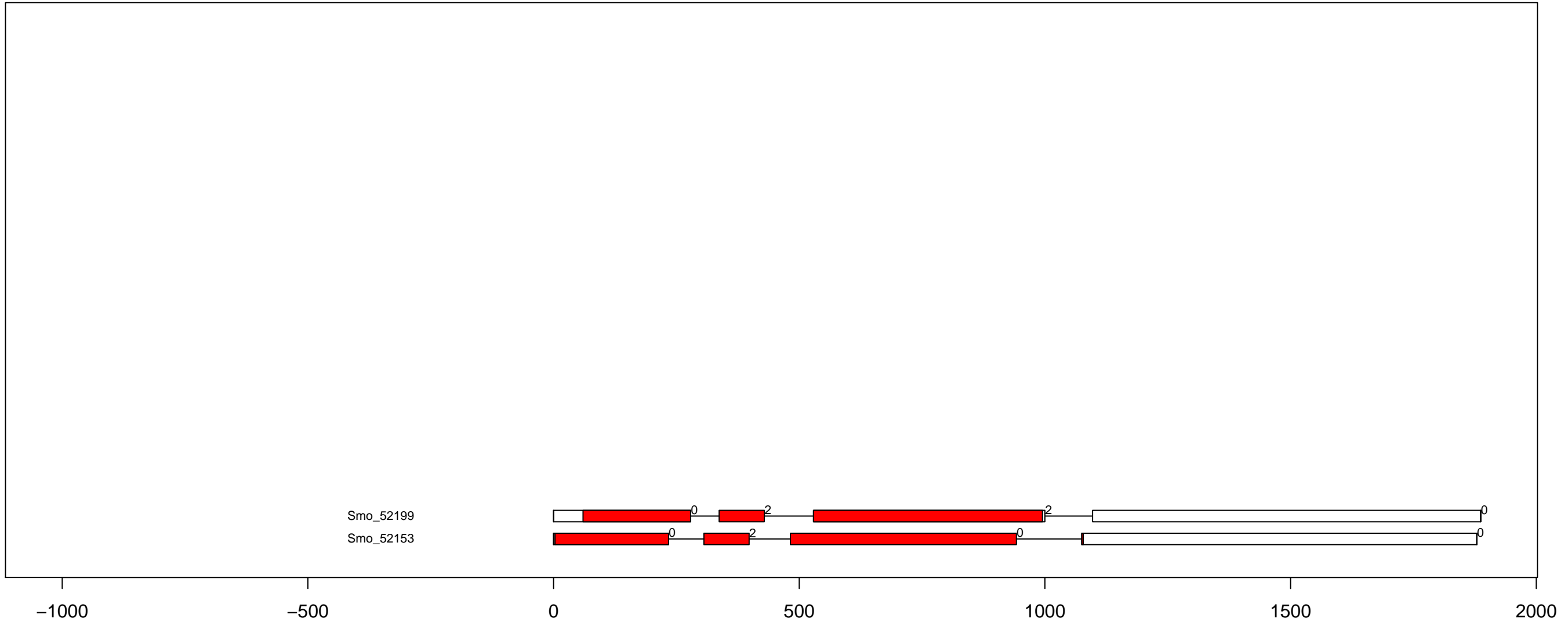

S.mo TKL-PI-2 exon-intron and kinase domain diagram (all)

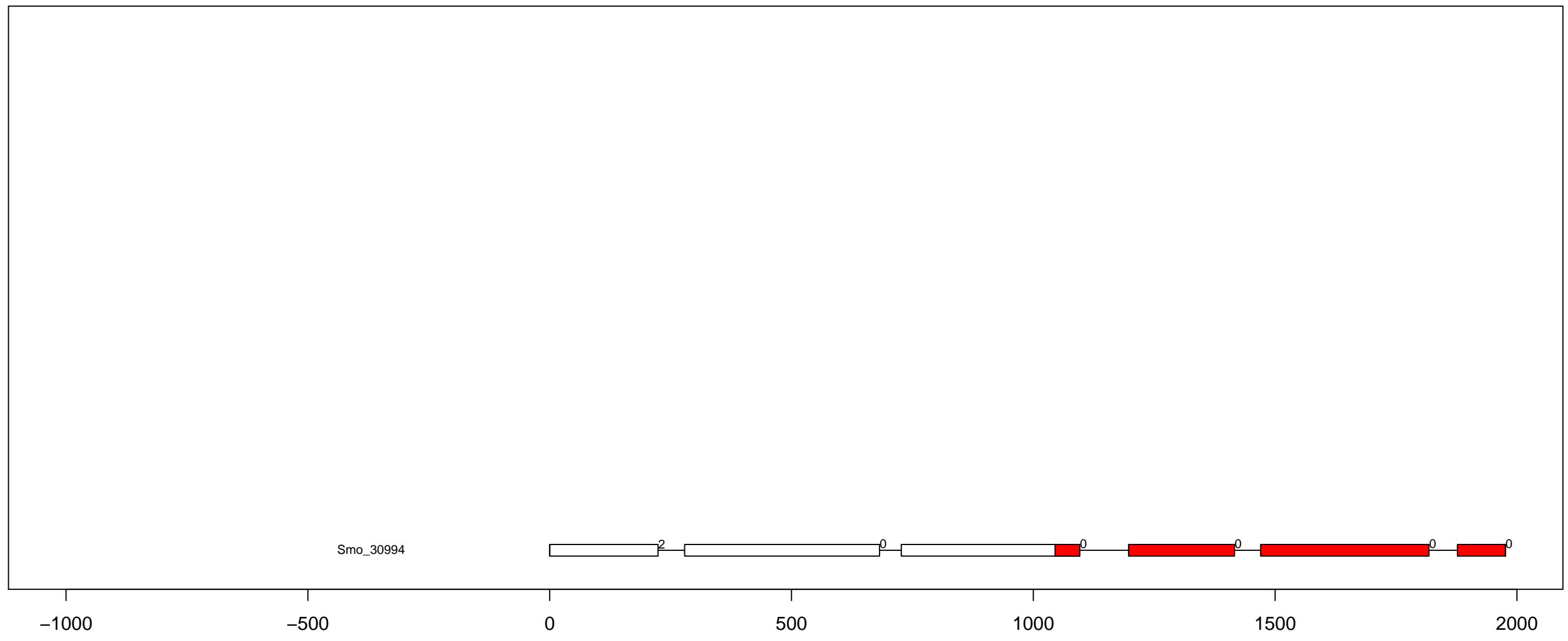

S.mo TKL-PI-3 exon-intron and kinase domain diagram (all)

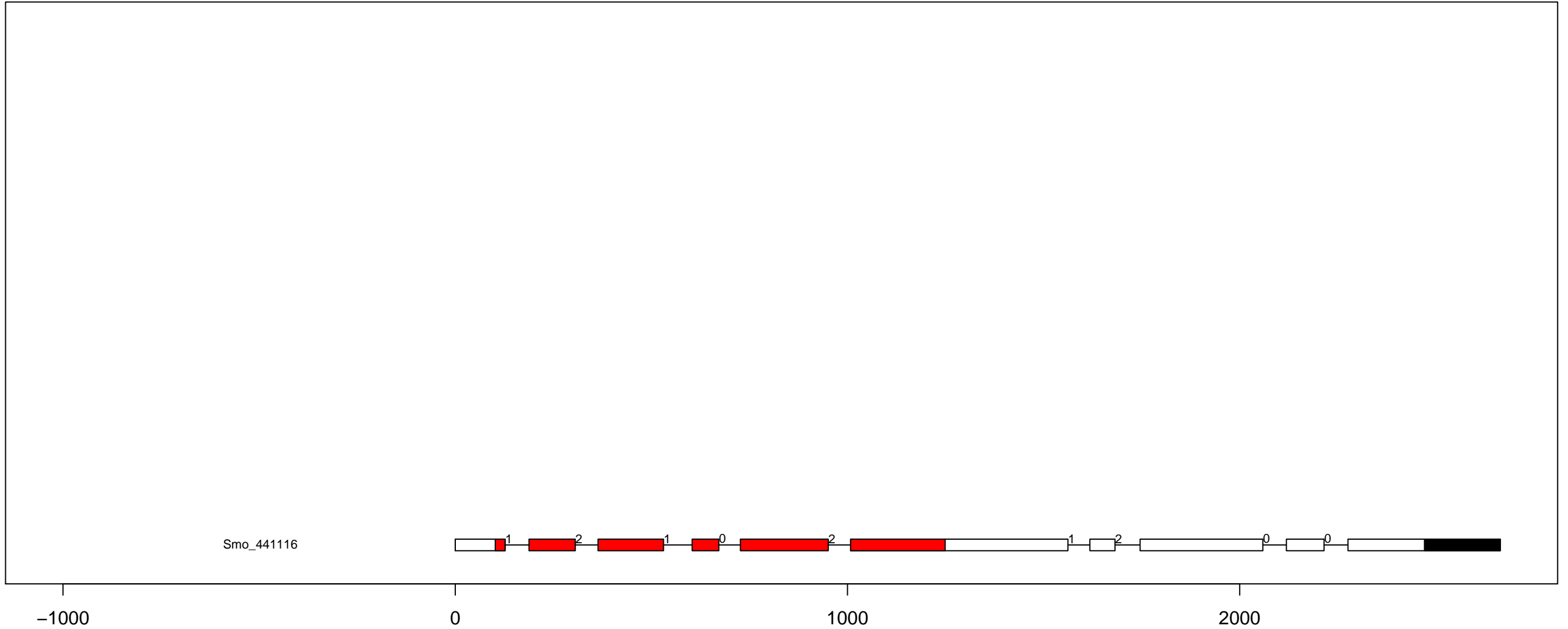

S.mo TKL-PI-4 exon-intron and kinase domain diagram (all)

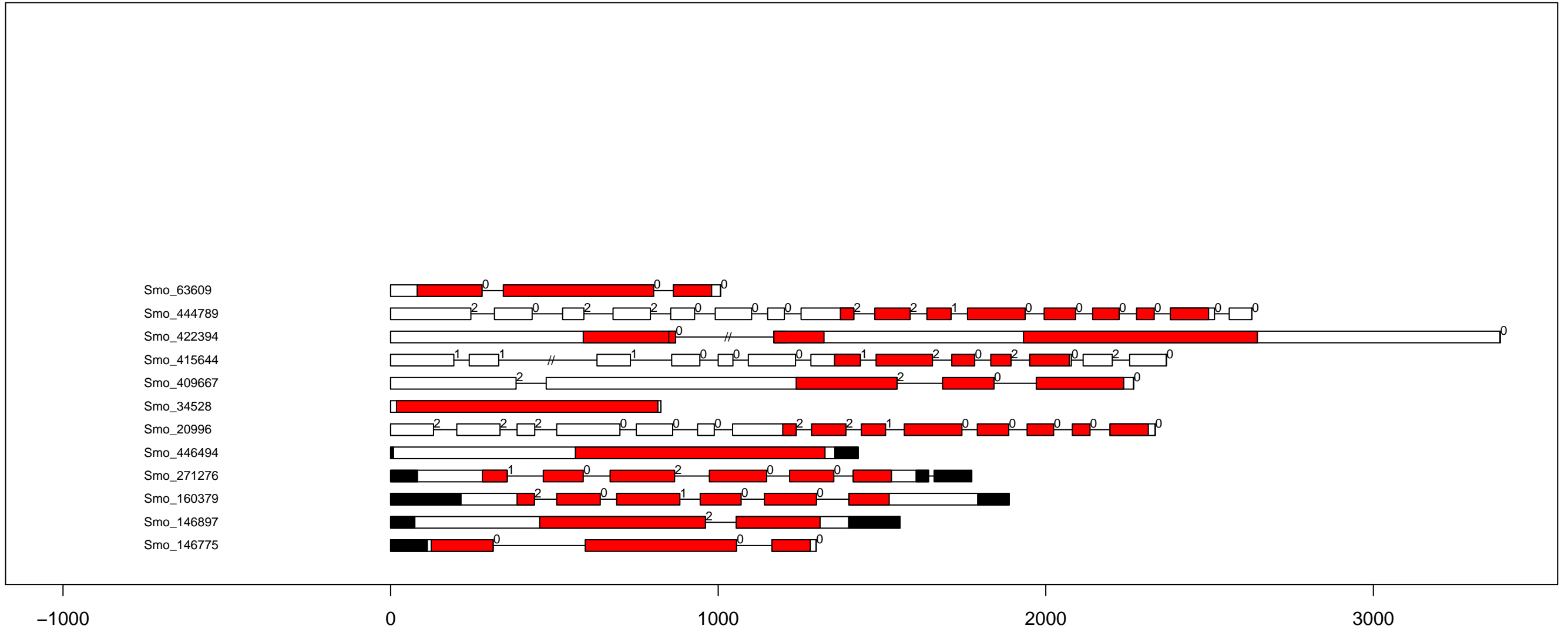

S.mo TKL-PI-5 exon-intron and kinase domain diagram (all)

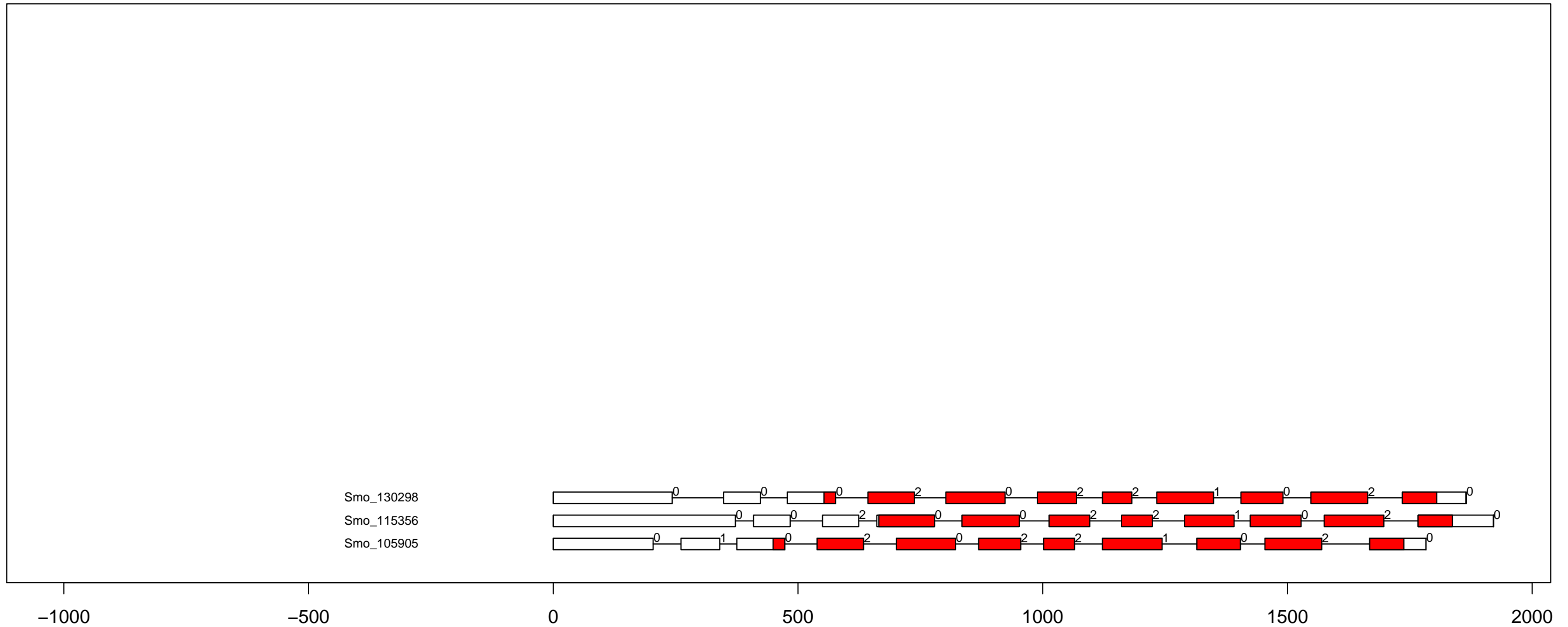

S.mo TKL-PI-6 exon-intron and kinase domain diagram (all)

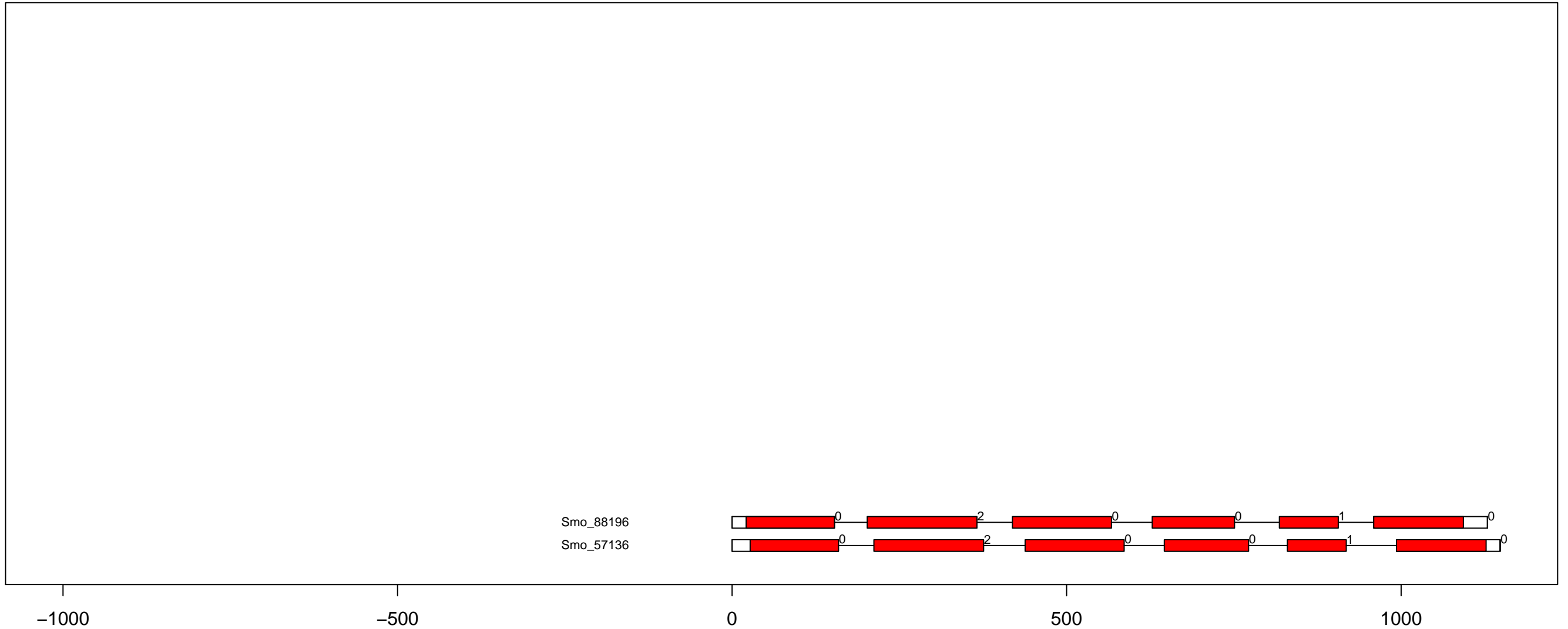

S.mo TKL-PI-8 exon-intron and kinase domain diagram (all)

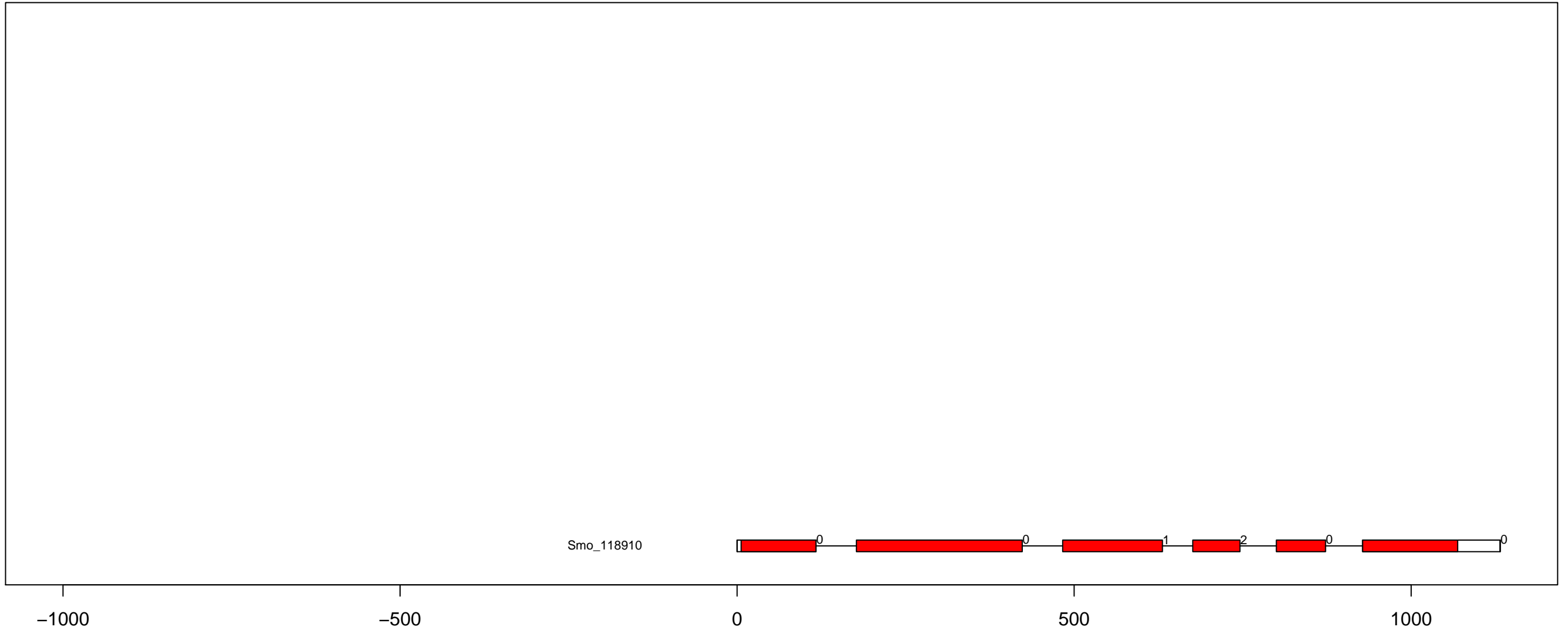

S.mo TLK exon-intron and kinase domain diagram (all)

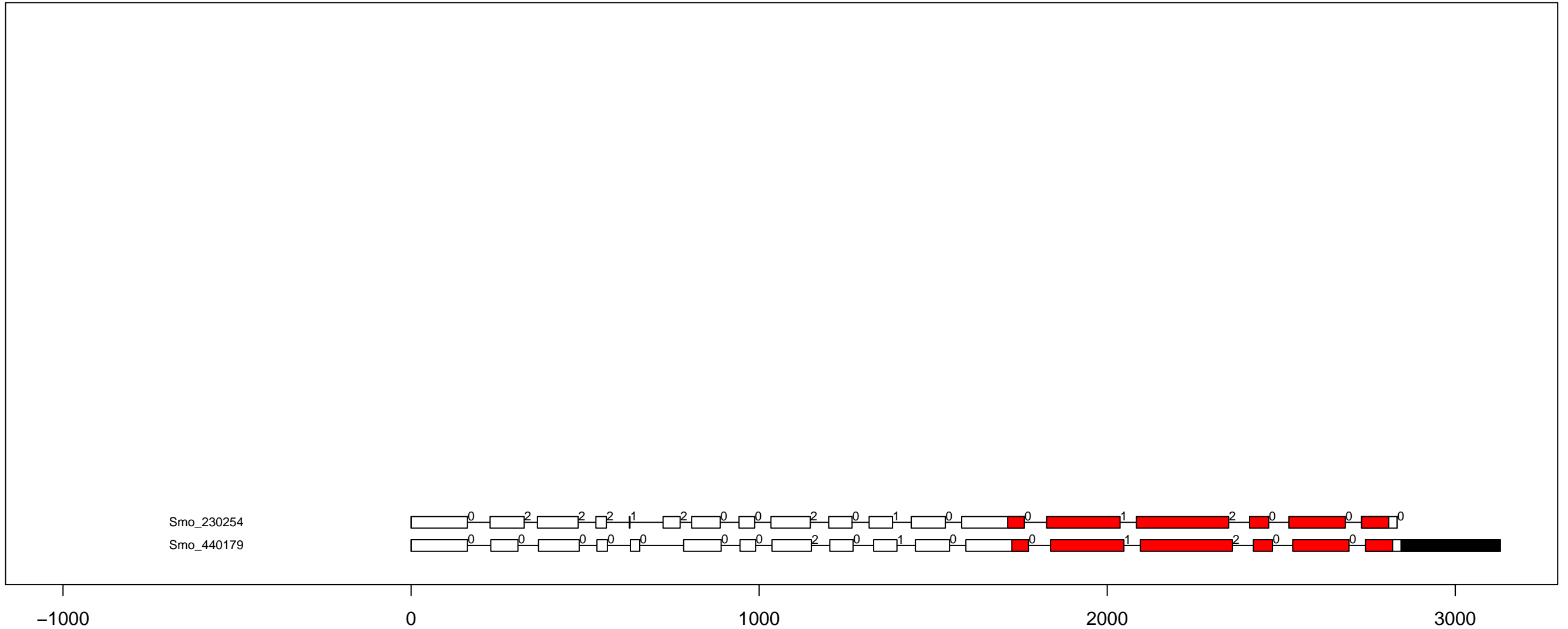

S.mo TTK exon-intron and kinase domain diagram (all)

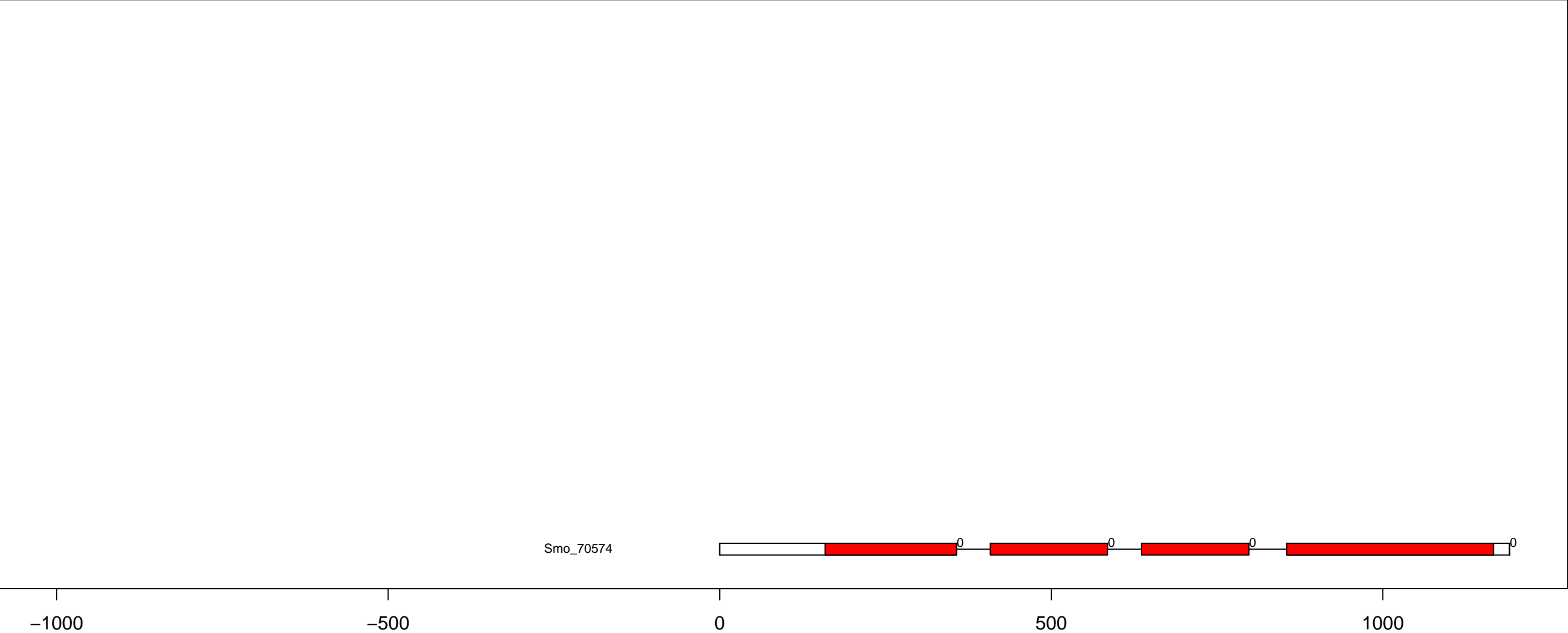

S.mo ULK_Fused exon-intron and kinase domain diagram (all)

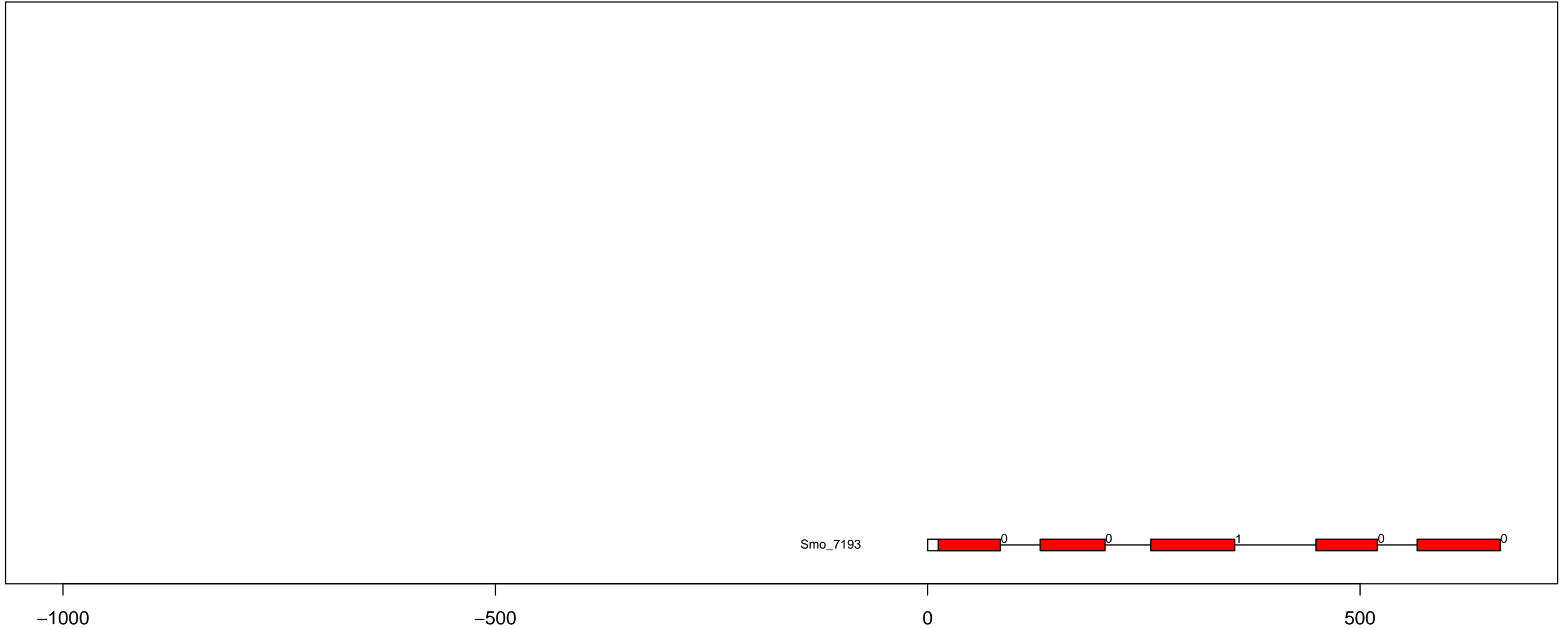

S.mo WEE exon-intron and kinase domain diagram (all)

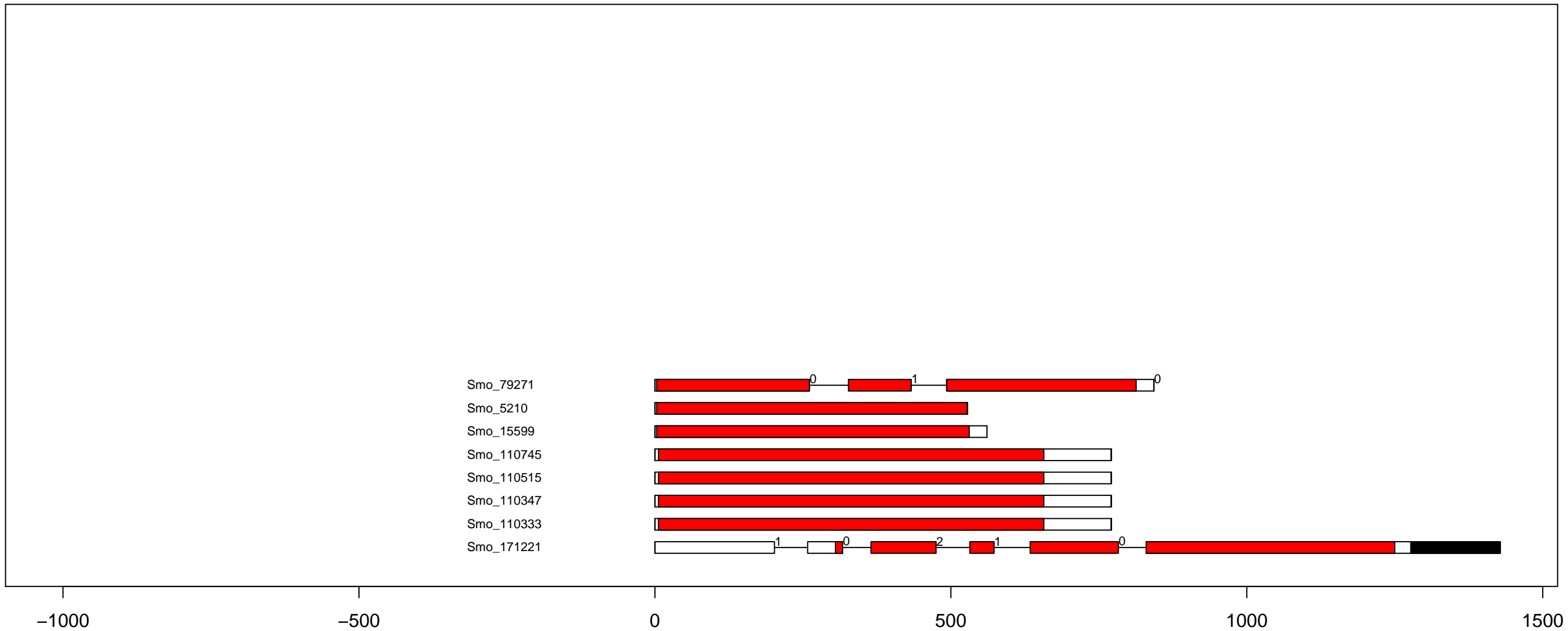

S.mo WNK_NRBP exon-intron and kinase domain diagram (all)

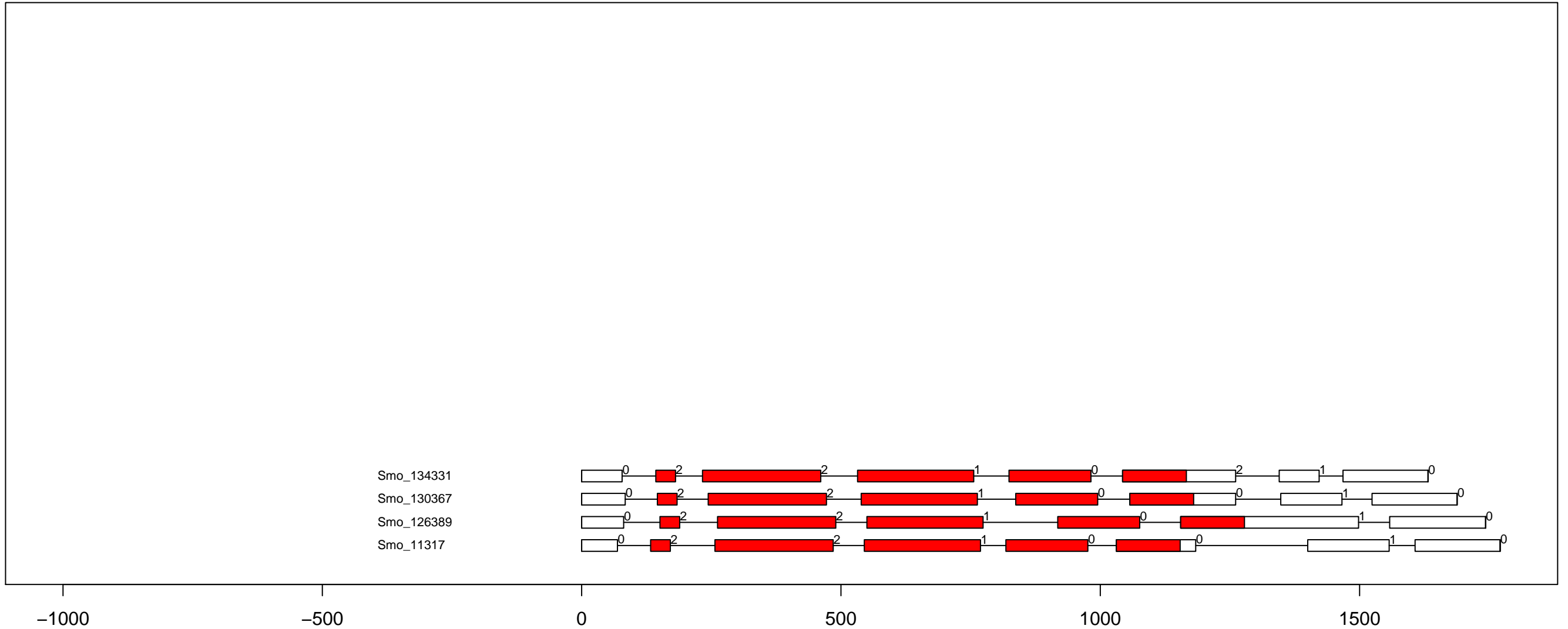

P.pa AGC_MAST exon-intron and kinase domain diagram (all)

Ppa_Pp1s285_54V6

Ppa_Pp1s275_5V6

Ppa_Pp1s172_42V6

Ppa_Pp1s353_26V6

Ppa_Pp1s323_77V6

-2000

0

2000

4000

6000

8000

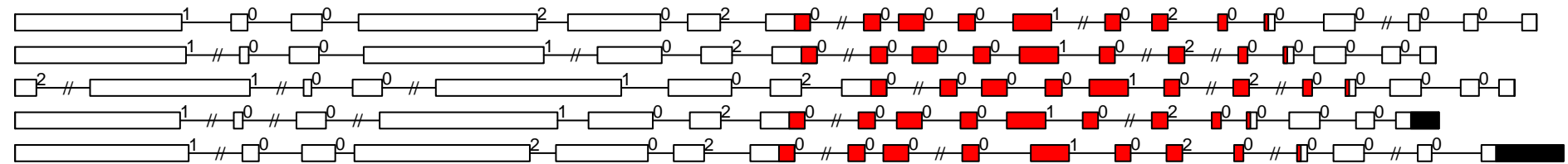

P.pa AGC_NDR exon-intron and kinase domain diagram (all)

Ppa_Pp1s87_129V6
Ppa_Pp1s86_95V6
Ppa_Pp1s86_100V6
Ppa_Pp1s22_429V6
Ppa_Pp1s22_423V6
Ppa_Pp1s11_341V6

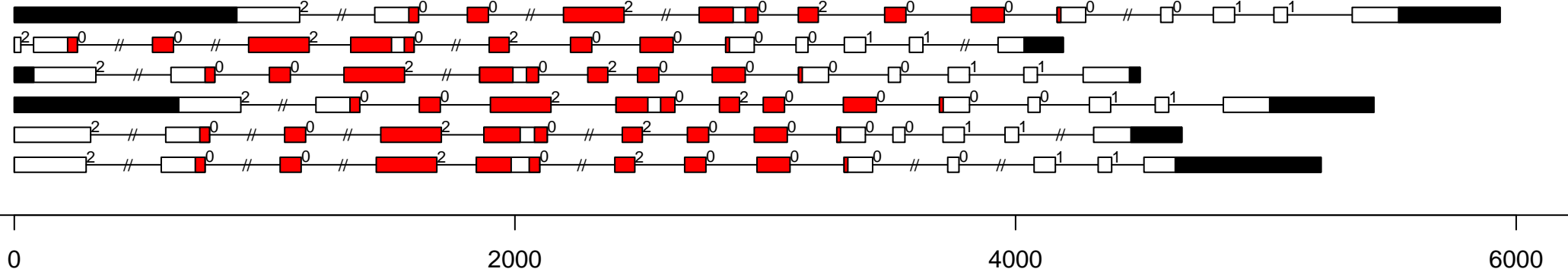

P.pa AGC_PDK1 exon-intron and kinase domain diagram (all)

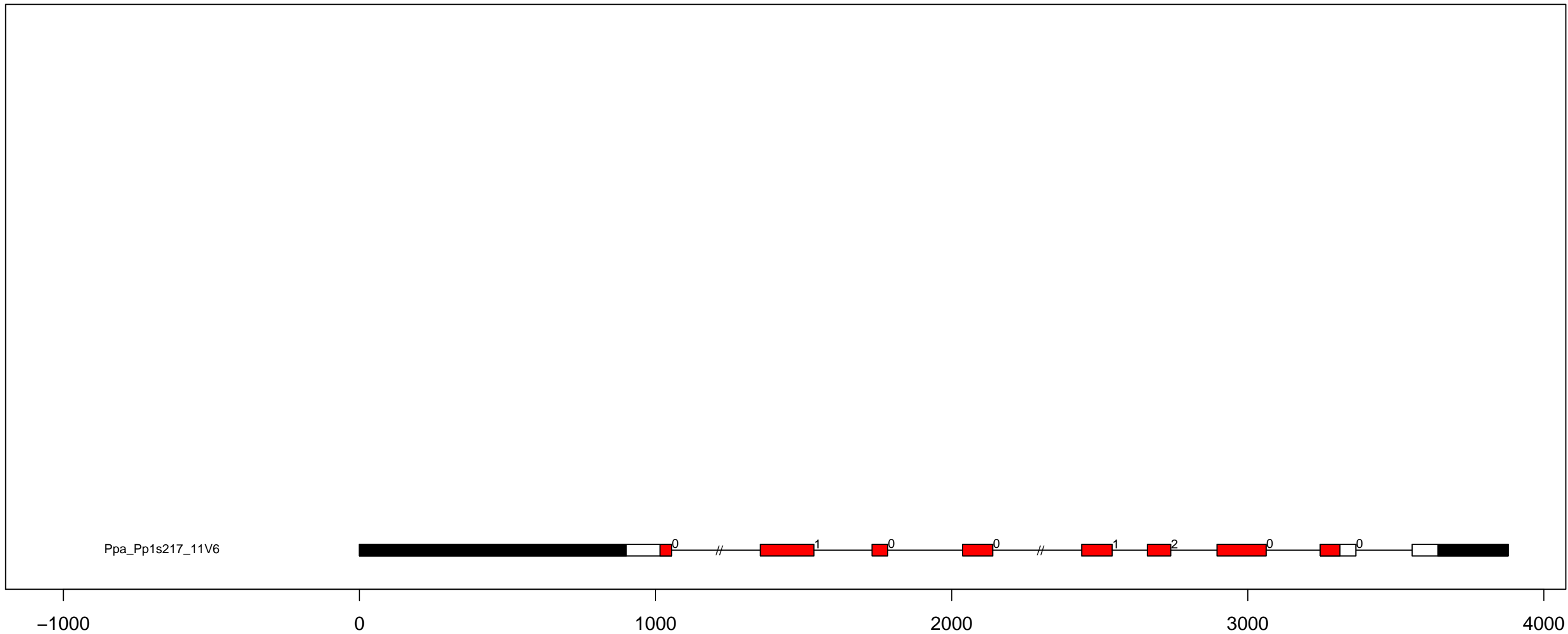

P.pa AGC_PKA-PKG exon-intron and kinase domain diagram (all)

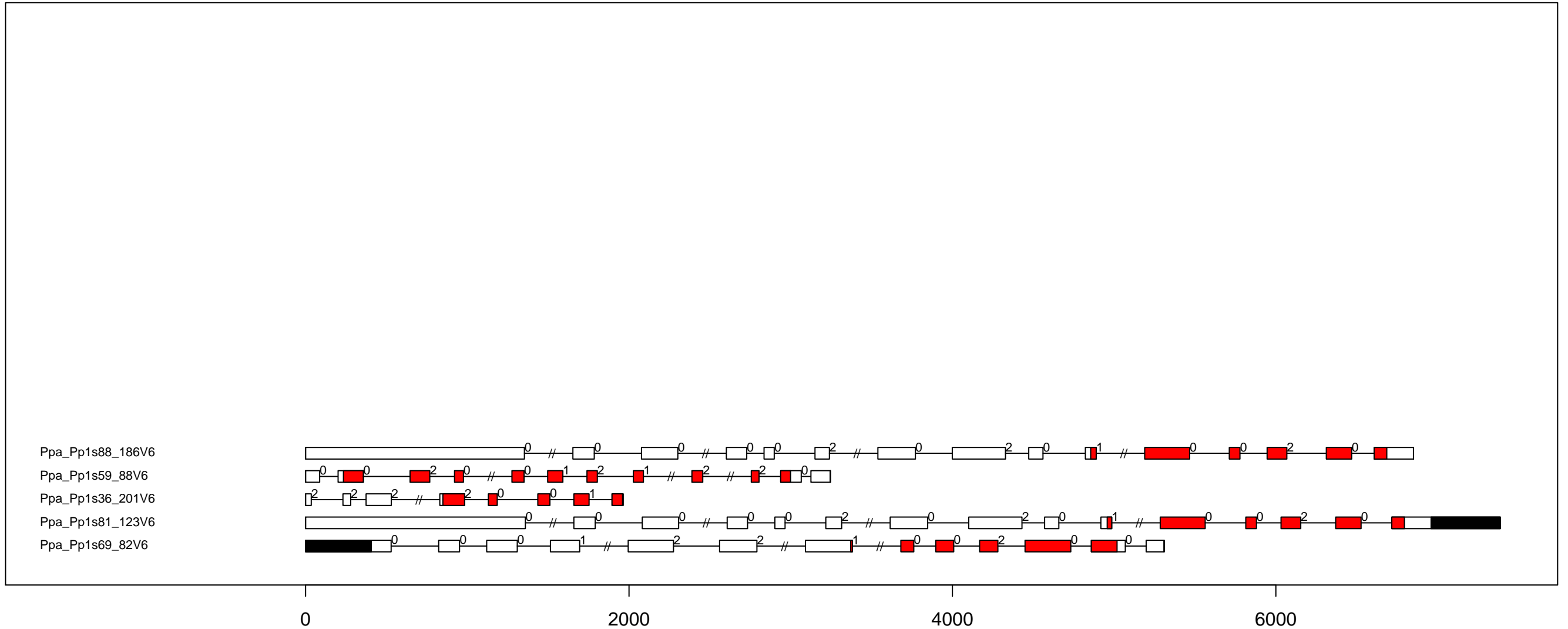

P.pa AGC_RSK-2 exon-intron and kinase domain diagram (all)

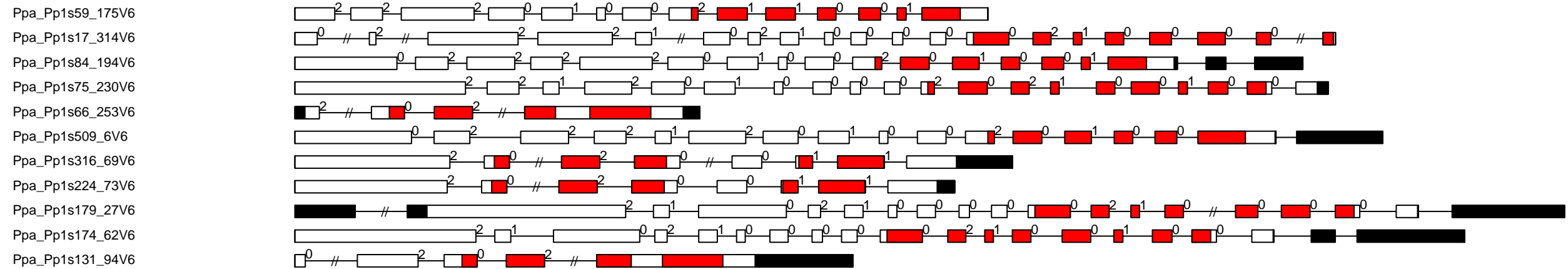

0

2000

4000

6000

P.pa AGC-PI exon-intron and kinase domain diagram (all)

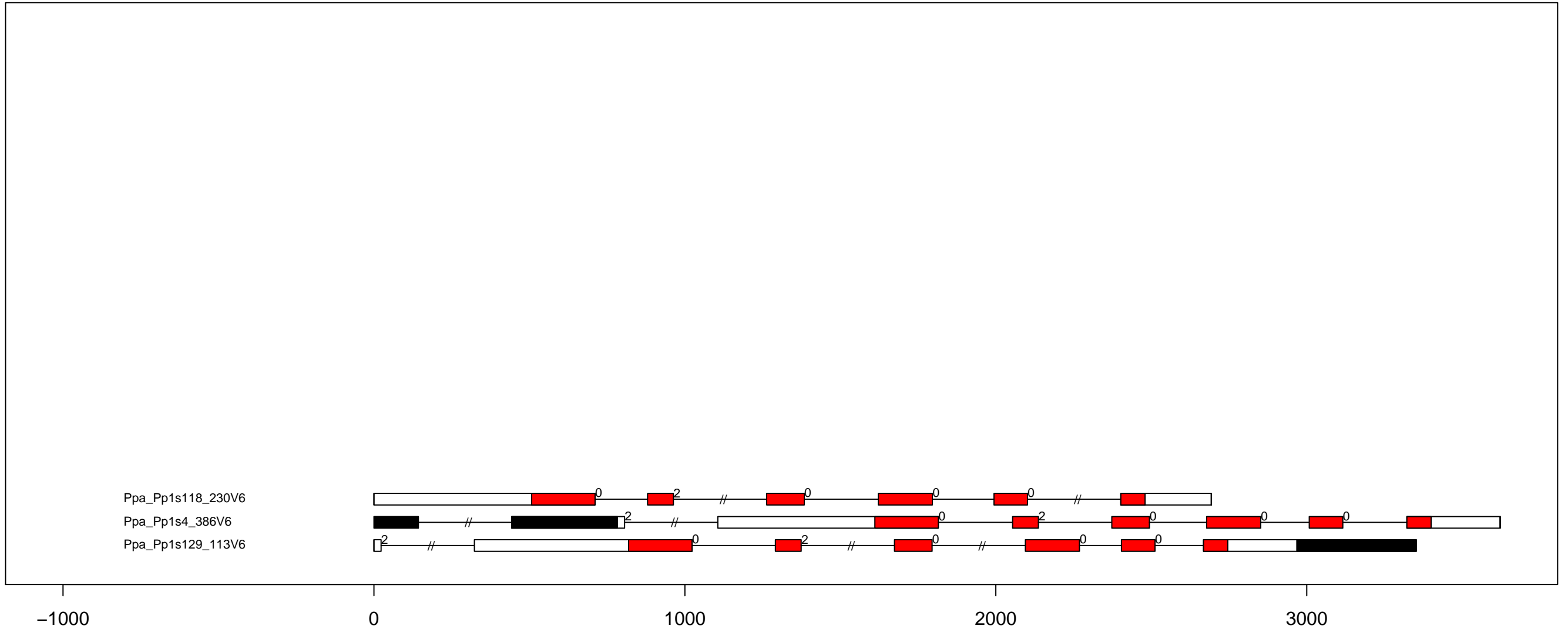

P.pa Aur exon-intron and kinase domain diagram (all)

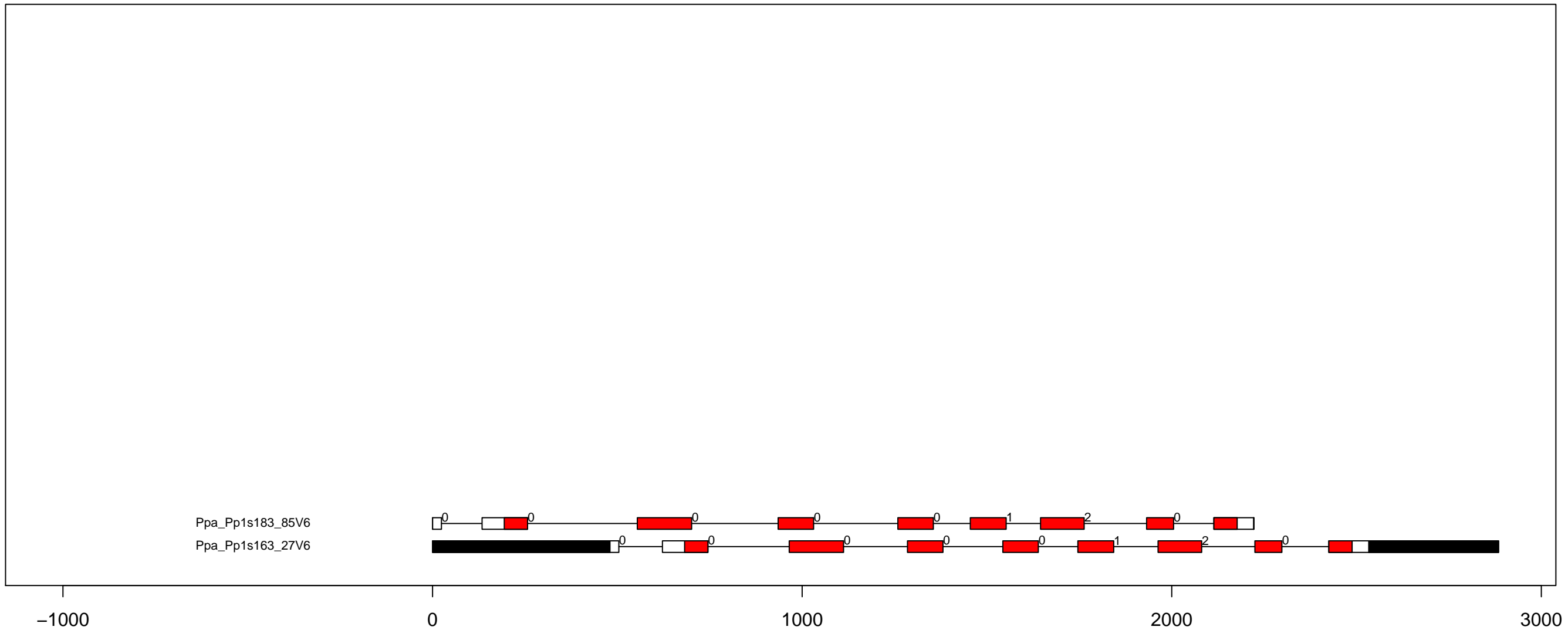

P.pa CAMK_AMPK exon-intron and kinase domain diagram (all)

Ppa_Pp1s3_550V6
Ppa_Pp1s7_365V6
Ppa_Pp1s28_12V6
Ppa_Pp1s1_782V6
Ppa_Pp1s107_182V6

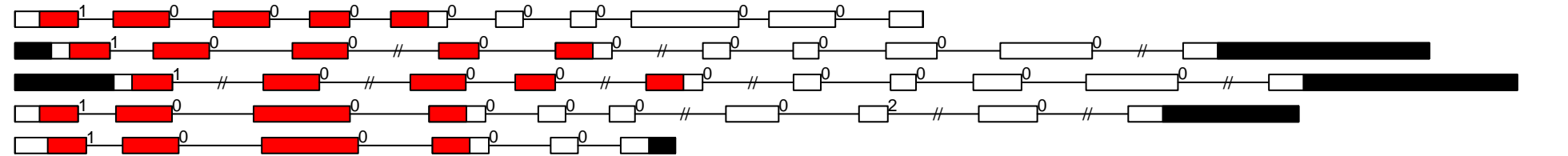

-1000

0

1000

2000

3000

4000

5000

P.pa CAMK_CAMK1-DCAMKL exon-intron and kinase domain diagram (all)

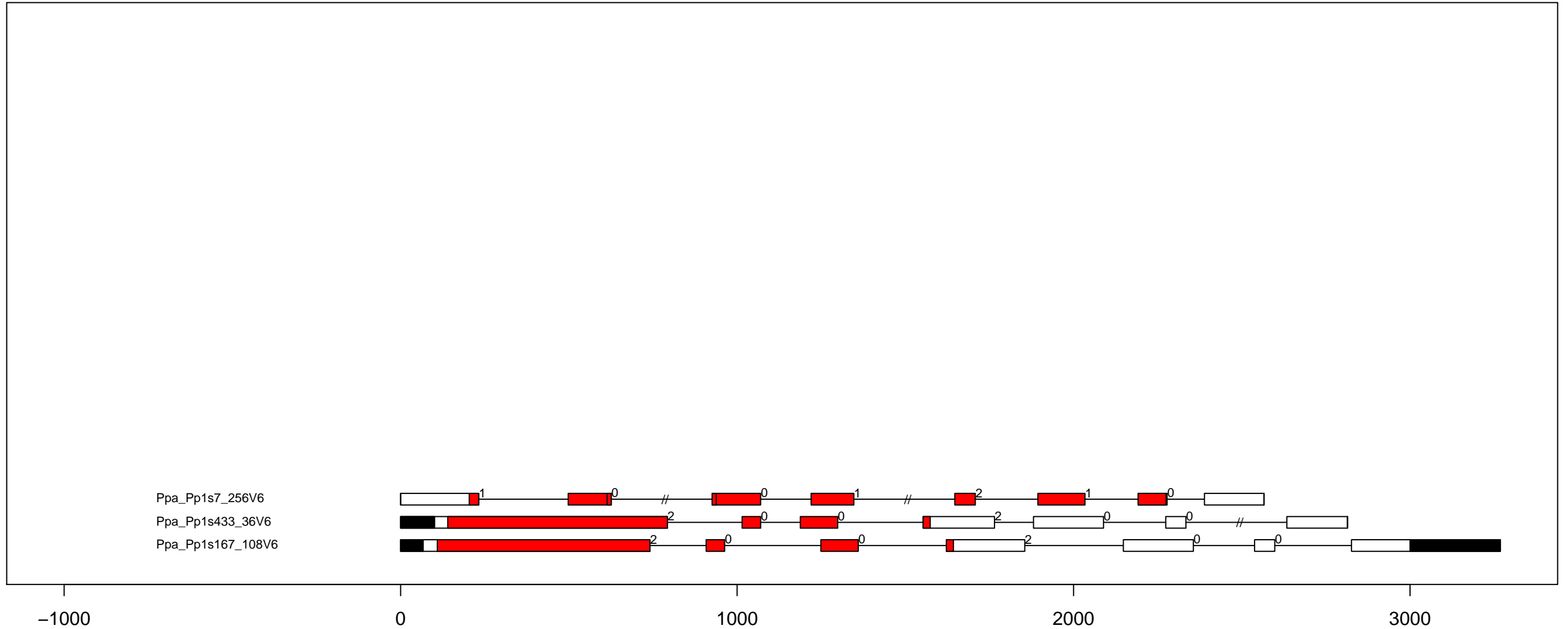

P.pa CAMK_CAMKL-CHK1 exon-intron and kinase domain diagram (all)

Ppa_Pp1s211_132V6
Ppa_Pp1s186_77V6
Ppa_Pp1s79_209V6
Ppa_Pp1s58_13V6
Ppa_Pp1s30_102V6
Ppa_Pp1s205_16V6
Ppa_Pp1s15_28V6

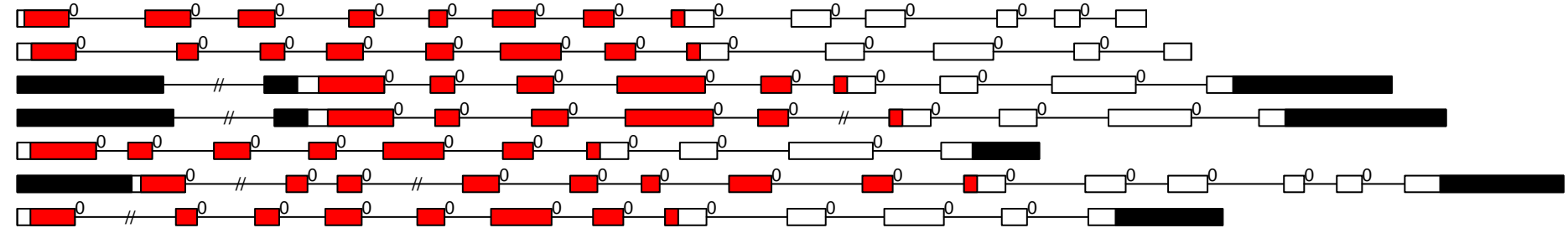

P.pa CAMK_CAMKL-LKB exon-intron and kinase domain diagram (all)

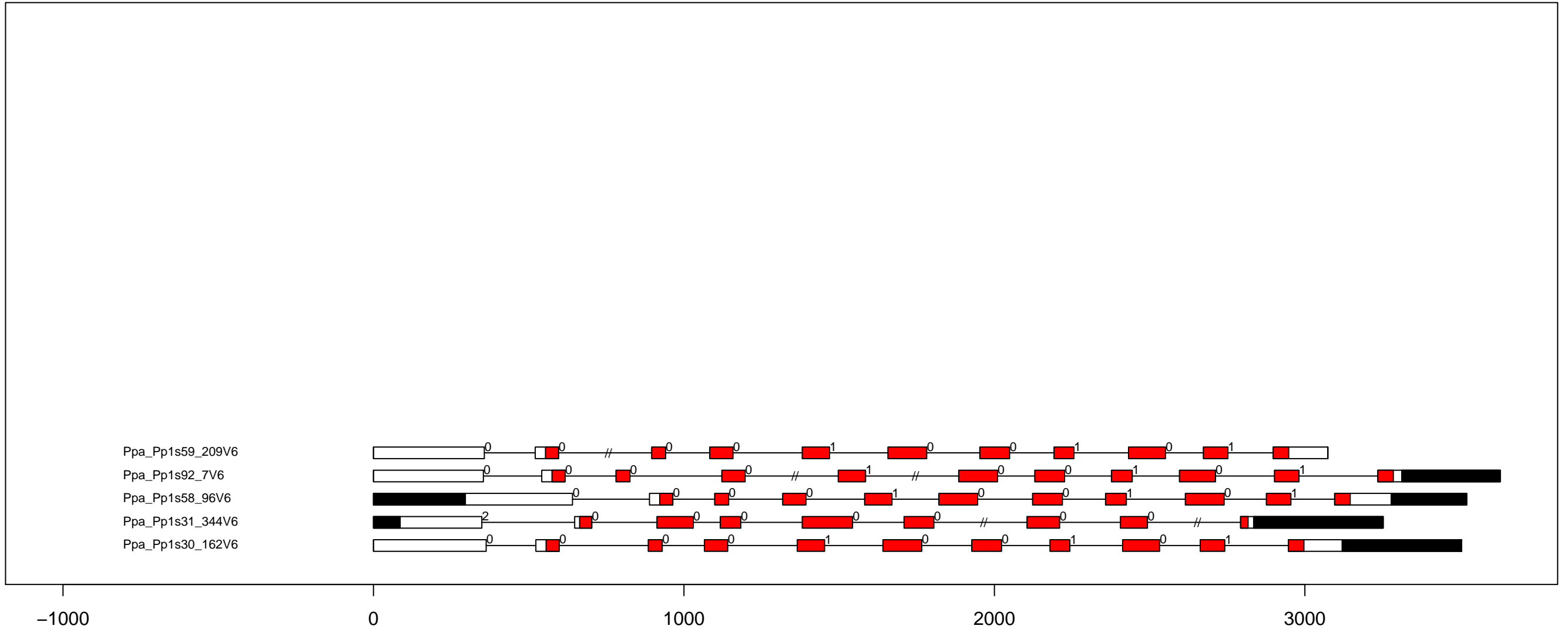

P.pa CAMK_CDPK exon-intron and kinase domain diagram (part 1)

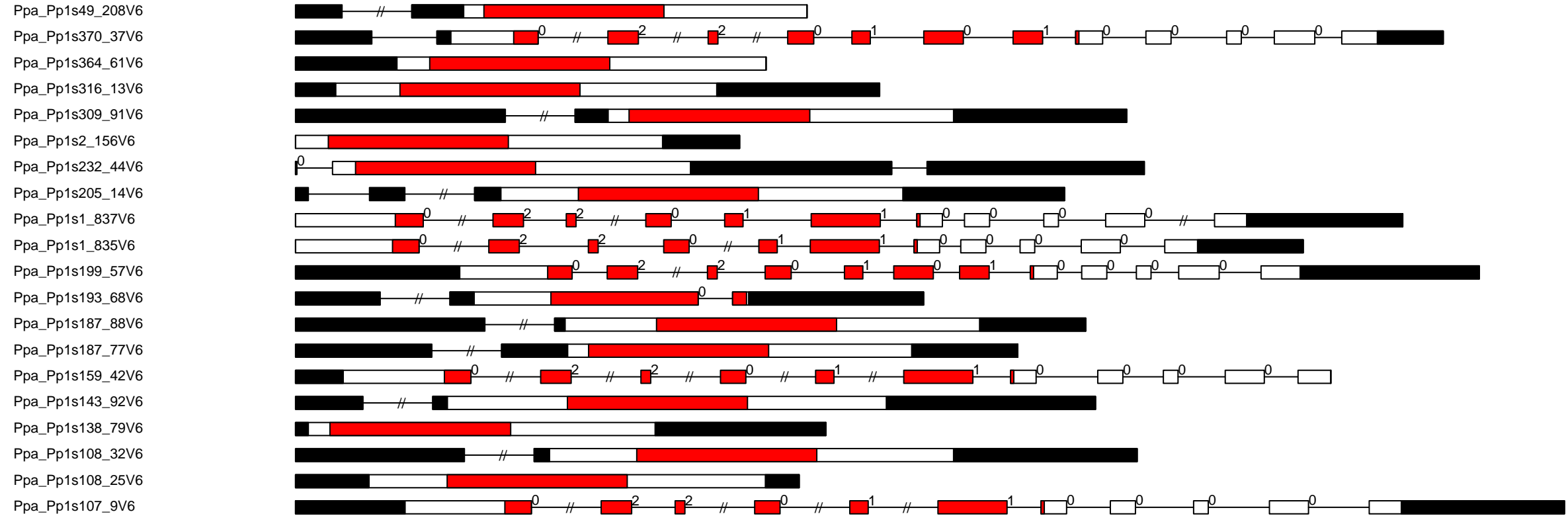

P.pa CAMK_CDPK exon-intron and kinase domain diagram (part 2)

Ppa_Pp1s49_200V6
Ppa_Pp1s364_58V6
Ppa_Pp1s325_31V6
Ppa_Pp1s2_191V6
Ppa_Pp1s166_57V6
Ppa_Pp1s97_71V6
Ppa_Pp1s96_216V6
Ppa_Pp1s83_8V6
Ppa_Pp1s83_172V6
Ppa_Pp1s60_259V6

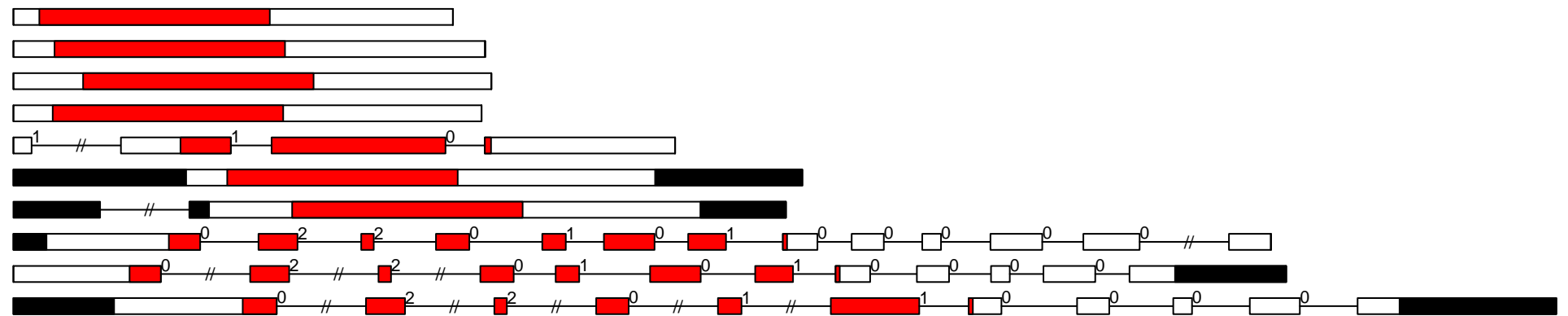

-1000

0

1000

2000

3000

4000

5000

P.pa CAMK_CDPK-Pp exon-intron and kinase domain diagram (all)

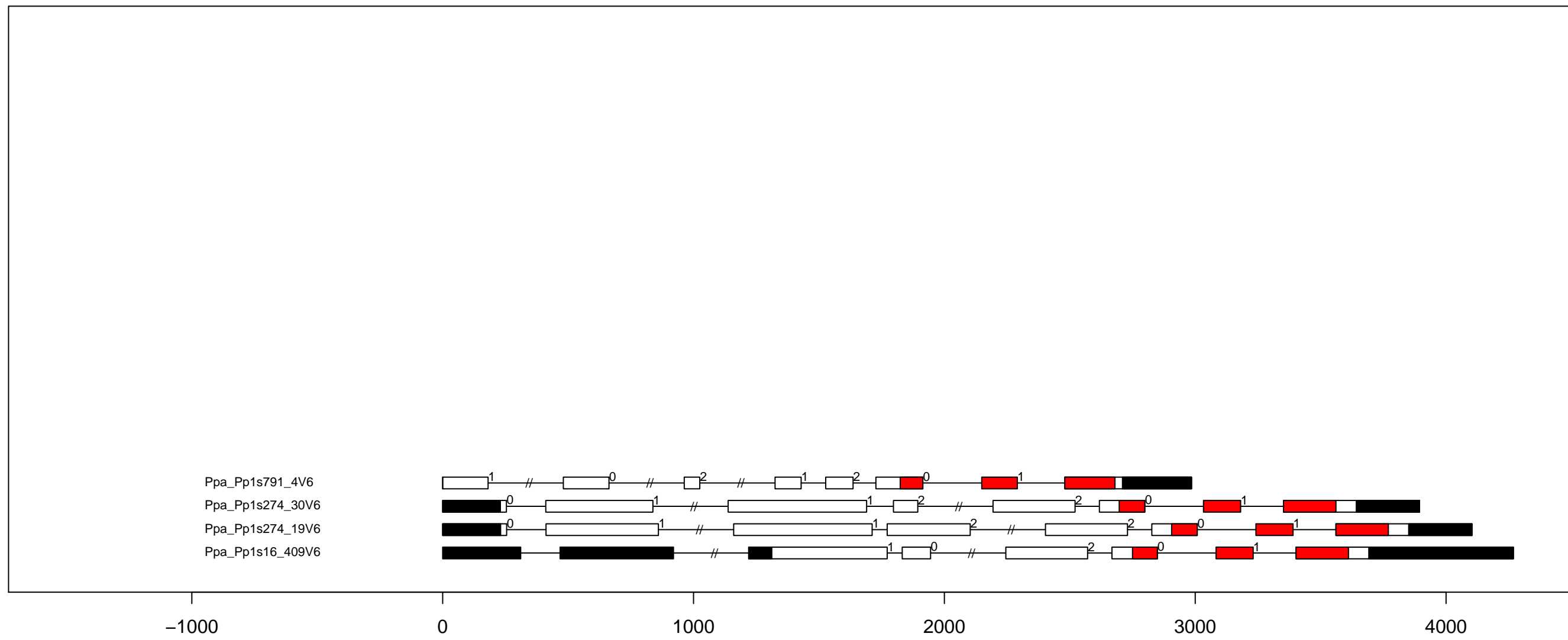

P.pa CAMK_OST1L exon-intron and kinase domain diagram (all)

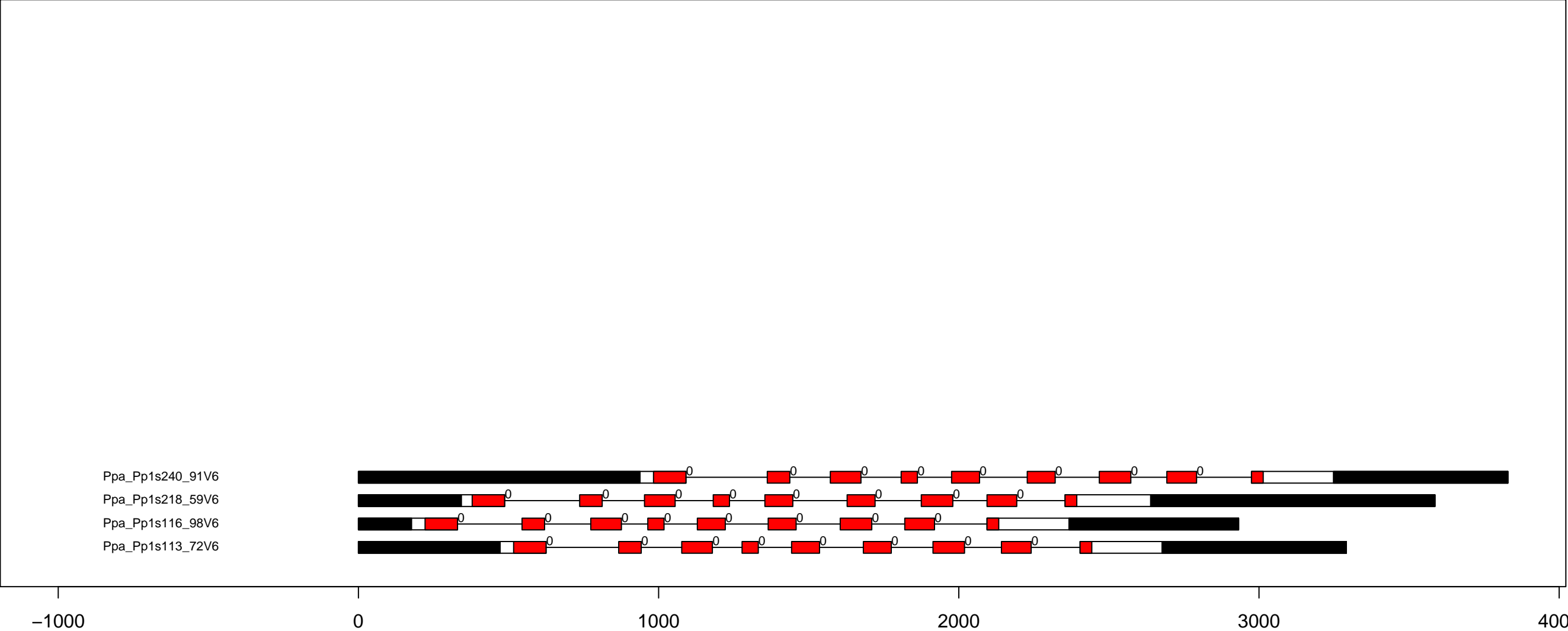

P.pa CK1_CK1 exon-intron and kinase domain diagram (all)

Ppa_Pp1s114_178V6
 Ppa_Pp1s430_12V6
 Ppa_Pp1s216_7V6
 Ppa_Pp1s182_90V6
 Ppa_Pp1s182_82V6
 Ppa_Pp1s151_38V6

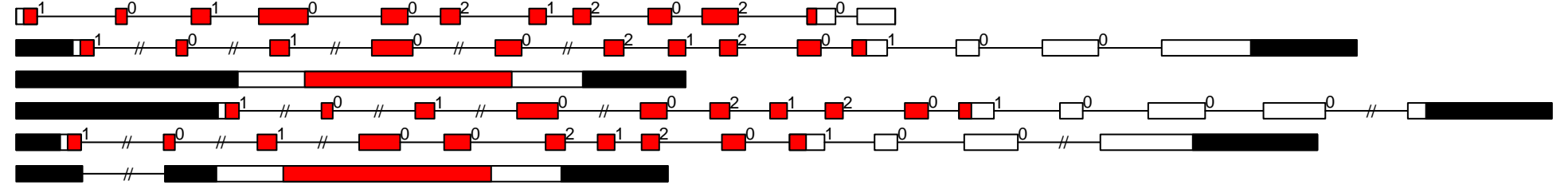

-1000

0

1000

2000

3000

4000

5000

P.pa CK1-CK1-PI exon-intron and kinase domain diagram (all)

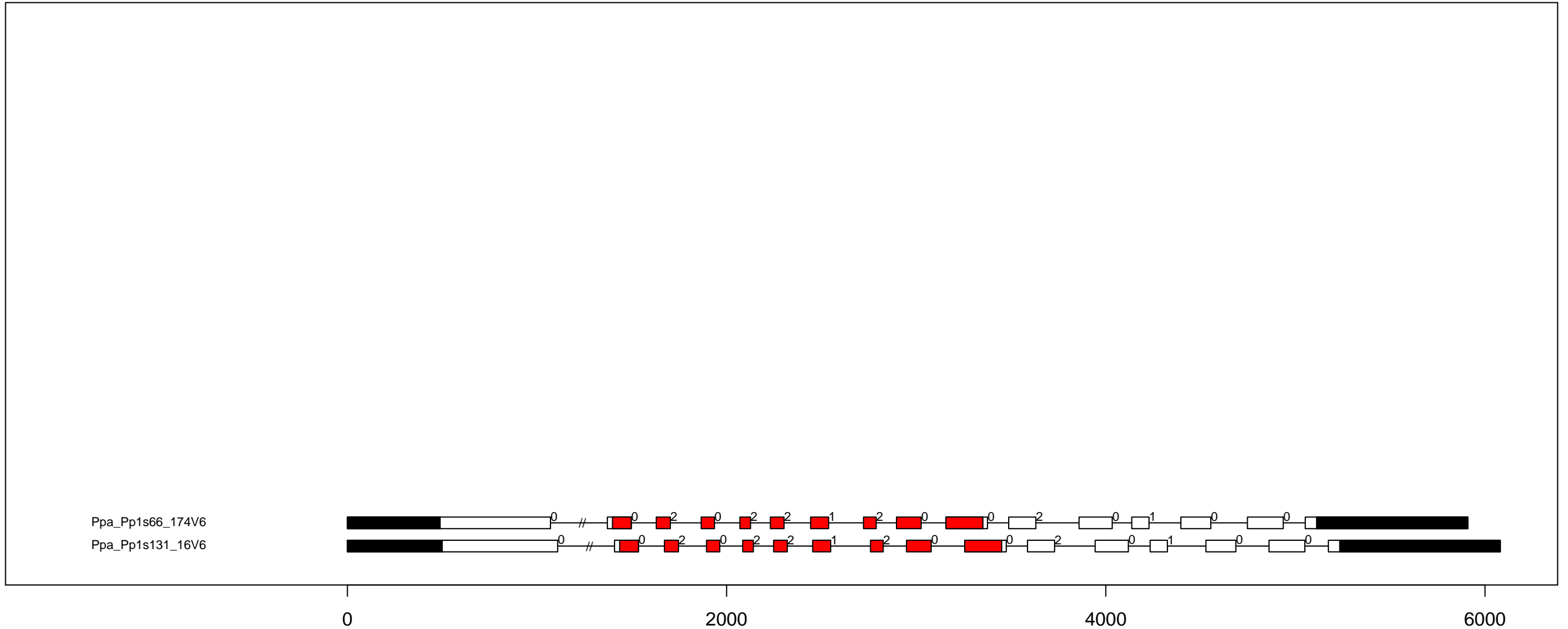

P.pa CMGC_CDK-CCRK exon-intron and kinase domain diagram (all)

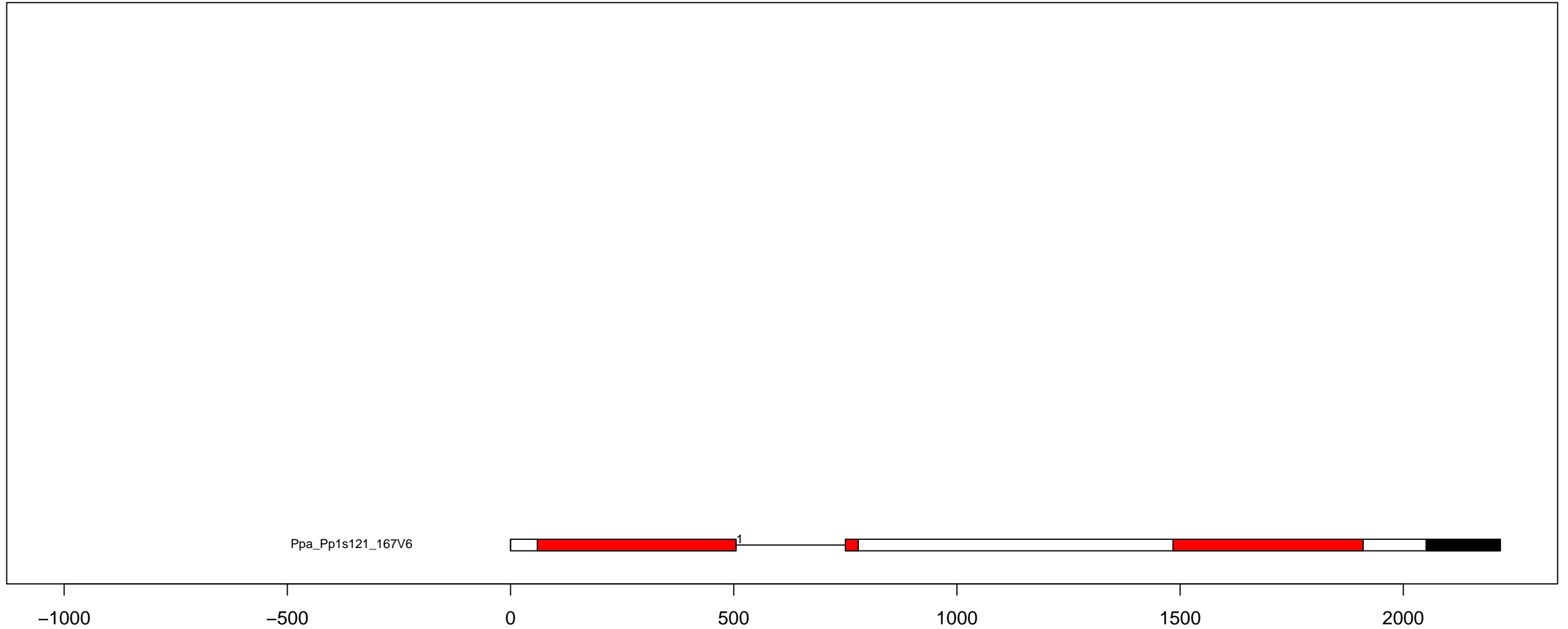

P.pa CMGC_CDK-CDK7 exon-intron and kinase domain diagram (all)

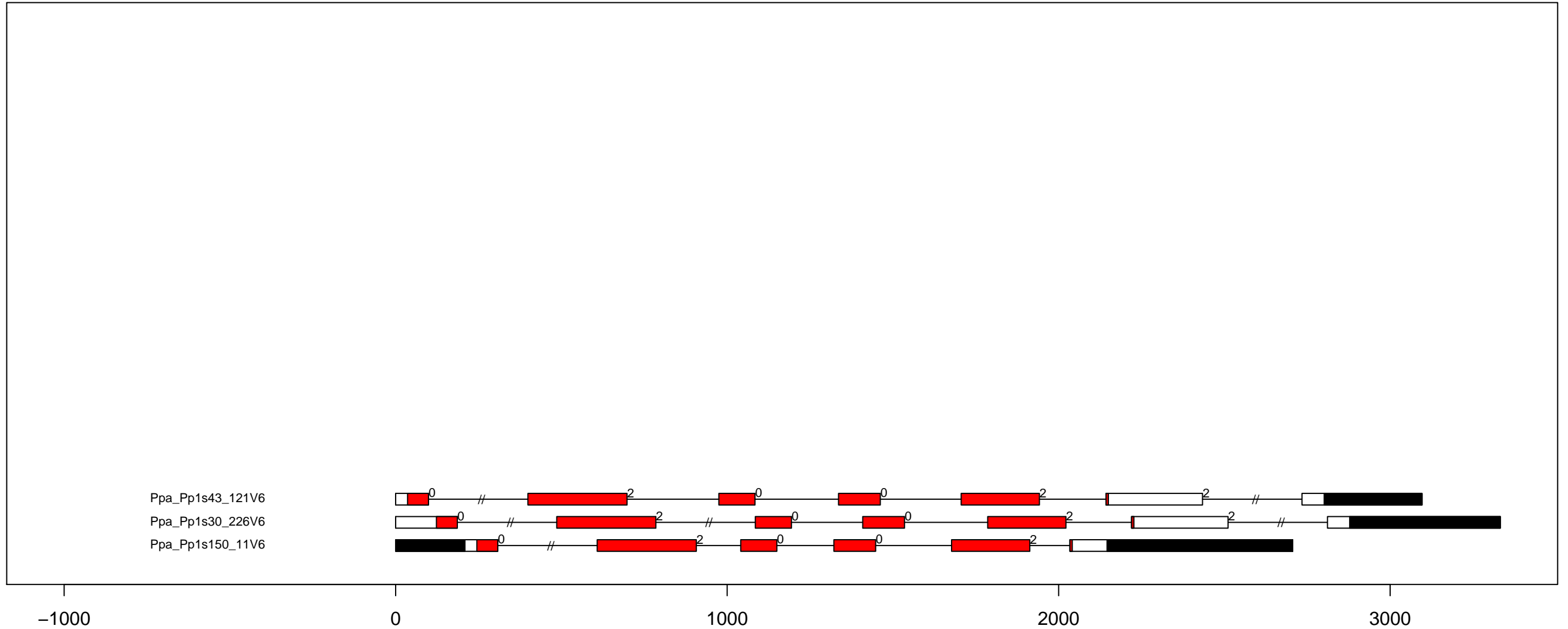

P.pa CMGC_CDK-CDK8 exon-intron and kinase domain diagram (all)

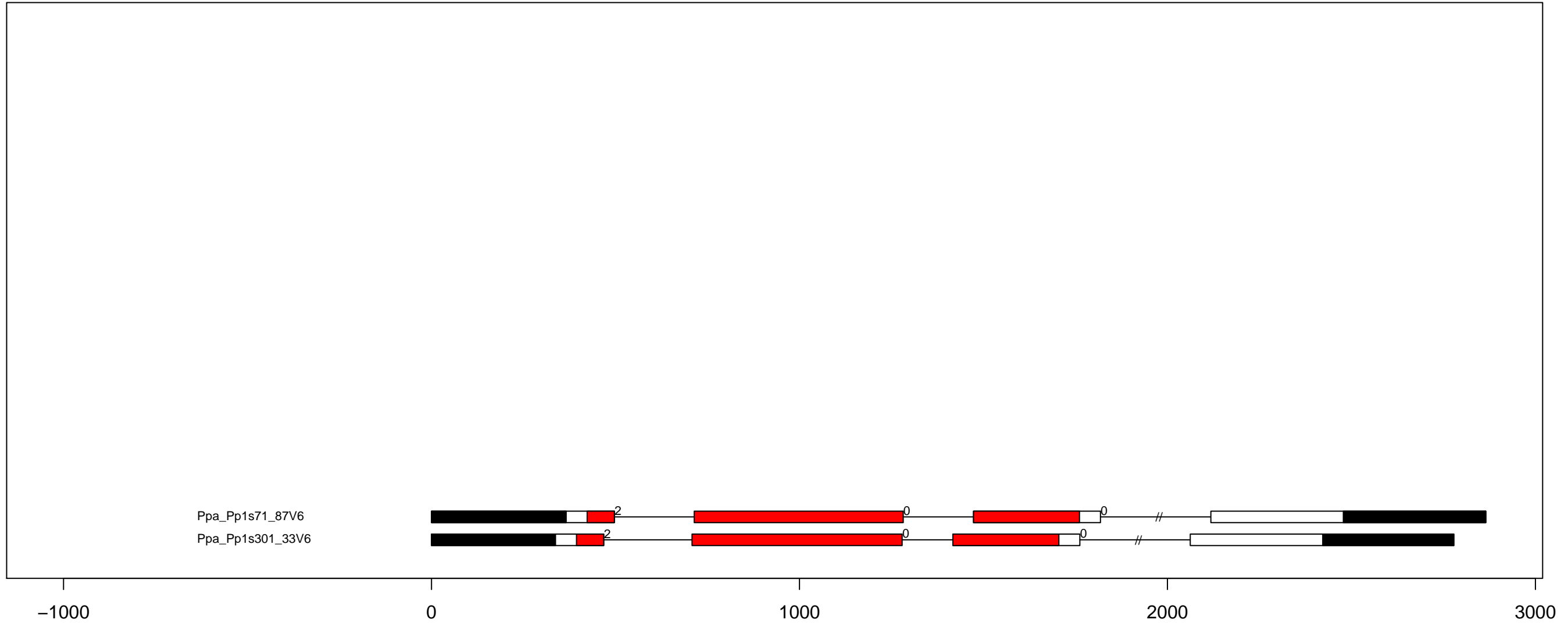

P.pa CMGC_CDK-CRK7-CDK9 exon-intron and kinase domain diagram (all)

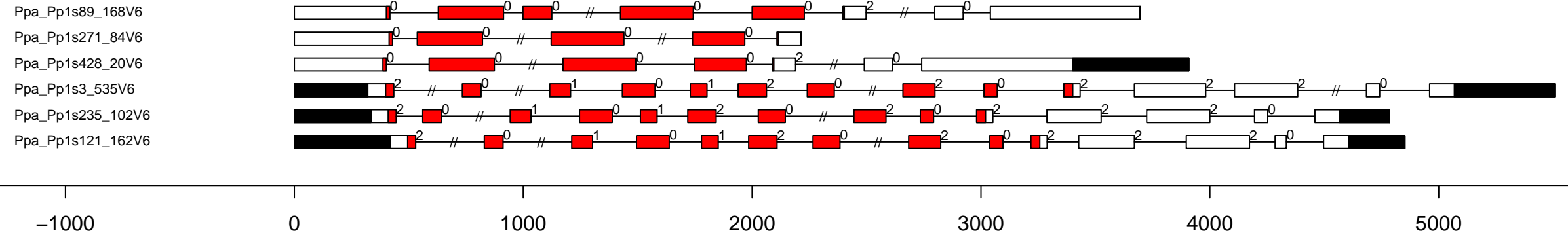

P.pa CMGC_CDK-PITSLRE exon-intron and kinase domain diagram (all)

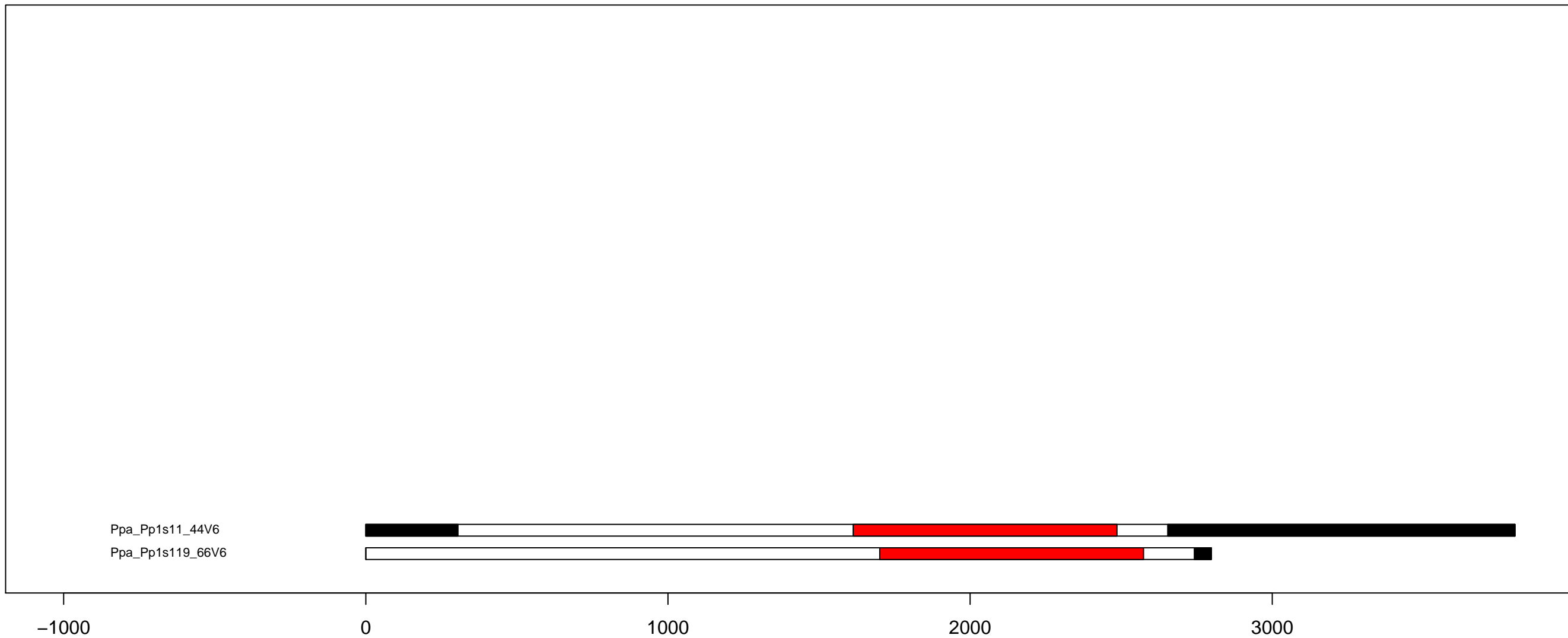

P.pa CMGC_CDK-PI exon-intron and kinase domain diagram (all)

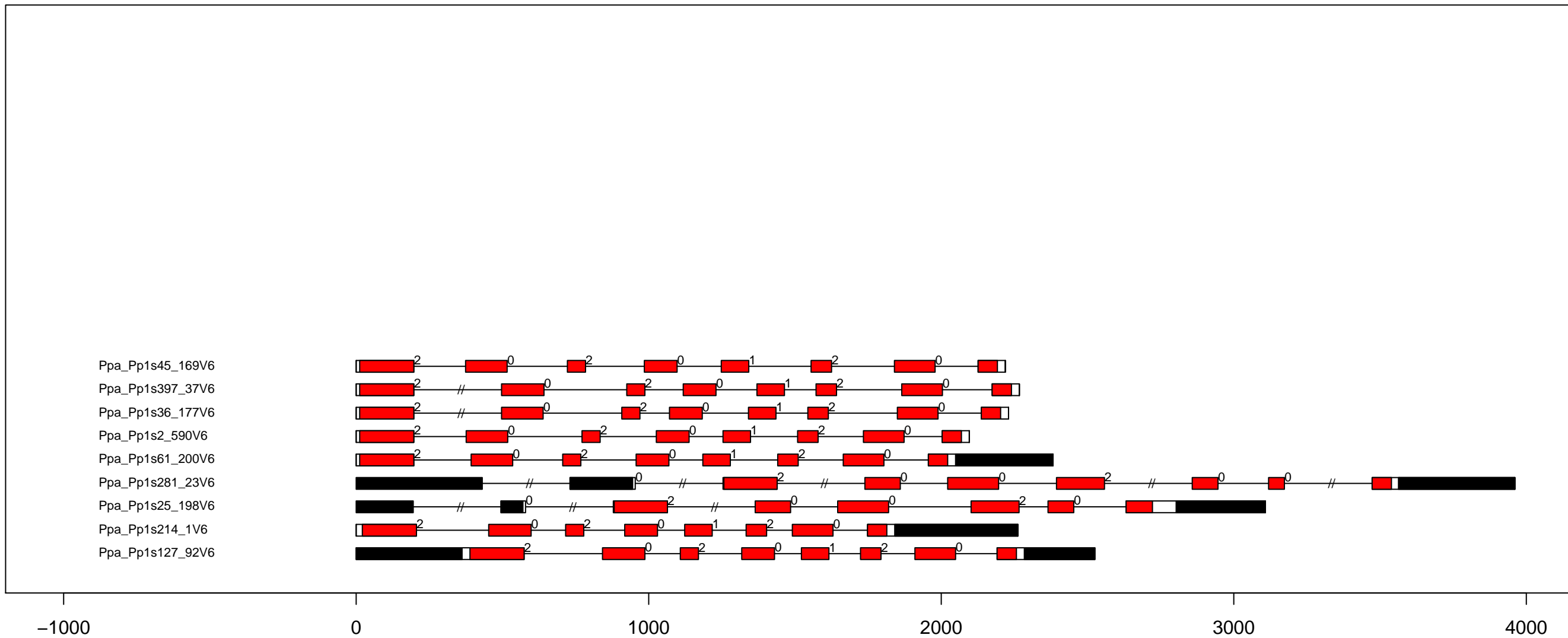

P.pa CMGC_CK2 exon-intron and kinase domain diagram (all)

Ppa_Pp1s63_208V6
Ppa_Pp1s230_93V6
Ppa_Pp1s165_119V6
Ppa_Pp1s165_107V6

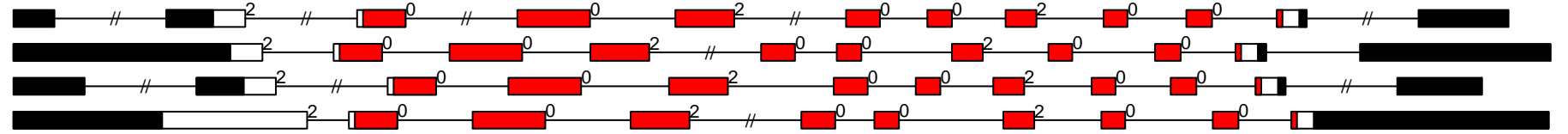

-1000

0

1000

2000

3000

4000

P.pa CMGC_CLK exon-intron and kinase domain diagram (all)

Ppa_Pp1s132_58V6
 Ppa_Pp1s425_6V6
 Ppa_Pp1s100_121V6

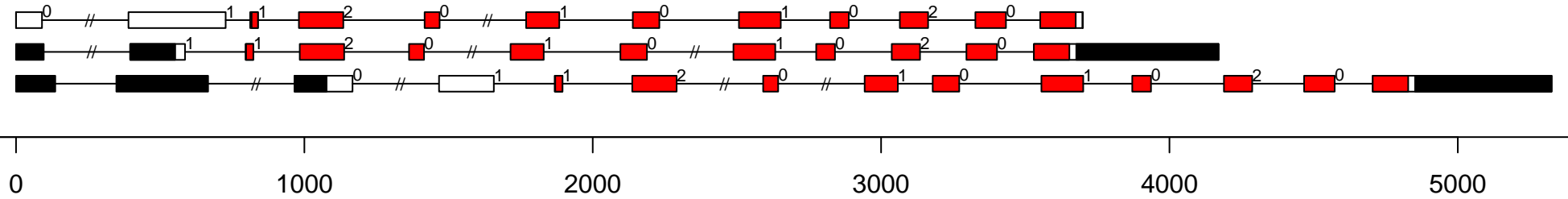

P.pa CMGC_DYRK–DRYK2 exon–intron and kinase domain diagram (all)

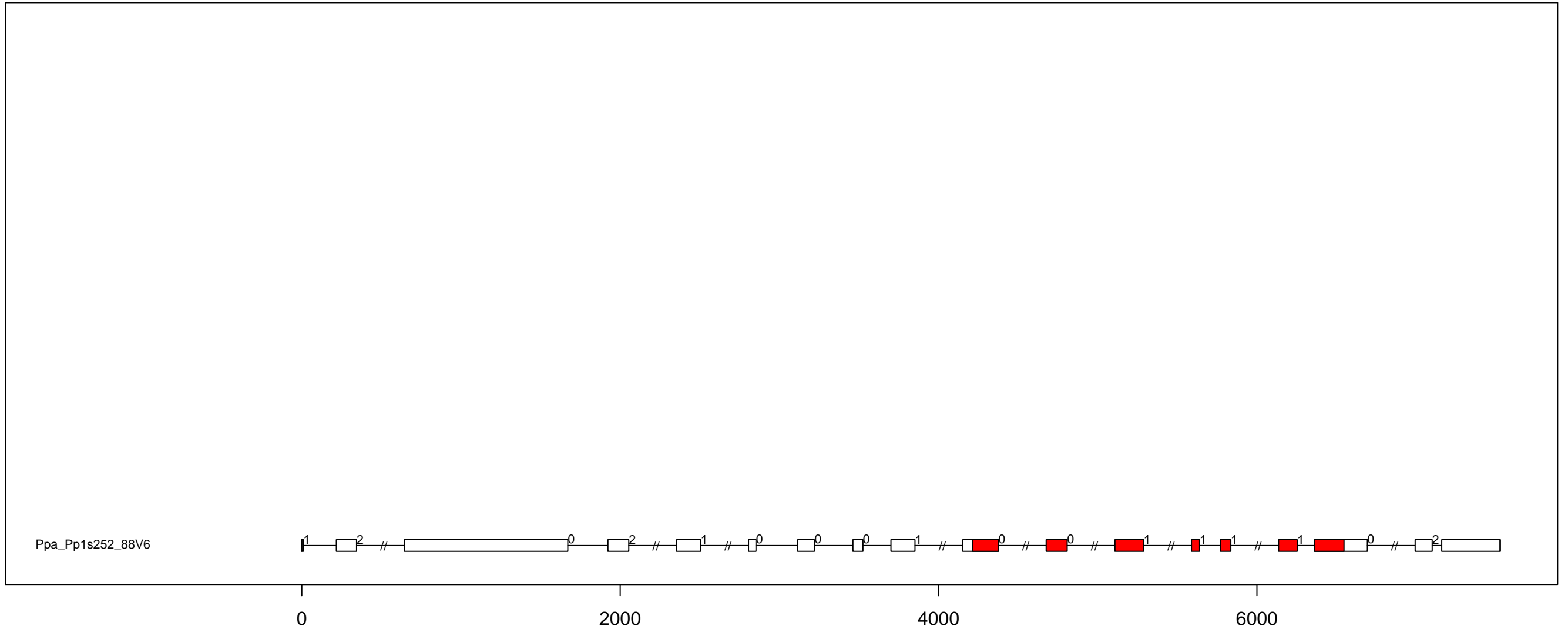

P.pa CMGC_DYRK-PRP4 exon-intron and kinase domain diagram (all)

Ppa_Pp1s250_28V6

Ppa_Pp1s213_125V6

Ppa_Pp1s47_312V6

Ppa_Pp1s381_39V6

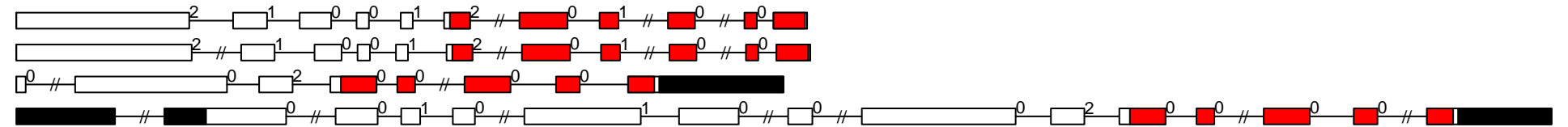

-2000

0

2000

4000

6000

8000

P.pa CMGC_DYRK-YAK exon-intron and kinase domain diagram (all)

Ppa_Pp1s401_7V6
Ppa_Pp1s3_592V6
Ppa_Pp1s192_46V6
Ppa_Pp1s16_333V6
Ppa_Pp1s132_192V6

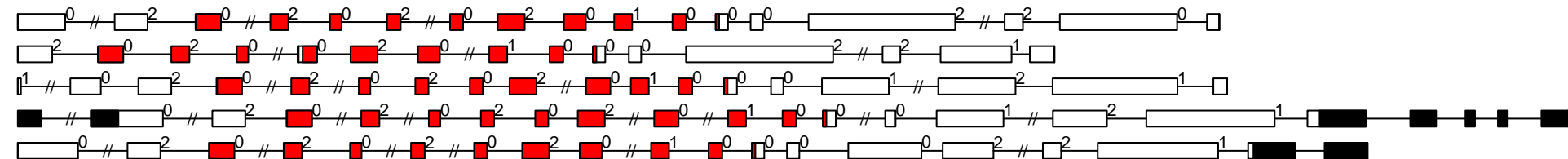

-2000

0

2000

4000

6000

8000

P.pa CMGC_MAPK exon-intron and kinase domain diagram (all)

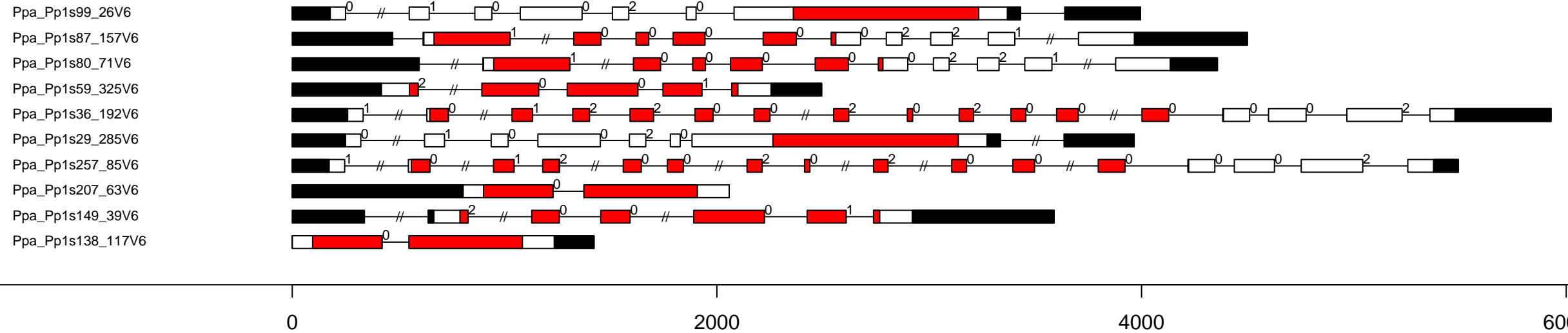

P.pa CMGC_PI-Tthe exon-intron and kinase domain diagram (all)

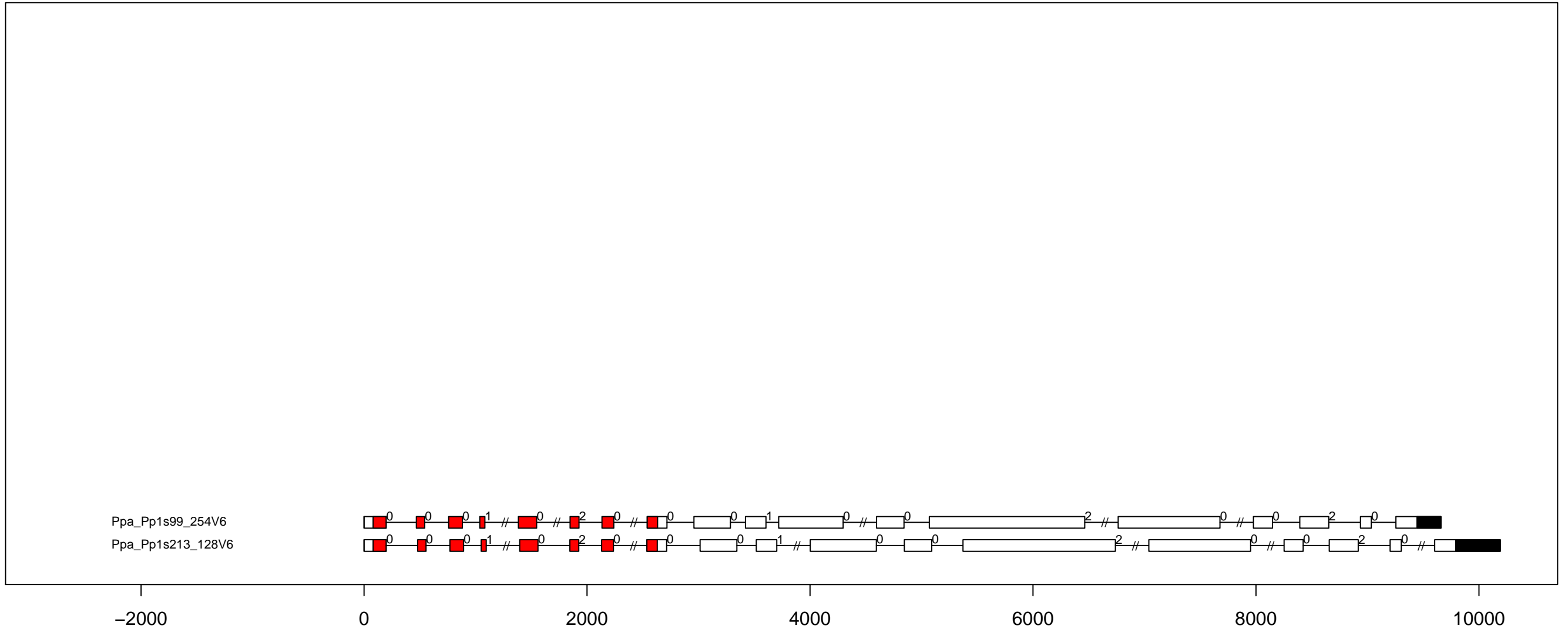

P.pa CMGC_RCK exon-intron and kinase domain diagram (all)

Ppa_Pp1s34_221V6
Ppa_Pp1s479_13V6
Ppa_Pp1s28_184V6
Ppa_Pp1s173_136V6

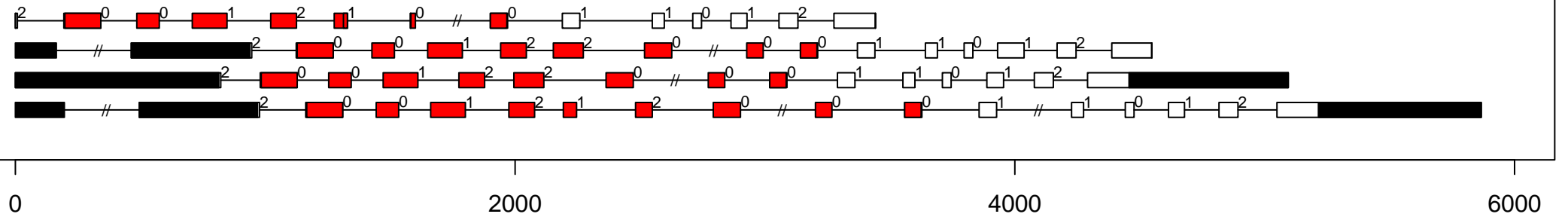

P.pa CMGC_SRPK exon-intron and kinase domain diagram (all)

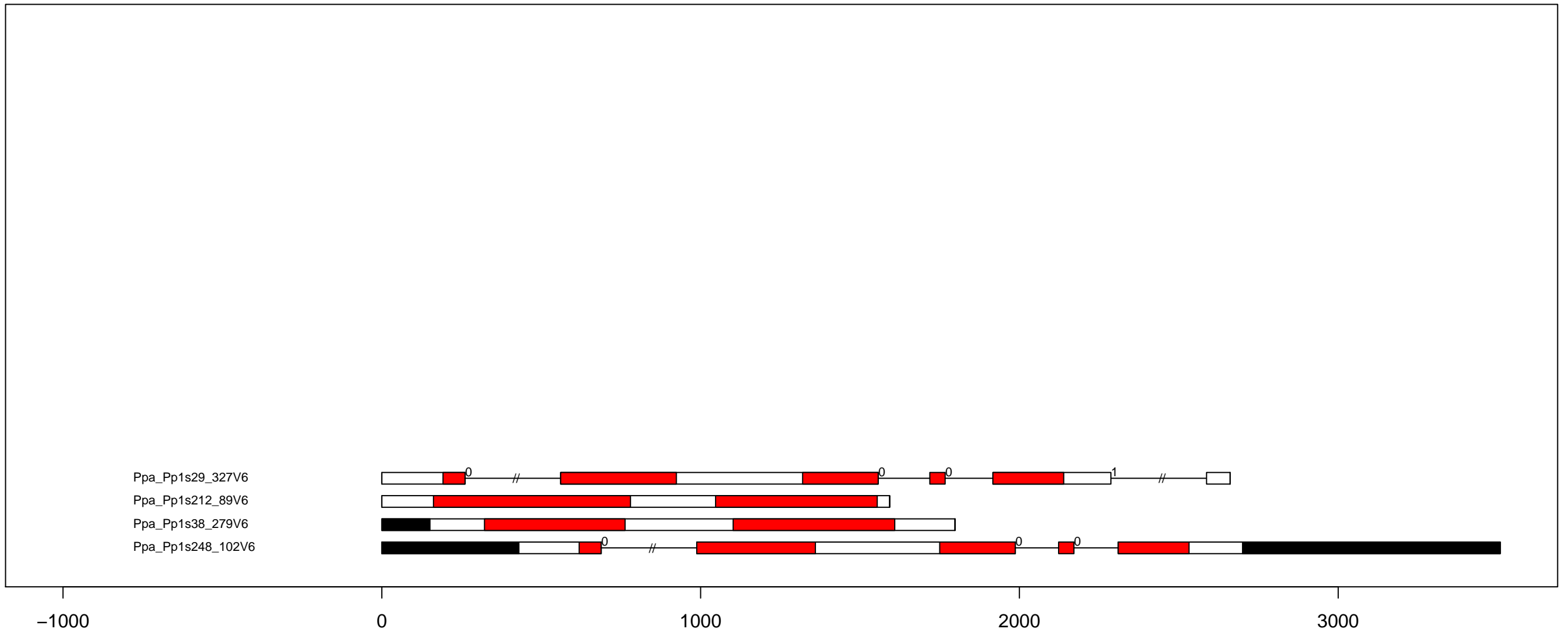

P.pa Group-PI-1 exon-intron and kinase domain diagram (all)

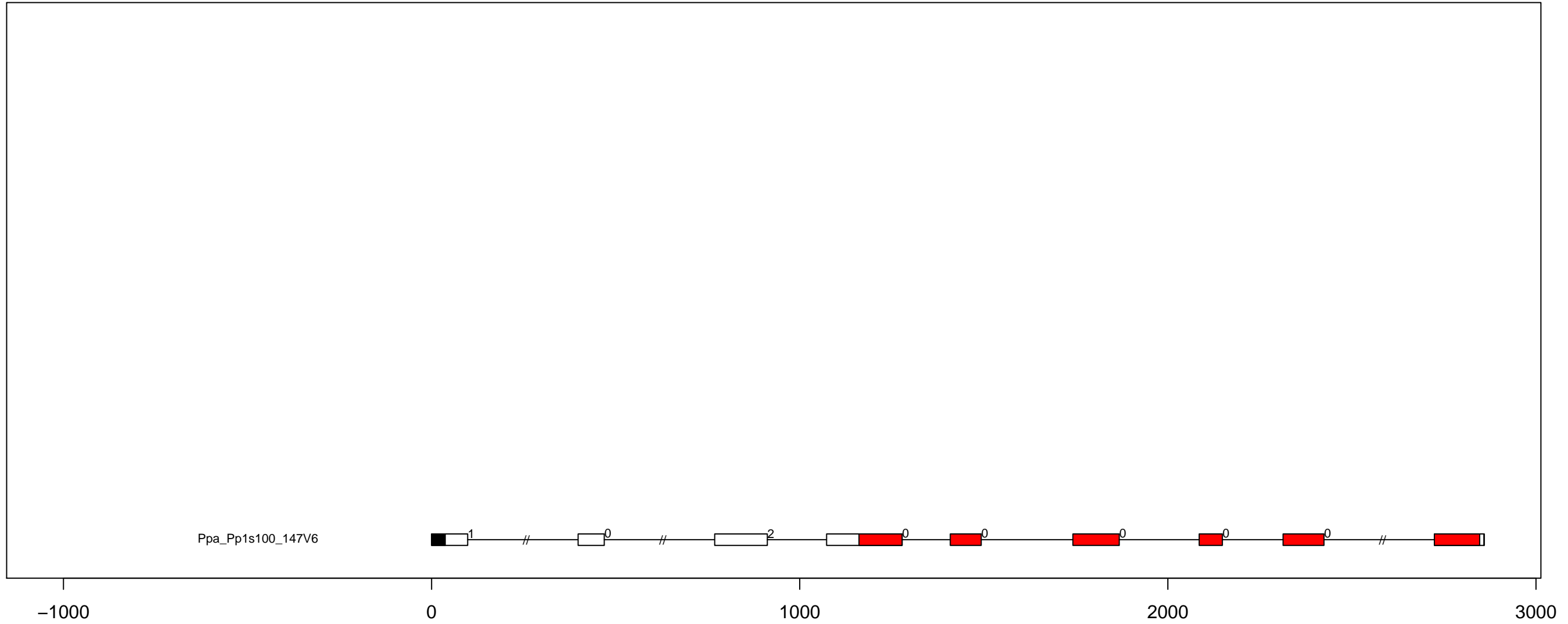

P.pa Group-PI-3 exon-intron and kinase domain diagram (all)

Ppa_Pp1s517_5V6

Ppa_Pp1s33_270V6

Ppa_Pp1s191_16V6

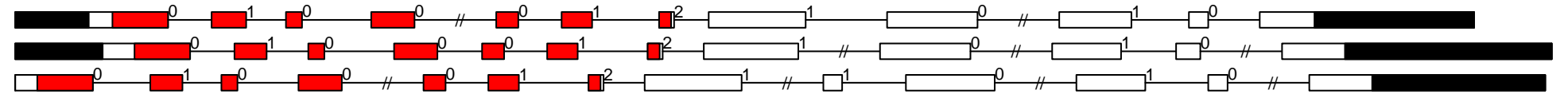

-1000

0

1000

2000

3000

4000

5000

P.pa Group-PI-4 exon-intron and kinase domain diagram (all)

Ppa_Pp1s38_294V6
 Ppa_Pp1s293_17V6
 Ppa_Pp1s159_111V6
 Ppa_Pp1s110_47V6

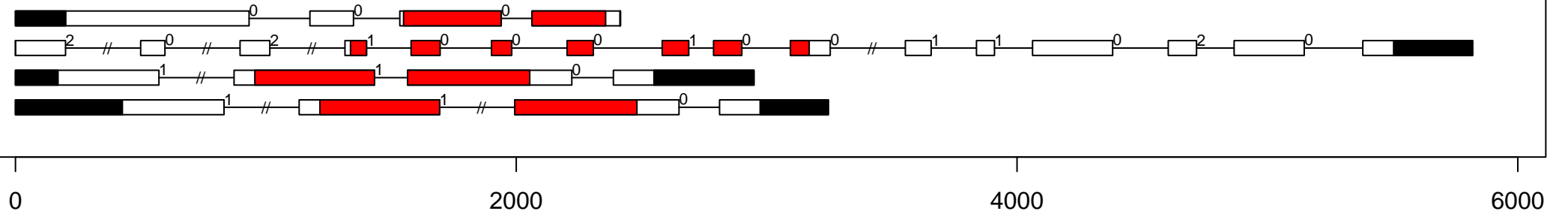

P.pa IRE1 exon-intron and kinase domain diagram (all)

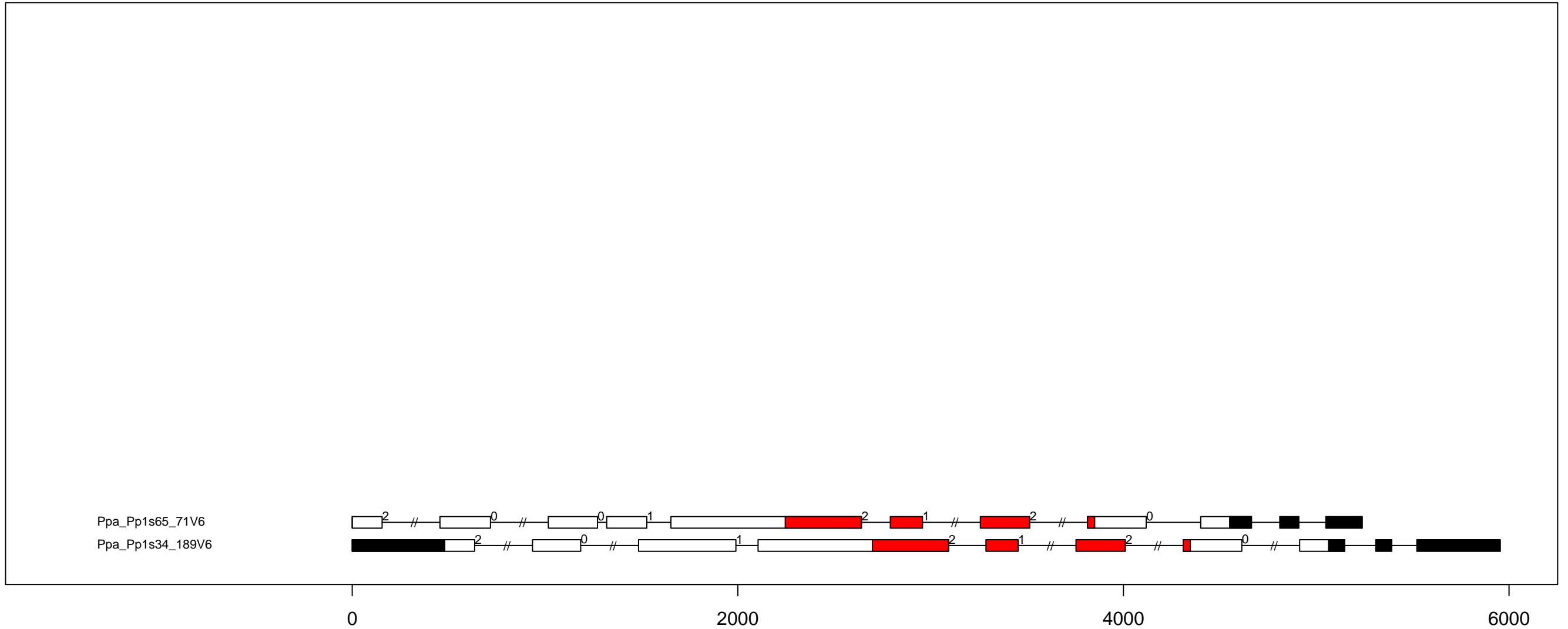

P.pa NAK exon-intron and kinase domain diagram (all)

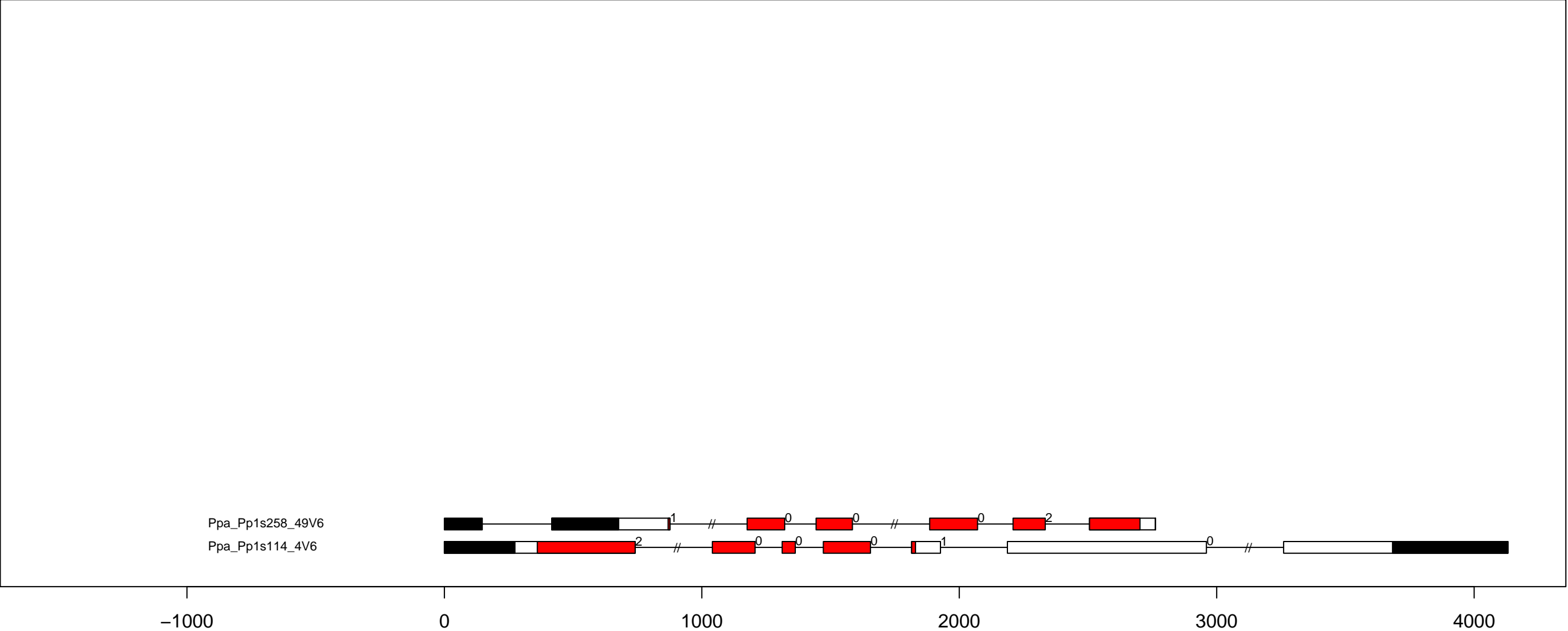

P.pa NEK exon-intron and kinase domain diagram (all)

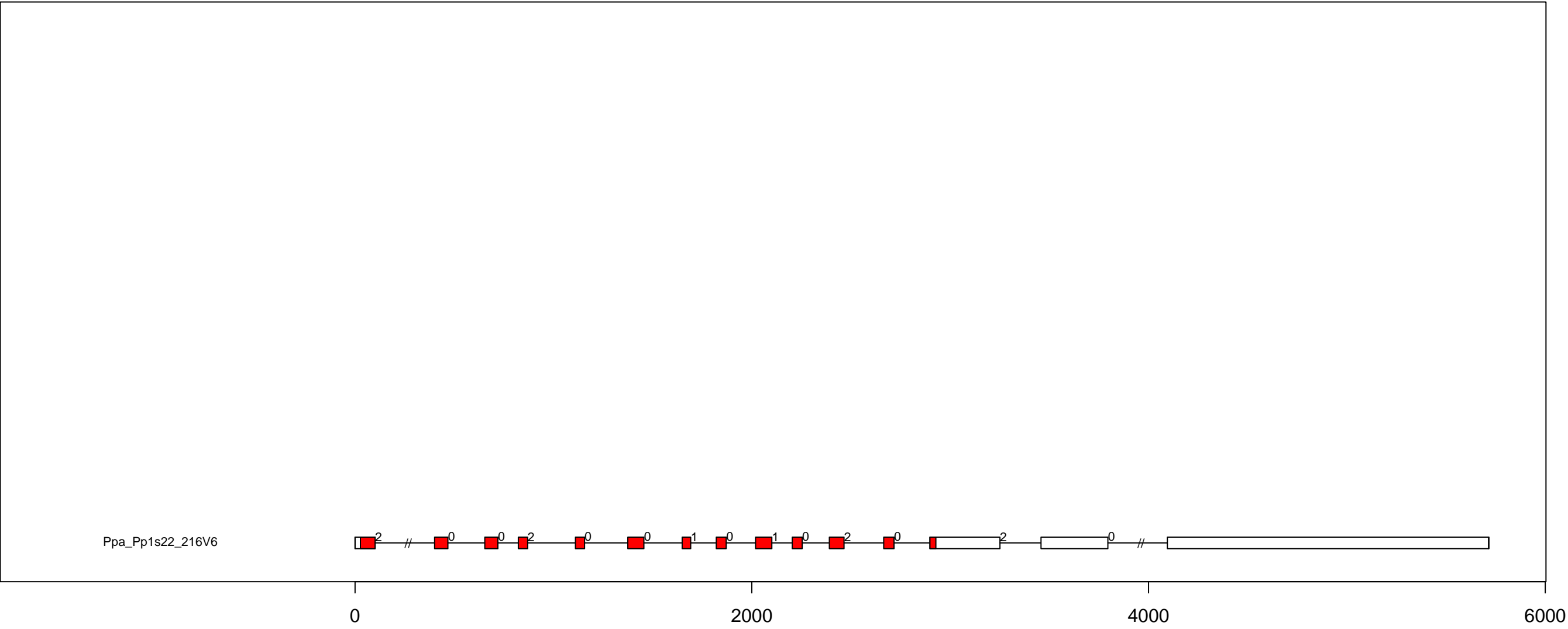

P.pa PEK_GCIN2 exon-intron and kinase domain diagram (all)

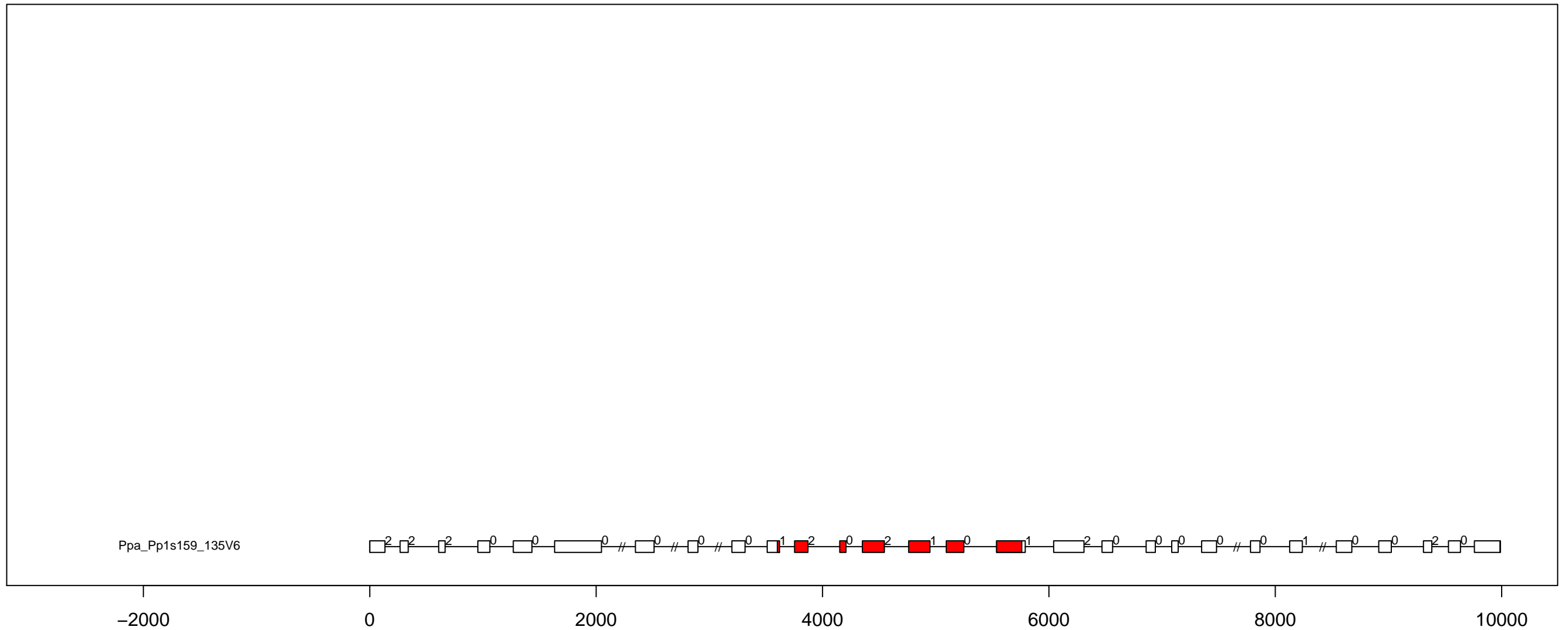

P.pa RLK-Pelle_C-LEC exon-intron and kinase domain diagram (all)

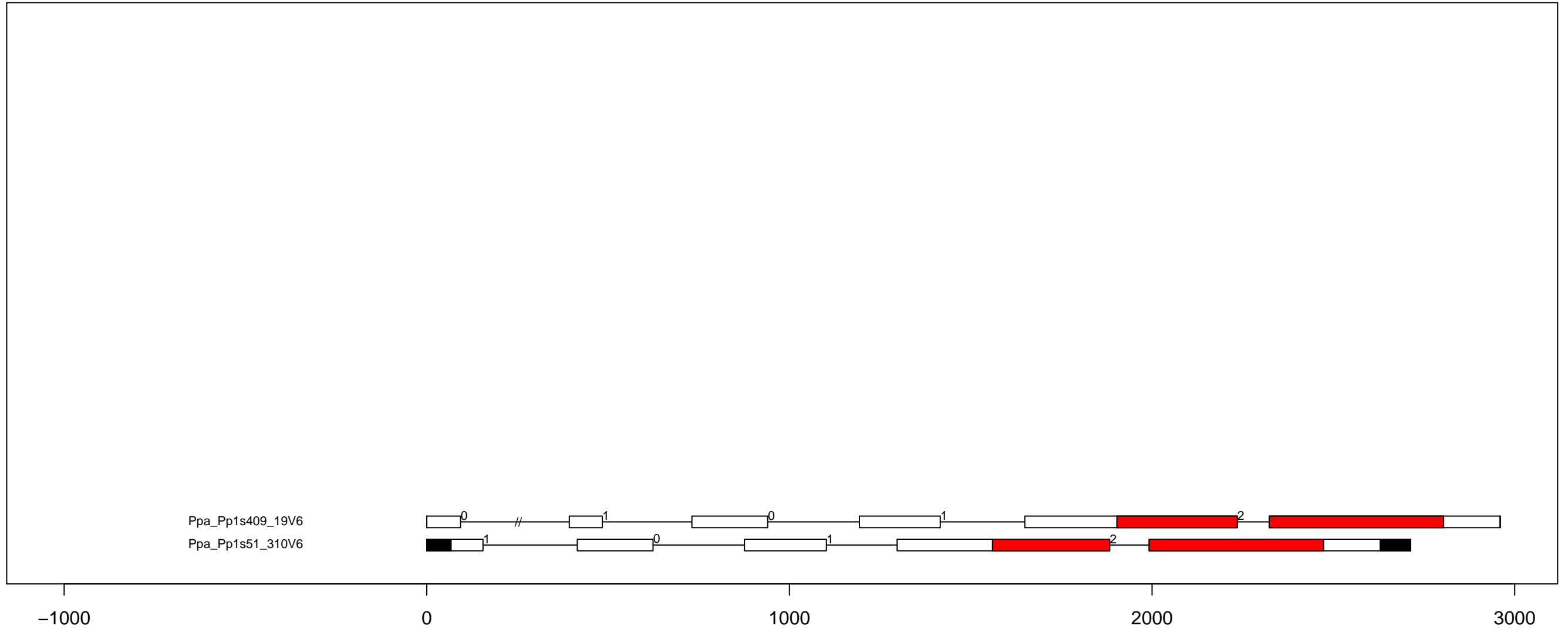

P.pa RLK-Pelle_CR4L exon-intron and kinase domain diagram (all)

Ppa_Pp1s64_17V6
 Ppa_Pp1s199_5V6
 Ppa_Pp1s126_187V6
 Ppa_Pp1s53_23V6
 Ppa_Pp1s51_222V6
 Ppa_Pp1s384_15V6
 Ppa_Pp1s21_330V6
 Ppa_Pp1s206_38V6
 Ppa_Pp1s14_256V6
 Ppa_Pp1s103_89V6

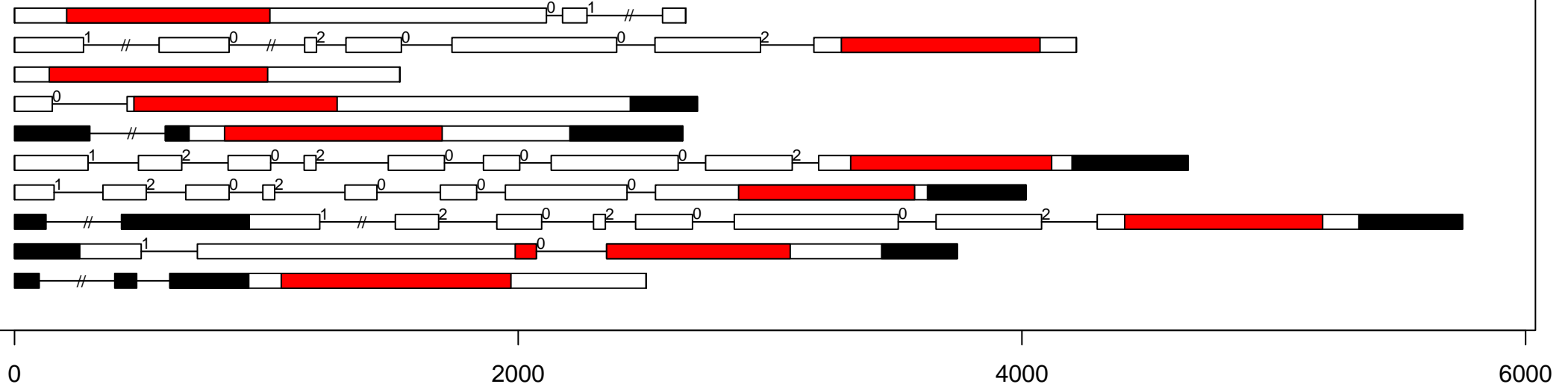

P.pa RLK-Pelle_CrRLK1L-1 exon-intron and kinase domain diagram (all)

Ppa_Pp1s44_215V6

Ppa_Pp1s44_178V6

Ppa_Pp1s262_67V6

Ppa_Pp1s29_343V6

Ppa_Pp1s24_5V6

-1000

0

1000

2000

3000

4000

5000

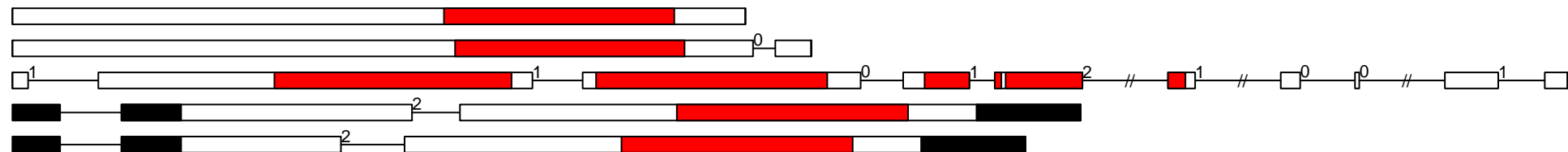

P.pa RLK-Pelle_DLSV exon-intron and kinase domain diagram (part 1)

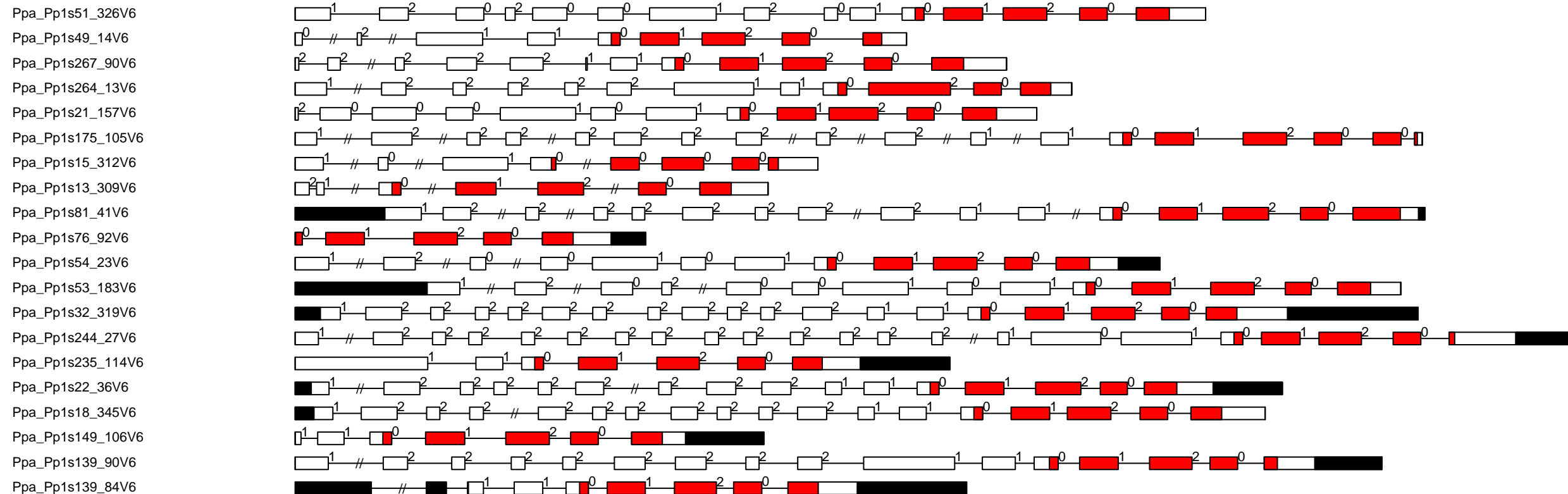

P.pa RLK-Pelle_DLSV exon-intron and kinase domain diagram (part 2)

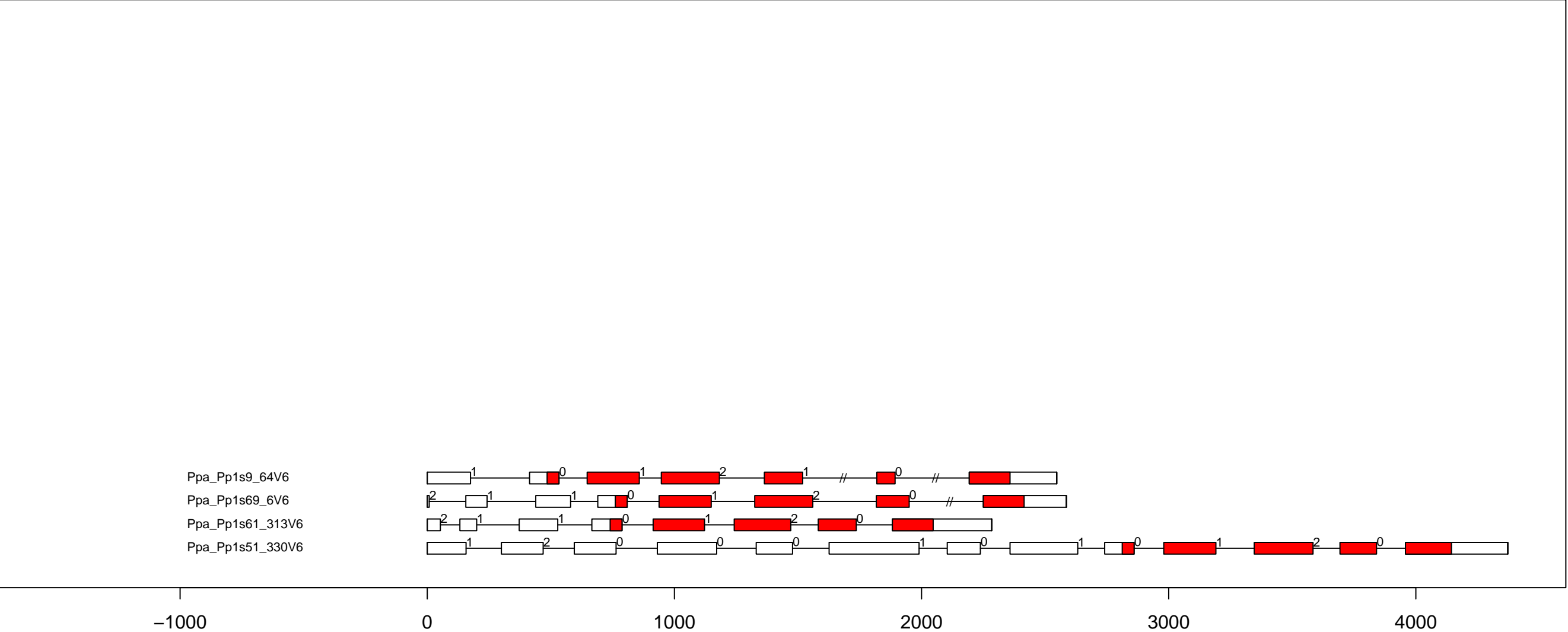

P.pa RLK-Pelle_DSLV exon-intron and kinase domain diagram (all)

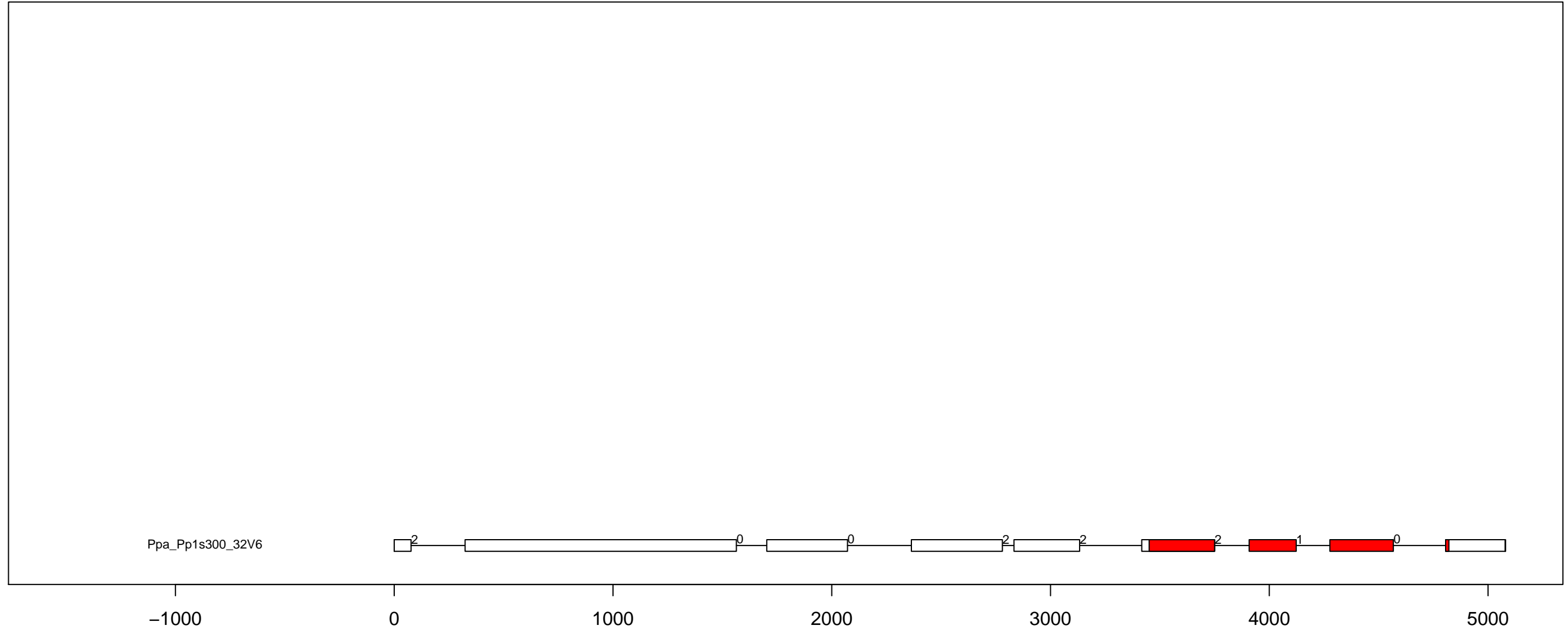

P.pa RLK-Pelle_Extensin exon-intron and kinase domain diagram (all)

Ppa_Pp1s95_115V6
 Ppa_Pp1s79_45V6
 Ppa_Pp1s43_35V6
 Ppa_Pp1s293_24V6
 Ppa_Pp1s116_191V6
 Ppa_Pp1s115_198V6
 Ppa_Pp1s478_19V6
 Ppa_Pp1s343_14V6
 Ppa_Pp1s255_47V6

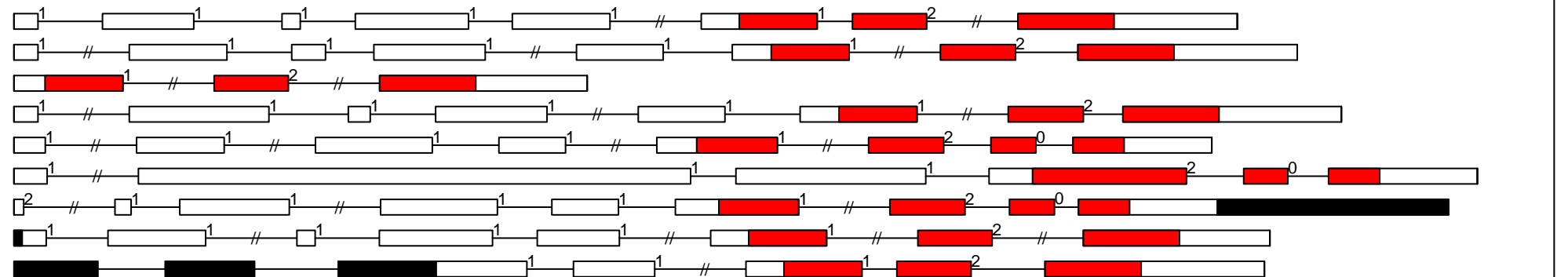

-1000

0

1000

2000

3000

4000

5000

P.pa RLK-Pelle_L-LEC exon-intron and kinase domain diagram (all)

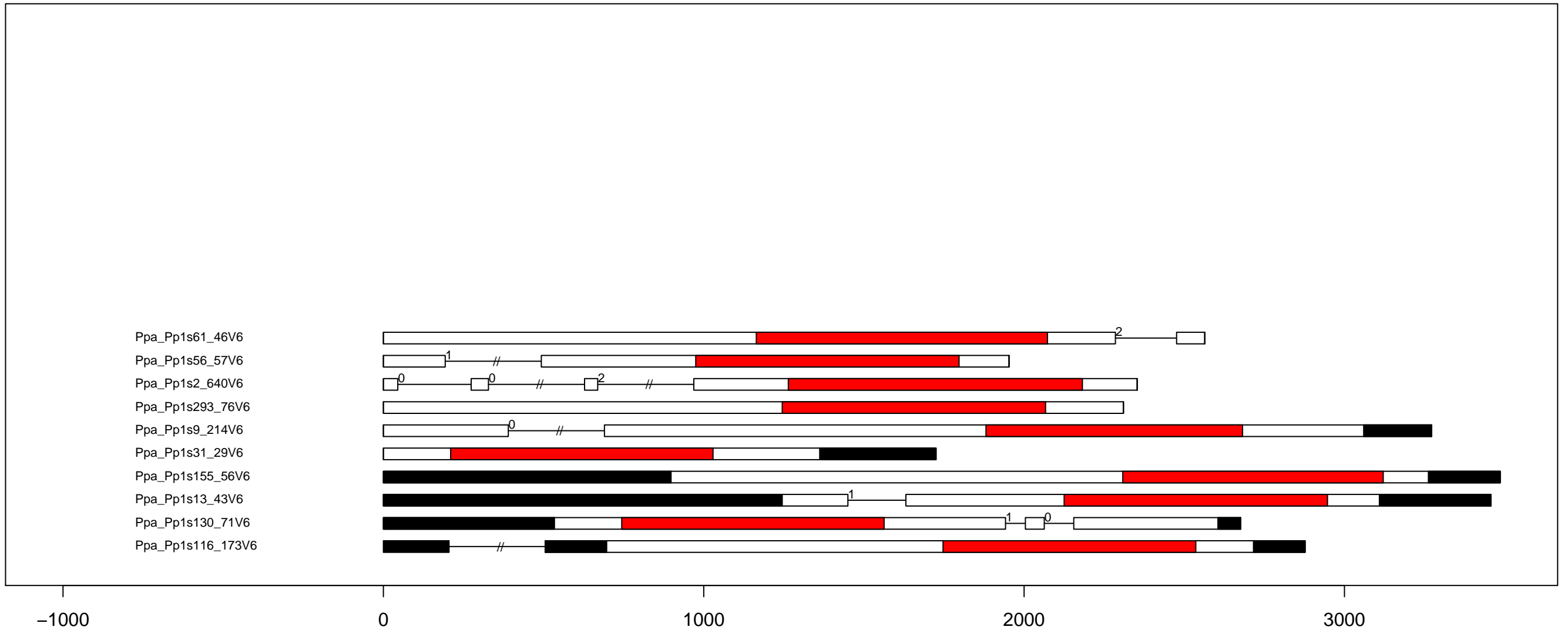

P.pa RLK-Pelle_LRR-I-1 exon-intron and kinase domain diagram (all)

Ppa_Pp1s97_232V6
 Ppa_Pp1s70_10V6
 Ppa_Pp1s333_16V6
 Ppa_Pp1s29_130V6
 Ppa_Pp1s262_62V6
 Ppa_Pp1s1_213V6
 Ppa_Pp1s160_39V6
 Ppa_Pp1s124_7V6
 Ppa_Pp1s115_69V6
 Ppa_Pp1s97_129V6
 Ppa_Pp1s59_282V6
 Ppa_Pp1s59_264V6
 Ppa_Pp1s59_259V6
 Ppa_Pp1s55_6V6
 Ppa_Pp1s38_96V6
 Ppa_Pp1s245_95V6
 Ppa_Pp1s13_83V6
 Ppa_Pp1s13_72V6
 Ppa_Pp1s13_59V6
 Ppa_Pp1s133_62V6

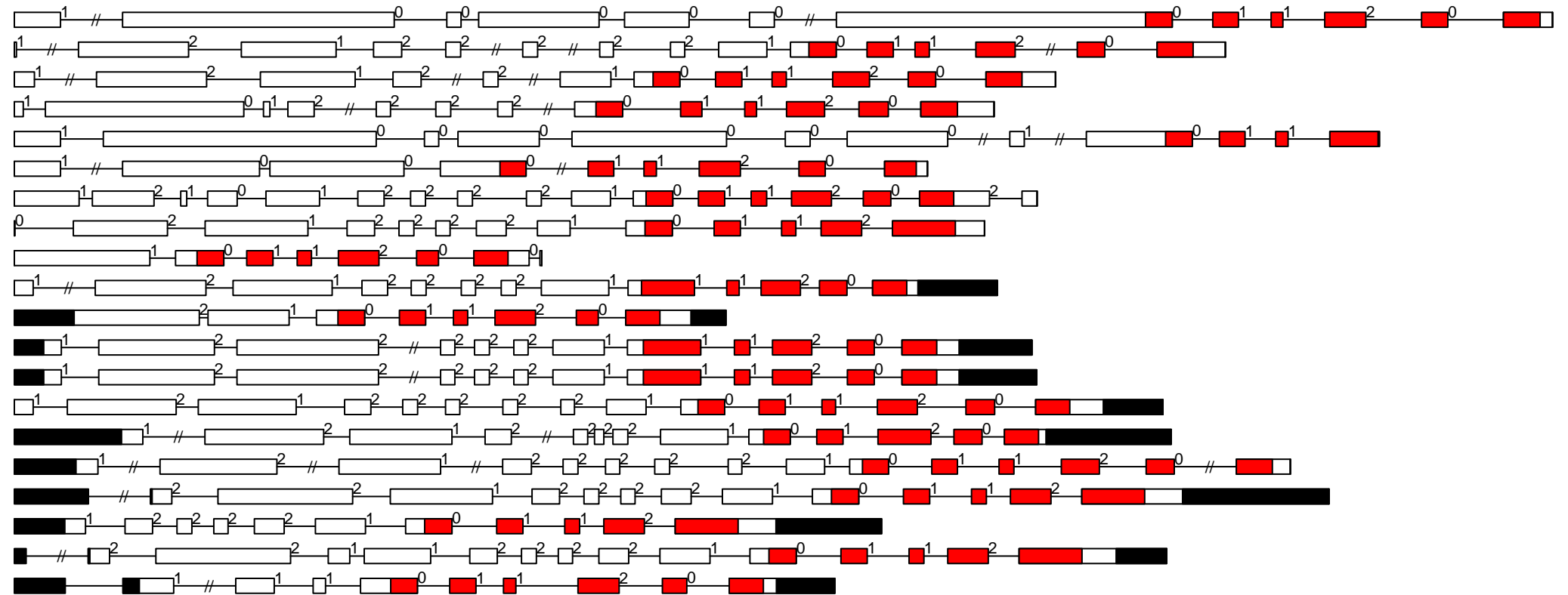

0 2000 4000 6000

P.pa RLK-Pelle_LRR-I-2 exon-intron and kinase domain diagram (all)

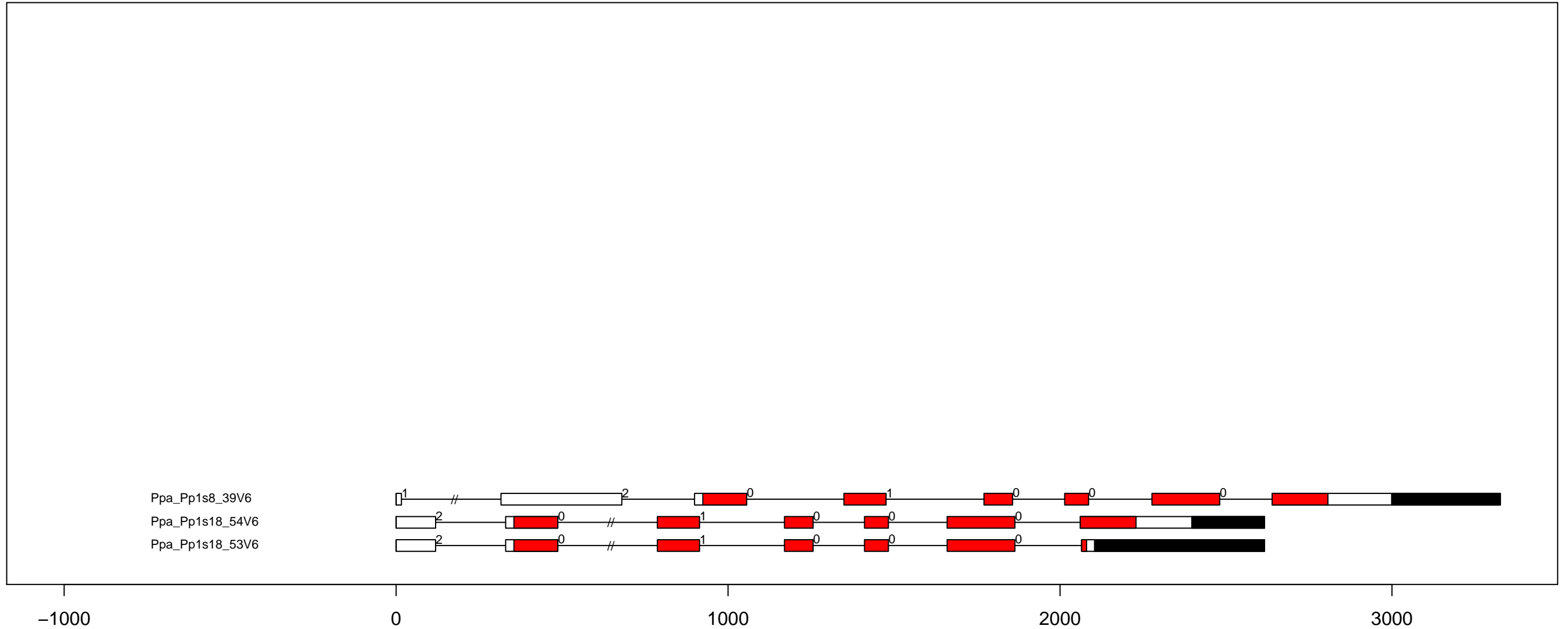

P.pa RLK-Pelle_LRR-III exon-intron and kinase domain diagram (all)

Ppa_Pp1s66_118V6
 Ppa_Pp1s39_174V6
 Ppa_Pp1s34_385V6
 Ppa_Pp1s343_19V6
 Ppa_Pp1s33_57V6
 Ppa_Pp1s324_19V6
 Ppa_Pp1s170_55V6
 Ppa_Pp1s513_5V6
 Ppa_Pp1s43_33V6
 Ppa_Pp1s3_381V6
 Ppa_Pp1s3_377V6
 Ppa_Pp1s235_117V6
 Ppa_Pp1s235_116V6
 Ppa_Pp1s22_20V6
 Ppa_Pp1s20_213V6
 Ppa_Pp1s170_56V6
 Ppa_Pp1s157_83V6
 Ppa_Pp1s12_368V6
 Ppa_Pp1s129_205V6
 Ppa_Pp1s121_138V6

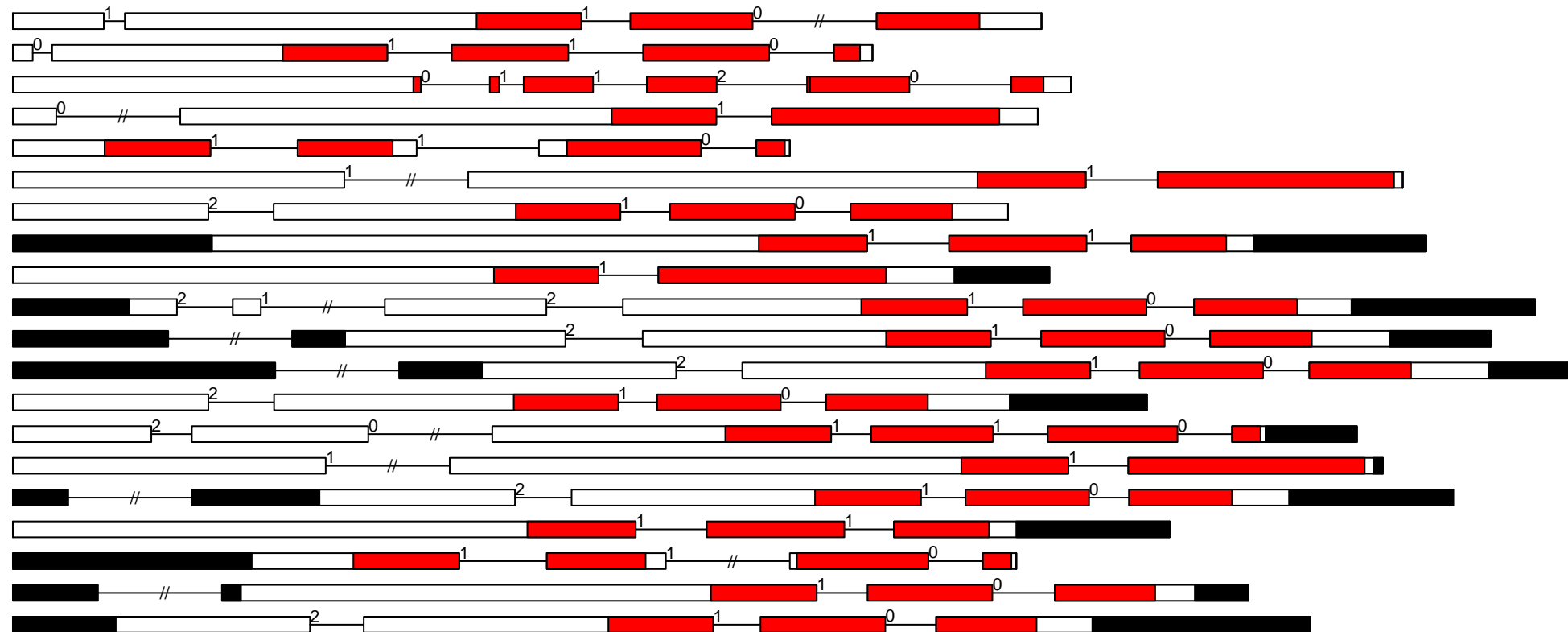

-1000

0

1000

2000

3000

P.pa RLK-Pelle_LRR-II exon-intron and kinase domain diagram (all)

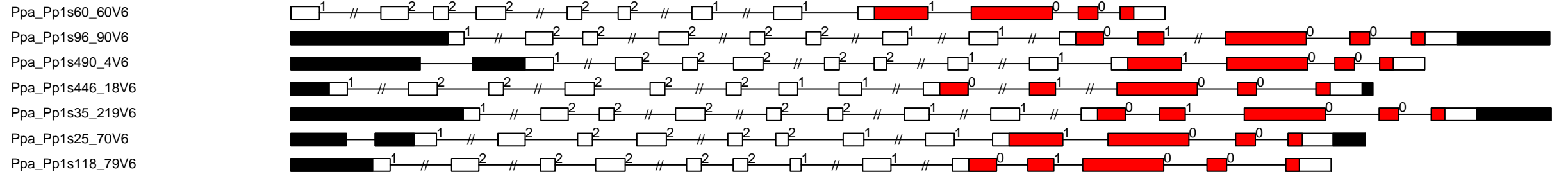

P.pa RLK-Pelle_LRR-IV exon-intron and kinase domain diagram (all)

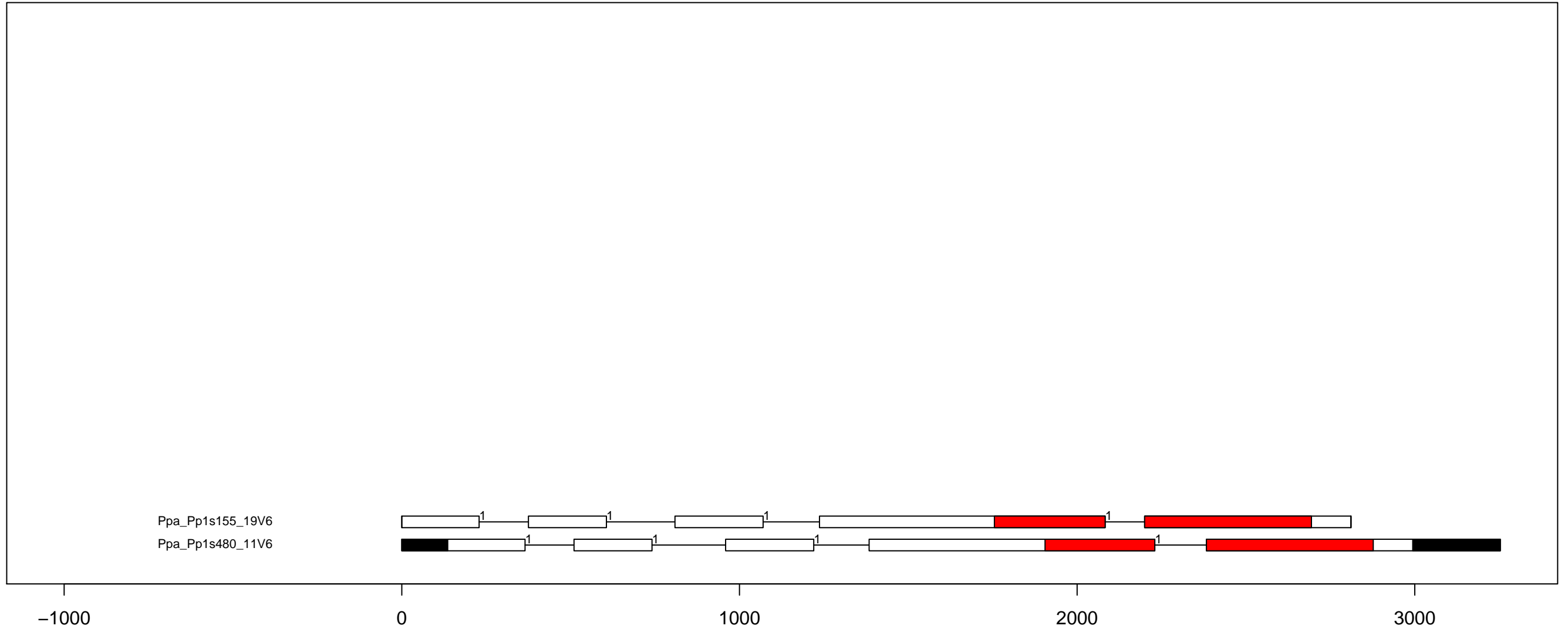

P.pa RLK-Pelle_LRR-IX exon-intron and kinase domain diagram (all)

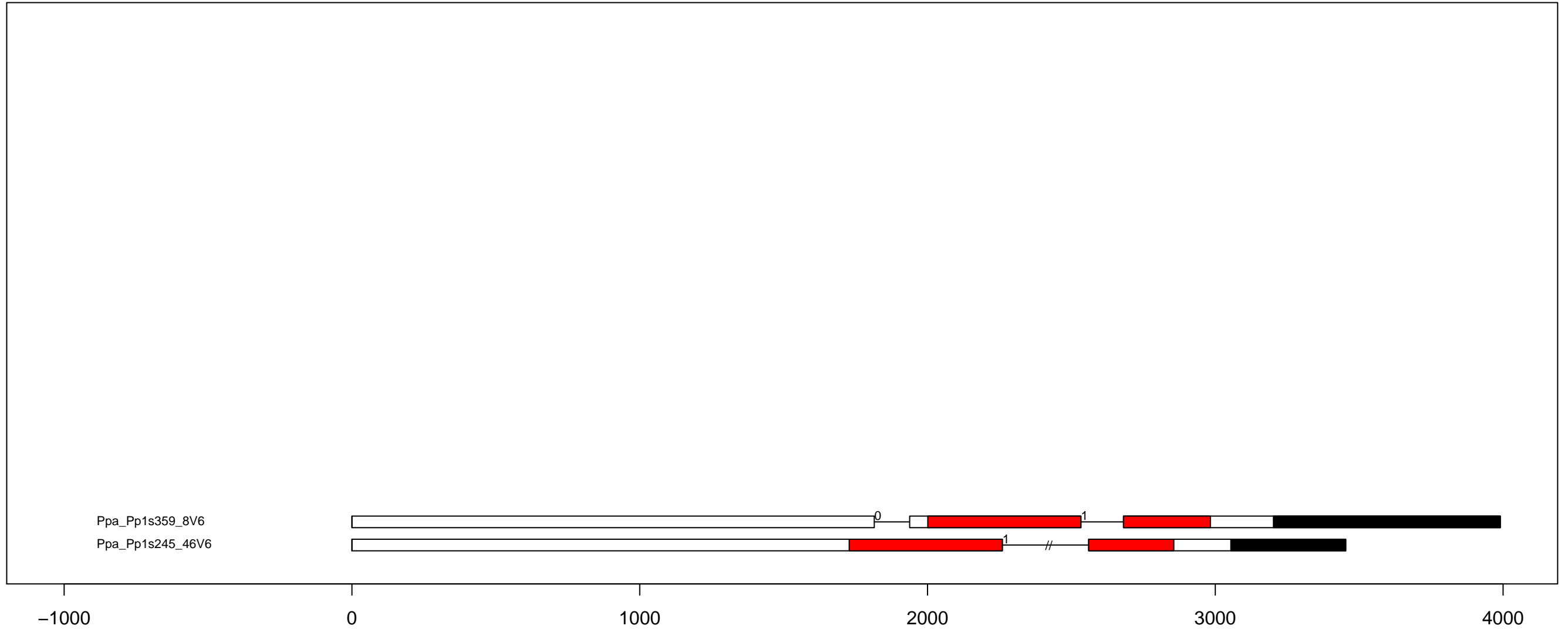

P.pa RLK-Pelle_LRR-VI-1 exon-intron and kinase domain diagram (all)

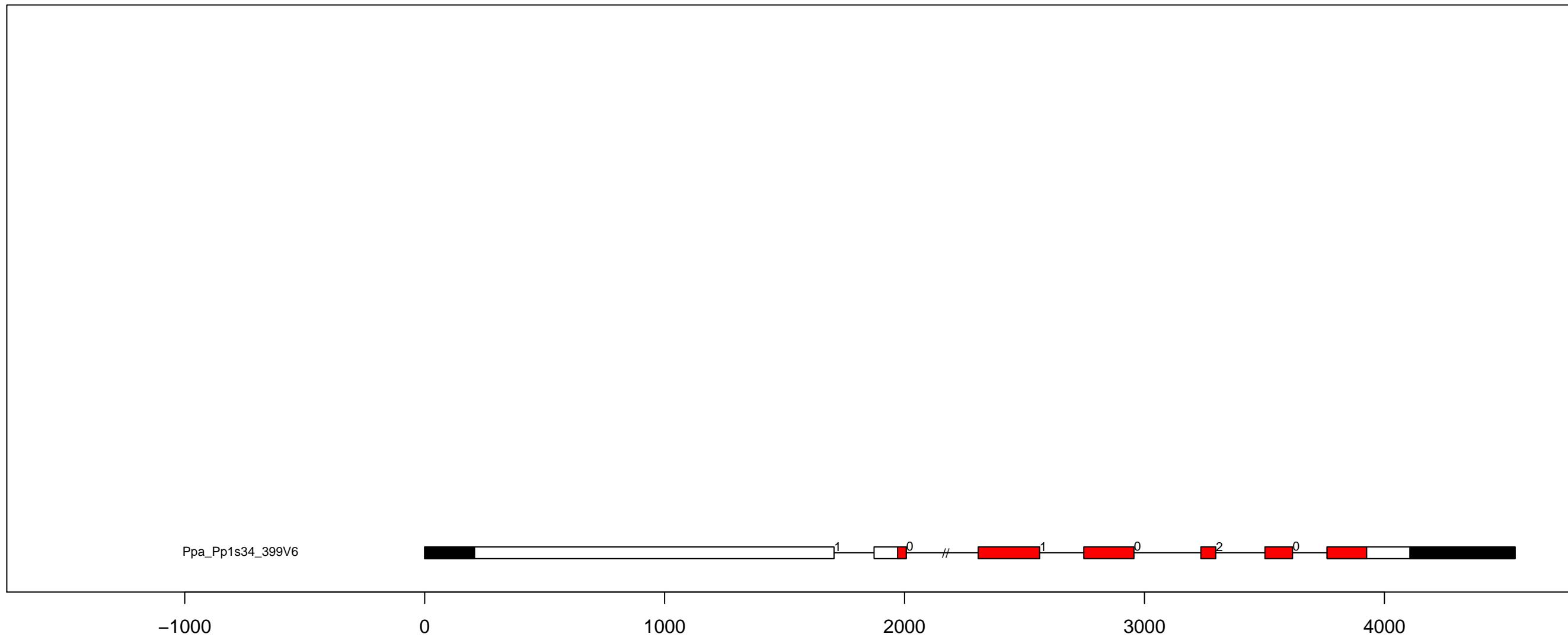

P.pa RLK-Pelle_LRR-VI-2 exon-intron and kinase domain diagram (all)

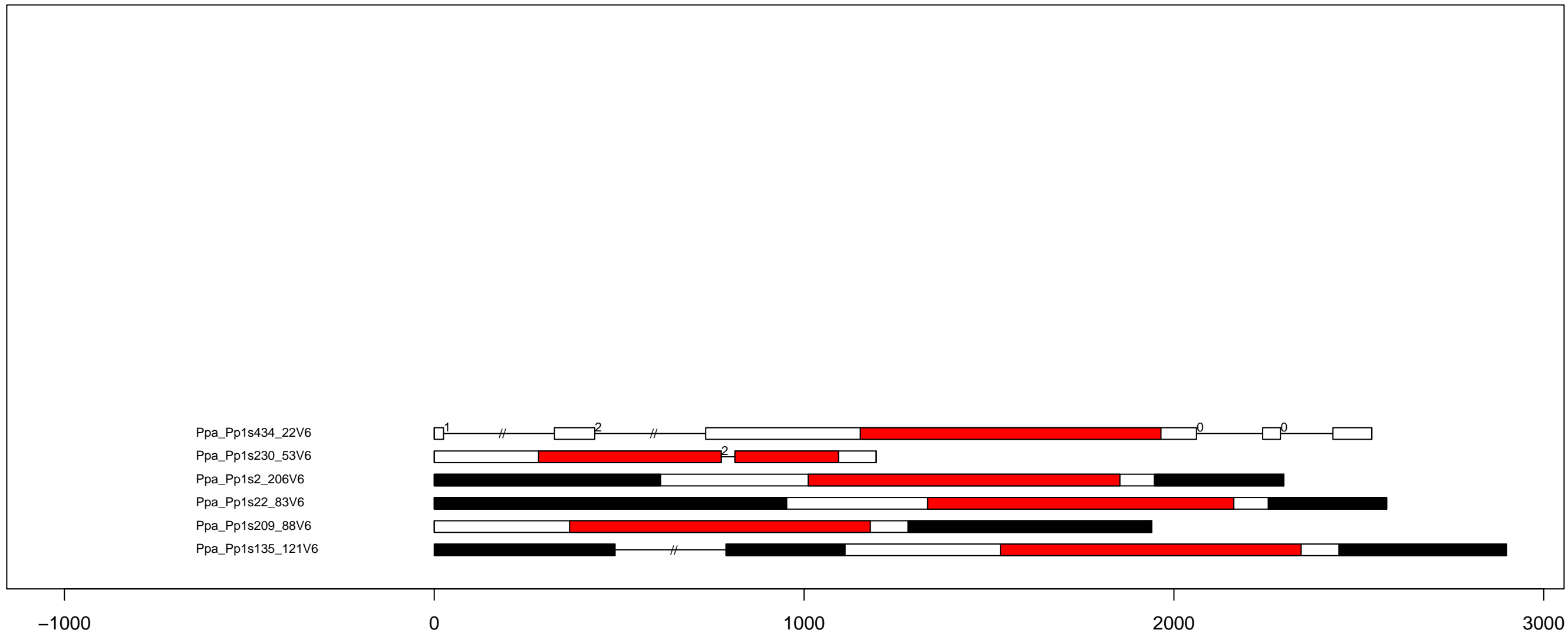

P.pa RLK-Pelle_LRR-VII-1 exon-intron and kinase domain diagram (all)

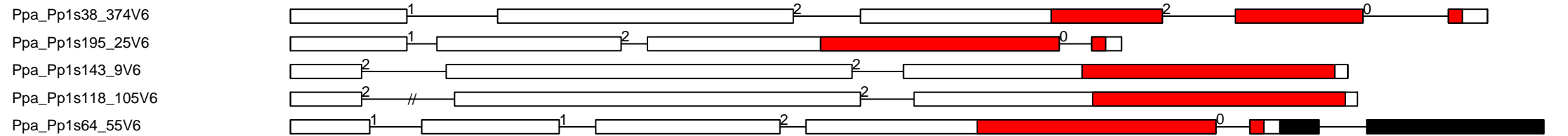

P.pa RLK-Pelle_LRR-VII-2 exon-intron and kinase domain diagram (all)

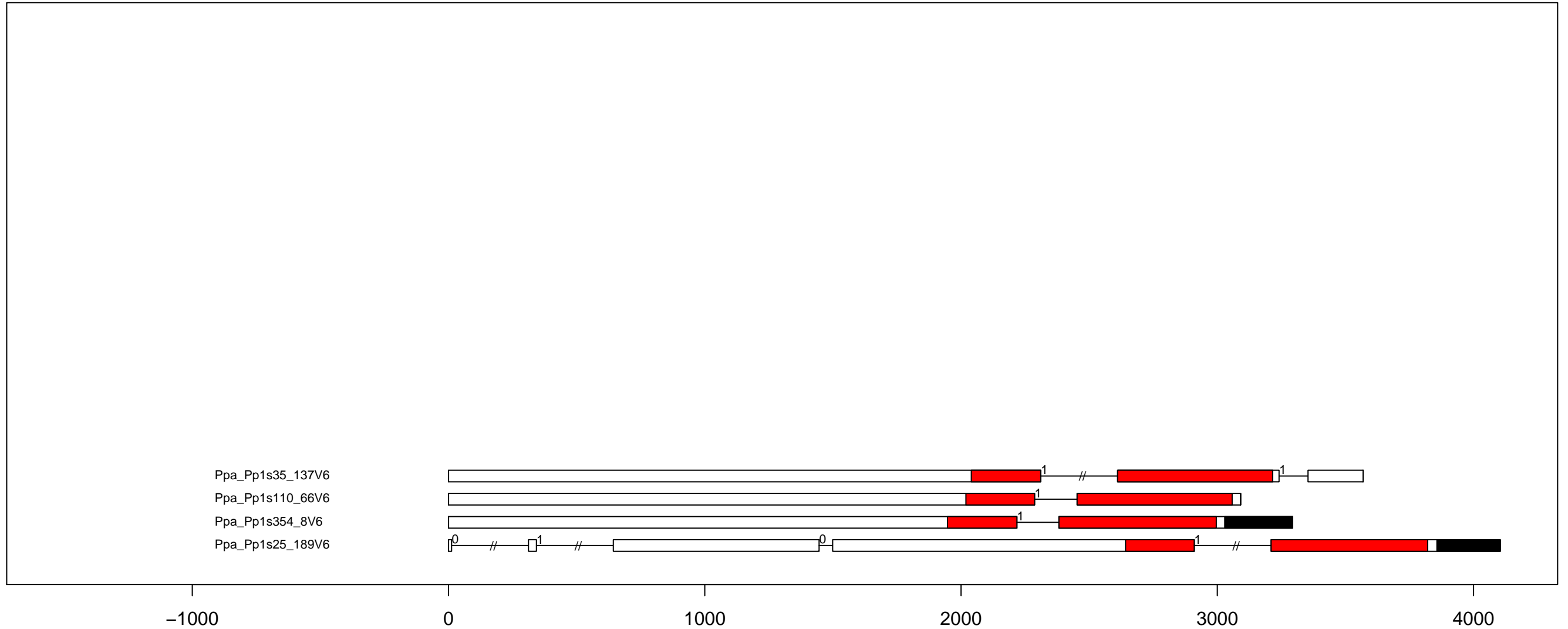

P.pa RLK-Pelle_LRR-VII-3 exon-intron and kinase domain diagram (all)

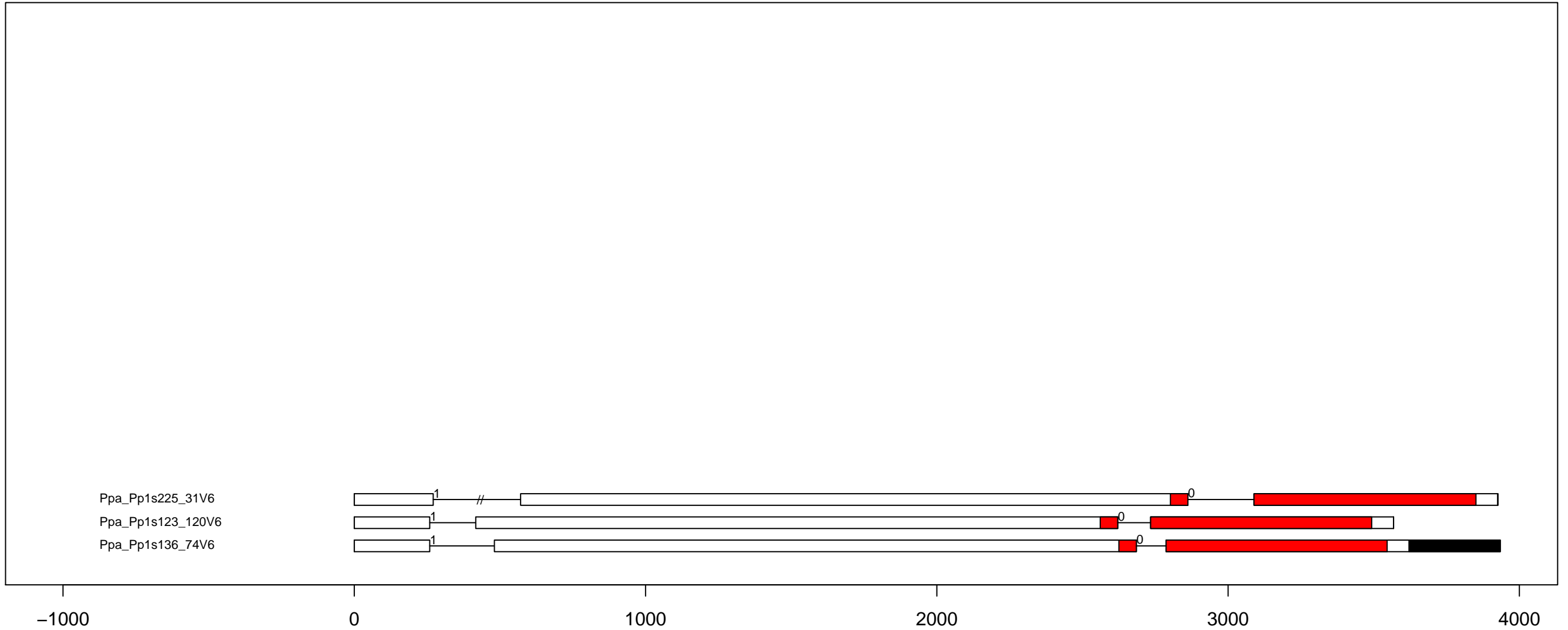

P.pa RLK-Pelle_LRR-VIII-1 exon-intron and kinase domain diagram (all)

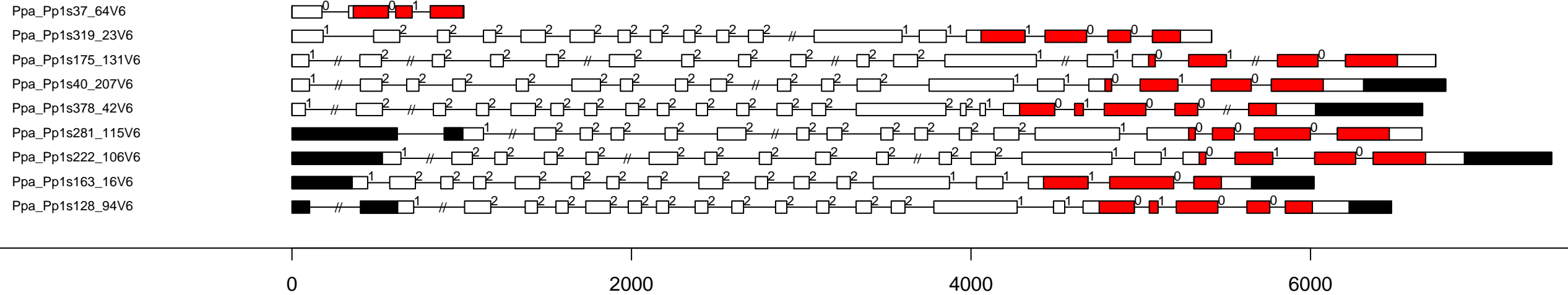

P.pa RLK-Pelle_LRR-V exon-intron and kinase domain diagram (all)

Ppa_Pp1s379_14V6

Ppa_Pp1s279_14V6

Ppa_Pp1s64_28V6

Ppa_Pp1s284_52V6

Ppa_Pp1s242_37V6

Ppa_Pp1s204_22V6

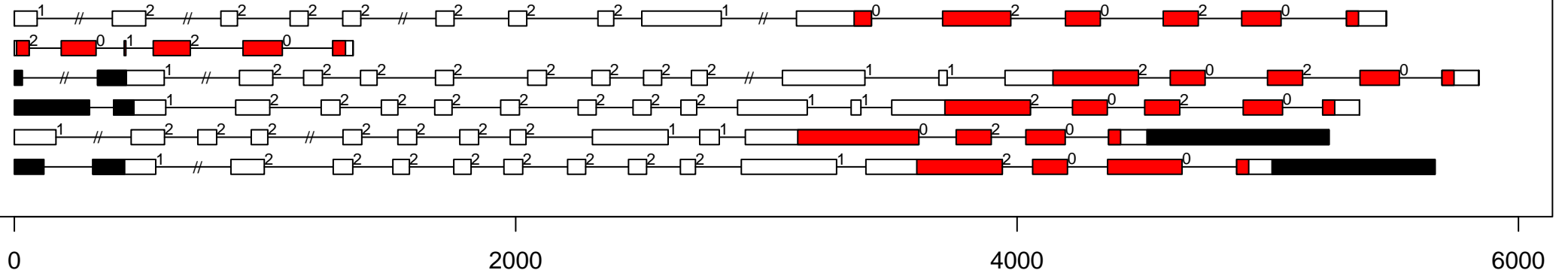

P.pa RLK-Pelle_LRR-Xa exon-intron and kinase domain diagram (all)

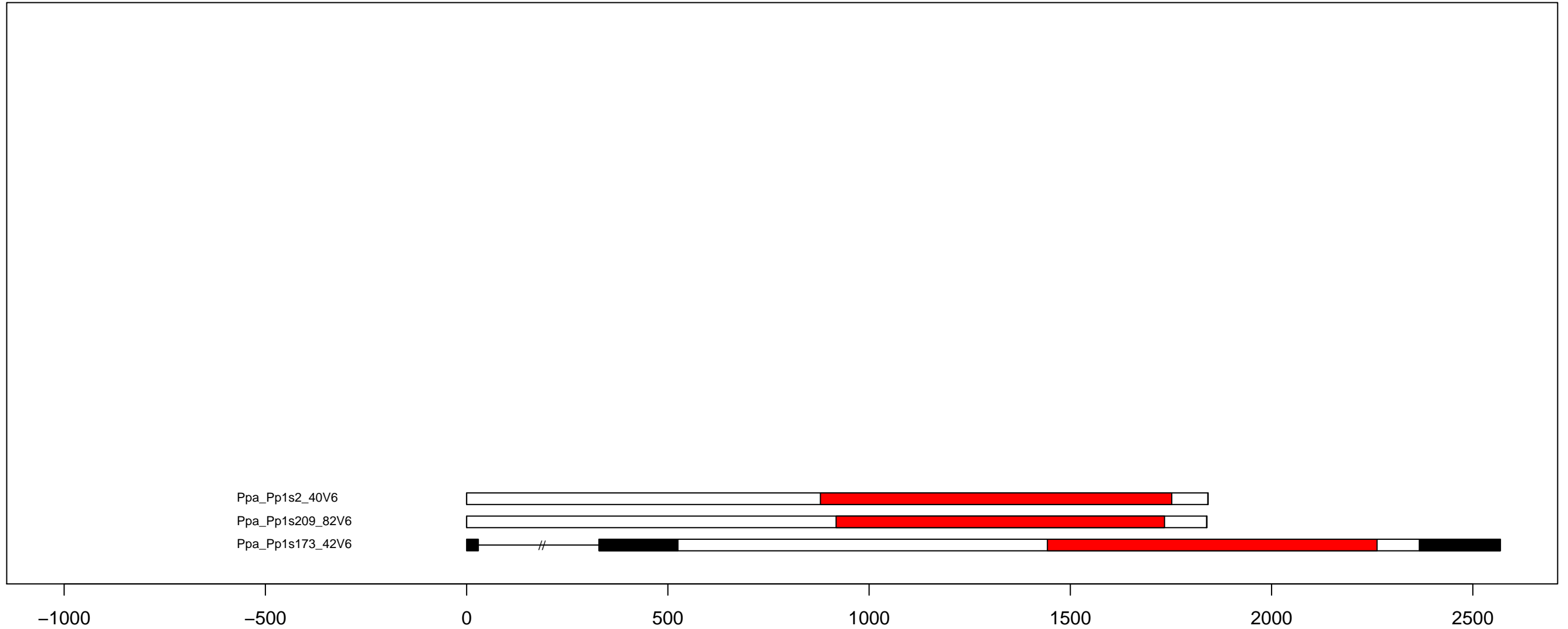

P.pa RLK-Pelle_LRR-Xb-1 exon-intron and kinase domain diagram (all)

Ppa_Pp1s63_130V6
Ppa_Pp1s33_130V6
Ppa_Pp1s244_6V6
Ppa_Pp1s172_87V6
Ppa_Pp1s159_97V6
Ppa_Pp1s111_101V6
Ppa_Pp1s68_46V6
Ppa_Pp1s48_171V6
Ppa_Pp1s27_27V6
Ppa_Pp1s141_73V6

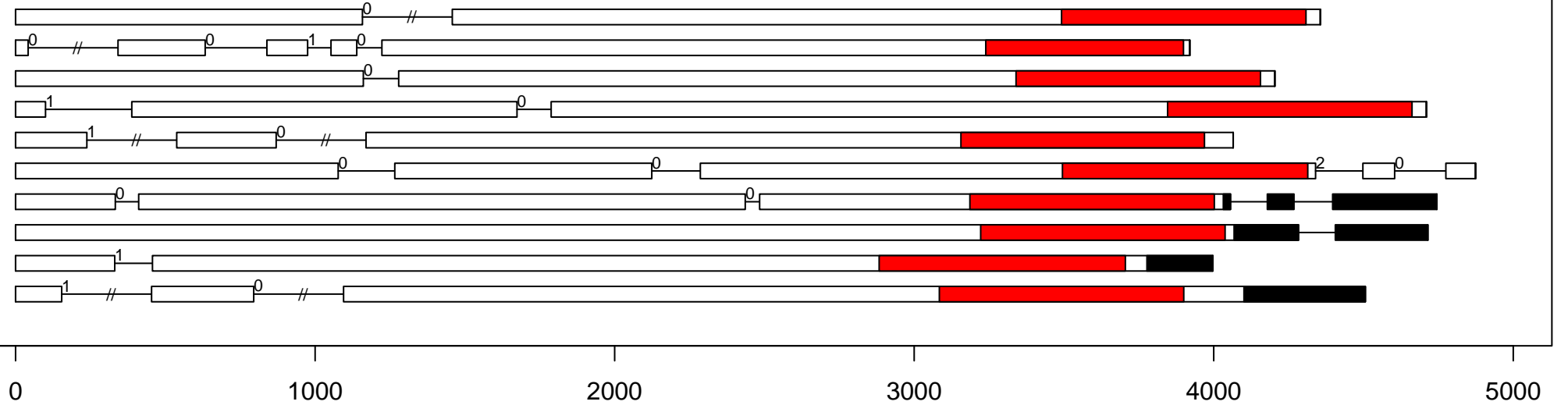

P.pa RLK-Pelle_LRR-XI-1 exon-intron and kinase domain diagram (all)

Ppa_Pp1s281_13V6
 Ppa_Pp1s186_31V6
 Ppa_Pp1s178_41V6
 Ppa_Pp1s14_454V6
 Ppa_Pp1s14_447V6
 Ppa_Pp1s5_68V6
 Ppa_Pp1s247_8V6
 Ppa_Pp1s212_3V6
 Ppa_Pp1s182_56V6
 Ppa_Pp1s178_122V6
 Ppa_Pp1s161_36V6
 Ppa_Pp1s102_217V6

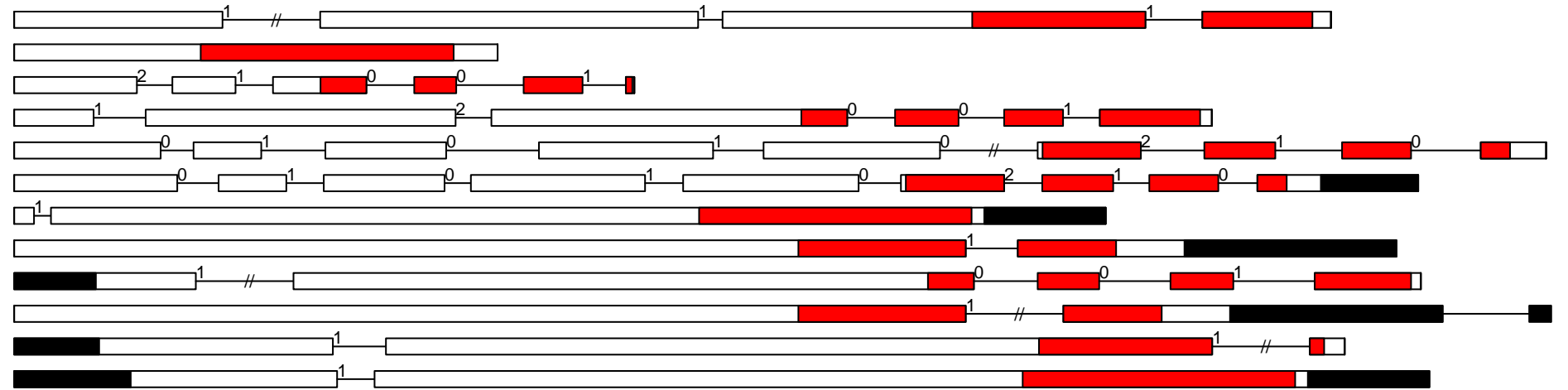

-1000

0

1000

2000

3000

4000

P.pa RLK-Pelle_LRR-XI-2 exon-intron and kinase domain diagram (all)

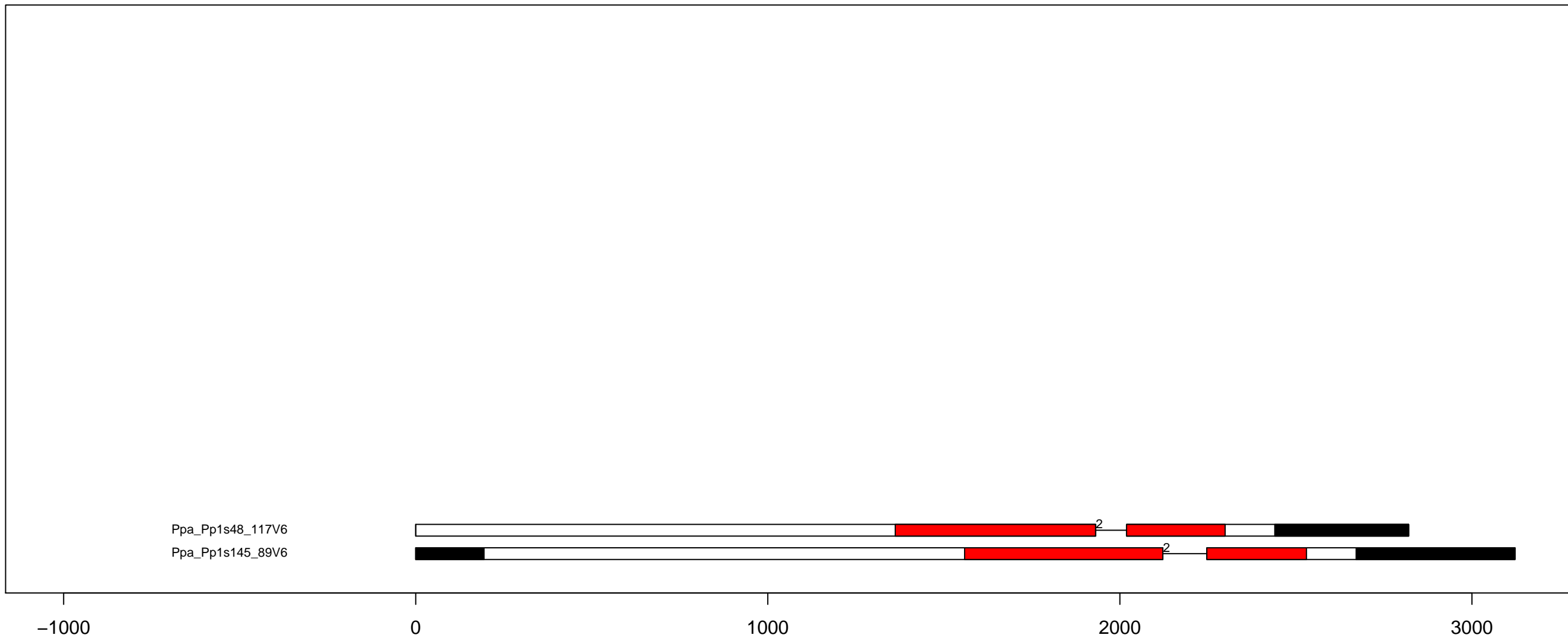

P.pa RLK-Pelle_LRR-XII-1 exon-intron and kinase domain diagram (all)

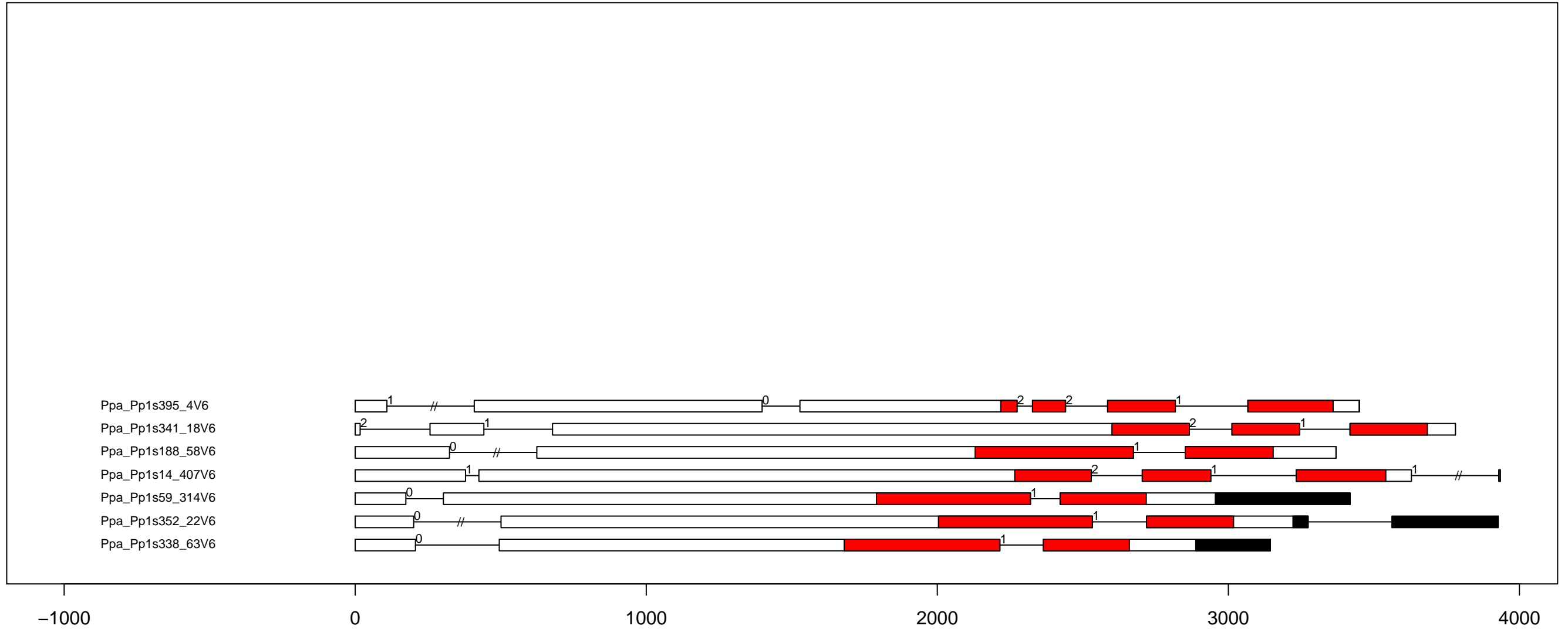

P.pa RLK-Pelle_LRR-XIIIa exon-intron and kinase domain diagram (all)

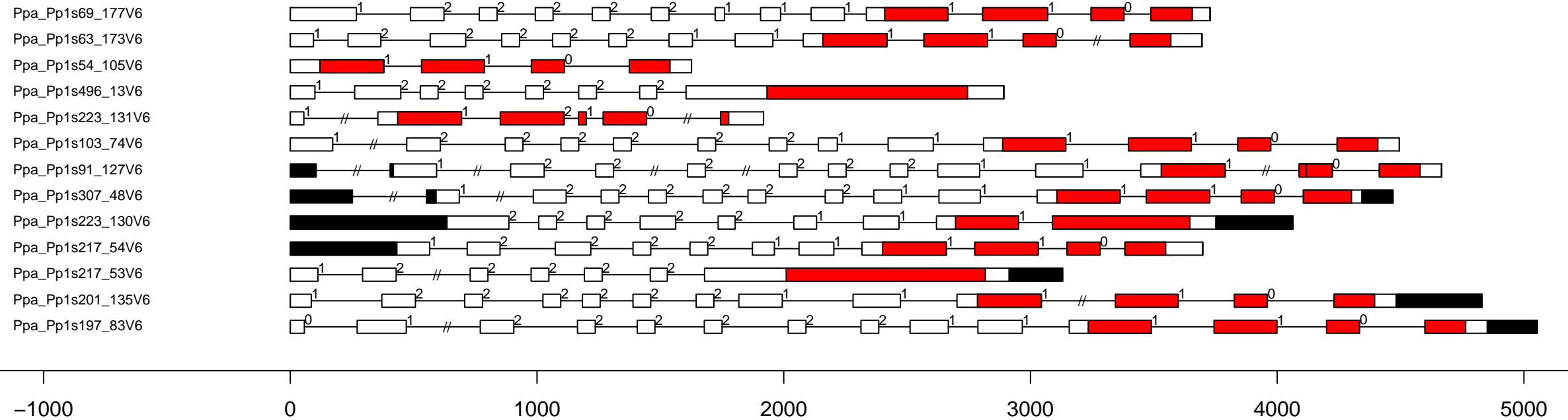

P.pa RLK-Pelle_LRR-XIIIb exon-intron and kinase domain diagram (all)

Ppa_Pp1s63_16V6
Ppa_Pp1s19_291V6
Ppa_Pp1s125_96V6
Ppa_Pp1s353_18V6
Ppa_Pp1s121_69V6

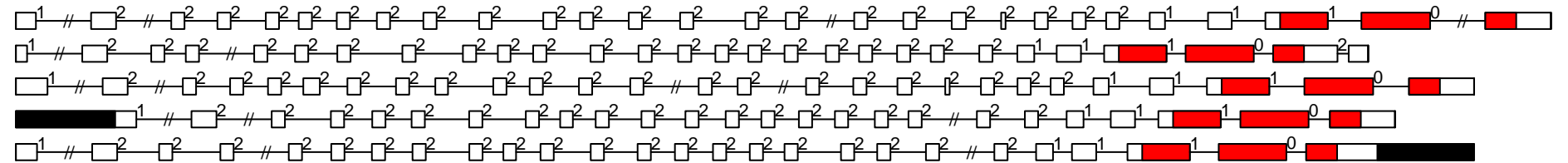

P.pa RLK-Pelle_LRR-XIV exon-intron and kinase domain diagram (all)

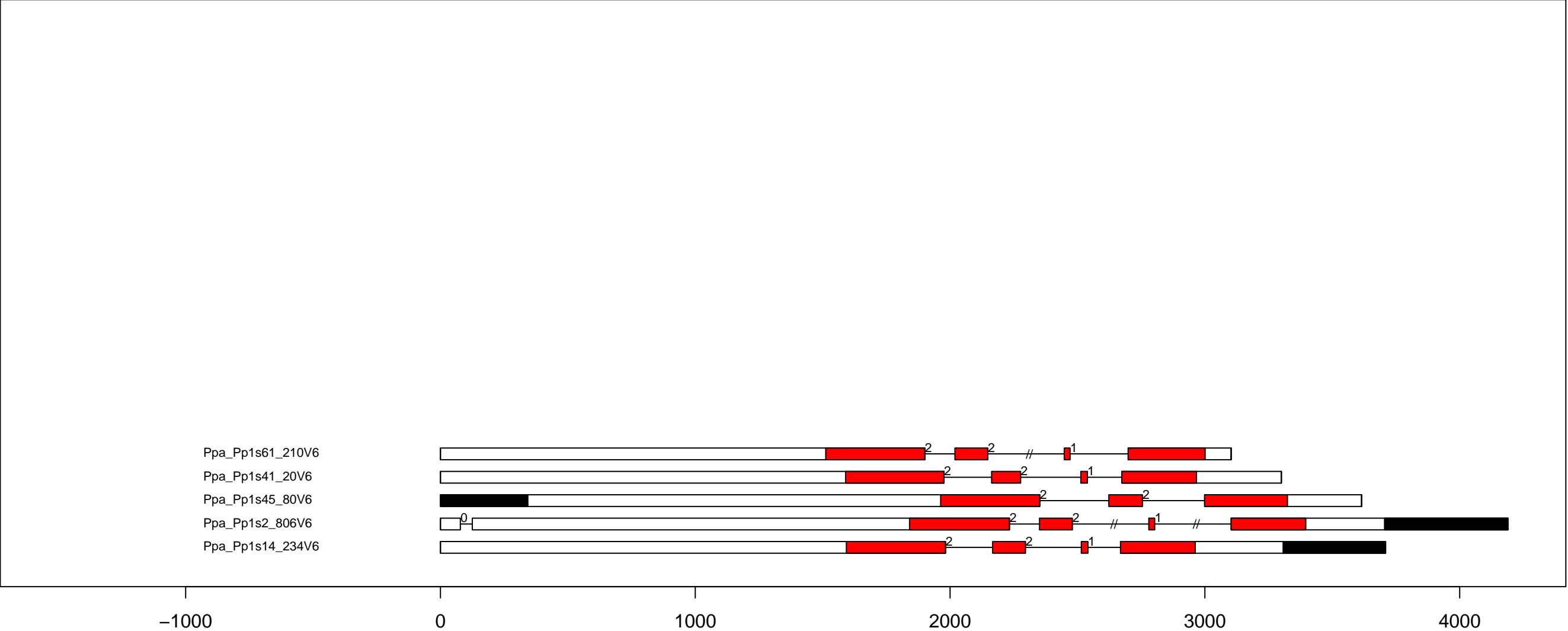

P.pa RLK-Pelle_LRR-XV exon-intron and kinase domain diagram (all)

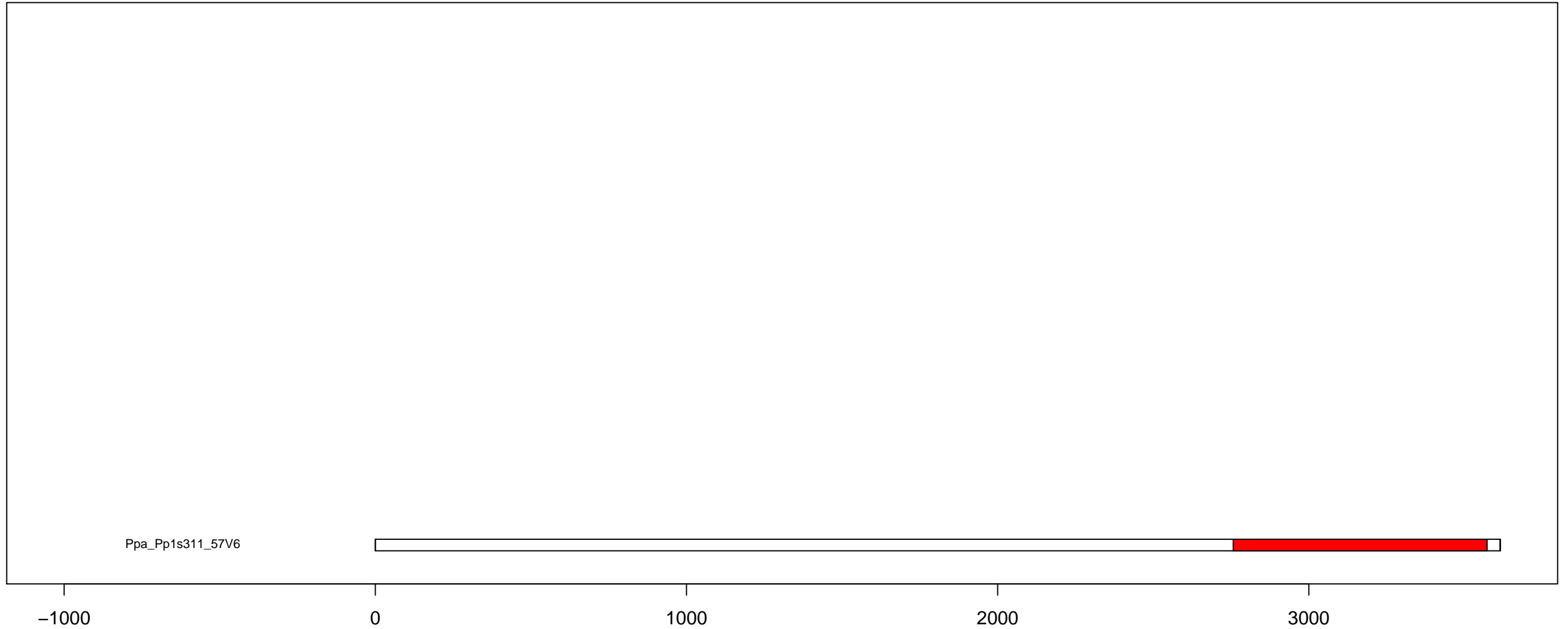

P.pa RLK-Pelle_LysM exon-intron and kinase domain diagram (all)

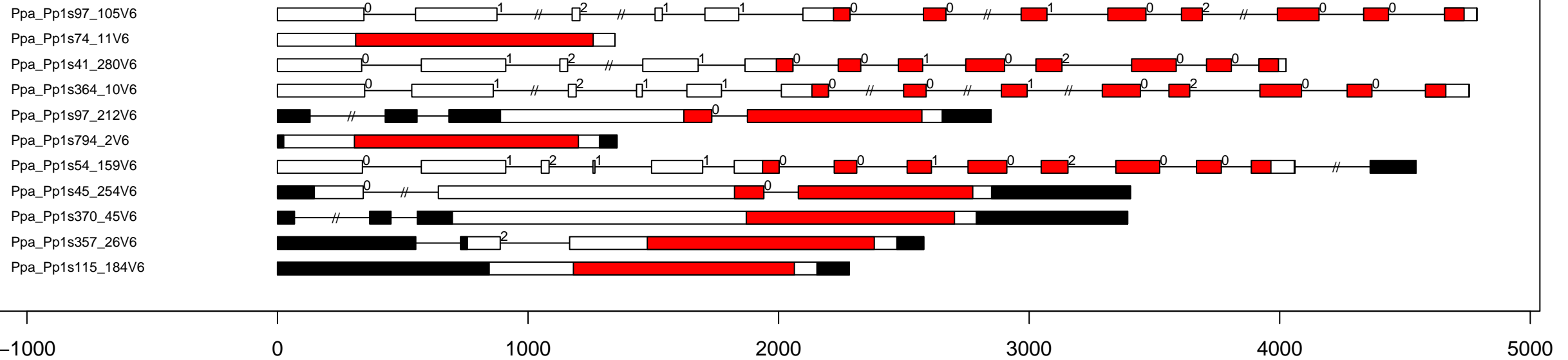

P.pa RLK-Pelle_PERK-1 exon-intron and kinase domain diagram (all)

Ppa_Pp1s145_144V6
Ppa_Pp1s83_193V6
Ppa_Pp1s160_128V6
Ppa_Pp1s134_145V6
Ppa_Pp1s118_23V6

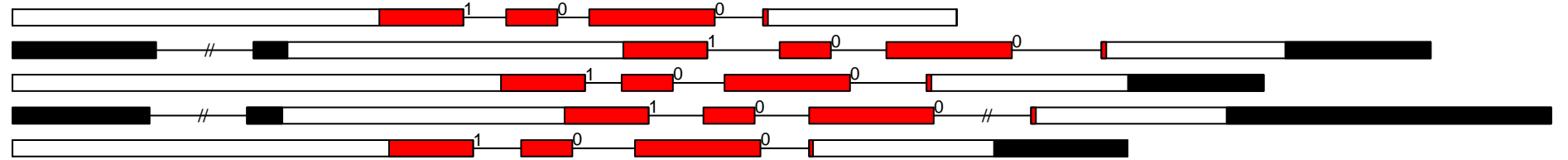

-1000

0

1000

2000

3000

4000

P.pa RLK-Pelle_PERK-2 exon-intron and kinase domain diagram (all)

Ppa_Pp1s65_158V6
Ppa_Pp1s533_5V6
Ppa_Pp1s123_164V6
Ppa_Pp1s59_359V6
Ppa_Pp1s336_36V6
Ppa_Pp1s136_94V6

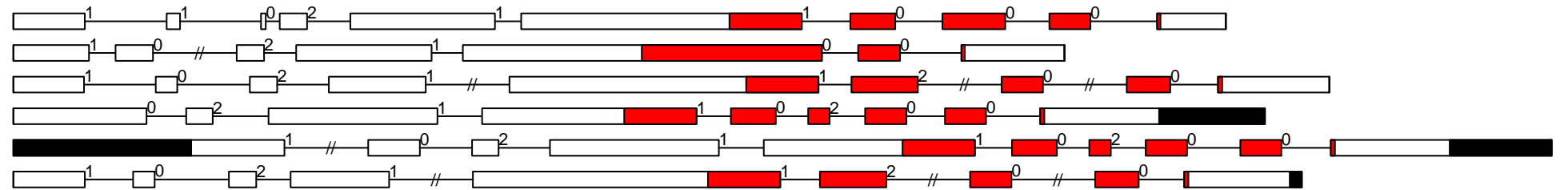

-1000

0

1000

2000

3000

4000

5000

P.pa RLK-Pelle_Pp exon-intron and kinase domain diagram (all)

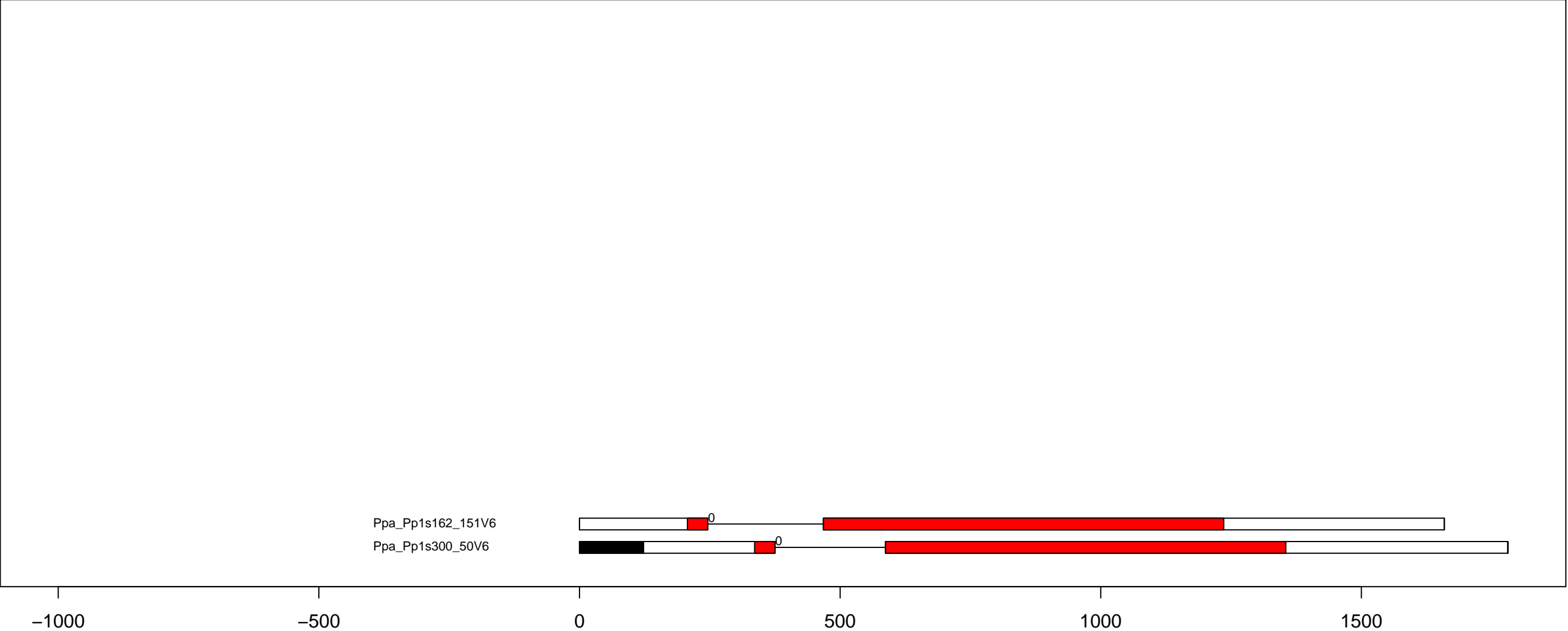

P.pa RLK-Pelle_RKF3 exon-intron and kinase domain diagram (all)

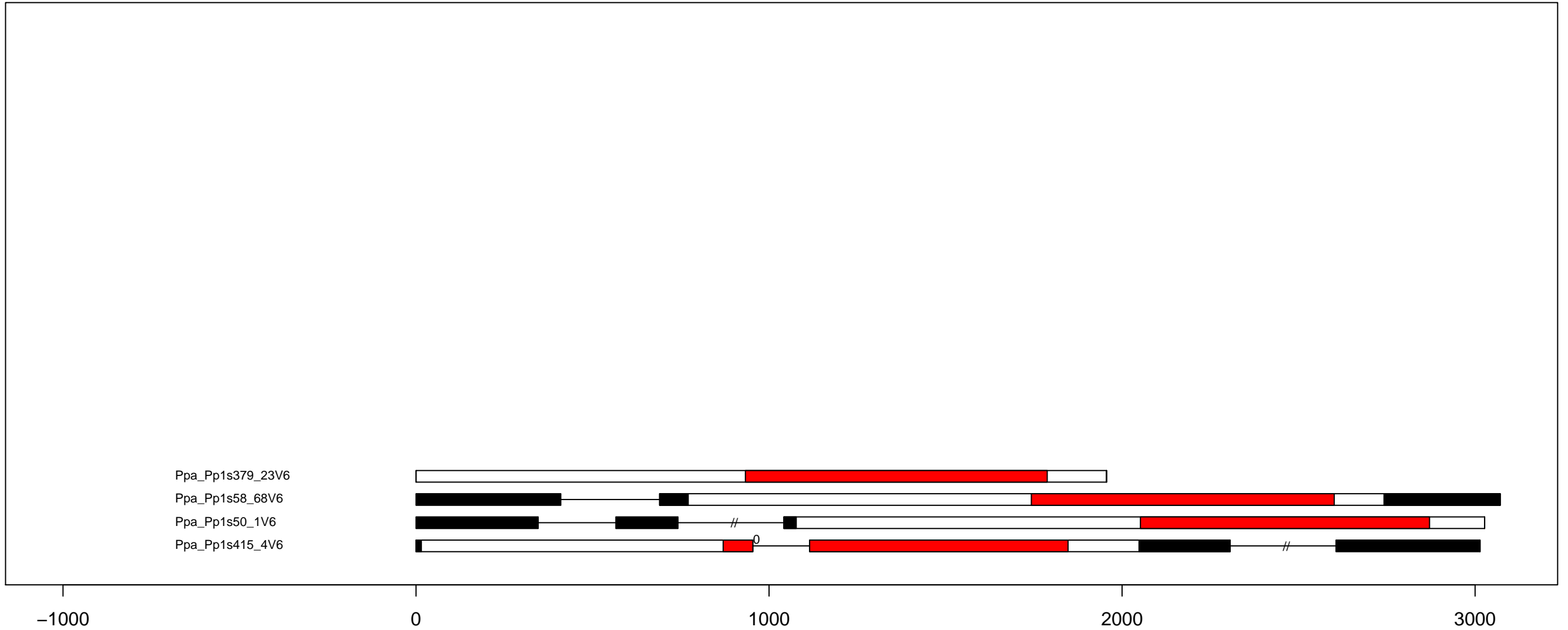

P.pa RLK-Pelle_RLCK-II exon-intron and kinase domain diagram (all)

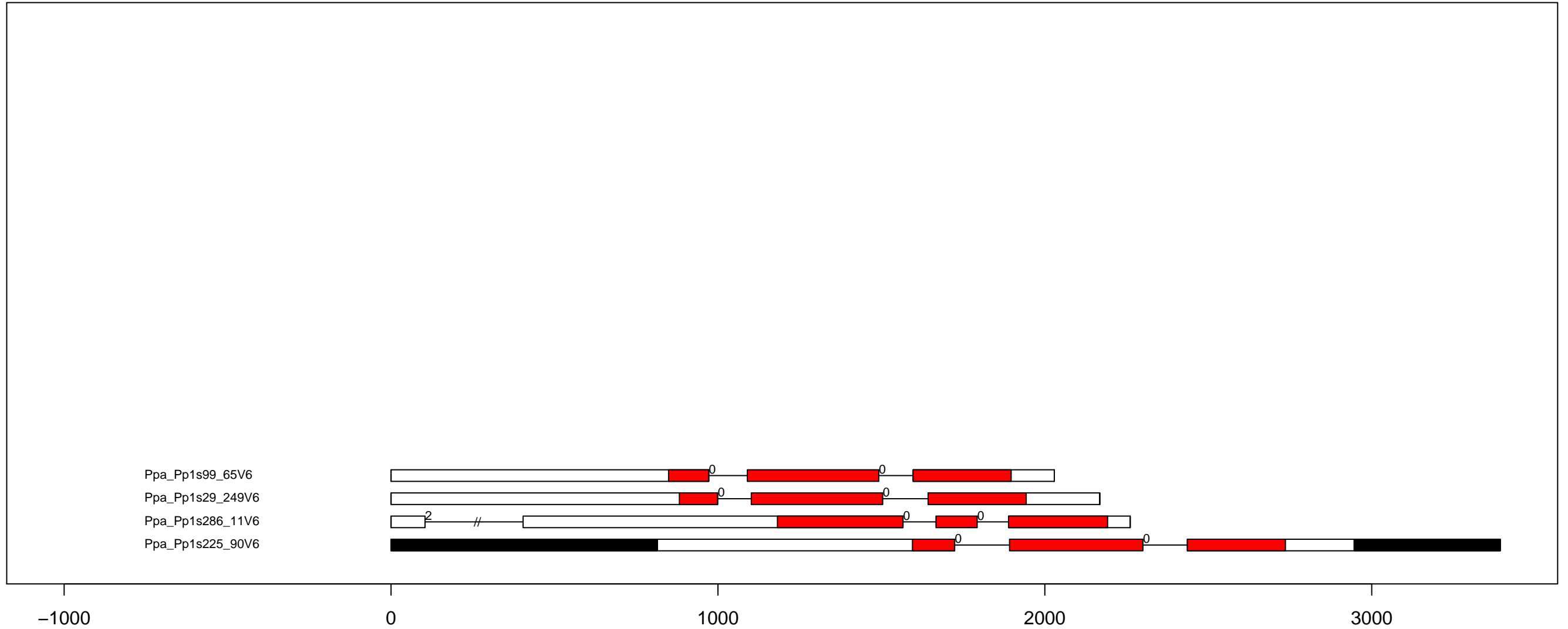

P.pa RLK-Pelle_RLCK-IV exon-intron and kinase domain diagram (all)

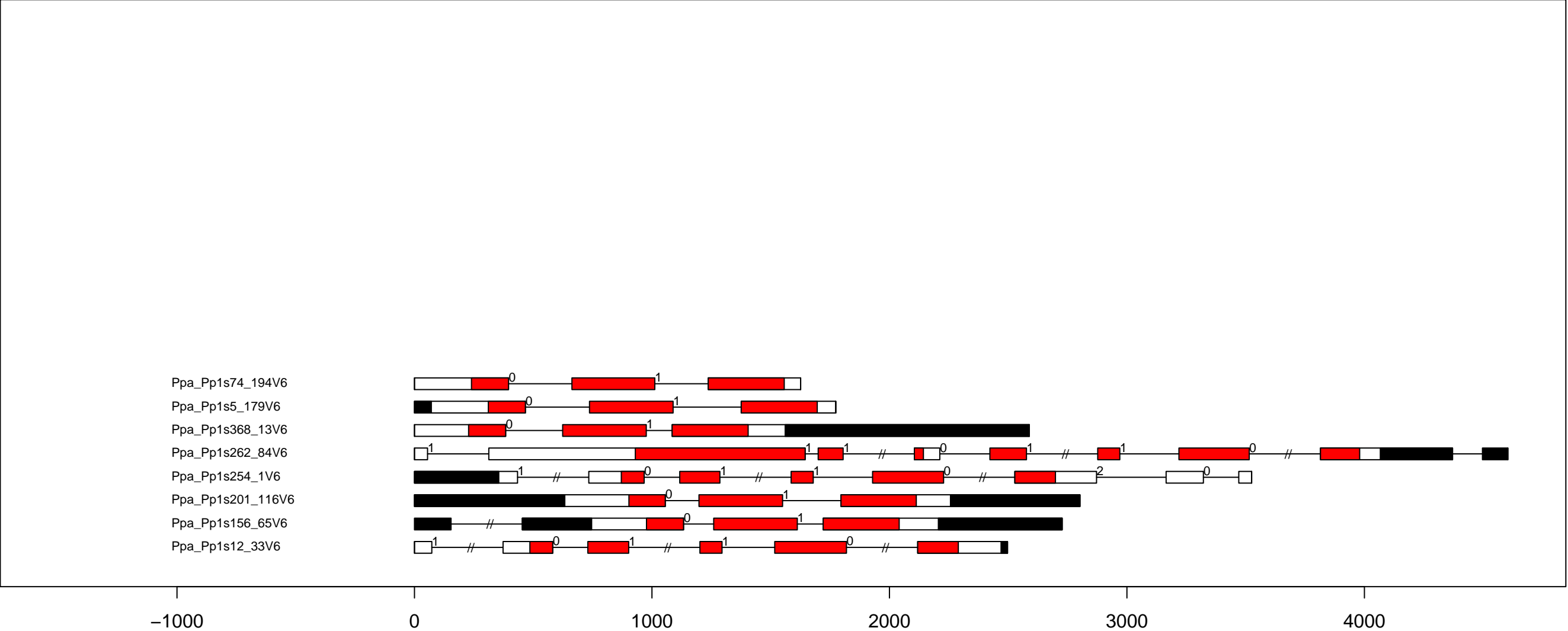

P.pa RLK-Pelle_RLCK-VIIa-1 exon-intron and kinase domain diagram (all)

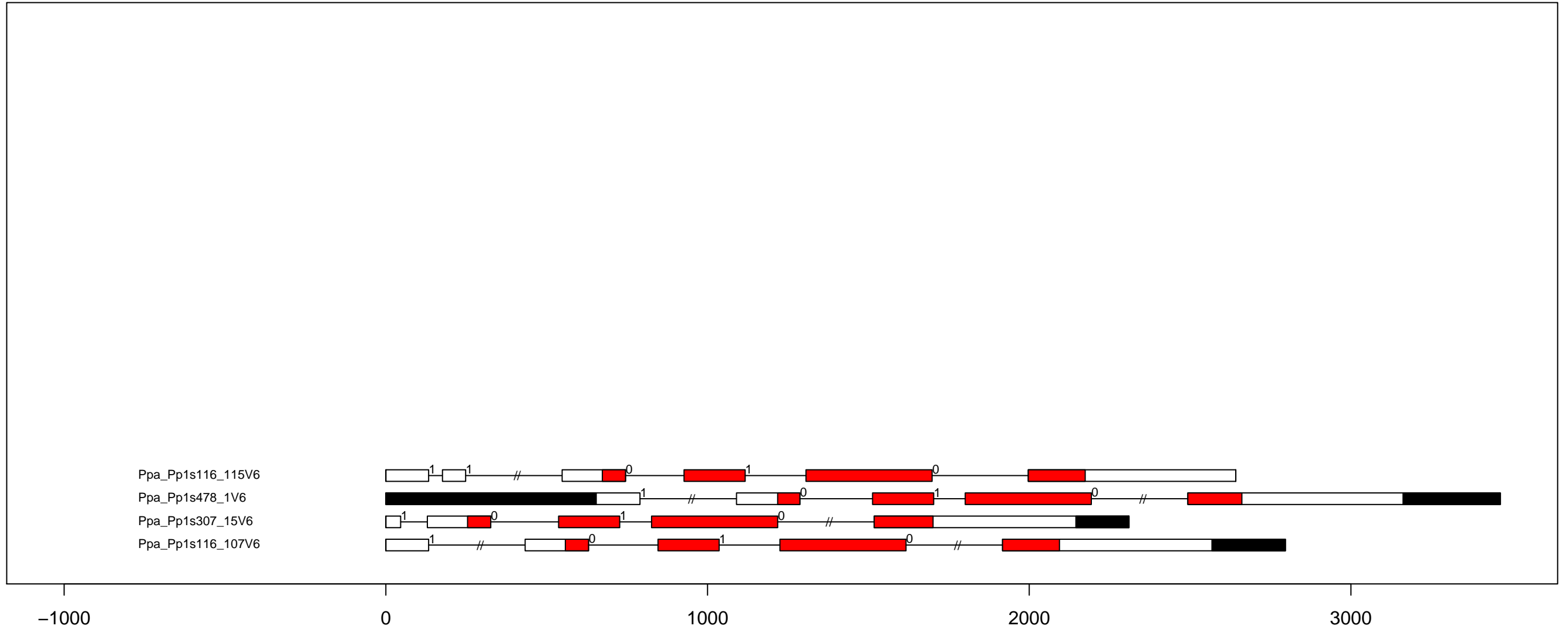

P.pa RLK-Pelle_RLCK-VIIa-2 exon-intron and kinase domain diagram (all)

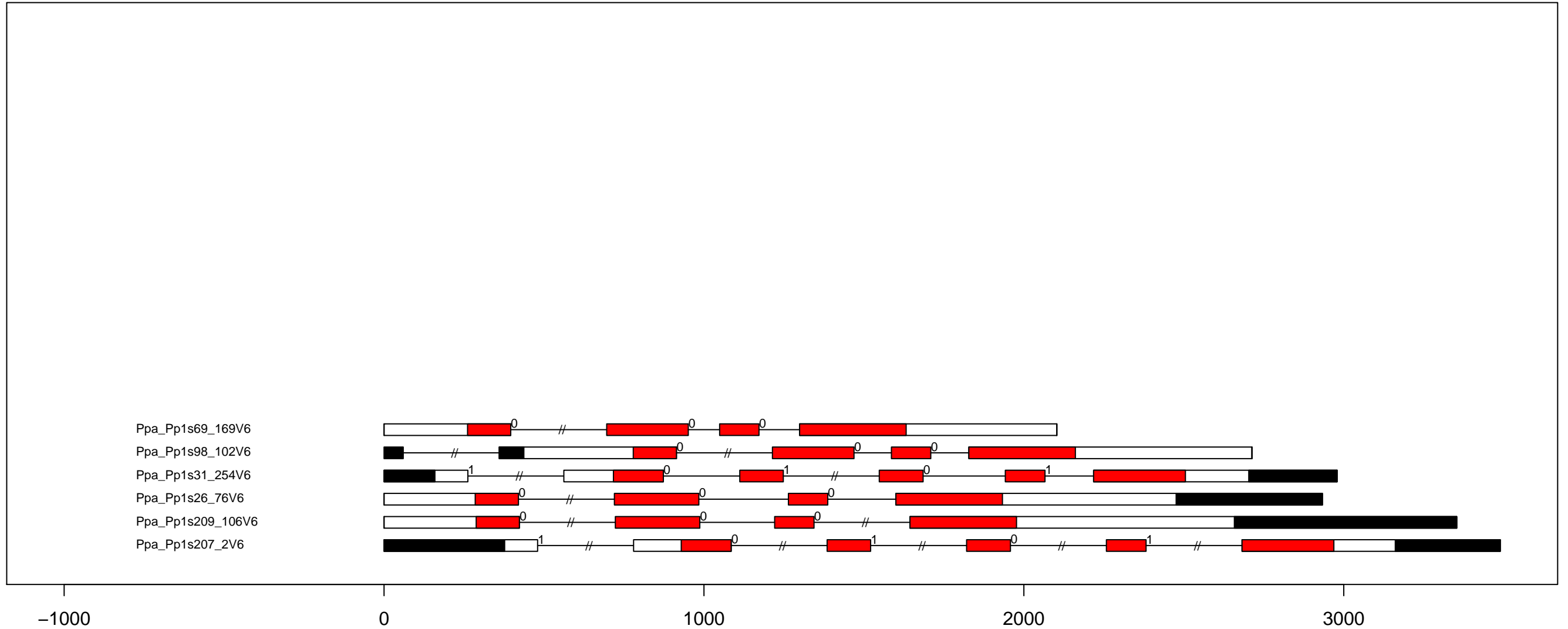

P.pa RLK-Pelle_RLCK-VIII exon-intron and kinase domain diagram (all)

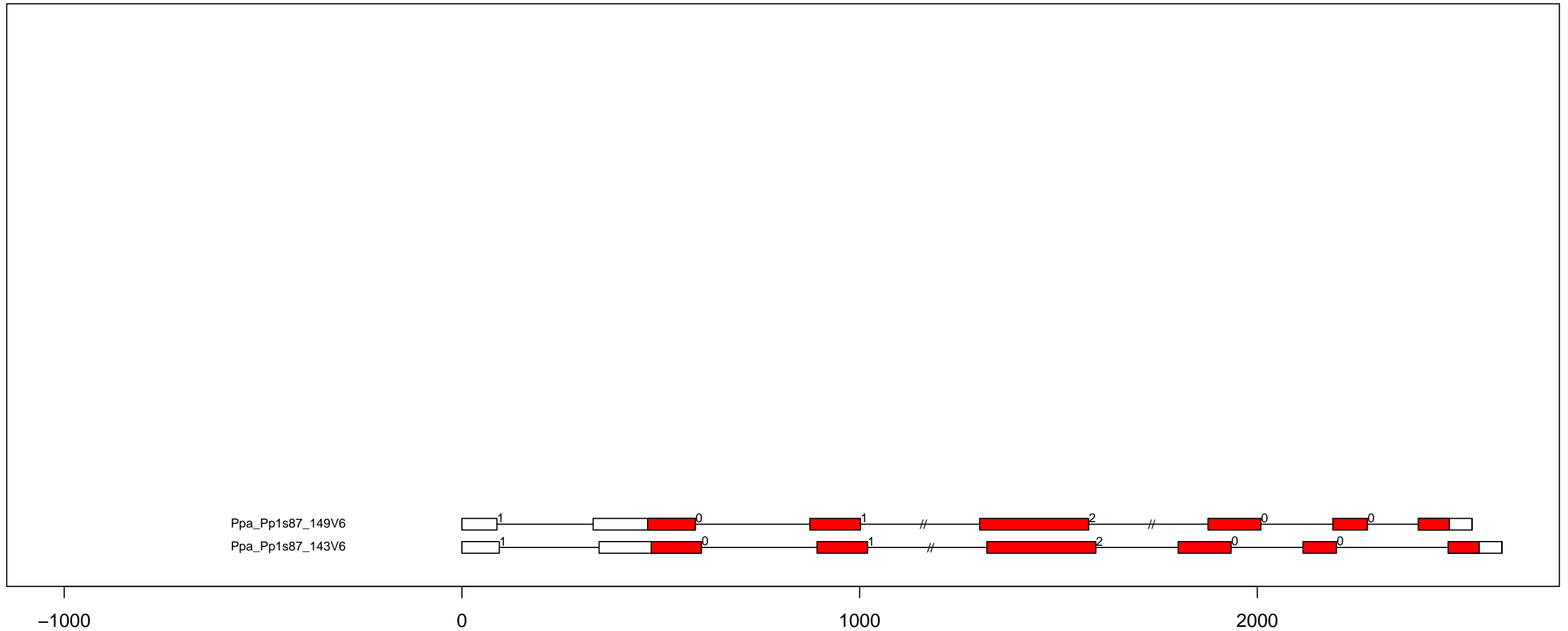

P.pa RLK-Pelle_RLCK-VI exon-intron and kinase domain diagram (all)

- Ppa_Pp1s9_56V6
- Ppa_Pp1s36_280V6
- Ppa_Pp1s215_104V6
- Ppa_Pp1s114_107V6
- Ppa_Pp1s111_81V6
- Ppa_Pp1s249_93V6
- Ppa_Pp1s242_29V6
- Ppa_Pp1s226_111V6
- Ppa_Pp1s16_314V6

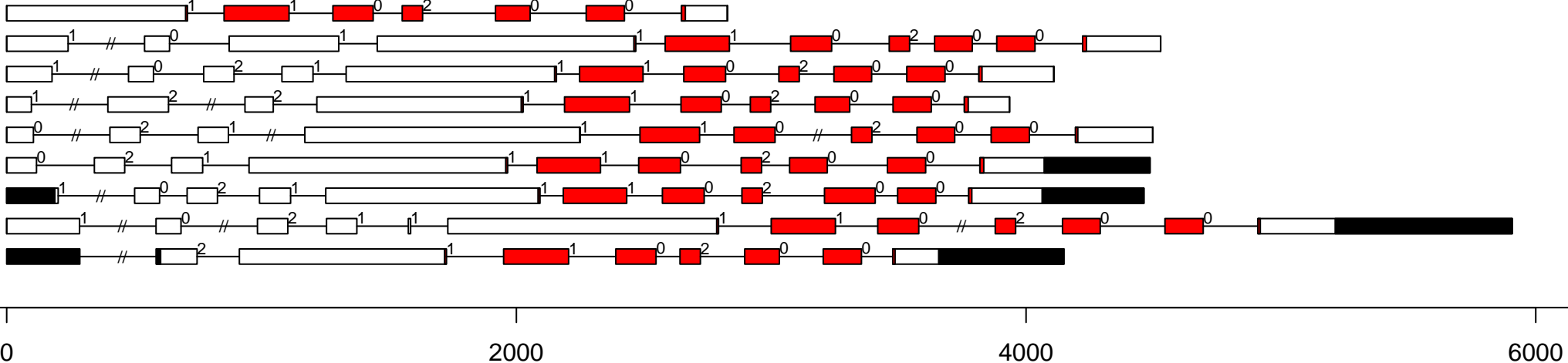

P.pa RLK-Pelle_RLCK-V exon-intron and kinase domain diagram (all)

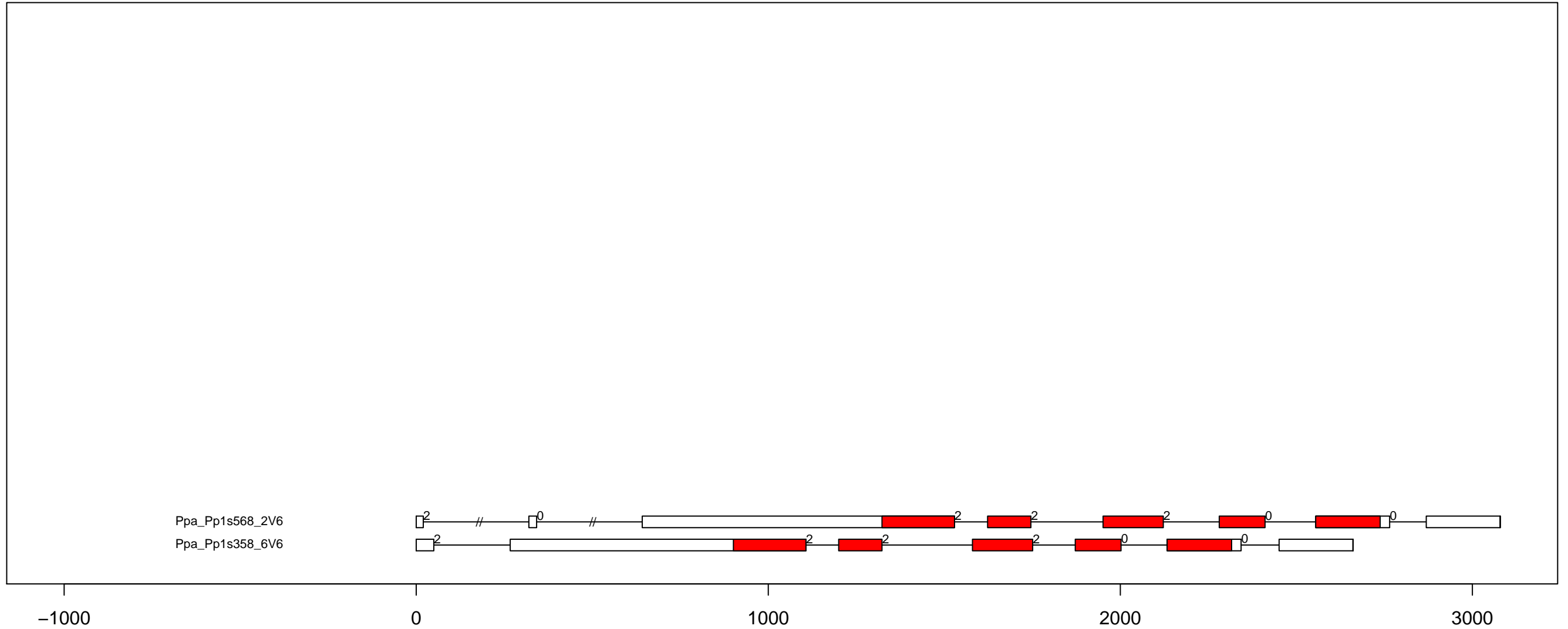

P.pa RLK-Pelle_RLCK-XII-1 exon-intron and kinase domain diagram (all)

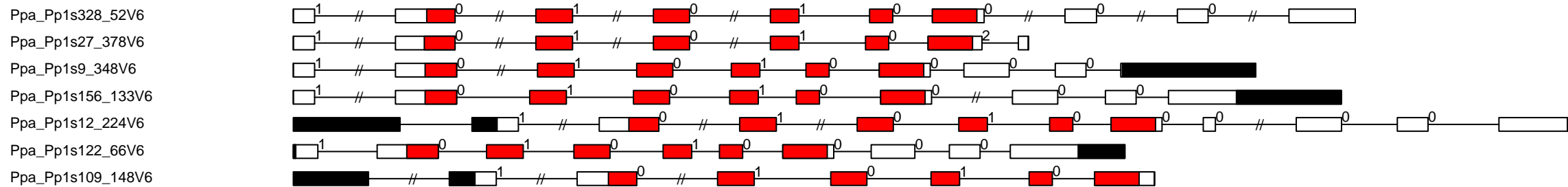

-1000

0

1000

2000

3000

4000

P.pa RLK-Pelle_RLCK-XI exon-intron and kinase domain diagram (all)

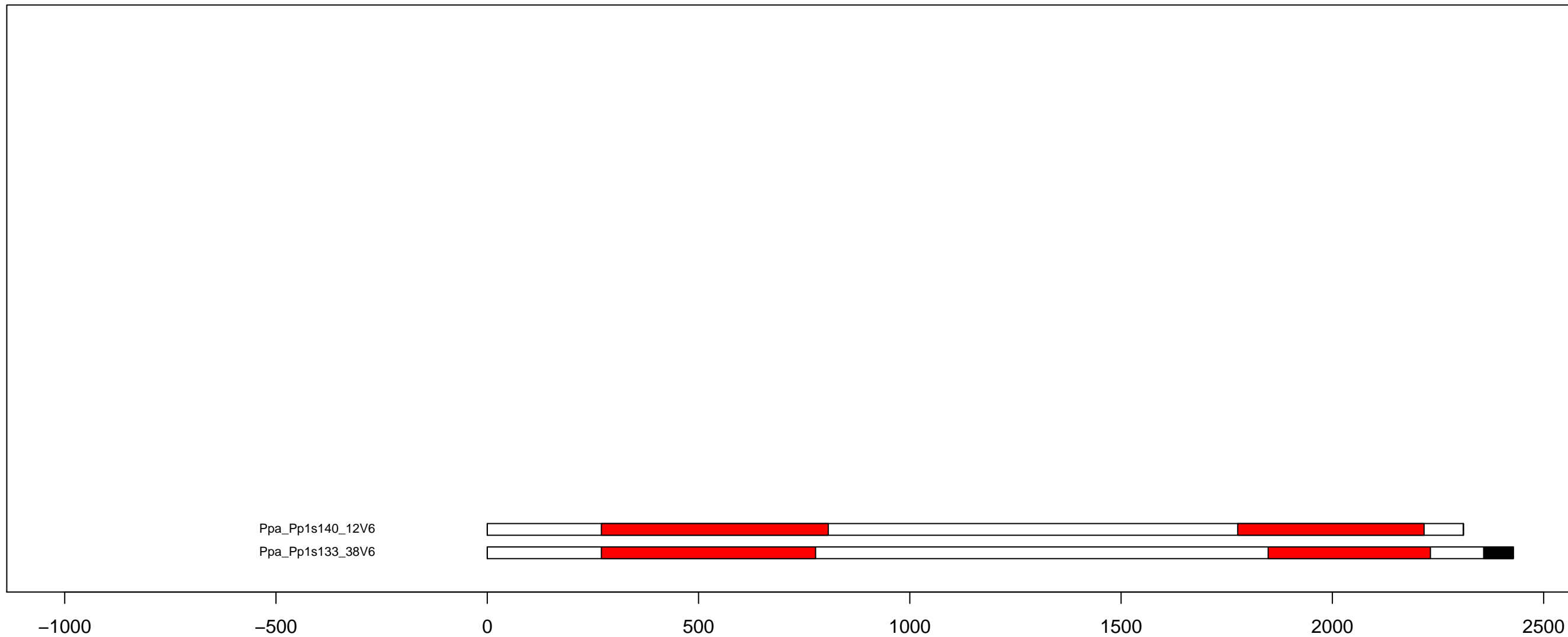

P.pa RLK-Pelle_RLCK-X exon-intron and kinase domain diagram (all)

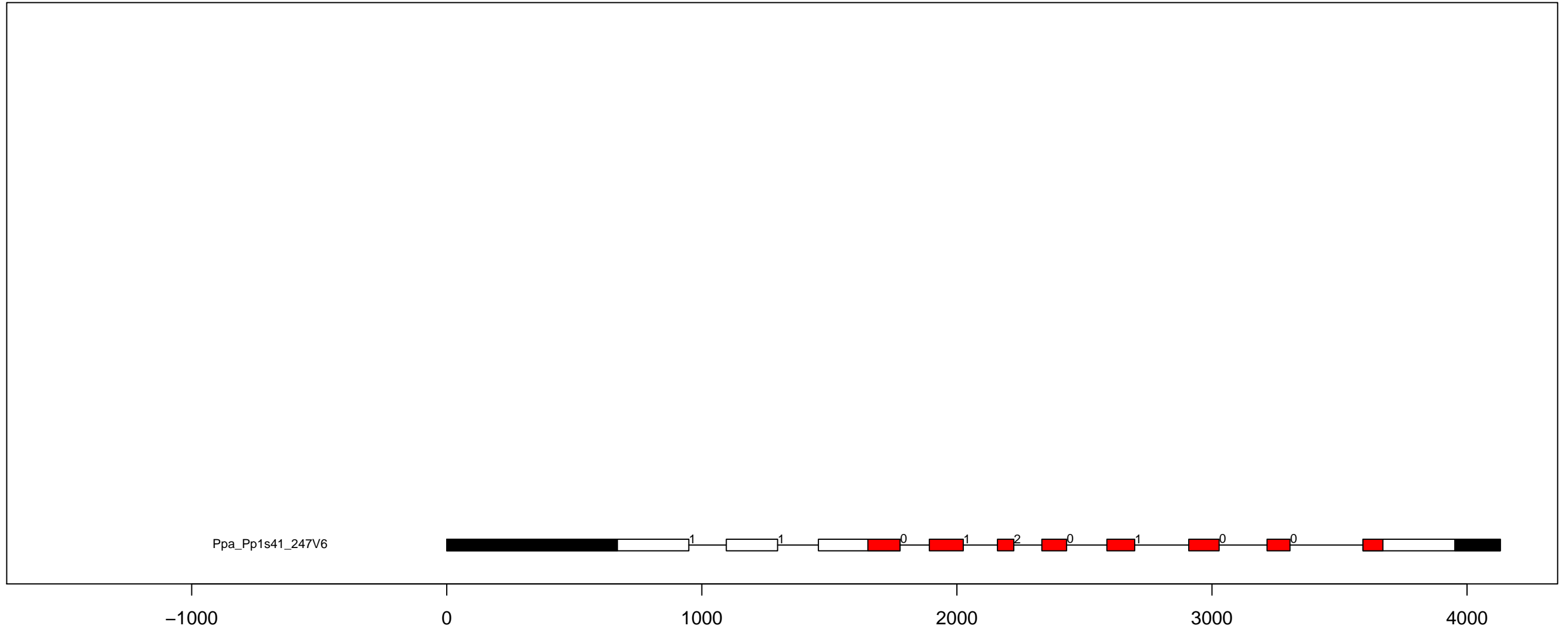

P.pa RLK-Pelle_RLCK-XV exon-intron and kinase domain diagram (all)

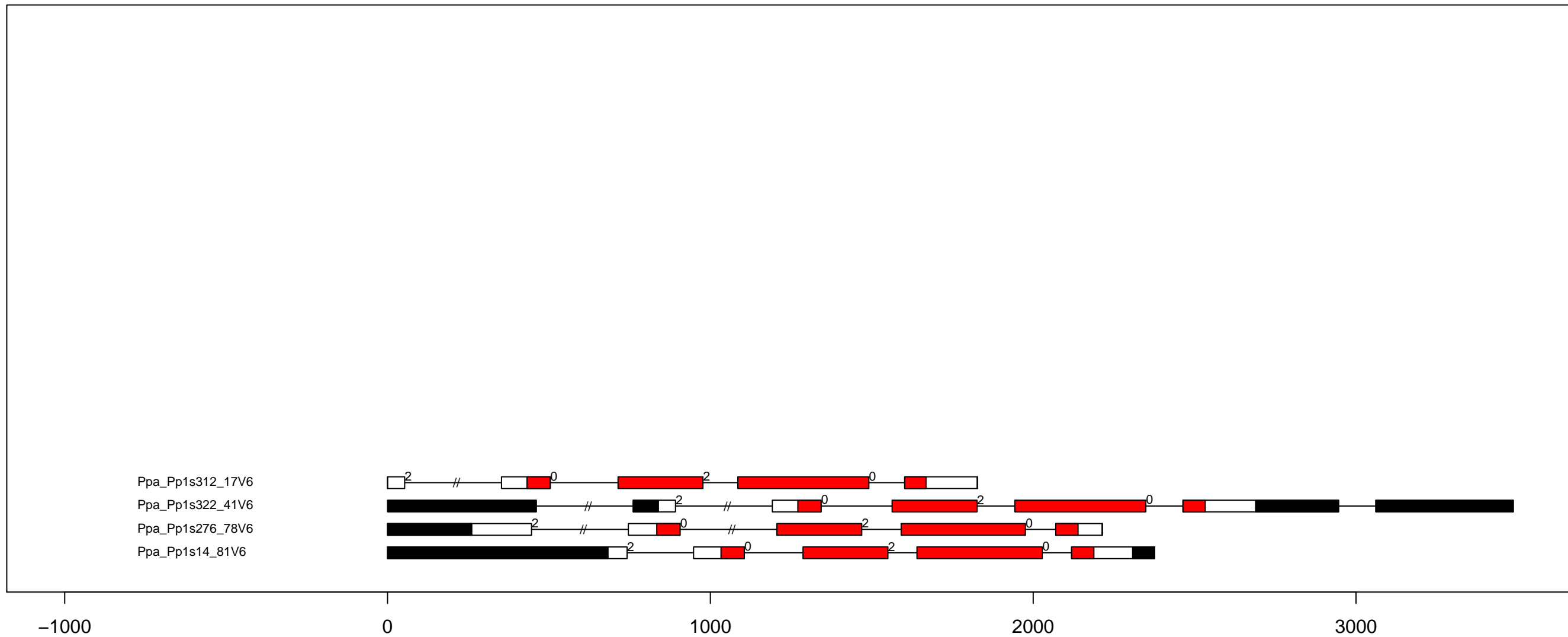

P.pa RLK-Pelle_SD-2b exon-intron and kinase domain diagram (all)

Ppa_Pp1s67_113V6
 Ppa_Pp1s4_109V6
 Ppa_Pp1s194_112V6
 Ppa_Pp1s98_96V6
 Ppa_Pp1s88_8V6
 Ppa_Pp1s69_179V6
 Ppa_Pp1s373_43V6
 Ppa_Pp1s315_62V6
 Ppa_Pp1s180_50V6
 Ppa_Pp1s160_110V6
 Ppa_Pp1s112_185V6

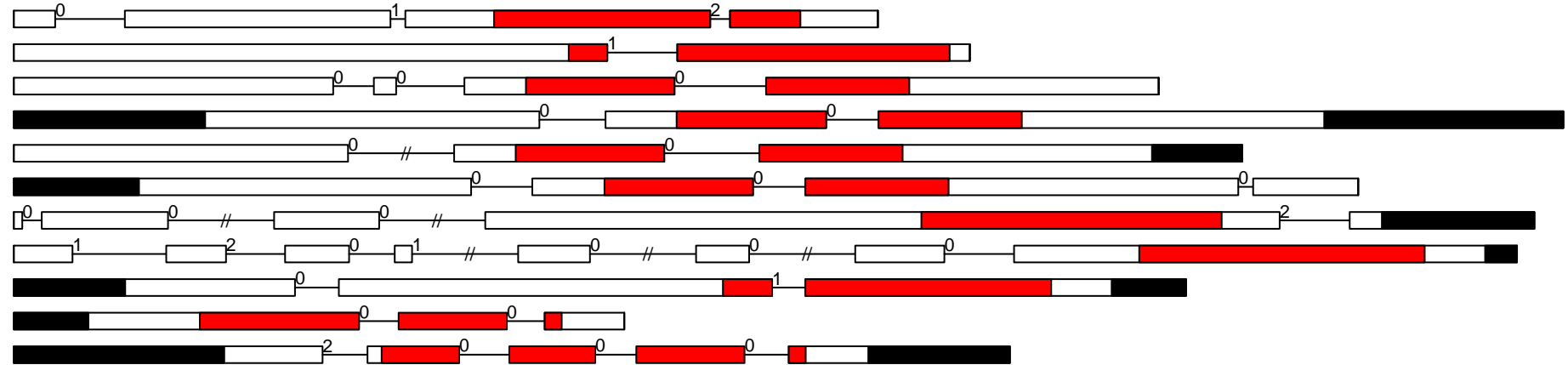

-1000

0

1000

2000

3000

4000

P.pa RLK-Pelle_Singleton exon-intron and kinase domain diagram (all)

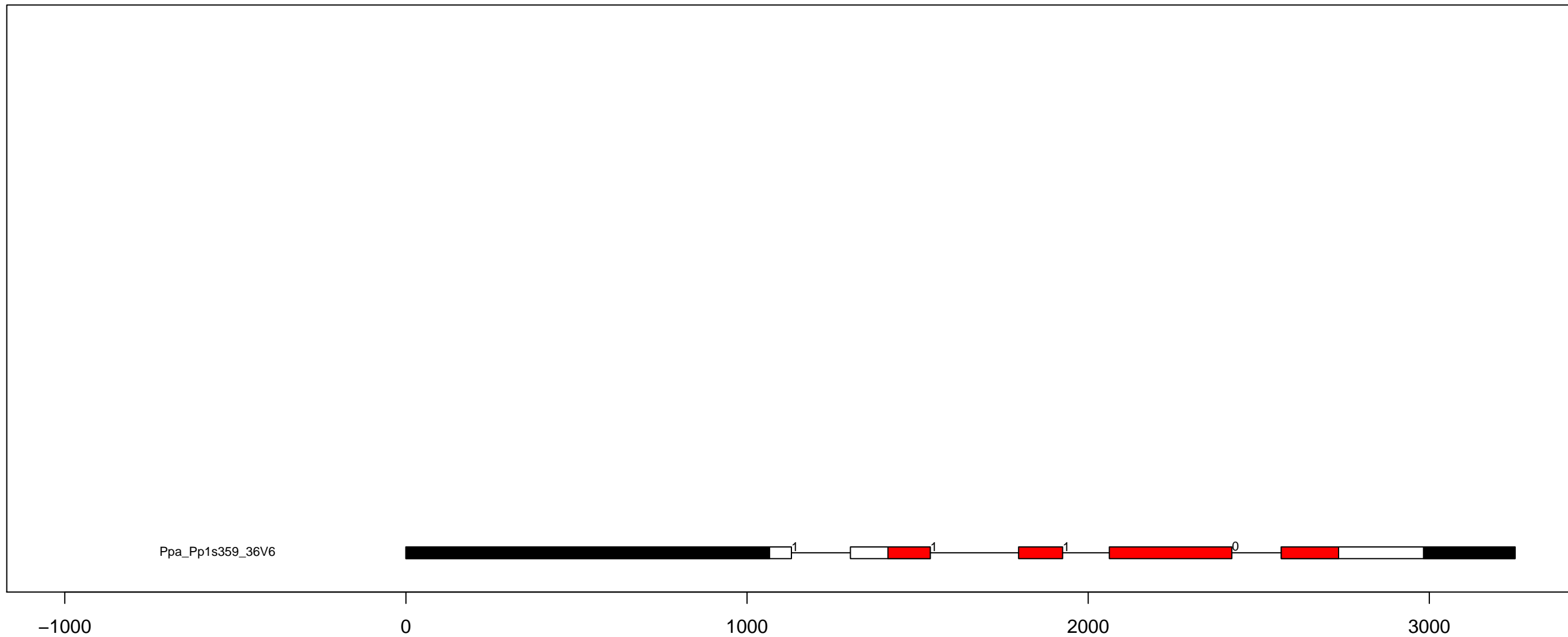

P.pa RLK-Pelle_URK-Pp-1 exon-intron and kinase domain diagram (all)

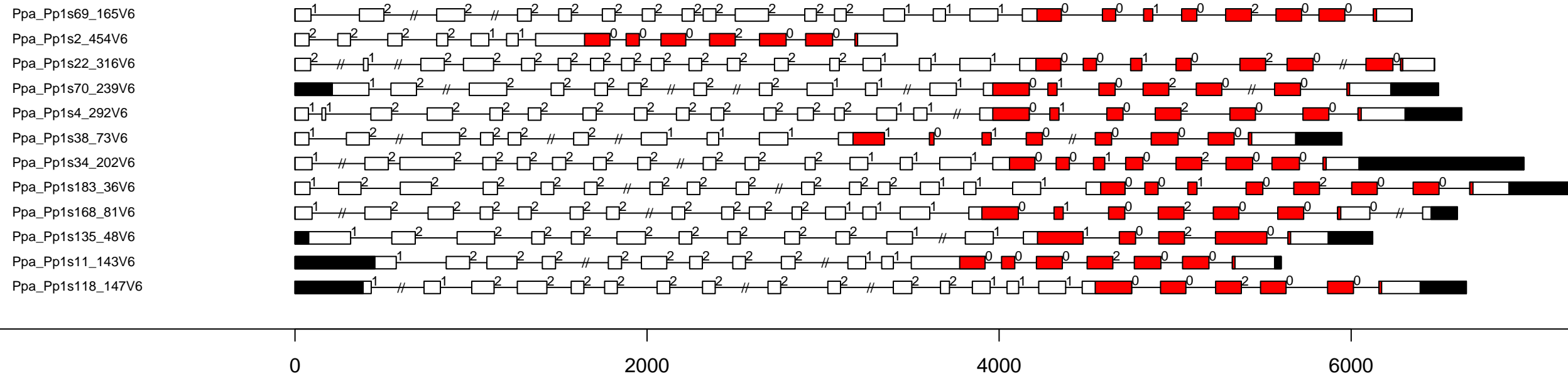

P.pa RLK-Pelle_URK-Pp-2 exon-intron and kinase domain diagram (all)

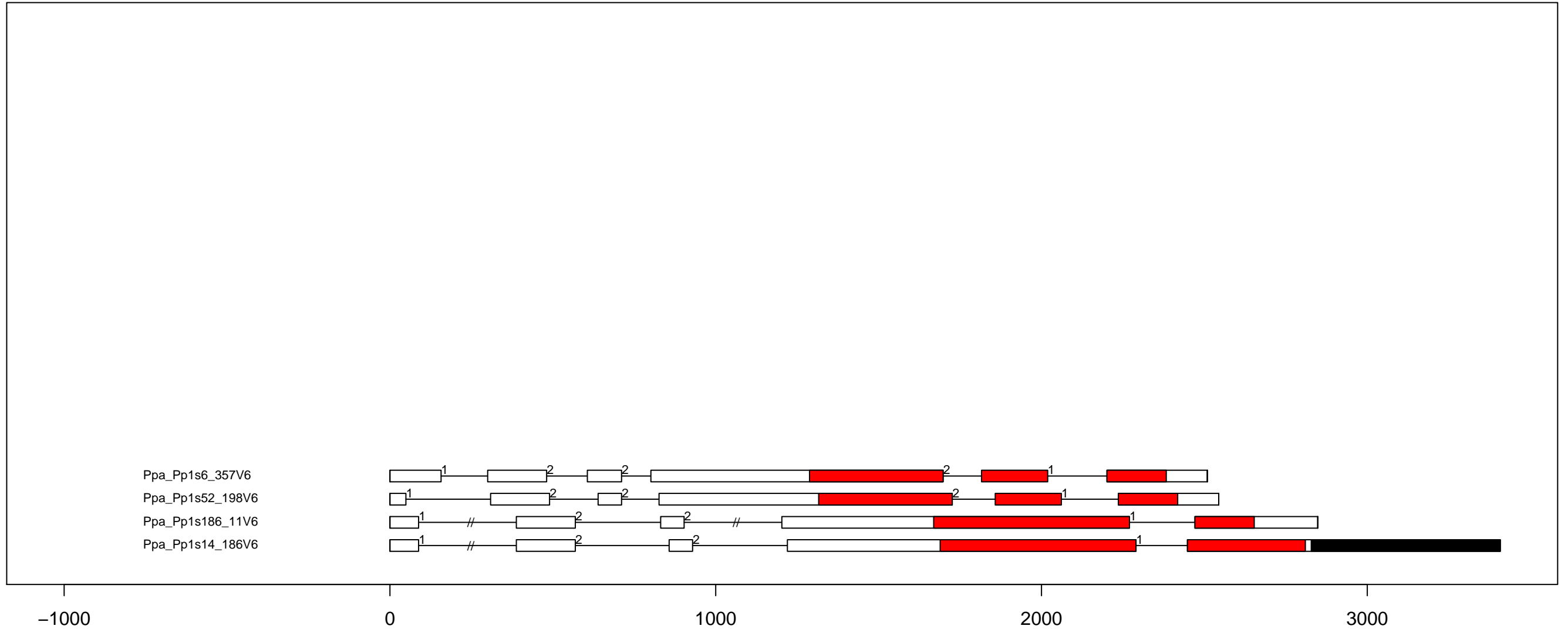

P.pa RLK-Pelle_WAK_LRK10L-1 exon-intron and kinase domain diagram (all)

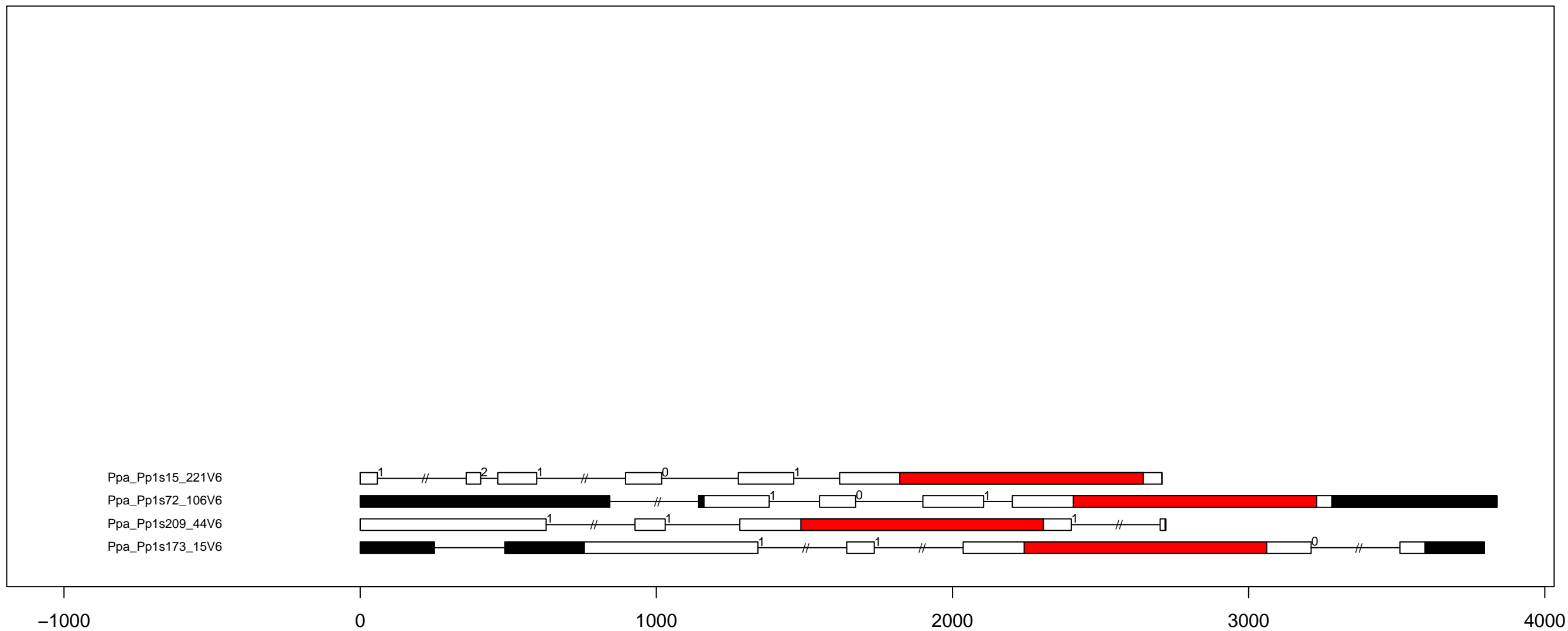

P.pa STE_STE11 exon-intron and kinase domain diagram (all)

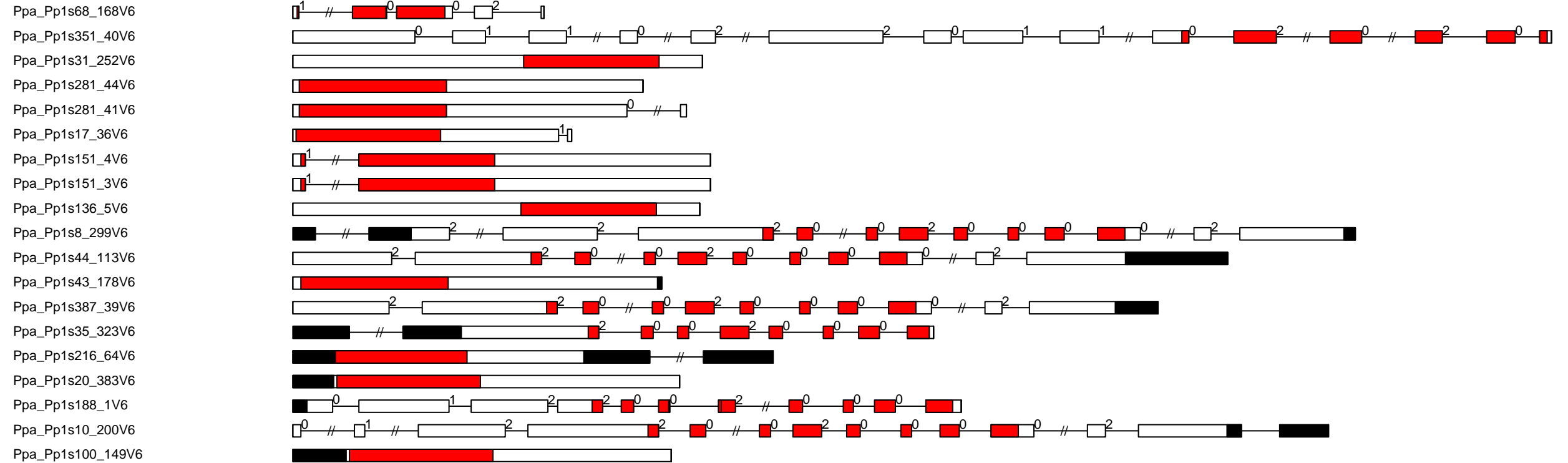

P.pa STE_STE20-Fray exon-intron and kinase domain diagram (all)

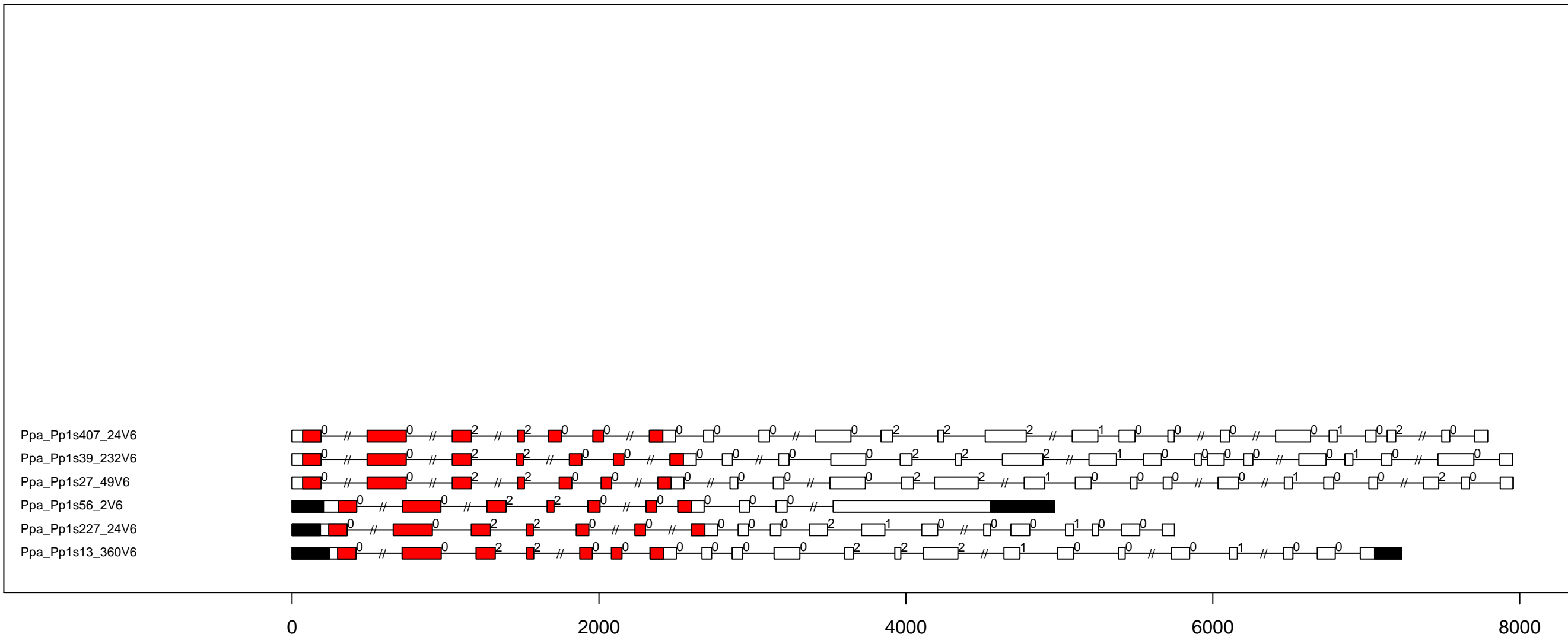

P.pa STE_STE20-PI exon-intron and kinase domain diagram (all)

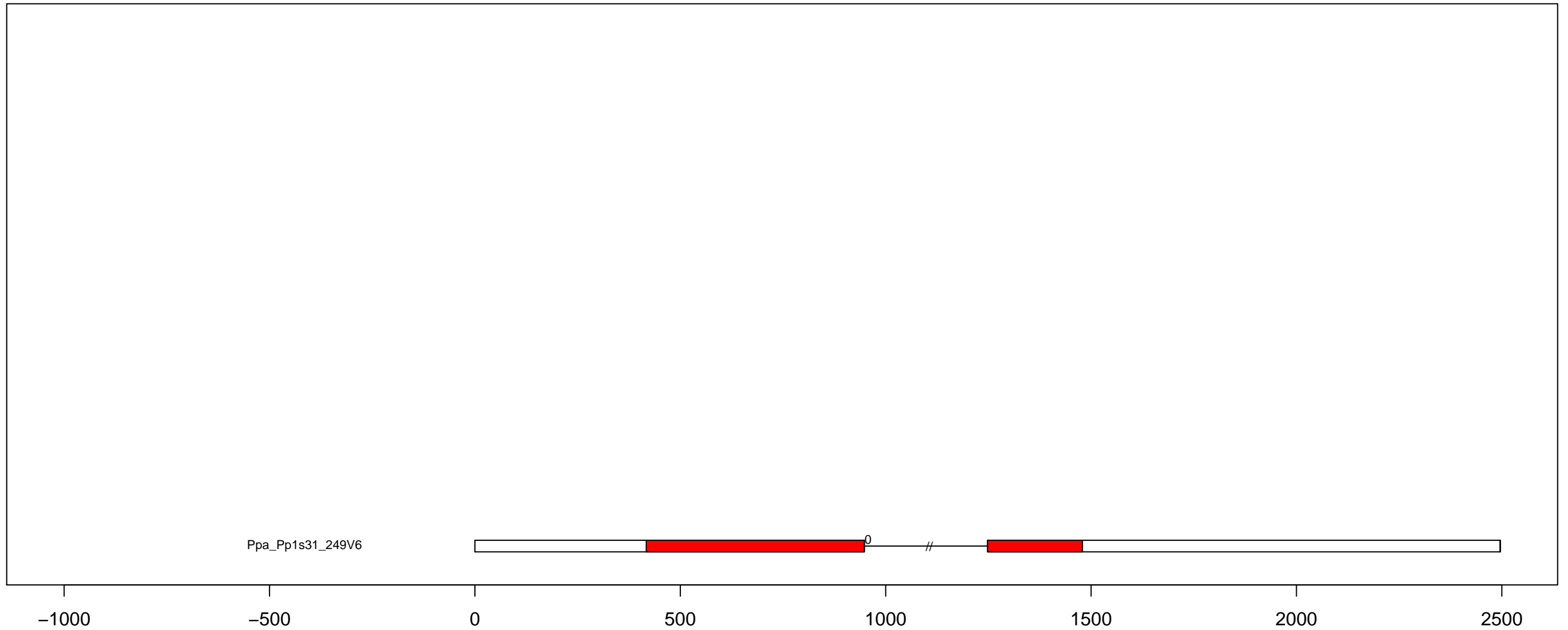

P.pa STE_STE20-YSK exon-intron and kinase domain diagram (all)

Ppa_Pp1s98_82V6
Ppa_Pp1s59_173V6

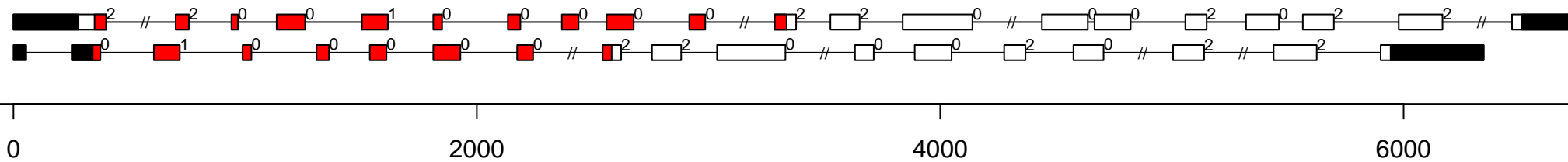

P.pa STE_STE7 exon-intron and kinase domain diagram (all)

Ppa_Pp1s92_27V6



Ppa_Pp1s106_83V6

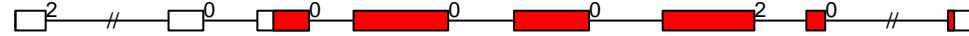

Ppa_Pp1s50_83V6

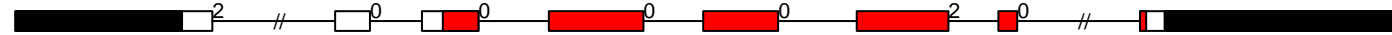

Ppa_Pp1s32_219V6

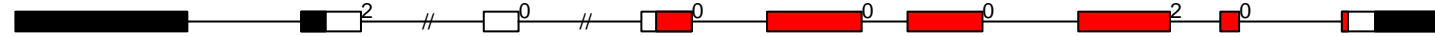

Ppa_Pp1s16_334V6



Ppa_Pp1s151_2V6



Ppa_Pp1s114_89V6



-1000

0

1000

2000

3000

4000

P.pa STE_STE-PI exon-intron and kinase domain diagram (all)

Ppa_Pp1s99_12V6

Ppa_Pp1s66_286V6

Ppa_Pp1s131_142V6

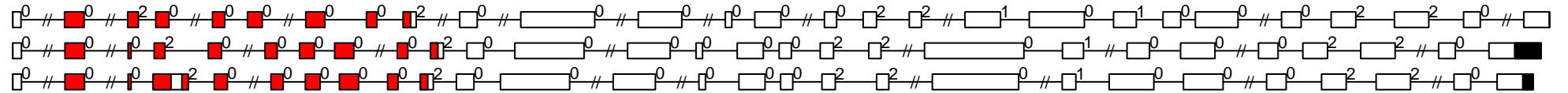

-2000

0

2000

4000

6000

8000

10000

P.pa TKL_CTR1-DRK-1 exon-intron and kinase domain diagram (all)

Ppa_Pp1s63_65V6
Ppa_Pp1s75_1V6
Ppa_Pp1s11_61V6

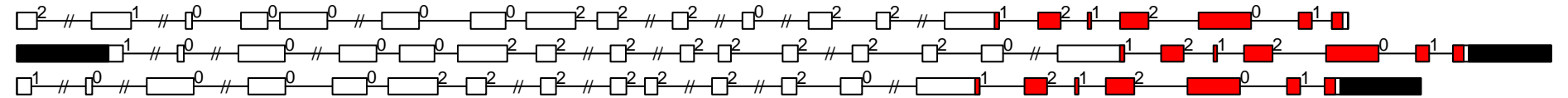

P.pa TKL_CTRL1-DRK-2 exon-intron and kinase domain diagram (all)

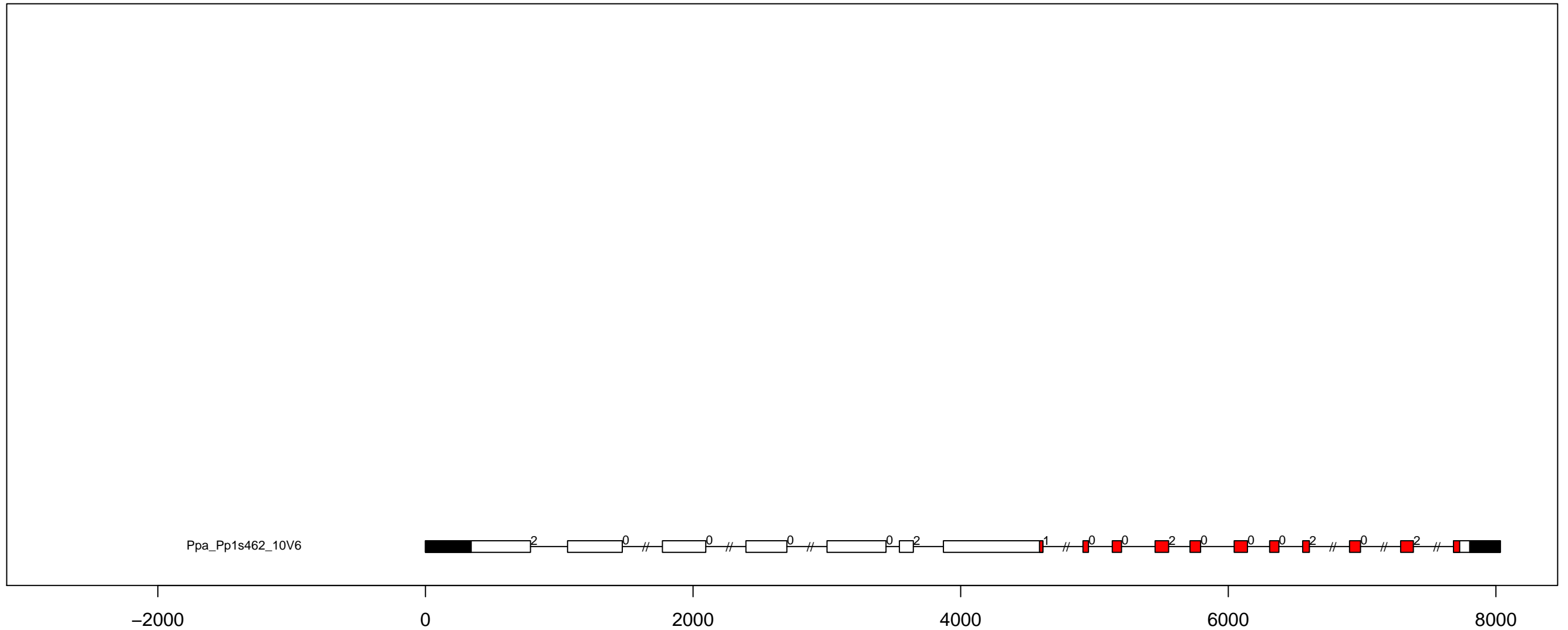

P.pa TKL_Gdt exon-intron and kinase domain diagram (part 1)

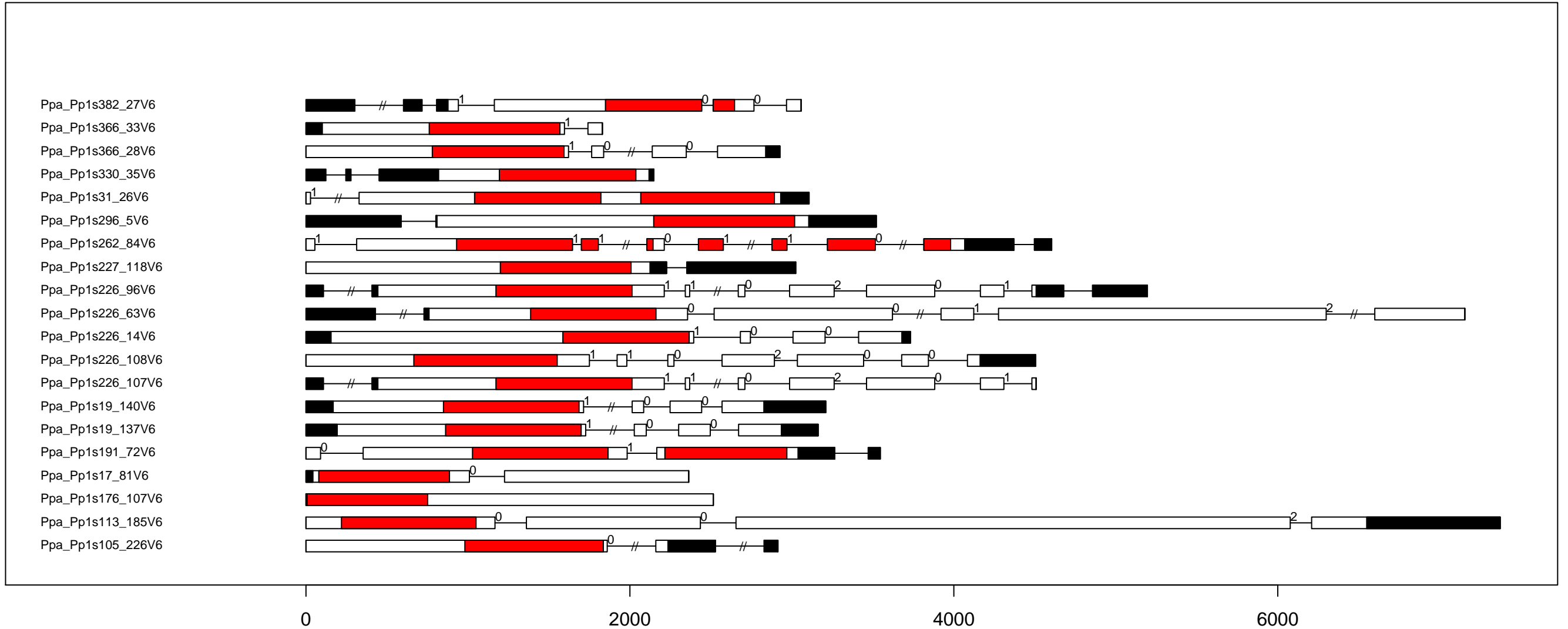

P.pa TKL_Gdt exon-intron and kinase domain diagram (part 2)

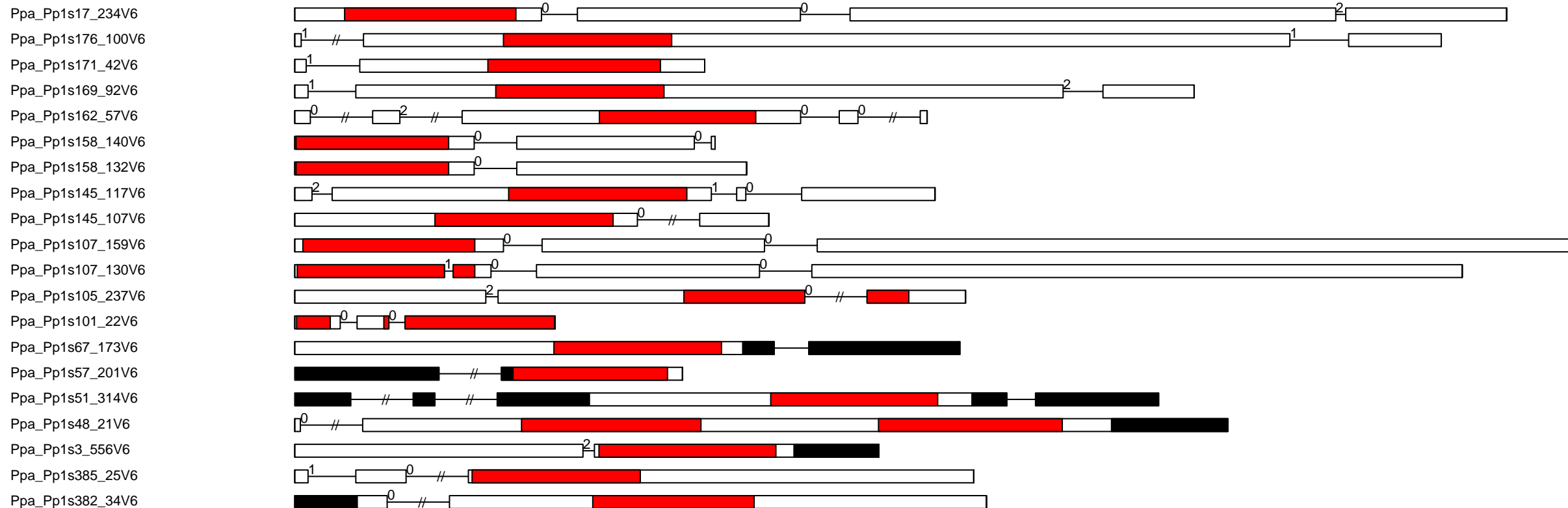

P.pa TKL_Gdt exon-intron and kinase domain diagram (part 3)

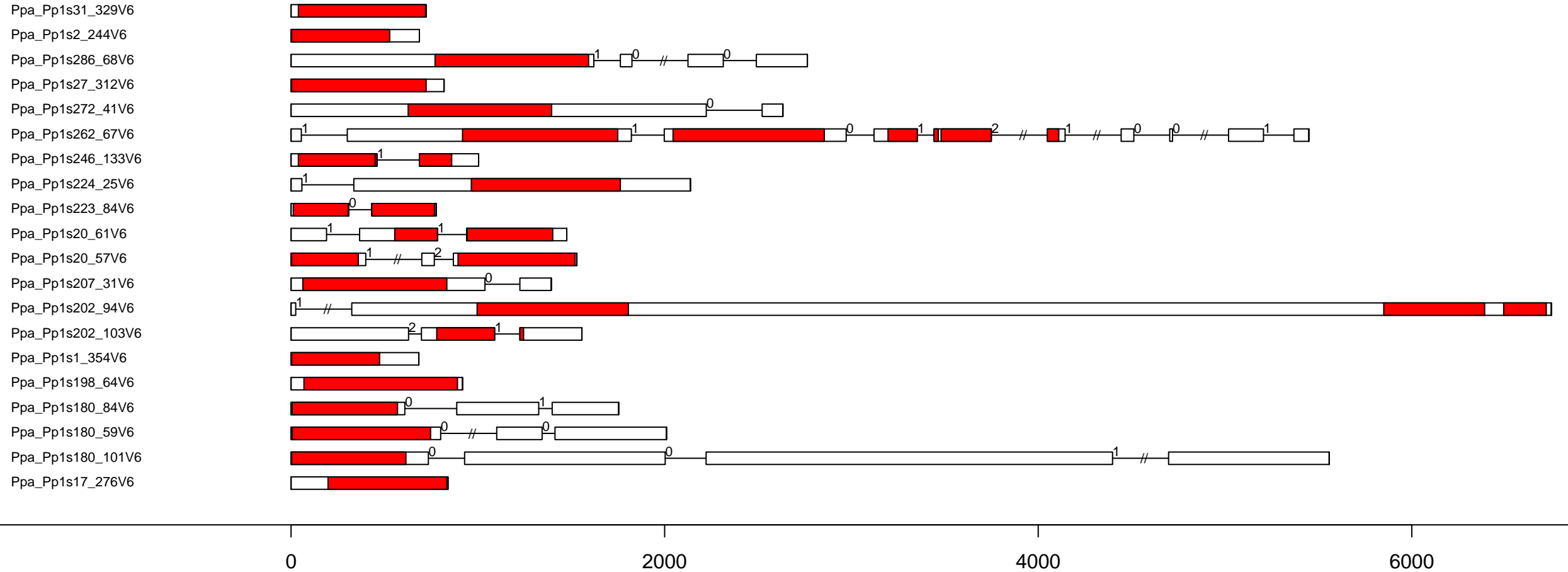

P.pa TKL_RIPK exon-intron and kinase domain diagram (all)

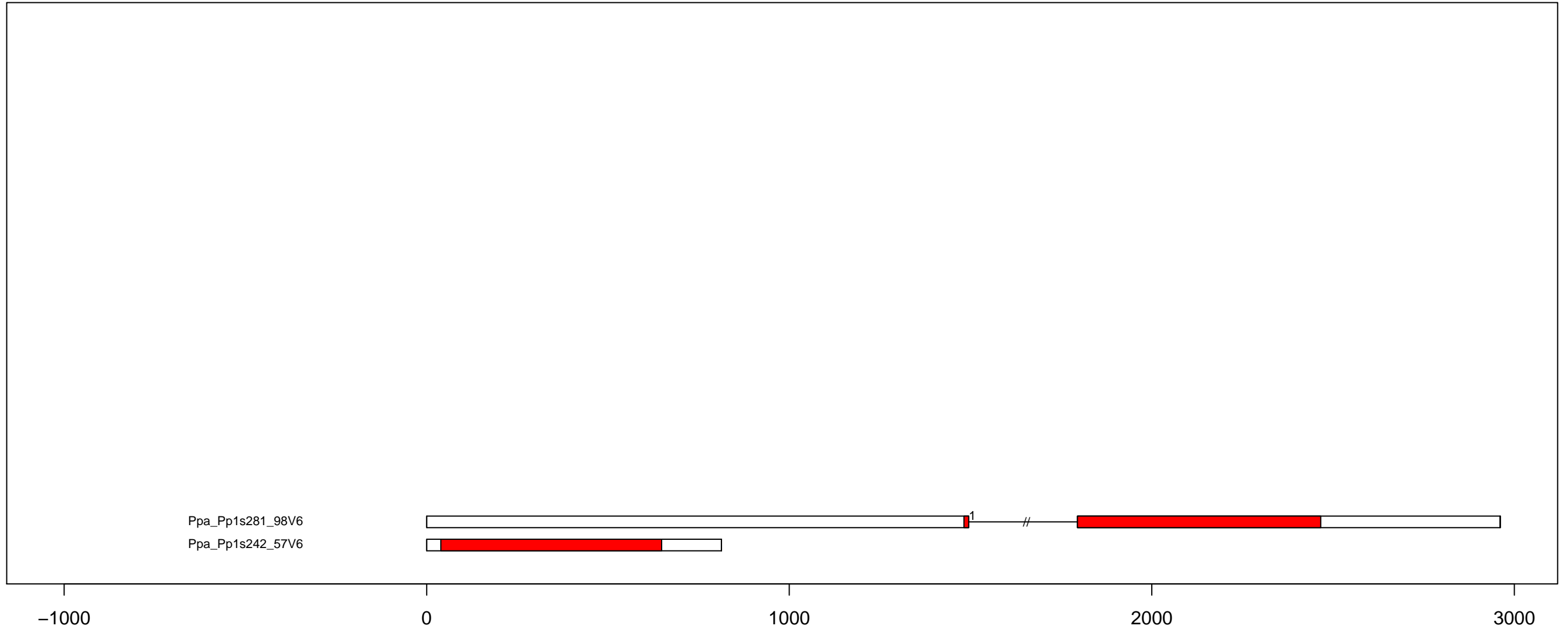

P.pa TKL-PI-1 exon-intron and kinase domain diagram (all)

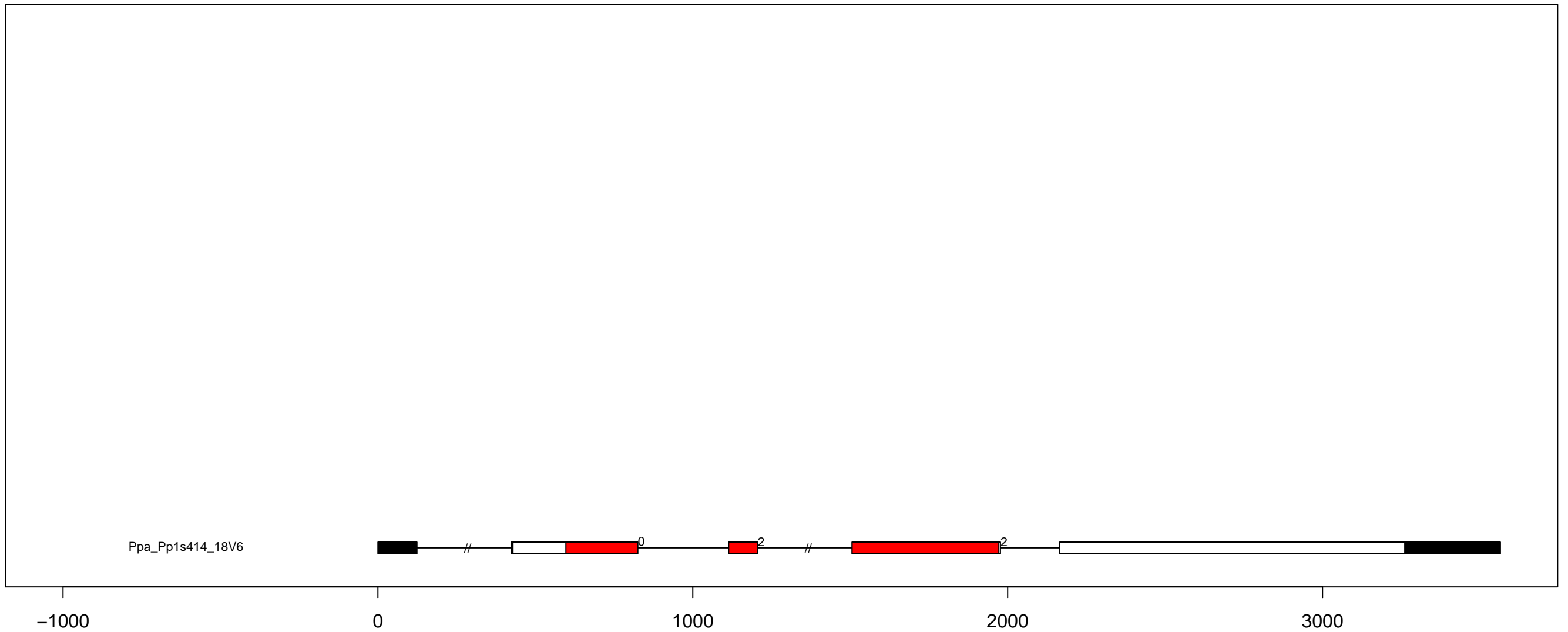

P.pa TKL-PI-2 exon-intron and kinase domain diagram (all)

Ppa_Pp1s134_154V6

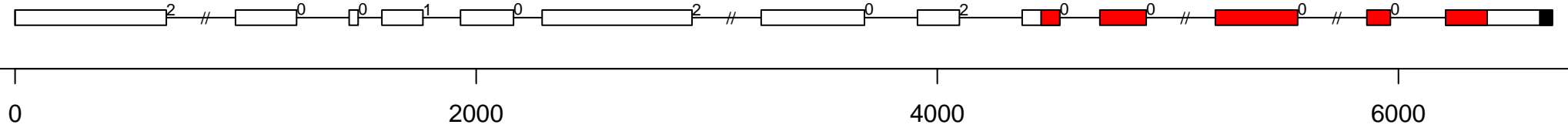

P.pa TKL-PI-3 exon-intron and kinase domain diagram (all)

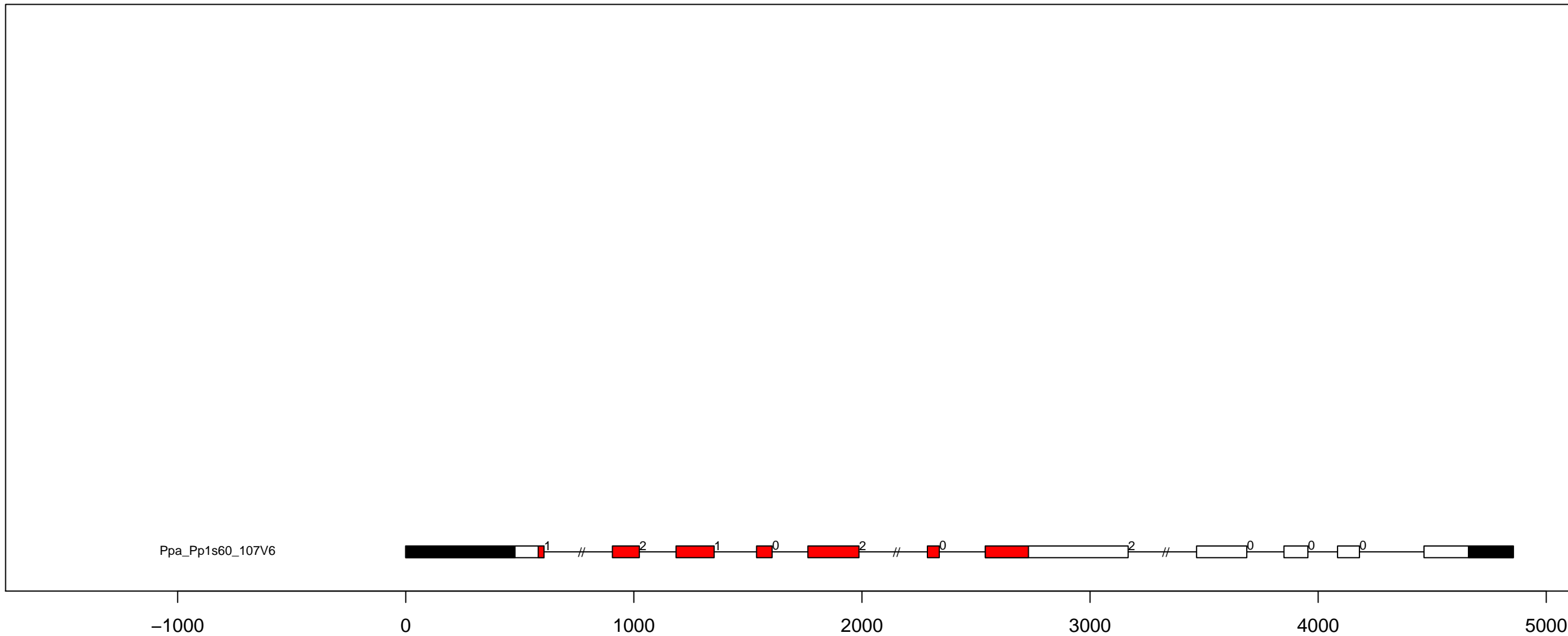

P.pa TKL-PI-4 exon-intron and kinase domain diagram (part 1)

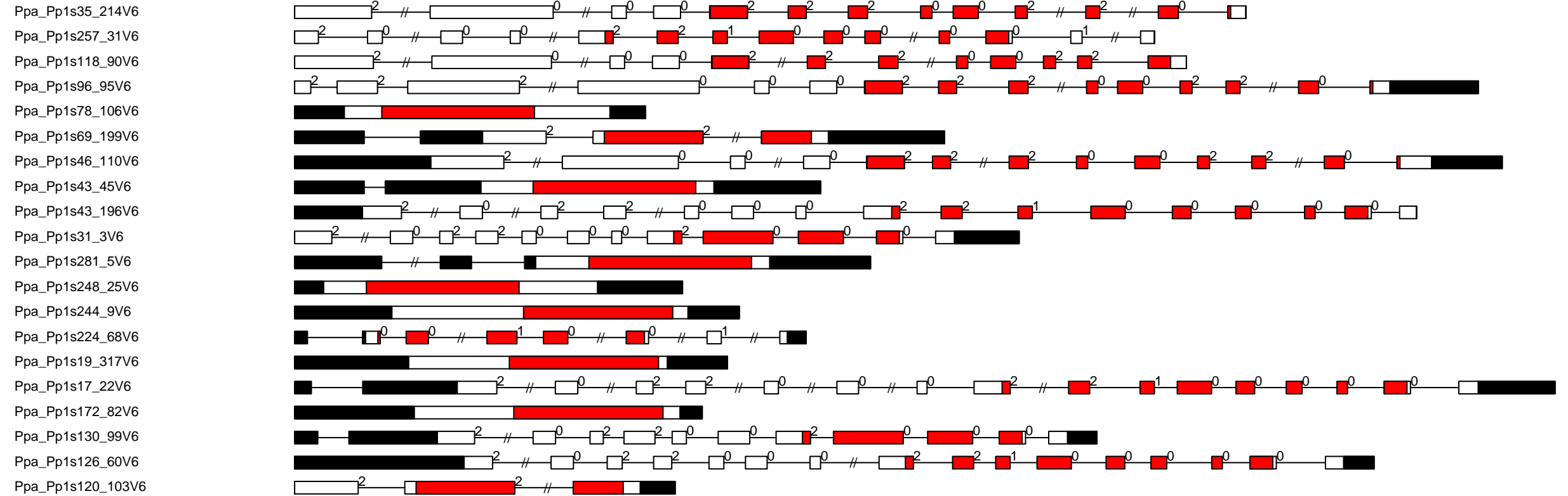

P.pa TKL-PI-4 exon-intron and kinase domain diagram (part 2)

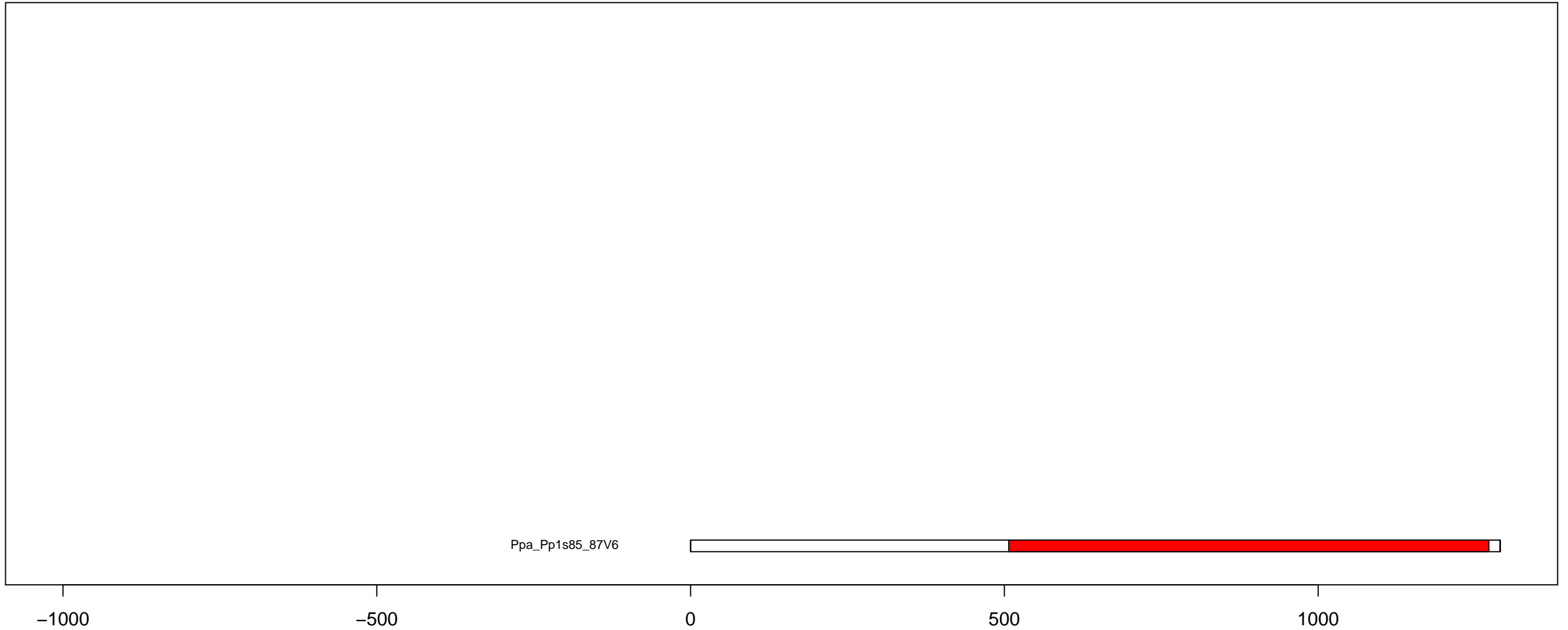

P.pa TKL-PI-5 exon-intron and kinase domain diagram (all)

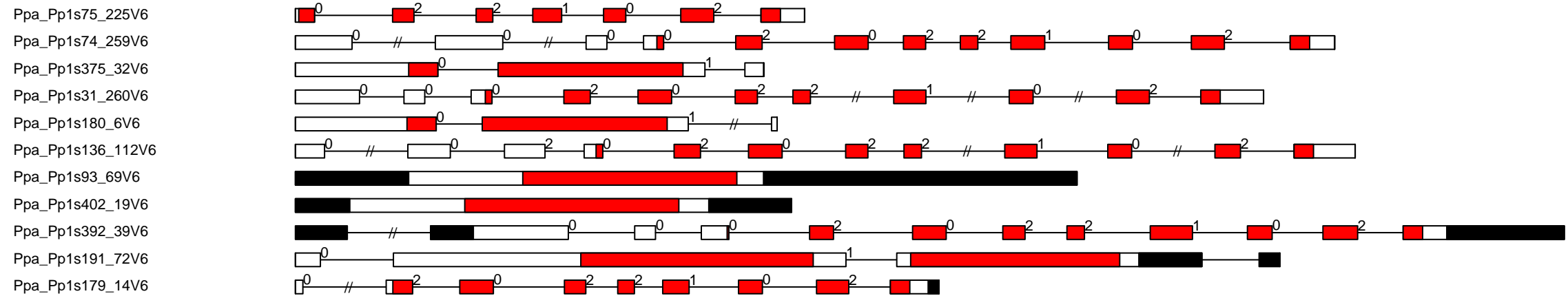

-1000

0

1000

2000

3000

4000

P.pa TKL-PI-6 exon-intron and kinase domain diagram (all)

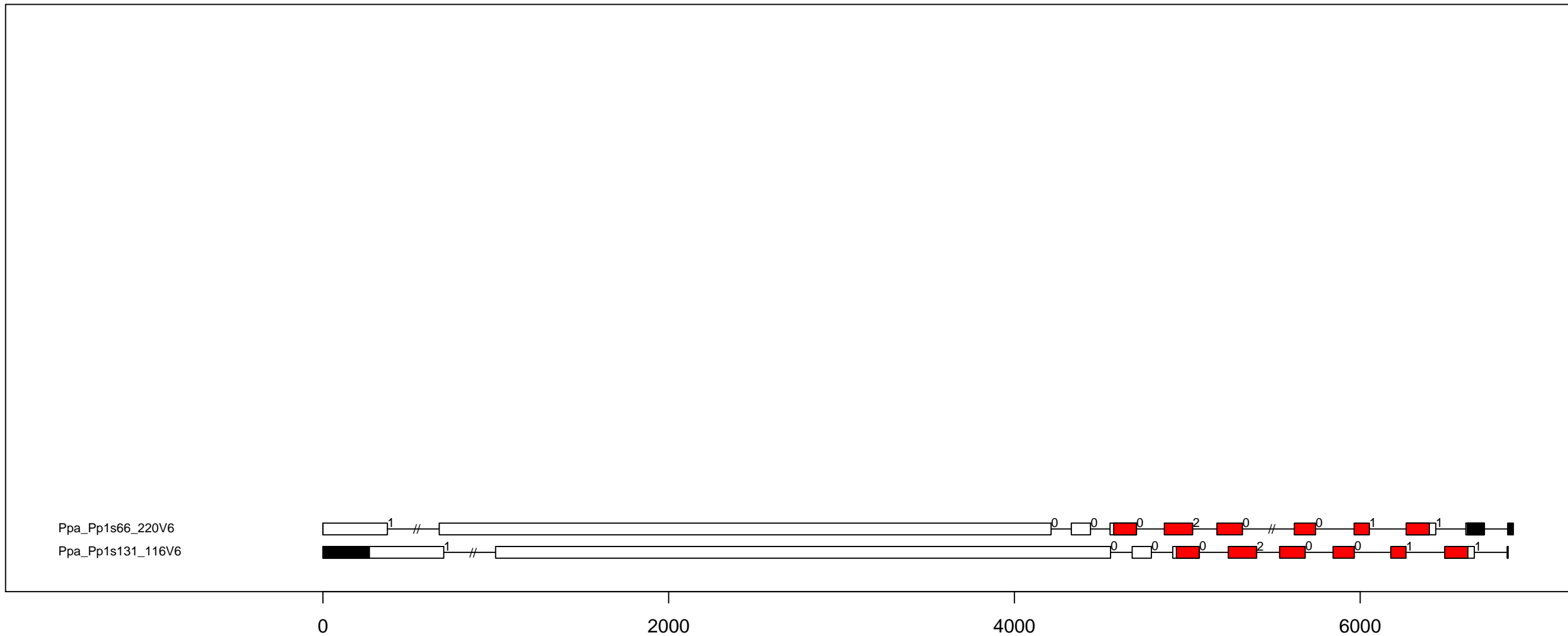

P.pa TLK exon-intron and kinase domain diagram (all)

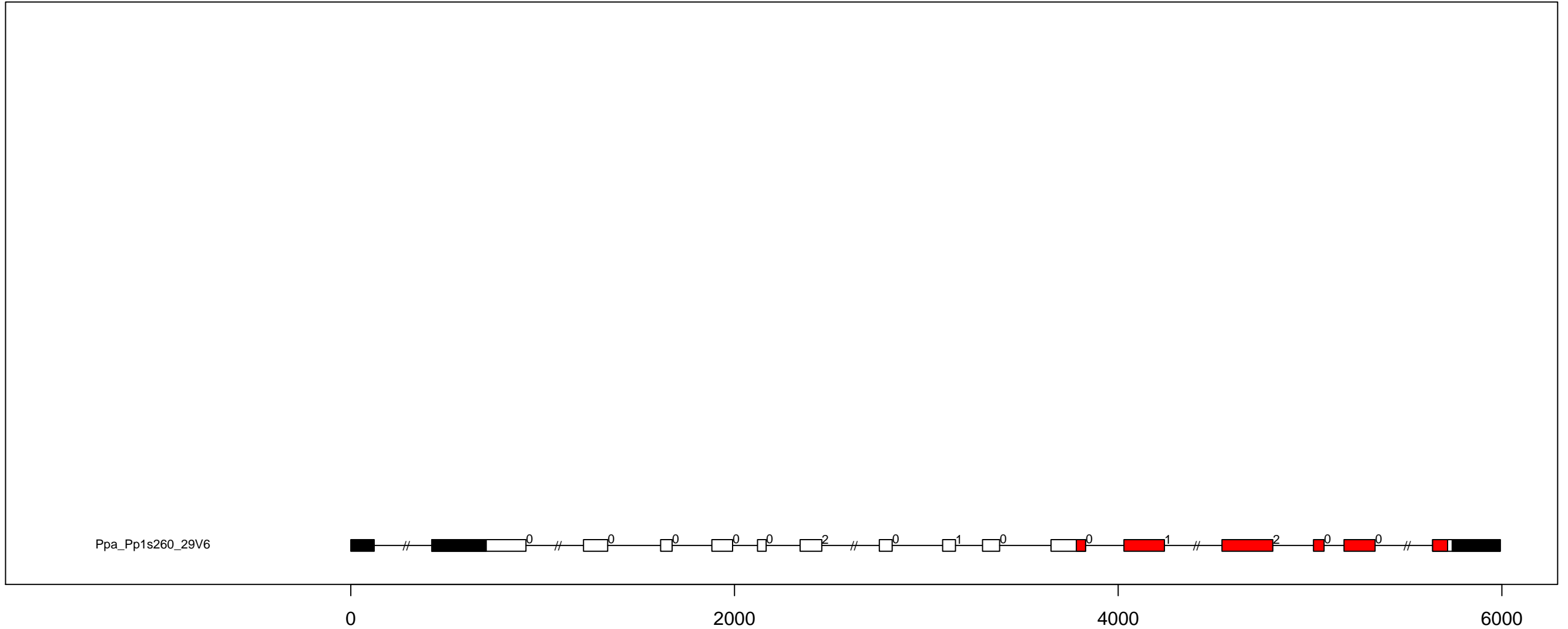

P.pa TTK exon-intron and kinase domain diagram (all)

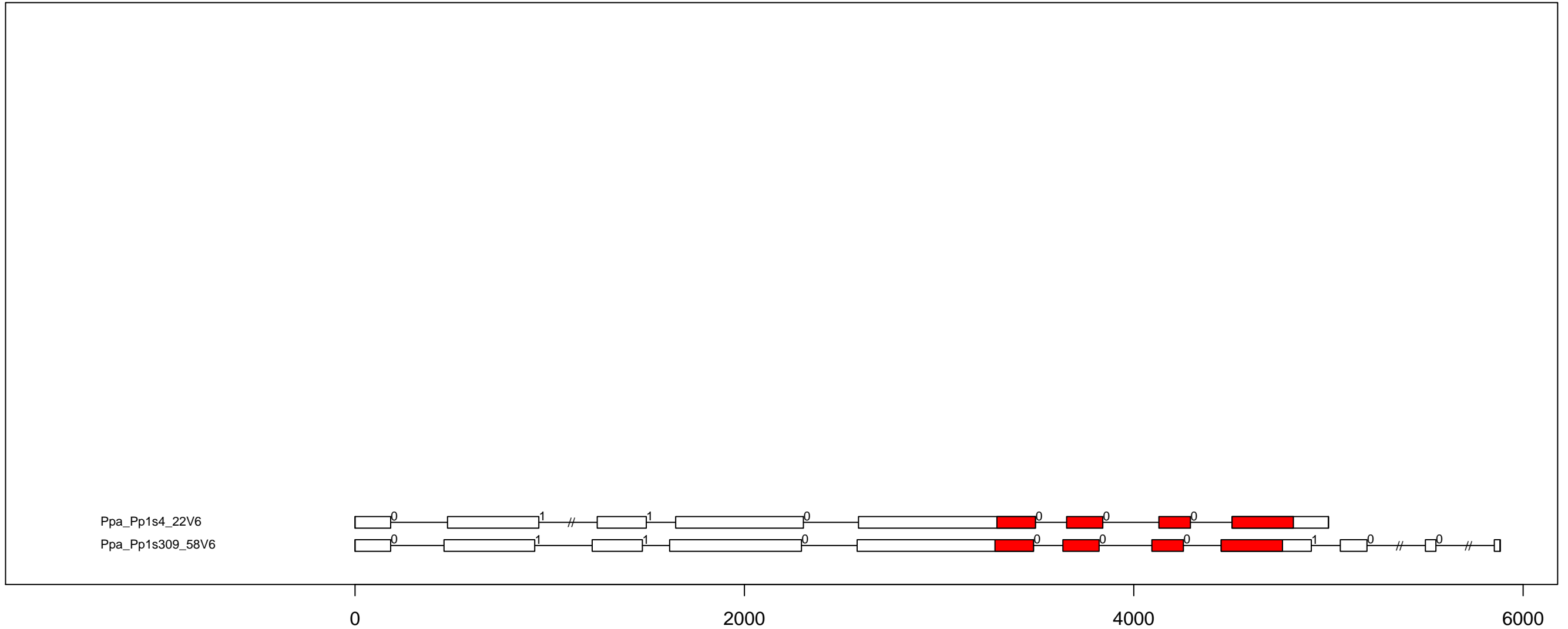

P.pa ULK_Fused exon-intron and kinase domain diagram (all)

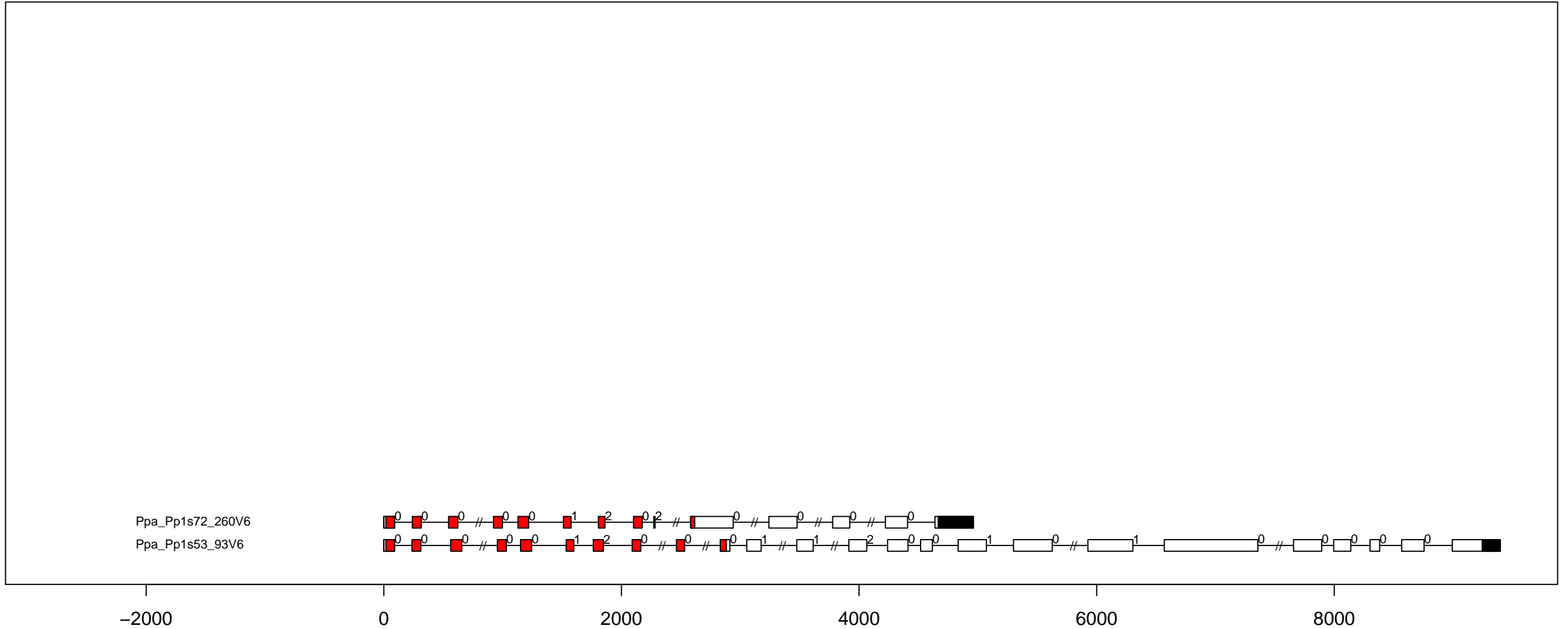

P.pa ULK_ULK4 exon-intron and kinase domain diagram (all)

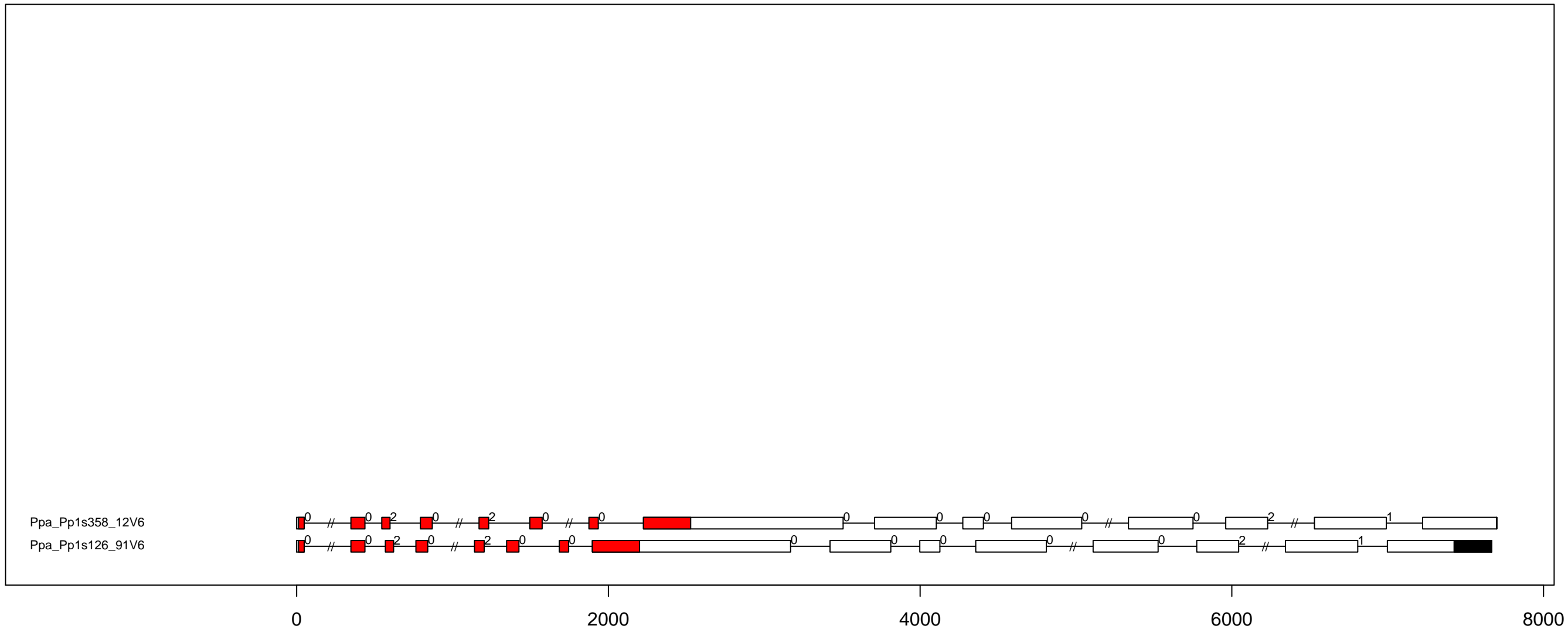

P.pa WEE exon-intron and kinase domain diagram (all)

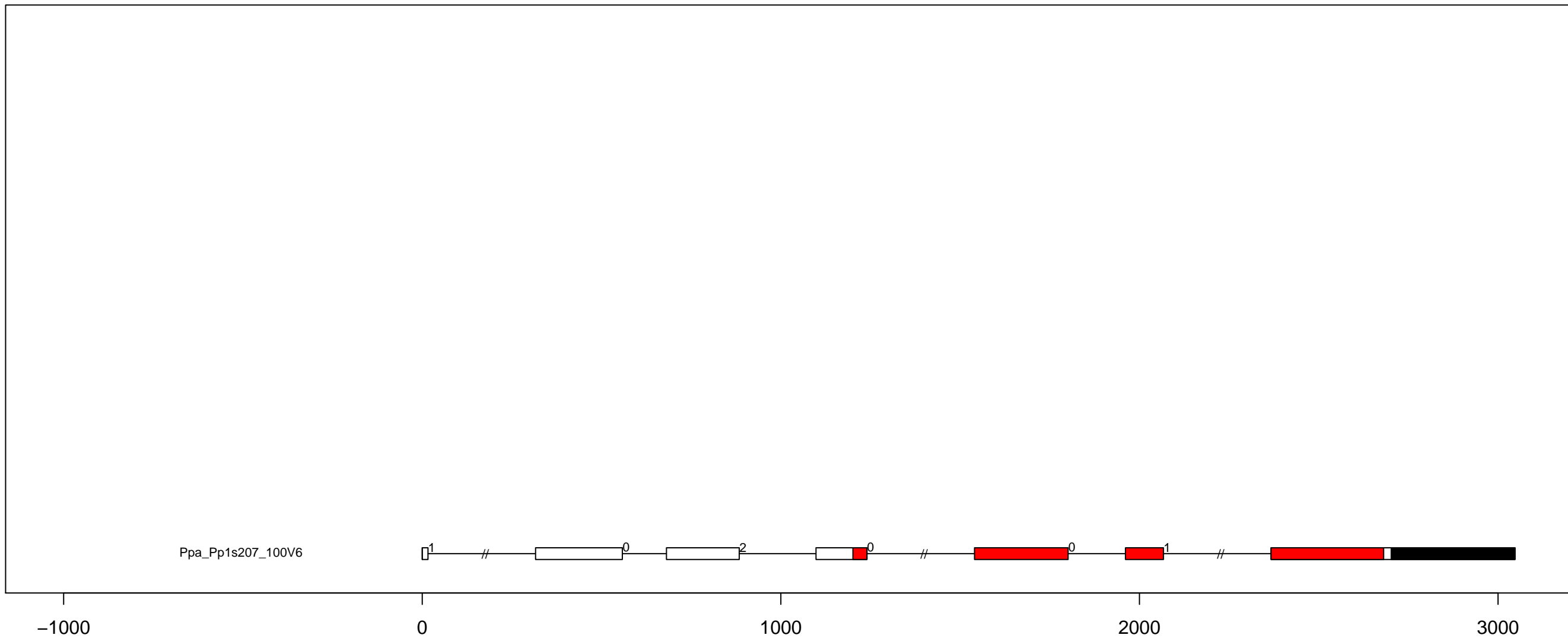

C.re AGC_NDR exon-intron and kinase domain diagram (all)

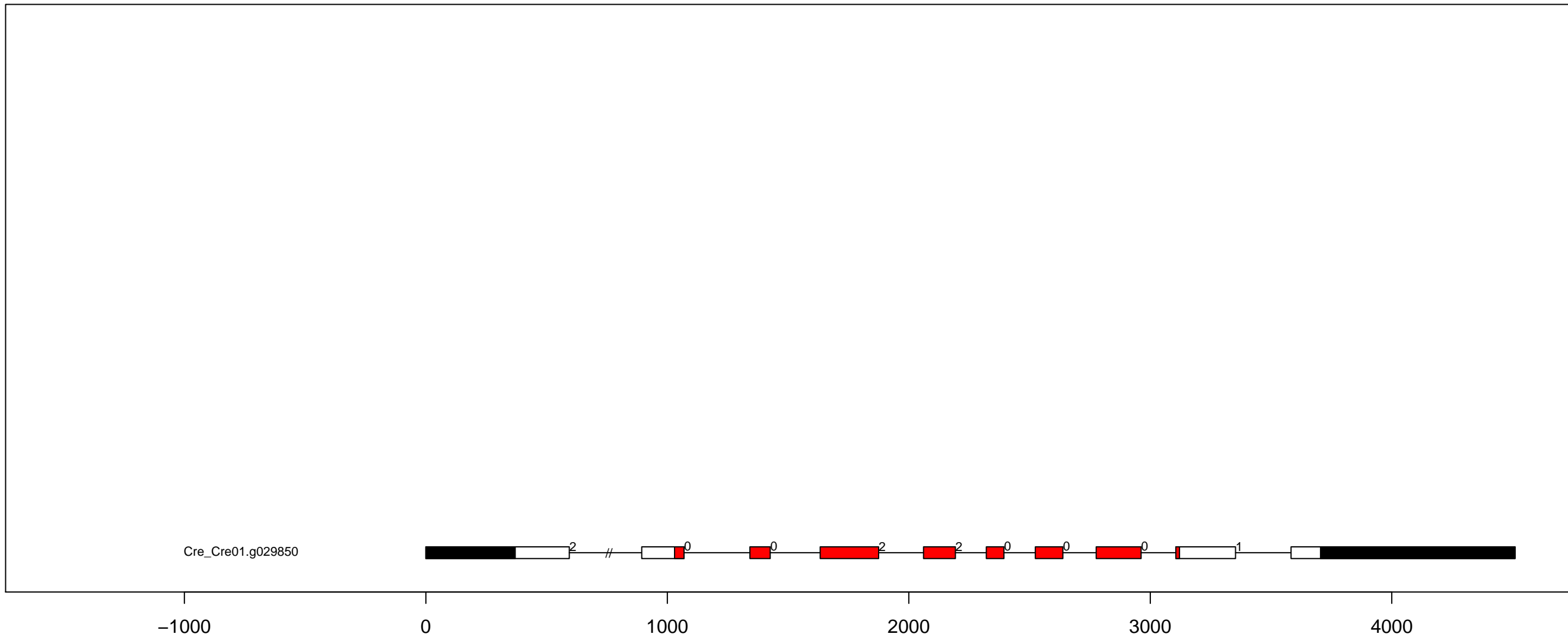

C.re AGC_PKA-PKG exon-intron and kinase domain diagram (all)

Cre_Cre16.g669800

Cre_Cre16.g663200

Cre_Cre12.g493250

Cre_Cre10.g443550

Cre_Cre03.g199050

Cre_Cre03.g190050

Cre_Cre02.g076900

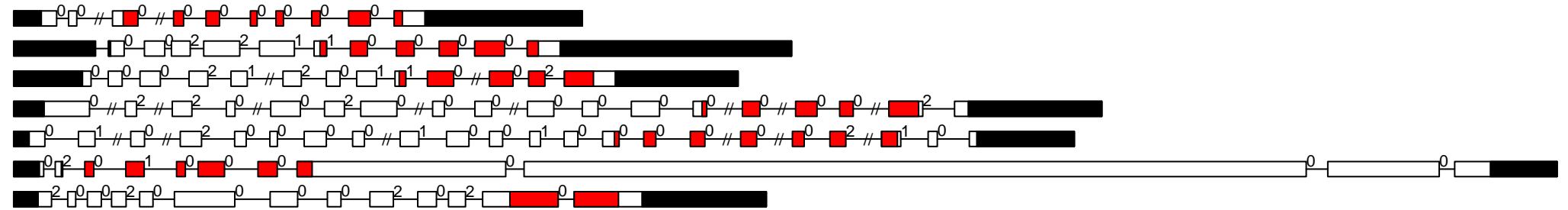

0

5000

10000

C.re AGC_RSK-1 exon-intron and kinase domain diagram (all)

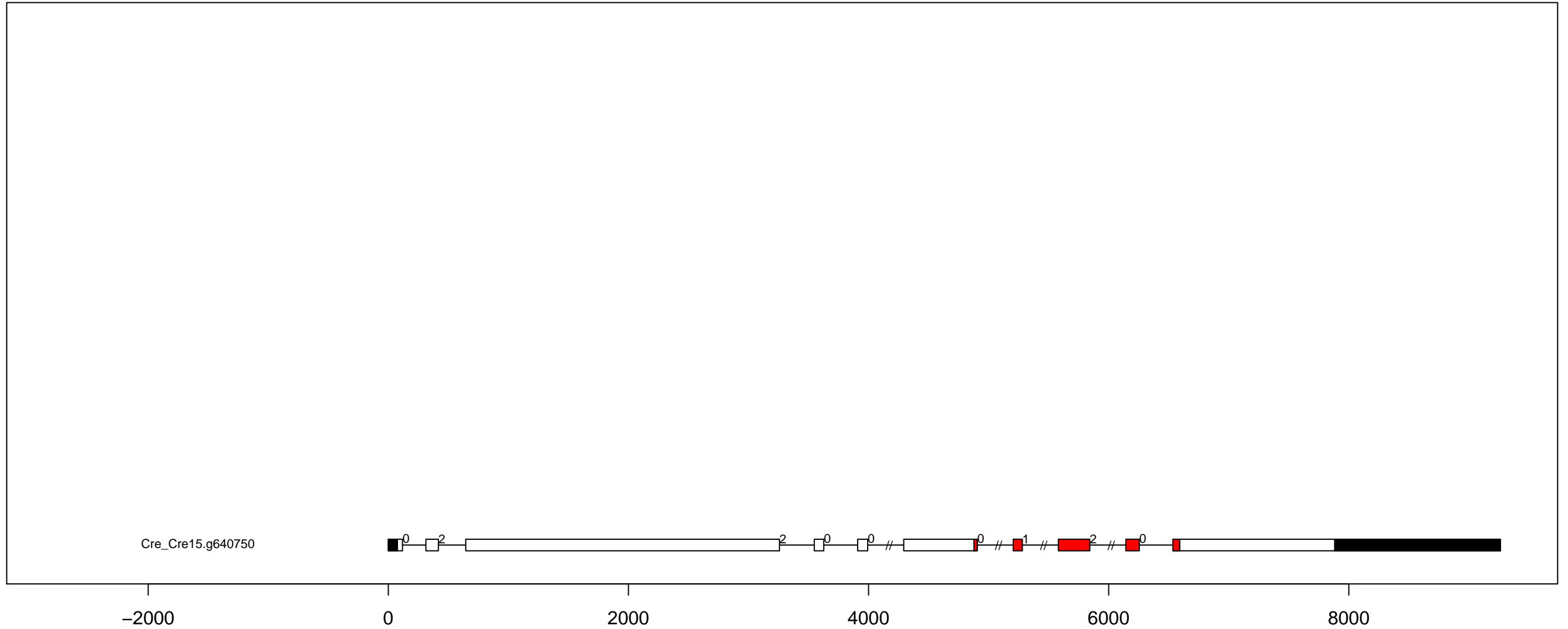

C.re AGC_RSK-2 exon-intron and kinase domain diagram (all)

Cre_Cre03.g199000

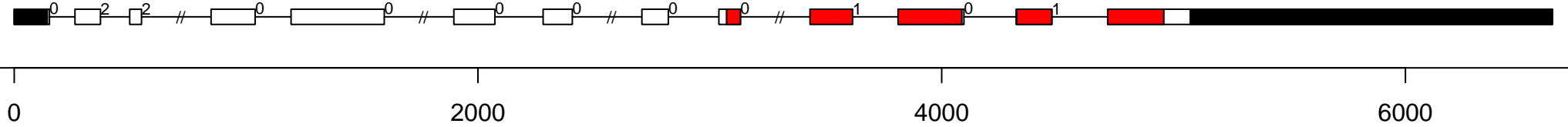

C.re AurL-Cr-1 exon-intron and kinase domain diagram (part 1)

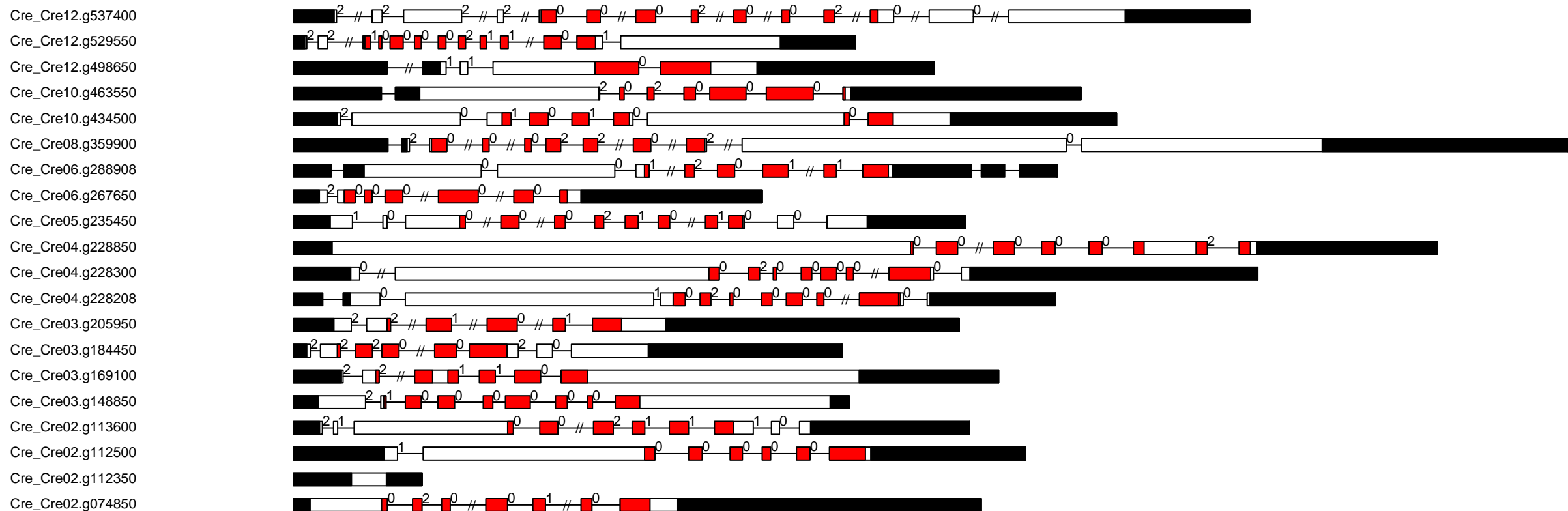

C.re AurL-Cr-1 exon-intron and kinase domain diagram (part 2)

Cre_Cre17.g735550
Cre_Cre17.g719450
Cre_Cre13.g592000

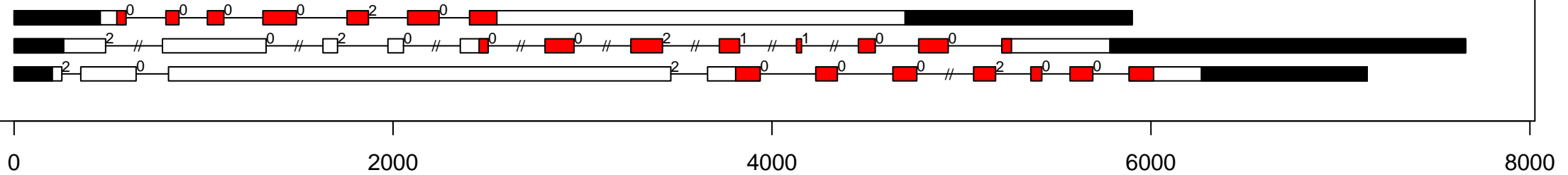

C.re AurL-Cr-2 exon-intron and kinase domain diagram (all)

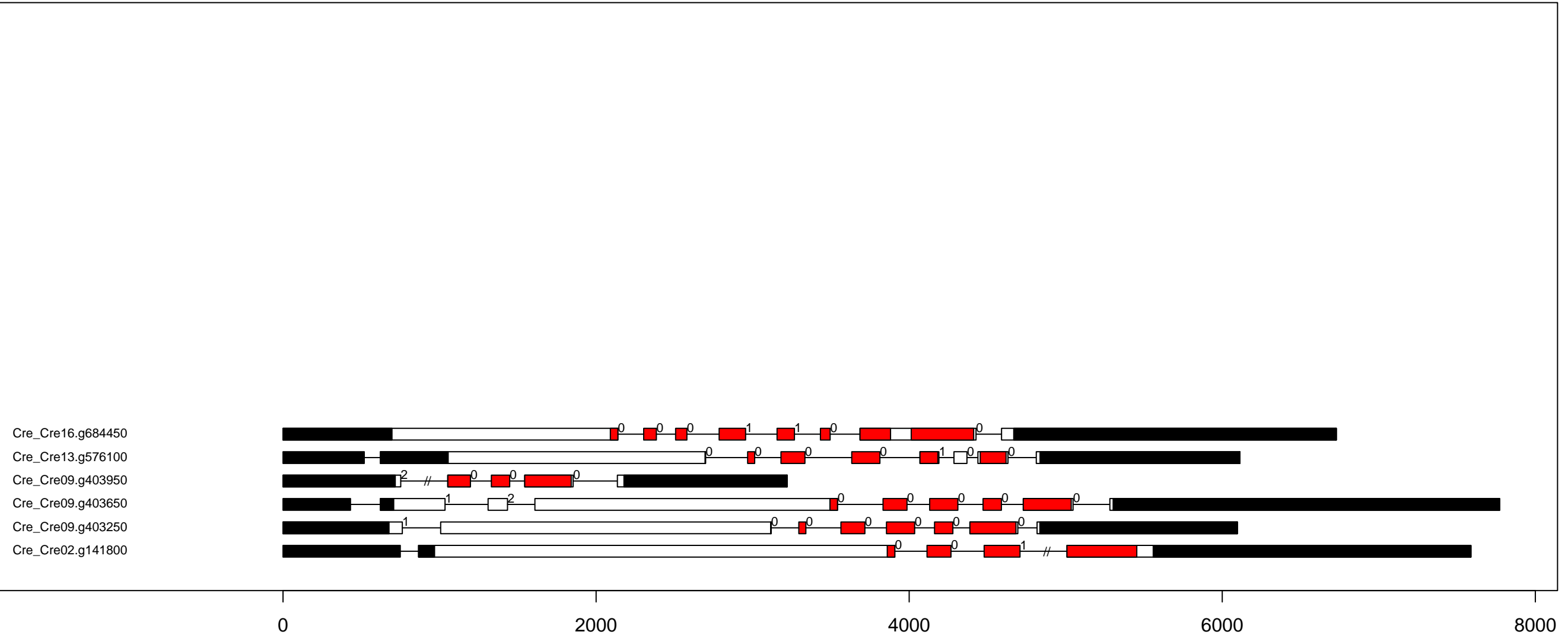

C.re Aur exon-intron and kinase domain diagram (all)

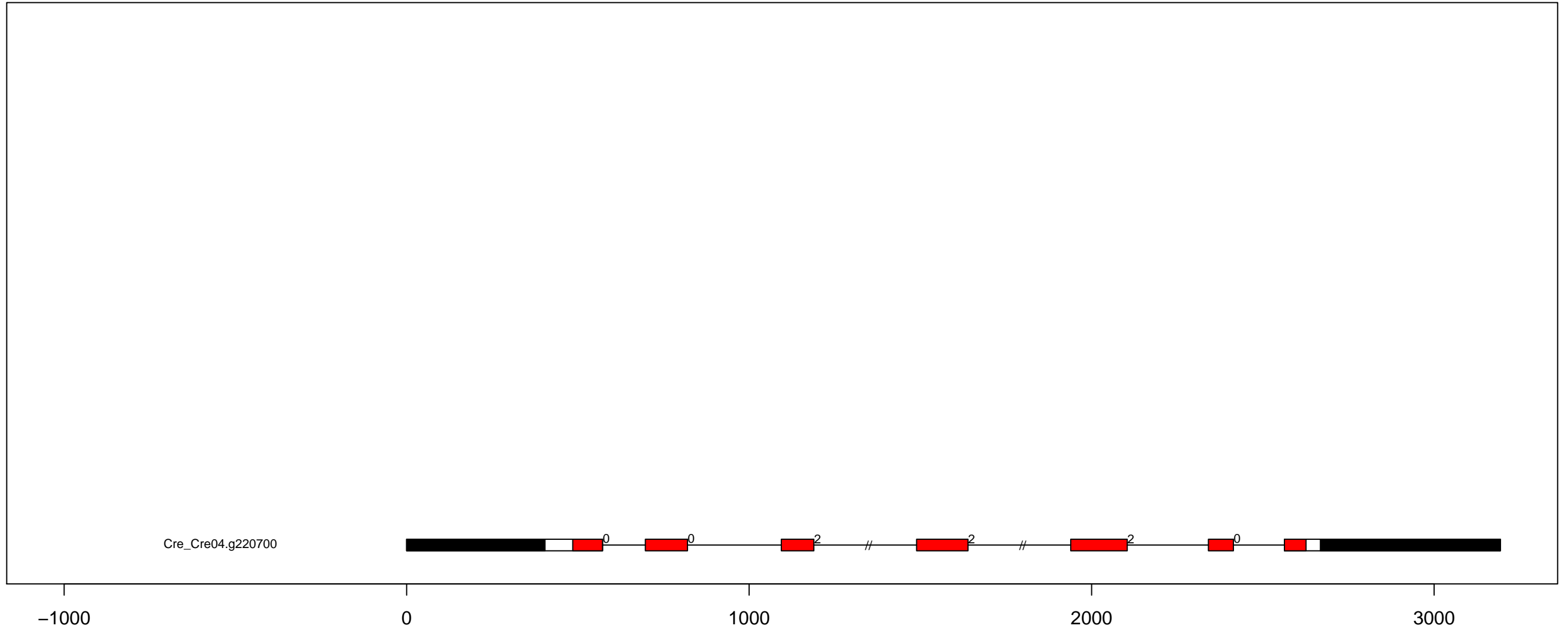

C.re CAMK_AMPK exon-intron and kinase domain diagram (all)

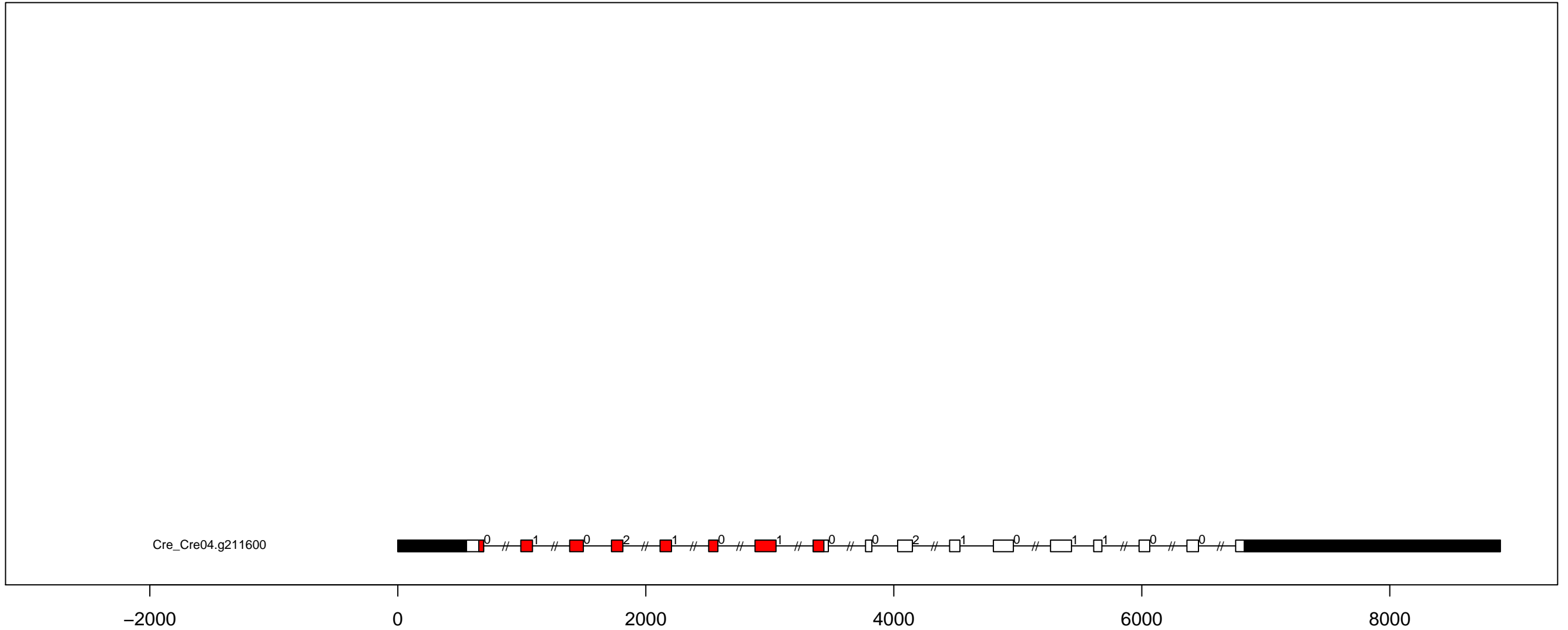

C.re CAMK_CAMK1-DCAMKL exon-intron and kinase domain diagram (all)

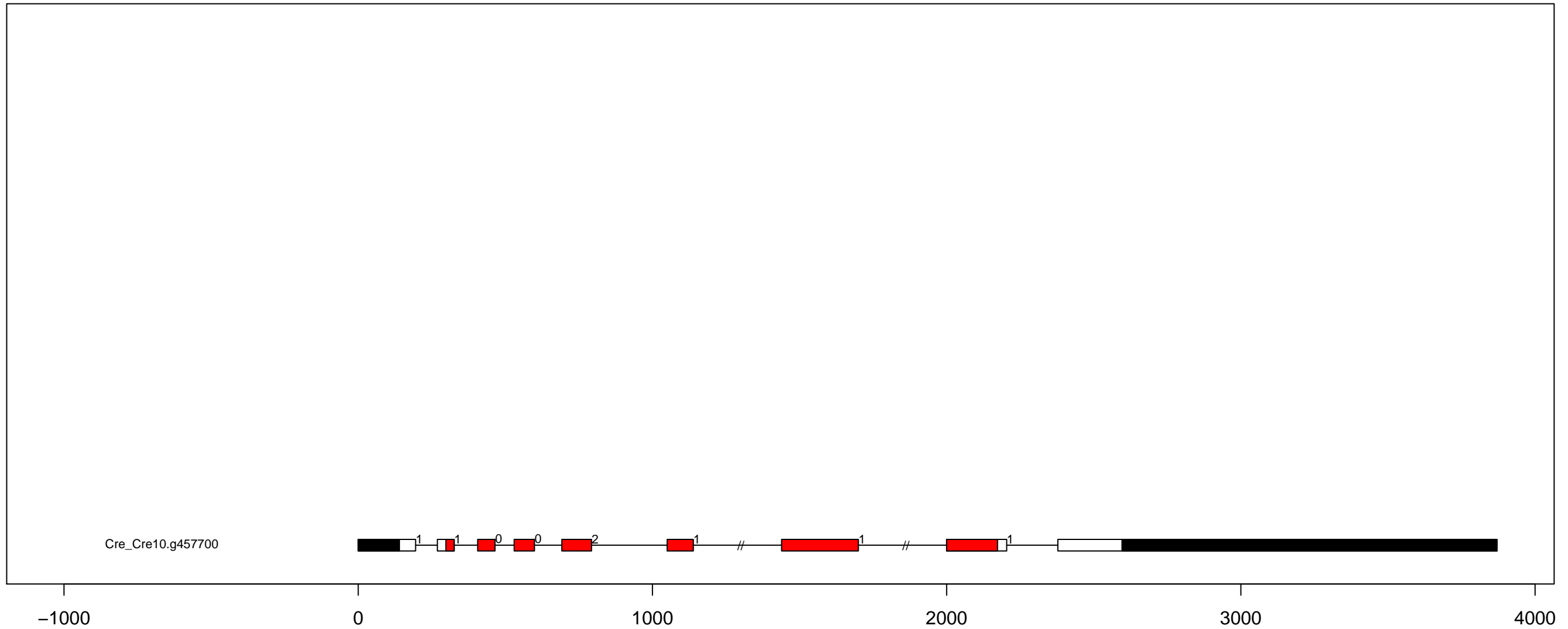

C.re CAMK_CAMK1–Scer exon–intron and kinase domain diagram (all)

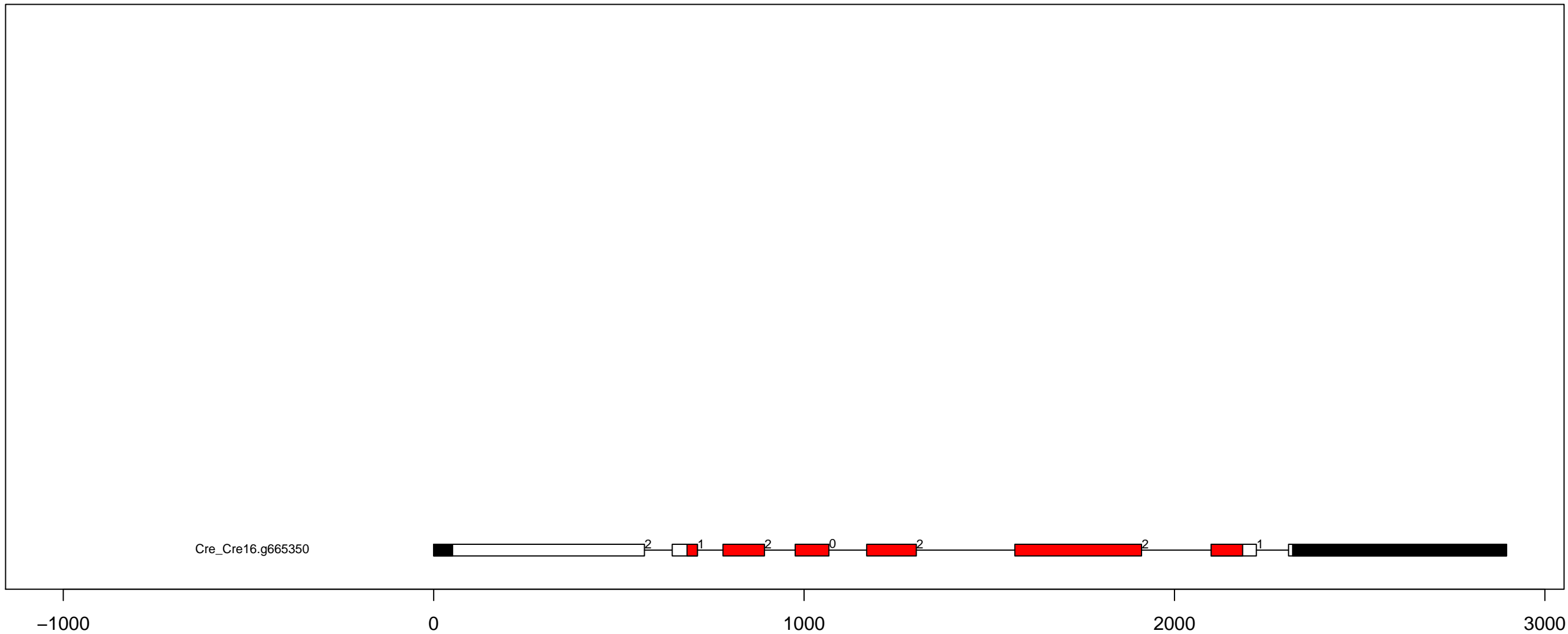

C.re CAMK_CAMK1-Tthe exon-intron and kinase domain diagram (all)

Cre_Cre13.g571700

Cre_Cre13.g564500

Cre_Cre06.g296200

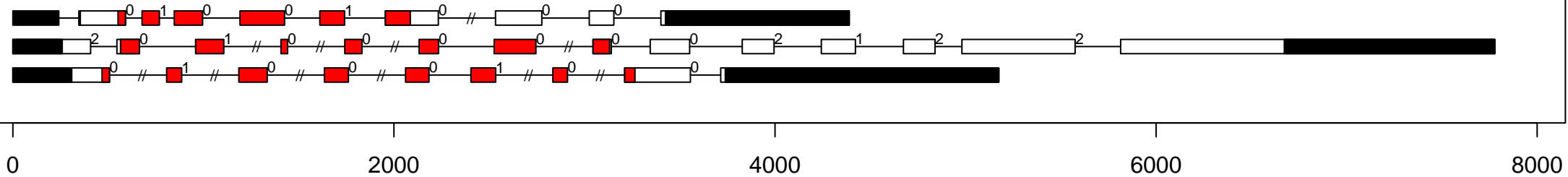

C.re CAMK_CAMKL-LKB exon-intron and kinase domain diagram (all)

Cre_Cre17.g705350
Cre_Cre12.g486350
Cre_Cre10.g428650
Cre_Cre01.g029500

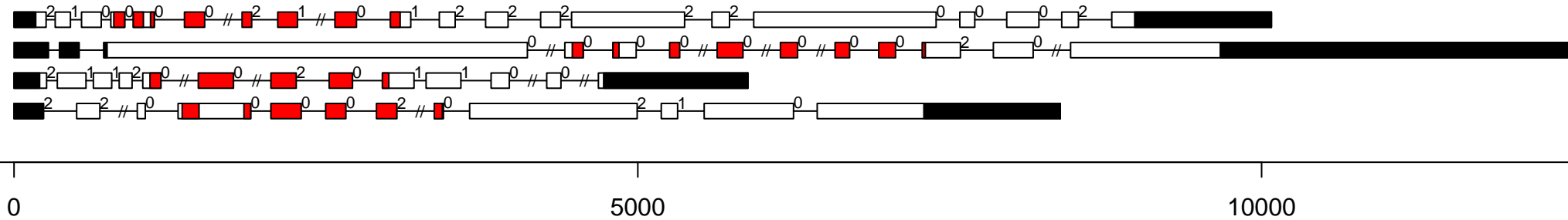

C.re CAMK_CAMKL-MARK-Scer exon-intron and kinase domain diagram (all)

Cre_Cre01.g037100

Cre_Cre01.g036700

Cre_Cre01.g036650

Cre_Cre01.g036250

Cre_Cre01.g034900

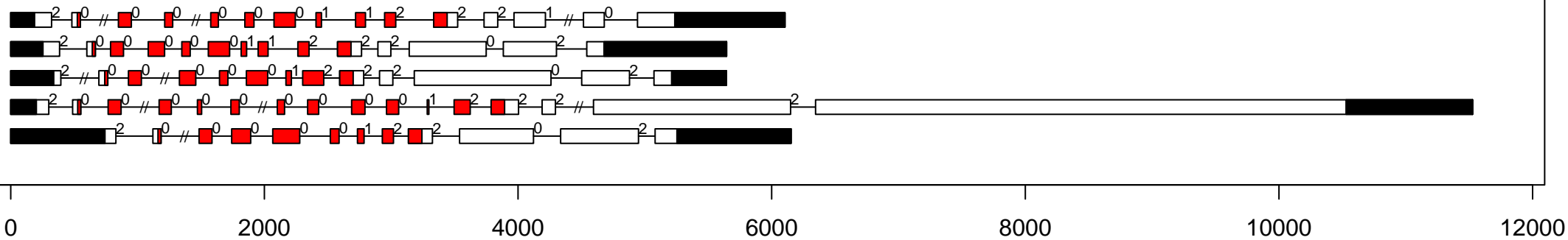

C.re CAMK_CDPK exon-intron and kinase domain diagram (all)

Cre_Cre17.g705000
 Cre_Cre12.g527000
 Cre_Cre10.g418900
 Cre_Cre08.g382800
 Cre_Cre07.g348450
 Cre_Cre07.g328900
 Cre_Cre06.g265550
 Cre_Cre03.g206650
 Cre_Cre02.g114750
 Cre_Cre02.g106650
 Cre_Cre02.g074370
 Cre_Cre01.g048650
 Cre_Cre01.g031300
 Cre_Cre01.g009500

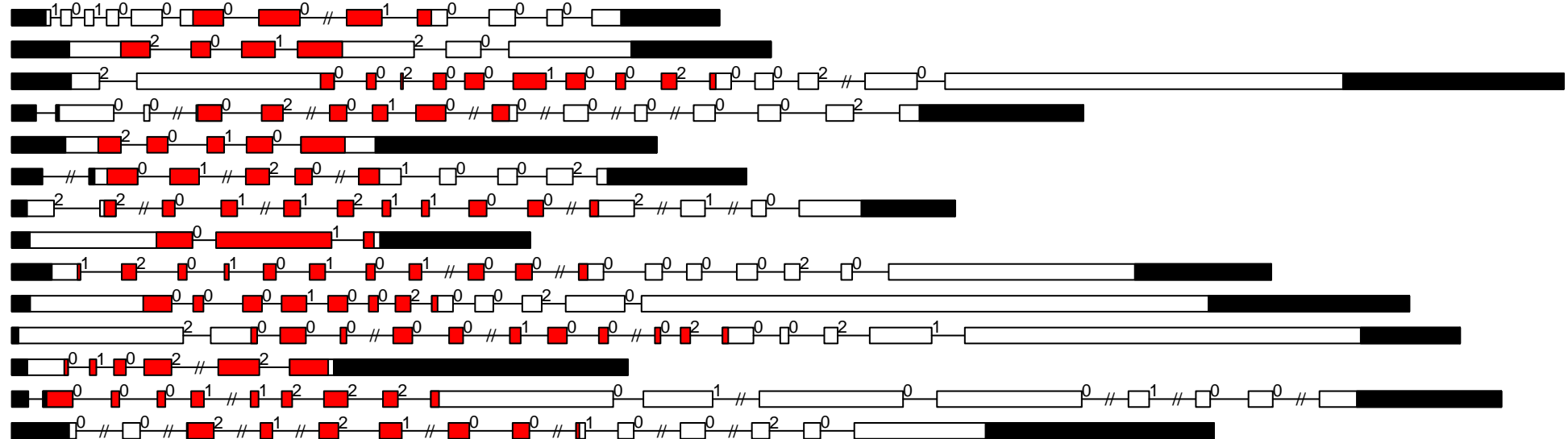

-2000

0

2000

4000

6000

8000

10000

C.re CAMK_Cr-1 exon-intron and kinase domain diagram (all)

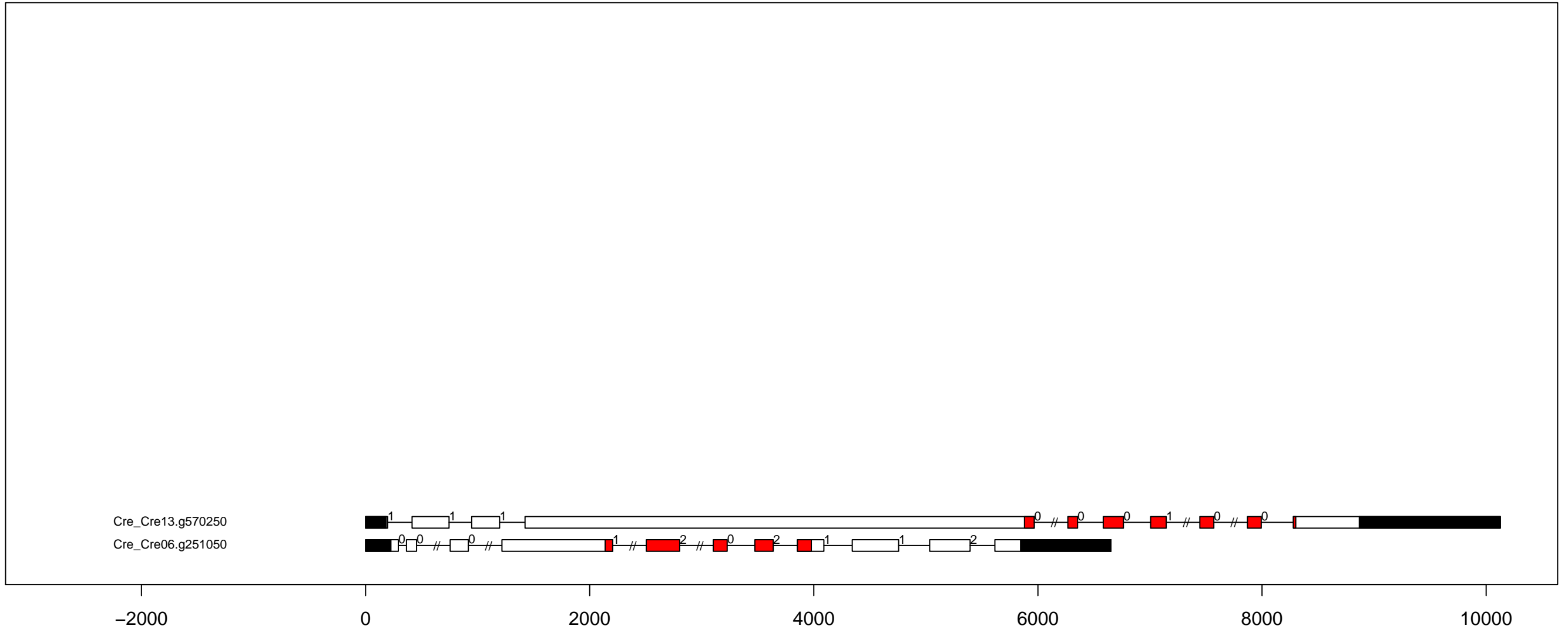

C.re CAMK_Cr-single exon-intron and kinase domain diagram (all)

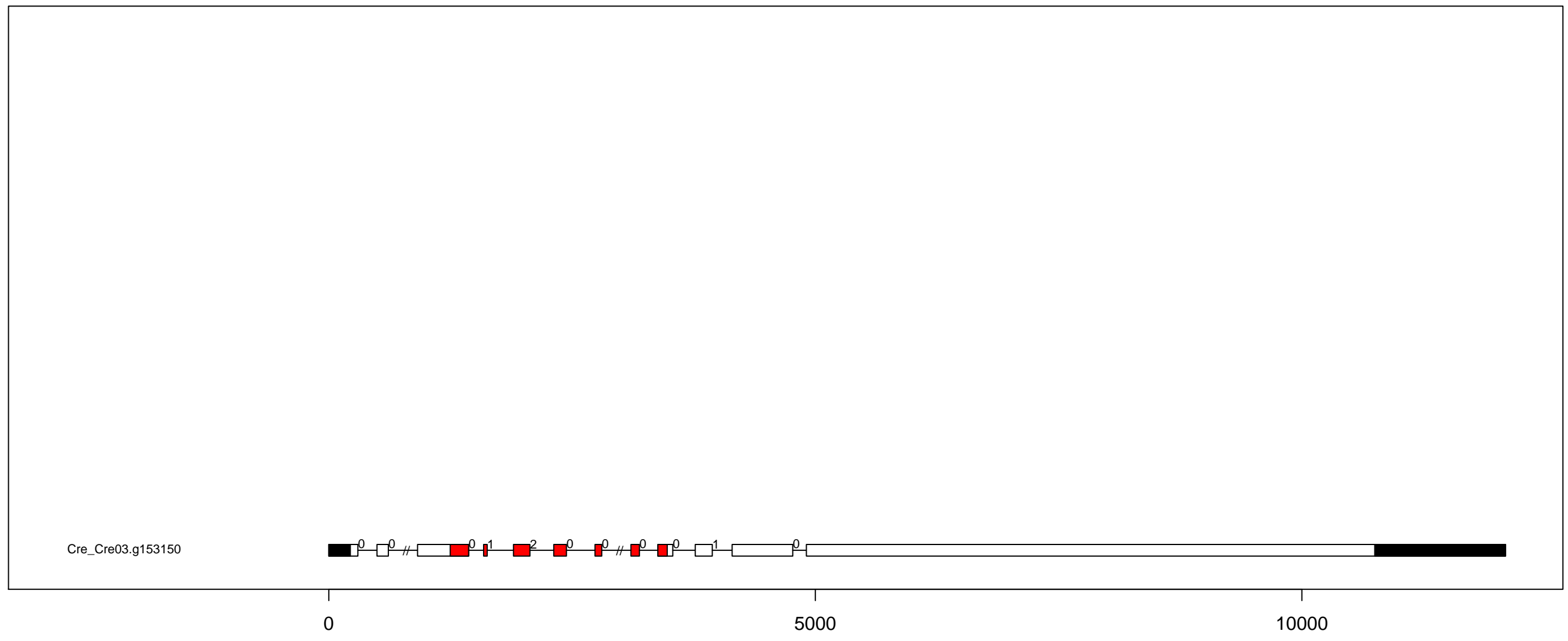

C.re CK1_CK1 exon-intron and kinase domain diagram (all)

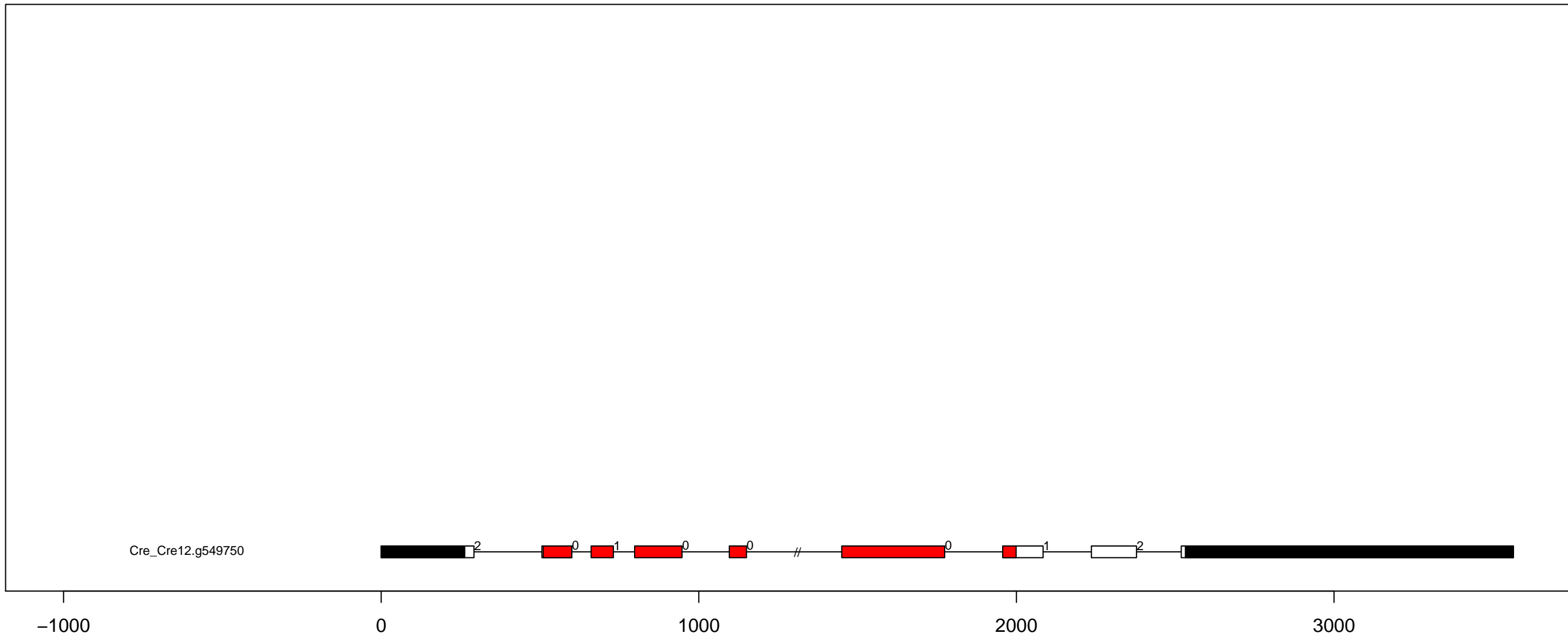

C.re CK1-CK1-PI exon-intron and kinase domain diagram (all)

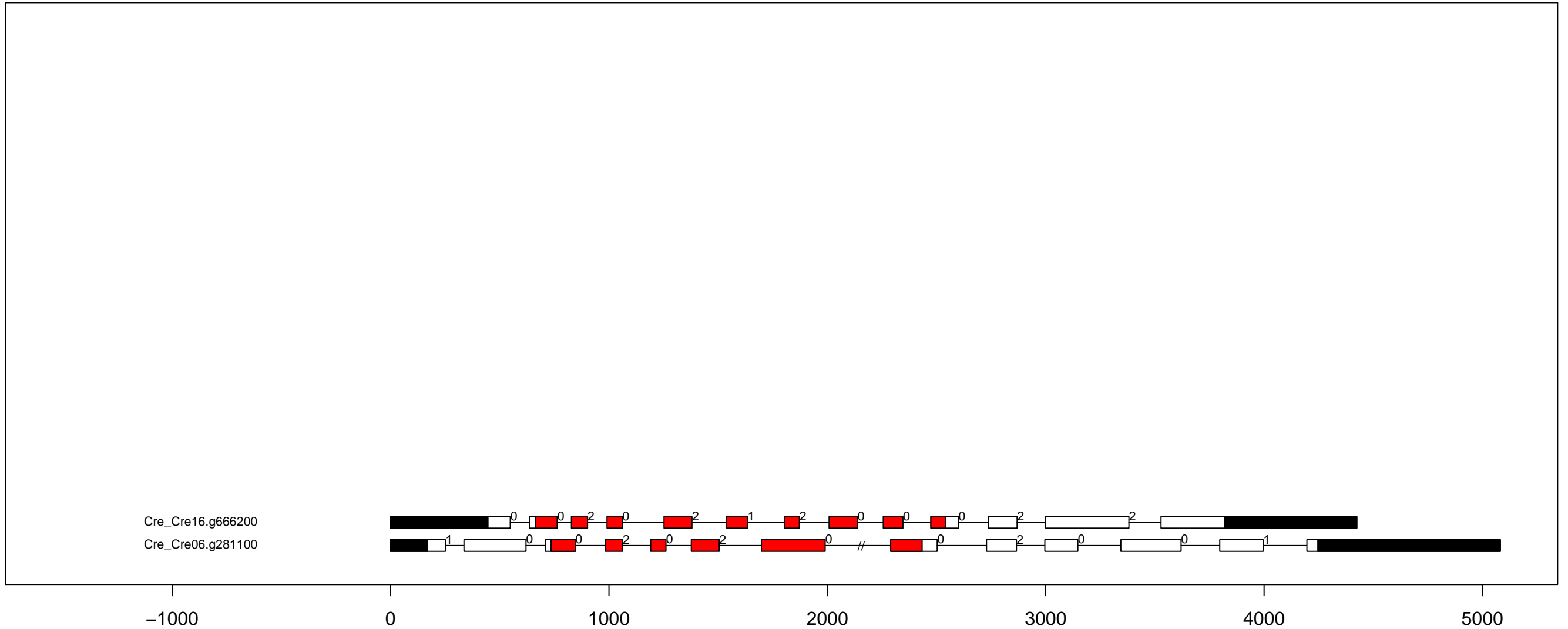

C.re CMGC_CDK-CCRK exon-intron and kinase domain diagram (all)

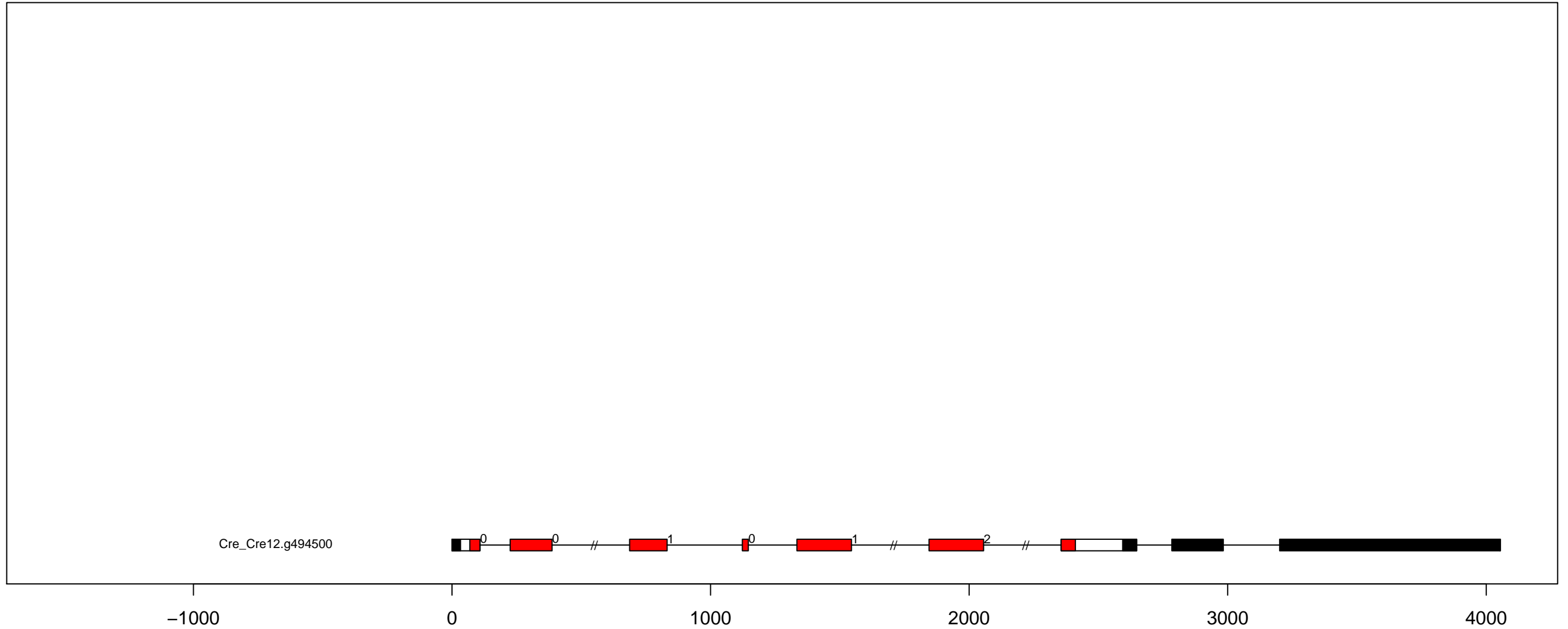

C.re CMGC_CDK-CDK7 exon-intron and kinase domain diagram (all)

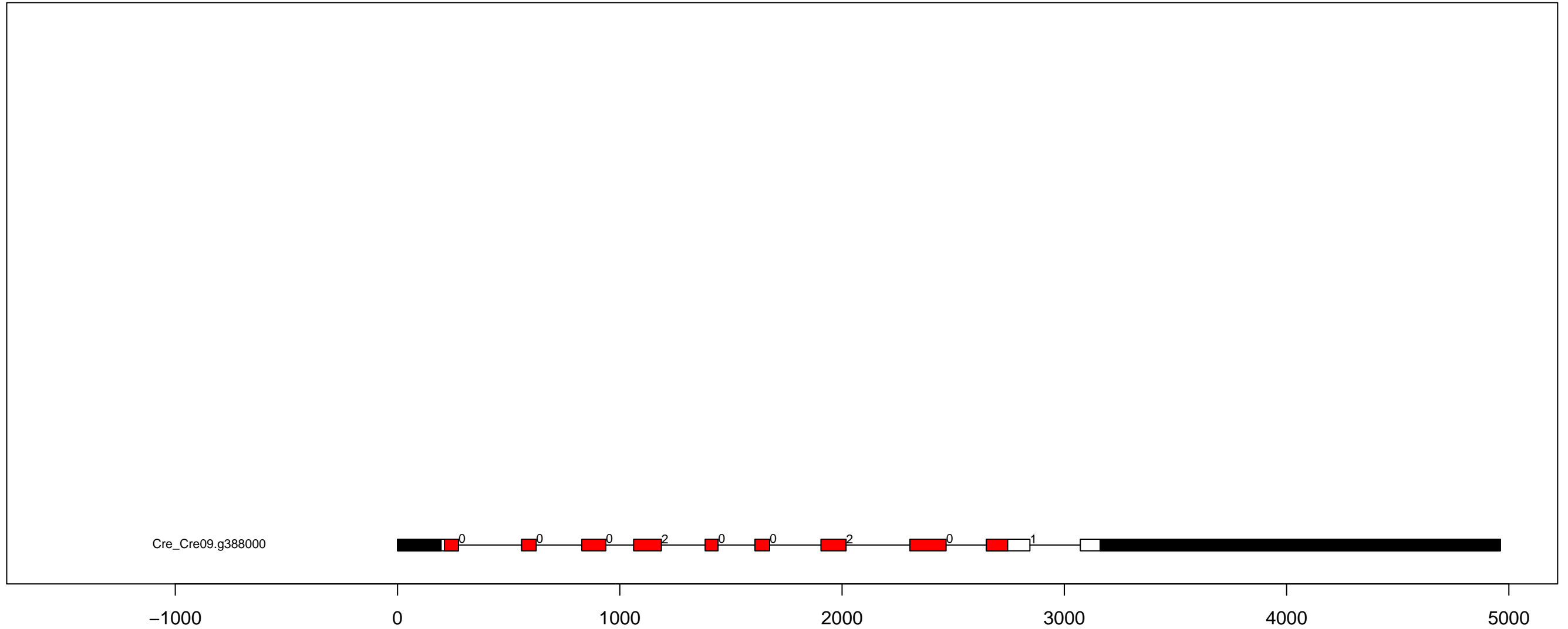

C.re CMGC_CDK-CRK7-CDK9 exon-intron and kinase domain diagram (all)

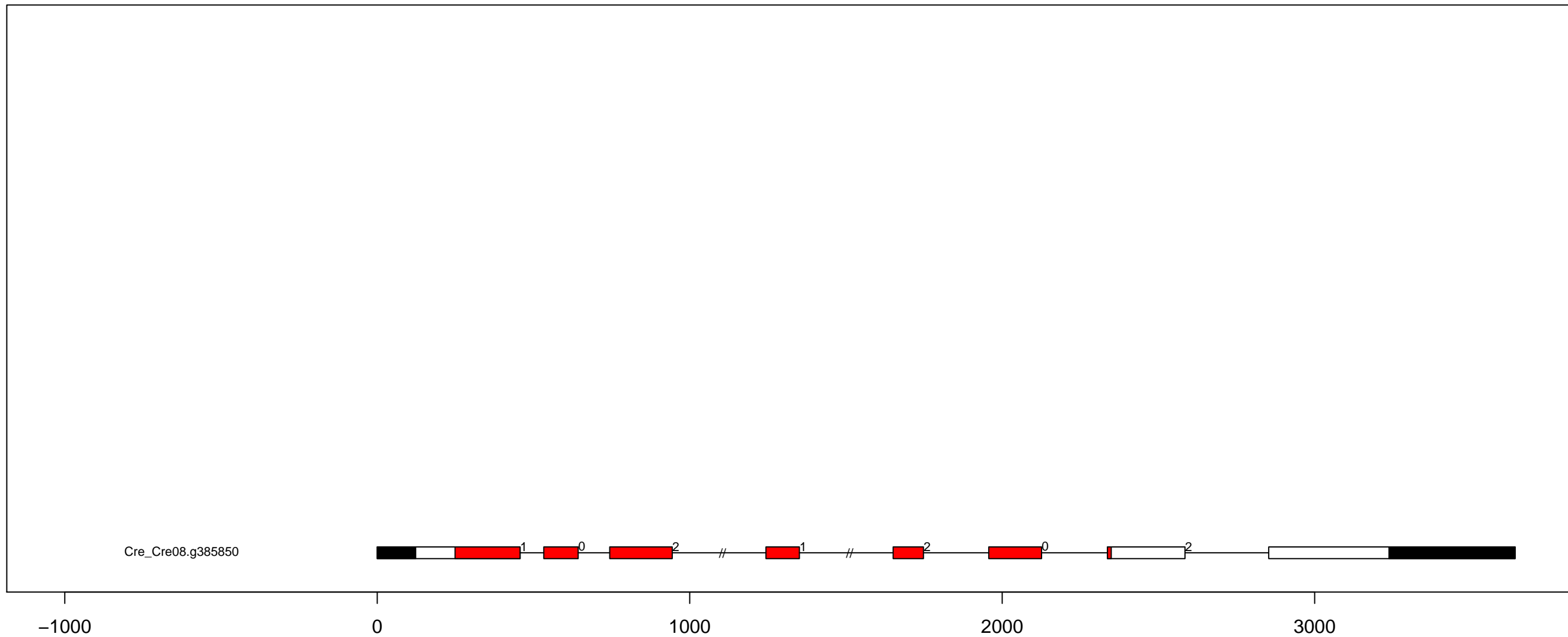

C.re CMGC_CDK-Cr exon-intron and kinase domain diagram (all)

Cre_Cre17.g742250
Cre_Cre06.g271100
Cre_Cre02.g107000

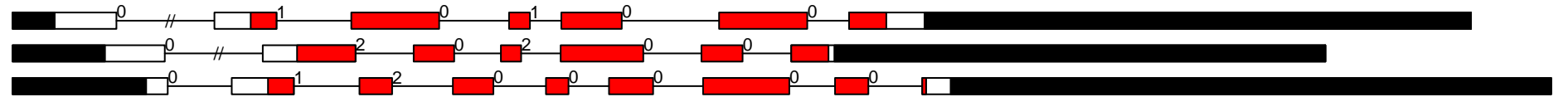

-1000

0

1000

2000

3000

4000

C.re CMGC_CDKL-Cr exon-intron and kinase domain diagram (part 1)

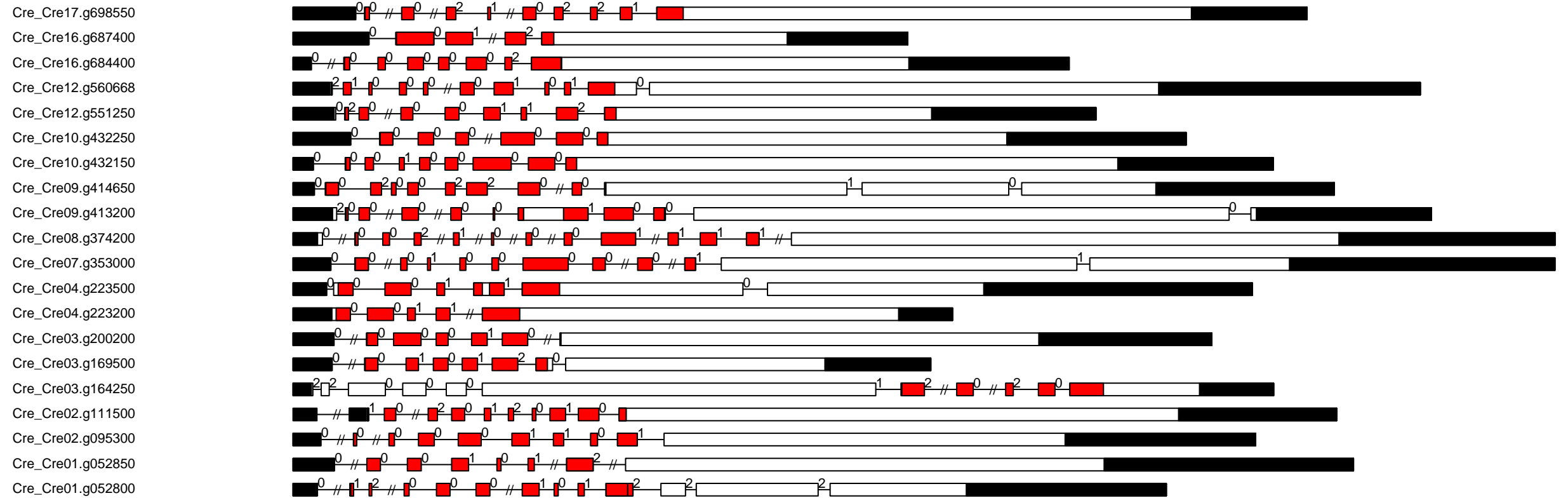

C.re CMGC_CDK-PITSLRE exon-intron and kinase domain diagram (all)

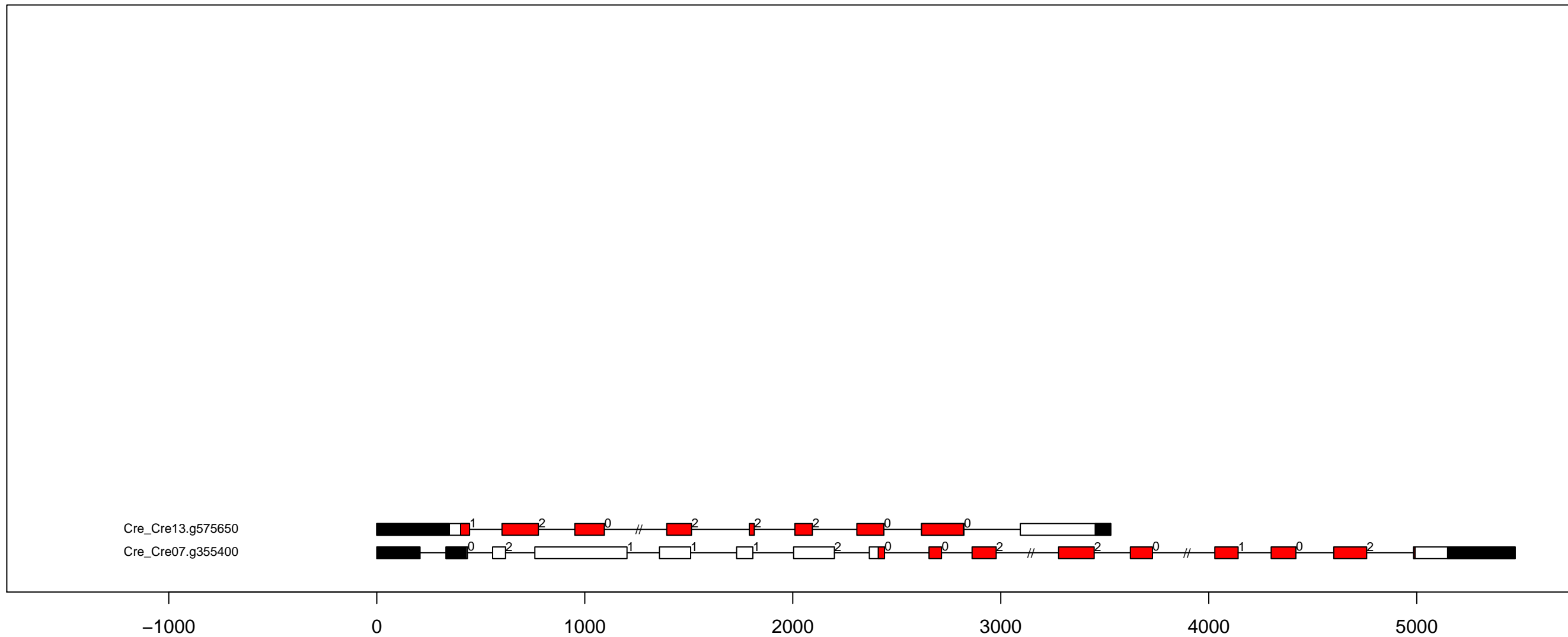

C.re CMGC_CDK-PI exon-intron and kinase domain diagram (all)

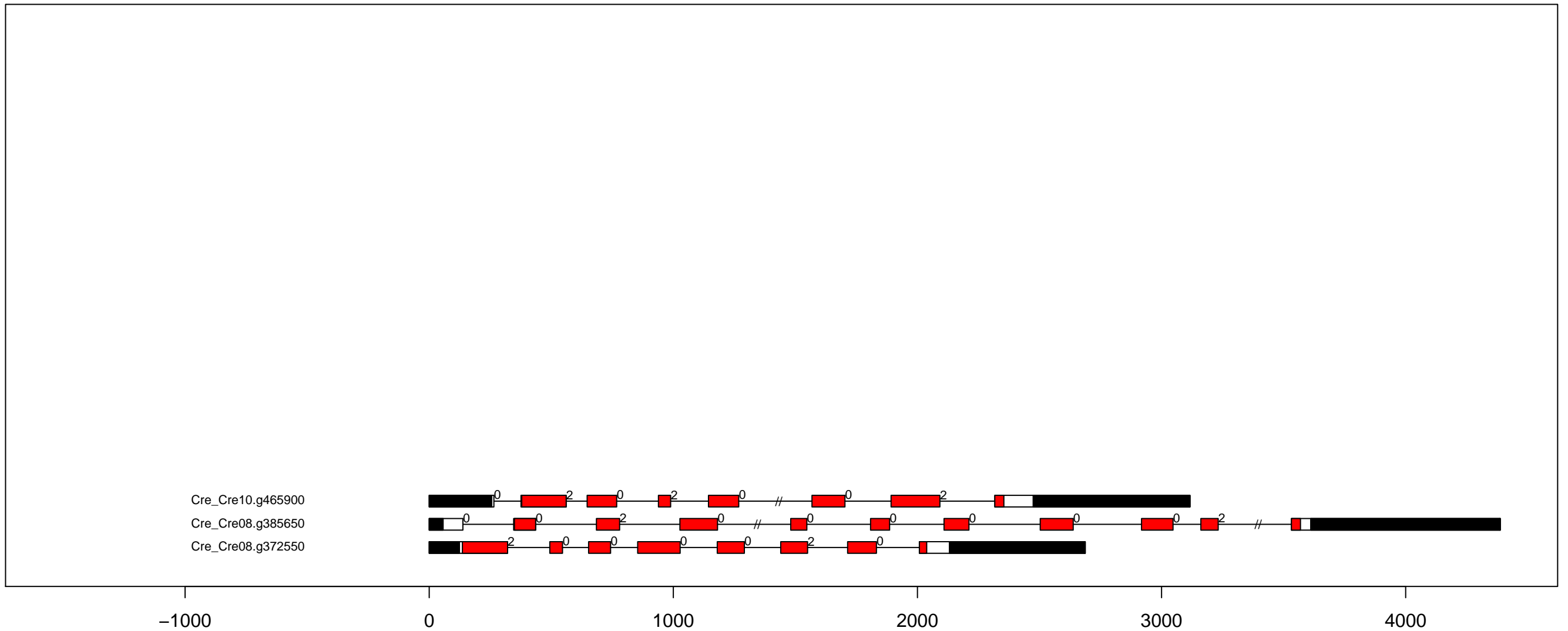

C.re CMGC_CK2 exon-intron and kinase domain diagram (all)

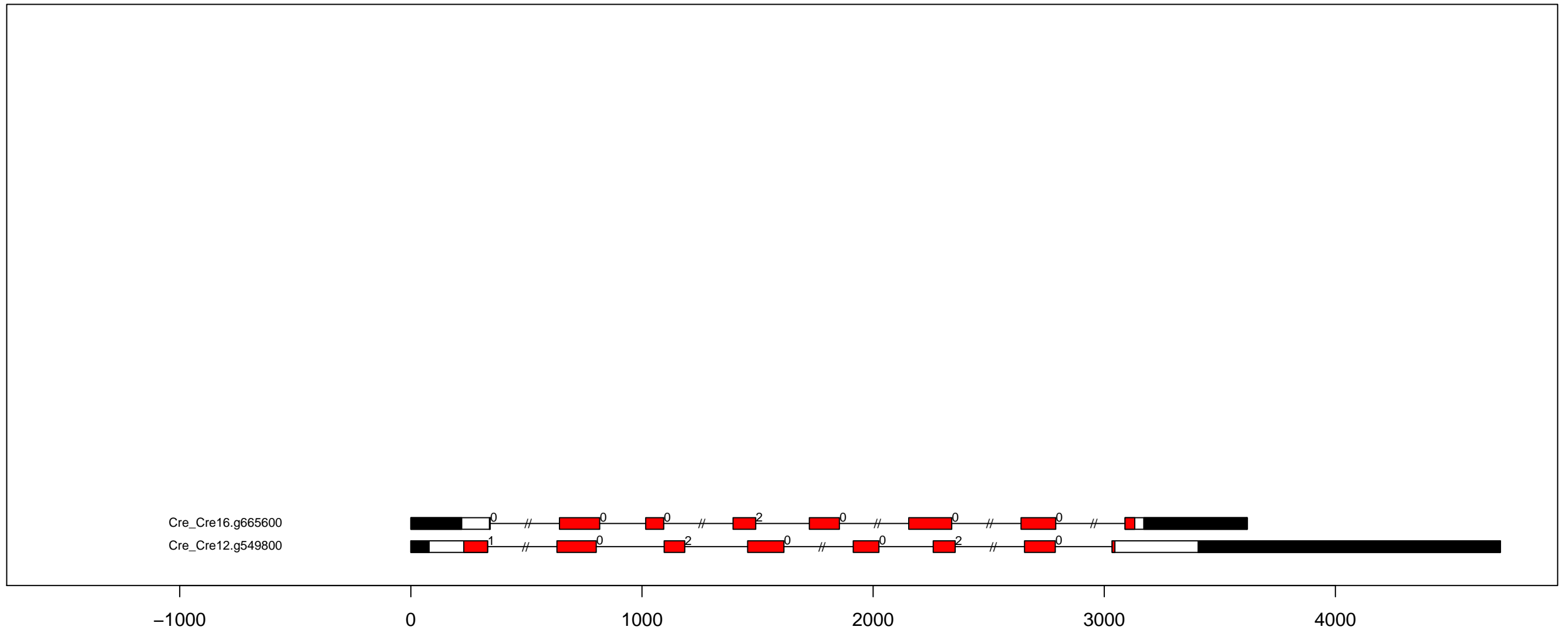

C.re CMGC_CLK exon-intron and kinase domain diagram (all)

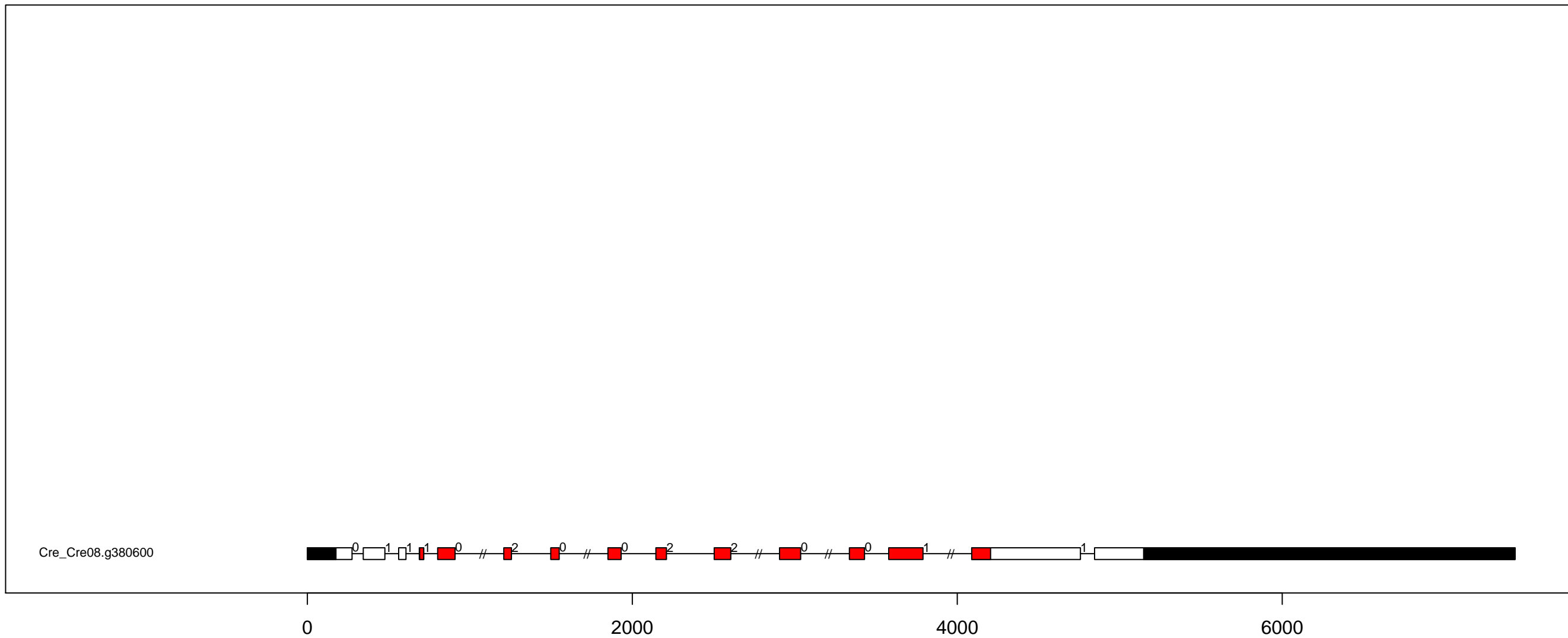

C.re CMGC_DYRK-DRYK2 exon-intron and kinase domain diagram (all)

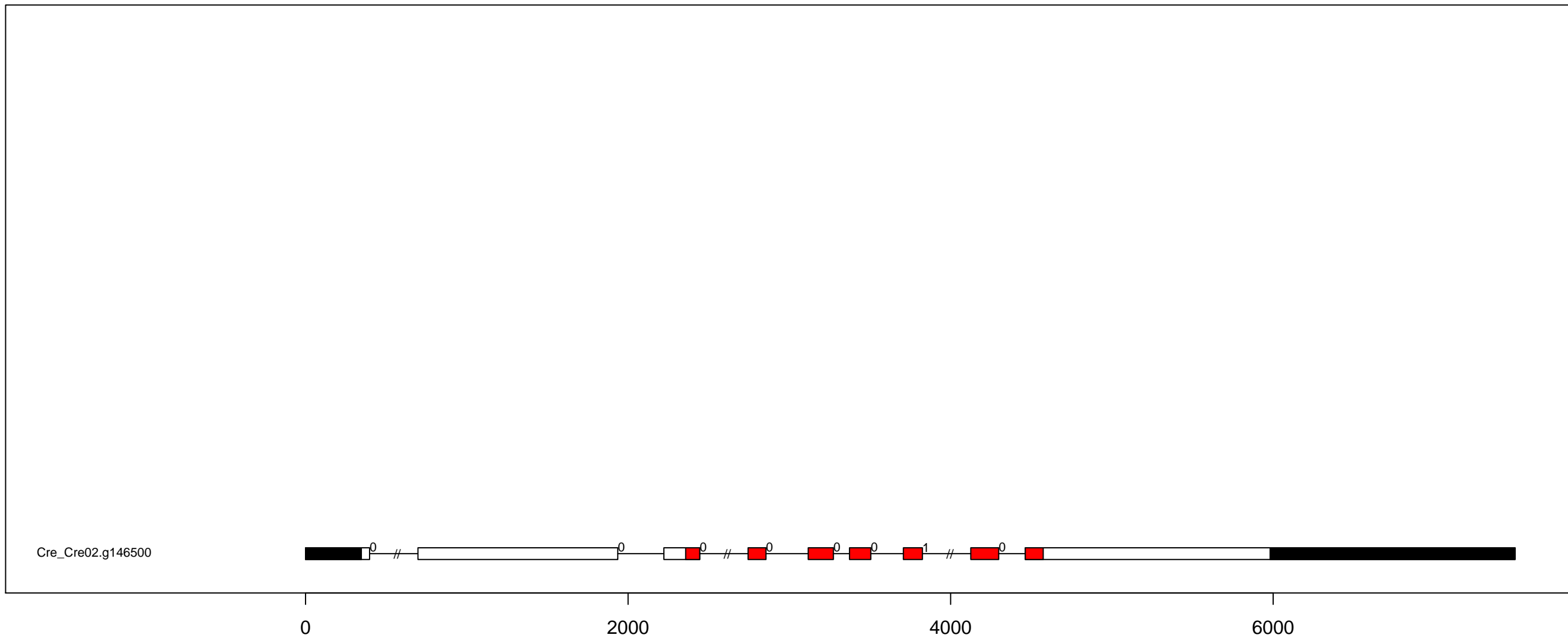

C.re CMGC_DYRK-PRP4 exon-intron and kinase domain diagram (all)

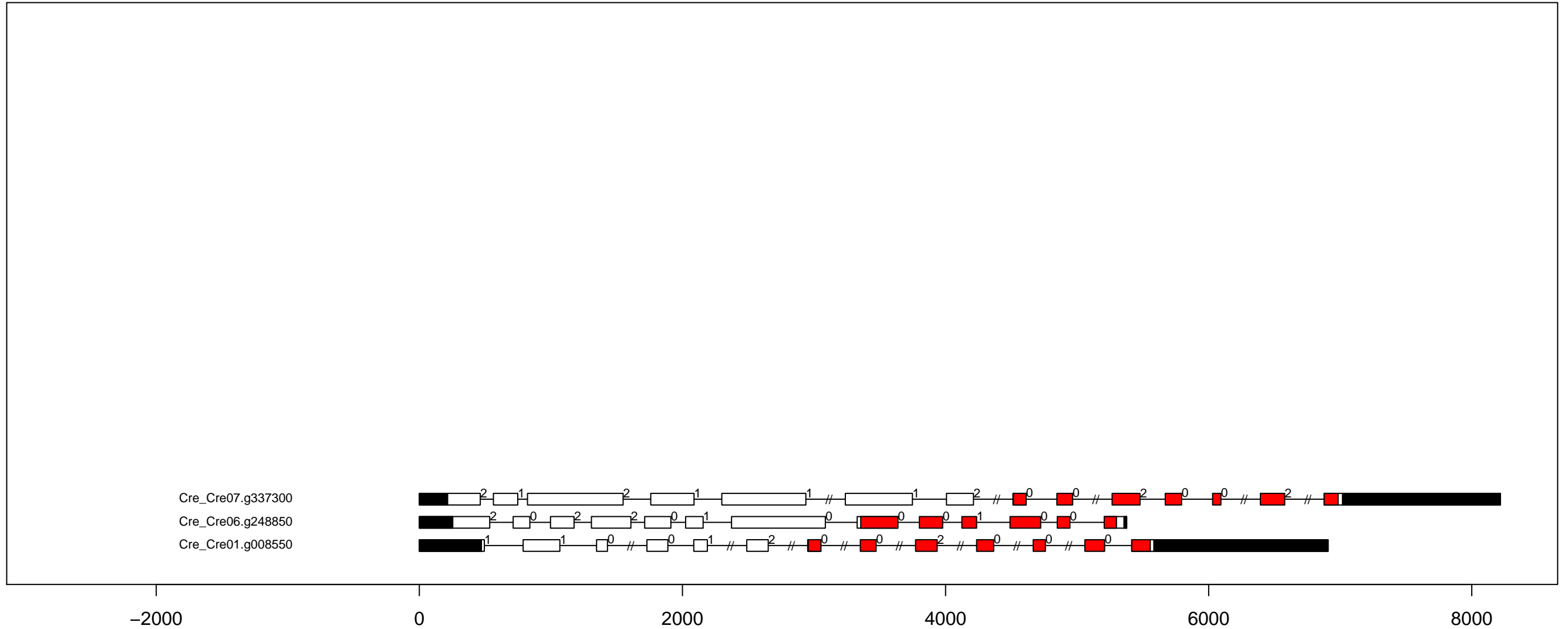

C.re CMGC_GSK exon-intron and kinase domain diagram (all)

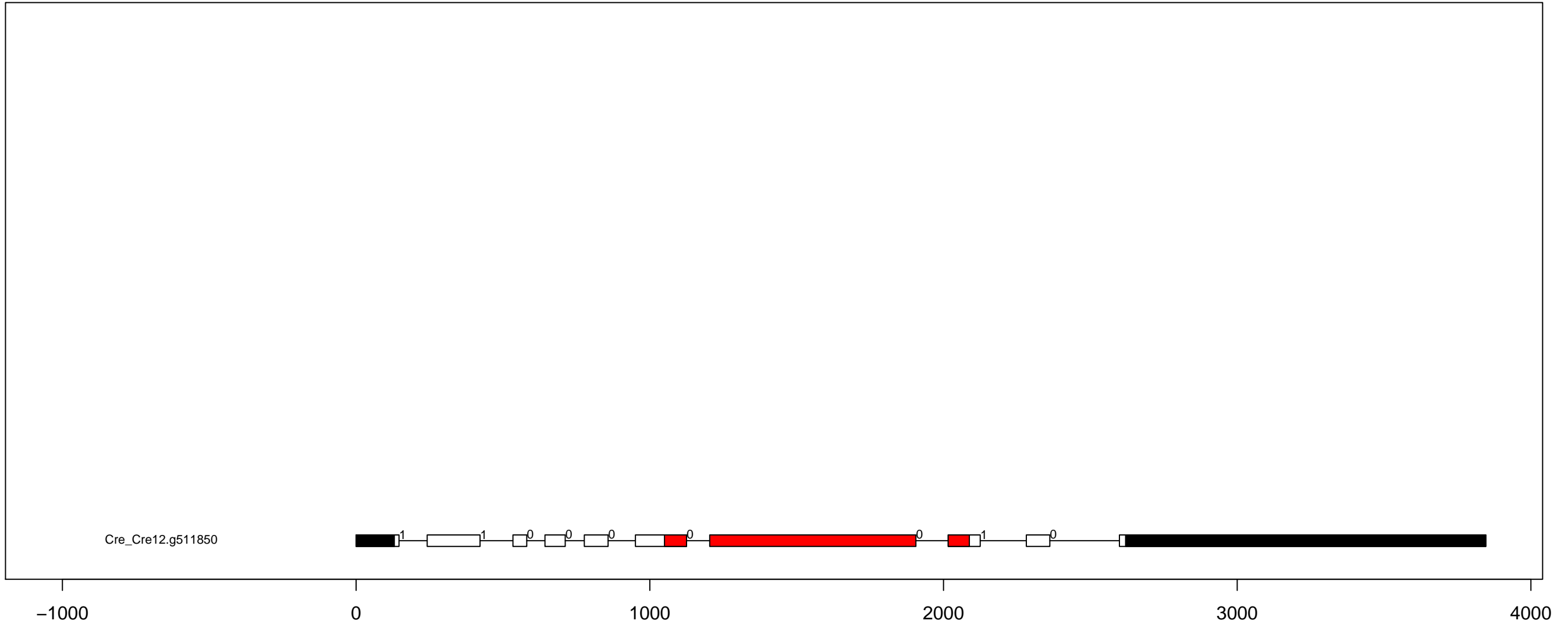

C.re CMGC_MAPK exon-intron and kinase domain diagram (all)

Cre_Cre13.g607300

Cre_Cre12.g530000

Cre_Cre12.g509000

Cre_Cre12.g508900

Cre_Cre08.g385050

Cre_Cre01.g010000

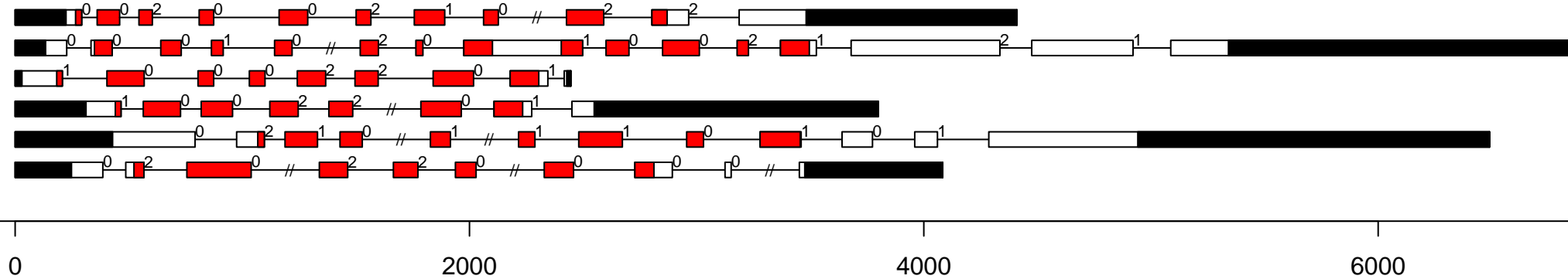

C.re CMGC_RCK exon-intron and kinase domain diagram (all)

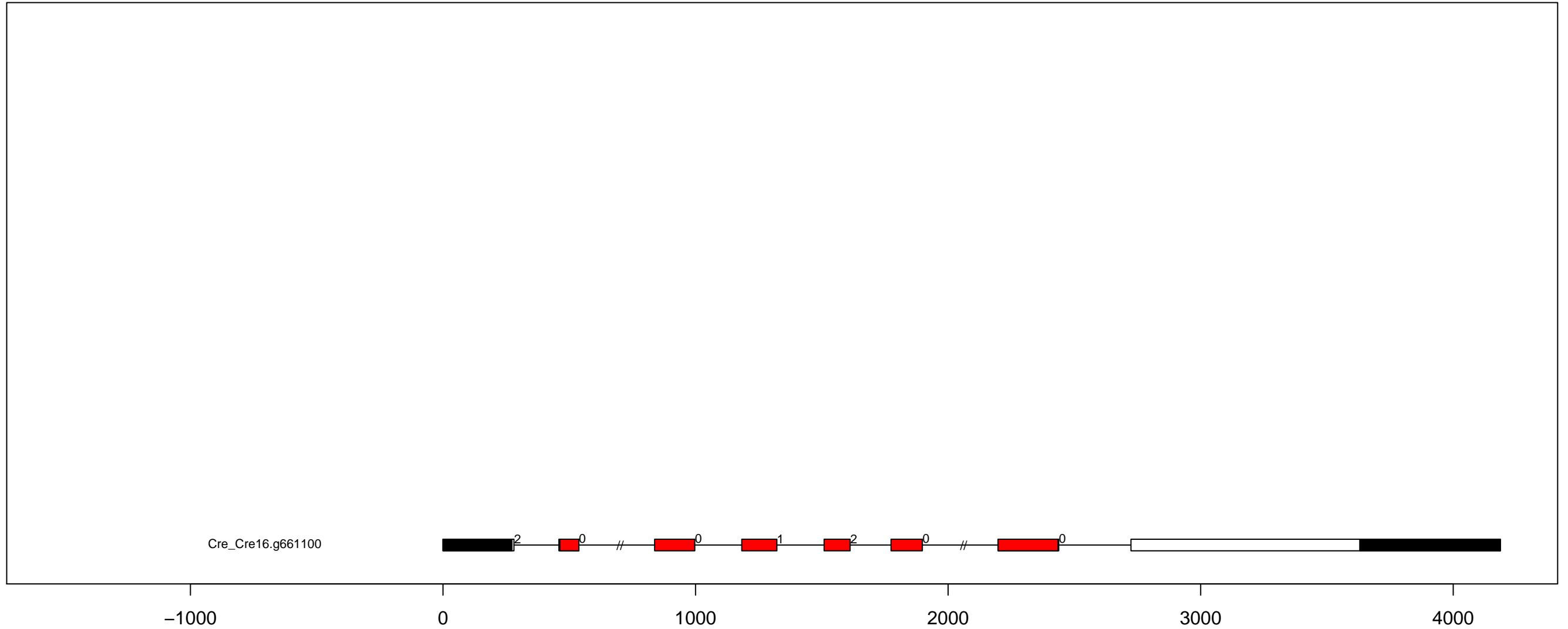

C.re Group-Cr-2 exon-intron and kinase domain diagram (all)

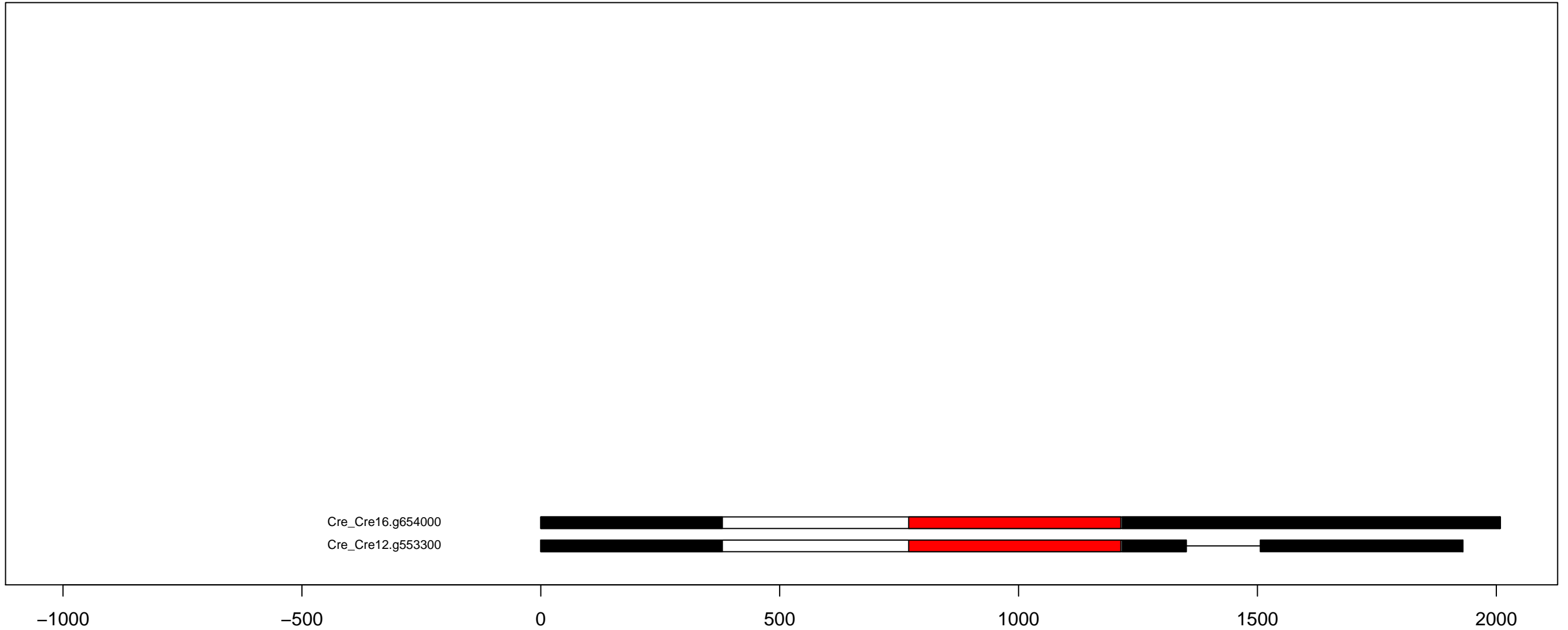

C.re Group-PI-1 exon-intron and kinase domain diagram (all)

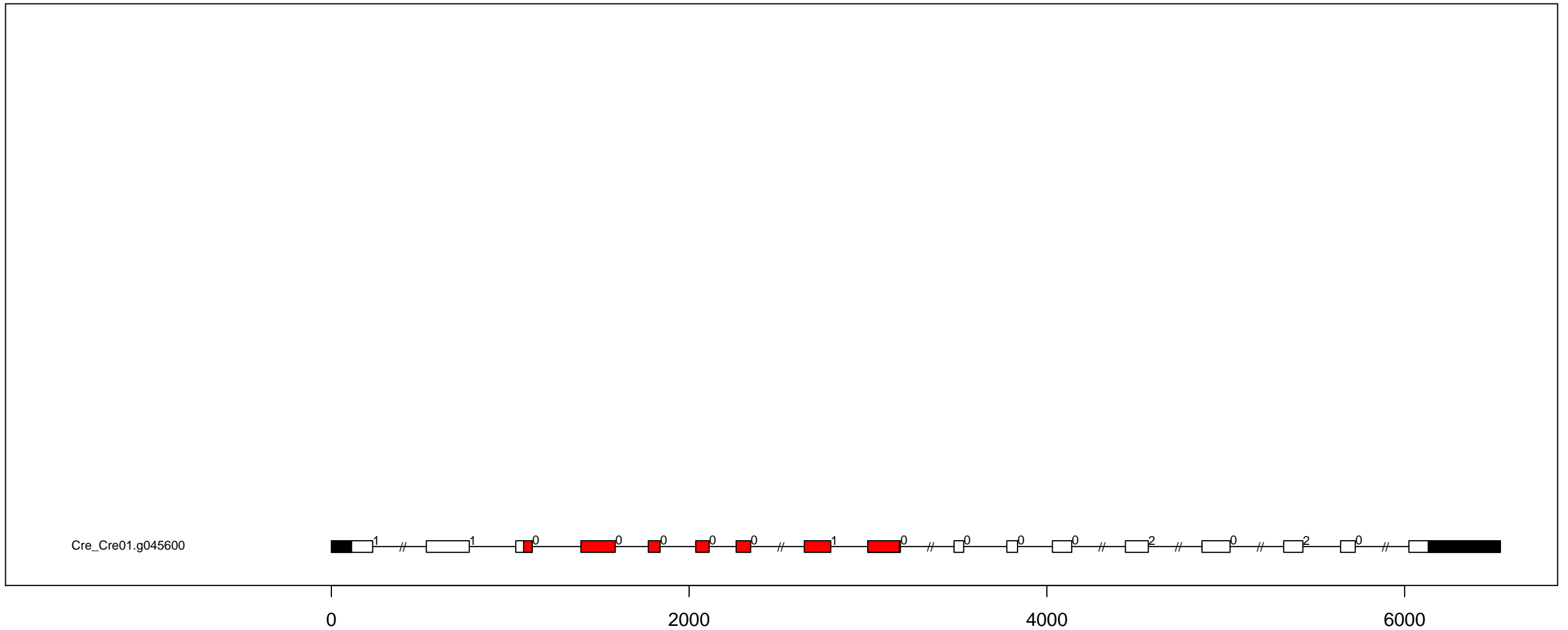

C.re Group-PI-4 exon-intron and kinase domain diagram (all)

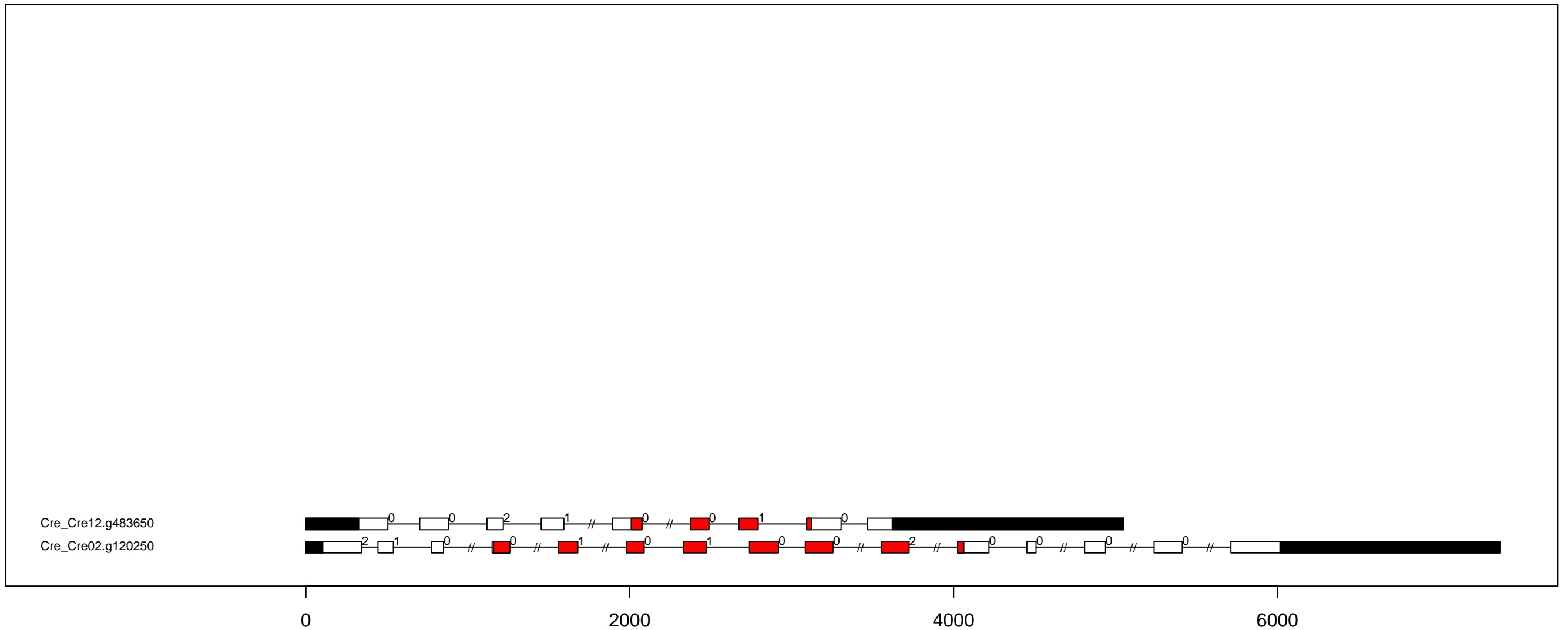

C.re NAK exon-intron and kinase domain diagram (all)

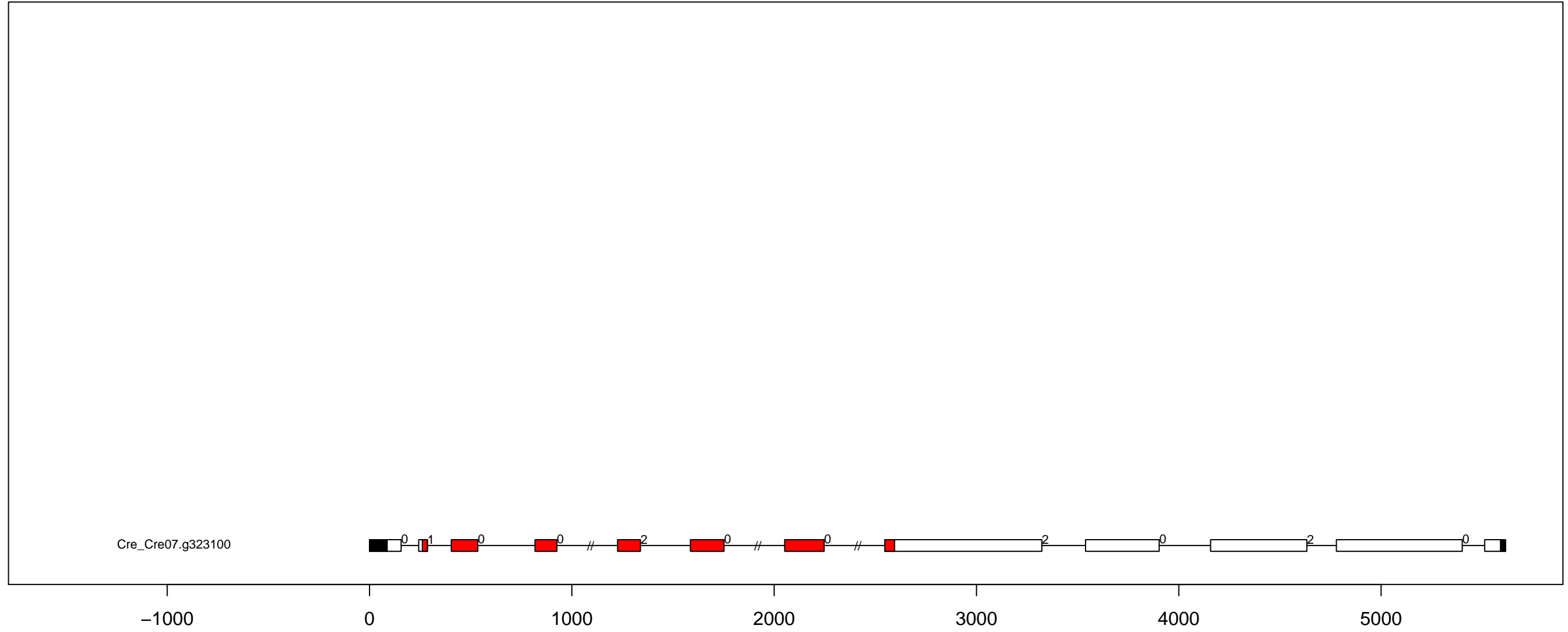

C.re PEK_GCN2 exon-intron and kinase domain diagram (all)

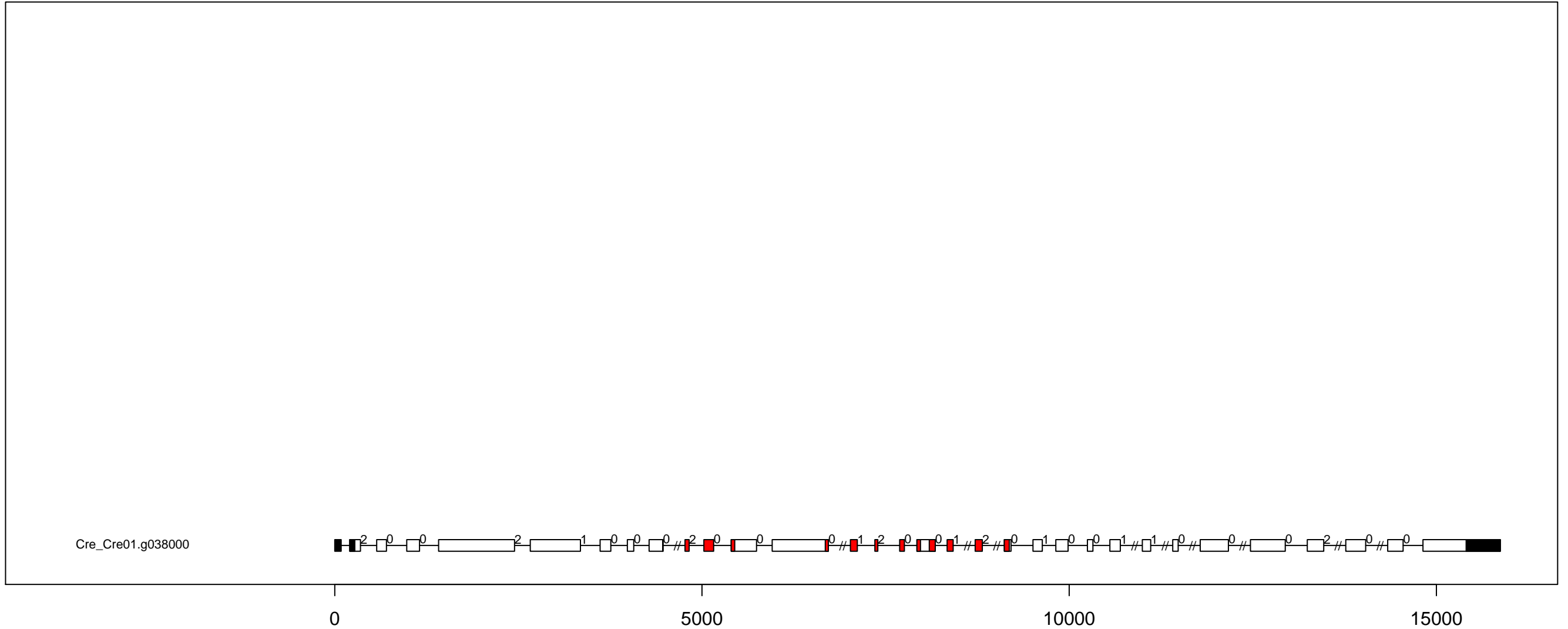

C.re RLK-Pelle_RLCK-IXb exon-intron and kinase domain diagram (all)

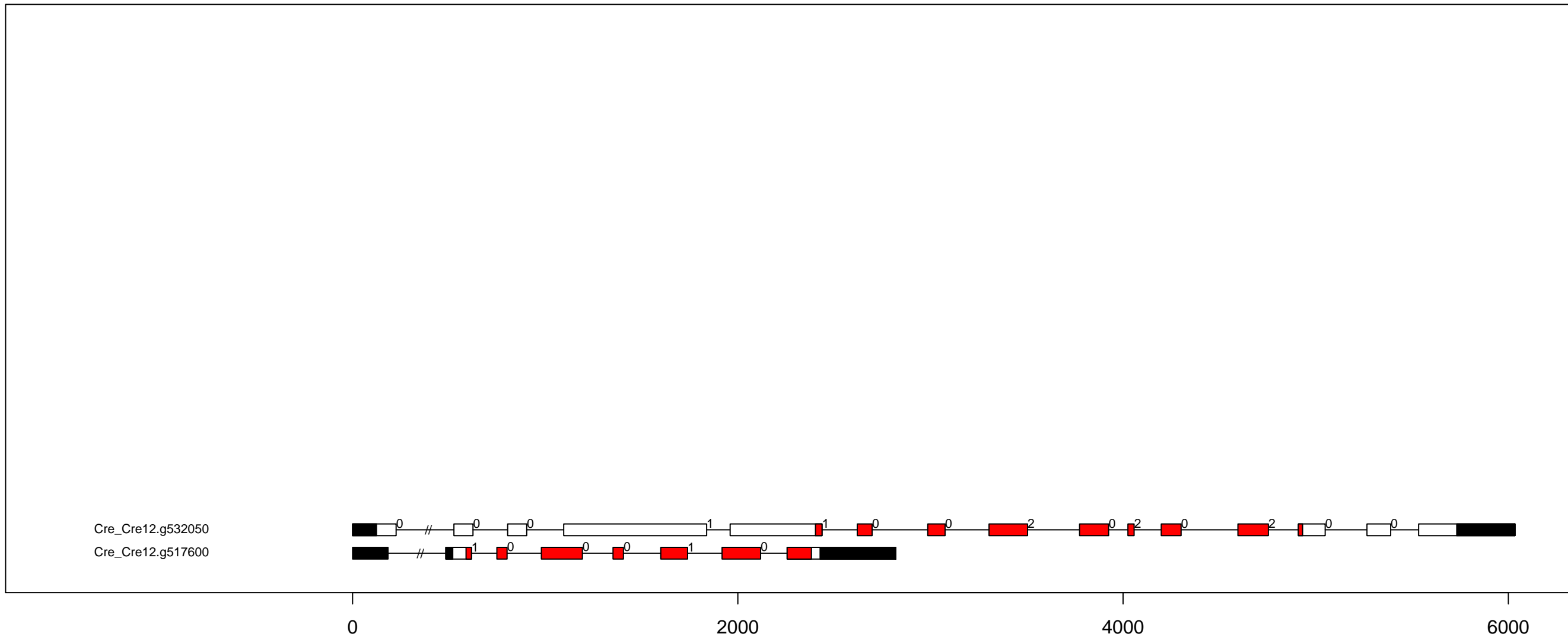

C.re SCY1_SCYL1 exon-intron and kinase domain diagram (all)

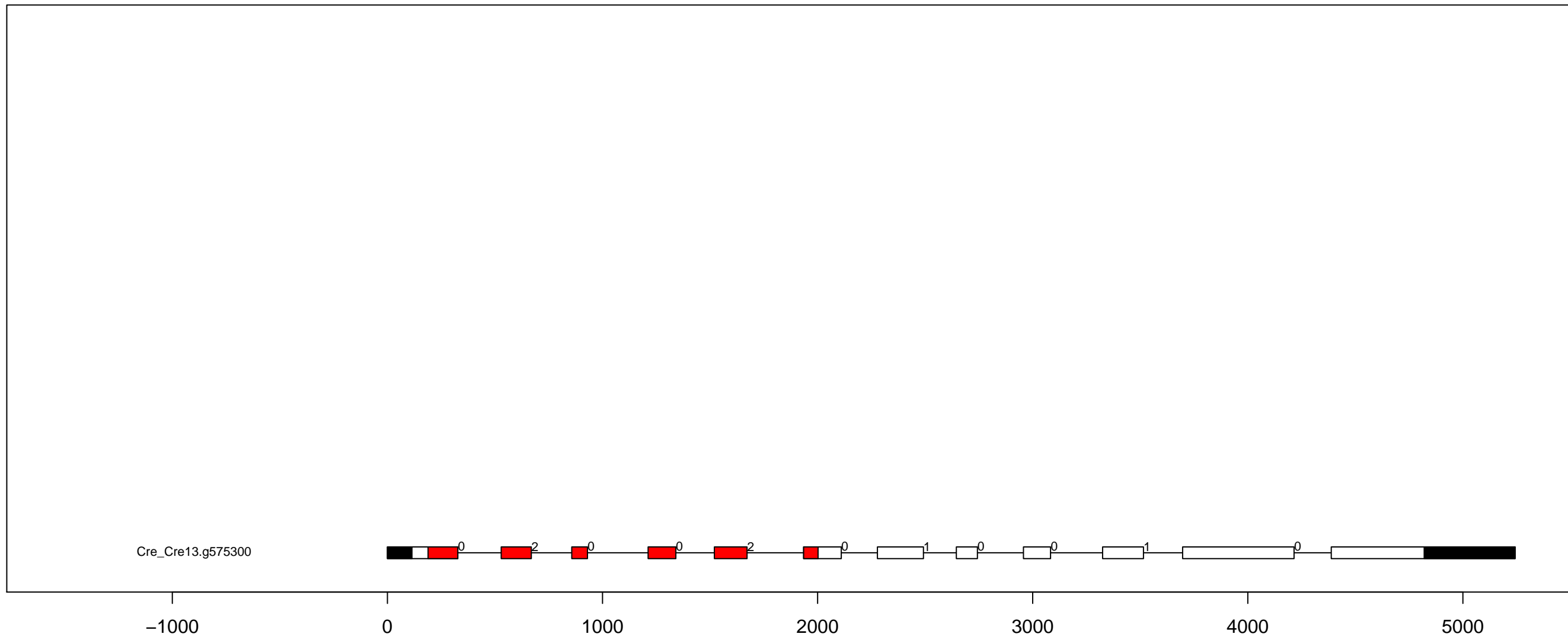

C.re STE_STE11 exon-intron and kinase domain diagram (all)

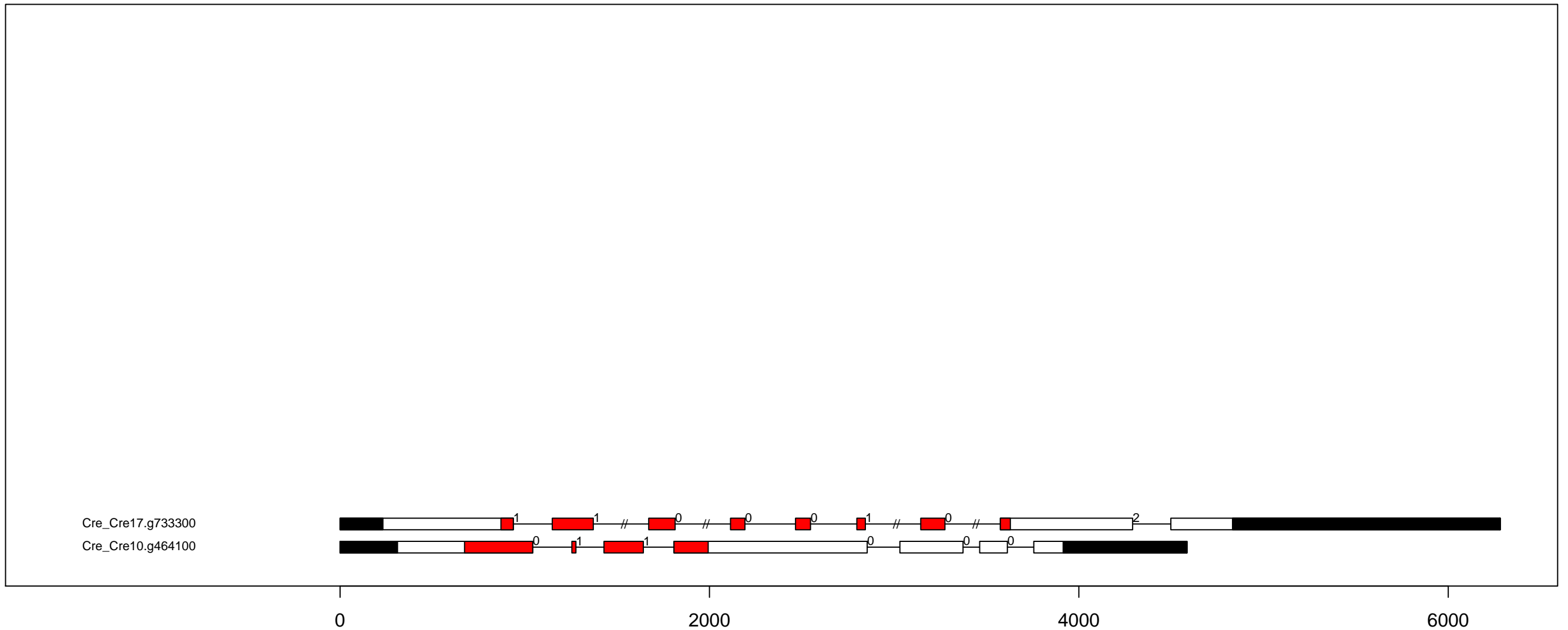

C.re STE_STE20-Fray exon-intron and kinase domain diagram (all)

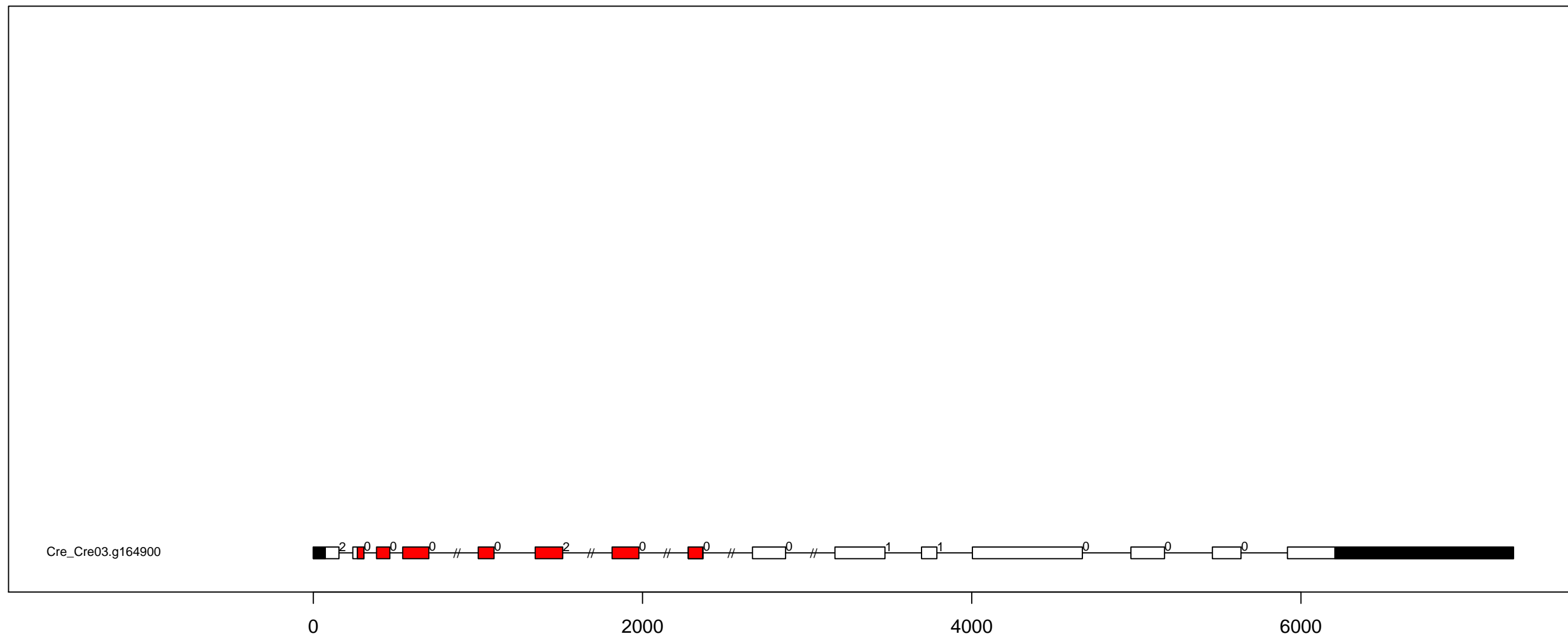

C.re STE_STE20-PI exon-intron and kinase domain diagram (all)

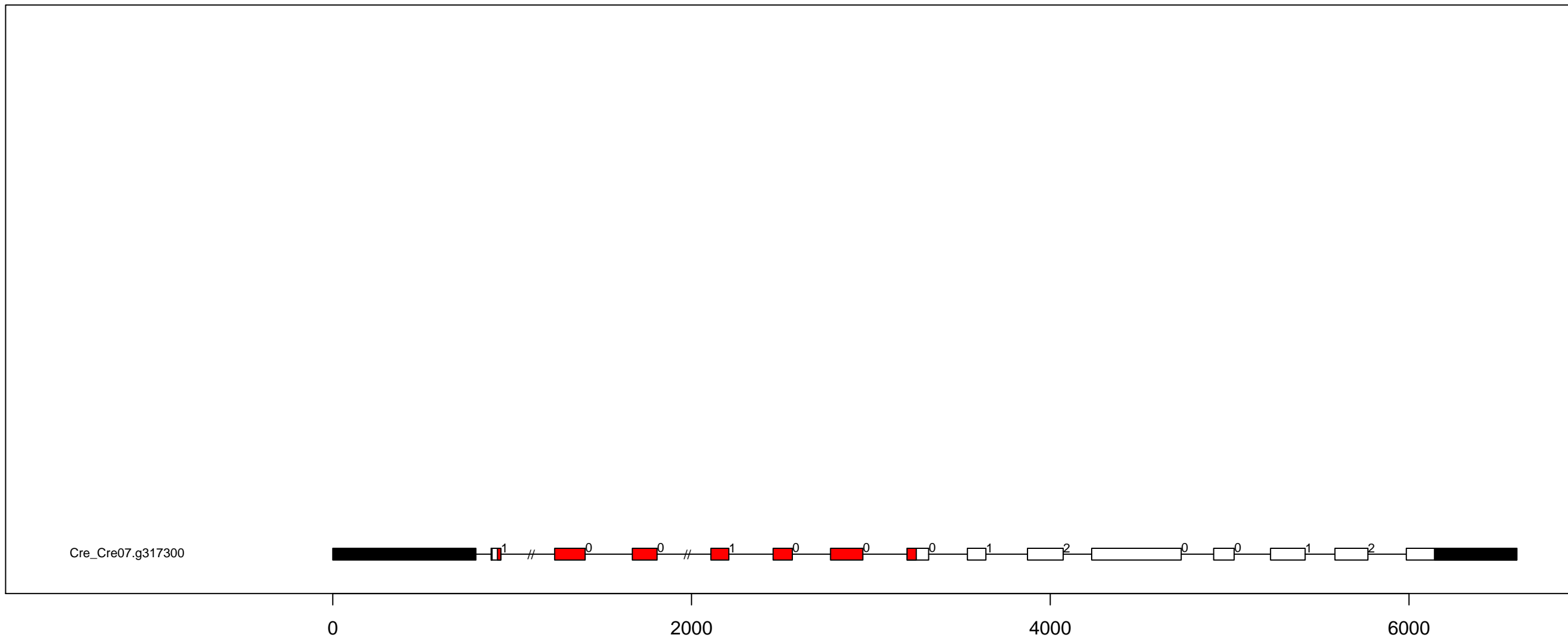

C.re STE_STE20-YSK exon-intron and kinase domain diagram (all)

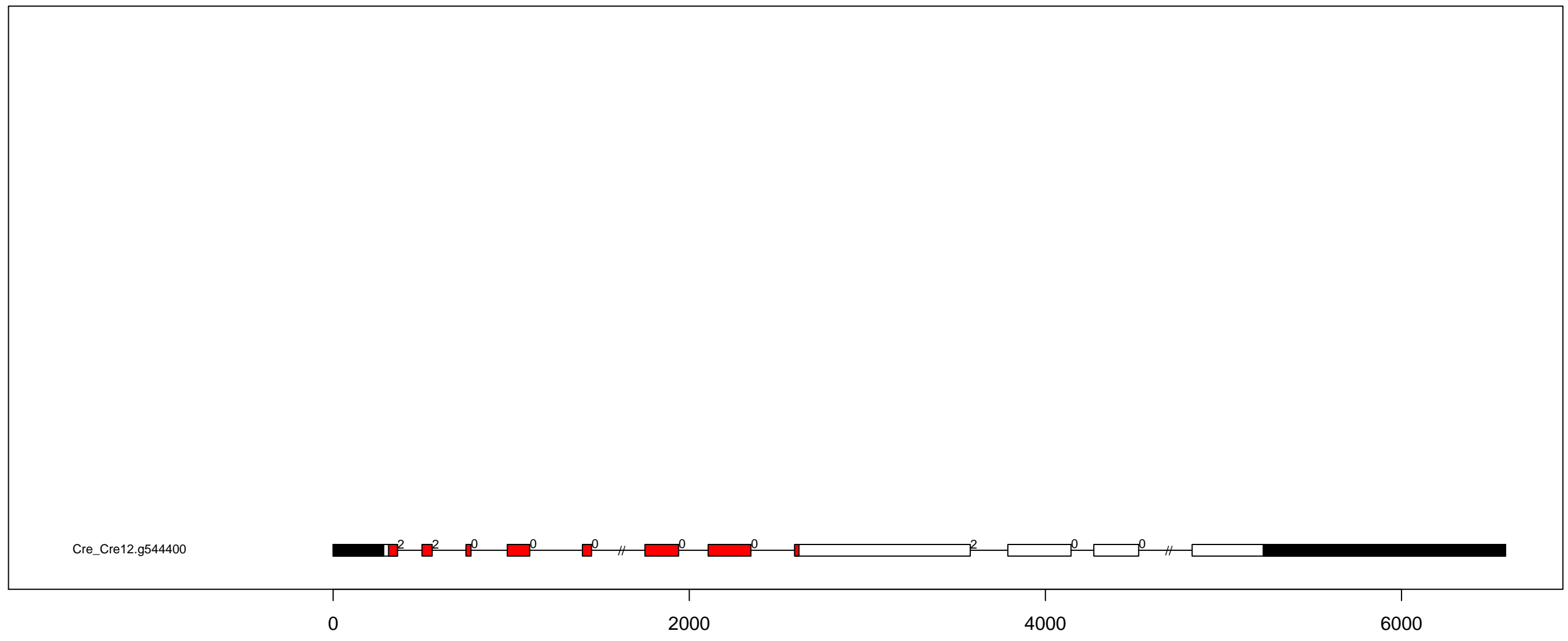

C.re STE_STE7 exon-intron and kinase domain diagram (all)

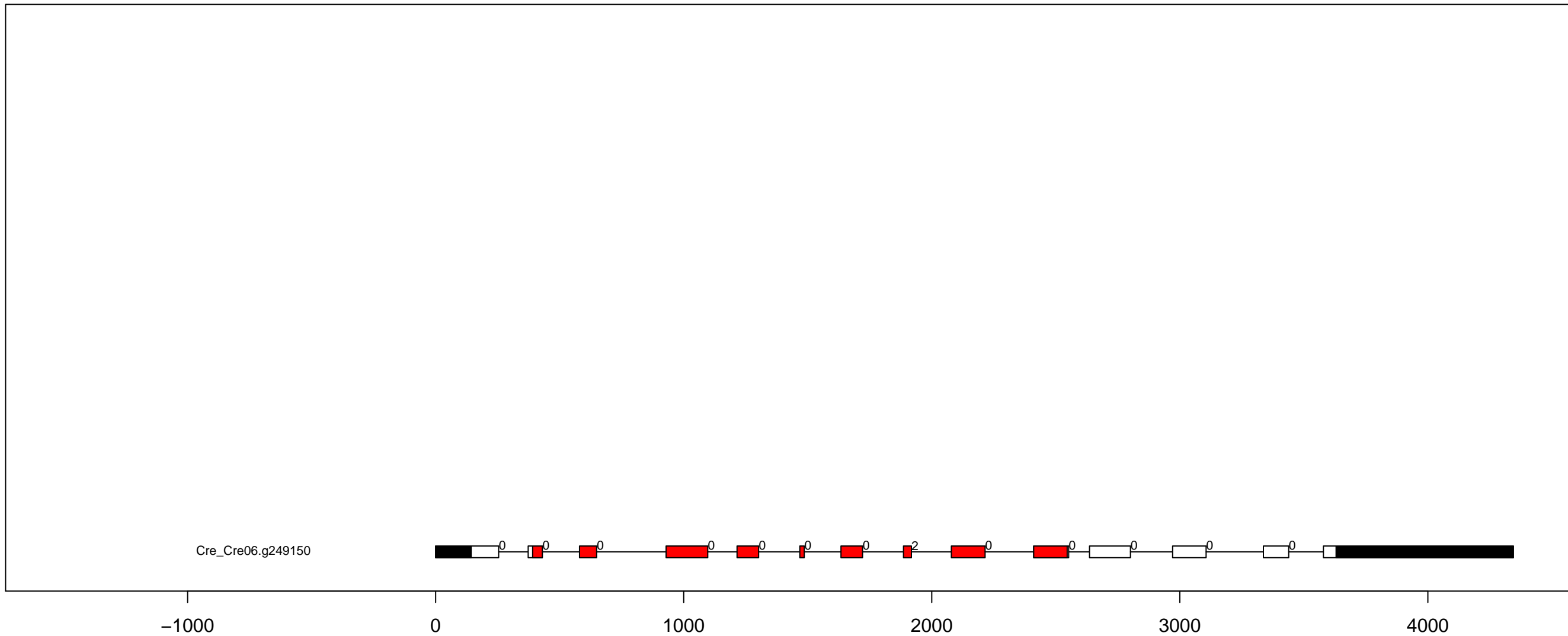

C.re TK_TK-Cr exon-intron and kinase domain diagram (all)

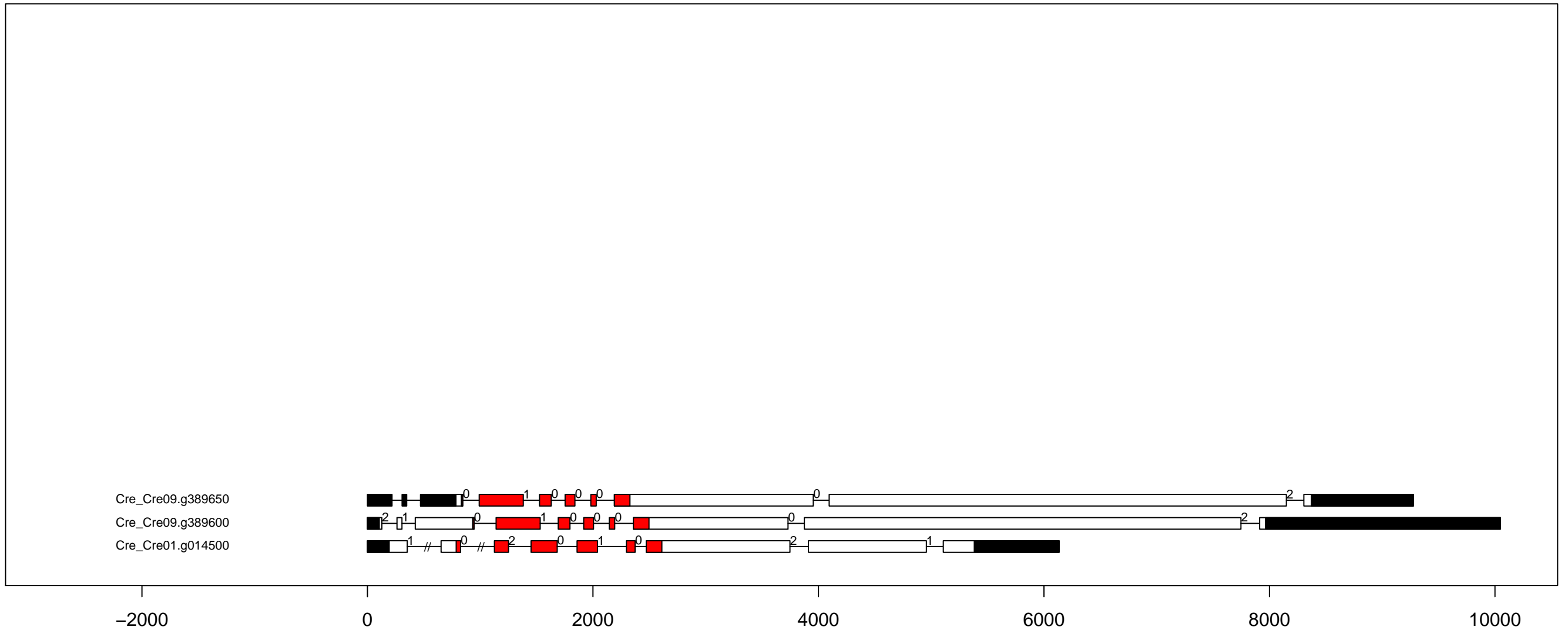

C.re TKL_CTR1-DRK-2 exon-intron and kinase domain diagram (all)

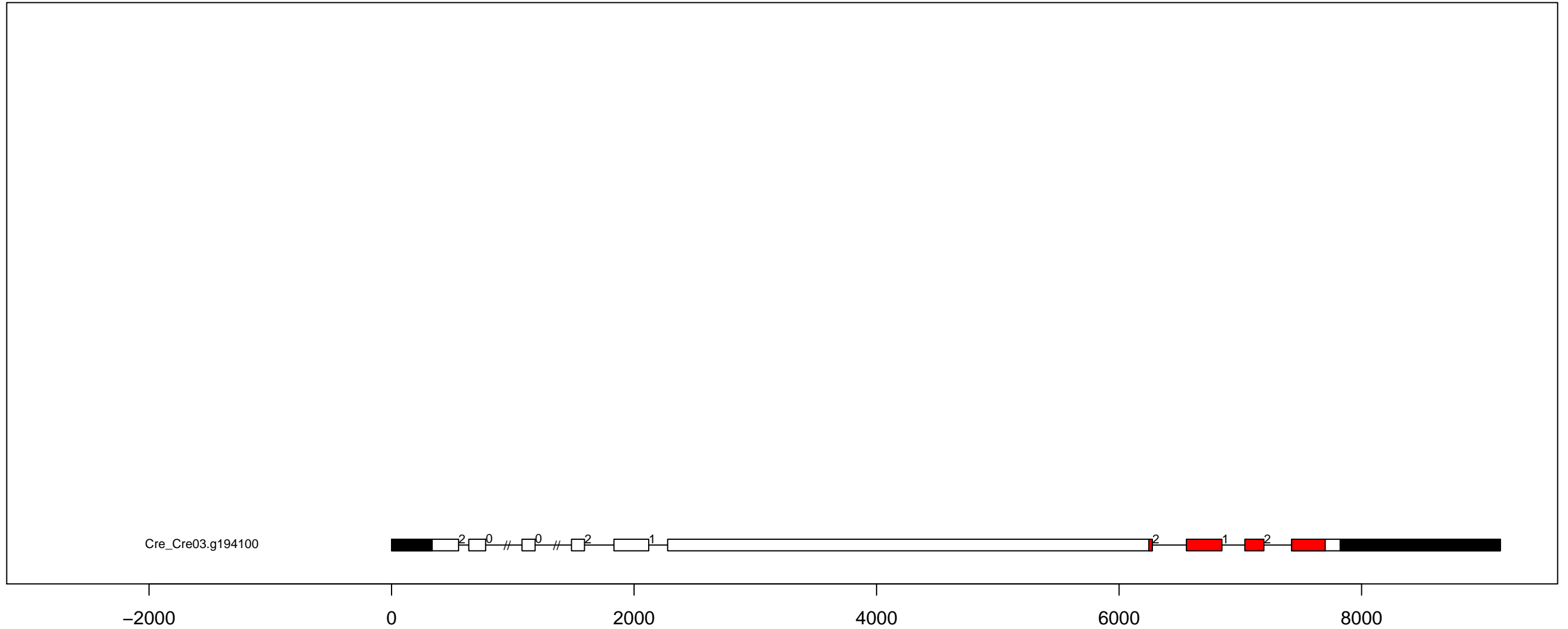

C.re TKL_CTR1-DRK-Cr exon-intron and kinase domain diagram (all)

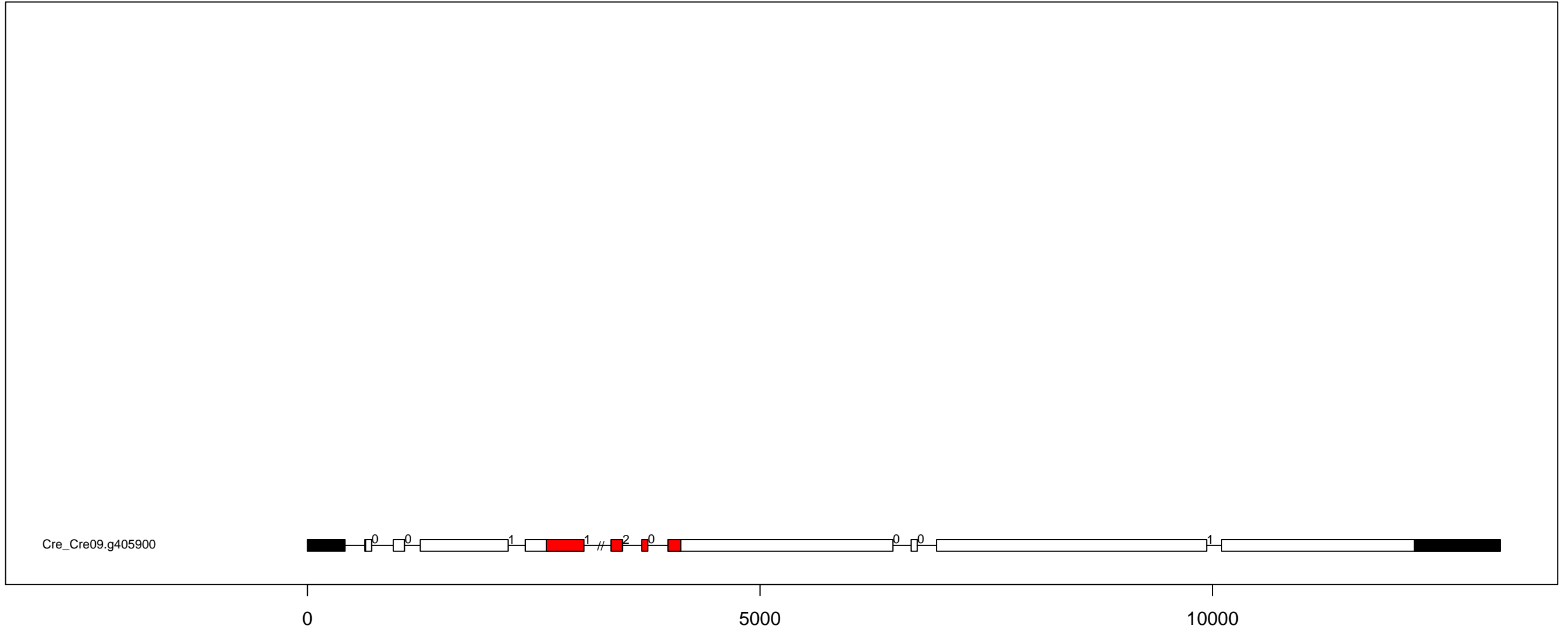

C.re TKL-Cr-1 exon-intron and kinase domain diagram (all)

Cre_Cre07.g351800

Cre_Cre05.g236000

Cre_Cre03.g160900

Cre_Cre03.g160350

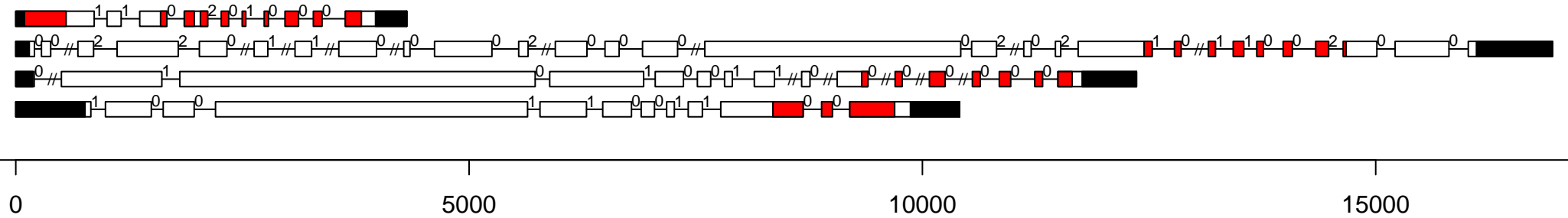

C.re TKL-Cr-2 exon-intron and kinase domain diagram (all)

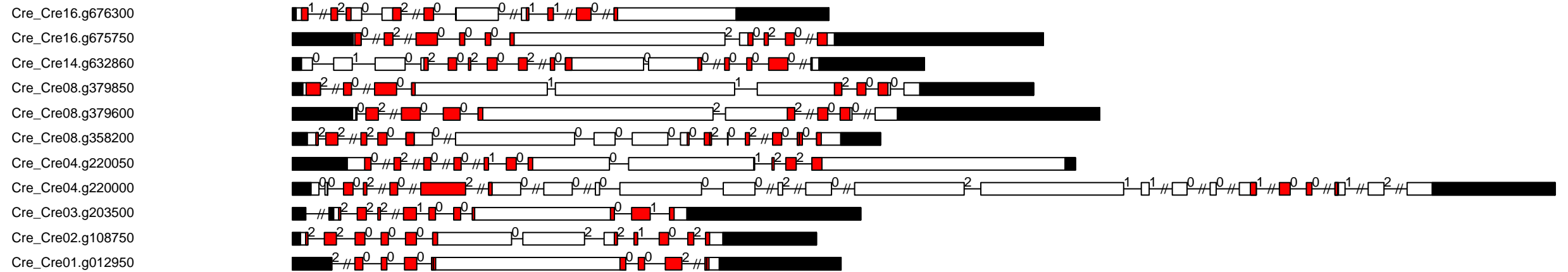

C.re TKL-Cr-3 exon-intron and kinase domain diagram (part 1)

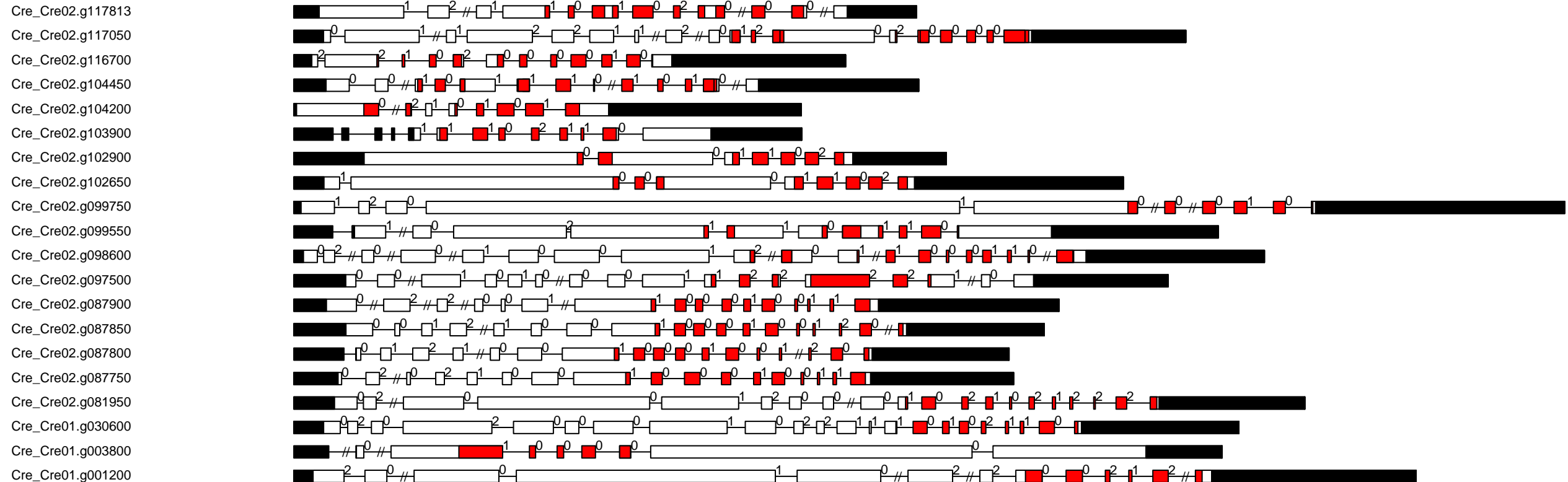

0

5000

10000

C.re TKL-Cr-3 exon-intron and kinase domain diagram (part 2)

Cre_Cre07.g339850
Cre_Cre07.g334950
Cre_Cre07.g322350
Cre_Cre07.g316650
Cre_Cre07.g314500
Cre_Cre06.g310100
Cre_Cre06.g303150
Cre_Cre06.g293300
Cre_Cre06.g287700
Cre_Cre06.g274550
Cre_Cre06.g268950
Cre_Cre06.g268850
Cre_Cre06.g267400
Cre_Cre06.g253200
Cre_Cre05.g238100
Cre_Cre04.g224450
Cre_Cre03.g157250
Cre_Cre03.g157200
Cre_Cre03.g154250
Cre_Cre02.g145500

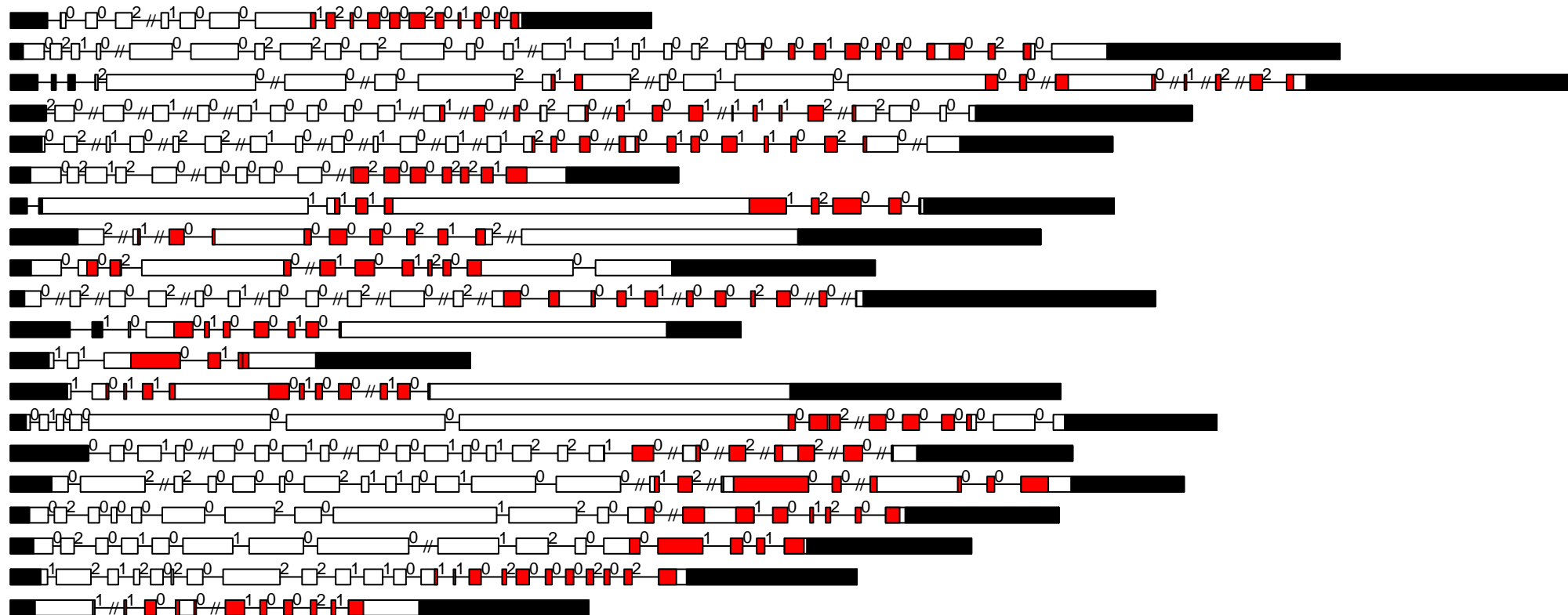

C.re TKL-Cr-3 exon-intron and kinase domain diagram (part 3)

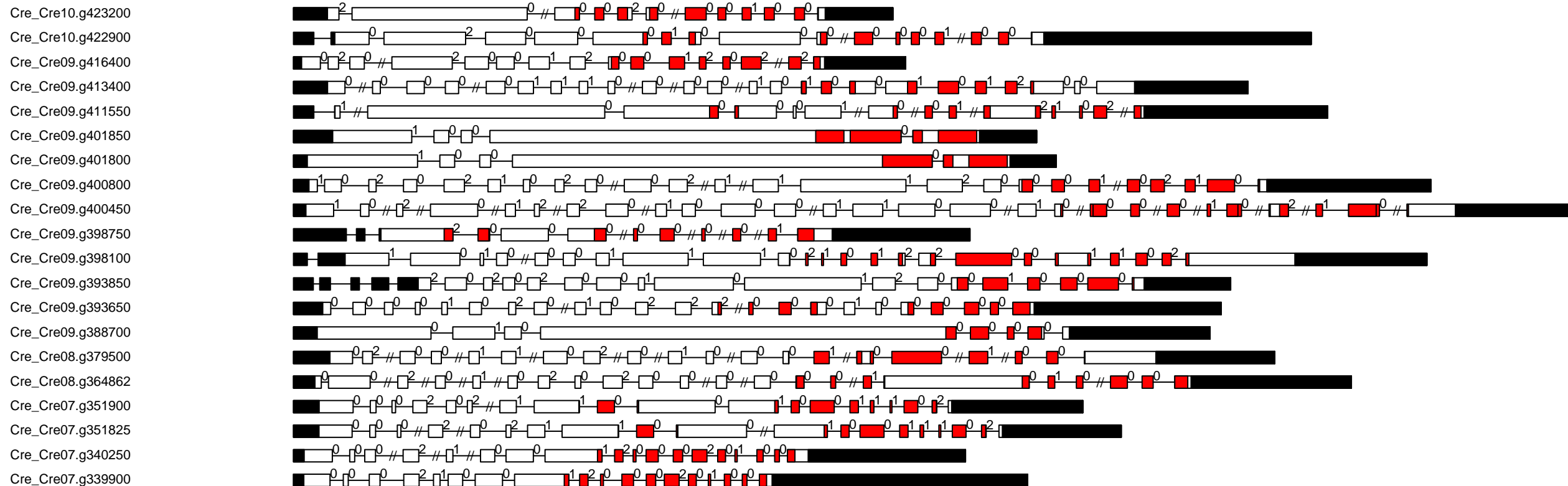

0

5000

10000

C.re TKL-Cr-3 exon-intron and kinase domain diagram (part 4)

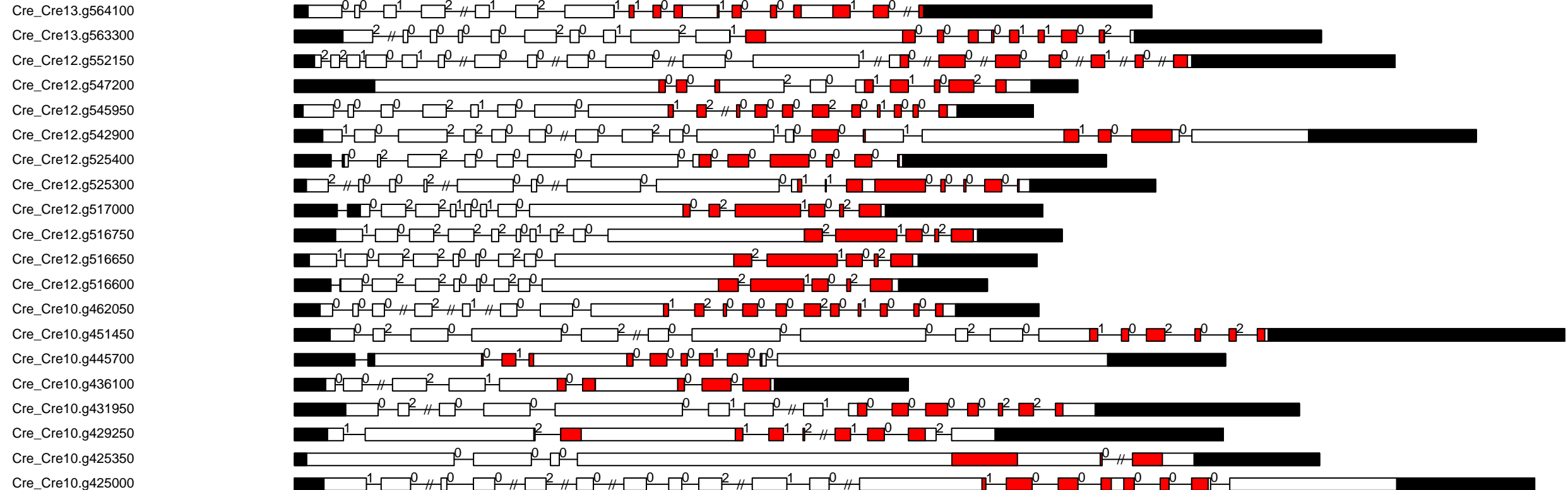

0

5000

10000

C.re TKL-Cr-3 exon-intron and kinase domain diagram (part 5)

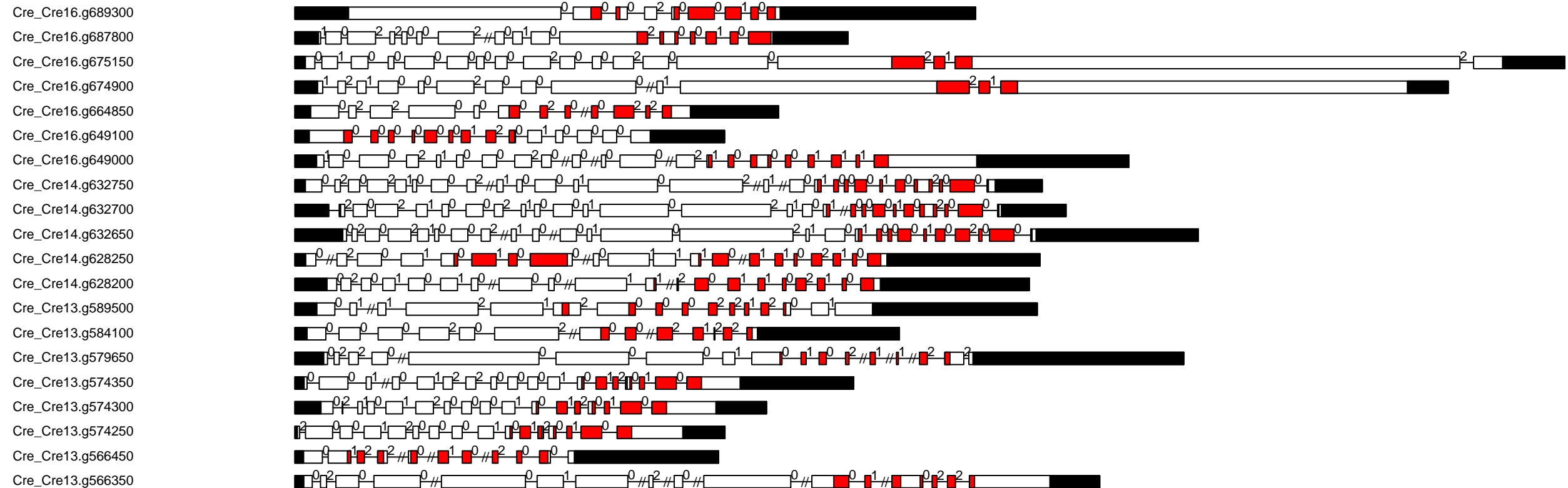

C.re TKL-Cr-3 exon-intron and kinase domain diagram (part 6)

Cre_Cre17.g734250

Cre_Cre17.g710650

Cre_Cre17.g710600

Cre_Cre17.g710000

Cre_Cre17.g709900

Cre_Cre17.g702600

Cre_Cre16.g692350

Cre_Cre16.g689550

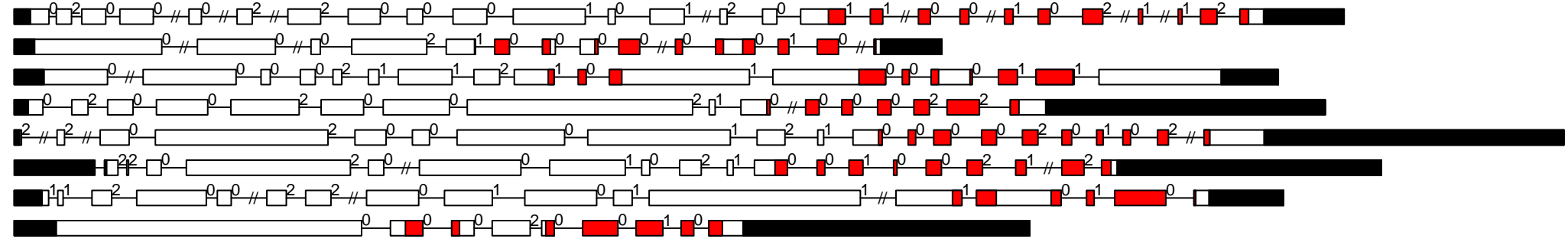

0

5000

10000

C.re TKL-Cr-4 exon-intron and kinase domain diagram (part 1)

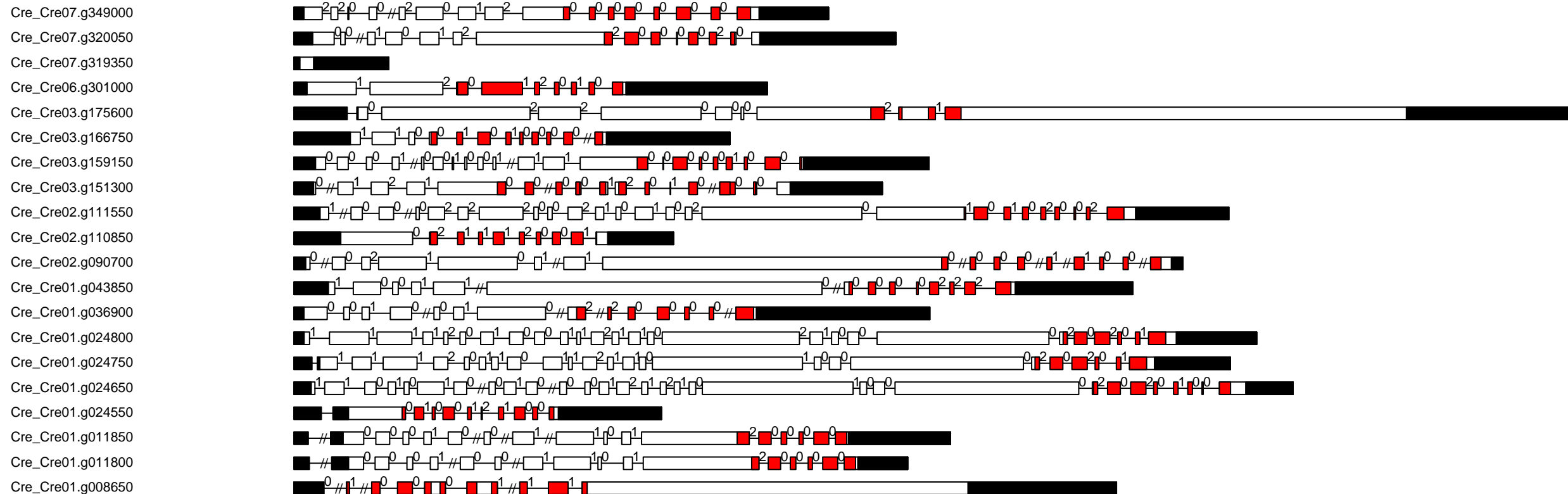

C.re TKL-Cr-4 exon-intron and kinase domain diagram (part 2)

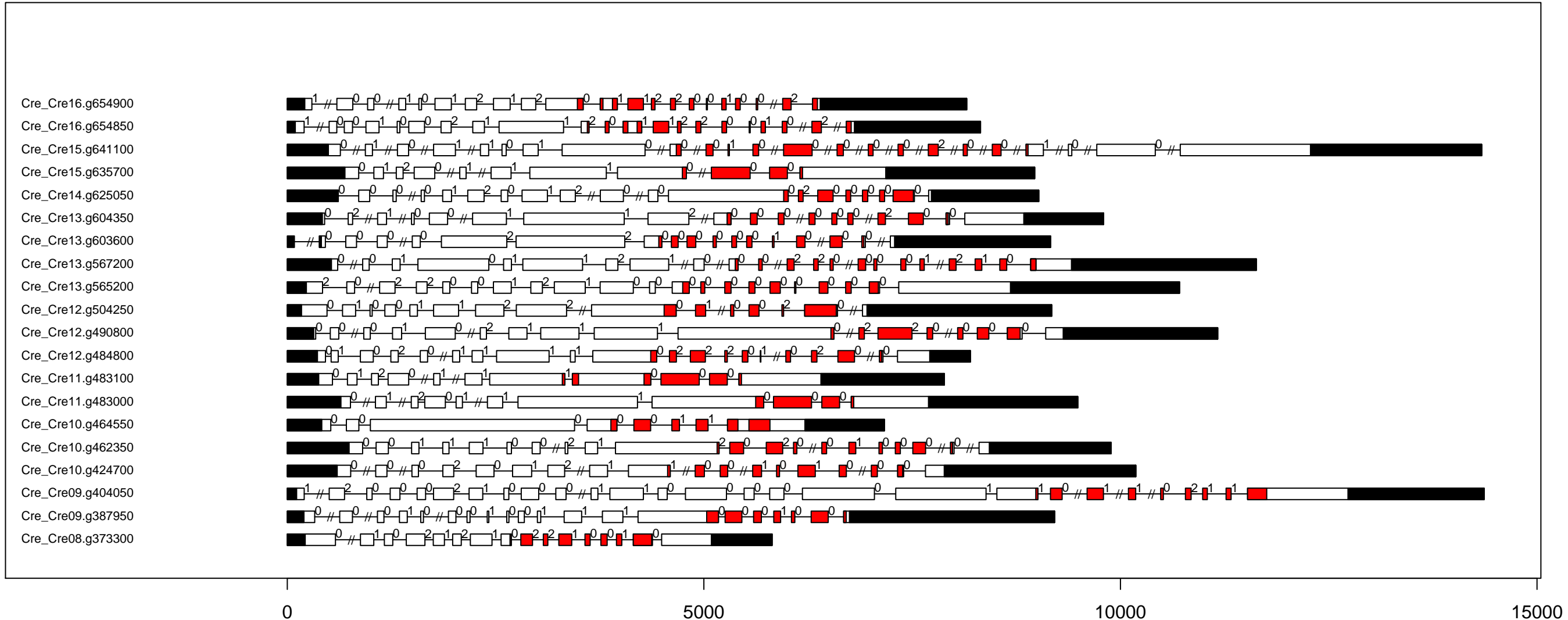

C.re TKL-Cr-4 exon-intron and kinase domain diagram (part 3)

Cre_Cre17.g741900
Cre_Cre17.g713050
Cre_Cre17.g696950
Cre_Cre17.g696900
Cre_Cre16.g695218
Cre_Cre16.g694550
Cre_Cre16.g666300

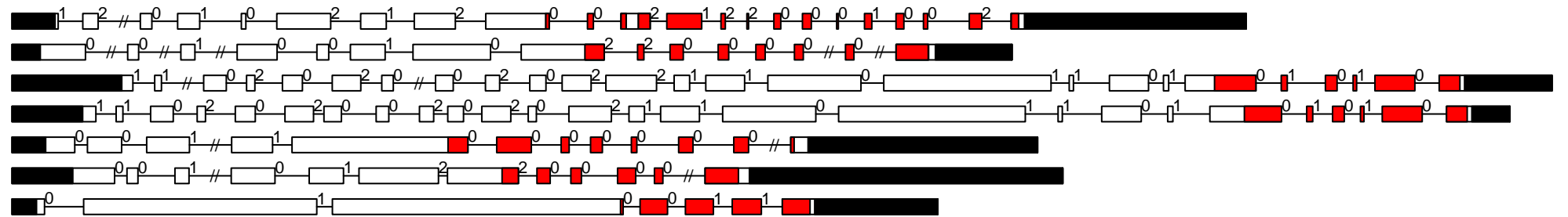

C.re TKL-Cr-Single exon-intron and kinase domain diagram (all)

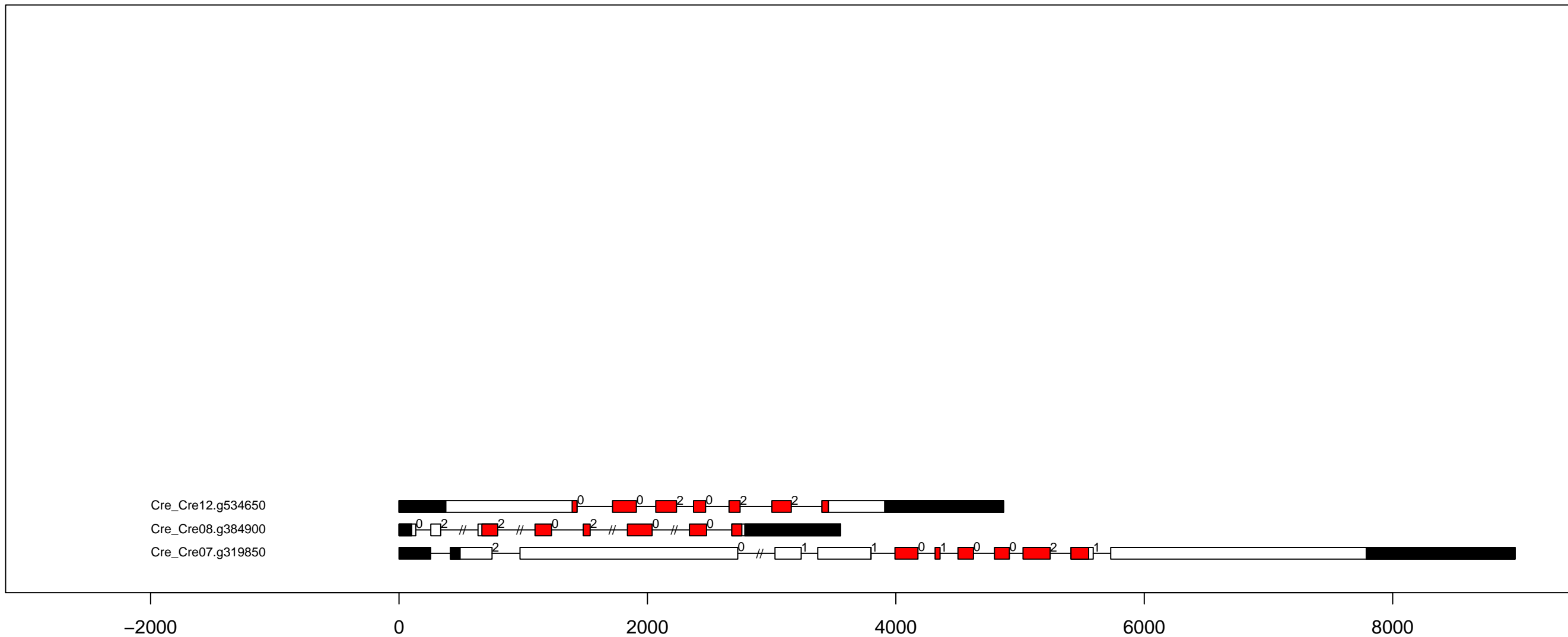

C.re TKL-PI-1 exon-intron and kinase domain diagram (all)

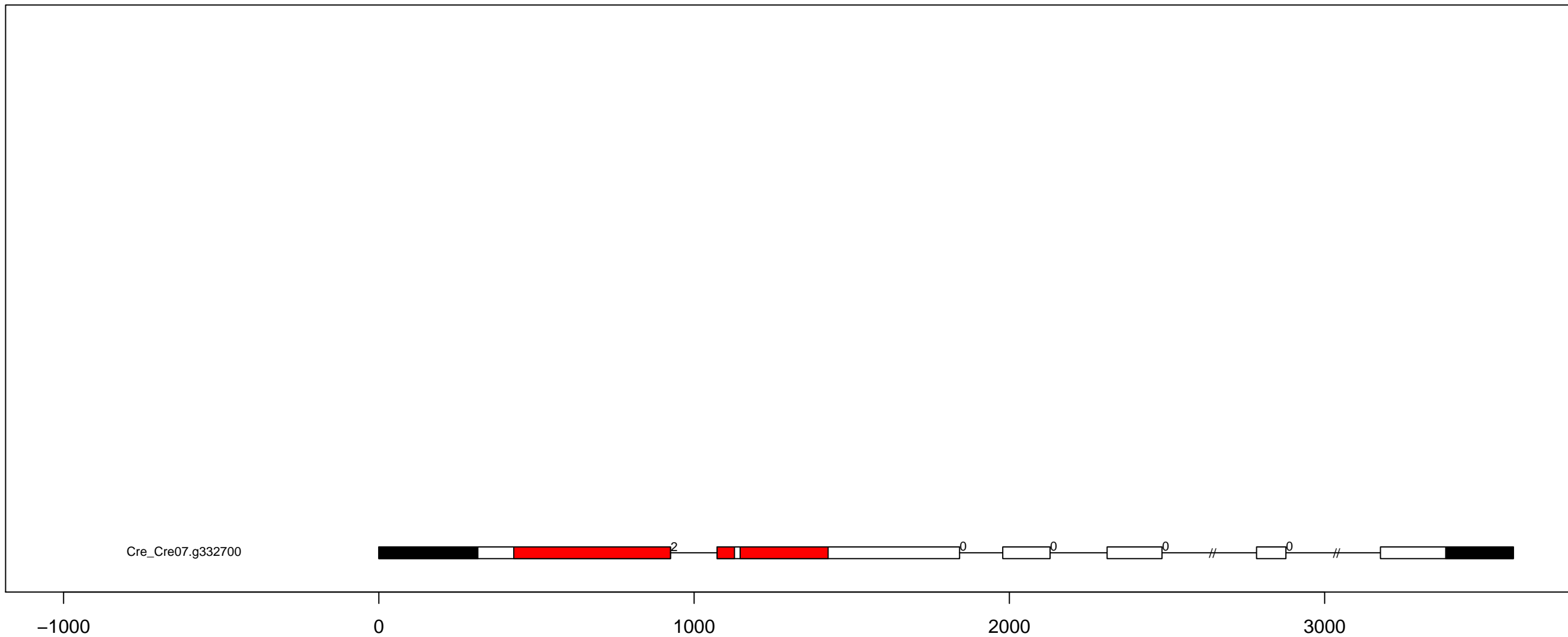

C.re TKL-PI-3 exon-intron and kinase domain diagram (all)

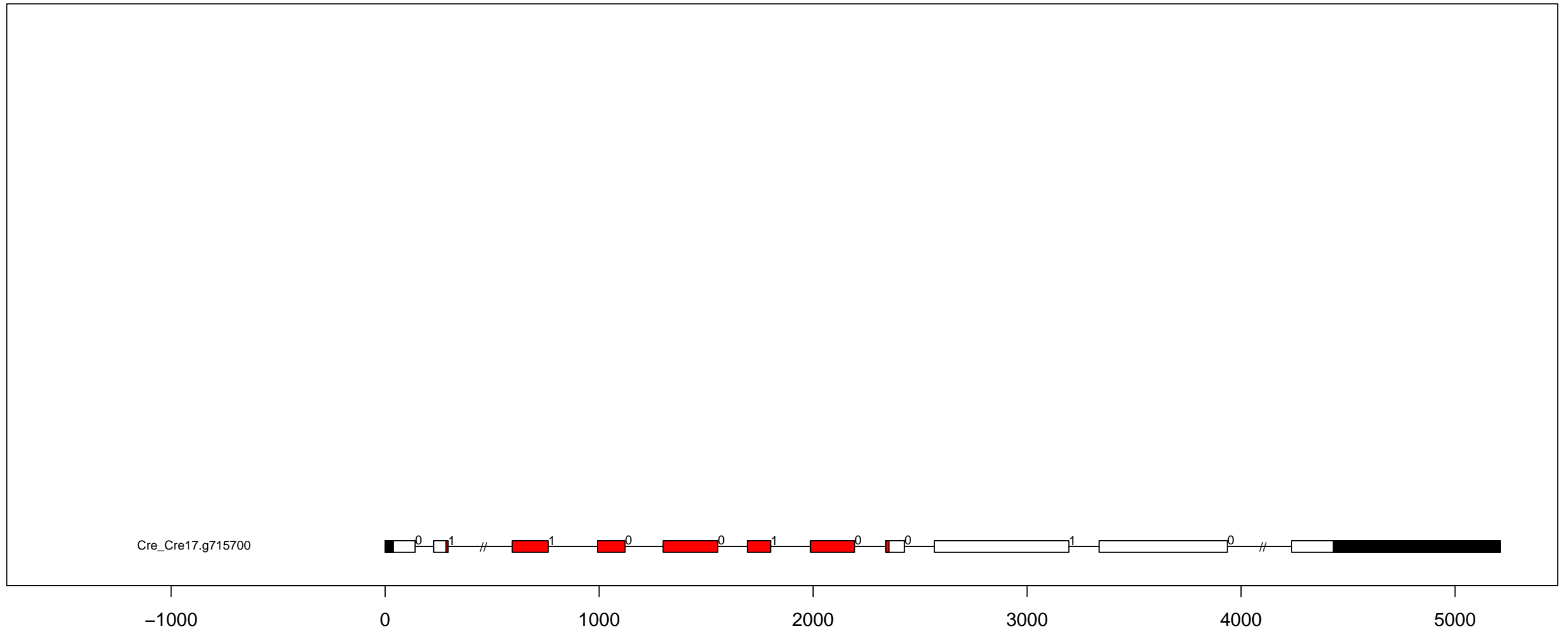

C.re TKL-PI-4 exon-intron and kinase domain diagram (all)

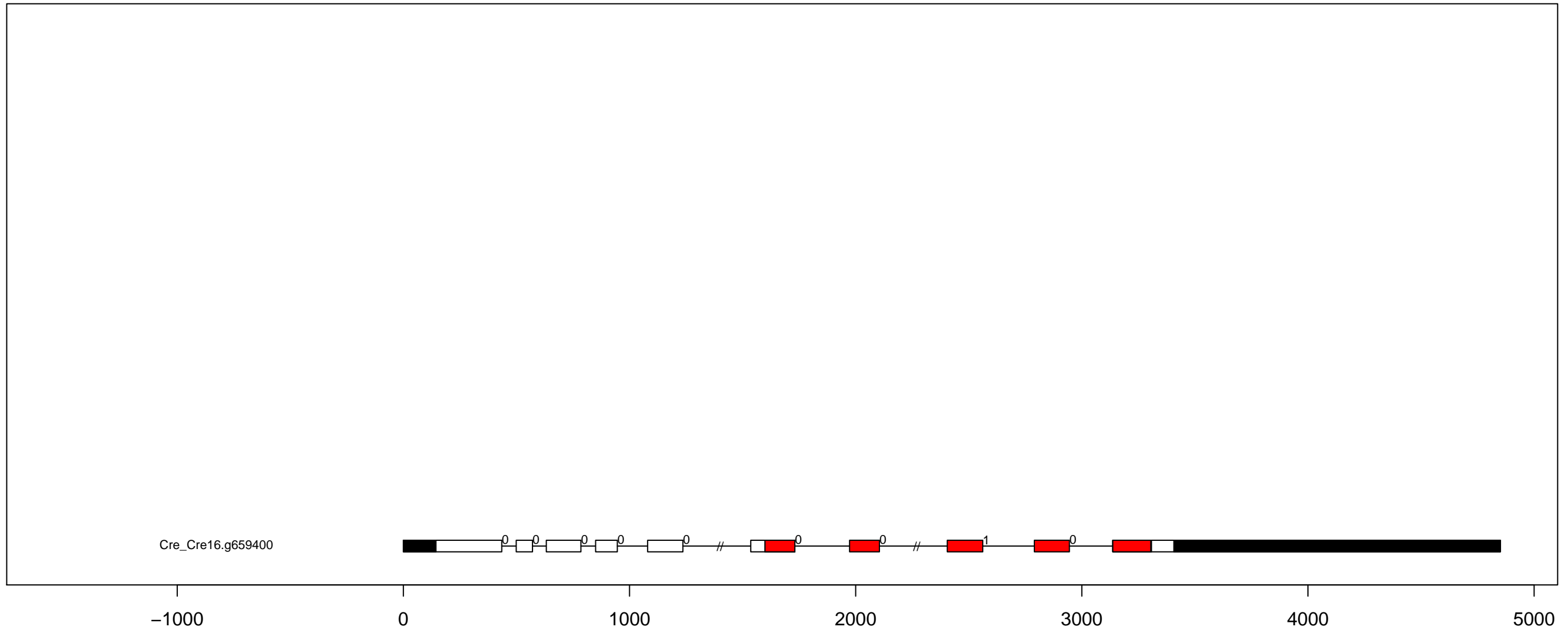

C.re TKL-PI-5 exon-intron and kinase domain diagram (all)

Cre_Cre12.g507750

Cre_Cre03.g168150

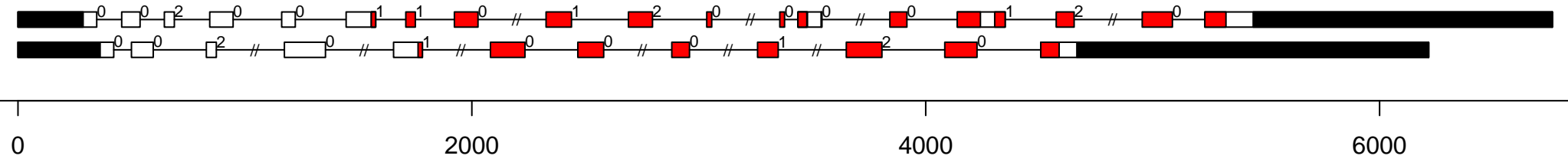

C.re TKL-PI-6 exon-intron and kinase domain diagram (all)

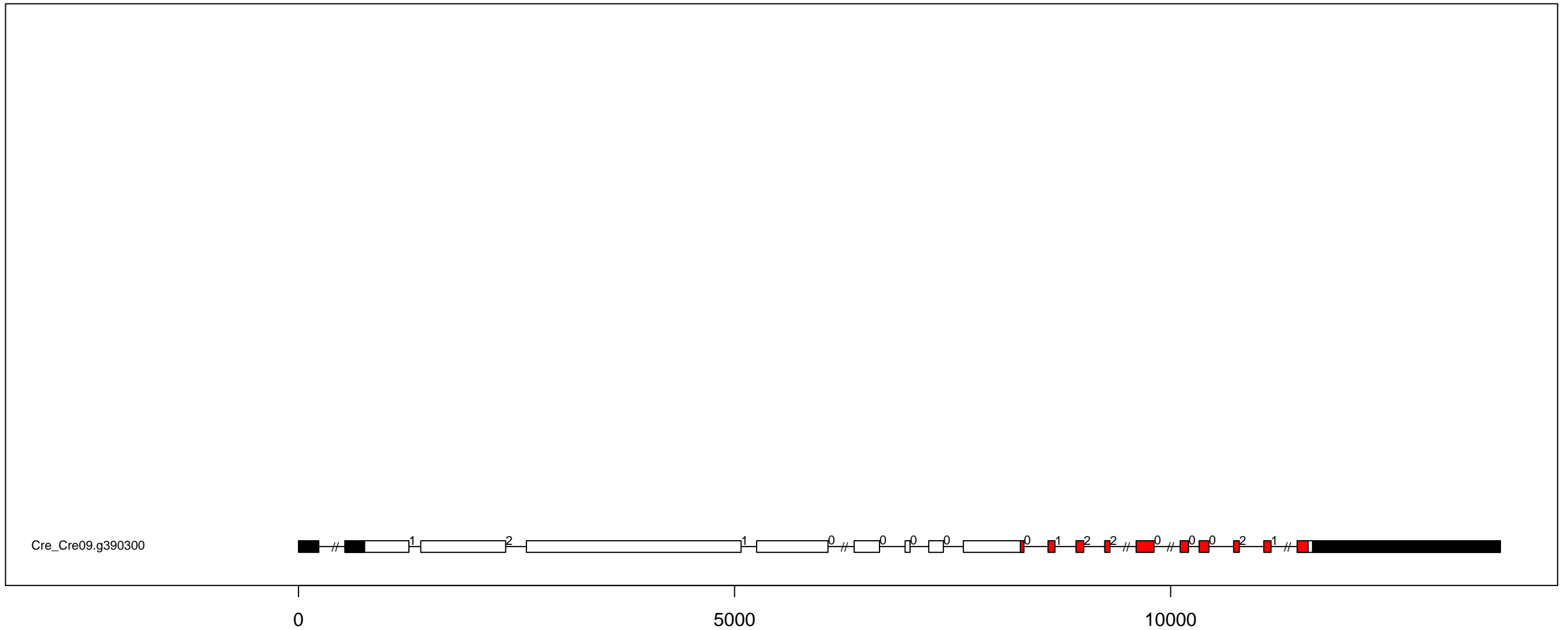

C.re TKL-PI-8 exon-intron and kinase domain diagram (all)

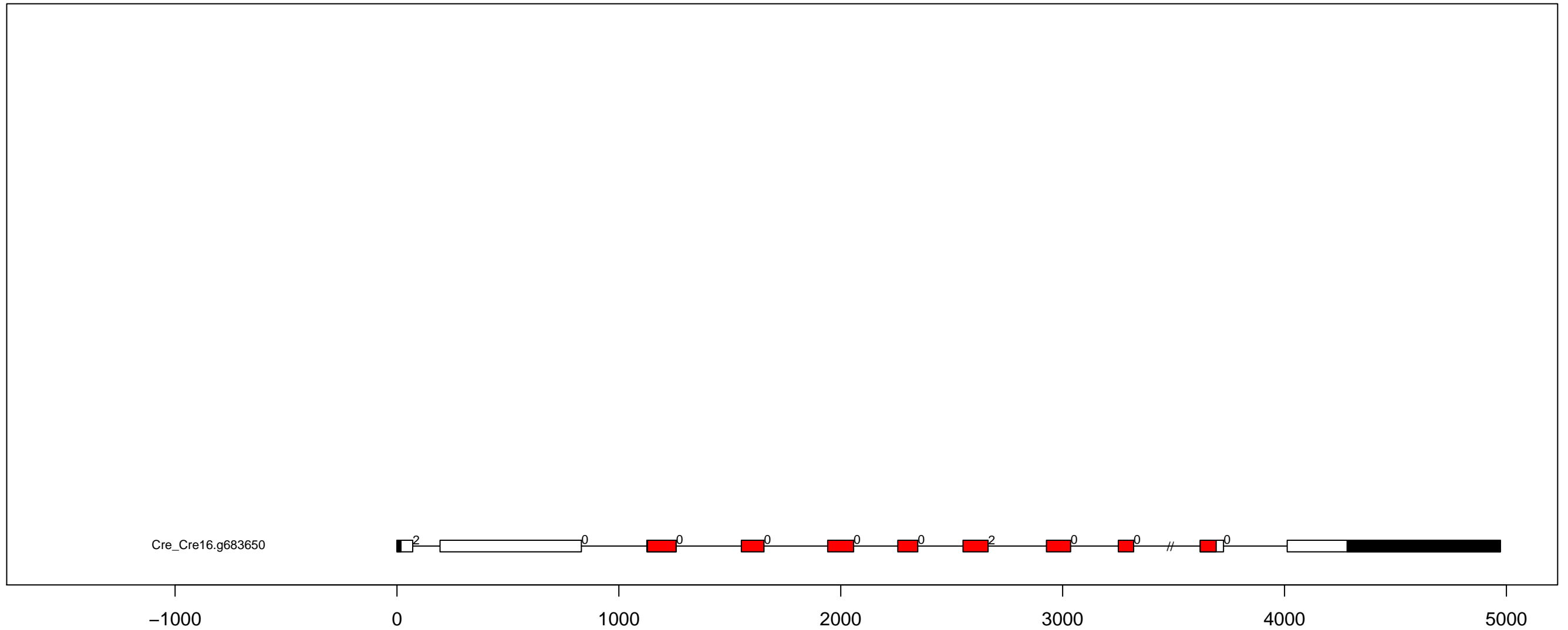

C.re TLK exon-intron and kinase domain diagram (all)

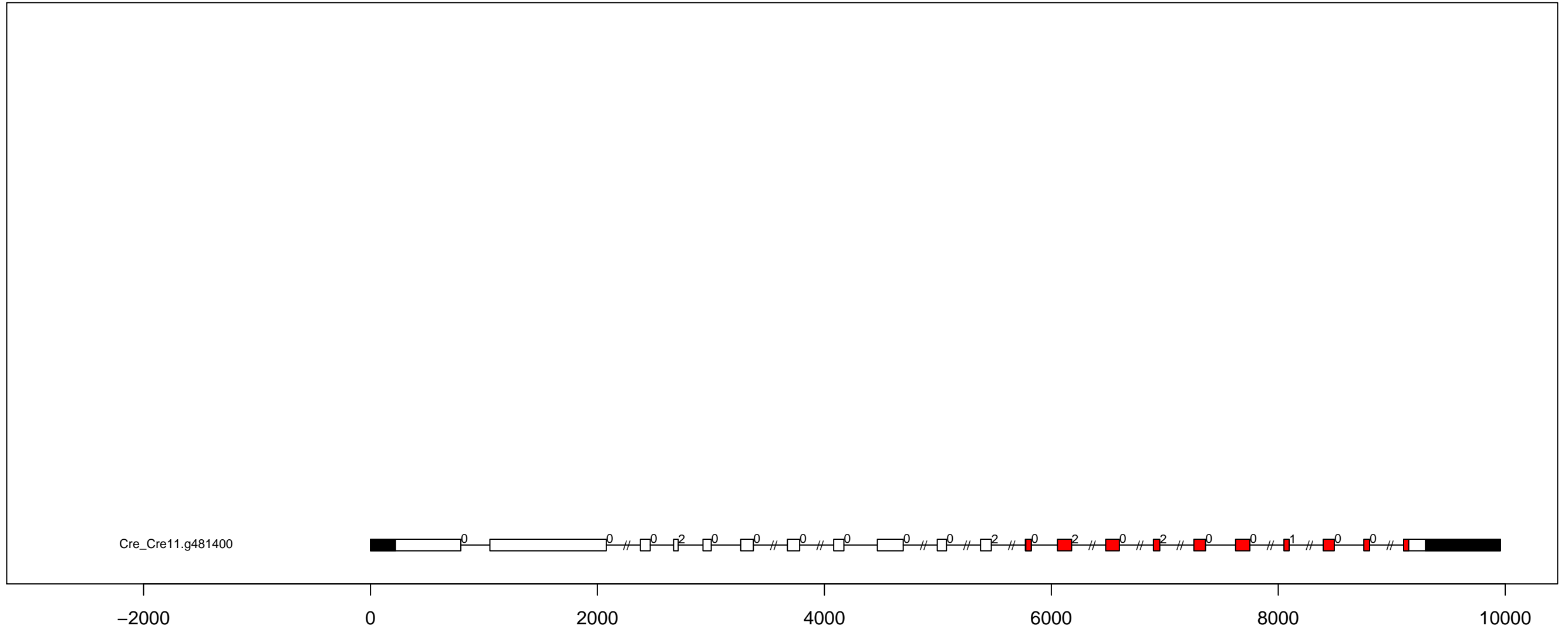

C.re TTK exon-intron and kinase domain diagram (all)

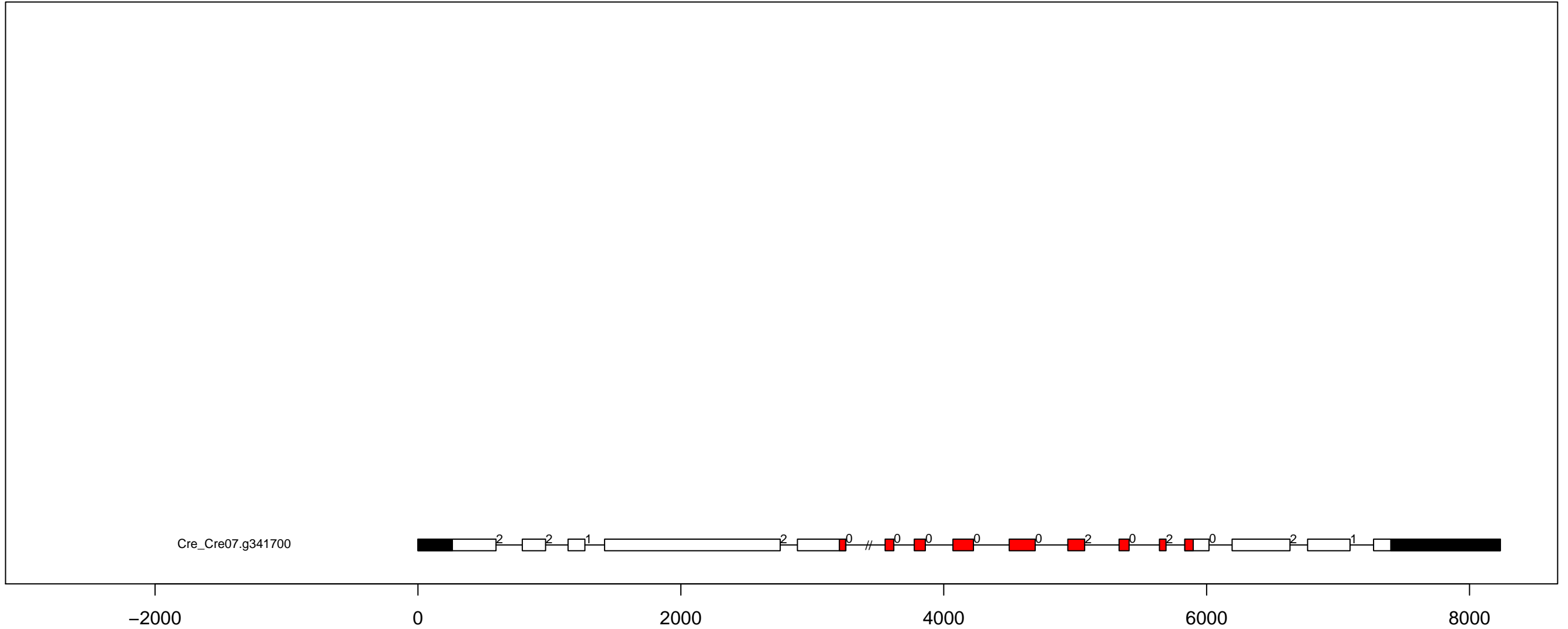

C.re ULK_Fused exon-intron and kinase domain diagram (all)

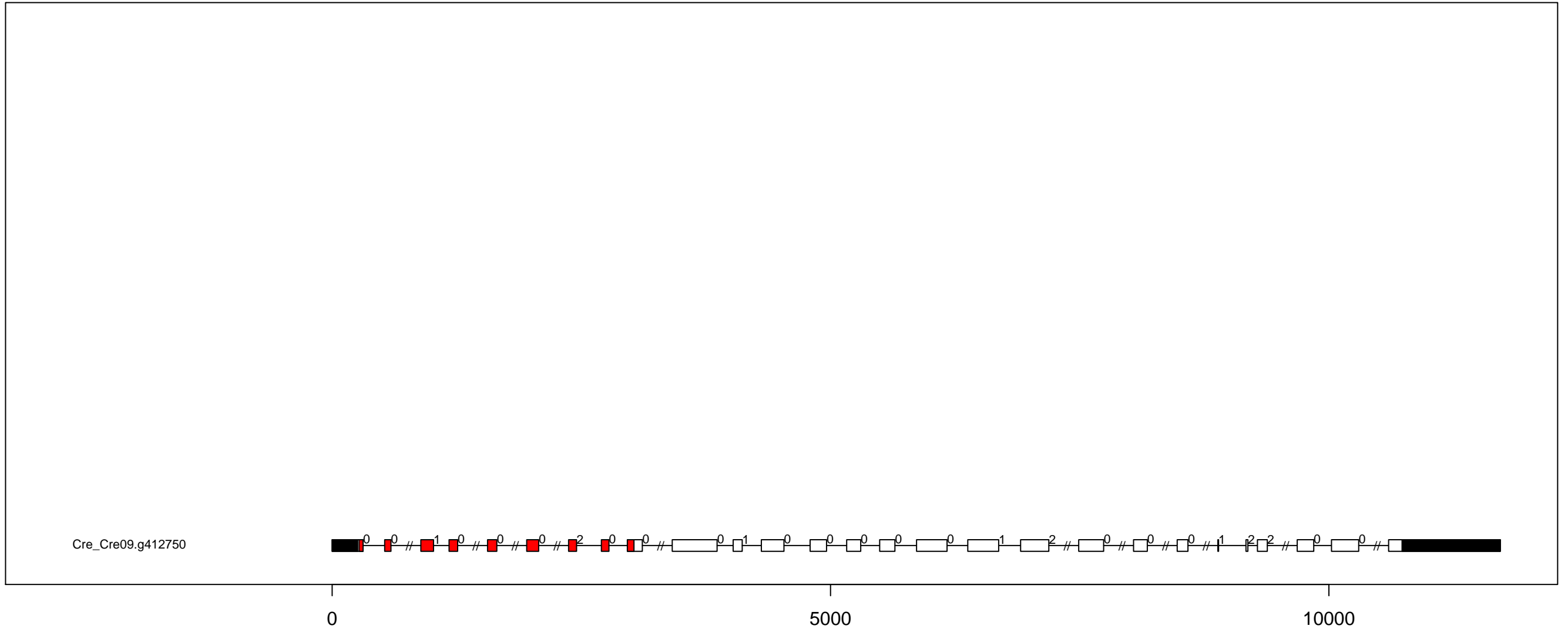

C.re ULK_ULK4 exon-intron and kinase domain diagram (all)

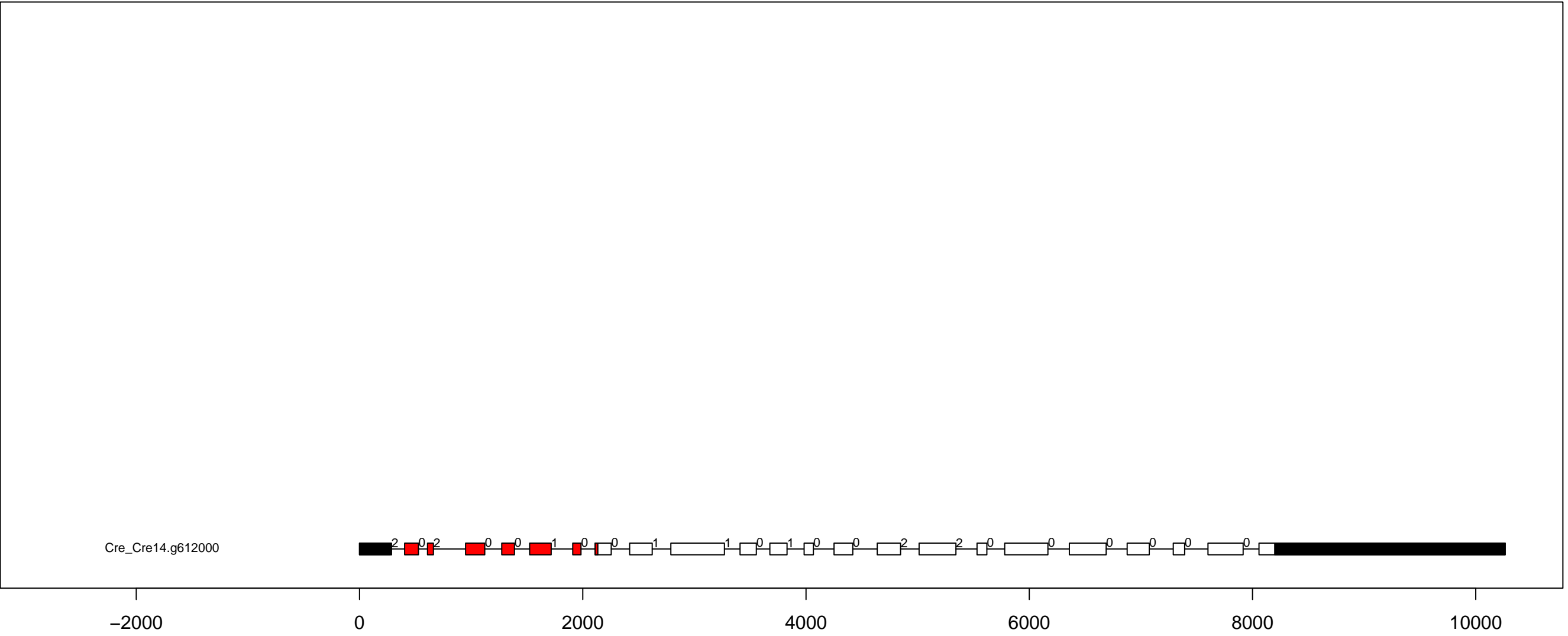

C.re WEE exon-intron and kinase domain diagram (all)

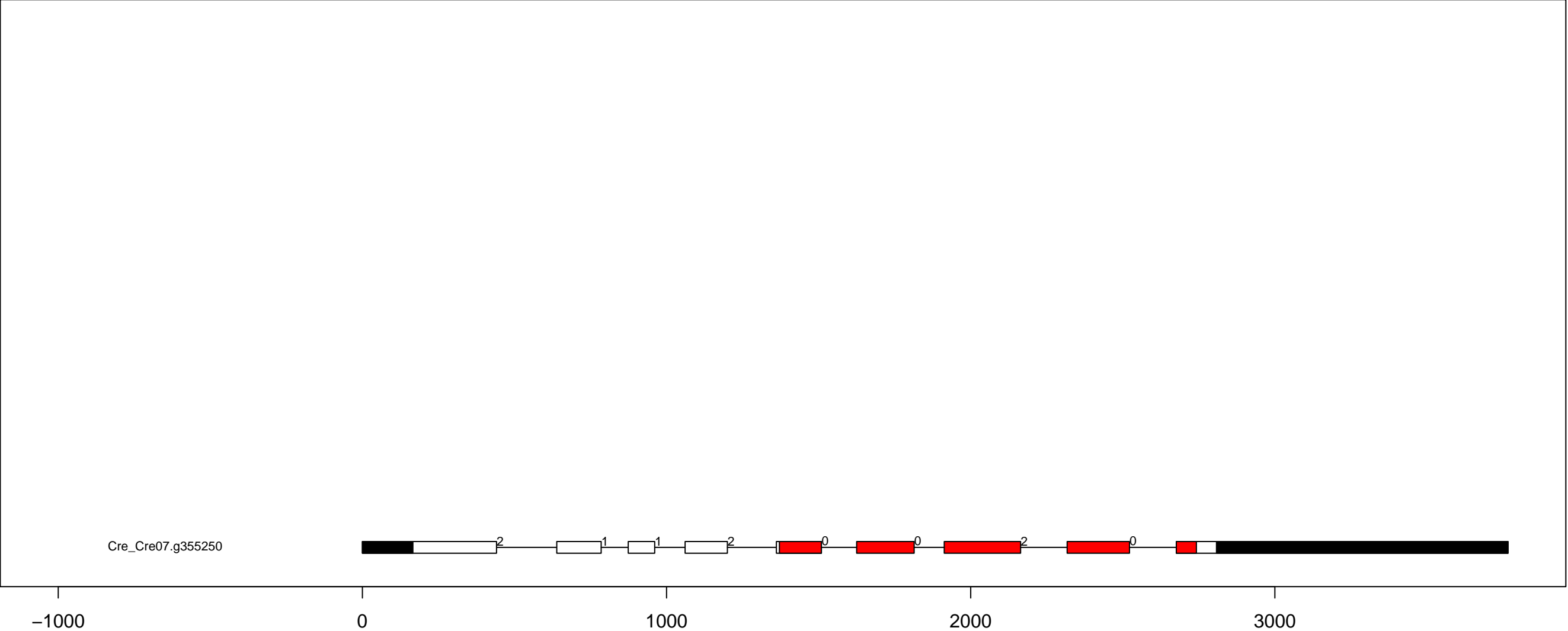

C.re WNK_NRBP exon-intron and kinase domain diagram (all)

Cre_Cre06.g302800
Cre_Cre01.g040200
Cre_Cre01.g040150

