

C/EBP γ is dispensable for steady-state and emergency granulopoiesis

Miroslava Kardosova,^{1,2} Polina Zjablovskaja,^{1,3,4} Petr Daneš,¹ Pavla Angelisova,¹ Lorena Lobo de Figueiredo-Pontes,⁵ Robert S. Welner,⁶ Tomas Brdicka,¹ Sanghoon Lee,⁷ Daniel G. Tenen^{8,9*} and Meritxell Alberich-Jorda^{1,3,4*}

¹Institute of Molecular Genetics of the Czech Academy of Sciences, Prague, Czech Republic; ²Department of Cell Biology, Charles University, Faculty of Science, Prague, Czech Republic; ³CLIP-Childhood Leukaemia Investigation, Prague, Czech Republic; ⁴Department of Paediatric Haematology and Oncology, Charles University, Second Faculty of Medicine, Prague, Czech Republic; ⁵Hematology/Oncology Division of the Department of Internal Medicine, Medical School of Ribeirao Preto, University of São Paulo, Brazil; ⁶Hematology/Oncology Department, University of Alabama at Birmingham, AL, USA; ⁷Department of Systems Biology, University of Texas MD Anderson Cancer Center, Houston, TX, USA; ⁸Cancer Science Institute, National University of Singapore, Singapore and ⁹Harvard Stem Cell Institute, Harvard Medical School, Boston, MA, USA

*DGT and MA-J contributed equally to this work

Correspondence: alberich@img.cas.cz
doi:10.3324/haematol.2017.173781

SUPPLEMENTARY APPENDIX**C/EBP γ is dispensable for steady-state and emergency granulopoiesis**

Miroslava Kardosova^{1,2}, Polina Zjablovskaja^{1,3,4}, Petr Danek¹, Pavla Angelisova¹, Lorena Lobo de Figueiredo-Pontes⁵, Robert S. Welner⁶, Tomas Brdicka¹, Sanghoon Lee⁷, Daniel G. Tenen^{8,9*}, and Meritxell Alberich-Jorda^{1,3,4*}

¹Institute of Molecular Genetics of the Czech Academy of Sciences, Prague, Czech Republic

²Department of Cell Biology, Charles University, Faculty of Science, Prague, Czech Republic

³CLIP-Childhood Leukaemia Investigation, Prague, Czech Republic

⁴Department of Paediatric Haematology and Oncology, Charles University, Second Faculty of Medicine, Prague, Czech Republic

⁵Hematology/Oncology Division of the Department of Internal Medicine, Medical School of Ribeirao Preto, University of São Paulo, Ribeirao Preto, Brazil

⁶Hematology/Oncology Department, University of Alabama at Birmingham, Birmingham, AL, USA

⁷Department of Systems Biology, University of Texas MD Anderson Cancer Center, Houston, TX, USA

⁸Cancer Science Institute, National University of Singapore, Singapore

⁹Harvard Stem Cell Institute, Harvard Medical School, Boston, MA, USA

*DGT and MA-J contributed equally to this work

Supplementary material and methods

Generation of *Cebpg* KO mice

A targeting vector (pL253) containing a 5.4 kb 5' homologous region, a *Cebpg* coding region flanked by loxP sites, an IRES-tdTOMATO-pGK-neomycin resistance gene cassette flanked by FRT sites, and a 3.3 kb 3' homologous region was used to replace exon 2 of the targeted *Cebpg* gene. After sequencing, the construct was linearized with BstBI, electroporated into ES cells, and correctly targeted ES cells were injected into blastocysts from C57BL/6NCrl mice. Once chimeras were born, correct genotypes were bred to ensure for germline transmission to C57BL/6NCrl mice. To induce deletion of the floxed *Cebpg* exon 2 in the hematopoietic system from early stages of hematopoietic development, *Cebpg*^{fl} mice were crossed to Vav-iCre transgenic mice (C57BL/6NCrl background)¹, generating *Cebpg*^{fl/fl} Vav-iCre⁻ and *Cebpg*^{fl/fl} Vav-iCre⁺ animals. Of note, excision mediated by the Vav-iCre model is not restricted to hematopoietic cells, and it has been reported in other cell types such as endothelial cells². For genotyping the WT, flox allele, and determine excision, primers listed in Supplementary Table S4 were used. All animals were maintained in the animal facility of the Institute of Molecular Genetics in Prague. All experiments and procedures were approved by the ethical committee of the Institute.

Southern blot analysis

15 μ g genomic DNA extracted from ES cells or animal tails was digested with *XbaI*, resolved on a 0.8% agarose gel and transferred to nitrocellulose membrane for Southern blot analysis with a ³²P-labeled 3' flanking probe. The probe detected a 5.2 kb fragment from the wild-type allele and a 4.1 kb fragment from the targeted allele.

RNA isolation, cDNA preparation and quantitative RT-PCR

RNA from murine BM cells was extracted with Tri Reagent RT (Molecular Research Center, Cincinnati, OH, USA) and treated with DNaseI (Thermo Fisher Scientific, Waltham, MA, USA) according to manufacturer's instructions. Briefly, cDNA was prepared using SuperScript II Reverse Transcriptase (Thermo Fisher Scientific, Waltham, MA, USA). Quantitative RT-PCR was performed using a LightCycler® 480 SYBR Green I Master mix and samples were run on a LightCycler® 480 Instrument II (both Roche Molecular Systems, Pleasanton, CA, USA). For each sample, transcript levels of tested genes were normalized to glyceraldehyde-3-phosphate dehydrogenase (*Gapdh*). Primer sequences used for Quantitative RT-PCR can be found in Supplemental Table S4.

Generation of antibodies against murine C/EBP γ

The hybridoma producing mAb mC/EBP γ -01 (IgG2a) was generated by a standard protocol from Sp2/0 myeloma cell line and splenocytes of *Cebpg* KO mice immunized with peptide CISTETTATNSDNPQ (present in the C-terminus of the C/EBP γ protein, aa 136-150)³ coupled to Inject™ Maleimide-Activated mKLH carrier protein (ThermoFisher Scientific, Waltham, MA, USA) according to manufacturer's protocol. The mAb was purified using Protein A Sepharose and conjugated with horseradish peroxidase (HRP) (Exbio Praha, Vestec, Czech Republic).

Immunoprecipitation followed by western blot analysis

Single-cell suspensions from splenocytes (5×10^7) were solubilized in 1 ml of 20mM Tris pH 8.2, containing 100mM NaCl, and 1% SDS, sonicated, and SDS replaced by 1% Triton X-100 using Sephadex G-25 columns. Protein A/G PLUS-Agarose (Santa Cruz Biotechnology, Dallas, TX, USA) was coated with purified mC/EBP γ -01mAb (10 μ g/ml) by incubating on

rotator for 2 hrs at 4°C, washed with buffer containing 0.1% Triton X-100, 20mM Tris pH 8.2, 100mM NaCl, 50mM NaF, 10mM Na₂P₂O₇, 10mM EDTA, and then blocked with BSA (1 mg/ml). Such mAb-coated beads (30 μ l) were incubated with 0.8 ml of lysate by rotating for 3.5 hrs at 4°C, and then washed 5 times with the Tris/NaCl buffer containing 0.1% Triton X-100 on MicroBio-Spin Chromatography Columns (Bio-Rad, Hercules, CA, USA). Immunisolated proteins were eluted with 120 μ l of non-reducing SDS-PAGE sample buffer, separated on 15% SDS-PAGE gels, and transferred to nitrocellulose membrane (BioTrace, Life Sciences, Pensacola, FL, USA). Immunoblots were blocked with 5% dried skimmed milk and stained with purified mC/EBP γ -01 mAb conjugated with HRP.

Flow cytometric analysis and BM sorting

Murine blood samples were obtained by bleeding from the cheek. Blood was analyzed with an Auto Hematology Analyser (BC 5300 Vet, Mindray Bio-Medical Electronics, Shenzhen, China). BM was collected from femur and tibia of mice by grinding the muscle free bones. For flow cytometric analysis, single cell suspensions of PB, BM and spleen (SP) from WT and *Cebpg* KO mice were subjected to red cell lysis. Cells were stained with fluorescence-conjugated antibodies and analyzed using a LSRII instrument (BD Biosciences, San Jose, CA, USA). The antibodies used were Ter 119 Pacific Blue (TER-119), CD45/B220 APC, CD45/B220 FITC (RA3-6B2), CD3 ϵ APC (145-2C11), Ly6G FITC (1A8), and CD11b FITC (M1/70), anti-mouse Lineage Cocktail Pacific Blue (including CD3(17A2); Gr1 (RB6-8C5); CD11b (M1/70); CD45R/B220 (RA3-6B2); TER-119 (Ter-119)), c-kit PerCP/Cy 5.5 (2B8), Sca-1 APC (E13-161.7), Fc γ RII/III Pe-Cy7 (93), CD34 FITC or Alexa-Fluor 700. BM transplant recipients were analyzed using the following antibodies: CD45.2 PE/Cy7 (104), CD45.1 PB or FITC (A20), Gr1 FITC, APC or PerCP/Cy 5.5 (RB6-8C5), CD11b APC (M1/70), CD45R/B220 APC or FITC

(RA3-6B2), CD3 FITC or Pacific Blue (17A2). Preparation of cells for sorting of long-term HSCs (LT-HSCs) for transplantation assays was performed in 2 steps. First, Lin⁺ cells were labeled with biotinylated lineage markers: CD45/B220 (RA3-6B2), CD3 (145-2c11), Ter119 (TER-119), Gr1 (RB6-8C5), and CD11b (M1/70) and depleted using anti-biotin magnetic beads (Miltenyi Biotec, Bergisch Gladbach, Germany) on MACS separator (Miltenyi Biotec, Bergisch Gladbach, Germany) according to manufacturer's protocol. Second, Lin⁻ cells were labeled with different combinations of the following antibodies: c-kit-PerCP/Cy 5.5 (2B8), Sca-1 APC (E13-161.7), CD150 Pe-Cy7 (TC15-12F12.2), CD48 FITC (HM48-1), streptavidin-eFluor450. An Influx instrument (BD Biosciences, San Jose, CA, USA) was employed to sort LT-HSCs according to the following sorting strategy⁴: Lin⁻, c-kit⁺, Sca-1⁺; CD150⁺, CD48⁻. To exclude dead cells, cell suspensions were stained with Hoechst 33258. All antibodies were purchased from BD Biosciences (San Jose, CA, USA), eBioscience (San Diego, CA, USA), BioLegend (San Diego, CA, USA), or Exbio (Praha, Vestec, Czech Republic). Data were acquired using Diva software (BD Biosciences, San Jose, CA, USA) and analyzed with the FlowJo software (Tree Star Incorporation, Ashland, OR, USA).

Morphological analysis and BM differential counting

Morphological analysis and manual leukocyte differential counts of bone marrow cells were performed using May-Grünwald Giemsa stained cytopins. A minimum of 100 cells was analyzed. Blood smears stained with the same technique were used to assess morphology of blood neutrophils.

Methylcellulose colony assays

Myeloid colony culture assays were performed using Methocult M3434 or M3231 (Stemcell Technologies, Vancouver, BC, Canada). M3231 was supplemented with distinct

combinations of recombinant cytokines: murine macrophage colony-stimulating factor (M-CSF, 100 ng/ml), human granulocyte colony-stimulating factor (G-CSF, 50 ng/ml), murine stem cell factor (SCF, 100 ng/ml), murine granulocyte-macrophage colony-stimulating factor (GM-CSF, 20 ng/ml), murine interleukin-3 (IL-3, 30 ng/ml), human thrombopoietin (TPO, 100 ng/ml), and human FMS-like tyrosine kinase 3 ligand (FLT-3 ligand, 100 ng/ml), as indicated. For re-plating assays 1×10^4 whole BM cells were initially plated, after 10-14 days cells were collected, and 1×10^3 cells re-plated. Colonies were scored after 10 to 14 days of *in vitro* culture. All cytokines except G-CSF (Neupogen, Amgen, Thousand Oaks, CA, USA) were purchased from Peprotech.

Limiting dilution assay to measure frequency of LT-HSCs

In BM transplantation assays congenic C57BL/6NCr1 mice (CD45.1⁺) were employed as recipients and lethally irradiated two times using 7,5 Gy with 4 hours interval. Donor cells were isolated from *Cebpg*^{wt/wt} Vav-iCre⁺ (WT) and *Cebpg*^{fl/fl} Vav-iCre⁺ (KO) CD45.2⁺ murine BM. 5 different doses (50, 100, 150, 200, 1000) of LT-HSCs were transplanted along with 0.5×10^6 splenocytes as a support (CD45.1⁺). Blood of recipients was obtained and analyzed 16 weeks after transplantation.

Lipopolysaccharide (LPS), G-CSF, cyclophosphamide and *Candida albicans* (*C. albicans*) treatment

For induction of emergency granulopoiesis, mice were treated as previously described with minor changes⁵. Mice received two intraperitoneal injections with 1400 mg/kg of body weight ultrapure LPS from *Escherichia coli* 0127:B8 (Sigma-Aldrich, St. Louis, MO, USA) 48 hours apart and were analyzed 24 hours after second injection. Alternatively, 250 μ g/kg of body weight of human recombinant G-CSF (Neupogen, Amgen, Thousand Oaks, CA, USA) was injected intraperitoneally in a twelve-hour interval for up to 6 days and analyzed 24 hours after

last injection. Infection with *C. albicans* was performed as described, with minor modifications⁶. Briefly, *C. albicans* (18804, American Type Culture Collection) was plated on Sabouraud dextrose agar plates and grown for 24 hours at 37°C. Plates were stored at 4°C for a maximum of 4 weeks. Before each experiment, one colony was picked from the plate and grown in 5 ml Sabouraud dextrose broth (Sigma-Aldrich, St. Louis, MO, USA) at 37°C overnight. Fungi were washed twice with sterile pyrogen-free phosphate-buffered saline (PBS) and resuspended in PBS. For induction of disseminated candidiasis, mice were injected intravenously in right tail vein with 5×10^5 colony forming units (CFUs) /25 g body weight. Different doses were used in survival experiments, 4×10^5 or 8×10^5 CFUs /25 g body weight. In survival assays, animals were monitored on daily bases and sacrificed when signs of candidemia were evident. The CFU dose counts were verified by diluting and plating the same suspensions with which animals were inoculated. Right kidney was homogenized in 5 ml PBS and dilutions of homogenate were plated on Sabouraud plates and incubated at 37°C for evaluation of fungal burden. Colonies were counted after 36 hours.

Electrophoretic mobility shift assay

Nuclear extracts were isolated from BM or SP cells (4×10^7) by NE-PER Nuclear and Cytoplasmic Extraction Reagents (Thermo Fisher Scientific, Waltham, MA, USA). Electrophoretic mobility shift assay (EMSA) was performed using a probe containing the consensus C/EBP site, as described previously³. Probe was end labeled using ATP, [γ -³²P], 3000 Ci/mmol (PerkinElmer, Waltham, MA) and T4 Polynucleotide Kinase (Thermo Fisher Scientific, Waltham, MA, USA) according to manufacturer's protocol. DNA-protein binding assays were carried out in 25 μ l reaction mixtures containing 3 μ g of nuclear extract, 20 mM HEPES (pH 7.9), 200 mM NaCl, 5 % Ficoll, 1 mM EDTA, 50 mM DTT, 0.01% Nonidet P-40, and 2×10^4

cpm probe. Unspecific binding was reduced by addition of 1.75 μ g Poly (dI-dC). After incubation for 20 min at room temperature, binding reaction was loaded onto 7% polyacrylamide gel in TBE (90 mM Tris base, 90 mM boric acid, 0.5 mM EDTA) buffer and electrophoresed at 160 V for 4 h. The gel was dried before autoradiography and analysed using Molecular Imager FX Pro Plus (Biorad, CA, USA). Supershift assays were assigned by preincubation of the nuclear extract with 2 μ g of the appropriate antibody at 4°C for 30 min (C/EBP α (D5) Ab, C/EBP β (C19) Ab, both obtained from Santa Cruz Biotechnology, Dallas, TX, USA) or overnight (mC/EBP γ -01, homemade) before the addition of the binding reaction mixture.

Gene expression analysis

Total RNA was isolated from LT-HSC, defined as lineage⁻, c-kit⁺, Sca-1⁺, CD48⁻, CD150⁺ sorted from WT and *Cepbg* KO murine bone marrow. RNA extraction was performed using RNeasy Plus Mini Kit (Qiagen). RNA integrity was analyzed by Agilent Bioanalyzer 2100 (Agilent), and only samples with intact RNA profiles were used for expression profiling (RIN > 7). Four biological replicates were used for each phenotype. 600 pg RNA was amplified with PicoSL WTASystem V2 (NuGEN), labeled with Encore Biotin IL Module (NuGEN) and 750 ng of labeled RNA was hybridized on MouseRef-8 v2.0 Expression BeadChip (Illumina) according to the manufacturer procedure. Raw data were processed using the bead array package of Bioconductor and analyzed as described previously⁷. Gene set enrichment analysis (GSEA) was performed using the Enrichr gene analysis tool (<http://amp.pharm.mssm.edu/Enrichr>)⁸. Microarray data were deposited in ArrayExpress (<http://www.ebi.ac.uk/arrayexpress>) under accession number E-MTAB-6245.

Statistical analysis

LT-HSCs frequencies were calculated by the Extreme Limiting Dilution Analysis software⁹ using Poisson statistics and the method of maximum likelihood to the proportion of negative recipients in a limiting dilution setting. Survival analysis was performed using the Kaplan-Meier method. Differences between survival distributions were analyzed using the log-rank (Mantle-Cox) test. Otherwise, statistical significance for indicated data sets was determined using two-sided, unpaired Student t-test. Statistical computations were performed using GraphPad Prism. P values <0.05 were considered statistically significant. Scatter dot plots indicate mean with standard deviation (s.d).

Supplementary References

1. Shimshek DR, Kim J, Hubner MR, et al. Codon-improved Cre recombinase (iCre) expression in the mouse. *Genesis*. 2002;32(1):19-26.
2. Georgiades P, Ogilvy S, Duval H, et al. VavCre transgenic mice: a tool for mutagenesis in hematopoietic and endothelial lineages. *Genesis*. 2002;34(4):251-256.
3. Parkin SE, Baer M, Copeland TD, Schwartz RC, Johnson PF. Regulation of CCAAT/enhancer-binding protein (C/EBP) activator proteins by heterodimerization with C/EBP γ (Ig/EBP). *J Biol Chem*. 2002;277(26):23563-23572.
4. Kiel MJ, Yilmaz OH, Iwashita T, Terhorst C, Morrison SJ. SLAM family receptors distinguish hematopoietic stem and progenitor cells and reveal endothelial niches for stem cells. *Cell*. 2005;121(7):1109-1121.
5. Boettcher S, Gerosa RC, Radpour R, et al. Endothelial cells translate pathogen signals into G-CSF-driven emergency granulopoiesis. *Blood*. 2014;124(9):1393-1403.
6. Basu S, Hodgson G, Zhang HH, Katz M, Quilici C, Dunn AR. "Emergency" granulopoiesis in G-CSF-deficient mice in response to *Candida albicans* infection. *Blood*. 2000;95(12):3725-3733.
7. Melenovsky V, Benes J, Skaroupkova P, et al. Metabolic characterization of volume overload heart failure due to aorto-caval fistula in rats. *Mol Cell Biochem*. 2011;354(1-2):83-96.
8. Chen EY, Tan CM, Kou Y, et al. Enrichr: interactive and collaborative HTML5 gene list enrichment analysis tool. *BMC Bioinformatics*. 2013;14:128.
9. Hu Y, Smyth GK. ELDA: extreme limiting dilution analysis for comparing depleted and enriched populations in stem cell and other assays. *J Immunol Methods*. 2009;347(1-2):70-78.

10. Satake S, Hirai H, Hayashi Y, et al. C/EBPbeta is involved in the amplification of early granulocyte precursors during candidemia-induced "emergency" granulopoiesis. *J Immunol.* 2012;189(9):4546-4555.

Supplementary Table S1. List of top 20 probes downregulated in *Cebpg* KO versus WT LT-HSC (p<0.05 and fold change >1).

Symbol	Gene name	ID	Entrez	Ensembl	Log FC	p-value	FDR	signal KO	signal WT
Fadd	Fas (TNFRSF6)-associated via death domain	ILMN_2662509	14082	ENSMUSG00000031077	-3.38	0.00014	0.34	4.938	-8.316
Rhd	Rh blood group, D antigen	ILMN_2651609	19746	ENSMUSG00000028825	-2.8	0.0057	0.95	5.504	-8.308
Tango2	transport and golgi organization 2	ILMN_2842999	27883	ENSMUSG00000013539	-2.56	0.0018	0.95	5.868	-8.427
Cd163	CD163 antigen	ILMN_2964560	93671	ENSMUSG00000008845	-2.51	0.017	0.95	4.425	-6.934
Cwf1912	CWF19-like 2, cell cycle control (<i>S. pombe</i>)	ILMN_2860135	244672	ENSMUSG00000025898	-2.42	0.03	0.95	6.077	-8.499
Ttpal	tocopherol (alpha) transfer protein-like	ILMN_2722769	76080	ENSMUSG00000017679	-2.39	0.023	0.95	5.596	-7.983
Get4	golgi to ER traffic protein 4 homolog (<i>S. cerevisiae</i>)	ILMN_2621472	67604	ENSMUSG00000025858	-2.36	0.034	0.95	6.218	-8.576
Dst	dystonin	ILMN_1244098	13518	ENSMUSG00000026131	-2.36	0.0025	0.95	6.616	-8.978
Galnt2	UDP-N-acetyl-alpha-D-galactosamine:polypeptide N-acetylgalactosaminyl-transferase 2	ILMN_1240257	108148	ENSMUSG0000008970, ENSMUSG00000092329	-2.32	0.035	0.95	5.988	-8.307
Rap2c	RAP2C, member of RAS oncogene family	ILMN_3058391	72065	ENSMUSG00000050029	-2.32	0.022	0.95	6.838	-9.162
Camta2	calmodulin binding transcription activator 2	ILMN_1220834	216874	ENSMUSG00000040712	-2.31	0.027	0.95	5.813	-8.122
Suds3	suppressor of defective silencing 3 homolog (<i>S. cerevisiae</i>)	ILMN_2609948	71954	ENSMUSG00000066900	-2.31	0.0032	0.95	5.139	-7.453
Irf9	interferon regulatory factor 9	ILMN_1233461	16391	ENSMUSG00000002325	-2.28	0.07	0.95	6.062	-8.347
Mbd1	methyl-CpG binding domain protein 1	ILMN_1224291	17190	ENSMUSG00000024561	-2.24	0.0032	0.95	6.323	-8.562
Odf3b	outer dense fiber of sperm tails 3B	ILMN_2759088	70113	ENSMUSG00000047394	-2.23	0.0043	0.95	5.171	-7.401
Ifngr1	interferon gamma receptor 1	ILMN_2651575	15979	ENSMUSG00000020009	-2.21	8.90E-06	0.093	4.920	-7.134
Pif1	PIF1 5'-to-3' DNA helicase homolog (<i>S. cerevisiae</i>)	ILMN_2714678	208084	ENSMUSG00000041064	-2.19	0.034	0.95	4.727	-6.919
Vimp	VCP-interacting membrane protein	ILMN_1214090	109815	ENSMUSG00000075701	-2.17	0.00052	0.62	5.583	-7.754
Get4	golgi to ER traffic protein 4 homolog (<i>S. cerevisiae</i>)	ILMN_2621471	67604	ENSMUSG00000025858	-2.15	0.036	0.95	6.033	-8.179
Zfp868	zinc finger protein 868	ILMN_3143088	234362	ENSMUSG00000060427	-2.15	0.00051	0.62	4.967	-7.116

Supplementary Table S2. List of top 20 probes upregulated in *Cebpg* KO versus WT LT-HSC

(p<0.05 and fold change >1).

Symbol	Gene name	ID	Entrez	Ensembl	Log FC	p-value	FDR	signal KO	signal WT
Srek1	splicing regulatory glutamine/lysine-rich protein 1	ILMN_2662996	218543	ENSMUSG00000032621	2.04	0.0082	0.95	7.510	-5.470
Ppp2r5d	protein phosphatase 2, regulatory subunit B (B56), delta isoform	ILMN_2608394	21770	ENSMUSG00000059409	2.06	0.059	0.95	6.822	-4.763
Mblac2	metallo-beta-lactamase domain containing 2	ILMN_3160416	72852	ENSMUSG00000051098	2.08	0.11	0.95	7.142	-5.059
Tmem9b	TMEM9 domain family, member B	ILMN_1246495	56786	ENSMUSG00000031021	2.09	0.0065	0.95	7.740	-5.654
Dnajc30	DnaJ (Hsp40) homolog, subfamily C, member 30	ILMN_2465068	66114	ENSMUSG00000061118	2.1	0.0015	0.95	7.181	-5.079
Ap2b1	adaptor-related protein complex 2, beta 1 subunit	ILMN_2655488	71770	ENSMUSG00000035152	2.11	0.0039	0.95	7.091	-4.983
Uck2	uridine-cytidine kinase 2	ILMN_2880529	80914	ENSMUSG00000026558	2.12	0.018	0.95	8.759	-6.642
Acad8	acyl-Coenzyme A dehydrogenase family, member 8	ILMN_2615170	66948	ENSMUSG00000031969	2.13	0.036	0.95	6.984	-4.857
Nampt	nicotinamide phospho-ribosyltransferase	ILMN_2821850	59027	ENSMUSG00000020572	2.13	0.0057	0.95	7.961	-5.829
Kbtbd7	kelch repeat and BTB (POZ) domain containing 7	ILMN_3077630	211255	ENSMUSG00000043881	2.15	0.039	0.95	8.187	-6.036
Pdcl	phosducin-like	ILMN_2997256	67466	ENSMUSG0000009030	2.16	0.0056	0.95	7.245	-5.087
Fam199x	family with sequence similarity 199, X-linked	ILMN_2632964	245622	ENSMUSG00000042595	2.19	0.0027	0.95	7.945	-5.752
Nars2	asparaginyl-tRNA synthetase 2 (mitochondrial), (putative)	ILMN_1241088	244141	ENSMUSG00000018995	2.24	0.00035	0.54	7.448	-5.207
Rnf185	ring finger protein 185	ILMN_2732291	193670	ENSMUSG00000020448	2.28	0.035	0.95	6.808	-4.527
Pycard	PYD and CARD domain containing	ILMN_2936476	66824	ENSMUSG00000030793	2.31	0.026	0.95	8.093	-5.781
Tcf12	transcription factor 12	ILMN_1215928	21406	ENSMUSG00000032228	2.42	0.012	0.95	8.016	-5.601
Tapbp1	TAP binding protein-like	ILMN_2974611	213233	ENSMUSG00000038213	2.49	9.20E-05	0.34	7.759	-5.271
Erlin2	ER lipid raft associated 2	ILMN_1246564	244373	ENSMUSG00000031483	2.51	0.022	0.95	7.237	-4.723
Rbm6	RNA binding motif protein 6	ILMN_2738475	19654	ENSMUSG00000032582	2.55	0.00086	0.77	9.874	-7.328
Cdk5r1	cyclin-dependent kinase 5, regulatory subunit 1 (p35)	ILMN_1259339	12569	ENSMUSG00000048895	3.07	0.031	0.95	9.291	-6.219

Supplementary Table S3. *Cebpg* deletion in LT-HSC results in differential pathway

enrichment analysis. Results of KEGG 2016 (A) and Panther 2016 (B) pathway analysis of differentially expressed genes ($p < 0.05$ and fold change > 1) in WT versus *Cebpg* KO LT-HSC.

A.

Index	Name	P-value	Adjusted p-value	Z-score	Combined score
1	Chagas disease (American trypanosomiasis)_Homo sapiens_hsa05142	0.001271	0.2492	-1.83	12.22
2	Endocrine and other factor-regulated calcium reabsorption_Homo sapiens_hsa04961	0.00256	0.2509	-1.96	11.69
3	Endocytosis_Homo sapiens_hsa04144	0.00691	0.4515	-1.91	9.51
4	Glycosphingolipid biosynthesis - lacto and neolacto series_Homo sapiens_hsa00601	0.01527	0.7483	-1.37	5.75
5	Long-term depression_Homo sapiens_hsa04730	0.03349	0.9493	-1.8	6.12
6	Colorectal cancer_Homo sapiens_hsa05210	0.03714	0.9493	-1.81	5.95
7	mRNA surveillance pathway_Homo sapiens_hsa03015	0.03787	0.9493	-1.56	5.11
8	Primary bile acid biosynthesis_Homo sapiens_hsa00120	0.04573	0.9493	-0.69	2.13
9	FoxO signaling pathway_Homo sapiens_hsa04068	0.05422	0.9493	-1.62	4.73
10	Terpenoid backbone biosynthesis_Homo sapiens_hsa00900	0.07273	0.9493	-0.88	2.31

B.

Index	Name	P-value	Adjusted p-value	Z-score	Combined score
1	DNA replication_Homo sapiens_P00017	0.056	0.7712	-1.36	3.92
2	Apoptosis signaling pathway_Homo sapiens_P00006	0.05686	0.7712	-1.6	4.57
3	De novo purine biosynthesis_Homo sapiens_P02738	0.09711	0.7712	-1	2.33
4	Coenzyme A biosynthesis_Homo sapiens_P02736	0.1158	0.7712	0.63	-1.36
5	N-acetylglucosamine metabolism_Homo sapiens_P02756	0.1158	0.7712	1.56	-3.36
6	FAS signaling pathway_Homo sapiens_P00020	0.1302	0.7712	-0.69	1.41
7	p38 MAPK pathway_Homo sapiens_P05918	0.1371	0.7712	-0.69	1.37
8	FGF signaling pathway_Homo sapiens_P00021	0.1423	0.7712	-0.95	1.85
9	p53 pathway_Homo sapiens_P00059	0.1749	0.7712	-0.72	1.25
10	EGF receptor signaling pathway_Homo sapiens_P00018	0.1811	0.7712	-0.89	1.51

Supplementary Table S4. Primer sequences used in the study. Oligos a-c were employed for genotyping; c-b amplified the Cebpg WT allele, a-b the Cebpg floxed allele, and d-e demonstrated Cebpg excision. m in oligo name indicates murine.

	Oligo Name	Application	Primer 5'- 3'
Forward	a	Genotyping PCR	CTCCAGACTGCCTTGGGAAA
Reverse	b	Genotyping PCR	AAAGAGCCATTTCTGGGGAAGT
Forward	c	Genotyping PCR	AGTGTCATTCATACTCAGGCACA
Forward	Vav-iCre	Genotyping PCR	AGATGCCAGGACATCAGGAACCTG
Reverse	Vav-iCre	Genotyping PCR	ATCAGCCACACCAGACACAGAGATG
Forward	Flp	Genotyping PCR	TACTTCTTTAGCGCAAGGGGTAG
Reverse	Flp	Genotyping PCR	TCCCACAACATTAGTCAACTCCG
Forward	d	Excision PCR	TACGGTTTGCAGTTGCTGTC
Reverse	e	Excision PCR	AGGAACTGCTTCCTTCACGA
Forward	f	Excision RT PCR	CTTCTGAGCCAACCTTACCTTTTG
Reverse	g	Excision RT PCR	TGCATGGACTTATAACACAGTAGG
Forward	mCebpg	RT PCR	GCGCAGAGAGCGGAACAA
Reverse	mCebpg	RT PCR	GTATCTTGAGCTTTCTGCTTGCT
Forward	mGapdh	RT PCR	CCAGCCTCGTCCCGTAGAC
Reverse	mGapdh	RT PCR	CCCTTGACTGTGCCGTTG
Forward	Tomato	RT PCR	ACCTGGTGGAGTTCAAGA
Reverse	Tomato	RT PCR	TGGTGTAGTCCTCGTTGT
Forward	mMMP9	RT PCR	ACGGTTGGTACTGGAAGTTCC
Reverse	mMMP9	RT PCR	CCAACCTATCCAGACTCCTGG
Forward	mLactoferrin	RT PCR	TATTTCTTGAGGCCCTTGGA
Reverse	mLactoferrin	RT PCR	TCTCATCTCGTTCTGCCACC
Forward	mCathepsinG	RT PCR	CTGACTAAGCAACGGTTCTGG
Reverse	mCathepsinG	RT PCR	GATTGTAATCAGGATGGCGG
Forward	mELA 2	RT PCR	ACTCTGGCTGCCATGCTACT
Reverse	mELA 2	RT PCR	GCCACCAACAATCTCTGA
Forward	mMPO	RT PCR	GGAAGGAGACCTAGAGG
Reverse	mMPO	RT PCR	TAGCACAGGAAGGCCAAT

Supplementary Figure 1

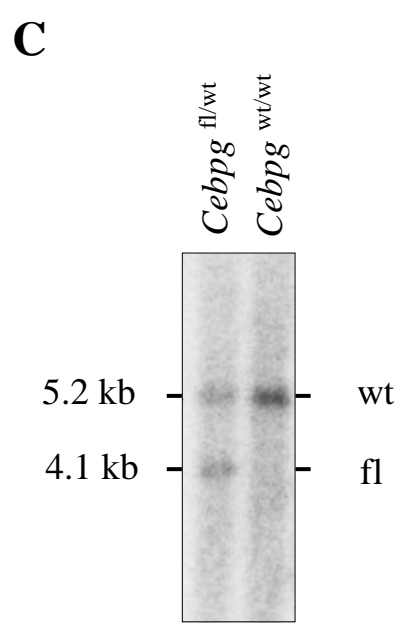
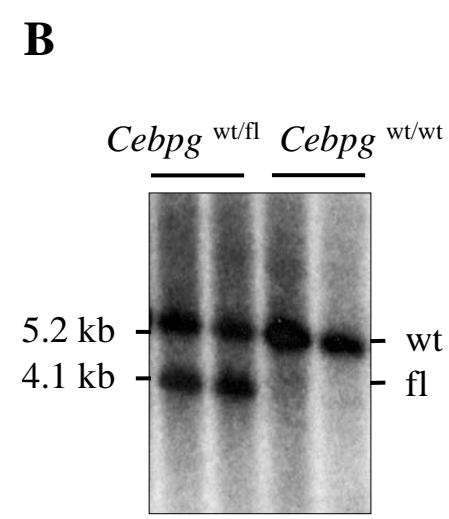
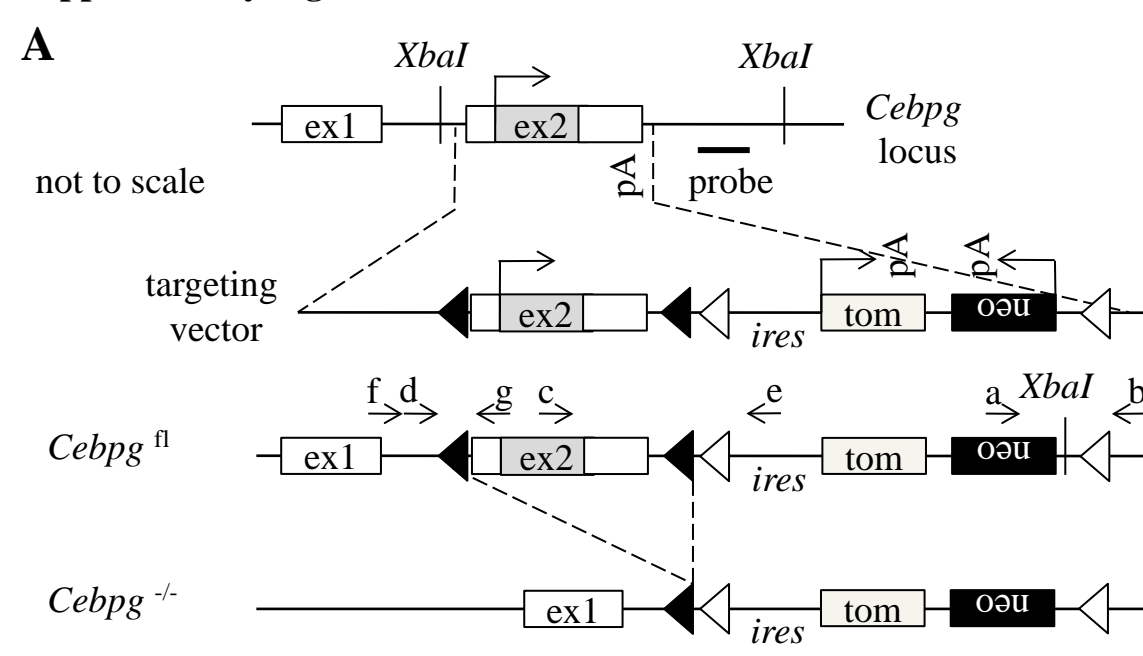

Supplementary Figure 1. Generation of conditional *Cebpg* knock-in/knock-out mice. (A) *Cebpg* conditional allele. The *Cebpg* targeting construct containing exon 2 (ex2) of *Cebpg* surrounded by Lox P sites (◄) and a reporter cassette flanked by Frt sites (◄). The reporter cassette contains an internal ribosome entry site-tdTomato (ires-tom) and the selection marker neomycin (neo). Arrows indicate the direction of transcription. The targeting construct was introduced into the *Cebpg* locus by homologous recombination to generate the *Cebpg*^{fl} allele. When crossing to Vav-iCre transgenic mouse strain^{1,2}, exon 2 was deleted, generating *Cebpg*^{-/-}, referred here as KO. Letters from a to g indicate primer location for genotyping and excision. 3'probe indicates probe location for southern blot analysis. (B-C) Southern blot analysis of *XbaI*-digested ES clones (B) and tail DNA isolated from murine chimeras (C). A 3'probe was used for hybridization, which detected a 5.2 kb fragment for the WT allele (WT) and a 4.1 kb fragment for the *Cebpg*^{fl} allele (fl).

Supplementary Figure 2

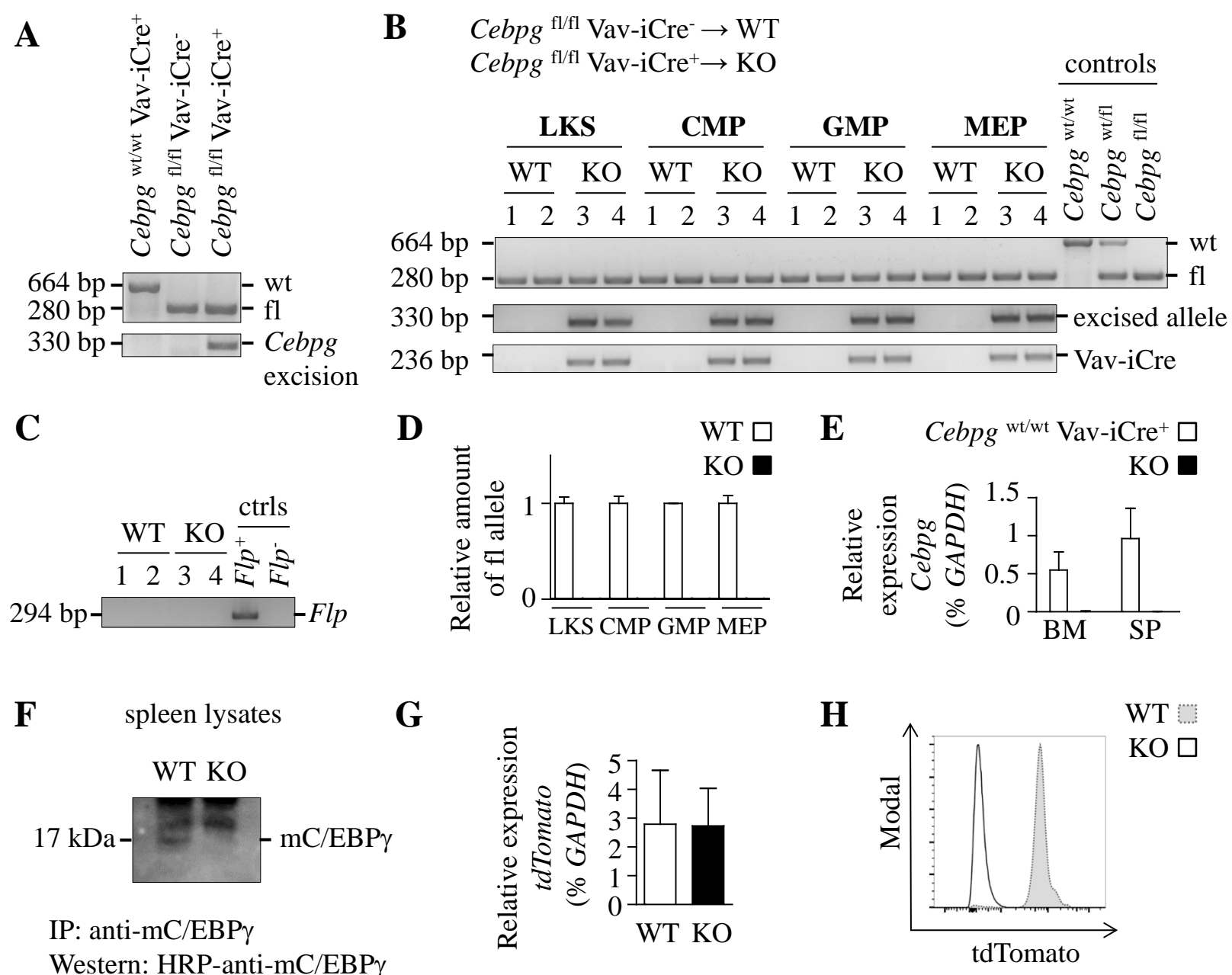

Supplementary Figure 2. Conditional deletion of *Cebpg* in mice. Unless indicated otherwise WT refers to *Cebpg*^{fl/fl} *Vav-iCre*⁻ and KO to *Cebpg*^{fl/fl} *Vav-iCre*⁺. (A-C) Genotyping and excision PCR using tail (A and C) and progenitor (B) gDNA. A 664 bp band indicates amplification of the wild-type allele (wt, oligos c-b), a 280 bp band indicates amplification of the floxed allele (fl, oligos a-b), a 330 bp band (oligos d-e) indicates excision of the floxed allele, and a 236 bp indicates presence of *Vav-iCre* transgene. Mice were not crossed to *Flp* mice, as shown by the absence of a *Flp* band (294 bp). As controls (last 2 lanes), tail gDNA from *Flp*⁺ and *Flp*⁻ mice was used. Number 1 and 2 indicate material isolated from 2 WT mice, and 3 and 4 indicate material from 2 KO mice. (D) Quantitative RT-PCR using gDNA isolated from sorted BM populations (LKS, CMP, GMP, MEP) demonstrate absence of floxed allele upon excision in KO mice. LKS: population Lineage⁻, c-kit⁺, Sca1⁺; CMP: common myeloid progenitors; GMP: granulocyte-monocyte progenitors; MEP: megakaryocyte-erythroid progenitors. (E) Quantitative RT-PCR in BM and SP cells isolated from WT (*Cebpg*^{wt/wt} *Vav-iCre*⁺) and *Cebpg* KO (*Cebpg*^{fl/fl} *Vav-iCre*⁺) mice. Y axis indicates *Cebpg* expression relative to *Gapdh*. (F) Western blot analysis for C/EBP γ expression in WT and *Cebpg* KO mice splenocytes. C/EBP γ protein was immunoprecipitated using the anti-mC/EBP γ antibody and samples were assessed by western blotting using the same antibody. Positions of m.w. standards (kDa) are shown on the left. (G) Quantitative RT-PCR in BM cells isolated from WT and *Cebpg* KO mice. Y axis indicates *tdTomato* expression relative to *Gapdh*. (H) Representative flow cytometry histogram. X axis indicate *tdTomato* expression in WT (shaded area) and *Cebpg* KO (white area) BM cells. Surprisingly, although *tdTomato* mRNA levels were preserved upon cre-mediated excision, *tdTomato* protein could not be detected by flow cytometric analysis or western blot analysis (data not shown). We hypothesize that the discrepancy is caused by either generation of an alternative RNA 17 splicing form between exon 1 and tomato, or by generation of a non-functional IRES upon excision.

Supplementary Figure 3

A

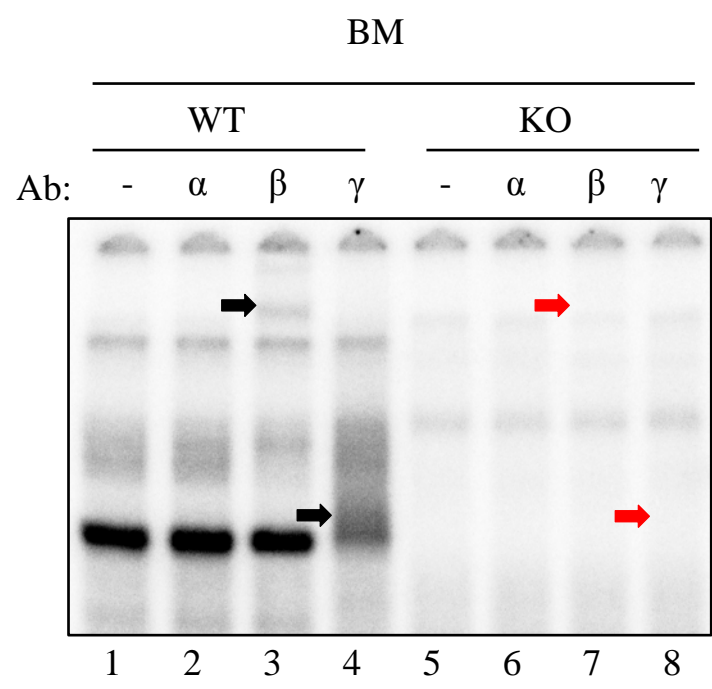

B

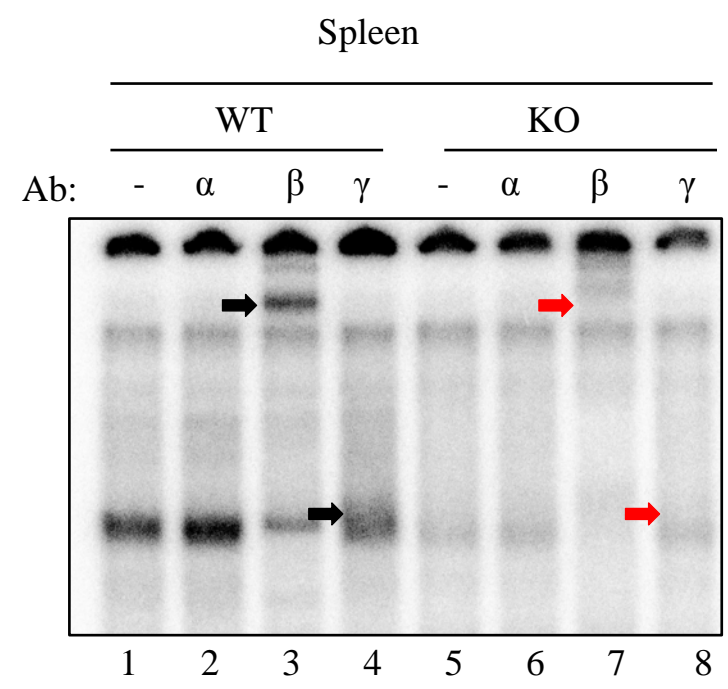

Supplementary Figure 3. Heterodimers formed by C/EBP γ and C/EBP β , but not C/EBP α , are present in the nucleoli of BM and SP cells. (A-B) Electrophoretic mobility shift assays performed using radiolabeled consensus C/EBP site probe³ in the absence (-) or presence of antibodies (Ab) against C/EBP α (α), C/EBP β (β) and C/EBP γ (γ). Nuclear extracts were isolated from BM (A) or SP (B) cell lysates of WT and *Cebpg* KO mice. The presence of C/EBP γ :C/EBP β heterodimers was confirmed by antibody supershift (lanes 3 and 4). Black arrows indicate complex supershifted with C/EBP β and C/EBP γ antibody in WT nuclear extracts, whereas red arrows show that this complex is missing in *Cebpg* KO BM and SP (lanes 7 and 8). The gel was cropped to show only the region containing DNA-protein complexes. Representative pictures of 3 independent experiments are shown.

Supplementary Figure 4

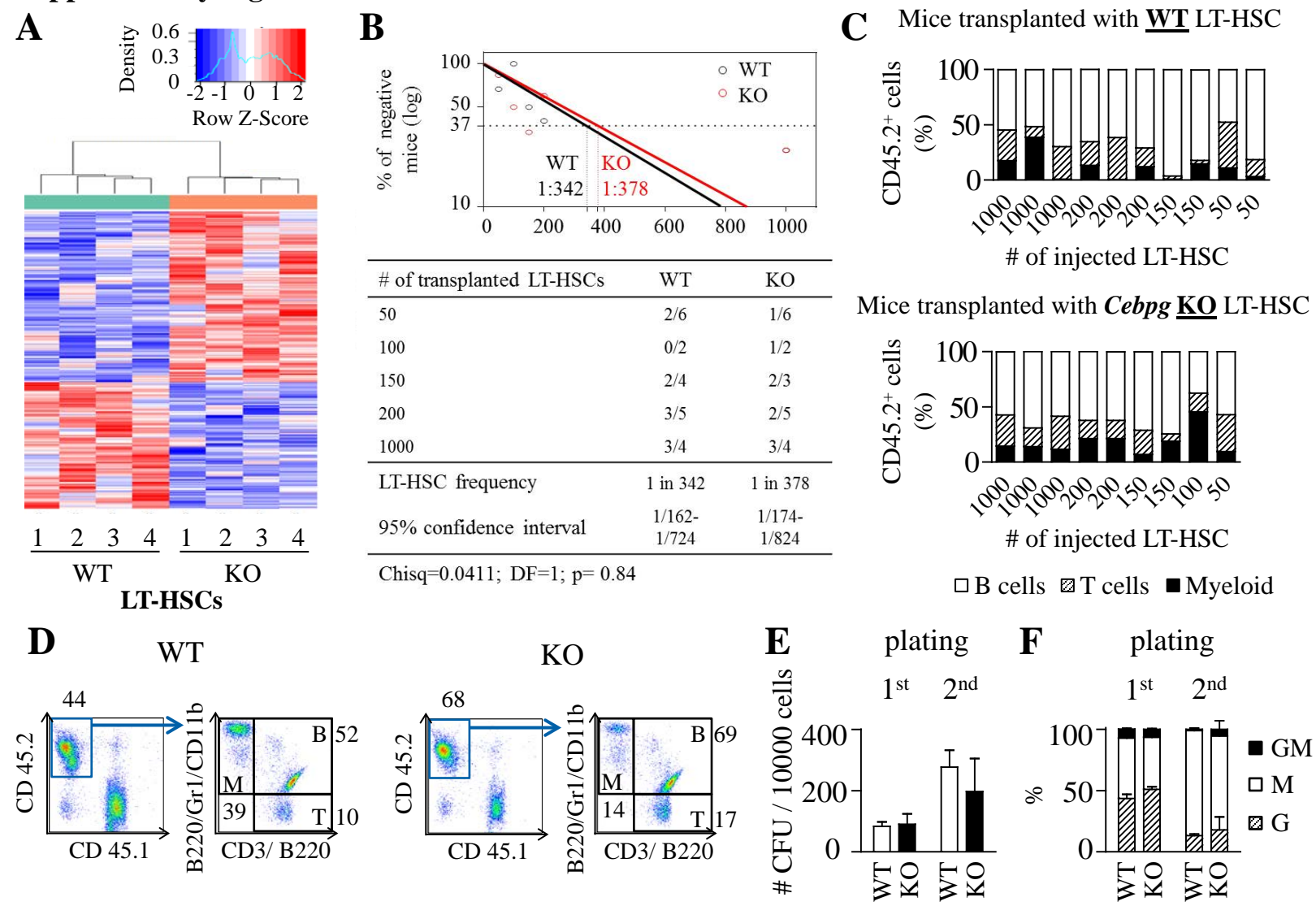

Supplementary Figure 4. *Cebpg* KO HSCs retain normal BM repopulating abilities in primary transplanted recipients. (A) Heat map visualization of hierarchical clustering of genes differentially regulated in *Cebpg* KO versus WT LT-HSCs (426 probes, $p < 0.05$ and fold change > 1). LT-HSCs were isolated from WT and *Cebpg* KO murine BM and sorted according to expression of LKS SLAM⁺ markers⁴. Data were normalized to z-scores for each gene. Red/blue color indicates increase/decrease in gene expression relative to the universal mean for each gene. For detailed list of top 20 downregulated/upregulated genes see Supplementary Table S1 and S2. (B) Frequency of functional LT-HSCs after *Cebpg* deletion measured by limiting dilution assay. Upper panel: logarithmic plot showing the percentage of negative recipients transplanted with different cell doses of sorted WT or *Cebpg* KO LT-HSCs. Only recipients at 20 weeks with engraftment of Ly5.2 cells $\geq 1\%$ and contribution to all lineages (T cells, B cells and granulocytes) higher than 0.5 % were considered responders. Lower panel: table showing the number of responders and the total number of recipients transplanted per cell dose. Frequencies of LT-HSCs were calculated according to Poisson statistics using ELDA software based on data from three independent experiments (Chi-square test; Chisq= 0.0411; $p=0.84$). (C) Contribution of donor LT-HSCs (CD45.2+) to tri-lineage reconstitution (myeloid, B-cell and T-cell) evaluated by flow cytometric analysis. Each column represents a mouse considered responder transplanted with WT (upper panel) or *Cebpg* KO (lower panel) donor LT-HSC. Analysis was performed 20 weeks after transplantation. Number shown in x axes indicates the number of transplanted LT-HSCs per recipient. (D) Flow cytometric strategy to determine the percentage of myeloid cells (M), B cells (B), and T cells (T) in WT and *Cebpg* KO peripheral blood (PB). Blue box represents the percentage of donor cells as determined by the CD45.2 positivity. (E) Colony re-plating assays of WT (white bars) and *Cebpg* KO (black bars) BM cells using Methocult M3434. Initially 10000 BM nucleated cells were plated per well (1st plating) and 1000 cells were re-plated (2nd plating). Colonies were quantified under microscope and re-plated after 10-14 days in semisolid medium. The y axis indicates the number of colony forming units (CFUs) per 10000 cells. Results indicate the average of 3 independent cultures. (F) Quantification of CFU-GM, CFU-M, and CFU-G in semi-solid cultures (day 12) from WT and *Cebpg* deficient mice in 1st and 2nd plating as indicated. The y axis indicates the percentage of colonies relative to 100. Average and s.d of 3 independent experiments. 19

Supplementary Figure 5

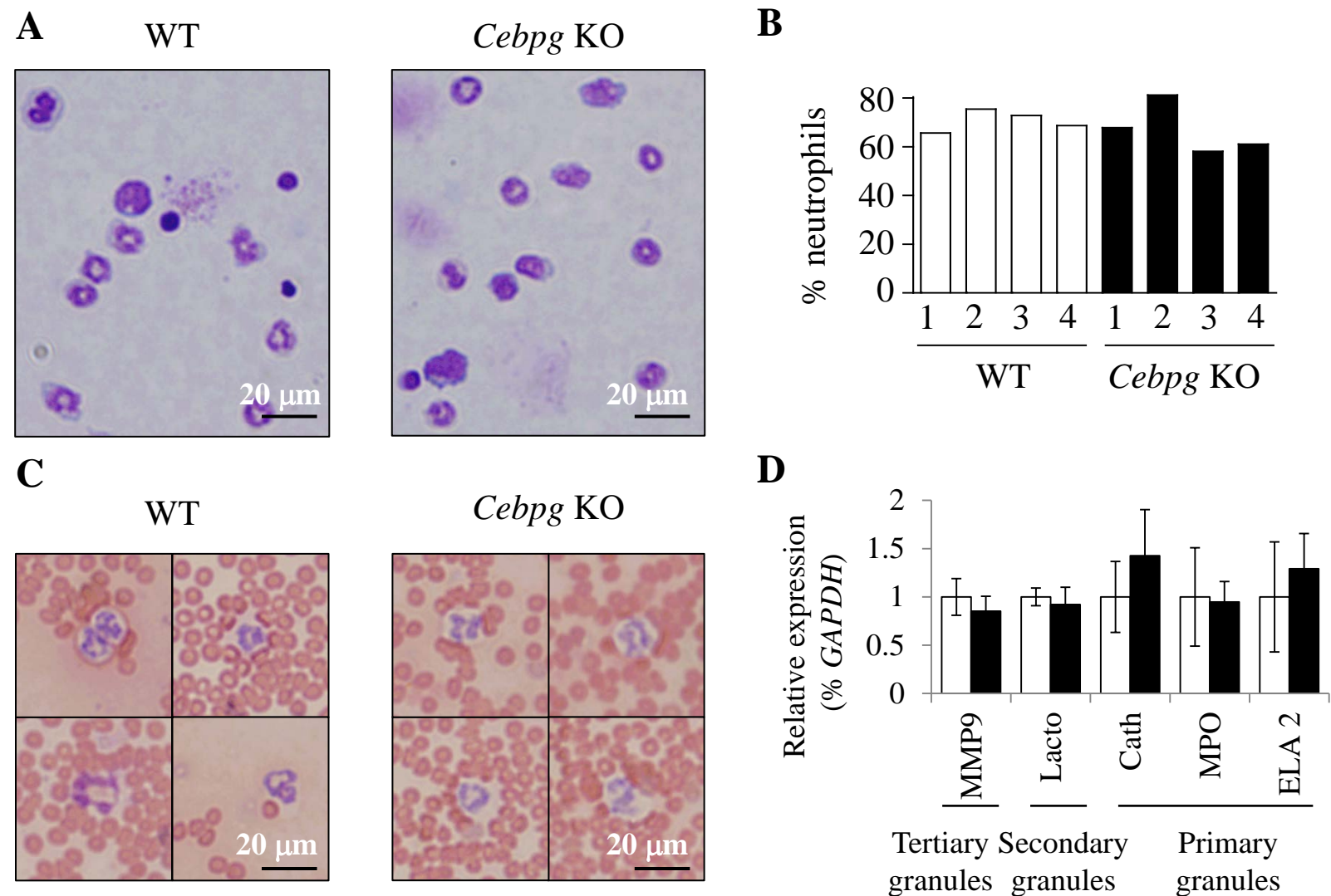

Supplementary Figure 5. Neutrophils from *Cebpg* KO mice exhibit normal morphology, BM differential counts and have similar granule content as control littermates. (A) Representative pictures of WT (left panel) and *Cebpg* KO (right panel) bone marrow cells. Cytospins from BM single cell suspensions were stained with May-Grünwald Giemsa. Scale bar 20 μ m. (B) BM differential counting was performed counting 100-200 leukocytes per one cytopsin. Y-axis indicates the percentage of neutrophils. Each group contains 4 mice. Data are representative of two independent experiments. (C) Morphological analysis of mature neutrophils by blood smears from WT (left panel) and *Cebpg* KO (right panel) mice stained with May-Grünwald Giemsa. Mature neutrophils have characteristic segmented nuclei. Pictures are representative of two independent experiments. Scale bar 20 μ m. (D) Quantitative RT-PCR on WT and *Cebpg* KO BM cells. Y-axis represents relative expression as % of *Gapdh*. *MMP9* (Matrix metalloproteinase 9), *Lacto* (Lactoferrin), *Cath* (Cathepsin G), *MPO* (Myeloperoxidase), and *ELA 2* (Neutrophil elastase 2). Each group contains 4 mice. Data are representative of two independent experiments.

Supplementary Figure 6

A

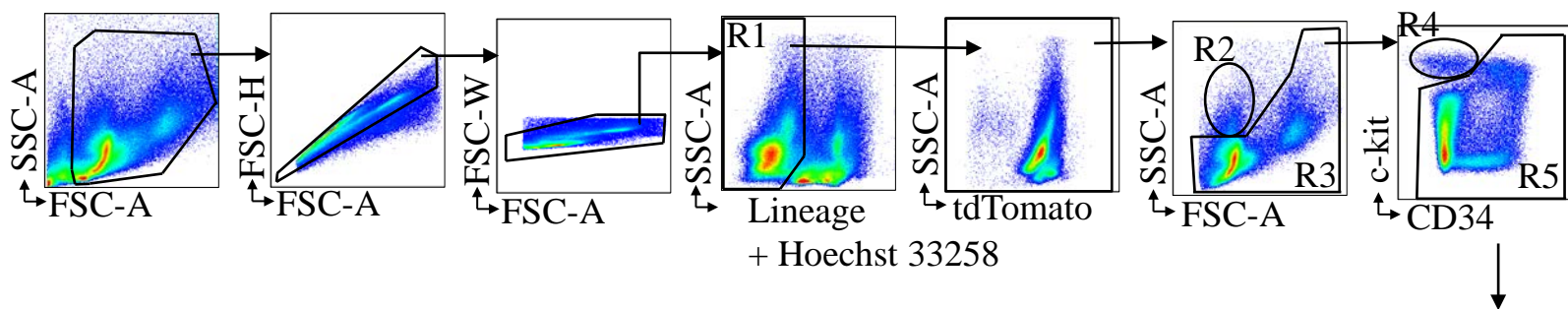

B

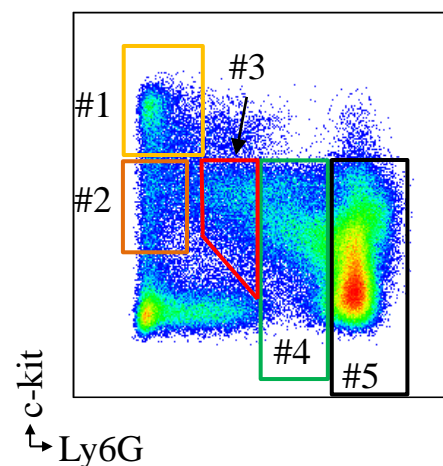
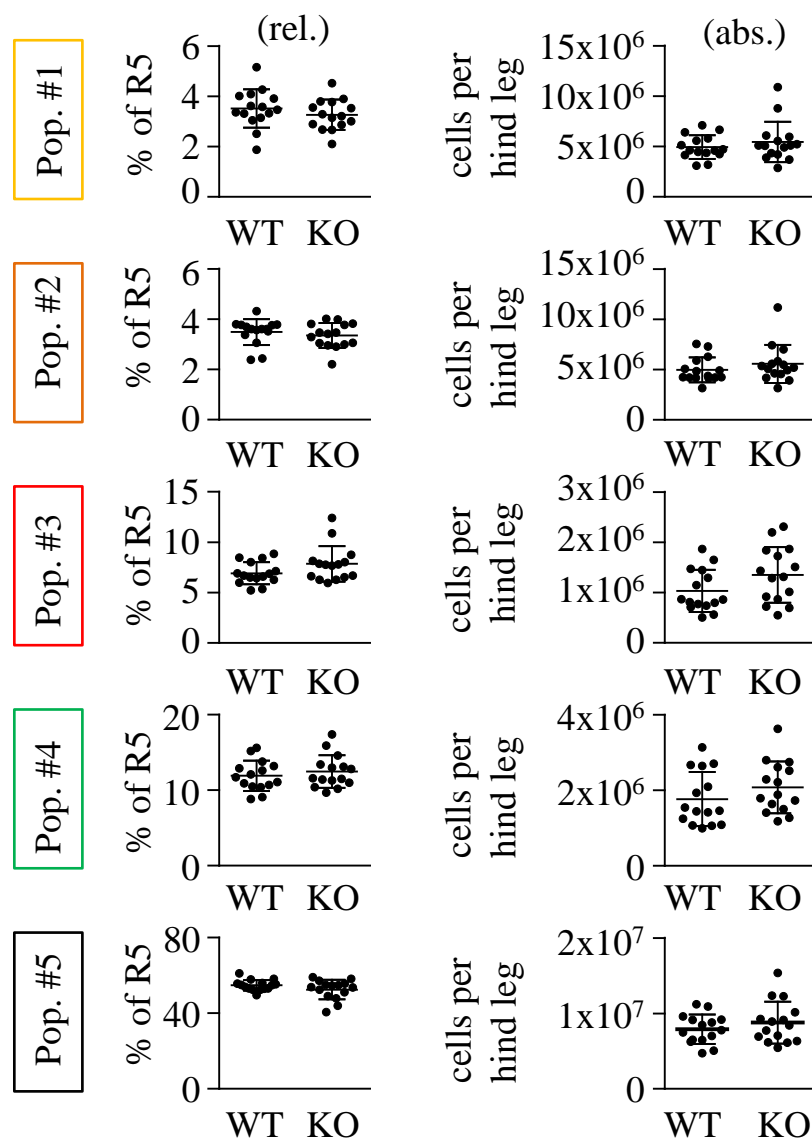

Supplementary Figure 6. Detailed analysis of granulopoietic compartment in BM. (A) Representative flow cytometric plots demonstrating gating strategy. Cells with no potential to give rise to granulocytes were excluded (lineage⁺, R2, and R4). The remaining cells (R5) were further separated according to cell surface expression of c-kit and Ly6G. Populations from #1 (yellow box) through #2 (orange box), #3 (red box), #4 (green box) to #5 (black box) represent a gradient of differentiation, where #5 harbors the most mature neutrophils. For further details refer to¹⁰. (B) Relative (rel) and absolute (abs) quantification of populations #1 to #5 in WT and *Cebpg* KO BM cells.

Supplementary Figure 7

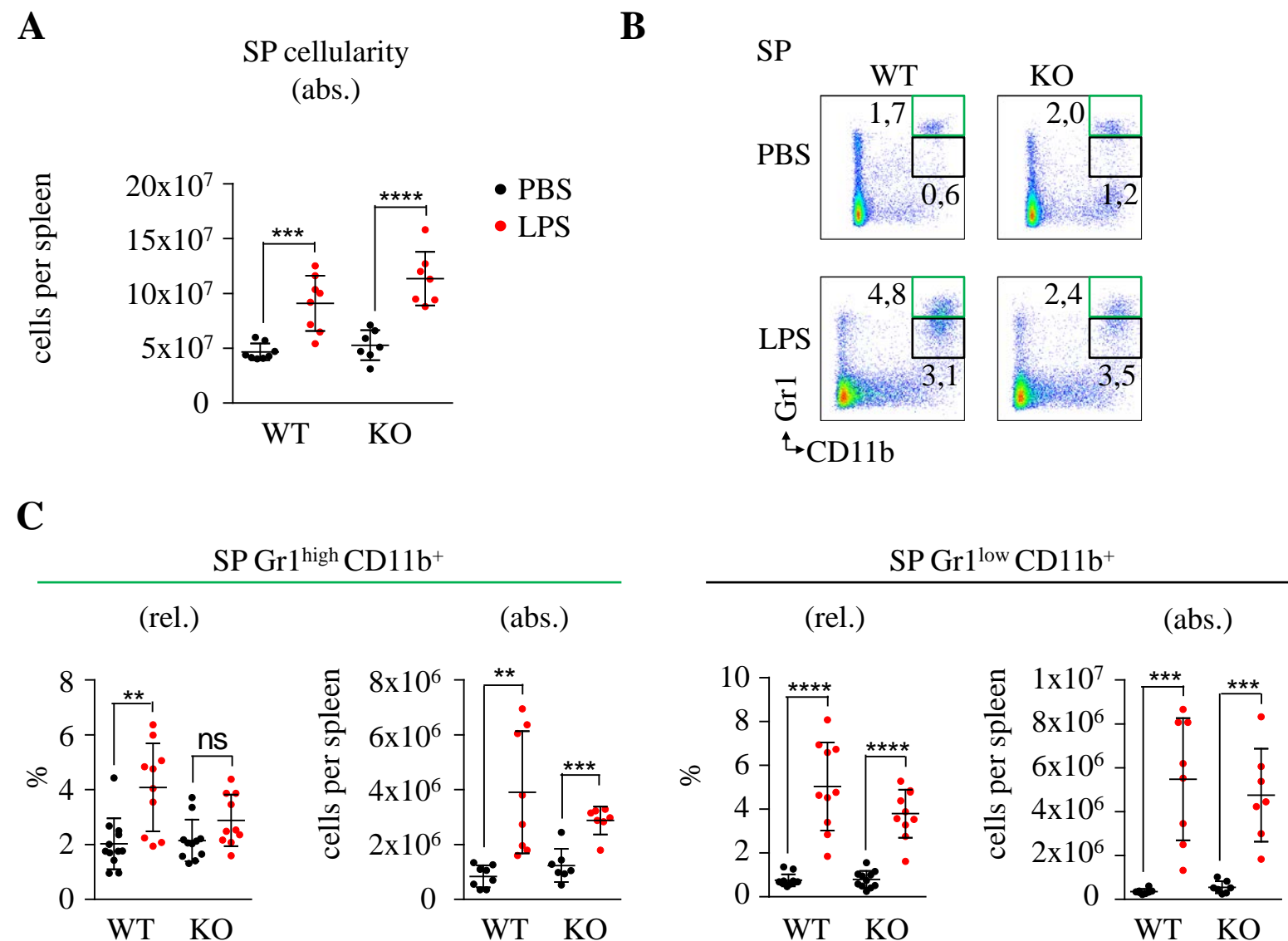

Supplementary Figure 7. *Cebpg* KO mice respond normally to LPS injection. (A) SP cellularity in WT (n=8 in each condition) and KO (n=7 in each condition) mice treated with PBS vehicle control (black) or LPS (red). Y axis indicates the number of cells per spleen. (B) Representative flow cytometry plots from WT and *Cebpg* KO SP cells 72 hours after first PBS or LPS injection. Cells were stained for Gr1 and CD11b cell surface markers. Green boxes indicate percentage of Gr1^{high} CD11b⁺ cells and black boxes indicate percentage of Gr1^{low} CD11b⁺ cells. (C) Quantification of panel B. At least 7 animals were included in each group. Panels indicate relative (rel) and absolute (abs) number of Gr1^{high} CD11b⁺ cells (left) and Gr1^{low} CD11b⁺ cells (right). Black symbols indicate PBS vehicle control and red symbols indicate LPS treated mice. Two-tailed Student's t-tests were used to assess statistical significance. ns: not significant, **p < 0,01, ***p < 0,0001, ****p < 0,001.

Supplementary Figure 8

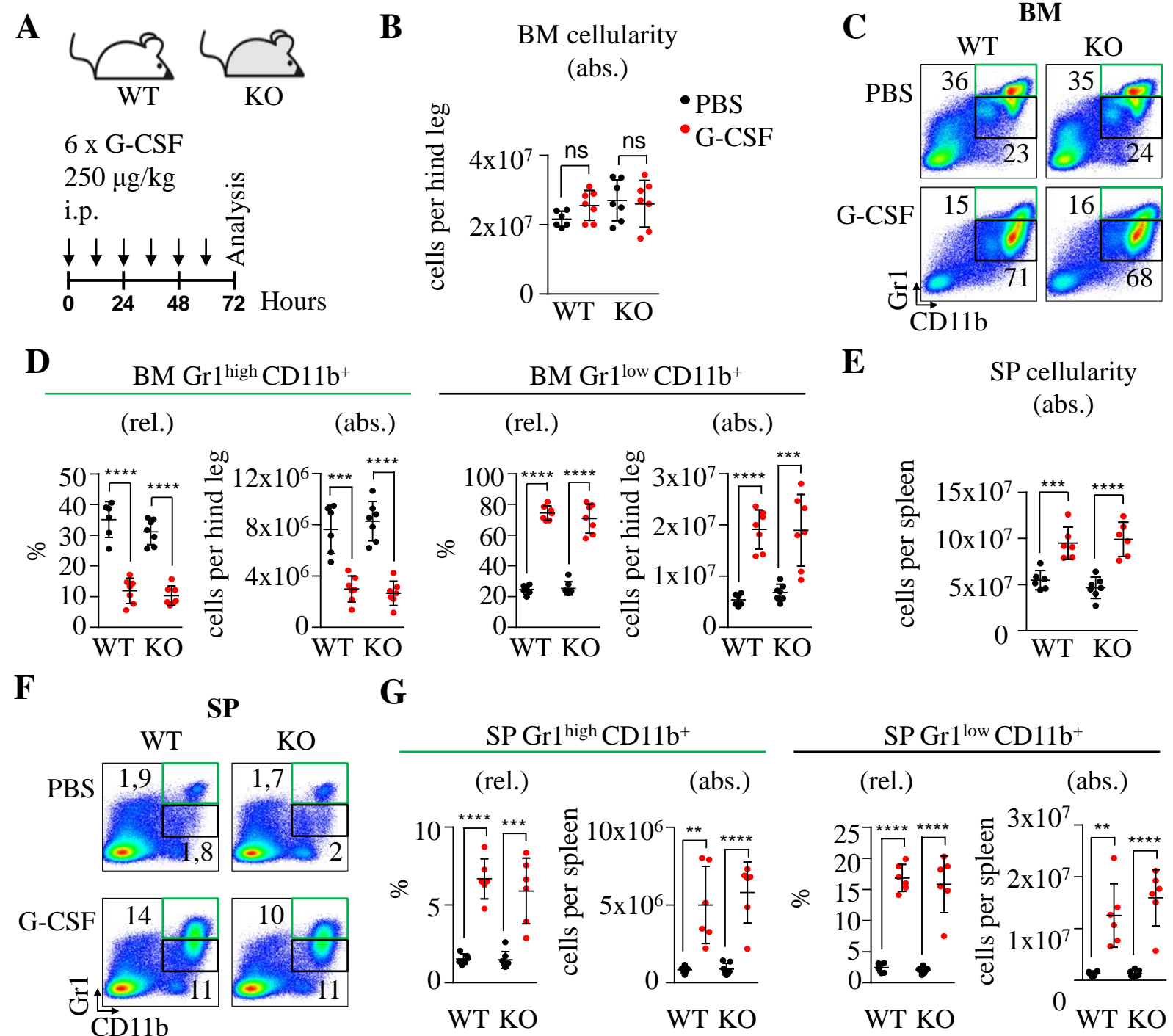

Supplementary Figure 8. Similar G-CSF-induced emergency granulopoiesis in WT and *Cebpg* KO mice. (A) Schematic representation of the experimental setup. WT and *Cebpg* KO mice received six intraperitoneal (i.p.) injections of G-CSF (250 mg/kg) or PBS at the indicated time points. Emergency granulopoiesis was evaluated 72 hours after the first injection. (B) BM cellularity in WT and *Cebpg* KO mice treated with PBS (black) or G-CSF (red). Y axis indicates the number of cells per hind leg. ns: not significant. (C) Representative flow cytometry plots from WT and *Cebpg* KO BM cells 72 hours after first PBS or G-CSF injection. Cells were stained for Gr1 and CD11b cell surface markers. Green boxes indicate percentage of Gr1^{high} CD11b⁺ cells and black boxes indicate percentage of Gr1^{low} CD11b⁺ cells. (D) Quantification of panel C. Left graphs indicate relative and absolute number of Gr1^{high} CD11b⁺ cells. Right graphs indicate relative and absolute number of Gr1^{low} CD11b⁺ cells. (E) SP cellularity in WT and KO mice treated with PBS vehicle control (black) or G-CSF (red). Y axis indicates the number of cells per spleen. (F) Representative flow cytometry plots from WT and *Cebpg* KO SP cells 72 hours after first PBS or G-CSF injection. Cells were stained for Gr1 and CD11b cell surface markers. Green boxes indicate percentage of Gr1^{high} CD11b⁺ cells and black boxes indicate percentage of Gr1^{low} CD11b⁺ cells. (G) Quantification of panel F. Panels indicate relative (rel) and absolute (abs) number of Gr1^{high} CD11b⁺ cells (left) and Gr1^{low} CD11b⁺ cells (right) in spleen. Black symbols indicate PBS vehicle control and red symbols indicate G-CSF treated mice. All data represent mean ±s.d. from two experiments (n=6 or 7 mice). Two-tailed Student's t-tests were used to assess statistical significance. ns: not significant, **p < 0,01, ***p < 0,0001, ****p < 0,001.

Supplementary Figure 9

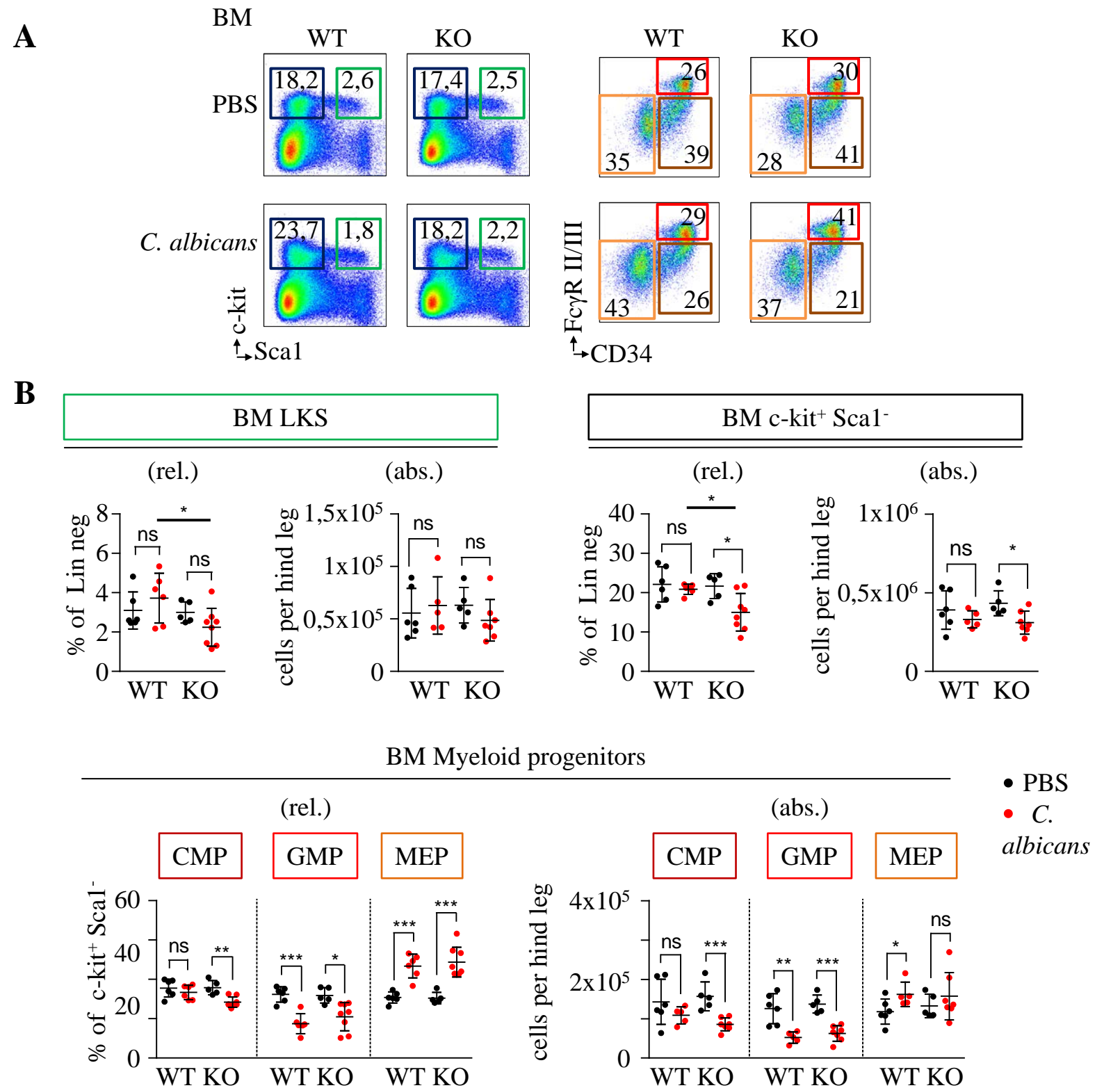

Supplementary Figure 9. Myeloid progenitors from *Cebpg* deficient and WT mice respond to *C. albicans* infection in the same fashion. (A) Representative flow cytometry plots from WT and *Cebpg* KO BM cells isolated from animals treated with either PBS or *C. albicans*. c-kit and Sca1 plots were generated by gating on lineage negative cells, allowing the identification of the following populations: lineage- c-kit⁺ Sca1⁻ (blue box) and LKS (green box). FcγRII/III and CD34 plots were generated from lineage- c-kit⁺ Sca1⁻ (blue box) and identified CMP (brown box), GMP (red box) cells and MEP (orange box) cells. Numbers indicate percentages in each population. CMP: common myeloid progenitors; GMP: granulocyte-monocyte progenitors; MEP: megakaryocyte-erythroid progenitors. (B) Relative quantification (%) and absolute quantification (cells per hind leg) in the distinct BM populations defined by flow cytometry as shown in panel A. Black indicates PBS treatment and red indicates *C. albicans* treatment. All data represent mean ± s.d. from two independent experiments. 5 to 8 mice were included in each group. Two-tailed Student's t-tests were used to assess statistical significance. ns: not significant, *p < 0,05, **p < 0,01, ***p < 0,0001.

Supplementary Figure 10

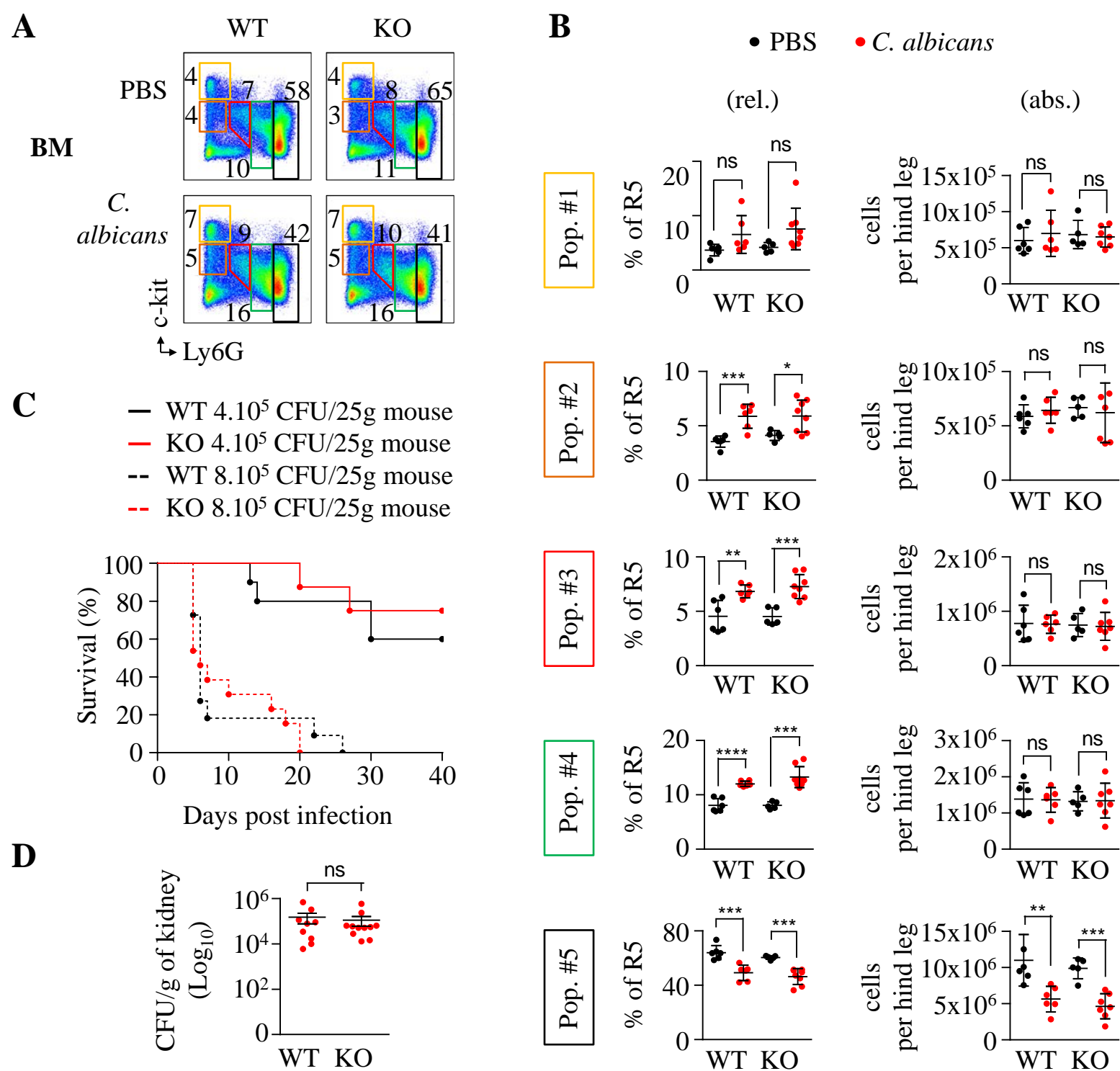

Supplementary Figure 10. Analysis of BM granulocytic development in WT and *Cebpg* KO mice after *Candida albicans* infection. (A) Representative flow cytometric plots of gating strategy showing granulocytic development in BM isolated from WT and *Cebpg* KO mice 24 hours after *C. albicans* was injected. Cells were stained as shown in Supplementary Figure 6. Colored boxes indicate percentage of population #1 (yellow), #2 (orange), #3 (red), #4 (green) and #5 (black). (B) Relative (percentage, left panels) and absolute (cells per hind leg, right panels) numbers of cells in populations #1 to #5, defined by flow cytometry as shown in panel A. Black symbols indicate PBS injection, red symbols indicate *C. albicans* treatment. Each group contains at least 6 mice. Data represent the mean \pm s.d. from two independent experiments. (C) Kaplan-Meier survival analysis of WT (black lines) or *Cebpg* KO mice (red lines) i.v. injected with different dose of *C. albicans*, $4 \cdot 10^5$ CFU/25g mouse (solid line), $8 \cdot 10^5$ CFU/25g mouse (dashed line). WT lower dose n=10, KO lower dose n=8, WT higher dose n=11, and KO higher dose n=13, p (lower dose)=0,53, p (higher dose)=0,6. Results include data from two independent experiments. (D) Quantification of kidney burden 24 hours after *C. albicans* infection. The y axis indicate number of *C. albicans* colonies per 1 g of kidney tissue. Each group contains at least 9 mice. Data represent the mean \pm s.e.m. from two independent experiments. Two-tailed Student's t-tests were used to assess statistical significance. ns: not significant, *p < 0,05, **p < 0,01, ***p < 0,0001, ****p < 0,001.