

trnK-trnQ

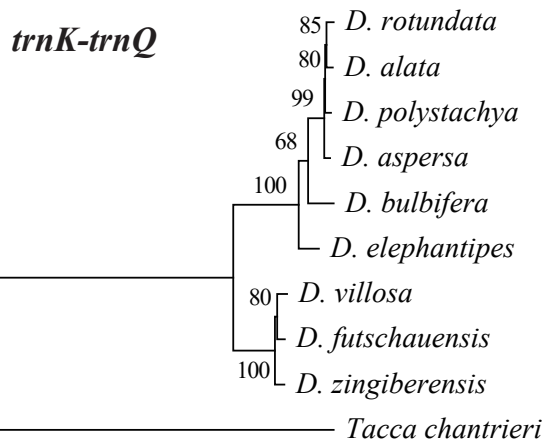

trnC-petN

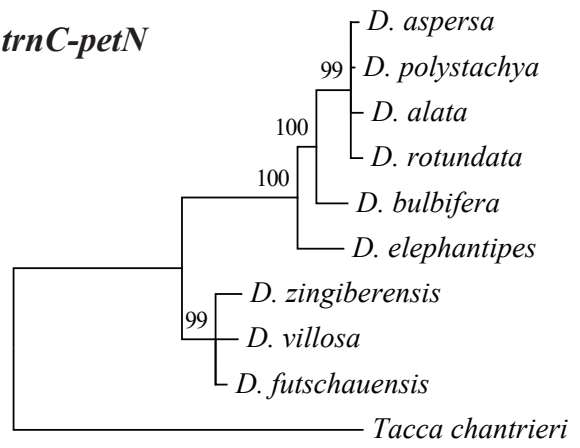

petG-trnW-trnP

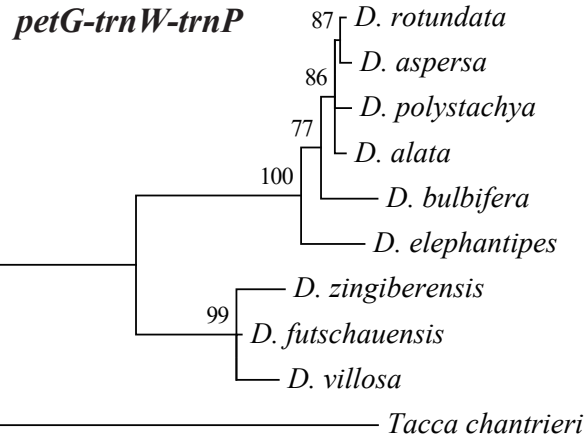

trnL-rpl32

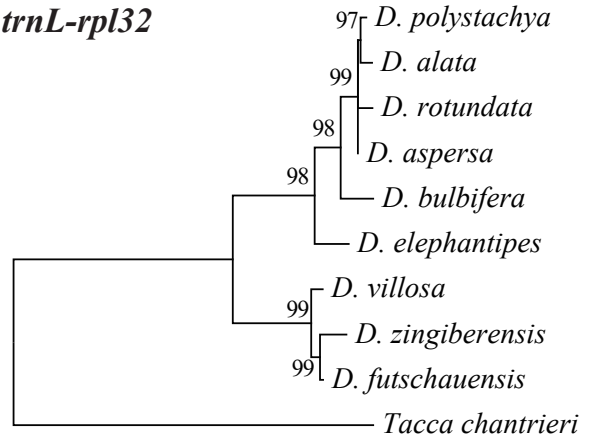

ndhF

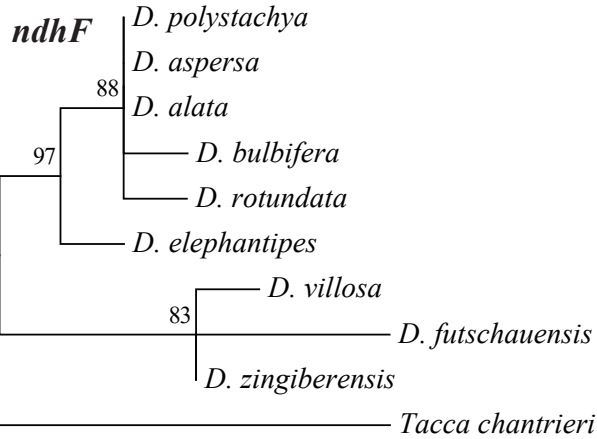

trnS-trnG

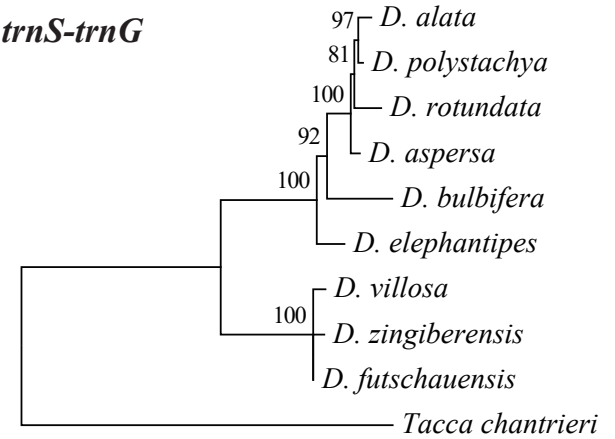

trnE-trnT

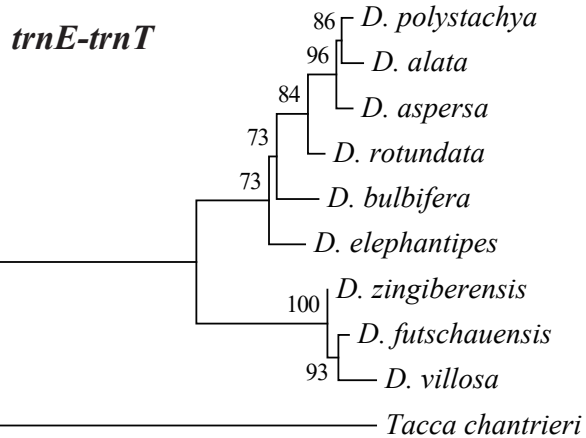

yef1

