

Supplementary Online Content

Reardon MJ, Heijmen RH, Van Mieghem NM, et al. Transcatheter and Surgical Aortic Valve Replacement Outcomes for Patients with Coronary Artery Bypass Grafts in SURTAVI: A Randomized Clinical Trial

This supplement contains the following items:

1. First SURTAVI protocol implemented (V3)
2. Last SURTAVI protocol (V12 – US and V12.1 – Canada and EU)
3. Summary of protocol changes
4. Original SAP
5. Final SAP
6. Summary of SAP changes



SURTAVI

Surgical Replacement and Transcatheter Aortic Valve Iplantation

Clinical Investigation Plan

VERSION 3.0

18 November 2011

Sponsor:

Medtronic, Inc.
Clinical Research
Mailstop: MVS66
Mounds View South
8200 Coral Sea St NE
Mounds View, MN 55112 USA

Medtronic Bakken Research Center
CardioVascular Department
Endepolsdomein 5
6229 GW Maastricht
The Netherlands

Contact Information Details*

Study Chair

Prof. Patrick W. Serruys, MD, PhD (Study Chair)
Professor of Medicine
Head of Interventional Cardiology
Erasmus Medical Center
Dept. of Interventional Cardiology, Thoraxcenter Room
BD 381
's Gravendijkwal 230
3015 CE Rotterdam, The Netherlands

Dr. Nicolas M. Van Mieghem, MD (Deputy Study Chair)
Interventional Cardiologist
Erasmus Medical Center
Dept. of Interventional Cardiology, Thoraxcenter Room
BD 171
's Gravendijkwal 230
3015 CE Rotterdam, The Netherlands

Principal Investigators

Prof. Stephan Windecker, MD, PhD
Head of Interventional Cardiology
Bern University Hospital
Department of Cardiology
Swiss Cardiovascular Center Bern
Freiburgstrasse 4
CH-3010 Bern, Switzerland

Prof. A. Pieter Kappetein, MD, PhD
Cardio-Thoracic Surgeon
Erasmus Medical Center
Dept. of Thoracic Surgery
Room BD 569
's Gravendijkwal 230
3015 CE Rotterdam, The Netherlands

Prof. Rüdiger Lange, MD, PhD
Direktor der Klinik für Herz- und Gefäßchirurgie
Deutsches Herzzentrum München
Lazarettstr. 36
80636 München, Germany

Prof. Thomas Walther, MD, PhD
Direktor der Abteilung Herzchirurgie
Kerckhoff-Klinik
Benkestr. 2-8
61231 Bad Nauheim; Germany

Dr. Jeffrey J. Popma, MD
Director, Interventional Cardiology
Beth Israel Deaconess Medical Center
185 Pilgrim Rd.
Boston, MA 02215 USA

Dr. Michael J. Reardon, MD
Professor, Cardiothoracic Surgery
The Methodist Hospital
6550 Fannin St., Suite 1401
Houston, TX 77030 USA

Dr. David H. Adams, MD
Marie-Josée and Henry R. Kravis Professor and
Chairman
Department of Cardiothoracic Surgery
The Mount Sinai Medical Center
1190 Fifth Avenue
New York, NY 10029 USA

Trial Oversight	<p>Will Prather Clinical Research Director Medtronic CardioVascular Phone: (763) 514.9897 Email: william.c.prather@medtronic.com</p> <p>Francesca Barbieri – <i>EU</i> Clinical Research Director BRC – Cardiac Surgery Clinical Phone: (+31-43) 3566 824 Email: francesca.barbieri@medtronic.com</p>
Sponsor	<p>Medtronic, Inc. Clinical Research Mailstop: MVS66 Mounds View South 8200 Coral Sea Street NE Mount View, MN 55112 USA</p> <p>Medtronic Bakken Research Center CardioVascular Department Endepolsdomein 5 6229 GW Maastricht The Netherlands</p>
Randomization Telephone Number	The Randomization telephone number (IXRS) will be provided in the investigator site file.

* Updated contact information will be provided as applicable. Additional information regarding contacts listed above available upon request.

CONFIDENTIAL and PROPRIETARY

This document contains confidential information and is solely the property of Medtronic, Inc. Acceptance of this document constitutes an agreement by the recipient that no unpublished information contained herein will be published or disclosed without the prior written approval of Medtronic, Inc. This document may be disclosed to the appropriate Institutional Review Board (IRB)/Ethics Committee (EC) with the stipulation that the IRB/EC treats the information contained herein as the confidential property of Medtronic, Inc.

TABLE OF CONTENTS

A	SYNOPSIS	9
B	PURPOSE	14
B.1	Background.....	14
B.2	Medtronic CoreValve® System and Intended Use.....	16
B.2.1	Device Description	16
B.2.2	Device Approval Status	17
B.2.3	Intended Use of the Device	17
B.3	Study Objectives.....	17
B.3.1	Primary	17
B.3.2	Secondary	17
B.3.3	Exploratory	17
C	TRIAL PROTOCOL.....	18
C.1	Ethics and Regulatory Compliance	18
C.1.1	Applicable Regulations.....	18
C.1.2	Institutional Review Board (IRB)/Medical Ethics Committee (MEC)	18
C.1.3	Regulatory Submission	18
C.1.4	Ethical Conduct of the Trial	19
C.2	Trial Administration.....	19
C.2.1	Steering Committee.....	19
C.2.2	Publication Committee	19
C.3	Methodology	20
C.3.1	Purpose	20
C.3.2	Patient Population	20
C.3.3	Design	20
C.3.4	Investigational Centers.....	20
C.3.5	Number of Subjects.....	21
C.3.6	Inclusion/Exclusion Criteria	21
C.3.6.1	Inclusion Criteria	21
C.3.6.2	Exclusion Criteria.....	22
C.3.7	Informed Consent.....	23
C.3.8	Revisions in Patient Information and Informed Consent Form	24
C.3.9	Enrollment Flowchart for Randomization to MCS TAVI or SAVR	24
C.3.10	Trial Training	25
C.4	Trial Procedures	25
C.4.1	Screening Procedures.....	25
C.4.2	Heart Team Procedures	26
C.4.3	Enrollment and Randomization	27
C.4.4	Baseline Assessments	27

C.4.5 Medtronic CoreValve® System TAVI or Surgical Aortic Valve Replacement Procedure	28
C.4.5.1 MCS TAVI.....	28
C.4.5.2 Surgical Aortic Valve Replacement	33
C.4.6 Assessments done at discharge (both SAVR and TAVI).....	37
C.4.7 Follow-Up Evaluations.....	38
C.4.7.1 30 Days.....	38
C.4.7.2 3 Months	38
C.4.7.3 6 Months	39
C.4.7.4 12 Months	39
C.4.7.5 18 Months	39
C.4.7.6 24 Months	40
C.4.7.7 3-5 Years	40
C.4.8 Echo Assessment.....	40
C.4.9 Neurologic Assessment.....	41
C.4.10 Angiographic and Computed Tomography Assessment	41
C.4.11 Data Collection.....	41
C.4.12 Unscheduled Follow-up Assessments.....	44
C.4.13 Missed Follow-up Visits	44
C.4.14 Investigational Product Accountability	44
C.4.15 Device Malfunction or Explant	44
C.4.16 Protocol Deviations	45
C.4.17 Subject Withdrawal or Discontinuation	46
C.4.18 Termination or Discontinuation of Trial	46
C.5 Adverse Events.....	46
C.5.1 Definitions.....	46
C.5.1.1 Adverse Event	46
C.5.1.2 Serious Adverse Event	47
C.5.1.3 Major Adverse Cardiovascular and Cerebrovascular Events.....	47
C.5.1.4 Major Adverse Event	48
C.5.1.5 Adverse Device Effect (ADE) or Device-Related Adverse Event.....	48
C.5.1.6 Unanticipated Adverse Device Effect (UADE).....	48
C.5.1.7 Device Deficiency	48
C.5.1.8 Technical Observation	48
C.5.2 Reporting.....	49
C.5.2.1 Serious Adverse Events (SAEs).....	49
C.5.2.2 Unanticipated Adverse Device Effects	49
C.5.2.3 Device Deficiencies and Technical Observations	50
C.5.2.4 All Other Adverse Events	50
C.5.2.5 Anticipated Adverse Events.....	50

C.5.2.6	Deaths	51
C.5.3	Clinical Events Committee (CEC)	51
C.5.4	Data Safety Monitoring Board (DSMB)	52
C.6	Statistical Methods and Analysis	53
C.6.1	Statistical considerations and analysis.....	53
C.6.2	Reports	53
C.6.3	Description of Baseline Variables	53
C.6.4	Analysis Populations	53
C.6.4.1	Screening population	53
C.6.4.2	Randomized population.....	53
C.6.5	Primary analysis	54
C.6.5.1	Hypothesis of non-inferiority	54
C.6.5.2	Sample size and power calculation	54
C.6.6	Description of performed analysis, per population	55
C.6.6.1	Analysis of screening population	55
C.6.6.2	Analysis of – ITT population	55
C.6.6.3	Analysis of as treated population.....	56
C.6.6.4	Analysis of implanted population	56
C.6.7	Statistical methods to be used	56
C.6.8	Procedure for accounting data, treatment for missing, unused or spurious data ...	56
C.6.9	Interim analysis	56
C.6.10	Pre-Defined Subgroups	57
C.6.11	Health-Related Quality of Life (HRQoL) and Treatment Costs.....	57
C.6.11.1	Quality of Life.....	57
C.6.11.2	Economic Outcomes/Cost-Effectiveness	57
C.6.12	Secondary Endpoints.....	58
C.7	Data and Quality Management.....	62
C.7.1	Electronic Data Capture	62
C.7.2	Data Collection	62
C.7.3	Core Laboratories Procedures	62
C.7.4	Source Documents.....	62
C.8	Records and Reports.....	63
C.8.1	Responsibilities of the Sponsor.....	63
C.8.2	Responsibilities of the Investigator.....	64
D	RISK / BENEFIT ANALYSIS	66
D.1	Methods to Minimize Risk.....	67
D.2	Potential Benefits.....	67

E	DESCRIPTION OF MEDTRONIC® COREVALVE SYSTEM	68
E.1	Investigational Product Description	68
E.2	Medtronic CoreValve Ordering, Storage, and Disposition.....	70
F	MONITORING AND AUDITING	71
F.1	Monitoring.....	71
F.2	Auditing.....	71
G	LABELING	72
H	CONSENT MATERIALS	72
I	IRB/MEC INFORMATION	72
J	OTHER INSTITUTIONS	72
K	ADDITIONAL RECORDS AND REPORTS	72
L	REPORT OF PRIOR INVESTIGATIONS	72
M	PUBLICATION POLICY	73
N	AMENDMENTS TO THE CLINICAL INVESTIGATION PLAN	74
O	ABBREVIATIONS AND DEFINITIONS	75
O.1	List of Abbreviations	75
O.2	Definitions of Terms.....	78
P	STUDY MANAGEMENT	93
P.1	Miscellaneous	93
P.1.1	Insurance.....	93
P.1.2	Reimbursement	93
P.1.3	Indemnification	93
P.1.4	Subject confidentiality.....	93
Q	REFERENCES	94

R	APPENDIX	98
R.1	Sample Informed Consents	
R.2	Investigative Site and IRB Information	
R.3	Other Institutions	
R.4	Additional Records and Reports	
R.5	Sample Case Report Forms	
R.6	Aortogram Acquisition Guidelines	
R.7	Echocardiography Acquisition Guidelines	
R.8	Electrocardiogram (ECG) Submission	
R.9	Computed Tomography (CT) Angiography Acquisition Guidelines	
R.10	Interactive Voice/Web Resapnse System (IXRS) Vendor Information	
R.11	Explanted Device/Pathology and Return Procedures	
R.12	Economic and Quality of Life Data Collection	
R.13	Pacing Guidelines	
R.14	Six Minute Walk Test Instructions	
R.15	National Institute of Health Stroke Scale (NIHSS)	
R.16	Modified Rankin Scale (mRS) Instructions	
R.17	Mini Mental State Exam (MMSE-2)	
R.18	Additional Neurological Assessments	
R.19	Medtronic CoreValve [®] Clinical Assessments	
R.20	Katz Index of Independence in Activities of Daily Living	
R.21	Investigator Brochure / Report of Prior Investigations for the Medtronic CoreValve [®] System	
R.22	SURTA VI Risk Model	

A SYNOPSIS

Title of Trial:	Surgical Replacement And Transcatheter Aortic Valve Implantation (SURTAVI)
Name of Product:	Medtronic CoreValve [®] System
Purpose:	The purpose of this study is to investigate the safety and efficacy of transcatheter aortic valve implantation (TAVI) in patients with severe, symptomatic Aortic Stenosis (AS) at intermediate surgical risk by randomizing patients to either Surgical Aortic Valve Replacement (SAVR) or TAVI with the Medtronic CoreValve [®] System. The total trial duration is expected to be approximately seven years.
Design:	Subjects will be randomized on a 1:1 basis to either transcatheter aortic valve implant (TAVI) with the Medtronic CoreValve [®] System (MCS) or to surgical aortic valve replacement (SAVR)
Primary Objective:	The primary objective of this trial is to evaluate in a prospective randomized fashion whether TAVI is non-inferior to SAVR with respect to the event free survival of the combined endpoint of all-cause mortality and major stroke at 24 months in patients with symptomatic severe aortic stenosis and at intermediate surgical risk.
Secondary Objective:	The secondary objective of this trial is to assess differences in quality of life, clinical benefit (combined efficacy endpoint) and health economics in patients with symptomatic severe aortic stenosis and at intermediate risk treated with either Transcatheter Aortic Valve Implantation (TAVI) or Surgical Aortic Valve Replacement (SAVR).
Exploratory Objective:	An analysis will be conducted to determine if patients can be identified as intermediate risk for Transcatheter Aortic Valve Implantation (TAVI) based upon age and the presence of a defined list of co-morbidities commonly associated with patients undergoing TAVI procedures.
Primary Endpoint:	All-cause mortality or major stroke at 24 months
Secondary Endpoints:	<p>The following secondary endpoints will be compared between MCS TAVI and SAVR subjects cohorts:</p> <ol style="list-style-type: none"> 1. Major Adverse Cardiovascular and Cerebrovascular Events (MACCE)-free survival at 30 days, 6 months, 12 months, 18 months, 24 months, and annually thereafter up to 5 years. MACCE is defined as a composite of: <ul style="list-style-type: none"> • All-cause death • Myocardial infarction (MI) • All stroke, and • Reintervention (defined as any cardiac surgery or percutaneous reintervention catheter procedure that repairs, otherwise alters or adjusts, or replaces a previously implanted valve)

	<ol style="list-style-type: none"> 2. The occurrence of individual MACCE components at 30 days, 6 months, 12 months, 18 months, 24 months, and annually thereafter up to 5 years. 3. Major Adverse Events (MAE) at 30 days, 6 months, 12 months, 18 months, 24 months, and annually thereafter up to 5 years. 4. Conduction disturbance requiring permanent pacemaker implantation at 30 days, 6 months, 12 months, 18 months, 24 months, and annually thereafter up to 5 years. 5. Change in NYHA class from baseline at 30 days, 6 months, 12 months, 18 months, 24 months, and annually thereafter up to 5 years. 6. Change in distance walked during 6-minute walk test (6MWT) from baseline to 30 days, baseline to 12 months, and baseline to 24 months. 7. Ratio of days alive out of hospital versus total days alive assessed at 12 months and 24 months follow-up. 8. Quality of Life (QoL) change from baseline at 30 days, 3 months, 6 months, 12 months, 18 months, 24 months, and annually thereafter up to 5 years. 9. Echocardiographic assessment of prosthetic valve performance at discharge, 6 months, 12 months, 24 months, and annually thereafter up to 5 years using the following measures: <ul style="list-style-type: none"> • transvalvular mean gradient • effective orifice area • degree of prosthetic aortic valve regurgitation (transvalvular and paravalvular). 10. Aortic valve disease related hospitalizations. 11. Cardiovascular deaths and valve-related deaths. 12. Strokes and TIAs. 13. Peri-procedural neurological injury. 14. Index procedure related MAEs. 15. Length of index procedure hospital stay. <p>The following secondary endpoints will be assessed for the MCS TAVI cohort subjects only:</p> <ol style="list-style-type: none"> 16. Device success defined as follows: <ul style="list-style-type: none"> • Successful vascular access, delivery and deployment of the device, and successful retrieval of the delivery system, • Correct position of the device in the proper anatomical location (placement in the annulus with no impedance on device function), • Intended performance of the prosthetic valve (aortic valve area > 1.2 cm² (by echocardiography using the continuity equation) and mean aortic valve gradient < 20 mmHg or peak velocity < 3 m/sec, without moderate or severe prosthetic valve AR) • Only one valve implanted in the proper anatomical location.
--	---

	<p>17. Procedural success, defined as device success and absence of in-hospital MACCE.</p> <p>18. Evidence of prosthetic valve dysfunction at 30 days, 6 months, 12 months, 18 months, 24 months, and annually thereafter up to 5 years.</p>
Trial Sites:	Up to 50 sites globally
Sample Size:	1200 patients (600 MCS TAVI, 600 SAVR)
Patient Population:	Patients who have symptomatic severe Aortic Stenosis at intermediate surgical risk defined by a Society of Thoracic Surgeons' (STS) mortality risk of $\geq 3\%$ and $\leq 8\%$ will be presented to the Heart Team for inclusion in the trial. In the United States, patients must have STS mortality risk of $\geq 4\%$ and $\leq 8\%$ to be presented to the Heart Team.
Inclusion Criteria:	<ol style="list-style-type: none"> 1. Subject must have STS mortality risk score $\geq 3\%$ and $\leq 8\%$ (in United States, STS mortality risk score $\geq 4\%$ and $\leq 8\%$) 2. Heart Team consisting of at least one interventional cardiologist and one cardiac surgeon agree on indication, treatment proposal, and eligibility for randomization based on their clinical judgment (including anatomy assessment, risk factors, etc.); 3. Critical aortic valve area defined as an initial aortic valve area of $\leq 1.0 \text{ cm}^2$ or aortic valve area index $< 0.6 \text{ cm}^2/\text{m}^2$; 4. In presence of normal LV function: <ol style="list-style-type: none"> a) Mean gradient $> 40\text{mmHg}$ OR $V_{\text{max}} > 4\text{m/sec}$ OR b) In presence of low flow, low gradient severe AS, a dobutamine stress echo must be conducted that demonstrates presence of contractile reserve defined as follows $\geq 20\%$ increase in stroke volume and mean gradient $> 40\text{mmHg}$; 5. Subject is symptomatic from his/her aortic valve stenosis, as demonstrated by New York Heart Association (NYHA) Functional Class II or greater; 6. The subject and the treating physician agree that the subject will return for all required post-procedure follow-up visits; 7. Subject meets the legal minimum age to provide informed consent based on local regulatory requirements.

<p>Exclusion Criteria:</p>	<ol style="list-style-type: none"> 1. Hypersensitivity or contraindication to aspirin, heparin, ticlopidine, clopidogrel, coumadin, nitinol, or sensitivity to contrast media which cannot be adequately pre-medicated; 2. Blood dyscrasias as defined: leukopenia (WBC <1000mm³), thrombocytopenia (platelet count <50,000 cells/mm³), history of bleeding diathesis or coagulopathy; 3. Ongoing sepsis, including active endocarditis; 4. Any condition considered a contraindication to extracorporeal assistance; 5. Any percutaneous coronary or peripheral interventional procedure performed within 30 days prior to randomization with bare metal stents and 6 months with drug eluting stents; 6. Symptomatic carotid or vertebral artery disease or successful treatment of carotid stenosis within six weeks of randomization; 7. Cardiogenic shock manifested by low cardiac output, vasopressor dependence, or mechanical hemodynamic support; 8. Recent (within 6 months of randomization) cerebrovascular accident (CVA) or transient ischemic attack (TIA); 9. Active gastrointestinal (GI) bleeding within the past 3 months; 10. Subject refuses a blood transfusion; 11. Severe dementia (resulting in either inability to provide informed consent for the trial/procedure, prevents independent lifestyle outside of a chronic care facility, or will fundamentally complicate rehabilitation from the procedure or compliance with follow-up visits); 12. Multivessel coronary artery disease with a Syntax score >22; 13. Estimated life expectancy of less than 24 months due to associated non-cardiac co-morbid conditions; 14. Other medical, social, or psychological conditions that in the opinion of the Investigator precludes the subject from appropriate consent or adherence to the protocol required follow-ups exams; 15. Currently participating in an investigational drug or another device trial (excluding registries); 16. Evidence of an acute myocardial infarction ≤30 days before the index procedure; 17. Need for emergency surgery for any reason; 18. True porcelain aorta; 19. Extensive mediastinal radiation; 20. Liver failure (Child-C);
----------------------------	--

	<p>21. Reduced ventricular function with left ventricular ejection fraction (LVEF) <20% as measured by resting echocardiogram;</p> <p>22. Uncontrolled atrial fibrillation;</p> <p>23. Pregnancy or intent to become pregnant prior to completion of all protocol follow-up requirements;</p> <p>24. End stage renal disease requiring chronic dialysis or creatinine clearance < 20 cc/min.</p> <p>Anatomical Exclusion Criteria</p> <p>25. Native aortic annulus size <20 mm or >29 mm per the baseline diagnostic imaging;</p> <p>26. Pre-existing prosthetic heart valve in any position;</p> <p>27. Mixed aortic valve disease [aortic stenosis and aortic regurgitation with predominant aortic regurgitation (3-4+)];</p> <p>28. Severe mitral or severe tricuspid regurgitation;</p> <p>29. Severe mitral stenosis;</p> <p>30. Hypertrophic obstructive cardiomyopathy;</p> <p>31. Echocardiographic or Multislice Computed Tomography (MSCT) evidence of intracardiac mass, thrombus or vegetation;</p> <p>32. Ascending aorta diameter >43 mm unless the aortic annulus is 20-23 mm in which case the ascending aorta diameter >40 mm;</p> <p>33. Femoral and left subclavian/axillary access:</p> <p style="padding-left: 20px;">a) Aortic root angulation (angle between plane of aortic valve annulus and horizontal plane/vertebrae) > 70°;</p> <p style="text-align: center;">OR</p> <p style="padding-left: 20px;">b) Right subclavian/axillary access: Aortic root angulation > 30°;</p> <p>34. Congenital bicuspid or unicuspid valve verified by echocardiography.</p> <p>Vascular Exclusion Criteria</p> <p>35. Transarterial access not able to accommodate an 18Fr sheath.</p>
Enrollment Phase:	20 months
Follow-up Evaluations:	Subjects will be followed through 5 years with assessments at 30 days, 3 months, 6 months, 12 months, 18 months, 24 months, and 3, 4, and 5 years post MCS TAVI or post SAVR.

B PURPOSE

B.1 Background

Aortic valve stenosis (AS) is the most prevalent valve disorder in the adult population in developed countries affecting approximately 2% to 4% of people over 65 years of age (2, 3) . This corresponds to approximately 3 million people with AS in Europe alone. One in five will eventually progress to symptomatic AS representing 600,000 patients.

Prevalence of Aortic Stenosis European Union 2008

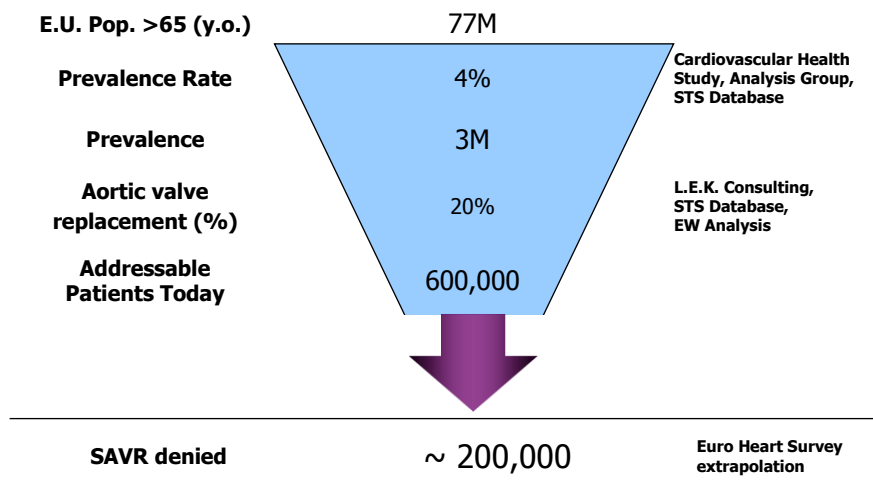

2

Patients with severe AS face a grim prognosis once they become symptomatic. The landmark paper on symptomatic AS by Ross and Braunwald in 1968 highlighted this premise: median survival averages only 2, 3 and 5 years after symptom onset of angina, syncope and heart failure respectively(4). Furthermore mortality is already substantial in the months following the first symptoms (5). The dismal prognosis of patients with untreated severe, symptomatic aortic stenosis has been recently corroborated in the conservative treatment arm of the PARTNER B cohort. Both, the ESC and ACC/AHA cardiology societies have endorsed guidelines on valvular heart disease emphasizing the need for surgical aortic valve replacement (SAVR) once symptoms develop or in case of impaired LV function (Level of evidence grade 1)(6, 7).

Despite these well-established guidelines, one in every three patients with symptomatic AS is considered at too high a risk for surgery mostly because of age, left ventricular dysfunction and co-morbidities(8). If we would assume that only two in every three patients with symptomatic AS would be referred for SAVR and there are 600,000 patients with symptomatic AS in Europe alone, this means that hypothetically about 200,000 patients would not be considered for intervention(9). This unmistakably underscores an unmet clinical need. Conversely relieving the AS would not clear the patients from his/her co-morbidities implicating not only a higher operative risk but also a more or less reserved life expectancy. Undoubtedly this reality and patients' and physicians' preferences for lesser invasive strategies have fuelled the ongoing interest in developing minimally invasive transcatheter therapies.

Alain Cribier pioneered the transcatheter aortic valve implantation (TAVI) technology and reported the first in man experience of TAVI in a patient with symptomatic AS who was deemed inoperable in 2002(10). Subsequent feasibility studies validated the proof of concept (11, 12). The Edwards-SAPIEN valve (Edwards Lifesciences, Irvine, CA, USA) and the Medtronic-

CoreValve system (Medtronic Corporation, Minneapolis, MN, USA) are the only two TAVI platforms with CE mark approval since 2007. Numerous single-center and multi-center observational registries followed with dazzling speed suggesting the safety and efficacy of the TAVI technology (13-17). The TAVI technology comes with its own specific hurdles and complications (18), not necessarily overlapping with those of SAVR: vascular injury; stroke, cardiac injury such as heart block, coronary obstruction, and cardiac perforation; paravalvular leak; and valve misplacement. The non-uniformity in presenting respective data makes comparison of results from different centers hazardous and impractical (19, 20). The Valvular Academic Research Consortium (VARC), a FDA endorsed collaboration between academic research organizations and professional societies in the United States and Europe is an initiative to generate a consensus statement on TAVI related definitions aiming to create order and uniformity making data more prone to analysis and comparison (21, 22).

Technical refinements and commercial entrepreneurship have made the technology accessible to many centers worldwide. This might pose future implications especially in the current era where randomized trials with TAVI are strikingly lacking.

Grossly, there are three types of medical practices: the first is the institution with on-site interventional cardiologic and cardiothoracic surgical activity and with close inter-disciplinary collaboration where interventional cardiologists and cardiothoracic surgeons reach a consensus on which patients to select for a specific surgical or interventional treatment strategy (9). These centers would reasonably respect and adhere to the so-called CE mark labeling indications. Secondly there are centers where interventional cardiologists and cardiothoracic surgeons do not really convene and work as two separate departments. Finally there are practices running an interventional cardiology program without on-site cardiothoracic surgery, estimated to make up 37% of all PCI centers in the European Union. Expectedly, these kinds of organizations without intimate collaboration between cardiothoracic surgeons and interventional cardiologists will look to broaden their interventional activities with an attractive innovation like TAVI. Whether this kind of uncontrolled and widespread distribution of a new technology is appropriate and timely is debatable. The flipside would be a worldwide practice being less controllable, potentially clouding the safety and efficacy profile of the procedure. Needless to say that criticism by the medical community and health authorities could jeopardize future reimbursement policies (23, 24). The advent of randomized trial data is crucial and this next step in establishing a new treatment strategy should not be taken for granted as governmental authorities entitled to grant premarket approval to cardiovascular devices are under increased scrutiny and quality control (25).

After nearly a decade of worldwide mounting TAVI experience, the Cohort –B from the much anticipated PARTNER (Placement of AoRTic TraNscatheter Valve Trial) trial representing the first randomized data set, reporting a dramatic 20% absolute reduction in mortality in favor of TAVI compared to medical therapy in patients who, as determined by surgeons could not undergo conventional surgical valve replacement (26).

In the Cohort-A from the PARTNER trial, patients for whom a surgeon and cardiologist concur that the predicted risk of operative mortality is $\geq 15\%$ and/or with a minimum STS score of 10, are randomized to TAVI or SAVR. The trial completed its randomization early 2009 and first data was presented at ACC, April 2011 reporting achievement of the primary endpoint (TAVR was non-inferior to AVR for all-cause mortality at 1 year).

At the PCR London Valves meeting in October 2010 was reported that over 22000 patients have been treated with TAVI worldwide. More specifically, over 12000 Medtronic CoreValve System have been implanted worldwide (data on file provided by Medtronic). Inevitably, with increased operator experience and access to the device, physicians will shift their attention to younger patients with a less pronounced operative risk. Similar to the coronary revascularization arena (27), the blending of surgical and interventional expertise has created unique interdisciplinary dynamics paving the way for a randomized trial comparing TAVI with SAVR in a surgical intermediate risk patient population.

It is in this spirit that the SURTAVI trial (SURgical and Transcatheter Aortic Valve Implantation) was conceived. The interdisciplinary approach and consensus of the so-called Heart Team (the cardiothoracic surgeon, interventional cardiologist and other treating physicians if necessary) is crucial. This aspect of decision making cannot be over-emphasized and is essential for the quality of current medical practice in general and any planned randomized trial of TAVI versus

SAVR in particular. The VARC publication (21, 22) on TAVI definitions and the accumulating TAVI expertise in Europe has created a unique momentum for such a European based randomized initiative complementary to the US pivotal IDE randomized trial in AS patients with high operative risk.

For a new technology to be accepted as a new asset in the armamentarium for treating symptomatic AS several essential questions need to be answered: is the technology effective? Which patients are likely to benefit (patient selection)? How does this new strategy compare with the alternatives? And what's the cost of the intervention? The proof of concept has been validated. The innovative less invasive transcatheter strategy should be at least as effective and safe than conventional SAVR or have proof of superiority for both safety and efficacy compared to medical therapy.

Theoretical benefits of this transcatheter approach in a beating heart by avoiding the need of musculoskeletal incisions, cardioplegic arrest, aortic cross clamping, aortotomy, full cardiopulmonary bypass seem evident. Ultimately the cost-effectiveness will determine whether the new treatment strategy is a valid option to be considered for reimbursement by governmental health institutions.

B.2 Medtronic CoreValve[®] System and Intended Use

B.2.1 Device Description

The Medtronic CoreValve System consists of the following product elements:

- Percutaneous Aortic Valve Bioprosthesis (PAV): consisting of a multi-level self-expanding frame with porcine pericardial bioprosthesis. The bioprosthesis is processed with an antimineralization treatment of alpha-amino oleic acid (AOA) a compound derived from oleic acid, a naturally occurring long-chain fatty acid.
- Delivery Catheter System (DCS): designed to house the tissue valve prosthesis in the collapsed position for percutaneous delivery to the patient's aortic annulus.
- Compression Loading System (CLS): facilitates consistent and trauma-free manual loading of the PAV into the DCS.

The models to be used are:

- Percutaneous Aortic Valve Prosthesis (PAV) - Model MCS-P3-26-AOA (26mm) and MCS-P3-29-AOA (29mm) and MCS-P3-31-AOA (31mm) (CE mark application pending)
- Delivery Catheter System (DCS) – DCS-C4-18Fr AccuTrak[®] Delivery System (CE marked in July 2010)
- Compression Loading System (CLS) - Model CLS-3000-18Fr (CE marked in 2007)

In addition, any future approved models may be used in the study.

The PAV is adapted to a range of aortic annulus and ascending aorta diameters as shown in **Table 1**.

Table 1: Patient Anatomical Diameters

MCS-PAV and patient's Characteristics		
REF#	Aortic Annulus Diameter (range in mm)	Aortic Diameter @ Sino-tubular Junction (range in mm)
MCS-P3-26-AOA	20-23	≤40
MCS-P3-29-AOA	23-27	≤43
MCS-P3-31-AOA	26-29	≤43

B.2.2 Device Approval Status

The Notified Body NSAI granted an approval for CE Marking for the 18Fr CoreValve ReValving™ System (renamed to “Medtronic CoreValve System” after acquisition from CoreValve Inc. by Medtronic Inc. on 9 April 2009) effective March 1, 2007. Model MCS-P3-640 (26mm) and MCS-P3-943 (29mm) received CE mark effective 2006) and MCS-P3-943 (31mm) received CE marked in July 2011. The models to be used in this trial, listed in Table 1, are identical to the CE marked device with exception of the addition of antimicrobial treatment of alpha-amino oleic acid AOA to the device.

A new Delivery Catheter System (DCS) with AccuTrak® Stability Layer was designed to optimize the valve positioning and will be used in this trial. CE mark approval was received on July 2010. The DCS and CLS components used for this trial are the CE marked product.

Medtronic submitted an Original IDE (G100012) to seek approval to initiate an Investigational Device Exemption for the Medtronic CoreValve System. This study is intended for use in subjects with severe symptomatic Aortic Stenosis (AS) necessitating aortic valve replacement in Extreme Risk and High Risk Patient Populations. This IDE was conditionally approved on October 13, 2010 and received full approval on November 10, 2011.

B.2.3 Intended Use of the Device

The Medtronic CoreValve® System is intended for use in patients who have symptomatic severe aortic stenosis (AS) necessitating valve replacement and who are at intermediate surgical risk defined by a Society of Thoracic Surgeons' (STS) mortality risk of $\geq 3\%$ and $\leq 8\%$ and presenting with anatomical dimensions as described in Table 1.

B.3 Study Objectives

B.3.1 Primary

The primary objective of this trial is to evaluate in a prospective randomized fashion whether TAVI is non-inferior to SAVR with respect to the event free survival of the combined endpoint of all-cause mortality and major stroke at 24 months in patients with symptomatic severe aortic stenosis and at intermediate surgical risk.

B.3.2 Secondary

The secondary objective of this trial is to assess differences in quality of life, clinical benefit (combined efficacy endpoint) and health economics in patients with symptomatic severe aortic stenosis and at intermediate risk treated with either Transcatheter Aortic Valve Implantation (TAVI) or Surgical Aortic Valve Replacement (SAVR).

B.3.3 Exploratory

An analysis will be conducted to determine if patients can be identified as intermediate risk for Transcatheter Aortic Valve Implantation (TAVI) based upon age and the presence of a defined list of co-morbidities commonly associated with patients undergoing TAVI procedures. A complete discussion of this exploratory objective can be found in **Appendix R.22**.

C TRIAL PROTOCOL

C.1 Ethics and Regulatory Compliance

C.1.1 *Applicable Regulations*

This trial will be conducted in compliance with the protocol, the Sponsor's standard operating procedures and/or guidelines, the United States Food and Drug Administration (FDA) and local regulations where applicable, the International Conference on Harmonization (ICH) Good Clinical Practice (GCP) guidelines, ISO14155 (2011), and the Declaration of Helsinki.

C.1.2 *Institutional Review Board (IRB)/Medical Ethics Committee (MEC)*

The trial will be conducted in accordance with 21 CFR 56 Institutional Review Boards. The trial protocol and consent must be approved by the responsible Institutional Review Board (IRB) or Medical Ethics Committee (MEC) at each investigational site. Trial activities must not commence prior to receipt of documentation of IRB/MEC approval by the site and Medtronic. The Investigator and trial staff must comply with the requirements of their IRB/MEC.

Prior to enrolling subjects in this study, each investigation site's IRB/MEC will be required to approve the current study clinical investigation plan, the Patient Information and Informed Consent form, and any other written information to be provided to the subjects. The approved consent form should clearly reflect the IRB/MEC approval date. In the US, Investigator must also utilize IRB approved Health Insurance Portability and Accountability Act (HIPAA) Authorization.

IRB/MEC approval of the clinical study must be received in the form of a letter and provided to Medtronic before commencement of the study at an investigation site. The approval letter must contain enough information to identify the version or date of the documents approved. In addition the approval letter needs to be accompanied by an IRB/MEC roster or letter of compliance, to allow verification that the investigator, other center study staff, and/or Medtronic personnel are not members of the IRB/MEC. If they are members of the IRB/MEC, written documentation is required stating that he/she did not participate in the approval process. Investigators must inform Medtronic of any change in status of IRB/MEC approval once the investigation site has started enrolment.

C.1.3 *Regulatory Submission*

Prior to enrolling any patients in the study, all local regulatory requirements must be fulfilled. Each study site must have written documentation of site/investigator readiness, including but not limited to IRB/MEC approval of the current version of the Investigational Plan, Informed Consent form, a signed Investigator's Agreement, current investigator curriculum vitae, and documentation of training. The coordinating and principal investigators shall agree to this investigational plan and any amendments and indicate their approval by signing and dating the Investigator's Agreement.

Approval from the Regulatory Authorities, if applicable, is required prior to the first patient enrollment in a particular center. Medtronic will obtain a copy of the approval letter, directly from the Regulatory Authorities.

If any action is taken by an IRB/MEC with respect to the investigation, that information will be forwarded to Medtronic by the respective investigator.

Other documents that are referred to in this Clinical Investigation Plan are listed below and will be made available upon request:

- Monitoring Plan
- Data Management Plan
- Statistical Analysis Plan
- Patient Information and Informed Consent Form
- Case Report Forms

C.1.4 Ethical Conduct of the Trial

The trial will be conducted in accordance with the design and specific provisions of this protocol, in accordance with the ethical principles that have their origin in the Declaration of Helsinki, and that are consistent with Good Clinical Practice (GCP) and the applicable regulatory requirements.

The principles of the Declaration of Helsinki have all been implemented in this study by means of the patient informed consent process, IRB/MEC approval, study training, clinical trial registration, preclinical testing, risk benefit assessment, and publication policy.

C.2 Trial Administration

C.2.1 Steering Committee

The Steering Committee will be an advisory body to Medtronic. Their roles and responsibilities may include, but are not limited to the following:

- Overall conduct of the study with regard to
 - Protocol development and implementation
 - Study progress
 - Patient safety
 - Data quality and integrity
- Quality performance at individual sites
 - The Steering Committee will support site investigators in resolving any clinical or procedural issues that may impact patient well-being or integrity of the study
 - Any site placed on probation for any reason may be terminated from the study after an appropriate review by the Steering Committee
- Review of all Data Safety Monitoring Board (DSMB) recommendations
- Assess requests for sub-studies
- Assist with Publication efforts by disseminating study information through appropriate scientific sessions and publications
 - All requests for abstract and manuscript preparation and submission require Steering Committee review and approval. All final decisions will be made by Medtronic; however, the recommendations made by the Steering Committee will be highly considered
- Participate in Investigator Meetings (and other study related meetings)
- Serve as a contact for other study investigators (providing peer consultation)

Prior to the onset of the trial, the Steering Committee will establish a charter. The Steering Committee charter will be approved by Medtronic and the Steering Committee members.

C.2.2 Publication Committee

The Publication Committee will review and approve publication ideas and facilitate submissions, including abstracts and manuscripts. The Publication Committee will consist of SURTAVI trial investigators (interventional cardiologists and cardiac surgeons) and Medtronic representatives.

The Publication Committee will be responsible for:

- Defining and refining the publication strategy
- Overseeing the development of manuscripts, abstracts, and presentations
- Identifying and appointing the manuscript/abstract first author(s)/writer(s)/presenters(s)
- Reviewing the publication

Prior to the onset of the trial, the Publication Committee will establish a plan. The Publication Committee plan will be approved by Medtronic and the Publication Committee members.

C.3 Methodology

C.3.1 Purpose

The purpose of this study is to investigate the safety and efficacy of transcatheter aortic valve implantation (TAVI) in patients with severe, symptomatic Aortic Stenosis (AS) at intermediate surgical risk by randomizing patients to either Surgical Aortic Valve Replacement (SAVR) or TAVI with the Medtronic CoreValve[®] System. The total trial duration is expected to be approximately seven years.

Data from this trial will be used to support regulatory applications in seeking approval for the Medtronic CoreValve System in the intermediate surgical risk population.

C.3.2 Patient Population

Patients who have symptomatic severe Aortic Stenosis at intermediate surgical risk defined by a Society of Thoracic Surgeons' (STS) mortality risk of $\geq 3\%$ and $\leq 8\%$ will be presented to the Heart Team for inclusion in the trial. In the United States, patients must have STS mortality risk of $\geq 4\%$ and $\leq 8\%$ to be presented to the Heart Team. While results for the entire population of randomized patients with STS mortality risk of $\geq 3\%$ and $\leq 8\%$ will be used for publication purposes, the subgroup of patients with STS mortality risk of $\geq 4\%$ and $\leq 8\%$ will be analyzed for the purpose of obtaining FDA approval.

C.3.3 Design

This study is designed as a prospective, multi-center, multi-national, randomized, interventional study trial to investigate the safety and efficacy of transcatheter aortic valve implantation (TAVI) in patients with severe, symptomatic Aortic Stenosis (AS) at intermediate surgical.

Approximately, 1200 subjects will be recruited in up to 50 investigational centers located in the United States and Europe. The study may be expanded to include additional geographies based on enrolment rates and identification of qualified centers.

Subjects will be randomized on a 1:1 basis to either transcatheter aortic valve implant (TAVI) with the Medtronic CoreValve[®] System (MCS) or to surgical aortic valve replacement (SAVR).

To avoid bias in the study population the following measures have been taken:

- All sponsor and external study personnel will be trained on the Clinical Investigation Plan (CIP) and related study materials; and
- Subjects will be screened to confirm study eligibility with defined inclusion/exclusion criteria prior to enrollment.

C.3.4 Investigational Centers

The trial will be a multicenter, multinational trial conducted at up to 50 investigational centers.

For this study, the following investigator/center selection minimum criteria are considered:

- Center must have sufficient patient population
- Each participating CoreValve implanter must have completed at least 30 cumulative TAVI procedures
- There will be no other study ongoing during this study duration, which is in conflict with the SURTAVI study
- Investigator should have adequate staff that is accessible and has time to manage the study for 7 days per week, 24 hours per day
- Investigator, co-investigators, and study staff must be willing to provide his/her Curriculum Vitae
- Investigator and co-investigators must be willing to sign and comply with the protocol-specific Investigator Agreement
- Center must be willing to comply with the Clinical Investigation Plan and data requirements, including reporting Adverse Events

- Center has demonstrated experience with conducting clinical (device) trials that comply with applicable regulatory standards
- Center is willing to participate in follow-up of patients for 5 years
- Center has an internet connection with sufficient speed of data transfer

All investigators will be appropriately qualified practitioners legally entitled to practice, and experienced in the diagnosis and treatment of patients requiring an aortic valve treatment with a TAVI or SAVR.

For the purposes of the SURTAVI study, it is imperative that Medtronic leverages highly qualified surgeons for the surgical aortic valve replacements (SAVR) that will occur as a part of the trial. The following minimum criteria will be used for all cardiac surgeons performing SAVRs in the SURTAVI study:

- At least 5 years of experience post-residency
- At least 100 career aortic valve replacements post-residency
- At least 75 valve procedures in the last 3 years
- At least 35 surgical aortic valve replacements in the last 3 years
- At least 15 aortic valve replacements in the last year

C.3.5 Number of Subjects

1,200 subjects will be randomized [600 MCS TAVI: 600 Surgical Aortic Valve Replacement (SAVR)]. The anticipated enrollment rate is 60 subjects per month with total enrollment phase of approximately 20 months.

Enrollments shall not exceed 20% (240) of total randomized subjects at any individual site. Enrollment is competitive; therefore there is no set minimum number of subjects to be enrolled per site.

C.3.6 Inclusion/Exclusion Criteria

C.3.6.1 Inclusion Criteria

To participate in this trial, the subject must meet ALL of the following inclusion criteria.

1. Subject must have Society of Thoracic Surgeon (STS) mortality risk score $\geq 3\%$ and $\leq 8\%$ (in United States, STS mortality risk score $\geq 4\%$ and $\leq 8\%$);
2. Heart Team consisting of at least one interventional cardiologist and one cardiac surgeon agree on indication, treatment proposal, and eligibility for randomization based on their clinical judgment (including anatomy assessment, risk factors, etc.);
3. Critical aortic valve area defined as an initial aortic valve area of $\leq 1.0 \text{ cm}^2$ or aortic valve area index $< 0.6 \text{ cm}^2/\text{m}^2$;
4. In presence of normal left ventricular (LV) function:
 - a) Mean gradient $> 40\text{mmHg}$ OR $V_{\text{max}} > 4\text{m/sec}$

OR

 - b) In presence of low flow, low gradient severe AS, a dobutamine stress echo must be conducted that demonstrates presence of contractile reserve defined as follows $\geq 20\%$ increase in stroke volume and mean gradient $> 40\text{mmHg}$;
5. Subject is symptomatic from his/her aortic valve stenosis, as demonstrated by New York Heart Association (NYHA) Functional Class II or greater;
6. The subject and the treating physician agree that the subject will return for all required post-procedure follow-up visits;
7. Patient meets the legal minimum age to provide informed consent based on local regulatory requirements.

C.3.6.2 Exclusion Criteria

Subjects are NOT eligible for trial participation if they meet ANY of the following exclusion criteria:

1. Hypersensitivity or contraindication to aspirin, heparin, ticlopidine, clopidogrel, coumadin, nitinol, or sensitivity to contrast media which cannot be adequately pre-medicated;
2. Blood dyscrasias as defined: leukopenia (WBC $<1000\text{mm}^3$), thrombocytopenia (platelet count $<50,000\text{ cells/mm}^3$), history of bleeding diathesis or coagulopathy;
3. Ongoing sepsis, including active endocarditis;
4. Any condition considered a contraindication to extracorporeal assistance;
5. Any percutaneous coronary or peripheral interventional procedure performed within 30 days prior to randomization with bare metal stents and 6 months with drug eluting stents;
6. Symptomatic carotid or vertebral artery disease or successful treatment of carotid stenosis within six weeks of randomization;
7. Cardiogenic shock manifested by low cardiac output, vasopressor dependence, or mechanical hemodynamic support;
8. Recent (within 6 months of randomization) cerebrovascular accident (CVA) or transient ischemic attack (TIA);
9. Active gastrointestinal (GI) bleeding within the past 3 months;
10. Subject refuses a blood transfusion;
11. Severe dementia (resulting in either inability to provide informed consent for the trial/procedure, prevents independent lifestyle outside of a chronic care facility, or will fundamentally complicate rehabilitation from the procedure or compliance with follow-up visits);
12. Multivessel coronary artery disease with a Syntax score >22 ;
13. Estimated life expectancy of less than 24 months due to associated non-cardiac co-morbid conditions;
14. Other medical, social, or psychological conditions that in the opinion of the Investigator precludes the subject from appropriate consent or adherence to the protocol required follow-ups exams;
15. Currently participating in an investigational drug or another device trial (excluding registries);
16. Evidence of an acute myocardial infarction ≤ 30 days before the index procedure;
17. Need for emergency surgery for any reason;
18. True porcelain aorta;
19. Extensive mediastinal radiation;
20. Liver failure (Child-C);
21. Reduced ventricular function with left ventricular ejection fraction (LVEF) $<20\%$ as measured by resting echocardiogram;
22. Uncontrolled atrial fibrillation;
23. Pregnancy or intent to become pregnant prior to completion of all protocol follow-up requirements;
24. End stage renal disease requiring chronic dialysis or creatinine clearance $< 20\text{ cc/min}$.

Anatomical exclusion criteria

25. Native aortic annulus size <20 mm or >29 mm per the baseline diagnostic imaging;
26. Pre-existing prosthetic heart valve in any position;
27. Mixed aortic valve disease [aortic stenosis and aortic regurgitation with predominant aortic regurgitation (3-4+)];
28. Severe mitral or severe tricuspid regurgitation;
29. Severe mitral stenosis;
30. Hypertrophic obstructive cardiomyopathy;
31. Echocardiographic or Multislice Computed Tomography (MSCT) evidence of intracardiac mass, thrombus or vegetation;
32. Ascending aorta diameter >43 mm unless the aortic annulus is 20-23 mm in which case the ascending aorta diameter >40 mm;
33. Femoral and left subclavian/axillary access:
 - a) Aortic root angulation (angle between plane of aortic valve annulus and horizontal plane/vertebrae) > 70°**OR**
 - b) Right subclavian/axillary access: Aortic root angulation > 30°;
34. Congenital bicuspid or unicuspid valve verified by echocardiography.

Vascular Exclusion Criteria

35. Transarterial access not able to accommodate an 18Fr sheath.

C.3.7 Informed Consent

The investigator must obtain written informed consent prior to subjecting the subject to any study related activity.

Well in advance of the consent discussion, the subject should receive the MEC/IRB approved Patient Information and Informed Consent Form (ICF). During the consent discussion the investigator or his/her designee must fully inform the subject of all pertinent aspects of the study including the approval of the MEC/IRB of the written Patient Information. If a subject is illiterate, an impartial witness must be present during the entire informed consent discussion. All items discussed in the Patient Information and the ICF must be explained. The language used shall be in the subject's native language, as non-technical as possible and must be understandable to the subject and the impartial witness, where applicable.

The subject must have ample time and opportunity to inquire about details of the study, and to decide whether or not to participate in the clinical study. All questions about the study should be answered to the satisfaction of the subject.

Neither the investigator, nor the investigation site staff shall coerce or unduly influence a subject to participate or to continue to participate in the clinical study. The informed consent process shall not appear to waive the subject's rights.

When the subject decides to participate in the clinical study, the ICF must be signed and personally dated by the subject and investigator. If applicable, the witness shall also sign and personally date the consent form to attest that the information in the Patient Information and Informed Consent Form was accurately explained and clearly understood by the subject, and that informed consent was freely given.

Signing the ICF serves to document the written and verbal information that the Investigator or authorized delegate provides to the patient or legal representative, the patient or legal representative's understanding of the information, and their agreement to participate. The Investigator or authorized delegate must document in the patient's medical records that the patient was consented and the date on which the consent was obtained. The original signed consent form will be retained in the patient's trial records. A copy of the informed consent will

be provided to the patient or legal representative and a copy placed in the patient's medical record.

Data relating to the trial might be made available to third parties (for example in case of an audit performed by regulatory authorities), provided the data are treated as confidential and that the subject's privacy is guaranteed. In the United States, "Protected Health Information" will be maintained in compliance with the Health Insurance Portability and Accountability Act of 1996 (HIPAA).

C.3.8 Revisions in Patient Information and Informed Consent Form

Medtronic will inform the investigators whenever information becomes available that may be relevant to the subject's continued participation in the study. The investigator or his/her designee should inform the subject in a timely manner. Medtronic will revise the written ICF whenever new information becomes available that may be relevant to the subject's continued participation in the study. The revised information will be sent to the investigator for approval by the IRB/MEC. After approval by the IRB/MEC, a copy of this information must be provided to the participating subjects, and the informed consent process as described above needs to be repeated.

C.3.9 Enrollment Flowchart for Randomization to MCS TAVI or SAVR

Table 2: Enrollment Flowchart

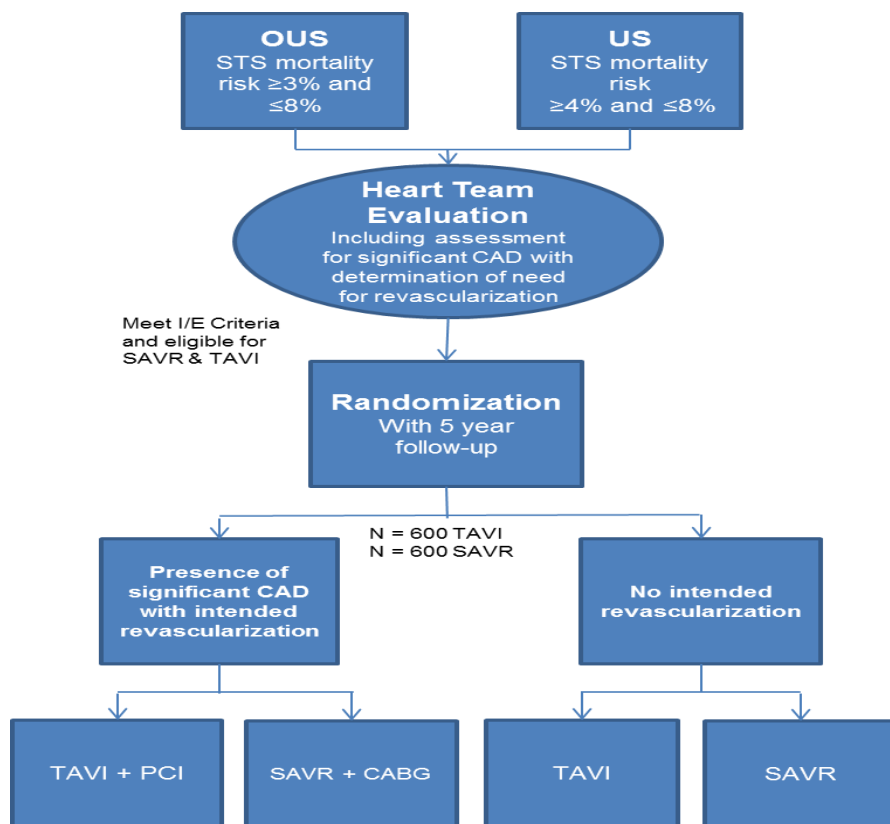

If the patient meets all of the inclusion criteria and none of the exclusion and Heart Team determines the patient is eligible for randomization in the SURTAVI trial, subjects will be randomized on a 1:1 basis to either TAVI or SAVR. Randomization will be stratified by the need for coronary revascularization. In case of required coronary revascularization, concomitant percutaneous coronary intervention (PCI) and TAVI is encouraged; however staging is left at the discretion of the operator. Coronary artery bypass graft (CABG) should be conducted during the index procedure.

A total of 1200 patients will be enrolled in the randomized trial (600 TAVI, 600 SAVR).

C.3.10 Trial Training

Prior to investigational site activation or subsequent involvement in study activities, Medtronic (or designee) will provide study training relevant and pertinent to the involvement of personnel conducting study activities, including investigator responsibilities, adverse event reporting as well as device training (if necessary, usage and handling of device under investigation). Training may be conducted via Site Initiation Visits, Investigator and Coordinator Meetings, and/or other media sessions. The sponsor will maintain documentation of attendance at each of these training opportunities, as applicable.

Additionally, Medtronic representative(s) may be present at each site's MCS TAVI procedures as part of the ongoing training process.

C.4 Trial Procedures

C.4.1 Screening Procedures

Prior to any trial-specific tests or procedures, written informed consent must be obtained from the subject. Failure to obtain a signed and hand dated informed consent prior to the procedure constitutes a protocol violation, which is reportable to the IRB/MEC, the Food and Drug Administration (FDA), and other regulatory authorities as applicable.

All potential subjects for trial entry must be screened for eligibility. All patients with symptomatic severe AS that provide informed consent will be entered into the Electronic Data Capture (EDC) system and total number of patients screened will be counted. The reasons why a patient did not enter the Heart Team meeting will be collected [e.g. patient does not have STS mortality risk score $\geq 3\%$ and $\leq 8\%$ (in United States $\geq 4\%$ and $\leq 8\%$)] and, age, STS score, and co-morbidities.

Data readily available in the patient's medical record may be utilized to fulfill screening requirements and do not need to be repeated. If not previously completed, the following tests and procedures must be performed prior to randomization to verify eligibility. The recommended timeframe for these tests and procedures is within 30 days prior to submission to the Heart Team, unless otherwise specified.

- Demographics and Medical History
- Clinical Assessments and Physical Examination including: vital signs and all major systems findings, weight, height, and body surface area (BSA); BSA will be calculated from height and weight by use of the formula by Dubois and Dubois ($BSA = 0.007184 \times \text{weight [kg]}^{0.425} \times \text{height [m]}^{0.725}$)
- NYHA classification
- STS Risk Score, Logistic EuroSCORE, SYNTAX Score, Katz Index of Independence in Activities of Daily Living
- Co-morbidities
- Routine Laboratory Tests:
 - Complete Blood Count:
 - White Blood Count
 - Hematocrit
 - Hemoglobin
 - Platelet Count
 - Creatinine and Creatinine Clearance
 - Cardiac Enzymes (CK/CK-MB)
 - International Normalized Ratio, if applicable
 - Activated Partial Thromboplastin Time
 - B-type Natriuretic Peptide (BNP) or NT-proBNP
 - Liver Panel:
 - ALT
 - AST
 - Albumin Sodium
 - Potassium

- Transthoracic Echocardiogram (TTE)
 - Comprehensive transthoracic two-dimensional (2D) echocardiogram (TTE). The TTE must be performed within 45 days prior to review by the Heart Team. [Note: if patient recently underwent balloon aortic valvuloplasty (BAV), a TTE should be obtained post-BAV; within 45 days prior to review by the Heart Team]. Echocardiograms will be performed according to the Echocardiography Procedures found in **Appendix R.7**. All echocardiograms for randomized subjects will be independently analyzed by the Echocardiographic Core Lab.
- Multi-Slice Computed Tomography (MSCT) Angiogram
 - Multi-Slice Computed Tomography (MSCT) angiograms with complete visualization of both iliacs, femorals and aorta (and subclavian/axillaries, if applicable), up to and including the aortic annulus. In the situation where subjects have compromised renal function that precludes contrast media, Magnetic Resonance (MR) imaging may be used as an alternative. MSCT angiograms will be performed according to the Computed Topography (CT) Angiography Acquisition Guidelines found in **Appendix R.9**. If the MSCT angiogram was conducted in the last 365 days and subject has not had a peripheral vascular intervention since the time of the image, a more recent exam is not required as long as visualization of both iliacs and femorals (and subclavian/axillaries, if applicable) to the aorta can be viewed. However, if the subject had a peripheral vascular intervention, the exam must be repeated after the intervention and within 90 days of review by the Heart Team.
- Coronary Arteriogram
 - Selective coronary arteriography to assess the presence and severity of coronary artery disease which should include angiograms of both coronary arteries and all bypass grafts (if applicable). If the coronary arteriogram has been performed within the last 365 days and the subject qualifies for the study (no significant coronary artery disease), a more recent exam is not required. However, if the subject had evidence of significant coronary artery disease and/or received a coronary intervention, the exam must be repeated after the intervention and within 90 days of review by the Heart Team.
- 12-lead Electrocardiogram (ECG)

C.4.2 Heart Team Procedures

Each center will utilize a Heart Team consisting of at least one interventional cardiologist and one cardiac surgeon to make final determination regarding eligibility of the prospective subject to be randomized in the SURTAVI trial. In order for a subject to be presented to the Heart Team, they must have an STS mortality risk score of $\geq 3\%$ and $\leq 8\%$. In the United States, patients must have STS mortality risk score of $\geq 4\%$ and $\leq 8\%$.

Prior to determining if a patient is eligible for randomization the Heart Team will review each patient's screening data and confirm the following:

- STS risk calculation was properly performed
- Any additional risk factors not accounted for in the STS risk calculator (e.g. frailty) that may increase the level of surgical risk:
 - Are properly documented
 - Confirm there is no incremental risk that would exclude the patient (i.e. increase relative surgical risk to greater than intermediate risk)
- All inclusion criteria are met and none of the exclusion criteria

The final decision of the local Heart Team will be documented in a co-signed decision form.

C.4.3 Enrollment and Randomization

Prior to randomization and enrollment of a subject, the following must occur:

- Confirm signed informed consent
- Confirm patient meets all of the inclusion and none of the exclusion criteria, including approval by the Heart Team

Subjects will be considered enrolled into the trial at the time of randomization¹ (i.e. time of treatment assignment). Randomization will occur only if the patient meets all inclusion criteria and does not meet any exclusion criteria and has been assessed by the Heart Team as being an appropriate candidate for randomization in the SURTAVI trial.

Due to the inclusion/exclusion criteria, not all patients that consent to the trial will be enrolled. All sites will be required to maintain a record of patients screened for the trial meeting general inclusion criteria who have signed the approved informed consent document. For subjects that do not meet trial criteria, the reason for not continuing in the trial must be documented and recorded in the EDC system. Patients consented but not randomized will be considered screen failures and no further study-related follow-up will be required.

Subjects must have their MCS TAVI or SAVR procedure no later than 30 days post-randomization.

Trial randomization will not be blinded. Once randomization is complete and a treatment arm is assigned, crossover from SAVR to TAVI treatment is not permitted. The sponsor will strictly monitor device dispensation to ensure that only those subjects randomized to the MCS TAVI treatment arm receive the Medtronic CoreValve[®] PAV.

Distribution of the subjects within the trial groups will be controlled at the implanting sites by means of central randomization using interactive voice/web randomization service (IXRS). The randomization scheme will be securely stored at the IXRS provider.

Randomization with an assignment to the treatment arm or control arm (MCS TAVI or SAVR) will be executed in a 1:1 ratio. Stratified randomization by investigational site and by the need for coronary revascularization will be used to ensure subjects will be allocated to each comparison group proportionately. Additionally, a blocked randomization scheme with random block sizes will be used within each stratum.

Subjects outside the United States with STS mortality risk score of $\geq 3\%$ and $< 4\%$ will be limited to a total of 300 subjects.

C.4.4 Baseline Assessments

The following baseline assessments should occur within 14 days prior to the index procedure.

- Clinical Assessment and Physical examination
- NYHA classification
- Concomitant medications
 - Use of relevant medications (diuretics, aspirin, anticoagulants, ACE-I, ARB, beta-blockers, statins and anti-platelets)
- Routine Laboratory Tests:
 - Complete Blood Count
 - White Blood Count
 - Hematocrit
 - Hemoglobin
 - Platelet Count
 - Creatinine and Creatinine Clearance
 - Cardiac Enzymes (CK/CK-MB)
 - International Normalized Ratio, if applicable

¹ Based on protocol design, the time of enrollment will be the same as randomization which is a deviation from ISO 14155 (2011)

- Activated Partial Thromboplastin Time (aPTT)
- B-type Natriuretic Peptide (BNP) or NT-proBNP
- Liver Panel:
 - ALT
 - AST
 - Albumin
- Sodium
- Potassium
- Neurological Assessments:
 - National Institute of Health Stroke Scale (NIHSS)
 - Modified Rankin Score (mRS) – for subjects with history of stroke only
 - Mini-Mental State Exam (MMSE-2) Additional Neurological testing:
 - Visual Fields Testing
 - Gait Assessment
 - Hand Function
 - Writing Evaluation
 - Drawing Assessment
- 12-lead Electrocardiogram (ECG)
- 6 Minute Walk Test
- Quality of Life Questionnaires
- Adverse Event Review

C.4.5 Medtronic CoreValve® System TAVI or Surgical Aortic Valve Replacement Procedure

C.4.5.1 MCS TAVI

General Procedural Considerations

Transcatheter Aortic Valve Implantation (TAVI) requires meticulous preparation and typically a multi-disciplinary team approach involving among others, interventional cardiologists, cardiac imaging specialists, cardio-thoracic surgeons and anesthesiologists.

In case of significant coronary artery disease that requires revascularization, the heart team will assess the feasibility of performing PCI simultaneously with the TAVI procedure based on the coronary lesion characteristics. When it is anticipated PCI can be performed in timely fashion with only a limited amount of additional contrast medium it is encouraged to perform PCI concomitant with the TAVI. When PCI is deemed challenging requiring relatively more time and contrast medium, staged PCI is recommended: TAVI will then be performed at least 7 days after PCI.

The implantation procedure itself takes place either in a catheterization laboratory with adequate hygiene precautions or ideally in a hybrid operating room equipped for state-of-the-art transcatheter and/or surgical procedures.

The execution of the TAVI involves an operating team typically consisting of 1 or 2 operators, an anesthesia team and at least 2 nurses/technicians.

Both the dedicated “valve team” and the operators should have the expertise to select the appropriate access route and device size on a patient-per-patient basis.

All patients undergoing TAVI should be treated using the ilio-femoral access route by default (first treatment strategy). Additional non-ilio-femoral access routes will only be used in case ilio-femoral access is not feasible.

The use of an embolic protection device during the TAVI procedure is not permitted.

Pre-Procedure

- If the patient is currently on warfarin therapy, or local equivalent, prior to the procedure:
 - Discontinue warfarin therapy 3 days prior to the procedure
 - Confirm that the INR < 1.8 prior to the procedure
 - Administer antiplatelet therapy:
 - Aspirin (75- 325 mg) daily **or**
 - Clopidogrel (75 mg) daily (or ticlopidine if clopidogrel is contraindicated) for 3 days prior to the procedure
- If the patient is currently **not** on warfarin therapy prior to the procedure:
 - Aspirin (75-325 mg) on the day of the procedure **and**
 - Clopidogrel (300 mg)
- Consider adjunctive proton pump inhibitors, H₂ antagonists or antacids
- Routine Laboratory Tests:
 - Complete Blood Count
 - White Blood Count
 - Hematocrit
 - Hemoglobin
 - Platelet Count
 - Creatinine and Creatinine Clearance
 - If the GFR < 60 cc/min, consider:
 - Fluid hydration on the day prior to the procedure
 - Discontinuation of NSAIDs and ACE inhibitors
 - Cardiac Enzymes (CK/CK-MB)
 - International Normalized Ratio, if applicable
 - Activated Partial Thromboplastin Time
 - B-type Natriuretic Peptide (BNP) or NT-proBNP
 - Liver Panel:
 - ALT
 - AST
 - Albumin
 - Sodium
 - Potassium
- 12-lead Electrocardiogram (ECG)

MCS TAVI Procedure

Medications

One hour prior to the procedure, prophylactic antibiotic therapy of the Investigator's choice should be initiated:

- Cefuroxime 750mg intravenous (IV) 1 hour pre-procedure, then 6 hours and 12 hours post-procedure
 - If allergic to Penicillin, prescribe Vancomycin 1g IV
 - Consider holding anti-hypertensives
- #### ***Anesthesia and Procedural Set Up***
- Establish a central venous line
 - Administer general anesthesia or conscious sedation per hospital protocol
 - Prior to beginning the Medtronic CoreValve[®] System implant, place a temporary 4-5 Fr. balloon-tip pacing wire in a stable location within the right ventricular (a screw-tip wire may be used for more secure placement for subjects at high-risk for dislodgement, if necessary)
 - Whenever possible, use the upper torso venous system (e.g., jugular, subclavian) for temporary pacing wire access
 - Use fluoroscopy to guide wire placement and stability
 - Confirm sensing and capture
 - Program the backup pacing rate to minimize ventricular pacing (e.g. 30-40 bpm). If heart block develops, adjust the rate accordingly

- Record ECG and angiogram during the procedure
- *Vascular Access*
 - The primary access artery will be used to introduce the CoreValve device and the balloon catheter; the secondary access artery will be used to introduce the reference pigtail
 - Insert a 6Fr introducer sheath into the secondary access artery
 - Insert 18Fr introducer sheath into the primary access artery using hospital protocol (either percutaneously or surgical cut down)
 - Administer anticoagulant therapy according to hospital protocol. If heparin is administered as an anticoagulant, check activated clotting time (ACT) at five minutes and monitor every 30-60 minutes after initial bolus of heparin
 - Maintain ACT \geq 250 seconds
 - Anticoagulant may be administered at any time prior to this point, but avoid delaying beyond this point
- *Crossing the native valve*
 - Advance the graduated pigtail catheter to the ascending aorta and position the distal tip in the noncoronary cusp of the native aortic valve
 - Identify the ideal annular viewing plane using contrast injections at various angiographic angles, preferably in the left anterior oblique (LAO) projection
 - Insert an angiographic catheter over a standard, J-tip guidewire into the primary access sheath and advance to the ascending aorta
 - Exchange the J-tip guidewire for a 0.035-in (0.889-mm) straight-tip guidewire. Advance the straight-tip guidewire across the native aortic valve into the left ventricle
 - After crossing the native aortic valve with the guidewire, advance the angiographic catheter into the left ventricle
 - Exchange the straight-tip guidewires for an exchange-length J-tip guidewire
 - Exchange the angiographic catheter for a 6Fr pigtail catheter
 - Remove the guidewire and connect the catheter to the transducer. Using both catheters, record the aortic pressure gradient
 - Using a right anterior oblique (RAO) projection, advance previously pigtail-shaped, 0.035-in (0.889-mm) high-support guidewire through the pigtail catheter and position in the apex of the left ventricle
 - Remove the pigtail catheter while maintaining guidewire position in the left ventricle
- *Rapid Pacing and Pre-dilatation of the Implant site*
 - Insert the valvuloplasty balloon through the 18Fr introducer sheath and advance it to the ascending aorta
 - Perform a rapid pacing test. A successful test is defined as 1-to-1 pacing capture with an immediate drop in pressure and elimination of the systolic-diastolic waveform
 - Reposition the angiographic equipment to the ideal viewing plane as previously described. Position the valvuloplasty balloon across the native valve, while maintaining strict fluoroscopic surveillance of the distal tip of the guidewire in the left ventricle (LV)
 - Perform BAV per hospital protocol and remove the valvuloplasty balloon while maintaining guidewire position across the native aortic valve
 - Balloon sizing directed to 1:1 sizing of the minimal annular diameter by computerized tomographic angiography (CTA) or echocardiogram with maximum 25 mm balloon
 - Perform full balloon expansion
- *Medtronic CoreValve[®] Implantation*
 - Insert the device over the 0.035-in (0.889-mm) guidewire and advance it, while maintaining strict fluoroscopic surveillance of the guidewire in the LV
 - When crossing the aortic arch, control the guidewire preventing it from moving forward
 - Advance the device through the native valve. Perform an angiogram to confirm that the graduated pigtail catheter is in position within the noncoronary cusp of the aortic root, preferably in the shallow LAO projection

- Use Fluoroscopy to identify the appropriate landmarks
 - Place the bioprosthesis within the aortic annulus. Optimal placement of the bioprosthesis is 4 mm - 6 mm below the annulus. The annulus is defined as the angiographic floor of the aortic root
 - After attaining optimal catheter position, slowly turn the micro knob and begin to deploy the bioprosthesis. As the inflow aspect of the bioprosthesis starts to flare outward, monitor bioprosthesis position under fluoroscopy
 - Caution: During implantation, if resistance to deployment is encountered (for example, the micro knob starts clicking or is tight or stuck), apply mild upward pressure to the macro slider while turning the micro knob. If the bioprosthesis still does not deploy, remove it from the patient and use another system
 - Perform an angiogram. Once annular contact is made, the bioprosthesis should not be advanced into a lower position
 - Continue deploying rapidly to the 2/3 deployment point; stop turning the micro knob
 - Perform an angiogram to assess the location of the bioprosthesis.
 - If the bioprosthesis is positioned low, carefully pull the DCS to reposition the bioprosthesis
 - Evaluate the valve position and valve function using hemodynamic, aortography, and possible echocardiography
 - When satisfactory position is achieved, continue to turn the micro knob until both frame loops disengage
 - Use orthogonal views under fluoroscopy to confirm that the frame loops have detached from the catheter tabs. If a frame loop is still attached to a catheter tab, under fluoroscopy, advance the catheter slightly and, if necessary, gently rotate the handle clockwise (<math><180^\circ</math>) and counterclockwise (<math><180^\circ</math>) to disengage the loop from the catheter tab
 - Withdraw the DCS carefully to the aorta avoiding contact with the inflow portion of the frame while maintaining guidewire position
- *Post Deployment*
 - Close the DCS capsule and remove the DCS through the 18Fr introducer sheath
 - Advance a 6Fr pigtail catheter over the guidewire into the left ventricle
 - Remove the guidewire and connect the pigtail catheter to the transducer
 - Using both pigtail catheters, record aortic pressure gradient
 - Withdraw 6Fr pigtail
 - Perform postimplant aortogram with the reference pigtail to assure coronary patency and assess aortic regurgitations. Aortogram Acquisition Guidelines are located in **Appendix R.6**
 - Remove the 18Fr introducer sheath and complete the puncture site closure per hospital protocol
 - Perform contrast angiography of the primary vessels to verify the absence of any vascular complications with the reference pigtail
 - Remove the reference pigtail catheter over a standard guidewire
 - Remove the 6Fr introducer and close the access site per hospital protocol

Ballooning as needed during the implant procedure is standard practice and should not be considered a reintervention.

Immediate Post-Procedure

The procedure is considered complete after final angiography has been performed, and the introducer sheath has been removed from the subject. Thereafter, if an introducer sheath is re-introduced, this is considered a repeat intervention, which must be documented on the reintervention Electronic Case Report Form (eCRF).

- Coronary Arteriogram
- Following the current recommendation all patients with prosthetic heart valves need endocarditis prophylaxis
- All patients should receive Deep Vein Thrombosis (DVT) prophylaxis with Heparin/Low Weight Molecular Heparin (LMWH) starting approximately 6 hours after TAVI if bleeding permits
- Anticoagulants should be discontinued per hospital standard
- Activated clotting time (ACT) should be monitored per hospital standards but recommendation is >250 seconds
- Cardiac Enzymes: CK within 8-12 hours post procedure and at any time when a clinical ischemic event is suspected. CK-MB is required if CK is elevated $\geq 2X$ the laboratory upper limit of normal. If a clinical event is confirmed, a total of 3 draws of cardiac enzymes within the first 24 hours (drawn approximately every 8 hours) following the clinical event should be obtained
- 12-lead Electrocardiogram (ECG) to be performed within 48 hours of procedure
- Abbreviated Neurological Assessment
 - National Institute of Health Stroke Scale (NIHSS) to be completed with 24 hours of procedure
- Transesophageal Echocardiogram (TTE)
 - Comprehensive transthoracic 2D echocardiogram (TTE) should be performed within 24-48 hours of procedure to assess device success. Echocardiograms will be performed according to Echocardiography Procedures found in **Appendix R.7**
- It is recommended that subjects are treated for a minimum of three months with dual anti-platelet medication
 - If the patient is on warfarin therapy post-procedure it is recommended that subjects are prescribed either daily:
 - Aspirin (75 to 325 mg) **or**
 - Clopidogrel (75 mg) (or ticlopidine, if clopidogrel is contraindicated) for at least three months following the procedure
 - If the patient will **not** be on warfarin therapy post-procedure it is recommended that subjects are prescribed daily:
 - Aspirin (75to 325 mg) **and**
 - Clopidogrel (75 mg) (or ticlopidine, if clopidogrel is contraindicated) for at least three months following the procedure
- Concomitant medications
- Documentation of all adverse events/serious adverse events from enrollment to discharge including all unanticipated adverse device effects (UADE), technical observations, reinterventions or repeat admissions to the catheterization suite and deaths
 - Any patient with evidence of a new neurological event should have a neurology consult and subsequently an imaging study if deemed necessary by the neurologist or stroke specialist

Post-Procedure Pacing Guidelines

- All patients should stay on telemetry until discharge
- Maintain temporary pacing until at least 48 hours post-implant in Cardiovascular Intensive Care Unit (CV-ICU) or local equivalent
- After 48 hours, obtain Electrocardiogram (ECG) and assess patient rhythm and conduction
- Based on assessment, and with the consult of an electrophysiologist as needed, take one of the following actions:
 - Discontinue temporary pacing
 - Continue temporary pacing for another 24 hours (longer if needed) to make further assessments
 - Place a permanent pacemaker according to ACC/AHA/HRS Guidelines for Device-Based Therapy of Cardiac Rhythm Abnormalities (Class I or IIb for Acquired Atrioventricular Block in Adults or Permanent Pacing in Chronic Bifascicular Block)
 - Prior to the permanent pacemaker implantation, document the reason for the placement of the permanent pacemaker via a 12-lead ECG
 - For complete heart block, review patient medications
 - Consider withholding some medications to assess for patient's intrinsic rate and conduction
 - If heart block persists off medications, a permanent pacemaker should be considered
 - If a permanent pacemaker is required, a dual chamber system is recommended to optimize patient hemodynamics
 - If a permanent pacemaker is implanted, perform a device interrogation and an assessment of AV conduction post insertion and prior to hospital discharge as well as at every follow-up visit to evaluate device utilization (Refer to the Pacing Guidelines in **Appendix R.13**)

C.4.5.2 Surgical Aortic Valve Replacement

Minimum Standards for Surgical Aortic Valve Replacement

Subjects randomized to SAVR should be treated according to the surgeon and hospital's standard practices. The surgeon or co-surgeon performing the SAVR must be a trial investigator for the site. The choice of surgical valve is left to the discretion of the investigator. ***However, the use of a bioprosthetic valve is required.***

General Procedural Considerations

One of the key requirements for good surgical outcome is an excellent collaboration of the dedicated multidisciplinary teams consisting of typically two cardiac surgeons with SAVR experience, a cardiac anesthesia team, an experienced cardio technician as well as at least two operation theater nurses.

Operation Theater

Surgical aortic valve replacement is to be performed in an operative theater with state-of-the-art technical equipment with certified sterility standards, adequate illumination, laminar flow, dedicated scrub nurses, and on site full technical support.

Perfusion

A dedicated, experienced perfusion team with greater than 75 Extracorporeal Circulation (ECC) runs per cardio technician per year who can perform all current cardioplegia strategies and is familiar with deep hypothermic circulatory arrest (DHCA) is recommended. The perfusion team should be capable of covering the full heart surgical spectrum including CABG, heart valve defect (HVD), Heart failure and assist devices, extracorporeal membrane oxygenation (ECMO) support, intra-aortic balloon pump (IABP), and cardiac transplant.

Pre-Procedure

- If the patient is currently on warfarin therapy, or local equivalent, prior to the procedure
 - Discontinue warfarin therapy 3 days prior to the procedure
 - Confirm that the INR < 1.8 prior to the procedure
 - Administer antiplatelet therapy:
 - Aspirin (75- 325 mg) **or**
 - Clopidogrel (75 mg) daily or ticlopidine if clopidogrel is contraindicated) for 3 days prior to the procedure
- If the patient is currently **not** on warfarin therapy prior to the procedure:
 - Aspirin (75-325 mg) on the day of the procedure **and**
 - Clopidogrel, 300 mg
- Consider adjunctive proton pump inhibitors, H₂ receptor antagonists or antacids
- Routine Laboratory Tests:
 - Complete Blood Count
 - White Blood Count
 - Hematocrit
 - Hemoglobin
 - Platelet Count
 - Creatinine and Creatinine Clearance
 - If the GFR < 60 cc/min, consider:
 - Discontinuation of NSAIDs and ACE inhibitors
 - Cardiac Enzymes (CK/CK-MB)
 - International Normalized Ratio, if applicable
 - Activated Partial Thromboplastin Time
 - B-type Natriuretic Peptide (BNP) or NT-proBNP
 - Liver Panel:
 - ALT
 - AST
 - Albumin
 - Sodium
 - Potassium
- 12-Lead Electrocardiogram
- One hour prior to the procedure, prophylactic antibiotic therapy of the Investigator's choice should be initiated:
 - Cefuroxime 750mg IV 1 hour pre-procedure, then 6 hours and 12 hours post-procedure
 - If allergic to Penicillin, prescribe Vancomycin 1g IV
 - Consider holding anti-hypertensives

Surgical Considerations

Surgical aortic valve replacement is typically performed with cardio-pulmonary bypass (CPB) on an arrested heart with a clamped aorta. Local practice and surgical standards should govern type of cardioplegia and the temperature/flow/pressure perfusion strategy as well as the activated clotting time used at either institution for safe CPB. Typically a minimum of 2 liters/m²/minute with a systemic arterial blood pressure of 60mmHg during CPB should be maintained and possibly increased in the elderly patients.

Cannulation for isolated SAVR CPB should be ascending aorta for arterial return unless there is ascending aortic arteriosclerosis or dilatation (>4cm in diameter), and right atrial for venous drainage. Embolic devices are not routinely used in SAVR.

Typical surgical workflow

- *Procedural set-up and Anatomic Evaluation:*
 - The patient is prepared and draped
 - IV antibiotics should be administered following the local standard of care
 - Following the presternal skin incision the sternum is split
 - Prepare the mediastinum and open the pericardium
 - Inspect the ascending aorta for calcifications (including epiaortic scan if necessary)
 - Complete heparin application and arterial and venous cannulation
 - Initiate CPB, and at surgeons discretion, left heart venting via right upper pulmonary vein or pulmonary artery
 - Cross clamp the aorta and initiate cardioplegic arrest
 - Perform an aortotomy
 - Complete annular decalcification (the surgeon should take all possible means to prevent embolization of debris)

- *Prosthesis Specific Sizing:*
 - If the aortic annulus does not permit valve replacement with a patient matched valve diameter, the aortic annulus should be enlarged at the surgeon's discretion

- *Valve Preparation and Implantation:*
 - The valve prosthesis should be prepared following the manufacturer recommendations
 - After rinsing bioprosthetic valves should be kept wet throughout the procedure
 - Anchoring of the prosthesis with, for example, interrupted Teflon reinforced Tycron sutures or an equivalent technique is recommended
 - De-air and close the aortotomy
 - Insert temporary ventricular and atrial pacing wires and chest tubes
 - Wean from ECC hemostasis
 - Complete sternal wiring and layered closure

- *Additional Procedural Considerations:*
 - In case of concomitant significant subvalvular left ventricular outflow tract occlusion (LVOTO) then resection is recommended
 - If there is a significant patent foramen ovale (PFO) closure is recommended in cases of substantial right to left flow
 - It might be recommendable to apply CO₂ surgical field flooding to ease de-airing

Intraoperative Aortic Assessment

Transesophageal echo (TEE) should be used in all cases to additionally assess for aortic calcifications before manipulating the aorta. In case of doubt an Epiaortic scan might further help for surgical decision making. Additionally the TEE should be used to assess for subvalvular LVOTO and persistent foramen ovale.

Before Termination of Surgery Repeat Intraoperative TEE

It is mandatory that TEE is used to assess the postoperative SAVR result in all patients. Assessment should include aortic valve function, central or paravalvular leakage, valve gradient, exclude remaining LVOTO from subvalvular stenosis as well as ventricular function with special emphasis on new segmental wall function abnormalities.

Any regurgitation of more than trace should be critically evaluated and at surgeons discretion the valve re-inspected and if necessary changed.

Immediate Post-Procedure

The procedure is considered complete at the time of skin closure. Immediately post-procedure the following tests and procedures must be performed and data collected:

- Cardiac Enzymes: CK within 8-12 hours post procedure and at any time when a clinical ischemic event is suspected. CK-MB is required if CK is elevated >2X the laboratory upper limit of normal. If a clinical event is confirmed, a total of 3 draws of cardiac enzymes within the first 24 hours (drawn approximately every 8 hours) following the clinical event should be obtained
- Concomitant Medications
- 12-lead Electrocardiogram (ECG) to be performed within 48 hours of procedure
- Abbreviated Neurological Assessment
 - National Institute of Health Stroke Scale (NIHSS) to be completed within 24 hours of procedure
- Transthoracic Echocardiogram (TTE)
 - Comprehensive transthoracic 2D echocardiogram (TTE) should be performed within 24-48 hours. Echocardiograms will be performed according to Echocardiography Procedures found in **Appendix R.7**
- Adverse Event review

Post-Procedural Medication

- It is recommended that subjects are treated with aspirin (75 -325mg daily) for a minimum of three months
- If warfarin therapy is indicated (e.g. A-fib): maintain therapeutic anticoagulation with Heparin or Low Molecular Weight Heparin until INR between 2 and 3 is reached after loading with warfarin
- The preoperative antibiotic therapy may be repeated within the next 6 to 12 hours
- All patients should receive DVT prophylaxis with Heparin/LMWH starting approximately 6 hours after SAVR if bleeding permits
- Following the current recommendation all patients with prosthetic heart valves need endocarditis prophylaxis

Post-Procedure Pacing Guidelines

- All patients should stay on telemetry until discharge
- Maintain temporary pacing until at least 48 hours post-implant in CV-ICU or local equivalent
- After 48 hours, obtain Electrocardiogram (ECG) and assess patient rhythm and conduction
- Based on assessment, and with the consult of an electrophysiologist as needed, take one of the following actions:
 - Discontinue temporary pacing
 - Continue temporary pacing for another 24 hours (longer if needed) to make further assessments
 - Place a permanent pacemaker according to ACC/AHA/HRS Guidelines for Device-Based Therapy of Cardiac Rhythm Abnormalities (Class I or IIb for Acquired Atrioventricular Block in Adults or Permanent Pacing in Chronic Bifascicular Block)
 - Prior to the permanent pacemaker implantation, document the reason for the placement of the permanent pacemaker via a 12-lead ECG
 - For complete heart block, review patient medications
 - Consider withholding some medications to assess for patient's intrinsic rate and conduction
 - If heart block persists off medications, a permanent pacemaker should be considered
 - If a permanent pacemaker is required, a dual chamber system is recommended to optimize patient hemodynamics

- If a permanent pacemaker is implanted, perform a device interrogation and an assessment of AV conduction post insertion and prior to hospital discharge as well as at every follow-up visit to evaluate device utilization (Refer to the Pacing Guidelines in **Appendix R.13**)

C.4.6 Assessments done at discharge (both SAVR and TAVI)

Prior to hospital discharge (or within 7 days post-MCS TAVI, whichever occurs first) the following tests and procedures must be performed and data collected:

- Clinical Assessment and Physical Examination
- Concomitant Medications
 - Use of relevant medications (diuretics, aspirin, anticoagulants, ACE-I, ARB, beta-blockers, statins and anti-platelets)
- Routine Laboratory Tests:
 - Complete Blood Count:
 - White Blood Count
 - Hematocrit
 - Hemoglobin
 - Platelet Count
 - Creatinine and Creatinine Clearance
 - Cardiac Enzymes (CK/CK-MB)
 - International Normalized Ratio, if applicable
 - Activated Partial Thromboplastin Time
 - B-type Natriuretic Peptide (BNP) or NT-proBNP
 - Liver Panel:
 - ALT
 - AST
 - Albumin
 - Sodium
 - Potassium
- Neurological Assessments
 - National Institute of Health Stroke Scale (NIHSS)
 - Mini-Mental State Exam (MMSE-2:SV)
 - Additional Neurological testing:
 - Visual Fields Testing
 - Gait Assessment
 - Hand Function
 - Writing Evaluation
 - Drawing Assessment
- Transthoracic Echocardiogram (TTE)
 - Comprehensive transthoracic 2D echocardiogram (TTE) should be performed as close to discharge (or 7 days, whichever comes first) as possible. Echocardiograms will be performed according to Echocardiography Procedures found in **Appendix R.7**
- 12-lead Electrocardiogram
- Adverse Event review

C.4.7 Follow-Up Evaluations

All randomized subjects will undergo in-clinic follow-up evaluations at the following time points post implant.

(All follow-up periods are defined as the number of days after the randomization date, except for the 30 days period, which is defined as the number of days since the date of procedure)

Note Day 0 = day of randomization:

- 30 days (- 7 days and + 14 days)
- 3 months (90 ± 14 days)
- 6 months (180 ± 30 days)
- 12 months (365 ± 30 days)
- 18 months (545 ± 60 days)
- 24 months (730 ± 60 days)
- 3 years (1080 ± 60 days)
- 4 years (1440 ± 60 days)
- 5 years (1800 ± 60 days)

All randomized subjects will complete long-term follow-up through 5 years. Upon completion of the final protocol visit (5 year visit or discontinuation) subject participation will be considered complete and the patient should then be followed per the local standard of care for their condition.

C.4.7.1 30 Days

The following assessments will be conducted at the 30 day visit.

- Clinical Assessment and Physical examination
- NYHA classification
- Concomitant Medications
 - Use of relevant medications (diuretics, aspirin, anticoagulants, ACE-I, ARB, beta-blockers, statins and anti-platelets)
- Routine Laboratory Tests:
 - Hemoglobin
 - Creatinine and Creatinine Clearance
- Abbreviated Neurological Assessment
 - National Institute of Health Stroke Scale (NIHSS)
- 12-lead Electrocardiogram
- 6 Minute Walk Test
- Quality of Life Questionnaires
- Adverse Event review

C.4.7.2 3 Months

The following assessments will be conducted via telephone at the 3 Month visit.

- Quality of Life Questionnaire
 - EQ-5D only

C.4.7.3 6 Months

The following assessments will be conducted at the 6 Month visit.

- Clinical Assessment and Physical examination
- NYHA classification
- Concomitant Medications
 - Use of relevant medications (diuretics, aspirin, anticoagulants, ACE-I, ARB, beta-blockers, statins and anti-platelets)
- Abbreviated Neurological Assessment
 - National Institute of Health Stroke Scale (NIHSS)
- Transthoracic Echocardiogram (TTE)
- 12-lead Electrocardiogram
- Quality of Life Questionnaires
- Adverse Event Review

C.4.7.4 12 Months

The following assessments will be conducted at the 12 Month visit.

- Clinical Assessment and Physical examination
- NYHA classification
- Concomitant Medications
 - Use of relevant medications (diuretics, aspirin, anticoagulants, ACE-I, ARB, beta-blockers, statins and anti-platelets)
- Neurological Assessments
 - National Institute of Health Stroke Scale (NIHSS)
 - Mini-Mental State Exam (MMSE-2)
 - Additional Neurological testing:
 - Visual Fields Testing
 - Gait Assessment
 - Hand Function
 - Writing Evaluation
 - Drawing Assessment
- Transthoracic Echocardiogram (TTE)
- 12-lead Electrocardiogram
- 6 Minute Walk Test
- Quality of Life Questionnaires
- Adverse Event review

C.4.7.5 18 Months

The following assessments will be conducted at the 18 Month visit.

- Clinical Assessment and Physical examination
- NYHA classification
- Concomitant Medications
 - Use of relevant medications (diuretics, aspirin, anticoagulants, ACE-I, ARB, beta-blockers, statins and anti-platelets)
- Abbreviated Neurological Assessment
 - National Institute of Health Stroke Scale (NIHSS)
- 12-lead Electrocardiogram
- Quality of Life Questionnaires
- Adverse Event review

C.4.7.6 24 Months

The following assessments will be conducted at the 24 Month visit.

- Clinical Assessment and Physical examination
- NYHA classification
- Concomitant medications
 - Use of relevant medications (diuretics, aspirin, anticoagulants, ACE-I, ARB, beta-blockers, statins and anti-platelets)
- Neurological Assessments
 - National Institute of Health Stroke Scale (NIHSS)
 - Mini-Mental State Exam (MMSE-2:SV)
 - Additional Neurological testing:
 - Visual Fields Testing
 - Gait Assessment
 - Hand Function
 - Writing Evaluation
 - Drawing Assessment
- Transthoracic Echocardiogram (TTE)
- 12-lead Electrocardiogram
- 6 Minute Walk Test
- Quality of Life Questionnaires
- Adverse Event review

C.4.7.7 3-5 Years

The following assessments will be conducted at the 3, 4, and 5 year visits.

- Clinical Assessment and Physical examination
- NYHA classification
- Abbreviated Neurological Assessment
 - National Institute of Health Stroke Scale (NIHSS)
- Transthoracic Echocardiogram (TTE)
- 12-lead Electrocardiogram
- Quality of Life Questionnaires
- Adverse Event review – refer to C.5.2 Reporting for AE reporting requirements post-24 Months

C.4.8 Echo Assessment

Echocardiography is the cornerstone of baseline and follow-up imaging. A comprehensive trans-thoracic echocardiogram (TTE) to assess the morphology and function of the respective heart chambers and valves is mandatory prior to implant. Calculation of the left ventricular Ejection Fraction (EF) by visual assessment, measurement of left ventricular end-diastolic volume and diameter and inter-ventricular septal thickness to characterize the left ventricle and transaortic jet velocity, mean transaortic gradient and aortic valve area by the continuity equation to illustrate AS severity are essential(1).

Echo assessment for all time periods will be conducted by a core laboratory.

Sites should make every effort to utilize the same echo machine for all subjects at all required interval throughout the duration of the protocol. Additionally, sites should perform regular maintenance and calibration of echo machines per local standards and ensure proper documentation is available for audit, as applicable.

C.4.9 Neurologic Assessment

The incidence of new clinically detectable neurological events or deficits, or any comparative change in indices of higher cognitive function following implantation of the Medtronic CoreValve® System in the treatment of patients with symptomatic severe aortic stenosis is an important clinical endpoint. Therefore, a baseline neurological examination by a qualified study-trained neurologist or stroke specialist is mandatory and as outlined in section C.4.7 Follow-Up Evaluations.

In case of a new neurological event, the diagnosis of stroke should be supported by complementary findings on neuro-imaging examination. The need for additional imaging is up to discretion of the Neurologist or Stroke Physician. Both diffusion-weighted Magnetic Resonance imaging and multi-slice Computed Tomography are valid neuro-imaging modalities (however CTA or MRA is preferred to CT or MRI), the selection of which will be left per institution's standard of care.

In addition to the neurological assessments at specified time periods, additional evaluations should be conducted as follows during the course of the trial:

- NIHSS:
 - For subjects with a new neurological event (stroke, TIA, or encephalopathy), additional NIHSS exams are to be performed at 30 days, and 3 months post-event
 - NIHSS also to be done within 24 hours of any aortic valve or ascending aortic intervention
 - Any patient with evidence of a new neurological event should have a neurology consult and an imaging study if deemed necessary
- Modified Rankin Scale
 - For subjects with new neurological event, assessment to be performed at 7 days or discharge (whichever occurs first), 30 days, and 3 months post-stroke
- Mini Mental State Exam (MMSE-2)
 - For subjects with a new neurological event assessments are to be performed at 30 days and 3 months post-stroke

Refer to the **Appendix R.18** for a description of the Additional Neurological Testing.

C.4.10 Angiographic and Computed Tomography Assessment

Complete angiographic (invasive or MSCT) assessment of the aortic bifurcation and ilio-femoral-arterial tree is mandatory prior to the Heart team Conference.

An additional benefit of Multislice CT scan in the TAVI cohort is to obtain a thorough assessment of the anatomy of the left ventricular outflow tract (LVOT) up to the common femoral arteries. MSCT also provides information on coronary and carotid anatomy, and might identify occult malignancy which is also valuable information in SAVR cohort.

The aortic valve calcification is evaluated using the Agatston score and a qualitative gradation (grade 1—no calcification; grade 2—mildly calcified (small isolated spots); grade 3—moderately calcified (multiple larger spots); grade 4 — heavily calcified (extensive calcification of all cusps)(53). With respect to the elliptical shape of the virtual aortic annulus, the axial plane where the 3 basal aortic leaflet attachments can be identified simultaneously is used for measuring the maximum and minimum annular diameter (most often corresponding to 2 orthogonal sagittal and coronal planes)(54). Additionally the maximum diameters of the LVOT, sinuses of Valsalva and sinotubular junction are obtained. Maximum diameter, calcification and tortuosity of the ascending and descending thoracic aorta are evaluated. As for the iliofemoral tree, the minimal luminal diameter, plaque and calcification burden and tortuosity are assessed in order to judge transfemoral accessibility for the Medtronic CoreValve® System.

C.4.11 Data Collection

All scheduled testing and procedures to be conducted during the baseline, index procedure, and follow-up assessments are summarized in Table 3.

Table 3: Schedule of Assessments

Parameter	Screening	RANDOMIZATION = DAY 0										
		Baseline (within 14 days of procedure)	Procedure	Discharge	30 days	3 Months	6 Month	12 Month	18 Month	24 Month	3 – 5 years	
Informed consent (and in US HIPAA Authorization)	•											
Inclusion/Exclusion	•											
Demographics and Medical history	•											
Clinical Assessment and Physical Examination	•	•		•	•		•	•	•	•	•	•
NYHA Class	•	•			•		•	•	•	•	•	•
STS Risk Score, Logistic EuroScore, SYNTAX Score, Katz Index	•											
Co-morbidities	•											
Concomitant Medications ¹²		•	•	•	•		•	•	•	•	•	•
Routine Laboratory Tests	•	•	• ^{1,2}	•	• ³							
Neurological Assessments ⁷ (NIHSS, MMSE and Additional Neurological Assessments) ¹⁰		• ⁹		•				•		•		
Abbreviated Neurological Assessment (NIHSS only)			• ⁸		•		•		•		•	
Transthoracic Echocardiogram (TTE)	•		• ⁵	•			•	•		•	•	
Transesophageal Echocardiogram (TEE)			•									
Computed Tomography (CT) Angiogram (MSCT required at screening) ⁶	•											
Coronary Arteriogram	•		(•)									
12-lead Electrocardiogram	•	•	• ⁴	•	•		•	•	•	•	•	•
6 Minute Walk Test		•			•			•		•		
Quality of Life Questionnaires (EQ-5D, KCCQ, and SF-12)		• ¹³			•		•	•	•	•	•	•
Quality of Life Questionnaire (EQ-5D only) ¹⁴						•						
Adverse Events		•	•	•	•		•	•	•	•	•	• ¹¹

(•) MCS TAVI subjects only (SAVR subjects will not have these assessments)

- ¹ Laboratory test results must be performed pre-procedure and CK to be obtained within 8-12 hours post-procedure
- ² Pre-procedure
- ³ Post-discharge and subsequent follow-up visits require only hemoglobin, creatinine and creatinine clearance are required to be collected
- ⁴ Electrocardiogram within 48 hours of procedure
- ⁵ TTE to be completed within 24-48 hours of procedure to assess device success
- ⁶ All subjects should have screening thoracic and abdominal CT angiograms with complete visualization of both iliacs, femorals, and aorta (and subclavian/axillaries, if applicable), up to and including the aortic annulus
- ⁷ In addition to the protocol required assessment (NIHSS and MMSE); for subjects with neurological event or stroke, additional NIHSS and MMSE exams are to be performed at 30 days and 90 days post-event. mRS should be completed at 7 days post-event or discharge (whichever occurs first), 30 days, and 90 days post-event. NIHSS is also to be done within 24 hours of any aortic valve or ascending aortic intervention
- ⁸ NIHSS to be done within 24 hours of the procedure
- ⁹ Modified Rankin to be performed at baseline for patients with a previous history of stroke only
- ¹⁰ Additional Neurological Assessments include: Visual Fields Testing, Gait Assessment, Hand Function, Writing Evaluation, and Drawing Assessment
- ¹¹ SAE, MAE, cardiovascular events, device-related events, including device-related technical observations, UADEs, all stroke (CVAs), and death reports
- ¹² Use of relevant medications (diuretics, aspirin, anticoagulants, ACE-I, ARB, beta-blockers, statins and anti-platelets)
- ¹³ Quality of Life Questionnaires should be completed prior to informing the subject of randomization assignment
- ¹⁴ Quality of Life Questionnaire – EQ-5D to be administered via telephone

C.4.12 Unscheduled Follow-up Assessments

If a subject returns to the institution between their scheduled follow-up visits the visit will be treated as an unscheduled visit and the assessments completed at this visit will be done at the discretion of the investigator. eCRFs are provided for unscheduled visits.

C.4.13 Missed Follow-up Visits

Every effort should be made to ensure subjects return to the clinic for all protocol required follow-up. If the subject is unable to return for an in-person clinic visit, the Investigator, or designee, must document in the patient record the reason the subject was unable to complete the visit and, if applicable, follow the requirements for deviation reporting as outlined in section C.4.16 Protocol Deviations.

The Investigator should also make every effort to contact the subject or subject's legal representative, within the visit window, to collect the subject's vital status as well as information related to potential adverse events, safety data, and hospitalizations.

C.4.14 Investigational Product Accountability

The Investigator is responsible for maintenance of the Shipment/Device Disposition Log. The log must detail the product and lot numbers as well as the location and status of all investigational devices (including DCS and CLS components, where applicable) received by the hospital and/or Investigator. At the end of the clinical trial the Principal Investigator must sign the original log.

This clinical trial will be conducted in some geographies where the Medtronic CoreValve® System is commercially available. In these geographies the device will be used outside the current approved indication, therefore the PAV will be labeled as investigational. Note, the DCS and CLS components are identical to the CE marked CoreValve System and will be supplied within the approved commercial CE marked labeling. The Investigator must provide full accountability for each PAV from the time of receipt through disposition and/or return. Accountability for the each DCS and CLS must include all disposition within the clinical trial.

In geographies where the device is not currently approved the PAV, DCS and CLS components will be labeled as investigational. The Investigator must provide full accountability for each PAV, DCS and CLS from the time of receipt through disposition.

At the end of the study enrollment period, all remaining investigational product must be returned to Medtronic.

C.4.15 Device Malfunction or Explant

In the event of a device malfunction of the Medtronic CoreValve® System (MCS) prior to implant or in the event that a Medtronic CoreValve® PAV is explanted after implant (due to reintervention or autopsy), the PAV and/or affected MCS components should be returned to Medtronic to the following:

Medtronic, Inc.
Attn: Explant Lab [PE#]
1851 E. Deere Avenue
Santa Ana, CA 92705-5720

Additional details surrounding the device return process are contained within the Medtronic explant kit and in **Appendix R.11**.

C.4.16 Protocol Deviations

A protocol deviation is defined as an event where the clinical investigator or site personnel did not conduct the trial according to the protocol or the Investigator agreement. Deviations will be reported regardless of whether medically justifiable, pre-approved by Medtronic, or taken to protect the patient in an emergency.

A protocol deviation form is to be completed for each trial protocol deviation, including, but not limited to:

- Failure to obtain informed consent
- Incorrect version of consent provided to patient
- Failure to obtain IRB/MEC protocol review and approval before starting the trial
- Enrollment of patient during an IRB/MEC approval lapse
- Clinical investigator exceeding enrollment limits specified by sponsor
- Patient did not meet inclusion/exclusion criteria
- Incorrectly performed testing
- Protocol-required testing and/or measurements not done or performed outside of window
- Source data permanently missing
- UADE not reported in the required timeframe

FDA regulations [21 CFR 812.140] require that the Investigator maintain accurate, complete, and current records, including documents showing the dates of and reasons for each deviation from the protocol. Relevant information for each deviation will be documented on a deviation form completed by site personnel and reviewed by the Investigator.

Federal regulations [21 CFR 812.150], ISO 14155, and local regulatory authorities (where applicable), require Investigators to obtain prior approval from the sponsor before initiating changes in or deviations from the protocol, except when necessary to protect the life or physical well being of a patient in an emergency.

Prior approval by the sponsor is expected in those situations in which the Investigator anticipates, contemplates or makes a conscious decision to depart from procedures specified in the protocol. Prior approval is generally not expected in situations where unforeseen circumstances are beyond the Investigator's control, but is still considered a deviation (e.g. a trial subject who fails to attend a scheduled follow-up visit, a trial subject too ill to perform a protocol-required test). To obtain approval, the Investigator must call or email and discuss the potential deviation with the Medtronic trial manager or designee prior to initiating any changes. If approval is granted, the Medtronic trial manager or designee will provide the applicable documentation to be maintained in the site files.

FDA regulations require the Investigator to notify the sponsor and the reviewing IRB/MEC within 5 working days of the following deviations [21 CFR 812.150]:

- a deviation from protocol to protect the life or physical wellbeing of a patient in an emergency
- failure to obtain an informed consent

Investigators or an authorized designee must notify Medtronic as soon as possible by calling the trial manager or designee and completing the protocol deviation form.

The Investigator is required to adhere to local IRB/MEC procedures for reporting deviations.

The DSMB may review protocol deviations to ensure compliance and overall study integrity.

C.4.17 Subject Withdrawal or Discontinuation

All subjects will be encouraged to remain in the trial through the last follow-up visit at month 60. Subjects who discontinue participation prematurely after randomization will be included in the analysis of results (as appropriate) but they will not be replaced in the enrollment of total trial subjects. If a trial subject is discontinued from the trial early, the reason for discontinuation should be documented in the patient file and a Study Exit eCRF must be completed.

The trial site and Sponsor will make every effort to have all subjects complete the follow up visit schedule. A subject will not be considered lost-to-follow-up unless all efforts to obtain compliance are unsuccessful. At a minimum, the effort to obtain follow-up information must include three attempts to make contact via telephone and if contact via phone is not successful, a traceable letter from the Investigator must be sent to the subject's last known address. Should both telephone and mail efforts to contact the subject be unsuccessful, the subject's primary physician should be contacted. Subjects will then be deemed lost to follow up. All contact efforts to obtain follow-up must be documented in both the subject's medical records and in the trial eCRFs.

If a patient officially withdraws from the study but is willing to allow either regular vital status determinations for the study or a one-time vital status determination, these are to be conducted per the follow-up visit schedule or only at the last planned follow-up visit, respectively, and may be conducted via telephone.

If a patient discontinues the trial at any time, is withdrawn from the study early, or completes all protocol required follow-up they should then be followed per the local standard of care for their condition.

C.4.18 Termination or Discontinuation of Trial

Medtronic may decide to suspend or prematurely terminate the study. If the study is terminated prematurely or suspended, Medtronic shall promptly inform the clinical investigators of the termination or suspension and the reason(s) for this. The investigator shall then promptly inform the reviewing MEC/IRB.

Possible reasons for early trial termination include:

- Unanticipated Adverse Device Effect (UADE) presents an unreasonable risk to patients
- Recommendation from DSMB

If the trial is terminated early, the Sponsor will, as soon as possible, provide a written statement to the Investigators to enable prompt notification of the IRB/MECs. The Sponsor will also inform the FDA. If the trial enrollment is terminated early, the follow-up visits will continue for all enrolled subjects.

C.5 Adverse Events

C.5.1 Definitions

The definitions presented in this section allow for a clear understanding of adverse event data collection and subsequent analysis.

C.5.1.1 Adverse Event

An adverse event (AE) is any untoward medical occurrence, unintended disease or injury, or untoward clinical signs (including abnormal laboratory findings) in subjects, users or other persons, whether or not related to the investigational medical device.

NOTE 1: This definition includes events related to the investigational medical device or the comparator.

NOTE 2: This definition includes events related to the procedures involved.

NOTE 3: For users or other persons, this definition is restricted to events related to investigational medical devices.

The following events in Table 4 are expected to occur with any surgical implant and therefore should not be reported as AEs, unless they occur outside of the stated timeframe:

Table 4: Expected Events

Description of the Event	Timeframe (hours) from Procedure
Anesthesia-related nausea and/or vomiting	24
Low-grade fever (<100°F or <37.8°C)	48
Back pain related to laying on the procedure table	72
Incisional pain (pain at access site)	72
Sleep problems or insomnia	72
Mild to moderate bruising or ecchymosis	168

C.5.1.2 Serious Adverse Event

A serious adverse event (SAE) is an event that:

- Led to death
- Led to serious deterioration in the health of the subject, that either resulted in:
 - a life threatening illness or injury, or
 - a permanent impairment of a body structure or a body function, or
 - inpatient or prolonged hospitalization, or
 - medical or surgical intervention to prevent life-threatening illness or injury or permanent impairment to a body structure of a body function
- Led to fetal distress, fetal death or a congenital anomaly or birth defect

NOTE: Planned hospitalization for a pre-existing condition, or a procedure required by the CIP, without serious deterioration in health, is not considered a serious adverse event.

In addition to above standard definition of SAE, the following events will also be defined as serious in the SURTAVI trial, including events that do not meet the above criteria for SAE.

- Stage 2 and 3 acute renal injuries
- Moderate or severe aortic regurgitation (AR)
- Moderate or severe aortic stenosis (AS)
- Life-threatening and Major bleeding events
- Any new or worsening LBBB or RBBB that requires the placement of a permanent pacemaker and/or surgical or invasive intervention
- Moderate or severe mitral stenosis (MS)
- All myocardial infarctions
- All moderate or severe paravalvular leaks
- Major strokes
- Major vascular complications

Events that do not meet these criteria are considered non-serious.

C.5.1.3 Major Adverse Cardiovascular and Cerebrovascular Events

Major adverse cardiovascular and cerebrovascular events (MACCE) is defined as a composite of:

- All-cause death
- Myocardial infarction (MI)
- All stroke, and
- Reintervention (defined as any cardiac surgery or percutaneous reintervention catheter procedure that repairs, otherwise alters or adjusts, or replaces a previously implanted valve)

C.5.1.4 Major Adverse Event

Major adverse event (MAE) includes:

- MACCE
- Acute kidney Injury
- Cardiac tamponade
- Prosthetic valve dysfunction
- Cardiogenic shock
- Valve endocarditis
- Valve embolism
- Life-threatening, disabling or major bleeding
- Major vascular complication
- Cardiac perforation
- Device migration

C.5.1.5 Adverse Device Effect (ADE) or Device-Related Adverse Event

An ADE is an adverse event related to the use of an investigational medical device. During this clinical investigation an event should be considered related to the device when it is the result of the Medtronic CoreValve[®] System (MCS):

- The percutaneous aortic valve (PAV)
- The delivery catheter system (DCS)
- The compression loading system (CLS)
- The implant procedure

An event should be considered not related to the device when it is the result of:

- A pre-existing medical condition
- A new illness, injury or condition
- Medication

NOTE 1: This definition includes adverse events resulting from insufficient or inadequate instructions for use deployment, implantation, installation, or operation, or any malfunction of the investigational medical device.

NOTE 2: This definition includes any event resulting from use error or from intentional misuse of the investigational medical device.

C.5.1.6 Unanticipated Adverse Device Effect (UADE)

An unanticipated adverse device effect or UADE is defined as “any serious adverse effect on health or safety or any life-threatening problem or death caused by, or associated with, a device, if that effect, problem, or death was not previously identified in nature, severity, or degree of incidence in the protocol or application (including a supplementary plan or application), or any other unanticipated serious problem associated with the device that relates to the rights, safety, or welfare of subjects” [21 CFR 812.3 (s)].

Those known adverse events related to the device, procedure or therapy are listed in Section C.5.2.5 and in the Risk/Benefit Analysis section (Section D) of this document.

C.5.1.7 Device Deficiency

Inadequacy of a medical device with respect to its identity, quality, durability, reliability, safety or performance

NOTE: Device deficiencies include malfunctions, use errors, and inadequate labeling.

C.5.1.8 Technical Observation

A technical observation is a defect, malfunction, or failure of any part of the Medtronic CoreValve[®] System. This may pertain to the device or system not functioning according to its design intent. Each technical observation (whether or not associated with any untoward medical occurrence in a subject) will be reported on the Adverse Event (AE) eCRF and tabulated as an AE.

C.5.2 Reporting

Investigators are required to keep records on “all relevant observations, including records concerning adverse device effects (whether anticipated or unanticipated)” [21 CFR 812.140]. Adverse event collection will begin from the point of study enrollment to study closure. All new or worsening (from baseline) adverse events and technical observations will be captured on the AE eCRF through the 24-month follow-up visit. It is the responsibility of the Investigator to assess the subject for adverse events and capture the required adverse event information on the AE eCRF.

Once a subject has completed their 24-month scheduled follow-up visit only serious adverse events, major adverse events, cardiovascular events, device-related adverse events, including device related technical observations, unanticipated adverse device effects (UADE), all strokes (CVAs) and deaths will be required to be reported. Reference section C.5.1 Adverse Events for event definitions and criteria. Medtronic representatives or their designees will conduct monitoring visits to review source documentation and verify the complete and accurate capturing of adverse events.

The Investigator must also notify the responsible IRB/MEC regarding new and significant safety information and any event identified by Medtronic that requires expedited FDA, and/or local regulatory agency, reporting as serious, unexpected, and related to the investigational device. It is the responsibility of the investigator to ensure site specific IRB/MEC safety reporting requirements are met.

Medtronic Clinical will ensure all device-related adverse events and all procedure-related SAEs are processed according to internal policies and procedures. When necessary, Medtronic Field Assurance will respond to sites in writing with the findings related to the product experiences.

The general procedure for investigators reporting any adverse event is as follows:

- Report the event to Medtronic as soon as possible but no later than the timeframes outlined below. (At the time of Site Initiation, sites will be provided with the contact information of the appropriate Medtronic designee).
- Complete all sections of the Adverse Event eCRF.
- Each unique event/diagnosis must be documented separately.
- Documented pre-existing conditions are not considered to be reportable AEs unless there is a change in the nature or severity of the condition.
- The Adverse Event eCRF must be reviewed by the Investigator.

Reporting guidelines related to specific types of adverse events are outlined below.

C.5.2.1 Serious Adverse Events (SAEs)

Medtronic requests that the Investigator notify the sponsor immediately but not later than within 3 working days of first learning of any SAE using the EDC system. If necessary, the Investigator may be requested to provide copies of source documentation regarding the event (e.g., physician/nurse notes or summaries). The Investigator should also notify their IRB/MEC and, if applicable, local regulatory agencies, per their requirements.

Medtronic will conduct an evaluation of the event and if it is determined by Medtronic to be a UADE, it will be reported as described in the following sections.

C.5.2.2 Unanticipated Adverse Device Effects

Investigators must report any (potential) unanticipated adverse device effects to Medtronic and their IRB/MEC immediately but no later than 10 working days after the Investigator first learns of the event [21 CFR 812.150]. UADEs should be reported immediately to Medtronic via telephone as well as on an eCRF. The Investigator should also notify their IRB/MEC and, if applicable, local regulatory agencies, per their requirements.

The Investigator should consider the device labeling and the Risk/Benefit Analysis section of this document (Section D) when determining whether an event is unanticipated or not.

If an event is determined by Medtronic to be a UADE, Medtronic will report the event to all investigators to enable reporting to their respective IRB/MECs. Medtronic will provide this

notification within 10 working days after Medtronic first receives notice of the effect. [21 CFR 812.150]

If Medtronic and the DSMB determine that the event presents an unreasonable risk to the participating subjects, Medtronic must terminate all investigations or parts of investigations presenting the risk in the clinical trial 5 working days after making that determination and not later than 15 working days after Medtronic first receives notice of the effect. [21 CFR 812.46] Follow-up visits for enrolled subjects will continue according to the schedule of assessments.

C.5.2.3 Device Deficiencies and Technical Observations

Device Deficiency information and Technical Observations will be collected throughout the study and reported to Medtronic.

Device Deficiencies and Technical Observations should be reported on an Adverse Event eCRF.

Device deficiencies that did not lead to an Adverse Event but could have led to an SADE

- a) if either suitable action had not been taken,
- b) if intervention had not been made, or
- c) if circumstances had been less fortunate,

require immediate reporting (see Table 8). Initial reporting may be done on the eCRF completing as much information as is available. The original completed eCRF must be submitted to Medtronic as soon as possible.

C.5.2.4 All Other Adverse Events

Medtronic requests that the Investigator notify the sponsor within 10 working days of first learning of any other AE using the EDC system. If necessary, the Investigator may be requested to provide copies of source documentation regarding the event (e.g., physician/nurse notes or summaries).

C.5.2.5 Anticipated Adverse Events

Potential risks associated with MCS TAVI may include, but are not limited to, the following:

- Death
- Acute myocardial infarction
- Stroke
- Urgent need for surgery
 - Coronary artery bypass
 - Heart valve replacement
 - Valve explant
- Urgent need for balloon valvuloplasty (note that BAV during implantation is expected)
- Urgent need for Percutaneous Coronary Intervention (PCI)
- Cardiogenic shock
- Perforation of the myocardium or vessel
- Cardiac Tamponade
- Ascending aorta trauma
- Myocardial ischemia
- Acute coronary artery occlusion
- Disturbances in the electrical system of the heart that may result in the permanent placement of a device (pacemaker)
 - Atrio-ventricular node block
 - Bundle branch block
 - Asystole
- Ventricular arrhythmias
- Valve or distal embolization
- Thrombosis (including valve thrombosis)
- Hemorrhage requiring transfusion

- Arteriovenous fistula
- Vessel dissection or spasm
- Valve migration
- Prosthetic valve dysfunction including but not limited to:
 - Fracture
 - Bending (out-of-round configuration) of the valve frame
 - Under-expansion of the valve frame
 - Calcification
 - Pannus
 - Wear, tear, prolapse, or retraction in the valve leaflet
 - Poor valve coaptation
 - Suture breaks or disruption
 - Leak
 - Mal-sizing (prosthesis-patient mismatch)
 - Malposition (either too high or too low)
 - Regurgitation
 - Stenosis
- Mitral valve regurgitation
- Hypotension or hypertension
- Acute renal injury
- Allergic reaction to antiplatelet agents or contrast medium
- Infection (including endocarditis)
- Bowel ischemia
- Vascular access site or access related complications, including but not limited to:
 - pain
 - bleeding
 - hematoma
 - pseudoaneurysm
 - irreversible nerve injury
 - compartment syndrome
 - stenosis

C.5.2.6 Deaths

The Investigator should notify Medtronic and his/her IRB/MEC immediately but not later than within 3 working days of learning of a subject's death, whether or not the death is related to the investigational device. The Investigator should also notify local regulatory agencies, if applicable, per their requirements. The Investigator should also attempt to determine, as conclusively as possible, whether such deaths are related to the Medtronic CoreValve[®] System. When an autopsy is conducted, a copy of the report should be provided to Medtronic. Medtronic will evaluate the event and if device-related and unexpected, the event will be reported as a UADE.

Any subject death will be reported on the Study Exit eCRF and accompanied by an Adverse Event eCRF identifying the cause of death.

C.5.3 Clinical Events Committee (CEC)

An independent Clinical Events Committee (CEC) will review and adjudicate, at a minimum, all deaths and endpoint related adverse events. The CEC will consist of interventional cardiologists, cardiologists, and cardiovascular surgeons, including a chairperson, who are not participants in the trial. Additional specialist, such as neurologists, may also be selected as part of the CEC.

The purpose of the CEC is to conduct a medical review and classify/adjudicate, at a minimum, all deaths and/or clinical endpoints collected in the trial according to definitions and processes outlined in the Medtronic CoreValve[®] SURTAVI Trial protocol and the CEC charter, which will be developed and approved by Medtronic and the CEC members.

Events will be reviewed and adjudicated by a minimum of three CEC members, who will meet at regular intervals, via teleconference or in person, as deemed necessary. All other events will

be reviewed and adjudicated by qualified internal Medtronic safety individual(s) to ensure they should not be adjudicated by the full CEC and that the events are appropriately classified by the investigator.

Prior to the onset of the trial, the CEC will establish explicit rules outlining the minimum amount of data required and the algorithm followed in order to classify/adjudicate a trial endpoint related clinical event. CEC decisions will be documented in meeting minutes, which will be maintained in the trial file.

C.5.4 Data Safety Monitoring Board (DSMB)

An independent, unblinded DSMB will be established and will be comprised of at least 3 experts, including a chairperson. The DSMB will have a minimum of one cardiac surgeon, one interventional cardiologist and one statistician, and will be independent of Medtronic and the trial investigators. Investigators participating in the trial may participate in the meetings to offer clarification surrounding events, but will not have voting privileges. Medtronic personnel may facilitate the DSMB meeting but will not have voting privileges. The DSMB will meet (via teleconference or in person) prior to the first subject enrollment to establish procedures for DSMB review, chairman appointment and guidelines for trial recommendations. The full DSMB will meet on a periodic basis to perform a comprehensive data review and will meet more frequently when needed. Primary and safety-related secondary endpoints may also be reviewed at these meetings. Meetings will consist of both open and closed sessions.

The DSMB will also perform a supplemental review of, at a minimum, all serious adverse events and deaths and any other data requested by the DSMB on a more frequent periodic basis to ensure patient safety. DSMB members will review the report, and when necessary provide recommendations about the conduct of the study and/or request a full DSMB meeting.

A DSMB charter will be developed and approved by Medtronic and the DSMB members. The committee will outline the criteria for both the full DSMB meeting and supplemental DSMB reviews within the DSMB charter.

Following each full DSMB meeting, the board will report to Medtronic in writing and may recommend changes in the conduct of the trial. These DSMB recommendations may include recommendations on trial status such as continuing the trial without modifications, continuing the trial with modifications, stopping the enrollment in the trial or a specific trial arm, or recommendations about trial conduct including recommendations around enrollment or protocol deviations.

In the case of UADEs, if Medtronic and the DSMB determine that the event presents an unreasonable risk to the participating subjects, Medtronic must terminate the clinical trial within 5 working days after making that determination and not later than 15 working days after Medtronic first receives notice of the effect. [21 CFR 812.46]. All clinical sites will be notified of this action.

The DSMB may call additional meetings if, at any time, there is concern about any aspect of the trial. All data presented at the meetings will be considered confidential and returned to the trial statistician at the closure of the DSMB meeting.

Additional details about the DSMB are outlined in the DSMB charter.

C.6 Statistical Methods and Analysis

Any deviations from this section and/or the Statistical Analysis Plan will be described and justified in the Final Report, as appropriate or justified in the CIP.

C.6.1 Statistical considerations and analysis

This section describes the statistical considerations and analysis plans for the SURTAVI trial. The statistical analysis will be performed by the statistics department of Medtronic. As primary analysis all randomized subjects will be analyzed following the intention to treat (ITT) approach, i.e. according to the randomized assignment, regardless of what therapy was actually received. All follow-up periods are defined as the number of days after the randomization date, except for the 30 days period, which is defined as the number of days since the procedure date.

C.6.2 Reports

Medtronic is responsible for the reports cited in Table 7 (Sponsor Reporting Responsibilities). These reports are subject to regulatory retention and inspection requirements. In addition to the reports listed in Table 7, FDA, Competent Authorities, or the reviewing IRB/MEC may request reports pertaining to any aspect of the clinical trial.

C.6.3 Description of Baseline Variables

Baseline demographic and clinical variables will be summarized for each of the treatment groups for the intent-to-treat, as treated, and per implanted populations. All continuous variables will be summarized as means, medians, standard deviations and interquartile ranges and compared between treatment groups using a two-sample t-test or the non-parametric Wilcoxon rank-sum test. Categorical variables will be summarized as frequencies and percentages and compared between treatment groups using Pearson's χ^2 test or Fisher's exact test, as appropriate. Ordinal variables will be compared using Cochran-Mantel-Haenszel test with row mean scores.

C.6.4 Analysis Populations

C.6.4.1 Screening population

All patients with symptomatic severe AS that provide informed consent will be considered screened and all available data will be entered into the EDC system.

C.6.4.2 Randomized population

If the patient signs informed consent, meets all inclusion and none of the exclusion criteria, and Heart Team determines the patient is suitable for randomization in the trial, the patient is added to the randomized population once the treatment assignment is made. Within the randomized population three populations are distinguished:

- The intention to treat (ITT) population, - Patients are reported according to the randomized assignment, SAVR or TAVI, regardless of what, if any, therapy was actually received
- The "as treated" population - This population includes the randomized patients on whom the assigned procedure was attempted, whether or not the procedure was accomplished and/or successful. A procedure attempt is defined as when the subject is brought into the procedure room and any of the following have occurred: anesthesia administered, vascular line placed, TEE placed or any monitoring line placed
- The implanted population: This population includes the "as treated" patients who are actually implanted with either the CoreValve device or a surgical valve

C.6.5 Primary analysis

The primary endpoint of all-cause mortality or major stroke at 24 months will be evaluated using the difference between the SAVR survival rate and the TAVI survival rate for all-cause mortality or major stroke during a fixed follow-up of 24 months' time, as resulting from the Kaplan-Meier analysis. The hypothesis test is designed to show non-inferiority of TAVI to SAVR for the primary endpoint.

The primary endpoint will be evaluated using the test statistic as suggested by Com-Nogue et al.²

$$z = \frac{(1 - \hat{S}_1) - (1 - \hat{S}_2) - \delta_0}{\sqrt{\hat{V}(\hat{S}_1) + \hat{V}(\hat{S}_2)}}$$

where δ_0 is the non-inferiority margin, \hat{S}_1 and \hat{S}_2 are the Kaplan-Meier survival estimates at 24-months for TAVI and SAVR respectively, and $\hat{V}(\hat{S}_1)$ and $\hat{V}(\hat{S}_2)$ are the corresponding Greenwood variance estimates. The Greenwood variance is calculated as shown in Cantor³.

C.6.5.1 Hypothesis of non-inferiority

The hypothesis test is designed to show non-inferiority of TAVI to SAVR for the primary endpoint with a one-sided alpha of 0.05. The null (H_0) and alternative (H_A) hypotheses are:

$$H_0: \pi_{\square \text{MCS TAVI}} \geq \pi_{\square \text{SAVR}} + 7.5\%$$

$$H_A: \pi_{\text{MCS TAVI}} < \pi_{\square \text{SAVR}} + 7.5\%$$

In the above expression $\pi_{\text{MCS TAVI}}$ and $\pi_{\square \text{SAVR}}$ denote rates of all-cause mortality or major stroke during a fixed follow-up of 24 months, for a population with an STS score in the range 3-8.

A 90% large sample confidence interval for the difference in rates will be calculated as:

$$\left((1 - \hat{S}_1) - (1 - \hat{S}_2) \right) \pm z_{\alpha/2} \sqrt{\hat{V}(\hat{S}_1) + \hat{V}(\hat{S}_2)}$$

If the upper limit of the interval does not exceed 7.5% TAVI will be declared non-inferior to SAVR.

If non-inferiority is met, then a superiority test will be performed with a two-sided alpha of 0.05.

C.6.5.2 Sample size and power calculation

For the sample size and power calculation the population value of $\pi_{\text{MCS TAVI}}$ and $\pi_{\square \text{SAVR}}$ are both assumed to be 25%. In the PARTNER Cohort A results, as presented at the ACC on April 3, 2011, the KM estimate at one-year follow-up for SAVR was 28.0%. This trial however had a higher-risk population than SURTAVI. The PARTNER rate is adjusted therefore downwards and a two-year follow-up period instead of a one-year follow-up period is used. The resulting 25% should be a conservative estimation of the 2Y SURTAVI rate.

Assumptions:

- 1:1 treatment allocation ratio
- One-sided alpha = 0.05
- Combined endpoint of mortality or major stroke follows a piecewise exponential distribution with 1-month, 12-month, and 24-month rates of 6%, 16%, and 25%, respectively, for both MCS TAVI and SAVR.
- Non-inferiority margin of 7.5%

² Com-Nogue, C., Rodary, C., Patte, C., 1993. How to establish equivalence when data are censored: a randomized trial of treatments for B non-Hodgkin lymphoma. *Statist. Med.* 12, 1353–1364.

³ Alan B. Cantor, 2001. Projecting the standard error of the Kaplan-Meier estimator, *Statist. Med.* 20 2091-2097

- Patients are lost to follow-up at a rate of 3% per year, following an exponential distribution.
- The analysis will take place when the time since implant is at least 24 months for all subjects.
- Subject enrollment is assumed to follow the rates presented in Table 5.

Table 5: Projected Monthly Enrollment Rates

Month	1	2-3	4	5	6	7	8-12	13+
Monthly Enrollment Rate	10	20	30	40	45	50	55	60

Thus the expected enrollment rate is 490 patients during the first 12 months and 720 during the next 12 months.

The above test statistic does not have a closed form solution for the calculation of sample size or power. Instead, the tables below present power estimates for two sample sizes. For each estimate, 10,000 simulations were run, resulting in a Monte Carlo standard error of about $\pm 0.5\%$. Sample sizes combine both MCS TAVI and SAVR. Estimates are also presented for the maximum observed difference in 24-month event rates that would still result in statistical significance (i.e., concluding non-inferiority).

Table 6: Estimated Power and Maximum Difference Resulting in Statistical Significance

		Power	Maximum Difference in Event Rates Resulting in Non-Inferiority
Sample Size	900	82.0%	3.0%
	1200	90.8%	3.5%

By using a sample size of 1200 patients (600 MCS TAVI, 600 SAVR) in the range of STS 3-8 more than 90% power is achieved. If in the trial the difference between the KM estimates for the rates of all-cause mortality or major stroke for MCS TAVI and SAVR does not exceed 3.5%, MCS TAVI is considered non-inferior to SAVR.

The subgroup for purpose of obtaining FDA approval is the STS 4-8 group. Assuming less than 25% of the 3-8 population has an STS-value of 3-4, more than 900 of the patients will fall in the STS 4-8 group. This group has therefore more than 80% power.

C.6.6 Description of performed analysis, per population

C.6.6.1 Analysis of screening population

For the screening population only descriptive statistical analysis will be performed, on variables that are captured in the EDC system.

C.6.6.2 Analysis of – ITT population

For the patients in the randomized population the primary analysis of the primary endpoint and inferential statistics for the following secondary endpoints will be performed on ITT basis:

- Major adverse cardiovascular and cerebrovascular events (MACCE)
- Individual MACCE components
- Major adverse events (MAE)
- Conduction disturbance requiring permanent pacemaker implantation
- NYHA
- Six-minute walk test
- Ratio of days alive out of hospital versus total days alive
- Quality of life
- Echocardiographic assessment of valve performance

- Aortic valve disease-related hospitalizations
- Cardiovascular deaths and valve-related deaths
- Strokes and TIAs.

C.6.6.3 Analysis of as treated population

The “as treated” population will be used for a secondary, supportive analysis of the primary endpoint. This result should be consistent with the result of the ITT analysis in order to demonstrate non-inferiority. The as treated population will also be used for analyzing the following secondary endpoints:

- Index procedure-related MAEs
- Length of index procedure hospital stay
- Device success
- Procedure success

C.6.6.4 Analysis of implanted population

The implanted population will be used for analyzing the secondary endpoint of prosthetic valve dysfunction. An additional analysis of the primary endpoint and of the secondary endpoint of echocardiographic assessment of valve performance will also be performed on the implanted population.

C.6.7 Statistical methods to be used

In general, binary variables will be summarized using counts, percentages, and exact 95% confidence intervals. For continuous variables, percentiles, means, standard deviations, and 95% confidence intervals for the mean using the Gaussian approximation will be calculated. Time-to-event data will be summarized using Kaplan-Meier estimates and 95% confidence intervals.

C.6.8 Procedure for accounting data, treatment for missing, unused or spurious data

Every effort will be undertaken to minimize missing data. In time-to-event outcomes the patient will be censored from the moment of (a) discontinuation of the study, (b) the first occurrence of the specific event, (c) the latest time information is available on the occurrence of the event, whichever comes first; consistent with the Kaplan-Meier approach.

No statistical techniques will be used to impute missing data for categorical or continuous outcomes.

To assess the potential impact of missing data for the primary endpoint, a sensitivity analysis will be conducted which will include a complete case, a best-case (assume missing MCS TAVI subjects are alive and event-free and SAVR subjects have died), a worst-case (assume missing MCS TAVI subjects have died and SAVR subjects are alive and event-free), and a tipping point analysis.

C.6.9 Interim analysis

No formal interim analysis will take place. However, data from the MCS TAVI arm may be utilized to seek CE Mark approval for the Intermediate Risk indication prior to study completion. This analysis will not impact the Type I error rate as there will not be an early analysis of randomized data.

Additionally, safety monitoring will be performed by an independent DSMB at regular intervals.

C.6.10 Pre-Defined Subgroups

While results for primary and secondary endpoints for the entire population of randomized patients with STS mortality risk of $\geq 3\%$ and $\leq 8\%$ will be used for publication purposes, the subgroup of patients with STS mortality risk of $\geq 4\%$ and $\leq 8\%$ will be analyzed for all primary and secondary endpoints for the purpose of obtaining FDA approval.

- Diabetes Mellitus (yes, no)
- Age (<70 years of age, 70-74 years of age, 75-79 years of age and ≥ 80 years of age)
- Sex (male, female)
- Presence of co-morbidities
- Need for coronary revascularization

A test for interaction between the treatment effect (SAVR versus TAVI) and the subgroup variable will be performed.

These comparisons are not powered, and will be for exploratory purposes only, not to be used to support labeling claims.

C.6.11 Health-Related Quality of Life (HRQoL) and Treatment Costs

Health-related quality of life (HRQoL) and treatment costs will be assessed alongside the core clinical trial to evaluate the impact of the TAVI and SAVR strategies on a range of relevant quality of life (QoL) domains and also to evaluate the cost-effectiveness of the two treatment strategies.

C.6.11.1 Quality of Life

Health Related Quality of Life (HRQoL) and functional status will be assessed using a combination of generic and disease-specific measures selected to cover a broad range of health domains that may be affected by severe aortic stenosis disease, its treatment, and its complications: the Medical Outcomes Study 12-item Short Form (SF-12),⁴ the Kansas City Cardiomyopathy Questionnaire (KCCQ), and the EuroQoL (EQ-5D). All patients will complete standardized, written questionnaires at baseline (prior to subject being informed of randomization), 30 days, 6 months, 12 months, 18 months, 24 months and annually thereafter up to 5 years. At 3 months subjects will also be contacted via telephone to complete the EQ-5D.

C.6.11.2 Economic Outcomes/Cost-Effectiveness

Data on resource utilization will be collected for the index hospitalization and through long-term follow-up for all enrolled subjects. These resource items will include number and duration in-patient stays in hospital by type of unit (e.g. intensive care, high-dependency care and standard ward care); number of clinic visits (by type of physician); and details of the main procedure undertaken. As part of the trial analysis, resource use estimates will be presented by randomized group (e.g. mean per patient plus standard deviation). These data, together with the EQ-5D data will provide an important input into cost effectiveness analysis. However, as such analysis is likely to be based on a modeling framework, to include evidence from a number of sources (e.g. a meta-analysis of other TAVI trials) and to vary according to the jurisdiction of interest, it is appropriate to detail the methods in separate protocols and analysis plans.

⁴ Ware JE, Kosinski M, Keller SD. A 12-item short-form health survey (SF-12): construction of scales and preliminary tests of reliability and validity. *Medical Care* 1996;32:220-33.

C.6.12 Secondary Endpoints

The following secondary endpoints will be compared between MCS TAVI and SAVR subject cohorts:

1. Major Adverse Cardiovascular and Cerebrovascular Events (MACCE)-free survival at 30 days, 6 months, 12 months, 18 months, 24 months, and annually thereafter up to 5 years. MACCE is defined as a composite of:

- All-cause death
- Myocardial infarction (MI)
- All stroke, and
- Reintervention (defined as any cardiac surgery or percutaneous reintervention catheter procedure that repairs, otherwise alters or adjusts, or replaces a previously implanted valve)

MACCE-free survival estimates will be provided for the randomized groups at 30 days, 6 months, 12 months, 18 months, 24 months, and annually thereafter up to 5 years. All randomized subjects will be included in the analysis.

The endpoint will be evaluated using Kaplan-Meier survival analysis and the log-rank test.

2. The occurrence of individual MACCE components at 30 days, 6 months, 12 months, 18 months, 24 months, and annually thereafter up to 5 years.

MACCE components will be summarized and MACCE component event-free rates will be provided at 30 days, 6 months, 12 months, 18 months, 24 months, and annually thereafter up to 5 years. All randomized subjects will be included in the analysis.

The endpoint will be evaluated using Kaplan-Meier survival analysis and the log-rank test.

3. Major Adverse Events (MAE) at 30 days, 6 months, 12 months, 18 months, 24 months, and annually thereafter up to 5 years.

MAE events will be summarized and MAE event-free rates will be provided at 30 days, 6 months, 12 months, 18 months, 24 months, and annually thereafter up to 5 years. All randomized subjects will be included in the analysis.

The endpoint will be evaluated using Kaplan-Meier survival analysis and the log-rank test.

4. Conduction disturbance requiring permanent pacemaker implantation at 30 days, 6 months, 12 months, 18 months, 24 months, and annually thereafter up to 5 years.

The incidence of conduction disturbance requiring permanent pacemaker implantation will be provided at 30 days, 6 months, 12 months, 18 months, 24 months, and annually thereafter up to 5 years, separately for new onset and pre-existing conduction disturbance. All randomized subjects will be included in the analysis.

The endpoint will be evaluated using Kaplan-Meier survival analysis and the log-rank test.

5. Change in NYHA class from baseline at 30 days, 6 months, 12 months, 18 months, 24 months, and annually thereafter up to 5 years.

For each subject with paired data, the number of classes changed from baseline (-2, -1, 0, 1, 2, or 3) will be calculated at 30 days, 6 months, 12 months, 18 months, 24 months, and annually thereafter up to 5 years.

The endpoint will be evaluated using a two-sample t-test or Wilcoxon rank-sum test as appropriate.

6. Change in distance walked during 6-minute walk test (6MWT) from baseline to 30 days, baseline to 12 months, and baseline to 24 months.

All subjects who are able to perform the six-minute walk evaluation; and those subjects who are unable to perform the walk evaluation due to heart failure symptoms at the time of the follow-up visit will be included in the analysis.

The six-minute walk evaluation will be evaluated at 30 days, 12 months, and at 24 months using a two-sample t-test or Wilcoxon rank-sum test as appropriate.

7. Ratio of days alive out of hospital versus total days alive assessed at 12 months and 24 months follow-up.

The proportion of post randomization days alive out of hospital against total days alive will be compared between groups at 12 and 24 months. The numerator will be the number of days alive out of hospital, and the denominator will be the number of days alive as of the follow-up visit date. All hospitalizations will be included in this analysis, including hospitalization for device implant. All randomized subjects will be included in the analysis.

The endpoint will be evaluated using continuous data analyses such as a two-sample t-test or Wilcoxon rank-sum test.

8. Quality of Life (QoL) change from baseline at 30 days, 3 months, 6 months, 12 months, 18 months, 24 months, and annually thereafter up to 5 years.

The Kansas City Cardiomyopathy Questionnaire (KCCQ), SF-12, and EuroQoL will be assessed at baseline, 30 days, 6 months, 12 months, 18 months, 24 months, and annually thereafter up to 5 years. All subjects completing the questionnaires will be evaluated and the reasons for missing data will be provided.

The changes in QoL scores will be evaluated using a two-sample t-test or Wilcoxon rank-sum test as appropriate.

9. Echocardiographic assessment of prosthetic valve performance at discharge, 6 months, 12 months, 24 months, and annually thereafter up to 5 years using the following measures:

- transvalvular mean gradient
- effective orifice area
- degree of prosthetic aortic valve regurgitation (transvalvular and paravalvular)

The four echocardiographic measurements will be evaluated at discharge, 6 months, 12 months, 24 months, and annually thereafter up to 5 years. All randomized subjects undergoing echocardiography procedures will be evaluated.

All measures will be evaluated using a two-sample t-test or the Wilcoxon rank-sum test for continuous variables, and the Mantel-Haenszel test for categorical variables, as appropriate.

10. Aortic valve disease related hospitalizations

The number of subjects re-hospitalized after the initial index procedure will be compared at 30 days, 6 months, 12 months, 18 months, 24 months, and annually thereafter up to 5 years. All randomized subjects will be included in the analysis.

Hospitalization-free rates will be provided at 30 days, 6 months, 12 months, 18 months, 24 months, and annually thereafter up to 5 years. All randomized subjects will be included in the analysis. The endpoint will be evaluated using Kaplan-Meier survival analysis and the log-rank test.

11. Cardiovascular deaths and valve-related deaths

The number of cardiovascular deaths and valve-related deaths at 30 days, 6 months, 12 months, 18 months, 24 months, and annually thereafter up to 5 years. All randomized subjects will be included in the analysis.

The endpoint will be evaluated using Kaplan-Meier survival analysis and the log-rank test.

12. Strokes and TIAs

The number of subjects with strokes (of any severity) and TIAs at 30 days, 6 months, 12 months, 18 months, 24 months, and annually thereafter up to 5 years. A separate analysis will be performed for each of the following:

- a composite of all strokes and TIAs
- major strokes only
- minor strokes only
- TIAs only

Each endpoint will be evaluated using Kaplan-Meier survival analysis and the log-rank test.

13. Peri-procedural Neurological Injury (Stroke, TIA, Encephalopathy)

For each treatment group, the proportion of subjects with a neurologic injury (stroke, TIA, or encephalopathy) at discharge or at 7 days post-index procedure (whichever occurs first) will be calculated. The numerator will be the number of subjects with a neurologic injury (stroke, TIA, or encephalopathy) at discharge or at 7 days post-index procedure (whichever occurs first), and the denominator will be the number of subjects in that treatment group. Results will also be presented separately for major stroke, minor stroke, TIA, and encephalopathy. Proportions will be compared between groups using the pooled z-test without correction for continuity.

14. Index procedure related MAEs

Index procedure-related MAE events will be summarized and event rates will be provided at 30 days. The numerator will be the number of procedure-related MAE events experienced by the end of the follow-up visit, and the denominator will be the number of subjects evaluated at the follow-up visit plus the number of subjects not evaluated but who experienced a procedure-related MAE event prior to the end of the follow-up visit window.

The endpoint is descriptive and no statistical hypothesis test will be performed.

15. Length of index procedure hospital stay

The length of TAVI or SAVR hospital stay will be summarized for all subjects.

Descriptive statistics will be provided. The endpoint is descriptive and no statistical hypothesis test will be performed.

The following secondary endpoints will be assessed for the MCS TAVI cohort subjects only:

16. Device success defined as follows:

- successful vascular access, delivery and deployment of the device, and successful retrieval of the delivery system,
- correct position of the device in the proper anatomical location (placement in the annulus with no impedance on device function),
- Intended performance of the prosthetic valve¹ (aortic valve area > 1.2 cm² (by echocardiography using the continuity equation) and mean aortic valve gradient < 20 mmHg or peak velocity < 3 m/sec, without moderate or severe prosthetic valve AR)
- Only one valve implanted in the proper anatomical location

¹ assessed acutely in a resting state, either within 24-48 hours after the index procedure or before hospital discharge

Device success, as defined above, will be calculated for all subjects undergoing the TAVI procedure.

The endpoint is descriptive and no statistical hypothesis test will be performed.

17. Procedural success, defined as device success and absence of in-hospital MACCE.

Procedure success, as defined above, will be calculated for all randomized subjects undergoing the TAVI procedure.

The endpoint is descriptive and no statistical hypothesis test will be performed.

18. Evidence of prosthetic valve dysfunction at 30 days, 6 months, 12 months, 18 months, 24 months, and annually thereafter up to 5 years.

The number of subjects with evidence of prosthetic valve dysfunction will be evaluated at 30 days, 6 months, 12 months, 18 months, 24 months, and annually thereafter up to 5 years. All subjects will be included in the analysis.

A Kaplan-Meier survival analysis will be performed. The endpoint is descriptive and no statistical hypothesis test will be performed.

C.7 Data and Quality Management

C.7.1 Electronic Data Capture

Medtronic will use the Oracle Clinical Remote Data Capture database system for data collection.

Oracle is a secure, password-protected, Part 11 compliant database which is backed up regularly (at a minimum once daily).

C.7.2 Data Collection

The investigator must ensure accuracy, completeness and timeliness of the data reported in the EDC system and in all other required reports. Data reported on the eCRFs which are derived from source documents must be consistent with the source documents or the discrepancies need to be justified in a documented rationale, signed and dated by the (principal) investigator, to be filed in the subject file.

Required data will be recorded on the eCRFs by authorized site personnel as indicated on the Delegation of Authority Log. The eCRFs must be completed and/or updated to reflect the latest observations on the subjects participating in the trial.

The investigator (or approved sub-investigator) will electronically sign the appropriate pages of each eCRF.

The EDC system maintains an audit trail on entries, changes or corrections in CRFs. If a person only authorized to complete CRFs makes changes to an already signed CRF, the investigator shall re-sign this CRF.

The sponsor and/or assigned designee will be responsible for the processing and quality control of the data. All trial-related documents must be retained for a period of at least 2 years after the last approval of a marketing application and until there are no pending or contemplated marketing applications in an ICH region, or at least 2 years have elapsed since the formal discontinuation of clinical development of the investigational device. Medtronic will inform the investigator/institution when these documents are no longer required to be retained.

No trial document or image should be destroyed without prior written agreement between the Sponsor and the investigator. Should the investigator wish to assign the trial records to another party or move them to another location, advance written notice should be given to the Sponsor.

Copies of the eCRFs to be used are included in **Appendix R.5**.

C.7.3 Core Laboratories Procedures

Data from the core lab will be transferred to Medtronic and stored in the Oracle Clinical Remote Data Capture system as described in the Medtronic CoreValve[®] SURTAVI Trial Data Management Plan.

C.7.4 Source Documents

Source documentation is defined as the first time the data appear and may include all clinical records, hospital records, surgery reports, autopsy reports, and any other material that contains original information used for trial data collection or adverse event reporting. No eCRFs may serve as source documents.

Source documentation may vary from site to site.

The source documents must be retained by the investigational site for a period of 2 years after trial conclusion and made available for monitoring or auditing by the sponsor's representative or representatives of the FDA and other applicable regulatory agencies. The Investigator must ensure the availability of source documents from which the information on the eCRFs was derived.

C.8 Records and Reports

C.8.1 Responsibilities of the Sponsor

The Sponsor must maintain the following records, at a minimum:

- All essential correspondence related to the clinical trial
- Signed Investigator Agreement
- Curriculum vitae for each Investigator
- Records of device shipment and disposition (shipping receipts, material destruction records, etc.)
- Adverse event information
- Complaint documentation
- All data forms, prepared and signed by the Investigators and received source documentation and core lab reports
- Protocol and report of prior investigations
- Site monitoring reports
- Financial disclosure information

The Sponsor is responsible for the preparation of, the accuracy of the data contained in, the review of and the submission of the reports listed in Table 7.

Table 7: Sponsor Reporting Responsibilities

Report	Submit to	Description
Unanticipated Adverse Device Effects (UADE)	IRB/MEC, Investigators, FDA, and local regulatory agencies, where applicable	Medtronic will report on any confirmed unanticipated adverse device effect evaluation as soon as possible but no later than within 10 working days after first receiving notice of the effect. (21 CFR 812.150) and in compliance with local regulatory requirements, as applicable.
Withdrawal of IRB/MEC approval	IRB/MEC, Investigators, FDA, and local regulatory agencies, where applicable	Notification, when appropriate, will be made within 5 working days after Medtronic receives notice of withdrawal of IRB/MEC approval.
Withdrawal of FDA approval	IRB/MEC, Investigators	Notification will be made within 5 working days after Medtronic receives notice of withdrawal of FDA approval.
Current Investigator List	FDA and local regulatory agencies, where applicable	Medtronic will submit a current list of the names and addresses of all participating Investigators at six-month intervals, beginning six months after FDA approval of IDE.
Progress Report	IRB/MEC, Investigators, FDA	A progress report will be submitted at least yearly.
Recall and Device Disposition	IRB/MEC, Investigators, FDA, and local regulatory agencies, where applicable	Notification will be made within 30 working days of Medtronic's request that an Investigator return, repair or otherwise dispose of any devices. Such notification will state why the request was made.

Report	Submit to	Description
Final Report	IRB/MEC, Investigators, FDA	Notification will be made within 30 working days of the completion or termination of the investigation. A final report will be submitted within six months after trial completion or termination.
Failure to obtain Informed Consent	FDA	Notification will be made within 5 working days after Medtronic's receipt of such notification indicating Informed Consent was not obtained.
Emergency Deviations from Investigational Plan	FDA and local regulatory agencies, where applicable	Notification will be made within 5 working days after Medtronic learns of an emergency deviation from the Investigational Plan where the deviation was made to protect the life or physical wellbeing of a subject.

C.8.2 Responsibilities of the Investigator

The Investigator is responsible for the preparation, review, signature, and retention of the records listed below:

- All essential correspondence that pertains to the investigation
- Device use/disposition records
- Records of each subject's case history and exposure to the device. Case histories include the CRFs and supporting data (source documentation), including, for example:
 - Signed and dated consent forms
 - Medical records, including, for example, progress notes of the physicians, the subject's hospital chart(s) and the nurses' notes
 - All adverse event information
 - A record of the exposure of each subject to the investigational device (e.g., date of implant procedure and follow-up assessment dates)
 - Documentation of any deviation from the protocol, including the date and the rationale for such deviation
- Screening Logs, Enrollment Logs and Patient Identification Logs
- Signed Investigator Agreement, curriculum vitae and training records
- Protocol and any amendments
- IRB/MEC approval documentation, and where applicable, other local regulatory approvals

The Investigator may withdraw from responsibility to maintain records by transferring custody to another person, who will accept responsibility for record and report maintenance.

The Investigator is responsible for the preparation, review, signature, and submission of the reports listed below in. These are also subject to inspection by government agencies and must be retained as specified above.

Table 8: Investigator Reporting Responsibilities

Report	Submitted to	Description
Unanticipated Adverse Device Effects (UADE)	Sponsor, IRB/MEC, and local regulatory agencies, where applicable	UADEs should be reported immediately via telephone as well as on an eCRF. UADEs must be submitted as soon as possible, but in no event later than 10 working days after the Investigator first learns of the effect. (21 CFR 812.150)
Serious Adverse Events and Deaths	Sponsor, and local regulatory agencies, where applicable	Medtronic requests that the Investigator's report on all serious adverse events and deaths be submitted immediately but not later than within 3 working days after the Investigator first learns of the event.
Withdrawal of IRB/MEC approval	Sponsor	The Investigator must report a withdrawal of the reviewing IRB/MEC, approval within 5 working days.
Progress Report	Sponsor, IRB/MEC	The Investigator must submit a progress report on an annual basis if the trial lasts longer than one year.
Failure to obtain Informed Consent	Sponsor, IRB/MEC	The Investigator must make notification within 5 working days after device implant.
Final Report	Sponsor, IRB/MEC	This report must be submitted within 3 months after termination or completion of the investigation.
Deviations from Investigational Plan (CFR 812.150)		
Emergency Use	Sponsor, IRB/MEC	Notification must be made within 5 working days of the occurrence of an emergency deviation made to protect the life or physical well-being of a subject.
Planned deviation	Sponsor, IRB/MEC, FDA	If the deviation affects scientific soundness of the trial or the rights, safety, or welfare of the subject and is not an emergency, prior approval must be obtained from Medtronic, the reviewing IRB/MEC, and FDA.
Other Deviations	Sponsor	Deviations that are beyond the control of the investigator (such as patient who fails to return to follow-up visit) or deviations that do not affect the scientific soundness of the trial or the rights, safety, or welfare of the subject and are not an emergency, should be submitted as they are identified by the site or Medtronic staff

D RISK / BENEFIT ANALYSIS

There are risks for participants in this trial. However, it should be noted that most of the risks of trial participation are not materially different than those entailed by an individual who undergoes the same treatment outside of the context of this trial.

Known adverse events that may result from TAVI include but may not be limited to:

- Death
- Acute myocardial infarction
- Stroke
- Urgent need for surgery
 - Coronary artery bypass
 - Heart valve replacement
 - Valve explant
- Urgent need for balloon valvuloplasty (note that BAV during implantation is expected)
- Urgent need for Percutaneous Coronary Intervention (PCI)
- Cardiogenic shock
- Perforation of the myocardium or vessel
- Cardiac Tamponade
- Ascending aorta trauma
- Myocardial ischemia
- Acute coronary artery occlusion
- Disturbances in the electrical system of the heart that may result in the permanent placement of a device (pacemaker)
 - Atrio-ventricular node block
 - Bundle branch block
 - Asystole
- Ventricular arrhythmias
- Valve or distal embolization
- Thrombosis (including valve thrombosis)
- Hemorrhage requiring transfusion
- Arteriovenous fistula
- Vessel dissection or spasm
- Valve migration
- Prosthetic valve dysfunction including but not limited to:
 - Fracture
 - Bending (out-of-round configuration) of the valve frame
 - Under-expansion of the valve frame
 - Calcification
 - Pannus
 - Wear, tear, prolapse or retraction in the valve leaflet
 - Poor valve coaptation
 - Suture breaks or disruption
 - Leak
 - Mal-sizing (prosthesis-patient mismatch)
 - Malposition (either too high or too low)
 - Regurgitation
 - Stenosis
- Mitral valve regurgitation
- Hypotension or hypertension
- Acute renal injury
- Allergic reaction to antiplatelet agents or contrast medium
- Infection (including endocarditis)
- Bowel ischemia

- Vascular access site or access related complications, including but not limited to:
 - pain
 - bleeding
 - hematoma
 - pseudoaneurysm
 - irreversible nerve injury
 - compartment syndrome
 - stenosis

Additional information regarding risk analysis is located in the Investigator Brochure (**Appendix R.21**).

D.1 Methods to Minimize Risk

The investigational plan is specifically designed to manage and minimize risks through careful patient selection, thorough training of investigators, adherence to the pre-determined time points to assess subject clinical status and regular clinical monitoring visits by Sponsor appointed monitoring personnel.

In addition, an independent Data Safety Monitoring Board will monitor safety of the subjects throughout the trial.

D.2 Potential Benefits

Patients treated with the Medtronic CoreValve® System may experience improvement in quality of life, morbidity and mortality compared to traditional open-heart aortic valve replacement. Potential benefits include, but are not limited to, absence of open-heart surgery-related risks, reduced procedure time, reduced anesthesia procedure time, shorter hospital stay and earlier return to normal activities than after open-heart aortic valve replacement.

There is no direct benefit associated to participation in this study, but the information obtained during this study will be used scientifically. The results of this study can help physicians understand the implications of percutaneous treatment of patients with intermediate risk for surgery using the Medtronic CoreValve® System.

E DESCRIPTION OF MEDTRONIC[®] COREVALVE SYSTEM

E.1 Investigational Product Description

The Medtronic CoreValve[®] System (MCS) consists of 3 components: the Percutaneous Aortic Valve Bioprosthesis (PAV) in Figure 1 below, the Delivery Catheter System (DCS) in Figure 2, and the Compression Loading System (CLS) in Figure 3.

Percutaneous Aortic Valve Bioprosthesis

Figure 1: Percutaneous Aortic Valve (PAV)

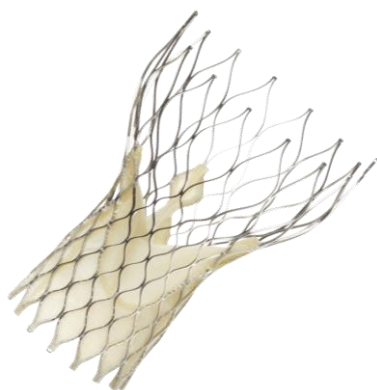

The PAV is manufactured by suturing valve leaflets and a skirt, made from a single layer of porcine pericardium, into a tri-leaflet configuration. The PAV is designed to replace the native aortic heart valve without open heart surgery and without concomitant surgical removal of the failed native valve.

The bioprosthesis is processed with an antimineralization treatment of alpha-amino oleic acid (AOA) a compound derived from oleic acid, a naturally occurring long-chain fatty acid.

The self-expanding multi-level frame is made of Nitinol and is radiopaque.

The PAV is available for a range of aortic annulus and ascending aortic diameters as shown in Table 9 below.

Table 9: Patient Anatomical Diameters

Model	Size (mm)	Aortic Annulus Diameter (range in mm)	Ascending Aortic Diameter (mm)
MCS-P3-26-AOA	26	20-23	≤40
MCS-P3-29-AOA	29	23-27	≤43
MCS-P3-31-AOA	31	26-29	≤43

Delivery Catheter System

The AccuTrak[®] DCS (DCS-C4-18FR) is compatible with a 0.889-mm (0.035-in) guidewire. The working length of the AccuTrak[®] DCS is 112.5 cm. It incorporates a protective deployment sheath that houses and deploys the PAV. The AccuTrak[®] DCS can be used to house and deliver all commercially available sizes of the PAV (26mm,29mm, and 31mm PAV). The outer diameter of the DCS is 12Fr, the stability layer is 15Fr and the outer diameter of the valve capsule is 18 Fr.

Figure 2: Delivery Catheter System (DCS)

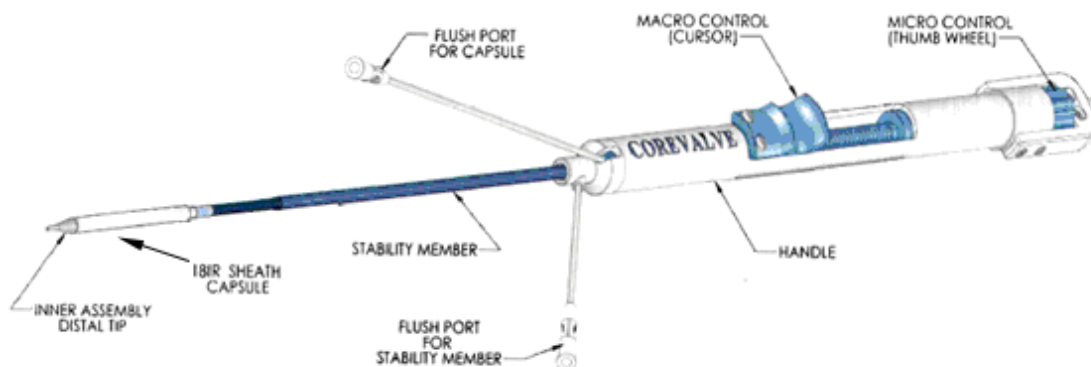

The AccuTrak[®] DCS features an integrated handle designed to provide the user with accurate and controlled deployment. After the DCS is placed in the vicinity of the aortic annulus, the user retracts the deployment sheath, thereby deploying the PAV to the desired location. In use, the deployment sheath can be partially pulled back to evaluate the PAV location prior to fully releasing the PAV. In this way, the user can make slight adjustments to the PAV location if needed prior to release.

Compression Loading System (Model CLS-3000-18 FR)

Figure 3: Compression Loading System (CLS)

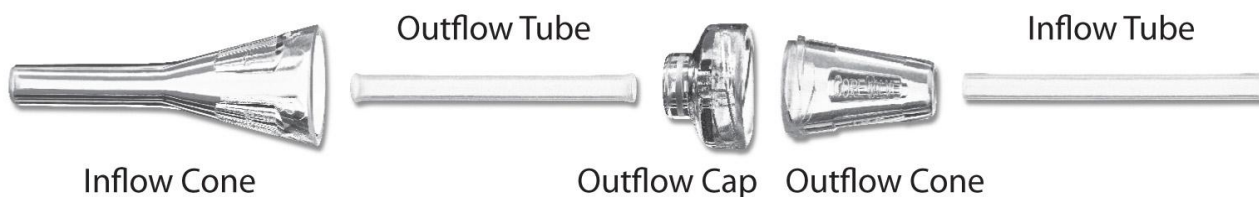

The CLS (Model CLS-3000-18FR) compresses the PAV into the DCS. The CLS is comprised of the following elements:

- inflow cone
- inflow tube (straight tube)
- outflow cap
- outflow cone
- outflow tube (tube with flared ends)

Medtronic may incorporate additional devices into this clinical study providing they receive regulatory approval and the scientific soundness of the study is not adversely affected.

Additional information regarding the Medtronic CoreValve[®] System (MCS) is available in the Investigator Brochure (**Appendix R.21**). Note the Instructions For Use are also located in **Appendix R.21**.

E.2 Medtronic CoreValve Ordering, Storage, and Disposition

The Medtronic CoreValve and all required delivery components will be ordered through Medtronic. Medtronic will only allow shipment of investigational devices to the hospital or investigator when the Clinical Research Specialist has declared the investigation site ready to start the study.

Devices will be shipped to sites as needed based on subject enrollment/randomization and procedures scheduled. Only one device should be used per patient, unless in case of device malfunctions or in case of complications. Sites will be supplied with sufficient device stock to complete scheduled procedures. Upon completion of scheduled procedures all unused devices must be returned to Medtronic. Instructions for device return are outlined on the Shipment/Device Disposition Log.

Investigational devices must be stored in a secured area. The method of storage shall prevent the use of investigational devices outside the applications as mentioned in this Clinical Investigation Plan. In addition, all information for the use, storage and handling of the investigational device as indicated in the Investigator's Brochure, must be taken into account.

Instructions for Use and storage recommendations are outlined in **Appendix R.21**.

F MONITORING AND AUDITING

F.1 Monitoring

The investigational site will be monitored to ensure compliance with the trial protocol, adherence to applicable regulations, and accuracy of trial data. Monitoring visits will be conducted primarily to ensure the safety and wellbeing of the subjects is preserved. Monitoring visits will also be used to verify that trial data submitted on case report forms are complete and accurate with respect to the subject records and to verify device accountability.

Site personnel will complete eCRFs following each subject visit. Trial data submitted will be reviewed against patient charts and other sources containing original records of patient data. Source document verification will be conducted via a risk based approach as outlined in the Monitoring Plan.

The responsible individual for this trial is included on the title page of the CIP.

The progress of the trial will be monitored by:

- On-site review, as deemed appropriate by the sponsor
- Telephone communications between the site personnel (e.g., Investigator, Trial Coordinator) and trial monitors
- Review of eCRFs and the associated clinical records
- Review of regulatory documents

Upon study completion Site Closeout Visits will be conducted, as outlined in the Monitoring Plan.

Monitoring and monitoring oversight will be provided by Medtronic CardioVascular (Mounds View, MN, USA, and Maastricht, the Netherlands). Representatives of Medtronic (i.e. contractors and designees) may also act as the trial monitors to the site.

Prior to the first site activation a monitoring plan will be established outlining the above activities, as well as study materials to be supplied to sites, the process for corrective and preventive actions and Investigator disqualification procedures.

F.2 Auditing

Medtronic may conduct audits at participating clinical sites. The purpose of an audit is to verify the performance of the monitoring process and the trial conduct, independently of the personnel directly involved in the trial. Regulatory bodies, such as the Food and Drug Administration, may also perform inspections at participating sites. The investigator and/or institution shall permit Medtronic and regulatory bodies direct access to source data and documents.

G LABELING

In Europe, the CoreValve PAV component labeling will not carry the CE mark and the labeling with state for “clinical study purposes only” in accordance with ISO14155. The Investigational Instructions for Use (IFU) is supplied in English with the PAV component and this will also not carry the CE mark. The DCS and CLS components are identical to the CE marked CoreValve System and will be supplied with the approved commercial CE marked labeling.

In the United States and other geographies, where CoreValve is not currently approved, the PAV, DCS and CLS will be labeled as Investigational.

Instructions for Use and additional labeling are attached in **Appendix R.21**.

H CONSENT MATERIALS

The template consents for the trial are attached in **Appendix R.1**.

I IRB/MEC INFORMATION

IRB/MEC information is attached in **Appendix R.2**.

J OTHER INSTITUTIONS

Information regarding other institutions involved in this trial is located in **Appendix R.3**.

K ADDITIONAL RECORDS AND REPORTS

Information regarding additional Records and Reports can be in found in **Appendix R.4**.

L REPORT OF PRIOR INVESTIGATIONS

The Report of Prior Investigations (RPI) is attached in the Investigator Brochure in **Appendix R.21**.

M PUBLICATION POLICY

Medtronic, as the Sponsor of this trial, recognizing the seminal importance of this investigation, is committed to the widespread dissemination of all primary and secondary endpoint results. A publication plan will be implemented and followed. At the conclusion of the trial, a multisite abstract reporting the primary results will be prepared by the Principal Investigators (in collaboration with others including but not limited to the Steering Committee, directors of the core laboratories, CEC, and Lead Investigators from high enrolling sites) and presented at an annual scientific meeting (e.g., Transcatheter Cardiovascular Therapeutics, EuroPCR, the American Heart Association, or the American College of Cardiology). A multisite publication will similarly be prepared for publication in a reputable scientific journal. The publication of the principal results from any single site experience within the trial is not allowed until both the preparation and publication of the multisite results, and then only with written permission from Medtronic.

Following analysis and presentation of the primary endpoint results, active participation of all committee members, Investigators from high enrolling sites, and core laboratory personnel will be solicited for data analysis and abstract and manuscript preparation. Submission of all abstracts and publications regarding the primary endpoint and secondary endpoints from the trial requires approval by the Principal Investigators after review by the Operations Committee.

A separate publication plan will provide detailed information about the publication committee, authorship, publication proposals, and requests for data.

N AMENDMENTS TO THE CLINICAL INVESTIGATION PLAN

All amendments to the CIP shall be agreed between the sponsor and the clinical investigator(s). Amendments will be recorded with a justification for the amendments in Table 10 below:

Table 10: Clinical Investigation Plan Change History

Version	Description of Change	Rationale for Change

O ABBREVIATIONS AND DEFINITIONS

O.1 List of Abbreviations

Please refer to Table 11 below for a list of abbreviations for use in the SURTAVI trial.

Table 11: List of Abbreviations

Abbreviation	Term
2D	Two Dimensional
6MWT	Six Minute Walk Test
AE	Adverse Event
ACT	Active Clotting Time
ADE	Adverse Device Effect
AF	Atrial Fibrillation
AOA	Alpha-amino Oleic Acid
AR	Aortic Regurgitation
AS	Aortic Stenosis
AVR	Aortic Valve Replacement
BAV	Balloon Aortic Valvuloplasty
BSA	Body Surface Area
BNP	B-type Natriuretic Peptide
BP	Blood Pressure
BSA	Body Surface Area
CA	Competent Authority
CE	European Conformity
CEC	Clinical Events Committee
CFR	U.S. Code of Federal Regulations
CIP	Clinical Investigation Plan
CLS	Compression Loading System
CRF	Case Report Form
CRO	Contract Research Organization
CT	Computed Tomography
CTA	Computerized tomographic angiography
CVA	Cerebrovascular Accident
CV-ICU	Cardiovascular Intensive Care Unit
DCS	Delivery Catheter System
DHCA	Deep Hypothermic Circulatory Arrest
DSMB	Data Safety Monitoring Board
DVT	Deep Vein Thrombosis

Abbreviation	Term
ECC	Extracorporeal Circulation
ECG	Electrocardiogram
ECMD	Extracorporeal Membrane Oxygenation
eCRF	Electronic Case Report Form
EDC	Electronic Data Capture
EF	Ejection Fraction
EuroSCORE	European System for Cardiac Operative Risk Evaluation
FDA	U.S. Food and Drug Administration
Fr	French
GCP	Good Clinical Practice
GI	Gastrointestinal
HVD	Heart Valve Dysfunction
HIPAA	Health Insurance Portability and Accountability Act
HR	Heart Rate
IABP	Intra-Aortic Balloon Pump
ICF	Informed Consent Form
IDE	Investigational Device Exemption
IRB/MEC	Institutional Review Board
IFU	Instructions for use
ITT	Intent-to-treat
IV	Intravenous
IXRS	Interactive Voice/Web Response System
LA	Left Atrial/Atrium
LAO	Left Anterior Oblique
LBBB	Left Bundle Branch Block
LVEF	Left Ventricular Ejection Fraction
LVOT	Left Ventricular Outflow Tract
LVOTO	Left Ventricular Outflow Tract Occlusion
LWMH	Low Weight Molecular Heparin
MACCE	Major Adverse Cardiovascular and Cerebrovascular Event
MAE	Major Adverse Event
MCS	Medtronic CoreValve® System
MEC	Medical Ethics Committee
MI	Myocardial Infarction
MMSE-2	Mini Mental State Exam
NIHSS	National Institute of Health Stroke Scale
mRS	Modified Rankin Score

Abbreviation	Term
NYHA	New York Heart Association
PAV	Percutaneous Aortic Valve
PCI	Percutaneous Coronary Intervention
PPM	Patient Prosthesis Mismatch
TAVI	Transcatheter aortic valve implant
QoL	Quality of Life
RAO	Right Anterior Oblique
RBBB	Right Bundle Branch Block
SAE	Serious Adverse Event
SADE	Serious Adverse Device Effect
SAVR	Surgical Aortic Valve Replacement
SOP	Standard Operating Procedures
STS	Society of Thoracic Surgeons
TEE	Transesophageal Echocardiography
TIA	Transient Ischemic Attack
TTE	Transthoracic Echocardiography
UADE	Unanticipated Adverse Device Effect

O.2 Definitions of Terms

ACUTE KIDNEY INJURY

Acute Kidney Injury will be defined according to the definition proposed by the Valve Academic Research Consortium (VARC) Consensus Report for Transcatheter Aortic Valve Implantation (TAVI); 2010-12-05.

Acute Kidney Injury: Modified RIFLE Classification	
Stages	Change in Serum Creatinine (up to 72 hours) compared to Baseline
Stage 1	Increase in serum creatinine to 150-200% (1.5-2.0 x increase compared with baseline) or increase of ≥ 0.3 mg/dl (≥ 26.4 μ mol/L)
Stage 2*	Increase in serum creatinine to 200-300% ($> 2-3$ x increase compared with baseline) or increase between >0.3 mg/dl (>26.4 μ mol/L) and <4.0 mg/dl (<354 μ mol/L)
Stage 3**	Increase in serum creatinine to $\geq 300\%$ (> 3 x increase compared with baseline) or serum creatinine of ≥ 4.0 mg/d (≥ 354 μ mol/L) with an acute increase of at least 0.5 mg/dl (44 μ mol/L)
* Stage 2 and 3 acute renal injuries will be considered to be serious adverse events.	
** Patients receiving renal replacement therapy are considered to meet Stage 3 criteria irrespective of other criteria	

ACUTE VESSEL OCCLUSION

The state of complete luminal obstruction with no antegrade blood flow.

ADVERSE EVENT (AE)

An adverse event is any untoward medical occurrence, unintended disease or injury, or untoward clinical signs (including abnormal laboratory findings) in subjects, users or other persons, whether or not related to the investigational medical device.

NOTE 1: This definition includes events related to the investigational medical device or the comparator.

NOTE 2: This definition includes events related to the procedures involved.

NOTE 3: For users or other persons, this definition is restricted to events related to investigational medical devices.

ADVERSE DEVICE EFFECT (ADE)

Adverse event related to the use of an investigational medical device

NOTE 1: This definition includes adverse events resulting from insufficient or inadequate instructions for use, deployment, implantation, installation, or operation, or any malfunction of the investigational medical device.

NOTE 2: This definition includes any event resulting from use error or from intentional misuse of the investigational medical device

AORTIC DISSECTION

Intimal tear resulting in blood splitting the aortic media and producing a false lumen that can progress in an antegrade or retrograde direction. Aortic dissection is further classified using Stanford classification (Types A and B) depending on whether ascending or descending aorta involved) or DeBakey classification (Types I, II and III) as shown below.

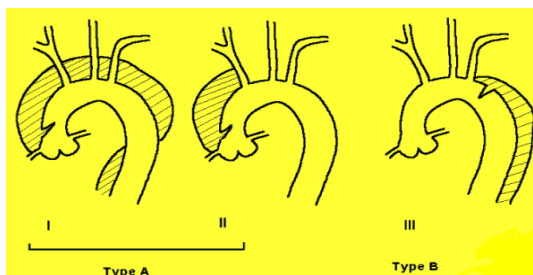

AORTIC REGURGITATION (AR)

Aortic valve incompetence resulting in backward flow of blood.

Aortic Valve Regurgitation will be defined according to the definition proposed by the Valve Academic Research Consortium (VARC) Consensus Report for Transcatheter Aortic Valve Implantation (TAVI); 2010-12-05.

Prosthetic Aortic Valve Regurgitation Criteria (Central and Paravalvular)			
Parameter	Mild	Moderate	Severe
Valve Structure and Motion Mechanical or bioprosthetic	Usually normal	Usually abnormal	Usually abnormal
Structural parameters Left ventricular size	Normal	Normal/mildly dilated	Dilated
Doppler parameters (qualitative or semiquantitative) Jet width in central jets (% LVO diameter): color* Jet density: CW Doppler Jet deceleration rate (PHT, ms): CW Doppler** LV outflow vs. pulmonary flow: PW Doppler	Narrow ($\leq 25\%$) Incomplete or faint Slow (>500) Slightly increased	Intermediate (26-64%) Dense Variable (200-500) Intermediate	Large ($\geq 65\%$) Dense Steep (<200) Greatly Increased
Diastolic: flow reversal in the descending aorta PW Doppler	Absent or brief early diastolic	Intermediate	Prominent, Holodiastolic
Circumferential extent of paraprosthetic AR (%)	<10	10-20	>20
Doppler parameters (quantitative) Regurgitant volume (mL/beat) Regurgitant fraction (%)	<30 <30	30-59 30-50	>60 >50

*Parameter applicable to central jets and is less accurate in eccentric jets

** Influenced by left ventricular compliance

AR=aortic regurgitation; CW= continuous wave; LVO= left ventricular outflow; PW= pulsed wave

2008 Focused Update Incorporated Into the ACC/AHA 2006 Guidelines for the Management of Patients With Valvular Heart Disease (published in the October 2008 issues of Journal of the American College of Cardiology and Circulation)

Classification of the Severity of Valve Disease in Adults			
Aortic Regurgitation			
	Mild	Moderate	Severe
Qualitative Angiographic grade Color Doppler jet width Doppler vena contracta width (cm)	1+ Central jet, width less 25% of LVOT < 0.3	2+ Greater than mild but no signs of AR 0.3-0.6	3-4+ Central jet, width greater than 65% LVOT > 0.6
Quantitative (cath or echo) Regurgitant volume (mL per beat) Regurgitant fraction (%) Regurgitant orifice area (cm ²)	< 30 < 30 < 0.10	30-59 30-49 0.10-0.29	≥ 60 ≥ 50 ≥ 0.30
Additional essential criteria Left ventricular size			Increased

Moderate or severe aortic regurgitation (AR) will be considered a serious adverse event.

AORTIC STENOSIS (AS)

A narrowing, stiffening or stricture of the aortic valve.

2008 Focused Update Incorporated Into the ACC/AHA 2006 Guidelines for the Management of Patients With Valvular Heart Disease (published in the October 2008 issues of Journal of the American College of Cardiology and Circulation)

Aortic Stenosis			
Indicator	Mild	Moderate	Severe
Jet velocity (m/s)	Less than 3.0	3.0-4.0	Greater than 4.0
Mean gradient (mmHg)	Less than 25	25-40	Greater than 40
Valve area (cm ²)	Greater than 1.5	1.0-1.5	Less than 1.0
Valve area index (cm ² /m ²)			Less than 0.6

Moderate or severe AS will be considered a serious adverse event.

ARRHYTHMIA

Any variation from the normal rhythm of the heartbeat, including sinus arrhythmia, premature beat, heart block, atrial fibrillation, atrial flutter and tachycardia.

- Major Arrhythmias: Complete heart block, ventricular tachycardia and ventricular fibrillation
- Serious Arrhythmias: Any arrhythmia requiring surgical or invasive intervention or DC cardioversion

BLEEDING EVENT

Bleeding event will be defined according to the definition proposed by the Valve Academic Research Consortium (VARC) Consensus Report for Transcatheter Aortic Valve Implantation (TAVI); 2010-12-05.

Life-threatening or Disabling Bleeding
<ul style="list-style-type: none"> • Fatal bleeding OR • Bleeding in a critical area or organ, such as intracranial, intraspinal, intraocular, or pericardial necessitating pericardiocentesis, or intramuscular with compartment syndrome OR • Bleeding causing hypovolemic shock or severe hypotension requiring vasopressors or surgery OR • Overt source of bleeding with drop in hemoglobin of ≥ 5 g/dL or whole blood or packed red blood cells (RBC) transfusion ≥ 4 units*
Major Bleeding
<ul style="list-style-type: none"> • Overt bleeding either associated with a drop in the hemoglobin level of at least 3.0g/dL or requiring transfusion of 2-3 units of whole blood/RBC AND • Does not meet criteria of life-threatening or disabling bleeding
Minor Bleeding
<ul style="list-style-type: none"> • Any bleeding worthy of clinical mention (e.g. access site hematoma) that does not qualify as life-threatening, disabling or major

* Given one unit of packed RBC typically will raise blood hemoglobin concentration by 1g/dL, an estimated decrease in hemoglobin will be calculated.

Life-threatening and Major bleeding events are considered to be serious.

BUNDLE BRANCH BLOCK

ACC/AHA/HRS 2006 Key Data Elements and Definitions for Electrophysiological Studies and Procedures; A Report of the American College of Cardiology/ American Heart Association Task Force on Clinical Data Standards (ACC/AHA/HRS Writing Committee to Develop Data Standards on Electrophysiology), JACC, Vol. 48, No. 11, 2006.

Left Bundle Branch Block (LBBB)

- QRS duration 120 ms or longer
- Delayed onset of intrinsicoid deflection in I, V5, and V6 \geq 60 ms
- Broad and notched or slurred R waves in I, aVL, V5, and V6
- rS or QS complexes in right precordial leads
- ST-segment and T waves in opposite polarity to the major QRS deflection

Right Bundle Branch Block (RBBB)

- QRS duration \geq 120 ms
- rsR \equiv or rSR \equiv complexes in V1 and V2
- Delayed onset of intrinsicoid deflection in V1 and V2 \geq 50 ms
- Broad, slurred S wave in I, V5,

Any new or worsening LBBB or RBBB that requires the placement of a permanent pacemaker and/or other surgical or invasive intervention will be considered to be serious.

CARDIAC TAMPONADE

Clinical syndrome caused by the accumulation of fluid in the pericardial space, resulting in reduced ventricular filling and subsequent hemodynamic compromise.

CARDIOGENIC SHOCK

Patient was, at the time of procedure, in a clinical state of hypoperfusion sustained for greater than 30 minutes, according to either of the following criteria:

1. Systolic BP $<$ 80 and/or Cardiac Index $<$ 1.8 despite maximal treatment; or
2. IV inotropes and/or IABP necessary to maintain Systolic BP $>$ 80 and/or CI $>$ 1.8

CHRONIC RENAL INSUFFICIENCY

Kidney damage or glomerular filtration rate (GFR) $<$ 60 mL/min/1.73 m² for \geq 3 months. Kidney damage is defined as pathologic abnormalities or markers of damage, including abnormalities in blood or urine test or imaging studies.

CONDUCTION DISTURBANCE REQUIRING PERMANENT PACEMAKER IMPLANTATION

ACC/AHA 2006 Guidelines for the Management of Patients with Valvular Heart Disease (published in the August 1, 2006, issues of Journal of the American College of Cardiology and Circulation)

Any disturbance in the cardiac electrical conduction system that meets the American College of Cardiology (ACC)/American Heart Association (AHA)/ Heart Rhythm Society (HRS) Class I or IIa Guidelines for Device-Based Therapy of Cardiac Rhythm Abnormalities for Acquired Atrioventricular Block in Adults or Permanent Pacing in Chronic Bifascicular Block.

DEATH

A serious adverse event that is classified by the following:

All-cause death: All deaths from any cause after a valve intervention. This includes all cardiovascular and non-cardiovascular deaths.

Cardiovascular Death:

(Cardiovascular death will be defined according to the definition proposed by the Valve Academic Research Consortium (VARC) Consensus Report for Transcatheter Aortic Valve Implantation (TAVI); 2010-12-05)

Any one of the following criteria:

- Any death due to proximate cardiac cause (e.g. MI, cardiac tamponade, worsening heart failure)
- Unwitnessed death and death of unknown cause
- All procedure-related deaths, including those related to a complication of the procedure or treatment for a complication of the procedure
- Death caused by non-coronary vascular conditions such as cerebrovascular disease, pulmonary embolism, ruptured aortic aneurysm, dissecting aneurysm, or other vascular disease

NOTE: All deaths are considered cardiac unless an unequivocal non-cardiac cause can be established. Specifically, any unexpected death even in subjects with coexisting potentially fatal non-cardiac disease (e.g. cancer, infection) should be classified as cardiac.

Non-cardiovascular death: Any death not covered by the above definitions, such as death caused by infection, malignancy, sepsis, pulmonary causes, accident, suicide, or trauma.

Valve-related death:

- Any death caused by prosthetic valve dysfunction, valve thrombosis, embolism, bleeding event, or implanted valve endocarditis;
- Death related to reintervention on the operated valve

DEVICE DEFICIENCY

Inadequacy of a medical device with respect to its identity, quality, durability, reliability, safety or performance

NOTE: Device deficiencies include malfunctions, use errors, and inadequate labeling.

DEVICE MIGRATION

Obvious movement of the Medtronic CoreValve[®] PAV from its documented original implant position, after access site closure, as confirmed by X-ray, echocardiography, CT scan or direct assessment during open heart surgery or autopsy.

DEVICE MALPLACEMENT

Placement of the Medtronic CoreValve[®] PAV in a non-therapeutic location, either inadvertently, or possibly intentionally due to unintended problems during the Medtronic CoreValve[®] System (MCS) delivery or procedure that necessitates placement in the non-therapeutic location.

DEVICE RELATED

Events that occur as the direct result of the Medtronic CoreValve[®] System (MCS) as it relates to delivery, placement, efficacy or durability; these may involve the implanted device or the delivery system components.

DEVICE RELATED COMPLICATIONS

Complications associated with the device as it relates to delivery, placement, efficacy or durability; these may involve the implanted device or the delivery system.

DEVICE SUCCESS

Device success is defined as follows:

- successful vascular access, delivery and deployment of the device, and successful retrieval of the delivery system,
- correct position of the device in the proper anatomical location (placement in the annulus with no impedance on device function),
- Intended performance of the prosthetic valve¹ (aortic valve area > 1.2 cm² (by echocardiography using the continuity equation) and mean aortic valve gradient < 20 mmHg or peak velocity < 3 m/sec, without moderate or severe prosthetic valve AR)
- Only one valve implanted in the proper anatomical location

¹ assessed acutely in a resting state, either within 24-48 hours after the index procedure or before hospital discharge

EMBOLISM

Free flowing blood clot or lesion material that is located in the systemic or pulmonary circulation that occurs in the absence of infection after the immediate perioperative period. Embolism may be manifested by a neurological event or a noncerebral embolic event.

ENCEPHALOPATHY

Altered mental state (e.g., seizures, delirium, confusion, hallucinations, dementia, coma, psychiatric episode, etc.).

ENDOCARDITIS

Implanted valve endocarditis: Any infection involving an implanted valve. The diagnosis of *operated valvular endocarditis* is based on one of the following criteria:

- re-operation with evidence of abscess, paravalvular leak, pus, or vegetation confirmed as secondary to infection by histological or bacteriologic studies;
- autopsy findings of abscess, pus, or vegetation involving a replaced valve; or
- in the absence of reoperation or autopsy, meeting of the Duke Criteria for endocarditis.

Infective endocarditis is diagnosed based on Duke Criteria and necessitates 2 major criteria, or 1 major and 3 minor criteria, or 5 minor criteria

Major criteria 1: Positive blood culture for infective endocarditis

Typical microorganism consistent with infective endocarditis from 2 separate blood cultures, as noted below:

- Viridans streptococci, *Streptococcus bovis*, or HACEK group (*Haemophilus*, *Actinobacillus actinomycetemcomitans*, *Cardiobacterium hominis*, *Eikenella corrodens*, *Kingella* or
- Community-acquired *Staphylococcus aureus* or enterococci, in the absence of a primary focus

-OR-

Microorganisms consistent with infective endocarditis from persistently positive blood cultures defined as:

- Two positive cultures of blood samples drawn >12 hours apart, or
- All of 3 or a majority of 4 separate cultures of blood (with first and last sample drawn 1 hour apart)

Major criteria 2: Evidence of endocardial involvement

Positive echocardiogram for infective endocarditis defined as:

- oscillating intracardiac mass on valve or supporting structures, in the path of regurgitant jets, or on implanted material in the absence of an alternative anatomic explanation, or
 - abscess, or
 - new partial dehiscence of prosthetic valve
- OR-**
- New valvular regurgitation (worsening or changing of pre-existing murmur not sufficient)

Minor criteria 1: Predisposition: predisposing heart condition or intravenous drug use

Minor criteria 2: Fever: temperature > 38.0° C (100.4° F)

Minor criteria 3: Vascular phenomena: major arterial emboli, septic pulmonary infarcts, mycotic aneurysm, intracranial hemorrhage, conjunctival hemorrhages, and Janeway lesions

Minor criteria 4: Immunologic phenomena: glomerulonephritis, Osler's nodes, Roth spots, and rheumatoid factor

Minor criteria 5: Microbiological evidence: positive blood culture but does not meet a major criterion as noted above or serological evidence of active infection with organism consistent with infective endocarditis

Minor criteria 6: Echocardiographic findings: consistent with infective endocarditis but do not meet a major criterion as noted above

EXPLANT

Removal of the investigational valve implant for any reason, including post-mortem.

HEMOLYSIS

A plasma free hemoglobin value > 40 mg/dL is considered to be hemolysis and a reportable adverse event.

- **Major hemolysis:** A plasma free hemoglobin value > 40 mg/dL that requires intervention (i.e. iron replacement, blood transfusion, folic acid administration, corticosteroids, Intravenous immunoglobulin G (IVIG) and/or surgery). Major hemolysis events will be considered to be serious adverse events.
- **Minor hemolysis:** A plasma free hemoglobin value > 40 mg/dL that does not require intervention.

HOSPITALIZATION FOR SIGNS AND SYMPTOMS RELATED TO AORTIC VALVE DISEASE

Aortic valve disease hospitalizations are defined as a non-elective hospital admission for signs and symptoms related to aortic valve disease (as described below) that results in at least a two-night stay (i.e., where the admission date and the discharge date differ by at least two calendar days). For the purpose of the protocol, overnight stays at nursing home facilities or extended care facilities do not meet the protocol definition of hospitalization. This does include the administration or augmentation of intravenous heart failure therapy (e.g., inotropes, diuretics, and/or vasodilators).

Patients with signs and symptoms related to aortic valve disease (as described below) who are hospitalized for less than two days or who are treated and released from the emergency department or an outpatient clinic (including treatment for intravenous heart failure therapy (e.g., inotropes, diuretics, and/or vasodilators)), will not be counted as aortic valve disease hospitalizations.

Aortic valve disease will be evaluated using documented evidence of the following signs and symptoms. An independent Clinical Events Committee (CEC) will review all available source documentation for all hospitalizations to determine if they are aortic valve disease hospitalizations. The CEC adjudication will be used for final analysis.

Signs and Symptoms of Aortic Valve Disease	
Sign/Symptom	Definition
Aortic Valve Dysfunction	
Shortness of breath/dyspnea	A feeling of difficult or labored breathing that is out of proportion to the patient's level of physical activity
Exercise intolerance	A condition where the patient is unable to do physical exercise at the level or for the duration that would be expected of someone in his/her general physical condition, or experiences unusually severe post-exercise pain, fatigue, or other negative effects
Dizziness/syncope	Lightheadness or unsteadiness of gait or a partial or complete loss of consciousness with interruption of awareness of oneself and ones surroundings
Chest pain	Discomfort and soreness in and around the chest
Worsening Heart Failure	
Volume Overload	
Orthopnea	Dyspnea in which the person can breathe comfortably only when standing or sitting erect
Paroxysmal nocturnal dyspnea	Acute dyspnea caused by the lung congestion and edema that results from partial heart failure and occurring suddenly at night, usually an hour or two after the individual has fallen asleep.
Jugular venous distension	With the patient is positioned under 45°, and the filling level of the jugular vein determined. An abnormal response is more than 3 centimeters above the sternal angle.
Hepatomegaly	Palpation of the edge of the liver below the edge of the ribs without inspiration
Peripheral edema	Swelling of tissues, usually in the lower limbs, due to the accumulation of fluids.
Pulmonary rales	Small clicking, bubbling, or rattling sounds in the lung associated with inspiration
Abdominal-jugular reflux	An elevation of venous pressure visible in the jugular veins and measurable in the veins of the arm, produced in active or impending congestive heart failure by firm pressure with the flat hand over the abdomen.
Radiographic evidence of pulmonary edema	NA
Elevated B-type natriuretic peptide level	NA
Hypoperfusion	
Narrow pulse pressure	Pulse pressure < 30 mmHg
Hypotension	Systolic BP < 90 systolic
Renal or hepatic dysfunction	<ul style="list-style-type: none"> • Rise in baseline creatinine by 25% • Increase in LFT (SGOT, SGPT) > 2 times normal
Low serum sodium concentration	Serum sodium < 130 mEq/dL

INFECTION

Elevated body temperature (fever), and White Blood Count (WBC) > 12,000/ml, and Significant leftward shift on Differential.

MAJOR ADVERSE CARDIOVASCULAR AND CEREBROVASCULAR EVENTS (MACCE)

Defined as a composite rate of

- all-cause death
- myocardial infarction (MI)
- all stroke, and
- reintervention (defined as any cardiac surgery or percutaneous reintervention catheter procedure that repairs, otherwise alters or adjusts, or replaces a previously implanted valve)

MAJOR ADVERSE EVENT (MAE)

Major Adverse events include the following:

- MACCE
- Acute kidney Injury
- Cardiac tamponade
- Prosthetic valve dysfunction
- Cardiogenic shock
- Valve endocarditis
- Valve embolism
- Life-threatening, disabling or major bleeding
- Major vascular complication
- Cardiac Perforation
- Device Migration

MITRAL REGURGITATION

Mitral valve incompetence resulting in backward flow of blood.

2008 Focused Update Incorporated into the ACC/AHA 2006 Guidelines for the Management of Patients with Valvular Heart Disease (published in the October 2008 issues of Journal of the American College of Cardiology and Circulation)

Classification of the Severity of Valve Disease in Adults			
Mitral Regurgitation			
	Mild	Moderate	Severe
Qualitative			
Angiographic grade	1+	2+	3-4+
Color Doppler jet area	Small, central jet, < 4cm ² or <20% LA area)	Signs of > mild present but no criteria for severe MR	Vena contracta with > 0.7cm with large central MR jet (area >40% of LA area) or with a wall-impinging jet of any size, swirling in LA
Doppler vena contracta width (cm)	< 0.3	0.3-0.69	≥ 0.70
Quantitative (cath or echo)			
Regurgitant volume (mL per beat)	< 30	30-59	≥ 60
Regurgitant fraction (%)	< 30	30-49	≥ 50
Regurgitant orifice area (cm ²)	< 0.20	0.29 – 0.39	≥ 0.40
Additional essential criteria			
Left atrial size			Enlarged
Left ventricular size			Enlarged

MITRAL STENOSIS

A narrowing, stiffening or stricture of the mitral valve.

2008 Focused Update Incorporated into the ACC/AHA 2006 Guidelines for the Management of Patients with Valvular Heart Disease (published in the October 2008 issues of Journal of the American College of Cardiology and Circulation)

Mitral Stenosis			
	Mild	Moderate	Severe
Mean Gradient (mmHg)	Less than 5	5-10	Greater than 10
Pulmonary artery systolic pressure (mmHg)	Less than 30	30-50	Greater than 50
Valve area (cm ²)	Greater than 1.5	1.0-1.5	Less than 1.0

Moderate or severe AS will be considered a serious adverse event.

MYOCARDIAL INFARCTION (MI)

Myocardial infarction will be defined according to the definition proposed by the Valve Academic Research Consortium (VARC) Consensus Report for Transcatheter Aortic Valve Implantation (TAVI); 2010-12-05.

Peri-Procedural MI (≤ 72 hours after the index procedure)
<ol style="list-style-type: none"> 1. New ischemic symptoms (e.g. chest pain or shortness of breath), or new ischemic signs (e.g. ventricular arrhythmias, new or worsening heart failure, new ST-segment changes, hemodynamic instability, or imaging evidence of new loss of viable myocardium or new wall motion abnormality) AND 2. Elevated cardiac biomarkers (preferably CK-MB) within 72 hours after the index procedure, consisting of two or more post-procedure samples that are ≥ 6-8 hours apart with a 20% increase in the second sample and a peak value exceeding 10x the 99th percentile upper reference limit (URL) or a peak value exceeding 5x the 99th percentile URL and with new pathological Q waves in at least 2 contiguous leads.

Spontaneous MI (> 72 hours after the index procedure)
<p>Any one of the following criteria:</p> <ol style="list-style-type: none"> 1. Detection of rise and/or fall of cardiac biomarkers (preferably troponin) with at least one value above the 99th percentile URL, together with evidence of myocardial ischemia with at least one of the following: <ul style="list-style-type: none"> • ECG changes indicative of new ischemia (new ST-T changes or new left bundle branch block [LBBB]); • New pathological Q waves in at least 2 contiguous leads; • Imaging evidence of new loss of viable myocardium or new regional wall motion abnormality 2. Sudden, unexpected cardiac death, involving cardiac arrest, often with symptoms suggestive of myocardial ischemia, and accompanied by presumably new ST elevation, or new LBBB, and/or evidence of fresh thrombus by coronary angiography and/or at autopsy, but death occurring before blood samples could be obtained, or at a time before the appearance of cardiac biomarkers in the blood. 3. Pathological findings of an acute myocardial infarction.

All myocardial infarctions will be considered serious adverse events.

NEUROLOGICAL EVENT

Any central, new neurological deficit, whether temporary or permanent and whether focal or global, that occurs after the subject emerges from anesthesia.

NEW YORK HEART ASSOCIATION CLASSIFICATION (NYHA)

Classification system for defining cardiac disease and related functional limitations into four broad categorizations:

Class I	Subject with cardiac disease but without resulting limitations of physical activity. Ordinary physical activity does not cause undue fatigue, palpitation, dyspnea, or anginal pain.
Class II	Subjects with cardiac disease resulting in slight limitation of physical activity. They are comfortable at rest. Ordinary physical activity results in fatigue, palpitation, dyspnea, or anginal pain.
Class III	Subjects with cardiac disease resulting in marked limitation of physical activity. They are comfortable at rest. Less than ordinary physical activity causes fatigue, palpitation, dyspnea, or anginal pain.
Class IV	Subjects with cardiac disease resulting in inability to carry on any physical activity without discomfort. Symptoms of cardiac insufficiency or of the anginal syndrome may be present even at rest. If any physical activity is undertaken, discomfort is increased.

PARAVALVULAR AORTIC REGURGITATION

Leakage due to a separation of the prosthetic valve from the annulus. Diagnosis of paravalvular leak may be obtained from echocardiogram; however definitive diagnosis is obtained at reoperation, explant, or autopsy.

All moderate or severe paravalvular leaks will be classified as Serious Adverse Events.

(Refer to the definition of Aortic Regurgitation for additional paravalvular leak severity criteria)

PATIENT PROSTHESIS MISMATCH (PPM)

Patient Prosthesis Mismatch will be defined according to the definition from Urso et al, Interact Cardiovasc Thorac Surg. 2009 Sep; 9(3):510-8. Epub 2009 Jun 4.

- Severe PPM will be defined as an EOA $\leq 0.65 \text{ cm}^2 / \text{m}^2 \text{ BSA}$
- Moderate PPM defined as a patient with an EOA $\leq 0.85 \text{ cm}^2 / \text{m}^2 \text{ BSA}$

PERMANENT PACEMAKER IMPLANTATION

Implantation of permanent pacemaker after the index procedure due to occurrence of conduction disturbances.

- **Procedure-related:** Permanent Pacemaker is implanted in subjects with new onset conduction disturbances or worsening of existing conduction disturbances
- **Not related to procedure:** Permanent Pacemaker is implanted in subjects with known conduction disturbances that did not advance after the index procedure.

PROCEDURE RELATED COMPLICATIONS

Complications associated with any part of the vascular access procedure, associated treatments or necessary secondary interventions that do not necessarily involve the device. This includes morbidity associated with either pre-medication, or anesthesia, or other adjunct to the surgical procedure. Other technical errors including inappropriate patient selection, inappropriate operator techniques, measurements, or judgment that do not involve the device itself are also included.

PROCEDURAL SUCCESS

Defined as device success without occurrence of in-hospital MACCE.

PROCEDURE-RELATED EVENTS

Events occurring during or as a direct result of the index procedure. Events that occur before extubation and before access site closure are classified as procedural.

PROSTHETIC VALVE DYSFUNCTION

Prosthetic Valve Dysfunction will be defined according to the definition proposed by the Valve Academic Research Consortium (VARC) Consensus Report for Transcatheter Aortic Valve Implantation (TAVI); 2010-12-05

Failure modes of prosthetic valve dysfunction include, but are not limited to, the following:

- Aortic Stenosis
 - Stent creep
 - Pannus
 - Calcification
 - Support structure deformation (out-of-round configuration), under-expansion, fracture, or trauma (cardio-pulmonary resuscitation, blunt chest trauma)
 - Mal-sizing [prosthesis-patient mismatch (PPM)]
 - Endocarditis
 - Prosthetic valve thrombosis
 - Native leaflet prolapse impeding prosthetic leaflet motion
- Aortic Regurgitation
 - Pannus
 - Calcification
 - Support structure deformation (out-of-round configuration), recoil, under-expansion, fracture, insufficient radial strength, or trauma (cardio-pulmonary resuscitation, blunt chest trauma)
 - Endocarditis
 - Prosthetic valve thrombosis
 - Mal-position (too high, too low)
 - Acute mal-coaptation
 - Leaflet wear, tear/perforation, prolapse or retraction
 - Suture breakage or disruption
 - Native leaflet prolapse impeding prosthetic leaflet motion

Prosthetic valve dysfunction will be considered serious when it meets the definition of a serious adverse event (SAE).

REINTERVENTION

Any surgical or percutaneous interventional catheter procedure that repairs, otherwise alters or adjusts, or replaces a previously implanted valve. In addition to surgical reoperations, balloon dilatation, interventional manipulation, repositioning, or retrieval, and other catheter-based interventions for valve-related complications are also considered *reinterventions*. Reintervention is further subdivided into *surgical* and *percutaneous*.

RESPIRATORY INSUFFICIENCY

Post-bronchodilator forced expiratory volume in one second (FEV1)/forced vital capacity (FVC) ratio [FEV1/FVC] less than 70%.

Post-bronchodilator FEV1 less than 80% predicted, with or without chronic symptoms (i.e., cough or sputum production).

RESPIRATORY FAILURE

The need for ventilatory support for > 72 hours associated with an inability to wean from the respirator for any reason.

RIGHT VENTRICULAR INSUFFICIENCY

Defined as sequelae of right ventricular failure including the following:

- Significantly decreased right ventricular systolic and/or diastolic function
- Tricuspid valvular regurgitation secondary to elevated pressure

Clinical symptoms to include:

- Hepatic congestion
- Ascites
- Anasarca
- Presence of “hepato-jugular reflux”
- Edema

SERIOUS ADVERSE DEVICE EFFECT (SADE)

Adverse device effect that has resulted in any of the consequences characteristic of a Serious Adverse Event

SERIOUS ADVERSE EVENT (SAE)

A serious adverse event (SAE) is an event that:

- Led to death,
- Led to serious deterioration in health of the subject, that either resulted in:
 - a life threatening illness or injury, or
 - a permanent impairment of a body structure or a body function, or
 - in-patient or prolonged hospitalization, or
 - medical or surgical intervention to prevent a life-threatening illness or injury or permanent impairment to a body structure or a body function
- Led to fetal distress, fetal death or a congenital abnormality or birth defect

NOTE: Planned hospitalization for pre-existing condition, or a procedure required by per protocol, without serious deterioration in health, is not considered a serious adverse event.

Events that do not meet these criteria are considered non-serious.

STROKE (CVA)

Stroke and TIA will be defined according to the definition proposed by the Valve Academic Research Consortium (VARC) Consensus Report for Transcatheter Aortic Valve Implantation (TAVI); 2010-12-05 and the FDA’s Current Thinking Regarding Neurological Assessments for Transcatheter Valve Trials (July 25, 2011).

Stroke Diagnostic Criteria
<ul style="list-style-type: none"> • Rapid onset of a focal or global neurological deficit with at least one of the following: change in level of consciousness, hemiplegia, hemiparesis, numbness or sensory loss affecting one side of the body, dysphasia or aphasia, hemianopia, amaurosis fugax, or other neurological signs or symptoms consistent with stroke • Duration of a focal or global neurological deficit ≥ 24 hours; OR < 24 hours, if therapeutic intervention(s) were performed (e.g. thrombolytic therapy or intracranial angioplasty); OR available neuroimaging documents a new hemorrhage or infarct; OR the neurologic deficit results in death • No other readily identifiable non-stroke cause for the clinical presentations (e.g. brain tumor, trauma, infection, hypoglycemia, peripheral lesion, pharmacological influences)* • Confirmation of the diagnosis by at least one of the following: <ul style="list-style-type: none"> ○ Neurology or neurosurgical specialist ○ Neuroimaging procedure (MR or CT scan or cerebral angiography) ○ Lumbar puncture (i.e. spinal fluid analysis diagnostic of intracranial hemorrhage)
Stroke Definitions
<ul style="list-style-type: none"> • Transient Ischemic Attack <ul style="list-style-type: none"> ○ New focal neurologic deficit with rapid symptom resolution (usually 1-2 hours), always within 24 hours ○ Neuroimaging without tissue injury • Stroke: (diagnosis as above, preferably with positive neuroimaging study)+ <ul style="list-style-type: none"> ○ Minor (non-clinically important disability) - modified Rankin score < 2 at 30-day and 90-days^{+,**} ○ Major (clinically important disability) - modified Rankin score ≥ 2 at 30-day and 90 days^{+,**}

* Patients with non-focal global encephalopathy will not be reported as a stroke without unequivocal evidence based upon neuroimaging studies

+ Modified Rankin score assessments should be made by qualified individuals according to certification process. If there is discordance between modified Rankin and NIHSS determination of major versus minor stroke, a final determination of major versus minor stroke will be adjudicated by the neurology member of the clinical events committee.

**** For the purposes of this protocol, the Modified Rankin Score at 90 days will be used to classify minor versus major stroke (<2 will be classified as minor and ≥ 2 will be classified as major).**

Modified Rankin Scale

SCORE	DESCRIPTION
0	No symptoms at all
1	No significant disability despite symptoms; able to carry out all usual duties and activities
2	Slight disability; unable to carry out all previous activities, but able to look after own affairs without assistance
3	Moderate disability; requiring some help, but able to walk without assistance
4	Moderately severe disability; unable to walk without assistance and unable to attend to own bodily needs without assistance
5	Severe disability; bedridden, incontinent and requiring constant nursing care and attention
6	Dead

Clinically important disabilities (major strokes) will be considered to be serious adverse events.

Strokes will be further categorized to the following:

- Ischemic stroke is defined as an acute symptomatic episode of focal cerebral, spinal, or retinal dysfunction caused by an infarction of central nervous system tissue.
- Hemorrhagic stroke is defined as an acute symptomatic episode of focal or global cerebral or spinal dysfunction caused by a nontraumatic intraparenchymal, intraventricular, or subarachnoid hemorrhage.
- Undetermined stroke is defined as a stroke with insufficient information to allow categorization as A or B.

TECHNICAL OBSERVATION

A defect, malfunction, or failure of any part of the Medtronic CoreValve® System. This may pertain to the device or delivery and/or loading system not functioning according to its design intent.

TRANSIENT ISCHEMIC ATTACK (TIA)

(Refer to the definition of TIA under stroke above)

- New focal neurologic deficit with rapid symptom resolution (usually 1-2 hours), always within 24 hours
- Neuroimaging without tissue injury

TRICUSPID REGURGITATION

2008 Focused Update Incorporated into the ACC/AHA 2006 Guidelines for the Management of Patients with Valvular Heart Disease (published in the October 2008 issues of Journal of the American College of Cardiology and Circulation)

Severe tricuspid regurgitation: vena contracta width greater than 0.7cm and systolic reversal in hepatic veins.

UNANTICIPATED SERIOUS ADVERSE DEVICE EFFECT (USADE)

Serious adverse device effect which by its nature, incidence, severity or outcome has not been identified in the current version of the risk analysis report

NOTE: Anticipated serious adverse device effect (ASADE) is an effect which by its nature, incidence, severity or outcome has been identified in the risk analysis report.

VALVE THROMBOSIS

Any thrombus not caused by infection attached to or near the trial valve that occludes part of the blood flow path, interferes with valve function, or is sufficiently large to warrant treatment. Valve thrombus found at autopsy in a subject whose cause of death was not valve-related or found at operation for an unrelated indication should also be counted as *valve thrombosis*.

VASCULAR COMPLICATIONS

Vascular Complications will be defined according to the definition proposed by the Valve Academic Research Consortium (VARC) Consensus Report for Transcatheter Aortic Valve Implantation (TAVI); 2010-12-05.

Vascular Access Site and Access Related Complications
Major Vascular Complications
<ol style="list-style-type: none"> 1. Any thoracic aortic dissection 2. Access site or access-related vascular injury (dissection, stenosis, perforation, rupture, arterio-venous fistula, pseudoaneurysm, hematoma, irreversible nerve injury, or compartment syndrome) leading to either death, need for significant blood transfusions (≥4 units), unplanned percutaneous or surgical intervention, or irreversible end-organ damage (e.g. hypogastric artery occlusion causing visceral ischemia or spinal artery injury causing neurologic impairment) 3. Distal embolization (non-cerebral) from a vascular source requiring surgery or resulting in amputation or irreversible end-organ damage
Minor Vascular Complications
<ol style="list-style-type: none"> 1. Access site or access-related vascular injury (dissection, stenosis, perforation, rupture, arterio-venous fistula or pseudoaneurysm requiring compression or thrombin injection therapy, or hematomas requiring transfusion of ≥ 2 but < 4 units) not requiring unplanned percutaneous or surgical intervention and not resulting in irreversible end-organ damage 2. Distal embolization treated with embolectomy and/or thrombectomy and not resulting in amputation or irreversible end-organ damage 3. Failure of percutaneous access site closure that did not result in an interventional or surgical correction and is not associated with death, need for significant blood transfusions (≥4 units), or irreversible end-organ damage.

Major vascular complications will be considered to be serious adverse events.

P STUDY MANAGEMENT

P.1 Miscellaneous

P.1.1 Insurance

The Medtronic Bakken Research Center B.V. is a wholly owned subsidiary of Medtronic Inc., which as the parent company of such entity maintains appropriate clinical study liability insurance coverage as required under applicable laws and regulations and will comply with applicable law and custom concerning specific insurance coverage. If required, a Clinical Trial Insurance statement/certificate will be provided to the IRB/MEC.

P.1.2 Reimbursement

Study reimbursement is outlined in the Clinical Trial Agreement.

P.1.3 Indemnification

Indemnification will be done according to local laws.

P.1.4 Subject confidentiality

At all times throughout the study confidentiality shall be observed by all parties involved. All information and data sent to parties involved in study conduct concerning patients or their participation in this study will be considered confidential. The patient identification number is to be recorded on all study documents and will link the study documents to the patient's name and medical record at the investigator's site. To maintain confidentiality, the patient's name or any other personal identifiers should not be recorded on any study document other than the informed consent form.

Q REFERENCES

1. Baumgartner H, Hung J, Bermejo J, Chambers JB, Evangelista A, Griffin BP, Jung B, Otto CM, Pellikka PA, Quinones M. Echocardiographic assessment of valve stenosis: EAE/ASE recommendations for clinical practice. *J Am Soc Echocardiogr* 2009; 22(1):1-23; quiz 101-102.
2. Jung B, Baron G, Butchart EG, Delahaye F, Gohlke-Barwolf C, Levang OW, Tornos P, Vanoverschelde JL, Vermeer F, Boersma E, Ravaud P, Vahanian A. A prospective survey of patients with valvular heart disease in Europe: The Euro Heart Survey on Valvular Heart Disease. *Eur Heart J* 2003; 24(13):1231-1243.
3. Supino PG, Borer JS, Preibisz J, Bornstein A. The epidemiology of valvular heart disease: a growing public health problem. *Heart Fail Clin* 2006; 2(4):379-393.
4. Ross J, Jr., Braunwald E. Aortic stenosis. *Circulation* 1968; 38(1 Suppl):61-67.
5. Rosenhek R, Zilberszac R, Schemper M, Czerny M, Mundigler G, Graf S, Bergler-Klein J, Grimm M, Gabriel H, Maurer G. Natural history of very severe aortic stenosis. *Circulation*; 121(1):151-156.
6. Bonow RO, Carabello BA, Chatterjee K, de Leon AC, Jr., Faxon DP, Freed MD, Gaasch WH, Lytle BW, Nishimura RA, O'Gara PT, O'Rourke RA, Otto CM, Shah PM, Shanewise JS. 2008 Focused update incorporated into the ACC/AHA 2006 guidelines for the management of patients with valvular heart disease: a report of the American College of Cardiology/American Heart Association Task Force on Practice Guidelines (Writing Committee to Revise the 1998 Guidelines for the Management of Patients With Valvular Heart Disease): endorsed by the Society of Cardiovascular Anesthesiologists, Society for Cardiovascular Angiography and Interventions, and Society of Thoracic Surgeons. *Circulation* 2008; 118(15):e523-661.
7. Vahanian A, Baumgartner H, Bax J, Butchart E, Dion R, Filippatos G, Flachskampf F, Hall R, Jung B, Kasprzak J, Nataf P, Tornos P, Torracca L, Wenink A. Guidelines on the management of valvular heart disease: The Task Force on the Management of Valvular Heart Disease of the European Society of Cardiology. *Eur Heart J* 2007; 28(2):230-268.
8. Jung B, Cachier A, Baron G, Messika-Zeitoun D, Delahaye F, Tornos P, Gohlke-Barwolf C, Boersma E, Ravaud P, Vahanian A. Decision-making in elderly patients with severe aortic stenosis: why are so many denied surgery? *Eur Heart J* 2005; 26(24):2714-2720.
9. Serruys PW. Keynote address--EuroPCR 2008, Barcelona, May 14th, 2008. Transcatheter aortic valve implantation: state of the art. *EuroIntervention* 2009; 4(5):558-565.
10. Cribier A, Eltchaninoff H, Bash A, Borenstein N, Tron C, Bauer F, Derumeaux G, Anselme F, Laborde F, Leon MB. Percutaneous transcatheter implantation of an aortic valve prosthesis for calcific aortic stenosis: first human case description. *Circulation* 2002; 106(24):3006-3008.
11. Webb JG, Pasupati S, Humphries K, Thompson C, Altwegg L, Moss R, Sinhal A, Carere RG, Munt B, Ricci D, Ye J, Cheung A, Lichtenstein SV. Percutaneous transarterial aortic valve replacement in selected high-risk patients with aortic stenosis. *Circulation* 2007; 116(7):755-763.
12. Grube E, Laborde JC, Gerckens U, Felderhoff T, Sauren B, Buellesfeld L, Mueller R, Menichelli M, Schmidt T, Zickmann B, Iversen S, Stone GW. Percutaneous implantation of the CoreValve self-expanding valve prosthesis in high-risk patients with aortic valve disease: the Siegburg first-in-man study. *Circulation* 2006; 114(15):1616-1624.
13. Piazza N, Grube E, Gerckens U, den Heijer P, Linke A, Luha O, Ramondo A, Ussia G, Wenaweser P, Windecker S, Laborde JC, de Jaegere P, Serruys PW. Procedural and 30-day outcomes following transcatheter aortic valve implantation using the third generation (18 Fr) corevalve revalving system: results from the multicentre, expanded evaluation registry 1-year following CE mark approval. *EuroIntervention* 2008; 4(2):242-249.
14. Bleiziffer S, Ruge H, Mazzitelli D, Hutter A, Opitz A, Bauernschmitt R, Lange R. Survival after transapical and transfemoral aortic valve implantation: talking about two different patient populations. *J Thorac Cardiovasc Surg* 2009; 138(5):1073-1080.
15. Webb JG, Altwegg L, Boone RH, Cheung A, Ye J, Lichtenstein S, Lee M, Masson JB, Thompson C, Moss R, Carere R, Munt B, Nietlispach F, Humphries K. Transcatheter aortic valve implantation: impact on clinical and valve-related outcomes. *Circulation* 2009; 119(23):3009-3016.

16. Thomas M, Schymik G, Walther T, Himbert D, Lefevre T, Treede H, Eggebrecht H, Rubino P, Michev I, Lange R, Anderson WN, Wendler O. Thirty-Day Results of the SAPIEN Aortic Bioprosthesis European Outcome (SOURCE) Registry. A European Registry of Transcatheter Aortic Valve Implantation Using the Edwards SAPIEN Valve. *Circulation*.
17. Gerckens U, Latsios G, Mueller R, Buellesfeld L, John D, Yucel S, Sauren B, Felderhof T, Iversen S, Grube E. Procedural and mid-term results in patients with aortic stenosis treated with implantation of 2 (in-series) CoreValve prostheses in 1 procedure. *JACC Cardiovasc Interv*; 3(2):244-250.
18. Masson JB, Kovac J, Schuler G, Ye J, Cheung A, Kapadia S, Tuzcu ME, Kodali S, Leon MB, Webb JG. Transcatheter aortic valve implantation: review of the nature, management, and avoidance of procedural complications. *JACC Cardiovasc Interv* 2009; 2(9):811-820.
19. Piazza N, Cutlip DE, Onuma Y, Kappetein AP, de Jaegere P, Serruys PW. Clinical endpoints in transcatheter aortic valve implantation: a call to ARC for standardised definitions. *EuroIntervention* 2009; 5(1):29-31.
20. Thomas M, Wendler O. Transcatheter aortic valve implantation (TAVI): how to interpret the data and what data is required? *EuroIntervention* 2009; 5(1):25-27.
21. Leon MB, Piazza N, Nikolsky E, Blackstone EH, Cutlip DE, Kappetein AP, Krucoff MW, Mack MM, R., Miller C, Morel M, Petersen JP, J.J., Takkenberg JJM, Vahanian A, van Es G, Vranckx P, Smith C, Webb JG, Mohr F, Windecker S, Serruys PW. Standardized endpoint definitions for Transcatheter Aortic Valve Implantation Clinical Trials: a consensus report from the Valve Academic Research Consortium. *J Am Coll Cardiol* 2011.
22. Leon MB, Piazza N, Nikolsky E, Blackstone EH, Cutlip DE, Kappetein AP, Krucoff MW, Mack MM, R., Miller C, Morel M, Petersen JP, J.J., Takkenberg JJM, Vahanian A, van Es G, Vranckx P, Smith C, Webb JG, Mohr F, Windecker S, Serruys PW. Standardized endpoint definitions for Transcatheter Aortic Valve Implantation Clinical Trials: a consensus report from the Valve Academic Research Consortium. *European Heart Journal* 2011.
23. Van Brabandt H, Neyt M. Safety of percutaneous aortic valve insertion. A systematic review. *BMC Cardiovasc Disord* 2009; 9:45.
24. Van Brabandt H, Neyt M. What is the evidence in favor of percutaneous aortic valve insertion? *Am J Cardiol* 2009; 103(4):575.
25. Dhruva SS, Bero LA, Redberg RF. Strength of study evidence examined by the FDA in premarket approval of cardiovascular devices. *JAMA* 2009; 302(24):2679-2685.
26. Leon MB, Smith CR, Mack M, Miller DC, Moses JW, Svensson LG, Tuzcu EM, Webb JG, Fontana GP, Makkar RR, Brown DL, Block PC, Guyton RA, Pichard AD, Bavaria JE, Herrmann HC, Douglas PS, Petersen JL, Akin JJ, Anderson WN, Wang D, Pocock S. Transcatheter aortic-valve implantation for aortic stenosis in patients who cannot undergo surgery. *N Engl J Med*; 363(17):1597-1607.
27. Serruys PW, Morice MC, Kappetein AP, Colombo A, Holmes DR, Mack MJ, Stahle E, Feldman TE, van den Brand M, Bass EJ, Van Dyck N, Leadley K, Dawkins KD, Mohr FW. Percutaneous coronary intervention versus coronary-artery bypass grafting for severe coronary artery disease. *N Engl J Med* 2009; 360(10):961-972.
28. Piazza N, van Gameren M, Juni P, Wenaweser P, Carrel T, Onuma Y, Gahl B, Hellige G, Otten A, Kappetein AP, Takkenberg JJ, van Domburg R, de Jaegere P, Serruys PW, Windecker S. A comparison of patient characteristics and 30-day mortality outcomes after transcatheter aortic valve implantation and surgical aortic valve replacement for the treatment of aortic stenosis: a two-centre study. *EuroIntervention* 2009; 5(5):580-588.
29. Ong AT, Serruys PW, Mohr FW, Morice MC, Kappetein AP, Holmes DR, Jr., Mack MJ, van den Brand M, Morel MA, van Es GA, Kleijne J, Koglin J, Russell ME. The SYNergy between percutaneous coronary intervention with TAXus and cardiac surgery (SYNTAX) study: design, rationale, and run-in phase. *Am Heart J* 2006; 151(6):1194-1204.
30. Roques F, Nashef SA, Michel P, Gauducheau E, de Vincentiis C, Baudet E, Cortina J, David M, Faichney A, Gabrielle F, Gams E, Harjula A, Jones MT, Pintor PP, Salamon R, Thulin L. Risk factors and outcome in European cardiac surgery: analysis of the EuroSCORE multinational database of 19030 patients. *Eur J Cardiothorac Surg* 1999; 15(6):816-822; discussion 822-813.
31. Shahian DM, O'Brien SM, Filardo G, Ferraris VA, Haan CK, Rich JB, Normand SL, DeLong ER, Shewan CM, Dokholyan RS, Peterson ED, Edwards FH, Anderson RP. The Society of Thoracic Surgeons 2008 cardiac surgery risk models: part 3--valve plus coronary artery bypass grafting surgery. *Ann Thorac Surg* 2009; 88(1 Suppl):S43-62.

32. Jin R, Grunkemeier GL, Starr A. Validation and refinement of mortality risk models for heart valve surgery. *Ann Thorac Surg* 2005; 80(2):471-479.
33. Edwards FH, Peterson ED, Coombs LP, DeLong ER, Jamieson WR, Shroyer ALW, Grover FL. Prediction of operative mortality after valve replacement surgery. *J Am Coll Cardiol* 2001; 37(3):885-892.
34. Hannan EL, Wu C, Bennett EV, Carlson RE, Culliford AT, Gold JP, Higgins RS, Smith CR, Jones RH. Risk index for predicting in-hospital mortality for cardiac valve surgery. *Ann Thorac Surg* 2007; 83(3):921-929.
35. Gardner SC, Grunwald GK, Rumsfeld JS, Cleveland JC, Jr., Schooley LM, Gao D, Grover FL, McDonald GO, Shroyer AL. Comparison of short-term mortality risk factors for valve replacement versus coronary artery bypass graft surgery. *Ann Thorac Surg* 2004; 77(2):549-556.
36. Dewey TM, Brown D, Ryan WH, Herbert MA, Prince SL, Mack MJ. Reliability of risk algorithms in predicting early and late operative outcomes in high-risk patients undergoing aortic valve replacement. *J Thorac Cardiovasc Surg* 2008; 135(1):180-187.
37. Nowicki ER, Birkmeyer NJ, Weintraub RW, Leavitt BJ, Sanders JH, Dacey LJ, Clough RA, Quinn RD, Charlesworth DC, Sisto DA, Uhlig PN, Olmstead EM, O'Connor GT. Multivariable prediction of in-hospital mortality associated with aortic and mitral valve surgery in Northern New England. *Ann Thorac Surg* 2004; 77(6):1966-1977.
38. van Gameren M, Kappetein AP, Steyerberg EW, Venema AC, Berenschot EA, Hannan EL, Bogers AJ, Takkenberg JJ. Do we need separate risk stratification models for hospital mortality after heart valve surgery? *Ann Thorac Surg* 2008; 85(3):921-930.
39. van Gameren M, Piazza N, Bogers AJ, Takkenberg JJ, Kappetein AP. How to assess risks of valve surgery: quality, implementation and future of risk models. *Heart* 2009; 95(23):1958-1963.
40. Lee DH, Buth KJ, Martin BJ, Yip AM, Hirsch GM. Frail patients are at increased risk for mortality and prolonged institutional care after cardiac surgery. *Circulation*; 121(8):973-978.
41. Chang AS, Smedira NG, Chang CL, Benavides MM, Myhre U, Feng J, Blackstone EH, Lytle BW. Cardiac surgery after mediastinal radiation: extent of exposure influences outcome. *J Thorac Cardiovasc Surg* 2007; 133(2):404-413.
42. Girardi LN, Krieger KH, Mack CA, Isom OW. No-clamp technique for valve repair or replacement in patients with a porcelain aorta. *Ann Thorac Surg* 2005; 80(5):1688-1692.
43. Wijns W, Kolh P, Danchin N, Di Mario C, Falk V, Folliguet T, Garg S, Huber K, James S, Knuuti J, Lopez-Sendon J, Marco J, Menicanti L, Ostojic M, Piepoli MF, Pirllet C, Pomar JL, Reifart N, Ribichini FL, Schalij MJ, Sergeant P, Serruys PW, Silber S, Sousa Uva M, Taggart D, Vahanian A, Auricchio A, Bax J, Ceconi C, Dean V, Filippatos G, Funck-Brentano C, Hobbs R, Kearney P, McDonagh T, Popescu BA, Reiner Z, Sechtem U, Sirnes PA, Tendera M, Vardas PE, Widimsky P, Alfieri O, Dunning J, Elia S, Kappetein P, Lockowandt U, Sarris G, Vouhe P, von Segesser L, Agewall S, Aladashvili A, Alexopoulos D, Antunes MJ, Atalar E, Brutel de la Riviere A, Doganov A, Eha J, Fajadet J, Ferreira R, Garot J, Halcox J, Hasin Y, Janssens S, Kervinen K, Laufer G, Legrand V, Nashef SA, Neumann FJ, Niemela K, Nihoyannopoulos P, Noc M, Piek JJ, Pirk J, Rozenman Y, Sabate M, Starc R, Thielmann M, Wheatley DJ, Windecker S, Zembala M. Guidelines on myocardial revascularization: The Task Force on Myocardial Revascularization of the European Society of Cardiology (ESC) and the European Association for Cardio-Thoracic Surgery (EACTS). *Eur Heart J*; 31(20):2501-2555.
44. Lund O, Nielsen TT, Pilegaard HK, Magnussen K, Knudsen MA. The influence of coronary artery disease and bypass grafting on early and late survival after valve replacement for aortic stenosis. *J Thorac Cardiovasc Surg* 1990; 100(3):327-337.
45. Dickstein K, Vardas PE, Auricchio A, Daubert JC, Linde C, McMurray J, Ponikowski P, Priori SG, Sutton R, van Veldhuisen DJ, Vahanian A, Bax J, Ceconi C, Dean V, Filippatos G, Funck-Brentano C, Hobbs R, Kearney P, McDonagh T, Popescu BA, Reiner Z, Sechtem U, Sirnes PA, Tendera M, Vardas P, Widimsky P, Anker SD, Blanc JJ, Gasparini M, Hoes AW, Israel CW, Kalarus Z, Merkely B, Swedberg K, Camm AJ. 2010 Focused Update of ESC Guidelines on device therapy in heart failure: an update of the 2008 ESC Guidelines for the diagnosis and treatment of acute and chronic heart failure and the 2007 ESC guidelines for cardiac and resynchronization therapy. Developed with the special contribution of the Heart Failure Association and the European Heart Rhythm Association. *Eur Heart J*; 31(21):2677-2687.

46. Goldstein LB, Adams R, Alberts MJ, Appel LJ, Brass LM, Bushnell CD, Culebras A, DeGraba TJ, Gorelick PB, Guyton JR, Hart RG, Howard G, Kelly-Hayes M, Nixon JV, Sacco RL. Primary prevention of ischemic stroke: a guideline from the American Heart Association/American Stroke Association Stroke Council: cosponsored by the Atherosclerotic Peripheral Vascular Disease Interdisciplinary Working Group; Cardiovascular Nursing Council; Clinical Cardiology Council; Nutrition, Physical Activity, and Metabolism Council; and the Quality of Care and Outcomes Research Interdisciplinary Working Group. *Circulation* 2006; 113(24):e873-923.
47. Sacco RL, Adams R, Albers G, Alberts MJ, Benavente O, Furie K, Goldstein LB, Gorelick P, Halperin J, Harbaugh R, Johnston SC, Katzan I, Kelly-Hayes M, Kenton EJ, Marks M, Schwamm LH, Tomsick T. Guidelines for prevention of stroke in patients with ischemic stroke or transient ischemic attack: a statement for healthcare professionals from the American Heart Association/American Stroke Association Council on Stroke: co-sponsored by the Council on Cardiovascular Radiology and Intervention: the American Academy of Neurology affirms the value of this guideline. *Circulation* 2006; 113(10):e409-449.
48. Adams RJ, Albers G, Alberts MJ, Benavente O, Furie K, Goldstein LB, Gorelick P, Halperin J, Harbaugh R, Johnston SC, Katzan I, Kelly-Hayes M, Kenton EJ, Marks M, Sacco RL, Schwamm LH. Update to the AHA/ASA recommendations for the prevention of stroke in patients with stroke and transient ischemic attack. *Stroke* 2008; 39(5):1647-1652.
49. O'Brien SM, Shahian DM, Filardo G, Ferraris VA, Haan CK, Rich JB, Normand SL, DeLong ER, Shewan CM, Dokholyan RS, Peterson ED, Edwards FH, Anderson RP. The Society of Thoracic Surgeons 2008 cardiac surgery risk models: part 2--isolated valve surgery. *Ann Thorac Surg* 2009; 88(1 Suppl):S23-42.
50. Pauwels RA, Buist AS, Calverley PM, Jenkins CR, Hurd SS. Global strategy for the diagnosis, management, and prevention of chronic obstructive pulmonary disease. NHLBI/WHO Global Initiative for Chronic Obstructive Lung Disease (GOLD) Workshop summary. *Am J Respir Crit Care Med* 2001; 163(5):1256-1276.
51. Levey AS, Coresh J, Balk E, Kausz AT, Levin A, Steffes MW, Hogg RJ, Perrone RD, Lau J, Eknoyan G. National Kidney Foundation practice guidelines for chronic kidney disease: evaluation, classification, and stratification. *Ann Intern Med* 2003; 139(2):137-147.
52. Zoghbi WA, Chambers JB, Dumesnil JG, Foster E, Gottdiener JS, Grayburn PA, Khandheria BK, Levine RA, Marx GR, Miller FA, Jr., Nakatani S, Quinones MA, Rakowski H, Rodriguez LL, Swaminathan M, Waggoner AD, Weissman NJ, Zabalgoitia M. Recommendations for evaluation of prosthetic valves with echocardiography and doppler ultrasound: a report From the American Society of Echocardiography's Guidelines and Standards Committee and the Task Force on Prosthetic Valves, developed in conjunction with the American College of Cardiology Cardiovascular Imaging Committee, Cardiac Imaging Committee of the American Heart Association, the European Association of Echocardiography, a registered branch of the European Society of Cardiology, the Japanese Society of Echocardiography and the Canadian Society of Echocardiography, endorsed by the American College of Cardiology Foundation, American Heart Association, European Association of Echocardiography, a registered branch of the European Society of Cardiology, the Japanese Society of Echocardiography, and Canadian Society of Echocardiography. *J Am Soc Echocardiogr* 2009; 22(9):975-1014; quiz 1082-1014.
53. Delgado V, Ng AC, van de Veire NR, van der Kley F, Schuijff JD, Tops LF, de Weger A, Tavilla G, de Roos A, Kroft LJ, Schalij MJ, Bax JJ. Transcatheter aortic valve implantation: role of multi-detector row computed tomography to evaluate prosthesis positioning and deployment in relation to valve function. *Eur Heart J*; 31(9):1114-1123.
54. Schultz CJ, Moelker A, Piazza N, Tzikas A, Otten A, Nuis RJ, Neeffjes LA, van Geuns RJ, de Feyter P, Krestin G, Serruys PW, de Jaegere PP. Three dimensional evaluation of the aortic annulus using multislice computer tomography: are manufacturer's guidelines for sizing for percutaneous aortic valve replacement helpful? *Eur Heart J*; 31(7):849-856.



SURTAVI

Surgical Replacement and Transcatheter Aortic Valve Iplantation

Appendix

VERSION 3.0

18 November 2011

Sponsor:

Medtronic, Inc.
Clinical Research
Mailstop: MVS66
Mounds View South
8200 Coral Sea St NE
Mounds View, MN 55112 USA

Medtronic Bakken Research Center
CardioVascular Department
Endepolsdomein 5
6229 GW Maastricht
The Netherlands

TABLE OF CONTENTS

R	APPENDICES	100
R.1	Sample Informed Consent.....	100
R.2	List of Participating Investigational Centers	125
R.3	Other Institutions.....	126
R.4	Additional Records and Reports.....	127
R.5	Sample Case Report Forms	128
R.6	Aortogram Acquisition Guidelines	129
R.7	Echocardiography Acquisition Guidelines	131
R.8	Electrocardiogram (ECG) Submission.....	150
R.9	Computed Tomography (CT) Angiography Acquisition Guidelines.....	151
R.10	Interactive Voice/Web Response System (IXRS)	163
R.11	Explanted Device/Pathology and Return Procedures	164
R.12	Economic and Quality of Life Data Collection	166
R.13	Pacing Guidelines.....	167
R.14	Six Minute Walk Test Instructions	171
R.15	National Institute of Health Stroke Scale (NIHSS)	184
R.16	Modified Rankin Scale (mRS) Instructions	188
R.17	Mini Mental State Exam (MMSE-2)	189
R.18	Additional Neurological Assessments	190
R.19	Medtronic CoreValve® Clinical Assessment Guidelines.....	192
R.20	Katz Index of Independence in Activities of Daily Living	193
R.21	Investigator Brochure / Report of Prior Investigations for the Medtronic CoreValve® System.....	194
R.22	SURTAVI Risk Model	195
R.22.1	SURTAVI Risk Model Rationale	195
R.22.2	SURTAVI co-morbidity list	198

R.1 Sample Informed Consent

Attached are the informed consent form templates:

US
OUS

INFORMED CONSENT FORM
US Template
Medtronic CoreValve[®] SURTAVI Trial

You are being asked to read this form so that you understand this research study and how you might take part in it. By signing this form, you will show that you understand and that you agree to take part in this research study. Your signature on this form is required before you can take part in this research study.

BACKGROUND

You are being asked to take part in a research study entitled “Medtronic CoreValve[®] SURTAVI Trial” because you have a disease of your aortic valve. This disease is called aortic stenosis.

The aortic valve is one of the four heart valves that control the flow of blood into and out of the heart. The aortic valve lets oxygen-containing blood to be pumped out of the heart, from the left ventricle (main pumping chamber of the heart) into the aorta (main artery delivering blood to the body). If the valve becomes abnormally narrow through a process of thickening and stiffening (aortic stenosis) the heart must work harder to pump the same amount of blood with each beat.

As the heart works harder, the heart muscle thickens (hypertrophy), and the heart chamber (ventricle) may become larger (dilate). Open-heart surgery to replace the diseased aortic valve is the standard treatment.

As an alternative to open heart surgery, the Medtronic CoreValve[®] System has been developed to replace a diseased aortic heart valve without the need for open heart surgery. This system allows the percutaneous aortic valve (study valve) to be implanted (inserted) through a long, thin flexible tube that is inserted through an incision in the skin and threaded through the bloodstream (percutaneous).

A description of this clinical trial will be available on <http://www.ClinicalTrials.gov>, as required by U.S. Law. This Web site will not include information that can identify you. At most, the Web site will include a summary of the results. You can search the Web site at any time.

You are being asked to participate in this study because doctors have determined your aortic valve is no longer working properly. However, your doctors have also decided that your risk of experiencing major problems while undergoing open-heart surgery is moderate due to medical reasons or anatomical reasons (relating to how and where your heart, aortic valve and blood vessels are placed within your body). This means that your doctor believes your health is acceptable for open-heart surgery, but there is still a risk of potential problems.

PURPOSE OF THE STUDY

The purpose of this clinical study is to determine if replacing the aortic valve without open-heart surgery is as safe as or safer than open-heart surgery in patients with similar medical conditions as you.

The study valve is considered an “investigational device”, which means that clinical studies are required to determine if it is safe and provides clinical benefit. Medtronic, Inc. is sponsoring this study to obtain data on the safety and performance of the Medtronic CoreValve[®] System. The

Medtronic CoreValve[®] System includes the valve described below and two parts that help load and deliver the valve correctly.

This study will involve up to 1200 subjects at up to 50 hospitals in the United States and around the world, and is anticipated to take approximately 7 years to complete. Your participation in this study is expected to last approximately five years from the day you are enrolled in the study.

STUDY DEVICE

The study valve is made from animal tissue attached to a metal frame.

The study valve is designed to be implanted (inserted) using a delivery system catheter (long, thin flexible tube) to replace your diseased aortic heart valve without open-heart surgery.

Although the Medtronic CoreValve system is not approved by the US Food & Drug Administration (FDA) it has been approved in other parts of the world since 2006 and has been implanted in over 10,000 patients.

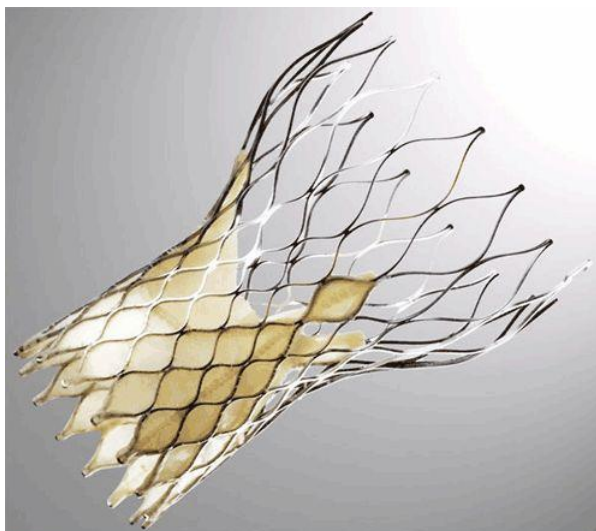

PROCEDURES TO BE FOLLOWED

If you agree to be in this study, data such as your age, gender, medical history and medication use will be recorded. You will undergo the following tests:

- Physical examination
- Computed tomography (CT) - a scan performed using an x-ray machine, which is linked to a computer to take pictures of your body. Sometimes a CT will require the use of a type of dye that makes the kidneys work harder and may be harmful to the kidneys. You may have an MRI in place of a CT scan if your doctor believes your kidneys are not working well enough for you to have a CT scan. MRI stands for magnetic resonance imaging and is a test that uses a strong magnet and a complex computer system to produce detailed images of your internal organs and soft body tissues.
- Blood tests (about 2 tablespoons)
- Echocardiography (transthoracic echocardiogram (TTE)) - a test that uses sound waves to take pictures of your heart and measure the degree of narrowing of your aortic valve; a probe with gel is placed on the outside of your chest to take pictures of your heart
- Electrocardiogram (ECG) - a test that records electrical impulses of your heart; patches are placed on the outside of your chest
- Heart catheterization/angiography - a test that takes pictures of your heart and blood vessels; a special dye is injected through long, flexible tubes into the coronary arteries (vessels delivering blood to the heart) and bypass grafts if you have them

If you are of child-bearing potential, we will ask you to take a pregnancy test. If you are pregnant, you will not be able to participate in this study.

These procedures and tests are standard procedures and are not experimental. If you have already had any of these tests performed before, they may to be used for the study if your study doctor determines they don't need to be repeated for study purposes. The results from your exams and tests will be reviewed by your doctors who will determine if you are eligible to be in the study.

Your study doctors may determine after reviewing your test results that you are not eligible to be in the study and/or it will not be possible to implant the study valve. If so, you will not be allowed to participate in the study.

If your doctors decide you are eligible to be in the study your treatment will be determined in a way similar to flipping a coin, called randomization. You will be assigned to one of two groups. One group will receive a transcatheter aortic valve implant (TAVI), the other group will open-heart surgical aortic valve replacement (SAVR). On average, one out of every two participants will receive TAVI. The other participants will receive SAVR. You will not be able to choose your treatment assignment.

Your enrollment in the study will begin once you are assigned to your treatment group.

If you are enrolled in the study, you will be required to have the following additional tests completed within 14 days prior to the procedure (TAVI or SAVR):

- Physical exam, including a determination of neurological (brain) status where you will be asked to answer a series of questions and perform a series of tasks such as writing and drawing
- Blood tests (about 2 tablespoons)
- Walking test – a test that records your breathing, heart rate, and how you feel after 6 minutes of walking
- Electrocardiogram (ECG) - a test that records electrical impulses of your heart; patches are placed on the outside of your chest

You will also be asked to complete surveys about the quality of your life and your ability to do normal daily activities, called Quality of Life Questionnaires (QOL).

Your personal physician will be informed about your participation in this clinical study.

If you are assigned to the TAVI group:

TAVI is an experimental procedure.

Before the TAVI procedure, it will be strongly recommended that you take blood thinning medications, used to prevent your blood from clotting (thickening). These medications will be described to you by your study doctor. You may be advised to continue these medications for at least three months following your procedure.

Before the procedure you will be given an antibiotic (a medicine that kills bacteria or germs) to decrease your chance of developing an infection. Your study doctor will choose the antibiotic that he or she thinks is best suited for you and decide whether you need additional medication.

You will also have blood tests (about 2 tablespoons) and an ECG before the procedure.

Immediately prior to the procedure, you will receive medications to make you more relaxed and comfortable during the procedure. Your study doctor may decide that general anesthesia is necessary, meaning you need to be put to sleep for the procedure. Your doctor will inform you of this need before the procedure. Additionally, if your study doctor decides that it is necessary during the procedure, you will be put under general anesthesia at that time.

Your study doctor will decide what sites are best for inserting the long, thin flexible tubes required for TAVI and getting all of the pictures that are necessary. Additionally, your study doctor will decide if performing a surgical incision to any of the site(s) is necessary.

During the procedure you may have a transesophageal echocardiogram which is also called a TEE. This test uses sound waves to take a closer look at the inside structures of the heart. To perform the test you will swallow a thin flexible tube with a special tip. This tube sits in the esophagus (the tube that connects the mouth to the stomach). The special tip of the tube sends out sound waves (ultrasound) that echo within the chest wall. The esophagus is located behind the heart so these echoes are picked up and create a picture of the heart that is displayed on a video monitor. The pictures will allow your study doctor to take a closer look at your valve.

You will have a temporary pacemaker put in place during the TAVI procedure. A temporary pacemaker is a thin wire inserted through your skin and into one of your veins and threaded through your vein into the right side of your heart. The wire is attached to a battery operated device outside of your body. This temporary pacemaker will help keep your heart rate (speed) and rhythm steady. This temporary pacemaker will not be removed for at least 48 hours after your TAVI procedure.

After your study doctor has taken a good look at your valve, a balloon valvuloplasty will be performed. Balloon valvuloplasty is a procedure used to widen a stiff or narrowed heart valve. A wire and a thin tube are guided by x-rays through the heart and positioned through the diseased heart valve. A balloon is placed over the wire and inflated, enlarging the opening through the diseased valve allowing the study valve to be placed.

Your doctor will then implant (insert) the study valve through the long, thin flexible tube that is inserted through an incision in the skin and threaded through the bloodstream. TAVI is performed using x-ray machines which will allow your doctor to see the study valve, your blood vessels and heart. The study valve will be guided through your blood vessels to your existing aortic valve and then the study valve will be placed over your existing valve.

During the TAVI procedure, your doctor will perform angiography (x-ray pictures) and ECGs (recordings of the electrical impulses of your heart through patches placed on the chest) to observe your heart function and make sure that the study valve fits and works properly.

Doctors from other hospitals who have experience with the TAVI procedure may assist your study doctor with the procedure. Medtronic staff may assist the physician in the loading of the study valve.

If you are assigned to the SAVR group:

Open heart surgery, surgical repair and/or replacement of your aortic valve, are not experimental procedures.

If you are assigned to the SAVR group, your doctors will replace your diseased aortic valve through open heart surgery. During surgery, you are asleep under general anesthesia. SAVR often requires a median sternotomy, where the bone in the center of the chest (sternum) is split down the middle. The chest is then opened to provide your doctor with access to the heart and chest cavity, in order to replace your aortic valve. Your surgery is performed while the function of your heart is taken over by a heart lung machine (called CPB for cardiopulmonary bypass).

You may have a TEE (a thin tube sits in the esophagus and sends out sound waves to create a picture of your heart) and a temporary pacemaker (thin wire threaded through your vein to right side of heart to keep your heart rate and rhythm steady) during the procedure.

Your doctor may remove any tissue and calcium deposits that are interfering with the normal function of the valve. Your damaged valve may be completely removed. The new valve will be sewn into the space where your own valve used to be. After your doctor makes sure your valve is working properly, blood flow will be restored to your heart and the incisions will be closed. You will also have blood drawn for testing before and after the procedure.

If your doctor is unable to implant (insert) the study valve in you during the TAVI or SAVR procedure, you will still be considered enrolled in the study and will need to return to the clinic for the required follow-up visits as described in the "Follow-up Visits after TAVI and SAVR" section.

After TAVI and SAVR Procedure:

After the TAVI and SAVR procedure, your study doctors will continue to monitor your progress and recovery.

You will have the following tests performed within the two days following the procedure and before you are discharged from the hospital:

- Determination of neurological (brain) status where you will be asked to answer a series of questions and perform a series of tasks
- Blood tests (about 2 tablespoons)
- Echocardiogram (TTE)
- ECG

Follow-up Visits after TAVI and SAVR:

You will need to return to the clinic for required follow-up visits at 30 days, 6 months, 12 months (1 year), 18 months, 24 months (2 years), and 3, 4, and 5 years after the procedure. Most of the follow-up tests and examinations are routine, not experimental. Each visit will take about 1 ½ to 2 hours.

Your evaluations at 30 days, 6 and 18 months will include:

- Physical examination, including a determination of neurological (brain) status where you will be asked to answer a series of questions and perform a series of tasks
- You will be asked about your health since the last follow-up visit
- Quality of Life Questionnaires
- ECG
- Blood tests (about 2 tablespoons) – 30 day visit only
- Walking test – 30 day visit only
- Echocardiogram (TTE) – 6 month visit only

Your evaluation at 12 months, 24 months, and 3, 4, 5 years will include:

- Physical examination, including a determination of neurological (brain) status where you will be asked to answer a series of questions and perform a series of tasks
- You will be asked about your health since the last clinic visit
- Blood tests (about 2 tablespoons)
- Echocardiogram (TTE)
- Quality of Life Questionnaires
- ECG
- Walking test – 12 and 24 months visits only

In addition to the in-clinic follow-up visits, at 3 months you will be contacted via phone to complete a Quality of Life Questionnaire.

If you have additional heart surgeries or cath lab procedures to work on or replace your aortic valve or study valve, you will be asked to answer questions and perform activities that will help the study doctors and nurses to determine your neurological (brain) status within 24 hours after each additional procedure.

If you have a stroke, have been inform by a doctor that you experienced a stroke, or experience any of the following symptoms, notify Dr. **Principal Investigator** at xxx-xxx-xxxx as soon as possible: sudden numbness, tingling, loss of movement (especially on 1 side of the body), vision changes, confusion or trouble understanding simple statements, severe headaches, or seizures. Any of these symptoms could indicate that you are having problems with your neurological (brain) function. If a doctor confirms that you had a stroke, you will have tests performed to determine your neurological (brain) status where you will be asked to answer a series of questions and perform a series of tasks. These tests will be performed at 7 days, 30 days and 3 months after you have any of these symptoms.

If you have any other problems or complications, seen by any other doctors, or are hospitalized during your participation in this study you should immediately notify Dr. **Principal Investigator** at xxx-xxx-xxxx.

If the study valve is removed for any reason, we will request that it be returned to Medtronic for additional analysis. Your study doctor will determine if you will need to have another valve implanted.

In the event of your death, we will request an autopsy. We will also request that either the whole heart and valve or just the valve are removed and returned to Medtronic for additional analysis.

The autopsy and the removal of the heart and/or valve would be done to provide additional information about the research and the investigational valve.

Your family and your "legally authorized representatives", have the right to refuse the autopsy and refuse the request to remove the heart and/or valve even if you sign this consent form.

TAVI

Potential risks associated with the implantation of the study valve may include, but are not limited to, the following:

- **Death**
- **Acute myocardial infarction** - heart attack; decrease blood flow to the heart causing death of an area of the heart muscle
- **Stroke** - decreased blood flow to the brain causing death of brain cells
- **Urgent need for surgery**
 - Coronary artery bypass – (CABG) a surgery where the chest is opened to place new vessels around the existing blocked vessels of the heart to improve blood supply to the heart.
 - Heart valve replacement – replacing the existing heart valve with a new heart valve
 - Valve explant – the removal of the existing valve
- **Urgent need for balloon valvuloplasty** (balloon valvuloplasty during the TAVI procedure is expected) – a procedure through the vessels inside the body and heart in which a narrowed heart valve is stretched open by a balloon
- **Urgent need for Percutaneous Coronary Intervention (PCI)** – a procedure through the vessels inside the body and heart used to treat or open narrowed vessels of the heart
- **Cardiogenic shock** – failure of the heart to pump enough blood to the body organs
- **Perforation of the myocardium or vessel** – a hole in the heart muscle or a blood vessel
- **Cardiac Tamponade** – the constriction or inability of the heart to pump due to buildup of blood or fluid around the lining of the heart
- **Ascending aorta trauma** – injury to the large blood vessel leading blood away from the heart
- **Myocardial ischemia** – reduced blood supply to the heart
- **Acute coronary artery occlusion** – blockage or closure of an artery that supplies the heart with blood
- **Disturbances in the electrical system of the heart that may result in the permanent placement of a device (pacemaker) that delivers electrical impulses to the heart to help your heart beat normally.**
 - Atrio-ventricular node block – a block in the electrical path from the top part of the heart (atria) to the bottom part of the heart (ventricle)
 - Bundle branch block – a delay or block in the electrical path in the bottom part of the heart (ventricle)
 - Asystole – when the heart stops beating
- **Ventricular arrhythmias** – abnormal fast or slow heart beats in the lower part of the heart (ventricles)
- **Embolism** – an abnormal particle (air, blood clots) floating in the blood stream or attached to an object, including the valve
- **Thrombosis (including valve thrombosis)** - blood clot, including a blood clot on the valve
- **Hemorrhage requiring transfusion** – bleeding requiring blood to be put back into the body
- **Arteriovenous fistula** – abnormal connection between an artery vessel that takes blood away from the heart and a vein vessel that takes blood to the heart
- **Vessel dissection or spasm** – the separation of the walls of a vessel or a sudden narrowing of the vessel)
- **Valve migration** – upward or downward movement of the device from where it was originally placed
- **Valve dysfunctions of the CoreValve® including but not limited to:**
 - Fracture (break) in the valve frame
 - Bending of the valve frame
 - The valve frame does not open (expand) all the way
 - Calcification (build-up of calcium on the valve)

- Pannus – the formation of scar tissue that may cover or block the valve from functioning normally
- Wear, tear or movement forward (prolapse) or backward (retraction) from the normal position of the valve leaflets
- The valve leaflets do not close together
- A break in the stitches (sutures) of the valve frame or leaflets
- Leakage through or around the valve or valve frame
- Incorrect size of the valve implanted
- Incorrect position of the valve, either too high or too low
- Regurgitation – backward flow of blood through the valve
- Stenosis – narrowing of the opening of the valve
- **Mitral valve regurgitation** – a leaking valve between the left upper (left atrium) and left lower (left ventricle) parts of the heart where blood flows backward through the valve
- **Hypotension or hypertension** - low or high blood pressure
- **Acute renal injury** - failure of the kidneys to work correctly
- **Allergic reaction (unfavorable reaction by the body) to:**
 - Antiplatelet agents - drugs that keep blood clots from forming
 - Contrast medium - a substance used to increase the visualization of body structures such as x-ray dye
- **Infection including infection of the heart or heart valves (endocarditis)** – an abnormal growth of germs in the body or body part
- **Bowel ischemia** – decrease blood supply to the intestines
- **Complications at the area where the doctor opened the skin or related to opening the skin, including but not limited to:**
 - Pain
 - Bleeding
 - Hematoma –blood collecting under the skin
 - Pseudoaneurysm - blood collecting on the outside of a vessel wall causing a balloon-like widening
 - Irreversible nerve damage – permanent damage to nerves
 - Compartment syndrome – squeezing of nerves and muscles in a closed space that could cause muscle or nerve damage
 - Stenosis – narrowing of a vessel (artery)

SAVR

Although SAVR is not experimental there are potential risks associated with the procedure. These risks are the same even if you undergo the SAVR procedure and you decide not to participate in this study. Some of these risks include, but may not be limited to the following:

- Obstruction of blood flow to the heart (angina) resulting in damage to the heart tissue
- (myocardial infarction/heart attack)
- Abnormal heart beat (cardiac arrhythmia and dysrhythmia)
- Blood leaking around the outside of the prosthetic valve (paravalvular leak) or any
- Problem with the valve that causes leaking of blood after the valve has closed (transvalvular leak).
- Damage to red blood cells (hemolysis) that can result in anemia (decreased red blood cells)
- Death
- Inflammation of the lining of the heart (endocarditis)
- Heart failure
- Any problem with the prosthetic valve that causes narrowing of the valve opening (stenosis)
- Blood clots that develop in the heart or on the replacement valve. These clots may break loose and travel through the bloodstream (thromboembolism). This problem may cause
- Stroke (decrease blood flow to the brain causing damage to the brain) or heart attack.
- Failure of the valve to open and close properly

If you become pregnant there may be risks, discomforts, or side effects to you and the embryo/fetus that are not yet known. Please notify your study doctor as soon as possible to discuss any of these potential risks.

POSSIBLE BENEFITS

The possible benefits you may receive from participating in this research are that you may be able to receive a new heart valve without having open-heart surgery. Another possible benefit is that your new valve may work better than the way your diseased valve currently works. This may improve how you feel and may improve your daily activity.

Your participation in this research may improve procedures that may guide the future treatment of heart surgery, by using procedures that are less invasive, meaning less cutting, entering or breaking through the body, which may benefit others in the future. However, there is no guarantee that you will benefit from being in this research.

ALTERNATIVE TREATMENTS

The current long-term effective treatment for severe aortic stenosis is open heart surgery to replace the aortic valve. For patients who are at high risk for open heart surgery, other treatment options include percutaneous (through an artery in the groin) aortic valve implantation, or medical management to relieve symptoms, which may include balloon valvuloplasty. Ask your study doctor about other treatment options you may have.

IF PROBLEMS DEVELOP

If you believe that you have been injured as a result of your participation in the study, you should notify Dr. Principal Investigator at xxx-xxx-xxxx as soon as possible or in serious cases, go to the emergency room.

If you are assigned to the TAVI group

For those patients receiving the Medtronic CoreValve System and the TAVI procedure,

Medtronic has agreed to pay back [name of institutions that are parties to the CTA] for the costs of medical or surgical care they provide for any serious and unanticipated illness or injury under the following conditions:

- The illness or injury must be related to a defect or malfunction of the Medtronic CoreValve System or in the TAVI procedure as described in the Protocol, and not related to procedures that are routine standard of care.
- The illness or injury cannot be caused by (a) the negligence or intentional misconduct of the study staff or [name of institutions that are parties to the CTA]; (b) because the study staff or [name of institution(s)] that are parties to the CTA did not follow the protocol for the study; or (c) the natural progression of your illness.
- The illness or injury must have happened before the study closes (last patient is seen for the 5 year follow-up visit) at this [Name of institution(s)].
- [Name of institution(s) that are parties to the CTA] must notify Medtronic within one year of the date the study closes at all study sites or before the study closes at this site, whichever is earlier.

Subject to the above conditions, Medtronic will pay back the costs that are not covered by your health insurance or Medicare. The amount Medtronic will pay back is the amount Medicare pays [name of institution(s) that are parties to the CTA] plus 10%.

If you are assigned to the SAVR group

In the event of physical injury or physical illness related to a procedure required for the SAVR group, no monetary compensation or subsidized (paid) will be provided. Medical treatment will be routinely provided to you by any person involved in this study including the study doctors, the

hospital, or the study sponsor. Any immediate medical treatment, however, that may be necessary will be provided.

By agreeing to the above, you do not waive any of your legal rights which you otherwise would have as a research subject, nor do you release the study sponsor (Medtronic, Inc.), study doctors, or the hospital from liability for negligence.

PAYMENT FOR PARTICIPATION IN THE STUDY

You will not be paid to take part in the study. However, you may be reimbursed for local mileage and parking expenses directly related to any study related visits. Your study doctor or research coordinator will tell you how to get reimbursement.

There is no monetary advantage to the study doctor for participation in this study.

MEDICAL EXPENSES

Your private or public health insurance company (for example Medicare) will be billed for the valve procedure and the cardiac catheterization and other procedures that are required by the study and you will be responsible for paying for any co-payment, co-insurance or deductible. It is possible that your private or public health insurance will not pay for some or all of the procedures, including the valve procedure or the cardiac catheterization procedure because you are participating in this study. Any costs not covered by your public or private insurance will be your responsibility. You should discuss the estimate of these costs with your study doctor. You will not be charged for the cost of collecting the data for this study and other clinic visits and diagnostic tests done solely for the purposes of this study.

BASIS OF PARTICIPATION

Your participation in this study is voluntary. If you refuse to be in this study there will be no penalty or loss of benefits to which you are otherwise entitled. You may withdraw from the study at any time and will not lose your benefits or be treated any differently as a result of withdrawing from the study. Any new findings (decisions or conclusions) that may influence your willingness to participate will be provided to you. If you decide to leave the study before it is finished, please tell one of the persons listed in the section below "Obtaining Additional Information". It may be requested that, if you withdraw, you return to your study doctor for a final visit.

The study doctor may end your participation in the study at any time if:

- He or she determines it is not in the best interest of your health
- The study doctor loses contact with you and you do not return for your study visits as scheduled
- You refuse to allow the use of private health information during the course of the study

The study doctor will make the decision and let you know if it is not possible for you to continue in the study.

You may be removed from the study without your consent if the sponsor (Medtronic, Inc.) ends the study. If this happens, you will be notified and the reasons will be explained to you. Your physician will continue to provide the appropriate medical therapy.

PERMISSION FOR ACCESS TO AND USE OF HEALTH INFORMATION

This section governs how your health information will be used and shared by the study doctors during and after the study. The health information that may be used and shared includes all information collected during the study and any health information in your medical records that is relevant to the study.

1. PROVIDERS' DISCLOSURE OF HEALTH INFORMATION IN YOUR RECORDS

You agree to permit [hospital and/or clinic], your doctors, and your other health care providers ("Providers") to share health information in your medical records with [investigator(s)] and [his/her/his/her/its] staff ("Researchers"). You agree to permit Providers to share your health information:

- With the Researchers;
- With the study sponsor, Medtronic, Inc. and its agents and contractors (together "Medtronic");
- As required by law;
 - With government organizations and review boards required to watch over the safety and effectiveness of medical products and therapies and the conduct of research; and
 - With other persons who are required to watch over the safety and effectiveness of medical products and therapies and the conduct of research.

2. RESEARCHER'S USE AND DISCLOSURE OF YOUR HEALTH INFORMATION

You agree to permit the Researchers to use and share your health information:

- Among themselves to conduct the study;
- With other researchers in the study to conduct the study;
- With Medtronic;
- With government organizations and review boards required to watch over the safety and effectiveness of medical products and therapies and the conduct of research; and
- With other persons who are required to watch over the safety and effectiveness of medical products and therapies and the conduct of research.

Once Providers or Researchers have shared your health information with a third party, the information may be subject to further sharing by the third party. Federal privacy laws may no longer protect it from further sharing.

While the study is in progress, you will not be allowed to see your health information that is created or collected for the study. After the study is finished, you may see this information as described in the [hospital/clinical trial site]'s Notice of Information practices.

This permission to share your health information does not have an ending date. You do not have to give this permission, but if you do not, you will not be allowed to be in the study. You may change your mind and take back this permission to use your health information at any time. To take back this permission, you must write to [name and contact information]. If you take back this permission, you cannot continue in the study. Even if you take back this permission, Medtronic and Researchers may continue to use and share the health information already received as described in this informed consent

Economic Study

This study contains a health economics review that will be done to compare the in-hospital, 12 month and 24 month follow-up medical care resource utilization and cost for patients in each of the treatment groups. As part of this study, you will be asked to sign a Medical Billing Release Form. This form will be used by a third party to collect hospital bills from the patient accounting department at any hospital to which you are admitted, from the time of your enrollment in Medtronic CoreValve® SURTAVI Trial through the study follow-up period. You may also be asked to sign a document that gives us your permission to review your billing information sent directly from the Medicare system in order to evaluate medical cost data. This information will be kept strictly confidential and be used solely to assess the medical expenses which occur as a direct result of participating in the Medtronic CoreValve® SURTAVI Trial.

Quality of Life Questionnaire

Medtronic CoreValve® SURTAVI Trial will also contain a quality of life study. As part of this study, your research coordinator will have you or your legal representative complete a questionnaire called a Quality of Life Questionnaire. You will need to complete this questionnaire when you are enrolled in the study and 1 month, 3 months, 6 months, 12 months, 18 months, 2 years, 3 years, 4 years and 5 years after your study procedure.

OBTAINING ADDITIONAL INFORMATION

You are encouraged and have the right to ask questions at any time concerning potential and/or known risks of this study. The study doctor will inform you of any new significant information, when it becomes available, which may affect your willingness to continue to participate in this study. If you have any questions about this study or if you experience any health problems, you should contact Dr. Principal Investigator at xxx-xxx-xxxx.

If you have questions about your rights as a participant in this study, you should contact the chairman of the Institutional Review Board at xxx-xxx-xxxx.

MEDTRONIC'S USE AND DISCLOSURE OF YOUR HEALTH INFORMATION

This section describes what Medtronic will do with the study data, including your health information received during the study.

Medtronic will keep your health information confidential in keeping with all applicable laws and regulations. Medtronic may use your health information to conduct this study. Medtronic may use your health information for other purposes, such as:

- Watch over and improve the performance of its device;
- New medical research;
- Proposals for making new medical products or procedures; and
- Other business purposes.

Any reports or publications about the study or any other research will not include your name or a description of you. Any records identifying you will not be made publically available. Information received during the study will not be used to market to you; your name will not be placed on any mailing lists or sold to anyone for marketing purposes.

The US Food and Drug Administration's regulations, as well as other applicable laws, control Medtronic's work in developing and assuring the safety and quality performance of its medical devices. Medtronic may disclose your health information to the FDA, as well as to other US and foreign government authorities responsible for assuring the safety of medical devices. Medtronic also may disclose your health information to institutional review boards and other persons who are required to watch over the safety and effectiveness of medical products and therapies and the conduct of research. You agree to allow Medtronic to use study data in these ways. You also agree to allow FDA and other governmental authorities to inspect your health information.

CONSENT

I confirm that:

- I have read the informed consent form of this study and my physician has answered all my questions regarding the study.
- I had sufficient time to consider my participation into this study, I am aware that participation into this study is completely voluntary, and I agree to follow the instructions from the investigator.
- I realize that I may decide to refuse participation or stop participation at any time without penalty and without affecting the quality of my health care or the relationship with my physician.
- I understand and agree that personal information about me will be collected from my medical records, used and processed (manually and by computer) by the manufacturer of a medical device used in my treatment or any other designated party that is involved in the study (e.g. hospital, physician, regulatory authorities, ethics committees).
- I understand and agree that representatives from Medtronic, regulatory authorities and the Institutional Review Board will be granted direct access to my medical records.
- I understand and agree that the physician(s) / hospital will release the relevant personal information about me for the purpose of the clinical investigational.
- I fully understand there is limited experience with this device in humans and that its safety and effectiveness have not been established and there are risks of serious complications associated with this study.
- I also understand that the doctors might determine after I give consent that it is not possible to implant the study valve.

I hereby give my consent to participate in the “*Medtronic CoreValve[®] SURTAVI Trial*”. I have been given a copy of this consent form, and am also aware that the investigator will keep a copy in his or her files.

Patient Name or Legal Representative (please print)

Patient or Legal Representative Signature Date

(MM/DD/YYYY)

Statement from Person Obtaining Consent

I certify that I have explained the nature of the device and the study to the above-named person.

I have also explained the contents of this informed consent form to the above-named person. I have asked whether or not there are any questions. I have answered any questions that were raised by this person.

Person Obtaining Consent Name (please print)

Signature of Person Obtaining Consent Date

(MM/DD/YYYY)

PATIENT INFORMED CONSENT FORM - INFORMATION SHEET
OUS Template

Medtronic CoreValve® SURTAVI Trial

You are being asked to read this form so that you understand this clinical study and how you might take part in it. By signing this form, you will show that you understand and that you agree to take part in this clinical study. Your signature on this form is required before you can take part in this clinical study.

Background

You are being asked to take part in a clinical study entitled “*The Medtronic CoreValve® SURTAVI Trial*” because you have a disease of your aortic valve. This disease is called aortic stenosis.

The aortic valve is one of the four heart valves that control the flow of blood into and out of the heart. The aortic valve lets oxygen-containing blood to be pumped out of the heart, from the lower chamber of the heart (ventricle) into the main artery delivering blood to the body (aorta). If the valve becomes abnormally narrow through a process of thickening and stiffening (aortic stenosis), then the heart must work harder to pump the same amount of blood with each beat. As the heart works harder, the heart muscle thickens (hypertrophy), and the lower chamber (ventricle) may become larger (dilate). Open-heart surgery to replace the diseased aortic valve is the standard treatment. For some patients, the risk of experiencing major problems during open-heart surgery is greater because of other health problems.

As an alternative to open-heart surgery, the Medtronic CoreValve® System has been developed to replace a diseased aortic heart valve without the need for open-heart surgery. This system allows the percutaneous aortic valve (study valve) to be implanted (inserted) through a long, thin flexible tube that is inserted through an incision in the skin and threaded through the bloodstream (percutaneous).

You are being asked to participate in this study because doctors have determined your aortic valve is no longer working properly. However, your doctors have also decided that your risk of experiencing major problems while undergoing open-heart surgery is moderate due to medical reasons or anatomical reasons (relating to how and where your heart, aortic valve and blood vessels are placed within your body). This means that your doctor believes your health is acceptable for open-heart surgery, but there is still a risk of potential problems.

Purpose of the Study

The purpose of this clinical study is to determine if replacing the aortic valve without open-heart surgery is as safe as or safer than open-heart surgery in patients with similar medical conditions as you.

The Medtronic CoreValve® System is considered an “investigational device” by the United States Food and Drug Administration (FDA) which means that clinical studies are required to determine if it is safe and provides clinical benefit. Medtronic, Inc. is sponsoring this study to obtain data on the safety and performance of CoreValve® and its delivery system to gain FDA approval.

The study will involve up to 1200 patients, and is being conducted at up to 50 hospitals in Europe, the United States and around the world. It is anticipated to take approximately seven years to complete. Your participation in this study is expected to last approximately five years from the day you are enrolled.

As a participant in the study, you have certain responsibilities. You have the responsibility to be truthful regarding your health and medication history.

You are expected to return to your study doctor’s office for the study visits. The evaluations performed at these visits are a component of the study. They are important for data collection and for monitoring that the Medtronic CoreValve® System is working properly. These evaluations will take place at baseline, implant procedure, discharge, and follow-up visits (30

days, 6, 12, 18, 24, 36, 48, and 60 months). You should not take part in this study if you will not be available for the study visits.

You also have the responsibility to report any injuries, hospitalizations, emergency room visits or other medical visits, symptoms or complaints to the study doctor or study nurse as soon as possible.

Medtronic CoreValve® System Description

The study valve is made from animal tissue attached to a metal frame. The study valve is designed to be implanted (inserted) using a delivery system catheter (long, thin flexible tube) to replace your diseased aortic heart valve without open-heart surgery.

The Medtronic CoreValve® system was CE marked in 2006 and has been implanted in over 10,000 patients.

Once it is implanted, CoreValve® acts in the same method of the native valve.

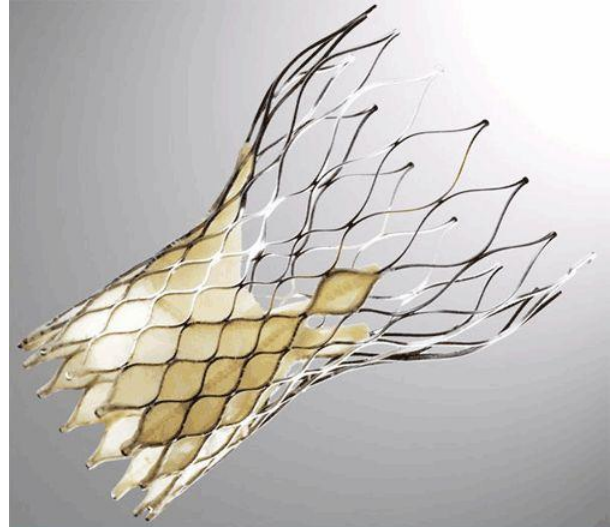

Procedures to Be Followed

- If you agree to be in this study, data such as your age, gender, ethnic origin, medical history and medication use will be recorded. You will undergo the following tests to determine if you are suitable for receiving the CoreValve®:
- Transthoracic echocardiography (TTE): a test that uses sound waves to take pictures of your heart and measure the degree of narrowing of your aortic valve; a probe is placed on the outside of your chest to take pictures of your heart
- Computed Tomography (CT): a scan performed using an x-ray machine, which is linked to a computer to take pictures of your heart and aortic valve
- If your doctor decides it is unsafe for you to have a CT scan, you will have a Magnetic Resonance Imaging (MRI) test. MRI is a scan that uses the magnetic properties of your tissues to take pictures of your heart. For the MRI test, you will lie on a special exam table while the pictures are taken.
- Blood tests: about two tablespoons
- An electrocardiogram (ECG): a test that records electrical impulses of your heart; patches are placed on the outside of your chest
- A physical examination
- Heart catheterization/angiography - a test that takes pictures of your heart and blood vessels; a special dye is injected through long, flexible tubes into the coronary arteries (vessels delivering blood to the heart) and bypass grafts if you have them

If you are of child-bearing potential, we will ask you to take a pregnancy test. If you are pregnant, you will not be able to participate in this study.

All of these procedures and tests are standard procedures for patients with aortic valve disease, and are not experimental. If you have already had any of these tests performed before, they may be used for the study if your study doctor determines they do not need to be repeated for study purposes.

If your doctors decide you are eligible to be in the study, your treatment will be determined in a way similar to flipping a coin, called randomization. You will be assigned to one of two groups. One group will receive a transcatheter aortic valve implant (TAVI), the other group will have an open-heart surgical aortic valve replacement (SAVR). One out of every two participants will receive TAVI. The other participants will receive SAVR. You will not be able to choose your treatment assignment.

Your enrollment in the study will begin once you are assigned to your treatment group. If you are enrolled in the study; you will be required to have the following additional tests completed within 14 days prior to the procedure (TAVI or SAVR):

- Physical exam, including a determination of neurological (brain) status where you will be asked to answer a series of questions and perform a series of tasks
- Blood tests (about two tablespoons)
- Six-Minute walking test – a test that records your breathing, heart rate, and how you feel
- Electrocardiogram (ECG) - a test that records electrical impulses of your heart; patches are placed on the outside of your chest

You will also be asked to complete surveys about the quality of your life and your ability to do normal daily activities, called Quality of Life (QOL) Questionnaires.

If you are assigned to the TAVI group:

Before the TAVI procedure, it will be strongly recommended that you take blood thinning medications, used to prevent your blood from clotting (thickening). These medications I will be described to you by your study doctor. You may be advised to continue taking blood thinning medications for at least three months following your procedure.

Before the procedure you will be given a medicine that kills bacteria or germs (antibiotic) to decrease your chance of developing an infection. Your study doctor will choose the antibiotic that he or she thinks is best suited for you and decide whether you need additional medication.

You will also have blood tests (about two tablespoons) and an ECG before the procedure.

Immediately prior to the procedure, you will receive medications to make you more relaxed and comfortable during the procedure. Your study doctor may decide that general anesthesia is necessary, meaning you need to be put to sleep for the procedure. Your doctor will inform you of this need before the procedure. Additionally, if your study doctor decides that it is necessary during the procedure, you will be put under general anesthesia at that time.

Your study doctor will decide what areas are best for inserting the long, thin flexible tubes required for TAVI and getting all of the pictures that are necessary. Additionally, your study doctor will decide if performing a surgical incision to any of the area(s) is necessary.

During the procedure, you may have a transesophageal echocardiogram which is also called a TEE. This test uses sound waves to take a closer look at the inside structures of the heart. To perform the test, you will swallow a thin flexible tube with a special tip. This tube sits in the tube that connects the mouth to the stomach (esophagus). The special tip of the tube sends out sound waves (ultrasound) that echo within the chest wall. The esophagus is located behind the heart so these echoes are picked up and create a picture of the heart that is displayed on a video monitor. The pictures will allow your study doctor to take a closer look at your valve.

You will have a temporary pacemaker put in place during the TAVI procedure. A temporary pacemaker is a thin wire inserted through your skin and into one of your veins. It is then threaded through your vein into the right side of your heart. The wire is attached to a battery-operated device that is outside of your body. This temporary pacemaker will help keep your heart rate and beat steady. This temporary pacemaker will not be removed for at least 48 hours after your TAVI procedure.

After your study doctor has taken a good look at your valve, a balloon valvuloplasty will be performed. This is a procedure used to widen a hard or thin heart valve. A wire and a thin tube are guided by x-rays through the heart and positioned through the diseased heart valve. A balloon is placed over the wire and inflated, enlarging the opening through the diseased valve allowing the study valve to be placed.

Your doctor will then insert the study valve through the long, thin flexible tube that is inserted through an incision in the skin and threaded through the bloodstream. TAVI is performed using x-ray machines which will allow your doctor to see the study valve, your blood vessels and heart. The study valve will be guided through your blood vessels to your existing aortic valve and then the study valve will be placed over your existing valve.

During the TAVI procedure, your doctor will perform x-ray pictures (angiogram) and recordings of the electrical impulses of your heart through patches placed on the chest (ECG) to observe your heart function and make sure that the study valve fits and works properly.

Doctors from other hospitals who have experience with the TAVI procedure may assist your study doctor with the procedure. Medtronic staff may assist the physician in the loading of the study valve.

If you are assigned to the SAVR group:

If you are assigned to the SAVR group, your doctors will replace your diseased aortic valve through open-heart surgery. During surgery, you are asleep under general anesthesia. SAVR often requires a median sternotomy, where the bone in the center of the chest (sternum) is split down the middle. The chest is then opened to provide your doctor with access to the heart and chest cavity, in order to replace your aortic valve. Your surgery is performed while the function of your heart is taken over by a heart lung machine (called CPB for cardiopulmonary bypass).

You may have a TEE (a thin tube sits in the esophagus and sends out sound waves to create a picture of your heart) and a temporary pacemaker (thin wire threaded through your vein to right side of heart to keep your heart rate and rhythm steady) during the procedure.

Your doctor may remove any tissue and calcium deposits that are interfering with the normal function of the valve. Your damaged valve may be completely removed. The new valve will be sewn into the space where your own valve used to be. After your doctor makes sure your valve is working properly, blood flow will be restored to your heart and the incisions will be closed. You will also have blood drawn for testing before and after the procedure.

After TAVI and SAVR Procedure:

After your TAVI and SAVR procedure, your study doctors will continue to monitor your progress and recovery.

You will have the following tests performed within the two days following your TAVI procedure and before you leave the hospital:

- Determination of neurological (brain) status where you will be asked to answer a series of questions and perform a series of tasks
- Blood tests (about two tablespoons)
- Echocardiogram (TTE)
- ECG

Follow-up Visits after TAVI and SAVR:

You will need to return to the clinic for required follow-up visits at 30 days, 6 months, 12 months, 18 months, 24 months (3 years) and 3, 4, and 5 years after the procedure. The follow-up tests and examinations are not experimental and most are performed on a routine basis. Each visit will take about 1 ½ to 2 hours.

Your evaluations at 30 days, 6 and 18 months will include:

- Physical examination, including a determination of neurological (brain) status where you will be asked to answer a series of questions and perform a series of tasks
- You will be asked about your health since the last follow-up visit
- Blood tests (about two tablespoons) – 30 day visit only
- Quality of Life (QoL) Questionnaires
- ECG
- Six-Minute walking test – 30 day visit only
- Echocardiogram (TTE) – 6 month visit only

Your evaluation at 12, 24, 36, 48 and 60 months will include:

- Physical examination, including a determination of neurological (brain) status where you will be asked to answer a series of questions and perform a series of tasks
- You will be asked about your health since the last follow-up visit
- Echocardiogram (TTE)
- QoL Questionnaires
- ECG
- Six-Minute walking test – 12 and 24 months visit only

In addition to the in-clinic follow-up visits, at 3 months you will be contacted via phone to complete a Quality of Life Questionnaire.

If the study doctor is unable to implant the study valve, you will still be followed for safety and will need to return to the clinic for the required follow-up visits as described above.

If you have additional heart surgeries or cath lab procedures to work on or replace your aortic valve or study valve, you will be asked to answer questions and perform activities that will help the study doctors and nurses to determine your neurological (brain) status within 24 hours after each additional procedure.

If you have a stroke, have been informed by a doctor that you experienced a stroke, experience any of the following symptoms, notify your study doctor at xxx-xxx-xxxx as soon as possible: sudden numbness, tingling on, loss of movement (occurring on one side of the body), sudden vision changes, confusion or trouble understanding simple statements, unable to speak, severe headaches, or seizures. Any of these symptoms could indicate that you are having problems with your neurological (brain) function. You will have tests performed to determine your neurological (brain) status where you will be asked to answer a series of questions and perform a series of tasks. These tests will be performed at 7 days, 30 days and 3 months after you have any of these symptoms.

If you have any other problems or complications, seen by any other doctors, or are hospitalized during your participation in this study you should immediately notify Dr. Principal Investigator at xxx-xxx-xxxx.

If the study valve is removed for any reason, we will request that it be returned to Medtronic for additional analysis. The study doctor will determine if you will need to have another valve implanted.

In the event of your death and an autopsy is performed, the study doctor will ask your family or "legally authorized representatives" for either the whole heart and valve or just the valve are removed and returned to Medtronic for additional analysis.

The autopsy and the removal of the heart and/or valve would be done to provide additional information about the research and the investigational valve.

Your family and your "legally authorized representatives", have the right to refuse the autopsy and refuse the request to remove the heart and/or valve even if you sign this consent form.

POSSIBLE RISKS AND DISCOMFORTS

TAVI

Potential risks associated with the implantation of the study valve may include, but are not limited to, the following:

- **Death**
- **Acute myocardial infarction** - heart attack; decrease blood flow to the heart causing death of an area of the heart muscle
- **Stroke** - decreased blood flow to the brain causing death of brain cells
- **Urgent need for surgery**
 - Coronary artery bypass – (CABG) a surgery where the chest is opened to place new vessels around the existing blocked vessels of the heart to improve blood supply to the heart.
 - Heart valve replacement – replacing the existing heart valve with a new heart valve
 - Valve explant – the removal of the existing valve
- **Urgent need for balloon valvuloplasty** (balloon valvuloplasty during the TAVI procedure is expected) – a procedure through the vessels inside the body and heart in which a narrowed heart valve is stretched open by a balloon
- **Urgent need for Percutaneous Coronary Intervention (PCI)** – a procedure through the vessels inside the body and heart used to treat or open narrowed vessels of the heart
- **Cardiogenic shock** – failure of the heart to pump enough blood to the body organs
- **Perforation of the myocardium or vessel** – a hole in the heart muscle or a blood vessel
- **Cardiac Tamponade** – the constriction or inability of the heart to pump due to buildup of blood or fluid around the lining of the heart
- **Ascending aorta trauma** – injury to the large blood vessel leading blood away from the heart
- **Myocardial ischemia** – reduced blood supply to the heart
- **Acute coronary artery occlusion** – blockage or closure of an artery that supplies the heart with blood
- **Disturbances in the electrical system of the heart that may result in the permanent placement of a device (pacemaker) that delivers electrical impulses to the heart to help your heart beat normally.**
 - Atrio-ventricular node block – a block in the electrical path from the top part of the heart (atria) to the bottom part of the heart (ventricle)
 - Bundle branch block – a delay or block in the electrical path in the bottom part of the heart (ventricle)
 - Asystole – when the heart stops beating
- **Ventricular arrhythmias** – abnormal fast or slow heart beats in the lower part of the heart (ventricles)
- **Embolism** – an abnormal particle (air, blood clots) floating in the blood stream or attached to an object, including the valve
- **Thrombosis (including valve thrombosis)** - blood clot, including a blood clot on the valve
- **Hemorrhage requiring transfusion** – bleeding requiring blood to be put back into the body
- **Arteriovenous fistula** – abnormal connection between an artery vessel that takes blood away from the heart and a vein vessel that takes blood to the heart
- **Vessel dissection or spasm** – the separation of the walls of a vessel or a sudden narrowing of the vessel)

- **Valve migration** – upward or downward movement of the device from where it was originally placed
- **Valve dysfunctions of the CoreValve® including but not limited to:**
 - Fracture (break) in the valve frame
 - Bending of the valve frame
 - The valve frame does not open (expand) all the way
 - Calcification (build-up of calcium on the valve)
 - Pannus – the formation of scar tissue that may cover or block the valve from functioning normally
 - Wear, tear or movement forward (prolapse) or backward (retraction) from the normal position of the valve leaflets
 - The valve leaflets do not close together
 - A break in the stitches (sutures) of the valve frame or leaflets
 - Leakage through or around the valve or valve frame
 - Incorrect size of the valve implanted
 - Incorrect position of the valve, either too high or too low
 - Regurgitation – backward flow of blood through the valve
 - Stenosis – narrowing of the opening of the valve
- **Mitral valve regurgitation** – a leaking valve between the left upper (left atrium) and left lower (left ventricle) parts of the heart where blood flows backward through the valve
- **Hypotension or hypertension** - low or high blood pressure
- **Acute renal injury** - failure of the kidneys to work correctly
- **Allergic reaction (unfavorable reaction by the body) to:**
 - antiplatelet agents - drugs that keep blood clots from forming
 - contrast medium - a substance used to increase the visualization of body structures such as x-ray dye
- **Infection including infection of the heart or heart valves (endocarditis) – an abnormal growth of germs in the body or body part**
- **Bowel ischemia – decrease blood supply to the intestines**
- **Complications at the area where the doctor opened the skin or related to opening the skin, including but not limited to:**
 - pain
 - bleeding
 - hematoma –blood collecting under the skin
 - pseudoaneurysm - blood collecting on the outside of a vessel wall causing a balloon-like widening
 - irreversible nerve damage – permanent damage to nerves
 - compartment syndrome – squeezing of nerves and muscles in a closed space that could cause muscle or nerve damage
 - stenosis – narrowing of a vessel (artery)

SAVR

Although SAVR is not experimental there are potential risks associated with the procedure. These risks are the same even if you undergo the SAVR procedure and you decide not to participate in this study. Some of these risks include, but may not be limited to the following:

- Obstruction of blood flow to the heart (angina) resulting in damage to the heart tissue (myocardial infarction/heart attack)
- Abnormal heart beat (cardiac arrhythmia and dysrhythmia)
- Blood leaking around the outside of the prosthetic valve (paravalvular leak) or any problem with the valve that causes leaking of blood after the valve has closed (transvalvular leak).
- Damage to red blood cells (hemolysis) that can result in anemia (decreased red blood cells)
- Death

- Inflammation of the lining of the heart (endocarditis)
- Heart failure
- Any problem with the prosthetic valve that causes narrowing of the valve opening (stenosis)
- Blood clots that develop in the heart or on the replacement valve. These clots may break loose and travel through the bloodstream (thromboembolism). This problem may cause
- Stroke (decrease blood flow to the brain causing damage to the brain) or heart attack.
- Failure of the valve to open and close properly

If you are or you become pregnant, there may be risks, discomforts or side effects to you and your unborn child that are not yet known.

Some possible inconveniences may include, but is not limited to the following:

- Transportation to and from the clinic for follow-up visits
- Parking
- Follow-up visit scheduling

There may be other discomforts and risks related to the device and/or this study that are not foreseen at this time.

CT Angiogram

- Risks associated with heavy sedation, if used
- Allergic reaction to contrast
- Risk of cancer from radiation

Potential Benefits for You

The possible benefits you may receive from participating in this clinical study are that you may be able to receive a new heart valve without having open-heart surgery. Another possible benefit is that your new study valve may work better than the way your diseased valve currently works. This may improve how you feel and may improve your daily activity. However, there is no guarantee that you will benefit from being in this clinical study.

Potential Benefits for Other Patients

Your participation in this clinical study may improve procedures that may guide the future treatment of aortic stenosis, by using procedures that are less invasive (meaning less cutting, entering or breaking through the body), which may benefit others in the future.

Alternative Therapy

The current long-term effective treatment for severe aortic stenosis is open heart surgery to replace the aortic valve. For patients who are at high risk for open heart surgery, other treatment options include percutaneous (through an artery in the groin) aortic valve implantation, or medical management to relieve symptoms, which may include balloon valvuloplasty. Ask your study doctor about other treatment options you may have.

Compensation for Illness or Injury

If you are physically injured as a result of your participation in this study, reasonable and appropriate medical treatment will be provided to you free of charge by the study sponsor, if such treatment is not already covered by your medical insurance.

Medtronic maintains appropriate clinical trial liability insurance coverage as required under applicable laws and regulations and will comply with applicable local law and custom concerning specific insurance coverage. If required, a Clinical Trial insurance statement/certificate will be provided to your Medtronic Institution's Ethics Committee.

Compensation and Additional Costs

You will not receive any compensation for your participation in this clinical investigation (including follow up). There is no monetary advantage to the study doctor for participation in this study.

You may request for reimbursement for costs associated with travel expenses for the purpose of the follow-up visits.

To ensure your safety while participating in the study, all necessary precautions are taken. In addition, a patient insurance is in place to compensate for a financial loss as a result of study-related health damage.

Role of the Sponsor's Representative

Your study doctor will delegate study activities not only to other study personnel (both doctors and study nurses), but also sponsor representatives. These study activities may include support during the procedure and supporting during data collection throughout the study. These activities are performed under supervision and responsibility of the investigator and will not bias the data integrity in any way.

Use of Personal Data/Confidentiality

Your participation in this study is entirely confidential.

While participating in this study, personal information, including medical and health data, will be collected from your medical records. Such information may include data on ethnic origin. These data will be used and processed manually and by computer by Medtronic (meaning the Medtronic, Inc. group of companies). Other designated parties that are involved in the study, including third party data processors, the institution in which you are treated, your physician(s), regulatory authorities and ethics committees, may receive and also be granted access to your personal information in order to comply with legal and regulatory requirements. Your data may be communicated to the above-mentioned parties located in the country in which you are treated, the European Economic Area and in other countries, such as the United States of America, where the European Directive on Data Protection does not apply.

Your personal data are collected for medical research purposes, to gather information on the device and its performance during and after this study and may be used for obtaining assessments for approvals for the device, additional scientific research, educational purposes and publications as well as for future health studies.

Your confidential personal information will be made anonymous and key-coded, unless it may be impossible to make it anonymous it, for instance, where your name cannot be removed from the data carrier, such as: x-ray, angiogram or echocardiography.

Study results may be published without disclosing your name or any other identifying characteristics. In all cases, your personal information will be handled at all times in accordance with appropriate confidentiality standards and all applicable data protection and privacy laws.

You are entitled to access the personal information collected about you and to have inaccuracies corrected.

Your personal physician will be informed about your participation in the clinical investigation.

Voluntary Participation

Your participation in this study is entirely voluntary. You are free to refuse participation and you are free to discontinue participation in the study at any time without fear of penalty or loss of medical care. In addition, you will be notified of any significant new findings that may develop during the course of the study, which may relate to your willingness to continue your participation.

Your physician or the sponsor may decide to terminate your participation in the study at any time without your prior consent. If this happens you will be notified and the reasons explained to you.

Medtronic can also suspend or terminate the study at any time without your prior consent. If this happens, you will be notified and the reasons will be explained to you. Your physician will continue to provide the appropriate medical treatment.

Questions

In case of any question, you can contact one of the following people:

Questions about the clinical investigation:

Questions in the event of illness or injury:

Questions about patient rights :

PATIENT INFORMED CONSENT FORM - SIGNATURE SHEET**Medtronic CoreValve® SURTAVI Trial**

I have read the patient information of this study and my physician has answered all my questions regarding the study.

I had sufficient time to consider my participation into this study, I am aware that participation into this study is completely voluntary, and I agree to follow the instructions from the investigator.

I realize that I may decide to refuse participation or stop participation at any time without penalty and without affecting the quality of my health care or the relationship with my physician.

I understand and agree that personal information about me will be collected from my medical records, used and processed (manually and by computer) by the manufacturer of a medical device used in my treatment or any other designated party that is involved in the study (e.g. hospital, physician, regulatory authorities, ethics committees).

I understand and agree that representatives from Medtronic, regulatory authorities and the Ethics Committee will be granted direct access to my medical records.

I understand and agree that the physician(s) / hospital will release the relevant personal information about me for the purpose of the clinical investigation.

I understand that I am entitled to access the personal information collected about me and to have inaccuracies corrected.

I have received a copy of the Patient Information and hereby I agree to participate voluntarily in and comply with this study.

I agree to participate in this study and I have consented before the initiation of any study specific procedures.

Patient:

_____	_____	_____
Name	Signature	Date (dd MMM yyyy)
	Must be written by patient	Must be written by patient

Legal Representative if patient is unable to give consent:

_____	_____	_____
Name	Signature	Date (dd MMM yyyy)
	Must be written by	Must be written by
	Legal Representative	Legal Representative

Only persons officially trained and authorized on the delegated task list are allowed to sign off

Investigator or designated person by investigator:

I have conducted the informed consent discussion.

Name Signature Date (dd MMM yyyy)

If patient, or patient's legally acceptable representative, is unable to read:

I have attended the entire informed consent discussion. I attest that the information in the consent form and any other written information was accurately explained to, and apparently understood by, the patient or the patient's legally acceptable representative. Informed consent was freely given by the patient or the patient's legally acceptable representative.

Impartial Witness:

Name Signature Date (dd MMM yyyy)

Section should be filled in by impartial witness

R.2 List of Participating Investigational Centers

The list of participating Investigational Centers will be provided under separate cover.

R.3 Other Institutions

The following institutions/organizations will participate in the Medtronic CoreValve® SURTAVI Trial. An updated list of “Other Institutions” will be provided in progress reports and/or upon request.

Clinical Events Committee (CEC) / Data Safety Monitoring Committee (DSMB):

Cardilysis
Westblaak 92
3012 KM Rotterdam
The Netherlands

Explanted Device/Pathology Core Lab:

CVPath Institute, Inc.
19 Firstfield Road
Gaithersburg, MD 20878

Imaging Core Lab (CT, Echocardiography, and Electrocardiogram)

Cardilysis
Westblaak 92
3012 KM Rotterdam
The Netherlands

InteleGRID™ (imaging sharing network)

Intelemage, LLC
5400 Kennedy Ave
Cincinnati, OH 45213

Interactive Voice Response System (IXRS):

United BioSource Corporation (UBC)
303 2nd Street, Suite 700
7th Floor South Tower
San Francisco, CA 94107

R.4 Additional Records and Reports

No additional records and/or reports, other than those previously described in this investigational plan or required by FDA, will be maintained for this clinical investigation.

R.5 Sample Case Report Forms

Sample Case Report Forms (CRFs) will be provided under separate cover.

R.6 Aortogram Acquisition Guidelines

The purpose of the acquisition guidelines is to increase consistency and effectiveness in adjudicating the procedural aortograms.

1. Required aortogram:

- Index Procedure – MCS TAVI

2. Required cine runs:

- Pre-procedure aortogram in a projection with 3 aortic cusps aligned (for comparison of final aortogram with pre-procedure aortogram)
- Aortogram after deployment of the MCS and removal of the delivery catheter. This cine run is used to obtain the time of deployment/implantation
- Final aortogram at least 10 minutes after MCS implantation in the exact same projection as the pre-procedure aortogram (in order to measure depth of implantation and assess grade of aortic regurgitation)

NOTE: If the apex is not clearly visible in the final projection and in case of adequate renal function, in order to assess grade of AR, perform an additional final aortogram in RAO 30° with visualization of the left ventricle in long axis, including the apex.

3. Guidelines on how final aortogram after deployment of the valve should be performed:

- Use at least 20 ml of contrast, with an injection rate of 20 ml/sec
- Position the pigtail catheter in the upper third part of the frame
- Preferably use non-diluted contrast. 50%-diluted contrast is acceptable in case of renal insufficiency
- Use the angiographic projection with the three aortic cusps aligned in 1 plane:
 - Whenever available this optimal projection can be suggested by baseline MSCT exam
 - Pragmatic approach might be to use a shallow LAO or RAO projection, and adjust in a cranial or caudal position respectively to approach the optimal projection
- Confirm visualization of the left ventricular apex on the final aortogram
- Perform the final aortogram at least 10 minutes after deployment of the MCS; include a time indication on the aortogram
- Use marker pigtail or provide the French-size of the pigtail catheter for calibration purpose

4. General imaging and recording procedures:

- Use a fixed table system and biplane x-ray equipment, if available
- Recommended resolution: 1024 x 1024 pixels
- All cine runs should be ECG-gated
- Preferred acquisition speed: 25 frames/second
- One single cine run should have a duration of at least 5 heart beats
- The digital clock should be activated
- The maximum magnification factor should be applied during cine run without losing the image of the entire frame
- There should be no overlap of the frame with other catheters or electrodes

- Foreshortening of the frame should be avoided as much as possible
- Store all images on CDROM (DICOM format) and label the CDROM with:
 - hospital name
 - study name (i.e. SURTAVI)
 - patient ID
 - acquisition/procedure date

5. Core lab analysis:

The procedural aortograms will be analyzed for:

- Grade of aortic regurgitation
- Depth of implantation

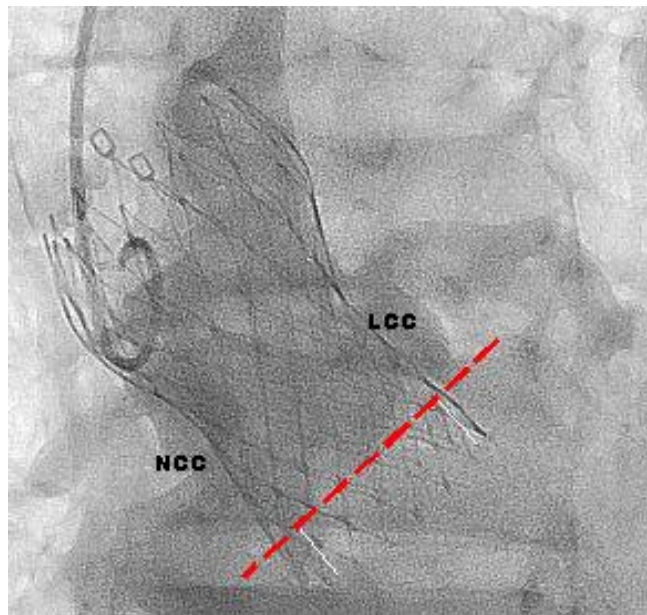

Figure 1: Example of depth of implantation measurement.

R.7 Echocardiography Acquisition Guidelines

1. Scope of the document

These guidelines aim to increase consistency and effectiveness in adjudicating the echocardiography data of selected candidates for the SURTAVI study. Optimal image acquisition, storage, and transmission will be described.

2. Protocol required echocardiograms

Transthoracic echocardiography is required at the following intervals:

Screening	- 45 days of Heart Team review
Post Procedure	Between 24 and 48 hours post procedure
Discharge	Prior to hospital discharge
Six months	± 30 days
One year	± 30 days
At 2,3,4,5 years afterwards	± 60 days

3. Four general rules for echocardiography recordings

3.1 Rule #1 for overall recordings: adhere STRICTLY to the PROTOCOL regarding:

- number of recordings (40 to 52)
- order of recordings (start with item # 1 and finish with # 46 **see section 5 table 1**)
- do NOT perform measurements on the echo recordings
- at end of echo exam, export the required recordings in DICOM3 format to a DVD.
- fill in the TRANSMITTAL form and send it to Cardialysis along with the echo DVD.
- only one echographer (+ 1 replacement) is allowed to participate in the study, he/she should print his/her name, fill in contact details and sign the transmittal form

3.2 Rule #2 for Doppler recordings:

- Unless stated otherwise, all pulsed-wave and continuous-wave Doppler signals should be recorded at a sweep speed of 50-100 mm/sec (recording must contain three heartbeats) with optimized gain and filter setting, baseline position, and velocity range.

3.3 Rule #3 for apical 2D views (4-, 5-, 2-, and 3-Chamber views)

- pay attention to ultrasound sector depth and gain settings
- the aortic valve should be out of scan plane in the 4-CH view
- exclude patient or transducer motion
- make sure the whole LV is in the scan sector in particular at end-diastole

3.4 Rule #4 for EF calculation (apical 4-, 2-, and 3-Chamber views focused on LV)

- Record 3 runs (run 1: 3 beats, run 2: 3 beats, run 3: 10 beats)

Refer to the accompanying MS PowerPoint file "SURTAVI_echo_acq.ppt" The file provides a demo of the echocardiography recordings needed for the SURTAVI study

4. Data requirements

Participating centers in the SURTAVI study should obtain the appropriate Doppler and echocardiography recordings to document the following variables.

- Aortic annulus long-axis diameter in mid-systole (screening/baseline only)
- LVOT long axis diameter in mid-systole
- Sinus of Valsalva diameter (SOV) at end diastole (screening/baseline only)
- Sino-tubular junction diameter (STJ) at end diastole (screening/baseline only)
- Sinus of Valsalva height (SOVH) at end-diastole (screening/baseline only)
- Max aortic valve velocity (V2) by CW Doppler
- Velocity time integral (VTI) across aortic valve by CW Doppler
- Mean gradient across aortic valve (MGV2) by CW Doppler
- Peak LVOT velocity (V1) by PW Doppler
- Velocity time integral (VTI) of LVOT velocity by PW Doppler
- Mean LVOT gradient (MGV1) by PW Doppler
- Grade of aortic transvalvular regurgitation
- Grade of aortic paravalvular regurgitation
- Grade of mitral regurgitation
- PISA for MR (optional)
- Max tricuspid regurgitant (TR) jet velocity (if TR is present)
- Left ventricular (LV) end-diastolic diameter (LVEDD)
- Left ventricular (LV) end-systolic diameter (LVESD)
- Interventricular septal thickness at end diastole
- Left ventricular posterior wall thickness at end diastole
- Left atrial diameter (AP linear dimension) at systole
- Left ventricular ejection fraction by visual estimate
- Heart rate
- Mitral inflow "A" velocity
- Mitral inflow "E" velocity
- Mitral inflow deceleration time
- Mitral annular tissue Doppler systolic velocity (septal and lateral)
- Mitral annular tissue Doppler early diastolic velocity (septal and lateral)
- Mitral annular tissue Doppler late diastolic velocity (septal and lateral)

Procedures for acquiring aortic root measurements and key hemodynamic variables are described in the following sections. For Doppler velocities, the values reported should represent the average of measurements from at least three cardiac cycles for patients in sinus rhythm, and the average of measurements from five cardiac cycles for patients not in sinus rhythm. For aortic valve, TR jet, and tissue Doppler velocities, the reported values should represent the average of the highest velocities obtained from the same transducer position.

5. Table 1. list of echo recordings

Fifty-two (minimum 40) echo recordings (frozen images and cine loops) are required in the following order:

A: From parasternal long-axis window

1. Gray scale standard view displaying the left ventricle (LV), left atrium, LV outflow tract, aortic root and right ventricle
2. Colour Doppler of mitral regurgitation
3. Colour Doppler of aortic (or prosthetic) regurgitation
4. Only if aortic regurgitation is present: repeat #3 with ZOOM & narrow sector with focus on vena contracta of regurgitant jet
5. Gray scale ZOOM LV outflow tract
6. Gray scale ZOOM at an intercostal space higher (aortic root / aortic prosthesis)

B: From parasternal short-axis window

7. Gray scale LV at mitral valve level
8. Gray scale LV at papillary muscle level (use same depth setting as #7)
9. Repeat #8 gray scale with M-mode (LV dimensions and anteroseptal / inferolateral wall thickness)
10. Gray scale LV at apical level: lower your transducer position by 1 or 2 intercostal spaces and record the LV as circular as possible, just proximal to the level with end-systolic LV luminal obliteration (use same depth setting as #7)
11. Gray scale at the aortic valve level (post TAVI the native annulus is usually identified by maximal calcification)
12. Repeat #11 gray scale with M-mode (left atrial & aortic dimensions)
13. Repeat #11 colour Doppler: for central and paravalvular regurgitation: in post-TAVI start scanning from highest position and record first visible aortic regurgitation jet, scan more downwards and try to pick up additional jets
14. Gray scale at the aortic level focussed on RV outflow tract
15. Pulsed-wave Doppler of RV outflow tract velocity (5 to 10mm below the pulmonic valve) (frozen image)

C: From special parasternal long-axis window (RV inflow)

16. Colour Doppler of tricuspid regurgitation
17. Only if tricuspid regurgitation is present in #16, continuous-wave Doppler of tricuspid regurgitation (frozen image)

D: From the apical 4-Chamber window

18. Gray scale standard view displaying in the middle of the sector the LV and left atrium
19. Colour Doppler of mitral regurgitation
20. Only if mitral regurgitation is present in #19, colour Doppler ZOOM & narrow sector, shift Nyquist 35-40 for PISA measurements
21. Only if mitral regurgitation is present in #19, record continuous-wave Doppler of mitral regurgitation (frozen image)
22. Colour Doppler of tricuspid regurgitation
23. Only if tricuspid regurgitation (TR) is present in #22, record continuous-wave Doppler of TR (frozen image)
24. Pulsed-wave Doppler of transmitral flow at mitral valve tips at a sweep speed of 50-100 mm/s (frozen image)
25. Tissue Doppler of the septal mitral annulus (frozen image and annotate "MED")
26. Tissue Doppler of the lateral mitral annulus (frozen image and annotate "LAT")
27. 3 x Gray scale focussed on LV with decreased depth (3 recordings; run 1: 3 beats, run 2: 3 beats, run 3: 10 beats)

E: Apical 5-chamber window

28. Gray scale standard view displaying in the middle of the sector the LV and left atrium
29. Colour Doppler of aortic regurgitation
30. Only if aortic regurgitation is present continuous-wave Doppler of aortic regurgitation (frozen image)
31. Continuous-wave Doppler of aortic forward flow (frozen image)
32. Pulsed-wave Doppler of LV outflow tract flow velocity (5 to 10mm below the aortic valve or in case of TAVI below the zone of flow acceleration) (frozen image)

F: Apical 2-Chamber window

33. Gray scale standard view displaying in the middle of the sector the LV and left atrium
34. 3 x Gray scale focussed on LV with decreased depth (3 recordings; run 1: 3 beats, run 2: 3 beats, run 3: 10 beats)

G: Apical 3-chamber window

35. Gray scale standard view displaying in the middle of the sector the LV and left atrium
36. Colour Doppler of mitral regurgitation
37. Only if mitral regurgitation is present in #36, colour Doppler ZOOM & narrow sector, shift Nyquist 35-40 for PISA
38. Only if mitral regurgitation is present in #36, record continuous-wave Doppler of mitral regurgitation (frozen image)
39. Colour Doppler of aortic regurgitation
40. Only if aortic regurgitation is present continuous-wave Doppler of aortic regurgitation (frozen image)
41. Continuous-wave Doppler of aortic forward flow (frozen image)
42. Pulsed-wave Doppler of LV outflow tract flow velocity (5 to 10mm below the aortic valve or in case of TAVI below the zone of flow acceleration) (frozen image)
43. 3 x Gray scale focussed on LV with decreased depth (3 recordings; run 1: 3 beats, run 2: 3 beats, run 3: 10 beats)

H: special recordings

44. Only if aortic regurgitation is present, suprasternal pulsed-wave Doppler of descending aorta diastolic flow (frozen image)
45. Only if aortic regurgitation is present, subcostal pulsed-wave Doppler of abdominal aortic diastolic flow (frozen image)
46. Only at baseline continuous-wave Doppler right parasternal aortic flow (frozen image)

6. Detailed instructions for acquisition of SURTAVI echocardiography recordings

6.1 Quality control of the investigational site (initial site validation)

- Before starting the study, participating centers will have to send a test echo examination to assess the quality of the recording and the transmission and most importantly the ADHERENCE to the PROTOCOL.
- Each centre will have to wait for the validation (feedback letter) of the Echo Core Lab Office before starting to select any patient. The Echo Core Lab Office will complete the validation procedure within 72 hours after receipt of the echocardiography material.

6.2 Guidelines for study object confidentiality

- Site-Patient identification: study subjects are to be identified by a specific study identification number as supplied by the sponsor.
- The following items will be entered in the patient identification section of ultrasound system and should be clearly shown on all digital cine loops or still frames.
 - Site-patient ID (XXXXX-YYY), date of exam and study interval
- To ensure adherence to the HIPAA (Health Insurance Portability and Accountability Act of 1996) guidelines for study subject confidentiality, no study subject names or other Protected Health Information (date of birth, hospital record number, etc) should be displayed.

6.3 Echocardiography data storage and submission of material

- Echocardiograms of SURTAVI study participants at all time intervals should be recorded on DVD in a DICOM-3 format.
- Each echocardiogram, per patient and per visit, should be recorded on a separate DVD. Do not archive echocardiograms from multiple patients or multiple echocardiograms from one patient on the same disc. The paths in the DICOM directory should point to the correct files. Delete all unnecessary recordings from your echo machine before burning the DVD (limit the number of thumbnails on digital DVD grid to the ones needed, as described in the protocol).

6.4 Submission

- Participating site should submit the DVD to the Core Laboratory immediately post-acquisition for processing, analysis, and blinded reading. To avoid data loss and/or damage from shipping, the investigational sites should retain a digital copy of the echocardiogram prior to sending the original to the Core Laboratory. The original DVD will be stored at the Core Laboratory until completion of the study. The Core Laboratory will not return submitted material, will not provide a clinical report of the echocardiogram, and will not notify the investigational sites of any abnormal findings on the echocardiograms. It is the responsibility of each site to perform a local interpretation of the study and to manage the subject according to the local interpretation.

6.5 Labelling and identification

- Each site will be supplied with labels to attach to the DVD. Before sending the DVD to the Core Laboratory, the label should be completed with the required information. Stick the completed label on the box of the DVD; never stick the labels on the DVD. Write the same information on the DVD with a marker intended for writing on DVD. The following information should be documented on the DVD box (Site-Patient ID, Exam date and Study interval)

6.6 Further inquiries:

- For any questions, contact your monitor or Cardialysis via phone at +31 10 206 282.

7. Technical guidelines: how to optimize the echocardiography images

7.1 ECG gating.

- All cine-loops and still frames must clearly display a single lead electrocardiographic recording in which P-, QRS-, and T-waves (but in particular the R wave) are clearly identifiable

7.2 Number of recorded heart cycles.

- In sinus rhythm, record 3 continuous beats, unless indicated otherwise. In atrial fibrillation, record 5 continuous beats, unless indicated otherwise. Try to exclude premature beats

7.3 Effects of respiration and timing of recordings.

- During all recordings, respiration should be quiet. Tissue Doppler measurements should be recorded after non-forced end-expiration

7.4 Two-dimensional echocardiography general settings

- Use harmonic-imaging mode with maximized (mechanical index >1) power output
- Gain (and time-gain compensation) settings should be adjusted to eliminate background noise and to allow for a clear blood-tissue border. An optimal gain setting consists of a left ventricular cavity with minimal (but not completely absent) noise
- The gray scale / dynamic range should be adjusted to provide an image with marked contrast between light and dark areas
- The focus point should be set at the middle of the region of interest
- Depth settings should be minimized (do not display structures outside the region of interest)

7.5 (Tissue) Doppler settings

- Use a display speed of 50 to 100 mm/sec and a sample volume length of 3-4 mm (in extremely low heart rates use a speed of 150 mm/sec). For mitral E-wave deceleration, time one recording is needed at a sweep speed of 150 mm/s
- Adjust gain, filter settings, position and velocity range to maximize the velocity excursion
- Minimize the angle between the direction of motion of the investigated structure or flow and the Doppler beam
- Transmitral flow should be assessed at the tips of the mitral valve
- Annotate the tissue Doppler recordings

7.6 Colour Doppler settings

- Minimize the colour sector and use a velocity range of approximately ± 60 cm/sec

7.7 Parasternal long-axis view

- Minimize the angle between the left ventricle and aorta (the inferolateral wall should be as perpendicular as possible to the transducer) the anteroseptal wall is visualized at the same distance from the transducer as the anterior wall of the ascending aorta

7.8 Apical two and four-chamber view

- The left ventricular apex should be visible in the top of the sector
- The aortic valve should be out of the image plane
- Maximize the internal long-axis of the left ventricle (avoid foreshortening) by looking for a window one intercostal space lower (in particular when the left ventricle does not appear ellipsoid)

- To ensure that the proper rotation has been made for a two-chamber view, the transducer is angled posteriorly to intersect both papillary muscles symmetrically. Then the transducer is angled slightly anteriorly so that neither papillary muscle is seen in its long axis in this view

7.9 Special considerations for aortic regurgitation by colour flow imaging¹⁻³

In addition to the abovementioned recommendations:

- Standardize the machine settings for all examinations
- Colour gain should be set step by step just below the appearance of colour noise artefacts
- For Vena contracta: use a parasternal long-axis view in ZOOM mode with minimal colour sector size and imaging depth to maximize lateral and temporal resolution

7.10 Subcostal window

In order to provide optimal image acquisition from subcostal window, the following steps are required:

- The knee-flexed position relaxes the upper abdominal muscles and thereby improves visualization
- From the subcostal four-chamber view, anti-clockwise rotation of the transducer permits visualization and pulsed Doppler examination of the upper abdominal aorta

8. Measurements of aortic root geometry⁴

The following measurements of the aortic root are obtained from the parasternal long-axis view (screening/baseline exams only):

- Aortic annulus long axis diameter.** The aortic annulus long axis diameter is measured perpendicular to the long axis of the root, measured between the endothelial point that trisects the posterior aortic wall, non-coronary cusp hinge and anterior mitral leaflet hinge (posterior hinge point), and the point that bisects the septal endocardium and the right coronary cusp hinge (anterior hinge point). Measurements should be made at mid-systole and inclusive of cusp calcifications (Figure 1). To accurately incorporate cusp calcification for aortic annulus sizing, measure from the white-black interfaces of the posterior and anterior aortic cusp hinge points and add 2 mm to the measurement.
- Sinus of Valsalva diameter (SoV).** The SoV diameter is perpendicular to the long axis of the root and typically parallel to the aortic valve annulus. It is the widest intra-luminal distance within the sinuses (measured at end-diastole from inner edge to inner edge, Figure 2, A).
- Sino-tubular junction diameter (STJ).** The STJ diameter is the intra-luminal diameter parallel to the SoV diameter, where the sinuses narrow and join the ascending aorta (measured at end-diastole from inner edge to inner edge, Figure 2, B).
- Sinus of Valsalva height (SoVH).** The SoVH is the distance between the STJ and the aortic annulus long-annulus diameter (measured at end-diastole, Figure 3).

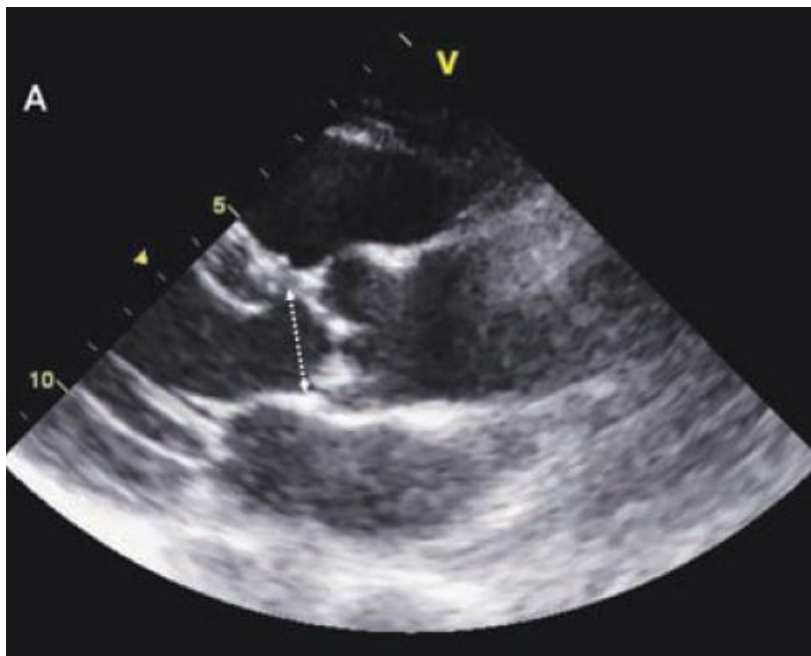

Figure 1. Examples of measurement of the aortic annulus long axis diameter

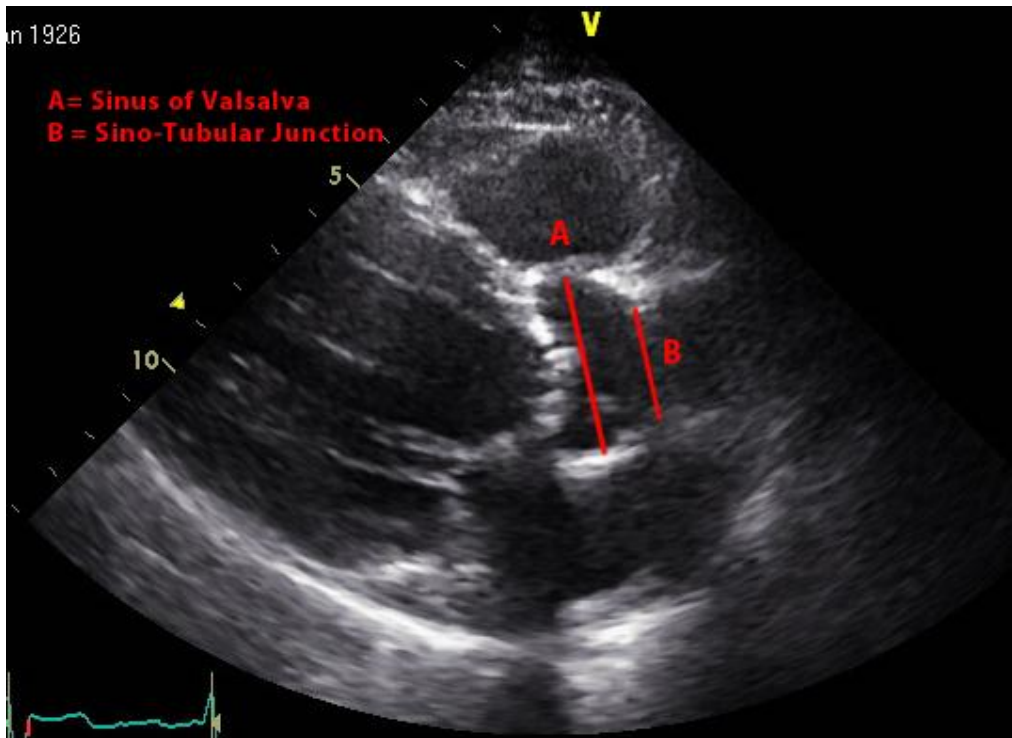

Figure 2. Example of measurement of the Sinus of Valsalva (A) and Sino-Tubular Junction (B) diameters.

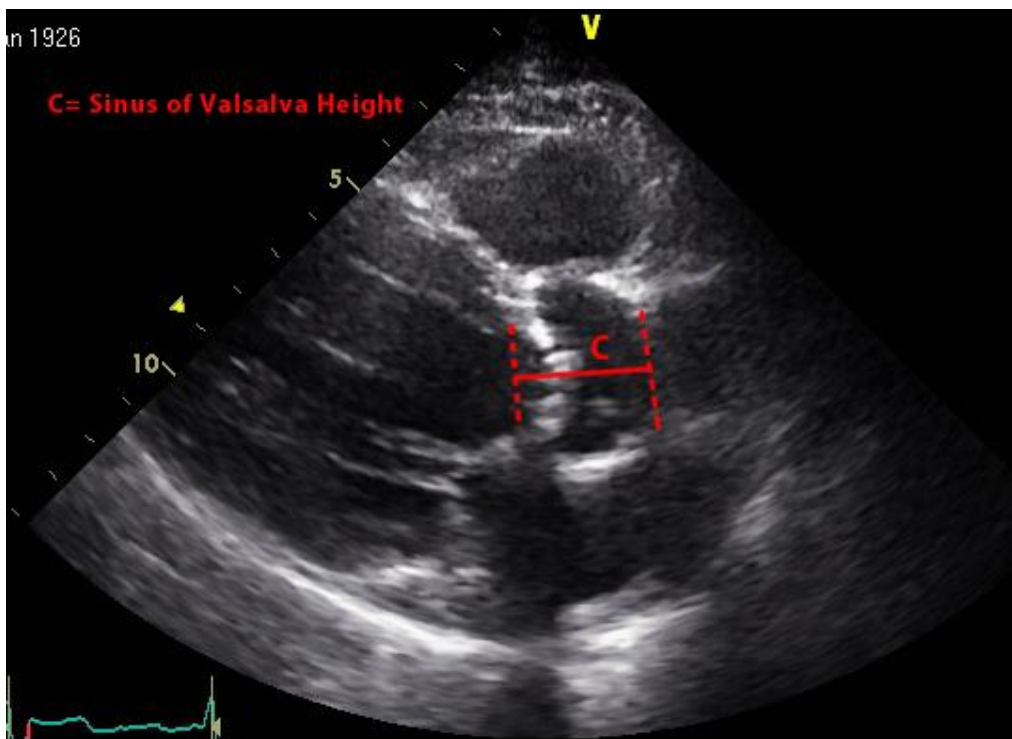

Figure 3. Example of measurement of the Sinus of Valsalva Height (C)

9. Measurement of Left Ventricular Outflow Tract (LVOT) Diameter

The LVOT long axis diameter is measured in the parasternal long-axis view at early to mid systole. The optimal imaging plane is through the long axis of the aorta; therefore, the anterior and posterior walls of the aortic root should be parallel with the maximal aortic diameter.

For native aortic valves, the LVOT long axis diameter is measured from the white-black interface of the septal endocardium to the anterior mitral leaflet, parallel to the aortic valve plane and within 0.5 cm - 1 cm of the valve orifice (Figure 4)¹. Following implantation of the CoreValve device, the LVOT diameters and the LVOT area are measured immediately proximal to the inflow aspect of the stent (Figure 5).

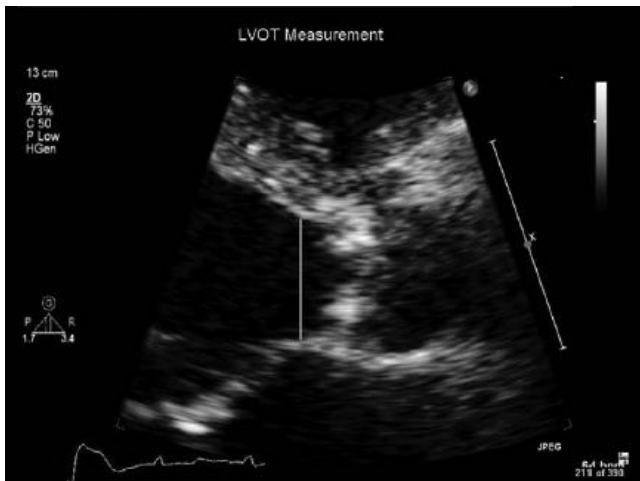

Figure 4. TTE mid-systolic frame showing measurement of the LVOT diameter for derivation of native aortic valve area.

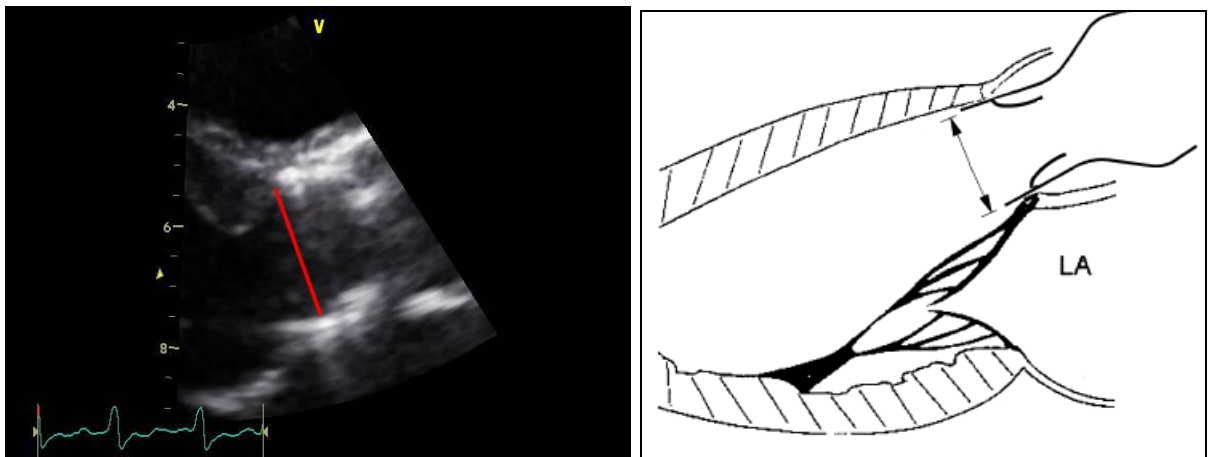

Figure 5. Cursor placement for measurement of LVOT diameter for derivation of prosthetic effective orifice area.

10. Measurement of LVOT Velocity⁵

LVOT velocity is recorded with PW Doppler from the apical transducer position, either in the apical long-axis view or in the anteriorly angulated four-chamber view or “five-chamber view.” The PW sample volume is positioned just proximal to the aortic valve, with care to avoid the zone of pre-valve acceleration. The recommended procedure is to initially place the sample volume within the aortic valve leaflets (prosthetic or native), and then gradually move it apically until a clear spectral waveform is observed with a well-defined peak and minimal spectral broadening (Figure 6). The optimal sample volume placement is usually between 0.5 and 1.0 cm upstream from the valve annulus.² Post implantation, the sample volume should be placed at the entrance of the inlet of the CoreValve prosthesis.

11. Measurement of Aortic Valve Velocity⁵

The aortic valve velocity and VTI should be interrogated with CW Doppler from all transducer positions (apical, right parasternal, suprasternal notch, left supraclavicular, subcostal). The position that provides the highest velocity is used for measurements. A smooth velocity curve with a clear outer edge and maximal velocity should be recorded. The maximal velocity is measured at the outer edge of the dark signal; fine linear signals at the peak should not be included in measurements. The outer edge of the dark “envelope” of the velocity curve is traced to provide both the VTI for the continuity equation and the mean gradient (Figure 7).¹

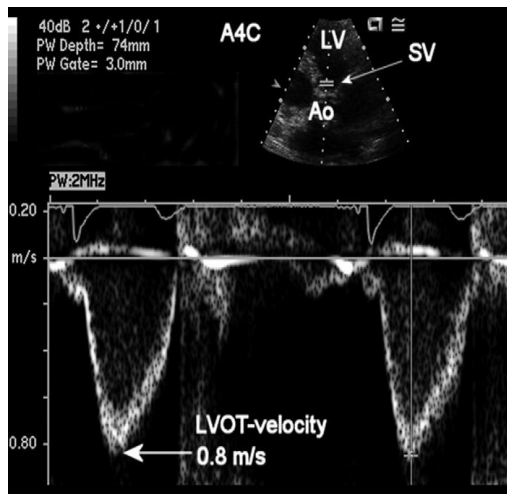

Figure 6. An optimal LVOT signal shows a smooth velocity curve with a narrow velocity range at each time point.

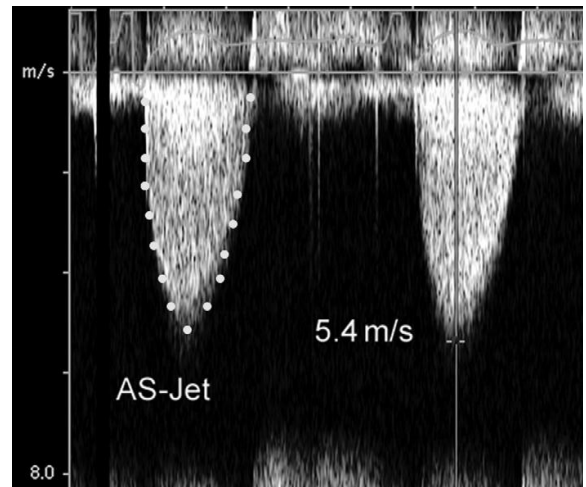

Figure 7. CW Doppler of severe AS jet showing measurement of maximal velocity and tracing of the Velocity curve to calculate mean gradient.

12. Assessment of Aortic Regurgitation^{6,7}

An integrated exam approach using colour flow, pulsed-wave (PW), and continuous-wave (CW) Doppler is used to assess the severity of transvalvular and paravalvular regurgitation. Colour flow Doppler imaging should be performed from the parasternal long and short-axis views, and the apical long-axis and/or 5-chamber views. A recording of the aortic regurgitant signal should be obtained with CW Doppler. If the degree of aortic regurgitation appears more than mild by visual estimate, the velocity in the proximal descending aorta and the abdominal aorta should be recorded with PW Doppler.

The degree of transvalvular and paravalvular regurgitation will be graded as none, trace, mild, moderate, and severe based on the synthesis of the Doppler parameters shown in Table 2.^{3,4} The category of "trace" is used in cases where regurgitation is barely detectable by colour Doppler. Regurgitant signals observed to originate within the stent will be considered transvalvular, and regurgitant signals observed to originate outside the stent will be considered paravalvular.

Paravalvular regurgitant jets will be characterized by the extent of the aortic regurgitant jet relative to the short axis circumference of the aortic valve (Table 2- Valve Academic Research Consortium (VARC) Consensus Report for Transcatheter Aortic Valve Implantation (TAVI) or any update that will be available before start of analysis; and Table 3a and b -2008 Focused Update Incorporated Into the ACC/AHA 2006 Guidelines for the Management of Patients With Valvular Heart Disease (published in the October 2008 issues of Journal of the American College of Cardiology and Circulation).

Table 2. Parameters for evaluation of the severity of aortic regurgitation^{1,6,8}.

Prosthetic Aortic Valve Regurgitation Criteria (Central and Paravalvular)			
Parameter	Mild	Moderate	Severe
Valve Structure and Motion Mechanical or bioprosthetic	Usually normal	Usually abnormal†	Usually abnormal†
Structural parameters Left ventricular size	Normal ‡	Normal/ mildly dilated ‡	Dilated
Doppler parameters (qualitative or semi quantitative) Jet width in central jets (% LVO diameter): color* Jet density: CW Doppler Jet deceleration rate (PHT [†] , ms): CW Doppler** LV outflow vs. pulmonary flow: PW Doppler Diastolic: flow reversal in the descending aorta PW Doppler Circumferential extent of paraprosthetic AR (%)	Narrow (≤25%) Incomplete or faint Slow (>500) Slightly increased Absent or brief early diastolic <10	Intermediate (26-64%) Dense Variable (200-500) Intermediate Intermediate 10-20	Large (≥65%) Dense Steep (<200) Greatly Increased Prominent, Holodiastolic >20
Doppler parameters (quantitative) Regurgitant volume (mL/beat) Regurgitant fraction (%)	<30 <30	30-59 30-50	>60 >50

* Parameter applicable to central jets and is less accurate in eccentric jets

** Influenced by left ventricular compliance

AR=aortic regurgitation; CW= continuous wave; LVO= left ventricular outflow; PW= pulsed wave

† PHT is shortened with increasing LV diastolic pressure and vasodilator therapy, and may be lengthened in chronic adaptation to severe aortic regurgitation. As such, PH, in contrast to the other parameters, does not reflect the volumetric severity of aortic regurgitation, but rather its hemodynamic impact. Therefore, in the setting of acute paravalvular or transvalvular leaks, intermediate values between 200 and 500 ms should not be used to classify the degree of regurgitation.

‡ Abnormal mechanical valves, for example, immobile occluder (valvular regurgitation), dehiscence or rocking (paravalvular regurgitation); abnormal biologic valves, for example, leaflet thickening or prolapse (valvular), dehiscence or rocking (paravalvular regurgitation).

‡ Applies to chronic, late postoperative AR in the absence of other etiologies.

Table 3a. Parameters for evaluation of the severity of aortic regurgitation

Classification of the Severity of Valve Disease in Adults with Aortic Regurgitation			
	Mild	Moderate	Severe
Qualitative Angiographic grade Color Doppler jet width Doppler vena contracta width (cm)	1+ Central jet, width less 25% of LVOT Less than 0.3	2+ Greater than mild but no signs of AR 0.3-0.6	3-4+ Central jet, width greater than 65% LVOT Greater than 0.6
Quantitative (cath or echo) Regurgitant volume (mL per beat) Regurgitant fraction (%) Regurgitant orifice area (cm ²)	< 30 < 30 < 0.10	30-59 30-49 0.10-0.29	≥ 60 ≥ 50 ≥ 0.30
Additional essential criteria Left ventricular size			Increased

13. Assessment of Mitral Regurgitation^{2, 8}

Colour flow Doppler imaging of the left atrium should be performed from the parasternal long-axis view, and from the apical four, two, and long axis views. Mitral regurgitant signals should be recorded with CW Doppler using a velocity scale that allows assessment of the density, shape, duration, and peak velocity of the mitral regurgitant signal. If the severity appears moderate or greater by visual assessment, pulmonary vein velocities should be recorded with PW Doppler to assess for the presence of systolic flow reversal. Grading of the severity of mitral regurgitation should be integrative using the parameters in Table 3.⁴

Table 3b. Classification of the Severity of Valve Disease in Adults Mitral Regurgitation

Classification of the Severity of Valve Disease in Adults Mitral Regurgitation			
	Mild	Moderate	Severe
Qualitative Angiographic grade Color Doppler jet area Doppler vena contracta width (cm)	1+ Small, central jet, < 4cm ² or <20% LA area)	2+ Signs of > mild present but no criteria for severe MR	3-4+ Vena contracta with > 0.7cm with large central MR jet (area >40% of LA area) or with a wall-impinging jet of any size, swirling in LA ≥ 0.70
Quantitative (cath or echo) Regurgitant volume (mL per beat) Regurgitant fraction (%) Regurgitant orifice area (cm ²)	< 30 < 30 < 0.20	30-59 30-49 0.29 – 0.39	≥ 60 ≥ 50 ≥ 0.40
Additional essential criteria Left atrial size Left ventricular size			Enlarged Enlarged

14. Assessment of Left Ventricular Function and Left Atrial Size⁹

M-mode recordings of the left ventricle and left atrium should be obtained using 2-D guided beam alignment (Figures 7 and 8). Left ventricular chamber dimensions and wall thicknesses will be measured from 2D parasternal long axis views and should be utilized preferentially if M-mode images are suboptimal. Chamber dimensions are measured using the American Society of Echocardiography (ASE) measurement convention.⁵ In addition, standard 2-D views of the left ventricle should be obtained from parasternal and apical transducer positions for visual estimation and quantitative assessment of left ventricular ejection fraction by visual estimate.

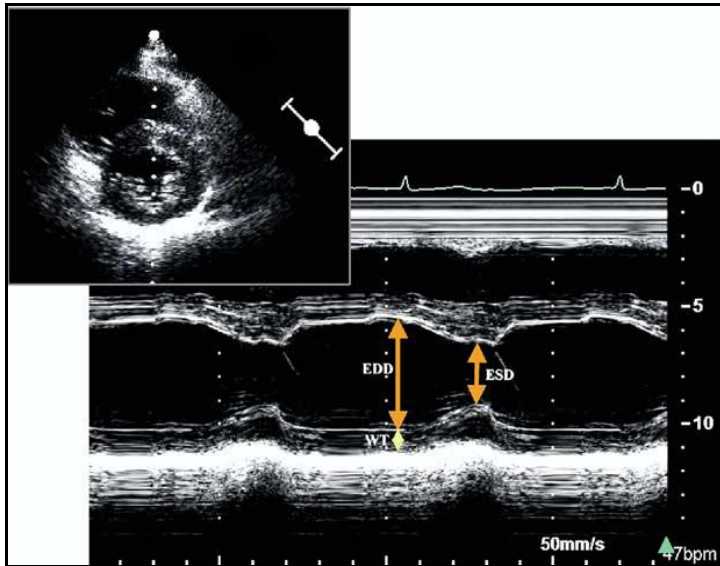

Figure 7. Measurement of left ventricular end-diastolic diameter (EDD) and end-systolic (ESD) from 2-D guided m-mode to optimize medial-lateral beam orientation.

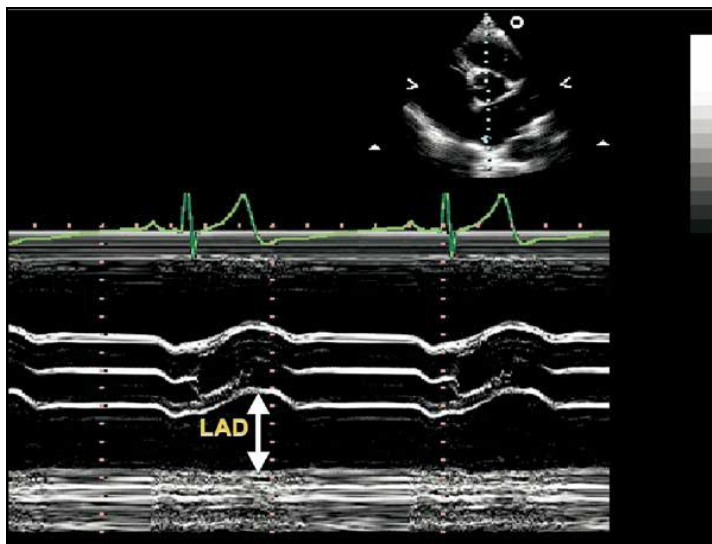

Figure 8. Measurement of left atrial diameter (LAD) by 2-D guided m-mode.

15. Acquisition of Mitral Inflow Velocities

A spectral Doppler recording of mitral inflow velocities should be obtained with PW Doppler in the apical 4-chamber view, using a 1 to 3 mm sample volume placed between the mitral leaflet tips during diastole (Figure 9). The spectral gain and wall filter settings should be optimized to clearly display the onset and cessation of left ventricular inflow.⁶

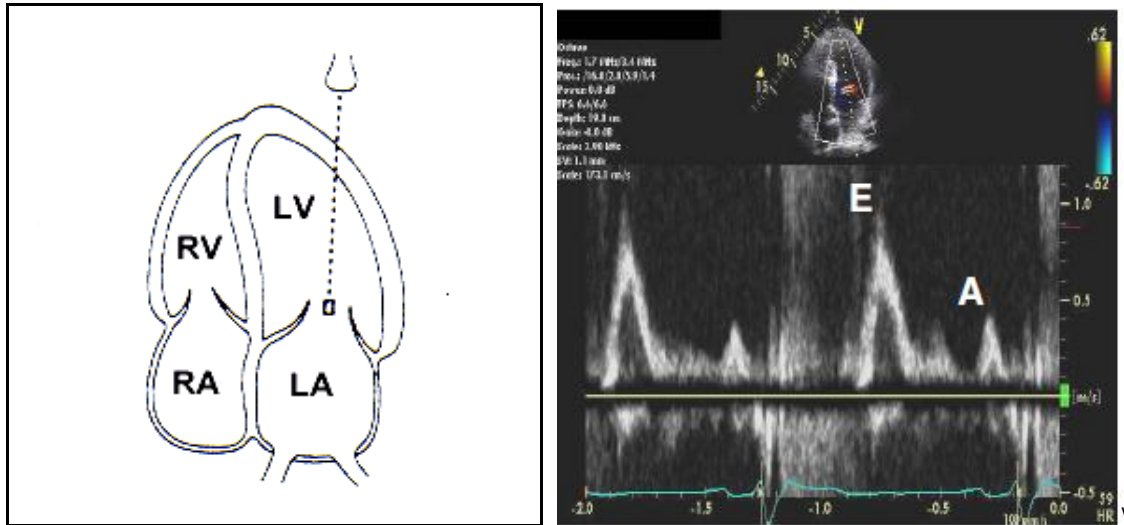

Figure 9. Positioning of the sample volume for recording of mitral inflow velocities.

16. Acquisition of Mitral Annular Tissue Doppler Velocities

Mitral annular velocities should be obtained from the lateral and septal aspects of the mitral annulus using PW tissue Doppler performed in the apical 4-chamber view. The sample volume should be positioned at or 1 cm within the septal and lateral insertion sites of the mitral leaflets and adjusted as necessary (usually 5 to 10 mm) to cover the longitudinal excursion of the mitral annulus in both systole and diastole. Minimal angulations (<20 degrees) should be present between the ultrasound beam and the plane of cardiac motion.⁶ The Doppler gain should be minimized to prevent “blooming” of the signal to facilitate accurate measurement of the annular velocities.

17. Assessment of Device Migration

CoreValve device placement site and migration will be assessed from the parasternal long axis view at each follow up point and compared to the initial post-procedural echo. A zoomed image of the left ventricular outflow tract including the anterior mitral leaflet and the anterior aortic wall should be included at each follow up echo. The location of the device will be determined by measurement of the distance from the proximal edge of the left ventricular outflow tract anteriorly, to the edge of the CoreValve device (Figure 10). Optimal placement of the valve should be within the left ventricular outflow tract just below the aortic annulus (Figure 11).

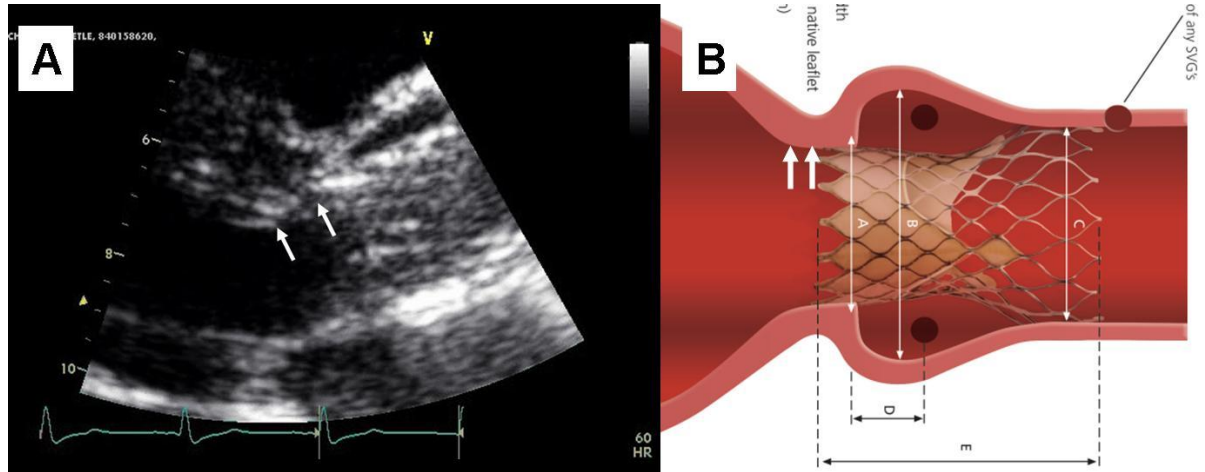

Figure 10. Zoomed view of the left ventricular outflow tract (panel A) and schematic (panel B). Measurement of the distance from the proximal edge of the anterior aspect of the left ventricular outflow tract to the edge of the CoreValve device (arrows).

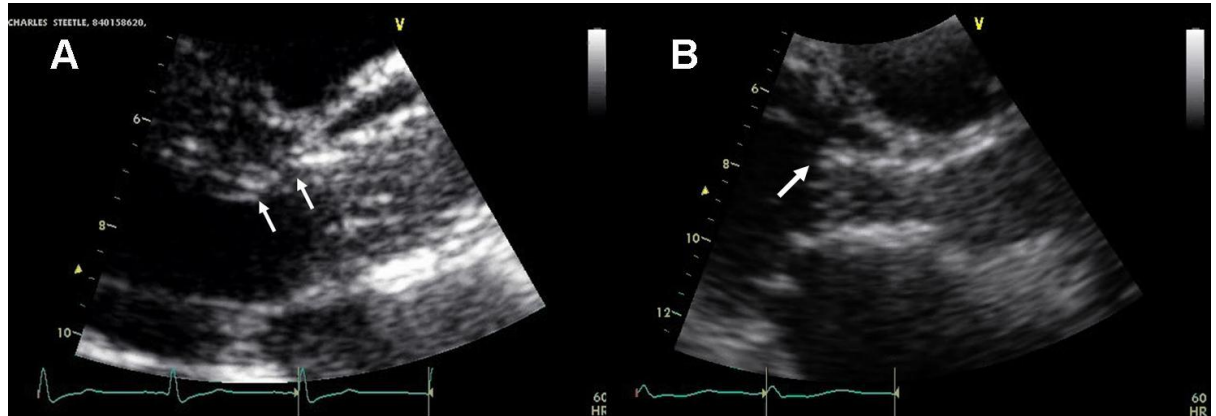

Figure 11. Zoomed view of the left ventricular outflow tract. Panel A. Optimal device placement of the CoreValve device within the left ventricular outflow tract with the proximal edge of the device just below the aortic annulus. Panel B. Low placement of the CoreValve device extends beyond the left ventricular outflow tract into the left ventricular chamber, encroaching on anterior mitral valve leaflet.

18. Echo Core Lab Analysis^{5,7}

Data generated by the Echo Core Lab will be the primary data used for analysis and reporting. Qualitative assessment of valvular regurgitation will be performed using the criteria previously described in sections 8 and 9 of this Appendix. The Echo Core Lab will report the following variables:

- Aortic annulus long-axis diameter in mid-systole (screening/baseline only)
- LVOT long axis diameter in mid-systole
- Sinus of Valsalva diameter (SOV) at end diastole (screening/baseline only)
- Sino-tubular junction diameter (STJ) at end diastole (screening/baseline only)
- Sinus of Valsalva height (SOVH) at end-diastole (screening/baseline only)
- Device location and migration
- Max aortic valve velocity (V2) by CW Doppler
- Velocity time integral (VTI) across aortic valve by CW Doppler
- Mean gradient across aortic valve (MGV2) by CW Doppler
- Peak LVOT velocity (V1) by PW Doppler
- Velocity time integral (VTI) of LVOT velocity by PW Doppler
- Mean LVOT gradient (MGV1) by PW Doppler
- Grade of aortic transvalvular regurgitation
- Grade of aortic paravalvular regurgitation
- Grade of mitral regurgitation
- ERO for MR (if available)
- Max tricuspid regurgitant (TR) jet velocity (if TR is present)
- Left ventricular (LV) end-diastolic diameter (LVEDD)
- Left ventricular (LV) end-systolic diameter (LVESD)
- Interventricular septal thickness at end diastole
- Left ventricular posterior wall thickness at end diastole
- Left atrial diameter (AP linear dimension) at systole
- Left ventricular ejection fraction by visual estimate
- Heart rate
- Mitral inflow "A" velocity
- Mitral inflow "E" velocity
- Mitral inflow deceleration time
- Mitral annular tissue Doppler systolic (s) velocity (septal and lateral)
- Mitral annular tissue Doppler early diastolic (e') velocity (septal and lateral)
- Mitral annular tissue Doppler late diastolic (a') velocity (septal and lateral)

In addition, the following variables will be derived by the central database from the appropriate measurements reported by the Echo Core Lab⁵:

- **Mean Transvalvular Gradient (Mean ΔP) Across the Prosthetic Valve in mmHg**

$$\text{Mean } \Delta P = \text{MG}_{V_2} - \text{MG}_{V_1}$$

Where: MG_{V_2} is the mean pressure gradient across the prosthesis in mmHg, and MG_{V_1} is the mean pressure gradient from the left ventricular outflow tract in mmHg

- **Peak Pressure Gradient (Peak ΔP) Across the Aortic Prosthetic Valve in mmHg**

$$\text{Peak } \Delta P = 4 \times (V_2^2 - V_1^2)$$

Where: V_2 is the peak velocity across the prosthesis in m/sec, and V_1 is the peak velocity from the left ventricular outflow tract in m/sec

- **Effective Orifice Area (EOA) in cm^2**

$$\text{EOA} = \text{LVOT Long Axis diameter}^2 \times 0.785 \times (\text{VTI}_{V_1} / \text{VTI}_{V_2})$$

Where: VTI_{V_1} is the velocity time integral of the left ventricular outflow tract in cm, and VTI_{V_2} is the velocity time integral of the aortic prosthesis in cm. Alternatively, using velocity instead of VTI for simplification:

$$\text{AVA} = \pi(\text{radius of LVOT})^2 \times V_{\text{LVOT}} / V_{\text{max}}$$

Where V_{max} is the maximum flow velocity across aortic valve, V_{LVOT} is the maximum velocity across the LVOT.

- **Effective Orifice Area Index (EOAI) in cm^2/m^2**

$$\text{EOAI} = \text{EOA} / \text{BSA}$$

Where: EOA is the effective orifice area in cm^2 , and BSA is the body surface area in m^2

- **Velocity Time Integral Ratio (VTI Ratio)**

$$\text{VTI Ratio} = \text{VTI}_{V_1} / \text{VTI}_{V_2}$$

Where: VTI_{V_1} is the velocity time integral of the left ventricular outflow tract in cm, and VTI_{V_2} is the time velocity integral of the prosthetic aortic valve in cm

- **Stroke Volume (SV) in ml/beat**

$$\text{SV} = \text{LVOT long axis diameter}^2 \times 0.785 \times \text{VTI}_{V_1}$$

Where: VTI_{V_1} is the velocity time integral from the left ventricular outflow tract in cm

- **Cardiac Output (CO) in l/min**

$$\text{CO} = (\text{SV} \times \text{HR}) / 1000$$

Where: SV is the stroke volume in ml/beat, and HR is the heart rate in beats per minute

- **Left Ventricular Mass (LVM) in grams**

$$\text{LVM} = 0.83 \times [(\text{LVEDD} + \text{LVPW} + \text{IVS})^3 - (\text{LVEDD})^3] + 0.6$$

Where: LVEDD is the left ventricular end-diastolic diameter in cm, LVPW is the left ventricular posterior wall thickness at end diastole in cm, and IVS is the interventricular wall thickness at end diastole in cm.

- **Left Ventricular Mass Index (LVMI) in g/m^2 body surface area**

$$\text{LVMI} = \text{LVM} / \text{BSA}$$

Where: LVM is left ventricular mass in g, and BSA is body surface area in m^2

- **Fractional Shortening (FS) in %**

$$\text{FS} = [(\text{LVEDD} - \text{LVESD}) / \text{LVEDD}] \times 100$$

Where: LVEDD is left ventricular end-diastolic diameter in cm, and LVESD is left ventricular end-systolic diameter in cm

- **Estimated Right Ventricular Systolic Pressure (RVSP) in mmHg**

$$RVSP = (4 \times MV_{TR\text{ jet}}^2) + 10$$

Where: $MV_{TR\text{ jet}}$ is the max velocity of the tricuspid regurgitant jet, and 10 = the assumed mean right atrial pressure in mmHg

- **Aortic Regurgitant volume (ml/beat) and fraction (%)**

The regurgitant volume across the aortic valve may be calculated as the difference between the LVOT volume and the transmitral volume, assuming there is no significant mitral regurgitation

$$RV = \text{Total stroke volume} - \text{forward stroke volume}$$

$$RV = SV_{AV} - SV_{MV}$$

$$RF = [RV/SV] \times 100$$

$$SV_{AV} = 0.785 \times (LVOT)^2 \times VTI_{LVOT} \text{ (by Pulsed-wave Doppler)}$$

$$SV_{MV} = 0.785 \times (D_{MV})^2 \times VTI_{MV} \text{ (by Pulsed-wave Doppler)}$$

Where: SV is stroke volume in mL, AV is aortic valve and MV is mitral valve

- **Regurgitant Orifice Area (EROA)**

The regurgitant orifice area or EROA represents the average size of the defect in the aortic valve during diastole and is proportional to regurgitant severity.

The regurgitant orifice area may be calculated as the regurgitant volume multiplied by the VTI of the continuous wave Doppler jet

$$EROA_{AV} = RV / VTI_{AR\text{ jet}} \text{ (by Continuous-wave Doppler)}$$

19. Echocardiography References

1. Zoghbi WA, Chambers JB, Dumesnil JG, Foster E, Gottdiener JS, Grayburn PA, Khandheria BK, Levine RA, Marx GR, Miller FA, Jr., Nakatani S, Quinones MA, Rakowski H, Rodriguez LL, Swaminathan M, Waggoner AD, Weissman NJ, Zabalgoitia M. Recommendations for evaluation of prosthetic valves with echocardiography and doppler ultrasound: A report from the american society of echocardiography's guidelines and standards committee and the task force on prosthetic valves, developed in conjunction with the american college of cardiology cardiovascular imaging committee, cardiac imaging committee of the american heart association, the european association of echocardiography, a registered branch of the european society of cardiology, the japanese society of echocardiography and the canadian society of echocardiography, endorsed by the american college of cardiology foundation, american heart association, european association of echocardiography, a registered branch of the european society of cardiology, the japanese society of echocardiography, and canadian society of echocardiography. *J Am Soc Echocardiogr.* 2009;22:975-1014; quiz 1082-1014
2. Lancellotti P, Moura L, Pierard LA, Agricola E, Popescu BA, Tribouilloy C, Hagendorff A, Monin JL, Badano L, Zamorano JL. European association of echocardiography recommendations for the assessment of valvular regurgitation. Part 2: Mitral and tricuspid regurgitation (native valve disease). *Eur J Echocardiogr.* 2010;11:307-332
3. Lancellotti P, Tribouilloy C, Hagendorff A, Moura L, Popescu BA, Agricola E, Monin JL, Pierard LA, Badano L, Zamorano JL. European association of echocardiography recommendations for the assessment of valvular regurgitation. Part 1: Aortic and pulmonary regurgitation (native valve disease). *Eur J Echocardiogr.* 2010;11:223-244
4. Evangelista A, Flachskampf FA, Erbel R, Antonini-Canterin F, Vlachopoulos C, Rocchi G, Sicari R, Nihoyannopoulos P, Zamorano J, Pepi M, Breithardt OA, Plonska-Gosciniak E. Echocardiography in aortic diseases: Eae recommendations for clinical practice. *Eur J Echocardiogr.* 2010;11:645-658
5. Baumgartner H, Hung J, Bermejo J, Chambers JB, Evangelista A, Griffin BP, lung B, Otto CM, Pellikka PA, Quinones M. Echocardiographic assessment of valve stenosis: Eae/ase recommendations for clinical practice. *J Am Soc Echocardiogr.* 2009;22:1-23; quiz 101-102
6. Zoghbi WA. New recommendations for evaluation of prosthetic valves with echocardiography and doppler ultrasound. *Methodist Debaquey Cardiovasc J.* 2010;6:20-26
7. Chambers J, Shah PM. Recommendations for the echocardiographic assessment of replacement heart valves. *J Heart Valve Dis.* 1995;4:9-13
8. Leon MB, Piazza N, Nikolsky E, Blackstone EH, Cutlip DE, Kappetein AP, Krucoff MW, Mack M, Mehran R, Miller C, Morel MA, Petersen J, Popma JJ, Takkenberg JJ, Vahanian A, van Es GA, Vranckx P, Webb JG, Windecker S, Serruys PW. Standardized endpoint definitions for transcatheter aortic valve implantation clinical trials: A consensus report from the valve academic research consortium. *Eur Heart J.* 2011;32:205-217
9. Lang RM, Bierig M, Devereux RB, Flachskampf FA, Foster E, Pellikka PA, Picard MH, Roman MJ, Seward J, Shanewise JS, Solomon SD, Spencer KT, Sutton MS, Stewart WJ. Recommendations for chamber quantification: A report from the american society of echocardiography's guidelines and standards committee and the chamber quantification writing group, developed in conjunction with the european association of echocardiography, a branch of the european society of cardiology. *J Am Soc Echocardiogr.* 2005;18:1440-1463

R.8 Electrocardiogram (ECG) Submission

The standard 12 lead ECG will be utilized as a diagnostic and prognostic tool in patients participating in this study. All ECGs are analyzed by cardiologists/electrophysiologist utilizing both qualitative and quantitative methodology. The accuracy of these interpretations depends critically **upon** the quality of the ECG tracings. The qualitative reading of ECGs will include analysis of rhythm, rate, conduction abnormalities, Q waves and major/minor ST and T wave changes.

Acquisition:

1. Standard 12-lead ECGs must be obtained (with the exception of implant procedure)
2. ECG should be conducted with the subject at rest
3. ECGs should be provided on a single page printout (i.e. lead strips are not acceptable) using standard amplification of 1mV/cm and paper speed of 25mm/sec (50mm/sec is strongly discouraged)
4. Visible lead annotation
5. More than 1 normal beat per lead. No average ECGs
6. ECG without Pace-Maker beats is preferred

Labeling:

7. Protect subject confidentiality. Effectively block out any subject confidential information recorded on the ECG
8. ECG labels are to be placed on top of the tracing, being careful not to obstruct any of the lead recordings
9. Labels with Study name will be provided by Medtronic and shall be filled out completely, including
 - a) Site number
 - b) Subject identification number
 - c) ECG date and time
 - d) Applicable visit/interval (i.e. screening, Discharge)
10. Incomplete labeling will result in the generation of a data clarification query and untimely interpretation of the tracing

Submission:

11. Original ECGs are strongly encouraged but high quality photocopies with good visible gridline are accepted
12. Submission of all ECGs within appropriate timeframe is imperative
13. Send complete packets collectively for each patient (i.e. Index ECGs: Screening-Baseline and Discharge)

R.9 Computed Tomography (CT) Angiography Acquisition Guidelines

Background

Cardiac Multislice Computed Tomographic Angiography (Cardiac MSCT Angiography) is intended to evaluate aortic valve anatomy, aortic root dimensions for device sizing, and assessment of peripheral vessel dimensions and anatomy. This appendix is meant as a guideline to help with the proper acquisition of the images necessary for assessment of the above mentioned items. The primary objective should be to acquire the highest resolution images and perform the correct measurements, as specified below, by tailoring the acquisition to your particular hardware and experience.

Equipment Requirements

- Multi-detector CT scanner (64-slice minimum) with ECG-gating capability
 - The scans acquired and submitted for analysis of the aortic root MUST be ECG-gated
 - Non-gated scans in areas with cardiac motion lead to measurement inaccuracy and therefore incomplete information for device selection
 - Peripheral vessel image acquisition may be non-gated
- Ability to electronically transfer the imaging data via secure network (InteleGRID)

Scans Acquired

- Chest Topogram
- ECG-gated contrast enhanced aortic root*
- Non ECG-gated contrast enhanced peripheral vessels*

*Sub-millimeter slice thickness is required

Scanning Procedures

The scan protocol is similar to a CT coronary angiogram. The aim is to get adequate contrast in the region of interest which includes: endo-luminal surface for visualization of left heart, aorta, and peripheral access vessels (i.e., femorals and subclavians, when necessary). Temporal resolution should be optimized to reduce motion artifact. Spatial resolution should be as high as possible (goal is smallest isotropic voxel size).

Step 1: Patient preparation

- Administer medication per institution standard practice for CT scanning (suggest avoid sublingual nitrate, avoid or caution with B-blockers)
- Attach ECG electrodes for gating of scan (suggest: avoiding large respiratory muscles as these may introduce ECG-artifact). Verify quality and stability of ECG tracing on scanner console during an inspiratory breath hold
- Prepare large intravenous line (i.e., 18 or 20 gauge) for administration of contrast media
- Instruct patient to lie still during scan, even if they experience warmth or tingling due to the injection of contrast
- Instruct patient in practice breath-hold at end-inspiration for 10-15 seconds (duration required will depend on specific scanner performance). Assess heart rate variability during breath-hold. If heart rate is >65 bpm or unstable, consider cautious titration of beta-blockers

Step 2: Chest Topogram

- Acquire a chest topogram for use in planning the following imaging protocol



Figure CTA-1: Example image of chest topogram

Step 3: ECG-gated contrast enhanced scan of aortic root

The aim of this scan is to assess the aortic root and valve anatomy. Ensure the required scan parameters are used; these are listed below in Table 1. The following parameters are crucial to the optimum required scan:

- The recommended coverage area is from superior to the aortic arch to inferior to the cardiac apex. The minimum required coverage area is from 50mm above the aortic annulus to the inferior border of the heart. Coverage less than this will not allow for proper assessment of the patients anatomic suitability
- The scan requires dynamic 4D acquisition using retrospective ECG-gating
- The required detector collimation is 0.4-0.625mm
- The required slice thickness is $\leq 0.8\text{mm}$
- The recommended slice overlap is 0.4mm

Contrast Enhanced Scan Execution

- Prepare iodinated contrast injection apparatus (recommendations in scan parameters are provided in Table 1)
- Set up scan parameters per the table below
- Instruct patient to lie still during scan, even if they experience warmth or tingling due to the injection of contrast
- Initiate contrast injection
- When contrast reaches threshold at bolus-tracking location, instruct patient to hold breath at end-inspiration, then initiate main scan protocol
- At completion of scan verify scan is of adequate quality
- Record amount of contrast given. Note: this is not on the CRF, but is recommended in this patient population
- Record heart rate average and range. Note: this is not on the CRF, but is recommended for explanation of image quality issues

Post-processing

- Verify heart rate ECG triggers are at consistent place in cardiac cycle, edit if necessary. Additional editing/removal of arrhythmias may be performed
- Reconstruct at multiple phases (10 increments of 10%), with ≤ 0.8 mm slice thickness. If the system has the capability, also reconstruct a “best systolic” and “best diastolic” phase. If image quality of the aortic root is not good in the end systolic phase the phase with the best image quality may be selected instead

Table 1. Recommended Scan Parameters

	Recommended Parameters
IV injection with iodine contrast	80-100 (320mg/ml or higher), modify per patient as appropriate
Injection rate	4-6 mL/sec
Bolus tracking, delay	Delay time calculated using protocol for current scanner (bolus tracking or similar) with peak of contrast concentration in the ascending aorta during acquisition. Bolus tracking is the preferred method.
ECG Leads	Required
ECG-gating	Retrospective (Prospective may be used in centers with much experience of the technique and in patients with stable heart rate)
Scan direction	Cranial-caudal
Scan coverage	From above the aortic arch to past the cardiac apex
Detector collimation	0.4 – 0.625 mm
Pitch	0.2–0.43 adapted to the heart rate
Dose modulation	Modulation and full current between 30 and 80% of the cardiac cycle (or no modulation i.e. full dose throughout)
Slice thickness	0.8mm
Slice overlap	0.4mm
Reconstruction kernel	Medium Smooth
Post-processing	Use single segmental reconstruction algorithm that minimizes motion artifact. Reconstruct at multiple phases (10 minimum, 20 preferred, increments of 5-10%). Reconstructed slice thickness 0.75-1mm.

Step 4: Non ECG-gated contrast enhanced scan of vessels

The aim of this scan is to assess the peripheral access vessels and abdominal aorta for suitability for the procedure.

- Standard radiology CT angiography protocol should be used.
- Can be non ECG-gated
- Contrast Volume: 40-50 cc, Injection rate: 4 cc/sec. Modify per patient as necessary to acquire good quality images
- Delay time calculated using protocol for current scanner (bolus tracking, etc) with peak of contrast concentration in the abdominal aorta and iliac arteries
- Suggested coverage areas:
 - Femoral access only screening: abdominal aorta above celiac artery and down to the femoral head. Use this option there if you are confident that femoral access will be suitable for this patient
 - Subclavian access only screening: above the subclavian arteries and down to mid-thorax. Use this option if prior information (i.e., CT scan) exists which demonstrates that femoral access will not be possible in this patient
 - Combined access screening: above the subclavian arteries and down to the femoral head. This is the recommended option. An additional option for subclavian screening is to include the subclavian vessels in the ECG-gated portion and use femoral only screening for the rest of the vessels
- Source data reconstructed using sub-millimeter slice thickness

Aortic Root and Peripheral Vessel Measurements

CT measurements are conducted in different parts of the cardiac cycle to correlate most closely with corresponding echo measurements

- Systole for aortic annulus measurements
- Diastole for sinus of Valsalva diameters, sinus of Valsalva heights, maximum ascending aorta diameter, and aortic root angulation

Table 2: Required CT Measurements

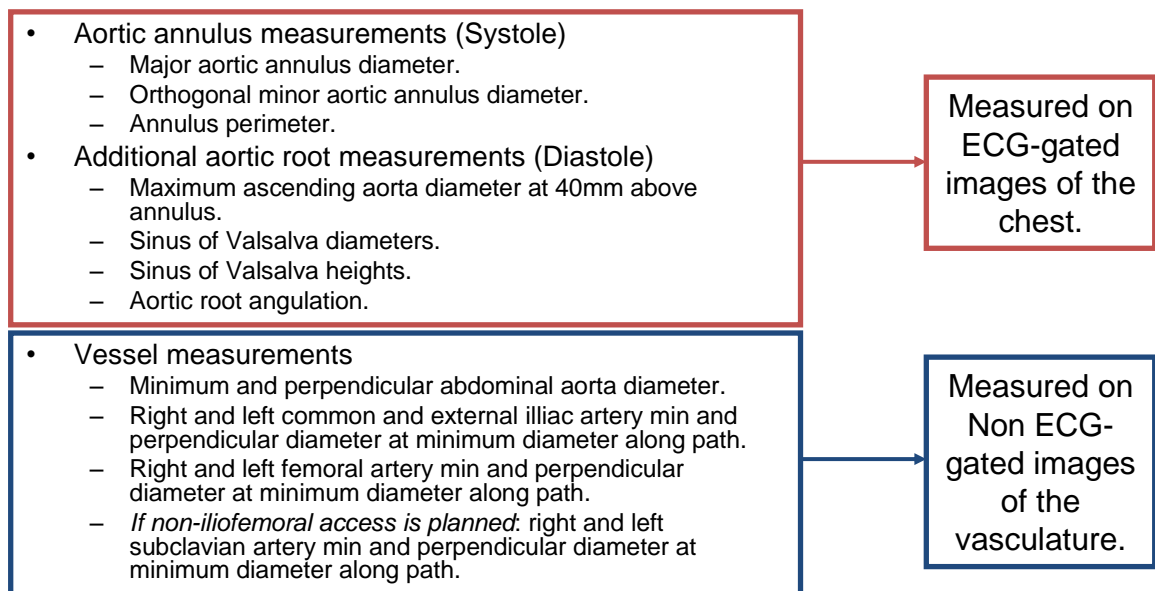

Proper Aortic Annulus Measurements

The aortic annulus is not co-planar with the planes of the body (i.e., axial, sagittal, or coronal). Therefore, multi-planar reformatting of the CT images to create a double-oblique axial image is required for annulus measurements. This reformatting is critical; if the plane is not correctly aligned, it may be going through the sinuses or the LVOT. This can lead to improper device selection.

The methods described here for measurement of the aortic annulus (virtual basal ring) are similar to those reported in Schultz et al. EuroIntervention Supplement (2010) Volume 6 (Supplement G) G6-G13.

Step 1: Reformatting of Images

- Center image cross-hairs on aortic root in all windows where it is visible. Lock cross-hairs so they remain orthogonal for all steps
- In the coronal window, rotate cross-hairs (horizontal line) counter-clockwise to align with virtual basal plane, as shown in Figure CTA-2 (upper left panel)
- In the sagittal window, the horizontal line has to be rotated clockwise or counter-clockwise to align with virtual basal plane, as shown in Figure CTA-2 (lower left panel)
- On the newly defined double-oblique axial image, scroll up and down through the aortic root until the most caudal attachment points of the three native leaflets come into view (indicated by arrowheads in Figure CTA-3 below). If one of the leaflets comes into view at a more cranial or caudal slice, adjust the coronal or sagittal cross-hairs until all three leaflets come into view on the same axial slice

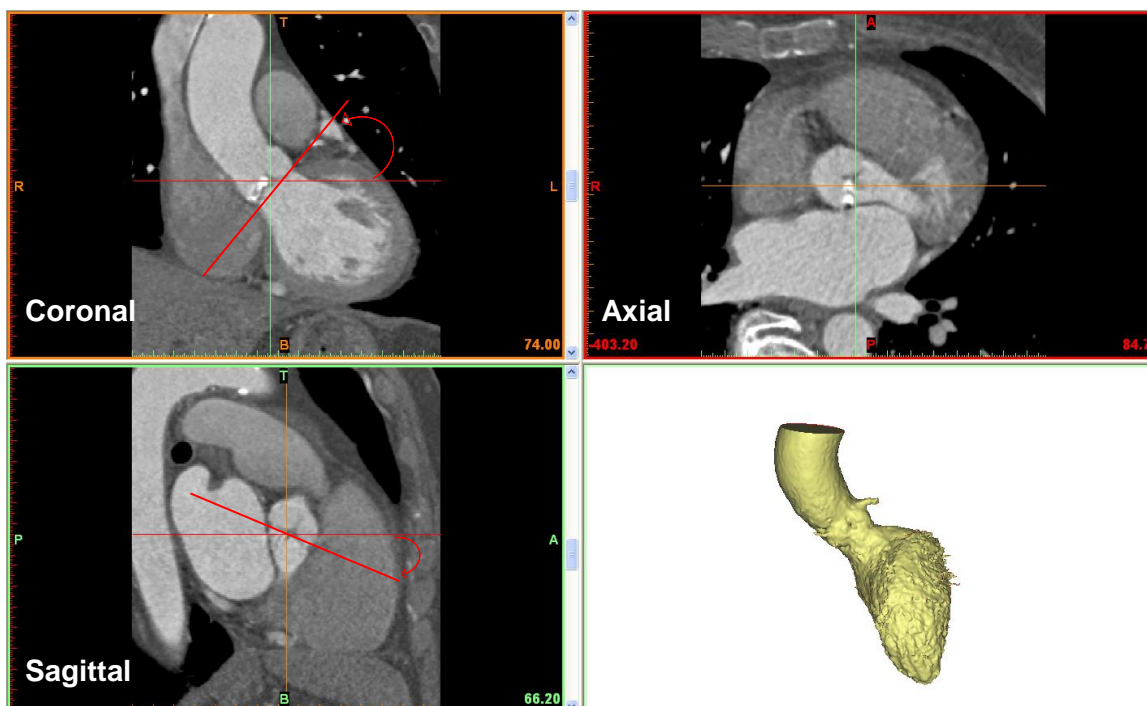

Figure CTA-2: Example images in original orientation (axial, coronal and sagittal). Red curved arrow and line indicate adjustment of coronal and sagittal planes to align with aortic basal annulus.

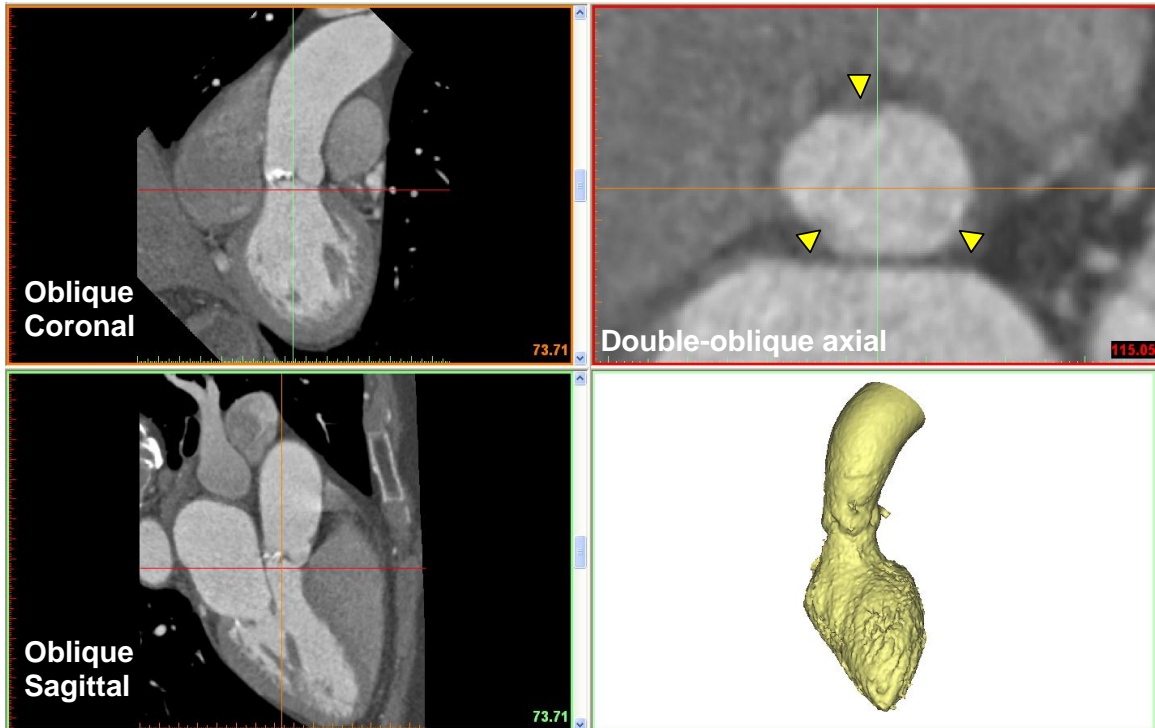

Figure CTA-3: Example images of reformatted oblique coronal (upper left), oblique sagittal (lower left), double oblique axial (upper right) and 3D reconstruction lower right. Yellow arrowheads indicate most caudal attachment of three leaflets of aortic valve.

- For confirmation of the correct aortic annulus plane, scroll through the double oblique axial images starting in the mid sinus and ending at the level of the aortic annulus. The sinuses should appear to be relatively the same size at the level of the mid-sinus and the leaflets should all disappear equally at the level of the annulus

Step 2: Aortic Root Measurements

Aortic Annulus Measurements

- Choose the cleanest systolic images for the aortic annulus measurements
- Aortic annulus measurements should be completed on the properly reformatted double-oblique axial image at aortic annulus level
- Trace the perimeter of the basal annulus (Figure CTA-4, left). Place cross-hairs at center of basal annulus, create major diameter through the center, create minor diameter defined as perpendicular to major and through center (Figure CTA-4, right). Record perimeter, major and minor diameter measurements on the screening worksheet

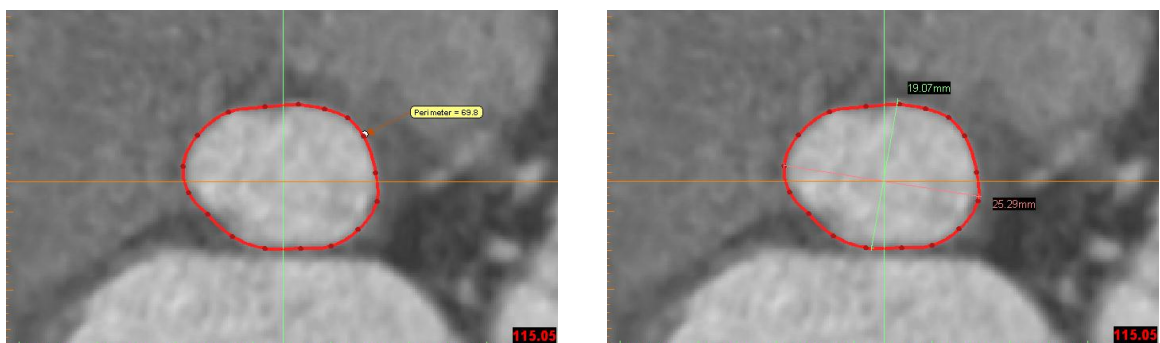

Figure CTA-4: Example of perimeter measurement (left) and major and minor diameter measurements (right).

Additional Aortic Root Measurements

- Choose the best diastolic images for measurement of sinus of Valsalva diameters, sinus of Valsalva heights, maximum ascending aorta diameter (40 mm from annulus), and aortic root angulation. Sinus of Valsalva diameters, heights, and maximum ascending aorta diameter should be completed on reformatted images using the same reformatting technique as used for the aortic annulus measurements

Sinus of Valsalva Diameters

- Select the double oblique axial image where the widest portion of the three sinuses is visible
- Measure a diameter from each commissure through the center of the root to the opposite sinus. Complete for all three sinuses (Figure CTA-5)

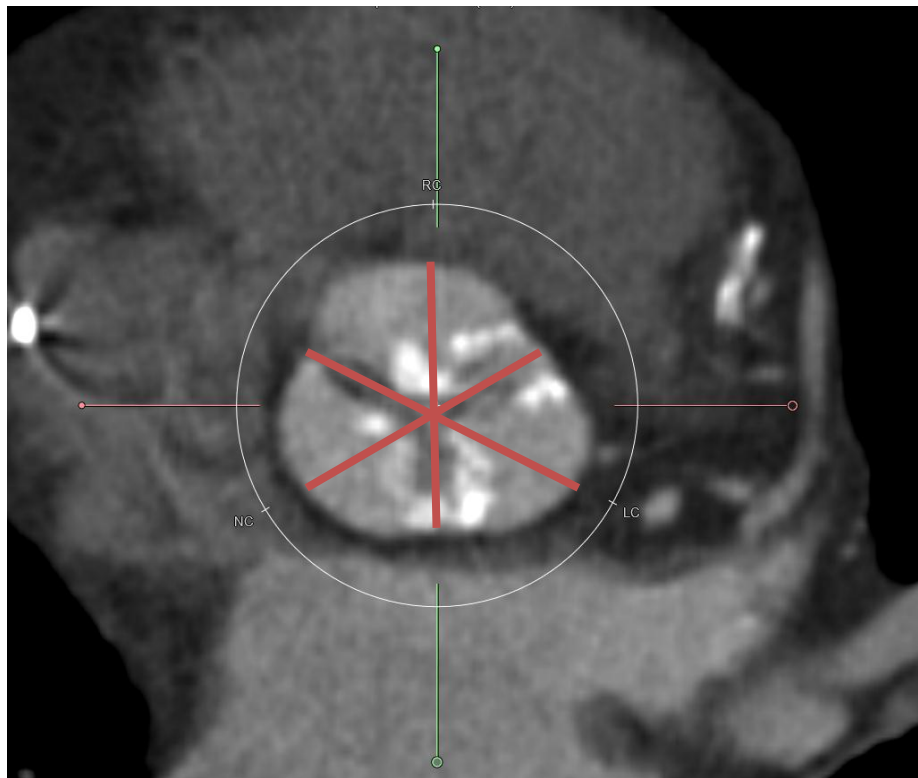
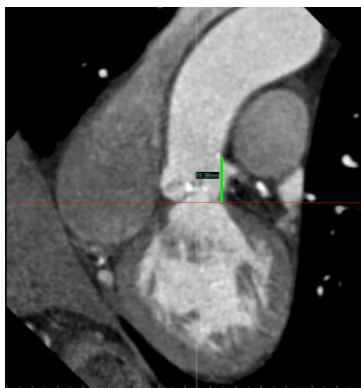

Figure CTA-5: Example of sinus of Valsalva diameters.

Sinus of Valsalva Heights

- The sinotubular junction is typically not co-planar with the aortic annulus. Therefore, a sinus of Valsalva height must be measured for each of the three sinuses. This height is defined as the distance between the aortic annular plane and the tallest point in the sinus
- Choose the double oblique axial image so that it is located at the level of the aortic annulus. The reformatting line representing the double oblique axial image should now be visible in the oblique coronal and oblique sagittal images at the level of the aortic annulus
- For the left coronary and non-coronary heights, use the oblique coronal image. For the right coronary height, use the oblique sagittal image
- To complete the measurement, scroll through the oblique coronal or sagittal image (depending on which sinus you are measuring) and locate the heights location of the sinotubular junction. On that image, measure the distance along the path of the aortic root from the aortic annular plane, marked by the reformatting line, to the sinotubular junction (Figure CTA-6).\



Left coronary height

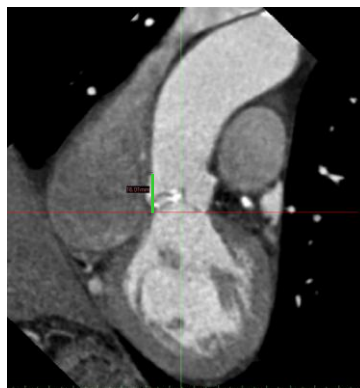

Non coronary height

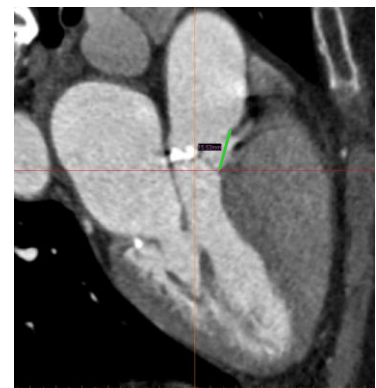

Right coronary height

Figure CTA-6: Example of sinus of Valsalva heights.

Maximum Ascending Aorta Diameter

- Choose the double oblique axial image so that it is located at the level of the aortic annulus. The reformatting line representing the double oblique axial image should now be visible in the oblique coronal and oblique sagittal images at the level of the aortic annulus
- Choose the oblique coronal image that is in the center of the aortic root
- Measure a distance of 40mm from the line representing the aortic annular plane
- Center the images at this level, and reformat the images so that the double oblique is perpendicular to the ascending aorta at this level (Figure CTA-7)
- Measure the maximum diameter at this level (Figure CTA-7)

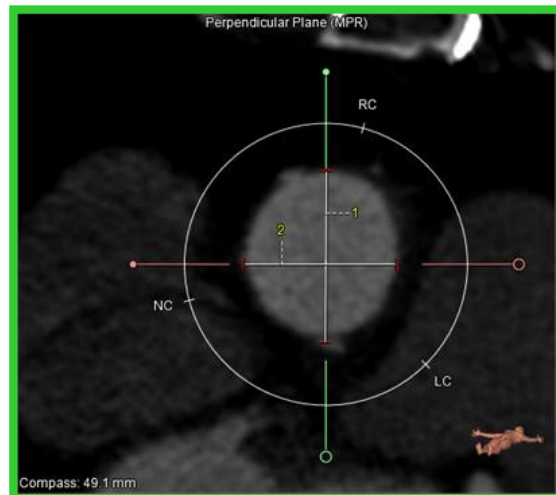
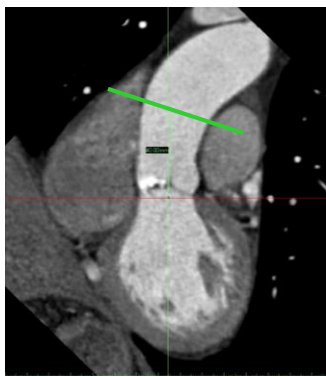

Figure CTA-7: Oblique coronal with measurement of 40mm above the aortic annulus (left) and double-oblique reformatted to be perpendicular to that location (right).

Aortic Root Angulation

- The aortic root angle measured in this study is the angle between the aortic annulus and the true axial plane of the patient
- To measure, use the standard coronal diastolic image, before any reformatting
- Scroll to the middle of the aortic root in these images (Figure CTA-8)
- Use the angle tool to draw a line first across the aortic annulus and second horizontal to the coronal image, which represents the axial plane of the patient. Start the angle measurement in the upper left of the patient, so that the angle is to the lower right of the patient (Figure CTA-8)

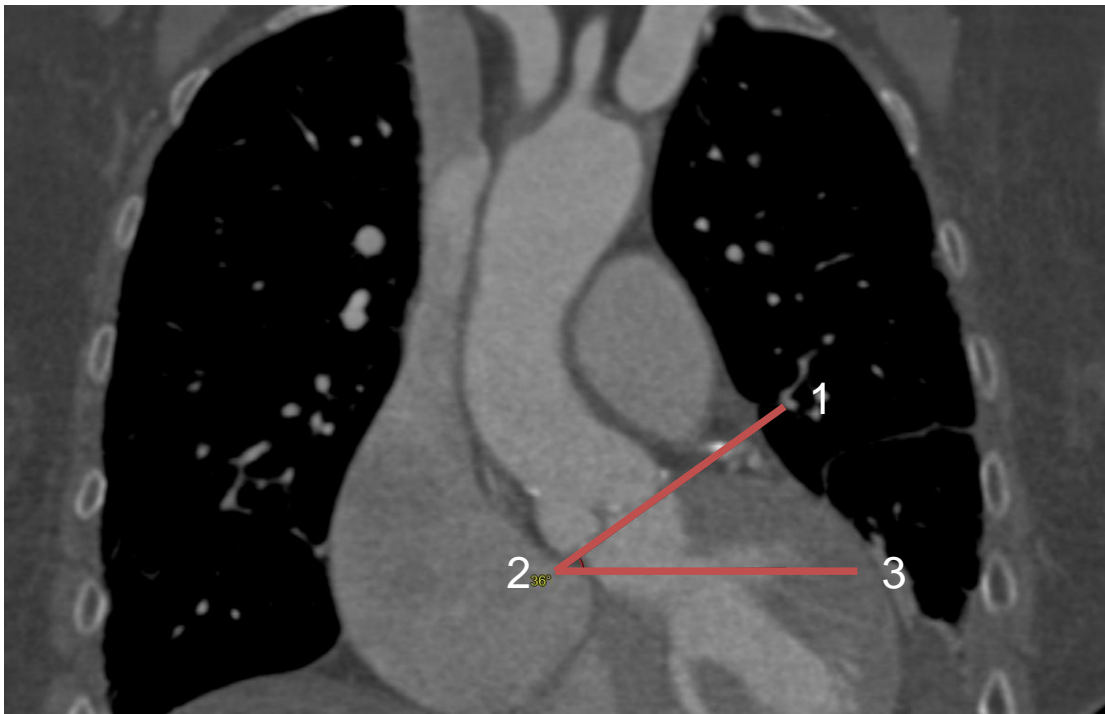

Figure CTA-8: Aortic root angulation measurement on the standard coronal image. Use the angle tool beginning at point 1, with point 2 on the lower right of the patient, and the final point on the lower left of the patient. The first line, between points 1 and 2 should be along the aortic annulus. The second line, between points 2 and 3, should be horizontal in the coronal image, which represents the axial plane of the patient.

Step 3: Access Vessel Measurements

Peripheral vessel measurements are made on non-gated CT and measured on images perpendicular to the vessel. The intent of these measurements is to determine the minimum diameters for the potential access routes. All vessel measurements should be completed on images that are perpendicular to the vessels of interest.

Minimum Abdominal Aortic Diameter

- Use a stretched vessel view to locate the minimum luminal abdominal aortic diameter
- Measure the minimum lumen diameter and a perpendicular diameter on the image orthogonal to the vessel at the minimum location (Figure CTA-9)

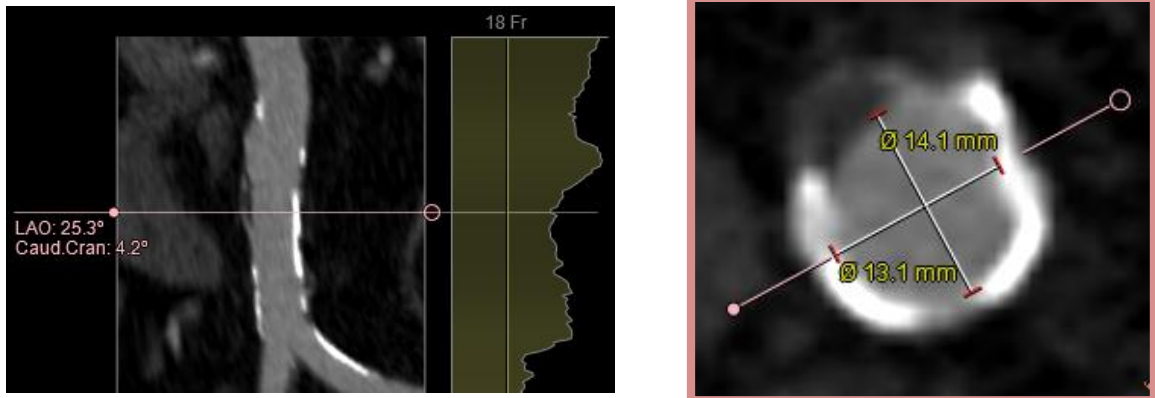

Figure CTA-9: Example of minimum abdominal aortic diameter. Stretched vessel (left), with the pink line at the location of the minimum luminal abdominal diameter. Orthogonal image (right), showing the minimum luminal diameter and the perpendicular diameter.

Peripheral Vessel Measurements

- These techniques are to be used for measurements on the following arteries:
 - Right and left femorals
 - Right and left common and external iliacs
 - If non-femoral access is planned – right and left subclavians
- Use a stretched vessel view to locate the minimum luminal diameter
- Measure the minimum lumen diameter and a perpendicular diameter on the image orthogonal to the vessel at the minimum location (Figure CTA-10)

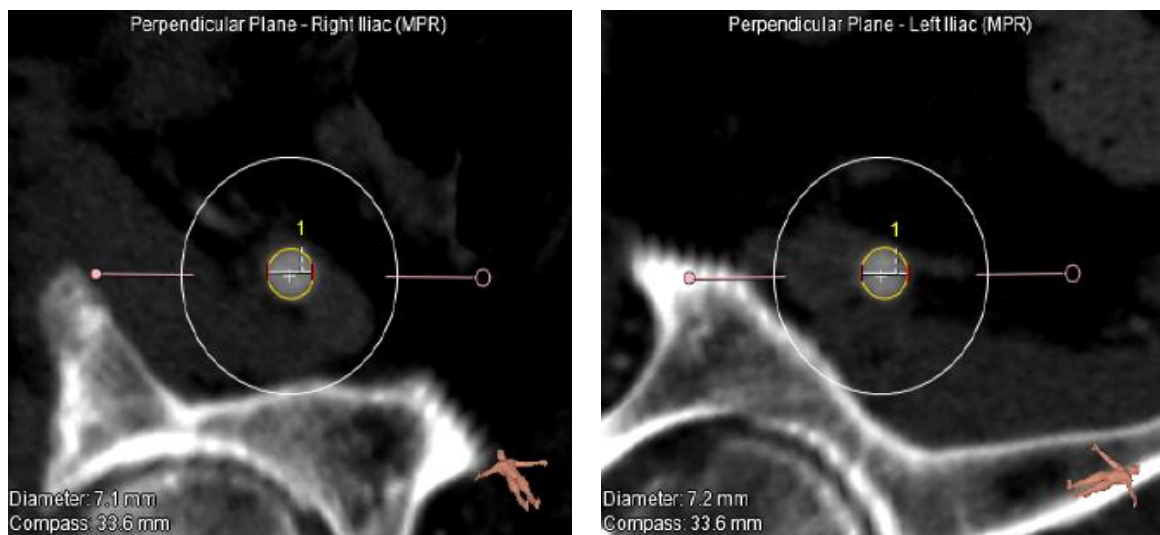

Figure CTA-10: Example of the peripheral vessels and measurements for the right (left) and left (right) iliac arteries.

Additional CT Measurements

- In the case of a thoracic aortic aneurysm, measure the maximum diameter in the aneurysm.
- To determine the maximum location, use similar methods to the other vessel measurements (stretched vessel view)
- Complete the measurement on the orthogonal images and report the maximum diameter

Prepare data for submission

- Data should be stored in DICOM 3.0 format
- If possible, de-identify all images prior to uploading
- Burn images to DICOM DVD/CD or upload to internal electronic records system
- Ensure all required images are included on DVD/CD or internal electronic records system for upload:
 - ECG-gated contrast enhanced aortic root. Upload on 4 time-points: 30% & 40% (systole) and 60% & 70% (diastole). If the system has “best-systolic” and “best-diastolic,” only upload those 2 phases.
 - Non ECG-gated contrast enhanced peripheral vessels – upload entire set.
 - Screenshots of all measurements
- Upload all images to InteleGRID (secure electronic system used for transferring images)

R.10 Interactive Voice/Web Response System (IXRS)

Medtronic will utilize an Interactive Voice/Web Response (IXRS) System to manage subject screen failures and randomization into the Medtronic CoreValve[®] SURTAVI Trial.

The IXRS system will assign patients a Screening ID to be used for all patients that sign the Informed Consent Form and are considered for possible enrollment by the Heart Team. If a patient is screened and does not meet eligibility criteria, the IXRS system will capture the reason for screen failure and disposition of the patient (if known).

Upon meeting eligibility criteria, the IXRS system will randomize the patient and assign a Subject ID to be used in the Oracle Clinical Database upon enrollment.

The IXRS system will assign subjects within one of four groups:

- TAVI with planned PCI
- TAVI without planned PCI
- SAVR with planned CABG
- SAVR without planned CABG

Users can sign in to the Medtronic CoreValve[®] SURTAVI Trial study web site by using the URL below and use the sign in box labeled "IVRS Login":

www.unitedbiosource.com/login.aspx

The first time a user accesses the study web site, they will be prompted to update their password. The password must be at least 8 characters in length and contain at least 1 capital letter and 1 number or symbol.

Remember that the User ID and Password are private and should not be shared with other individuals.

For technical questions, contact UBC Technical Support at 888-794-0122 or at support@unitedbiosource.com

R.11 Explanted Device/Pathology and Return Procedures

In the event of a device malfunction of the Medtronic CoreValve® System (MCS) prior to or during implant, or in the event that a Medtronic CoreValve® PAV is explanted after implant (due to reintervention or autopsy), the PAV and/or affected MCS components should be returned to Medtronic.

SHIPPING INSTRUCTIONS

System Malfunction (CoreValve Device, Delivery Catheter System (DCS) and/or Compression Loading System (CLS) Before or During Procedure

1. Always retain original product packaging until the procedure is completed.
2. Place product back into original packaging if it was not clinically used (i.e. in contact with blood or body fluids)
3. If clinically used, use heart valve return kit to ship the valve or CLS. Use a DCS return kit for the DCS, if applicable.

Explant of CoreValve at Reoperation

1. Photograph the PAV in situ (if possible).
2. If possible, indicate with a suture on the frame, the relation of the CoreValve to the midpoint of the mitral valve.
3. Following explantation, rinse blood from the lumen with a physiologic solution (e.g. Ringer's lactate solution).
4. Do not disturb or alter the valve leaflets in any way (as possible).
5. Remove all packaging material and forms from kit. Temperature indicator should remain in box unless it has been activated. If it has been activated, discard noting that the kit is still usable.
6. Immerse the PAV and any surrounding tissue in the solution provided in the explant kit.
7. Place the jar into the yellow absorbent pouch and close, then into the zip lock bag and seal.

Explant of CoreValve at Autopsy

1. Remove all packaging material and forms from kit.
2. If possible, leave aortic root intact with an ample margin between the valve and descending aorta.
3. Whole hearts should be immersion fixed in formalin in the local autopsy suite or pathology lab for at least 24-48 hours prior to shipping. Note: hospitals or contract pathology labs should have formalin available for use.
4. Use the plastic container provided in the return kit for fixing the heart.
5. Before shipping, remove most of the formalin from the container and wrap the heart in the cloth specimen bag that is provided, which has been thoroughly soaked in formalin. Place the heart and specimen bag back into the container.
6. Label the outside of the container (lid and container) with the CoreValve device serial number, patient ID, center name and study name.
7. Seal the container tightly and wrap the container-lid interface with parafilm (if available).

All Explants/Returns

1. Complete the Product Experience Report (PER) form and email a copy to rs.structuralheartfieldassurance@medtronic.com to receive a PE number.
 - a. If an adverse event form has already been reported for this event and a PE number has already been issued via the AE, use the PE number from the AE correspondence. In this instance, sending the PER to field assurance to receive a PCR number is not required.
2. Note the PE number on the Product Experience Report and place the completed form and autopsy heart in the box.
3. Using the pre-paid/pre-printed form, ship by Federal Express or other overnight carrier if a form is not provided for your convenience. For further assistance, call the number below.

If a return kit is required, contact Customer Service:**1-800-556-4247****All return product should be sent to:**

Medtronic, Inc.

Attn: Explant Lab/ [PE #]

1851 E. Deere Ave.

Santa Ana, CA 92705

USA

1-800-854-3570

R.12 Economic and Quality of Life Data Collection

Throughout this trial, resource utilization data will be collected by the research coordinator along with clinical data using case report forms.

Prior to enrollment in the study, patients will be asked to provide the information and permission to obtain such billing records for the length of their follow-up period. All related data will be kept in a secure and confidential database.

The QOL questionnaire will be administered to all subjects in languages where translation is available. It is not a deviation if a subject does not complete a Quality of Life Questionnaire because a translation is not available in the subject's language.

All QOL assessments will be by written, self-administered questionnaires.

QOL assessments will be performed by personnel at the study site. It is recommended that the assessment is performed prior to informing the subject of their randomization.

Ample, uninterrupted time should be provided for the subject to complete the questionnaire. Every effort should be made to have the subject complete the questionnaire him or herself.

Kansas City Cardiomyopathy Questionnaire (KCCQ)

The Kansas City Cardiomyopathy Questionnaire (KCCQ) is a validated self-administered 23-item questionnaire that quantifies physical limitations, symptoms, self-efficacy, social interference and quality of life.

SF-12

QualityMetric's SF-12v2® Health Survey is a shorter version of the SF-36v2® Health Survey that uses 12 questions to measure functional health and well-being from the patient's point of view.

EuroQoL EQ-5D

The EQ-5D is a measure of self-reported health outcomes that is applicable to a wide range of health conditions and treatments. It consists of two parts: a descriptive system (Part I) and a visual analogue scale (VAS) (Part II). Part I of the scale consists of 5 single-item dimensions including: mobility, self-care, usual activities, pain/discomfort, and anxiety/depression. Each dimension has a 3 point response scale designed to indicate the level of the problem. Part II uses a vertical graduated VAS (thermometer) to measure health status, ranging from worst imaginable health state to best imaginable health state.

R.13 Pacing Guidelines

Recommendations for pacing pre-, peri- and post-operatively are provided below (see also Medtronic CoreValve® System Instructions For Use). These are recommendations, however, and final decisions should be made via clinical presentation and physician discretion. Programmed settings for temporary and permanent pacing are per patient condition and physician discretion.

Pre-operative Recommendations

- Ensure subject is informed about the placement of temporary pacing wires during the procedure and any additional associated risks.
- Ensure subject is informed about the potential for the placement of a permanent pacemaker and any additional associated risks.
- Obtain a baseline 12-lead ECG and assess for patient's conduction status
- **Subjects with a pre-existing permanent pacemaker only:** Conduct a full interrogation and AV conduction assessment. Print a copy of the interrogation and save the data on a diskette. Label the diskette with labels provided by Medtronic, including center name, patient ID, date and time of visit/interrogation and type of visit. Retain the printout and diskette in the subject's file for source verification.
 - **Recommended AV conduction assessment:**
 - Conduct an atrial threshold test with a long AV delay (e.g. 350ms) in DDD mode.
 - If the subject's ventricular rhythm doesn't come through within the 350 ms, the subject would be considered dependent on ventricular pacing.

Peri-operative Recommendations

- Prior to beginning the Medtronic CoreValve® System implant, place a temporary 4-5 Fr. balloon-tip pacing wire in a stable location within the right ventricular (a screw-tip wire may be used for more secure placement for subjects at high-risk for dislodgement, if necessary and experienced with implantation technique).
 - Whenever possible, use the upper torso venous system (e.g., jugular, sub-clavian) for temporary pacing wire access due to the recommendation to leave this system in for at least 48 hours post-procedure.
 - Use fluoroscopy to guide wire placement and stability.
 - Confirm sensing and capture
 - Program the backup pacing rate to minimize ventricular pacing (e.g. 30-40 bpm). If heart block develops, adjustment the rate accordingly.
- Rapid pacing during balloon valvuloplasty
 - Conduct a rapid pacing test prior to balloon valvuloplasty.
 - Successful test is defined as 1-to-1 pacing capture with an immediate drop in pressure and elimination of the systolic-diastolic waveform.

Post-operative Recommendations

- All patients should stay on telemetry until discharge
- Maintain temporary pacing until at least 48 hours post-implant
 - Ensure a clean, sterile environment is maintained
- After 48 hours, obtain ECG and assess patient rhythm and conduction
 - Based on assessment, and with the consult of an electrophysiologist as needed, take one of the following actions:
 - Discontinue temporary pacing

- Continue temporary pacing for another 24 hours (longer if needed) to make further assessments
- Place a permanent pacemaker according to ACC/AHA/HRS Guidelines for Device-Based Therapy of Cardiac Rhythm Abnormalities¹ (Class I or IIa for Acquired Atrioventricular Block in Adults or Permanent Pacing in Chronic Bifascicular Block)
 - Prior to the permanent pacemaker implantation, document the reason for the placement of the permanent pacemaker via a 12-lead ECG.
- For complete heart block, review patient medications. Consider withholding some medications to assess for patient's intrinsic rate and conduction. If heart block persists off medications, a permanent pacemaker should be considered.
- If a permanent pacemaker is required, a dual chamber system is recommended to optimize patient hemodynamics.
- If a permanent pacemaker is implanted, perform a device interrogation and AV conduction assessment post insertion and prior to hospital discharge as well as at every follow-up visit to evaluate device utilization. Print a copy of the interrogation and save the data on a diskette. Label the diskette with labels provided by Medtronic, including center name, patient ID, date and time of visit/interrogation and type of visit. Retain the printout and diskette in the subject's file for source verification.
 - **Recommended AV conduction assessment:**
 - Conduct an atrial threshold test with a long AV delay (350ms) in DDD mode.
 - If the subject's ventricular rhythm doesn't come through within the 350 ms, the subject would be considered dependent on ventricular pacing.

¹ ACC/AHA/HRS 2008 Guidelines for Device-Based Therapy of Cardiac Rhythm Abnormalities: J Am Coll Cardiol 2008; 51:2085–105; Circulation 2008;117:2820–40

ACC/AHA/HRS 2008 Guidelines for Device-Based Therapy of Cardiac Rhythm Abnormalities

Recommendations for Acquired Atrioventricular Block in Adults

Class I Permanent pacemaker implantation is indicated for:

- Third-degree and advanced second-degree atrioventricular (AV) block at any anatomic level associated with bradycardia with symptoms (including heart failure) or ventricular arrhythmias presumed to be due to AV block. (LOE: C)
- Third-degree and advanced second-degree AV block at any anatomic level associated with arrhythmias and other medical conditions that require drug therapy that results in symptomatic bradycardia. (LOE: C)
- Third-degree and advanced second-degree AV block at any anatomic level in awake, symptom-free patients in sinus rhythm, with documented periods of asystole greater than or equal to 3.0 seconds or any escape rate less than 40 bpm, or with an escape rhythm that is below the AV node. (LOE: C)
- Third-degree and advanced second-degree AV block at any anatomic level in awake, symptom-free patients with atrial fibrillation and bradycardia with 1 or more pauses of at least 5 seconds or longer. (LOE: C)
- Third-degree and advanced second-degree AV block at any anatomic level after catheter ablation of the AV junction. (LOE: C)
- Third-degree and advanced second-degree AV block at any anatomic level associated with postoperative AV block that is not expected to resolve after cardiac surgery. (LOE: C)
- Third-degree and advanced second-degree AV block at any anatomic level associated with neuromuscular diseases with AV block, such as myotonic muscular dystrophy, Kearns-Sayre syndrome, Erb dystrophy (limb-girdle muscular dystrophy), and peroneal muscular atrophy, with or without symptoms. (LOE: B)
- Second-degree AV block with associated symptomatic bradycardia regardless of type or site of block. (LOE: B)
- Asymptomatic persistent third-degree AV block at any anatomic site with average awake ventricular rates of 40 bpm or faster if cardiomegaly or left ventricular (LV) dysfunction is present or if the site of block is below the AV node. (LOE: B)
- Second- or third-degree AV block during exercise in the absence of myocardial ischemia. (LOE: C)

Class IIa Permanent pacemaker implantation is reasonable for:

- Persistent third-degree AV block with an escape rate greater than 40 bpm in asymptomatic adult patients without cardiomegaly. (LOE: C)
- Asymptomatic second-degree AV block at intra or infra-His levels found at electrophysiological study. (LOE: B)
- First- or second-degree AV block with symptoms similar to those of pacemaker syndrome or hemodynamic compromise. (LOE: B)
- Asymptomatic type II second-degree AV block with a narrow QRS. When type II second-degree AV block occurs with a wide QRS, including isolated right bundle-branch block, pacing becomes a Class I recommendation (see Section 2.1.3, "Chronic Bifascicular Block," in the full-text guidelines). (LOE: B)

Recommendations for Permanent Pacing in Chronic Bifascicular Block

Class I Permanent pacemaker implantation is indicated for:

- Advanced second-degree AV block or intermittent third-degree AV block. (LOE: B)
- Type II second-degree AV block. (LOE: B)
- Alternating bundle-branch block. (LOE: C)

Class IIa Permanent pacemaker implantation is reasonable for:

- Syncope not demonstrated to be due to AV block when other likely causes have been excluded, specifically ventricular tachycardia (VT). (LOE: B)
- Incidental finding at electrophysiological study of a markedly prolonged HV interval (greater than or equal to 100 milliseconds) in asymptomatic patients. (LOE: B)
- Incidental finding at electrophysiological study of pacing-induced infra-His block that is not physiological. (LOE: B)

R.14 Six Minute Walk Test Instructions

American Thoracic Society

ATS Statement: Guidelines for the Six-Minute Walk Test

THIS OFFICIAL STATEMENT OF THE AMERICAN THORACIC SOCIETY WAS APPROVED BY THE ATS BOARD OF DIRECTORS MARCH 2002

CONTENTS

- Purpose and Scope
- Background
- Indications and Limitations
- Contraindications
- Safety Issues
- Technical Aspects of the 6-Minute Walk Test
- Required Equipment
- Patient Preparation
- Measurements
- Quality Assurance
- Interpretation
- References

PURPOSE AND SCOPE

This statement provides practical guidelines for the 6-minute walk test (6MWT). Specifically, it reviews indications, details factors that influence results, presents a brief step-by-step protocol, outlines safety measures, describes proper patient preparation and procedures, and offers guidelines for clinical interpretation of results. These recommendations are not intended to limit the use of alternative protocols for research studies. We do not discuss the general topic of clinical exercise testing.

As with other American Thoracic Society statements on pulmonary function testing, these guidelines come out of a consensus conference. Drafts were prepared by two members (P.L.E. and R.J.Z.) and were based on a comprehensive Medline literature search from 1970 through 2001, augmented by suggestions from other committee members. Each draft responded to comments from the working committee. The guidelines follow previously published methods as closely as possible and provide a rationale for each specific recommendation. The final recommendations represent a consensus of the committee. The committee recommends that these guidelines be reviewed in five years and in the meantime encourages further research in areas of controversy.

BACKGROUND

There are several modalities available for the objective evaluation of functional exercise capacity. Some provide a very complete assessment of all systems involved in exercise performance (high tech), whereas others provide basic information but are low tech and are simpler to perform. The modality used should be chosen based on the clinical question to be addressed and on available resources. The most popular clinical exercise tests in order of increasing complexity are stair climbing, a 6MWT, a shuttle-walk test, detection of exercise-induced asthma, a cardiac stress test (e.g., Bruce protocol), and a cardiopulmonary exercise test (1, 2). Other professional organizations have published standards for cardiac stress testing (3, 4).

Assessment of functional capacity has traditionally been done by merely asking patients the following: "How many flights of stairs can you climb or how many blocks can you walk?" However, patients vary in their recollection and may report overestimations or underestimations of their true functional capacity. Objective measurements are usually better than self-reports. In the early 1960s, Balke developed a simple test to evaluate the functional capacity by measuring the distance walked during a defined period of time (5). A 12-minute field performance test was then developed to evaluate the level of physical fitness of healthy individuals (6). The walking test was also adapted to assess disability in patients with chronic bronchitis (7). In an attempt to accommodate patients with respiratory disease for whom walking 12 minutes was too

exhausting, a 6-minute walk was found to perform as well as the 12-minute walk (8). A recent review of functional walking tests concluded that "the 6MWT is easy to administer, better tolerated, and more reflective of activities of daily living than the other walk tests" (9).

The 6MWT is a practical simple test that requires a 100-ft hallway but no exercise equipment or advanced training for technicians. Walking is an activity performed daily by all but the most severely impaired patients. This test measures the distance that a patient can quickly walk on a flat, hard surface in a period of 6 minutes (the 6MWD). It evaluates the global and integrated responses of all the systems involved during exercise, including the pulmonary and cardiovascular systems, systemic circulation, peripheral circulation, blood, neuromuscular units, and muscle metabolism. It does not provide specific information on the function of each of the different organs and systems involved in exercise or the mechanism of exercise limitation, as is possible with maximal cardiopulmonary exercise testing. The self-paced 6MWT assesses the submaximal level of functional capacity. Most patients do not achieve maximal exercise capacity during the 6MWT; instead, they choose their own intensity of exercise and are allowed to stop and rest during the test. However, because most activities of daily living are performed at submaximal levels of exertion, the 6MWD may better reflect the functional exercise level for daily physical activities.

INDICATIONS AND LIMITATIONS

The strongest indication for the 6MWT is for measuring the response to medical interventions in patients with moderate to severe heart or lung disease. The 6MWT has also been used as a one-time measure of functional status of patients, as well as a predictor of morbidity and mortality (see [Table 1](#) for a list of these indications). The fact that investigators have used the 6MWT in these settings does not prove that the test is clinically useful (or the best test) for determining functional capacity or changes in functional capacity due to an intervention in patients with these diseases. Further studies are necessary to determine the utility of the 6MWT in various clinical situations.

TABLE 1. Indications for the Six-Minute Walk Test

Pretreatment and post treatment comparisons

- Lung transplantation (9, 10)
- Lung resection (11)
- Lung volume reduction surgery (12, 13)
- Pulmonary rehabilitation (14, 15)
- COPD (16–18)
- Pulmonary hypertension
- Heart failure (19, 20)

Functional status (single measurement)

- COPD (21, 22)
- Cystic fibrosis (23, 24)
- Heart failure (25–27)
- Peripheral vascular disease (28, 29)
- Fibromyalgia (30)
- Older patients (31)

Predictor of morbidity and mortality

- Heart failure (32, 33)
 - COPD (34, 35)
 - Primary pulmonary hypertension (10, 36)
-

Definition of abbreviation: COPD = chronic obstructive pulmonary disease.

Formal cardiopulmonary exercise testing provides a global assessment of the exercise response, an objective determination of functional capacity and impairment, determination of the appropriate intensity needed to perform prolonged exercise, quantification of factors limiting exercise, and a definition of the underlying pathophysiologic mechanisms such as the contribution of different organ systems involved in exercise. The 6MWT does not determine peak oxygen uptake, diagnose the cause of dyspnea on exertion, or evaluate the causes or mechanisms of exercise limitation (1, 2). The information provided by a 6MWT should be considered complementary to cardiopulmonary exercise testing, not a replacement for it.

Despite the difference between these two functional tests, some good correlations between them have been reported. For example, a significant correlation ($r = 0.73$) between 6MWD and peak oxygen uptake has been reported for patients with end-stage lung diseases (36).

In some clinical situations, the 6MWT provides information that may be a better index of the patient's ability to perform daily activities than is peak oxygen uptake; for example, 6MWD correlates better with formal measures of quality of life (37). Changes in 6MWD after therapeutic interventions correlate with subjective improvement in dyspnea (38, 39). The reproducibility of the 6MWD (with a coefficient of variation of approximately 8%) appears to be better than the reproducibility of 1-second forced expiratory volume in patients with chronic obstructive pulmonary disease (COPD) (8, 39–42). Questionnaire indices of functional status have a larger short-term variability (22–33%) than does the 6MWD (37).

The shuttle-walking test is similar to the 6MWT, but it uses an audio signal from a tape cassette to direct the walking pace of the patient back and forth on a 10-m course (43–45). The walking speed is increased every minute, and the test ends when the patient cannot reach the turnaround point within the required time. The exercise performed is similar to a symptom-limited, maximal, incremental treadmill test. An advantage of the shuttle walking test is that it has a better correlation with peak oxygen uptake than the 6MWD (46, 47). Disadvantages include less validation, less widespread use, and more potential for cardiovascular problems.

CONTRAINDICATIONS

Absolute contraindications for the 6MWT include the following: unstable angina during the previous month and myocardial infarction during the previous month. Relative contraindications include a resting heart rate of more than 120, a systolic blood pressure of more than 180 mm Hg, and a diastolic blood pressure of more than 100 mm Hg.

Patients with any of these findings should be referred to the physician ordering or supervising the test for individual clinical assessment and a decision about the conduct of the test. The results from a resting electrocardiogram done during the previous 6 months should also be reviewed before testing. Stable exertional angina is not an absolute contraindication for a 6MWT, but patients with these symptoms should perform the test after using their antiangina medication, and rescue nitrate medication should be readily available.

Rationale

Patients with the previously mentioned risk factors may be at increased risk for arrhythmias or cardiovascular collapse during testing. However, each patient determines the intensity of their exercise, and the test (without electrocardiogram monitoring) has been performed in thousands of older persons (31, 48) and thousands of patients with heart failure or cardiomyopathy (32, 49, 50) without serious adverse events. The contraindications listed previously here were used by study investigators based on their impressions of the general safety of the 6MWT and their desire to be prudent, but it is unknown whether adverse events would occur if such patients performed a 6MWT; they are, therefore, listed as relative contraindications.

SAFETY ISSUES

1. Testing should be performed in a location where a rapid, appropriate response to an emergency is possible. The appropriate location of a crash cart should be determined by the physician supervising the facility.
2. Supplies that must be available include oxygen, sublingual nitroglycerine, aspirin, and albuterol (metered dose inhaler or nebulizer). A telephone or other means should be in place to enable a call for help.
3. The technician should be certified in cardiopulmonary resuscitation with a minimum of Basic Life Support by an American Heart Association–approved cardiopulmonary resuscitation course. Advanced cardiac life support certification is desirable. Training, experience, and certification in related health care fields (registered nurse, registered respiratory therapist, certified pulmonary function technician, etc.) are also desirable. A certified individual should be readily available to respond if needed.

4. Physicians are not required to be present during all tests. The physician ordering the test or a supervising laboratory physician may decide whether physician attendance at a specific test is required.
5. If a patient is on chronic oxygen therapy, oxygen should be given at their standard rate or as directed by a physician or a protocol.

Reasons for immediately stopping a 6MWT include the following: (1) chest pain, (2) intolerable dyspnea, (3) leg cramps, (4) staggering, (5) diaphoresis, and (6) pale or ashen appearance.

Technicians must be trained to recognize these problems and the appropriate responses. If a test is stopped for any of these reasons, the patient should sit or lie supine as appropriate depending on the severity or the event and the technician's assessment of the severity of the event and the risk of syncope. The following should be obtained based on the judgment of the technician: blood pressure, pulse rate, oxygen saturation, and a physician evaluation. Oxygen should be administered as appropriate.

TECHNICAL ASPECTS OF THE 6MWT

Location

The 6MWT should be performed indoors, along a long, flat, straight, enclosed corridor with a hard surface that is seldom traveled. If the weather is comfortable, the test may be performed outdoors. The walking course must be 30 m in length. A 100-ft hallway is, therefore, required. The length of the corridor should be marked every 3 m. The turnaround points should be marked with a cone (such as an orange traffic cone). A starting line, which marks the beginning and end of each 60-m lap, should be marked on the floor using brightly colored tape.

Rationale

A shorter corridor requires patients to take more time to reverse directions more often, reducing the 6MWD. Most studies have used a 30-m corridor (51), but some have used 20- or 50-m corridors (52, 53). A recent multicenter study found no significant effect of the length of straight courses ranging from 50 to 164 ft, but patients walked farther on continuous (oval) tracks (mean 92 ft farther) (54).

The use of a treadmill to determine the 6MWD might save space and allow constant monitoring during the exercise, but the use of a treadmill for 6-minute walk testing is not recommended. Patients are unable to pace themselves on a treadmill. In one study of patients with severe lung disease, the mean distance walked on the treadmill during 6 minutes (with the speed adjusted by the patients) was shorter by a mean of 14% when compared with the standard 6MWD using a 100-ft hallway (55). The range of differences was wide, with patients walking between 400–1,300 ft on the treadmill who walked 1,200 ft in the hallway. Treadmill test results, therefore, are not interchangeable with corridor tests.

REQUIRED EQUIPMENT

1. Countdown timer (or stopwatch)
2. Mechanical lap counter
3. Two small cones to mark the turnaround points
4. A chair that can be easily moved along the walking course
5. Worksheets on a clipboard
6. A source of oxygen
7. Sphygmomanometer
8. Telephone
9. Automated electronic defibrillator

PATIENT PREPARATION

1. Comfortable clothing should be worn.
2. Appropriate shoes for walking should be worn.
3. Patients should use their usual walking aids during the test (cane, walker, etc.).
4. The patient's usual medical regimen should be continued.
5. A light meal is acceptable before early morning or early afternoon tests.
6. Patients should not have exercised vigorously within 2 hours of beginning the test.

MEASUREMENTS

1. Repeat testing should be performed about the same time of day to minimize intraday variability.
2. A "warm-up" period before the test should not be performed.
3. The patient should sit at rest in a chair, located near the starting position, for at least 10 minutes before the test starts. During this time, check for contraindications, measure pulse and blood pressure, and make sure that clothing and shoes are appropriate. Complete the first portion of the worksheet (see the [APPENDIX](#)).
4. Pulse oximetry is optional. If it is performed, measure and record baseline heart rate and oxygen saturation (SpO₂) and follow manufacturer's instructions to maximize the signal and to minimize motion artifact ([56](#)). Make sure the readings are stable before recording. Note pulse regularity and whether the oximeter signal quality is acceptable.

The rationale for measuring oxygen saturation is that although the distance is the primary outcome measure, improvement during serial evaluations may be manifest either by an increased distance or by reduced symptoms with the same distance walked ([38](#)). The SpO₂ should not be used for constant monitoring during the exercise. The technician must not walk with the patient to observe the SpO₂. If worn during the walk, the pulse oximeter must be lightweight (less than 2 pounds), battery powered, and held in place (perhaps by a "fanny pack") so that the patient does not have to hold or stabilize it and so that stride is not affected. Many pulse oximeters have considerable motion artifact that prevents accurate readings during the walk ([57](#)).

5. Have the patient stand and rate their baseline dyspnea and overall fatigue using the Borg scale (see [Table 2](#) for the Borg scale and instructions [[58](#)]).
6. Set the lap counter to zero and the timer to 6 minutes. Assemble all necessary equipment (lap counter, timer, clipboard, Borg Scale, worksheet) and move to the starting point.
7. Instruct the patient as follows:

"The object of this test is to walk as far as possible for 6 minutes. You will walk back and forth in this hallway. Six minutes is a long time to walk, so you will be exerting yourself. You will probably get out of breath or become exhausted. You are permitted to slow down, to stop, and to rest as necessary. You may lean against the wall while resting, but resume walking as soon as you are able.

You will be walking back and forth around the cones. You should pivot briskly around the cones and continue back the other way without hesitation. Now I'm going to show you. Please watch the way I turn without hesitation."

Demonstrate by walking one lap yourself. Walk and pivot around a cone briskly.

"Are you ready to do that? I am going to use this counter to keep track of the number of laps you complete. I will click it each time you turn around at this starting line. Remember that the object is to walk AS FAR AS POSSIBLE for 6 minutes, but don't run or jog.

Start now, or whenever you are ready."

TABLE 2. The Borg scale

0	Nothing at all
0.5	Very, very slight (just noticeable)
1	Very slight
2	Slight (light)
3	Moderate
4	Somewhat severe
5	Severe (heavy)
6	
7	Very severe
8	
9	
10	Very, very severe (maximal)

This Borg scale should be printed on heavy paper (11 inches high and perhaps laminated) in 20-point type size. At the beginning of the 6-minute exercise, show the scale to the patient and ask the patient this: *"Please grade your level of shortness of breath using this scale."* Then ask this: *"Please grade your level of fatigue using this scale."* At the end of the exercise, remind the patient of the breathing number that they chose before the exercise and ask the patient to grade their breathing level again. Then ask the patient to grade their level of fatigue, after reminding them of their grade before the exercise.

8. Position the patient at the starting line. You should also stand near the starting line during the test. Do not walk with the patient. As soon as the patient starts to walk, start the timer
9. Do not talk to anyone during the walk. Use an even tone of voice when using the standard phrases of encouragement. Watch the patient. Do not get distracted and lose count of the laps. Each time the participant returns to the starting line, click the lap counter once (or mark the lap on the worksheet). Let the participant see you do it. Exaggerate the click using body language, like using a stopwatch at a race.

After the first minute, tell the patient the following (in even tones): *"You are doing well. You have 5 minutes to go."*

When the timer shows 4 minutes remaining, tell the patient the following: *"Keep up the good work. You have 4 minutes to go."*

When the timer shows 3 minutes remaining, tell the patient the following: *"You are doing well. You are halfway done."*

When the timer shows 2 minutes remaining, tell the patient the following: *"Keep up the good work. You have only 2 minutes left."*

When the timer shows only 1 minute remaining, tell the patient: *"You are doing well. You have only 1 minute to go."*

Do not use other words of encouragement (or body language to speed up).

If the patient stops walking during the test and needs a rest, say this: *"You can lean against the wall if you would like; then continue walking whenever you feel able."* Do not stop the timer. If the patient stops before the 6 minutes are up and refuses to continue (or you decide that they should not continue), wheel the chair over for the patient to sit on, discontinue the walk, and note on the worksheet the distance, the time stopped, and the reason for stopping prematurely.

When the timer is 15 seconds from completion, say this: *"In a moment I'm going to tell you to stop. When I do, just stop right where you are and I will come to you."*

When the timer rings (or buzzes), say this: *"Stop!"* Walk over to the patient. Consider taking the chair if they look exhausted. Mark the spot where they stopped by placing a bean bag or a piece of tape on the floor.

10. Post-test: Record the postwalk Borg dyspnea and fatigue levels and ask this: *"What, if anything, kept you from walking farther?"*

11. If using a pulse oximeter, measure SpO₂ and pulse rate from the oximeter and then remove the sensor.
12. Record the number of laps from the counter (or tick marks on the worksheet).
13. Record the additional distance covered (the number of meters in the final partial lap) using the markers on the wall as distance guides. Calculate the total distance walked, rounding to the nearest meter, and record it on the worksheet.
14. Congratulate the patient on good effort and offer a drink of water.

QUALITY ASSURANCE

Sources of Variability

There are many sources of 6MWD variability (see [Table 3](#)). The sources of variability caused by the test procedure itself should be controlled as much as possible. This is done by following the standards found in this document and by using a quality-assurance program.

TABLE 3. 6MWD Sources of Variability

Factors reducing the 6MWD
Shorter height
Older age
Higher body weight
Female sex
Impaired cognition
A shorter corridor (more turns)
Pulmonary disease (COPD, asthma, cystic fibrosis, interstitial lung disease)
Cardiovascular disease (angina, MI, CHF, stroke, TIA, PVD, AAI)
Musculoskeletal disorders (arthritis, ankle, knee, or hip injuries, muscle wasting, etc.)
Factors increasing the 6MWD
Taller height (longer legs)
Male sex
High motivation
A patient who was previously performed the test
Medication for a disabling disease taken just before the test
Oxygen supplementation in patients with exercise induced hypoxemia

Definition of abbreviations: COPD = chronic obstructive pulmonary disease; 6MWD = 6-minute walking distance.

Practice Tests

A practice test is not needed in most clinical settings but should be considered. If a practice test is done, wait for at least 1 hour before the second test and report the highest 6MWD as the patient's 6MWD baseline.

Rationale

The 6MWD is only slightly higher for a second 6MWT performed a day later. The mean reported increase ranges from 0 to 17% ([23](#), [27](#), [40](#), [41](#), [54](#), [59](#)). A multicenter study of 470 highly motivated patients with severe COPD performed two 6MWTs 1 day apart, and on average, the 6MWD was only 66 ft (5.8%) higher on the second day ([54](#)).

Performance (without an intervention) usually reaches a plateau after two tests done within a week ([8](#), [60](#)). The training effect may be due to improved coordination, finding optimal stride length, and overcoming anxiety. The possibility of a practice or training effect from tests repeated after more than a month has not been studied or reported; however, it is likely that the effect of training wears off (does not persist) after a few weeks.

Technician Training and Experience

Technicians who perform 6MWTs should be trained using the standard protocol and then supervised for several tests before performing them alone. They should also have completed cardiopulmonary resuscitation training.

Rationale

One multicenter study of older people found that after correction for many other factors, two of the technicians had mean 6MWDs that were approximately 7% lower than the other two sites (31).

Encouragement

Only the standardized phrases for encouragement (as specified previously here) must be used during the test.

Rationale

Encouragement significantly increases the distance walked (42). Reproducibility for tests with and without encouragement is similar. Some studies have used encouragement every 30 seconds, every minute, or every 2 minutes. We have chosen every minute and standard phrases. Some studies (53) have instructed patients to walk as fast as possible. Although larger mean 6MWDs may be obtained thereby, we recommend that such phrases not be used, as they emphasize initial speed at the expense of earlier fatigue and possible excessive cardiac stress in some patients with heart disease.

Supplemental Oxygen

If oxygen supplementation is needed during the walks and serial tests are planned (after an intervention other than oxygen therapy), then during all walks by that patient oxygen should be delivered in the same way with the same flow. If the flow must be increased during subsequent visits due to worsening gas exchange, this should be noted on the worksheet and considered during interpretation of the change noted in 6MWD. The type of oxygen delivery device should also be noted on the report: for instance, the patient carried liquid oxygen or pushed or pulled an oxygen tank, the delivery was pulsed or continuous, or a technician walked behind the patient with the oxygen source (not recommended). Measurements of pulse and SpO₂ should be made after waiting at least 10 minutes after any change in oxygen delivery.

Rationale

For patients with COPD or interstitial lung disease, oxygen supplementation increases the 6MWD (17, 59, 61). Carrying a portable gas container (but not using it for supplemental oxygen) reduced the mean 6MWD by 14% in one study of patients with severe respiratory disability, but using the container to deliver supplemental oxygen during the exercise increased the mean 6MWD by 20–36% (59).

Medications

The type of medication, dose, and number of hours taken before the test should be noted.

Rationale

Significant improvement in the distance walked, or the dyspnea scale, after administration of bronchodilators has been demonstrated in patients with COPD (62, 63), as well as cardiovascular medications in patients with heart failure (19).

INTERPRETATION

Most 6MWTs will be done before and after intervention, and the primary question to be answered after both tests have been completed is whether the patient has experienced a clinically significant improvement. With a good quality-assurance program, with patients tested by the same technician, and after one or two practice tests, short-term reproducibility of the 6MWD is excellent (36). It is not known whether it is best for clinical purposes to express change in 6MWD as (1) an absolute value, (2) a percentage change, or (3) a change in the percentage of predicted value. Until further research is available, we recommend that change in 6MWD be expressed as an absolute value (e.g., the patient walked 50 m farther).

A statistically significant mean increase in 6MWD in a group of study participants is often much less than a clinically significant increase in an individual patient. In one study of 112 patients (half of them women) with stable, severe COPD, the smallest difference in 6MWD that was associated with a noticeable clinical difference in the patients' perception of exercise

performance was a mean of 54 m (95% confidence interval, 37–71 m) (64). This study suggests that for individual patients with COPD, an improvement of more than 70 m in the 6MWD after an intervention is necessary to be 95% confident that the improvement was significant. In an observational study of 45 older patients with heart failure, the smallest difference in 6MWD that was associated with a noticeable difference in their global rating of worsening was a mean of 43 m (20). The 6MWD was more responsive to deterioration than to improvement in heart failure symptoms.

Reported Mean Changes in 6MWD After Interventions

Supplemental oxygen (6 L/min) during exercise in patients with COPD or interstitial lung disease increased mean 6MWD by approximately 83 m (36%) in one study (59). Patients taking an inhaled corticosteroid experienced a mean 33 m (8%) increase in 6MWD in an international COPD study (16). Patients with COPD in a study of the effects of exercise and diaphragmatic strength training experienced a mean increase in 6MWD of 50 m (20%) (65). Lung volume reduction surgery in patients with very severe COPD has been reported to increase 6MWD by a mean of 55 m (20%) (13).

Cardiac rehabilitation in patients referred with various heart diseases increased 6MWD by a mean of 170 m (15%) in a recent study (66). In 25 older patients with heart failure, an angiotensin-converting enzyme inhibitor medication (50 mg captopril per day) improved 6MWD a mean of 64 m (39%) compared with a mean increase of only 8% in those receiving a placebo (19).

Interpreting Single Measurements of Functional Status

Optimal reference equations from healthy population-based samples using standardized 6MWT methods are not yet available. In one study, the median 6MWD was approximately 580 m for 117 healthy men and 500 m for 173 healthy women (48). A mean 6MWD of 630 m was reported by another study of 51 healthy older adults (53). Differences in the population sampled, type and frequency of encouragement, corridor length, and number of practice tests may account for reported differences in mean 6MWD in healthy persons. Age, height, weight, and sex independently affect the 6MWD in healthy adults; therefore, these factors should be taken into consideration when interpreting the results of single measurements made to determine functional status. We encourage investigators to publish reference equations for healthy persons using the previously mentioned standardized procedures.

A low 6MWD is nonspecific and nondiagnostic. When the 6MWD is reduced, a thorough search for the cause of the impairment is warranted. The following tests may then be helpful: pulmonary function, cardiac function, ankle–arm index, muscle strength, nutritional status, orthopedic function, and cognitive function.

Conclusions

The 6MWT is a useful measure of functional capacity targeted at people with at least moderately severe impairment. The test has been widely used for preoperative and postoperative evaluation and for measuring the response to therapeutic interventions for pulmonary and cardiac disease. These guidelines provide a standardized approach to performing the 6MWT. The committee hopes that these guidelines will encourage further research into the 6MWT and allow direct comparisons among different studies.

APPENDIX

The following elements should be present on the 6MWT worksheet and report:

Lap counter: _____

Patient name: _____ Patient ID# _____

Walk # _____ Tech ID: _____ Date: _____

Gender: M F Age: _____ Race: _____ Height: _____ ft _____ in, _____ meters

Weight: _____ lbs, _____ kg Blood pressure: _____ / _____

Medications taken before the test (dose and time): _____

Supplemental oxygen during the test: No Yes, flow _____ L/min, type _____

	Baseline	End of Test
Time	____:____	____:____
Heart Rate	_____	_____
Dyspnea	_____	_____ (Borg scale)
Fatigue	_____	_____ (Borg scale)
SpO ₂	_____ %	_____ %

Stopped or paused before 6 minutes? No Yes, reason: _____

Other symptoms at end of exercise: angina dizziness hip, leg, or calf pain

Number of laps: _____ (x60 meters) + final partial lap: _____ meters =

Total distance walked in 6 minutes: _____ meters

Predicted distance: _____ meters Percent predicted: _____ %

Tech comments:

Interpretation (including comparison with a preintervention 6MWD):

Acknowledgments

This statement was developed by the ATS Committee on Proficiency Standards for Clinical Pulmonary Function Laboratories.

Members of the committee are:

ROBERT O. CRAPO, M.D., *Chair* *
RICHARD CASABURI, PH.D, M.D.
ALLAN L. COATES, M.D.
PAUL L. ENRIGHT, M.D.*
NEIL R. MACINTYRE, M.D.
ROY T. MCKAY, PH.D.
DOUGLAS JOHNSON, M.D.
JACK S. WANGER, M.S.
R. JORGE ZEBALLOS, M.D.*

Ad Hoc Committee members are:

VERA BITTNER, M.D.
CARL MOTTRAM, R.R.T.

*Writing Committee Members

REFERENCES

1. Wasserman K, Hansen JE, Sue DY, Casaburi R, Whipp BJ. Principles of exercise testing and interpretation, 3rd edition. Philadelphia: Lippincott, Williams & Wilkins; 1999.
2. Weisman IM, Zeballos RJ. An integrated approach to the interpretation of cardiopulmonary exercise testing. *Clin Chest Med* 1994;15:421–445.
3. Fletcher GF, Balady G, Froelicher VF, Hartley LH, Haskell WL, Pollock ML. Exercise standards: a statement for healthcare professionals from the American Heart Association: writing group. *Circulation* 1995; 91:580–615.
4. Pina IL, Balady GJ, Hanson P, Labovitz AJ, Madonna DW, Myers J. Guidelines for clinical exercise testing laboratories: a statement for healthcare professionals from the Committee on Exercise and Cardiac Rehabilitation, American Heart Association. *Circulation* 1995;91:912–921.
5. Balke B. A simple field test for the assessment of physical fitness. *CARI Report* 1963;63:18.
6. Cooper KH. A means of assessing maximal oxygen intake: correlation between field and treadmill testing. *JAMA* 1968;203:201–204.
7. McGavin CR, Gupta SP, McHardy GJR. Twelve-minute walking test for assessing disability in chronic bronchitis. *BMJ* 1976;1:822–823.
8. Butland RJA, Pang J, Gross ER, Woodcock AA, Geddes DM. Two-, six-, and 12-minute walking tests in respiratory disease. *BMJ* 1982; 284:1607–1608.
9. Solway S, Brooks D, Lacasse Y, Thomas S. A qualitative systematic overview of the measurement properties of functional walk tests used in the cardiorespiratory domain. *Chest* 2001;119:256–270.
10. Kadikar A, Maurer J, Kesten S. The six-minute walk test: a guide to assessment for lung transplantation. *J Heart Lung Transplant* 1997;16: 313–319.
11. Holden DA, Rice TW, Stelmach K, Meeker DP. Exercise testing, 6 min walk, and stair climb in the evaluation of patients at high risk for pulmonary resection. *Chest* 1992;102:1774–1779.
12. Sciruba FC, Rogers RM, Keenan RJ, Slivka WA, Gorcsan J 3rd, Ferson PF, Holbert JM, Brown ML, Landreneau RJ. Improvement in pulmonary function and elastic recoil after lung-reduction surgery for diffuse emphysema. *N Engl J Med* 1996;334:1095–1099.
13. Criner GJ, Cordova FC, Furukawa S, Kuzma AM, Travaline JM, Leyenson V, O'Brien GM. Prospective randomized trial comparing bilateral lung volume reduction surgery to pulmonary rehabilitation in severe COPD. *Am J Respir Crit Care Med* 1999;160:2018–2027.
14. Sinclair DJM, Ingram CG. Controlled trial of supervised exercise training in chronic bronchitis. *BMJ* 1980;280:519–521.
15. Roomi J, Johnson MM, Waters K, Yohannes A, Helm A, Connolly MJ. Respiratory rehabilitation, exercise capacity and quality of life in chronic airways disease in old age. *Age Ageing* 1996;25:12–16.
16. Paggiaro PL, Dahle R, Bakran I, Frith L, Hollingworth K, Efthimiou J. Multicentre randomised placebo-controlled trial of inhaled fluticasone propionate in patients with COPD. *Lancet* 1998;351:773–780.
17. Leggett RJ, Flenley DC. Portable oxygen and exercise tolerance in patients with chronic hypoxic cor pulmonale. *BMJ* 1977;2:84–86.

18. Spence DPS, Hay JG, Carter J, Pearson MG, Calverley PMA. Oxygen desaturation and breathlessness during corridor walking in COPD: effect of oxitropium bromide. *Thorax* 1993;48:1145–1150.
19. DeBock V, Mets T, Romagnoli M, Derde MP. Captopril treatment of chronic heart failure in the very old. *J Gerontol* 1994;49:M148–M152.
20. O'Keeffe ST, Lye M, Donnellan C, Carmichael DN. Reproducibility and responsiveness of quality of life assessment and six minute walk test in elderly heart failure patients. *Heart* 1998;80:377–382.
21. Bernstein ML, Despars JA, Singh NP, Avalos K, Stansbury DW, Light RW. Re-analysis of the 12 minute walk in patients with COPD. *Chest* 1994;105:163–167.
22. Hajiro T, Nishimura K, Tsukino M, Ikeda A, Koyama H, Izumi T. Analysis of clinical methods used to evaluate dyspnea in patients with COPD. *Am J Respir Crit Care Med* 1998;158:1185–1189.
23. Gulmans VAM, vanVeldhoven NHMJ, deMeer K, Helders PJM. The six-minute walking test in children with cystic fibrosis: reliability and validity. *Pediatr Pulmonol* 1996;22:85–89.
24. Nixon PA, Joswiak ML, Fricker FJ. A six-minute walk test for assessing exercise tolerance in severely ill children. *J Pediatr* 1996;129:362–366.
25. Bittner V. Six-minute walk test in patients with cardiac dysfunction. *Cardiologia* 1997;42:897–902.
26. Peeters P, Mets T. The 6 minute walk as an appropriate exercise test in elderly patients with chronic heart failure. *J Gerontol* 1996;51A: M147–M151.
27. Zugck C, Kruger C, Durr S, Gerber SH, Haunstetter A, Hornig K, Kubler W, Haass M. Is the 6-minute walk test a reliable substitute for peak oxygen uptake in patients with dilated cardiomyopathy? *Eur Heart J* 2000;21:540–549.
28. Montgomery PS, Gardner AW. The clinical utility of a six-minute walk test in peripheral arterial occlusive disease patients. *J Am Geriatr Soc* 1998;46:706–711.
29. Cahan MA, Montgomery P, Otis RB, Clancy R, Flinn W, Gardner A. The effect of cigarette smoking status on six-minute walk distance in patients with intermittent claudication. *Angiology* 1999;50:537–546.
30. King S, Wessel J, Bhambhani Y, Maikala R, Sholter D, Maksymowych W. Validity and reliability of the 6 minute walk in persons with fibromyalgia. *J Rheumatol* 1999;26:2233–2237.
31. Enright PL, McBurnie MA, Bittner V, Tracy RP, McNamara R, Newman AB, the Cardiovascular Health Study. The six minute walk test: a quick measure of functional status in elderly adults. *Chest* (In press)
32. Bittner V, Weiner DH, Yusuf S, Rogers WJ, McIntyre KM, Bangdiwala SI, Kronenberg MW, Kostis JB, Kohn RM, Guillothe M, *et al.* Prediction of mortality and morbidity with a 6-minute walk test in patients with left ventricular dysfunction. *JAMA* 1993;270:1702–1707.
33. Cahalin LP, Mathier MA, Semigran MJ, Dec GW, DiSalvo TG. The six-minute walk test predicts peak oxygen uptake and survival in patients with advanced heart failure. *Chest* 1996;110:325–332.
34. Cote CG, Celli BR. In patients with COPD, the 6 minute walking distance is a better predictor of health care utilization than FEV1, blood gases, and dyspnea [abstract]. *Eur Respir J* 1998;383.
35. Kessler R, Faller M, Fourgaut G, Mennecier B, Weitzenblum E. Predictive factors of hospitalization for acute exacerbation in a series of 64 patients with chronic obstructive pulmonary disease. *Am J Respir Crit Care Med* 1999;159:158–164.
36. Cahalin L, Pappagianopoulos P, Prevost S, Wain J, Ginns L. The relationship of the 6-min walk test to maximal oxygen consumption in transplant candidates with end-stage lung disease. *Chest* 1995;108:452–459.
37. Guyatt GH, Thompson PJ, Berman LB, Sullivan MJ, Townsend M, Jones NL, Pugsley SO. How should we measure function in patients with chronic heart and lung disease? *J Chronic Dis* 1985;38:517–524.
38. Guyatt GH, Townsend M, Keller J, Singer J, Nogradi S. Measuring functional status in chronic lung disease: conclusions from a random control trial. *Respir Med* 1991;85(Suppl B):17–21.
39. Niederman MS, Clemente PH, Fein AM, Feinsilver SH, Robinson DA, Ilowitz JS, Bernstein MG. Benefits of a multidisciplinary pulmonary rehabilitation program: improvements are independent of lung function. *Chest* 1991;99:798–804.
40. Nosedá A, Carpioux J, Prigogine T, Schmerber J. Lung function, maximum and submaximum exercise testing in COPD patients: reproducibility over a long interval. *Lung* 1989;167:247–257.
41. Knox AJ, Morrison JF, Muers MF. Reproducibility of walking test results in chronic obstructive airways disease. *Thorax* 1988;43:388–392.
42. Guyatt GH, Pugsley SO, Sullivan MJ, Thompson PJ, Berman LB, Jones NL, Fallen EL, Taylor DW. Effect of encouragement on walking test performance. *Thorax* 1984;39:818–822.
43. Leger LA. A maximal multistage 20-m shuttle run test to predict VO2 max. *Eur J Appl Physiol* 1982;49:1–12.
44. Singh SJ, Morgan MDL, Scott S, Walters D, Hardman AE. Development of a shuttle walking test of disability in patients with chronic airways obstruction. *Thorax* 1992;47:1019–1024.
45. Revill SM, Morgan MDL, Singh SJ, Williams J, Hardman AE. The endurance shuttle walk: a new field test for the assessment of endurance capacity in chronic obstructive pulmonary disease. *Thorax* 1999;54:213–222.

46. Singh SJ, Morgan MDL, Hardman AE, Rowe C, Bardsley PA. Comparison of oxygen uptake during a conventional treadmill test and the shuttle walking test in chronic airflow limitation. *Eur Respir J* 1994;7: 2016–2020.
47. Morales FJ, Martinez A, Mendez M, Agarrado A, Ortega F, Fernandez-Guerra J, Montemayor T, Burgos J. A shuttle walk test for assessment of functional capacity in chronic heart failure. *Am Heart J* 1999;138:292–298.
48. Enright PL, Sherrill DL. Reference equations for the six-minute walk in healthy adults. *Am J Respir Crit Care Med* 1998;158:1384–1387.
49. Barst RJ, Rubin LJ, McGoon MD, Caldwell EJ, Long WA, Levy PS. Survival in primary pulmonary hypertension with long-term continuous intravenous prostacyclin. *Ann Intern Med* 1994;121:409–415.
50. Miyamoto S, Nagaya N, Satoh T, Kyotani S, Sakamaki F, Fujita M, Nakanishi N, Miyatake K. Clinical correlates and prognostic significance of six-minute walk test in patients with primary pulmonary hypertension. *Am J Respir Crit Care Med* 2000;161:487–492.
51. Guyatt GH, Sullivan MJ, Thompson PJ, Fallen EL, Pugsley SO, Taylor DW, Berman LB. The 6-minute walk: a new measure of exercise capacity in patients with chronic heart failure. *Can Med Assoc J* 1985; 132:919–923.
52. Lipkin DP, Scrivin AJ, Crake T, Poole-Wilson PA. Six minute walking test for assessing exercise capacity in chronic heart failure. *BMJ* 1986; 292:653–655.
53. Troosters T, Gosselink R, Decramer M. Six minute walking distance in healthy elderly subjects. *Eur Respir J* 1999;14:270–274.
54. Weiss RA, *et al*. Six minute walk test in severe COPD: reliability and effect of walking course layout and length. Paper presented at ACCP Conference; September 2000; San Francisco.
55. Stevens D, Elpern E, Sharma K, Szidon P, Ankin M, Kesten S. Comparison of hallway and treadmill six-minute walk tests. *Am J Respir Crit Care Med* 1999;160:1540–1543.
56. Jensen LA, Onyskiw JE, Prasad NGN. Meta-analysis of arterial oxygen saturation monitoring by pulse oximetry in adults. *Heart Lung* 1998; 27:387–408.
57. Barthelemy JC, Geysant A, Riffat J, Antoniadis A, Berruyer J, LaCour JR. Accuracy of pulse oximetry during moderate exercise: a comparative study. *Scand J Clin Lab Invest* 1990;50:533–539.
58. Borg GAV. Psycho-physical bases of perceived exertion. *Med Sci Sports Exerc* 1982;14:377–381.
59. Leach RM, Davidson AC, Chinn S, Twort CHC, Cameron IR, Batemen NT. Portable liquid oxygen and exercise ability in severe respiratory disability. *Thorax* 1992;47:781–789.
60. Mungall IPF, Hainsworth R. Assessment of respiratory function in patients with chronic obstructive airways disease. *Thorax* 1979;34:254–258.
61. Roberts CM, Bell J, Wedzicha JA. Comparison of the efficacy of a demand oxygen delivery system with continuous low flow oxygen in subjects with stable COPD and severe oxygen desaturation on walking. *Thorax* 1996;51:831–834.
62. Hay JG, Stone P, Carter J, Church S, Eyre-Brook A, Pearson MG, Woodcock AA, Calverley PM. Bronchodilator reversibility, exercise performance and breathlessness in stable chronic obstructive pulmonary disease. *Eur Respir J* 1992;5:659–664.
63. Grove A, Lipworth BJ, Reid P, Smith RP, Lamage L, Ingram CG, Jenkins RJ, Winter JH, Dhillon DP. Effects of regular salmeterol on lung function and exercise capacity in patients with COPD. *Thorax* 1996;51:689–693.
64. Redelmeier DA, Bayoumi AM, Goldstein RS, Guyatt GH. Interpreting small differences in functional status: The six minute walk test in chronic lung disease patients. *Am J Respir Crit Care Med* 1997;155:1278–1282.
65. Weiner P, Magadle R, Berar-Yanay N, Davidovich A, Weiner M. The cumulative effect of long-acting bronchodilators, exercise, and inspiratory muscle training on the perception of dyspnea in patients with advanced COPD. *Chest* 2000;118:672–678.
66. Bittner V, Sanderson B, Breland J, Adams C, Schuman C. Assessing functional capacity as an outcome in cardiac rehabilitation: role of the 6 minute walk test. *Clinical Exercise Physiology* 2000.

R.15 National Institute of Health Stroke Scale (NIHSS)

Administer stroke scale items in the order listed. Record performance in each category after each subscale exam. Do not go back and change scores. Follow directions provided for each exam technique. Scores should reflect what the patient does, not what the clinician thinks the patient can do. The clinician should record answers while administering the exam and work quickly. Except where indicated, the patient should not be coached (i.e., repeated requests to patient to make a special effort).

Instructions	Scale Definition	Score
<p>1a. Level of Consciousness: The investigator must choose a response if a full evaluation is prevented by such obstacles as an endotracheal tube, language barrier, orotracheal trauma/bandages. A 3 is scored only if the patient makes no movement (other than reflexive posturing) in response to noxious stimulation.</p>	<p>0 = Alert; keenly responsive.</p> <p>1 = Not alert; but arousable by minor stimulation to obey, answer, or respond.</p> <p>2 = Not alert; requires repeated stimulation to attend, or is obtunded and requires strong or painful stimulation to make movements (not stereotyped).</p> <p>3 = Responds only with reflex motor or autonomic effects or totally unresponsive, flaccid, and areflexic.</p>	<p>_____</p>
<p>1b. LOC Questions: The patient is asked the month and his/her age. The answer must be correct - there is no partial credit for being close. Aphasic and stuporous patients who do not comprehend the questions will score 2. Patients unable to speak because of endotracheal intubation, orotracheal trauma, severe dysarthria from any cause, language barrier, or any other problem not secondary to aphasia are given a 1. It is important that only the initial answer be graded and that the examiner not "help" the patient with verbal or non-verbal cues.</p>	<p>0 = Answers both questions correctly.</p> <p>1 = Answers one question correctly.</p> <p>2 = Answers neither question correctly.</p>	<p>_____</p>
<p>1c. LOC Commands: The patient is asked to open and close the eyes and then to grip and release the non-paretic hand. Substitute another one step command if the hands cannot be used. Credit is given if an unequivocal attempt is made but not completed due to weakness. If the patient does not respond to command, the task should be demonstrated to him or her (pantomime), and the result scored (i.e., follows none, one or two commands). Patients with trauma, amputation, or other physical impediments should be given suitable one-step commands. Only the first attempt is scored.</p>	<p>0 = Performs both tasks correctly.</p> <p>1 = Performs one task correctly.</p> <p>2 = Performs neither task correctly.</p>	<p>_____</p>

<p>2. Best Gaze: Only horizontal eye movements will be tested. Voluntary or reflexive (oculocephalic) eye movements will be scored, but caloric testing is not done. If the patient has a conjugate deviation of the eyes that can be overcome by voluntary or reflexive activity, the score will be 1. If a patient has an isolated peripheral nerve paresis (CN III, IV or VI), score a 1. Gaze is testable in all aphasic patients. Patients with ocular trauma, bandages, pre-existing blindness, or other disorder of visual acuity or fields should be tested with reflexive movements, and a choice made by the investigator. Establishing eye contact and then moving about the patient from side to side will occasionally clarify the presence of a partial gaze palsy.</p>	<p>0 = Normal.</p> <p>1 = Partial gaze palsy; gaze is abnormal in one or both eyes, but forced deviation or total gaze paresis is not present.</p> <p>2 = Forced deviation, or total gaze paresis not overcome by the oculocephalic maneuver.</p>	<p>_____</p>
<p>3. Visual: Visual fields (upper and lower quadrants) are tested by confrontation, using finger counting or visual threat, as appropriate. Patients may be encouraged, but if they look at the side of the moving fingers appropriately, this can be scored as normal. If there is unilateral blindness or enucleation, visual fields in the remaining eye are scored. Score 1 only if a clear-cut asymmetry, including quadrantanopia, is found. If patient is blind from any cause, score 3. Double simultaneous stimulation is performed at this point. If there is extinction, patient receives a 1, and the results are used to respond to item 11.</p>	<p>0 = No visual loss.</p> <p>1 = Partial hemianopia.</p> <p>2 = Complete hemianopia.</p> <p>3 = Bilateral hemianopia (blind including cortical blindness).</p>	<p>_____</p>
<p>4. Facial Palsy: Ask – or use pantomime to encourage – the patient to show teeth or raise eyebrows and close eyes. Score symmetry of grimace in response to noxious stimuli in the poorly responsive or non-comprehending patient. If facial trauma/bandages, orotracheal tube, tape or other physical barriers obscure the face, these should be removed to the extent possible.</p>	<p>0 = Normal symmetrical movements.</p> <p>1 = Minor paralysis (flattened nasolabial fold, asymmetry on smiling).</p> <p>2 = Partial paralysis (total or near-total paralysis of lower face).</p> <p>3 = Complete paralysis of one or both sides (absence of facial movement in the upper and lower face).</p>	<p>_____</p>
<p>5. Motor Arm: The limb is placed in the appropriate position: extend the arms (palms down) 90 degrees (if sitting) or 45 degrees (if supine). Drift is scored if the arm falls before 10 seconds. The aphasic patient is encouraged using urgency in the voice and pantomime, but not noxious stimulation. Each limb is tested in turn, beginning with the non-paretic arm. Only in the case of amputation or joint fusion at the shoulder, the examiner should record the score as untestable (UN), and clearly write the explanation for this choice.</p>	<p>0 = No drift; limb holds 90 (or 45) degrees for full 10 seconds.</p> <p>1 = Drift; limb holds 90 (or 45) degrees, but drifts down before full 10 seconds; does not hit bed or other support.</p> <p>2 = Some effort against gravity; limb cannot get to or maintain (if cued) 90 (or 45) degrees, drifts down to bed, but has some effort against gravity.</p> <p>3 = No effort against gravity; limb falls.</p> <p>4 = No movement.</p> <p>UN = Amputation or joint fusion, explain:</p> <p>_____</p> <p style="text-align: right;">5a. Left Arm</p> <p style="text-align: right;">5b. Right Arm</p>	<p>_____</p> <p>_____</p>

<p>6. Motor Leg: The limb is placed in the appropriate position: hold the leg at 30 degrees (always tested supine). Drift is scored if the leg falls before 5 seconds. The aphasic patient is encouraged using urgency in the voice and pantomime, but not noxious stimulation. Each limb is tested in turn, beginning with the non-paretic leg. Only in the case of amputation or joint fusion at the hip, the examiner should record the score as untestable (UN), and clearly write the explanation for this choice.</p>	<p>0 = No drift; leg holds 30-degree position for full 5 seconds.</p> <p>1 = Drift; leg falls by the end of the 5-second period but does not hit bed.</p> <p>2 = Some effort against gravity; leg falls to bed by 5 seconds, but has some effort against gravity.</p> <p>3 = No effort against gravity; leg falls to bed immediately.</p> <p>4 = No movement.</p> <p>UN = Amputation or joint fusion, explain: _____</p> <p style="text-align: right;">6a. Left Leg _____ 6b. Right _____</p>	
<p>7. Limb Ataxia: This item is aimed at finding evidence of a unilateral cerebellar lesion. Test with eyes open. In case of visual defect, ensure testing is done in intact visual field. The finger-nose-finger and heel-shin tests are performed on both sides, and ataxia is scored only if present out of proportion to weakness. Ataxia is absent in the patient who cannot understand or is paralyzed. Only in the case of amputation or joint fusion, the examiner should record the score as untestable (UN), and clearly write the explanation for this choice. In case of blindness, test by having the patient touch nose from extended arm position.</p>	<p>0 = Absent.</p> <p>1 = Present in one limb.</p> <p>2 = Present in two limbs.</p> <p>UN = Amputation or joint fusion, explain: _____</p>	
<p>8. Sensory: Sensation or grimace to pinprick when tested, or withdrawal from noxious stimulus in the obtunded or aphasic patient. Only sensory loss attributed to stroke is scored as abnormal and the examiner should test as many body areas (arms [not hands], legs, trunk, face) as needed to accurately check for hemisensory loss. A score of 2, "severe or total sensory loss," should only be given when a severe or total loss of sensation can be clearly demonstrated. Stuporous and aphasic patients will, therefore, probably score 1 or 0. The patient with brainstem stroke who has bilateral loss of sensation is scored 2. If the patient does not respond and is quadriplegic, score 2. Patients in a coma (item 1a=3) are automatically given a 2 on this item.</p>	<p>0 = Normal; no sensory loss.</p> <p>1 = Mild-to-moderate sensory loss; patient feels pinprick is less sharp or is dull on the affected side; or there is a loss of superficial pain with pinprick, but patient is aware of being touched.</p> <p>2 = Severe to total sensory loss; patient is not aware of being touched in the face, arm, and leg.</p>	

<p>9. Best Language: A great deal of information about comprehension will be obtained during the preceding sections of the examination. For this scale item, the patient is asked to describe what is happening in the attached picture, to name the items on the attached naming sheet and to read from the attached list of sentences. Comprehension is judged from responses here, as well as to all of the commands in the preceding general neurological exam. If visual loss interferes with the tests, ask the patient to identify objects placed in the hand, repeat, and produce speech. The intubated patient should be asked to write. The patient in a coma (item 1a=3) will automatically score 3 on this item. The examiner must choose a score for the patient with stupor or limited cooperation, but a score of 3 should be used only if the patient is mute and follows no one-step commands.</p>	<p>0 = No aphasia; normal.</p> <p>1 = Mild-to-moderate aphasia; some obvious loss of fluency or facility of comprehension, without significant limitation on ideas expressed or form of expression. Reduction of speech and/or comprehension, however, makes conversation about provided materials difficult or impossible. For example, in conversation about provided materials, examiner can identify picture or naming card content from patient's response.</p> <p>2 = Severe aphasia; all communication is through fragmentary expression; great need for inference, questioning, and guessing by the listener. Range of information that can be exchanged is limited; listener carries burden of communication. Examiner cannot identify materials provided from patient response.</p> <p>3 = Mute, global aphasia; no usable speech or auditory comprehension.</p>	<p>_____</p>
<p>10. Dysarthria: If patient is thought to be normal, an adequate sample of speech must be obtained by asking patient to read or repeat words from the attached list. If the patient has severe aphasia, the clarity of articulation of spontaneous speech can be rated. Only if the patient is intubated or has other physical barriers to producing speech, the examiner should record the score as untestable (UN), and clearly write an explanation for this choice. Do not tell the patient why he or she is being tested.</p>	<p>0 = Normal.</p> <p>1 = Mild-to-moderate dysarthria; patient slurs at least some words and, at worst, can be understood with some difficulty.</p> <p>2 = Severe dysarthria; patient's speech is so slurred as to be unintelligible in the absence of or out of proportion to any dysphasia, or is mute/anarthric.</p> <p>UN = Intubated or other physical barrier, explain: _____</p>	<p>_____</p>
<p>11. Extinction and Inattention (formerly Neglect): Sufficient information to identify neglect may be obtained during the prior testing. If the patient has a severe visual loss preventing visual double simultaneous stimulation, and the cutaneous stimuli are normal, the score is normal. If the patient has aphasia but does appear to attend to both sides, the score is normal. The presence of visual spatial neglect or anosagnosia may also be taken as evidence of abnormality. Since the abnormality is scored only if present, the item is never untestable.</p>	<p>0 = No abnormality.</p> <p>1 = Visual, tactile, auditory, spatial, or personal inattention or extinction to bilateral simultaneous stimulation in one of the sensory modalities.</p> <p>2 = Profound hemi-inattention or extinction to more than one modality; does not recognize own hand or orients to only one side of space.</p>	<p>_____</p>

R.16 Modified Rankin Scale (mRS) Instructions

Instructions:

- The mRS is to be determined after the NIHSS and Barthel Index have been determined and graded and by the same rater.
- The determination of the scale should be made from 5 to 0, i.e., the order presented.
- The purpose of the mRS is to record whether the patient is dead, severely, moderately, or slightly disabled and if not dead or disabled, whether the patient is performing all usual activities without symptoms or not. Because subjects and family members may understate the severity of disability, it is important for the rating clinician to understand that the mRS is a clinical scale and not a patient-reported outcome. The rater may ask questions but must assess the disability whether or not in agreement with the subject or family.

5 Severe disability; someone needs to be available at all times; care may be provided by either a trained or an untrained caregiver.

Question: Does the person require constant care?

4 Moderately severe disability; need for assistance with some basic ADL, but not requiring constant care.

Question: Is assistance essential for eating, using the toilet, daily hygiene, or walking?

3 Moderate disability; need for assistance with some instrumental ADL but not basic ADL.

Question: Is assistance essential for preparing a simple meal, doing household chores, looking after money, shopping, or traveling locally?

2 Slight disability; limitations in participation in usual social roles, but independent for ADL.

Questions:

- Has there been a change in the person's ability to work or look after others if these were roles before stroke?
- Has there been a change in the person's ability to participate in previous social and leisure activities?
- Has the person had problems with relationships or become isolated?
- Do any of the following interfere with the subject's ability to perform all usual activities: difficulty reading or writing, difficulty speaking or finding the right word, problems with balance or coordination, visual problems, numbness (face, arms, legs, hands, feet), loss of movement (face, arms, legs, hands, feet), difficulty with swallowing, or other symptom resulting from stroke?

1 No significant disability; symptoms present but not other limitations.

Question: Does the subject have any symptoms that do not interfere with the performance of all usual activities?

0 No symptoms at all; no limitations and no symptoms.

Note: The above questions are a modification of the questions from **Wilson, et. al, Stroke. 2002:33:2243-2246** and **are modified here for the use in percutaneous heart valve trials for the FDA Division of CV Devices.**

R.17 Mini Mental State Exam (MMSE-2)

Mini Mental Status Exam1: The MMSE-2 Standard Version should be used.

Procedure:

Administer the MMSE-2 exam utilizing the standardized worksheets provided.

<http://www.minimental.com/>

R.18 Additional Neurological Assessments

Visual Field Testing

Visual fields, (upper and lower quadrants) are tested by confrontation, using finger counting or visual threat as appropriate.

Visual fields may be impaired by lesions anywhere in the neural visual pathways, from the optic nerves to the occipital lobes.

- **Individual eyes:**

In direct confrontation, examiner should sit directly in front of the patient, at the same level and approximately one meter apart. Ask the patient to cover one eye and maintain a fixed gaze on the examiners eye or nose. The examiner brings a small target (e.g. a match or a finger) from the periphery of the patient's visual field into each of the 4 visual quadrants and requests that the patient indicate when they first visualize the object. Wiggling the target assists in the patients separating and defining it.

Repeat the testing for the other eye.

Any abnormalities in target detection should prompt detailed testing with more precise instruments.

- **Bilateral eyes:**

In the same position, and with the patients fixed gaze on the examiners nose or eyes, use finger counting or visual threat to identify any asymmetry in the visual field.

Gait Assessment

Not tested as part of the NIH Stroke Scale.

Ask the patient to walk down a straight hallway under observation, if ambulatory.

Note any apparent abnormalities of gait. (Ataxic, lateralized hemi-paretic, 'shuffling' or 'small-step' or other abnormality).

Hand Function

- **Motor assessment**

The extensors are weaker than the flexors in the upper extremities. Consequently, following a neurological event, the arm eventually assumes a flexed position. Therefore the biceps will be stronger than the triceps, the wrist and finger flexors stronger than the extensors. For this reason it is not a good idea to monitor for stroke progression by testing grip strength. Test finger extensor strength instead.

Muscle power is classically graded on a scale of 0 – 5, with 0 being no power and 5 being normal power. For the purposes of documenting subtleties in potential deficits, power in finger muscle groups should be documented on a 0 – 10 scale as follows.

Grade 0	No muscle contraction
Grade 2	Muscle contraction without joint movement
Grade 4	Partial movement with gravity eliminated
Grade 6	Movement against gravity
Grade 8	Movement against some resistance
Grade 10	Normal strength

(Use odd numbers to document when physical findings fall between grades).

- **Finger Abductors**

Instruct the patient to “Spread your fingers apart, push your index finger towards the other hand. Don’t let me push it back”. Push on the finger at the Proximal Interphalangeal (PIP) joint level.

- **Finger Adductors**

Ask patient to ‘grip a sheet of paper’ between their fingers. Try to pull the sheet away from them.

- **Finger Extensors**

Instruct the patient to “Keep your fingers out straight, and don’t let me bend them”. This is a test of extension at the metacarpophalangeal (MCP) joints. It is important to support the palm and apply pressure to the PIP joints, testing extension at only one set of joints, because extension at the PIP joints is performed by the small hand muscles.

- **Sensory Assessment**

In a seated position, ask the patient to place both hands on their lap with palms facing down. Instruct them to close their eyes, and using their index finger point to the position touched by the examiner on fingers of the opposite hand. Repeat for both hands.

This should be documented as: ‘normal sensation’ or ‘can feel but unable to localize’ or ‘no sensation’ for each hand.

Writing Evaluation

Ask the patient to write two sentences about a particular subject. (e.g. their hometown). There is no time limit, and patient can be given time prior to neurological examination as necessary.

Note the patient’s ‘use of paper’, including the position of writing. Also, note whether the written subject is appropriate to that asked, and the correctness of the grammar, spelling and syntax used.

Document as ‘fail’ or ‘pass’ or ‘subject unable to attempt test’ if patient is unable.

Drawing Assessment

The ‘clock-drawing’ test is used for screening for cognitive impairment and dementia, and as a measure of spatial dysfunction and neglect. Doing the test requires verbal understanding, memory and spatially coded knowledge in addition to constructive skills.

Constructional apraxia may occur with lesions in either the left or right parietal lobe, although it is more frequent after right parietal damage (visually dominant).

Clock drawing has been used as a diagnostic measure of unilateral spatial neglect, with neglect patients omitting numbers on one half, with or without transposition of the numbers from the neglect side to the other, or demonstrating inattention to parts of the spatial layout of numbers.

The test has a high correlation with the MMSE and other tests of cognitive dysfunction.

- Ask patient to draw the face of a clock and put the numbers in the correct position.
- Then ask patient to draw in the hands at a particular time (e.g., “twenty minutes after eight”).
- There is no time limit.

One point will be assigned for each of the following items completed (draws closed circle, includes all 12 correct numbers, places numbers in correct positions, places hands in correct positions) for a total of four points.

R.19 Medtronic CoreValve® Clinical Assessment Guidelines

Clinical Assessments will be collected to help assess the overall health and frailty¹ of study participants at the time of screening. These assessments include measures of nutrition, strength and balance, independence in average daily living, mental status, and medical comorbidities.

The following are guidelines provided for administering the strength examination.

Grip strength test²: The grip strength test is used to determine the strength in each of the participant's hands.

Procedure:

1. Equipment: Hand Dynamometer
2. Illustrate the use of the instrument to the participant prior to testing.
3. The participant should be in a seated position.
4. Ask the participant to squeeze the dynamometer with as much force as possible, being careful to squeeze only once for each measurement.
5. Three trials should be made for the right hand followed by three trials for left hand with a pause of about 10-20 seconds between each trial to avoid the effects of muscle fatigue.
6. The highest reading for each hand should be reported on the case report form.

¹ Fried LP et al, (2001). Frailty in older adults: Evidence for a phenotype. *Journal of Gerontology: Medical Science*, 56A (3), M146-M156.

² Luna-Heredia E, Martin-Pena G, Ruiz-Galiana J. Handgrip dynamometry in healthy adults. *Clinical Nutrition* 2005; 24:250-258

R.20 Katz Index of Independence in Activities of Daily Living

Activities Points (1 or 0)	Independence (1 POINT) NO supervision, direction or personal assistance	Dependence (0 Points) WITH supervision, direction, personal assistance or total assistance
BATHING Points: _____	(1 POINT) Bathes self completely or needs help in bathing only a single part of the body such as the back, genital area or disabled extremity.	(0 POINTS) Needs help with bathing more than one part of the body, getting in or out of the tub or shower. Requires total bathing.
DRESSING Points: _____	(1 POINT) Gets clothes from closets and drawers and puts on clothes and outer garments complete with fasteners. May have help tying shoes.	0 POINTS) Needs help with dressing self or needs to be completely dressed.
TOILETING Points: _____	(1 POINT) Goes to toilet, gets on and off, arranges clothes, cleans genital area without help	(0 POINTS) Needs help transferring to the toilet, cleaning self or uses bedpan or commode.
TRANSFERRING Points: _____	(1 POINT) Moves in and out of bed or chair unassisted. Mechanical transferring aides are acceptable.	(0 POINTS) Needs help in moving from bed to chair or requires a complete transfer.
CONTINENCE Points: _____	(1 POINT) Exercises complete self-control over urination and defecation.	(0 POINTS) Is partially or totally incontinent of bowel or bladder.
FEEDING Points: _____	(1 POINT) Gets food from plate into mouth without help. Preparation of food may be done by another person.	(0 POINTS) Needs partial or total help with feeding or requires parenteral feeding.

TOTAL POINTS = _____

6 = High (patient independent)

0 = Low (patient very dependent)

Slightly adapted from Katz S., Down, T.D., Cash, H.R. et al. (1970)
 Progress in the Development of the Index of ADL. Gerontologist
 10:20-30. Copyright The Gerontological Society of America

R.21 Investigator Brochure / Report of Prior Investigations for the Medtronic CoreValve[®] System

The geography-specific Instructions for Use and Investigator Brochure will be provided separately, as applicable.

R.22 SURTAVI Risk Model

Risk assessment is essential in the strategy to approach patients with valvular heart disease in general and AS in particular. Various risk models primarily focusing on short-term mortality have been validated for AS patients (30-38). Some were initially derived from a broader patient population undergoing any type of cardiac surgery, others were more explicitly tailored to patients with AS. Most notably, contemporary scoring models tend to be consistent in lower risk patients but diverge with increasing risk profile. This can be partly explained by the fact that these models were extracted from large databases where the average patient risk is fairly low. Therefore such models are less well validated for higher risk patients and expectedly perform less well in the “outlier” population currently considered for TAVI (39).

An in-depth reappraisal of existing scoring models reveals some concordant risk factors (e.g. age, gender) but also established risk factors that are clearly missing (e.g. mediastinal radiation, porcelain aorta and frailty) (40-42). Furthermore definitions of individual components are not uniform and do not correspond to current suggested guidelines/definitions by respective professional societies.

R.22.1 SURTAVI Risk Model Rationale

1. Joint database

Following the initial report by the Bern, Rotterdam collaboration (28) including 1122 patients with severe AS, four academic institutions in Bern, Rotterdam, Bad Nauheim and Munich have created a joint database on all consecutive patients with severe AS treated with either TAVI or SAVR between January 2006 and December 2009.

Preliminary analysis on 3688 patients has been performed, including 789 TAVI and 2899 SAVR patients.

The pre-specified primary outcome was all cause mortality at 1 year. Patients were actively followed up after the index procedure and their vital status confirmed by outpatient clinic visit, telephone contact, review of medical records or national civil registries.

2. Statistical methods

The propensity scores of SAVR patients were estimated using a probit model with all baseline characteristics as described above as independent variables. The propensity score is the probability that a patient would have been treated with SAVR given that patient's observed baseline characteristics. To ensure the quality of the matching using propensity scores the common support assumption was applied, using the Epanechnikov kernel probability density estimates. The IPT weighted multivariable analysis was used. The IPT weighted analyses used the inverse of the propensity score as weights in SAVR patients and the inverse of 1 minus the propensity score in TAVI patients. All analyses were based on logistic regression models on the 1 year mortality and were performed in the overall dataset and stratified according to presence or absence of sufficient overlap of propensity scores (propensity score <0.675 versus ≥ 0.675).

3. Type of patient (patient selection)

Preliminary analysis demonstrated a pre-dominance of patients with age >80 years old, and a logistic EuroSCORE $<20\%$ in the TAVI cohort (figure “scatterplot”). However, the majority of patients in the entire study population are between 65-and 83-years-old (figure “age distribution”). See also appendix L.2

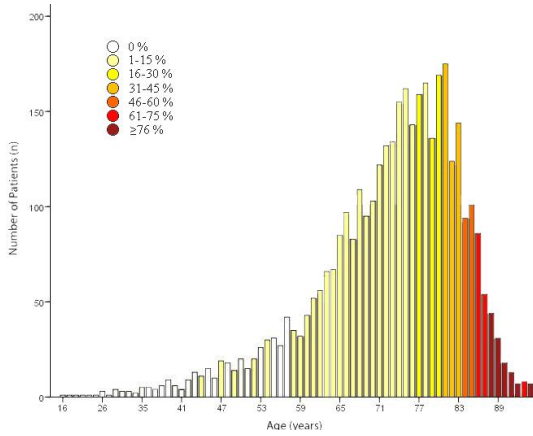

The distribution of age in patients treated for aortic stenosis. The color indicates the percentage of patients treated with TAVI in the corresponding age group

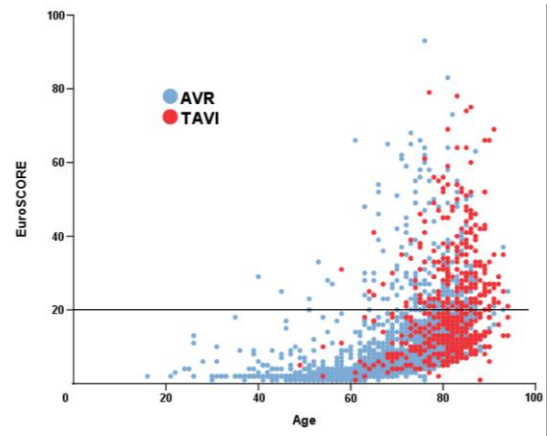

A scatterplot showing the age and corresponding EuroSCORE of patients treated for aortic stenosis. Indicated by colours are the treatment arms surgical aortic valve replacement and transcatheter aortic valve implantation. A previous commonly used EuroSCORE cut-off value of 20% is indicated in the graphic to show that many patients with lower scores are already treated by TAVI, but in lower ages this treatment remains limited due to the low EuroSCORE.

As it is well-known that both the STS score and EuroSCORE are suboptimal in operative risk assessment, these models are only used for descriptive purposes (39). Age is the predominant predictor of mortality in general, and after valve surgery in particular. Furthermore, the impact of other risk factors appears to be accentuated in an older age population.

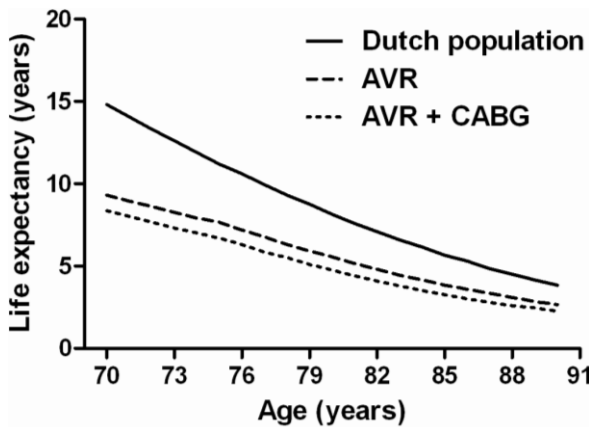

Survival curves of the general Dutch population (derived from death register); and patients undergoing an AVR (derived from meta-analysis data), or an AVR with the additional risk factor of coronary sclerosis (derived from meta-analysis data).

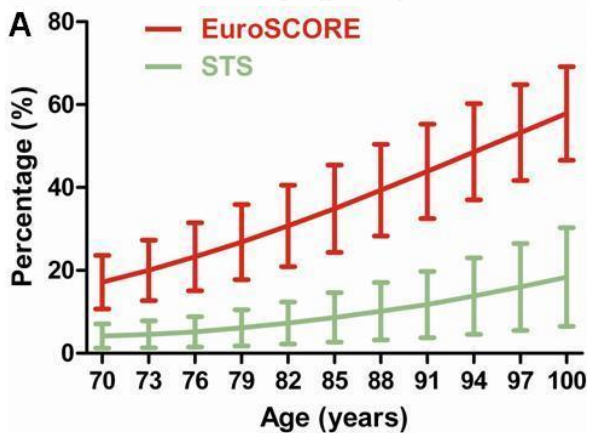

The range of both the EuroSCORE and STS score in a patient with 2 risk factors. The lower boundary indicates a score with risk factors that have little influence on the score, while the upper boundary indicates a score with risk factors that influence the score significantly

Therefore, we opt for a risk assessment based on age in combination with encoded co-morbidities selected from a pre-specified listing. Patients at intermediate risk are defined as age 70-74 years with 2 or 3 co-morbidities (cohort 1); age 75-79 years with 1 or 2 co-morbidities (cohort 2); and patients ≥80 years of age with ≤1 co-morbidities (cohort 3).

In-depth analysis and translation of the risk profile mentioned above to the STS score (table STS below):

- Cohort 1: range of 0.9% to 10.2% in males, and 1.4% to 14.8% in females
- Cohort 2: range of 1.2% to 8.5% in males, and 1.8% to 12.4% in females
- Cohort 3*: range of 1.7% to 8.9% in males, and 2.6% to 12.7% in females

Male		70 yr	73 yr	76 yr	79 yr	82 yr	85 yr	88 yr	91 yr
Risk factors	0	1.7	2.1	2.5	3.0
	1	1.2 - 3.6	1.4 - 4.3	1.7 - 5.2	2.1 - 6.2	2.5 - 7.4	3.0 - 8.9
	2	0.9 - 5.7	1.0 - 6.3	1.2 - 7.1	1.4 - 8.5
	3	1.1 - 9.3	1.2 - 10.2
Female		70 yr	73 yr	76 yr	79 yr	82 yr	85 yr	88 yr	91 yr
Risk factors	0	2.6	3.2	3.8	4.5
	1	1.8 - 5.4	2.2 - 6.5	2.6 - 7.7	3.2 - 9.2	3.8 - 10.9	4.5 - 12.7
	2	1.4 - 8.4	1.6 - 9.3	1.8 - 10.5	2.2 - 12.4
	3	1.7 - 13.5	1.9 - 14.8

STS score: ranges of scores are displayed as: score with least influential risk factors – score with most influential risk factors. *Upper age limit 91 years old

In-depth analysis and translation of the risk profile mentioned above to the logistic EuroSCORE (Table EuroSCORE below):

- Cohort 1: range of 9.1% to 42.3% in males, and 12.2% to 50.5% in females
- Cohort 2: range of 7.2% to 32.1% in males, and 9.8% to 39.6% in females
- Cohort 3*: range of 6.6% to 27.8% in males, and 9.0% to 34.9% in females

Male		70 yr	73 yr	76 yr	79 yr	82 yr	85 yr	88 yr	91 yr
Risk factors	0	6.6	8.0	9.6	11.4
	1	7.2 - 12.4	8.7 - 14.8	10.4 - 17.5	12.4 - 20.5	14.7 - 24.0	17.4 - 27.8
	2	9.1 - 20.6	10.9 - 24.0	13.0 - 27.9	15.4 - 32.1
	3	16.2 - 37.5	19.1 - 42.3
Female		70 yr	73 yr	76 yr	79 yr	82 yr	85 yr	88 yr	91 yr
Risk factors	0	9.0	10.7	12.8	15.2
	1	9.8 - 16.5	11.7 - 19.4	13.9 - 22.7	16.5 - 26.4	19.4 - 30.5	22.7 - 34.9
	2	12.2 - 26.5	14.5 - 30.6	17.2 - 35.0	20.2 - 39.6
	3	21.1 - 45.5	24.7 - 50.5

Euroscore: ranges of scores are displayed as: score with least influential risk factors – score with most influential risk factors. *Upper age limit 91 years old

4. Comparative patient outcome

One-year mortality amounts to 30% in the overall high-risk matched population with a logistic EuroSCORE of 15.8%. The hazard ratio of propensity matched patients between SAVR and TAVI is 0.97. This suggests equipoise for both treatment strategies and is the legitimation for a randomized trial in this intermediate risk AS population.

R.22.2 SURTAVI co-morbidity list

Methodology for identifying enlisted co-morbidities:

We first identified those components recurring in the previously published scoring models and looked for updated definitions by international professional societies. We then added missing risk factors, identified in the literature, which we felt, were essential. In addition, there exists an 'open box' to capture less prevalent and unanticipated risk factors (e.g. liver failure, mediastinal radiation, porcelain aorta, etc.)

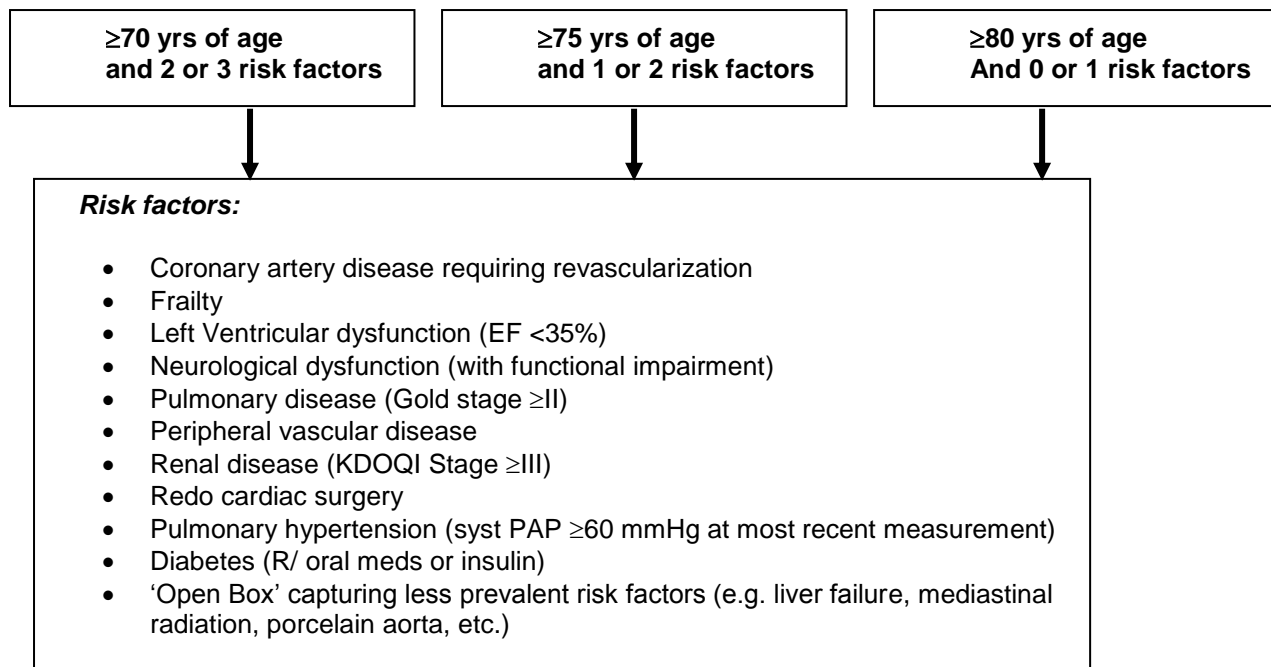



The above risk factors will guide the Heart Team in the selection of the treatment options but will not dictate patient allocation. The final decision treatment will be done by the local Heart Team.

1. **Significant concomitant Coronary Artery Disease:** defined as ≥70% stenosis by invasive coronary angiography because the combination of revascularization and aortic valve replacement reduces the rates of perioperative MI, perioperative mortality, late mortality and morbidity when compared with patients not undergoing simultaneous revascularization (ACC/AHA/ESC class IC recommendation)(6, 43, 44). Previous CABG or PCI is not considered to have considerable impact on short term outcome.
2. **Frailty:** in the absence of a generally accepted consensus definition Frailty is defined as suggested by Lee and co-workers by the presence of any 1 of the following⁽⁴⁰⁾:
 - a. Katz score(independence in Activities of Daily Living);
 - b. Ambulation (walking aid/assist?);
 - c. Diagnosis of (pre-)dementia.
3. **Left Ventricular dysfunction:** defined as EF < 35%, with respect to the pivotal position of this particular threshold in the heart failure population⁽⁴⁵⁾.
4. **Neurological dysfunction:** Cerebro-Vascular Disease, documented by any one of the following: CVA (symptoms lasting >24 hours or imaging of an acute clinically relevant brain lesion in patients with rapidly vanishing symptoms); TIA (brief episode of neurological dysfunction caused by a focal disturbance of brain or retinal ischemia, with clinical symptoms with recovery within 24 hrs and without evidence of infarction); Non-invasive carotid test with > 60% diameter occlusion or prior carotid surgery or symptomatic carotid stenosis > 50%⁽⁴⁶⁻⁴⁹⁾. Does not include neurological disease processes such as metabolic and/or anoxic ischemic encephalopathy.

5. Pulmonary disease: COPD Gold Stage II: moderate COPD with worsening airflow limitation (FEV1/FVC <70%; 50% \geq FEV1 <80% predicted), with shortness of breath typically developing on exertion⁽⁵⁰⁾.
6. Peripheral vascular disease: adapted from the STS risk model: Claudication, either with exertion or at rest; Amputation for arterial vascular insufficiency; Vascular reconstruction, bypass surgery, or percutaneous intervention to the extremities; Documented aortic aneurysm with or without repair; Positive non-invasive test (e.g., ankle brachial index \leq 0.9, ultrasound, magnetic resonance or computed tomography imaging of > 50% diameter stenosis in any peripheral artery, i.e., renal, subclavian, femoral, iliac)
7. Renal disease: at least moderate chronic kidney disease with GFR < 60 mL/min according to the National Kidney Foundation kidney disease outcome quality initiative advisory board⁽⁵¹⁾.
8. Redo cardiac surgery
9. Pulmonary hypertension (> 60mmHg at most recent measurement)
10. Diabetes Mellitus on oral or insulin therapy.
11. OPEN BOX: e.g., extensive mediastinal radiation, chest wall deformity, Liver Failure
Child-C



Patients available for screening
All patients

		Comorbidities (n)						
		0	1	2	3	4	≥5	Total cases
Age (yrs)	<60	107	85	17	11	1	1	222
	60-64	47	37	15	8	0	0	107
	65-69	57	53	24	10	5	0	149
	70-74	60	66	47	10	5	4	192
	75-79	64	89	38	20	5	2	218
	≥80	46	53	43	35	6	11	194
							1082	

	SAVR	668/1082	61.7%
	Random --> TAVI / SAVR	283/1082	26.2%
	Too high risk	131/1082	12.1%



SAVR patients

		Comorbidities (n)						
		0	1	2	3	4	≥5	Total cases
Age (yrs)	<60	106	84	17	11	0	0	218
	60-64	47	37	14	6	0	0	104
	65-69	57	52	23	8	3	0	143
	70-74	59	65	44	5	4	0	177
	75-79	60	83	33	14	1	0	191
	≥80	36	32	15	3	0	0	86
							919	

	SAVR	649/919	70.6%
	Random --> TAVI / SAVR	233/919	25.4%
	Too high risk	37/919	4.0%

TAVI patients

		Comorbidities (n)						
		0	1	2	3	4	≥5	Total Cases
Age (yrs)	≤ 60	1	1	0	0	1	1	4
	60-64	0	0	1	2	0	0	3
	65-69	0	1	1	2	2	0	6
	70-74	1	1	3	5	1	4	15
	75-79	4	6	5	6	4	2	27
	≥ 80	10	21	28	32	6	11	108
							163	

	SAVR	19/163	11.7%
	Random --> TAVI / SAVR	50/163	30.7%
	Too high risk	94/163	57.7%

Distribution of age and comorbidities in patients with severe aortic stenosis in the Rotterdam practice. In each age group, patients are divided by the total number of comorbidities as previously defined.

Indicated in green are the patients that are too low risk for randomization (62%). Indicated by orange are patients that will be randomized in SURTAVI (26%). In blue are patients too high risk for randomization (12%). Therefore, it is estimated that every 1 in 4 patients meets the inclusion criteria for screening.

STS versus Euro Score

This table illustrates the relative impact of common co-morbidities in STS score (vertical axis) and Euroscore (horizontal axis) risk model. This present panel relates specifically of a male patient of 70 years old with 0, 1 or 2 risk factors.

The black line separates the score values of the two respective models: below the line relates to STS score, above to Euroscore.

The empty boxes indicate that the specific risk factor is not accounted for in the risk model, e.g. diabetes in Euroscore.

If this patient has no co-morbidity he would have an STS score of 0.9 and a Euroscore of 3 (see first square in upper left corner).

If this patient has a poor LVEF combined with peripheral vascular disease he would have a STS score of 1.5 and Euroscore of 15.5

Redo surgery is displayed as “first reoperation / second reoperation”, and COPD as “moderate / severe”. Values indicated as “score - score” correspond to the range of scores possible when combining all 4 risk factors (for instance ‘moderate COPD + 1st redo’ - ‘severe COPD + 2nd redo’)

DM = diabetes mellitus; PVD = peripheral vascular disease; CVD = cerebrovascular disease; LVEF = left ventricular ejection fraction; CAD = coronary artery disease; NYHA = New York Heart Association; COPD = chronic obstructive pulmonary disease; PH = pulmonary hypertension

		EUROSCORE													
		None	DM	PVD	CVD	Poor LVEF	CAD	NYHA III / IV	Redo Surgery	Renal Failure	COPD	Dialysis	PH	Neurologic Dysfunction	
STS SCORE	None	0.9	3.0→	...	5.8	...	8.7	8.0	5.8	5.0	...	6.4	6.9
	DM	1.2	
	PVD	1.2	1.5		...	15.5	14.3	10.5	9.1	...	11.7	12.5	
	CVD	0.9	1.2	1.2		
	Poor LVEF	1.2	1.5	1.5	1.2		20.6	15.4	13.5	...	17.0	18.1	
	CAD	0.9	1.2	1.2	0.9	1.2		
	NYHA III / IV	0.9/1.3	1.2/1.7	1.2/1.6	0.9/1.3	1.2/1.7	0.9/1.3		
	Redo Surgery	1.5/1.8	1.9/2.2	1.9/2.2	1.5/1.8	2.0/2.3	1.5/1.8	1.5-2.5		14.3	12.4	...	15.7	16.8	
	Renal Failure	1.8	2.3	2.2	1.8	2.3	1.8	1.8/2.5	2.9/3.4		9.1	...	11.6	12.4	
	COPD	1.5/1.9	1.9/2.4	1.9/2.4	1.5/1.9	2.0/2.5	1.5/1.9	1.5-2.7	2.9/3.6	2.9/3.6		...	10.1	10.8	
	Dialysis	2.9	3.6	3.5	2.9	3.7	2.9	2.9/4.0	4.6/5.3	2.9	4.5/5.7		
	PH		13.7	
	Neurologic Dysfunction		



SURTAVI

Surgical Replacement and Transcatheter Aortic Valve Iplantation

Clinical Investigation Plan

VERSION 12.0

31 May 2016

Sponsor:

Medtronic, Inc.
Clinical Research
Mailstop: MVS66
Mounds View South
8200 Coral Sea St NE
Mounds View, MN 55112 USA

Medtronic Bakken Research Center
Coronary and Structural Heart Department
Endepolsdomein 5
6229 GW Maastricht
The Netherlands

Contact Information Details*

Study Chair

Prof. Patrick W. Serruys, MD, PhD (Study Chair)
Professor of Medicine
Erasmus Medical Center
Dept. of Interventional Cardiology, Thoraxcenter P.O.
Box 21253000 CC Rotterdam, The Netherlands
Dr. Nicolas M. Van Mieghem, MD, PhD (Deputy Study
Chair)
Interventional Cardiologist
Erasmus Medical Center
Dept. of Interventional Cardiology, Thoraxcenter Room
BD 171
's Gravendijkwal 230
3015 CE Rotterdam, The Netherlands

Principal Investigators

Prof. Stephan Windecker, MD, PhD
Head of Interventional Cardiology
Bern University Hospital
Department of Cardiology
Swiss Cardiovascular Center Bern
Freiburgstrasse 4
CH-3010 Bern, Switzerland

Prof. A. Pieter Kappetein, MD, PhD
Cardio-Thoracic Surgeon
Erasmus Medical Center
Dept. of Thoracic Surgery
Room BD 569
's Gravendijkwal 230
3015 CE Rotterdam, The Netherlands

Prof. Rüdiger Lange, MD, PhD
Direktor der Klinik für Herz- und Gefäßchirurgie
Deutsches Herzzentrum München
Lazarettstr. 36
80636 München, Germany

Prof. Thomas Walther, MD, PhD
Direktor der Abteilung Herzchirurgie
Kerckhoff-Klinik
Benkestr. 2-8
61231 Bad Nauheim; Germany

Dr. Jeffrey J. Popma, MD
Director, Interventional Cardiology
Beth Israel Deaconess Medical Center
185 Pilgrim Rd.
Boston, MA 02215 USA

Dr. Michael J. Reardon, MD
Professor, Cardiothoracic Surgery
The Methodist Hospital
6550 Fannin St., Suite 1401
Houston, TX 77030 USA

Dr. David H. Adams, MD
Marie-Josée and Henry R. Kravis Professor and
Chairman
Department of Cardiothoracic Surgery
The Mount Sinai Medical Center
1190 Fifth Avenue
New York, NY 10029 USA

Trial Oversight

Mike Boulware
Clinical Research Manager
Medtronic Coronary and Structural Heart
Phone: (763) 514.9826
Email: mike.j.boulware@medtronic.com

Maarten Hollander – *EU*
Clinical Research Manager
Medtronic Bakken Research Center
Phone: (+31-43) 3566864
Email: maarten.hollander@medtronic.com

Sponsor

Medtronic, Inc.
Clinical Research
Mailstop: MVS66
Mounds View South
8200 Coral Sea Street NE
Mounds View, MN
55112 USA

Medtronic Bakken Research Center
Coronary and Structural Heart Department
Endepolsdomein 5
6229 GW Maastricht
The Netherlands

Randomization System

Randomization (IXRS) information will be provided
in the investigator site file

* Updated contact information will be provided as applicable. Additional information regarding
contacts listed above available upon request.

CONFIDENTIAL and PROPRIETARY

This document contains confidential information and is solely the property of Medtronic, Inc. Acceptance of this document constitutes an agreement by the recipient that no unpublished information contained herein will be published or disclosed without the prior written approval of Medtronic, Inc. This document may be disclosed to the appropriate Institutional Review Board (IRB)/Ethics Committee (EC) with the stipulation that the IRB/EC treats the information contained herein as the confidential property of Medtronic, Inc.

TABLE OF CONTENTS

A	SYNOPSIS	8
B	PURPOSE	15
B.1	Background.....	15
B.2	Investigational Devices and Intended Use	17
B.2.1	Device Description	17
B.2.1.1	Medtronic CoreValve™ System.....	17
B.2.1.2	Medtronic CoreValve™ Evolut R™ System	17
B.2.2	Device Approval Status.....	19
B.2.2.1	European Union	19
B.2.2.2	United States	20
B.2.2.3	Canada	20
B.2.3	Intended Use of the Device / Indications for Use	20
B.3	Trial Objectives	21
B.3.1	Primary	21
B.3.2	Secondary	21
B.3.3	Exploratory	21
C	TRIAL PROTOCOL.....	22
C.1	Ethics and Regulatory Compliance	22
C.1.1	Applicable Regulations.....	22
C.1.2	Institutional Review Board (IRB)/Medical Ethics Committee (MEC)	22
C.1.3	Regulatory Submission	22
C.1.4	Ethical Conduct of the Trial	23
C.2	Trial Administration	23
C.2.1	Steering Committee.....	23
C.2.2	Publication Committee	23
C.3	Methodology	24
C.3.1	Purpose	24
C.3.2	Patient Population	24
C.3.3	Design	24
C.3.4	Investigational Centers.....	24
C.3.5	Number of Subjects.....	25
C.3.6	Inclusion/Exclusion Criteria	25
C.3.6.1	Inclusion Criteria	25
C.3.6.2	Exclusion Criteria.....	26
C.3.7	Informed Consent.....	28
C.3.8	Revisions in Patient Information and Informed Consent Form	28
C.3.9	Enrollment Flowchart for Randomization to TAVI or SAVR	29
C.3.10	Trial Training	29
C.4	Trial Procedures	30
C.4.1	Screening Procedures.....	30
C.4.2	Heart Team Procedures.....	32
C.4.2.1	Heart Team Composition.....	32
C.4.2.2	Heart Team Review and Decision	32
C.4.3	Screening Committee.....	33
C.4.4	Roll-in Subjects	33
C.4.5	Enrollment and Randomization	33

C.4.6	Baseline Assessments	35
C.4.7	Transcatheter Aortic Valve Implant or Surgical Aortic Valve Replacement Procedure	36
C.4.7.1	TAVI	36
C.4.7.2	Surgical Aortic Valve Replacement	43
C.4.8	Assessments done at discharge (both SAVR and TAVI)	47
C.4.9	Follow-Up Evaluations	48
C.4.9.1	30 Days	48
C.4.9.2	3 Months	49
C.4.9.3	6 Months	49
C.4.9.4	12 Months	49
C.4.9.5	18 Months	50
C.4.9.6	24 Months	50
C.4.9.7	3-5 Years	50
C.4.10	Echo Assessment	51
C.4.11	Neurologic Assessment	51
C.4.12	Angiographic and Computed Tomography Assessment	52
C.4.13	Data Collection	53
C.4.14	Unscheduled Follow-up Assessments	55
C.4.15	Missed Follow-up Visits	55
C.4.16	Investigational Product Accountability	55
C.4.17	Device Malfunction or Explant	55
C.4.18	Protocol Deviations	56
C.4.19	Subject Withdrawal or Discontinuation	57
C.4.20	Termination or Discontinuation of Trial	57
C.5	Adverse Events	58
C.5.1	Definitions	58
C.5.1.1	Adverse Event	58
C.5.1.2	Serious Adverse Event	58
C.5.1.3	Major Adverse Cardiovascular and Cerebrovascular Events	58
C.5.1.4	Major Adverse Event	59
C.5.1.5	Adverse Device Effect (ADE) or Device-Related Adverse Event	59
C.5.1.6	Serious Adverse Device Effects (SADEs)	59
C.5.1.7	Unanticipated Adverse Device Effect (UADE)	59
C.5.1.8	Unanticipated Serious Adverse Device Effect (USADE)	60
C.5.1.9	Device Deficiency	60
C.5.1.10	Technical Observation	60
C.5.2	Reporting	60
C.5.2.1	Serious Adverse Events (SAEs)	60
C.5.2.2	Serious Adverse Device Effects	61
C.5.2.3	Unanticipated Adverse Device Effects (UADE or USADE)	61
C.5.2.4	Device Deficiencies and Technical Observations	61
C.5.2.5	All Other Adverse Events	61
C.5.2.6	Anticipated Adverse Events	61
C.5.2.7	Deaths	63
C.5.2.8	Vigilance Reporting	63
C.5.3	Clinical Events Committee (CEC)	63
C.5.4	Data Safety Monitoring Board (DSMB)	64
C.6	Statistical Methods and Analysis	65

C.6.1	Statistical Considerations and Analysis	65
C.6.2	Reports	65
C.6.3	Description of Baseline Variables	65
C.6.4	Analysis Populations	65
C.6.4.1	Screening Population.....	65
C.6.4.2	Randomized Population	65
C.6.5	Primary Analysis.....	66
C.6.5.1	Hypothesis of Non-inferiority	66
C.6.5.2	Randomization, Sample Size and Analysis Plan.....	66
C.6.6	Missing Data and Planned Sensitivity Analyses (Primary Objective)	67
C.6.7	Description of Performed Analysis, per population	67
C.6.7.1	Analysis of Screening Population	67
C.6.7.2	Analysis of ITT and mITT Populations.....	67
C.6.7.3	Analysis of Implanted Population	68
C.6.8	Secondary Endpoints	69
C.6.8.1	Secondary Endpoints Compared Between TAVI and SAVR.....	69
C.6.8.2	Secondary Endpoints Assessed for TAVI Only	73
C.6.9	Rationale for Selection of Trial Endpoints	73
C.6.10	Multiplicity Considerations	73
C.6.10.1	Secondary Endpoints Tested to Support Labeling Claims	74
C.6.11	Heterogeneity/Poolability	77
C.6.12	Additional Analysis.....	77
C.6.12.1	Pre-Defined Subgroups	77
C.6.12.2	Analysis of VARC Endpoints and Definitions	78
C.6.13	Health-Related Quality of Life (HRQoL) and Treatment Costs.....	78
C.6.13.1	Quality of Life.....	78
C.6.13.2	Economic Outcomes/Cost-Effectiveness	78
C.6.14	Use of Data for CE Mark.....	78
C.7	Data and Quality Management.....	79
C.7.1	Electronic Data Capture	79
C.7.2	Data Collection	79
C.7.3	Core Laboratories Procedures	79
C.7.4	Source Documents.....	79
C.7.5	Maintenance and Calibration	79
C.8	Records and Reports.....	80
C.8.1	Responsibilities of the Sponsor.....	80
C.8.2	Responsibilities of the Investigator.....	81
D	RISK / BENEFIT ANALYSIS.....	83
D.1	Methods to Minimize Risk.....	84
D.2	Potential Benefits.....	84
E	DESCRIPTION OF MEDTRONIC COREVALVE™ SYSTEMS	85
E.1	Investigational Product Description	85
E.1.1	Medtronic CoreValve System.....	85
E.1.2	Medtronic CoreValve Evolut R System	88
E.2	Investigational Device Ordering, Storage, and Disposition	91
F	MONITORING AND AUDITING	92
F.1	Monitoring.....	92
F.2	Auditing.....	92

G	LABELING	93
H	CONSENT MATERIALS	93
I	IRB/MEC INFORMATION.....	93
J	OTHER INSTITUTIONS	93
K	ADDITIONAL RECORDS AND REPORTS.....	93
L	REPORT OF PRIOR INVESTIGATIONS.....	93
M	PUBLICATION POLICY	94
N	AMENDMENTS TO THE CLINICAL INVESTIGATION PLAN	95
O	ABBREVIATIONS AND DEFINITIONS.....	97
	O.1 List of Abbreviations	97
	O.2 Definitions of Terms.....	100
P	TRIAL MANAGEMENT	117
	P.1 Miscellaneous	117
	P.1.1 Insurance.....	117
	P.1.2 Reimbursement	117
	P.1.3 Indemnification	117
	P.1.4 Subject confidentiality.....	117
Q	REFERENCES	118
R	APPENDICIES.....	122
	R.1 Sample Informed Consent	
	R.2 List of Participating Investigational Centers	
	R.3 Other Institutions	
	R.4 Additional Records and Reports	
	R.5 Sample Case Report Forms	
	R.6 Aortogram Acquisition Guidelines	
	R.7 Echocardiography Acquisition Guidelines	
	R.8 Electrocardiogram (ECG) Submission	
	R.9 Computed Tomography (CT) Angiography Acquisition Guidelines	
	R.10 Interactive Voice/Web Response System (IXRS)	
	R.11 Explanted Device/Pathology and Return Procedures	
	R.12 Economic and Quality of Life Data Collection	
	R.13 Pacing Guidelines	
	R.14 Six Minute Walk Test Instructions	
	R.15 National Institute of Health Stroke Scale (NIHSS)	
	R.16 Modified Rankin Scale (mRS) Instructions	
	R.17 Mini Mental State Exam (MMSE-2:SV)	
	R.18 Additional Neurological Assessments	
	R.19 Medtronic CoreValve™ Clinical Assessment Guidelines	
	R.20 Katz Index of Independence in Activities of Daily Living	
	R.21 Investigator Brochure / Report of Prior Investigations	
	R.22 Instuctions For Use	
	R.23 Radiation Exposure and Data Collection	
	R.24 SURTAVI Risk Model	
	R.25 CMS Requirements for Coverage and Reimbursement – US ONLY	

A SYNOPSIS

Title of Trial:	Surgical Replacement and Transcatheter Aortic Valve Implantation (SURTAVI)
Name of Product:	Medtronic CoreValve™ System and CoreValve™ Evolut™ R System
Purpose:	The purpose of this trial is to investigate the safety and efficacy of transcatheter aortic valve implantation (TAVI) in patients with severe, symptomatic Aortic Stenosis (AS) at intermediate surgical risk by randomizing patients to either Surgical Aortic Valve Replacement (SAVR) or TAVI.
Design:	Subjects will be randomized on a 1:1 basis to either transcatheter aortic valve implant (TAVI) or to surgical aortic valve replacement (SAVR)
Primary Objective:	The primary objective of this trial is to evaluate in a prospective randomized fashion whether TAVI is non-inferior to SAVR with respect to composite endpoint of all-cause mortality and disabling stroke at 24 months in patients with symptomatic severe aortic stenosis and at intermediate surgical risk.
Secondary Objective:	The secondary objective of this trial is to assess differences in quality of life, clinical benefit (efficacy endpoints) and health economics in patients with symptomatic severe aortic stenosis and at intermediate risk treated with either Transcatheter Aortic Valve Implantation (TAVI) or Surgical Aortic Valve Replacement (SAVR).
Exploratory Objective:	An analysis will be conducted to determine if patients can be identified as intermediate risk for Transcatheter Aortic Valve Implantation (TAVI) based upon age and the presence of a defined list of co-morbidities commonly associated with patients undergoing TAVI procedures.
Primary Endpoint:	All-cause mortality or disabling stroke at 24 months
Secondary Endpoints:	<p>The following secondary endpoints will be compared between TAVI and SAVR subjects cohorts:</p> <ol style="list-style-type: none"> 1. Incidence of Major Adverse Cardiovascular and Cerebrovascular Events (MACCE)- at 30 days, 6 months, 12 months, 18 months, 24 months, and annually thereafter up to 5 years. MACCE is defined as a composite of: <ul style="list-style-type: none"> • All-cause death • Myocardial infarction (MI) • All stroke, and • Reintervention (defined as any cardiac surgery or percutaneous reintervention catheter procedure that repairs, otherwise alters or adjusts, or replaces a previously implanted valve) 2. The occurrence of individual MACCE components at 30 days, 6 months, 12 months, 18 months, 24 months, and annually thereafter up to 5 years. 3. Major Adverse Events (MAE) and individual components at 30 days, 6 months, 12 months, 18

	<p>months, 24 months, and annually thereafter up to 5 years.</p> <p>4. Incidence of Early safety at 30 days defined as a composite of:</p> <ul style="list-style-type: none"> • All-cause mortality • All stroke (disabling and non-disabling) • Life-threatening bleeding • Acute kidney injury—Stage 2 or 3 (including renal replacement therapy) • Coronary artery obstruction requiring intervention • Major vascular complication • Valve-related dysfunction requiring repeat procedure (BAV, TAVI, or SAVR) • All-cause death <p>Early safety composite endpoint-incidence estimates will be provided for the two treatment groups at 30 days.</p> <p>5. Incidence of Clinical Efficacy (after 30 days) at 6 months, 12 months, 18 months, 24 months and annually thereafter up to 5 years. Clinical efficacy defined as a composite of:</p> <ul style="list-style-type: none"> • All-cause mortality • All stroke (disabling and non-disabling) • Requiring hospitalizations for valve-related symptoms or worsening congestive heart failure • NYHA class III or IV • Valve-related dysfunction (mean aortic valve gradient ≥ 20 mmHg, effective orifice area (EOA) ≤ 0.9-1.1 cm² and/or doppler velocity index (DVI) < 0.35 m/s, AND/OR moderate or severe prosthetic valve regurgitation) <p>Clinical efficacy estimates will be provided for the two treatment groups at 6 months, 12 months, 18 months, 24 months and annually thereafter up to 5 years.</p> <p>6. Incidence of Time-Related Safety at 30 days, 6 months, 12 months, 18 months, 24 months and annually thereafter up to 5 years. Time-Related Safety defined as a composite of:</p> <ul style="list-style-type: none"> • Structural valve deterioration: <ul style="list-style-type: none"> ○ Valve-related dysfunction (mean aortic valve gradient ≥ 20 mmHg, EOA ≤ 0.9-1.1 cm² and/or DVI < 0.35 m/s, AND/OR moderate or severe prosthetic valve regurgitation) ○ Requiring repeat procedure (TAVI or SAVR) • Prosthetic valve endocarditis • Prosthetic valve thrombosis • Thromboembolic events (eg. stroke) • VARC bleeding, unless clearly unrelated to valve therapy (eg. trauma) <p>Time related safety composite endpoint-incidence estimates will be provided for the two treatment groups at 30 days, 6 months, 12 months, 18 months, 24 months and annually thereafter up to 5 years.</p> <p>7. Conduction disturbance requiring permanent pacemaker implantation at 30 days, 6 months, 12 months, 18 months, 24 months, and annually</p>
--	---

	<p>thereafter up to 5 years.</p> <ol style="list-style-type: none"> 8. Change in NYHA class from baseline at 30 days, 6 months, 12 months, 18 months, 24 months, and annually thereafter up to 5 years. 9. Change in distance walked during 6-minute walk test (6MWT) from baseline to 30 days, baseline to 12 months, and baseline to 24 months. 10. Ratio of days alive out of hospital versus total days alive assessed at 12 months and 24 months follow-up. 11. Quality of Life (QoL) change from baseline at 30 days, 3 months, 6 months, 12 months, 18 months, 24 months, and annually thereafter up to 5 years. 12. Echocardiographic assessment of prosthetic valve performance at discharge, 6 months, 12 months, 24 months, and annually thereafter up to 5 years using the following measures: <ul style="list-style-type: none"> • Transvalvular mean gradient • Effective orifice area • Degree of prosthetic aortic valve regurgitation (transvalvular and paravalvular). 13. Aortic valve disease related hospitalizations. 14. Cardiovascular deaths and valve-related deaths. 15. Strokes and TIAs. 16. Peri-procedural neurological injury. 17. Index procedure related MAEs. 18. Length of index procedure hospital stay. 19. Presence of atrial fibrillation at post-procedure, discharge, 30 days, 6 months, 12 months, 18 months, 24 months, and annually thereafter up to 5 years. <p>The following secondary endpoints will be assessed for the TAVI cohort subjects only:</p> <ol style="list-style-type: none"> 20. Device success defined as follows: <ul style="list-style-type: none"> • Absence of procedural mortality AND • Correct positioning of a single prosthetic heart valve into the proper anatomical location AND • Intended performance of the prosthetic heart valve (no prosthesis-patient mismatch and mean aortic valve gradient <20 mmHg or peak velocity <3 m/s, AND no moderate or severe prosthetic valve regurgitation) <ul style="list-style-type: none"> ○ Assessed acutely in resting state, either within 24-48 hours after the index procedure or before hospital discharge 21. Procedural success, defined as device success and absence of in-hospital MACCE. 22. Evidence of prosthetic valve dysfunction at 30 days, 6 months, 12 months, 24 months, and annually thereafter up to 5 years. 23. Resheath and recapture success (Evolut R only).
--	---

Trial Sites:	Up to 115 sites globally
Sample Size:	Approximately 1600 patients
Patient Population:	Patients who have symptomatic severe Aortic Stenosis who are determined by the Heart Team to be at intermediate surgical risk.
Inclusion Criteria:	<ol style="list-style-type: none"> 1. Subject must have co-morbidities such that Heart Team agrees predicted risk of operative mortality is $\geq 3\%$ and $< 15\%$ at 30 days (Intermediate Clinical Risk classification). Heart team evaluation of clinical surgical mortality risk for each patient includes the calculated STS score for predicted risk of surgical mortality augmented by consideration of the overall clinical status and co-morbidities unmeasured by the STS risk calculation; 2. Heart Team unanimously agree on treatment proposal and eligibility for randomization based on their clinical judgment (including anatomy assessment, risk factors, etc.); 3. Subject has severe aortic valve stenosis presenting with <ol style="list-style-type: none"> a) Critical aortic valve area defined as an initial aortic valve area of $\leq 1.0 \text{ cm}^2$ or aortic valve area index $< 0.6 \text{ cm}^2/\text{m}^2$ <p style="text-align: center;">AND</p> <ol style="list-style-type: none"> b) Mean gradient $> 40 \text{ mmHg}$ or $V_{\text{max}} > 4 \text{ m/sec}$ by resting echocardiogram or simultaneous pressure recordings at cardiac catheterization [or with dobutamine stress, if subject has a left ventricular ejection fraction (LVEF) $< 55\%$] or velocity ratio < 0.25; 4. Subject is symptomatic from his/her aortic valve stenosis, as demonstrated by New York Heart Association (NYHA) Functional Class II or greater; 5. Subject and the treating physician agree that the subject will return for all required post-procedure follow-up visits; 6. Subject meets the legal minimum age to provide informed consent based on local regulatory requirements.

<p>Exclusion Criteria:</p>	<ol style="list-style-type: none"> 1. Subject has refused surgical aortic valve replacement (SAVR) as a treatment option; 2. Any condition considered a contraindication for placement of a bioprosthetic valve (i.e. subject requires a mechanical valve); 3. A known hypersensitivity or contraindication to all anticoagulation/antiplatelet regimens (including inability to be anticoagulated for the index procedure), nitinol, or sensitivity to contrast media which cannot be adequately pre-medicated; 4. Blood dyscrasias as defined: leukopenia (WBC <1000mm³), thrombocytopenia (platelet count <50,000 cells/mm³), history of bleeding diathesis or coagulopathy; 5. Ongoing sepsis, including active endocarditis; 6. Any condition considered a contraindication to extracorporeal assistance; 7. Any percutaneous coronary or peripheral interventional procedure performed within 30 days prior to randomization (Subjects with recent placement of drug eluting stent(s) should be assessed for ability to safely proceed with SAVR within the protocol timeframe); 8. Symptomatic carotid or vertebral artery disease or successful treatment of carotid stenosis within six weeks of randomization; 9. Cardiogenic shock manifested by low cardiac output, vasopressor dependence, or mechanical hemodynamic support; 10. Recent (within 6 months of randomization) cerebrovascular accident (CVA) or transient ischemic attack (TIA); 11. Active gastrointestinal (GI) bleeding that would preclude anticoagulation; 12. Subject refuses a blood transfusion; 13. Severe dementia (resulting in either inability to provide informed consent for the trial/procedure, prevents independent lifestyle outside of a chronic care facility, or will fundamentally complicate rehabilitation from the procedure or compliance with follow-up visits); 14. Multivessel coronary artery disease with a Syntax score >22 and/or unprotected left main coronary artery (Syntax score calculation is not required for patients with history of previous revascularization if repeat revascularization is not planned); 15. Estimated life expectancy of less than 24 months due to associated non-cardiac co-morbid conditions; 16. Other medical, social, or psychological conditions that in the opinion of the Investigator precludes the subject from appropriate consent or adherence to the protocol required follow-up exams; 17. Currently participating in an investigational drug or
----------------------------	---

	<p>another device trial (excluding registries);</p> <ol style="list-style-type: none"> 18. Evidence of an acute myocardial infarction ≤ 30 days before the index procedure; 19. Need for emergency surgery for any reason; 20. True porcelain aorta (i.e. Heart Team agrees the aorta is not clampable for SAVR); 21. Extensive mediastinal radiation; 22. Liver failure (Child-C); 23. Reduced ventricular function with left ventricular ejection fraction (LVEF) $< 20\%$ as measured by resting echocardiogram; 24. Uncontrolled atrial fibrillation (eg. resting heart rate > 120bpm); 25. Pregnancy or intent to become pregnant prior to completion of all protocol follow-up requirements; 26. End stage renal disease requiring chronic dialysis or creatinine clearance < 20 cc/min; 27. Pulmonary Hypertension (systolic pressure > 80mmHg); 28. Severe Chronic Obstructive Pulmonary Disease (COPD) demonstrated by Forced Expiratory Volume (FEV1) < 750cc; 29. Frailty assessments identify: <ul style="list-style-type: none"> • Subject is < 80 years of age and three or more of the following apply • Subject is ≥ 80 years of age and two or more of the following apply <ul style="list-style-type: none"> ○ Wheelchair bound ○ Resides in an institutional care facility (eg. nursing home, skilled care center) ○ Body Mass Index < 20kg/m² ○ Grip strength < 16kg ○ Katz Index score ≤ 4 ○ Albumin < 3.5 g/dL. 30. Marfan syndrome or other known connective tissue disease that would necessitate aortic root replacement/intervention.
--	---

	<p>Anatomical Exclusion Criteria</p> <p>31. Native aortic annulus size <18 mm or >29 mm per the baseline diagnostic imaging;</p> <p>32. Pre-existing prosthetic heart valve in any position;</p> <p>33. Mixed aortic valve disease [aortic stenosis and aortic regurgitation with predominant aortic regurgitation (3-4+)];</p> <p>34. Severe mitral or severe tricuspid regurgitation;</p> <p>35. Severe mitral stenosis;</p> <p>36. Hypertrophic obstructive cardiomyopathy;</p> <p>37. Echocardiographic or Multislice Computed Tomography (MSCT) evidence of new or untreated intracardiac mass, thrombus or vegetation;</p> <p>38. Ascending aorta diameter greater than maximum diameter relative to the native aortic annulus size:</p> <table border="1" data-bbox="732 772 1289 960"> <thead> <tr> <th>Aortic Annulus Diameter</th> <th>Ascending Aorta Diameter</th> </tr> </thead> <tbody> <tr> <td>18 mm – 20 mm</td> <td>>34 mm</td> </tr> <tr> <td>20 mm – 23 mm</td> <td>>40 mm</td> </tr> <tr> <td>23 mm – 29 mm</td> <td>>43 mm</td> </tr> </tbody> </table> <p>39. Aortic root angulation (angle between plane of aortic valve annulus and horizontal plane/vertebrae)</p> <p>a) Femoral and left subclavian/axillary access > 70°</p> <p style="text-align: center;">OR</p> <p>b) Right subclavian/axillary access: Aortic root angulation > 30°;</p> <p>40. Congenital bicuspid or unicuspid valve verified by echocardiography;</p> <p>41. Sinus of Valsalva anatomy that would prevent adequate coronary perfusion.</p> <p>Vascular Exclusion Criteria</p> <p>42. Transarterial access not able to accommodate an 18Fr sheath.</p>	Aortic Annulus Diameter	Ascending Aorta Diameter	18 mm – 20 mm	>34 mm	20 mm – 23 mm	>40 mm	23 mm – 29 mm	>43 mm
Aortic Annulus Diameter	Ascending Aorta Diameter								
18 mm – 20 mm	>34 mm								
20 mm – 23 mm	>40 mm								
23 mm – 29 mm	>43 mm								
Enrollment Phase:	36 months								
Follow-up Evaluations:	Subjects will be followed through 5 years with assessments at 30 days, 3 months, 6 months, 12 months, 18 months, 24 months, and 3, 4, and 5 years post TAVI or post SAVR. The total trial duration is expected to be approximately 7 years.								

B PURPOSE

B.1 Background

Aortic valve stenosis (AS) is the most prevalent valve disorder in the adult population in developed countries affecting approximately 2% to 4% of people over 65 years of age (2, 3) . This corresponds to approximately 3 million people with AS in Europe and approximately 1.5 million in the United States. One in five will eventually progress to symptomatic AS representing more than 900,000 patients in these two geographies.

Patients with severe AS face a grim prognosis once they become symptomatic. The landmark paper on symptomatic AS by Ross and Braunwald in 1968 highlighted this premise: median survival averages only 2, 3 and 5 years after symptom onset of angina, syncope and heart failure respectively(4). Furthermore mortality is already substantial in the months following the first symptoms (5). The dismal prognosis of patients with untreated severe, symptomatic aortic stenosis has been recently corroborated in the conservative treatment arm of the PARTNER B cohort. Both, the ESC and ACC/AHA cardiology societies have endorsed guidelines on valvular heart disease emphasizing the need for surgical aortic valve replacement (SAVR) once symptoms develop or in case of impaired LV function (Level of evidence grade 1)(6, 7, 8).

Physicians' preferences for lesser invasive strategies have fuelled the ongoing interest in developing minimally invasive transcatheter therapies. Alain Cribier pioneered the transcatheter aortic valve implantation (TAVI) technology and reported the first-in-man experience of TAVI in a patient with symptomatic AS who was deemed inoperable in 2002(10). Subsequent feasibility studies validated the proof of concept (11, 12). The Edwards-SAPIEN valve (Edwards Lifesciences, Irvine, CA, USA) and the Medtronic CoreValve system (Medtronic Corporation, Minneapolis, MN, USA) were the first two TAVI platforms with CE mark approval, followed by the Symetis Acurate (Symetis, Ecublens, Switzerland) and JenaValve (JenaValve, Munich, Germany). Numerous single-center and multi-center observational registries followed suggesting the safety and performance of the TAVI technology (13-17). The TAVI technology comes with its own specific complications (18), not necessarily overlapping with those of SAVR: vascular injury; stroke, cardiac injury such as heart block, coronary obstruction, and cardiac perforation; paravalvular leak; and valve misplacement. The non-uniformity in presenting respective data makes a comparison of results from different centers challenging (19, 20). The Valvular Academic Research Consortium (VARC), a FDA-endorsed collaboration between academic research organizations and professional societies in the United States and Europe is an initiative to generate a consensus statement on TAVI related definitions aiming to create order and uniformity making data more prone to analysis and comparison (21, 22).

Technical refinements and commercial entrepreneurship have made the technology accessible to many centers worldwide. This might pose future implications since few randomized trials with TAVI have been performed.

There are three types of medical practices. The first is the institution with on-site interventional cardiologic and cardiothoracic surgical activity and with close inter-disciplinary collaboration, where interventional cardiologists and cardiothoracic surgeons reach a consensus on which patients to select for a specific surgical or interventional treatment strategy (9). These centers would reasonably respect and adhere to CE mark labeling indications. Second, there are centers where interventional cardiologists and cardiothoracic surgeons do not often convene, and usually work as two separate departments. Finally, there are practices with an interventional cardiology program but without on-site cardiothoracic surgery, estimated to make up 37% of all PCI centers in the European Union. Expectedly, these kinds of organizations without intimate collaboration between cardiothoracic surgeons and interventional cardiologists will look to broaden their interventional activities with an attractive innovation like TAVI. A worldwide practice that is less controlled would potentially cloud the safety and efficacy profile of the procedure. This criticism by the medical community and health authorities could jeopardize future reimbursement policies (23, 24). The advent of randomized trial data is crucial and this next step in establishing a new treatment strategy should not be taken for granted as governmental authorities entitled to grant premarket approval to cardiovascular devices are under increased scrutiny and quality control (25).

After nearly a decade of worldwide mounting TAVI experience, the Cohort B arm of the much-anticipated PARTNER (Placement of AoRTic TraNscathetER Valve Trial) trial representing the

first randomized data set, reported a dramatic 20% absolute reduction in mortality in favor of TAVI compared to medical therapy in patients who, as determined by surgeons could not undergo conventional surgical valve replacement (26).

In the Cohort A of the PARTNER trial, patients for whom a surgeon and cardiologist concurred that the predicted risk of operative mortality was $\geq 15\%$ and/or with a minimum STS score of 10 were randomized to TAVI or SAVR. The trial completed its randomization in early 2009 and first data were presented at ACC in April 2011, reporting successful achievement of the primary endpoint (TAVR was non-inferior to AVR for all-cause mortality at 1 year).

At the PCR London Valves meeting in October 2010, it was reported that over 22000 patients had been treated with TAVI worldwide. To date over 45,000 Medtronic CoreValve System have been implanted worldwide (data on file with Medtronic). Inevitably, with increased operator experience and access to the device, physicians will shift their attention to younger patients with a less pronounced operative risk due to the decreased invasiveness of the TAVI procedure as compared with SAVR, coupled with the safety and performance observed in the PARTNER trial and other literature reports in the extreme and high risk populations. Similar to the coronary revascularization arena (27), the blending of surgical and interventional expertise has created unique interdisciplinary dynamics paving the way for a randomized trial comparing TAVI with SAVR in a surgical intermediate risk patient population.

It is in this spirit that the SURTAVI trial (SURgical and Transcatheter Aortic Valve Implantation) was conceived. The interdisciplinary approach and consensus of the Heart Team (the cardiothoracic surgeon, interventional cardiologist and other treating physicians if necessary) is crucial. This aspect of decision making cannot be over-emphasized and is essential for the quality of current medical practice in general and any planned randomized trial of TAVI versus SAVR in particular. The VARC publication (21, 22) on TAVI definitions and the accumulating TAVI expertise in Europe has created a unique momentum for such a randomized initiative complementary to the US Pivotal IDE randomized trial in AS patients with high operative risk.

For a new technology to be accepted as a new asset for treating symptomatic AS several essential questions need to be answered: is the technology effective? Which patients are likely to benefit (patient selection)? How does this new strategy compare with the alternatives? And what is the cost of the intervention relative to alternatives? The proof of concept has been validated. The innovative and less invasive transcatheter approach should be at least as effective and safe as conventional SAVR or have proof of superiority for both safety and efficacy compared to medical therapy.

The theoretical benefits of this transcatheter approach seem evident by avoiding the need of musculoskeletal incisions, cardioplegic arrest, aortic cross clamping, aortotomy, and full cardiopulmonary bypass. Ultimately the cost-effectiveness will determine whether the new treatment strategy is a valid option to be considered for reimbursement by governmental health institutions.

B.2 Investigational Devices and Intended Use

B.2.1 Device Description

B.2.1.1 Medtronic CoreValve™ System

The Medtronic CoreValve™ System consists of the following product elements:

- Transcatheter Aortic Valve Bioprosthesis (TAV): consisting of a multi-level self-expanding frame with porcine pericardial bioprosthesis. The bioprosthesis is processed with an anti-mineralization treatment of alpha-amino oleic acid (AOA) a compound derived from oleic acid, a naturally occurring long-chain fatty acid.
- Delivery Catheter System (DCS): designed to house the tissue valve prosthesis in the collapsed position for transcatheter delivery to the patient's aortic annulus.
- Compression Loading System (CLS): facilitates consistent and trauma-free manual loading of the TAV into the DCS.

The models to be used are:

- Transcatheter Aortic Valve Prosthesis (TAV) - Models MCS-P4-23-AOA, MCS-P4-23-AOA-US (23mm), MCS-P3-26-AOA, MCS-P3-26-AOA-US (26mm), MCS-P3-29-AOA, MCS-P3-29-AOA-US (29mm), and MCS-P3-31-AOA, MCS-P3-31-AOA-US (31mm)
- Delivery Catheter System (DCS) – AccuTrak®: DCS-C4-18FR, DCS-C4-18F-US, DCS-C4-18FR-23MM, DCS-C4-18FR-23US (US), and DCS-C4-18FR-23 (OUS)
- Compression Loading System (CLS) - Model CLS-3000-18FR, CLS4-18F, CLS-3000-18FR-US, and CLS4-18F-23

B.2.1.2 Medtronic CoreValve™ Evolut R™ System

In addition, the CoreValve Evolut R System will be used in this trial. The system is comprised of the following product elements:

- Evolut R Transcatheter Aortic Valve (TAV): comprised of three leaflets and a sealing skirt constructed from glutaraldehyde-fixated porcine pericardium, sewn to a compressible and self-expandable Nitinol support frame. The TAV is processed with an anti-mineralization treatment of alpha-amino oleic acid (AOA), a compound derived from oleic acid, a naturally occurring long-chain fatty acid.
- EnVeo R Delivery Catheter System (DCS) with EnVeo R Inline Sheath: facilitates the placement of the TAV within the annulus of the aortic valve.
- EnVeo R Loading System (LS): facilitates manual loading of the TAV into the deployment sheath capsule of the DCS by gradually reducing the diameter of the bioprosthesis radially to an optimal diameter.

The models to be used for the CoreValve Evolut R System are:

- Evolut R Transcatheter Aortic Valve (TAV): EVOLUTR-23-C, EVOLUTR-23-US (23mm), EVOLUTR-26-C, EVOLUTR-26-US (26mm), and EVOLUTR-29-C, EVOLUTR-29-US (29mm)
- EnVeo R Delivery Catheter System (DCS) with EnVeo R Inline Sheath: ENVEOR –L, ENVEOR-L-C, ENVEOR-US
- EnVeo R Loading System (LS): LS-ENVEOR-23, LS-ENVEOR-23-C, LS-ENVEOR-23-US (23mm) and LS-ENVEOR-2629, LS-ENVEOR-2629-C,LS-ENVEOR-2629-US (26mm and 29mm)

In the US, commercial devices, as referenced in the sections above and in Table 1, are approved for use in the clinical trial, as necessary, in the event that an investigational device is not available.

Also, any future approved (i.e. CE marked) models or device iterations may be used in the trial.

The TAV is adapted to a range of aortic annulus and ascending aorta diameters as shown in **Table 1**.

Table 1: Patient Anatomical Diameters

CoreValve™ Evolut™ Bioprosthesis		
Model	Aortic Annulus Diameter (range in mm)	Aortic Diameter at the Sino-tubular Junction (range in mm)
MCS-P4-23-AOA MCS-P4-23-AOA-US	18-20	≤34
CoreValve™ Bioprosthesis		
Model	Aortic Annulus Diameter (range in mm)	Aortic Diameter at the Sino-tubular Junction (range in mm)
MCS-P3-26-AOA MCS-P3-26-AOA-US	20-23	≤40
MCS-P3-29-AOA MCS-P3-29-AOA-US	23-27	≤43
MCS-P3-31-AOA MCS-P3-31-AOA-US	26-29	≤43
CoreValve™ Evolut™ R Bioprosthesis		
Model	Aortic Annulus Diameter (range in mm)	Aortic Diameter at the Sino-tubular Junction (range in mm)
EVOLUTR-23-C EVOLUTR-23-US	18 – 20	NA
EVOLUTR-26-C EVOLUTR-26-US	20 – 23	NA
EVOLUTR-29-C EVOLUTR-29-US	23 – 26	NA

B.2.2 Device Approval Status

The approval statuses of the Medtronic CoreValve™ System and CoreValve™ Evolut™ R System are outlined in **Table 2** below. This table presents the current approval status for the respective CoreValve Systems where the clinical trial is conducted.

Table 2: Device Approval Status

Device Approval Status	United States	European Union	Canada
Medtronic CoreValve™ System			
TAV	Market Released	Market Released	26mm, 29mm, and 31mm - Market Released 23mm - Investigational
DCS	Market Released	Market Released	Market Released
CLS	Market Released	Market Released	Market Released
Medtronic CoreValve™ Evolut™ R System			
TAV	Market Released	Market Released	Investigational
DCS	Market Released	Market Released	Investigational
LS	Market Released	Market Released	Investigational

B.2.2.1 European Union

CoreValve

The notified body granted an approval for CE Marking for the 18Fr CoreValve ReValving™ System (renamed to “Medtronic CoreValve System” after acquisition from CoreValve Inc. by Medtronic Inc. on 9 April 2009) effective March 1, 2007. Model MCS-P3-640 (26mm) and MCS-P3-943 (29mm) received CE mark effective 2006) and MCS-P3-943 (31mm) received CE mark in July 2011. AOA treated valves (26mm, 29mm, and 31mm) received CE mark in March 2012. The AOA treated 23mm valve (MCS-P4-23-AOA) received CE mark in May 2012 (marketed as CoreValve™ Evolut™). The models to be used in this trial, listed in **Table 1**, are identical to the CE marked devices. The devices used in this trial will be used outside the current approved indication. The Medtronic CoreValve System is still under investigation for the intermediate risk indication.

The Delivery Catheter System (DCS) with AccuTrak® Stability Layer was designed to optimize the valve positioning and will be used in this trial. CE mark approval was received in July 2010. The Delivery System for 23mm TAV (DCS-C4-18FR-23) has a shortened capsule and plunger to house and deliver the 23 mm TAV. The DCS and CLS components used for this trial are the CE marked product.

CoreValve Evolut R

The notified body granted CE Mark approval for Model EVOLUTR-23 (23mm) of the CoreValve Evolut R System effective August 12, 2014. This included the TAV EVOLUTR-23 (23mm), EnVeo R DCS with EnVeo R Inline Sheath (ENVEOR-L) and EnVeo R LS [LS-ENVEOR-23 (23mm)]. CE Mark approval was granted on January 30, 2015 for Model Evolut R-26 (26mm) and Model Evolut R-29 (29mm). This included the TAV EVOLUTR-26 (26mm) and EVOLUTR-29 (29mm), EnVeo R DCS with EnVeo R Inline Sheath (ENVEOR-L) and EnVeo R LS [LS-ENVEOR-26/29 (26mm and 29mm)]. The CoreValve Evolut R System will not be made available for use in SURTAVI at any investigational sites in Canada (ie, regulatory approval for Evolut R usage within the trial will not be sought). The Medtronic CoreValve Evolut R System is still under investigation for the intermediate risk indication. The DCS and CLS components used for this trial are the CE marked product.

B.2.2.2 United States

CoreValve

Medtronic submitted an Original IDE (G100012) to seek approval to initiate an Investigational Device Exemption for the Medtronic CoreValve System (size 26mm and 29mm). This trial was intended for use in subjects with severe symptomatic Aortic Stenosis (AS) necessitating aortic valve replacement in Extreme Risk and High Risk Patient Populations. This IDE was conditionally approved on October 13, 2010 and received full approval on November 10, 2011. Medtronic added an additional 31mm TAV size to the IDE via G100012/S24 followed by 23mm TAV via G100012/S31.

The FDA granted marketing approval of CoreValve for Extreme Risk patients on January 17, 2014 and High Risk patients on June 12, 2014. The devices used in this trial will be used outside the current approved indication. The models to be used in this trial, listed in **Table 1**, are identical to the FDA approved devices. FDA granted approval for the use of commercially labeled devices in the trial on August 6, 2014. The devices used in this trial will be used outside the current approved indication. The Medtronic CoreValve System is still under investigation for the intermediate risk indication.

CoreValve Evolut R

Medtronic submitted an Original IDE (G140059) to seek approval to initiate an Investigational Device Exemption for the Medtronic CoreValve Evolut R System. This study was intended for use in subjects with severe symptomatic Aortic Stenosis (AS) necessitating aortic valve replacement in Extreme Risk and High Risk Patient Populations. This IDE was conditionally approved on May 2, 2014 and received full approval on September 29, 2014. The FDA granted marketing approval of CoreValve Evolut R for Extreme Risk and High Risk on June 22, 2015. The models to be used in this trial, listed in **Table 1**, are identical to the FDA approved devices. FDA granted approval for the use of commercially labeled devices in the trial on July 15, 2015. All components to the CoreValve Evolut R System are still under investigation for the intermediate risk indication.

B.2.2.3 Canada

CoreValve

The commercial application for the Medtronic CoreValve System (26mm and 29mm) was approved by Health Canada on August 2, 2012 and the 31mm on February 7, 2014. Medtronic CoreValve System 23mm is available only via Special Access, which is considered investigational and may be used upon special access granted by Health Canada. The models to be used in this trial, listed in **Table 1**, are identical to the Health Canada approved and Special Access devices. The devices used in this trial will be used outside the current approved indication. The Medtronic CoreValve System is still under investigation for the intermediate risk indication.

CoreValve Evolut R

The CoreValve Evolut R System will not be made available for use in SURTAVI at any investigational sites in Canada (ie, regulatory approval for Evolut R usage within the trial will not be sought). All components to the CoreValve Evolut R System are still under investigation for all risk classifications.

B.2.3 Intended Use of the Device / Indications for Use

The Medtronic CoreValve™ System and CoreValve™ Evolut R System are intended/indicated for use in patients who have symptomatic severe aortic stenosis (AS) necessitating valve replacement and who are at intermediate surgical risk and presenting with anatomical dimensions as described in **Table 1**.

B.3 Trial Objectives

B.3.1 Primary

The primary objective of this trial is to evaluate in a prospective randomized fashion whether Transcatheter Aortic Valve Implantation (TAVI) is non-inferior to Surgical Aortic Valve Replacement (SAVR) with respect to the composite endpoint of all-cause mortality and disabling stroke at 24 months in patients with symptomatic severe aortic stenosis and at intermediate surgical risk.

B.3.2 Secondary

The secondary objective of this trial is to assess differences in quality of life, clinical benefit (efficacy endpoints) and health economics in patients with symptomatic severe aortic stenosis and at intermediate risk treated with either Transcatheter Aortic Valve Implantation (TAVI) or Surgical Aortic Valve Replacement (SAVR).

B.3.3 Exploratory

An analysis will be conducted to determine if patients can be identified as intermediate risk for Transcatheter Aortic Valve Implantation (TAVI) based upon age and the presence of a defined list of co-morbidities commonly associated with patients undergoing TAVI procedures. A complete discussion of this exploratory objective can be found in **Appendix R.24**.

C TRIAL PROTOCOL

C.1 Ethics and Regulatory Compliance

C.1.1 *Applicable Regulations*

This trial will be conducted in compliance with the protocol, the Sponsor's standard operating procedures and/or guidelines, the United States Food and Drug Administration (FDA) and local regulations where applicable, the International Conference on Harmonization (ICH) Good Clinical Practice (GCP) guidelines, ISO14155 (2011), and the Declaration of Helsinki (2008 and subsequent versions). Additionally, the Medical Device Directive (MEDDEV 2.7/3) will be followed for Investigator reporting of Serious Adverse Events (SAEs) to the sponsor.

C.1.2 *Institutional Review Board (IRB)/Medical Ethics Committee (MEC)*

The trial will be conducted in accordance with 21 CFR 56 Institutional Review Boards and/or local regulations for Medical Ethics Committee (MEC). The trial protocol and consent must be approved by the responsible Institutional Review Board (IRB) or MEC at each investigational site. Trial activities must not commence prior to receipt of documentation of IRB/MEC approval by the site and Medtronic. The Investigator and trial staff must comply with the requirements of their IRB/MEC.

Prior to enrolling subjects in this trial, each investigation site's IRB/MEC will be required to approve the current trial clinical investigation plan, the Patient Information and Informed Consent form, and any other written information to be provided to the subjects. In the US, Investigator must also utilize IRB approved Health Insurance Portability and Accountability Act (HIPAA) Authorization.

IRB/MEC approval of the clinical trial must be received in the form of a letter and provided to Medtronic before commencement of the trial at an investigation site. The approval letter must contain enough information to identify the version or date of the documents approved. In addition the approval letter needs to be accompanied by an IRB/MEC roster or letter of compliance, to allow verification that the investigator, other center trial staff, and/or Medtronic personnel are not members of the IRB/MEC. If they are members of the IRB/MEC, written documentation is required stating that he/she did not participate in the approval process. Investigators must inform Medtronic of any change in status of IRB/MEC approval once the investigation site has started enrolment.

C.1.3 *Regulatory Submission*

Prior to enrolling any patients in the trial, all local regulatory requirements must be fulfilled. Each trial site must have written documentation of site/investigator readiness, including but not limited to IRB/MEC approval of the current version of the Investigational Plan, Informed Consent form, a signed Investigator's Agreement, current investigator curriculum vitae, and documentation of training. The coordinating and principal investigators shall agree to this investigational plan and any amendments and indicate their approval by signing and dating the Investigator's Agreement.

Approval from the Regulatory Authorities, if applicable, is required prior to the first patient enrollment in a particular center. Medtronic will obtain a copy of the approval letter, directly from the Regulatory Authorities.

If any action is taken by an IRB/MEC with respect to the investigation, that information will be forwarded to Medtronic by the respective investigator.

Other documents that are referred to in this Clinical Investigation Plan are listed below and will be made available upon request:

- Monitoring Plan
- Data Management Plan
- Statistical Analysis Plan
- Patient Information and Informed Consent Form
- Case Report Forms

C.1.4 Ethical Conduct of the Trial

The trial will be conducted in accordance with the design and specific provisions of this protocol, in accordance with the ethical principles that have their origin in the Declaration of Helsinki, and that are consistent with Good Clinical Practice (GCP) and the applicable regulatory requirements.

The principles of the Declaration of Helsinki have all been implemented in this trial by means of the patient informed consent process, IRB/MEC approval, trial training, clinical trial registration, preclinical testing, risk benefit assessment, and publication policy.

The sponsor will avoid improper influence on, or inducement of the subject, monitor, and investigator(s) or other parties participating in, or contributing to, the clinical investigation by implementing the patient informed consent process, clinical investigation agreements, and IRB/MEC review and approval.

C.2 Trial Administration

C.2.1 Steering Committee

The Steering Committee will be an advisory body to Medtronic. Their roles and responsibilities may include, but are not limited to the following:

- Overall conduct of the study with regard to
 - Protocol development and implementation
 - Study progress
 - Patient safety
 - Data quality and integrity
- Quality performance at individual sites
 - The Steering Committee will support site investigators in resolving any clinical or procedural issues that may impact patient well-being or integrity of the study
 - Any site placed on probation for any reason may be terminated from the study after an appropriate review by the Steering Committee
- Review of all Data Safety Monitoring Board (DSMB) recommendations
- Assess requests for sub-studies
- Assist with Publication efforts by disseminating study information through appropriate scientific sessions and publications
 - All requests for abstract and manuscript preparation and submission require Steering Committee review and approval. All final decisions will be made by Medtronic; however, the recommendations made by the Steering Committee will be highly considered
- Participate in Investigator Meetings (and other study related meetings)
- Serve as a contact for other study investigators (providing peer consultation)

Prior to the onset of the trial, the Steering Committee will establish a charter. The Steering Committee charter will be approved by Medtronic and the Steering Committee members.

C.2.2 Publication Committee

The Publication Committee will review and approve publication ideas and facilitate submissions, including abstracts and manuscripts. The Publication Committee will consist of SURTAVI trial investigators (interventional cardiologists and cardiac surgeons) and Medtronic representatives.

The Publication Committee will be responsible for:

- Defining and refining the publication strategy
- Overseeing the development of manuscripts, abstracts, and presentations
- Identifying and appointing the manuscript/abstract first author(s)/writer(s)/presenters(s)
- Reviewing the publication

C.3 Methodology

C.3.1 Purpose

The purpose of this trial is to investigate the safety and efficacy of transcatheter aortic valve implantation (TAVI) in patients with severe, symptomatic Aortic Stenosis (AS) at intermediate surgical risk by randomizing patients to either Surgical Aortic Valve Replacement (SAVR) or TAVI. Data from this trial will be used to support regulatory applications in seeking approval for the Medtronic CoreValve System and/or CoreValve Evolut R System in the intermediate surgical risk population.

C.3.2 Patient Population

Patients who have symptomatic severe Aortic Stenosis who are determined by the Heart Team to be at intermediate surgical risk.

C.3.3 Design

This trial is designed as a prospective, multi-center, multi-national, randomized, interventional trial to investigate the safety and efficacy of transcatheter aortic valve implantation (TAVI) in patients with severe, symptomatic Aortic Stenosis (AS) at intermediate surgical risk.

Approximately 1600 subjects will be recruited in up to 115 investigational centers located in the United States, Canada and Europe. The trial may be expanded to include additional geographies based on enrollment rates and identification of qualified centers.

Subjects will be randomized on a 1:1 basis to either transcatheter aortic valve implant (TAVI) or to surgical aortic valve replacement (SAVR).

To avoid bias in the trial population the following measures have been taken:

- All sponsor and external trial personnel will be trained on the Clinical Investigation Plan (CIP) and related trial materials; and
- Subjects will be screened to confirm trial eligibility with defined inclusion/exclusion criteria prior to enrollment.

The total trial duration is expected to be approximately eight years.

C.3.4 Investigational Centers

Site distribution is anticipated to include up to 75 centers in the United States, 10 in Canada and 30 in Europe.

For this study, the following investigator/center selection minimum criteria are considered:

- Center must have sufficient patient population
- Each center's Implant Team (i.e. 1st and 2nd operators) must have completed at least 30 cumulative TAVI procedures
- There will be no other study ongoing during this study duration, which would prevent the center from meeting enrollment goals for SURTAVI or provide adequate staffing
- Investigator should have adequate staff that is accessible and has time to manage the study for 7 days per week, 24 hours per day
- Investigator, co-investigators, and study staff must be willing to provide his/her Curriculum Vitae
- Investigator and co-investigators must be willing to sign and comply with the protocol-specific Investigator Agreement
- Center must be willing to comply with the Clinical Investigation Plan and data requirements, including reporting Adverse Events
- Center has demonstrated experience with conducting clinical (device) trials that comply with applicable regulatory standards
- Center is willing to participate in follow-up of patients for 5 years
- Center has an internet connection with sufficient speed of data transfer

All investigators will be appropriately qualified practitioners legally entitled to practice, and experienced in the diagnosis and treatment of patients requiring an aortic valve treatment with a TAVI or SAVR.

For the purposes of the SURTAVI trial, it is imperative that Medtronic leverages highly qualified surgeons for the surgical aortic valve replacements (SAVR) that will occur as a part of the trial. The following minimum criteria will be used for all cardiac surgeons performing SAVRs in the SURTAVI trial:

- At least 5 years of experience post-residency
- At least 100 career aortic valve replacements post-residency
- At least 75 valve procedures in the last 3 years
- At least 35 surgical aortic valve replacements in the last 3 years
- At least 15 aortic valve replacements in the last year

C.3.5 Number of Subjects

Up to 2000 subjects will be randomized [1:1, TAVI: Surgical Aortic Valve Replacement (SAVR)]. The enrollment phase is anticipated to be approximately 36 months. Subjects will be followed through 5 years for assessment of long-term safety and efficacy endpoints. The total trial duration is expected to be approximately 8 years.

Enrollments shall not exceed 20% (approximately 400) of total randomized subjects at any individual site. Enrollment is competitive; therefore there is no set minimum number of subjects to be enrolled per site. Appropriate measures will be taken to monitor enrollment across geographies to ensure at least 40% of the total patient population is enrolled within the United States.

C.3.6 Inclusion/Exclusion Criteria

C.3.6.1 Inclusion Criteria

To participate in this trial, the subject must meet ALL of the following inclusion criteria.

1. Subject must have co-morbidities such that Heart Team agrees predicted risk of operative mortality is $\geq 3\%$ and $< 15\%$ at 30 days (Intermediate Clinical Risk classification). Heart team evaluation of clinical surgical mortality risk for each patient includes the calculated STS score for predicted risk of surgical mortality augmented by consideration of the overall clinical status and co-morbidities unmeasured by the STS risk calculation;
2. Heart Team unanimously agree on treatment proposal and eligibility for randomization based on their clinical judgment (including anatomy assessment, risk factors, etc.);
3. Subject has severe aortic stenosis presenting with:
 - a) Critical aortic valve area defined as an initial aortic valve area of $\leq 1.0 \text{ cm}^2$ or aortic valve area index $< 0.6 \text{ cm}^2/\text{m}^2$

AND

 - b) Mean gradient $> 40\text{mmHg}$ **or** $V_{\text{max}} > 4\text{m/sec}$ by resting echocardiogram or simultaneous pressure recordings at cardiac catheterization [or with dobutamine stress, if subject has a left ventricular ejection fraction (LVEF) $< 55\%$] **or** velocity ratio < 0.25 ;
4. Subject is symptomatic from his/her aortic valve stenosis, as demonstrated by New York Heart Association (NYHA) Functional Class II or greater;
5. Subject and the treating physician agree that the subject will return for all required post-procedure follow-up visits;
6. Subject meets the legal minimum age to provide informed consent based on local regulatory requirements.

C.3.6.2 Exclusion Criteria

Subjects are NOT eligible for trial participation if they meet ANY of the following exclusion criteria:

1. Subject has refused surgical aortic valve replacement (SAVR) as a treatment option;
2. Any condition considered a contraindication for placement of a bioprosthetic valve (i.e. subject requires a mechanical valve);
3. A known hypersensitivity or contraindication to all anticoagulation/antiplatelet regimens (or inability to be anticoagulated for the index procedure), nitinol, or sensitivity to contrast media which cannot be adequately pre-medicated;
4. Blood dyscrasias as defined: leukopenia (WBC <1000mm³), thrombocytopenia (platelet count <50,000 cells/mm³), history of bleeding diathesis or coagulopathy;
5. Ongoing sepsis, including active endocarditis;
6. Any condition considered a contraindication to extracorporeal assistance;
7. Any percutaneous coronary or peripheral interventional procedure performed within 30 days prior to randomization (Subjects with recent placement of drug eluting stent(s) should be assessed for ability to safely proceed with SAVR within the protocol timeframe);
8. Symptomatic carotid or vertebral artery disease or successful treatment of carotid stenosis within six weeks of randomization;
9. Cardiogenic shock manifested by low cardiac output, vasopressor dependence, or mechanical hemodynamic support;
10. Recent (within 6 months of randomization) cerebrovascular accident (CVA) or transient ischemic attack (TIA);
11. Active gastrointestinal (GI) bleeding that would preclude anticoagulation;
12. Subject refuses a blood transfusion;
13. Severe dementia (resulting in either inability to provide informed consent for the trial/procedure, prevents independent lifestyle outside of a chronic care facility, or will fundamentally complicate rehabilitation from the procedure or compliance with follow-up visits);
14. Multivessel coronary artery disease with a Syntax score >22 and/or unprotected left main coronary artery (Syntax score calculation is not required for patients with history of previous revascularization if repeat revascularization is not planned);
15. Estimated life expectancy of less than 24 months due to associated non-cardiac co-morbid conditions;
16. Other medical, social, or psychological conditions that in the opinion of the Investigator precludes the subject from appropriate consent or adherence to the protocol required follow-up exams;
17. Currently participating in an investigational drug or another device trial (excluding registries);
18. Evidence of an acute myocardial infarction ≤30 days before the index procedure;
19. Need for emergency surgery for any reason;
20. True porcelain aorta (i.e. Heart Team agrees the aorta is not clampable for SAVR);
21. Extensive mediastinal radiation;
22. Liver failure (Child-C);
23. Reduced ventricular function with left ventricular ejection fraction (LVEF) <20% as measured by resting echocardiogram;
24. Uncontrolled atrial fibrillation (eg. resting heart rate >120bpm);
25. Pregnancy or intent to become pregnant prior to completion of all protocol follow-up requirements;
26. End stage renal disease requiring chronic dialysis or creatinine clearance < 20 cc/min;
27. Pulmonary Hypertension (systolic pressure > 80mmHg);
28. Severe Chronic Obstructive Pulmonary Disease (COPD) demonstrated by Forced Expiratory Volume (FEV1) < 750cc;

29. Frailty assessments identify:
- Subject is < 80 years of age and three or more of the following apply
 - Subject is ≥ 80 years of age and two or more of the following apply
 - Wheelchair bound
 - Resides in an institutional care facility (eg. nursing home, skilled care center)
 - Body Mass Index < 20 kg/m²
 - Grip strength <16 kg
 - Katz Index score ≤ 4
 - Albumin < 3.5 g/dL;
30. Marfan syndrome or other known connective tissue disease that would necessitate aortic root replacement/intervention.

Anatomical Exclusion Criteria

- 31. Native aortic annulus size <18 mm or >29 mm per the baseline diagnostic imaging;
- 32. Pre-existing prosthetic heart valve in any position;
- 33. Mixed aortic valve disease [aortic stenosis and aortic regurgitation with predominant aortic regurgitation (3-4+)];
- 34. Severe mitral or severe tricuspid regurgitation;
- 35. Severe mitral stenosis;
- 36. Hypertrophic obstructive cardiomyopathy;
- 37. Echocardiographic or Multislice Computed Tomography (MSCT) evidence of new or untreated intracardiac mass, thrombus or vegetation;
- 38. Ascending aorta diameter greater than maximum diameter relative to the native aortic annulus size:

Aortic Annulus Diameter	Ascending Aorta Diameter
18 mm – 20 mm	>34 mm
20 mm – 23 mm	>40 mm
23 mm – 29 mm	>43 mm

- 39. Aortic root angulation (angle between plane of aortic valve annulus and horizontal plane/vertebrae):
 - a) Femoral and left subclavian/axillary access > 70°

OR

 - b) Right subclavian/axillary access: Aortic root angulation > 30°;
- 40. Congenital bicuspid or unicuspid valve verified by echocardiography;
- 41. Sinus of Valsalva anatomy that would prevent adequate coronary perfusion.

Vascular Exclusion Criteria

- 42. Transarterial access not able to accommodate an 18Fr sheath.

C.3.7 Informed Consent

The investigator must obtain written informed consent prior to subjecting the subject to any trial related activity.

Well in advance of the consent discussion, the subject should receive the MEC/IRB approved Patient Information and Informed Consent Form (ICF). During the consent discussion the investigator or his/her designee must fully inform the subject of all pertinent aspects of the trial including the approval of the MEC/IRB of the written Patient Information. If a subject is illiterate, an impartial witness must be present during the entire informed consent discussion. All items discussed in the Patient Information and the ICF must be explained. The language used shall be in the subject's native language, as non-technical as possible and must be understandable to the subject and the impartial witness, where applicable.

The subject must have ample time and opportunity to inquire about details of the trial, and to decide whether or not to participate in the clinical trial. All questions about the trial should be answered to the satisfaction of the subject.

Neither the investigator, nor the investigation site staff shall coerce or unduly influence a subject to participate or to continue to participate in the clinical trial. The informed consent process shall not appear to waive the subject's rights.

When the subject decides to participate in the clinical trial, the ICF must be signed and personally dated by the subject and investigator. If applicable, the witness shall also sign and personally date the consent form to attest that the information in the Patient Information and Informed Consent Form was accurately explained and clearly understood by the subject, and that informed consent was freely given.

Signing the ICF serves to document the written and verbal information that the Investigator or authorized delegate provides to the patient, the patient understanding of the information, and their agreement to participate. The Investigator or authorized delegate must document in the patient's medical records that the patient was consented and the date on which the consent was obtained. The original signed consent form will be retained in the patient's trial records. A copy of the informed consent will be provided to the patient and a copy placed in the patient's medical record.

Data relating to the trial might be made available to third parties (for example in case of an audit performed by regulatory authorities), provided the data are treated as confidential and that the subject's privacy is guaranteed. In the United States, "Protected Health Information" will be maintained in compliance with the Health Insurance Portability and Accountability Act of 1996 (HIPAA).

C.3.8 Revisions in Patient Information and Informed Consent Form

Medtronic will inform the investigators whenever information becomes available that may be relevant to the subject's continued participation in the trial. The revised information will be sent to the investigator for approval by the IRB/MEC. After approval by the IRB/MEC, a copy of this information must be provided to the participating subjects, and the informed consent process as described above needs to be repeated. The investigator or his/her designee should inform the subject in a timely manner.

C.3.9 Enrollment Flowchart for Randomization to TAVI or SAVR

Figure 1: Enrollment Flowchart

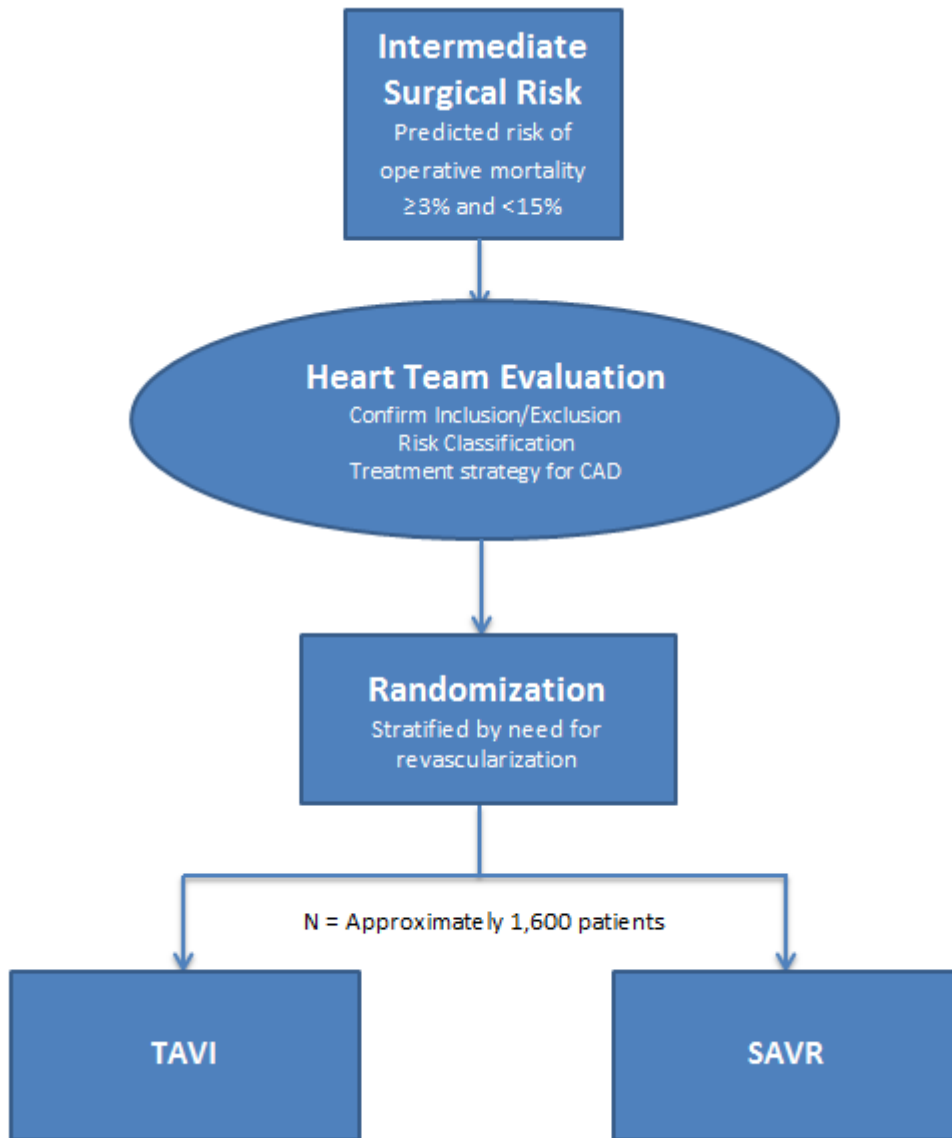

If the patient meets all of the inclusion criteria and none of the exclusion and Heart Team determines the patient is eligible for randomization in the SURTAVI trial, subjects will be randomized on a 1:1 basis to either TAVI or SAVR. Randomization will be stratified by the need for coronary revascularization. In case of required coronary revascularization, concomitant percutaneous coronary intervention (PCI) and TAVI is encouraged; however staging is left at the discretion of the operator. Coronary artery bypass graft (CABG) should be conducted during the index procedure.

C.3.10 Trial Training

Prior to investigational site activation or subsequent involvement in trial activities, Medtronic (or designee) will provide trial training relevant and pertinent to the involvement of personnel conducting trial activities, including investigator responsibilities, adverse event reporting as well as device training (if necessary, usage and handling of device under investigation). Training may be conducted via Site Initiation Visits, Investigator and Coordinator Meetings, and/or other

media sessions. The sponsor will maintain documentation of attendance at each of these training opportunities, as applicable.

Additionally, Medtronic representative(s) may be present at each site's TAVI procedures as part of the ongoing training process.

C.4 Trial Procedures

C.4.1 Screening Procedures

Prior to any trial-specific tests or procedures, written informed consent must be obtained from the subject. Failure to obtain a signed and hand dated informed consent prior to the procedure constitutes a protocol violation, which is reportable to the IRB/MEC, the Food and Drug Administration (FDA), and other regulatory authorities as applicable.

All potential subjects for trial entry must be screened for eligibility. All patients with symptomatic severe AS that provide informed consent will be entered into the Electronic Data Capture (EDC) system and total number of patients screened will be counted. The reasons why a patient did not enter the Heart Team meeting will be collected (eg. patient does not meet inclusion criteria or meets an exclusion criteria) and, age, STS score, and available screening data.

Data readily available in the patient's medical record may be utilized to fulfill screening requirements and do not need to be repeated. If not previously completed, the following tests and procedures must be performed prior to randomization to verify eligibility. The recommended timeframe for these tests and procedures is within 30 days prior to submission to the Heart Team, unless otherwise specified.

- Demographics and Medical History
- Clinical Assessments – Refer to **Appendix R.19**
 - 5-Meter Gait Speed
 - Grip Strength
- Physical Examination including:
 - Vital signs, weight, height, and body surface area (BSA);
 - BSA will be calculated from height and weight by use of the formula by Dubois and Dubois ($BSA = 0.007184 \times \text{weight [kg]}^{0.425} \times \text{height [m]}^{0.725}$)
 - Major systems findings
- NYHA Classification
- Risk Assessments:
 - STS Risk Score – Dataset Version 2.73
 - Logistic EuroSCORE
 - EuroSCORE II
 - SYNTAX Score
 - Katz Index of Independence in Activities of Daily Living
- Co-morbidities
- Routine Laboratory Tests:
 - Complete Blood Count:
 - White Blood Count
 - Hematocrit
 - Hemoglobin
 - Platelet Count
 - Creatinine and Creatinine Clearance
 - Cardiac Enzymes (CK/CK-MB)
 - International Normalized Ratio (INR), if applicable
 - Activated Partial Thromboplastin Time (aPTT)
 - B-type Natriuretic Peptide (BNP) or NT-proBNP
 - Liver Panel:
 - ALT
 - AST
 - Albumin
 - Sodium
 - Potassium

- Transthoracic Echocardiogram (TTE)
 - Comprehensive transthoracic two-dimensional (2D) echocardiogram (TTE) is required within 365 days prior to review by the Heart Team to confirm diagnosis of severe aortic stenosis(AS) including:
 - Aortic valve area / indexed aortic valve area
 - Mean gradient / peak velocity / velocity ratio
 - If a historical TTE is used to confirm AS diagnosis a repeat TTE must be performed within 45 days prior to review by the Heart Team to:
 - Assess:
 - Aortic regurgitation
 - Mitral and tricuspid valve status (stenosis and regurgitation)
 - LVEF
 - Rule out:
 - New or recent MI
 - New or untreated intracardiac mass, thrombus or vegetation
 - Congenital bicuspid or unicuspid valve
 - If the patient recently underwent balloon aortic valvuloplasty (BAV), a TTE should be obtained post-BAV; within 45 days prior to review by the Heart Team to reconfirm all inclusion/exclusion echocardiographic parameters
 - Protocol required echocardiograms should be performed according to the Echocardiography Procedures found in **Appendix R.7**.
- Multi-Slice Computed Tomography (MSCT) Angiogram
 - Multi-Slice Computed Tomography (MSCT) angiograms with complete visualization of both iliacs, femorals and aorta (and subclavian/axillaries, if applicable), up to and including the aortic annulus. In the situation where subjects have compromised renal function that precludes contrast media, Magnetic Resonance (MR) imaging may be used as an alternative. MSCT angiograms should be performed according to the Computed Topography (CT) Angiography Acquisition Guidelines found in **Appendix R.9**. If the MSCT angiogram was conducted in the last 365 days and subject has not had a peripheral vascular intervention since the time of the image, a more recent exam is not required as long as visualization of both iliacs and femorals (and subclavian/axillaries, if applicable) to the aorta can be viewed. However, if the subject had a peripheral vascular intervention, the exam must be repeated after the intervention and within 90 days of review by the Heart Team.
- Coronary Arteriogram
 - Selective coronary arteriography to assess the presence and severity of coronary artery disease which should include angiograms of both coronary arteries and all bypass grafts (if applicable). If the coronary arteriogram has been performed within the last 365 days and the subject qualifies for the trial (no significant coronary artery disease), a more recent exam is not required. However, if the subject had evidence of significant coronary artery disease and/or received a coronary intervention, the exam must be repeated after the intervention and within 90 days of review by the Heart Team.
- 12-lead Electrocardiogram (ECG)

C.4.2 Heart Team Procedures

Each center will utilize a Heart Team to make determinations regarding eligibility of the prospective subject to be randomized in the SURTAVI trial.

C.4.2.1 Heart Team Composition

Local Heart Teams must be comprised of a multidisciplinary team qualified by education and experience to determine appropriate patient treatment.

Minimum Membership¹

- Interventional Cardiologist - ≥ 1 representative is required
- Cardiac Surgeon - ≥ 1 representative is required

Additional Membership Considerations

Additional members of the Heart Team should be included based on current standard practices and patient specific consideration, including but not limited to:

- Echocardiographer
- Anesthesiologist
- Cardiologist (general or referring physician)
- Geriatrician
- Neurologist or stroke specialist
- Radiologist or imaging specialist
- Heart Failure specialist
- Intensivist
- Nurse(s)
- Social Worker

C.4.2.2 Heart Team Review and Decision

Prior to determining if a patient is eligible for randomization the Heart Team will review each patient's screening data and confirm the following:

- STS risk calculation was properly performed
- Any additional risk factors not accounted for in the STS risk calculator that may increase the level of surgical risk:
 - Heart Team should consider the following potential incremental risks:
 - Age ≥ 75
 - BNP ≥ 550pg/mL or NT proBNP ≥ 3200pg/mL
 - Prior Stroke/TIA
 - FEV1 750-1000cc
 - Home / Supplemental oxygen
 - Nocturnal Bi-level Positive Airway Pressure
 - 5-Meter Gait Speed ≥ 6 seconds
 - Severe Diastolic Dysfunction (Grade III or IV)
 - Liver Disease (Child A or B)
 - Pulmonary Hypertension (systolic pressure 60-80mmHg)
 - Frailty (eg. BMI <21 kg/m², Albumin <3.5 g/dL, etc.)
 - Other risks, as deemed applicable
 - Confirm the incremental risk, as determined by the Heart Team, does not result in a risk definition higher than intermediate risk
- All inclusion criteria are met and none of the exclusion criteria

Both the reviewing Interventional Cardiologist and Cardiac Surgeon(s) must unanimously agree the patient has a predicted risk of operative mortality ≥ 3% and < 15% and appropriate for trial enrollment. The decision of the local Heart Team must be documented on the "Heart Team Decision" form and signed by the reviewing Interventional Cardiologist and Cardiac Surgeon(s).

¹ US only - Protocol criteria for Heart Team approval may not meet the minimum requirements outlined by Centers for Medicare and Medicaid Services (CMS) for reimbursement. Reference **Appendix R.25** for additional information.

C.4.3 Screening Committee

The Screening Committee will ensure appropriate and consistent patient selection across all sites. Prior to the onset of the trial, a charter will be drafted to that outline roles and responsibilities as well as describe the Screening Committee process.

Final decisions on patient eligibility will be made by the Screening Committee.

C.4.4 Roll-in Subjects

For participating centers who meet the requirement of 30 cumulative TAVI procedures but have no previous CoreValve experience (eg. Investigational centers where CoreValve is not commercially available and/or centers that did not participate in the US Pivotal Extreme/High Risk protocols) the first three successfully enrolled subjects will be considered “roll-in” subjects, will not be randomized, and will automatically be assigned to TAVI. A maximum of three successful roll-in subjects are allowed per center.

The purpose of the roll-in subjects is to provide investigators the time for training and familiarization with the investigational TAVI device. The Training and Education team will review recommendations made by Medtronic field support, Medtronic CoreValve Proctors and the Steering Committee for transition of sites from the roll-in phase to the randomization phase of enrollment after the first three subjects have been treated.

A subject will be considered a treated roll-in subject once the TAVI delivery catheter system (DCS) is introduced into the subject. A site must have three treated roll-in subjects before they can be evaluated to move into the randomization phase. The Training and Education team or designee will review and document their decisions based on the technique of the investigators, as well as the frequency, severity and nature of events in the roll-in subjects.

Roll-in subjects will complete in-clinic follow-up evaluations at the following time points post implant as subjects randomized to TAVI. However, the results for the roll-in population will be analyzed separately from the randomized population.

C.4.5 Enrollment and Randomization

Prior to randomization and enrollment of a subject, the following must occur:

- Confirm patient signed informed consent
- Confirm patient meets all of the inclusion and none of the exclusion criteria, including approval by the Heart Team

Subjects will be considered enrolled into the trial at the time of randomization² (i.e. time of treatment assignment). Randomization will occur only if the patient meets all inclusion criteria and does not meet any exclusion criteria and has been assessed by the Heart Team as being an appropriate candidate for randomization in the SURTAVI trial.

Due to the inclusion/exclusion criteria, not all patients that consent to the trial will be enrolled. All sites will be required to maintain a record of patients screened for the trial meeting general inclusion criteria who have signed the approved informed consent document. For subjects that do not meet trial criteria, the reason for not continuing in the trial must be documented and recorded in the EDC system. Patients consented but not randomized will be considered screen failures and no further trial-related follow-up will be required.

Subjects must have their TAVI or SAVR procedure no later than 30 days post-randomization.

Trial randomization will not be blinded. Once randomization is complete and a treatment arm is assigned, crossover from SAVR to TAVI treatment is not permitted. The sponsor will strictly monitor device dispensation to ensure that only those subjects randomized to the TAVI treatment arm receive the Medtronic CoreValve™ or CoreValve™ Evolut™ R TAV.

² Based on protocol design, the time of enrollment will be the same as randomization which is a deviation from ISO 14155 (2011).

Distribution of the subjects within the trial groups will be controlled at the implanting sites by means of central randomization using interactive voice/web randomization service (IXRS). The randomization scheme will be securely stored at the IXRS provider.

Randomization with an assignment to the treatment arm or control arm (TAVI or SAVR) will be executed in a 1:1 ratio. Stratified randomization by investigational site and by the need for coronary revascularization will be used to ensure subjects will be allocated to each comparison group proportionately. Additionally, a blocked randomization scheme with random block sizes will be used within each stratum.

C.4.6 Baseline Assessments

The following baseline assessments should occur within 14 days prior to the index procedure.

- Physical examination
 - Vital signs
 - Major system findings
 - Skin assessment – refer to Radiation Exposure and Data Collection, **Appendix R.23**
- NYHA classification
- Concomitant medications
 - Use of relevant medications (diuretics, aspirin, anticoagulants, ACE-I, ARB, beta-blockers, statins and anti-platelets)
- Routine Laboratory Tests:
 - Complete Blood Count
 - White Blood Count
 - Hematocrit
 - Hemoglobin
 - Platelet Count
 - Creatinine and Creatinine Clearance
 - Cardiac Enzymes (CK/CK-MB)
 - International Normalized Ratio (INR), if applicable
 - Activated Partial Thromboplastin Time (aPTT)
 - B-type Natriuretic Peptide (BNP) or NT-proBNP
 - Liver Panel:
 - ALT
 - AST
 - Albumin
 - Sodium
 - Potassium
- Neurological Assessments:
 - National Institute of Health Stroke Scale (NIHSS)
 - Modified Rankin Score (mRS)
 - Mini-Mental State Exam (MMSE-2:SV)
 - Additional Neurological testing:
 - Visual Fields Testing
 - Gait Assessment
 - Hand Function
 - Writing Evaluation
 - Drawing Assessment
- 12-lead Electrocardiogram (ECG)
- 6 Minute Walk Test
- Quality of Life Questionnaires
 - Questionnaires may be administered any time after the subject has provided informed consent but should be collected prior to informing the subject of their treatment assignment
- Adverse Event Review

C.4.7 *Transcatheter Aortic Valve Implant or Surgical Aortic Valve Replacement Procedure*

C.4.7.1 TAVI

General Procedural Considerations

Transcatheter Aortic Valve Implantation (TAVI) requires meticulous preparation and typically a multi-disciplinary team approach involving among others, interventional cardiologists, cardiac imaging specialists, cardio-thoracic surgeons and anesthesiologists.

Within the United States, additional requirements apply for composition of the intra-operative team for TAVI procedures. Requirements are outlined in Appendix R.25.

In case of significant coronary artery disease that requires revascularization, the Heart Team will assess the feasibility of performing PCI simultaneously with the TAVI procedure based on the coronary lesion characteristics. When it is anticipated PCI can be performed in timely fashion with only a limited amount of additional contrast medium it is encouraged to perform PCI concomitant with the TAVI. When PCI is deemed challenging requiring relatively more time and contrast medium, staged PCI is recommended: TAVI will then be performed at least 7 days after PCI.

The implantation procedure itself takes place either in a catheterization laboratory with adequate hygiene precautions or ideally in a hybrid operating room equipped for state-of-the-art transcatheter and/or surgical procedures.

The execution of the TAVI involves an operating team typically consisting of 1 or 2 operators, an anesthesia team and at least 2 nurses/technicians. Medtronic representative(s) (eg. Therapy Development Specialists, proctors, etc.) may be present during TAVI procedures for training process, to perform valve loading or to provide general case support.

Both the dedicated “valve team” and the operators should have the expertise to select the appropriate access route and device size on a patient-per-patient basis.

All patients undergoing TAVI should be treated using the iliofemoral access route by default (first treatment strategy). Additional non-iliofemoral access routes will only be used in case iliofemoral access is not feasible. Alternative access is limited to subclavian and direct aortic.

The use of an embolic protection device during the TAVI procedure is not permitted.

Pre-Procedure

- Pre-medication recommendations:
 - If the subject is currently on warfarin therapy, or local equivalent, prior to the procedure:
 - Discontinue warfarin therapy 3 days prior to the procedure
 - Confirm that the INR < 1.8 prior to the procedure
 - Administer antiplatelet therapy:
 - Aspirin (75- 325 mg) daily **or**
 - Clopidogrel (75 mg) daily (or ticlopidine if clopidogrel is contraindicated) for 3 days prior to the procedure
 - If the subject is currently **not** on warfarin therapy prior to the procedure:
 - Aspirin (75-325 mg) on the day of the procedure **and**
 - Clopidogrel (300 mg)
 - Consider adjunctive proton pump inhibitors, H₂ antagonists or antacids
- Routine Laboratory Tests:
 - Complete Blood Count
 - White Blood Count
 - Hematocrit
 - Hemoglobin
 - Platelet Count
 - Creatinine and Creatinine Clearance
 - If the GFR < 60 cc/min, consider:
 - Fluid hydration on the day prior to the procedure
 - Discontinuation of NSAIDs and ACE inhibitors
 - Cardiac Enzymes (CK/CK-MB)
 - International Normalized Ratio (INR), if applicable
 - Activated Partial Thromboplastin Time (aPTT)
 - B-type Natriuretic Peptide (BNP) or NT-proBNP
 - Liver Panel:
 - ALT
 - AST
 - Albumin
 - Sodium
 - Potassium
- 12-lead Electrocardiogram (ECG)

TAVI Procedure

- *Medications*

One hour prior to the procedure, prophylactic antibiotic therapy of the Investigator's choice should be initiated:

- Cefuroxime 750mg intravenous (IV) 1 hour pre-procedure, then 6 hours and 12 hours post-procedure
- If allergic to Penicillin, prescribe Vancomycin 1g IV
- Consider holding anti-hypertensives

- *Anesthesia and Procedural Set Up*

- Establish a central venous line
- Administer general anesthesia or conscious sedation per hospital protocol
- Prior to beginning the investigational TAVI device system implant, place a temporary 4-5 Fr. balloon-tip pacing wire in a stable location within the right ventricular (a screw-tip wire may be used for more secure placement for subjects at high-risk for dislodgement, if necessary)
- Whenever possible, use the upper torso venous system (eg. jugular, subclavian) for temporary pacing wire access
- Use fluoroscopy to guide wire placement and stability
- Confirm sensing and capture
- Program the backup pacing rate to minimize ventricular pacing (eg. 30-40 bpm). If heart block develops, adjust the rate accordingly
- Record ECG and angiogram during the procedure

- *Vascular Access*
 - The primary access artery will be used to introduce the CoreValve device and the balloon catheter; the secondary access artery will be used to introduce the reference pigtail
 - Insert a 6Fr introducer sheath into the secondary access artery
 - Insert 18Fr introducer sheath into the primary access artery using hospital protocol (either percutaneously or surgical cut down)
 - Administer anticoagulant therapy according to hospital protocol. If heparin is administered as an anticoagulant, check activated clotting time (ACT) at five minutes and monitor every 30-60 minutes after initial bolus of heparin
 - Maintain ACT \geq 250 seconds
 - Anticoagulant may be administered at any time prior to this point, but avoid delaying beyond this point

- *Crossing the native valve*
 - Advance the graduated pigtail catheter to the ascending aorta and position the distal tip in the noncoronary cusp of the native aortic valve
 - Identify the ideal annular viewing plane using contrast injections at various angiographic angles, preferably in the left anterior oblique (LAO) projection.
 - An aortogram with the three aortic cusps aligned in one (1) plane should be obtained in order to proceed with the procedure and guarantee an optimal working view for eventual implantation
 - Insert an angiographic catheter over a standard, J-tip guidewire into the primary access sheath and advance to the ascending aorta
 - Exchange the J-tip guidewire for a 0.035-in (0.889-mm) straight-tip guidewire. Advance the straight-tip guidewire across the native aortic valve into the left ventricle
 - After crossing the native aortic valve with the guidewire, advance the angiographic catheter into the left ventricle
 - Exchange the straight-tip guidewires for an exchange-length J-tip guidewire
 - Exchange the angiographic catheter for a 6Fr pigtail catheter
 - Remove the guidewire and connect the catheter to the transducer. Using both catheters, record the aortic pressure gradient
 - Using a right anterior oblique (RAO) projection, advance previously pigtail-shaped, 0.035-in (0.889-mm) high-support guidewire through the pigtail catheter and position in the apex of the left ventricle
 - Remove the pigtail catheter while maintaining guidewire position in the left ventricle

- *Rapid Pacing and Pre-dilatation of the Implant site*
 - Insert the valvuloplasty balloon through the 18Fr introducer sheath and advance it to the ascending aorta
 - Perform a rapid pacing test. A successful test is defined as 1-to-1 pacing capture with an immediate drop in pressure and elimination of the systolic-diastolic waveform
 - Reposition the angiographic equipment to the ideal viewing plane as previously described. Position the valvuloplasty balloon across the native valve, while maintaining strict fluoroscopic surveillance of the distal tip of the guidewire in the left ventricle (LV)
 - Perform BAV per hospital protocol and remove the valvuloplasty balloon while maintaining guidewire position across the native aortic valve
 - Balloon sizing directed to 1:1 sizing of the minimal annular diameter by computerized tomographic angiography (CTA) or echocardiogram with maximum 25 mm balloon
 - Perform full balloon expansion

- *Medtronic CoreValve™ Implantation*
 - Insert the device over the 0.035-in (0.889-mm) guidewire and advance it, while maintaining strict fluoroscopic surveillance of the guidewire in the LV
 - When crossing the aortic arch, control the guidewire preventing it from moving forward
 - Advance the device through the native valve. Perform an angiogram to confirm that the graduated pigtail catheter is in position within the noncoronary cusp of the aortic root, preferably in the shallow LAO projection
 - Use Fluoroscopy to identify the appropriate landmarks
 - Place the bioprosthesis within the aortic annulus. Optimal placement of the bioprosthesis is 4 mm - 6 mm below the annulus. The annulus is defined as the angiographic floor of the aortic root
 - After attaining optimal catheter position, slowly turn the micro knob and begin to deploy the bioprosthesis. As the inflow aspect of the bioprosthesis starts to flare outward, monitor bioprosthesis position under fluoroscopy
 - Caution: During implantation, if resistance to deployment is encountered (for example, the micro knob starts clicking or is tight or stuck), apply mild upward pressure to the macro slider while turning the micro knob. If the bioprosthesis still does not deploy, remove it from the patient and use another system
 - Perform an angiogram. Once annular contact is made, the bioprosthesis should not be advanced into a lower position
 - Continue deploying rapidly to the 2/3 deployment point; stop turning the micro knob
 - Perform an angiogram to assess the location of the bioprosthesis.
 - If the bioprosthesis is positioned low, carefully pull the DCS to reposition the bioprosthesis
 - Evaluate the valve position and valve function using hemodynamic, aortography, and possible echocardiography
 - When satisfactory position is achieved, continue to turn the micro knob until both frame loops disengage
 - Use orthogonal views under fluoroscopy to confirm that the frame loops have detached from the catheter tabs. If a frame loop is still attached to a catheter tab, under fluoroscopy, advance the catheter slightly and, if necessary, gently rotate the handle clockwise (<math><180^\circ</math>) and counterclockwise (<math><180^\circ</math>) to disengage the loop from the catheter tab
 - Withdraw the DCS carefully to the aorta avoiding contact with the inflow portion of the frame while maintaining guidewire position
- *Medtronic CoreValve™ Post Deployment*
 - Close the DCS capsule and remove the DCS through the 18Fr introducer sheath
 - Advance a 6Fr pigtail catheter over the guidewire into the left ventricle
 - Remove the guidewire and connect the pigtail catheter to the transducer
 - Using both pigtail catheters, record aortic pressure gradient
 - Withdraw 6Fr pigtail
 - Perform post-implant aortogram with the reference pigtail to assure coronary patency and assess aortic regurgitations. Aortogram Acquisition Guidelines are located in **Appendix R.6**
 - Remove the 18Fr introducer sheath and complete the puncture site closure per hospital protocol
 - Perform contrast angiography of the primary vessels to verify the absence of any vascular complications with the reference pigtail
 - Remove the reference pigtail catheter over a standard guidewire
 - Remove the 6Fr introducer and close the access site per hospital protocol

- *Medtronic CoreValve™ Evolut R™ Implantation*
 - Prepare the vascular access site according to standard practice
 - Predilate the native aortic valve with an appropriate diameter valvuloplasty balloon
 - Backload the catheter onto the guidewire. Insert the catheter tip and capsule through the access site, while maintaining the EnVeo InLine™ sheath tip against the proximal end of the capsule. Then, insert the EnVeo InLine™ sheath through the access site, maintaining contact with the capsule. Maintain guidewire position across the aortic valve. Confirm the position of the trigger before crossing the aortic arch
 - Under fluoroscopic guidance, advance the catheter and EnVeo InLine™ sheath over the guidewire to the aortic annulus. Do not rotate the catheter as it is advanced; rotating the handle does not rotate the capsule
 - Position the catheter so that the bioprosthesis is at the optimal depth relative to the valve annulus
 - To deploy the bioprosthesis, rotate the blue actuator in the direction of the arrows. The capsule retracts and exposes the bioprosthesis. Continue deploying the bioprosthesis in a controlled manner, adjusting valve position as necessary and noting the position of the radiopaque capsule marker band and paddle attachment
 - Warning: Use the blue actuator to deploy and recapture the bioprosthesis. Do not use the trigger for deploying or recapturing because it could cause inaccurate placement of the bioprosthesis
 - Note: Slight repositioning of a partially deployed bioprosthesis (before the radiopaque capsule marker band reaches the distal end of the paddle attachment) can be achieved by carefully withdrawing the catheter
 - Caution: Use the catheter handle to reposition the bioprosthesis. Do not use the outer catheter shaft
 - Before the radiopaque capsule marker band reaches the distal end of the paddle attachment, evaluate the bioprosthesis position
 - Note: During deployment, the blue actuator clicks as a notification before the radiopaque capsule marker band reaches the paddle attachment
 - Either complete bioprosthesis deployment or initiate bioprosthesis recapture

- *Medtronic CoreValve™ Evolut R™ Recapture (Optional)*
 - The bioprosthesis should only be recaptured and redeployed a maximum of 2 times. The bioprosthesis can be recaptured a third time to remove the bioprosthesis from the subject
 - Rotate the blue actuator in the opposite direction of the arrows to recapture the bioprosthesis
 - Warning: Use the blue actuator to deploy and recapture the bioprosthesis.
 - Do not use the trigger for deploying or recapturing because it could cause inaccurate placement of the bioprosthesis
 - Continue rotating the blue actuator until the gap between the capsule and catheter tip is closed
 - Caution: Stop advancing the capsule once the gap to the catheter tip is closed. Advancing the capsule farther could damage the capsule
 - Reposition the recaptured bioprosthesis at the optimal depth relative to the valve annulus
 - Deploy the bioprosthesis
 - Either complete bioprosthesis deployment or initiate bioprosthesis recapture. If the bioprosthesis has been recaptured 2 times and then deployed in a non-optimal position, recapture and withdraw the bioprosthesis

- *Medtronic CoreValve™ Evolut R™ Post Deployment*
 - Close the catheter capsule before withdrawal
 - Caution: Close the capsule until it is aligned with the catheter tip. Do not overcapture the catheter tip, because it could interfere with catheter withdrawal through the introducer
 - Withdraw the catheter until the capsule meets the distal end of the EnVeo InLine™ sheath
 - Withdraw the catheter and EnVeo InLine™ sheath together, and dispose of the device in accordance with local regulations and hospital procedures
 - Perform routine aortogram to assess the bioprosthesis for proper expansion and function per the Aortogram Acquisition Guidelines located in **Appendix R.6**

Ballooning as needed during the implant procedure is standard practice and should not be considered a reintervention.

Immediate Post-Procedure

The procedure is considered complete after final angiography has been performed, and the introducer/InLine sheath has been removed from the subject. Thereafter, if an introducer/InLine sheath is re-introduced, this is considered a repeat intervention, which must be documented on the reintervention Electronic Case Report Form (eCRF).

- Coronary Arteriogram
- Following the current recommendation all patients with prosthetic heart valves need endocarditis prophylaxis
- All patients should receive Deep Vein Thrombosis (DVT) prophylaxis with Heparin/Low Weight Molecular Heparin (LMWH) starting approximately 6 hours after TAVI if bleeding permits
- Anticoagulants should be discontinued per hospital standard
- Activated clotting time (ACT) should be monitored per hospital standards but recommendation is >250 seconds
- Cardiac Enzymes: CK within 8-12 hours post procedure and at any time when a clinical ischemic event is suspected.
 - CK-MB is required if CK is elevated $\geq 2X$ the laboratory upper limit of normal.
 - If a clinical event is confirmed, a total of 3 draws of cardiac enzymes within the first 24 hours (drawn approximately every 8 hours) following the clinical event should be obtained
- 12-lead Electrocardiogram (ECG) to be performed within 48 hours of procedure
- Abbreviated Neurological Assessment
 - National Institute of Health Stroke Scale (NIHSS) to be completed with 24 hours of procedure
- Transthoracic Echocardiogram (TTE)
 - Comprehensive transthoracic 2D echocardiogram (TTE) should be performed within 24-48 hours post-procedure or prior to discharge to assess device success. Echocardiograms will be performed according to Echocardiography Procedures found in **Appendix R.7**
- It is recommended that subjects are treated for a minimum of three months with dual anti-platelet medication
 - If the patient is on warfarin therapy post-procedure it is recommended that subjects are prescribed either daily:
 - Aspirin (75 to 325 mg) **or**
 - Clopidogrel (75 mg) (or ticlopidine, if clopidogrel is contraindicated) for at least three months following the procedure
 - If the patient will **not** be on warfarin therapy post-procedure it is recommended that subjects are prescribed daily:
 - Aspirin (75to 325 mg) **and**
 - Clopidogrel (75 mg) (or ticlopidine, if clopidogrel is contraindicated) for at least three months following the procedure
- Concomitant medications
- Adverse events review
 - Document all adverse events, including all unanticipated adverse device effects (UADE) or unanticipated serious adverse device effects (USADE), technical observations, reinterventions or repeat admissions to the catheterization suite and deaths
 - Any patient with evidence of a new neurological event should have a neurology consult and subsequently an imaging trial if deemed necessary by the neurologist or stroke specialist
 - Any patient exposed to substantial radiation dose levels, as outlined in **Appendix R.23**, should be assessed for skin reactions

Post-Procedure Pacing Guidelines

- All patients should stay on telemetry until discharge
- Maintain temporary pacing until at least 48 hours post-implant in Cardiovascular Intensive Care Unit (CV-ICU) or local equivalent
- After 48 hours, obtain ECG and assess patient rhythm and conduction
- Based on assessment, and with the consult of an electrophysiologist as needed, take one of the following actions:
 - Discontinue temporary pacing
 - Continue temporary pacing for another 24 hours (longer if needed) to make further assessments
 - Place a permanent pacemaker according to ACC/AHA/HRS Guidelines for Device-Based Therapy of Cardiac Rhythm Abnormalities (Class I or IIb for Acquired Atrioventricular Block in Adults or Permanent Pacing in Chronic Bifascicular Block) as outlined in **Appendix R.13**
 - Prior to the permanent pacemaker implantation, document the reason for the placement of the permanent pacemaker via a 12-lead ECG
 - For complete heart block, review patient medications
 - Consider withholding some medications to assess for patient's intrinsic rate and conduction
 - If heart block persists off medications, a permanent pacemaker should be considered
 - If a permanent pacemaker is required, a dual chamber system is recommended to optimize patient hemodynamics
 - For additional information refer to the Pacing Guidelines in **Appendix R.13**

C.4.7.2 Surgical Aortic Valve Replacement

Minimum Standards for Surgical Aortic Valve Replacement

Subjects randomized to SAVR should be treated according to the surgeon and hospital's standard practices. The surgeon or co-surgeon performing the SAVR must be a trial investigator for the site. The choice of surgical valve is left to the discretion of the investigator. ***However, the use of a bioprosthetic valve is required.***

SAVR must be conducted as an isolated procedure with exception of subjects that have been randomized to SAVR with revascularization (eg. Aortic replacement or Maze procedures are not permitted). In cases of significant coronary artery disease that requires revascularization coronary artery bypass grafting (CABG) will be conducted concomitantly with SAVR.

Additional concomitant cardiac and non-cardiac procedures are not permitted with the exception of the procedures outlined under Additional Procedural Considerations.

General Procedural Considerations

One of the key requirements for good surgical outcome is an excellent collaboration of the dedicated multidisciplinary teams consisting of typically two cardiac surgeons with SAVR experience, a cardiac anesthesia team, an experienced cardio technician as well as at least two operation theater nurses.

Operation Theater

Surgical aortic valve replacement is to be performed in an operative theater with state-of-the-art technical equipment with certified sterility standards, adequate illumination, laminar flow, dedicated scrub nurses, and on site full technical support.

Perfusion

A dedicated, experienced perfusion team with greater than 75 Extracorporeal Circulation (ECC) runs per cardio technician per year who can perform all current cardioplegia strategies and is familiar with deep hypothermic circulatory arrest (DHCA) is recommended. The perfusion team should be capable of covering the full heart surgical spectrum including CABG, heart valve defect (HVD), Heart failure and assist devices, extracorporeal membrane oxygenation (ECMO) support, intra-aortic balloon pump (IABP), and cardiac transplant.

Pre-Procedure

- Pre-medication recommendations:
 - Discontinue warfarin therapy 3 days prior to the procedure, if applicable
 - Confirm that the INR < 1.8 prior to the procedure
 - Administer antiplatelet therapy, per local standards
 - Consider adjunctive proton pump inhibitors, H₂ receptor antagonists or antacids
- Routine Laboratory Tests:
 - Complete Blood Count
 - White Blood Count
 - Hematocrit
 - Hemoglobin
 - Platelet Count
 - Creatinine and Creatinine Clearance
 - If the GFR < 60 cc/min, consider:
 - Discontinuation of NSAIDs and ACE inhibitors
 - Cardiac Enzymes (CK/CK-MB)
 - International Normalized Ratio (INR), if applicable
 - Activated Partial Thromboplastin Time (aPTT)
 - B-type Natriuretic Peptide (BNP) or NT-proBNP
 - Liver Panel:
 - ALT
 - AST
 - Albumin
 - Sodium
 - Potassium
- 12-Lead Electrocardiogram
- One hour prior to the procedure, prophylactic antibiotic therapy of the Investigator's choice should be initiated:
 - Cefuroxime 750mg IV 1 hour pre-procedure, then 6 hours and 12 hours post-procedure
 - If allergic to Penicillin, prescribe Vancomycin 1g IV
 - Consider holding anti-hypertensives

Surgical Considerations

Surgical aortic valve replacement is typically performed with cardio-pulmonary bypass (CPB) on an arrested heart with a clamped aorta. Local practice and surgical standards should govern type of cardioplegia and the temperature/flow/pressure perfusion strategy as well as the activated clotting time used at either institution for safe CPB. Typically a minimum of 2 liters/m²/minute with a systemic arterial blood pressure of 60mmHg during CPB should be maintained and possibly increased in the elderly patients.

Cannulation for isolated SAVR CPB should be ascending aorta for arterial return unless there is ascending aortic arteriosclerosis or dilatation (>4cm in diameter), and right atrial for venous drainage. Embolic devices are not routinely used in SAVR.

Typical surgical workflow and general procedural recommendations

- *Procedural set-up and Anatomic Evaluation:*
 - The patient is prepared and draped
 - IV antibiotics should be administered following the local standard of care
 - Following the presternal skin incision the sternum is split
 - Prepare the mediastinum and open the pericardium
 - Inspect the ascending aorta for calcifications (including epiaortic scan if necessary)
 - Complete heparin application and arterial and venous cannulation
 - Initiate CPB, and at surgeons discretion, left heart venting via right upper pulmonary vein or pulmonary artery
 - Cross clamp the aorta and initiate cardioplegic arrest
 - Perform an aortotomy
 - Complete annular decalcification (the surgeon should take all possible means to prevent embolization of debris)

- *Prosthesis Specific Sizing:*
 - If the aortic annulus does not permit valve replacement with a patient matched valve diameter, the aortic annulus should be enlarged at the surgeon's discretion

- *Valve Preparation and Implantation:*
 - The valve prosthesis should be prepared following the manufacturer recommendations
 - After rinsing bioprosthetic valves should be kept wet throughout the procedure
 - Anchoring of the prosthesis with, for example, interrupted Teflon reinforced Tycron sutures or an equivalent technique is recommended
 - De-air and close the aortotomy
 - Insert temporary ventricular and atrial pacing wires and chest tubes
 - Wean from ECC hemostasis
 - Complete sternal wiring and layered closure

- *Additional Procedural Considerations:*
 - In case of concomitant significant subvalvular left ventricular outflow tract occlusion (LVOTO) then resection is recommended
 - If there is a significant patent foramen ovale (PFO) closure is recommended in cases of substantial right to left flow
 - It might be recommendable to apply CO₂ surgical field flooding to ease de-airing

- *Intraoperative Aortic Assessment*
 - Transesophageal echo (TEE) is recommended in all cases to additionally assess for aortic calcifications before manipulating the aorta. In case of doubt an Epiaortic scan might further help for surgical decision making
 - Additionally the TEE should be used to assess for subvalvular LVOTO and patent foramen ovale

- *Before Termination of Surgery Repeat Intraoperative TEE*
 - TEE is recommended to assess the postoperative SAVR result
 - Assessment should include aortic valve function, central or paravalvular leakage, valve gradient, exclude remaining LVOTO from subvalvular stenosis as well as ventricular function with special emphasis on new segmental wall function abnormalities.
 - Any regurgitation of more than trace should be critically evaluated and at surgeon's discretion the valve re-inspected and if necessary changed.

Immediate Post-Procedure

The procedure is considered complete at the time of skin closure. Immediately post-procedure the following tests and procedures must be performed and data collected:

- Cardiac Enzymes: CK within 8-12 hours post procedure and at any time when a clinical ischemic event is suspected.
 - CK-MB is required if CK is elevated >2X the laboratory upper limit of normal.
 - If a clinical event is confirmed, a total of 3 draws of cardiac enzymes within the first 24 hours (drawn approximately every 8 hours) following the clinical event should be obtained
- Concomitant Medications
- 12-lead Electrocardiogram (ECG) to be performed within 48 hours of procedure
- Abbreviated Neurological Assessment
 - National Institute of Health Stroke Scale (NIHSS) to be completed within 24 hours of procedure
- Transthoracic Echocardiogram (TTE)
 - Comprehensive transthoracic 2D echocardiogram (TTE) should be performed at least 24 hours post-procedure but prior to discharge to assess device success (and no later than 7 days, whichever comes first)
 - Echocardiograms will be performed according to Echocardiography Procedures found in **Appendix R.7**
- Adverse Event review

Post-Procedural Medication

- It is recommended that subjects are treated with aspirin (75-325mg daily) for a minimum of three months
- If warfarin therapy is indicated (eg. A-fib): maintain therapeutic anticoagulation with Heparin or Low Molecular Weight Heparin until INR between 2 and 3 is reached after loading with warfarin
- The preoperative antibiotic therapy may be repeated within the next 6 to 12 hours
- All patients should receive DVT prophylaxis with Heparin/LMWH starting approximately 6 hours after SAVR if bleeding permits
- Following the current recommendation all patients with prosthetic heart valves need endocarditis prophylaxis

Post-Procedure Pacing Guidelines

- All patients should stay on telemetry until discharge
- Maintain temporary pacing until at least 48 hours post-implant in CV-ICU or local equivalent
- After 48 hours, obtain ECG and assess patient rhythm and conduction
- Based on assessment, and with the consult of an electrophysiologist as needed, take one of the following actions:
 - Discontinue temporary pacing
 - Continue temporary pacing for another 24 hours (longer if needed) to make further assessments
 - Place a permanent pacemaker according to ACC/AHA/HRS Guidelines for Device-Based Therapy of Cardiac Rhythm Abnormalities (Class I or IIb for Acquired Atrioventricular Block in Adults or Permanent Pacing in Chronic Bifascicular Block) as outlined in **Appendix R.13**
 - Prior to the permanent pacemaker implantation, document the reason for the placement of the permanent pacemaker via a 12-lead ECG
 - For complete heart block, review patient medications
 - Consider withholding some medications to assess for patient's intrinsic rate and conduction
 - If heart block persists off medications, a permanent pacemaker should be considered
 - If a permanent pacemaker is required, a dual chamber system is recommended to optimize patient hemodynamics

- For additional information refer to the Pacing Guidelines in **Appendix R.13**

C.4.8 Assessments done at discharge (both SAVR and TAVI)

Prior to hospital discharge (or within 7 days post-index procedure, whichever occurs first) the following tests and procedures must be performed and data collected:

- Physical Examination
 - Vital signs
 - Major system findings
 - Skin Assessment – refer to Radiation Exposure and Data Collection, **Appendix R.23**
- Concomitant Medications
 - Use of relevant medications (diuretics, aspirin, anticoagulants, ACE-I, ARB, beta-blockers, statins and anti-platelets)
- Routine Laboratory Tests:
 - Complete Blood Count:
 - White Blood Count
 - Hematocrit
 - Hemoglobin
 - Platelet Count
 - Creatinine and Creatinine Clearance
 - Cardiac Enzymes (CK/CK-MB)
 - International Normalized Ratio (INR), if applicable
 - Activated Partial Thromboplastin Time (aPTT)
 - B-type Natriuretic Peptide (BNP) or NT-proBNP
 - Liver Panel:
 - ALT
 - AST
 - Albumin
 - Sodium
 - Potassium
- Neurological Assessments
 - National Institute of Health Stroke Scale (NIHSS)
 - Modified Rankin Score (mRS)
 - Mini-Mental State Exam (MMSE-2:SV)
 - Additional Neurological testing:
 - Visual Fields Testing
 - Gait Assessment
 - Hand Function
 - Writing Evaluation
 - Drawing Assessment
- Transthoracic Echocardiogram (TTE)
 - Comprehensive transthoracic 2D echocardiogram (TTE) should be performed at least 24hours post-procedure but prior to discharge to assess device success (and no later than 7 days, whichever comes first)
 - Echocardiograms will be performed according to Echocardiography Procedures found in **Appendix R.7**
- 12-lead Electrocardiogram
- Adverse Event review

C.4.9 Follow-Up Evaluations

All randomized subjects will undergo in-clinic follow-up evaluations at the following time points post implant.

All follow-up periods are defined as the number of days after the date of the index procedure (TAVI or SAVR).

Day 0 = day of index procedure (TAVI or SAVR):

- 30 days (- 7 days and + 14 days)
- 3 months (90 ± 14 days)
- 6 months (180 ± 30 days)
- 12 months (365 ± 30 days)
- 18 months (545 ± 60 days)
- 24 months (730 ± 60 days)
- 3 years (1080 ± 60 days)
- 4 years (1440 ± 60 days)
- 5 years (1800 ± 60 days)

All randomized subjects will complete long-term follow-up through at least 5 years. Based on clinical assessments or regulatory requirements, follow-up may be extended to up to 10 years post-index procedure. Upon completion of the final protocol visit (discontinuation) subject participation will be considered complete and the patient should then be followed per the local standard of care for their condition.

Note: For subjects where the Index Procedure is never attempted (eg. subject withdraws consent for the procedure but agrees to complete follow-up) follow-up intervals will be calculated from the 31st days post-randomization (i.e. the 1st day after the 30 day window from randomization to complete the Index Procedure).

C.4.9.1 30 Days

The following assessments will be conducted at the 30 day visit.

- Physical examination
 - Vital signs
 - Major system findings
 - Skin Assessment – refer to Radiation Exposure and Data Collection, **Appendix R.23**
- NYHA classification
- Concomitant Medications
 - Use of relevant medications (diuretics, aspirin, anticoagulants, ACE-I, ARB, beta-blockers, statins and anti-platelets)
- Routine Laboratory Tests:
 - Hemoglobin
 - Creatinine and Creatinine Clearance
- Abbreviated Neurological Assessment
 - National Institute of Health Stroke Scale (NIHSS)
- 12-lead Electrocardiogram
- 6 Minute Walk Test
- Quality of Life Questionnaires
- Adverse Event review

C.4.9.2 3 Months

The following assessments will be conducted **via telephone** at the 3 Month visit.

- Quality of Life Questionnaire
 - EQ-5D
 - SF-36 – in selected geographies. Refer to **Appendix R.12** for instructions on which geographies are required to collect the questionnaire

C.4.9.3 6 Months

The following assessments will be conducted at the 6 Month visit.

- Physical examination
 - Vital signs
 - Major system findings
- NYHA classification
- Concomitant Medications
 - Use of relevant medications (diuretics, aspirin, anticoagulants, ACE-I, ARB, beta-blockers, statins and anti-platelets)
- Abbreviated Neurological Assessment
 - National Institute of Health Stroke Scale (NIHSS)
- Transthoracic Echocardiogram (TTE)
- 12-lead Electrocardiogram
- Quality of Life Questionnaires
- Adverse Event Review

C.4.9.4 12 Months

The following assessments will be conducted at the 12 Month visit.

- Physical examination
 - Vital signs
 - Major system findings
- NYHA classification
- Concomitant Medications
 - Use of relevant medications (diuretics, aspirin, anticoagulants, ACE-I, ARB, beta-blockers, statins and anti-platelets)
- Neurological Assessments
 - National Institute of Health Stroke Scale (NIHSS)
 - Modified Rankin Score (mRS)
 - Mini-Mental State Exam (MMSE-2:SV)
 - Additional Neurological testing:
 - Visual Fields Testing
 - Gait Assessment
 - Hand Function
 - Writing Evaluation
 - Drawing Assessment
- Transthoracic Echocardiogram (TTE)
- 12-lead Electrocardiogram
- 6 Minute Walk Test
- Quality of Life Questionnaires
- Adverse Event review

C.4.9.5 18 Months

The following assessments will be conducted at the 18 Month visit.

- Physical examination
 - Vital signs
 - Major system findings
- NYHA classification
- Concomitant Medications
 - Use of relevant medications (diuretics, aspirin, anticoagulants, ACE-I, ARB, beta-blockers, statins and anti-platelets)
- Abbreviated Neurological Assessment
 - National Institute of Health Stroke Scale (NIHSS)
- 12-lead Electrocardiogram
- Quality of Life Questionnaires
- Adverse Event review

C.4.9.6 24 Months

The following assessments will be conducted at the 24 Month visit.

- Physical examination
 - Vital signs
 - Major system findings
- NYHA classification
- Concomitant medications
 - Use of relevant medications (diuretics, aspirin, anticoagulants, ACE-I, ARB, beta-blockers, statins and anti-platelets)
- Neurological Assessments
 - National Institute of Health Stroke Scale (NIHSS)
 - Modified Rankin Score (mRS)
 - Mini-Mental State Exam (MMSE-2:SV)
 - Additional Neurological testing:
 - Visual Fields Testing
 - Gait Assessment
 - Hand Function
 - Writing Evaluation
 - Drawing Assessment
- Transthoracic Echocardiogram (TTE)
- 12-lead Electrocardiogram
- 6 Minute Walk Test
- Quality of Life Questionnaires
- Adverse Event review

C.4.9.7 3-5 Years

The following assessments will be conducted at the 3, 4, and 5 year visits.

- Physical examination
 - Vital signs
 - Major system findings
- NYHA classification
- Abbreviated Neurological Assessment
 - National Institute of Health Stroke Scale (NIHSS)
- Transthoracic Echocardiogram (TTE)
- 12-lead Electrocardiogram
- Quality of Life Questionnaires
- Adverse Event review – refer to C.5.2 Reporting for AE reporting requirements post-24 Months

C.4.10 Echo Assessment

Echocardiography is the cornerstone of baseline and follow-up imaging. A comprehensive transthoracic echocardiogram (TTE) to assess the morphology and function of the respective heart chambers and valves is mandatory prior to implant. Calculation of LVEF by visual assessment, measurement of left ventricular end-diastolic volume and diameter and inter-ventricular septal thickness to characterize the left ventricle and transaortic jet velocity, mean transaortic gradient and aortic valve area by the continuity equation to illustrate AS severity are essential(1).

Echo assessment will be conducted by a core laboratory.

Sites should make every effort to utilize the same echo machine for all subjects at all required interval throughout the duration of the protocol.

C.4.11 Neurologic Assessment

The incidence of new clinically detectable neurological events or deficits, or any comparative change in indices of higher cognitive function following TAVI in the treatment of patients with symptomatic severe aortic stenosis is an important clinical endpoint. Therefore, a baseline and follow-up neurological examination by a qualified trial-trained neurologist or stroke specialist is mandatory and as outlined in section C.4.9 Follow-Up Evaluations. Abbreviated Neurological Assessments, requiring completion of only the NIHSS, may be conducted by certified site personnel.

If at any time there is change in a subject's NIHSS score of ≥ 4 further assessments should be conducted to identify potential adverse events and additional neurological evaluations should be conducted by a neurologist or stroke specialist, if a neurological event is suspected.

In case of a new neurological event, the diagnosis of stroke should be supported by complementary findings on neuro-imaging examination. The need for additional imaging is up to discretion of the Neurologist or Stroke Physician. Both diffusion-weighted Magnetic Resonance imaging and multi-slice Computed Tomography are valid neuro-imaging modalities (however CTA or MRA is preferred to CT or MRI), the selection of which will be left per institution's standard of care.

In addition to the neurological assessments at specified time periods, additional evaluations should be conducted, as follows during the course of the trial, if applicable:

- NIHSS:
 - For subjects with a new neurological event (stroke, TIA, or encephalopathy), additional NIHSS exams are to be performed at 30 days, and 3 months post-event
 - NIHSS also to be done within 24 hours of any aortic valve or ascending aortic intervention
 - Any patient with evidence of a new neurological event should have a neurology consult and an imaging study if deemed necessary
 - *NIHSS may be conducted by certified site personnel*
- Modified Rankin Scale
 - For subjects with new neurological event, assessment to be performed at 7 days or discharge (whichever occurs first), 30 days, and 3 months post-stroke
 - *All trial-required mRS testing should be conducted by a neurologist or stroke specialist*
- Mini Mental State Exam (MMSE-2:SV)
 - For subjects with a new neurological event assessments are to be performed at 30 days and 3 months post-stroke
 - *All trial-required MMSE testing should be conducted by a neurologist or stroke specialist*

Refer to the **Appendix R.18** for a description of the Additional Neurological Testing.

C.4.12 Angiographic and Computed Tomography Assessment

Complete angiographic (invasive or MSCT) assessment of the aortic bifurcation and ilio-femoral-arterial tree is mandatory prior to the Heart Team review.

An additional benefit of Multislice CT scan in the TAVI cohort is to obtain a thorough assessment of the anatomy of the left ventricular outflow tract (LVOT) up to the common femoral arteries. MSCT also provides information on coronary and carotid anatomy, and might identify occult malignancy which is also valuable information in SAVR cohort.

The aortic valve calcification should be evaluated to determine grade of severity. With respect to the elliptical shape of the virtual aortic annulus, the axial plane where the 3 basal aortic leaflet attachments can be identified simultaneously is used for measuring the maximum and minimum annular diameter (most often corresponding to 2 orthogonal sagittal and coronal planes)(53). Additionally the maximum diameters of the LVOT, sinuses of Valsalva and sinotubular junction are obtained. Maximum diameter, calcification and tortuosity of the ascending and descending thoracic aorta are evaluated. As for the iliofemoral tree, the minimal luminal diameter, plaque and calcification burden and tortuosity are assessed in order to judge transfemoral accessibility for the investigational TAVI device.

C.4.13 Data Collection

All scheduled testing and procedures to be conducted during the baseline, index procedure, and follow-up assessments are summarized in **Table 3**.

Table 3: Schedule of Assessments

Parameter	Screening	RANDOMIZATION										
		Baseline (within 14 days of procedure)	Procedure	Discharge	30 days	3 Months	6 Months	12 Months	18 Months	24 Months	3 – 5 years	
Informed consent (and in US HIPAA Authorization)	•											
Inclusion/Exclusion	•		•*									
Demographics and Medical history	•											
Physical Examination	•	•		•	•		•	•	•	•	•	•
Clinical Assessments	•											
NYHA Class	•	•			•		•	•	•	•	•	•
Risk Assessments: STS Risk Score, Logistic EuroSCORE, EuroSCORE II, SYNTAX Score, and Katz Index	•											
Co-morbidities	•											
Concomitant Medications ¹¹		•	•	•	•		•	•	•	•		
Routine Laboratory Tests	•	•	• ^{1,2}	•	• ³							
Neurological Assessments ⁷ (NIHSS, mRS, MMSE-2:SV and Additional Neurological Assessments) ⁹		•		•				•		•		
Abbreviated Neurological Assessment (NIHSS only)			• ⁸		•		•		•		•	•
Transthoracic Echocardiogram (TTE)	•			• ⁵			•	•		•	•	
Computed Tomography (CT) Angiogram (MSCT required at screening) ⁶	•											
Coronary Arteriogram	•		(•)									
Aortogram			(•)									
12-lead Electrocardiogram	•	•	• ⁴	•	•		•	•	•	•	•	•
6 Minute Walk Test		•			•			•		•		
Quality of Life Questionnaires (EQ-5D, KCCQ, and SF-36)		• ¹²			•	• ¹³	•	•	•	•	•	•
Adverse Events		•	•	•	•		•	•	•	•	•	• ¹⁰

- * Document any changes to subject condition that affect inclusion/exclusion criteria, confirm the subject does not meet any exclusion criteria specific to the Index Procedure (eg. percutaneous coronary or peripheral intervention and evidence of an acute myocardial infarction which must not occur within 30 days prior to the index procedure)
- (•) TAVI subjects only (SAVR subjects will not have these assessments)
 - ¹ Laboratory test results must be performed pre-procedure and CK to be obtained within 8-12 hours post-procedure
 - ² Pre-procedure
 - ³ Only hemoglobin, creatinine and creatinine clearance are required to be collected
 - ⁴ Electrocardiogram within 48 hours post-procedure
 - ⁵ TTE to be completed at least 24hours post-procedure but prior to discharge (and no later than 7 days post procedure) to assess device success
 - ⁶ All subjects should have screening thoracic and abdominal CT angiograms with complete visualization of both iliacs, femorals, and aorta (and subclavian/axillaries, if applicable), up to and including the aortic annulus
 - ⁷ In addition to the protocol required assessment (NIHSS and MMSE); for subjects with neurological event or stroke, additional NIHSS and MMSE exams are to be performed at 30 days and 90 days post-event. mRS should be completed at 7 days post-event or discharge (whichever occurs first), 30 days, and 90 days post-event. NIHSS is also to be done within 24 hours of any aortic valve or ascending aortic intervention
 - ⁸ NIHSS to be done within 24 hours post- procedure
 - ⁹ Additional Neurological Assessments include: Visual Fields Testing, Gait Assessment, Hand Function, Writing Evaluation, and Drawing Assessment
 - ¹⁰ SAE, MAE, cardiovascular events, device-related events, including device-related technical observations, UADEs, USADEs, all stroke (CVAs), and death reports
 - ¹¹ Use of relevant medications (diuretics, aspirin, anticoagulants, ACE-I, ARB, beta-blockers, statins and anti-platelets)
 - ¹² Quality of Life Questionnaires collected at baseline may be administered any time after the subject has provided informed consent but should be collected prior to informing the subject of randomization assignment
 - ¹³ Quality of Life Questionnaire – EQ-5D to be administered via telephone. SF-36 will also be collected in selected geographies, refer to **Appendix R.12**

C.4.14 Unscheduled Follow-up Assessments

If a subject returns to the institution between their scheduled follow-up visits the visit will be treated as an unscheduled visit and the assessments completed at this visit will be done at the discretion of the investigator. eCRFs are provided for unscheduled visits.

C.4.15 Missed Follow-up Visits

Every effort should be made to ensure subjects return to the clinic for all protocol required follow-up. If the subject is unable to return for an in-person clinic visit, the Investigator, or designee, must document in the patient record the reason the subject was unable to complete the visit and, if applicable, follow the requirements for deviation reporting as outlined in Section C.4.18 Protocol Deviations.

The Investigator should also make every effort to contact the subject or subject's legal representative, within the visit window, to collect the subject's vital status as well as information related to potential adverse events, safety data, and hospitalizations.

C.4.16 Investigational Product Accountability

The Investigator is responsible for maintenance of the Device Accountability Log. The log must detail the product and lot numbers as well as the location and status of all investigational devices (including DCS, CLS/ LS components, where applicable) received by the hospital and/or Investigator. At the end of the clinical trial the Principal Investigator must sign the original log, as applicable.

This clinical trial will be conducted in some geographies where the TAV device or its components are commercially available. In these geographies, the device will be used outside the current approved indication; therefore the TAV will be labeled as investigational. Note, the DCS and CLS/LS components are identical to the CE marked CoreValve System and will be supplied within the approved commercial CE marked labeling. The Investigator must provide full accountability for each TAV from the time of receipt through disposition and/or return. Accountability for the each DCS and CLS/LS must include all dispositions within the clinical trial. In the US, commercial devices, as referenced in Table 1, are approved for use in the clinical trial, as necessary, in the event that an investigational device is not available. In the event that a commercial device is used in a study subject, the device use will be documented in the Device Accountability Log.

In geographies where the device is not currently approved, the TAV, DCS, CLS/LS components will be labeled as investigational. The Investigator must provide full accountability for each TAV, DCS, and CLS/LS from the time of receipt through disposition.

At the end of the trial enrollment period, all remaining investigational product must be returned to Medtronic.

C.4.17 Device Malfunction or Explant

In the event of a device malfunction of the TAV device or its components prior to implant or in the event that a TAV is explanted after implant (due to reintervention or autopsy), the TAV and/or affected components should be returned to Medtronic to the following:

Medtronic, Inc.
Attn: Explant Lab [PE#]
1851 E. Deere Avenue
Santa Ana, CA 92705-5720

Additional details surrounding the device return process, including how to obtain the PE # (product experience number), are contained within the Medtronic explant kit and in **Appendix R.11**.

C.4.18 Protocol Deviations

A protocol deviation is defined as an event where the clinical investigator or site personnel did not conduct the trial according to the protocol or the Investigator agreement. Deviations will be reported regardless of whether medically justifiable, pre-approved by Medtronic, or taken to protect the patient in an emergency.

A protocol deviation form is to be completed for each trial protocol deviation, including, but not limited to:

- Failure to obtain informed consent
- Incorrect version of consent provided to patient
- Failure to obtain IRB/MEC protocol review and approval before starting the trial
- Enrollment of patient during an IRB/MEC approval lapse
- Clinical investigator exceeding enrollment limits specified by sponsor
- Patient did not meet inclusion/exclusion criteria
- Incorrectly performed testing
- Protocol-required testing and/or measurements not done or performed outside of window
- Source data permanently missing
- SAE, SADE, UADE or USADE not reported in the required timeframe

FDA regulations [21 CFR 812.140] require that the Investigator maintain accurate, complete, and current records, including documents showing the dates of and reasons for each deviation from the protocol. Relevant information for each deviation will be documented on a deviation form completed by site personnel and reviewed by the Investigator.

FDA regulations [21 CFR 812.150], ISO 14155 (2011), and local regulatory authorities (where applicable), require Investigators to obtain prior approval from the sponsor before initiating changes in or deviations from the protocol, except when necessary to protect the life or physical well-being of a patient in an emergency.

Prior approval by the sponsor is expected in those situations in which the Investigator anticipates, contemplates or makes a conscious decision to depart from procedures specified in the protocol. Prior approval is generally not expected in situations where unforeseen circumstances are beyond the Investigator's control, but is still considered a deviation (eg. a trial subject who fails to attend a scheduled follow-up visit, a trial subject too ill to perform a protocol-required test). To obtain approval, the Investigator must call or email and discuss the potential deviation with the Medtronic trial manager or designee prior to initiating any changes. If approval is granted, the Medtronic trial manager or designee will provide the applicable documentation to be maintained in the site files.

FDA regulations require the Investigator to notify the sponsor and the reviewing IRB/MEC within 5 working days of the following deviations [21 CFR 812.150]:

- a deviation from protocol to protect the life or physical wellbeing of a patient in an emergency
- failure to obtain an informed consent

Investigators or an authorized designee must notify Medtronic as soon as possible by calling the trial manager or designee and completing the protocol deviation form.

The Investigator is required to adhere to local IRB/MEC procedures for reporting deviations.

The DSMB may review protocol deviations to ensure compliance and overall trial integrity.

C.4.19 Subject Withdrawal or Discontinuation

All subjects will be encouraged to remain in the trial through the last follow-up visit at month 60. Subjects who discontinue participation prematurely after randomization will be included in the analysis of results (as appropriate) but they will not be replaced in the enrollment of total trial subjects. If a trial subject is discontinued from the trial early, the reason for discontinuation should be documented in the patient file and a Study Exit eCRF must be completed. If discontinuation is because of safety concerns or lack of effectiveness, the subject shall be asked to be followed for collection of ongoing safety data outside the clinical investigation.

The trial site and Sponsor will make every effort to have all subjects complete the follow up visit schedule. A subject will not be considered lost-to-follow-up unless all efforts to obtain compliance are unsuccessful. At a minimum, the effort to obtain follow-up information must include three attempts to make contact via telephone and if contact via phone is not successful, a traceable letter from the Investigator must be sent to the subject's last known address. Should both telephone and mail efforts to contact the subject be unsuccessful, the subject's primary physician should be contacted. Subjects will then be deemed lost to follow up. All contact efforts to obtain follow-up must be documented in both the subject's medical records and in the trial eCRFs.

If a subject officially withdraws from the trial but is willing to allow either regular vital status determinations for the trial or a one-time vital status determination, these are to be conducted per the follow-up visit schedule or only at the last planned follow-up visit, respectively, and may be conducted via telephone.

If a subject discontinues the trial at any time, is withdrawn from the trial early, or completes all protocol required follow-up they should then be followed per the local standard of care for their condition.

C.4.20 Termination or Discontinuation of Trial

Medtronic may decide to suspend or prematurely terminate the trial. If the trial is terminated prematurely or suspended, Medtronic shall promptly inform the clinical investigators of the termination or suspension and the reason(s) for this. The investigator shall then promptly inform the reviewing MEC/IRB.

Possible reasons for early trial termination include:

- Unanticipated Adverse Device Effect (UADE) or Unanticipated Serious Adverse Device Effect (USADE) presents an unreasonable risk to patients
- Recommendation from DSMB (eg. significant safety concerns, statistical futility)

If the trial is terminated early, the Sponsor will, as soon as possible, provide a written statement to the Investigators to enable prompt notification of the IRB/MECs. The Sponsor will also inform the FDA. If the trial enrollment is terminated early, the follow-up visits will continue for all enrolled subjects.

C.5 Adverse Events

C.5.1 Definitions

The definitions presented in this section allow for a clear understanding of adverse event data collection and subsequent analysis.

C.5.1.1 Adverse Event

An adverse event (AE) is any untoward medical occurrence, unintended disease or injury, or untoward clinical signs (including abnormal laboratory findings) in subjects, users or other persons, whether or not related to the investigational medical device.

NOTE 1: This definition includes events related to the investigational medical device or the comparator.

NOTE 2: This definition includes events related to the procedures involved.

NOTE 3: For users or other persons, this definition is restricted to events related to investigational medical devices. The following events in **Table 4** are expected to occur with any surgical implant and therefore should not be reported as AEs, unless they occur outside of the stated timeframe:

Table 4: Expected Events

Description of the Event	Timeframe (hours) from Procedure
Anesthesia-related nausea and/or vomiting	24
Low-grade fever (<100°F or <37.8°C)	48
Back pain related to laying on the procedure table	72
Incisional pain (pain at access site)	72
Sleep problems or insomnia	72
Mild to moderate bruising or ecchymosis	168

C.5.1.2 Serious Adverse Event

A serious adverse event (SAE) is an event that:

- Led to death
- Led to serious deterioration in the health of the subject, that either resulted in:
 - a life threatening illness or injury, or
 - a permanent impairment of a body structure or a body function, or
 - inpatient or prolonged hospitalization, or
 - medical or surgical intervention to prevent life-threatening illness or injury or permanent impairment to a body structure of a body function
- Led to fetal distress, fetal death or a congenital anomaly or birth defect

NOTE: Planned hospitalization for a pre-existing condition, or a procedure required by the CIP, without serious deterioration in health, is not considered a serious adverse event.

In addition to above standard definition of SAE, the following events will also be defined as serious in the SURTAVI Trial, including events that do not meet the above criteria for SAE.

- Stage 2 and 3 acute renal injuries
- Life-threatening and Major bleeding events
- Any new or worsening LBBB or RBBB that requires the placement of a permanent pacemaker and/or surgical or invasive intervention
- All myocardial infarctions
- Disabling strokes
- Major vascular complications

Events that do not meet these criteria are considered non-serious.

C.5.1.3 Major Adverse Cardiovascular and Cerebrovascular Events

Major adverse cardiovascular and cerebrovascular events (MACCE) is defined as a composite of:

- All-cause death
- Myocardial infarction (MI)
- All stroke, and

- Reintervention (defined as any cardiac surgery or percutaneous reintervention catheter procedure that repairs, otherwise alters or adjusts, or replaces a previously implanted valve)

C.5.1.4 Major Adverse Event

Major adverse event (MAE) includes:

- MACCE
- Acute kidney Injury
- Cardiac tamponade
- Prosthetic valve dysfunction
- Cardiogenic shock
- Prosthetic valve endocarditis
- Life-threatening, disabling or major bleeding
- Major vascular complication
- Cardiac perforation
- Valve malpositioning

C.5.1.5 Adverse Device Effect (ADE) or Device-Related Adverse Event

An ADE is an adverse event related to the use of an investigational medical device. During this clinical investigation an event should be considered related to the device when it is the result of the Medtronic CoreValve™ System (MCS) and CoreValve™ Evolut™ R System:

- The transcatheter aortic valve (TAV)
- The delivery catheter system (DCS)
- The compression loading system (CLS/LS)
- The implant procedure

An event should be considered not related to the device when it is the result of:

- A pre-existing medical condition
- A new illness, injury or condition
- Medication

NOTE 1: This definition includes adverse events resulting from insufficient or inadequate instructions for use deployment, implantation, installation, or operation, or any malfunction of the investigational medical device.

NOTE 2: This definition includes any event resulting from use error or from intentional misuse of the investigational medical device.

C.5.1.6 Serious Adverse Device Effects (SADEs)

Adverse device effect that has resulted in any of the consequences characteristic of a Serious Adverse Event.

C.5.1.7 Unanticipated Adverse Device Effect (UADE)

An unanticipated adverse device effect or UADE is defined as “any serious adverse effect on health or safety or any life-threatening problem or death caused by, or associated with, a device, if that effect, problem, or death was not previously identified in nature, severity, or degree of incidence in the protocol or application (including a supplementary plan or application), or any other unanticipated serious problem associated with the device that relates to the rights, safety, or welfare of subjects” [21 CFR 812.3 (s)].

Those known adverse events related to the device, procedure or therapy are listed in Section O and in the Risk/Benefit Analysis section (Section D) of this document.

C.5.1.8 Unanticipated Serious Adverse Device Effect (USADE)

Serious adverse device effect which by its nature, incidence, severity or outcome has not been identified in the current version of the risk analysis report.

NOTE: Anticipated serious adverse device effect (ASADE) is an effect, which by its nature, incidence, severity or outcome has been identified in the risk analysis report.

C.5.1.9 Device Deficiency

Inadequacy of a medical device with respect to its identity, quality, durability, reliability, safety or performance.

NOTE: Device deficiencies include malfunctions, use errors, and inadequate labeling.

C.5.1.10 Technical Observation

A technical observation is a defect, malfunction, or failure of any part of the TAV or its components. This may pertain to the device or system not functioning according to its design intent. Each technical observation (whether or not associated with any untoward medical occurrence in a subject) will be reported on the Adverse Event (AE) eCRF and tabulated as an AE.

C.5.2 Reporting

Investigators are required to keep records on “all relevant observations, including records concerning adverse device effects (whether anticipated or unanticipated)” [21 CFR 812.140; ISO 14155 (2011)]. Adverse event collection will begin from the point of trial enrollment to trial closure. All new or worsening (from baseline) adverse events and technical observations will be captured on the AE eCRF through the 24month follow-up visit. It is the responsibility of the Investigator to assess the subject for adverse events and capture the required adverse event information on the AE eCRF.

Once a subject has completed their 24-month scheduled follow-up visit only serious adverse events, major adverse events, cardiovascular events, device-related adverse events, including device related technical observations, unanticipated adverse device effects (UADE) or unanticipated serious adverse device effects (USADE), all strokes (CVAs) and deaths will be required to be reported. Reference section C.5.1 Adverse Events for event definitions and criteria. Medtronic representatives or their designees will conduct monitoring visits to review source documentation and verify the complete and accurate capturing of adverse events.

The Investigator must also notify the responsible IRB/MEC regarding new and significant safety information and any event identified by Medtronic that requires expedited FDA, and/or local regulatory agency, reporting as serious, unexpected, and related to the investigational device. It is the responsibility of the investigator to ensure site specific IRB/MEC safety reporting requirements are met.

Medtronic Clinical will ensure all device-related adverse events and all procedure-related SAEs are processed according to internal policies and procedures. When necessary, Medtronic Field Assurance will respond to sites in writing with the findings related to the product experiences.

The general procedure for investigators reporting any adverse event is as follows:

- Report the event to Medtronic as soon as possible but no later than the timeframes outlined below. (At the time of Site Initiation, sites will be provided with the telephone and other applicable contact information of the appropriate Medtronic designee).
- Complete all sections of the Adverse Event eCRF.
- Each unique event/diagnosis must be documented separately.
- Documented pre-existing conditions are not considered to be reportable AEs unless there is a change in the nature or severity of the condition.
- The Adverse Event eCRF must be reviewed by the Investigator.

Reporting guidelines related to specific types of adverse events are outlined below.

C.5.2.1 Serious Adverse Events (SAEs)

The Investigator shall notify the sponsor immediately but not later than within 3 calendar days of first learning of any SAE using the EDC system [MEDDEV 2.7/3]. If necessary, the Investigator may be requested to provide copies of source documentation regarding the event (eg., physician/nurse notes or summaries). The Investigator should also notify their IRB/MEC and, if applicable, local regulatory agencies, per their requirements.

Medtronic will conduct an evaluation of the event and if it is determined by Medtronic to be a UADE or USADE, it will be reported as described in the following sections.

C.5.2.2 Serious Adverse Device Effects

The Investigator shall notify the sponsor immediately, but not later than within 3 calendar days of the first learning of any SADE.

C.5.2.3 Unanticipated Adverse Device Effects (UADE or USADE)

Investigators must report any (potential) unanticipated adverse device effects, or unanticipated serious device effects, to Medtronic and their IRB/MEC immediately but no later than 3 calendar days after first learning of the event [MEDDEV 2.7/3]. UADEs and USADEs should be reported immediately to Medtronic via telephone as well as on an eCRF. The Investigator should also notify their IRB/MEC and, if applicable, local regulatory agencies, per their requirements.

The Investigator should consider the device labeling and the Risk/Benefit Analysis section of this document (Section D) when determining whether an event is unanticipated or not.

If an event is determined by Medtronic to be a UADE or USADE, Medtronic will report the event to all investigators to enable reporting to their respective IRB/MECs. Medtronic will provide this notification within 10 working days after Medtronic first receives notice of the effect. [21 CFR 812.150]

If Medtronic and the DSMB determine that the event presents an unreasonable risk to the participating subjects, Medtronic must terminate all investigations or parts of investigations presenting the risk in the clinical trial 5 working days after making that determination and not later than 15 working days after Medtronic first receives notice of the effect. [21 CFR 812.46] Follow-up visits for enrolled subjects will continue according to the schedule of assessments.

C.5.2.4 Device Deficiencies and Technical Observations

Device Deficiency information and Technical Observations will be collected throughout the trial and reported to Medtronic.

Device Deficiencies and Technical Observations should be reported on an Adverse Event eCRF.

Device deficiencies that did not lead to an Adverse Event but could have led to an SADE:

- a) if either suitable action had not been taken,
- b) if intervention had not been made, or
- c) if circumstances had been less fortunate,

require immediate reporting (see **Table 6**). Initial reporting may be done on the eCRF completing as much information as is available. The original completed eCRF must be submitted to Medtronic as soon as possible.

C.5.2.5 All Other Adverse Events

The Investigator shall notify the sponsor within 15 calendar days of first learning of any other AE using the EDC system. If necessary, the Investigator may be requested to provide copies of source documentation regarding the event (eg., physician/nurse notes or summaries).

C.5.2.6 Anticipated Adverse Events

Potential risks associated with TAVI device or its components (inclusive of CoreValve and Evolut R systems) may include, but are not limited to, the following:

- Death
- Cardiac arrest
- Coronary occlusion, obstruction, or vessel spasm (including acute coronary closure)
- Emergent surgery (eg., coronary artery bypass, heart valve replacement, valve explant)
- Multi-organ failure
- Heart failure
- Myocardial infarction
- Cardiogenic shock

- Respiratory insufficiency or respiratory failure
- Cardiovascular injury (including rupture, perforation, or dissection of vessels, ventricle, myocardium, or valvular structures that may require intervention)
- Perforation of the myocardium or a vessel
- Ascending aorta trauma
- Cardiac tamponade
- Cardiac failure or low cardiac output
- Prosthetic valve dysfunction including, but not limited to:
 - Fracture
 - Bending (out-of-round configuration) of the valve frame
 - Under-expansion of the valve frame
 - Calcification
 - Pannus, (wear, tear, prolapse, or retraction in the valve leaflets)
 - Poor valve coaptation
 - Suture breaks or disruption
 - Leaks
 - Mal-sizing (prosthesis-patient mismatch)
 - Malposition (either too high or too low)/malplacement
 - Regurgitation, stenosis
- Thrombosis/embolus (including valve thrombosis)
- Valve migration/valve embolization
- Ancillary device embolization
- Emergent percutaneous coronary intervention (PCI)
- Emergent balloon valvuloplasty
- Major or minor bleeding that may or may not require transfusion or intervention (including life-threatening or disabling bleeding)
- Allergic reaction to antiplatelet agents, contrast medium, or anesthesia
- Infection (including septicemia and endocarditis)
- Stroke, TIA, or other neurological deficits
- Permanent disability
- Renal insufficiency or renal failure (including acute kidney injury)
- Mitral valve regurgitation or injury
- Tissue erosion
- Vascular access related complications (eg., dissection, perforation, pain, bleeding, hematoma, pseudoaneurysm, irreversible nerve injury, compartment syndrome, arteriovenous fistula, stenosis)
- Conduction system disturbances (eg., atrioventricular node block, left-bundle branch block, asystole), which may require a permanent pacemaker
- Cardiac arrhythmias
- Encephalopathy
- Pulmonary edema
- Pericardial effusion
- Pleural effusion
- Myocardial ischemia
- Peripheral ischemia
- Bowel ischemia
- Heart murmur
- Hemolysis
- Cerebral infarction-asymptomatic
- Non-emergent reoperation
- Inflammation

- Fever
- Hypotension or hypertension
- Syncope
- Dyspnea
- Anemia
- Angina
- Abnormal lab values (including electrolyte imbalance)
- Exposure to radiation through fluoroscopy and angiography
- Delivery catheter malfunction resulting in need for additional re-crossing of the aortic valve and prolonged procedural time

C.5.2.7 Deaths

The Investigator shall notify Medtronic immediately but not later than within 3 calendar days of learning of a subject's death, whether or not the death is related to the investigational device. The Investigator should also notify his/her IRB/MEC and/or local regulatory agencies, if applicable, per their requirements. The Investigator should also attempt to determine, as conclusively as possible, whether such deaths are related to the investigational TAV device or its components. When an autopsy is conducted, a copy of the report should be provided to Medtronic. Medtronic will evaluate the event and if device-related and unexpected, the event will be reported as a UADE or USADE.

Any subject death will be reported on the Study Exit eCRF and accompanied by an Adverse Event eCRF identifying the cause of death.

C.5.2.8 Vigilance Reporting

A product complaint is defined as any written, electronic or oral communication that alleges deficiencies related to the identity, quality, durability, reliability, safety, effectiveness or performance of a medical device that has been placed on the market.

It is the responsibility of the investigator to report all product complaint(s) associated with a medical device distributed by Medtronic, regardless whether they are related to intended use, misuse or abuse of the product. Reporting must be done as soon as possible and without undue delay and via the regular channels for market released products. Note that although the reporting of product complaints is not part of the clinical study, all potential complaints that are collected as part of this study will be reviewed by the responsible person at Medtronic and, if applicable, reported to the designated complaint handling unit. Medtronic will ensure timely reporting to meet global regulatory requirements.

C.5.3 Clinical Events Committee (CEC)

An independent Clinical Events Committee (CEC) will review and adjudicate, at a minimum, all deaths and primary endpoint related adverse events. The CEC will consist of, at a minimum, interventional cardiologists and cardiac surgeons who are not participants in the trial. Additional specialist, such as neurologists, may also be selected as part of the CEC.

The purpose of the CEC is to conduct a medical review and classify/adjudicate, at a minimum, all deaths and/or clinical endpoints collected in the trial according to definitions and processes outlined in the Medtronic CoreValve™ SURTAVI Trial protocol and the CEC charter, which will be developed and approved by Medtronic and the CEC members.

All applicable events will be reviewed and adjudicated by a minimum of two CEC members. All other events will be reviewed and adjudicated by qualified internal Medtronic safety individual(s) to ensure they should not be adjudicated by the full CEC and that the events are appropriately classified by the investigator.

Prior to event adjudication, the CEC will draft a charter to establish explicit rules outlining the minimum amount of data required and the algorithm followed in order to classify/adjudicate a trial endpoint related clinical event. CEC decisions will be documented in meeting minutes, which will be maintained in the trial file.

C.5.4 Data Safety Monitoring Board (DSMB)

An independent, unblinded DSMB will be established and will be comprised of at least 3 experts, including a chairperson. The DSMB will have a minimum of one cardiac surgeon, one interventional cardiologist and one statistician, and will be independent of Medtronic and the trial investigators. Investigators participating in the trial may participate in the meetings to offer clarification surrounding events, but will not have voting privileges. Medtronic personnel may facilitate the DSMB meeting but will not have voting privileges. The DSMB will meet (via teleconference or in person) prior to the first subject enrollment to establish procedures for DSMB review, chairman appointment and guidelines for trial recommendations. The full DSMB will meet on a periodic basis to perform a comprehensive data review and will meet more frequently when needed. Primary and safety-related secondary endpoints may also be reviewed at these meetings. Meetings will consist of both open and closed sessions.

The DSMB will also perform a supplemental review of, at a minimum, all serious adverse events and deaths and any other data requested by the DSMB on a more frequent periodic basis to ensure patient safety. DSMB members will review the report, and when necessary provide recommendations about the conduct of the trial and/or request a full DSMB meeting.

A DSMB charter will be developed and approved by Medtronic and the DSMB members. The committee will outline the criteria for both the full DSMB meeting and supplemental DSMB reviews within the DSMB charter.

Following each full DSMB meeting, the board will report to Medtronic in writing and may recommend changes in the conduct of the trial. These DSMB recommendations may include recommendations on trial status such as continuing the trial without modifications, continuing the trial with modifications, stopping the enrollment in the trial or a specific trial arm, or recommendations about trial conduct including recommendations around enrollment or protocol deviations.

In the case of UADEs or USADEs, if Medtronic and the DSMB determine that the event presents an unreasonable risk to the participating subjects, Medtronic must terminate the clinical trial within 5 working days after making that determination and not later than 15 working days after Medtronic first receives notice of the effect. [21 CFR 812.46]. All clinical sites will be notified of this action.

The DSMB may call additional meetings if, at any time, there is concern about any aspect of the trial. All data presented at the meetings will be considered confidential and returned to the trial statistician at the closure of the DSMB meeting.

Additional details about the DSMB are outlined in the DSMB charter.

C.6 Statistical Methods and Analysis

C.6.1 Statistical Considerations and Analysis

This section describes the statistical considerations and analysis plans for the SURTAVI trial. The statistical analysis will be performed by the statistics department of Medtronic. As primary analysis all randomized subjects will be analyzed following the modified intention to treat (mITT) approach; ie. analyses will be conducted on the cohort of subjects who undergo an attempted trial treatment, analyzed according to the randomized assignment. A secondary analysis of key objectives will be performed according to the therapy actually received.

Roll-in subjects will not be included in the primary or secondary analysis; however, the data will be summarized separately with descriptive statistics.

All follow-up periods are defined as the number of days after the procedure date.

C.6.2 Reports

Medtronic is responsible for the reports cited in **Table 5** (Sponsor Reporting Responsibilities). These reports are subject to regulatory retention and inspection requirements. In addition to the reports listed in **Table 5**, FDA, Competent Authorities, and local regulatory agencies, where applicable, or the reviewing IRB/MEC may request reports pertaining to any aspect of the clinical trial.

C.6.3 Description of Baseline Variables

Baseline demographic and clinical variables will be summarized for each of the treatment groups for the intention-to-treat (ITT), modified intent-to-treat (mITT), and implanted populations. All continuous variables will be summarized as means, medians, standard deviations, interquartile ranges, minima and maxima and compared between treatment groups using a Bayesian analog of a two-sample t-test or the non-parametric Wilcoxon rank-sum test. Categorical variables will be summarized as frequencies and percentages and compared between treatment groups using a Bayesian version of a comparison of proportions.

C.6.4 Analysis Populations

C.6.4.1 Screening Population

All patients with symptomatic severe AS who provide informed consent will be considered screened and all available data will be entered into the EDC system.

C.6.4.2 Randomized Population

If the patient signs informed consent, meets all inclusion and none of the exclusion criteria, and the Heart Team determines the patient is suitable for randomization in the trial, then the subject is reviewed by the SURTAVI Screening Committee. If the subject is approved by the Screening Committee and the subject is enrolled/randomized to either TAVI or SAVR the subject is added to the randomized population. Within the randomized population three sub-populations are distinguished:

- Intention to treat (ITT) population - Subjects are reported according to the randomized assignment, SAVR or TAVI, regardless of what, if any, therapy was actually received
- Modified intention to treat (mITT) population - Randomized subjects in whom a procedure is attempted. Subjects who undergo an attempted trial treatment are reported according to the randomized assignment, SAVR or TAVI, regardless of what, if any, therapy was actually received. A procedure attempt is defined as when the subject is brought into the procedure room and any of the following have occurred: anesthesia administered, vascular line placed, TEE placed or any monitoring line placed
- Implanted population - population includes the mITT subjects who are actually implanted with either the investigational TAVI device or a surgical valve. Depending on context, subjects may be analyzed according to randomized treatment assignment or treatment actually received.

The primary analysis for the primary objective and most secondary objectives will use the mITT population. At the conclusion of the trial, an analysis using the ITT population will also be presented.

C.6.5 Primary Analysis

The primary endpoint of all-cause mortality or disabling stroke at 24 months will be evaluated using the absolute difference of the TAVI rate and the SAVR rate for all-cause mortality or disabling stroke during a fixed follow-up of 24 months' time. The hypothesis test is designed to show non-inferiority of TAVI to SAVR for the primary endpoint.

C.6.5.1 Hypothesis of Non-inferiority

The primary objective is to establish that TAVI is non-inferior to SAVR for the primary endpoint. The hypothesis of interest is:

$$H: \pi_T < \pi_C + \delta$$

where π_T and π_C denote binary rates of all-cause mortality or disabling stroke during a fixed follow-up of 24 months for the treatment (TAVI) and control (SAVR) groups, and $\delta = 0.07$. This trial is designed using Bayesian statistical techniques. TAVI will be declared to be non-inferior to SAVR if it can be established that the posterior probability $\Pr(H_{\delta=0.07} | \text{data}) > \Psi$, where Ψ is a pre-specified threshold value. If, in addition, it can be shown that $\Pr(H_A: \pi_T < \pi_C + 0 | \text{data}) > \Psi_{\text{SUP}}$, TAVI will be declared to be superior to SAVR. The values chosen for Ψ and Ψ_{SUP} are described below.

C.6.5.2 Randomization, Sample Size and Analysis Plan

Randomization will follow a 1:1 (treatment:control) allocation ratio and be stratified by site and need for revascularization, using a blocked randomization scheme with blocks of randomly varying sizes. The sample size for the mITT population is 1600 subjects.

Sample Size Justification

The assumed values $\pi_T = \pi_C = 0.17$ are based on the data published by Iturra et al³ and CoreValve US Pivotal High Risk study results. As reported in the Iturra paper, the incidence of all-cause mortality at 30 days was 2.8% and the late all-cause mortality Kaplan-Meier rate at 24 months was 12.1%. The overall 24-month all-cause mortality rate was approximately 15%. STS score reported in the Iturra paper (5.6 ± 1.1 , n=502) was similar to the STS score for subjects currently enrolled in the SURTAVI study⁴ (5.6 ± 1.4 , n=654), and it is believed that the 24-month all-cause mortality rate in SURTAVI will be approximately 15% at 24 months. The major stroke rate was 3.2% for subjects who survived to 1 year in the CoreValve Pivotal High Risk study. The High Risk study enrolled a higher-risk population than SURTAVI, therefore, the major stroke rate in the High Risk study is adjusted downward, and it is believed the disabling stroke rate at 24 months would be approximately 2% in the SURTAVI study. Overall, the estimation of the all-cause mortality or disabling stroke rate at 24 months is 17%.

Although the pre-specified analysis methods are Bayesian, the sample size is guided by a standard frequentist non-inferiority power analysis. Under the assumptions of $\pi_T = \pi_C = 0.17$, non-inferiority margin $\delta=0.07$, 1:1 randomization, $\alpha= 0.05$, and power = 95%, the method of Farrington and Manning⁵ as implemented in PASS 2008⁶ indicates that the required sample size for a single-look analysis is 1258. To allow for up to 6% dropout, 1339 subjects must be accrued. Furthermore, to compensate for power lost in a two-look group sequential analysis plan using Pocock-type alpha spending, the sample size would have to be increased by about 12.5%⁷. This leads to an estimated sample size of 1531. Thus a sample size of 1600 mITT subjects should provide ample power for establishing non-inferiority in the primary hypothesis test.

³ Iturra SA, Suri RM, Greason KL, et al. The Journal of thoracic and cardiovascular surgery 2014;147:127-132.

⁴ Medtronic CoreValve SURTAVI Trial 2014 FDA Annual Progress Report;

⁵ Farrington, C. P. and Manning, G. 1990. 'Test Statistics and Sample Size Formulae for Comparative Binomial Trials with Null

⁶ Hintze, J. (2004). NCSS and PASS, Number Cruncher Statistical Systems. Kaysville UT. www.ncss.com

⁷ Jennison C and Turnbull BW, Group Sequential Methods with Applications to Clinical Trials. Boca Raton: Chapman & Hall, 2000, p 27

Analysis Plan

An interim analysis (timed to occur when 1400 mITT subjects have reached 12 months) for the purpose of declaring an early win will be conducted. At this analysis, if $P(H_{\delta=0.07} | \text{data}) > \Psi$, non-inferiority will be declared at this time, and a regulatory submission will follow. Alternatively, if $P(H_{\delta=0.07} | \text{data}) \leq \Psi$, all mITT subjects will be followed to 24 months, when a final analysis will occur. At the final analysis, the standard for trial success will again be $P(H_{\delta=0.07} | \text{data}) > \Psi$. These two analyses are termed "Win Looks."

If, at the early (interim) "Win Look," non-inferiority is established, a test of superiority will immediately follow. If $P(H_{\delta=0} | \text{data}) > \Psi_{\text{SUP}}$, superiority will be established at this time. However, if $P(H_{\delta=0} | \text{data}) \leq \Psi_{\text{SUP}}$, subjects will continue to be followed and analyzed according to the same analysis plan. At the final "Win" analysis, if $P(H_{\delta=0} | \text{data}) > \Psi_{\text{SUP}}$, a delayed determination of superiority will be made.

The statistical approach for these analyses is Bayesian. The prior distributions for π_T and π_C in these calculations are Beta (1,1). The threshold Ψ is designated to be 0.971 for non-inferiority testing and $\Psi_{\text{SUP}} = 0.989$ for superiority testing; these values are selected by trial-and-error to achieve a type I error (under simulation) of at most 0.05 for non-inferiority testing and at most 0.025 for superiority testing. Of note, establishing $P(H_{\delta=0} | \text{data}) > \Psi_{\text{SUP}}$ means that superiority has been established to a standard equivalent to a nominal significance level of 0.025 (1-sided), but this does not automatically mean that a labeling claim of superiority is supported. See "Multiplicity Considerations" (Section C.12) for additional requirements regarding labeling claims on secondary objectives.

Further details of planned analyses are provided in the SAP.

C.6.6 Missing Data and Planned Sensitivity Analyses (Primary Objective)

Every effort will be undertaken to minimize missing data. However, some missing data is inevitable, and the trial is designed with the expectation that there may be up to 6% of primary data missing at 24 months. The reasons for missing data will be described in detail and evaluated for assessment of possible bias. The distribution of prognostic factors between patients with data and those without data will be examined to evaluate any potential sources of bias.

C.6.7 Description of Performed Analysis, per population

Any deviations from this section and/or the Statistical Analysis Plan will be described and justified in the Final Report or justified in a protocol amendment, as appropriate.

C.6.7.1 Analysis of Screening Population

For the screening population only descriptive statistical analysis will be performed, on variables that are captured in the EDC system.

C.6.7.2 Analysis of ITT and mITT Populations

For the subjects in the randomized population the primary analysis of the primary endpoint and inferential statistics for the following secondary endpoints will be performed on the ITT and mITT populations:

- Major adverse cardiovascular and cerebrovascular events (MACCE)
- Individual MACCE components
- Major adverse events (MAE)
- Conduction disturbance requiring permanent pacemaker implantation
- NYHA
- Six-minute walk test
- Ratio of days alive out of hospital versus total days alive
- Quality of life
- Echocardiographic assessment of valve performance

- Aortic valve disease-related hospitalizations
- Cardiovascular deaths and valve-related deaths
- Strokes and TIAs
- Per-procedural neurological injury
- Index procedure-related MAEs
- Length of index procedure hospital stay
- Device success
- Procedure success

C.6.7.3 Analysis of Implanted Population

The endpoints listed in C.6.7.2 will also be performed on the implanted population. Additionally, the implanted population will be used for analyzing the primary endpoint, secondary endpoint of prosthetic valve dysfunction, and echocardiographic assessment of valve performance.

C.6.8 Secondary Endpoints

C.6.8.1 Secondary Endpoints Compared Between TAVI and SAVR

1. Incidence of Major Adverse Cardiovascular and Cerebrovascular Events (MACCE) at 30 days, 6 months, 12 months, 18 months, 24 months, and annually thereafter up to 5 years. MACCE is defined as a composite of:

- All-cause death
- Myocardial infarction (MI)
- All stroke, and
- Reintervention (defined as any cardiac surgery or percutaneous reintervention catheter procedure that repairs, otherwise alters or adjusts, or replaces a previously implanted valve)

MACCE-incidence estimates will be provided for the two treatment groups at 30 days, 6 months, 12 months, 18 months, 24 months, and annually thereafter up to 5 years. The statistical method will be the Bayesian version of a comparison of proportions (with predictions).

Additionally, incidence of MACCE will be compared at 30 days or hospital discharge, whichever is later. The statistical method will be the Bayesian version of a comparison of proportions.

2. The occurrence of individual MACCE components at 30 days, 6 months, 12 months, 18 months, 24 months, and annually thereafter up to 5 years.

MACCE components will be summarized and their incidence estimates provided at 30 days, 6 months, 12 months, 18 months, 24 months, and annually thereafter up to 5 years. The statistical method will be the Bayesian version of a comparison of proportions (with predictions).

3. Major Adverse Events (MAE) and individual components at 30 days, 6 months, 12 months, 18 months, 24 months, and annually thereafter up to 5 years.

MAE events and individual components will be summarized and the incidence of MAEs will be provided at 30 days, 6 months, 12 months, 18 months, 24 months, and annually thereafter up to 5 years. The statistical method will be the Bayesian version of a comparison of proportions (with predictions).

Additionally, incidence of major vascular complications and incidence of major or life-threatening bleeding events at 30 days or hospital discharge, whichever is longer, will also be compared using the Bayesian version of a comparison of proportions.

4. Incidence of Early safety at 30 days defined as a composite of:

- All-cause mortality
- All stroke (disabling and non-disabling)
- Life-threatening bleeding
- Acute kidney injury—Stage 2 or 3 (including renal replacement therapy)
- Coronary artery obstruction requiring intervention
- Major vascular complication
- Valve-related dysfunction requiring repeat procedure (BAV, TAVI, or SAVR)
- All-cause death

Early safety composite endpoint-incidence estimates will be provided for the two treatment groups at 30 days. The statistical method will be the Bayesian version of a comparison of proportions.

5. Incidence of Clinical Efficacy (after 30 days) at 6 months, 12 months, 18 months, 24 months and annually thereafter up to 5 years. Clinical efficacy defined as a composite of:
- All-cause mortality
 - All stroke (disabling and non-disabling)
 - Requiring hospitalizations for valve-related symptoms or worsening congestive heart failure
 - NYHA class III or IV
 - Valve-related dysfunction (mean aortic valve gradient ≥ 20 mmHg, EOA ≤ 0.9 - 1.1 cm^2 and/or DVI < 0.35 m/s, AND/OR moderate or severe prosthetic valve regurgitation*)

Clinical efficacy estimates will be provided for the two treatment groups at 6 months, 12 months, 18 months, 24 months and annually thereafter up to 5 years. The statistical method will be the Bayesian version of a comparison of proportions (with predictions).

*Refers to VARC-2 definitions

6. Incidence of Time-Related Safety at 30 days, 6 months, 12 months, 18 months, 24 months and annually thereafter up to 5 years. Time-Related Safety defined as a composite of:
- Structural valve deterioration:
 - Valve-related dysfunction (mean aortic valve gradient ≥ 20 mmHg, EOA ≤ 0.9 - 1.1 cm^2 and/or DVI < 0.35 m/s, AND/OR moderate or severe prosthetic valve regurgitation*)
 - Requiring repeat procedure (TAVI or SAVR)
 - Prosthetic valve endocarditis
 - Prosthetic valve thrombosis
 - Thromboembolic events (eg. stroke)
 - VARC bleeding, unless clearly unrelated to valve therapy (eg. trauma)

Time related safety composite endpoint-incidence estimates will be provided for the two treatment groups at 30 days, 6 months, 12 months, 18 months, 24 months and annually thereafter up to 5 years. The statistical method will be the Bayesian version of a comparison of proportions (with predictions).

*Refers to VARC-2 definitions

7. Conduction disturbance requiring permanent pacemaker implantation at 30 days, 6 months, 12 months, 18 months, 24 months, and annually thereafter up to 5 years.

The incidence of conduction disturbance requiring permanent pacemaker implantation will be provided at 30 days, 6 months, 12 months, 18 months, 24 months, and annually thereafter up to 5 years, separately for new onset and pre-existing conduction disturbance. The statistical method will be the Bayesian version of a comparison of proportions (with predictions).

8. Change in NYHA class from baseline at 30 days, 6 months, 12 months, 18 months, 24 months, and annually thereafter up to 5 years.

For each subject with paired data, the number of classes changed from baseline (-3, -2, -1, 0, 1, 2, or 3) will be calculated at 30 days, 6 months, 12 months, 18 months, 24 months, and annually thereafter up to 5 years. The endpoint will be evaluated between groups using a Bayesian version of a t-test.

9. Change in distance walked during 6-minute walk test (6MWT) from baseline to 30 days, baseline to 12 months, and baseline to 24 months.

All subjects who are able to perform the six-minute walk evaluation at the time of the follow-up visit will be included in the analysis.

The endpoint will be evaluated using a Bayesian version of a t-test.

10. Ratio of days alive out of hospital versus total days alive assessed at 12 months and 24 months follow-up.

The proportion of post procedure days alive out of hospital against total days alive will be compared between groups at 12 and 24 months. The numerator will be the number of days alive out of hospital, and the denominator will be the number of post procedure days alive as of the last follow-up date. All hospitalizations will be included in this analysis, including hospitalization for device implant.

In addition, days alive out of hospital will be compared between groups at 12 months and 24 months.

The endpoint will be evaluated using a Bayesian version of a t-test.

11. Quality of Life (QoL) change from baseline at 30 days, 3 months, 6 months, 12 months, 18 months, 24 months, and annually thereafter up to 5 years.

The Kansas City Cardiomyopathy Questionnaire (KCCQ), SF-36, and EuroQoL (EQ-5D) will be assessed at baseline, 30 days, 6 months, 12 months, 18 months, 24 months, and annually thereafter up to 5 years. SF-36 and EQ-5D will also be assessed at 3 months. All subjects completing the questionnaires will be evaluated and the reasons for missing data will be provided.

The endpoint will be evaluated using a Bayesian version of a t-test .

12. Echocardiographic assessment of prosthetic valve performance at discharge, 6 months, 12 months, 24 months, and annually thereafter up to 5 years using the following measures:

- transvalvular mean gradient
- effective orifice area
- degree of prosthetic aortic valve regurgitation (including transvalvular and paravalvular)

The four echocardiographic measurements will be evaluated at discharge, 6 months, 12 months, 24 months, and annually thereafter up to 5 years. All implanted subjects undergoing echocardiography procedures will be evaluated.

Continuous measures will be evaluated using a Bayesian version of a two-sample t-test. Categorical variables will be evaluated using Bayesian version of a comparison of polytomous outcomes.

Additionally, incidence of moderate/severe aortic insufficiency at discharge will be compared between groups using the Bayesian version of a comparison of proportions.

13. Aortic valve disease related hospitalizations

The number of subjects re-hospitalized after the initial index procedure will be compared at 30 days, 6 months, 12 months, 18 months, 24 months, and annually thereafter up to 5 years.

Incidence of recurrent hospitalization will be provided at 30 days, 6 months, 12 months, 18 months, 24 months, and annually thereafter up to 5 years. The statistical method will be the Bayesian version of a comparison of proportions (with predictions).

14. Cardiovascular deaths and valve-related deaths

The number of subjects experiencing cardiovascular deaths and valve-related deaths at 30 days, 6 months, 12 months, 18 months, 24 months, and annually thereafter up to 5 years. Incidences will be compared between groups. The statistical method will be the Bayesian version of a comparison of proportions (with predictions).

15. Strokes and TIAs

The number of subjects with strokes (of any severity) and TIAs at 30 days, 6 months, 12 months, 18 months, 24 months, and annually thereafter up to 5 years. A separate analysis will be performed for each of the following:

- a composite of all strokes and TIAs
- disabling strokes only
- non-disabling strokes only
- TIAs only

The statistical method will be the Bayesian version of a comparison of proportions (with predictions).

Additionally, incidence of all strokes at 30 days or hospital discharge, whichever is longer, will be compared between groups using the Bayesian version of a comparison of proportions.

16. Peri-procedural Neurological Injury (Stroke, TIA, Encephalopathy)

For each treatment group, the proportion of subjects with a neurologic injury (stroke, TIA, or encephalopathy) at discharge or at 7 days post-index procedure (whichever occurs first) will be calculated. The numerator will be the number of subjects with a neurologic injury (stroke, TIA, or encephalopathy) at discharge or at 7 days post-index procedure (whichever occurs first), and the denominator will be the number of subjects in that treatment group. Results will also be presented separately for disabling stroke, non-disabling stroke, TIA, and encephalopathy. Proportions will be compared between groups using Bayesian version of a comparison of proportions.

17. Index procedure related MAEs

Index procedure-related MAE events will be summarized and event rates will be provided at 30 days. The numerator will be the number of procedure-related MAE events experienced by the end of the 30-day follow-up visit, and the denominator will be the number of subjects evaluated at the 30-day follow-up visit (or a later follow-up) plus the number of subjects not evaluated but who experienced a procedure-related MAE event prior to the end of the follow-up visit window.

The endpoint is descriptive and no statistical hypothesis test will be performed.

18. Length of index procedure hospital stay

The length of TAVI or SAVR hospital stay will be summarized for all subjects undergoing a trial procedure.

The endpoint will be evaluated between groups using a Bayesian version of a t-test.

19. Presence of atrial fibrillation at post-procedure, discharge, 30 days, 6 months, 12 months, 18 months, 24 months, and annually thereafter up to 5 years.

The statistical method will be the Bayesian version of a comparison of proportions (with predictions).

C.6.8.2 Secondary Endpoints Assessed for TAVI Only

The following secondary endpoints will be assessed for the TAVI cohort subjects only:

20. Device success defined as follows:

- Absence of procedural mortality AND
- Correct positioning of a single prosthetic heart valve into the proper anatomical location AND
- Intended performance of the prosthetic heart valve (no prosthesis-patient mismatch and mean aortic valve gradient <20 mmHg or peak velocity <3 m/s, AND no moderate or severe prosthetic valve regurgitation*)
 - Assessed acutely in a resting state, either within 24-48 hours after the index procedure or before hospital discharge

*Refers to VARC-2 definitions

Device success, as defined above, will be calculated for all subjects undergoing the TAVI procedure.

The endpoint is descriptive and no statistical hypothesis test will be performed.

21. Procedural success, defined as device success and absence of in-hospital MACCE.

Procedural success, as defined above, will be calculated for all randomized subjects undergoing the TAVI procedure.

The endpoint is descriptive and no statistical hypothesis test will be performed.

22. Evidence of prosthetic valve dysfunction at 30 days, 6 months, 12 months, 24 months, and annually thereafter up to 5 years.

The number of subjects with evidence of prosthetic valve dysfunction will be evaluated at 30 days, 6 months, 12 months, 18 months, 24 months, and annually thereafter up to 5 years. Point estimates and 95% BCIs for each time point will be presented using methods described below in the Bayesian version of a comparison of proportions (with predictions).

23. Resheath and Recapture (combined) success rate.

The success rate will be analyzed for all subjects in whom the resheath or recapture feature is attempted. The number and percentage of successful resheath or recapture attempts combined will be calculated. Separate resheathing and recapturing success rates will also be calculated.

The endpoint is descriptive and no statistical hypothesis test will be performed.

C.6.9 Rationale for Selection of Trial Endpoints

Trial endpoints were selected with following considerations:

- Clinically relevant and address important safety and performance aspects of the investigational TAVI device
- Objectively defined and measurable in the majority of subjects
- Consistent with current recommendations for endpoints in TAVI clinical studies and VARC-2

C.6.10 Multiplicity Considerations

It is recognized that with a multiplicity of tests comes inflation in the chance of a false finding of superiority or non-inferiority. Therefore, for the purpose of seeking approved labeling claims on designated secondary objectives, the following standard will be used: If the primary objective demonstrates non-inferiority, claims will be sought for selected secondary non-inferiority and superiority objectives and for superiority on the primary objective metric. These will be tested via a hierarchical (sequential) order that preserves the overall study-wise type I error rate at the level of 0.05, while requiring all non-inferiority tests to meet a nominal type I error rate of 0.05 and all superiority tests to meet a nominal type I error rate of 0.025. The testing order is specified below. The following objectives are tested in order, and testing continues if and only if all previous objectives have met their designated success criterion.

1. Primary endpoint (non-inferiority)
2. Transvalvular mean gradient at 12 months (non-inferiority)
3. Effective orifice area at 12 months (non-inferiority)
4. Change in NYHA classification from baseline to 12 months (non-inferiority)
5. Change in KCCQ score from baseline to 30 days (non-inferiority)

All of the above are non-inferiority tests and are tested with a type I error standard of 0.05. If all of the above tests meet their success criterion, the type I error rate of 0.05 that is passed on from the above tests will be split equally (using a Bonferroni justification) between the following parallel subfamilies, so that each subfamily is tested using a type I error rate of 0.025:

Subfamily #1: Primary endpoint (superiority)

Subfamily #2: Secondary (superiority) objectives #5–#18 as enumerated below, tested in ordered sequence such that all α is passed on to subsequent tests if a test criterion is met, while all testing stops if a test criterion is not met. This procedure controls the type I error rate of this subfamily at the level 0.025.

It is not necessary to “pass” all objectives in one subfamily in order to test the objective(s) in the other subfamily. For the purposes of seeking claims, these objectives will only be evaluated once, at the same time as non-inferiority of the primary objective is established. The only exception to this is the primary endpoint superiority test, which carries the possibility of a delayed determination of superiority (as described in Section 4.2.1) and may thus meet its success criterion at a different time.

The remaining secondary objectives may be of interest for scientific or financial reasons but will not be the basis for supporting labeling claims; they are thus outside of the hierarchical testing procedure. Similarly, for those objectives that test non-inferiority, if non-inferiority is established, a test of superiority will also be conducted, but unless specifically itemized in the list, such superiority testing is not part of the hierarchical testing procedure; these superiority tests may be of interest for scientific or financial reasons but will not be the basis for supporting labeling claims.

C.6.10.1 Secondary Endpoints Tested to Support Labeling Claims

The following secondary endpoints will be tested, in order, to support labeling claims:

1. Transvalvular mean gradient at 12 months (non-inferiority): TAVI vs. SAVR (secondary objective #12). The hypothesis of interest is

$$H: \mu_{TAVI} < \mu_{SAVR} + 5$$

where μ_{TAVI} and μ_{SAVR} denote the average mean gradient from at 12 months, measured in mmHg. This objective will be evaluated using a Bayesian version of a two-sample t-test (see Section C.11). The posterior probability $P(H | \text{data})$ will be calculated and compared to a threshold of 0.95.

2. Effective orifice area at 12 months (non-inferiority): TAVI vs. SAVR (secondary objective #12). The hypothesis of interest is

$$H: \mu_{TAVI} > \mu_{SAVR} - 0.1$$

where μ_{TAVI} and μ_{SAVR} denote the mean effective orifice area at 12 months, measured in cm^2 . This objective will be evaluated using a Bayesian version of a two-sample t-test (see Section C.11). The posterior probability $P(H | \text{data})$ will be calculated and compared to a threshold of 0.95.

3. Change in NYHA classification from baseline to 12 months (non-inferiority): TAVI vs. SAVR (secondary objective #8). The hypothesis of interest is

$$H: \mu_{TAVI} > \mu_{SAVR} - 0.375$$

where μ_{TAVI} and μ_{SAVR} denote the mean number of classification improvements in NYHA from baseline to 12 months. For subjects with NYHA categories at both baseline and 12 month visit, the NYHA classification improvements will be calculated as $NYHA_{baseline} - NYHA_{12month}$. This objective will be evaluated using a Bayesian version of a two-sample t-test (see Section C.11). The posterior probability $P(H | data)$ will be calculated and compared to a threshold of 0.95.

4. Change in Kansas City Cardiomyopathy Questionnaire (KCCQ) score from baseline to 30 days (non-inferiority): TAVI vs. SAVR (secondary objective #11). The hypothesis of interest is

$$H: \mu_{TAVI} > \mu_{SAVR} - 5$$

where μ_{TAVI} and μ_{SAVR} denote the mean improvements in the KCCQ score from baseline to 30 days. For subjects with KCCQ score at both baseline and 30 days, the improvement in KCCQ will be calculated as $KCCQ_{30day} - KCCQ_{baseline}$. This objective will be evaluated using a Bayesian version of a two-sample t-test (see Section C.11). The posterior probability $P(H | data)$ will be calculated and compared to a threshold of 0.95.

5. Length of index procedure hospital stay after TAVI vs. SAVR (secondary objective #18). The hypothesis of interest is

$$H: \mu_{TAVI} < \mu_{SAVR}$$

where μ_{TAVI} and μ_{SAVR} denote the mean length of index hospital stay. This objective will be evaluated using a Bayesian version of a two-sample t-test (see Section C.11). The posterior probability $P(H | data)$ will be calculated and compared to a threshold of 0.975.

6. Transvalvular mean gradient at 12 months (superiority): TAVI vs. SAVR (secondary objective #12). The hypothesis of interest is

$$H: \mu_{TAVI} < \mu_{SAVR}$$

where μ_{TAVI} and μ_{SAVR} denote the average mean gradient from at 12 months, measured in mmHg. This objective will be evaluated using a Bayesian version of a two-sample t-test (see Section C.11). The posterior probability $P(H | data)$ will be calculated and compared to a threshold of 0.975.

7. Effective orifice area at 12 months (superiority): TAVI vs. SAVR (secondary objective #12). The hypothesis of interest is

$$H: \mu_{TAVI} > \mu_{SAVR}$$

where μ_{TAVI} and μ_{SAVR} denote the mean effective orifice area at 12 months, measured in cm^2 . This objective will be evaluated using a Bayesian version of a two-sample t-test (see Section C.11). The posterior probability $P(H | data)$ will be calculated and compared to a threshold of 0.975.

8. Change in Kansas City Cardiomyopathy Questionnaire (KCCQ) score from baseline to 30 days (superiority): TAVI vs. SAVR (secondary objective #11). The hypothesis of interest is

$$H: \mu_{TAVI} > \mu_{SAVR}$$

where μ_{TAVI} and μ_{SAVR} denote the mean improvements in the KCCQ score from baseline to 30 days. For subjects with KCCQ score at both baseline and 30 days, the improvement in KCCQ will be calculated as $KCCQ_{30day} - KCCQ_{baseline}$. This objective will be evaluated using a Bayesian version of a two-sample t-test (see Section C.11). The posterior probability $P(H | data)$ will be calculated and compared to a threshold of 0.975.

9. Days alive out of the hospital at 12 months after TAVI vs. SAVR (secondary objective #10). The hypothesis of interest is

$$H: \mu_{TAVI} > \mu_{SAVR}$$

where μ_{TAVI} and μ_{SAVR} denote the mean number of days alive out of the hospital at 12 months. This objective will be evaluated using a Bayesian version of a two-sample t-test (see Section C.11). The posterior probability $P(H | \text{data})$ will be calculated and compared to a threshold of 0.975.

10. Days alive out of the hospital at 24 months after TAVI vs. SAVR (secondary objective #10). The hypothesis of interest is

$$H: \mu_{TAVI} > \mu_{SAVR}$$

where μ_{TAVI} and μ_{SAVR} denote the mean number of days alive out of the hospital at 24 months. This objective will be evaluated using a Bayesian version of a two-sample t-test (see Section C.11). The posterior probability $P(H | \text{data})$ will be calculated and compared to a threshold of 0.975.

11. Change in SF-36 Physical Summary Scale from baseline to 3 months: TAVI vs. SAVR (secondary objective #11). The hypothesis of interest is

$$H: \mu_{TAVI} > \mu_{SAVR}$$

where μ_{TAVI} and μ_{SAVR} denote the mean improvements in the SF-36 Physical Summary Scale from baseline to 3 months. This objective will be evaluated using a Bayesian version of a two-sample t-test (see Section C.11). The posterior probability $P(H | \text{data})$ will be calculated and compared to a threshold of 0.975.

12. Change in EQ-5D from baseline to 3 months: TAVI vs. SAVR (secondary objective #11). The hypothesis of interest is

$$H: \mu_{TAVI} > \mu_{SAVR}$$

where μ_{TAVI} and μ_{SAVR} denote the mean improvements in the EQ-5D from baseline to 3 months. This objective will be evaluated using a Bayesian version of a two-sample t-test (see Section C.11). The posterior probability $P(H | \text{data})$ will be calculated and compared to a threshold of 0.975.

13. Incidence of MACCE at 30 days or hospital discharge, whichever is longer: TAVI vs. SAVR (secondary objective #1). The hypothesis of interest is

$$H: \pi_{TAVI} < \pi_{SAVR}$$

where π_{TAVI} and π_{SAVR} denote the binary rate of MACCE at 30 days or hospital discharge (if longer). The posterior probability $P(H | \text{data})$ will be calculated and compared to a threshold of 0.975. The statistical method will be the Bayesian version of a comparison of proportions (see Section C.11).

14. Incidence of major vascular complications at 30 days or hospital discharge, whichever is longer: TAVI vs. SAVR (secondary objective #3). The hypothesis of interest is

$$H: \pi_{TAVI} < \pi_{SAVR}$$

where π_{TAVI} and π_{SAVR} denote the binary rate of major vascular complications at 30 days or hospital discharge (if longer). The posterior probability $P(H | \text{data})$ will be calculated and compared to a threshold of 0.975. The statistical method will be the Bayesian version of a comparison of proportions (see Section C.11).

15. Incidence of major or life-threatening bleeding event at 30 days or hospital discharge, whichever is longer: TAVI vs. SAVR (secondary objective #3). The hypothesis of interest is

$$H: \pi_{TAVI} < \pi_{SAVR}$$

where π_{TAVI} and π_{SAVR} denote the binary rate of major or life-threatening bleeding events at 30 days or hospital discharge (if longer). The posterior probability $P(H | \text{data})$ will be calculated and compared to a threshold of 0.975. The statistical method will be the Bayesian version of a comparison of proportions (see Section C.11).

16. Incidence of all strokes at 30 days or hospital discharge, whichever is longer: TAVI vs. SAVR (secondary objective #15). The hypothesis of interest is

$$H: \pi_{TAVI} < \pi_{SAVR}$$

where π_{TAVI} and π_{SAVR} denote the binary rate of strokes at 30 days or hospital discharge (if longer). The posterior probability $P(H | \text{data})$ will be calculated and compared to a threshold of 0.975. The statistical method will be the Bayesian version of a comparison of proportions (see Section C.11).

17. Incidence of moderate/severe aortic insufficiency after TAVI vs. SAVR (secondary objective #12). The hypothesis of interest is

$$H: \pi_{TAVI} < \pi_{SAVR}$$

where π_{TAVI} and π_{SAVR} denote the proportion of subjects with moderate/severe aortic insufficiency at the discharge echo. The posterior probability $P(H | \text{data})$ will be calculated and compared to a threshold of 0.975. The statistical method will be the Bayesian version of a comparison of proportions (see Section C.11).

18. New pacemaker implant rate for TAVI at 30 days or hospital discharge, whichever is longer (secondary objective #7). The hypothesis of interest is

$$H: \pi_{TAVI} < 30\%$$

where π_{TAVI} denote the binary rate of new pacemaker implants for TAVI at 30 days or hospital the discharge (if longer). The posterior probability $P(H | \text{data})$ will be calculated and compared to a threshold of 0.975. The statistical method will be the Bayesian version of a comparison of proportions (see Section C.11).

Other than the hierarchical testing procedure described above, no further multiplicity adjustments will be made in the analyses of the secondary endpoints. Summary data from other secondary objectives, such as device success and procedural success from secondary objectives #20 and #21, respectively, may be provided in the device labeling. However, no claims of statistical significance or other statistical inference will be made.

C.6.11 Heterogeneity/Poolability

A poolability analysis among investigational centers, access site (ilio-femoral or non-ilio-femoral), need for revascularization, and primary baseline demographics will be performed for the primary endpoint and will be described in the SAP. In particular, the primary endpoint and key secondary endpoints such as MACCE and MAE incidence will be examined for differences in outcome between genders, need for revascularization, and between access routes. Additionally, tests for these outcomes will be performed to evaluate potential interactions between treatment and gender and between treatments and need for revascularization and between treatment and access site.

C.6.12 Additional Analysis

C.6.12.1 Pre-Defined Subgroups

The following sub-groups will be analysed for publication purposes:

- Diabetes Mellitus (yes, no)
- Age [< 65 years of age (ie. Medicare population), 65-70 years of age, 71-74 years of age, 75-79 years of age and ≥ 80 years of age]
- Gender (male, female)
- STS score
- Presence of co-morbidities
- Need for coronary revascularization

A test for interaction between the treatment effect (SAVR versus TAVI) and the subgroup variable will be performed.

These comparisons are not powered, and will be for exploratory purposes only, not to be used to support labeling claims.

C.6.12.2 Analysis of VARC Endpoints and Definitions

Endpoints

Device success will be calculated per the definition outlined in O.2 as well as using the VARC-I definition, as appropriate.

Definitions

Events with definitions modified in revisions to VARC will be analyzed per both the definition outlined in O.2 and VARC-I. Applicable terms include:

- Acute Kidney Injury
- Bleeding
- Death
- Device Migration/ Valve Embolism
- Device Malplacement
- Myocardial Infarction
- Prosthetic Valve Dysfunction
- Stroke and TIA
- Vascular Complications

C.6.13 Health-Related Quality of Life (HRQoL) and Treatment Costs

Health-related quality of life (HRQoL) and treatment costs will be assessed alongside the core clinical trial to evaluate the impact of the TAVI and SAVR strategies on a range of relevant quality of life (QoL) domains and also to evaluate the cost-effectiveness of the two treatment strategies.

C.6.13.1 Quality of Life

Health Related Quality of Life (HRQoL) and functional status will be assessed using a combination of generic and disease-specific measures selected to cover a broad range of health domains that may be affected by severe aortic stenosis disease, its treatment, and its complications: the Medical Outcomes Study 36-item Short Form (SF-36), the Kansas City Cardiomyopathy Questionnaire (KCCQ), and the EuroQoL Five Dimensions (EQ-5D). All patients will complete standardized, written questionnaires at baseline (prior to subject being informed of randomization), 30 days, 6 months, 12 months, 18 months, 24 months and annually thereafter up to 5 years. At 3 months subjects will also be contacted via telephone to complete the EQ-5D, in select geographies SF-36 will also be collected. Additional information regarding the HRQoL assessments and administration is located in **Appendix R.12** Economic and Quality of Life Data Collection.

C.6.13.2 Economic Outcomes/Cost-Effectiveness

Data on resource utilization will be collected for the index hospitalization and through long-term follow-up for all enrolled subjects. These resource items will include number and duration in-patient stays in hospital by type of unit (eg. intensive care, high-dependency care and standard ward care); number of clinic visits (by type of physician); and details of the main procedure undertaken. As part of the trial analysis, resource use estimates will be presented by randomized group (eg. mean per patient plus standard deviation). This data, together with the EQ-5D data will provide an important input into cost effectiveness analysis. However, as such analysis is likely to be based on a modeling framework, to include evidence from a number of sources (eg. a meta-analysis of other TAVI trials) and to vary according to the jurisdiction of interest, it is appropriate to detail the methods in separate protocols and analysis plans.

C.6.14 Use of Data for CE Mark

Data from the TAVI arm may be utilized to seek CE Mark approval for the Intermediate Risk indication prior to trial completion. This is expected to include the experience of approximately the first 100 TAVI subjects out to 30 days. This analysis will not impact the Type I error rate of this trial as there will not be an early analysis of control (randomized) data, and no decisions to alter the pivotal trial are allowed based on this analysis. This data will not be made public and a limited number of personnel will have access to the results.

C.7 Data and Quality Management

C.7.1 Electronic Data Capture

Medtronic will use the Oracle Clinical Remote Data Capture database system for data collection. Oracle is a secure, password-protected, Part 11 compliant database which is backed up regularly (at a minimum once daily).

C.7.2 Data Collection

The investigator must ensure accuracy, completeness and timeliness of the data reported in the EDC system and in all other required reports. Data reported on the eCRFs which are derived from source documents must be consistent with the source documents or the discrepancies need to be justified in a documented rationale, signed and dated by the (principal) investigator, to be filed in the subject file.

Required data will be recorded on the eCRFs by authorized site personnel as indicated on the Delegation of Authority Log. The eCRFs must be completed and/or updated to reflect the latest observations on the subjects participating in the trial.

The investigator (or approved sub-investigator) will electronically sign the appropriate pages of each eCRF.

The EDC system maintains an audit trail on entries, changes or corrections in CRFs. If a person only authorized to complete CRFs makes changes to an already signed CRF, the investigator shall re-sign this CRF.

The sponsor and/or assigned designee will be responsible for the processing and quality control of the data. Data management will be done according to Medtronic SOPs and the applicable Data Management Plan. All trial-related documents must be retained for a period of at least 2 years after the last approval of a marketing application and until there are no pending or contemplated marketing applications in an ICH region, or at least 2 years have elapsed since the formal discontinuation of clinical development of the investigational device. Medtronic will inform the investigator/institution when these documents are no longer required to be retained.

No trial document or image should be destroyed without prior written agreement between the Sponsor and the investigator. Should the investigator wish to assign the trial records to another party or move them to another location, advance written notice should be given to the Sponsor.

Copies of the eCRFs to be used are included in **Appendix R.5**.

C.7.3 Core Laboratories Procedures

Data from the core lab will be transferred to Medtronic and stored in the Oracle Clinical Remote Data Capture system as described in the Medtronic CoreValve™ SURTAVI Trial Data Management Plan.

C.7.4 Source Documents

Source documentation is defined as the first time the data appear and may include all clinical records, hospital records, surgery reports, autopsy reports, and any other material that contains original information used for trial data collection or adverse event reporting. Where copies of the original source document as well as print outs of original electronic source documents are retained, these shall be signed and dated by a member of the investigation site team with a statement that it is a true reproduction of the original source document. No eCRFs may serve as source documents.

Source documentation may vary from site to site. The source documents must be retained by the investigational site for a period of 2 years after trial conclusion and made available for monitoring or auditing by the sponsor's representative or representatives of the FDA, IRB/MEC, and other applicable regulatory agencies. The Investigator must ensure the availability of source documents from which the information on the eCRFs was derived.

C.7.5 Maintenance and Calibration

Sites should perform regular maintenance and calibration of all equipment relevant to protocol required assessments. Maintenance and calibration should be conducted per local standards and ensure proper documentation must be on file for routine monitoring and audit, as applicable.

C.8 Records and Reports

C.8.1 Responsibilities of the Sponsor

The Sponsor must maintain the following records, at a minimum:

- All essential correspondence related to the clinical trial
- Signed Investigator Agreement
- Curriculum vitae for each Investigator
- Records of device shipment and disposition (shipping receipts, material destruction records, etc.)
- Adverse event information
- Complaint documentation
- All data forms, prepared and signed by the Investigators and received source documentation and core lab reports
- Protocol and report of prior investigations
- Site monitoring reports
- Financial disclosure information

The Sponsor is responsible for the preparation of, the accuracy of the data contained in, the review of and the submission of the reports listed in **Table 5**.

Table 5: Sponsor Reporting Responsibilities

Report	Submit to	Description
Unanticipated Adverse (Serious) Device Effects (UADE or USADE)	IRB/MEC, Investigators, FDA, and local regulatory agencies, where applicable	Medtronic will report on any confirmed unanticipated adverse device effect evaluation as soon as possible but no later than within 10 working days after first receiving notice of the effect. (21 CFR 812.150) and in compliance with local regulatory requirements, as applicable.
Withdrawal of IRB/MEC approval	IRB/MEC, Investigators, FDA, and local regulatory agencies, where applicable	Notification, when appropriate, will be made within 5 working days after Medtronic receives notice of withdrawal of IRB/MEC approval.
Withdrawal of FDA approval	IRB/MEC, Investigators	Notification will be made within 5 working days after Medtronic receives notice of withdrawal of FDA approval.
Current Investigator List	FDA and local regulatory agencies, where applicable	Medtronic will submit a current list of the names and addresses of all participating Investigators at six-month intervals, beginning six months after FDA approval of IDE.
Progress Report	IRB/MEC, Investigators, FDA	A progress report will be submitted at least yearly.
Recall and Device Disposition	IRB/MEC, Investigators, FDA, and local regulatory agencies, where applicable	Notification will be made within 30 working days of Medtronic's request that an Investigator return, repair or otherwise dispose of any devices. Such notification will state why the request was made.
Final Report	IRB/MEC, Investigators, FDA	Notification will be made within 30 working days of the completion or termination of the investigation. A final report will be submitted within six months after trial completion or termination.

Report	Submit to	Description
Failure to obtain Informed Consent	FDA	Notification will be made within 5 working days after Medtronic's receipt of such notification indicating Informed Consent was not obtained.
Emergency Deviations from Investigational Plan	FDA and local regulatory agencies, where applicable	Notification will be made within 5 working days after Medtronic learns of an emergency deviation from the Investigational Plan where the deviation was made to protect the life or physical wellbeing of a subject.

C.8.2 Responsibilities of the Investigator

The Investigator is responsible for the preparation, review, signature, and retention of the records listed below:

- All essential correspondence that pertains to the investigation
- Device use/disposition records
- Records of each subject's case history and exposure to the device. Case histories include the CRFs and supporting data (source documentation), including, for example:
 - Signed and dated consent forms
 - Medical records, including, for example, progress notes of the physicians, the subject's hospital chart(s) and the nurses' notes
 - All adverse event information
 - A record of the exposure of each subject to the investigational device (eg., date of implant procedure and follow-up assessment dates)
 - Documentation of any deviation from the protocol, including the date and the rationale for such deviation
- Screening Logs, Enrollment Logs and Patient Identification Logs
- Signed Investigator Agreement, curriculum vitae and training records
- Protocol and any amendments
- IRB/MEC approval documentation, and where applicable, other local regulatory approvals

The Investigator may withdraw from responsibility to maintain records by transferring custody to another person, who will accept responsibility for record and report maintenance.

The Investigator is responsible for the preparation, review, signature, and submission of the reports listed below in. These are also subject to inspection by government agencies and must be retained as specified above.

Table 6: Investigator Reporting Responsibilities

Report	Submitted to	Description
Unanticipated Adverse (Serious) Device Effects (UADE or USADE)	Sponsor, IRB/MEC, and local regulatory agencies, where applicable	UADEs and USADEs should be reported immediately via telephone as well as on an eCRF. UADEs and USADEs must be submitted as soon as possible, but in no event later than 3 calendar days after the Investigator first learns of the effect.
Serious Adverse Events and Deaths	Sponsor, and local regulatory agencies, where applicable	The Investigator shall notify the sponsor immediately (i.e. within 3 calendar days of first learning of any SAE) [MEDDEV 2.7/3].
Withdrawal of IRB/MEC approval	Sponsor	The Investigator must report a withdrawal of the reviewing IRB/MEC, approval within 5 working days.
Progress Report	Sponsor, IRB/MEC	The Investigator must submit a progress report on an annual basis if the trial lasts longer than one year.
Failure to obtain Informed Consent	Sponsor, IRB/MEC	The Investigator must make notification within 5 working days after device implant.
Final Report	Sponsor, IRB/MEC	This report must be submitted within 3 months after termination or completion of the investigation.
Deviations from Investigational Plan (CFR 812.150)		
Emergency Use	Sponsor, IRB/MEC	Notification must be made within 5 working days of the occurrence of an emergency deviation made to protect the life or physical well-being of a subject.
Planned deviation	Sponsor, IRB/MEC, FDA	If the deviation affects scientific soundness of the trial or the rights, safety, or welfare of the subject and is not an emergency, prior approval must be obtained from Medtronic, the reviewing IRB/MEC, and FDA.
Other Deviations	Sponsor	Deviations that are beyond the control of the investigator (such as patient who fails to return to follow-up visit) or deviations that do not affect the scientific soundness of the trial or the rights, safety, or welfare of the subject and are not an emergency, should be submitted as they are identified by the site or Medtronic staff.

D RISK / BENEFIT ANALYSIS

There are risks for participants in this trial. However, it should be noted that most of the risks of trial participation are not materially different than those entailed by an individual who undergoes the same treatment outside of the context of this trial.

Known adverse events that may result from TAVI (inclusive of CoreValve and Evolut R systems) include but may not be limited to:

- Death
- Cardiac arrest
- Coronary occlusion, obstruction, or vessel spasm (including acute coronary closure)
- Emergent surgery (eg., coronary artery bypass, heart valve replacement, valve explant)
- Multi-organ failure
- Heart failure
- Myocardial infarction
- Cardiogenic shock
- Respiratory insufficiency or respiratory failure
- Cardiovascular injury (including rupture, perforation, or dissection of vessels, ventricle, myocardium, or valvular structures that may require intervention)
- Perforation of the myocardium or a vessel
- Ascending aorta trauma
- Cardiac tamponade
- Cardiac failure or low cardiac output
- Prosthetic valve dysfunction including, but not limited to:
 - Fracture
 - Bending (out-of-round configuration) of the valve frame
 - Under-expansion of the valve frame
 - Calcification
 - Pannus, (wear, tear, prolapse, or retraction in the valve leaflets)
 - Poor valve coaptation
 - Suture breaks or disruption
 - Leaks
 - Mal-sizing (prosthesis-patient mismatch)
 - Malposition (either too high or too low)/malplacement
 - Regurgitation, stenosis
- Thrombosis/embolus (including valve thrombosis)
- Valve migration/valve embolization
- Ancillary device embolization
- Emergent percutaneous coronary intervention (PCI)
- Emergent balloon valvuloplasty
- Major or minor bleeding that may or may not require transfusion or intervention (including life-threatening or disabling bleeding)
- Allergic reaction to antiplatelet agents, contrast medium, or anesthesia
- Infection (including septicemia and endocarditis)
- Stroke, TIA, or other neurological deficits
- Permanent disability
- Renal insufficiency or renal failure (including acute kidney injury)
- Mitral valve regurgitation or injury
- Tissue erosion
- Vascular access related complications (eg., dissection, perforation, pain, bleeding, hematoma, pseudoaneurysm, irreversible nerve injury, compartment syndrome, arteriovenous fistula, stenosis)

- Conduction system disturbances (eg., atrioventricular node block, left-bundle branch block, asystole), which may require a permanent pacemaker
- Cardiac arrhythmias
- Encephalopathy
- Pulmonary edema
- Pericardial effusion
- Pleural effusion
- Myocardial ischemia
- Peripheral ischemia
- Bowel ischemia
- Heart murmur
- Hemolysis
- Cerebral infarction-asymptomatic
- Non-emergent reoperation
- Inflammation
- Fever
- Hypotension or hypertension
- Syncope
- Dyspnea
- Anemia
- Angina
- Abnormal lab values (including electrolyte imbalance)
- Exposure to radiation through fluoroscopy and angiography
- Delivery catheter malfunction resulting in need for additional re-crossing of the aortic valve and prolonged procedural time

Additional information regarding risk analysis is located in the Investigator Brochures (**Appendix R.21**).

D.1 Methods to Minimize Risk

The investigational plan is specifically designed to manage and minimize risks through careful patient selection, thorough training of investigators, adherence to the pre-determined time points to assess subject clinical status and regular clinical monitoring visits by Sponsor appointed monitoring personnel.

In addition, an independent Data Safety Monitoring Board will monitor safety of the subjects throughout the trial.

D.2 Potential Benefits

Patients treated with TAVI may experience improvement in quality of life, morbidity and mortality compared to traditional open-heart aortic valve replacement. Potential benefits include, but are not limited to, absence of open-heart surgery-related risks, reduced procedure time, reduced anesthesia procedure time, shorter hospital stay and earlier return to normal activities than after open-heart aortic valve replacement.

There is no direct benefit associated to participation in this trial, but the information obtained during this trial will be used scientifically. The results of this trial can help physicians understand the implications of transcatheter treatment of patients with intermediate risk for surgery.

E DESCRIPTION OF MEDTRONIC COREVALVE™ SYSTEMS

E.1 Investigational Product Description

E.1.1 Medtronic CoreValve System

The Medtronic CoreValve™ System (MCS) consists of 3 components: the Transcatheter Aortic Valve Bioprosthesis (TAV) in

Figure 2 below, the Delivery Catheter System (DCS) in **Figure 3** and **Figure 4**, and the Compression Loading System (CLS) in **Figure 5** and **Figure 6**.

Transcatheter Aortic Valve Bioprosthesis

Figure 2: Transcatheter Aortic Valve (TAV)

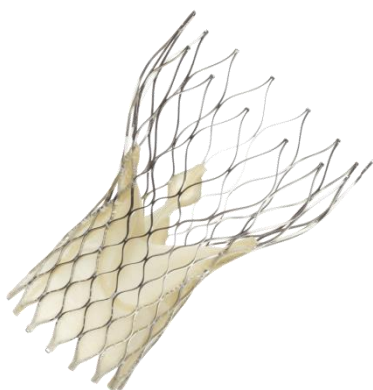

The TAV is manufactured by suturing valve leaflets and a skirt, made from a single layer of porcine pericardium, into a tri-leaflet configuration. The TAV is designed to replace the native aortic heart valve without open heart surgery and without concomitant surgical removal of the failed native valve.

The bioprosthesis is processed with an antimineralization treatment of alpha-amino oleic acid (AOA) a compound derived from oleic acid, a naturally occurring long-chain fatty acid.

The self-expanding multi-level frame is made of Nitinol and is radiopaque.

The TAV is available for a range of aortic annulus and ascending aortic diameters as shown in **Table 7** below.

Table 7: Medtronic CoreValve System Patient Anatomical Diameters

CoreValve™ Evolut™ Bioprosthesis			
Model	Size (mm)	Aortic Annulus Diameter (range in mm)	Ascending Aortic Diameter (mm)
MCS-P4-23-AOA MCS-P4-23-AOA-US	23	18-20	≤34
CoreValve™ Bioprosthesis			
Model	Size (mm)	Aortic Annulus Diameter (range in mm)	Ascending Aortic Diameter (mm)
MCS-P3-26-AOA MCS-P3-26-AOA-US	26	20-23	≤40

MCS-P3-29-AOA MCS-P3-29-AOA-US	29	23-27	≤43
MCS-P3-31-AOA MCS-P3-31-AOA-US	31	26-29	≤43

Delivery Catheter System

The AccuTrak® DCS (DCS-C4-18FR and DCS-C4-18FR-US) is compatible with a 0.889-mm (0.035-in) guidewire. The working length of the AccuTrak® DCS is 112.5 cm. It incorporates a protective deployment sheath that houses and deploys the TAV. The AccuTrak® DCS can be used to house and deliver all commercially available sizes of the TAV (26mm, 29mm, and 31mm TAV). The outer diameter of the DCS is 12Fr, the stability layer is 15Fr and the outer diameter of the valve capsule is 18 Fr.

Figure 3: Delivery Catheter System (DCS)

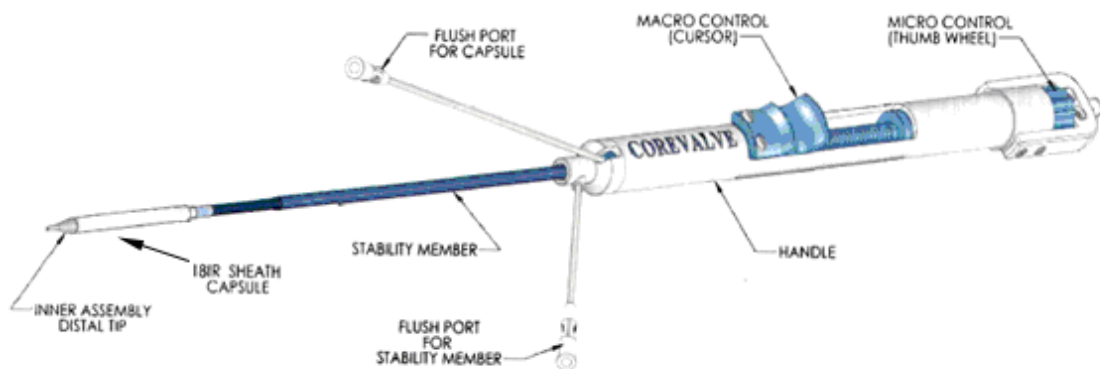

A new Delivery Catheter System (DCS-C4-18FR-23MM and DCS-C4-18F-23US) will be used to deploy 23mm Transcatheter Aortic Valve (TAV). The DCS-C4-18FR-23MM, DCS-C4-18FR-23 and DCS-C4-18FR-23US has a shortened Capsule and Plunger (5mm) for delivery of the 23mm TAV but the working length of the new AccuTrak™ DCS is 112.5 cm similar to DCS-C4-18FR used to deploy other TAV sizes.

Figure 4: Design Changes for Delivery Catheter System (DCS) specific to 23mm

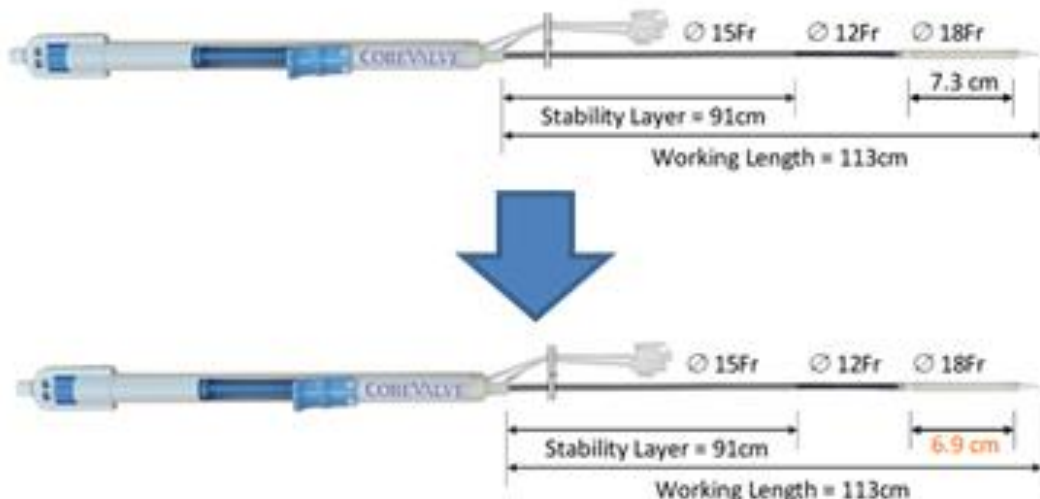

The AccuTrak® DCS features an integrated handle designed to provide the user with accurate and controlled deployment. After the DCS is placed in the vicinity of the aortic annulus, the user retracts the deployment sheath, thereby deploying the TAV to the desired location. In use, the deployment sheath can be partially pulled back to evaluate the TAV location prior to fully releasing the TAV. In this way, the user can make slight adjustments to the TAV location if needed prior to release.

Compression Loading Systems

The CLS (Model CLS-3000-18FR and CLS-3000-18F-US) and next generation CLS (Model CLS4-18F and Model CLS4-18F-23) is a system of reduction cones and tubing, which is designed to gradually reduce the diameter of the TAV to an optimal diameter to facilitate manual loading of the TAV into the deployment sheath capsule of the DCS.

The CLS is comprised of the following elements:

- inflow cone
- inflow tube (straight tube)
- outflow cap
- outflow cone
- outflow tube (tube with flared ends)

Figure 5: Compression Loading System (CLS) (Model CLS-3000-18 FR and CLS-3000-18FR-US)

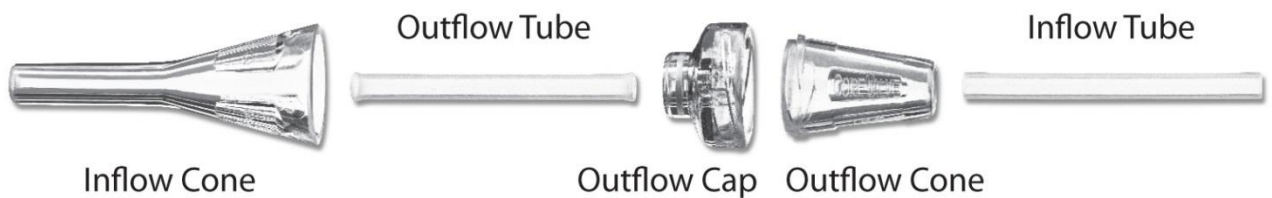
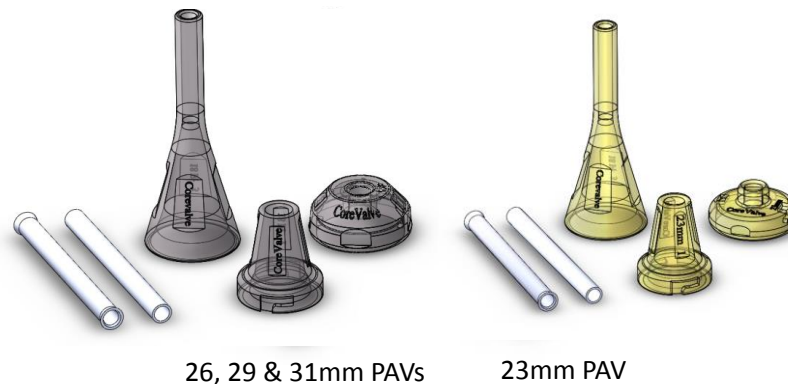

Figure 6: Compression Loading System (CLS) Models CLS4-18F-C and CLS-3000-18FR-US (left) and CLS4-18F-23-C (right)



The inflow cone, outflow cone, and outflow cap components of the next generation CLS models are tinted, and the locking mechanism has been modified from the previous generation. The purpose and function of all CLS models is the same, but the next generation includes 2 models, one intended for use with the 23mm TAV (CLS4-18F-23-C), which has an orange tint, and another model intended for use with the 26 mm, 29 mm & 31mm TAVs (CLS4-18F-C and CLS-3000-18F-US), which has a blue tint.

E.1.2 Medtronic CoreValve Evolut R System

The CoreValve™ Evolut™ R System is comprised of the following 3 components: Evolut R Transcatheter Aortic Valve (TAV) in **Figure 7**, EnVeo R Delivery Catheter System (DCS) with EnVeo R Inline Sheath in **Figure 8** and the EnVeo R Loading System (LS) in **Figure 9**.

Evolut R Transcatheter Aortic Valve (TAV)

Figure 7: Evolut R Transcatheter Aortic Valve (TAV)



The Evolut R TAV is available in three sizes (23mm, 26mm, and 29mm) in this trial, covering an aortic annulus diameter of 18 to 26mm. The TAV is comprised of three leaflets and a sealing skirt constructed from glutaraldehyde-fixated porcine pericardium, sewn to a compressible and self-expandable Nitinol support frame. The TAV is processed with an anti-mineralization treatment of alpha-amino oleic acid (AOA), a compound derived from oleic acid, a naturally occurring long-chain fatty acid.

The TAV is available for a range of aortic annulus and ascending aortic diameters as shown in **Table 8** below.

Table 8: CoreValve™ Evolut™ R TAV Patient Anatomical Diameters

CoreValve™ Evolut™ R Bioprosthesis		
Model	Aortic Annulus Diameter (range in mm)	Aortic Diameter at the Sino-tubular Junction (range in mm)
EVOLUTR-23-C EVOLUTR-23-US	18 – 20	NA
EVOLUTR-26-C EVOLUTR-26-US	20 – 23	NA
EVOLUTR-29-C EVOLUTR-29-US	23 – 26	NA

EnVeo R Catheter Delivery System with EnVeo Inline Sheath

The EnVeo R delivery catheter system facilitates the placement of the TAV within the annulus of the aortic valve. The catheter assembly is flexible and compatible with a 0.035 in (0.889 mm) guidewire. The distal (deployment) end of the system features an atraumatic, radiopaque catheter tip and a capsule that covers and maintains the bioprosthesis in a crimped position. The capsule includes a distal flare to enable full recapture of the bioprosthesis after partial deployment. A stability layer is fixed at the handle and extends down the outside of the catheter

shaft. It provides a barrier between the retractable catheter and the introducer sheath and vessel walls, thus enabling the catheter to retract freely.

The EnVeo R Inline Sheath is assembled over the stability layer, which functions as a hemostatic introducer sheath and minimizes the access site size to the capsule diameter. The EnVeo R Inline Sheath is also compatible with an 18 Fr introducer.

The delivery catheter system consists of a catheter with an integrated handle to provide the user with accurate and controlled deployment. The handle is on the proximal end of the catheter and is used to load, deploy, recapture, and reposition the bioprosthesis. The handle features a gray front grip used to stabilize the system. The blue actuator turns to deploy the bioprosthesis precisely. Arrows on the actuator indicate the direction of rotation required to deploy the bioprosthesis. If desired, the blue actuator can be turned in the opposite direction to recapture the bioprosthesis if the radiopaque capsule marker band has not yet reached the distal end of the spindle. The blue actuator also features a trigger, which can be engaged to make macro adjustments to the capsule position. A blue hand rest connects to the blue actuator. The end of the handle features a tip-retrieval mechanism, which can be used to withdraw the catheter tip to meet the capsule after the device has been fully deployed.

Figure 8: EnVeo R Delivery Catheter System

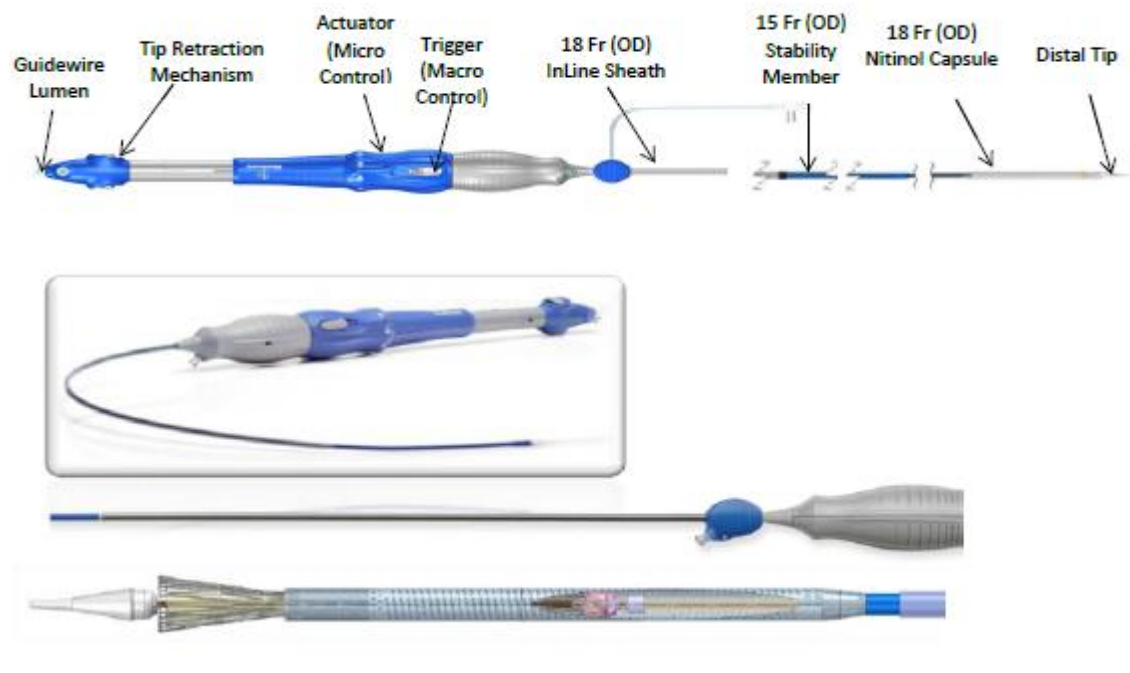

The catheter packaging contains an integrated loading bath and a removable tray with 3 rinsing bowls for loading and rinsing the bioprosthesis. The integrated loading bath features a mirror, which aids in accurate placement of the bioprosthesis frame paddles during loading. In addition, the device packaging is swiveled and secured to facilitate the bioprosthesis loading procedure.

EnVeo R Loading System

The EnVeo R loading system facilitates manual loading of the TAV into the deployment sheath capsule of the catheter delivery system by gradually reducing the diameter of the bioprosthesis radially to an optimal diameter (Figure 9). The manual loading is performed during the procedure prior to implantation. The loading procedure is performed while immersing the loading system, the TAV, and the distal end of the catheter delivery system in cold sterile saline.

Figure 9: EnVeo R Loading System



Medtronic may incorporate additional devices into this clinical trial providing they receive regulatory approval and the scientific soundness of the trial is not adversely affected.

Additional information regarding the Medtronic CoreValve™ System and CoreValve™ Evolut™ R are available in the Investigator Brochures (**Appendix R.21**). Note the Instructions For Use (IFU) are also located in **Appendix R.22**.

E.2 Investigational Device Ordering, Storage, and Disposition

The TAV and all required delivery components will be ordered through Medtronic. Medtronic will only allow shipment of investigational devices to the hospital or investigator when the Clinical Research Specialist has declared the investigation site ready to start the trial.

Devices will be shipped to sites as needed based on subject enrollment/randomization and procedures scheduled. Only one device should be used per patient, unless in case of device malfunctions or in case of complications. Sites will be supplied with sufficient device stock to complete scheduled procedures. Upon completion of scheduled procedures all unused devices must be returned to Medtronic. Instructions for device return are outlined on the Device Accountability Log. In the US, commercial devices, as referenced in Table 1, are approved for use in the clinical trial, as necessary, in the event that an investigational device is not available.

Investigational devices must be stored in a secured area. The method of storage shall prevent the use of investigational devices outside the applications as mentioned in this Clinical Investigation Plan. In addition, all information for the use, storage and handling of the investigational device as indicated in the Investigator's Brochure, must be taken into account.

Instructions for Use and storage recommendations are outlined in **Appendix R.22**.

F MONITORING AND AUDITING

F.1 Monitoring

The investigational site will be monitored to ensure compliance with the trial protocol, adherence to applicable regulations, and accuracy of trial data. Monitoring visits will be conducted primarily to ensure the safety and wellbeing of the subjects is preserved. Monitoring visits will also be used to verify that trial data submitted on case report forms are complete and accurate with respect to the subject records and to verify device accountability.

The Investigator(s), his/her delegate(s) and the study coordinator(s) shall be accessible to during monitoring. Accessibility is of particular importance for reviewing data in the eCRF.

Site personnel will complete eCRFs following each subject visit. Trial data submitted will be reviewed against patient charts and other sources containing original records of patient data. Source document verification will be conducted via a risk based approach as outlined in the Monitoring Plan.

The responsible individual for this trial is included on the title page of the CIP.

The progress of the trial will be monitored by:

- On-site review, as deemed appropriate by the sponsor
- Telephone communications between the site personnel (eg., Investigator, Trial Coordinator) and trial monitors
- Review of eCRFs and the associated clinical records
- Review of regulatory documents

Upon trial completion Site Closeout Visits will be conducted, as outlined in the Monitoring Plan.

Monitoring and monitoring oversight will be provided by Medtronic Coronary and Structural Heart (Mounds View, MN, USA, and Maastricht, the Netherlands). Representatives of Medtronic (i.e. contractors and designees) may also act as the trial monitors to the site. Medtronic will maintain an updated list of applicable representative and provide a copy to sites upon request.

Prior to the first site activation a monitoring plan will be established outlining the above activities, as well as trial materials to be supplied to sites, the process for corrective and preventive actions and Investigator disqualification procedures.

F.2 Auditing

Medtronic may conduct audits at participating clinical sites. The purpose of an audit is to verify the performance of the monitoring process and the trial conduct, independently of the personnel directly involved in the trial. Regulatory bodies, such as the Food and Drug Administration, may also perform inspections at participating sites. The investigator and/or institution shall permit Medtronic and regulatory bodies direct access to source data and documents.

G LABELING

In Europe, the TAV component labeling will not carry the CE mark and the labeling will state for “clinical study purposes only” in accordance with ISO14155. The Investigational Instructions for Use (IFU) and labeling is supplied in English (and the local language, if required) with the TAV component and this will also not carry the CE mark. The DCS and CLS/LS components are identical to the CE marked CoreValve System and will be supplied with the approved commercial CE marked labeling.

In the United States and other geographies, where TAV is not currently approved, the TAV, DCS and CLS/LS will be labeled as Investigational.

Instructions for Use and additional labeling are attached in **Appendix R.22**.

H CONSENT MATERIALS

The template consents for the trial are attached in **Appendix R.1**.

I IRB/MEC INFORMATION

IRB/MEC information is attached in **Appendix R.2**.

J OTHER INSTITUTIONS

Information regarding other institutions involved in this trial is located in **Appendix R.3**.

K ADDITIONAL RECORDS AND REPORTS

Information regarding additional Records and Reports can be in found in **Appendix R.4**.

L REPORT OF PRIOR INVESTIGATIONS

The Report of Prior Investigations (RPI) is attached in the Investigator Brochure in **Appendix R.21**.

M PUBLICATION POLICY

Medtronic, as the Sponsor of this trial, recognizing the seminal importance of this investigation, is committed to the widespread dissemination of all primary and secondary endpoint results. A publication plan will be implemented and followed. At the conclusion of the trial, a multisite abstract reporting the primary results will be prepared by the Principal Investigators (in collaboration with others including but not limited to the Steering Committee, directors of the core laboratories, CEC, and Lead Investigators from high enrolling sites) and presented at an annual scientific meeting (eg., Transcatheter Cardiovascular Therapeutics, EuroPCR, the American Heart Association, or the American College of Cardiology). A multisite publication will similarly be prepared for publication in a reputable scientific journal. The publication of the principal results from any single site experience within the trial is not allowed until both the preparation and publication of the multisite results, and then only with written permission from Medtronic.

Following analysis and presentation of the primary endpoint results, active participation of all committee members, Investigators from high enrolling sites, and core laboratory personnel will be solicited for data analysis and abstract and manuscript preparation. Submission of all abstracts and publications regarding the primary endpoint and secondary endpoints from the trial requires approval by Medtronic and the Publications Committee.

A separate publication plan will provide detailed information about the publication committee, authorship, publication proposals, and requests for data.

N AMENDMENTS TO THE CLINICAL INVESTIGATION PLAN

All amendments to the CIP shall be agreed between the sponsor and the clinical investigator(s). The investigator may propose appropriate modification(s) of the Clinical Investigation Plan or investigational device or investigational device use. Medtronic will review this proposal and decide whether the modification(s) will be implemented.

Medtronic will submit any significant amendment to the Clinical Investigation Plan, including a justification for this amendment, to the appropriate regulatory authorities and to the investigators to obtain approval from their IRB/MEC. The investigator will only implement the amendment after approval of the IRB/MEC, regulatory authority and sponsor.

Amendments will be recorded with a justification for the amendments in Table 9 below:

Table 9: Clinical Investigation Plan Change History

Version	Description of Change	Rationale for Change
3.0	Initial Release	NA
4.0	<ul style="list-style-type: none"> • Inclusion/Exclusion Criteria updated • Device status updates: <ul style="list-style-type: none"> ○ Addition of 23mm PAV and applicable DCS ○ AOA CE mark status • Modification of statistical methods to relative risk design and addition of adaptive trial design • Addition of Canada as a participating geography • Appendix updates: <ul style="list-style-type: none"> ○ Informed Consent templates ○ Clinical Assessments ○ Investigator Brochure ○ Instructions For Use ○ Radiation Exposure and Data Collection 	<ul style="list-style-type: none"> • Changes based on FDA pre-IDE feedback • Device status updates: <ul style="list-style-type: none"> ○ 23mm PAV and applicable DCS CE mark approval ○ AOA CE mark approval
5.0	<ul style="list-style-type: none"> • Stroke classifications changed from major vs. minor to disabling vs. non-disabling • Inclusion/Exclusion Criteria updated • Additional neurological testing added (mRS) • Clarification of local Heart Team composition and decision making • Appendix updates: <ul style="list-style-type: none"> ○ CMS Requirements for Coverage and Reimbursement – US ONLY – <i>added</i> 	<ul style="list-style-type: none"> • Changes based on FDA IDE deficiencies • General updates and corrections
6.0	<ul style="list-style-type: none"> • Device status update – Canadian approval • Total number of investigational centers increased • Inclusion criteria #3 updated • Roll-in subjects added • Definitions of terms updated in alignment with VARC-2 • Appendix updates: <ul style="list-style-type: none"> ○ Informed Consent templates 	<ul style="list-style-type: none"> • Changes based on FDA recommendations • Publication of VARC-2 • General updates and corrections

Version	Description of Change	Rationale for Change
	<ul style="list-style-type: none"> ○ Echocardiography Acquisition Guidelines ○ Aortogram Acquisition Guidelines 	
7.0 OBSOLETE prior to distribution	<ul style="list-style-type: none"> ● Device Description updated to include EnVeo™ DCS and next generation CLS 	<ul style="list-style-type: none"> ● FDA IDE supplement to incorporate EnVeo/G5 and the next generation CLS in the United States
8.0	<ul style="list-style-type: none"> ● Modification to Patient Population (re-defined Intermediate Risk) ● Inclusion / Exclusion modifications and clarifications ● Clarification of adverse event reporting requirements ● All references to Percutaneous Aortic Valve (PAV) updated to Transcatheter Aortic Valve (TAV) ● Addition of the next regeneration Compression Loading Systems ● Appendix updates: <ul style="list-style-type: none"> ○ Informed Consent templates ○ Instructions for Use ○ Investigator Brochure ○ Echocardiography Acquisition Guidelines ○ Electrocardiogram (ECG) Submission 	<ul style="list-style-type: none"> ● General updates and corrections ● Updated trial utilization of core laboratories
8.1	<ul style="list-style-type: none"> ● Inclusion criteria clarification 	<ul style="list-style-type: none"> ● Updated to include upper limit of risk classification
9.0	<ul style="list-style-type: none"> ● All references to Cardiovascular Department updated to Coronary and Structural Heart ● Addition of CoreValve Evolut R System ● All references to MCS TAVI updated to TAVI ● Appendix updates: <ul style="list-style-type: none"> ○ Informed Consent templates ○ Other Institutions ○ Instruction for Use ○ Investigator Brochure 	<ul style="list-style-type: none"> ● General updates and corrections ● Updated to include the use of CoreValve Evolut R System ● Updated change to Imaging Core Lab
10.0	<ul style="list-style-type: none"> ● Updated Device Approval Status ● Statistical Methods and Analysis: <ul style="list-style-type: none"> ○ Updated assumed event rates ○ Modified non-inferiority margin ○ Updated sample size look <ul style="list-style-type: none"> ▪ Updated maximum sample size from 3700 to 2000 ● Appendix updates: <ul style="list-style-type: none"> ○ Informed consent templates 	<ul style="list-style-type: none"> ● General updates and corrections ● Updated Statistical Methods and Analysis per agreement from FDA
11.0 OBSOLETE prior to distribution	<ul style="list-style-type: none"> ● Updated Device Approval Status ● Removed AR/AS/MR as SAEs in absence of clinical symptoms ● Statistical Methods and Analysis 	<ul style="list-style-type: none"> ● General updates and corrections ● Updated Statistical Methods and Analysis per agreement from FDA
12.0	<ul style="list-style-type: none"> ● Update Device Description ● Removed moderate or severe mitral or aortic regurgitation or stenosis as default SAEs in absence of clinical symptoms ● Added section about Vigilance Reporting ● Statistical Methods and Analysis 	<ul style="list-style-type: none"> ● General updates and corrections ● Updated Statistical Methods and Analysis

Version	Description of Change	Rationale for Change
	<ul style="list-style-type: none"> • Investigational Device Accountability • Appendix updates: <ul style="list-style-type: none"> ○ Informed consent templates 	

O ABBREVIATIONS AND DEFINITIONS

O.1 List of Abbreviations

Please refer to **Table 10** below for a list of abbreviations for use in the SURTAVI trial.

Table 10: List of Abbreviations

Abbreviation	Term
2D	Two Dimensional
6MWT	Six Minute Walk Test
AE	Adverse Event
ACT	Active Clotting Time
ADE	Adverse Device Effect
AF	Atrial Fibrillation
AOA	Alpha-amino Oleic Acid
aPTT	Activated Partial Thromboplastin Time
AR	Aortic Regurgitation
AS	Aortic Stenosis
AVR	Aortic Valve Replacement
BAV	Balloon Aortic Valvuloplasty
BNP	B-type Natriuretic Peptide
BPM	Beats Per Minute
BP	Blood Pressure
BSA	Body Surface Area
CA	Competent Authority
CE	European Conformity
CEC	Clinical Events Committee
CFR	U.S. Code of Federal Regulations
CIP	Clinical Investigation Plan
CLS	Compression Loading System
CMS	Centers for Medicare and Medicaid Services
CRF	Case Report Form
CRO	Contract Research Organization
CT	Computed Tomography
CTA	Computerized tomographic angiography
CVA	Cerebrovascular Accident

Abbreviation	Term
CV-ICU	Cardiovascular Intensive Care Unit
DCS	Delivery Catheter System
DHCA	Deep Hypothermic Circulatory Arrest
DSMB	Data Safety Monitoring Board
DVI	Doppler Velocity Index
DVT	Deep Vein Thrombosis
ECC	Extracorporeal Circulation
ECG	Electrocardiogram
ECMO	Extracorporeal Membrane Oxygenation
eCRF	Electronic Case Report Form
EDC	Electronic Data Capture
EOA	Effective Orifice Area
EQ-5D	EuroQoL Five Dimensions
EuroSCORE	European System for Cardiac Operative Risk Evaluation
FDA	U.S. Food and Drug Administration
Fr	French
GCP	Good Clinical Practice
GI	Gastrointestinal
HVD	Heart Valve Dysfunction
HIPAA	Health Insurance Portability and Accountability Act
HR	Heart Rate
IABP	Intra-Aortic Balloon Pump
ICF	Informed Consent Form
IDE	Investigational Device Exemption
IFU	Instructions for use
INR	International Normalized Ratio
IRB	Institutional Review Board
ITT	Intent-to-treat
IV	Intravenous
IXRS	Interactive Voice/Web Response System
KCCQ	Kansas City Cardiomyopathy Questionnaire
LA	Left Atrial/Atrium
LAO	Left Anterior Oblique
LBBB	Left Bundle Branch Block
LMWH	Low Molecular Weight Heparin
LS	Loading System
LVEF	Left Ventricular Ejection Fraction
LVOT	Left Ventricular Outflow Tract

Abbreviation	Term
LVOTO	Left Ventricular Outflow Tract Occlusion
MACCE	Major Adverse Cardiovascular and Cerebrovascular Event
MAE	Major Adverse Event
MCS	Medtronic CoreValve™ System
MEC	Medical Ethics Committee
MI	Myocardial Infarction
MMSE-2:SV	Mini Mental State Exam
NIHSS	National Institute of Health Stroke Scale
mRS	Modified Rankin Score
NYHA	New York Heart Association
PCI	Percutaneous Coronary Intervention
PE	Product Experience
PPM	Patient Prosthesis Mismatch
QoL	Quality of Life
RAO	Right Anterior Oblique
RBBB	Right Bundle Branch Block
SAE	Serious Adverse Event
SADE	Serious Adverse Device Effect
SAP	Statistical Analysis Plan
SAVR	Surgical Aortic Valve Replacement
SF-36	Short Form (36) Health Survey
SOP	Standard Operating Procedures
STS	Society of Thoracic Surgeons
TAV	Transcatheter Aortic Valve
TAVI	Transcatheter Aortic Valve Implant
TEE	Transesophageal Echocardiography
TIA	Transient Ischemic Attack
TTE	Transthoracic Echocardiography
UADE	Unanticipated Adverse Device Effect
USADE	Unanticipated Serious Adverse Device Effect

O.2 Definitions of Terms

ACUTE KIDNEY INJURY

Acute Kidney Injury will be defined according to the Valve Academic Research Consortium (VARC)-2; Updated Standardized Endpoint Definitions for Transcatheter Aortic Valve Implantation (TAVI); 2012-10-09.

Acute Kidney Injury (AKIN Classification)	
Stages	Change in Serum Creatinine (up to 7 days post-index procedure) compared to Baseline
Stage 1	Increase in serum creatinine to 150-199% (1.5-1.9 x increase compared with baseline) OR increase of ≥ 0.3 mg/dl (≥ 26.4 μ mol/L) OR urine output <0.5 ml/kg/hour for >6 but <12 hours
Stage 2*	Increase in serum creatinine to 200-299% (> 2.0 - 2.9 x increase compared with baseline) OR urine output <0.5 ml/kg/hour for >12 but <24 hours
Stage 3**	Increase in serum creatinine to $\geq 300\%$ (> 3 x increase compared with baseline) OR serum creatinine of > 4.0 mg/d (≥ 354 μ mol/L) with an acute increase of at least 0.5 mg/dl (44 μ mol/L) OR urine output <0.3 ml/kg/hour for >24 hours OR anuria for > 12 hours
* Stage 2 and 3 acute renal injuries will be considered to be serious adverse events.	
** Patients receiving renal replacement therapy are considered to meet Stage 3 criteria irrespective of other criteria	

ACUTE VESSEL OCCLUSION

The state of complete luminal obstruction with no antegrade blood flow.

ADVERSE EVENT (AE)

An adverse event is any untoward medical occurrence, unintended disease or injury, or untoward clinical signs (including abnormal laboratory findings) in subjects, users or other persons, whether or not related to the investigational medical device.

NOTE 1: This definition includes events related to the investigational medical device or the comparator.

NOTE 2: This definition includes events related to the procedures involved.

NOTE 3: For users or other persons, this definition is restricted to events related to investigational medical devices.

ADVERSE DEVICE EFFECT (ADE)

Adverse event related to the use of an investigational medical device

NOTE 1: This definition includes adverse events resulting from insufficient or inadequate instructions for use, deployment, implantation, installation, or operation, or any malfunction of the investigational medical device.

NOTE 2: This definition includes any event resulting from use error or from intentional misuse of the investigational medical device

AORTIC DISSECTION

Intimal tear resulting in blood splitting the aortic media and producing a false lumen that can progress in an antegrade or retrograde direction. Aortic dissection is further classified using Stanford classification (Types A and B) depending on whether ascending or descending aorta involved) or DeBakey classification (Types I, II and III) as shown below.

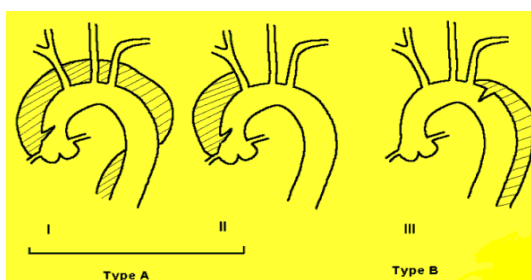

AORTIC REGURGITATION (AR)

Aortic valve incompetence resulting in backward flow of blood. **Reference Appendix R.7 Echocardiography Acquisition Guidelines** for additional information regarding assessment of aortic regurgitation.

AORTIC STENOSIS (AS)

A narrowing, stiffening or stricture of the aortic valve.

Aortic stenosis of the native valve (i.e. inclusion criteria) will be defined based on the 2008 Focused Update Incorporated Into the ACC/AHA 2006 Guidelines for the Management of Patients With Valvular Heart Disease (published in the October 2008 issues of Journal of the American College of Cardiology and Circulation)

Aortic Stenosis			
Indicator	Mild	Moderate	Severe
Jet velocity (m/s)	Less than 3.0	3.0-4.0	Greater than 4.0
Mean gradient (mmHg)	Less than 25	25-40	Greater than 40
Valve area (cm ²)	Greater than 1.5	1.0-1.5	Less than 1.0
Valve area index (cm ² /m ²)			Less than 0.6

Stenosis of trial valve will be defined based on the definition of the Valve Academic Research Consortium (VARC)-2 Updated Standardized Endpoint Definitions for Consensus Report for Transcatheter Aortic Valve Implantation (TAVI); 2012-10-09. **See Prosthetic Valve Dysfunction – Prosthetic Aortic Valve Stenosis.**

ARRHYTHMIA

Any variation from the normal rhythm of the heartbeat, including sinus arrhythmia, premature beat, heart block, atrial fibrillation, atrial flutter and tachycardia.

- **Major Arrhythmias:** Complete heart block, ventricular tachycardia and ventricular fibrillation
- **Serious Arrhythmias:** Any arrhythmia requiring surgical or invasive intervention or DC cardioversion

ATRIAL FIBRILLATION

Atrial fibrillation will be classified according to the International Consensus on Nomenclature and Classification of Atrial Fibrillation; A Collaborative Project of the Working Group on Arrhythmias and the Working Group on Cardiac Pacing of the European Society of Cardiology and the North American Society of Pacing and Electrophysiology, Europace 2003, Vol 5.

- **Paroxysmal:** spontaneous termination within 7 days and most often <48 hours
- **Persistent:** is not self-terminating; lasts longer than 7 days; or prior cardioversion
- **Permanent (accepted):** does not terminate, or terminated but relapsed; no cardioversion attempt

BLEEDING EVENT

Bleeding event will be defined according to the Valve Academic Research Consortium (VARC)-2; Updated Standardized Endpoint Definitions for Transcatheter Aortic Valve Implantation (TAVI); 2012-10-09.

Life-threatening or Disabling Bleeding
<ul style="list-style-type: none">• Fatal bleeding (<i>BARC type 5</i>) OR• Bleeding in a critical area or organ, such as intracranial, intraspinal, intraocular, or pericardial necessitating pericardiocentesis, or intramuscular with compartment syndrome (<i>BARC type 3b</i>) OR• Bleeding causing hypovolemic shock or severe hypotension requiring vasopressors or surgery OR• Overt source of bleeding with drop in hemoglobin of ≥ 5 g/dL or whole blood or packed red blood cells (RBC) transfusion ≥ 4 units* (<i>BARC type 3b</i>)
Major Bleeding (<i>BARC type 3a</i>)
<ul style="list-style-type: none">• Overt bleeding either associated with a drop in the hemoglobin level of at least 3.0g/dL or requiring transfusion of 2-3 units of whole blood/RBC, or causing hospitalization or permanent injury or requiring surgery AND• Does not meet criteria of life-threatening or disabling bleeding
Minor Bleeding (<i>BARC type 2 or 3a, depending on severity</i>)
<ul style="list-style-type: none">• Any bleeding worthy of clinical mention (eg. access site hematoma) that does not qualify as life-threatening, disabling or major

* Given one unit of packed RBC typically will raise blood hemoglobin concentration by 1g/dL, an estimated decrease in hemoglobin will be calculated.

BARC = Bleeding Academic Research Consortium

Life-threatening and Major bleeding events are considered to be serious.

BUNDLE BRANCH BLOCK

ACC/AHA/HRS 2006 Key Data Elements and Definitions for Electrophysiological Studies and Procedures; A Report of the American College of Cardiology/ American Heart Association Task Force on Clinical Data Standards (ACC/AHA/HRS Writing Committee to Develop Data Standards on Electrophysiology), JACC, Vol. 48, No. 11, 2006.

Left Bundle Branch Block (LBBB)

- QRS duration 120 ms or longer
- Delayed onset of intrinsicoid deflection in I, V5, and V6 ≥ 60 ms
- Broad and notched or slurred R waves in I, aVL, V5, and V6
- rS or QS complexes in right precordial leads
- ST-segment and T waves in opposite polarity to the major QRS deflection

Right Bundle Branch Block (RBBB)

- QRS duration ≥ 120 ms
- rsR= or rSR= complexes in V1 and V2
- Delayed onset of intrinsicoid deflection in V1 and V2 ≥ 50 ms
- Broad, slurred S wave in I, V5,

Any new or worsening LBBB or RBBB that requires the placement of a permanent pacemaker and/or other surgical or invasive intervention will be considered to be serious.

CARDIAC PERFORATION

A laceration or tearing of the walls of the ventricles or atria of the heart, of the interatrial or interventricular septum, of the papillary muscles or chordae tendineae or of the one of the valves of the heart.

Cardiac perforation events will be classified into additional subgroups according to the Valve Academic Research Consortium (VARC)-2; Updated Standardized Endpoint Definitions for Transcatheter Aortic Valve Implantation (TAVI); 2012-10-09

Mitral valve apparatus damage or dysfunction

Angiographic or echocardiographic evidence of new damage (chordae papillary muscle, or to the leaflet) to the mitral valve apparatus or dysfunction (eg. opening restrictions due to the THV) of the mitral valve during or after the TAVI procedure.

Ventricular septal perforation

Angiographic or echocardiographic evidence of a new septal perforation during or after the TAVI procedure.

CARDIAC TAMPONADE

Clinical syndrome caused by the accumulation of fluid in the pericardial space, resulting in reduced ventricular filling and subsequent hemodynamic compromise.

CARDIOGENIC SHOCK

Patient was, at the time of procedure, in a clinical state of hypoperfusion sustained for greater than 30 minutes, according to either of the following criteria:

1. Systolic BP < 80 and/or Cardiac Index < 1.8 despite maximal treatment; or
2. IV inotropes and/or IABP necessary to maintain Systolic BP > 80 and/or CI > 1.8

CHRONIC RENAL INSUFFICIENCY

Kidney damage or glomerular filtration rate (GFR) <60 mL/min/1.73 m² for or ≥3 months. Kidney damage is defined as pathologic abnormalities or markers of damage, including abnormalities in blood or urine test or imaging studies.

CONDUCTION DISTURBANCE REQUIRING PERMANENT PACEMAKER IMPLANTATION

ACC/AHA 2006 Guidelines for the Management of Patients with Valvular Heart Disease (published in the August 1, 2006, issues of Journal of the American College of Cardiology and Circulation)

Any disturbance in the cardiac electrical conduction system that meets the American College of Cardiology (ACC)/American Heart Association (AHA)/ Heart Rhythm Society (HRS) Class I or IIa Guidelines for Device-Based Therapy of Cardiac Rhythm Abnormalities for Acquired Atrioventricular Block in Adults or Permanent Pacing in Chronic Bifascicular Block.

CONVERSION TO OPEN HEART SURGERY

Valve Academic Research Consortium (VARC)-2; Updated Standardized Endpoint Definitions for Transcatheter Aortic Valve Implantation (TAVI); 2012-10-09.

Conversion to open sternotomy during the TAVI procedure secondary to any procedure-related complications.

CORONARY OBSTRUCTION

Valve Academic Research Consortium (VARC)-2; Updated Standardized Endpoint Definitions for Transcatheter Aortic Valve Implantation (TAVI); 2012-10-09.

Angiographic or echocardiographic evidence of a new, partial or complete, obstruction of a coronary ostium, either by the valve prosthesis itself, the native leaflets, calcifications, or dissection, occurring during or after the TAVI procedure.

DEVICE DEFICIENCY

Inadequacy of a medical device with respect to its identity, quality, durability, reliability, safety or performance

NOTE: Device deficiencies include malfunctions, use errors, and inadequate labeling.

DEVICE RELATED

Events that occur as the direct result of the Medtronic CoreValve™ System (MCS) or CoreValve™ Evolut R System as it relates to delivery, placement, efficacy or durability; these may involve the implanted device or the delivery system components.

DEVICE RELATED COMPLICATIONS

Complications associated with the device as it relates to delivery, placement, efficacy or durability; these may involve the implanted device or the delivery system.

EMBOLISM

Free flowing blood clot or lesion material that is located in the systemic or pulmonary circulation that occurs in the absence of infection after the immediate perioperative period. Embolism may be manifested by a neurological event or a noncerebral embolic event.

ENCEPHALOPATHY

Altered mental state (eg., seizures, delirium, confusion, hallucinations, dementia, coma, psychiatric episode, etc.).

ENDOCARDITIS

Implanted valve endocarditis: Any infection involving an implanted valve. The diagnosis of *operated valvular endocarditis* is based on one of the following criteria:

- re-operation with evidence of abscess, paravalvular leak, pus, or vegetation confirmed as secondary to infection by histological or bacteriologic studies;
- autopsy findings of abscess, pus, or vegetation involving a replaced valve; or
- in the absence of reoperation or autopsy, meeting of the Duke Criteria for endocarditis.

Infective endocarditis is diagnosed based on Duke Criteria and necessitates 2 major criteria, or 1 major and 3 minor criteria, or 5 minor criteria

Major criteria 1: Positive blood culture for infective endocarditis

Typical microorganism consistent with infective endocarditis from 2 separate blood cultures, as noted below:

- Viridans streptococci, *Streptococcus bovis*, or HACEK group (*Haemophilus*, *Actinobacillus actinomycetemcomitans*, *Cardiobacterium hominis*, *Eikenella corrodens*, *Kingella* or
- Community-acquired *Staphylococcus aureus* or enterococci, in the absence of a primary focus

-OR-

Microorganisms consistent with infective endocarditis from persistently positive blood cultures defined as:

- Two positive cultures of blood samples drawn >12 hours apart, or
- All of 3 or a majority of 4 separate cultures of blood (with first and last sample drawn 1 hour apart)

Major criteria 2: Evidence of endocardial involvement

Positive echocardiogram for infective endocarditis defined as:

- oscillating intracardiac mass on valve or supporting structures, in the path of regurgitant jets, or on implanted material in the absence of an alternative anatomic explanation, or
- abscess, or
- new partial dehiscence of prosthetic valve

-OR-

- New valvular regurgitation (worsening or changing of pre-existing murmur not sufficient)

Minor criteria 1: Predisposition: predisposing heart condition or intravenous drug use

Minor criteria 2: Fever: temperature > 38.0° C (100.4° F)

Minor criteria 3: Vascular phenomena: major arterial emboli, septic pulmonary infarcts, mycotic aneurysm, intracranial hemorrhage, conjunctival hemorrhages, and Janeway lesions

Minor criteria 4: Immunologic phenomena: glomerulonephritis, Osler's nodes, Roth spots, and rheumatoid factor

Minor criteria 5: Microbiological evidence: positive blood culture but does not meet a major criterion as noted above or serological evidence of active infection with organism consistent with infective endocarditis

Minor criteria 6: Echocardiographic findings: consistent with infective endocarditis but do not meet a major criterion as noted above

EXPLANT

Removal of the investigational valve implant for any reason, including post-mortem.

HEMOLYSIS

A plasma free hemoglobin value > 40 mg/dL is considered to be hemolysis and a reportable adverse event.

- **Major hemolysis:** A plasma free hemoglobin value > 40 mg/dL that requires intervention (i.e. iron replacement, blood transfusion, folic acid administration, corticosteroids, Intravenous immunoglobulin G (IVIG) and/or surgery). Major hemolysis events will be considered to be serious adverse events.
- **Minor hemolysis:** A plasma free hemoglobin value > 40 mg/dL that does not require intervention.

INFECTION

Elevated body temperature (fever), and White Blood Count (WBC) > 12,000/ml, and Significant leftward shift on Differential.

MAJOR ADVERSE CARDIOVASCULAR AND CEREBROVASCULAR EVENTS (MACCE)

Defined as a composite rate of

- all-cause death
- myocardial infarction (MI)
- all stroke, and
- reintervention (defined as any cardiac surgery or percutaneous reintervention catheter procedure that repairs, otherwise alters or adjusts, or replaces a previously implanted valve)

MAJOR ADVERSE EVENT (MAE)

Major Adverse events include the following:

- MACCE
- Acute kidney Injury
- Cardiac tamponade
- Prosthetic valve dysfunction Cardiogenic shock
- Prosthetic valve endocarditis
- Life-threatening, disabling or major bleeding
- Major vascular complication
- Cardiac Perforation
- Valve malpositioning

MITRAL REGURGITATION

Mitral valve incompetence resulting in backward flow of blood.

2008 Focused Update Incorporated into the ACC/AHA 2006 Guidelines for the Management of Patients with Valvular Heart Disease (published in the October 2008 issues of Journal of the American College of Cardiology and Circulation)

Classification of the Severity of Valve Disease in Adults			
Mitral Regurgitation			
	Mild	Moderate	Severe
Qualitative Angiographic grade Color Doppler jet area	1+ Small, central jet, < 4cm ² or <20% LA area)	2+ Signs of > mild present but no criteria for severe MR	3-4+ Vena contracta with > 0.7cm with large central MR jet (area >40% of LA area) or with a wall-impinging jet of any size, swirling in LA
Doppler vena contracta width (cm)	< 0.3	0.3-0.69	≥ 0.70
Quantitative (cath or echo) Regurgitant volume (mL per beat)	< 30	30-59	≥ 60
Regurgitant fraction (%)	< 30	30-49	≥ 50
Regurgitant orifice area (cm ²)	< 0.20	0.29 – 0.39	≥ 0.40
Additional essential criteria Left atrial size Left ventricular size			Enlarged Enlarged

MITRAL STENOSIS

A narrowing, stiffening or stricture of the mitral valve.

2008 Focused Update Incorporated into the ACC/AHA 2006 Guidelines for the Management of Patients with Valvular Heart Disease (published in the October 2008 issues of Journal of the American College of Cardiology and Circulation)

Mitral Stenosis			
	Mild	Moderate	Severe
Mean Gradient (mmHg)	Less than 5	5-10	Greater than 10
Pulmonary artery systolic pressure (mmHg)	Less than 30	30-50	Greater than 50
Valve area (cm ²)	Greater than 1.5	1.0-1.5	Less than 1.0

MORTALITY

A serious adverse event that is classified by the following:

All-cause mortality: All deaths from any cause after a valve intervention. This includes all cardiovascular and non-cardiovascular deaths.

Cardiovascular mortality:

Cardiovascular death will be defined according to the Valve Academic Research Consortium (VARC)-2; Updated Standardized Endpoint Definitions for Transcatheter Aortic Valve Implantation (TAVI); 2012-10-09.

A death meeting any one of the following criteria:

- Death due to proximate cardiac cause (eg. myocardial infarction, cardiac tamponade, worsening heart failure)
- Death caused by non-coronary vascular conditions such as neurological events, pulmonary embolism, ruptured aortic aneurysm, dissecting aneurysm, or other vascular disease
- All procedure-related deaths, including those related to a complication of the procedure or treatment for a complication of the procedure
- All valve-related deaths including structural or non-structural valve dysfunction or other valve-related adverse events
- Sudden or unwitnessed death
- Death of unknown cause

Non-cardiovascular mortality: Any death in which primary cause of death is clearly related to another condition (eg. trauma, cancer, suicide)

NOTE: All deaths are considered cardiac unless an unequivocal non-cardiac cause can be established. Specifically, any unexpected death even in subjects with coexisting potentially fatal non-cardiac disease (eg. cancer, infection) should be classified as cardiac.

MYOCARDIAL INFARCTION (MI)

Myocardial infarction will be defined according to the Valve Academic Research Consortium (VARC)-2; Updated Standardized Endpoint Definitions for Transcatheter Aortic Valve Implantation (TAVI); 2012-10-09.

Peri-Procedural MI (<72 hours after the index procedure)
<ol style="list-style-type: none">1. New ischemic symptoms (eg. chest pain or shortness of breath), or new ischemic signs (eg. ventricular arrhythmias, new or worsening heart failure, new ST-segment changes, hemodynamic instability, new pathological Q-waves in at least two continuous leads, imaging evidence of new loss of viable myocardium or new wall motion abnormality) AND2. Elevated cardiac biomarkers (preferably CK-MB) within 72 hours after the index procedure, consisting of two or more post-procedure samples with a peak value exceeding 15x the upper reference limit (URL) for troponin or 5x for CK-MB. If cardiac biomarkers are increased at baseline (>99th percentile), a further increase in at least 50% post-procedure is required AND the peak value must exceed the previously stated limit

Spontaneous MI (> 72 hours after the index procedure)
<p>Any one of the following criteria:</p> <ol style="list-style-type: none">1. Detection of rise and/or fall of cardiac biomarkers (preferably troponin) with at least one value above the 99th percentile URL, together with evidence of myocardial ischemia with at least one of the following:<ul style="list-style-type: none">• Symptoms of ischemia• ECG changes indicative of new ischemia [new ST-T changes or new left bundle branch block (LBBB)];• New pathological Q waves in at least two contiguous leads;• Imaging evidence of new loss of viable myocardium or new regional wall motion abnormality2. Sudden, unexpected cardiac death, involving cardiac arrest, often with symptoms suggestive of myocardial ischemia, and accompanied by presumably new ST elevation, or new LBBB, and/or evidence of fresh thrombus by coronary angiography and/or at autopsy, but death occurring before blood samples could be obtained, or at a time before the appearance of cardiac biomarkers in the blood.3. Pathological findings of an acute myocardial infarction.

All myocardial infarctions will be considered serious adverse events.

NEUROLOGICAL EVENT

Any central, new neurological deficit, whether temporary or permanent and whether focal or global, that occurs after the subject emerges from anesthesia.

NEW YORK HEART ASSOCIATION CLASSIFICATION (NYHA)

Classification system for defining cardiac disease and related functional limitations into four broad categorizations:

Class I	Subject with cardiac disease but without resulting limitations of physical activity. Ordinary physical activity does not cause undue fatigue, palpitation, dyspnea, or anginal pain.
Class II	Subjects with cardiac disease resulting in slight limitation of physical activity. They are comfortable at rest. Ordinary physical activity results in fatigue, palpitation, dyspnea, or anginal pain.
Class III	Subjects with cardiac disease resulting in marked limitation of physical activity. They are comfortable at rest. Less than ordinary physical activity causes fatigue, palpitation, dyspnea, or anginal pain.
Class IV	Subjects with cardiac disease resulting in inability to carry on any physical activity without discomfort. Symptoms of cardiac insufficiency or of the anginal syndrome may be present even at rest. If any physical activity is undertaken, discomfort is increased.

PARAVALVULAR AORTIC REGURGITATION

Leakage due to a separation of the prosthetic valve from the annulus. Diagnosis of paravalvular leak may be obtained from echocardiogram; however definitive diagnosis is obtained at reoperation, explant, or autopsy.

(Refer to the definition of Aortic Regurgitation for additional paravalvular leak severity criteria)

PATIENT PROSTHESIS MISMATCH (PPM)

Patient prosthesis mismatch (PPM) is defined under the definition of Prosthetic Valve Dysfunction according to the Valve Academic Research Consortium (VARC)-2 Updated Standardized Endpoint Definitions for Consensus Report for Transcatheter Aortic Valve Implantation (TAVI); 2012-10-09

Reference prosthetic valve dysfunction.

PERMANENT PACEMAKER IMPLANTATION

Implantation of permanent pacemaker after the index procedure due to occurrence of conduction disturbances.

- **Procedure-related:** Permanent Pacemaker is implanted in subjects with new onset conduction disturbances or worsening of existing conduction disturbances
- **Not related to procedure:** Permanent Pacemaker is implanted in subjects with known conduction disturbances that did not advance after the index procedure.

PROCEDURE RELATED COMPLICATIONS

Complications associated with any part of the vascular access procedure, associated treatments or necessary secondary interventions that do not necessarily involve the device. This includes morbidity associated with either pre-medication, or anesthesia, or other adjunct to the surgical procedure. Other technical errors including inappropriate patient selection, inappropriate operator techniques, measurements, or judgment that do not involve the device itself are also included.

PROCEDURAL SUCCESS

Defined as device success without occurrence of in-hospital MACCE.

PROCEDURE-RELATED EVENTS

All events occurring during or as a direct result of the index procedure.

All events that occur before extubation and/or before access site closure are classified as procedure-related regardless of event timing.

PROSTHETIC VALVE DYSFUNCTION

Prosthetic Valve Dysfunction will be defined according to the Valve Academic Research Consortium (VARC)-2 Updated Standardized Endpoint Definitions for Consensus Report for Transcatheter Aortic Valve Implantation (TAVI); 2012-10-09

Failure modes of prosthetic valve dysfunction include, but are not limited to, the following:

- Aortic Stenosis
 - Stent creep
 - Pannus
 - Calcification
 - Support structure deformation (out-of-round configuration), under-expansion, fracture, or trauma (cardio-pulmonary resuscitation, blunt chest trauma)
 - Mal-sizing [prosthesis-patient mismatch(PPM)]
 - Endocarditis
 - Prosthetic valve thrombosis
 - Native leaflet prolapse impeding prosthetic leaflet motion
- Aortic Regurgitation
 - Pannus
 - Calcification
 - Support structure deformation (out-of-round configuration), recoil, under-expansion, fracture, insufficient radial strength, or trauma (cardio-pulmonary resuscitation, blunt chest trauma)
 - Endocarditis
 - Prosthetic valve thrombosis
 - Mal-position (too high, too low)
 - Acute mal-coaptation
 - Leaflet wear, tear/perforation, prolapse or retraction
 - Suture breakage or disruption
 - Native leaflet prolapse impeding prosthetic leaflet motion

Prosthetic valve dysfunction will be considered serious when it meets the definition of a serious adverse event (SAE).

Prosthetic valve dysfunction			
Prosthetic aortic valve stenosis*			
	Normal	Mild Stenosis	Moderate/Severe Stenosis
Quantitative Parameters (Flow-dependent)†			
Peak velocity	<3 m/s	3-4 m/s	>4 m/s
Mean gradient	<20 mmHg	20-40 mmHg	>40 mmHg
Quantitative Parameters (Flow-independent)			
Doppler velocity index‡	>0.35	0.35-0.25	<0.25
Effective orifice area†	>1.1 cm ²	1.1-0.8 cm ²	<0.8 cm ²
Effective orifice area§	>0.9 cm ²	0.9-0.6 cm ²	<0.6 cm ²
Prosthesis-patient mismatch (PPM)			
	Insignificant	Moderate	Severe
Indexed effective orifice area**	>0.85 cm ² /m ²	0.85-0.65 cm ² /m ²	<0.65 cm ² /m ²
Indexed effective orifice area††	>0.70 cm ² /m ²	0.70-0.60 cm ² /m ²	<0.60 cm ² /m ²
Prosthetic aortic valve regurgitation			
	Mild	Moderate	Severe
Semi-quantitative Parameters			
Diastolic flow reversal in the descending aorta—PW	Absent or brief early diastolic	Intermediate	Prominent, holodiastolic
Circumferential extent of prosthetic valve paravalvular regurgitation (%)†††	<10%	10-29%	≥30%
Quantitative Parameters‡			
Regurgitant volume (ml/beat)	<30 ml	30-59 ml	≥60 ml
Regurgitant fraction (%)	<30%	30-49%	≥50%
EROA (cm ²)	<0.10 cm ²	0.10-0.29 cm ²	≥0.30 cm ²

*In conditions of normal or near normal stroke volume (50–70 mL)

†These parameters are more affected by flow, including concomitant aortic regurgitation

‡For LVOT >2.5 cm, significant stenosis criteria is <0.20

†Use in setting of BSA ≥1.6 cm² (note: dependent on the size of the valve and the size of the native annulus)

§Use in setting of BSA <1.6 cm²

**Use in setting of BMI <30 kg/cm²

††Use in setting of BMI ≥30 kg/cm²

†††Not well-validated and may overestimate severity compared to quantitative Doppler

Moderate or severe AS and AR will be considered a serious adverse event when the dysfunction is accompanied with clinical sequelae at the time of the event detection, and the clinical sequelae are chronologically and physiologically associated with the dysfunction.

RECURRENT HOSPITALIZATION

Recurrent hospitalization is defined as a non-elective hospital admission for signs and symptoms related to aortic valve disease (as described below), as well as complications related to aortic valve procedures including neurological events, infection, additional procedures (eg. implant of permanent pacemaker), and renal failure. For the purposes of the protocol a hospitalization is an admission that results in at least a one night stay (i.e., one midnight/change in calendar day).

Overnight stays at nursing home facilities, extended care facilities, or emergency room visits that do not result in an in-patient admission do not meet the protocol definition of recurrent hospitalization. Patients with signs and symptoms related to aortic valve disease (as described below) who are hospitalized for less than one night or who are treated and released from the emergency department or an outpatient clinic [including treatment for intravenous heart failure therapy (eg., inotropes, diuretics, and/or vasodilators)], does not meet the protocol definition of as recurrent hospitalizations.

Aortic valve disease will be evaluated using documented evidence of the following signs and symptoms. An independent Clinical Events Committee (CEC) will review all available source documentation for all hospitalizations to determine if they are aortic valve disease hospitalizations. The CEC adjudication will be used for final analysis.

Signs and Symptoms of Aortic Valve Disease	
Sign/Symptom	Definition
Aortic Valve Dysfunction	
Shortness of breath/dyspnea	A feeling of difficult or labored breathing that is out of proportion to the patient's level of physical activity
Exercise intolerance	A condition where the patient is unable to do physical exercise at the level or for the duration that would be expected of someone in his/her general physical condition, or experiences unusually severe post-exercise pain, fatigue, or other negative effects
Dizziness/syncope	Lightheadness or unsteadiness of gait or a partial or complete loss of consciousness with interruption of awareness of oneself and ones surroundings
Chest pain	Discomfort and soreness in and around the chest
Worsening Heart Failure	
Volume Overload	
Orthopnea	Dyspnea in which the person can breathe comfortably only when standing or sitting erect
Paroxysmal nocturnal dyspnea	Acute dyspnea caused by the lung congestion and edema that results from partial heart failure and occurring suddenly at night, usually an hour or two after the individual has fallen asleep.
Jugular venous distension	With the patient is positioned under 45°, and the filling level of the jugular vein determined. An abnormal response is more than 3 centimeters above the sternal angle.
Hepatomegaly	Palpation of the edge of the liver below the edge of the ribs without inspiration
Peripheral edema	Swelling of tissues, usually in the lower limbs, due to the accumulation of fluids.
Pulmonary rales	Small clicking, bubbling, or rattling sounds in the lung associated with inspiration
Abdominal-jugular reflux	An elevation of venous pressure visible in the jugular veins and measurable in the veins of the arm, produced in active or impending congestive heart failure by firm pressure with the flat hand over the abdomen.
Radiographic evidence of pulmonary edema	NA
Elevated B-type natriuretic peptide level	NA
Hypoperfusion	
Narrow pulse pressure	Pulse pressure < 30 mmHg
Hypotension	Systolic BP < 90 systolic

Renal or hepatic dysfunction	<ul style="list-style-type: none"> •Rise in baseline creatinine by 25% •Increase in LFT (SGOT, SGPT) > 2 times normal
Low serum sodium concentration	Serum sodium < 130 mEq/dL

REINTERVENTION

Any surgical or percutaneous interventional catheter procedure that repairs, otherwise alters or adjusts, or replaces a previously implanted valve. In addition to surgical reoperations, balloon dilatation, interventional manipulation, repositioning, or retrieval, and other catheter-based interventions for valve-related complications are also considered *reinterventions*. Reintervention is further subdivided into *surgical* and *percutaneous*.

RESPIRATORY INSUFFICIENCY

Post-bronchodilator forced expiratory volume in one second (FEV1)/forced vital capacity (FVC) ratio [FEV1/FVC] less than 70%.

Post-bronchodilator FEV1 less than 80% predicted, with or without chronic symptoms (i.e., cough or sputum production).

RESPIRATORY FAILURE

The need for ventilatory support for > 72 hours associated with an inability to wean from the respirator for any reason.

RIGHT VENTRICULAR INSUFFICIENCY

Defined as sequelae of right ventricular failure including the following:

- Significantly decreased right ventricular systolic and/or diastolic function
- Tricuspid valvular regurgitation secondary to elevated pressure

Clinical symptoms to include:

- Hepatic congestion
- Ascites
- Anasarca
- Presence of “hepato-jugular reflux”
- Edema

SERIOUS ADVERSE DEVICE EFFECT (SADE)

Adverse device effect that has resulted in any of the consequences characteristic of a Serious Adverse Event

SERIOUS ADVERSE EVENT (SAE)

A serious adverse event (SAE) is an event that:

- Led to death,
- Led to serious deterioration in health of the subject, that either resulted in:
 - a life threatening illness or injury, or
 - a permanent impairment of a body structure or a body function, or
 - in-patient or prolonged hospitalization, or
 - medical or surgical intervention to prevent a life-threatening illness or injury or permanent impairment to a body structure or a body function
- Led to fetal distress, fetal death or a congenital abnormality or birth defect

NOTE: Planned hospitalization for pre-existing condition, or a procedure required by per protocol, without serious deterioration in health, is not considered a serious adverse event.

Events that do not meet these criteria are considered non-serious.

STROKE and TIA

Stroke and TIA will be defined according to the Valve Academic Research Consortium (VARC)-2; Updated Standardized Endpoint Definitions for Transcatheter Aortic Valve Implantation (TAVI); 2012-10-09 and the FDA's Current Thinking Regarding Neurological Assessments for Transcatheter Valve Trials (July 25, 2011).

Diagnostic Criteria
<ul style="list-style-type: none">• Acute episode of a focal or global neurological deficit with at least one of the following: change in level of consciousness, hemiplegia, hemiparesis, numbness or sensory loss affecting one side of the body, dysphasia or aphasia, hemianopia, amaurosis fugax, or other neurological signs or symptoms consistent with stroke• Stroke: duration of a focal or global neurological deficit ≥ 24 hours; OR < 24 hours available neuroimaging documents a new hemorrhage or infarct; OR the neurologic deficit results in death• TIA: duration of a focal or global neurological deficit < 24 hours, any variable neuroimaging does not demonstrate a new hemorrhage or infarct• No other readily identifiable non-stroke cause for the clinical presentations (eg. brain tumor, trauma, infection, hypoglycemia, peripheral lesion, pharmacological influences) to be determined by or in conjunction with designated neurologist*• Confirmation of the diagnosis by at least one of the following:<ul style="list-style-type: none">○ Neurology or neurosurgical specialist○ Neuroimaging procedure (CT scan or brain MRI), but stroke be diagnosed on clinical grounds alone
Stroke Classification
<ul style="list-style-type: none">• Ischemic: an acute episode of focal cerebral, spinal or retinal dysfunctions caused by infarction of the central nervous system tissue• Hemorrhagic: an acute episode of focal cerebral, spinal or spinal dysfunctions caused by intraparenchymal, intraventricular, or subarachnoid hemorrhage
Stroke Definitions
<ul style="list-style-type: none">• Disabling stroke: an mRS score of 2 or more at 90 days and an increase in at least one mRS category from an individual's pre-stroke baseline• Non-disabling stroke: an mRS score of < 2 at 90 days or one that does not result in an increase in at least one mRS category from an individual's pre-stroke baseline

* Patients with non-focal global encephalopathy will not be reported as a stroke without unequivocal evidence based upon neuroimaging studies

+ Modified Rankin score assessments should be made by qualified individuals according to certification process.

Clinically important disabilities (disabling strokes) will be considered to be serious adverse events.

TAV-in-TAV DEPLOYMENT

Valve malpositioning will be defined according to the Valve Academic Research Consortium (VARC))-2; Updated Standardized Endpoint Definitions for Transcatheter Aortic Valve Implantation (TAVI); 2012-10-09.

An additional valve prosthesis is implanted within a previously implanted prosthesis because of suboptimal device position and/or function, during or after the index procedure.

TECHNICAL OBSERVATION

A defect, malfunction, or failure of any part of the Medtronic CoreValve™ System or CoreValve™ Evolut R System. This may pertain to the device or delivery and/or loading system not functioning according to its design intent.

TRICUSPID REGURGITATION

2008 Focused Update Incorporated into the ACC/AHA 2006 Guidelines for the Management of Patients with Valvular Heart Disease (published in the October 2008 issues of Journal of the American College of Cardiology and Circulation)

Severe tricuspid regurgitation: vena contracta width greater than 0.7cm and systolic reversal in hepatic veins.

UNANTICIPATED SERIOUS ADVERSE DEVICE EFFECT (USADE)

Serious adverse device effect which by its nature, incidence, severity or outcome has not been identified in the current version of the risk analysis report

NOTE: Anticipated serious adverse device effect (ASADE) is an effect which by its nature, incidence, severity or outcome has been identified in the risk analysis report.

UNPLANNED USE OF CARDIOPULMONARY BYPASS (CPB)

Unplanned use of CPB for hemodynamic support at any time during the TAVI procedure.

VALVE THROMBOSIS

Any thrombus not caused by infection attached to or near the trial valve that occludes part of the blood flow path, interferes with valve function, or is sufficiently large to warrant treatment. Valve thrombus found at autopsy in a subject whose cause of death was not valve-related or found at operation for an unrelated indication should also be counted as *valve thrombosis*.

VALVE MALPOSITIONING

Valve malpositioning will be defined according to the Valve Academic Research Consortium (VARC))-2; Updated Standardized Endpoint Definitions for Transcatheter Aortic Valve Implantation (TAVI); 2012-10-09.

Valve migration

After initial correct positioning, the valve prosthesis moves upward or downward, within the aortic annulus from its initial position, with or without consequences

Valve embolization

The valve prosthesis moves during or after deployment such that it loses contact with the aortic annulus

Ectopic valve deployment

Permanent deployment of the valve prosthesis in a location other than the aortic root

VASCULAR COMPLICATIONS

Vascular Complications will be defined according to the Valve Academic Research Consortium (VARC))-2; Updated Standardized Endpoint Definitions for Transcatheter Aortic Valve Implantation (TAVI); 2012-10-09.

Vascular Access Site and Access Related Complications
Major Vascular Complications
<ul style="list-style-type: none"> • Any aortic dissection, aortic rupture, annulus rupture, left ventricle perforation, or new apical aneurysm/pseudo-aneurysm OR • Access site or access-related vascular injury (dissection, stenosis, perforation, rupture, arterio-venous fistula, pseudoaneurysm, hematoma, irreversible nerve injury, compartment syndrome, percutaneous closure device failure) leading to death, life-threatening or major bleeding*, visceral ischemia or neurological impairment OR • Distal embolization (non-cerebral) from a vascular source requiring surgery or resulting in amputation or irreversible end-organ damage OR • The use of unplanned endovascular or surgical intervention associated with death, major bleeding, visceral ischaemia or neurological impairment OR • Any new ipsilateral lower extremity ischemia documented by patient symptoms, physical exam, and/or decreased or absent blood flow on lower extremity angiogram OR • Surgery for access site-related nerve injury OR • Permanent access site-related nerve injury
Minor Vascular Complications
<ul style="list-style-type: none"> • Access site or access-related vascular injury (dissection, stenosis, perforation, rupture, arterio-venous fistula, pseudoaneuysms, hematomas, percutaneous closure device failure) not leading to death, life-threatening or major bleeding*, visceral ischemia or neurological impairment OR • Distal embolization treated with embolectomy and/or thrombectomy and not resulting in amputation or irreversible end-organ damage OR • Any unplanned endovascular stenting or unplanned surgical intervention not meeting the criteria for a major vascular complication OR • Vascular repair or the need for vascular repair (via surgery, ultrasound-guided compression, transcatheter embolization, or stent-graft)
Percutaneous closure device failure
<ul style="list-style-type: none"> • Failure of a closure device to achieve hemostasis at the arteriotomy site leading to alternative treatment (other than manual compression or adjunctive endovascular ballooning)

Major vascular complications will be considered to be serious adverse events.

*Refers to VARC bleeding definitions.

P TRIAL MANAGEMENT

P.1 Miscellaneous

P.1.1 Insurance

The Medtronic Bakken Research Center B.V. is a wholly owned subsidiary of Medtronic Inc., which as the parent company of such entity maintains appropriate clinical trial liability insurance coverage as required under applicable laws and regulations and will comply with applicable law and custom concerning specific insurance coverage. If required, a Clinical Trial Insurance statement/certificate will be provided to the IRB/MEC.

P.1.2 Reimbursement

Trial reimbursement is outlined in the Clinical Trial Agreement.

P.1.3 Indemnification

Indemnification will be done according to local laws.

P.1.4 Subject confidentiality

At all times throughout the trial confidentiality shall be observed by all parties involved. All information and data sent to parties involved in trial conduct concerning patients or their participation in this trial will be considered confidential. The patient identification number is to be recorded on all trial documents and will link the trial documents to the patient's name and medical record at the investigator's site. To maintain confidentiality, the patient's name or any other personal identifiers should not be recorded on any trial document other than the informed consent form.

Q REFERENCES

1. Baumgartner H, Hung J, Bermejo J, Chambers JB, Evangelista A, Griffin BP, Lung B, Otto CM, Pellikka PA, Quinones M. Echocardiographic assessment of valve stenosis: EAE/ASE recommendations for clinical practice. *J Am Soc Echocardiogr* 2009; 22(1):1-23; quiz 101-102.
2. Lung B, Baron G, Butchart EG, Delahaye F, Gohlke-Barwolf C, Levang OW, Tornos P, Vanoverschelde JL, Vermeer F, Boersma E, Ravaut P, Vahanian A. A prospective survey of patients with valvular heart disease in Europe: The Euro Heart Survey on Valvular Heart Disease. *Eur Heart J* 2003; 24(13):1231-1243.
3. Supino PG, Borer JS, Preibisz J, Bornstein A. The epidemiology of valvular heart disease: a growing public health problem. *Heart Fail Clin* 2006; 2(4):379-393.
4. Ross J, Jr., Braunwald E. Aortic stenosis. *Circulation* 1968; 38(1 Suppl):61-67.
5. Rosenhek R, Zilberszac R, Schemper M, Czerny M, Mundigler G, Graf S, Bergler-Klein J, Grimm M, Gabriel H, Maurer G. Natural history of very severe aortic stenosis. *Circulation*; 121(1):151-156.
6. Bonow RO, Carabello BA, Chatterjee K, de Leon AC, Jr., Faxon DP, Freed MD, Gaasch WH, Lytle BW, Nishimura RA, O'Gara PT, O'Rourke RA, Otto CM, Shah PM, Shanewise JS. 2008 Focused update incorporated into the ACC/AHA 2006 guidelines for the management of patients with valvular heart disease: a report of the American College of Cardiology/American Heart Association Task Force on Practice Guidelines (Writing Committee to Revise the 1998 Guidelines for the Management of Patients With Valvular Heart Disease): endorsed by the Society of Cardiovascular Anesthesiologists, Society for Cardiovascular Angiography and Interventions, and Society of Thoracic Surgeons. *Circulation* 2008; 118(15):e523-661.
7. Vahanian A, Baumgartner H, Bax J, Butchart E, Dion R, Filippatos G, Flachskampf F, Hall R, Lung B, Kasprzak J, Nataf P, Tornos P, Torracca L, Wenink A. Guidelines on the management of valvular heart disease: The Task Force on the Management of Valvular Heart Disease of the European Society of Cardiology. *Eur Heart J* 2007; 28(2):230-268.
8. Lung B, Cachier A, Baron G, Messika-Zeitoun D, Delahaye F, Tornos P, Gohlke-Barwolf C, Boersma E, Ravaut P, Vahanian A. Decision-making in elderly patients with severe aortic stenosis: why are so many denied surgery? *Eur Heart J* 2005; 26(24):2714-2720.
9. Serruys PW. Keynote address--EuroPCR 2008, Barcelona, May 14th, 2008. Transcatheter aortic valve implantation: state of the art. *EuroIntervention* 2009; 4(5):558-565.
10. Cribier A, Eltchaninoff H, Bash A, Borenstein N, Tron C, Bauer F, Derumeaux G, Anselme F, Laborde F, Leon MB. Percutaneous transcatheter implantation of an aortic valve prosthesis for calcific aortic stenosis: first human case description. *Circulation* 2002; 106(24):3006-3008.
11. Webb JG, Pasupati S, Humphries K, Thompson C, Altwegg L, Moss R, Sinhal A, Carere RG, Munt B, Ricci D, Ye J, Cheung A, Lichtenstein SV. Percutaneous transarterial aortic valve replacement in selected high-risk patients with aortic stenosis. *Circulation* 2007; 116(7):755-763.
12. Grube E, Laborde JC, Gerckens U, Felderhoff T, Sauren B, Buellesfeld L, Mueller R, Menichelli M, Schmidt T, Zickmann B, Iversen S, Stone GW. Percutaneous implantation of the CoreValve self-expanding valve prosthesis in high-risk patients with aortic valve disease: the Siegburg first-in-man study. *Circulation* 2006; 114(15):1616-1624.
13. Piazza N, Grube E, Gerckens U, den Heijer P, Linke A, Luha O, Ramondo A, Ussia G, Wenaweser P, Windecker S, Laborde JC, de Jaegere P, Serruys PW. Procedural and 30-day outcomes following transcatheter aortic valve implantation using the third generation (18 Fr) corevalve revalving system: results from the multicentre, expanded evaluation registry 1-year following CE mark approval. *EuroIntervention* 2008; 4(2):242-249.
14. Bleiziffer S, Ruge H, Mazzitelli D, Hutter A, Opitz A, Bauernschmitt R, Lange R. Survival after transapical and transfemoral aortic valve implantation: talking about two different patient populations. *J Thorac Cardiovasc Surg* 2009; 138(5):1073-1080.
15. Webb JG, Altwegg L, Boone RH, Cheung A, Ye J, Lichtenstein S, Lee M, Masson JB, Thompson C, Moss R, Carere R, Munt B, Nietlispach F, Humphries K. Transcatheter aortic valve implantation: impact on clinical and valve-related outcomes. *Circulation* 2009; 119(23):3009-3016.

16. Thomas M, Schymik G, Walther T, Himbert D, Lefevre T, Treede H, Eggebrecht H, Rubino P, Michev I, Lange R, Anderson WN, Wendler O. Thirty-Day Results of the SAPIEN Aortic Bioprosthesis European Outcome (SOURCE) Registry. A European Registry of Transcatheter Aortic Valve Implantation Using the Edwards SAPIEN Valve. *Circulation*.
17. Gerckens U, Latsios G, Mueller R, Buellesfeld L, John D, Yucel S, Sauren B, Felderhof T, Iversen S, Grube E. Procedural and mid-term results in patients with aortic stenosis treated with implantation of 2 (in-series) CoreValve prostheses in 1 procedure. *JACC Cardiovasc Interv*; 3(2):244-250.
18. Masson JB, Kovac J, Schuler G, Ye J, Cheung A, Kapadia S, Tuzcu ME, Kodali S, Leon MB, Webb JG. Transcatheter aortic valve implantation: review of the nature, management, and avoidance of procedural complications. *JACC Cardiovasc Interv* 2009; 2(9):811-820.
19. Piazza N, Cutlip DE, Onuma Y, Kappetein AP, de Jaegere P, Serruys PW. Clinical endpoints in transcatheter aortic valve implantation: a call to ARC for standardised definitions. *EuroIntervention* 2009; 5(1):29-31.
20. Thomas M, Wendler O. Transcatheter aortic valve implantation (TAVI): how to interpret the data and what data is required? *EuroIntervention* 2009; 5(1):25-27.
21. Leon MB, Piazza N, Nikolsky E, Blackstone EH, Cutlip DE, Kappetein AP, Krucoff MW, Mack MM, R., Miller C, Morel M, Petersen JP, J.J., Takkenberg JJM, Vahanian A, van Es G, Vranckx P, Smith C, Webb JG, Mohr F, Windecker S, Serruys PW. Standardized endpoint definitions for Transcatheter Aortic Valve Implantation Clinical Trials: a consensus report from the Valve Academic Research Consortium. *J Am Coll Cardiol* 2011.
22. Leon MB, Piazza N, Nikolsky E, Blackstone EH, Cutlip DE, Kappetein AP, Krucoff MW, Mack MM, R., Miller C, Morel M, Petersen JP, J.J., Takkenberg JJM, Vahanian A, van Es G, Vranckx P, Smith C, Webb JG, Mohr F, Windecker S, Serruys PW. Standardized endpoint definitions for Transcatheter Aortic Valve Implantation Clinical Trials: a consensus report from the Valve Academic Research Consortium. *European Heart Journal* 2011.
23. Van Brabandt H, Neyt M. Safety of percutaneous aortic valve insertion. A systematic review. *BMC Cardiovasc Disord* 2009; 9:45.
24. Van Brabandt H, Neyt M. What is the evidence in favor of percutaneous aortic valve insertion? *Am J Cardiol* 2009; 103(4):575.
25. Dhruva SS, Bero LA, Redberg RF. Strength of study evidence examined by the FDA in premarket approval of cardiovascular devices. *JAMA* 2009; 302(24):2679-2685.
26. Leon MB, Smith CR, Mack M, Miller DC, Moses JW, Svensson LG, Tuzcu EM, Webb JG, Fontana GP, Makkar RR, Brown DL, Block PC, Guyton RA, Pichard AD, Bavaria JE, Herrmann HC, Douglas PS, Petersen JL, Akin JJ, Anderson WN, Wang D, Pocock S. Transcatheter aortic-valve implantation for aortic stenosis in patients who cannot undergo surgery. *N Engl J Med*; 363(17):1597-1607.
27. Serruys PW, Morice MC, Kappetein AP, Colombo A, Holmes DR, Mack MJ, Stahle E, Feldman TE, van den Brand M, Bass EJ, Van Dyck N, Leadley K, Dawkins KD, Mohr FW. Percutaneous coronary intervention versus coronary-artery bypass grafting for severe coronary artery disease. *N Engl J Med* 2009; 360(10):961-972.
28. Piazza N, van Gameren M, Juni P, Wenaweser P, Carrel T, Onuma Y, Gahl B, Hellige G, Otten A, Kappetein AP, Takkenberg JJ, van Domburg R, de Jaegere P, Serruys PW, Windecker S. A comparison of patient characteristics and 30-day mortality outcomes after transcatheter aortic valve implantation and surgical aortic valve replacement for the treatment of aortic stenosis: a two-centre study. *EuroIntervention* 2009; 5(5):580-588.
29. Ong AT, Serruys PW, Mohr FW, Morice MC, Kappetein AP, Holmes DR, Jr., Mack MJ, van den Brand M, Morel MA, van Es GA, Kleijne J, Koglin J, Russell ME. The SYNergy between percutaneous coronary intervention with TAXus and cardiac surgery (SYNTAX) study: design, rationale, and run-in phase. *Am Heart J* 2006; 151(6):1194-1204.
30. Roques F, Nashef SA, Michel P, Gauducheau E, de Vincentiis C, Baudet E, Cortina J, David M, Faichney A, Gabrielle F, Gams E, Harjula A, Jones MT, Pintor PP, Salamon R, Thulin L. Risk factors and outcome in European cardiac surgery: analysis of the EuroSCORE multinational database of 19030 patients. *Eur J Cardiothorac Surg* 1999; 15(6):816-822; discussion 822-813.
31. Shahian DM, O'Brien SM, Filardo G, Ferraris VA, Haan CK, Rich JB, Normand SL, DeLong ER, Shewan CM, Dokholyan RS, Peterson ED, Edwards FH, Anderson RP. The Society of Thoracic Surgeons 2008 cardiac surgery risk models: part 3--valve plus coronary artery bypass grafting surgery. *Ann Thorac Surg* 2009; 88(1 Suppl):S43-62.
32. Jin R, Grunkemeier GL, Starr A. Validation and refinement of mortality risk models for heart valve surgery. *Ann Thorac Surg* 2005; 80(2):471-479.

33. Edwards FH, Peterson ED, Coombs LP, DeLong ER, Jamieson WR, Shroyer ALW, Grover FL. Prediction of operative mortality after valve replacement surgery. *J Am Coll Cardiol* 2001; 37(3):885-892.
34. Hannan EL, Wu C, Bennett EV, Carlson RE, Culliford AT, Gold JP, Higgins RS, Smith CR, Jones RH. Risk index for predicting in-hospital mortality for cardiac valve surgery. *Ann Thorac Surg* 2007; 83(3):921-929.
35. Gardner SC, Grunwald GK, Rumsfeld JS, Cleveland JC, Jr., Schooley LM, Gao D, Grover FL, McDonald GO, Shroyer AL. Comparison of short-term mortality risk factors for valve replacement versus coronary artery bypass graft surgery. *Ann Thorac Surg* 2004; 77(2):549-556.
36. Dewey TM, Brown D, Ryan WH, Herbert MA, Prince SL, Mack MJ. Reliability of risk algorithms in predicting early and late operative outcomes in high-risk patients undergoing aortic valve replacement. *J Thorac Cardiovasc Surg* 2008; 135(1):180-187.
37. Nowicki ER, Birkmeyer NJ, Weintraub RW, Leavitt BJ, Sanders JH, Dacey LJ, Clough RA, Quinn RD, Charlesworth DC, Sisto DA, Uhlig PN, Olmstead EM, O'Connor GT. Multivariable prediction of in-hospital mortality associated with aortic and mitral valve surgery in Northern New England. *Ann Thorac Surg* 2004; 77(6):1966-1977.
38. van Gameren M, Kappetein AP, Steyerberg EW, Venema AC, Berenschot EA, Hannan EL, Bogers AJ, Takkenberg JJ. Do we need separate risk stratification models for hospital mortality after heart valve surgery? *Ann Thorac Surg* 2008; 85(3):921-930.
39. van Gameren M, Piazza N, Bogers AJ, Takkenberg JJ, Kappetein AP. How to assess risks of valve surgery: quality, implementation and future of risk models. *Heart* 2009; 95(23):1958-1963.
40. Lee DH, Buth KJ, Martin BJ, Yip AM, Hirsch GM. Frail patients are at increased risk for mortality and prolonged institutional care after cardiac surgery. *Circulation*; 121(8):973-978.
41. Chang AS, Smedira NG, Chang CL, Benavides MM, Myhre U, Feng J, Blackstone EH, Lytle BW. Cardiac surgery after mediastinal radiation: extent of exposure influences outcome. *J Thorac Cardiovasc Surg* 2007; 133(2):404-413.
42. Girardi LN, Krieger KH, Mack CA, Isom OW. No-clamp technique for valve repair or replacement in patients with a porcelain aorta. *Ann Thorac Surg* 2005; 80(5):1688-1692.
43. Wijns W, Kolh P, Danchin N, Di Mario C, Falk V, Folliguet T, Garg S, Huber K, James S, Knuuti J, Lopez-Sendon J, Marco J, Menicanti L, Ostojic M, Piepoli MF, Pirllet C, Pomar JL, Reifart N, Ribichini FL, Schalij MJ, Sergeant P, Serruys PW, Silber S, Sousa Uva M, Taggart D, Vahanian A, Auricchio A, Bax J, Ceconi C, Dean V, Filippatos G, Funck-Brentano C, Hobbs R, Kearney P, McDonagh T, Popescu BA, Reiner Z, Sechtem U, Sirnes PA, Tendera M, Vardas PE, Widimsky P, Alfieri O, Dunning J, Elia S, Kappetein P, Lockowandt U, Sarris G, Vouhe P, von Segesser L, Agewall S, Aladashvili A, Alexopoulos D, Antunes MJ, Atalar E, Brutel de la Riviere A, Doganov A, Eha J, Fajadet J, Ferreira R, Garot J, Halcox J, Hasin Y, Janssens S, Kervinen K, Laufer G, Legrand V, Nashef SA, Neumann FJ, Niemela K, Nihoyannopoulos P, Noc M, Piek JJ, Pirk J, Rozenman Y, Sabate M, Starc R, Thielmann M, Wheatley DJ, Windecker S, Zembala M. Guidelines on myocardial revascularization: The Task Force on Myocardial Revascularization of the European Society of Cardiology (ESC) and the European Association for Cardio-Thoracic Surgery (EACTS). *Eur Heart J*; 31(20):2501-2555.
44. Lund O, Nielsen TT, Pilegaard HK, Magnussen K, Knudsen MA. The influence of coronary artery disease and bypass grafting on early and late survival after valve replacement for aortic stenosis. *J Thorac Cardiovasc Surg* 1990; 100(3):327-337.
45. Dickstein K, Vardas PE, Auricchio A, Daubert JC, Linde C, McMurray J, Ponikowski P, Priori SG, Sutton R, van Veldhuisen DJ, Vahanian A, Bax J, Ceconi C, Dean V, Filippatos G, Funck-Brentano C, Hobbs R, Kearney P, McDonagh T, Popescu BA, Reiner Z, Sechtem U, Sirnes PA, Tendera M, Vardas P, Widimsky P, Anker SD, Blanc JJ, Gasparini M, Hoes AW, Israel CW, Kalarus Z, Merkely B, Swedberg K, Camm AJ. 2010 Focused Update of ESC Guidelines on device therapy in heart failure: an update of the 2008 ESC Guidelines for the diagnosis and treatment of acute and chronic heart failure and the 2007 ESC guidelines for cardiac and resynchronization therapy. Developed with the special contribution of the Heart Failure Association and the European Heart Rhythm Association. *Eur Heart J*; 31(21):2677-2687.

46. Goldstein LB, Adams R, Alberts MJ, Appel LJ, Brass LM, Bushnell CD, Culebras A, DeGraba TJ, Gorelick PB, Guyton JR, Hart RG, Howard G, Kelly-Hayes M, Nixon JV, Sacco RL. Primary prevention of ischemic stroke: a guideline from the American Heart Association/American Stroke Association Stroke Council: cosponsored by the Atherosclerotic Peripheral Vascular Disease Interdisciplinary Working Group; Cardiovascular Nursing Council; Clinical Cardiology Council; Nutrition, Physical Activity, and Metabolism Council; and the Quality of Care and Outcomes Research Interdisciplinary Working Group. *Circulation* 2006; 113(24):e873-923.
47. Sacco RL, Adams R, Albers G, Alberts MJ, Benavente O, Furie K, Goldstein LB, Gorelick P, Halperin J, Harbaugh R, Johnston SC, Katzan I, Kelly-Hayes M, Kenton EJ, Marks M, Schwamm LH, Tomsick T. Guidelines for prevention of stroke in patients with ischemic stroke or transient ischemic attack: a statement for healthcare professionals from the American Heart Association/American Stroke Association Council on Stroke: co-sponsored by the Council on Cardiovascular Radiology and Intervention: the American Academy of Neurology affirms the value of this guideline. *Circulation* 2006; 113(10):e409-449.
48. Adams RJ, Albers G, Alberts MJ, Benavente O, Furie K, Goldstein LB, Gorelick P, Halperin J, Harbaugh R, Johnston SC, Katzan I, Kelly-Hayes M, Kenton EJ, Marks M, Sacco RL, Schwamm LH. Update to the AHA/ASA recommendations for the prevention of stroke in patients with stroke and transient ischemic attack. *Stroke* 2008; 39(5):1647-1652.
49. O'Brien SM, Shahian DM, Filardo G, Ferraris VA, Haan CK, Rich JB, Normand SL, DeLong ER, Shewan CM, Dokholyan RS, Peterson ED, Edwards FH, Anderson RP. The Society of Thoracic Surgeons 2008 cardiac surgery risk models: part 2--isolated valve surgery. *Ann Thorac Surg* 2009; 88(1 Suppl):S23-42.
50. Pauwels RA, Buist AS, Calverley PM, Jenkins CR, Hurd SS. Global strategy for the diagnosis, management, and prevention of chronic obstructive pulmonary disease. NHLBI/WHO Global Initiative for Chronic Obstructive Lung Disease (GOLD) Workshop summary. *Am J Respir Crit Care Med* 2001; 163(5):1256-1276.
51. Levey AS, Coresh J, Balk E, Kausz AT, Levin A, Steffes MW, Hogg RJ, Perrone RD, Lau J, Eknoyan G. National Kidney Foundation practice guidelines for chronic kidney disease: evaluation, classification, and stratification. *Ann Intern Med* 2003; 139(2):137-147.
52. Zoghbi WA, Chambers JB, Dumesnil JG, Foster E, Gottdiener JS, Grayburn PA, Khandheria BK, Levine RA, Marx GR, Miller FA, Jr., Nakatani S, Quinones MA, Rakowski H, Rodriguez LL, Swaminathan M, Waggoner AD, Weissman NJ, Zabalgoitia M. Recommendations for evaluation of prosthetic valves with echocardiography and doppler ultrasound: a report From the American Society of Echocardiography's Guidelines and Standards Committee and the Task Force on Prosthetic Valves, developed in conjunction with the American College of Cardiology Cardiovascular Imaging Committee, Cardiac Imaging Committee of the American Heart Association, the European Association of Echocardiography, a registered branch of the European Society of Cardiology, the Japanese Society of Echocardiography and the Canadian Society of Echocardiography, endorsed by the American College of Cardiology Foundation, American Heart Association, European Association of Echocardiography, a registered branch of the European Society of Cardiology, the Japanese Society of Echocardiography, and Canadian Society of Echocardiography. *J Am Soc Echocardiogr* 2009; 22(9):975-1014; quiz 1082-1014.
53. Schultz CJ, Moelker A, Piazza N, Tzikas A, Otten A, Nuis RJ, Neefjes LA, van Geuns RJ, de Feyter P, Krestin G, Serruys PW, de Jaegere PP. Three dimensional evaluation of the aortic annulus using multislice computer tomography: are manufacturer's guidelines for sizing for percutaneous aortic valve replacement helpful? *Eur Heart J*; 31(7):849-856.



SURTAVI

Surgical Replacement and Transcatheter Aortic Valve Iplantation

Appendix

VERSION 12.0

31 May 2016

Sponsor:

Medtronic, Inc.
Clinical Research
Mailstop: MVS66
Mounds View South
8200 Coral Sea St NE
Mounds View, MN 55112 USA

Medtronic Bakken Research Center
Coronary and Structural Heart Department
Endepolsdomein 5
6229 GW Maastricht
The Netherlands

TABLE OF CONTENTS

R	APPENDICES.....	124
R.1	Sample Informed Consent.....	124
	R.1.1 United States.....	125
	R.1.2 United States – Roll-in Subjects.....	140
	R.1.3 Europe.....	153
	R.1.4 Canada.....	166
	R.1.4 Canada – Roll-in Subjects.....	182
R.2	List of Participating Investigational Centers	198
R.3	Other Institutions.....	199
R.4	Additional Records and Reports.....	200
R.5	Sample Case Report Forms	201
R.6	Aortogram Acquisition Guidelines	202
R.7	Echocardiography Acquisition Guidelines	204
R.8	Electrocardiogram (ECG) Submission.....	225
R.9	Computed Tomography (CT) Angiography Acquisition Guidelines.....	226
R.10	Interactive Voice/Web Response System (IXRS)	238
R.11	Explanted Device/Pathology and Return Procedures	239
R.12	Economic and Quality of Life Data Collection	241
	R.12.1 Health Economic Data Collection	241
	R.12.2 Quality of Life Data Collection	241
	R.12.2.1 Schedule of Assessments	241
	R.12.2.2 Questionnaires.....	242
R.13	Pacing Guidelines.....	243
R.14	Six Minute Walk Test Instructions	247
R.15	National Institute of Health Stroke Scale (NIHSS)	260
R.16	Modified Rankin Scale (mRS) Instructions.....	264
R.17	Mini Mental State Exam (MMSE-2:SV)	265
R.18	Additional Neurological Assessments	266
R.19	Medtronic CoreValve™ Clinical Assessment Guidelines	268
R.20	Katz Index of Independence in Activities of Daily Living	269
R.21	Investigator Brochure / Report of Prior Investigations for the Investigational Devices ...	270
R.22	Investigational Devices Instructions For Use	271
R.23	Radiation Exposure and Data Collection.....	272
R.24	SURTAVI Risk Model	275
	R.24.1 SURTAVI Risk Model Rationale	275
	R.24.2 SURTAVI co-morbidity list	278
R.25	CMS Considerations for Coverage and Reimbursement – US ONLY	282

R.1 Sample Informed Consent

Attached are the informed consent form templates:

- United States
- United States - *Roll-in Subjects*
- Europe
- Canada
- Canada – *Roll-in Subjects*

R.1.1 R.1.1 United States

INFORMED CONSENT FORM**Medtronic CoreValve™ SURTAVI Trial**

You are being asked to read this form so that you understand this research study and how you might take part in it. By signing this form, you will show that you understand and that you agree to take part in this research study. Your signature on this form is required before you can take part in this research study.

BACKGROUND

You are being asked to take part in a research study entitled “*Medtronic CoreValve™ SURTAVI Trial*” because you have a disease of your aortic valve. This disease is called aortic stenosis.

The aortic valve is one of the four heart valves that control the flow of blood into and out of the heart. The aortic valve lets oxygen-containing blood to be pumped out of the heart, from the left ventricle (main pumping chamber of the heart) into the aorta (main artery delivering blood to the body). If the valve becomes abnormally narrow through a process of thickening and stiffening (aortic stenosis) the heart must work harder to pump the same amount of blood with each beat.

As the heart works harder, the heart muscle thickens (hypertrophy), and the heart chamber (ventricle) may become larger (dilate). Open-heart surgery to replace the diseased aortic valve is the standard treatment.

As an alternative to open heart surgery, the Medtronic CoreValve™ System and Medtronic CoreValve™ Evolut R™ System have been developed to replace a diseased aortic heart valve without the need for open heart surgery. This system allows the percutaneous aortic valve (study valve) to be implanted (inserted) through a long, thin flexible tube that is inserted through an incision in the skin and threaded through the bloodstream (percutaneous).

A description of this clinical trial will be available on <http://www.ClinicalTrials.gov>, as required by U.S. Law. This website will not include information that can identify you. At most, the website will include a summary of the results. You can search this website at any time.

You are being asked to participate in this study because doctors have determined your aortic valve is no longer working properly. However, your doctors have also decided that your risk of experiencing major problems while undergoing open-heart surgery is moderate due to medical reasons or anatomical reasons (relating to how and where your heart, aortic valve and blood vessels are placed within your body). This means that you doctor believes your health is acceptable for open-heart surgery, but there are still a risk of potential problems.

PURPOSE OF THE STUDY

The purpose of this clinical study is to determine if replacing the aortic valve without open-heart surgery is as safe as or safer than open-heart surgery in patients with similar medical conditions as you.

The study valve is considered an “investigational device”, which means that clinical studies are required to determine if it is safe and provides clinical benefit. Medtronic, Inc. is sponsoring this study to obtain data on the safety and performance of the investigational device. The Medtronic CoreValve™ System and Medtronic CoreValve™ Evolut™ R System includes the valves described below and two parts that help load and deliver the valves correctly.

This study will involve approximately 1600 subjects at up to 115 hospitals in the United States and around the world, and is anticipated to take approximately 8 years to complete. Your participation in

this study is expected to last approximately five years from the day you are enrolled in the study. Annual follow-up may be extended to up to 10 years after the implant procedure.

STUDY DEVICES

Both study valves are made from animal tissue attached to a metal frame.

The study valves are designed to be implanted (inserted) using a delivery system catheter (long, thin flexible tube) to replace your diseased aortic heart valve without open-heart surgery. A unique feature of the Evolut R device is that it can be re-captured, making it easier for doctors to place the device in a correct position. Once it is implanted, CoreValve™ study valves acts in the same method of the native valve.

The Medtronic CoreValve system is approved by the US Food & Drug Administration (FDA) since 2014 and in other parts of the world since 2006. It has been implanted in over 45,000 patients. The Medtronic CoreValve™ System is currently approved for use in Europe, South America, and parts of Asia. The Medtronic CoreValve™ Evolut™ R system is currently approved in US and Europe.

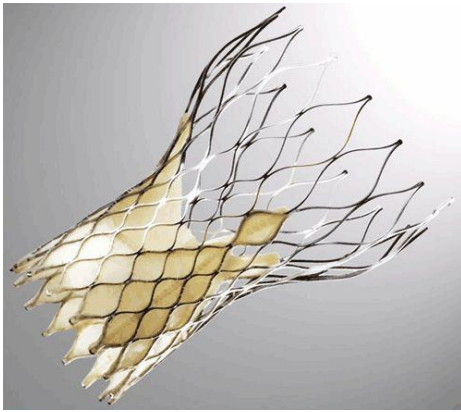

Figure 10: Medtronic CoreValve™ “Study Valve”



Figure 11: Medtronic CoreValve™ Evolut™ R “Study Valve”

PROCEDURES TO BE FOLLOWED

If you agree to be in this study, and after you have signed this informed consent form, data such as your age, gender, medical history and medication use will be recorded. You will undergo the following tests:

- Physical examination
- Computed tomography (CT) - a scan performed using an x-ray machine, which is linked to a computer to take pictures of your body. Sometimes a CT will require the use of a type of dye that makes the kidneys work harder and may be harmful to the kidneys. You may have an MRI in place of a CT scan if your doctor believes your kidneys are not working well enough for you to have a CT scan. MRI stands for magnetic resonance imaging and is a test that uses a strong magnet and a complex computer system to produce detailed images of your internal organs and soft body tissues.
- Blood tests (about 2 tablespoons)
- Echocardiography [transthoracic echocardiogram (TTE)] - a test that uses sound waves to take pictures of your heart and measure the degree of narrowing of your aortic valve; a probe with gel is placed on the outside of your chest to take pictures of your heart
- Electrocardiogram (ECG) - a test that records electrical impulses of your heart; patches are placed on the outside of your chest
- Heart catheterization/angiography - a test that takes pictures of your heart and blood vessels; a special dye is injected through long, flexible tubes into the coronary arteries (vessels delivering blood to the heart) and bypass grafts if you have them

If you are of child-bearing potential, we will ask you to take a pregnancy test. If you are pregnant, you will not be able to participate in this study.

These procedures and tests are standard procedures and are not experimental. If you have already had any of these tests performed before, they may to be used for the study if your study doctor determines they don't need to be repeated for study purposes.

The results from your exams and tests will be reviewed by your doctor and a committee of study doctors who will determine if you are eligible to be in the study.

Your study doctor and the committee may determine after reviewing your test results that you are not eligible to be in the study and/or it will not be possible to implant the study valve. If so, you will not be allowed to participate in the study.

If your doctor and the committee decide you are eligible to be in the study your treatment will be determined in a way similar to flipping a coin, called randomization. You will be assigned to one of two groups. One group will receive a transcatheter aortic valve implant (TAVI), the other group will receive open-heart surgical aortic valve replacement (SAVR). On average, one out of every two participants will receive TAVI. The other participants will receive SAVR. You will not be able to choose your treatment assignment.

Your enrollment in the study will begin once you sign this consent and you are assigned to your treatment group.

If you are enrolled in the study, you will be required to have the following additional tests completed within 14 days prior to the procedure (TAVI or SAVR):

- Physical exam, including a determination of neurological (brain) status where you will be asked to answer a series of questions and perform a series of tasks such as writing and drawing
- Blood tests (about 2 tablespoons)
- Walking test – a test that records your breathing, heart rate, and how you feel after 6 minutes of walking

- Electrocardiogram (ECG) - a test that records electrical impulses of your heart; patches are placed on the outside of your chest

You will also be asked to complete surveys about the quality of your life and your ability to do normal daily activities, called Quality of Life Questionnaires (QOL).

Your personal physician will be informed about your participation in this clinical study.

If you are assigned to the TAVI group:

The study valve is an experimental valve which means you can only receive the valve if you are part of this study. Your study doctor will decide if you will either receive the Medtronic CoreValve™ System or the Medtronic CoreValve™ Evolut™ R System.

Before the TAVI procedure, it will be strongly recommended that you take blood thinning medications, used to prevent your blood from clotting (thickening). These medications will be described to you by your study doctor. You may be advised to continue these medications for at least three months following your procedure.

Before the procedure you will be given an antibiotic (a medicine that kills bacteria or germs) to decrease your chance of developing an infection. Your study doctor will choose the antibiotic that he or she thinks is best suited for you and decide whether you need additional medication.

You will also have blood tests (about 2 tablespoons) and an ECG before the procedure.

Immediately prior to the procedure, you will receive medications to make you more relaxed and comfortable during the procedure. Your study doctor may decide that general anesthesia is necessary, meaning you need to be put to sleep for the procedure. Your doctor will inform you of this need before the procedure. Additionally, if your study doctor decides that it is necessary during the procedure, you will be put under general anesthesia at that time.

Your study doctor will decide what locations are best for inserting the long, thin flexible tubes required for TAVI and getting all of the pictures that are necessary. These pictures are described in the next paragraphs. Additionally, your study doctor will decide if performing a surgical incision to any of the site(s) is necessary.

During the procedure you may have a transesophageal echocardiogram which is also called a TEE. This test uses sound waves to take a closer look at the inside structures of the heart. If your doctor decides these pictures are necessary, to perform the test you will swallow a thin flexible tube with a special tip. This tube sits in the esophagus (the tube that connects the mouth to the stomach). The special tip of the tube sends out sound waves (ultrasound) that echo within the chest wall. The esophagus is located behind the heart so these echoes are picked up and create a picture of the heart that is displayed on a video monitor. The pictures will allow your study doctor to take a closer look at your valve.

You will have a temporary pacemaker put in place during the TAVI procedure. A temporary pacemaker is a thin wire inserted through your skin and into one of your veins and threaded through your vein into the right side of your heart. The wire is attached to a battery operated device outside of your body. This temporary pacemaker will help keep your heart rate (speed) and rhythm steady. This temporary pacemaker will not be removed for at least 48 hours after your TAVI procedure.

After your study doctor has taken a good look at your valve, a balloon valvuloplasty will be performed. Balloon valvuloplasty is a procedure used to widen a stiff or narrowed heart valve. A wire and a thin tube are guided by x-rays through the heart and positioned through the diseased heart valve. A balloon is placed over the wire and inflated, enlarging the opening through the diseased valve allowing the study valve to be placed.

Your doctor will then implant (insert) the study valve through the long, thin flexible tube that is inserted through an incision in the skin and threaded through the bloodstream. TAVI is performed using x-ray machines which will allow your doctor to see the study valve, your blood vessels and

heart. The study valve will be guided through your blood vessels to your existing aortic valve and then the study valve will be placed over your existing valve.

During the TAVI procedure, your doctor will perform angiography (x-ray pictures) and ECGs (recordings of the electrical impulses of your heart through patches placed on the chest) to observe your heart function and make sure that the study valve fits and works properly.

Doctors from other hospitals who have experience with the TAVI procedure may assist your study doctor with the procedure. Medtronic staff may assist the physician in the loading of the study valve.

If you are assigned to the SAVR group:

Open heart surgery, surgical repair and/or replacement of your aortic valve, are not experimental procedures.

If you are assigned to the SAVR group, your doctors will replace your diseased aortic valve through open heart surgery. During surgery, you are asleep under general anesthesia. SAVR often requires a median sternotomy, where the bone in the center of the chest (sternum) is split down the middle. The chest is then opened to provide your doctor with access to the heart and chest cavity, in order to replace your aortic valve. Your surgery is performed while the function of your heart is taken over by a heart lung machine (called CPB for cardiopulmonary bypass).

You may have a TEE (a thin tube sits in the esophagus and sends out sound waves to create a picture of your heart) and a temporary pacemaker (thin wire threaded through your vein to right side of heart to keep your heart rate and rhythm steady) during the procedure.

Your doctor may remove any tissue and calcium deposits that are interfering with the normal function of the valve. Your damaged valve may be completely removed. The new valve will be sewn into the space where your own valve used to be. After your doctor makes sure your valve is working properly, blood flow will be restored to your heart and the incisions will be closed. You will also have blood drawn for testing before and after the procedure.

If your doctor is unable to implant (insert) the study valve in you during the TAVI or SAVR procedure, you will still be considered enrolled in the study and will need to return to the clinic for the required follow-up visits as described in the "Follow-up Visits after TAVI and SAVR" section.

After TAVI and SAVR Procedure:

After the TAVI and SAVR procedure, your study doctors will continue to monitor your progress and recovery.

You will have the following tests performed within the two days following the procedure and before you are discharged from the hospital:

- Determination of neurological (brain) status where you will be asked to answer a series of questions and perform a series of tasks
- Blood tests (about 2 tablespoons)
- Echocardiogram (TTE)
- ECG

Follow-up Visits after TAVI and SAVR:

You will need to return to the clinic for required follow-up visits at 30 days, 6 months, 12 months (1 year), 18 months, 24 months (2 years), and 3, 4, and 5 years after the procedure. Most of the follow-up tests and examinations are routine, not experimental. Each visit will take about 1 ½ to 2 hours.

Your evaluations at 30 days, 6 and 18 months will include:

- Physical examination, including a determination of neurological (brain) status where you will be asked to answer a series of questions and perform a series of tasks

- You will be asked about your health since the last follow-up visit
- Quality of Life Questionnaires
- ECG
- Blood tests (about 2 tablespoons) – 30 day visit only
- Walking test – 30 day visit only
- Echocardiogram (TTE) – 6 month visit only

Your evaluation at 12 months, 24 months, and 3, 4, 5 years will include:

- Physical examination, including a determination of neurological (brain) status where you will be asked to answer a series of questions and perform a series of tasks
- You will be asked about your health since the last clinic visit
- Blood tests (about 2 tablespoons)
- Echocardiogram (TTE)
- Quality of Life Questionnaires
- ECG
- Walking test – 12 and 24 months visits only

In addition to the in-clinic follow-up visits, at 3 months you will be contacted via phone to complete a Quality of Life Questionnaire.

If, during the 5 years of follow-up, you have additional heart surgeries or cath lab procedures to work on or replace your aortic valve or study valve, you will be asked to answer questions and perform activities that will help the study doctors and nurses to determine your neurological (brain) status within 24 hours after each additional procedure.

If you have a stroke, have been informed by a doctor that you experienced a stroke, or experience any of the following symptoms, notify Dr. **Principal Investigator** at xxx-xxx-xxxx as soon as possible: sudden numbness, tingling, loss of movement (especially on 1 side of the body), vision changes, confusion or trouble understanding simple statements, severe headaches, or seizures. Any of these symptoms could indicate that you are having problems with your neurological (brain) function. If a doctor confirms that you had a stroke, you will be asked to come to the clinical to have tests performed to determine your neurological (brain) status where you will be asked to answer a series of questions and perform a series of tasks. These tests will be performed at 7 days, 30 days and 3 months after you have any of these symptoms.

If you have any other problems or complications, are seen by any other doctors for problems, or are hospitalized during your participation in this study you should immediately notify Dr. **Principal Investigator** at xxx-xxx-xxxx.

If the study valve is removed for any reason, we will request that it be returned to Medtronic for additional analysis. Your study doctor will determine if you will need to have another valve implanted.

In the event of your death, we will request an autopsy. We will also request that either the whole heart and valve or just the valve are removed and returned to Medtronic for additional analysis.

The autopsy and the removal of the heart and/or valve would be done to provide additional information about the research and the investigational valve.

Your family and your "legally authorized representatives", have the right to refuse the autopsy and refuse the request to remove the heart and/or valve even if you sign this consent form.

TAVI

Potential risks associated with the implantation of the study valve may include, but are not limited to, the following:

- **Death**
- **Cardiac arrest** – heart stops beating and blood flow through the body is interrupted or stopped
- **Coronary occlusion, obstruction, or vessel spasm (including acute coronary closure)** – blockage or closure of an artery that supplies the heart with blood
- **Emergent surgery**
 - Coronary artery bypass – (CABG) a surgery where the chest is opened to place new vessels around the existing blocked vessels of the heart to improve blood supply to the heart.
 - Heart valve replacement – replacing the existing heart valve with a new heart valve
 - Valve explant – the removal of the existing valve
- **Multi-organ failure** – more than one organ of the body not functioning correctly
- **Heart failure** – heart does not pump blood to the body
- **Myocardial infarction** - decreased blood flow to the heart causing death of heart muscle cells
- **Cardiogenic shock** – failure of the heart to pump enough blood to the body organs
- **Respiratory insufficiency or respiratory failure** – not enough oxygen or not able to supply oxygen to the body
- **Cardiovascular injury (including rupture, perforation, or dissection of vessels, ventricle, myocardium, or valvular structures that may require intervention)**
- **Perforation of the myocardium or a vessel** – a hole in the heart muscle or a blood vessel
- **Ascending aorta trauma** – injury to the large blood vessel leading blood away from the heart
- **Cardiac tamponade** – the constriction or inability of the heart to pump due to buildup of blood or fluid around the lining of the heart
- **Cardiac failure or low cardiac output**
- **Prosthetic valve dysfunction including, but not limited to:**
 - Fracture (break) in the valve frame
 - Bending of the valve frame
 - The valve frame does not open (expand) all the way
 - Calcification (build-up of calcium on the valve)
 - Pannus – the formation of scar tissue that may cover or block the valve from functioning normally
 - Wear, tear or movement forward (prolapse) or backward (retraction) from the normal position of the valve leaflets
 - The valve leaflets do not close together
 - A break in the stitches (sutures) of the valve frame or leaflets
 - Leakage through or around the valve or valve frame
 - Incorrect size of the valve implanted
 - Incorrect position of the valve, either too high or too low
 - Regurgitation – backward flow of blood through the valve
 - Stenosis – narrowing of the opening of the valve

- **Thrombosis/embolus (including valve thrombosis)** - an abnormal particle (air, blood clots) floating in the blood stream or attached to an object, including the valve
- **Valve migration/valve embolization** – upward or downward movement of the device from where it was originally placed
- **Ancillary device embolization** – a broken piece of the tube that delivers the valve floating in the blood stream
- **Emergent percutaneous coronary intervention (PCI)** – a procedure through the vessels inside the body and heart used to treat or open narrowed vessels of the heart
- **Emergent balloon valvuloplasty** (balloon valvuloplasty during the TAVI procedure is expected) – a procedure through the vessels inside the body and heart in which a narrowed heart valve is stretched open by a balloon
- **Bleeding that may or may not require transfusion or intervention**
- **Allergic reaction to:**
 - Antiplatelet agents (blood thinning medication)
 - Contrast medium (dye used to see vessels with x-ray), or
 - Anesthesia (medication used to put you to sleep during the procedure)
- **Infection (including septicemia and endocarditis)** – an abnormal growth of germs in the body or body part
- **Stroke, TIA, or other neurological deficits** – decreased blood flow to the brain causing death of brain cells
- **Permanent disability** – injury that does not allow that impairs normal/previous physical or mental function
- **Renal insufficiency or renal failure (including acute kidney injury)** – failure of the kidneys to work correctly
- **Mitral valve regurgitation or injury** – a leaking valve between the left upper (left atrium) and left lower (left ventricle) parts of the heart where blood flows backward through the valve or damage to the valve that may cause it to not function correctly
- **Tissue erosion** – damage to the tissue of the heart or blood vessels that could result in a tear or hole
- **Vascular access related complications, such as:**
 - Dissection - a tear in a blood vessel
 - Perforation – puncture of a blood vessel
 - Pain
 - Bleeding
 - Hematoma –blood collecting under the skin
 - Pseudoaneurysm - blood collecting on the outside of a vessel wall causing a balloon-like widening
 - Irreversible nerve damage – permanent damage to nerves
 - Compartment syndrome – squeezing of nerves and muscles in a closed space that could cause muscle or nerve damage
 - Arteriovenous fistula – abnormal connection between an artery vessel that takes blood away from the heart and a vein vessel that takes blood to the heart
 - Stenosis – narrowing of a vessel (artery)
- **Cardiac arrhythmias**
 - Disturbances in the electrical system of the heart that may result in the permanent placement of a device (pacemaker) that delivers electrical impulses to the heart to help your heart beat normally

- Atrio-ventricular node block – a block in the electrical path from the top part of the heart (atria) to the bottom part of the heart (ventricle)
- Bundle branch block – a delay or block in the electrical path in the bottom part of the heart (ventricle)
- Asystole – when the heart stops beating
- Ventricular arrhythmias – abnormal fast or slow heart beats in the lower part of the heart (ventricles)
- **Encephalopathy** – altered mental state
- **Pulmonary edema** – fluid build-up in or in the space around the lungs
- **Pericardial effusion** – fluid around the heart
- **Pleural effusion** – fluid build-up in the space around the lungs that makes breathing difficult
- **Myocardial ischemia** – reduced or interrupted blood supply to the heart
- **Peripheral ischemia** – reduced or interrupted blood supply to arms and legs
- **Bowel ischemia** – decrease blood supply to the intestines
- **Heart murmur** – an extra or unusual sound hear during a heartbeat
- **Hemolysis** – break down of blood cells
- **Cerebral infarction-asymptomatic** – silent stroke
- **Non-emergent reoperation**
- **Inflammation** – swelling of tissue
- **Fever** – increase in body temperature
- **Hypotension or hypertension** – low or high blood pressure
- **Syncope** – fainting
- **Dyspnea** – shortness of breath
- **Anemia** – not enough oxygen carrying cells in the blood
- **Angina** – chest pain
- **Abnormal lab values (including electrolyte imbalance)** – changes in blood test results
- Exposure to radiation through fluoroscopy and angiography
- Delivery catheter malfunction resulting in need for additional re-crossing of the aortic valve and prolonged procedural time

There may also be additional risks, discomforts, or side effects that are not yet known.

SAVR

Although SAVR is not experimental there are potential risks associated with the procedure. These risks are the same even if you undergo the SAVR procedure and you decide not to participate in this study. Some of these risks include, but may not be limited to the following:

- Obstruction of blood flow to the heart (angina) resulting in damage to the heart tissue
- (myocardial infarction/heart attack)
- Abnormal heart beat (cardiac arrhythmia and dysrhythmia)
- Blood leaking around the outside of the prosthetic valve (paravalvular leak) or any
- Problem with the valve that causes leaking of blood after the valve has closed (transvalvular leak).
- Damage to red blood cells (hemolysis) that can result in anemia (decreased red blood cells)
- Death

- Inflammation of the lining of the heart (endocarditis)
- Heart failure
- Any problem with the prosthetic valve that causes narrowing of the valve opening (stenosis)
- Blood clots that develop in the heart or on the replacement valve. These clots may break loose and travel through the bloodstream (thromboembolism). This problem may cause stroke (decrease blood flow to the brain causing damage to the brain) or heart attack
- Failure of the valve to open and close properly

If you become pregnant there maybe risks, discomforts, or side effects to you and the embryo/fetus that are not yet known. Please notify your study doctor as soon as possible to discuss any of these potential risks.

RADIATION EXPOSURE RISKS

Some of the test and procedures that are part of this study require exposure to radiation (x-rays). These tests or treatments involve a small amount of radiation. To give you an idea about how much radiation you will get, in the following descriptions the radiation is compared to the amounts that people are exposed to in daily life. There is radiation that naturally occurs from space and from rocks in the soil. This natural radiation is greater at higher altitudes.

CT of Chest and Abdomen and Coronary Angiography

The radiation exposure received from the screening tests (CTA of abdomen and thorax and coronary angiogram) is approximately 10 times the radiation exposure received in one year from background radiation (naturally occurring radiation you are exposed to everyday). The exposure is less than the radiation exposure limit an occupational worker is allowed to receive in one year.

Valve implantation

The estimated radiation exposure for the valve procedure is approximately 10-15 times the amount of radiation exposure received in one year from background radiation (naturally occurring radiation you are exposed to everyday). The exposure is approximately the amount an occupational worker is allowed to receive in one year.

There are additional risks or side effects from being exposed to x-rays. Most side effects do not occur often and resolve without major problems. It is possible that skin reddening or other alterations to the skin's appearance may occur if you are exposed to enough radiation during the procedure or if you have recently had another cardiac angiogram. You should contact your doctor in the event that you observe this. If you have a reaction to the x-rays you may need to have extra follow-up visits with your doctor to watch your recovery more closely.

Your doctor will explain to you how many x-rays you will receive, what x-rays are part of your normal care and what, if any, are extra for the study.

POSSIBLE BENEFITS

The possible benefits you may receive from participating in this research are that you may be able to receive a new heart valve without having open-heart surgery. Another possible benefit is that your new valve may work better than the way your diseased valve currently works. This may improve how you feel and may improve your daily activity.

Your participation in this research may improve procedures that may guide the future treatment of heart surgery, by using procedures that are less invasive, meaning less cutting, entering or breaking through the body, which may benefit others in the future. However, there is no guarantee that you will benefit from being in this research.

ALTERNATIVE TREATMENTS

The current long-term effective treatment for severe aortic stenosis is open heart surgery to replace the aortic valve. For patients who are at high risk for open heart surgery, other treatment options

include percutaneous (through an artery in the groin) aortic valve implantation, or medical management to relieve symptoms, which may include balloon valvuloplasty. Ask your study doctor about other treatment options you may have.

IF PROBLEMS DEVELOP

If you believe that you have been injured as a result of your participation in the study, you should notify Dr. Principal Investigator at xxx-xxx-xxxx as soon as possible or in serious cases, go to the emergency room.

Immediate necessary medical care is available at [Name of institution(s)] in the event that you are injured as a result of your participation in this research study.

If you are assigned to the TAVI group

Immediate necessary medical care is available at [name of institution] in the event that you are injured as a result of your participation in this research study.

For those patients receiving the investigational device and the TAVI procedure,

Medtronic has agreed to pay back [name of institutions that are parties to the CTA] for the costs of medical or surgical care they provide for any serious and unanticipated illness or injury under the following conditions:

- The illness or injury must be related to a defect or malfunction of the investigational device or in the TAVI procedure as described in the Protocol, and not related to procedures that are routine standard of care.
- The illness or injury cannot be caused by (a) the negligence or intentional misconduct of the study staff or [name of institutions that are parties to the CTA]; (b) because the study staff or [name of institution(s)] that are parties to the CTA did not follow the protocol for the study; or (c) the natural progression of your illness.
- The illness or injury must have happened before the study closes (last patient is seen for the 5 year follow-up visit) at this [Name of institution(s)].
- [Name of institution(s) that are parties to the CTA] must notify Medtronic within one year of the date the study closes at all study sites or before the study closes at this site, whichever is earlier.

Subject to the above conditions, Medtronic will pay back the costs that are not covered by your health insurance or Medicare. The amount Medtronic will pay back is the amount Medicare pays [name of institution(s) that are parties to the CTA] plus 10%.

If you are assigned to the SAVR group

In the event of physical injury or physical illness related to a procedure required for the SAVR group, no monetary compensation or subsidized (paid) will be provided. Medical treatment will be routinely provided to you by any person involved in this study including the study doctors, or the hospital. Any immediate medical treatment, however, that may be necessary will be provided.

By agreeing to the above, you do not waive any of your legal rights which you otherwise would have as a research subject, nor do you release the study sponsor (Medtronic, Inc.), study doctors, or the hospital from liability for negligence.

PAYMENT FOR PARTICIPATION IN THE STUDY

You will not be paid to take part in the study. However, you may be reimbursed for local mileage and parking expenses directly related to any study related visits. Your study doctor or research coordinator will tell you how to get reimbursement.

There is no monetary advantage to the study doctor for participation in this study.

MEDICAL EXPENSES

Your private or public health insurance company (for example Medicare) will be billed for the valve procedure and the cardiac catheterization and other procedures that are required by the study and you will be responsible for paying for any co-payment, co-insurance or deductible. It is possible that your private or public health insurance will not pay for some or all of the procedures, including the valve procedure or the cardiac catheterization procedure because you are participating in this study. Any costs not covered by your public or private insurance will be your responsibility. You should discuss the estimate of these costs with your study doctor. You will not be charged for the cost of collecting the data for this study and other clinic visits and diagnostic tests done solely for the purposes of this study.

BASIS OF PARTICIPATION

Your participation in this study is voluntary. If you refuse to be in this study there will be no penalty or loss of benefits to which you are otherwise entitled. You may withdraw from the study at any time and will not lose your benefits or be treated any differently as a result of withdrawing from the study. Any new findings (decisions or conclusions) that may influence your willingness to participate will be provided to you. If you decide to leave the study before it is finished, please tell one of the persons listed in the section below “Obtaining Additional Information”. It may be requested that, if you withdraw, you return to your study doctor for a final visit.

The study doctor may end your participation in the study at any time if:

- He or she determines it is not in the best interest of your health
- The study doctor loses contact with you and you do not return for your study visits as scheduled
- You refuse to allow the use of private health information during the course of the study

The study doctor will make the decision and let you know if it is not possible for you to continue in the study.

You may be removed from the study without your consent if the sponsor (Medtronic, Inc.) ends the study. If this happens, you will be notified and the reasons will be explained to you. Your physician will continue to provide the appropriate medical therapy.

PERMISSION FOR ACCESS TO AND USE OF HEALTH INFORMATION

This section governs how your health information will be used and shared by the study doctors during and after the study. The health information that may be used and shared includes all information collected during the study and any health information in your medical records that is relevant to the study.

1. PROVIDERS’ DISCLOSURE OF HEALTH INFORMATION IN YOUR RECORDS

You agree to permit [hospital and/or clinic], your doctors, and your other health care providers (“Providers”) to share health information in your medical records with [investigator(s)] and [his/her/his/her/its] staff (“Researchers”). You agree to permit Providers to share your health information:

- With the Researchers;
- With the study sponsor, Medtronic, Inc. and its agents and contractors (together “Medtronic”);
- As required by law;
 - With government organizations and review boards required to watch over the safety and effectiveness of medical products and therapies and the conduct of research; and
 - With other persons who are required to watch over the safety and effectiveness of medical products and therapies and the conduct of research.

2. RESEARCHER’S USE AND DISCLOSURE OF YOUR HEALTH INFORMATION

You agree to permit the Researchers to use and share your health information:

- Among themselves to conduct the study;
- With other researchers in the study to conduct the study;
- With Medtronic;
- With government organizations and review boards required to watch over the safety and effectiveness of medical products and therapies and the conduct of research; and
- With other persons who are required to watch over the safety and effectiveness of medical products and therapies and the conduct of research.

Once Providers or Researchers have shared your health information with a third party, the information may be subject to further sharing by the third party. Federal privacy laws may no longer protect it from further sharing.

While the study is in progress, you will not be allowed to see your health information that is created or collected for the study. After the study is finished, you may see this information as described in the [hospital/clinical trial site]'s Notice of Information practices.

This permission to share your health information does not have an ending date. You do not have to give this permission, but if you do not, you will not be allowed to be in the study. You may change your mind and take back this permission to use your health information at any time. To take back this permission, you must write to [name and contact information]. If you take back this permission, you cannot continue in the study. Even if you take back this permission, Medtronic and Researchers may continue to use and share the health information already received as described in this informed consent

Economic Study

This study contains a health economics review that will be done to compare the in-hospital, 12 month and 24 month follow-up medical care resource utilization and cost for patients in each of the treatment groups. As part of this study, you may be asked to sign a separate document that gives us your permission to review your billing information sent directly from the Medicare system in order to evaluate medical cost data. This information will be kept strictly confidential and be used solely to assess the medical expenses which occur as a direct result of participating in the Medtronic CoreValve™ SURTAVI Trial.

Quality of Life Questionnaire

Medtronic CoreValve™ SURTAVI Trial will also contain a quality of life study. As part of this study, your research coordinator will have you or your legal representative complete a questionnaire called a Quality of Life Questionnaire. You will need to complete this questionnaire when you are enrolled in the study and 1 month, 3 months, 6 months, 12 months, 18 months, 2 years, 3 years, 4 years and 5 years after your study procedure.

OBTAINING ADDITIONAL INFORMATION

You are encouraged and have the right to ask questions at any time concerning potential and/or known risks of this study. The study doctor will inform you of any new significant information, when it becomes available, which may affect your willingness to continue to participate in this study. If you have any questions about this study or if you experience any health problems, you should contact Dr. Principal Investigator at xxx-xxx-xxxx.

If you have questions about your rights as a participant in this study, you should contact the chairman of the Institutional Review Board at xxx-xxx-xxxx.

MEDTRONIC'S USE AND DISCLOSURE OF YOUR HEALTH INFORMATION

This section describes what Medtronic as study sponsor will do with the study data, including your health information received during the study.

Medtronic will keep your health information confidential in keeping with all applicable laws and regulations. Medtronic may use your health information to conduct this study. Medtronic may use your health information for other purposes, such as:

- Watch over and improve the performance of its device;
- New medical research;
- Proposals for making new medical products or procedures; and
- Other business purposes.

Any reports or publications about the study or any other research will not include your name or a description of you. Any records identifying you will not be made publically available. Information received during the study will not be used to market to you; your name will not be placed on any mailing lists or sold to anyone for marketing purposes.

The US Food and Drug Administration's regulations, as well as other applicable laws, control Medtronic's work in developing and assuring the safety and quality performance of its medical devices. Medtronic may disclose your health information to the FDA, as well as to other US and foreign government authorities responsible for assuring the safety of medical devices. Medtronic also may disclose your health information to institutional review boards and other persons who are required to watch over the safety and effectiveness of medical products and therapies and the conduct of research. You agree to allow Medtronic to use study data in these ways. You also agree to allow FDA and other governmental authorities to inspect your health information.

PRIMARY CARE PHYSICIAN / SPECIALIST NOTIFICATION OPTION

Please indicate below whether you would like us to notify your primary care physician or your specialist of your participation in this study.

(Initial only one box).

Yes, I want the study doctor to inform my primary care physician/specialist of my participation in this study

No. I do not want the study doctor to inform my primary care physician/specialist of my participation in this study.

I do not have a primary care physician/specialist.

The study doctor is my primary care physician/specialist.

CONSENT

I confirm that:

- I have read the informed consent form of this study and my physician has answered all my questions regarding the study.
- I had sufficient time to consider my participation into this study, I am aware that participation into this study is completely voluntary, and I agree to follow the instructions from the investigator.
- I realize that I may decide to refuse participation or stop participation at any time without penalty and without affecting the quality of my health care or the relationship with my physician.
- I understand and agree that personal information about me will be collected from my medical records, used and processed (manually and by computer) by the manufacturer of a medical device used in my treatment or any other designated party that is involved in the study (e.g. hospital, physician, regulatory authorities, ethics committees).
- I understand and agree that representatives from Medtronic, regulatory authorities and the Institutional Review Board will be granted direct access to my medical records.
- I understand and agree that the physician(s) / hospital will release the relevant personal information about me for the purpose of the clinical investigation.
- I fully understand there is limited experience with this device in humans and that its safety and effectiveness have not been established and there are risks of serious complications associated with this study.
- I also understand that the doctors might determine after I give consent that it is not possible to implant the study valve.

I hereby give my consent to participate in the “*Medtronic CoreValve™ SURTAVI Trial*”. I have been given a copy of this consent form, and am also aware that the investigator will keep a copy in his or her files.

Patient Name (please print)

Patient Signature

Date (MM/DD/YYYY)

Statement from Person Obtaining Consent

I certify that I have explained the nature of the device and the study to the above-named person. I have also explained the contents of this informed consent form to the above-named person. I have asked whether or not there are any questions. I have answered any questions that were raised by this person.

Person Obtaining Consent Name (please print)

Signature of Person Obtaining Consent

Date (MM/DD/YYYY)

R.1.2 R.1.2 United States – Roll-in Subjects

INFORMED CONSENT FORM**FOR ROLL-IN SUBJECTS****Medtronic CoreValve™ SURTAVI Trial**

You are being asked to read this form so that you understand this research study and how you might take part in it. By signing this form, you will show that you understand and that you agree to take part in this research study. Your signature on this form is required before you can take part in this research study.

BACKGROUND

You are being asked to take part in a research study entitled “*Medtronic CoreValve™ SURTAVI Trial*” because you have a disease of your aortic valve. This disease is called aortic stenosis.

The aortic valve is one of the four heart valves that control the flow of blood into and out of the heart. The aortic valve lets oxygen-containing blood to be pumped out of the heart, from the left ventricle (main pumping chamber of the heart) into the aorta (main artery delivering blood to the body). If the valve becomes abnormally narrow through a process of thickening and stiffening (aortic stenosis) the heart must work harder to pump the same amount of blood with each beat.

As the heart works harder, the heart muscle thickens (hypertrophy), and the heart chamber (ventricle) may become larger (dilate). Open-heart surgery to replace the diseased aortic valve is the standard treatment.

As an alternative to open heart surgery, the Medtronic CoreValve™ System and Medtronic CoreValve™ Evolut™ R System have been developed to replace a diseased aortic heart valve without the need for open heart surgery. This system allows the percutaneous aortic valve (study valve) to be implanted (inserted) through a long, thin flexible tube that is inserted through an incision in the skin and threaded through the bloodstream (percutaneous).

A description of this clinical trial will be available on <http://www.ClinicalTrials.gov>, as required by U.S. Law. This website will not include information that can identify you. At most, the website will include a summary of the results. You can search this website at any time.

You are being asked to participate in this study because doctors have determined your aortic valve is no longer working properly. However, your doctors have also decided that your risk of experiencing major problems while undergoing open-heart surgery is moderate due to medical reasons or anatomical reasons (relating to how and where your heart, aortic valve and blood vessels are placed within your body). This means that your doctor believes your health is acceptable for open-heart surgery, but there are still a risk of potential problems.

PURPOSE OF THE STUDY

The purpose of this clinical study is to determine if replacing the aortic valve without open-heart surgery is as safe as or safer than open-heart surgery in patients with similar medical conditions as you.

The study valve is considered an “investigational device”, which means that clinical studies are required to determine if it is safe and provides clinical benefit. Medtronic, Inc. is sponsoring this study to obtain data on the safety and performance of the investigational device. The Medtronic CoreValve™ System and Medtronic CoreValve™ Evolut™ R System includes the valves described below and two parts that help load and deliver the valves correctly.

This study will involve approximately subjects at up to 115 hospitals in the United States and around the world, and is anticipated to take approximately 8 years to complete. Your participation in this study is expected to last approximately five years from the day you are enrolled in the study. Annual follow-up may be extended to up to 10 years after the implant procedure.

STUDY DEVICES

Both study valves are made from animal tissue attached to a metal frame.

The study valves are designed to be implanted (inserted) using a delivery system catheter (long, thin flexible tube) to replace your diseased aortic heart valve without open-heart surgery. A unique feature of the Evolut R device is that it can be re-captured, making it easier for doctors to place the device in a correct position. Once it is implanted, CoreValve™ study valves acts in the same method of the native valve.

The Medtronic CoreValve system is approved by the US Food & Drug Administration (FDA) since 2014 and it has been approved in other parts of the world since 2006. It has been implanted in over 45,000 patients. The Medtronic CoreValve™ System is currently approved for use in Europe, South America, and parts of Asia. The Medtronic CoreValve™ Evolut™ R system is currently being studied in Europe and Australia.

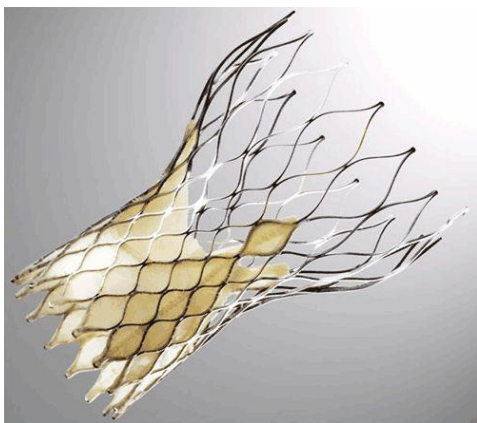

Figure 12: Medtronic CoreValve™ “Study Valve”



Figure 13: Medtronic CoreValve™ Evolut™ R “Study Valve”

PROCEDURES TO BE FOLLOWED

If you agree to be in this study, and after you have signed this informed consent form, data such as your age, gender, medical history and medication use will be recorded. You will undergo the following tests:

- Physical examination
- Computed tomography (CT) - a scan performed using an x-ray machine, which is linked to a computer to take pictures of your body. Sometimes a CT will require the use of a type of

dye that makes the kidneys work harder and may be harmful to the kidneys. You may have an MRI in place of a CT scan if your doctor believes your kidneys are not working well enough for you to have a CT scan. MRI stands for magnetic resonance imaging and is a test that uses a strong magnet and a complex computer system to produce detailed images of your internal organs and soft body tissues.

- Blood tests (about 2 tablespoons)
- Echocardiography (transthoracic echocardiogram (TTE)) - a test that uses sound waves to take pictures of your heart and measure the degree of narrowing of your aortic valve; a probe with gel is placed on the outside of your chest to take pictures of your heart
- Electrocardiogram (ECG) - a test that records electrical impulses of your heart; patches are placed on the outside of your chest
- Heart catheterization/angiography - a test that takes pictures of your heart and blood vessels; a special dye is injected through long, flexible tubes into the coronary arteries (vessels delivering blood to the heart) and bypass grafts if you have them

If you are of child-bearing potential, we will ask you to take a pregnancy test. If you are pregnant, you will not be able to participate in this study.

These procedures and tests are standard procedures and are not experimental. If you have already had any of these tests performed before, they may to be used for the study if your study doctor determines they don't need to be repeated for study purposes.

The results from your exams and tests will be reviewed by your doctor and a committee of study doctors who will determine if you are eligible to be in the study.

Your study doctor and the committee may determine after reviewing your test results that you are not eligible to be in the study and/or it will not be possible to implant the study valve. If so, you will not be allowed to participate in the study.

If your doctor and the committee decide you are eligible to be in the study, you will be one of the first three (3) patients at this hospital to be enrolled in this study. You will receive a transcatheter aortic valve implant (TAVI).

Your enrollment in the study will begin once you sign this consent and you are assigned to the roll-in treatment group. If you are enrolled in the study, you will be required to have the following additional tests completed within 14 days prior to the procedure (TAVI):

- Physical exam, including a determination of neurological (brain) status where you will be asked to answer a series of questions and perform a series of tasks such as writing and drawing
- Blood tests (about 2 tablespoons)
- Walking test – a test that records your breathing, heart rate, and how you feel after 6 minutes of walking
- Electrocardiogram (ECG) - a test that records electrical impulses of your heart; patches are placed on the outside of your chest

You will also be asked to complete surveys about the quality of your life and your ability to do normal daily activities, called Quality of Life Questionnaires (QOL).

TAVI Procedure:

The study valve is an experimental valve which means you can only receive the valve if you are part of this study. Your study doctor will decide if you will either receive the Medtronic CoreValve™ System or the Medtronic CoreValve™ Evolut™ R System.

Before the TAVI procedure, it will be strongly recommended that you take blood thinning medications, used to prevent your blood from clotting (thickening). These medications will be described to you by your study doctor. You may be advised to continue these medications for at least three months following your procedure.

Before the procedure you will be given an antibiotic (a medicine that kills bacteria or germs) to decrease your chance of developing an infection. Your study doctor will choose the antibiotic that he or she thinks is best suited for you and decide whether you need additional medication.

You will also have blood tests (about 2 tablespoons) and an ECG before the procedure.

Immediately prior to the procedure, you will receive medications to make you more relaxed and comfortable during the procedure. Your study doctor may decide that general anesthesia is necessary, meaning you need to be put to sleep for the procedure. Your doctor will inform you of this need before the procedure. Additionally, if your study doctor decides that it is necessary during the procedure, you will be put under general anesthesia at that time.

Your study doctor will decide what locations are best for inserting the long, thin flexible tubes required for TAVI and getting all of the pictures that are necessary. These pictures are described in the next paragraphs. Additionally, your study doctor will decide if performing a surgical incision to any of the site(s) is necessary.

During the procedure you may have a transesophageal echocardiogram which is also called a TEE. This test uses sound waves to take a closer look at the inside structures of the heart. If your doctor decides this picture is necessary, to perform the test you will swallow a thin flexible tube with a special tip. This tube sits in the esophagus (the tube that connects the mouth to the stomach). The special tip of the tube sends out sound waves (ultrasound) that echo within the chest wall. The esophagus is located behind the heart so these echoes are picked up and create a picture of the heart that is displayed on a video monitor. The pictures will allow your study doctor to take a closer look at your valve.

You will have a temporary pacemaker put in place during the TAVI procedure. A temporary pacemaker is a thin wire inserted through your skin and into one of your veins and threaded through your vein into the right side of your heart. The wire is attached to a battery operated device outside of your body. This temporary pacemaker will help keep your heart rate (speed) and rhythm steady. This temporary pacemaker will not be removed for at least 48 hours after your TAVI procedure.

After your study doctor has taken a good look at your valve, a balloon valvuloplasty will be performed. Balloon valvuloplasty is a procedure used to widen a stiff or narrowed heart valve. A wire and a thin tube are guided by x-rays through the heart and positioned through the diseased heart valve. A balloon is placed over the wire and inflated, enlarging the opening through the diseased valve allowing the study valve to be placed.

Your doctor will then implant (insert) the study valve through the long, thin flexible tube that is inserted through an incision in the skin and threaded through the bloodstream. TAVI is performed using x-ray machines which will allow your doctor to see the study valve, your blood vessels and heart. The study valve will be guided through your blood vessels to your existing aortic valve and then the study valve will be placed over your existing valve.

During the TAVI procedure, your doctor will perform angiography (x-ray pictures) and ECGs (recordings of the electrical impulses of your heart through patches placed on the chest) to observe your heart function and make sure that the study valve fits and works properly.

Doctors from other hospitals who have experience with the TAVI procedure may assist your study doctor with the procedure. Medtronic staff may assist the physician in the loading of the study valve.

AFTER TAVI PROCEDURE:

After the TAVI procedure, your study doctors will continue to monitor your progress and recovery.

You will have the following tests performed within the two days following the procedure and before you are discharged from the hospital:

- Determination of neurological (brain) status where you will be asked to answer a series of questions and perform a series of tasks
- Blood tests (about 2 tablespoons)
- Echocardiogram (TTE)

- ECG

FOLLOW-UP VISITS AFTER TAVI PROCEDURE:

You will need to return to the clinic for required follow-up visits at 30 days, 6 months, 12 months (1 year), 18 months, 24 months (2 years), and 3, 4, and 5 years after the procedure. Most of the follow-up tests and examinations are routine, not experimental. Each visit will take about 1 ½ to 2 hours.

Your evaluations at 30 days, 6 and 18 months will include:

- Physical examination, including a determination of neurological (brain) status where you will be asked to answer a series of questions and perform a series of tasks
- You will be asked about your health since the last follow-up visit
- Quality of Life Questionnaires
- ECG
- Blood tests (about 2 tablespoons) – 30 day visit only
- Walking test – 30 day visit only
- Echocardiogram (TTE) – 6 month visit only

Your evaluation at 12 months, 24 months, and 3, 4, 5 years will include:

- Physical examination, including a determination of neurological (brain) status where you will be asked to answer a series of questions and perform a series of tasks
- You will be asked about your health since the last clinic visit
- Blood tests (about 2 tablespoons)
- Echocardiogram (TTE)
- Quality of Life Questionnaires
- ECG
- Walking test – 12 and 24 months visits only

In addition to the in-clinic follow-up visits, at 3 months you will be contacted via phone to complete a Quality of Life Questionnaire.

If, during the 5 years of follow-up, you have additional heart surgeries or cath lab procedures to work on or replace your aortic valve or study valve, you will be asked to answer questions and perform activities that will help the study doctors and nurses to determine your neurological (brain) status within 24 hours after each additional procedure.

If you have a stroke, have been inform by a doctor that you experienced a stroke, or experience any of the following symptoms, notify Dr. **Principal Investigator** at xxx-xxx-xxxx as soon as possible: sudden numbness, tingling, loss of movement (especially on 1 side of the body), vision changes, confusion or trouble understanding simple statements, severe headaches, or seizures. Any of these symptoms could indicate that you are having problems with your neurological (brain) function. If a doctor confirms that you had a stroke, you will be asked to come to the clinical to have tests performed to determine your neurological (brain) status where you will be asked to answer a series of questions and perform a series of tasks. These tests will be performed at 7 days, 30 days and 3 months after you have any of these symptoms.

If you have any other problems or complications, are seen by any other doctors for problems, or are hospitalized during your participation in this study you should immediately notify Dr. **Principal Investigator** at xxx-xxx-xxxx.

If the study valve is removed for any reason, we will request that it be returned to Medtronic for additional analysis. Your study doctor will determine if you will need to have another valve implanted.

In the event of your death, we will request an autopsy. We will also request that either the whole heart and valve or just the valve are removed and returned to Medtronic for additional analysis.

The autopsy and the removal of the heart and/or valve would be done to provide additional information about the research and the investigational valve.

Your family and your "legally authorized representatives", have the right to refuse the autopsy and refuse the request to remove the heart and/or valve even if you sign this consent form.

POSSIBLE RISKS AND DISCOMFORTS

Potential risks associated with the implantation of the study valve may include, but are not limited to, the following:

- **Death**
- **Cardiac arrest** –heart stops beating and blood flow through the body is interrupted or stopped
- **Coronary occlusion, obstruction, or vessel spasm (including acute coronary closure)** – blockage or closure of an artery that supplies the heart with blood
- **Emergent surgery**
 - Coronary artery bypass – (CABG) a surgery where the chest is opened to place new vessels around the existing blocked vessels of the heart to improve blood supply to the heart.
 - Heart valve replacement – replacing the existing heart valve with a new heart valve
 - Valve explant – the removal of the existing valve
- **Multi-organ failure** – more than one organ of the body not functioning correctly
- **Heart failure** – heart does not pump blood to the body
- **Myocardial infarction** - decreased blood flow to the heart causing death of heart muscle cells
- **Cardiogenic shock** – failure of the heart to pump enough blood to the body organs
- **Respiratory insufficiency or respiratory failure** – not enough oxygen or not able to supply oxygen to the body
- **Cardiovascular injury (including rupture, perforation, or dissection of vessels, ventricle, myocardium, or valvular structures that may require intervention)**
- **Perforation of the myocardium or a vessel** – a hole in the heart muscle or a blood vessel
- **Ascending aorta trauma** – injury to the large blood vessel leading blood away from the heart
- **Cardiac tamponade** – the constriction or inability of the heart to pump due to buildup of blood or fluid around the lining of the heart
- **Cardiac failure or low cardiac output**
- **Prosthetic valve dysfunction including, but not limited to:**
 - Fracture (break) in the valve frame
 - Bending of the valve frame
 - The valve frame does not open (expand) all the way
 - Calcification (build-up of calcium on the valve)
 - Pannus – the formation of scar tissue that may cover or block the valve from functioning normally
 - Wear, tear or movement forward (prolapse) or backward (retraction) from the normal position of the valve leaflets
 - The valve leaflets do not close together
 - A break in the stitches (sutures) of the valve frame or leaflets
 - Leakage through or around the valve or valve frame
 - Incorrect size of the valve implanted
 - Incorrect position of the valve, either too high or too low
 - Regurgitation – backward flow of blood through the valve

- Stenosis – narrowing of the opening of the valve
- **Thrombosis/embolus (including valve thrombosis)** - an abnormal particle (air, blood clots) floating in the blood stream or attached to an object, including the valve
- **Valve migration/valve embolization** – upward or downward movement of the device from where it was originally placed
- **Ancillary device embolization** – a broken piece of the tube that delivers the valve floating in the blood stream
- **Emergent percutaneous coronary intervention (PCI)** – a procedure through the vessels inside the body and heart used to treat or open narrowed vessels of the heart
- **Emergent balloon valvuloplasty** (balloon valvuloplasty during the TAVI procedure is expected) – a procedure through the vessels inside the body and heart in which a narrowed heart valve is stretched open by a balloon
- **Bleeding that may or may not require transfusion or intervention**
- **Allergic reaction to:**
 - Antiplatelet agents (blood thinning medication)
 - Contrast medium (dye used to see vessels with x-ray), or
 - Anesthesia (medication used to put you to sleep during the procedure)
- **Infection (including septicemia and endocarditis)** – an abnormal growth of germs in the body or body part
- **Stroke, TIA, or other neurological deficits** – decreased blood flow to the brain causing death of brain cells
- **Permanent disability** – injury that does not allow that impairs normal/previous physical or mental function
- **Renal insufficiency or renal failure (including acute kidney injury)** – failure of the kidneys to work correctly
- **Mitral valve regurgitation or injury** – a leaking valve between the left upper (left atrium) and left lower (left ventricle) parts of the heart where blood flows backward through the valve or damage to the valve that may cause it to not function correctly
- **Tissue erosion** – damage to the tissue of the heart or blood vessels that could result in a tear or hole
- **Vascular access related complications, such as:**
 - Dissection - a tear in a blood vessel
 - Perforation – puncture of a blood vessel
 - Pain
 - Bleeding
 - Hematoma –blood collecting under the skin
 - Pseudoaneurysm - blood collecting on the outside of a vessel wall causing a balloon-like widening
 - Irreversible nerve damage – permanent damage to nerves
 - Compartment syndrome – squeezing of nerves and muscles in a closed space that could cause muscle or nerve damage
 - Arteriovenous fistula – abnormal connection between an artery vessel that takes blood away from the heart and a vein vessel that takes blood to the heart
 - Stenosis – narrowing of a vessel (artery)
- **Cardiac arrhythmias**
 - Disturbances in the electrical system of the heart that may result in the permanent placement of a device (pacemaker) that delivers electrical impulses to the heart to help your heart beat normally

- Atrio-ventricular node block – a block in the electrical path from the top part of the heart (atria) to the bottom part of the heart (ventricle)
- Bundle branch block – a delay or block in the electrical path in the bottom part of the heart (ventricle)
- Asystole – when the heart stops beating
- Ventricular arrhythmias – abnormal fast or slow heart beats in the lower part of the heart (ventricles)
- **Encephalopathy** – altered mental state
- **Pulmonary edema** – fluid build-up in or in the space around the lungs
- **Pericardial effusion** – fluid around the heart
- **Pleural effusion** – fluid build-up in the space around the lungs that makes breathing difficult
- **Myocardial ischemia** – reduced or interrupted blood supply to the heart
- **Peripheral ischemia** – reduced or interrupted blood supply to arms and legs
- **Bowel ischemia** – decrease blood supply to the intestines
- **Heart murmur** – an extra or unusual sound hear during a heartbeat
- **Hemolysis** – break down of blood cells
- **Cerebral infarction-asymptomatic** – silent stroke
- **Non-emergent reoperation**
- **Inflammation** – swelling of tissue
- **Fever** – increase in body temperature
- **Hypotension or hypertension** – low or high blood pressure
- **Syncope** – fainting
- **Dyspnea** – shortness of breath
- **Anemia** – not enough oxygen carrying cells in the blood
- **Angina** – chest pain
- **Abnormal lab values (including electrolyte imbalance)** – changes in blood test results
- Exposure to radiation through fluoroscopy and angiography
- Delivery catheter malfunction resulting in need for additional re-crossing of the aortic valve and prolonged procedural time

There may also be additional risks, discomforts, or side effects that are not yet known. If you become pregnant there maybe risks, discomforts, or side effects to you and the embryo/fetus that are not yet known. Please notify your study doctor as soon as possible to discuss any of these potential risks.

RADIATION EXPOSURE RISKS

Some of the test and procedures that are part of this study require exposure to radiation (x-rays). These tests or treatments involve a small amount of radiation. To give you an idea about how much radiation you will get, in the following descriptions the radiation is compared to the amounts that people are exposed to in daily life. There is radiation that naturally occurs from space and from rocks in the soil. This natural radiation is greater at higher altitudes.

CT of Chest and Abdomen and Coronary Angiography

The radiation exposure received from the screening tests (CTA of abdomen and thorax and coronary angiogram) is approximately 10 times the radiation exposure received in one year from background radiation (naturally occurring radiation you are exposed to everyday). The exposure is less than the radiation exposure limit an occupational worker is allowed to receive in one year.

Valve implantation

The estimated radiation exposure for the valve procedure is approximately 10-15 times the amount of radiation exposure received in one year from background radiation (naturally occurring radiation you are exposed to everyday). The exposure is approximately the amount an occupational worker is allowed to receive in one year.

There are additional risks or side effects from being exposed to x-rays. Most side effects do not occur often and resolve without major problems. It is possible that skin reddening or other alterations to the skin's appearance may occur if you are exposed to enough radiation during the procedure or if you have recently had another cardiac angiogram. You should contact your doctor in the event that you observe this. If you have a reaction to the x-rays you may need to have extra follow-up visits with your doctor to watch your recovery more closely.

Your doctor will explain to you how many x-rays you will receive, what x-rays are part of your normal care and what, if any, are extra for the study.

POSSIBLE BENEFITS

The possible benefits you may receive from participating in this research are that you may be able to receive a new heart valve without having open-heart surgery. Another possible benefit is that your new valve may work better than the way your diseased valve currently works. This may improve how you feel and may improve your daily activity.

Your participation in this research may improve procedures that may guide the future treatment of heart surgery, by using procedures that are less invasive, meaning less cutting, entering or breaking through the body, which may benefit others in the future. However, there is no guarantee that you will benefit from being in this research.

ALTERNATIVE TREATMENTS

The current long-term effective treatment for severe aortic stenosis is open heart surgery to replace the aortic valve. For patients who are at high risk for open heart surgery, other treatment options include percutaneous (through an artery in the groin) aortic valve implantation, or medical management to relieve symptoms, which may include balloon valvuloplasty. Ask your study doctor about other treatment options you may have.

IF PROBLEMS DEVELOP

If you believe that you have been injured as a result of your participation in the study, you should notify Dr. Principal Investigator at xxx-xxx-xxxx as soon as possible or in serious cases, go to the emergency room.

Immediate necessary medical care is available at [Name of institution(s)] in the event that you are injured as a result of your participation in this research study

Medtronic has agreed to pay back [name of institutions that are parties to the CTA] for the costs of medical or surgical care they provide for any serious and unanticipated illness or injury under the following conditions:

- The illness or injury must be related to a defect or malfunction of the investigational device or in the TAVI procedure as described in the Protocol, and not related to procedures that are routine standard of care.
- The illness or injury cannot be caused by (a) the negligence or intentional misconduct of the study staff or [name of institutions that are parties to the CTA]; (b) because the study staff or [name of institution(s)] that are parties to the CTA did not follow the protocol for the study; or (c) the natural progression of your illness.
- The illness or injury must have happened before the study closes (last patient is seen for the 5 year follow-up visit) at this [Name of institution(s)].
- [Name of institution(s) that are parties to the CTA] must notify Medtronic within one year of the date the study closes at all study sites or before the study closes at this site, whichever is earlier.

Subject to the above conditions, Medtronic will pay back the costs that are not covered by your health insurance or Medicare. The amount Medtronic will pay back is the amount Medicare pays [name of institution(s) that are parties to the CTA] plus 10%.

PAYMENT FOR PARTICIPATION IN THE STUDY

You will not be paid to take part in the study. However, you may be reimbursed for local mileage and parking expenses directly related to any study related visits. Your study doctor or research coordinator will tell you how to get reimbursement.

There is no monetary advantage to the study doctor for participation in this study.

MEDICAL EXPENSES

Your private or public health insurance company (for example Medicare) will be billed for the valve procedure and the cardiac catheterization and other procedures that are required by the study and you will be responsible for paying for any co-payment, co-insurance or deductible. It is possible that your private or public health insurance will not pay for some or all of the procedures, including the valve procedure or the cardiac catheterization procedure because you are participating in this study. Any costs not covered by your public or private insurance will be your responsibility. You should discuss the estimate of these costs with your study doctor. You will not be charged for the cost of collecting the data for this study and other clinic visits and diagnostic tests done solely for the purposes of this study.

BASIS OF PARTICIPATION

Your participation in this study is voluntary. If you refuse to be in this study there will be no penalty or loss of benefits to which you are otherwise entitled. You may withdraw from the study at any time and will not lose your benefits or be treated any differently as a result of withdrawing from the study. Any new findings (decisions or conclusions) that may influence your willingness to participate will be provided to you. If you decide to leave the study before it is finished, please tell one of the persons listed in the section below "Obtaining Additional Information". It may be requested that, if you withdraw, you return to your study doctor for a final visit.

The study doctor may end your participation in the study at any time if:

- He or she determines it is not in the best interest of your health
- The study doctor loses contact with you and you do not return for your study visits as scheduled
- You refuse to allow the use of private health information during the course of the study

The study doctor will make the decision and let you know if it is not possible for you to continue in the study.

You may be removed from the study without your consent if the sponsor (Medtronic, Inc.) ends the study. If this happens, you will be notified and the reasons will be explained to you. Your physician will continue to provide the appropriate medical therapy.

PERMISSION FOR ACCESS TO AND USE OF HEALTH INFORMATION

This section governs how your health information will be used and shared by the study doctors during and after the study. The health information that may be used and shared includes all information collected during the study and any health information in your medical records that is relevant to the study.

1. PROVIDERS' DISCLOSURE OF HEALTH INFORMATION IN YOUR RECORDS

You agree to permit [hospital and/or clinic], your doctors, and your other health care providers ("Providers") to share health information in your medical records with [investigator(s)] and [his/her/his/her/its] staff ("Researchers"). You agree to permit Providers to share your health information:

- With the Researchers;
- With the study sponsor, Medtronic, Inc. and its agents and contractors (together "Medtronic");
- As required by law;

- With government organizations and review boards required to watch over the safety and effectiveness of medical products and therapies and the conduct of research; and
- With other persons who are required to watch over the safety and effectiveness of medical products and therapies and the conduct of research.

2. RESEARCHER'S USE AND DISCLOSURE OF YOUR HEALTH INFORMATION

You agree to permit the Researchers to use and share your health information:

- Among themselves to conduct the study;
- With other researchers in the study to conduct the study;
- With Medtronic;
- With government organizations and review boards required to watch over the safety and effectiveness of medical products and therapies and the conduct of research; and
- With other persons who are required to watch over the safety and effectiveness of medical products and therapies and the conduct of research.

Once Providers or Researchers have shared your health information with a third party, the information may be subject to further sharing by the third party. Federal privacy laws may no longer protect it from further sharing.

While the study is in progress, you will not be allowed to see your health information that is created or collected for the study. After the study is finished, you may see this information as described in the [hospital/clinical trial site]'s Notice of Information practices.

This permission to share your health information does not have an ending date. You do not have to give this permission, but if you do not, you will not be allowed to be in the study. You may change your mind and take back this permission to use your health information at any time. To take back this permission, you must write to [name and contact information]. If you take back this permission, you cannot continue in the study. Even if you take back this permission, Medtronic and Researchers may continue to use and share the health information already received as described in this informed consent

Economic Study

This study contains a health economics review that will be done to compare the in-hospital, 12 month and 24 month follow-up medical care resource utilization and cost for patients in each of the treatment groups. As part of this study, you may be asked to sign a separate document that gives us your permission to review your billing information sent directly from the Medicare system in order to evaluate medical cost data. This information will be kept strictly confidential and be used solely to assess the medical expenses which occur as a direct result of participating in the Medtronic CoreValve™ SURTAVI Trial.

Quality of Life Questionnaire

Medtronic CoreValve™ SURTAVI Trial will also contain a quality of life study. As part of this study, your research coordinator will have you or your legal representative complete a questionnaire called a Quality of Life Questionnaire. You will need to complete this questionnaire when you are enrolled in the study and 1 month, 3 months, 6 months, 12 months, 18 months, 2 years, 3 years, 4 years and 5 years after your study procedure.

OBTAINING ADDITIONAL INFORMATION

You are encouraged and have the right to ask questions at any time concerning potential and/or known risks of this study. The study doctor will inform you of any new significant information, when it becomes available, which may affect your willingness to continue to participate in this study. If you have any questions about this study or if you experience any health problems, you should contact Dr. Principal Investigator at xxx-xxx-xxxx.

If you have questions about your rights as a participant in this study, you should contact the chairman of the Institutional Review Board at xxx-xxx-xxxx.

MEDTRONIC'S USE AND DISCLOSURE OF YOUR HEALTH INFORMATION

This section describes what Medtronic as study sponsor will do with the study data, including your health information received during the study.

Medtronic will keep your health information confidential in keeping with all applicable laws and regulations. Medtronic may use your health information to conduct this study. Medtronic may use your health information for other purposes, such as:

- Watch over and improve the performance of its device;
- New medical research;
- Proposals for making new medical products or procedures; and
- Other business purposes.

Any reports or publications about the study or any other research will not include your name or a description of you. Any records identifying you will not be made publically available. Information received during the study will not be used to market to you; your name will not be placed on any mailing lists or sold to anyone for marketing purposes.

The US Food and Drug Administration's regulations, as well as other applicable laws, control Medtronic's work in developing and assuring the safety and quality performance of its medical devices. Medtronic may disclose your health information to the FDA, as well as to other US and foreign government authorities responsible for assuring the safety of medical devices. Medtronic also may disclose your health information to institutional review boards and other persons who are required to watch over the safety and effectiveness of medical products and therapies and the conduct of research. You agree to allow Medtronic to use study data in these ways. You also agree to allow FDA and other governmental authorities to inspect your health information.

PRIMARY CARE PHYSICIAN / SPECIALIST NOTIFICATION OPTION

Please indicate below whether you would like us to notify your primary care physician or your specialist of your participation in this study.

(Initial only one box).

Yes, I want the study doctor to inform my primary care physician/specialist of my participation in this study

No. I do not want the study doctor to inform my primary care physician/specialist of my participation in this study.

I do not have a primary care physician/specialist.

The study doctor is my primary care physician/specialist.

CONSENT

I confirm that:

- I have read the informed consent form of this study and my physician has answered all my questions regarding the study.
- I had sufficient time to consider my participation into this study, I am aware that participation into this study is completely voluntary, and I agree to follow the instructions from the investigator.
- I realize that I may decide to refuse participation or stop participation at any time without penalty and without affecting the quality of my health care or the relationship with my physician.
- I understand and agree that personal information about me will be collected from my medical records, used and processed (manually and by computer) by the manufacturer of a medical device used in my treatment or any other designated party that is involved in the study (e.g. hospital, physician, regulatory authorities, ethics committees).
- I understand and agree that representatives from Medtronic, regulatory authorities and the Institutional Review Board will be granted direct access to my medical records.
- I understand and agree that the physician(s) / hospital will release the relevant personal information about me for the purpose of the clinical investigation.
- I fully understand there is limited experience with this device in humans and that its safety and effectiveness have not been established and there are risks of serious complications associated with this study.
- I also understand that the doctors might determine after I give consent that it is not possible to implant the study valve.

I hereby give my consent to participate in the “*Medtronic CoreValve™ SURTAVI Trial*”. I have been given a copy of this consent form, and am also aware that the investigator will keep a copy in his or her files.

Patient Name (please print)

Patient Signature

Date (MM/DD/YYYY)

Statement from Person Obtaining Consent

I certify that I have explained the nature of the device and the study to the above-named person. I have also explained the contents of this informed consent form to the above-named person. I have asked whether or not there are any questions. I have answered any questions that were raised by this person.

Person Obtaining Consent Name (please print)

Signature of Person Obtaining Consent

Date (MM/DD/YYYY)

R.1.3 Europe

PATIENT INFORMED CONSENT FORM - INFORMATION SHEET**Medtronic CoreValve™ SURTAVI Trial**

You are being asked to read this form so that you understand this clinical study and how you might take part in it. By signing this form, you will show that you understand and that you agree to take part in this clinical study. Your signature on this form is required before you can take part in this clinical study.

Background

You are being asked to take part in a clinical study entitled “*The Medtronic CoreValve™ SURTAVI Trial*” because you have a disease of your aortic valve. This disease is called aortic stenosis.

The aortic valve is one of the four heart valves that control the flow of blood into and out of the heart. The aortic valve lets oxygen-containing blood to be pumped out of the heart, from the lower chamber of the heart (ventricle) into the main artery delivering blood to the body (aorta). If the valve becomes abnormally narrow through a process of thickening and stiffening (aortic stenosis), then the heart must work harder to pump the same amount of blood with each beat. As the heart works harder, the heart muscle thickens (hypertrophy), and the lower chamber (ventricle) may become larger (dilate). Open-heart surgery to replace the diseased aortic valve is the standard treatment. For some patients, the risk of experiencing major problems during open-heart surgery is greater because of other health problems.

As an alternative to open-heart surgery, the Medtronic CoreValve™ System and Medtronic CoreValve™ Evolut™ R System have been developed to replace a diseased aortic heart valve without the need for open-heart surgery. This system allows the percutaneous aortic valve (study valve) to be implanted (inserted) through a long, thin flexible tube that is inserted through an incision in the skin and threaded through the bloodstream (percutaneous).

You are being asked to participate in this study because doctors have determined your aortic valve is no longer working properly. However, your doctors have also decided that your risk of experiencing major problems while undergoing open-heart surgery is moderate due to medical reasons or anatomical reasons (relating to how and where your heart, aortic valve and blood vessels are placed within your body). This means that your doctor believes your health is acceptable for open-heart surgery, but there is still a risk of potential problems.

Purpose of the Study

The purpose of this clinical study is to determine if replacing the aortic valve without open-heart surgery is as safe as or safer than open-heart surgery in patients with similar medical conditions as you.

The Medtronic CoreValve™ System and Medtronic CoreValve™ Evolut™ R System are considered “investigational devices” by the United States Food and Drug Administration (FDA) which means that clinical studies are required to determine if it is safe and provides clinical benefit. Medtronic, Inc. is sponsoring this study to obtain data on the safety and performance of the investigational devices and its delivery systems to gain FDA approval.

The study will involve approximately 1600 patients and is being conducted at up to 115 hospitals in Europe, Canada and the United States and around the world. It is anticipated to take approximately eight years to complete. Your participation in this study is expected to last approximately five years from the day you are enrolled. Annual follow-up may be extended to up to 10 years after the implant procedure.

As a participant in the study, you have certain responsibilities. You have the responsibility to be truthful regarding your health and medication history.

You are expected to return to your study doctor’s office for the study visits. The evaluations performed at these visits are a component of the study. They are important for data collection and for monitoring that the investigational devices are working properly. These evaluations will take place at baseline, implant procedure, discharge, and follow-up visits (30 days, 6, 12, 18, 24, 36, 48, and 60 months). You should not take part in this study if you will not be available for the study visits.

You also have the responsibility to report any injuries, hospitalizations, emergency room visits or other medical visits, symptoms or complaints to the study doctor or study nurse as soon as possible.

Study Devices

Both study valves are made from animal tissue attached to a metal frame. The study valve is designed to be implanted (inserted) using a delivery system catheter (long, thin flexible tube) to replace your diseased aortic heart valve without open-heart surgery. A unique feature of the Evolut™ R device is that it can be re-captured, making it easier for doctors to place the device in a correct position. Once it is implanted, CoreValve™ study valves acts in the same method of the native valve.

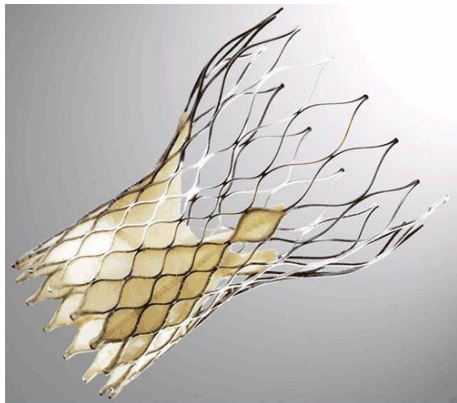

Figure 14: Medtronic CoreValve™ “Study Valve”



Figure 15: Medtronic CoreValve™ Evolut™ R “Study Valve”

The Medtronic CoreValve™ system was CE marked in 2006 and has been implanted in over 45,000 patients. The Medtronic CoreValve Evolut R system is currently being studied in Europe and Australia.

The CoreValve™ being implanted in this study is identical to the valve that was CE marked in 2006 with the exception of adding a coating, but is being used outside the current approved patient population that is approved under the current CE mark. This coating is designed to help the study valve last longer (i.e. function as it is supposed to) and to help keep the study valve from becoming calcified like your native valve did. The coating received CE mark in March 2012.

Procedures to Be Followed

- If you agree to be in this study, and after you have signed this informed consent form, data such as your age, gender, ethnic origin, medical history and medication use will be

recorded. You will undergo the following tests to determine if you are suitable for receiving the investigational device:

- Transthoracic echocardiography (TTE): a test that uses sound waves to take pictures of your heart and measure the degree of narrowing of your aortic valve; a probe is placed on the outside of your chest to take pictures of your heart
- Computed Tomography (CT): a scan performed using an x-ray machine, which is linked to a computer to take pictures of your heart and aortic valve
- If your doctor decides it is unsafe for you to have a CT scan, you will have a Magnetic Resonance Imaging (MRI) test. MRI is a scan that uses the magnetic properties of your tissues to take pictures of your heart. For the MRI test, you will lie on a special exam table while the pictures are taken.
- Blood tests: about two tablespoons
- An electrocardiogram (ECG): a test that records electrical impulses of your heart; patches are placed on the outside of your chest
- A physical examination
- Heart catheterization/angiography - a test that takes pictures of your heart and blood vessels; a special dye is injected through long, flexible tubes into: the coronary arteries (vessels delivering blood to the heart) and bypass grafts if you have them

If you are of child-bearing potential, we will ask you to take a pregnancy test. If you are pregnant, you will not be able to participate in this study.

All of these procedures and tests are standard procedures for patients with aortic valve disease, and are not experimental. If you have already had any of these tests performed before, they may be used for the study if your study doctor determines they do not need to be repeated for study purposes.

The results from your exams and tests will be reviewed by your doctor and a committee of study doctors who will determine if you are eligible to be in the study.

Your study doctor and the committee may determine after reviewing your test results that you are not eligible to be in the study and/or it will not be possible to implant the study valve. If so, you will not be allowed to participate in the study.

If your doctors and the committee decide you are eligible to be in the study, your treatment will be determined in a way similar to flipping a coin, called randomization. You will be assigned to one of two groups. One group will receive a transcatheter aortic valve implant (TAVI), the other group will have an open-heart surgical aortic valve replacement (SAVR). One out of every two participants will receive TAVI. The other participants will receive SAVR. You will not be able to choose your treatment assignment.

Your enrollment in the study will begin once you sign this consent and you are assigned to your treatment group. If you are enrolled in the study; you will be required to have the following additional tests completed within 14 days prior to the procedure (TAVI or SAVR):

- Physical exam, including a determination of neurological (brain) status where you will be asked to answer a series of questions and perform a series of tasks
- Blood tests (about two tablespoons)
- Six-Minute walking test – a test that records your breathing, heart rate, and how you feel
- Electrocardiogram (ECG) - a test that records electrical impulses of your heart; patches are placed on the outside of your chest

You will also be asked to complete surveys about the quality of your life and your ability to do normal daily activities, called Quality of Life (QOL) Questionnaires.

If you are assigned to the TAVI group:

Your study doctor will decide if you will either receive the Medtronic CoreValve™ System or the Medtronic CoreValve™ Evolut™ R System. Before the TAVI procedure, it will be strongly recommended that you take blood thinning medications, used to prevent your blood from clotting (thickening). These medications will be described to you by your study doctor. You may be

advised to continue taking blood thinning medications for at least three months following your procedure.

Before the procedure you will be given a medicine that kills bacteria or germs (antibiotic) to decrease your chance of developing an infection. Your study doctor will choose the antibiotic that he or she thinks is best suited for you and decide whether you need additional medication.

You will also have blood tests (about two tablespoons) and an ECG before the procedure.

Immediately prior to the procedure, you will receive medications to make you more relaxed and comfortable during the procedure. Your study doctor may decide that general anesthesia is necessary, meaning you need to be put to sleep for the procedure. Your doctor will inform you of this need before the procedure. Additionally, if your study doctor decides that it is necessary during the procedure, you will be put under general anesthesia at that time.

Your study doctor will decide what areas are best for inserting the long, thin flexible tubes required for TAVI and getting all of the pictures that are necessary. These pictures are described in the next paragraphs. Additionally, your study doctor will decide if performing a surgical incision to any of the area(s) is necessary.

During the procedure, you may have a transesophageal echocardiogram which is also called a TEE. This test uses sound waves to take a closer look at the inside structures of the heart. If your doctor decides this picture is necessary, to perform the test, you will swallow a thin flexible tube with a special tip. This tube sits in the tube that connects the mouth to the stomach (esophagus). The special tip of the tube sends out sound waves (ultrasound) that echo within the chest wall. The esophagus is located behind the heart so these echoes are picked up and create a picture of the heart that is displayed on a video monitor. The pictures will allow your study doctor to take a closer look at your valve.

You will have a temporary pacemaker put in place during the TAVI procedure. A temporary pacemaker is a thin wire inserted through your skin and into one of your veins. It is then threaded through your vein into the right side of your heart. The wire is attached to a battery-operated device that is outside of your body. This temporary pacemaker will help keep your heart rate and beat steady. This temporary pacemaker will not be removed for at least 48 hours after your TAVI procedure.

After your study doctor has taken a good look at your valve, a balloon valvuloplasty will be performed. This is a procedure used to widen a hard or thin heart valve. A wire and a thin tube are guided by x-rays through the heart and positioned through the diseased heart valve. A balloon is placed over the wire and inflated, enlarging the opening through the diseased valve allowing the study valve to be placed.

Your doctor will then insert the study valve through the long, thin flexible tube that is inserted through an incision in the skin and threaded through the bloodstream. TAVI is performed using x-ray machines which will allow your doctor to see the study valve, your blood vessels and heart. The study valve will be guided through your blood vessels to your existing aortic valve and then the study valve will be placed over your existing valve.

During the TAVI procedure, your doctor will perform x-ray pictures (angiogram) and recordings of the electrical impulses of your heart through patches placed on the chest (ECG) to observe your heart function and make sure that the study valve fits and works properly.

Doctors from other hospitals who have experience with the TAVI procedure may assist your study doctor with the procedure. Medtronic staff may assist the physician in the loading of the study valve.

If you are assigned to the SAVR group:

If you are assigned to the SAVR group, your doctors will replace your diseased aortic valve through open-heart surgery. During surgery, you are asleep under general anesthesia. SAVR often requires a median sternotomy, where the bone in the center of the chest (sternum) is split down the middle. The chest is then opened to provide your doctor with access to the heart and chest cavity, in order to replace your aortic valve. Your surgery is performed while the function of your heart is taken over by a heart lung machine (called CPB for cardiopulmonary bypass).

You may have a TEE (a thin tube sits in the esophagus and sends out sound waves to create a picture of your heart) and a temporary pacemaker (thin wire threaded through your vein to right side of heart to keep your heart rate and rhythm steady) during the procedure.

Your doctor may remove any tissue and calcium deposits that are interfering with the normal function of the valve. Your damaged valve may be completely removed. The new valve will be sewn into the space where your own valve used to be. After your doctor makes sure your valve is working properly, blood flow will be restored to your heart and the incisions will be closed. You will also have blood drawn for testing before and after the procedure.

After TAVI and SAVR Procedure:

After your TAVI and SAVR procedure, your study doctors will continue to monitor your progress and recovery.

You will have the following tests performed within the two days following your TAVI procedure and before you leave the hospital:

- Determination of neurological (brain) status where you will be asked to answer a series of questions and perform a series of tasks
- Blood tests (about two tablespoons)
- Echocardiogram (TTE)
- ECG

Follow-up Visits after TAVI and SAVR:

You will need to return to the clinic for required follow-up visits at 30 days, 6 months, 12 months, 18 months, 24 months (3 years) and 3, 4, and 5 years after the procedure. The follow-up tests and examinations are not experimental and most are performed on a routine basis. Each visit will take about 1 ½ to 2 hours.

Your evaluations at 30 days, 6 and 18 months will include:

- Physical examination, including a determination of neurological (brain) status where you will be asked to answer a series of questions and perform a series of tasks
- You will be asked about your health since the last follow-up visit
- Blood tests (about two tablespoons) – 30 day visit only
- Quality of Life (QoL) Questionnaires
- ECG
- Six-Minute walking test – 30 day visit only
- Echocardiogram (TTE) – 6 month visit only

Your evaluation at 12, 24, 36, 48 and 60 months will include:

- Physical examination, including a determination of neurological (brain) status where you will be asked to answer a series of questions and perform a series of tasks
- You will be asked about your health since the last follow-up visit
- Echocardiogram (TTE)
- QoL Questionnaires
- ECG
- Six-Minute walking test – 12 and 24 months visit only

In addition to the in-clinic follow-up visits, at 3 months you will be contacted via phone to complete a Quality of Life Questionnaire.

If the study doctor is unable to implant the study valve, you will still be followed for safety and will need to return to the clinic for the required follow-up visits as described above.

If, during the 5 years of follow-up, you have additional heart surgeries or cath lab procedures to work on or replace your aortic valve or study valve, you will be asked to answer questions and perform activities that will help the study doctors and nurses to determine your neurological (brain) status within 24 hours after each additional procedure.

If you have a stroke, have been informed by a doctor that you experienced a stroke, experience any of the following symptoms, notify your study doctor at xxx-xxx-xxxx as soon as possible: sudden numbness, tingling on, loss of movement (occurring on one side of the body), sudden

vision changes, confusion or trouble understanding simple statements, unable to speak, severe headaches, or seizures. Any of these symptoms could indicate that you are having problems with your neurological (brain) function. You will be asked to come to the clinical to have tests performed to determine your neurological (brain) status where you will be asked to answer a series of questions and perform a series of tasks. These tests will be performed at 7 days, 30 days and 3 months after you have any of these symptoms.

If you have any other problems or complications, are seen by any other doctors for problems, or are hospitalized during your participation in this study you should immediately notify Dr. **Principal Investigator** at xxx-xxx-xxxx.

If the study valve is removed for any reason, we will request that it be returned to Medtronic for additional analysis. The study doctor will determine if you will need to have another valve implanted.

In the event of your death and an autopsy is performed, the study doctor will ask your family or "legally authorized representatives" for either the whole heart and valve or just the valve are removed and returned to Medtronic for additional analysis.

The autopsy and the removal of the heart and/or valve would be done to provide additional information about the research and the investigational valve.

Your family and your "legally authorized representatives", have the right to refuse the autopsy and refuse the request to remove the heart and/or valve even if you sign this consent form.

POSSIBLE RISKS AND DISCOMFORTS

TAVI

Potential risks associated with the implantation of the study valve may include, but are not limited to, the following:

- **Death**
- **Cardiac arrest** – heart stops beating and blood flow through the body is interrupted or stopped
- **Coronary occlusion, obstruction, or vessel spasm (including acute coronary closure)** – blockage or closure of an artery that supplies the heart with blood
- **Emergent surgery**
 - Coronary artery bypass – (CABG) a surgery where the chest is opened to place new vessels around the existing blocked vessels of the heart to improve blood supply to the heart.
 - Heart valve replacement – replacing the existing heart valve with a new heart valve
 - Valve explant – the removal of the existing valve
- **Multi-organ failure** – more than one organ of the body not functioning correctly
- **Heart failure** – heart does not pump blood to the body
- **Myocardial infarction** - decreased blood flow to the heart causing death of heart muscle cells
- **Cardiogenic shock** – failure of the heart to pump enough blood to the body organs
- **Respiratory insufficiency or respiratory failure** – not enough oxygen or not able to supply oxygen to the body
- **Cardiovascular injury (including rupture, perforation, or dissection of vessels, ventricle, myocardium, or valvular structures that may require intervention)**
- **Perforation of the myocardium or a vessel** – a hole in the heart muscle or a blood vessel
- **Ascending aorta trauma** – injury to the large blood vessel leading blood away from the heart
- **Cardiac tamponade** – the constriction or inability of the heart to pump due to buildup of blood or fluid around the lining of the heart

- **Cardiac failure or low cardiac output**
- **Prosthetic valve dysfunction including, but not limited to:**
 - Fracture (break) in the valve frame
 - Bending of the valve frame
 - The valve frame does not open (expand) all the way
 - Calcification (build-up of calcium on the valve)
 - Pannus – the formation of scar tissue that may cover or block the valve from functioning normally
 - Wear, tear or movement forward (prolapse) or backward (retraction) from the normal position of the valve leaflets
 - The valve leaflets do not close together
 - A break in the stitches (sutures) of the valve frame or leaflets
 - Leakage through or around the valve or valve frame
 - Incorrect size of the valve implanted
 - Incorrect position of the valve, either too high or too low
 - Regurgitation – backward flow of blood through the valve
 - Stenosis – narrowing of the opening of the valve
- **Thrombosis/embolus (including valve thrombosis)** - an abnormal particle (air, blood clots) floating in the blood stream or attached to an object, including the valve
- **Valve migration/valve embolization** – upward or downward movement of the device from where it was originally placed
- **Ancillary device embolization** – a broken piece of the tube that delivers the valve floating in the blood stream
- **Emergent percutaneous coronary intervention (PCI)** – a procedure through the vessels inside the body and heart used to treat or open narrowed vessels of the heart
- **Emergent balloon valvuloplasty** (balloon valvuloplasty during the TAVI procedure is expected) – a procedure through the vessels inside the body and heart in which a narrowed heart valve is stretched open by a balloon
- **Bleeding that may or may not require transfusion or intervention**
- **Allergic reaction to:**
 - Antiplatelet agents (blood thinning medication)
 - Contrast medium (dye used to see vessels with x-ray), or
 - Anesthesia (medication used to put you to sleep during the procedure)
- **Infection (including septicemia and endocarditis)** – an abnormal growth of germs in the body or body part
- **Stroke, TIA, or other neurological deficits** – decreased blood flow to the brain causing death of brain cells
- **Permanent disability** – injury that does not allow that impairs normal/previous physical or mental function
- **Renal insufficiency or renal failure (including acute kidney injury)** – failure of the kidneys to work correctly
- **Mitral valve regurgitation or injury** – a leaking valve between the left upper (left atrium) and left lower (left ventricle) parts of the heart where blood flows backward through the valve or damage to the valve that may cause it to not function correctly
- **Tissue erosion** – damage to the tissue of the heart or blood vessels that could result in a tear or hole
- **Vascular access related complications, such as:**
 - Dissection - a tear in a blood vessel
 - Perforation – puncture of a blood vessel
 - Pain

- Bleeding
- Hematoma –blood collecting under the skin
- Pseudoaneurysm - blood collecting on the outside of a vessel wall causing a balloon-like widening
- Irreversible nerve damage – permanent damage to nerves
- Compartment syndrome – squeezing of nerves and muscles in a closed space that could cause muscle or nerve damage
- Arteriovenous fistula – abnormal connection between an artery vessel that takes blood away from the heart and a vein vessel that takes blood to the heart
- Stenosis – narrowing of a vessel (artery)
- **Cardiac arrhythmias**
 - Disturbances in the electrical system of the heart that may result in the permanent placement of a device (pacemaker) that delivers electrical impulses to the heart to help your heart beat normally
 - Atrio-ventricular node block – a block in the electrical path from the top part of the heart (atria) to the bottom part of the heart (ventricle)
 - Bundle branch block – a delay or block in the electrical path in the bottom part of the heart (ventricle)
 - Asystole – when the heart stops beating
 - Ventricular arrhythmias – abnormal fast or slow heart beats in the lower part of the heart (ventricles)
- **Encephalopathy** – altered mental state
- **Pulmonary edema** – fluid build-up in or in the space around the lungs
- **Pericardial effusion** – fluid around the heart
- **Pleural effusion** – fluid build-up in the space around the lungs that makes breathing difficult
- **Myocardial ischemia** – reduced or interrupted blood supply to the heart
- **Peripheral ischemia** – reduced or interrupted blood supply to arms and legs
- **Bowel ischemia** – decrease blood supply to the intestines
- **Heart murmur** – an extra or unusual sound hear during a heartbeat
- **Hemolysis** – break down of blood cells
- **Cerebral infarction-asymptomatic** – silent stroke
- **Non-emergent reoperation**
- **Inflammation** – swelling of tissue
- **Fever** – increase in body temperature
- **Hypotension or hypertension** – low or high blood pressure
- **Syncope** – fainting
- **Dyspnea** – shortness of breath
- **Anemia** – not enough oxygen carrying cells in the blood
- **Angina** – chest pain
- **Abnormal lab values (including electrolyte imbalance)** – changes in blood test results
- Exposure to radiation through fluoroscopy and angiography
- Delivery catheter malfunction resulting in need for additional re-crossing of the aortic valve and prolonged procedural time

There may also be additional risks, discomforts, or side effects that are not yet known.

SAVR

Although SAVR is not experimental there are potential risks associated with the procedure. These risks are the same even if you undergo the SAVR procedure and you decide not to participate in this study. Some of these risks include, but may not be limited to the following:

- Obstruction of blood flow to the heart (angina) resulting in damage to the heart tissue (myocardial infarction/heart attack)
- Abnormal heart beat (cardiac arrhythmia and dysrhythmia)
- Blood leaking around the outside of the prosthetic valve (paravalvular leak) or any problem with the valve that causes leaking of blood after the valve has closed (transvalvular leak).
- Damage to red blood cells (hemolysis) that can result in anemia (decreased red blood cells)
- Death
- Inflammation of the lining of the heart (endocarditis)
- Heart failure
- Any problem with the prosthetic valve that causes narrowing of the valve opening (stenosis)
- Blood clots that develop in the heart or on the replacement valve. These clots may break loose and travel through the bloodstream (thromboembolism). This problem may cause stroke (decrease blood flow to the brain causing damage to the brain) or heart attack.
- Failure of the valve to open and close properly

If you are or you become pregnant, there may be risks, discomforts or side effects to you and your unborn child that are not yet known.

Some possible inconveniences may include, but is not limited to the following:

- Transportation to and from the clinic for follow-up visits
- Parking
- Follow-up visit scheduling

There may be other discomforts and risks related to the device and/or this study that are not foreseen at this time.

RADIATION EXPOSURE RISKS

Some of the test and procedures that are part of this study require exposure to radiation (x-rays). These tests or treatments involve a small amount of radiation. To give you an idea about how much radiation you will get, in the following descriptions the radiation is compared to the amounts that people are exposed to in daily life. There is radiation that naturally occurs from space and from rocks in the soil. This natural radiation is greater at higher altitudes.

CT of Chest and Abdomen and Coronary Angiography

The radiation exposure received from the screening tests (CTA of abdomen and thorax and coronary angiogram) is approximately 10 times the radiation exposure received in one year from background radiation (naturally occurring radiation you are exposed to everyday). The exposure is less than the radiation exposure limit an occupational worker is allowed to receive in one year.

Valve implantation

The estimated radiation exposure for the valve procedure is approximately 10-15 times the amount of radiation exposure received in one year from background radiation (naturally occurring radiation you are exposed to everyday). The exposure is approximately the amount an occupational worker is allowed to receive in one year.

There are additional risks or side effects from being exposed to x-rays. Most side effects do not occur often and resolve without major problems. It is possible that skin reddening or other alterations to the skin's appearance may occur if you are exposed to enough radiation during the procedure or if you have recently had another cardiac angiogram. You should contact your doctor in the event that you observe this. If you have a reaction to the x-rays you may need to have extra follow-up visits with your doctor to watch your recovery more closely.

Your doctor will explain to you how many x-rays you will receive, what x-rays are part of your normal care and what, if any, are extra for the study.

Potential Benefits for You

The possible benefits you may receive from participating in this clinical study are that you may be able to receive a new heart valve without having open-heart surgery. Another possible benefit is that your new study valve may work better than the way your diseased valve currently works. This may improve how you feel and may improve your daily activity. However, there is no guarantee that you will benefit from being in this clinical study.

Potential Benefits for Other Patients

Your participation in this clinical study may improve procedures that may guide the future treatment of aortic stenosis, by using procedures that are less invasive (meaning less cutting, entering or breaking through the body), which may benefit others in the future.

Alternative Therapy

The current long-term effective treatment for severe aortic stenosis is open heart surgery to replace the aortic valve. For patients who are at high risk for open heart surgery, other treatment options include percutaneous (through an artery in the groin) aortic valve implantation, or medical management to relieve symptoms, which may include balloon valvuloplasty. Ask your study doctor about other treatment options you may have and their related benefits and risks.

Compensation for Illness or Injury

If you are physically injured as a result of your participation in this study, reasonable and appropriate medical treatment will be provided to you free of charge by the study sponsor, if such treatment is not already covered by your medical insurance.

Medtronic maintains appropriate clinical trial liability insurance coverage as required under applicable laws and regulations and will comply with applicable local law and custom concerning specific insurance coverage. If required, a Clinical Trial insurance statement/certificate will be provided to your Institution's Ethics Committee.

Compensation and Additional Costs

You will not receive any compensation for your participation in this study (including follow up). There is no monetary advantage to the study doctor for participation in this study.

You may request for reimbursement for costs associated with travel expenses for the purpose of the follow-up visits.

Role of the Sponsor's Representative

Your study doctor will delegate study activities not only to other study personnel (both doctors and study nurses), but also sponsor representatives. These study activities may include support during the procedure and supporting during data collection throughout the study. These activities are performed under supervision of the study doctor and will not bias the data integrity in any way.

Use of Personal Data/Confidentiality

Your participation in this study is entirely confidential.

While participating in this study the following personal data will be collected:

- medical and health data from your medical records
- data on your ethnic origins

(Hereinafter "personal data")

Representatives of the institution or hospital in which you are treated, including your physician(s) who conduct(s) the study, the monitor(s) on behalf of the study sponsor and other designated parties that are involved in the study (for example third party data processors) have direct access to your personal data. Furthermore, representatives of national, European or other international regulatory bodies, members of the ethics committees or any other public authority may be granted direct access to your personal data in order to comply with legal and regulatory requirements. If it

is necessary, your personal data may also be transferred to the above-mentioned parties, which are located in the country in which you are treated and in member states of the European Economic Area but maybe also in countries where the European Directive on Data Protection does not apply.

For conducting the study your personal data will be transferred to and processed by Medtronic (meaning the Medtronic, Inc. as well as all affiliates of this group of companies) or a third party designated by Medtronic – but solely in a key coded form, unless it may be impossible to make it anonymous, for instance, where your name cannot be removed from the data carrier, such as x-ray, angiogram or echocardiography. This means that these data will be transferred to a Medtronic entity or a third party designated by Medtronic which is located in the country where you are treated, in a member state of the European Economic Area but maybe also in the United States or another country where the European Directive on Data Protection does not apply.

Medtronic, or a third party designated by Medtronic, will process these data manually or by computer, including the use of internet or cloud computing.

Your personal data are collected for medical research purposes, to gather information on the device and its performance during and after this study and may be used for obtaining assessments for approvals for the device, additional scientific research, educational purposes and publications as well as for future health studies.

Study results may be published without disclosing your name or any other identifying characteristics. In all cases, your personal data will be handled at all times in accordance with appropriate confidentiality standards and all applicable data protection and privacy laws.

You are entitled to access the personal data collected about you and to have inaccuracies corrected.

If you agree upon, your personal physician will be informed about your participation in the study.

Voluntary Participation

Your participation in this study is entirely voluntary. You are free to refuse participation and you are free to discontinue participation in the study at any time without fear of penalty or loss of medical care. In addition, you will be notified in written form of any significant new findings that may develop during the course of the study or the reasons for any amendment to the study protocol which may relate to your willingness to continue your participation.

Your physician, Medtronic, the Ethics Committee or the Competent Authority may decide to terminate your participation in the study at any time without your prior consent. If this happens you will be notified and the reasons explained to you.

Medtronic can also suspend or terminate the study at any time without your prior consent. If this happens, you will be notified and the reasons will be explained to you. Your physician will continue to provide the appropriate medical treatment.

If you discontinue your participation or if the study sponsor decides to terminate your participation in the study all your personal data collected for the study can still be used by the study sponsor unless you object and ask for deletion of the data.

Questions

In case of any question, you can contact one of the following people:

Questions about the study:

Questions in the event of illness or injury:

Questions about patient rights:

**PATIENT INFORMED CONSENT FORM - SIGNATURE SHEET
Medtronic CoreValve™ SURTAVI Trial**

I have read the patient information of this study and my physician has answered all my questions regarding the study.

I had sufficient time to consider my participation into this study, I am aware that participation into this study is completely voluntary, and I agree to follow the instructions from the investigator.

I realize that I may decide to refuse participation or stop participation at any time without penalty and without affecting the quality of my health care or the relationship with my physician.

I understand and agree that personal data about me will be collected and used for the purpose of the study. For conducting the study these data will be transferred to and processed by Medtronic or third parties designated by Medtronic as described in the section 'use of personal data/confidentiality.'

I understand and agree that representatives from Medtronic, regulatory authorities and the Ethics Committee will be granted direct access to my medical records.

I understand and agree that the physician(s) / hospital will release the relevant personal information about me for the purpose of the study.

I understand that I am entitled to access the personal information collected about me and to have inaccuracies corrected.

I have received a copy of the Patient Information and hereby I agree to participate voluntarily in and comply with this study.

You may agree or disagree that your personal physician is informed on your participation in this study.

Please, check **one** option below indicating your choice:

! must be checked by patient

- I agree that my personal physician is informed about my participation in this study.
- I disagree that my personal physician is informed about my participation in this study.

I agree to participate in this study and I have consented before the initiation of any study specific procedures.

Patient:

Name

Signature

Date (dd MMM yyyy)

Must be written by patient

Must be written by patient

Study Doctor or designated person by Study Doctor:

I have conducted the informed consent discussion.

Only persons officially trained and authorized on the delegated task list are allowed to sign off

Name Signature Date (dd MMM yyyy)

If patient is unable to read:

I have attended the entire informed consent discussion. I attest that the information in the consent form and any other written information was accurately explained to, and apparently understood by, the patient. Informed consent was freely given by the patient.

Impartial Witness:

Name Signature Date (dd MMM yyyy)

Section should be filled in by impartial witness

INFORMED CONSENT FORM

Medtronic CoreValve™ SURTAVI Trial

You are being asked to read this form so that you understand this research study and how you might take part in it. By signing this form, you will show that you understand and that you agree to take part in this research study. Your signature on this form is required before you can take part in this research study.

BACKGROUND

You have been invited to participate in this research project because you have aortic stenosis (a disease of one of your heart valves). Before deciding to participate in the study you should be familiar with its requirements, risks and benefits. This document provides information about the study. It may contain words you do not fully understand. Please read it carefully and ask the study staff any questions you may have. They will discuss the study with you in detail. If you decide to participate, you will be asked to sign this form and a copy will be given to you.

The aortic valve is one of the four heart valves that control the flow of blood into and out of the heart. The aortic valve lets oxygen-containing blood to be pumped out of the heart, from the left ventricle (main pumping chamber of the heart) into the aorta (main artery delivering blood to the body). If the valve becomes abnormally narrow through a process of thickening and stiffening (aortic stenosis) the heart must work harder to pump the same amount of blood with each beat.

As the heart works harder, the heart muscle thickens (hypertrophy), and the heart chamber (ventricle) may become larger (dilate). Open-heart surgery to replace the diseased aortic valve is usually the standard treatment.

As an alternative to open heart surgery, the Medtronic CoreValve™ System and Medtronic CoreValve™ Evolut™ R System have been developed to replace a diseased aortic heart valve without the need for open heart surgery. A description of the valves is included under the section **Study Devices**.

A description of this clinical trial will be available on <http://www.ClinicalTrials.gov>. This website will not include information that can identify you. At most, the website will include a summary of the results. You can search this website at any time.

You are being asked to participate in this study because doctors have determined your aortic valve is no longer working the way it should. However, your doctors have also decided that your risk of experiencing major problems while having open-heart surgery is moderate. This means that your doctor believes your health is good enough for open-heart surgery, but there is still a risk of potential problems.

PURPOSE OF THE STUDY

The purpose of this clinical study is to figure out if replacing the aortic valve without open-heart surgery is as safe as or safer than open-heart surgery in patients with similar medical conditions as you.

The study valve is considered an “investigational device”, which means that Health Canada has not yet approved it to be used for standard of care purposes and is only allowed to be used for the study. Medtronic, Inc. is sponsoring this study to obtain data on the safety and performance of the investigational device. The Medtronic CoreValve™ System and Medtronic CoreValve™ Evolut™ R System includes the valves described below and two parts that help load and deliver the valves correctly.

This study will involve approximately 1600 subjects at up to 115 hospitals in the United States, Canada and around the world, and is anticipated to take approximately 8 years to complete. Your participation in this study is expected to last approximately five years from the day you are enrolled in the study. Annual follow-up may be extended to up to 10 years after the implant procedure.

STUDY DEVICES

Both study valves are made from animal tissue attached to a metal frame.

The study valves are designed to be inserted using a long, thin flexible tube (delivery system) to replace your diseased aortic heart valve through an incision in the skin and threaded through the bloodstream (percutaneous) and without open-heart surgery. A unique feature of the Evolut R device is that it can be re-captured, making it easier for doctors to place the device in a correct position. Once it is implanted, CoreValve™ study valves acts in the same method of the native valve.

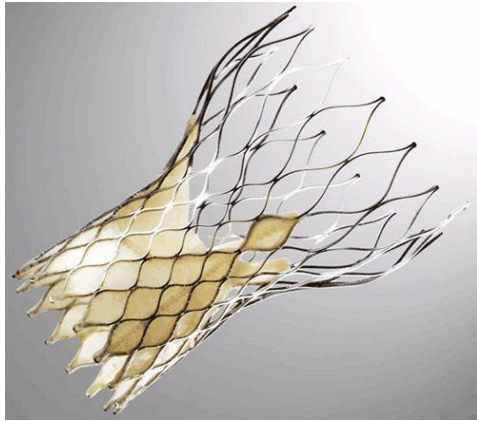

Figure 1: Medtronic CoreValve™ “Study Valve”



Figure 2: Medtronic CoreValve™ Evolut™ R “Study Valve”

Although the Medtronic CoreValve™ system and Medtronic CoreValve™ Evolut™ R system are not approved by the US Food & Drug Administration (FDA), or Health Canada, it has been approved in other parts of the world since 2006 and has been implanted in over 45,000 patients.

The Medtronic CoreValve™ System is currently approved for use in Europe, South America, and parts of Asia. The Medtronic CoreValve™ Evolut™ R system is currently being studied in Europe and Australia.

PROCEDURES TO BE FOLLOWED

If you agree to be in this study, and after you have signed this informed consent form, information such as your age, gender, medical history and medication use will be recorded. You will have the following tests:

- Physical examination
- Computed tomography (CT) - a scan performed using an x-ray machine that takes pictures of your body. Sometimes a CT will require the use of a type of dye that makes the kidneys work harder and may be harmful to the kidneys. You may have an MRI in place of a CT scan if your doctor believes your kidneys are not working well enough for you to have a CT scan. MRI stands for magnetic resonance imaging and is a test that also takes pictures of your internal organs.
- Blood tests (about 2 tablespoons). These tests include the following:
 - Complete blood count - counting the amount of white and red blood cells you have
 - Blood chemistry – tests to make sure your liver and kidneys are working as they should as well as make sure other minerals (enzymes) in your blood are normal
 - Creatinine and Creatinine clearance - tests to make sure your kidneys are functioning as they should
 - Cardiac Enzymes (CK/CK-MB) – test to make sure you have not had heart attack or other heart problems
 - International Normalized Ratio – only if you are taking a medicine called coumadin or warfarin. The test shows how fast your blood clots and if your medication dosage is working
 - Activated Partial Thromboplastin Time – test to determine the thickness of your blood
 - B-Type Natriuretic Peptide (BNP) or NT-proBNP – tests that show if your heart is working harder than normal to pump blood through your body
- Echocardiography (transthoracic echocardiogram (TTE)) - a test that uses sound waves to take pictures of your heart and measure the degree of narrowing of your aortic valve; a probe with gel is placed on the outside of your chest to take pictures of your heart
- Electrocardiogram (ECG) - a test that records electrical impulses of your heart; patches are placed on the outside of your chest
- Heart catheterization/angiography - a test that takes pictures of your heart and blood vessels; a special dye is injected through long, flexible tubes into the coronary arteries (vessels delivering blood to the heart) and bypass grafts if you have them

These procedures and tests are standard procedures required for the treatment of your disease and are not experimental. If you have already had any of these tests performed before, they may be used for the study if your study doctor determines they don't need to be repeated for study purposes. The results from your exams and tests will be reviewed by your doctors who will determine if you are eligible to be in the study.

The results from your exams and tests will be reviewed by your doctor and a committee of study doctors who will determine if you are eligible to be in the study.

Your study doctor and the committee may determine after reviewing your test results that you are not eligible to be in the study and/or it will not be possible to implant the study valve. If so, you will not be allowed to participate in the study.

If your doctors and the committee decide you are eligible to be in the study, your treatment will be determined in a way similar to flipping a coin, called randomization. You will be assigned to one of two groups. One group will receive a transcatheter aortic valve implant (TAVI); the other group will receive an open-heart surgical aortic valve replacement (SAVR). On average, one out of every two participants will receive TAVI. The other participants will receive SAVR. You will not be able to choose your treatment assignment.

You will be considered enrolled in the study once you are assigned to a treatment group.

If you are enrolled in the study, you will be required to have the following additional tests (for study purposes only) completed within 14 days prior to the procedure (TAVI or SAVR):

- Physical exam, including determining your neurological (brain) status where you will be asked to answer some questions and perform some tasks such as writing and drawing
- Blood tests (about 2 tablespoons) These tests include the following:

- Complete blood count - counting the amount of white and red blood cells you have
- Blood chemistry – tests to make sure your liver and kidneys are working as they should as well as make sure other minerals (enzymes) in your blood are normal
- Creatinine and Creatinine clearance - tests to make sure your kidneys are functioning as they should
- Cardiac Enzymes (CK/CK-MB) – test to make sure you have not had heart attack or other heart problems
- International Normalized Ratio – only if you are taking a medicine called coumadin or warfarin. The test shows how fast your blood clots and if your medication dosage is working
- Activated Partial Thromboplastin Time – test to determine the thickness of your blood
- B-Type Natriuretic Peptide (BNP) or NT-proBNP – tests that show if your heart is working harder than normal to pump blood through your body
- Walking test – a test that records your breathing, heart rate, and how you feel after 6 minutes of walking
- Electrocardiogram (ECG) - a test that records electrical impulses of your heart; patches are placed on the outside of your chest

You will also be asked to complete surveys about the quality of your life and your ability to do normal daily activities, called Quality of Life Questionnaires (QOL). Completing the questionnaires should take about 10-15 minutes each.

Your personal physician will be informed about your participation in this clinical study.

If you are assigned to the TAVI group:

The study valve is an experimental valve which means you can only receive the valve if you are part of this study. Your study doctor will decide if you will either receive the Medtronic CoreValve™ System or the Medtronic CoreValve™ Evolut™ R System.

Before the TAVI procedure, it will be strongly recommended that you take blood thinning medications, used to prevent your blood from clotting (thickening). These medications will be described to you by your study doctor. You may be advised to continue these medications for at least three months after your procedure.

Before the procedure you will be given an antibiotic (a medicine that kills bacteria or germs) to decrease your chance of developing an infection. Your study doctor will choose the antibiotic that he or she thinks is best suited for you and decide whether you need additional medication.

You will also have blood tests (about 2 tablespoons) and an ECG before the procedure.

Immediately prior to the procedure, you will receive medications to make you more relaxed and comfortable during the procedure. Your study doctor may decide that general anesthesia is necessary, meaning you need to be put to sleep for the procedure. Your doctor will inform you of this need before the procedure. Additionally, if your study doctor decides that it is necessary during the procedure, you will be put under general anesthesia at that time.

Your study doctor will decide what locations are best for inserting the long, thin flexible tubes required for TAVI and getting all of the pictures that are necessary. These pictures are described in the next paragraphs.

During the procedure, one of the pictures that may be needed is a transesophageal echocardiogram which is also called a TEE. This test uses sound waves to take a closer look at the inside structures of the heart. If your doctor decides this picture is necessary, to perform the test you will swallow a thin flexible tube with a special tip. This tube sits in the esophagus (the tube that connects the mouth to the stomach). The special tip of the tube sends out sound waves (ultrasound) that echo within the chest wall. The esophagus is located behind the heart so these echoes are picked up and create a picture of the heart that is displayed on a video monitor. The pictures will allow your study doctor to take a closer look at your valve.

You will have a temporary pacemaker put in your heart during the TAVI procedure. A temporary pacemaker is a thin wire inserted through your skin and into one of your veins and threaded through your vein into the right side of your heart. The wire is attached to a battery operated device outside of your body. This temporary pacemaker will help keep your heart rate (speed) and rhythm steady. This temporary pacemaker will not be removed for at least 48 hours after your TAVI procedure.

After your study doctor has taken a good look at your valve, a balloon valvuloplasty will be performed. Balloon valvuloplasty is a procedure used to widen a stiff or narrowed heart valve. A wire and a thin tube are guided by x-rays through the heart and positioned through the diseased heart valve. A balloon is placed over the wire and inflated, making the opening bigger through the diseased valve allowing the study valve to be placed.

Your doctor will then implant (insert) the study valve through the long, thin flexible tube that is inserted through an incision in the skin and threaded through the bloodstream. TAVI is performed using x-ray machines which will allow your doctor to see the study valve, your blood vessels and heart. The study valve will be guided through your blood vessels and then it will be placed over your existing aortic valve.

During the TAVI procedure, your doctor will perform angiography (x-ray pictures) and ECGs (recordings of the electrical impulses of your heart through patches placed on the chest) to observe your heart function and make sure that the study valve fits and works properly.

Doctors from other hospitals who have experience with the TAVI procedure may assist your study doctor with the procedure. Medtronic staff may assist the physician in the loading of the study valve onto the tube that helps deliver the valve to the heart.

If you are assigned to the SAVR group:

Open heart surgery, surgical repair and/or replacement of your aortic valve, are not experimental procedure; meaning you could have this procedure if you did not take part in this study.

If you are assigned to the SAVR group, your doctors will replace your diseased aortic valve through open heart surgery. During surgery, you are asleep under general anesthesia. SAVR often requires the bone in the center of the chest (sternum) to be split down the middle. The chest is then opened to provide your doctor with access to the heart and chest cavity, in order to replace your aortic valve. Your surgery is performed while the function of your heart is taken over by a heart lung machine (called CPB for cardiopulmonary bypass).

You may have a TEE (a thin tube that sits in the esophagus and sends out sound waves to create a picture of your heart) and a temporary pacemaker (thin wire threaded through your vein to right side of heart to keep your heart rate and rhythm steady) during the procedure.

Your doctor may remove any tissue and calcium deposits (extra calcium that has collected on the valve) that are interfering with the normal function of the valve. Your damaged valve may be completely removed. The new valve will be sewn into the space where your own valve used to be. After your doctor makes sure your valve is working properly, blood flow will be returned to your heart and the incisions will be closed. You will also have blood drawn for testing before and after the procedure.

If your doctor is unable to implant (insert) the a valve in you during the TAVI or SAVR procedure, you will still be considered enrolled in the study and will need to return to the clinic for the required follow-up visits as described in the "Follow-up Visits after TAVI and SAVR" section.

After TAVI and SAVR Procedure:

After the TAVI and SAVR procedure, your study doctors will continue to monitor your progress and recovery.

You will have the following tests performed within the two days following the procedure and before you are discharged from the hospital:

- Physical exam, including determining your neurological (brain) status where you will be asked to answer a some questions and perform some tasks such as writing and drawing

- Blood tests (about 2 tablespoons) These tests include the following:
 - Complete blood count - counting the amount of white and red blood cells you have
 - Blood chemistry – tests to make sure your liver and kidneys are working as they should as well as make sure other minerals (enzymes) in your blood are normal
 - Creatinine and Creatinine clearance - tests to make sure your kidneys are functioning as they should
 - Cardiac Enzymes (CK/CK-MB) – test to make sure you have not had heart attack or other heart problems
 - International Normalized Ratio – only if you are taking a medicine called coumadin or warfarin. The test shows how fast your blood clots and if your medication dosage is working
 - Activated Partial Thromboplastin Time – test to determine the thickness of your blood
 - B-Type Natriuretic Peptide (BNP) or NT-proBNP – tests that show if your heart is working harder than normal to pump blood through your body
- Echocardiogram (TTE)
- ECG

Follow-up Visits after TAVI and SAVR:

You will need to return to the clinic for required follow-up visits at 30 days, 6 months, 12 months (1 year), 18 months, 24 months (2 years), and 3, 4, and 5 years after the procedure. Most of the follow-up tests and examinations are routine, not experimental. Each visit will take about 1 ½ to 2 hours.

Your evaluations at 30 days, 6 and 18 months will include:

- Physical exam, including determining your neurological (brain) status where you will be asked to answer some questions and perform some tasks such as writing and drawing
- You will be asked about your health since the last follow-up visit
- Quality of Life Questionnaires
- ECG
- Blood tests (about 2 tablespoons) – 30 day visit only
 - Hemoglobin – test how much of a protein that carries oxygen to your body's organs and tissues and transports carbon dioxide from your organs and tissues back to your lungs you have in your blood
 - Creatinine and Creatinine clearance - tests to make sure your kidneys are functioning as they should
- Walking test – 30 day visit only
- Echocardiogram (TTE) – 6 month visit only

Your evaluation at 12 months, 24 months, and 3, 4, 5 years will include:

- Physical exam, including determining your neurological (brain) status where you will be asked to answer some questions and perform some tasks such as writing and drawing
- You will be asked about your health since the last clinic visit
- Blood tests (about 2 tablespoons)
- Echocardiogram (TTE)
- Quality of Life Questionnaires
- ECG
- Walking test – 12 and 24 months visits only

In addition to the in-clinic follow-up visits, at 3 months you will be contacted by phone, by someone from your clinic, to complete a Quality of Life Questionnaire.

If, during the 5 years of follow-up you have additional heart surgeries or cath lab procedures to work on or replace your aortic valve or study valve, you will be asked to answer questions and perform activities that will help the study doctors and nurses to determine your neurological (brain) status within 24 hours after each additional procedure.

If you have a stroke, have been informed by a doctor that you experienced a stroke, or experience any of the following symptoms, notify Dr. **Principal Investigator** at xxx-xxx-xxxx as soon as possible: sudden numbness, tingling, loss of movement (especially on 1 side of the body), vision changes, confusion or trouble understanding simple statements, severe headaches, or seizures. Any of these symptoms could indicate that you are having problems with your neurological (brain) function. If a doctor confirms that you had a stroke, you will be asked to come to the clinical to have tests performed to determine your neurological (brain) status where you will be asked to answer a series of questions and perform a series of tasks. These tests will be performed at 7 days, 30 days and 3 months after you have any of these symptoms.

If you have any other problems or complications, are seen by any other doctors for problems, or are hospitalized during your participation in this study you should immediately notify Dr. **Principal Investigator** at xxx-xxx-xxxx.

If the study valve is removed for any reason, we will request that it be returned to Medtronic for additional analysis. Your study doctor will determine if you will need to have another valve implanted.

In the event of your death, we would like to do an autopsy. We will ask that either your whole heart and valve or just the valve are removed and returned to Medtronic for additional analysis.

The autopsy and the removal of the heart and/or valve would be done to provide additional information about the research and the study valve.

Your family and your "legally authorized representatives", has the right to refuse the autopsy and refuse the request to remove the heart and/or valve even if you sign this consent form. You may still participate in this study if you do not want to have an autopsy done.

POSSIBLE RISKS AND DISCOMFORTS

TAVI

Potential risks associated with the implantation of the study valve may include, but are not limited to, the following:

- **Death**
- **Cardiac arrest** – heart stops beating and blood flow through the body is interrupted or stopped
- **Coronary occlusion, obstruction, or vessel spasm (including acute coronary closure)** – blockage or closure of an artery that supplies the heart with blood
- **Emergent surgery**
 - Coronary artery bypass – (CABG) a surgery where the chest is opened to place new vessels around the existing blocked vessels of the heart to improve blood supply to the heart.
 - Heart valve replacement – replacing the existing heart valve with a new heart valve
 - Valve explant – the removal of the existing valve
- **Multi-organ failure** – more than one organ of the body not functioning correctly
- **Heart failure** – heart does not pump blood to the body
- **Myocardial infarction** - decreased blood flow to the heart causing death of heart muscle cells
- **Cardiogenic shock** – failure of the heart to pump enough blood to the body organs
- **Respiratory insufficiency or respiratory failure** – not enough oxygen or not able to supply oxygen to the body
- **Cardiovascular injury (including rupture, perforation, or dissection of vessels, ventricle, myocardium, or valvular structures that may require intervention)**

- **Perforation of the myocardium or a vessel** – a hole in the heart muscle or a blood vessel
- **Ascending aorta trauma** – injury to the large blood vessel leading blood away from the heart
- **Cardiac tamponade** – the constriction or inability of the heart to pump due to buildup of blood or fluid around the lining of the heart
- **Cardiac failure or low cardiac output**
- **Prosthetic valve dysfunction including, but not limited to:**
 - Fracture (break) in the valve frame
 - Bending of the valve frame
 - The valve frame does not open (expand) all the way
 - Calcification (build-up of calcium on the valve)
 - Pannus – the formation of scar tissue that may cover or block the valve from functioning normally
 - Wear, tear or movement forward (prolapse) or backward (retraction) from the normal position of the valve leaflets
 - The valve leaflets do not close together
 - A break in the stitches (sutures) of the valve frame or leaflets
 - Leakage through or around the valve or valve frame
 - Incorrect size of the valve implanted
 - Incorrect position of the valve, either too high or too low
 - Regurgitation – backward flow of blood through the valve
 - Stenosis – narrowing of the opening of the valve
- **Thrombosis/embolus (including valve thrombosis)** - an abnormal particle (air, blood clots) floating in the blood stream or attached to an object, including the valve
- **Valve migration/valve embolization** – upward or downward movement of the device from where it was originally placed
- **Ancillary device embolization** – a broken piece of the tube that delivers the valve floating in the blood stream
- **Emergent percutaneous coronary intervention (PCI)** – a procedure through the vessels inside the body and heart used to treat or open narrowed vessels of the heart
- **Emergent balloon valvuloplasty** (balloon valvuloplasty during the TAVI procedure is expected) – a procedure through the vessels inside the body and heart in which a narrowed heart valve is stretched open by a balloon
- **Bleeding that may or may not require transfusion or intervention**
- **Allergic reaction to:**
 - Antiplatelet agents (blood thinning medication)
 - Contrast medium (dye used to see vessels with x-ray), or
 - Anesthesia (medication used to put you to sleep during the procedure)
- **Infection (including septicemia and endocarditis)** – an abnormal growth of germs in the body or body part
- **Stroke, TIA, or other neurological deficits** – decreased blood flow to the brain causing death of brain cells
- **Permanent disability** – injury that does not allow that impairs normal/previous physical or mental function
- **Renal insufficiency or renal failure (including acute kidney injury)** – failure of the kidneys to work correctly
- **Mitral valve regurgitation or injury** – a leaking valve between the left upper (left atrium) and left lower (left ventricle) parts of the heart where blood flows backward through the valve or damage to the valve that may cause it to not function correctly

- **Tissue erosion** – damage to the tissue of the heart or blood vessels that could result in a tear or hole
- **Vascular access related complications, such as:**
 - Dissection - a tear in a blood vessel
 - Perforation – puncture of a blood vessel
 - Pain
 - Bleeding
 - Hematoma –blood collecting under the skin
 - Pseudoaneurysm - blood collecting on the outside of a vessel wall causing a balloon-like widening
 - Irreversible nerve damage – permanent damage to nerves
 - Compartment syndrome – squeezing of nerves and muscles in a closed space that could cause muscle or nerve damage
 - Arteriovenous fistula – abnormal connection between an artery vessel that takes blood away from the heart and a vein vessel that takes blood to the heart
 - Stenosis – narrowing of a vessel (artery)
- **Cardiac arrhythmias**
 - Disturbances in the electrical system of the heart that may result in the permanent placement of a device (pacemaker) that delivers electrical impulses to the heart to help your heart beat normally
 - Atrio-ventricular node block – a block in the electrical path from the top part of the heart (atria) to the bottom part of the heart (ventricle)
 - Bundle branch block – a delay or block in the electrical path in the bottom part of the heart (ventricle)
 - Asystole – when the heart stops beating
 - Ventricular arrhythmias – abnormal fast or slow heart beats in the lower part of the heart (ventricles)
- **Encephalopathy** – altered mental state
- **Pulmonary edema** – fluid build-up in or in the space around the lungs
- **Pericardial effusion** – fluid around the heart
- **Pleural effusion** – fluid build-up in the space around the lungs that makes breathing difficult
- **Myocardial ischemia** – reduced or interrupted blood supply to the heart
- **Peripheral ischemia** – reduced or interrupted blood supply to arms and legs
- **Bowel ischemia** – decrease blood supply to the intestines
- **Heart murmur** – an extra or unusual sound hear during a heartbeat
- **Hemolysis** – break down of blood cells
- **Cerebral infarction-asymptomatic** – silent stroke
- **Non-emergent reoperation**
- **Inflammation** – swelling of tissue
- **Fever** – increase in body temperature
- **Hypotension or hypertension** – low or high blood pressure
- **Syncope** – fainting
- **Dyspnea** – shortness of breath
- **Anemia** – not enough oxygen carrying cells in the blood
- **Angina** – chest pain
- **Abnormal lab values (including electrolyte imbalance)** – changes in blood test results

- Exposure to radiation through fluoroscopy and angiography
- Delivery catheter malfunction resulting in need for additional re-crossing of the aortic valve and prolonged procedural time

There may also be additional risks, discomforts, or side effects that are not yet known.

SAVR

Although SAVR is not experimental there are potential risks associated with this procedure and any surgery. These risks are the same even if you undergo the SAVR procedure and you decide not to participate in this study. Your study doctor will explain these risks to you and you will be asked to sign a separate surgical informed consent.

If you become pregnant there may be risks, discomforts, or side effects to you and the embryo/fetus that are not yet known. Please notify your study doctor as soon as possible to discuss any of these potential risks.

RADIATION EXPOSURE RISKS

Some of the test and procedures that are part of this study require exposure to radiation (x-rays). These tests or treatments involve a small amount of radiation. To give you an idea about how much radiation you will get, in the following descriptions the radiation is compare to the amounts that people are exposed to in daily life. There is radiation that naturally occurs from space and from rocks in the soil. This natural radiation is greater at higher altitudes.

CT of Chest and Abdomen and Coronary Angiography

The radiation exposure received from the screening tests (CTA of abdomen and thorax and coronary angiogram) is approximately 10 times the radiation exposure received in one year from background radiation (naturally occurring radiation you are exposed to everyday). The exposure is less than the radiation exposure limit an occupational worker is allowed to receive in one year.

Valve implantation

The estimated radiation exposure for the valve procedure is approximately 10-15 times the amount of radiation exposure received in one year from background radiation (naturally occurring radiation you are exposed to everyday). The exposure is approximately the amount an occupational worker is allowed to receive in one year.

There are additional risks or side effects from being exposed to x-rays. Most side effects do not occur often and resolve without major problems. It is possible that skin reddening or other alterations to the skin's appearance may occur if you are exposed to enough radiation during the procedure or if you have recently had another cardiac angiogram. You should contact your doctor in the event that you observe this. If you have a reaction to the x-rays you may need to have extra follow-up visits with your doctor to watch your recovery more closely.

Your doctor will explain to you how many x-rays you will receive, what x-rays are part of your normal care and what, if any, are extra for the study.

POSSIBLE BENEFITS

The possible benefits you may receive from participating in this research are that you may be able to receive a new heart valve without having open-heart surgery.

Your participation in this research may improve procedures that may guide the future treatment of heart surgery, by using procedures that are less invasive, meaning less cutting, entering or breaking through the body, which may benefit others in the future. However, there is no guarantee that you will benefit from being in this research.

ALTERNATIVE TREATMENTS

The current long-term effective treatment for severe aortic stenosis is open heart surgery to replace the aortic valve. For patients who are at high risk for open heart surgery, other treatment options include percutaneous (through an artery in the groin) aortic valve implantation, or medical

management to relieve symptoms, which may include balloon valvuloplasty. Ask your study doctor about other treatment options you may have.

IF PROBLEMS DEVELOP

If you believe that you have been injured as a result of your participation in the study, you should notify Dr. Principal Investigator at xxx-xxx-xxxx as soon as possible or in serious cases, go to the emergency room.

Immediate necessary medical care is available at [Name of institution(s)] in the event that you are injured as a result of your participation in this research study

If you are assigned to the TAVI group

For those patients receiving the investigational device and the TAVI procedure,

Medtronic has agreed to pay back [name of institutions that are parties to the CTA] for the costs of reasonable medical or surgical care they provide for any serious and unanticipated illness or injury under the following conditions:

- The illness or injury must be directly related to a defect or malfunction of the investigational device or in the TAVI procedure as described in the Protocol, and not related to procedures that are routine standard of care.
- The illness or injury cannot be caused (a) by the negligence or intentional misconduct of the study staff or [name of institutions that are parties to the CTA]; (b) because the study staff or [name of institution(s)] that are parties to the CTA did not follow the protocol for the study; or (c) by the natural progression of your illness.
- The illness or injury must have happened before the study closes (last patient is seen for the 5 year follow-up visit) at this [Name of institution(s)].
- [Name of institution(s) that are parties to the CTA] must notify Medtronic of the illness or injury within one year of the date the study closes at all study sites or before the study closes at this site, whichever is earlier.

Subject to the above conditions, Medtronic will pay back the costs that are not covered by your applicable provincial health insurance or third party insurer. The amount Medtronic will pay back is the applicable provincial health insurance plan rate.

If you are assigned to the SAVR group

In the event of physical injury or physical illness related to a procedure required for the SAVR group, no monetary compensation or subsidy (payment) will be provided. Medical treatment will be routinely provided to you through your regular provincial health insurance plan.

By agreeing to the above, you do not waive any of your legal rights which you otherwise would have as a research subject, nor do you release the study sponsor (Medtronic, Inc.), study doctors, or the hospital from liability for negligence.

PAYMENT FOR PARTICIPATION IN THE STUDY

You will not be paid to take part in the study. However, you may be reimbursed for local mileage and parking expenses directly related to any study-only related visits. Your study doctor or research coordinator will tell you how to get reimbursement.

There is no monetary advantage to the study doctor for participation in this study. Your participation in this study may contribute to the development of commercial products from which Medtronic may receive economic benefit. Medtronic is paying the study site for the work involved in collecting study data and managing the study at this site.

MEDICAL EXPENSES

All necessary medical procedures should be covered by Provincial Health Insurance Plan.

BASIS OF PARTICIPATION

Your participation in this study is voluntary. If you refuse to be in this study there will be no penalty or loss of benefits to which you are otherwise entitled. You may withdraw from the study at any time and will not lose your benefits or be treated any differently as a result of withdrawing from the study. Any new findings (decisions or conclusions) that may influence your willingness to participate will be provided to you. If you decide to leave the study before it is finished, please tell one of the persons listed in the section below "Obtaining Additional Information". It may be requested that, if you withdraw, you return to your study doctor for a final visit.

The study doctor may end your participation in the study at any time if:

- He or she determines it is not in the best interest of your health
- The study doctor loses contact with you and you do not return for your study visits as scheduled
- You refuse to allow the use of private health information during the course of the study

The study doctor will make the decision and let you know if it is not possible for you to continue in the study.

You may be removed from the study without your consent if the sponsor (Medtronic, Inc.) ends the study. If this happens, you will be notified and the reasons will be explained to you. Your physician will continue to provide the appropriate medical care.

What are my responsibilities as a research subject?

As a subject in a research study, it is important that you:

- Be truthful about your health and medication history;
- Return to the office for the study visits that the physician has scheduled with you;
- Call the study doctor's office to reschedule a missed visit as soon as possible;
- Report any injuries, hospitalizations, emergency room visits, symptoms or complaints to the study doctor or nurse as soon as possible.

PERMISSION FOR ACCESS TO AND USE OF HEALTH INFORMATION

While you take part in this research study, the researcher in charge and study staff will collect and take down information about you in a file. Only information necessary for the research study will be collected.

The information in your file could include your past and present medical history, information about your way of life and test results from exams and procedures done during this study. Your file could also contain other information, such as your name, sex, date of birth and ethnic origin.

All the information collected about you during the study will remain confidential as the law demands. To protect your privacy, your information will be identified with numbers and or letters. Only the researcher in charge of the study knows the numbers and or letters that link them to you.

The study researcher will send the research study information collected about you to the sponsor or sponsor representatives. This information does not include your name or address.

The sponsor will use the information collected about you only to reach the study goals as they are explained in this Informed Consent Form.

The information collected about you can be shared by itself, or together with other information collected from other studies with government groups in Canada or in other countries, or with the people that do business with the study's sponsor Medtronic. This means that your study information could be sent to other countries. The sponsor must respect applicable Canadian privacy laws and those in all the countries where your study information will be sent. Your study information will be kept for at least 25 years by the researcher in charge of the study and by the sponsor.

The study information may help the government approve the sale of the study device. The study information may also be used for other reasons related to the study or to help develop future studies.

The study information could be printed in medical journals or shared with other people at scientific meetings, but, it will be impossible to identify you.

To make sure the study is being done properly; your research study file as well as your medical file could be checked by a person authorized by the Research Ethics Board of the [Name of hospital or clinic(s)], or by the institution, by a person authorized by special people or groups (Health Canada) as well as by the sponsor's representatives. These people and groups are obliged to respect your privacy.

For your safety and to be able to reach you quickly, your family name, first name, how to contact you and the date you started and ended the study will be kept for one year after the study ends in a separate list kept by the researcher in charge of the study or by the institution.

You have the right to look at your study file in order to check the information gathered about you and to correct it, if necessary, as long as the study researcher or the institution keeps this information. However, you may only have access to certain information once the study has ended so that the quality of the research study is protected.

Economic Study

This study contains a health economics review that will be done to compare the in-hospital, follow-up medical care resource utilization and cost for patients in each of the treatment groups. You may also be asked to sign a separate document that gives us your permission to review your billing information sent directly from your payer in order to evaluate medical cost data. This information will be kept strictly confidential and be used solely to assess the medical expenses which occur as a direct result of participating in the Medtronic CoreValve™ SURTAVI Trial.

Quality of Life Questionnaire

Medtronic CoreValve™ SURTAVI Trial will also contain a quality of life study. As part of this study, your research coordinator will have you or your caregiver complete a questionnaire called a Quality of Life Questionnaire. You will need to complete this questionnaire when you are enrolled in the study and 1 month, 3 months, 6 months, 12 months, 18 months, 2 years, 3 years, 4 years and 5 years after your study procedure.

OBTAINING ADDITIONAL INFORMATION

You are encouraged and have the right to ask questions at any time concerning potential and/or known risks of this study. The study doctor will inform you of any new significant information, when it becomes available, which may affect your willingness to continue to participate in this study. If you have any questions about this study or if you experience any health problems, you should contact **Dr. Principal Investigator** at xxx-xxx-xxxx.

If you have questions about your rights as a participant in this study, you should contact the chairman of the Institutional Review Board at xxx-xxx-xxxx.

MEDTRONIC'S USE AND DISCLOSURE OF YOUR HEALTH INFORMATION

This section describes what Medtronic as study sponsor will do with the study data, including your health information received during the study.

Medtronic will keep your health information confidential in keeping with all applicable laws and regulations. Medtronic may use your health information to conduct this study. Medtronic may use your health information for other purposes, such as:

- Watch over and improve the performance of its device;
- New medical research;
- Proposals for making new medical products or procedures; and
- Other business purposes.

Any reports or publications about the study or any other research will not include your name or a description of you. Any records identifying you will not be made publically available. Information

received during the study will not be used to market to you; your name will not be placed on any mailing lists or sold to anyone for marketing purposes.

The United States Food and Drug Administration's (FDA) and Health Canada's regulations, as well as other applicable laws, control Medtronic's work in developing and assuring the safety and quality performance of its medical devices. Medtronic may disclose your health information to the FDA, Health Canada, as well as to other U.S. and foreign government authorities responsible for assuring the safety of medical devices. Medtronic also may disclose your health information to research ethics boards and other persons who are required to watch over the safety and effectiveness of medical products and therapies and the conduct of research. In addition, Medtronic representatives or delegates of Medtronic may inspect/monitor your medical records during the course of the clinical study in order to ensure compliance with the study protocol and study procedures. You agree to allow Medtronic to use study data in these ways. You also agree to allow Health Canada, the FDA and other governmental authorities to inspect your health information.

You may change your mind and take back this permission to use your health information at any time. To take back this permission, you must write to [name and contact information]. If you take back this permission, you cannot continue in the study. Even if you take back this permission, Medtronic and Researchers may continue to use and share the health information already received as described in this Informed consent.

PRIMARY CARE PHYSICIAN / SPECIALIST NOTIFICATION OPTION

Please indicate below whether you would like us to notify your primary care physician or your specialist of your participation in this study.

(Initial only one box).

Yes, I want the study doctor to inform my primary care physician/specialist of my participation in this study

No. I do not want the study doctor to inform my primary care physician/specialist of my participation in this study.

I do not have a primary care physician/specialist.

The study doctor is my primary care physician/specialist.

**INFORMED CONSENT FOR THE MEDTRONIC
SURTA VI TRIAL****PATIENT INFORMED CONSENT FORM SIGNATURE SHEET**

I confirm that:

- I have read the informed consent form of this study and my physician has answered all my questions regarding the study.
- I had sufficient time to consider my participation into this study, I am aware that participation into this study is completely voluntary, and I agree to follow the instructions from the investigator.
- I realize that I may decide to refuse participation or stop participation at any time without penalty and without affecting the quality of my health care or the relationship with my physician.
- I understand and agree that personal information about me will be collected from my medical records, used and processed (manually and by computer) by the manufacturer of a medical device used in my treatment or any other designated party that is involved in the study (e.g. hospital, physician, regulatory authorities, ethics committees).
- I understand and agree that representatives from Medtronic, regulatory authorities and the Institutional Review Board will be granted direct access to my medical records.
- I understand and agree that the physician(s) / hospital will release the relevant personal information about me for the purpose of the clinical investigation.
- I understand that I am entitled to access the personal information collected about me and to have inaccuracies corrected.
- I fully understand there is limited experience with this device in humans and that its safety and effectiveness have not been established and there are risks of serious complications associated with this study.
- I also understand that the doctors might determine after I give consent that it is not possible to implant the study valve.

Signature of the subject or subject's legally authorized representative

I hereby give my consent to participate in the "*Medtronic CoreValve™ SURTA VI Trial*". I have been given a copy of this consent form, and am also aware that the investigator will keep a copy in his or her files.

<hr/> Printed name of subject	
<hr/> Signature of subject	<hr/> Date (must be written in by subject)

Signature of a witness in the event that the subject or subject's legally authorized representative is unable to read or write

<p style="text-align: center;">_____</p> <p>Printed name of witness (if applicable)</p>	
<p style="text-align: center;">_____</p> <p>Signature of witness (if applicable)</p>	<p style="text-align: center;">_____</p> <p>Date (must be written in by witness)</p>

Signature of the principal investigator or authorized designee for conducting the informed consent process

<ul style="list-style-type: none"> • I certify that I have explained the nature of the device and the study to the above-named person. • I have also explained the contents of this informed consent form to the above-named person. I have asked whether or not there are any questions. I have answered any questions that were raised by this person. <p style="text-align: center;">_____</p> <p>Printed name of principal investigator or authorized designee for conducting the informed consent process</p>	
<p style="text-align: center;">_____</p> <p>Signature of principal investigator or authorized designee</p>	<p style="text-align: center;">_____</p> <p>Date (must be written in by principal investigator or authorized designee)</p>

R.1.4 Canada – Roll-in Subjects

INFORMED CONSENT FORM**FOR ROLL-IN SUBJECTS****Medtronic CoreValve™ SURTAVI Trial**

You are being asked to read this form so that you understand this research study and how you might take part in it. By signing this form, you will show that you understand and that you agree to take part in this research study. Your signature on this form is required before you can take part in this research study.

BACKGROUND

You have been invited to participate in this research project because you have aortic stenosis (a disease of one of your heart valves). Before deciding to participate in the study you should be familiar with its requirements, risks and benefits. This document provides information about the study. It may contain words you do not fully understand. Please read it carefully and ask the study staff any questions you may have. They will discuss the study with you in detail. If you decide to participate, you will be asked to sign this form and a copy will be given to you.

The aortic valve is one of the four heart valves that control the flow of blood into and out of the heart. The aortic valve lets oxygen-containing blood to be pumped out of the heart, from the left ventricle (main pumping chamber of the heart) into the aorta (main artery delivering blood to the body). If the valve becomes abnormally narrow through a process of thickening and stiffening (aortic stenosis) the heart must work harder to pump the same amount of blood with each beat.

As the heart works harder, the heart muscle thickens (hypertrophy), and the heart chamber (ventricle) may become larger (dilate). Open-heart surgery to replace the diseased aortic valve is usually the standard treatment.

As an alternative to open heart surgery, the Medtronic CoreValve™ System and Medtronic CoreValve™ Evolut™ R System have been developed to replace a diseased aortic heart valve without the need for open heart surgery. A description of the study valve is included under the section **Study Device**.

A description of this clinical trial will be available on <http://www.ClinicalTrials.gov>. This website will not include information that can identify you. At most, the website will include a summary of the results. You can search this website at any time.

You are being asked to participate in this study because doctors have determined your aortic valve is no longer working the way it should. However, your doctors have also decided that your risk of experiencing major problems while having open-heart surgery is moderate. This means that you doctor believes your health is good enough for open-heart surgery, but there is still a risk of potential problems.

PURPOSE OF THE STUDY

The purpose of this clinical study is to figure out if replacing the aortic valve without open-heart surgery is as safe as or safer than open-heart surgery in patients with similar medical conditions as you.

The study valve is considered an “investigational device”, which means that Health Canada has not yet approved it to be used for standard of care purposes and is only allowed to be used for the study. Medtronic, Inc. is sponsoring this study to obtain data on the safety and performance of the investigational device. The Medtronic CoreValve™ System and Medtronic CoreValve™ Evolut™ R System includes the valves described below and two parts that help load and deliver the valves correctly.

This study will involve up to 2000 subjects at up to 115 hospitals in the United States, Canada and around the world, and is anticipated to take approximately 8 years to complete. Your

participation in this study is expected to last approximately five years from the day you are enrolled in the study. Annual follow-up may be extended to up to 10 years after the implant procedure.

STUDY DEVICES

Both study valves are made from animal tissue attached to a metal frame.

The study valves are designed to be inserted using a long, thin flexible tube (delivery system) to replace your diseased aortic heart valve through an incision in the skin and threaded through the bloodstream (percutaneous) and without open-heart surgery. A unique feature of the Evolut R device is that it can be re-captured, making it easier for doctors to place the device in a correct position. Once it is implanted, CoreValve™ study valves acts in the same method of the native valve.

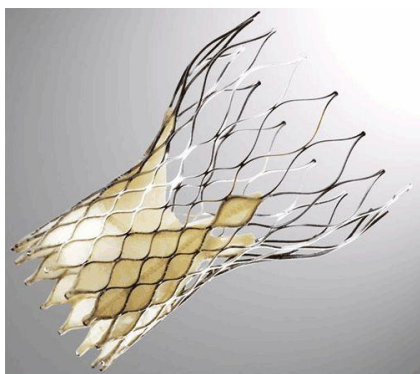

Figure 1: Medtronic CoreValve™ “Study Valve”



Figure 2: Medtronic CoreValve™ Evolut™ R “Study Valve”

Although the Medtronic CoreValve™ system is not approved by the US Food & Drug Administration (FDA), or Health Canada, it has been approved in other parts of the world since 2006 and has been implanted in over 45,000 patients.

The Medtronic CoreValve™ System is currently approved for use in Europe, South America, and parts of Asia. The Medtronic CoreValve™ Evolut™ R system is currently being studied in Europe and Australia.

PROCEDURES TO BE FOLLOWED

If you agree to be in this study, and after you have signed this informed consent form, information such as your age, gender, medical history and medication use will be recorded. You will have the following tests:

- Physical examination
- Computed tomography (CT) - a scan performed using an x-ray machine that takes pictures of your body. Sometimes a CT will require the use of a type of dye that makes the kidneys work harder and may be harmful to the kidneys. You may have an MRI in place of a CT scan if your doctor believes your kidneys are not working well enough for you to have a CT scan. MRI stands for magnetic resonance imaging and is a test that also takes pictures of your internal organs.
- Blood tests (about 2 tablespoons). These tests include the following:
 - Complete blood count - counting the amount of white and red blood cells you have
 - Blood chemistry – tests to make sure your liver and kidneys are working as they should as well as make sure other minerals (enzymes) in your blood are normal
 - Creatinine and Creatinine clearance - tests to make sure your kidneys are functioning as they should
 - Cardiac Enzymes (CK/CK-MB) – test to make sure you have not had heart attack or other heart problems
 - International Normalized Ratio – only if you are taking a medicine called coumadin or warfarin. The test shows how fast your blood clots and if your medication dosage is working
 - Activated Partial Thromboplastin Time – test to determine the thickness of your blood
 - B-Type Natriuretic Peptide (BNP) or NT-proBNP – tests that show if your heart is working harder than normal to pump blood through your body
- Echocardiography (transthoracic echocardiogram (TTE)) - a test that uses sound waves to take pictures of your heart and measure the degree of narrowing of your aortic valve; a probe with gel is placed on the outside of your chest to take pictures of your heart
- Electrocardiogram (ECG) - a test that records electrical impulses of your heart; patches are placed on the outside of your chest
- Heart catheterization/angiography - a test that takes pictures of your heart and blood vessels; a special dye is injected through long, flexible tubes into the coronary arteries (vessels delivering blood to the heart) and bypass grafts if you have them

These procedures and tests are standard procedures required for the treatment of your disease and are not experimental. If you have already had any of these tests performed before, they may be used for the study if your study doctor determines they don't need to be repeated for study purposes.

The results from your exams and tests will be reviewed by your doctor and a committee of study doctors who will determine if you are eligible to be in the study.

Your study doctor and the committee may determine after reviewing your test results that you are not eligible to be in the study and/or it will not be possible to implant the study valve. If so, you will not be allowed to participate in the study.

If your doctor and the committee decide you are eligible to be in the study, you will be one of the first three (3) patients at this hospital to be enrolled in this study. You will receive a transcatheter aortic valve implant (TAVI).

Your enrollment in the study will begin once you sign this consent and you are assigned to the roll-in treatment group. If you are enrolled in the study, you will be required to have the following additional tests (for study purposes only) completed within 14 days prior to the procedure (TAVI):

- Physical exam, including determining your neurological (brain) status where you will be asked to answer some questions and perform some tasks such as writing and drawing
- Blood tests (about 2 tablespoons) These tests include the following:
 - Complete blood count - counting the amount of white and red blood cells you have
 - Blood chemistry – tests to make sure your liver and kidneys are working as they should as well as make sure other minerals (enzymes) in your blood are normal

- Creatinine and Creatinine clearance - tests to make sure your kidneys are functioning as they should
- Cardiac Enzymes (CK/CK-MB) – test to make sure you have not had heart attack or other heart problems
- International Normalized Ratio – only if you are taking a medicine called coumadin or warfarin. The test shows how fast your blood clots and if your medication dosage is working
- Activated Partial Thromboplastin Time – test to determine the thickness of your blood
- B-Type Natriuretic Peptide (BNP) or NT-proBNP – tests that show if your heart is working harder than normal to pump blood through your body
- Walking test – a test that records your breathing, heart rate, and how you feel after 6 minutes of walking
- Electrocardiogram (ECG) - a test that records electrical impulses of your heart; patches are placed on the outside of your chest

You will also be asked to complete surveys about the quality of your life and your ability to do normal daily activities, called Quality of Life Questionnaires (QOL). Completing the questionnaires should take about 10-15 minutes each.

Your personal physician will be informed about your participation in this clinical study.

TAVI PROCEDURE:

The study valve is an experimental valve which means you can only receive the valve if you are part of this study. Your study doctor will decide if you will either receive the Medtronic CoreValve™ System or the Medtronic CoreValve™ Evolut™ R System.

Before the TAVI procedure, it will be strongly recommended that you take blood thinning medications, used to prevent your blood from clotting (thickening). These medications will be described to you by your study doctor. You may be advised to continue these medications for at least three months after your procedure.

Before the procedure you will be given an antibiotic (a medicine that kills bacteria or germs) to decrease your chance of developing an infection. Your study doctor will choose the antibiotic that he or she thinks is best suited for you and decide whether you need additional medication.

You will also have blood tests (about 2 tablespoons) and an ECG before the procedure.

Immediately prior to the procedure, you will receive medications to make you more relaxed and comfortable during the procedure. Your study doctor may decide that general anesthesia is necessary, meaning you need to be put to sleep for the procedure. Your doctor will inform you of this need before the procedure. Additionally, if your study doctor decides that it is necessary during the procedure, you will be put under general anesthesia at that time.

Your study doctor will decide what locations are best for inserting the long, thin flexible tubes required for TAVI and getting all of the pictures that are necessary.

During the procedure you may have a transesophageal echocardiogram which is also called a TEE. This test uses sound waves to take a closer look at the inside structures of the heart. To perform the test you will swallow a thin flexible tube with a special tip. This tube sits in the esophagus (the tube that connects the mouth to the stomach). The special tip of the tube sends out sound waves (ultrasound) that echo within the chest wall. The esophagus is located behind the heart so these echoes are picked up and create a picture of the heart that is displayed on a video monitor. The pictures will allow your study doctor to take a closer look at your valve.

You will have a temporary pacemaker put in your heart during the TAVI procedure. A temporary pacemaker is a thin wire inserted through your skin and into one of your veins and threaded through your vein into the right side of your heart. The wire is attached to a battery operated device outside of your body. This temporary pacemaker will help keep your heart rate (speed) and rhythm steady. This temporary pacemaker will not be removed for at least 48 hours after your TAVI procedure.

After your study doctor has taken a good look at your valve, a balloon valvuloplasty will be performed. Balloon valvuloplasty is a procedure used to widen a stiff or narrowed heart valve. A wire and a thin tube are guided by x-rays through the heart and positioned through the diseased heart valve. A balloon is placed over the wire and inflated, making the opening bigger through the diseased valve allowing the study valve to be placed.

Your doctor will then implant (insert) the study valve through the long, thin flexible tube that is inserted through an incision in the skin and threaded through the bloodstream. TAVI is performed using x-ray machines which will allow your doctor to see the study valve, your blood vessels and heart. The study valve will be guided through your blood vessels and then it will be placed over your existing aortic valve.

During the TAVI procedure, your doctor will perform angiography (x-ray pictures) and ECGs (recordings of the electrical impulses of your heart through patches placed on the chest) to observe your heart function and make sure that the study valve fits and works properly.

Doctors from other hospitals who have experience with the TAVI procedure may assist your study doctor with the procedure. Medtronic staff may assist the physician in the loading of the study valve.

AFTER TAVI PROCEDURE:

After the TAVI procedure, your study doctors will continue to monitor your progress and recovery. You will have the following tests performed within the two days following the procedure and before you are discharged from the hospital:

- Physical exam, including determining your neurological (brain) status where you will be asked to answer a some questions and perform some tasks such as writing and drawing
- Blood tests (about 2 tablespoons) These tests include the following:
 - Complete blood count - counting the amount of white and red blood cells you have
 - Blood chemistry – tests to make sure your liver and kidneys are working as they should as well as make sure other minerals (enzymes) in your blood are normal
 - Creatinine and Creatinine clearance - tests to make sure your kidneys are functioning as they should
 - Cardiac Enzymes (CK/CK-MB) – test to make sure you have no had heart attack or other heart problems
 - International Normalized Ratio – only if you are taking a medicine called coumadin or warfarin. The test shows how fast your blood clots and if your medication dosage is working
 - Activated Partial Thromboplastin Time – test to determine the thickness of your blood
 - B-Type Natriuretic Peptide (BNP) or NT-proBNP – tests that show if your heart is working harder than normal to pump blood through your body
- Echocardiogram (TTE)
- ECG

FOLLOW-UP VISITS AFTER TAVI:

You will need to return to the clinic for required follow-up visits at 30 days, 6 months, 12 months (1 year), 18 months, 24 months (2 years), and 3, 4, and 5 years after the procedure. Most of the follow-up tests and examinations are routine, not experimental. Each visit will take about 1 ½ to 2 hours.

Your evaluations at 30 days, 6 and 18 months will include:

- Physical exam, including determining your neurological (brain) status where you will be asked to answer a some questions and perform some tasks such as writing and drawing
- You will be asked about your health since the last follow-up visit
- Quality of Life Questionnaires

- ECG
- Blood tests (about 2 tablespoons) – 30 day visit only
 - Hemoglobin – test how much of a protein that carries oxygen to your body's organs and tissues and transports carbon dioxide from your organs and tissues back to your lungs you have in your blood
 - Creatinine and Creatinine clearance - tests to make sure your kidneys are functioning as they should
- Walking test – 30 day visit only
- Echocardiogram (TTE) – 6 month visit only

Your evaluation at 12 months, 24 months, and 3, 4, 5 years will include:

- Physical exam, including determining your neurological (brain) status where you will be asked to answer a some questions and perform some tasks such as writing and drawing
- You will be asked about your health since the last clinic visit
- Blood tests (about 2 tablespoons)
- Echocardiogram (TTE)
- Quality of Life Questionnaires
- ECG
- Walking test – 12 and 24 months visits only

In addition to the in-clinic follow-up visits, at 3 months you will be contacted by phone, by someone from your clinic, to complete a Quality of Life Questionnaire.

If, during the 5 years of follow-up, you have had additional heart surgeries or cath lab procedures to work on or replace your aortic valve or study valve, you will be asked to answer questions and perform activities that will help the study doctors and nurses to determine your neurological (brain) status within 24 hours after each additional procedure.

If you have a stroke, have been informed by a doctor that you experienced a stroke, or experience any of the following symptoms, notify Dr. Principal Investigator at xxx-xxx-xxxx as soon as possible: sudden numbness, tingling, loss of movement (especially on 1 side of the body), vision changes, confusion or trouble understanding simple statements, severe headaches, or seizures. Any of these symptoms could indicate that you are having problems with your neurological (brain) function. If a doctor confirms that you had a stroke, you will be asked to come to the clinical to have tests performed to determine your neurological (brain) status where you will be asked to answer a series of questions and perform a series of tasks. These tests will be performed at 7 days, 30 days and 3 months after you have any of these symptoms.

If you have any other problems or complications, are seen by any other doctors for problems, or are hospitalized during your participation in this study you should immediately notify Dr. Principal Investigator at xxx-xxx-xxxx.

If the study valve is removed for any reason, we will request that it be returned to Medtronic for additional analysis. Your study doctor will determine if you will need to have another valve implanted.

In the event of your death, we would like to do an autopsy. We will ask that either your whole heart and valve or just the valve are removed and returned to Medtronic for additional analysis.

The autopsy and the removal of the heart and/or valve would be done to provide additional information about the research and the study valve.

Your family and your "legally authorized representatives", has the right to refuse the autopsy and refuse the request to remove the heart and/or valve even if you sign this consent form. You may still participate in this study if you do not want to have an autopsy done.

POSSIBLE RISKS AND DISCOMFORTS

Potential risks associated with the implantation of the study valve may include, but are not limited to, the following:

- **Death**
- **Cardiac arrest** – heart stops beating and blood flow through the body is interrupted or stopped
- **Coronary occlusion, obstruction, or vessel spasm (including acute coronary closure)** – blockage or closure of an artery that supplies the heart with blood
- **Emergent surgery**
 - Coronary artery bypass – (CABG) a surgery where the chest is opened to place new vessels around the existing blocked vessels of the heart to improve blood supply to the heart.
 - Heart valve replacement – replacing the existing heart valve with a new heart valve
 - Valve explant – the removal of the existing valve
- **Multi-organ failure** – more than one organ of the body not functioning correctly
- **Heart failure** – heart does not pump blood to the body
- **Myocardial infarction** - decreased blood flow to the heart causing death of heart muscle cells
- **Cardiogenic shock** – failure of the heart to pump enough blood to the body organs
- **Respiratory insufficiency or respiratory failure** – not enough oxygen or not able to supply oxygen to the body
- **Cardiovascular injury (including rupture, perforation, or dissection of vessels, ventricle, myocardium, or valvular structures that may require intervention)**
- **Perforation of the myocardium or a vessel** – a hole in the heart muscle or a blood vessel
- **Ascending aorta trauma** – injury to the large blood vessel leading blood away from the heart
- **Cardiac tamponade** – the constriction or inability of the heart to pump due to buildup of blood or fluid around the lining of the heart
- **Cardiac failure or low cardiac output**
- **Prosthetic valve dysfunction including, but not limited to:**
 - Fracture (break) in the valve frame
 - Bending of the valve frame
 - The valve frame does not open (expand) all the way
 - Calcification (build-up of calcium on the valve)
 - Pannus – the formation of scar tissue that may cover or block the valve from functioning normally
 - Wear, tear or movement forward (prolapse) or backward (retraction) from the normal position of the valve leaflets
 - The valve leaflets do not close together
 - A break in the stitches (sutures) of the valve frame or leaflets
 - Leakage through or around the valve or valve frame
 - Incorrect size of the valve implanted
 - Incorrect position of the valve, either too high or too low
 - Regurgitation – backward flow of blood through the valve
 - Stenosis – narrowing of the opening of the valve
- **Thrombosis/embolus (including valve thrombosis)** - an abnormal particle (air, blood clots) floating in the blood stream or attached to an object, including the valve
- **Valve migration/valve embolization** – upward or downward movement of the device from where it was originally placed
- **Ancillary device embolization** – a broken piece of the tube that delivers the valve floating in the blood stream

- **Emergent percutaneous coronary intervention (PCI)** – a procedure through the vessels inside the body and heart used to treat or open narrowed vessels of the heart
- **Emergent balloon valvuloplasty** (balloon valvuloplasty during the TAVI procedure is expected) – a procedure through the vessels inside the body and heart in which a narrowed heart valve is stretched open by a balloon
- **Bleeding that may or may not require transfusion or intervention**
- **Allergic reaction to:**
 - Antiplatelet agents (blood thinning medication)
 - Contrast medium (dye used to see vessels with x-ray), or
 - Anesthesia (medication used to put you to sleep during the procedure)
- **Infection (including septicemia and endocarditis)** – an abnormal growth of germs in the body or body part
- **Stroke, TIA, or other neurological deficits** – decreased blood flow to the brain causing death of brain cells
- **Permanent disability** – injury that does not allow that impairs normal/previous physical or mental function
- **Renal insufficiency or renal failure (including acute kidney injury)** – failure of the kidneys to work correctly
- **Mitral valve regurgitation or injury** – a leaking valve between the left upper (left atrium) and left lower (left ventricle) parts of the heart where blood flows backward through the valve or damage to the valve that may cause it to not function correctly
- **Tissue erosion** – damage to the tissue of the heart or blood vessels that could result in a tear or hole
- **Vascular access related complications, such as:**
 - Dissection - a tear in a blood vessel
 - Perforation – puncture of a blood vessel
 - Pain
 - Bleeding
 - Hematoma –blood collecting under the skin
 - Pseudoaneurysm - blood collecting on the outside of a vessel wall causing a balloon-like widening
 - Irreversible nerve damage – permanent damage to nerves
 - Compartment syndrome – squeezing of nerves and muscles in a closed space that could cause muscle or nerve damage
 - Arteriovenous fistula – abnormal connection between an artery vessel that takes blood away from the heart and a vein vessel that takes blood to the heart
 - Stenosis – narrowing of a vessel (artery)
- **Cardiac arrhythmias**
 - Disturbances in the electrical system of the heart that may result in the permanent placement of a device (pacemaker) that delivers electrical impulses to the heart to help your heart beat normally
 - Atrio-ventricular node block – a block in the electrical path from the top part of the heart (atria) to the bottom part of the heart (ventricle)
 - Bundle branch block – a delay or block in the electrical path in the bottom part of the heart (ventricle)
 - Asystole – when the heart stops beating
 - Ventricular arrhythmias – abnormal fast or slow heart beats in the lower part of the heart (ventricles)
- **Encephalopathy** – altered mental state

- **Pulmonary edema** – fluid build-up in or in the space around the lungs
- **Pericardial effusion** – fluid around the heart
- **Pleural effusion** – fluid build-up in the space around the lungs that makes breathing difficult
- **Myocardial ischemia** – reduced or interrupted blood supply to the heart
- **Peripheral ischemia** – reduced or interrupted blood supply to arms and legs
- **Bowel ischemia** – decrease blood supply to the intestines
- **Heart murmur** – an extra or unusual sound hear during a heartbeat
- **Hemolysis** – break down of blood cells
- **Cerebral infarction-asymptomatic** – silent stroke
- **Non-emergent reoperation**
- **Inflammation** – swelling of tissue
- **Fever** – increase in body temperature
- **Hypotension or hypertension** – low or high blood pressure
- **Syncope** – fainting
- **Dyspnea** – shortness of breath
- **Anemia** – not enough oxygen carrying cells in the blood
- **Angina** – chest pain
- **Abnormal lab values (including electrolyte imbalance)** – changes in blood test results
- Exposure to radiation through fluoroscopy and angiography
- Delivery catheter malfunction resulting in need for additional re-crossing of the aortic valve and prolonged procedural time

There may also be additional risks, discomforts, or side effects that are not yet known. If you become pregnant there maybe risks, discomforts, or side effects to you and the embryo/fetus that are not yet known. Please notify your study doctor as soon as possible to discuss any of these potential risks.

RADIATION EXPOSURE RISKS

Some of the test and procedures that are part of this study require exposure to radiation (x-rays). These tests or treatments involve a small amount of radiation. To give you an idea about how much radiation you will get, in the following descriptions the radiation is compared to the amounts that people are exposed to in daily life. There is radiation that naturally occurs from space and from rocks in the soil. This natural radiation is greater at higher altitudes.

CT of Chest and Abdomen and Coronary Angiography

The radiation exposure received from the screening tests (CTA of abdomen and thorax and coronary angiogram) is approximately 10 times the radiation exposure received in one year from background radiation (naturally occurring radiation you are exposed to everyday). The exposure is less than the radiation exposure limit an occupational worker is allowed to receive in one year.

Valve implantation

The estimated radiation exposure for the valve procedure is approximately 10-15 times the amount of radiation exposure received in one year from background radiation (naturally occurring radiation you are exposed to everyday). The exposure is approximately the amount an occupational worker is allowed to receive in one year.

There are additional risks or side effects from being exposed to x-rays. Most side effects do not occur often and resolve without major problems. It is possible that skin reddening or other alterations to the skin's appearance may occur if you are exposed to enough radiation during the procedure or if you have recently had another cardiac angiogram. You should contact your doctor in the event that you observe this. If you have a reaction to the x-rays you may need to have extra follow-up visits with your doctor to watch your recovery more closely.

Your doctor will explain to you how many x-rays you will receive, what x-rays are part of your normal care and what, if any, are extra for the study.

POSSIBLE BENEFITS

The possible benefits you may receive from participating in this research are that you may be able to receive a new heart valve without having open-heart surgery.

Your participation in this research may improve procedures that may guide the future treatment of heart surgery, by using procedures that are less invasive, meaning less cutting, entering or breaking through the body, which may benefit others in the future. However, there is no guarantee that you will benefit from being in this research.

ALTERNATIVE TREATMENTS

The current long-term effective treatment for severe aortic stenosis is open heart surgery to replace the aortic valve. For patients who are at high risk for open heart surgery, other treatment options include percutaneous (through an artery in the groin) aortic valve implantation, or medical management to relieve symptoms, which may include balloon valvuloplasty. Ask your study doctor about other treatment options you may have.

IF PROBLEMS DEVELOP

If you believe that you have been injured as a result of your participation in the study, you should notify Dr. **Principal Investigator** at xxx-xxx-xxxx as soon as possible or in serious cases, go to the emergency room.

Immediate necessary medical care is available at [Name of institution(s)] in the event that you are injured as a result of your participation in this research study.

Medtronic has agreed to pay back [name of institutions that are parties to the CTA] for the costs of reasonable medical or surgical care they provide for any serious and unanticipated illness or injury under the following conditions:

- The illness or injury must be directly related to a defect or malfunction of the investigational device or in the TAVI procedure as described in the Protocol, and not related to procedures that are routine standard of care.
- The illness or injury cannot be caused (a) by the negligence or intentional misconduct of the study staff or [name of institutions that are parties to the CTA]; (b) because the study staff or [name of institution(s)] that are parties to the CTA] did not follow the protocol for the study; or (c) by the natural progression of your illness.
- The illness or injury must have happened before the study closes (last patient is seen for the 5 year follow-up visit) at this [Name of institution(s)].
- [Name of institution(s) that are parties to the CTA] must notify Medtronic of the illness or injury within one year of the date the study closes at all study sites or before the study closes at this site, whichever is earlier.

Subject to the above conditions, Medtronic will pay back the costs that are not covered by your applicable provincial health insurance or third party insurer. The amount Medtronic will pay back is the applicable provincial health insurance plan rate.

PAYMENT FOR PARTICIPATION IN THE STUDY

You will not be paid to take part in the study. However, you may be reimbursed for local mileage and parking expenses directly related to any study-only related visits. Your study doctor or research coordinator will tell you how to get reimbursement.

There is no monetary advantage to the study doctor for participation in this study. Your participation in this study may contribute to the development of commercial products from which Medtronic may receive economic benefit. Medtronic is paying the study site for the work involved in collecting study data and managing the study at this site.

MEDICAL EXPENSES

All necessary medical procedures should be covered by Provincial Health Insurance Plan.

BASIS OF PARTICIPATION

Your participation in this study is voluntary. If you refuse to be in this study there will be no penalty or loss of benefits to which you are otherwise entitled. You may withdraw from the study at any time and will not lose your benefits or be treated any differently as a result of withdrawing from the study. Any new findings (decisions or conclusions) that may influence your willingness to participate will be provided to you. If you decide to leave the study before it is finished, please tell one of the persons listed in the section below "Obtaining Additional Information". It may be requested that, if you withdraw, you return to your study doctor for a final visit.

The study doctor may end your participation in the study at any time if:

- He or she determines it is not in the best interest of your health
- The study doctor loses contact with you and you do not return for your study visits as scheduled
- You refuse to allow the use of private health information during the course of the study

The study doctor will make the decision and let you know if it is not possible for you to continue in the study.

You may be removed from the study without your consent if the sponsor (Medtronic, Inc.) ends the study. If this happens, you will be notified and the reasons will be explained to you. Your physician will continue to provide the appropriate medical care.

What are my responsibilities as a research subject?

As a subject in a research study, it is important that you:

- Be truthful about your health and medication history;
- Return to the office for the study visits that the physician has scheduled with you;
- Call the study doctor's office to reschedule a missed visit as soon as possible;
- Report any injuries, hospitalizations, emergency room visits, symptoms or complaints to the study doctor or nurse as soon as possible.

PERMISSION FOR ACCESS TO AND USE OF HEALTH INFORMATION

While you take part in this research study, the researcher in charge and study staff will collect and take down information about you in a file. Only information necessary for the research study will be collected.

The information in your file could include your past and present medical history, information about your way of life and test results from exams and procedures done during this study. Your file could also contain other information, such as your name, sex, date of birth and ethnic origin.

All the information collected about you during the study will remain confidential as the law demands. To protect your privacy, your information will be identified with numbers and or letters. Only the researcher in charge of the study knows the numbers and or letters that link them to you.

The study researcher will send the research study information collected about you to the sponsor or sponsor representatives. This information does not include your name or address.

The sponsor will use the information collected about you only to reach the study goals as they are explained in this Informed and Consent Form.

The information collected about you can be shared by itself, or together with other information collected from other studies with government groups in Canada or in other countries, or with the people that do business with the study's sponsor Medtronic. This means that your study information could be sent to other countries. The sponsor must respect applicable Canadian privacy laws and those in all the countries where your study information will be sent. Your study information will be kept for at least 25 years by the researcher in charge of the study and by the sponsor.

The study information may help the government approve the sale of the study device. The study information may also be used for other reasons related to the study or to help develop future studies.

The study information could be printed in medical journals or shared with other people at scientific meetings, but, it will be impossible to identify you.

To make sure the study is being done properly; your research study file as well as your medical file could be checked by a person authorized by the Research Ethics Board of the [Name of hospital or clinic(s)], or by the institution, by a person authorized by special people or groups (Health Canada) as well as by the sponsor's representatives. These people and groups are obliged to respect your privacy.

For your safety and to be able to reach you quickly, your family name, first name, how to contact you and the date you started and ended the study will be kept for one year after the study ends in a separate list kept by the researcher in charge of the study or by the institution.

You have the right to look at your study file in order to check the information gathered about you and to correct it, if necessary, as long as the study researcher or the institution keeps this information. However, you may only have access to certain information once the study has ended so that the quality of the research study is protected.

Economic Study

This study contains a health economics review that will be done to compare the in-hospital, follow-up medical care resource utilization and cost for patients in each of the treatment groups. You may also be asked to sign a separate document that gives us your permission to review your billing information sent directly from your payer in order to evaluate medical cost data. This information will be kept strictly confidential and be used solely to assess the medical expenses which occur as a direct result of participating in the Medtronic CoreValve™ SURTAVI Trial.

Quality of Life Questionnaire

Medtronic CoreValve™ SURTAVI Trial will also contain a quality of life study. As part of this study, your research coordinator will have you or your caregiver complete a questionnaire called a Quality of Life Questionnaire. You will need to complete this questionnaire when you are enrolled in the study and 1 month, 3 months, 6 months, 12 months, 18 months, 2 years, 3 years, 4 years and 5 years after your study procedure.

OBTAINING ADDITIONAL INFORMATION

You are encouraged and have the right to ask questions at any time concerning potential and/or known risks of this study. The study doctor will inform you of any new significant information, when it becomes available, which may affect your willingness to continue to participate in this study. If you have any questions about this study or if you experience any health problems, you should contact Dr. **Principal Investigator** at xxx-xxx-xxxx.

If you have questions about your rights as a participant in this study, you should contact the chairman of the Institutional Review Board at xxx-xxx-xxxx.

MEDTRONIC'S USE AND DISCLOSURE OF YOUR HEALTH INFORMATION

This section describes what Medtronic as study sponsor will do with the study data, including your health information received during the study.

Medtronic will keep your health information confidential in keeping with all applicable laws and regulations. Medtronic may use your health information to conduct this study. Medtronic may use your health information for other purposes, such as:

- Watch over and improve the performance of its device;
- New medical research;
- Proposals for making new medical products or procedures; and
- Other business purposes.

Any reports or publications about the study or any other research will not include your name or a description of you. Any records identifying you will not be made publically available. Information received during the study will not be used to market to you; your name will not be placed on any mailing lists or sold to anyone for marketing purposes.

The United States Food and Drug Administration's (FDA) and Health Canada's regulations, as well as other applicable laws, control Medtronic's work in developing and assuring the safety and quality performance of its medical devices. Medtronic may disclose your health information to the FDA, Health Canada, as well as to other U.S. and foreign government authorities responsible for assuring the safety of medical devices. Medtronic also may disclose your health information to research ethics boards and other persons who are required to watch over the safety and effectiveness of medical products and therapies and the conduct of research. In addition, Medtronic representatives or delegates of Medtronic may inspect/monitor your medical records during the course of the clinical study in order to ensure compliance with the study protocol and study procedures. You agree to allow Medtronic to use study data in these ways. You also agree to allow Health Canada, the FDA and other governmental authorities to inspect your health information.

You may change your mind and take back this permission to use your health information at any time. To take back this permission, you must write to [name and contact information]. If you take back this permission, you cannot continue in the study. Even if you take back this permission, Medtronic and Researchers may continue to use and share the health information already received as described in this Informed consent.

PRIMARY CARE PHYSICIAN / SPECIALIST NOTIFICATION OPTION

Please indicate below whether you would like us to notify your primary care physician or your specialist of your participation in this study.

(Initial only one box).

Yes, I want the study doctor to inform my primary care physician/specialist of my participation in this study

No. I do not want the study doctor to inform my primary care physician/specialist of my participation in this study.

I do not have a primary care physician/specialist.

The study doctor is my primary care physician/specialist.

**INFORMED CONSENT FOR THE MEDTRONIC
SURTA VI TRIAL****PATIENT INFORMED CONSENT FORM SIGNATURE SHEET**

I confirm that:

- I have read the informed consent form of this study and my physician has answered all my questions regarding the study.
- I had sufficient time to consider my participation into this study, I am aware that participation into this study is completely voluntary, and I agree to follow the instructions from the investigator.
- I realize that I may decide to refuse participation or stop participation at any time without penalty and without affecting the quality of my health care or the relationship with my physician.
- I understand and agree that personal information about me will be collected from my medical records, used and processed (manually and by computer) by the manufacturer of a medical device used in my treatment or any other designated party that is involved in the study (e.g. hospital, physician, regulatory authorities, ethics committees).
- I understand and agree that representatives from Medtronic, regulatory authorities and the Institutional Review Board will be granted direct access to my medical records.
- I understand and agree that the physician(s) / hospital will release the relevant personal information about me for the purpose of the clinical investigation.
- I understand that I am entitled to access the personal information collected about me and to have inaccuracies corrected.
- I fully understand there is limited experience with this device in humans and that its safety and effectiveness have not been established and there are risks of serious complications associated with this study.
- I also understand that the doctors might determine after I give consent that it is not possible to implant the study valve.

Signature of the subject or subject's legally authorized representative

I hereby give my consent to participate in the "*Medtronic CoreValve™ SURTA VI Trial*". I have been given a copy of this consent form, and am also aware that the investigator will keep a copy in his or her files.

<hr/> Printed name of subject	
<hr/> Signature of subject	<hr/> Date (must be written in by subject)

Signature of a witness in the event that the subject or subject's legally authorized representative is unable to read or write

Printed name of witness (if applicable)	
 _____	 _____
Signature of witness (if applicable)	Date (must be written in by witness)

Signature of the principal investigator or authorized designee for conducting the informed consent process

<ul style="list-style-type: none">• I certify that I have explained the nature of the device and the study to the above-named person.• I have also explained the contents of this informed consent form to the above-named person. I have asked whether or not there are any questions. I have answered any questions that were raised by this person. _____	
Printed name of principal investigator or authorized designee for conducting the informed consent process	
 _____	 _____
Signature of principal investigator or authorized designee	Date (must be written in by principal investigator or authorized designee)

R.2 List of Participating Investigational Centers

The list of participating Investigational Centers will be provided under separate cover.

R.3 Other Institutions

The following institutions/organizations will participate in the Medtronic CoreValve SURTA VI Trial. An updated list of "Other Institutions" will be provided in progress reports and/or upon request.

Clinical Events Committee (CEC) / Data Safety Monitoring Committee (DSMB):

Cardialysis

Westblaak 92

3012 KM Rotterdam

The Netherlands

Explanted Device/Pathology Core Lab:

CVPath Institute, Inc.

19 Firstfield Road

Gaithersburg, MD 20878

Imaging Core Lab:

Mayo Clinic

200 First Street SW

Rochester, MN 55905

InteleGRID™ (imaging sharing network):

Intelemage, LLC

5400 Kennedy Ave

Cincinnati, OH 45213

Interactive Voice/Web Response System (IXRS):

United BioSource Corporation (UBC)

303 2nd Street, Suite 700

7th Floor South Tower

San Francisco, CA 94107

R.4 Additional Records and Reports

No additional records and/or reports, other than those previously described in this investigational plan or required by FDA, will be maintained for this clinical investigation.

R.5 Sample Case Report Forms

Sample Case Report Forms (CRFs) will be provided under separate cover.

R.6 Aortogram Acquisition Guidelines

The purpose of the acquisition guidelines is to increase consistency and effectiveness in reviewing the procedural aortograms.

1. Required aortogram:

- Index Procedure –TAVI

2. Required cine runs:

- Pre-procedure aortogram in a projection with 3 aortic cusps aligned (for comparison of final aortogram with pre-procedure aortogram)
- Final aortogram at least 10 minutes after TAVI implantation in the exact same projection as the pre-procedure aortogram (in order to measure depth of implantation and assess grade of aortic regurgitation)

NOTE: If the apex is not clearly visible in the final projection and in case of adequate renal function, in order to assess grade of AR, perform an additional final aortogram in RAO 30° with visualization of the left ventricle in long axis, including the apex.

3. Guidelines on how final aortogram after deployment of the valve should be performed:

- Use at least 20 ml of contrast, with an injection rate of 20 ml/sec
- Position the pigtail catheter in the upper third part of the frame
- Preferably use non-diluted contrast. 50%-diluted contrast is acceptable in case of renal insufficiency
- Use the angiographic projection with the three aortic cusps aligned in 1 plane:
 - Whenever available this optimal projection can be suggested by baseline MSCT exam
 - Pragmatic approach might be to use a shallow LAO or RAO projection, and adjust in a cranial or caudal position respectively to approach the optimal projection
- Confirm visualization of the left ventricular apex on the final aortogram
- Perform the final aortogram at least 10 minutes after deployment of the investigational TAVI device; include a time indication on the aortogram
- Use marker pigtail or provide the French-size of the pigtail catheter for calibration purpose

4. General imaging and recording procedures:

- Use a fixed table system and biplane x-ray equipment, if available
- Recommended resolution: 1024 x 1024 pixels
- Preferred acquisition speed: 25 frames/second
- One single cine run should have a duration of at least 5 heart beats
- The digital clock should be activated
- The maximum magnification factor should be applied during cine run without losing the image of the entire frame
- There should be no overlap of the frame with other catheters or electrodes
- Foreshortening of the frame should be avoided as much as possible
- Upload all images to InteleGRID (secure electronic system used for transferring images)

5. Core lab analysis:

The procedural aortograms may be analyzed by a core laboratory. Analysis would include:

- Grade of aortic regurgitation
- Depth of implantation

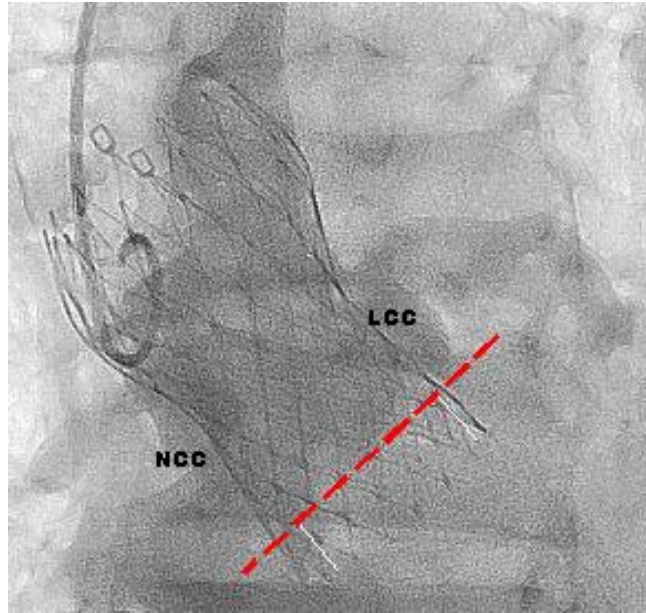

Figure 1: Example of depth of implantation measurement.

R.7 Echocardiography Acquisition Guidelines

1. Scope of the document

These guidelines aim to increase consistency and effectiveness in collection and adjudication of echocardiography data of selected candidates for the SURTAVI trial. Optimal image acquisition, storage, and transmission will be described.

2. Protocol required echocardiograms

Transthoracic echocardiography is required at the following intervals:

Screening	- 45 days of Heart Team review
Post-Procedure OR Discharge	Between 24hrs post-procedure and hospital discharge (but no later than 7 days from post Index Procedure)
6 months	± 30 days
12 months	± 30 days
24 months	± 60 days
3,4,5 years	± 60 days

3. Four general rules for echocardiography recordings

3.1 Rule #1 for overall recordings: adhere STRICTLY to the PROTOCOL regarding:

- **number** and **order** of recordings as listed on the Table
- **do not perform measurements** on the echo recordings, except screening echo to be submitted for screening committee review (see measurements noted in section 4)
- at end of echo exam, export all required recordings in **DICOM** format and upload it to InteleGRID
- only one **certified** echocardiographer (+ 1 replacement) is allowed to participate in the study, he/she should print his/her name, fill in contact details and sign the transmittal form

3.2 Rule #2 for Doppler recordings:

- Unless stated otherwise, all pulsed-wave and continuous-wave Doppler signals should be recorded at a **sweep speed of 50-100 mm/sec** (recording must contain minimum of three heartbeats) with optimized gain and filter setting, baseline position, and velocity range.

3.3 Rule #3 for apical 2D views (4-, 5-, 2-, and 3-Chamber views)

- pay attention to ultrasound sector **depth** and **gain** settings
- the aortic valve should be out of scan plane in the 4-CH view
- please avoid patient or transducer **motion** and record during **quite respiration** unless stated otherwise
- make sure the **entire LV myocardium** (including epicardium and apex) is recorded in the scan sector in particular at end-diastole
- make sure **Frame Rate** is more than 30Hz for 2D grey-scale and around 20Hz for colour Doppler aortic regurgitation

3.4 Rule #4 for EF calculation (apical 4-, 2-, and 3-Chamber views focused on LV)

- Record **3 runs** (run 1: 3 beats, run 2: 3 beats, run 3: 10 beats)

4. Data requirements

Participating centers in the SURTAVI study should obtain the appropriate Doppler and echocardiography recordings to document the following variables.

- Aortic annulus long-axis diameter in mid-systole (screening/baseline only)*
- LVOT long axis diameter in mid-systole
- Sinus of Valsalva diameter (SOV) at end diastole (screening/baseline only)*
- Sino-tubular junction diameter (STJ) at end diastole (screening/baseline only)*
- Sinus of Valsalva height (SOVH) at end-diastole (screening/baseline only)*
- Max aortic valve velocity (V2) by CW Doppler
- Velocity time integral (VTI) across aortic valve by CW Doppler
- Mean gradient across aortic valve (MGV2) by CW Doppler*
- Peak LVOT velocity (V1) by PW Doppler
- Velocity Ratio (V1 / V2)
- Velocity time integral (VTI) of LVOT velocity by PW Doppler
- Mean LVOT gradient (MGV1) by PW Doppler
- Doppler Velocity Index (DVI) = VTI_{LVOT} / VTI_{Ao}
- Grade of aortic transvalvular regurgitation
- Grade of aortic paravalvular regurgitation
- Grade of mitral regurgitation
- PISA for MR (optional)
- Max tricuspid regurgitant (TR) jet velocity (if TR is present)
- Left ventricular (LV) end-diastolic diameter (LVEDD)
- Left ventricular (LV) end-systolic diameter (LVESD)
- Interventricular septal thickness at end diastole
- Left ventricular posterior wall thickness at end diastole
- Left atrial diameter (AP linear dimension) at end systole
- Left ventricular ejection fraction by visual estimate
- Heart rate from Doppler signal
- Mitral inflow "A" velocity
- Mitral inflow "E" velocity
- Mitral inflow E-wave deceleration time
- Mitral annular tissue Doppler systolic velocity (septal and lateral)
- Mitral annular tissue Doppler early diastolic velocity (septal and lateral)
- Mitral annular tissue Doppler late diastolic velocity (septal and lateral)

Procedures for acquiring aortic root measurements and key hemodynamic variables are described in the following sections. For Doppler velocities, the values reported should represent the average of measurements from at least three cardiac cycles for patients in sinus rhythm, and the average of measurements from five cardiac cycles for patients not in sinus rhythm. For aortic valve, TR jet, and tissue Doppler velocities, the reported values should represent the average of the highest velocities obtained from the same transducer position.

* Screening/baseline measurements should be noted on the echo submitted for Screening Committee review.

5. Table 1. list of echo recordings (views)

- Please include all LV walls including epicardium are within the scan sector
- Please enter patient's height, weight, and blood pressure during echo acquisition
- Please optimize frame rate of 2D colour Doppler around 20 Hz if possible
- Shift the colour flow zero baseline downwards or upwards in the regurgitant jet direction in the left PLAX view depending on the jet orientation and upwards in the apical view
- Record frozen images & cine loops in the following order:

A: From parasternal long-axis window

1. 2D greyscale standard view
2. 2D Colour Doppler of mitral regurgitation (MR)
3. 2D Colour Doppler of aortic (or prosthetic) regurgitation (AR)
4. If AR is present, **ZOOM** & narrow sector with focus on vena contracta of regurgitant jet
5. If AR is present, **ZOOM** & narrow sector, shift Nyquist 35-40 for PISA measurements
6. 2D greyscale **ZOOM** for LV outflow tract diameter (LVOT) (**3 recordings**)
7. 2D greyscale **ZOOM** at an intercostal space higher for aortic root / aortic prosthesis

B: From parasternal short-axis window (use same depth setting)

8. 2D greyscale LV at mitral valve level
9. 2D greyscale LV at papillary muscle level
10. 2D greyscale-guided M-mode at LV minor axis (LV dimensions, avoid papillary muscles)
11. 2D greyscale LV at apical level: *lower your transducer position by 1 or 2 intercostal spaces and record the LV as circular as possible, just proximal to the level with end-systolic LV luminal obliteration*
12. 2D greyscale aortic valve level (post TAVI the native annulus is usually identified by maximal calcification)
13. 2D greyscale-guided M-mode of left atrial & aortic dimensions
14. 2D Colour Doppler of AR: *in post-TAVI start scanning from highest position and record first visible AR jet, scan more downwards and try to pick up additional jets – **confirm origin of AR jets from PLAX***
15. 2D greyscale **ZOOM** & focussed on RV outflow tract (RVOT) – **pulmonic valve should be visible**
16. 2D Colour Doppler of pulmonary regurgitation (PR)
17. If PR is present, CWD of PR jet (include both systolic & diastolic signals)
18. PWD of RVOT velocity (**within 0.5 -1cm below the pulmonic valve**) (**frozen image**)

C: From special parasternal long-axis window (RV inflow)

19. 2D Colour Doppler of tricuspid regurgitation (TR)
20. If TR is present, CWD of TR jet (frozen image)

D: From the apical 4-Chamber window

21. 2D greyscale standard view
22. 2D Colour Doppler of MR
23. If MR is present, ZOOM & narrow sector, **shift Nyquist 35-40 for PISA measurements**
24. If MR is present, CWD of MR jet (frozen image)
25. 2D Colour Doppler of TR
26. If TR is present, CWD of TR jet (frozen image)

27. PWD of transmitral flow at mitral valve tips – at a sweep speed of 50-100 mm/s (frozen image)
28. Tissue Doppler of the septal mitral annulus – (frozen image)
29. Tissue Doppler of the lateral mitral annulus – (frozen image)
30. Tissue Doppler of RV free wall (frozen image)
31. M-mode tricuspid annular plane systolic excursion (TAPSE) – (frozen image)
32. 2D greyscale focussed on LV with decreased depth – three recordings: 3 beats, 3 beats, 10 beats)

E: Apical 5-chamber window

33. 2D greyscale standard view
34. 2D Colour Doppler of AR
35. If AR is present, ZOOM & narrow sector, shift Nyquist 35-40 for PISA measurements
36. If AR is present, CWD of AR jet (frozen image)
37. CWD of aortic forward flow (frozen image)
38. PWD LVOT in native aortic valve: within 0.5 - 1cm below native aortic valve
39. PWD LVOT in Core Valve, two recordings: immediately below and inside the inflow region of the stent

F: Apical 2-Chamber window

40. 2D greyscale standard view
41. 2D greyscale focussed on LV with decreased depth – three recordings: 3 beats, 3 beats, 10 beats)

G: Apical 3-chamber window

42. 2D greyscale standard view
43. 2D Colour Doppler of MR
44. If MR is present, use ZOOM & narrow sector – shift Nyquist 35-40 for PISA measurements
45. If MR is present, CWD of MR jet (frozen image)
46. 2D Colour Doppler of AR
47. If AR is present, CWD of AR jet (frozen image)
48. If AR is present, use ZOOM & narrow sector– shift Nyquist 35-40 for PISA measurements
49. CWD of aortic forward flow (frozen image)
50. PWD LVOT in native aortic valve: within 0.5 - 1cm below native aortic valve
51. PWD LVOT in Core Valve, two recordings: immediately below and inside the inflow region of the stent
52. 2D greyscale focussed on LV with decreased depth – three recordings: 3 beats, 3 beats, 10 beats)

H: special recordings

53. Suprasternal PWD of descending aorta diastolic flow (frozen image)
54. Subcostal PWD of abdominal aortic diastolic flow (frozen image)
55. CWD right parasternal aortic forward flow (frozen image)
56. 2D greyscale inferior vena cava – **sniff test for changes in IVC diameter**
57. Optional – biplane imaging at LVOT long-axis for measurement of LVOT area in SAX
58. Optional – 3D full volume acquisition of parasternal long-axis view focus LVOT and aortic root
59. Optional – 3D apical full volume acquisition (single beat or 7 beats)
60. Optional – 3D Colour Doppler from apical view – region of interest aortic valve for AR

6. Detailed instructions for acquisition of SURTAVI echocardiography recordings**6.1 Quality control of the investigational site (initial site validation)**

- The 1st subject with an echo examination submitted will be reviewed to assess the quality of the recording and the transmission and most importantly the ADHERENCE to the PROTOCOL.
- A “Core Laboratory Pre-Analysis” Report will be provided to the site

6.2 Guidelines for study object confidentiality

- **NO patients’ information should be present** on the echocardiogram.
- Site-Patient identification: study subjects are to be identified by a specific study identification number as supplied by the sponsor.
- The following items should be entered in the patient identification section of ultrasound system and should be clearly shown on all digital cine loops or still frames.
 - Site-subject ID (XXXXX-YYYY)
 - date of exam and
 - study interval
- To ensure adherence to the USA HIPAA (Health Insurance Portability and Accountability Act of 1996) guidelines for study subject confidentiality, no study subject names or other Protected Health Information (date of birth, hospital record number, etc.) should be displayed.

6.3 Submission

- Upload all study echocardiograms to InteleGRID (secure electronic system used for transferring images)

6.4 Further inquiries:

- For any questions, contact your monitor or Medtronic Clinical Research Specialist

7. Technical guidelines: how to optimize the echocardiography images

7.1 General recording recommendations

- Ensure ultrasound machines are maintained as instructed by the manufacture
- Ensure calibration of distance, velocity and time on each image
- Keep persistence and smoothening off

7.2 ECG gating

- All cine-loops and still frames must clearly display a single lead electrocardiographic recording in which P-, QRS-, and T-waves (but in particular the R wave) are clearly identifiable

7.3 Number of recorded heart cycles

- In sinus rhythm, record three continuous beats for all cine-loops and still frames, unless indicated otherwise.
- In the presence of irregular/non-sinus rhythm, record 5-10 continuous beats.
- Try to exclude premature beats.

7.4 Effects of respiration and timing of recordings

- During all recordings, respiration should be quiet.
- Tissue Doppler measurements should be recorded after non-forced end-expiration

7.5 Two-dimensional echocardiography general settings

- Use harmonic-imaging mode with maximized (mechanical index >1) power output
- Gain (and time-gain compensation (TGC)) settings should be adjusted to eliminate background noise and to allow for a clear blood-tissue border.
- An optimal gain setting consists of a left ventricular cavity with minimal (but not completely absent) noise
- The greyscale / dynamic range should be adjusted to provide an image with marked contrast between light and dark areas
- The focus point should be set at the middle of the region of interest
- Depth settings should be minimized (do not display structures outside the region of interest)

7.6 (Tissue) Doppler settings

- Use a display speed of 50 to 100 mm/sec and a sample volume length of 3-4 mm (in extremely low heart rates use a speed of 150 mm/sec).
- For mitral E-wave deceleration, time one recording is needed at a sweep speed of 150 mm/s
- Adjust gain, filter settings, position and velocity range to maximize the velocity excursion
- Minimize the angle between the direction of motion of the investigated structure or flow and the Doppler beam
- Transmitral flow should be assessed at the tips of the mitral valve
- Annotate the tissue Doppler recordings

7.7 Colour Doppler settings

- Minimize the colour sector and use a velocity range of approximately ± 60 cm/sec

7.8 Parasternal long-axis view

- Minimize the angle between the left ventricle and aorta (the inferolateral wall should be as perpendicular as possible to the transducer) the anteroseptal wall is visualized at the same distance from the transducer as the anterior wall of the ascending aorta

7.9 Apical two and four-chamber view

- The left ventricular apex should be visible in the top of the sector
- The aortic valve should be out of the image plane
- Maximize the internal long-axis of the left ventricle (avoid foreshortening) by looking for a window one intercostal space lower (in particular when the left ventricle does not appear ellipsoid)

- To ensure that the proper rotation has been made for a two-chamber view, the transducer is angled posteriorly to intersect both papillary muscles symmetrically. Then the transducer is angled slightly anteriorly so that neither papillary muscle is seen in its long axis in this view

7.10 Special considerations for aortic regurgitation by colour flow imaging¹⁻³

In addition to the abovementioned recommendations:

- Standardize the machine settings for all examinations. Keep the Frame Rate around 20 Hz when recording colour Doppler aortic regurgitation
- Colour gain should be set step by step just below the appearance of colour noise artefacts
- For Vena contracta: use a parasternal long-axis view in ZOOM mode with minimal colour sector size and imaging depth to maximize lateral and temporal resolution
- For PISA: Shift the colour flow zero baseline downwards or upwards in the regurgitant jet direction in the left PLAX view depending on the jet orientation and upwards in the apical view)

7.10 Subcostal window

In order to provide optimal image acquisition from subcostal window, the following steps are required:

- The knee-flexed position relaxes the upper abdominal muscles and thereby improves visualization
- From the subcostal four-chamber view, anti-clockwise rotation of the transducer permits visualization and pulsed Doppler examination of the upper abdominal aorta

8. Measurements of aortic root geometry⁴

The following measurements of the aortic root are obtained from the parasternal long-axis view (screening/baseline exams only):

- **Aortic annulus long axis diameter.** The aortic annulus long axis diameter is measured perpendicular to the long axis of the root, measured between the endothelial point that trisects the posterior aortic wall, non-coronary cusp hinge and anterior mitral leaflet hinge (posterior hinge point), and the point that bisects the septal endocardium and the right coronary cusp hinge (anterior hinge point). Measurements should be made at mid-systole and inclusive of cusp calcifications (Figure 1). To accurately incorporate cusp calcification for aortic annulus sizing, measure from the white-black interfaces of the posterior and anterior aortic cusp hinge points and add 2 mm to the measurement.
- **Sinus of Valsalva diameter (SoV).** The SoV diameter is perpendicular to the long axis of the root and typically parallel to the aortic valve annulus. It is the widest intra-luminal distance within the sinuses (measured at end-diastole from inner edge to inner edge, Figure 2, A).
- **Sino-tubular junction diameter (STJ).** The STJ diameter is the intra-luminal diameter parallel to the SoV diameter, where the sinuses narrow and join the ascending aorta (measured at end-diastole from inner edge to inner edge, Figure 2, B).
- **Sinus of Valsalva height (SoVH).** The SoVH is the distance between the STJ and the aortic annulus long-annulus diameter (measured at end-diastole, Figure 3).

Note: *Measurements should be noted on images submitted for Screening Committee review*

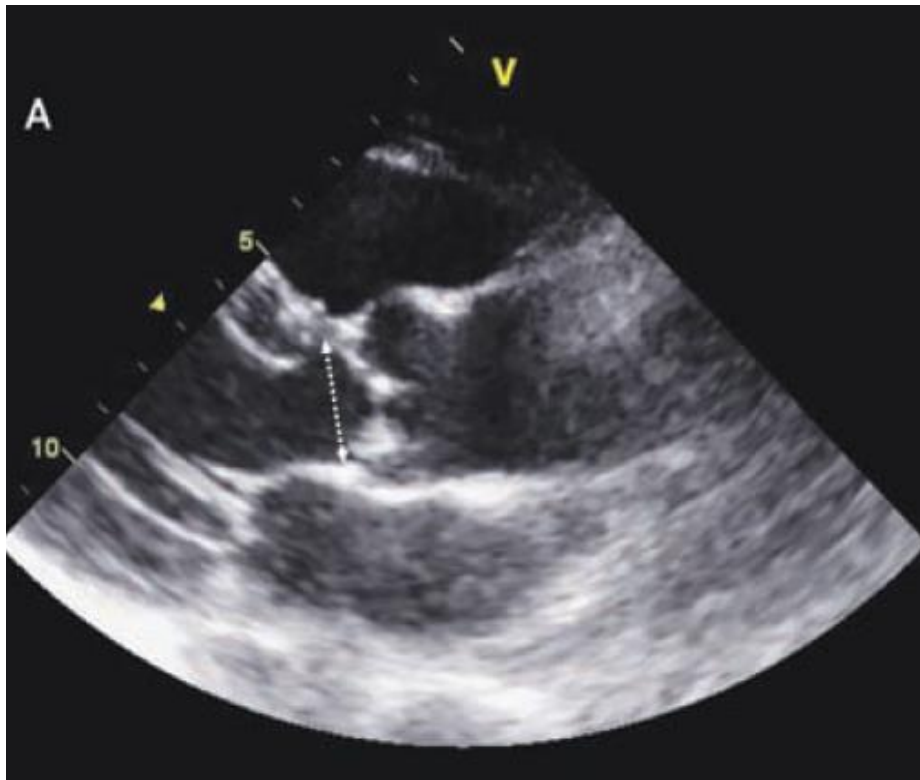

Figure 1. Examples of measurement of the aortic annulus long axis diameter

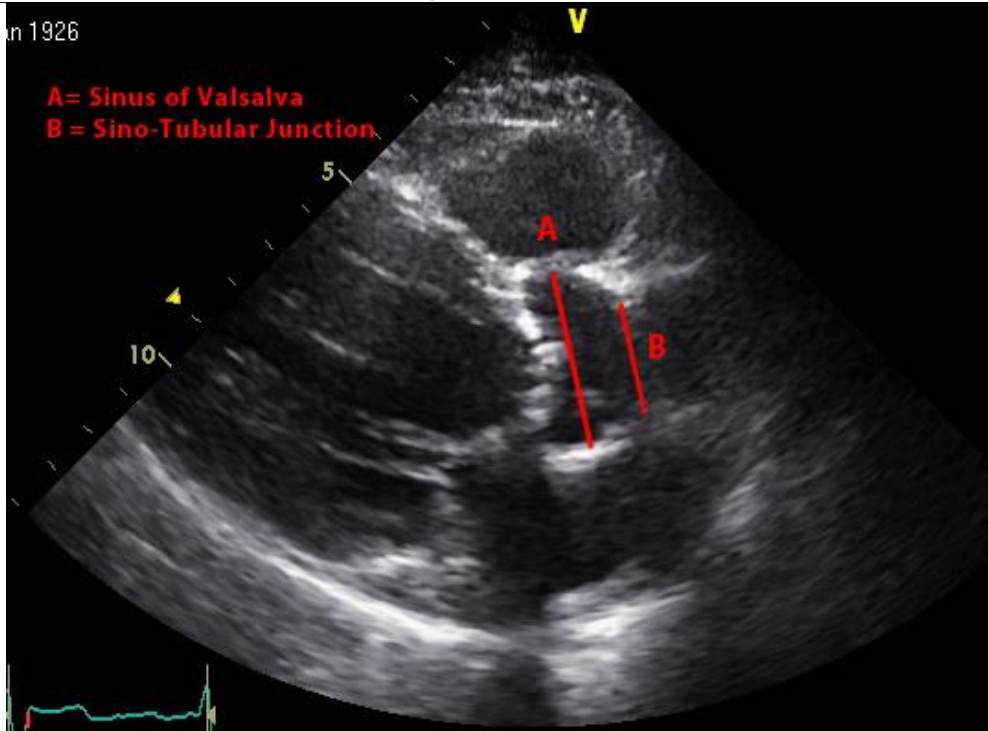

Figure 2. Example of measurement of the Sinus of Valsalva (A) and Sino-Tubular Junction (B) diameters

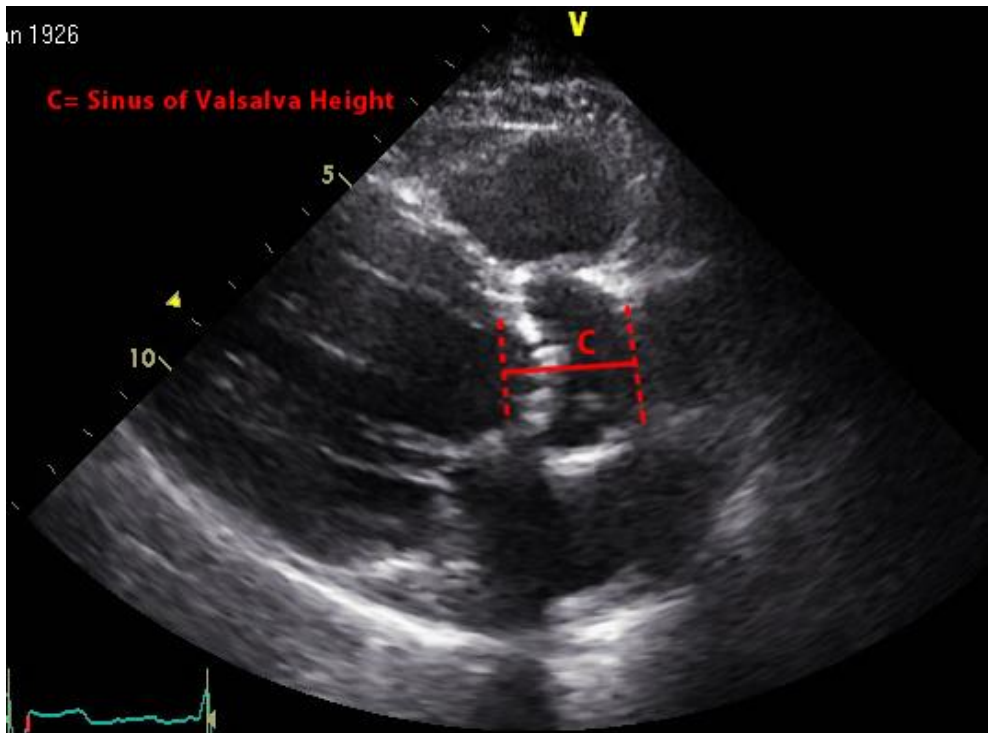

Figure 3. Example of measurement of the Sinus of Valsalva Height (C)

9. Measurement of Left Ventricular Outflow Tract (LVOT) Diameter

The LVOT long axis diameter is measured in the parasternal long-axis view at early to mid systole. The optimal imaging plane is through the long axis of the aorta; therefore, the anterior and posterior walls of the aortic root should be parallel with the maximal aortic diameter.

For native aortic valves, the LVOT long axis diameter is measured from the white-black interface of the septal endocardium to the anterior mitral leaflet, parallel to the aortic valve plane and within 0.5 cm - 1 cm of the valve orifice (Figure 4)¹. Following implantation of the CoreValve device, the LVOT diameters and the LVOT area are measured immediately proximal to the inflow aspect of the stent (Figure 5).

Note: For optimal results, LVOT diameter is averaged from 3 measurements from 3 consecutive high quality 2D ZOOM views.

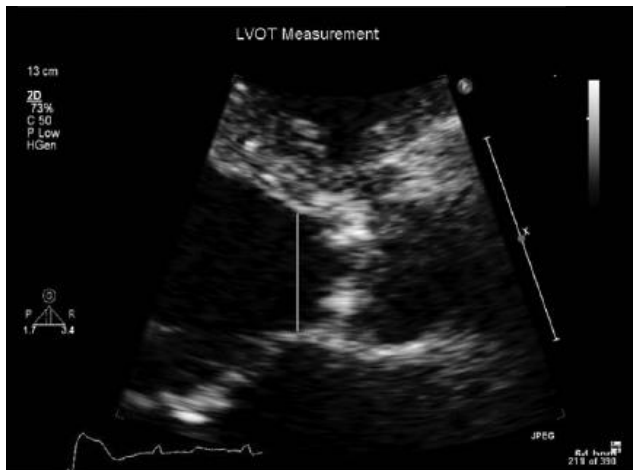

Figure 4. TTE mid-systolic frame showing measurement of LVOT diameter for derivation of native aortic valve area.

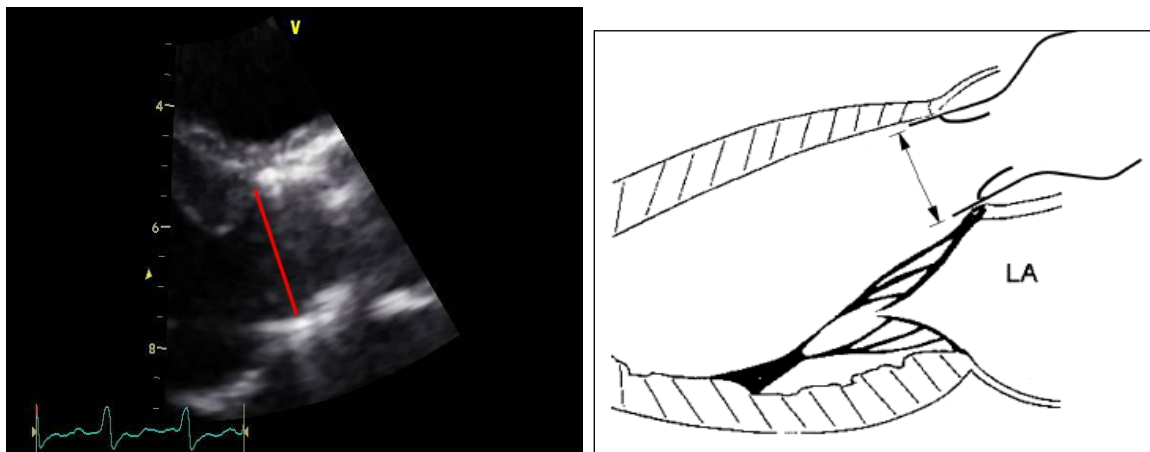

Figure 5. Cursor placement for measurement of LVOT diameter for derivation of prosthetic effective orifice area

10. Measurement of LVOT Velocity⁵

LVOT velocity is recorded with PW Doppler from the apical transducer position, either in the apical long-axis view or in the anteriorly angulated four-chamber view or “five-chamber view.” The PW sample volume is positioned just proximal to the aortic valve, with care to avoid the zone of pre-valve acceleration. The recommended procedure is to initially place the sample volume within the aortic valve leaflets (prosthetic or native), and then gradually move it apically until a clear spectral waveform is observed with a well-defined peak and minimal spectral broadening (Figure 6). No opening click should be seen. The optimal sample volume placement is usually between 0.5 and 1.0 cm upstream from the valve annulus.² Post implantation, the sample volume should be placed at the entrance of the inlet of the TAV prosthesis.

11. Measurement of Aortic Valve Velocity⁵

The aortic valve velocity and VTI should be interrogated with CW Doppler from all transducer positions (apical, right parasternal, suprasternal notch, left supraclavicular, subcostal). The position that provides the highest velocity is used for measurements. A smooth velocity curve with a clear outer edge and maximal velocity should be recorded. The maximal velocity is measured at the outer edge of the dark signal; fine linear signals at the peak should not be included in measurements. The outer edge of the dark “envelope” of the velocity curve is traced to provide both the VTI for the continuity equation and the mean gradient (Figure 7).¹

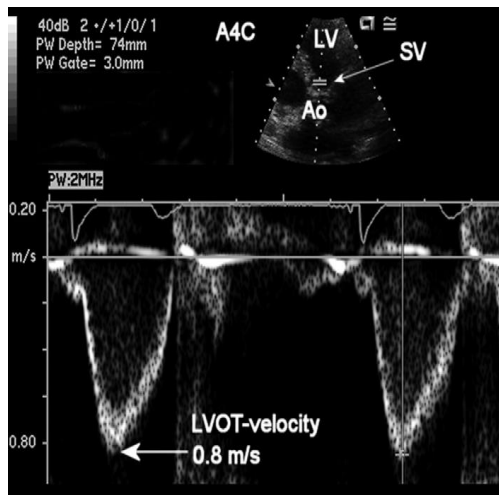

Figure 6. An optimal LVOT signal shows a smooth velocity curve with a narrow velocity range at each time point.

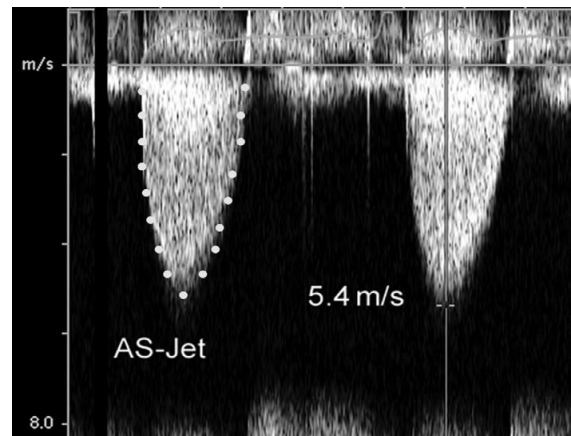

Figure 7. CW Doppler of severe AS jet showing measurement of maximal velocity and tracing of the Velocity curve to calculate mean gradient.

Note: Velocity tracings should be noted on images submitted for Screening Committee review

Note: Fine linear signals at peak velocity should not be included in the velocity tracings!

12. Assessment of Aortic Regurgitation^{6,7}

- **Use all echo modalities:** An integrated exam approach using colour flow, pulsed-wave (PW), and continuous-wave (CW) Doppler is used to assess the severity of transvalvular and paravalvular regurgitation.
- **Use four views:** Colour flow Doppler imaging should be performed from the parasternal long and short-axis views, and the apical long-axis and apical 5-chamber views. A recording of the aortic regurgitant signal should be obtained with CW Doppler. If the degree of aortic regurgitation appears more than mild by visual estimate, the velocity in the proximal descending aorta and the abdominal aorta should be recorded with PW Doppler.
- **Severity:** The degree of transvalvular and paravalvular AR will be graded as none, trace, mild, moderate, and severe based on the analysis of the parameters shown in Table 2a.^{3,4}
 - The category of “trace” is used in cases where regurgitation is barely detectable by colour Doppler.
 - Regurgitant signals observed to originate within the stent will be considered transvalvular, and regurgitant signals observed to originate outside the stent will be considered paravalvular.
- Paravalvular regurgitant jets will be characterized by the extent of the aortic regurgitant jet relative to the short axis circumference of the aortic valve (Table 2a- Valve Academic Research Consortium (VARC) Consensus Report for Transcatheter Aortic Valve Implantation (TAVI) and Table 2b. Updated standardized endpoint definitions for transcatheter aortic valve implantation: the VARC-2 consensus document, and Table 3a and b -2008 Focused Update Incorporated Into the ACC/AHA 2006 Guidelines for the Management of Patients With Valvular Heart Disease (published in the October 2008 issues of Journal of the American College of Cardiology and Circulation).

Table 2a. Parameters for evaluation of the severity of aortic regurgitation^{1, 6, 8}

Prosthetic Aortic Valve Regurgitation Criteria (Central and Paravalvular)			
Parameter	Mild	Moderate	Severe
Valve Structure and Motion Mechanical or bioprosthesis	Usually normal	Usually abnormal†	Usually abnormal†
Structural parameters Left ventricular size	Normal ‡	Normal/ mildly dilated ‡	Dilated
Doppler parameters (qualitative or semi quantitative) Jet width in central jets (% LVO diameter): colour* Jet density: CW Doppler Jet deceleration rate (PHT [†] , ms): CW Doppler** LV outflow vs. pulmonary flow: PW Doppler Diastolic: flow reversal in the descending aorta PW Doppler Circumferential extent of paraprosthetic AR (%)	Narrow (≤25%) Incomplete or faint Slow (>500) Slightly increased Absent or brief early diastolic <10	Intermediate (26-64%) Dense Variable (200-500) Intermediate Intermediate 10-20	Large (≥65%) Dense Steep (<200) Greatly Increased Prominent, Holodiastolic >20
Doppler parameters (quantitative) Regurgitant volume (mL/beat) Regurgitant fraction (%)	<30 <30	30-59 30-50	>60 >50

* Parameter applicable to central jets and is less accurate in eccentric jets

** Influenced by left ventricular compliance

AR=aortic regurgitation; CW= continuous wave; LVO= left ventricular outflow; PW= pulsed wave

† PHT is shortened with increasing LV diastolic pressure and vasodilator therapy, and may be lengthened in chronic adaptation to severe aortic regurgitation. As such, PH, in contrast to the other parameters, does not reflect the volumetric severity of aortic regurgitation, but rather its hemodynamic impact. Therefore, in the setting of acute paravalvular or transvalvular leaks, intermediate values between 200 and 500 ms should not be used to classify the degree of regurgitation.

‡ Abnormal mechanical valves, for example, immobile occluder (valvular regurgitation), dehiscence or rocking (paravalvular regurgitation); abnormal biologic valves, for example, leaflet thickening or prolapse (valvular), dehiscence or rocking (paravalvular regurgitation).

‡ Applies to chronic, late postoperative AR in the absence of other etiologies.

Table 2b. VARC-2 criteria for evaluation of the prosthetic valve dysfunction

Prosthetic valve dysfunction			
Prosthetic aortic valve stenosis*			
	Normal	Mild Stenosis	Moderate/Severe Stenosis
Quantitative Parameters (Flow-dependent)†			
Peak velocity	<3 m/s	3-4 m/s	>4 m/s
Mean gradient	<20 mmHg	20-40 mmHg	>40 mmHg
Quantitative Parameters (Flow-independent)			
Doppler velocity index‡	>0.35	0.35-0.25	<0.25
Effective orifice area¶	>1.1 cm ²	1.1-0.8 cm ²	<0.8 cm ²
Effective orifice area§	>0.9 cm ²	0.9-0.6 cm ²	<0.6 cm ²
Prosthesis-patient mismatch (PPM)			
	Insignificant	Moderate	Severe
Indexed effective orifice area**	>0.85 cm ² /m ²	0.85-0.65 cm ² /m ²	<0.65 cm ² /m ²
Indexed effective orifice area††	>0.70 cm ² /m ²	0.70-0.60 cm ² /m ²	<0.60 cm ² /m ²
Prosthetic aortic valve regurgitation			
	Mild	Moderate	Severe
Semi-quantitative Parameters			
Diastolic flow reversal in the descending aorta—PW	Absent or brief early diastolic	Intermediate	Prominent, holodiastolic
Circumferential extent of prosthetic valve paravalvular regurgitation (%)¶¶	<10%	10-29%	≥30%
Quantitative Parameters‡			
Regurgitant volume (ml/beat)	<30 ml	30-59 ml	≥60 ml
Regurgitant fraction (%)	<30%	30-49%	≥50%
EROA (cm ²)	<0.10 cm ²	0.10-0.29 cm ²	≥0.30 cm ²

*In conditions of normal or near normal stroke volume (50–70 mL)

†These parameters are more affected by flow, including concomitant aortic regurgitation

‡For LVOT >2.5 cm, significant stenosis criteria is <0.20

¶Use in setting of BSA ≥1.6 cm² (note: dependent on the size of the valve and the size of the native annulus)

§Use in setting of BSA <1.6 cm²

**Use in setting of BMI <30 kg/cm²

††Use in setting of BMI ≥30 kg/cm²

¶¶Not well-validated and may overestimate severity compared to quantitative Doppler

From the publication entitled “Updated standardized endpoint definitions for transcatheter aortic valve implantation: the valve academic research consortium-2 consensus document. Kappetein AP, et al. J Am Coll Cardiol. 2012 Oct 9;60(15):1438-54.”

Table 3a. Parameters for evaluation of the severity of aortic regurgitation

Classification of the Severity of Valve Disease in Adults with Aortic Regurgitation			
	Mild	Moderate	Severe
Qualitative Angiographic grade Color Doppler jet width Doppler vena contracta width (cm)	1+ Central jet, width less 25% of LVOT Less than 0.3	2+ Greater than mild but no signs of AR 0.3-0.6	3-4+ Central jet, width greater than 65% LVOT Greater than 0.6
Quantitative (cath or echo) Regurgitant volume (mL per beat) Regurgitant fraction (%) Regurgitant orifice area (cm ²)	< 30 < 30 < 0.10	30-59 30-49 0.10-0.29	≥ 60 ≥ 50 ≥ 0.30
Additional essential criteria Left ventricular size			Increased

13. Assessment of Mitral Regurgitation^{2, 8}

Colour flow Doppler imaging of the left atrium should be performed from the parasternal long-axis view, and from the apical four, two, and long axis views. Mitral regurgitant signals should be recorded with CW Doppler using a velocity scale that allows assessment of the density, shape, duration, and peak velocity of the mitral regurgitant signal. If the severity appears moderate or greater by visual assessment, pulmonary vein velocities should be recorded with PW Doppler to assess for the presence of systolic flow reversal. Grading of the severity of mitral regurgitation should be integrative using the parameters in Table 3b.⁴

Table 3b. Classification of the Severity of Valve Disease in Adults Mitral Regurgitation

Classification of the Severity of Valve Disease in Adults Mitral Regurgitation			
	Mild	Moderate	Severe
Qualitative Angiographic grade Colour Doppler jet area Doppler vena contracta width (cm)	1+ Small, central jet, < 4cm ² or <20% LA area)	2+ Signs of > mild present but no criteria for severe MR	3-4+ Vena contracta with > 0.7cm with large central MR jet (area >40% of LA area) or with a wall- impinging jet of any size, swirling in LA ≥ 0.70
Quantitative (cath or echo) Regurgitant volume (mL per beat) Regurgitant fraction (%) Regurgitant orifice area (cm ²)	< 30 < 30 < 0.20	30-59 30-49 0.29 – 0.39	≥ 60 ≥ 50 ≥ 0.40
Additional essential criteria Left atrial size Left ventricular size			Enlarged Enlarged

14. Assessment of Left Ventricular Function and Left Atrial Size⁹

M-mode recordings of the left ventricle and left atrium should be obtained using 2-D guided beam alignment (Figures 7 and 8). Left ventricular chamber dimensions and wall thicknesses will be measured from 2D parasternal long axis views and should be utilized preferentially if M-mode images are suboptimal. Chamber dimensions are measured using the American Society of Echocardiography (ASE) measurement convention.⁵ In addition, standard 2-D views of the left ventricle should be obtained from parasternal and apical transducer positions for visual estimation and quantitative assessment of left ventricular ejection fraction by visual estimate.

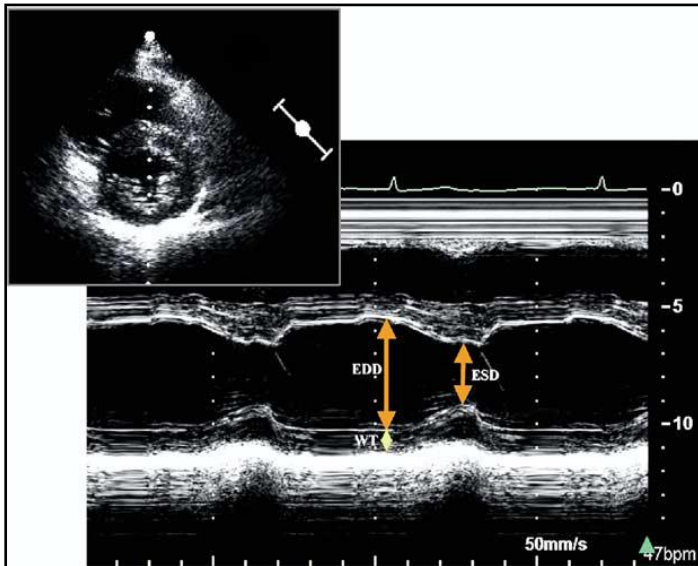

Figure 7. Measurement of left ventricular end-diastolic diameter (EDD) and end-systolic (ESD) from 2-D guided m-mode to optimize medial-lateral beam orientation.

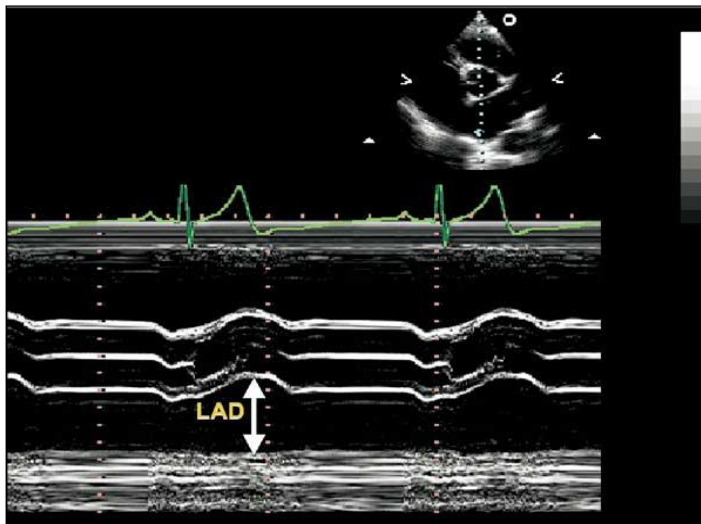

Figure 8. Measurement of left atrial diameter (LAD) by 2-D guided m-mode at end-systole.

15. Acquisition of Mitral Inflow Velocities

A spectral Doppler recording of mitral inflow velocities should be obtained with PW Doppler in the apical 4-chamber view, using a 1 to 3 mm sample volume placed between the mitral leaflet tips during diastole (Figure 9). The spectral gain and wall filter settings should be optimized to clearly display the onset and cessation of left ventricular inflow.⁶

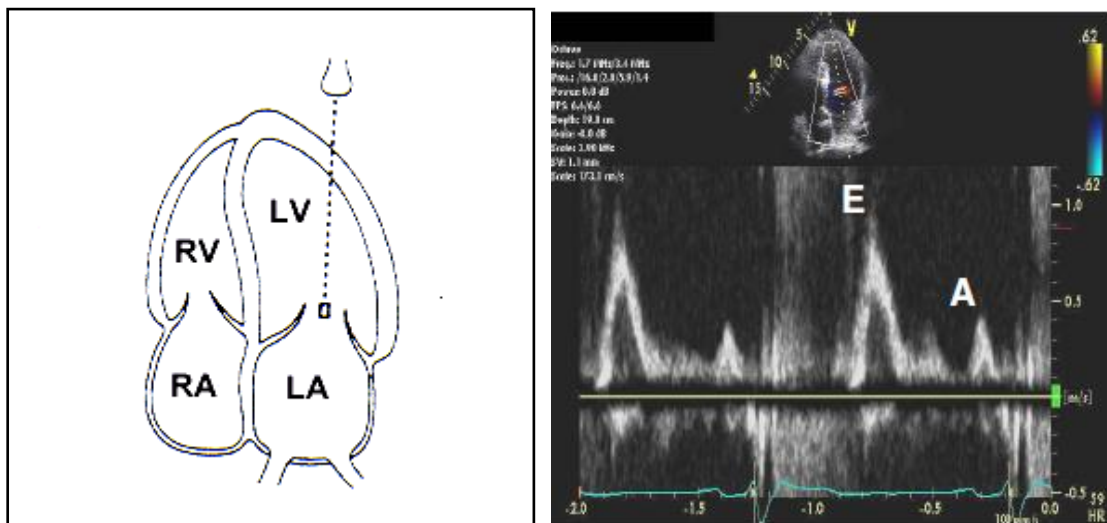

Figure 9. Positioning of the sample volume for recording of mitral inflow velocities.

16. Acquisition of Mitral Annular Tissue Doppler Velocities

Mitral annular velocities should be obtained from the lateral and septal aspects of the mitral annulus using PW tissue Doppler performed in the apical 4-chamber view. The sample volume should be positioned at or 1 cm within the septal and lateral insertion sites of the mitral leaflets and adjusted as necessary (usually 5 to 10 mm) to cover the longitudinal excursion of the mitral annulus in both systole and diastole. Minimal angulations (<20 degrees) should be present between the ultrasound beam and the plane of cardiac motion.⁶ The Doppler gain should be minimized to prevent “blooming” of the signal to facilitate accurate measurement of the annular velocities.

17. Assessment of Device Migration

CoreValve device placement site and migration will be assessed from the parasternal long axis view at each follow up point and compared to the initial post-procedural echo. A zoomed image of the left ventricular outflow tract including the anterior mitral leaflet and the anterior aortic wall should be included at each follow up echo. The location of the device will be determined by measurement of the distance from the proximal edge of the left ventricular outflow tract anteriorly, to the edge of the CoreValve device (Figure 10). Optimal placement of the valve should be within the left ventricular outflow tract just below the aortic annulus (Figure 11).

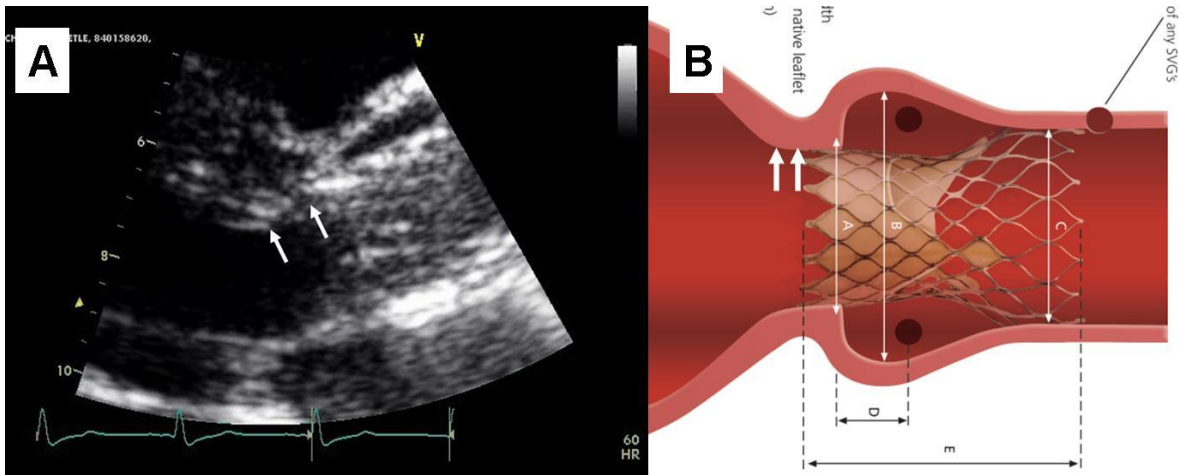

Figure 10. Zoomed view of the left ventricular outflow tract (panel A) and schematic (panel B). Measurement of the distance from the proximal edge of the anterior aspect of the left ventricular outflow tract to the edge of the CoreValve device (arrows).

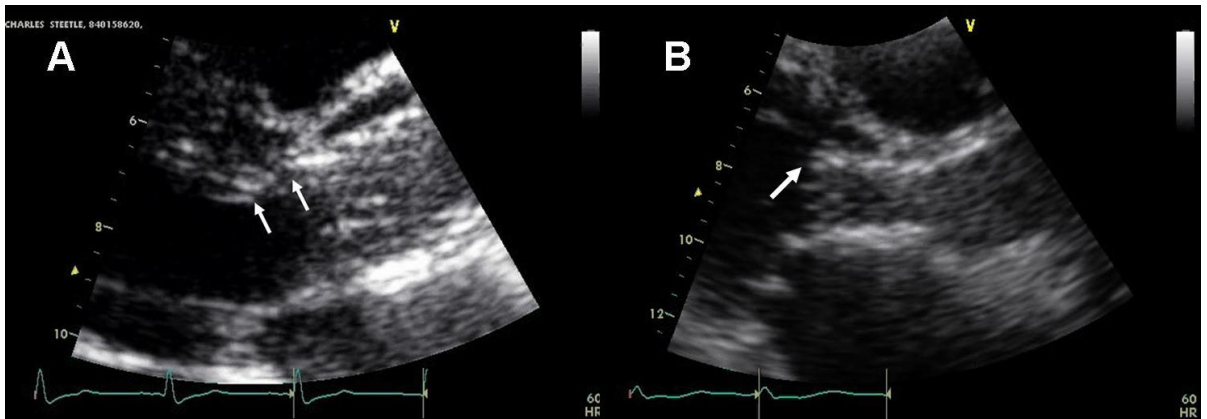

Figure 11. Zoomed view of the left ventricular outflow tract. Panel A. Optimal device placement of the CoreValve device within the left ventricular outflow tract with the proximal edge of the device just below the aortic annulus. Panel B. Low placement of the CoreValve device extends beyond the left ventricular outflow tract into the left ventricular chamber, encroaching on anterior mitral valve leaflet.

18. Echo Core Lab Analysis^{5,7}

Data generated by the Echo Core Lab will be the primary data used for analysis and reporting. Qualitative assessment of valvular regurgitation will be performed using the criteria previously described in sections 8 and 9 of this Appendix. The Echo Core Lab will report the following variables:

- Aortic annulus long-axis diameter in mid-systole (screening/baseline only)
- LVOT long axis diameter in mid-systole
- Sinus of Valsalva diameter (SOV) at end diastole (screening/baseline only)
- Sino-tubular junction diameter (STJ) at end diastole (screening/baseline only)
- Sinus of Valsalva height (SOVH) at end-diastole (screening/baseline only)
- Device location and migration
- Max aortic valve velocity (V2) by CW Doppler
- Velocity time integral (VTI) across aortic valve by CW Doppler
- Mean gradient across aortic valve (MGV2) by CW Doppler
- Peak LVOT velocity (V1) by PW Doppler
- Velocity Ratio (V1 / V2)
- Velocity time integral (VTI) of LVOT velocity by PW Doppler
- Mean LVOT gradient (MGV1) by PW Doppler
- Doppler Velocity Index (DVI)
- Grade of aortic transvalvular regurgitation
- Grade of aortic paravalvular regurgitation
- Grade of mitral regurgitation
- ERO for MR (if available)
- Max tricuspid regurgitant (TR) jet velocity (if TR is present)
- Left ventricular (LV) end-diastolic diameter (LVEDD)
- Left ventricular (LV) end-systolic diameter (LVESD)
- Interventricular septal thickness at end diastole
- Left ventricular posterior wall thickness at end diastole
- Left atrial diameter (AP linear dimension) at systole
- Left ventricular ejection fraction by visual estimate
- Heart rate
- Mitral inflow "A" velocity
- Mitral inflow "E" velocity
- Mitral inflow deceleration time
- Mitral annular tissue Doppler systolic (s) velocity (septal and lateral)
- Mitral annular tissue Doppler early diastolic (e') velocity (septal and lateral)
- Mitral annular tissue Doppler late diastolic (a') velocity (septal and lateral)

In addition, the following variables will be derived by the central database from the appropriate measurements reported by the Echo Core Lab⁵:

- **Mean Transvalvular Gradient (Mean ΔP) Across the Prosthetic Valve in mmHg**

$$\text{Mean } \Delta P = \text{MG}_{V_2} - \text{MG}_{V_1}$$
 Where: MG_{V_2} is the mean pressure gradient across the prosthesis in mmHg, and MG_{V_1} is the mean pressure gradient from the left ventricular outflow tract in mmHg
- **Peak Pressure Gradient (Peak ΔP) Across the Aortic Prosthetic Valve in mmHg**

$$\text{Peak } \Delta P = 4 \times (V_2^2 - V_1^2)$$
 Where: V_2 is the peak velocity across the prosthesis in m/sec, and V_1 is the peak velocity from the left ventricular outflow tract in m/sec
- **Effective Orifice Area (EOA) in cm^2**

$$\text{EOA} = \text{LVOT Long Axis diameter}^2 \times 0.785 \times (\text{VTI}_{V_1} / \text{VTI}_{V_2})$$
 Where: VTI_{V_1} is the velocity time integral of the left ventricular outflow tract in cm, and VTI_{V_2} is the velocity time integral of the aortic prosthesis in cm. Alternatively, using velocity instead of VTI for simplification:

$$\text{AVA} = \pi(\text{radius of LVOT})^2 \times V_{\text{LVOT}} / V_{\text{max}}$$
 Where V_{max} is the maximum flow velocity across aortic valve, V_{LVOT} is the maximum velocity across the LVOT.
- **Effective Orifice Area Index (EOAI) in cm^2/m^2**

$$\text{EOAI} = \text{EOA} / \text{BSA}$$
 Where: EOA is the effective orifice area in cm^2 , and BSA is the body surface area in m^2
- **Doppler Velocity Index = Velocity Time Integral Ratio (VTI Ratio)**

$$\text{DVI} = \text{VTI Ratio} = \text{VTI}_{V_1} / \text{VTI}_{V_2}$$
 Where: VTI_{V_1} is the velocity time integral of the left ventricular outflow tract in cm, and VTI_{V_2} is the time velocity integral of the prosthetic aortic valve in cm
- **Stroke Volume (SV) in ml/beat**

$$\text{SV} = \text{LVOT long axis diameter}^2 \times 0.785 \times \text{VTI}_{V_1}$$
 Where: VTI_{V_1} is the velocity time integral from the left ventricular outflow tract in cm
- **Cardiac Output (CO) in l/min**

$$\text{CO} = (\text{SV} \times \text{HR}) / 1000$$
 Where: SV is the stroke volume in ml/beat, and HR is the heart rate in beats per minute
- **Left Ventricular Mass (LVM) in grams**

$$\text{LVM} = 0.83 \times [(\text{LVEDD} + \text{LVPW} + \text{IVS})^3 - (\text{LVEDD})^3] + 0.6$$
 Where: LVEDD is the left ventricular end-diastolic diameter in cm, LVPW is the left ventricular posterior wall thickness at end diastole in cm, and IVS is the interventricular wall thickness at end diastole in cm.
- **Left Ventricular Mass Index (LVMI) in g/m^2 body surface area**

$$\text{LVMI} = \text{LVM} / \text{BSA}$$
 Where: LVM is left ventricular mass in g, and BSA is body surface area in m^2
- **Fractional Shortening (FS) in %**

$$\text{FS} = [(\text{LVEDD} - \text{LVESD}) / \text{LVEDD}] \times 100$$
 Where: LVEDD is left ventricular end-diastolic diameter in cm, and LVESD is left ventricular end-systolic diameter in cm
- **Estimated Right Ventricular Systolic Pressure (RVSP) in mmHg**

$$\text{RVSP} = (4 \times \text{MV}_{\text{TR jet}}^2) + 10$$
 Where: $\text{MV}_{\text{TR jet}}$ is the max velocity of the tricuspid regurgitant jet, and 10 = the assumed mean right atrial pressure in mmHg

- **Aortic Regurgitant volume (ml/beat) and fraction (%)**

The regurgitant volume across the aortic valve may be calculated as the difference between the LVOT volume and the transmitral volume, assuming there is no significant mitral regurgitation

$RV = \text{Total stroke volume} - \text{forward stroke volume}$

$RV = SV_{AV} - SV_{MV}$

$RF = [RV/SV] \times 100$

$SV_{AV} = 0.785 \times (LVOT)^2 \times VTI_{LVOT}$ (by Pulsed-wave Doppler)

$SV_{MV} = 0.785 \times (D_{MV})^2 \times VTI_{MV}$ (by Pulsed-wave Doppler)

Where: SV is stroke volume in mL, AV is aortic valve and MV is mitral valve

- **Regurgitant Orifice Area (EROA)**

The regurgitant orifice area or EROA represents the average size of the defect in the aortic valve during diastole and is proportional to regurgitant severity.

The regurgitant orifice area may be calculated as the regurgitant volume multiplied by the VTI of the continuous wave Doppler jet

$EROA_{AV} = RV / VTI_{AR \text{ jet}}$ (by Continuous-wave Doppler)

19. Echocardiography References

1. Zoghbi WA, Chambers JB, Dumesnil JG, Foster E, Gottdiener JS, Grayburn PA, Khandheria BK, Levine RA, Marx GR, Miller FA, Jr., Nakatani S, Quinones MA, Rakowski H, Rodriguez LL, Swaminathan M, Waggoner AD, Weissman NJ, Zabalgoitia M. Recommendations for evaluation of prosthetic valves with echocardiography and doppler ultrasound: A report from the american society of echocardiography's guidelines and standards committee and the task force on prosthetic valves, developed in conjunction with the american college of cardiology cardiovascular imaging committee, cardiac imaging committee of the american heart association, the european association of echocardiography, a registered branch of the european society of cardiology, the japanese society of echocardiography and the canadian society of echocardiography, endorsed by the american college of cardiology foundation, american heart association, european association of echocardiography, a registered branch of the european society of cardiology, the japanese society of echocardiography, and canadian society of echocardiography. *J Am Soc Echocardiogr.* 2009;22:975-1014; quiz 1082-1014.
2. Lancellotti P, Moura L, Pierard LA, Agricola E, Popescu BA, Tribouilloy C, Hagendorff A, Monin JL, Badano L, Zamorano JL. European association of echocardiography recommendations for the assessment of valvular regurgitation. Part 2: Mitral and tricuspid regurgitation (native valve disease). *Eur J Echocardiogr.* 2010;11:307-332.
3. Lancellotti P, Tribouilloy C, Hagendorff A, Moura L, Popescu BA, Agricola E, Monin JL, Pierard LA, Badano L, Zamorano JL. European association of echocardiography recommendations for the assessment of valvular regurgitation. Part 1: Aortic and pulmonary regurgitation (native valve disease). *Eur J Echocardiogr.* 2010;11:223-244.
4. Evangelista A, Flachskampf FA, Erbel R, Antonini-Canterin F, Vlachopoulos C, Rocchi G, Sicari R, Nihoyannopoulos P, Zamorano J, Pepi M, Breithardt OA, Plonska-Gosciniak E. Echocardiography in aortic diseases: Eae recommendations for clinical practice. *Eur J Echocardiogr.* 2010;11:645-658.
5. Baumgartner H, Hung J, Bermejo J, Chambers JB, Evangelista A, Griffin BP, Iung B, Otto CM, Pellikka PA, Quinones M. Echocardiographic assessment of valve stenosis: Eae/ase recommendations for clinical practice. *J Am Soc Echocardiogr.* 2009;22:1-23; quiz 101-102.
6. Zoghbi WA. New recommendations for evaluation of prosthetic valves with echocardiography and doppler ultrasound. *Methodist Debaquey Cardiovasc J.* 2010;6:20-26.
7. Chambers J, Shah PM. Recommendations for the echocardiographic assessment of replacement heart valves. *J Heart Valve Dis.* 1995;4:9-13.
8. Leon MB, Piazza N, Nikolsky E, Blackstone EH, Cutlip DE, Kappetein AP, Krucoff MW, Mack M, Mehran R, Miller C, Morel MA, Petersen J, Popma JJ, Takkenberg JJ, Vahanian A, van Es GA, Vranckx P, Webb JG, Windecker S, Serruys PW. Standardized endpoint definitions for transcatheter aortic valve implantation clinical trials: A consensus report from the valve academic research consortium. *Eur Heart J.* 2011;32:205-217.
9. Lang RM, Bierig M, Devereux RB, Flachskampf FA, Foster E, Pellikka PA, Picard MH, Roman MJ, Seward J, Shanewise JS, Solomon SD, Spencer KT, Sutton MS, Stewart WJ. Recommendations for chamber quantification: A report from the american society of echocardiography's guidelines and standards committee and the chamber quantification writing group, developed in conjunction with the european association of echocardiography, a branch of the european society of cardiology. *J Am Soc Echocardiogr.* 2005;18:1440-1463.
10. Updated standardized endpoint definitions for transcatheter aortic valve implantation: the valve academic research consortium-2 consensus document. Kappetein AP, Head SJ, G n reux P, Piazza N, van Mieghem NM, Blackstone EH, Brott TG, Cohen DJ, Cutlip DE, van Es GA, Hahn RT, Kirtane AJ, Krucoff MW, Kodali S, Mack MJ, Mehran R, Rod s-Cabau J, Vranckx P, Webb JG, Windecker S, Serruys PW, Leon MB. *J Am Coll Cardiol.* 2012 Oct 9;60(15):1438-54. doi: 10.1016/j.jacc.2012.09.001"

R.8 Electrocardiogram (ECG) Submission

The standard 12 lead ECG will be utilized as a diagnostic and prognostic tool in patients participating in this study.

Acquisition:

1. Standard 12-lead ECGs must be obtained (with the exception of implant procedure)
2. ECG should be conducted with the subject at rest
3. ECGs should be provided on a single page printout (i.e. lead strips are not acceptable) using standard amplification of 1mV/cm and paper speed of 25mm/sec (50mm/sec is strongly discouraged)
4. Visible lead annotation
5. More than 1 normal beat per lead. No average ECGs
6. ECG without Pace-Maker beats is preferred

Labeling:

7. Protect subject confidentiality. Effectively block out any subject confidential information recorded on the ECG
8. ECG labels are to be placed on top of the tracing, being careful not to obstruct any of the lead recordings
9. Labels with Study name will be provided by Medtronic and shall be filled out completely, including
 - a) Site number
 - b) Subject identification number
 - c) ECG date and time
 - d) Applicable visit/interval (i.e. screening, Discharge)
10. Incomplete labeling will result in the generation of a data clarification query and untimely interpretation of the tracing

Submission:

11. Original ECGs are strongly encouraged but high quality photocopies with good visible gridline are accepted
12. Submission of all ECGs within appropriate timeframe is imperative
13. Upload all ECGs to InteleGRID (secure electronic system used for transferring images)

R.9 Computed Tomography (CT) Angiography Acquisition Guidelines

Background

Cardiac Multislice Computed Tomographic Angiography (Cardiac MSCT Angiography) is intended to evaluate aortic valve anatomy, aortic root dimensions for device sizing, and assessment of peripheral vessel dimensions and anatomy. This appendix is meant as a guideline to help with the proper acquisition of the images necessary for assessment of the above mentioned items. The primary objective should be to acquire the highest resolution images and perform the correct measurements, as specified below, by tailoring the acquisition to your particular hardware and experience.

Equipment Requirements

- Multi-detector CT scanner (64-slice minimum) with ECG-gating capability
 - The scans acquired and submitted for analysis of the aortic root MUST be ECG-gated
 - Non-gated scans in areas with cardiac motion lead to measurement inaccuracy and therefore incomplete information for device selection
 - Peripheral vessel image acquisition may be non-gated
- Ability to electronically transfer the imaging data via secure network (InteleGRID)

Scans Acquired

- Chest Topogram
- ECG-gated contrast enhanced aortic root*
- Non ECG-gated contrast enhanced peripheral vessels*

*Sub-millimeter slice thickness is required

Scanning Procedures

The scan protocol is similar to a CT coronary angiogram. The aim is to get adequate contrast in the region of interest which includes: endo-luminal surface for visualization of left heart, aorta, and peripheral access vessels (i.e., femorals and subclavians, when necessary). Temporal resolution should be optimized to reduce motion artifact. Spatial resolution should be as high as possible (goal is smallest isotropic voxel size).

Step 1: Patient preparation

- Administer medication per institution standard practice for CT scanning (suggest avoid sublingual nitrate, avoid or caution with B-blockers)
- Attach ECG electrodes for gating of scan (suggest: avoiding large respiratory muscles as these may introduce ECG-artifact). Verify quality and stability of ECG tracing on scanner console during an inspiratory breath hold
- Prepare large intravenous line (i.e., 18 or 20 gauge) for administration of contrast media
- Instruct patient to lie still during scan, even if they experience warmth or tingling due to the injection of contrast
- Instruct patient in practice breath-hold at end-inspiration for 10-15 seconds (duration required will depend on specific scanner performance). Assess heart rate variability during breath-hold. If heart rate is >65 bpm or unstable, consider cautious titration of beta-blockers

Step 2: Chest Topogram

- Acquire a chest topogram for use in planning the following imaging protocol



Figure CTA-1: Example image of chest topogram

Step 3: ECG-gated contrast enhanced scan of aortic root

The aim of this scan is to assess the aortic root and valve anatomy. Ensure the required scan parameters are used; these are listed below in Table 1. The following parameters are crucial to the optimum required scan:

- The recommended coverage area is from superior to the aortic arch to inferior to the cardiac apex. The minimum required coverage area is from 50mm above the aortic annulus to the inferior border of the heart. Coverage less than this will not allow for proper assessment of the patients anatomic suitability
- The scan requires dynamic 4D acquisition using retrospective ECG-gating
- The required detector collimation is 0.4-0.625mm
- The required slice thickness is $\leq 0.8\text{mm}$
- The recommended slice overlap is 0.4mm

Contrast Enhanced Scan Execution

- Prepare iodinated contrast injection apparatus (recommendations in scan parameters are provided in Table 1)
- Set up scan parameters per the table below
- Instruct patient to lie still during scan, even if they experience warmth or tingling due to the injection of contrast
- Initiate contrast injection
- When contrast reaches threshold at bolus-tracking location, instruct patient to hold breath at end-inspiration, then initiate main scan protocol
- At completion of scan verify scan is of adequate quality
- Record amount of contrast given. Note: this is not on the CRF, but is recommended in this patient population
- Record heart rate average and range. Note: this is not on the CRF, but is recommended for explanation of image quality issues

Post-processing

- Verify heart rate ECG triggers are at consistent place in cardiac cycle, edit if necessary. Additional editing/removal of arrhythmias may be performed
- Reconstruct at multiple phases (10 increments of 10%), with ≤ 0.8 mm slice thickness. If the system has the capability, also reconstruct a “best systolic” and “best diastolic” phase. If image quality of the aortic root is not good in the end systolic phase the phase with the best image quality may be selected instead

Table 1. Recommended Scan Parameters

	Recommended Parameters
IV injection with iodine contrast	80-100 (320mg/ml or higher), modify per patient as appropriate
Injection rate	4-6 mL/sec
Bolus tracking, delay	Delay time calculated using protocol for current scanner (bolus tracking or similar) with peak of contrast concentration in the ascending aorta during acquisition. Bolus tracking is the preferred method.
ECG Leads	Required
ECG-gating	Retrospective (Prospective may be used in centers with much experience of the technique and in patients with stable heart rate)
Scan direction	Cranial-caudal
Scan coverage	From above the aortic arch to past the cardiac apex
Detector collimation	0.4 – 0.625 mm
Pitch	0.2–0.43 adapted to the heart rate
Dose modulation	Modulation and full current between 30 and 80% of the cardiac cycle (or no modulation i.e. full dose throughout)
Slice thickness	0.8mm
Slice overlap	0.4mm
Reconstruction kernel	Medium Smooth
Post-processing	Use single segmental reconstruction algorithm that minimizes motion artifact. Reconstruct at multiple phases (10 minimum, 20 preferred, increments of 5-10%). Reconstructed slice thickness 0.75-1mm.

Step 4: Non ECG-gated contrast enhanced scan of vessels

The aim of this scan is to assess the peripheral access vessels and abdominal aorta for suitability for the procedure.

- Standard radiology CT angiography protocol should be used.
- Can be non ECG-gated
- Contrast Volume: 40-50 cc, Injection rate: 4 cc/sec. Modify per patient as necessary to acquire good quality images
- Delay time calculated using protocol for current scanner (bolus tracking, etc) with peak of contrast concentration in the abdominal aorta and iliac arteries
- Suggested coverage areas:
 - Femoral access only screening: abdominal aorta above celiac artery and down to the femoral head. Use this option there if you are confident that femoral access will be suitable for this patient
 - Subclavian access only screening: above the subclavian arteries and down to mid-thorax. Use this option if prior information (i.e., CT scan) exists which demonstrates that femoral access will not be possible in this patient
 - Combined access screening: above the subclavian arteries and down to the femoral head. This is the recommended option. An additional option for subclavian screening is to include the subclavian vessels in the ECG-gated portion and use femoral only screening for the rest of the vessels
- Source data reconstructed using sub-millimeter slice thickness

Aortic Root and Peripheral Vessel Measurements

CT measurements are conducted in different parts of the cardiac cycle to correlate most closely with corresponding echo measurements

- Systole for aortic annulus measurements
- Diastole for sinus of Valsalva diameters, sinus of Valsalva heights, maximum ascending aorta diameter, and aortic root angulation

Table 2: Required CT Measurements

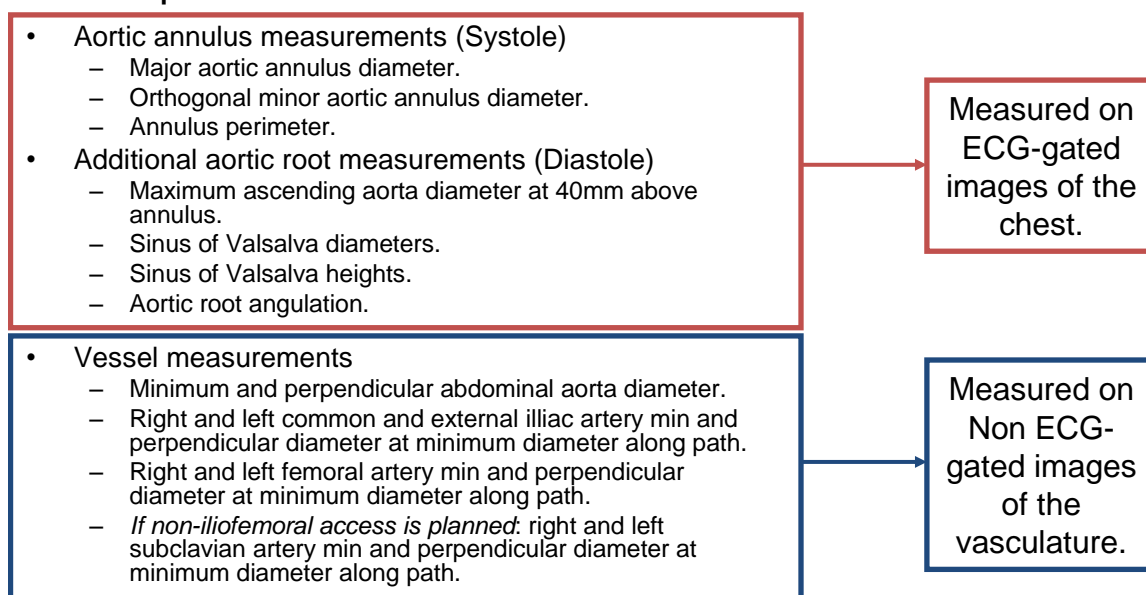

Proper Aortic Annulus Measurements

The aortic annulus is not co-planar with the planes of the body (i.e., axial, sagittal, or coronal). Therefore, multi-planar reformatting of the CT images to create a double-oblique axial image is required for annulus measurements. This reformatting is critical; if the plane is not correctly aligned, it may be going through the sinuses or the LVOT. This can lead to improper device selection.

The methods described here for measurement of the aortic annulus (virtual basal ring) are similar to those reported in Schultz et al. EuroIntervention Supplement (2010) Volume 6 (Supplement G) G6-G13.

Step 1: Reformatting of Images

- Center image cross-hairs on aortic root in all windows where it is visible. Lock cross-hairs so they remain orthogonal for all steps
- In the coronal window, rotate cross-hairs (horizontal line) counter-clockwise to align with virtual basal plane, as shown in Figure CTA-2 (upper left panel)
- In the sagittal window, the horizontal line has to be rotated clockwise or counter-clockwise to align with virtual basal plane, as shown in Figure CTA-2 (lower left panel)
- On the newly defined double-oblique axial image, scroll up and down through the aortic root until the most caudal attachment points of the three native leaflets come into view (indicated by arrowheads in Figure CTA-3 below). If one of the leaflets comes into view at a more cranial or caudal slice, adjust the coronal or sagittal cross-hairs until all three leaflets come into view on the same axial slice

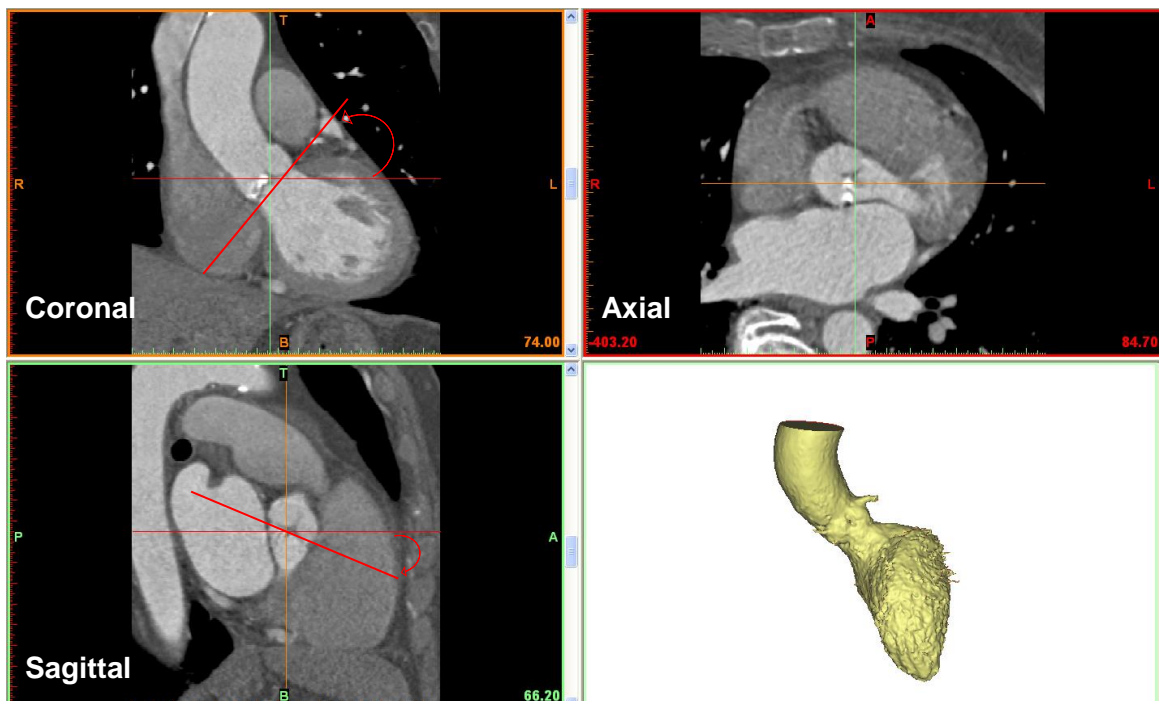

Figure CTA-2: Example images in original orientation (axial, coronal and sagittal). Red curved arrow and line indicate adjustment of coronal and sagittal planes to align with aortic basal annulus.

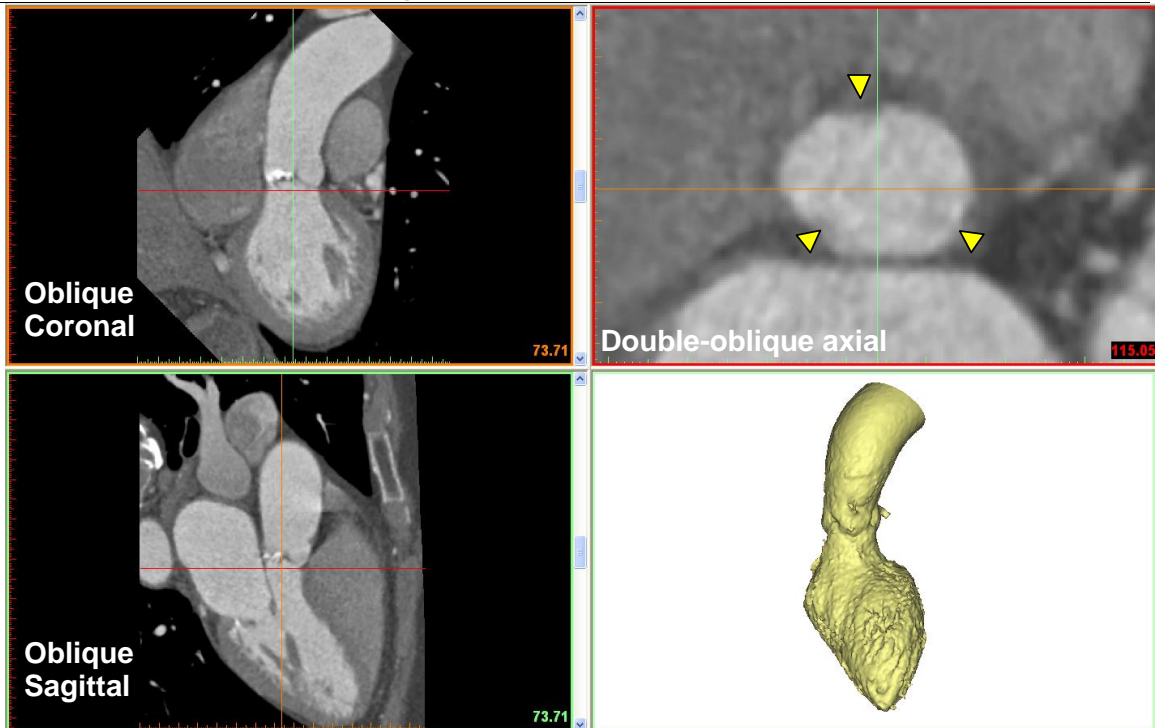

Figure CTA-3: Example images of reformatted oblique coronal (upper left), oblique sagittal (lower left), double oblique axial (upper right) and 3D reconstruction lower right. Yellow arrowheads indicate most caudal attachment of three leaflets of aortic valve.

- For confirmation of the correct aortic annulus plane, scroll through the double oblique axial images starting in the mid sinus and ending at the level of the aortic annulus. The sinuses should appear to be relatively the same size at the level of the mid-sinus and the leaflets should all disappear equally at the level of the annulus

Step 2: Aortic Root Measurements

Aortic Annulus Measurements

- Choose the cleanest systolic images for the aortic annulus measurements
- Aortic annulus measurements should be completed on the properly reformatted double-oblique axial image at aortic annulus level
- Trace the perimeter of the basal annulus (Figure CTA-4, left). Place cross-hairs at center of basal annulus, create major diameter through the center, create minor diameter defined as perpendicular to major and through center (Figure CTA-4, right). Record perimeter, major and minor diameter measurements on the screening worksheet

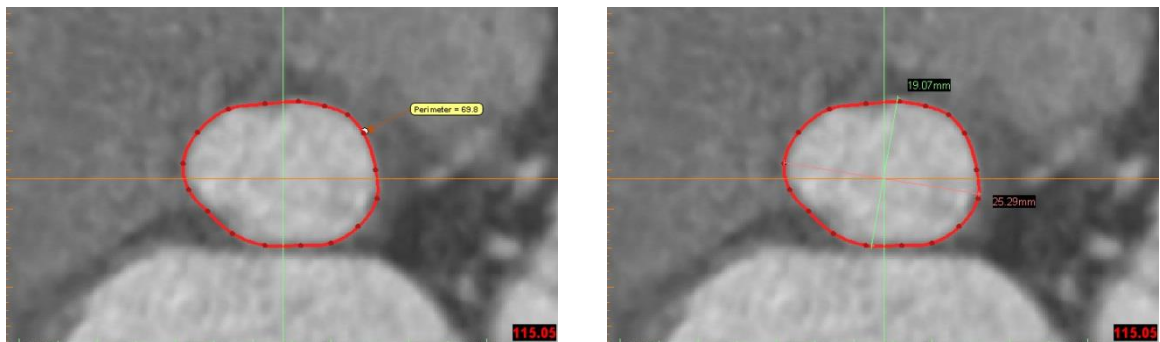

Figure CTA-4: Example of perimeter measurement (left) and major and minor diameter measurements (right).

Additional Aortic Root Measurements

- Choose the best diastolic images for measurement of sinus of Valsalva diameters, sinus of Valsalva heights, maximum ascending aorta diameter (40 mm from annulus), and aortic root angulation. Sinus of Valsalva diameters, heights, and maximum ascending aorta diameter should be completed on reformatted images using the same reformatting technique as used for the aortic annulus measurements

Sinus of Valsalva Diameters

- Select the double oblique axial image where the widest portion of the three sinuses is visible
- Measure a diameter from each commissure through the center of the root to the opposite sinus. Complete for all three sinuses (Figure CTA-5)

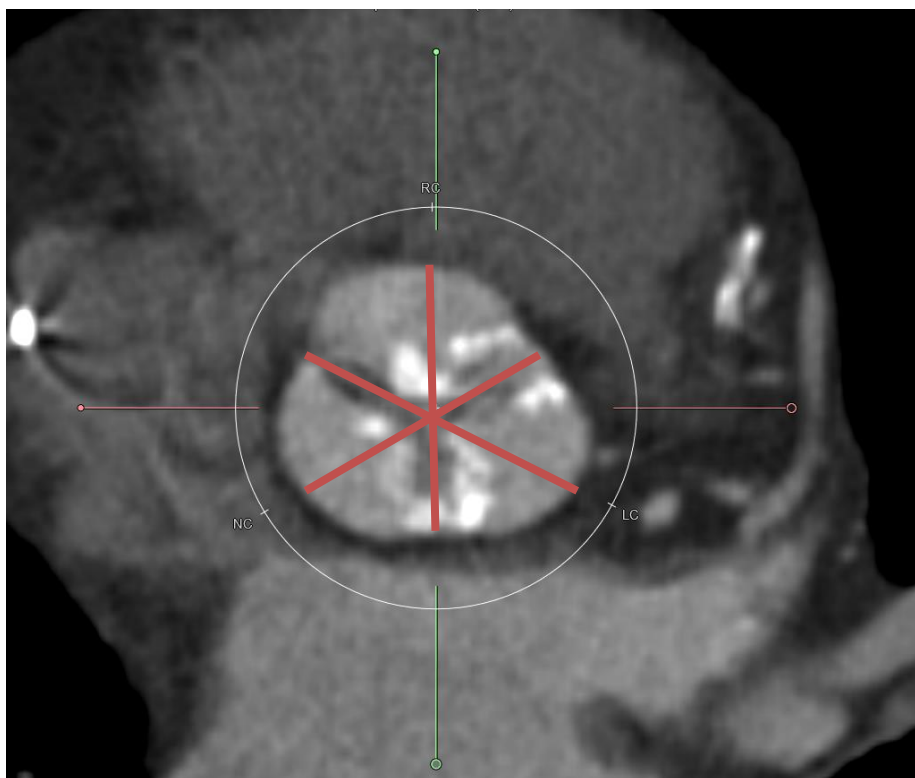

Figure CTA-5: Example of sinus of Valsalva diameters.

Sinus of Valsalva Heights

- The sinotubular junction is typically not co-planar with the aortic annulus. Therefore, a sinus of Valsalva height must be measured for each of the three sinuses. This height is defined as the distance between the aortic annular plane and the tallest point in the sinus
- Choose the double oblique axial image so that it is located at the level of the aortic annulus. The reformatting line representing the double oblique axial image should now be visible in the oblique coronal and oblique sagittal images at the level of the aortic annulus
- For the left coronary and non-coronary heights, use the oblique coronal image. For the right coronary height, use the oblique sagittal image
- To complete the measurement, scroll through the oblique coronal or sagittal image (depending on which sinus you are measuring) and locate the heights location of the sinotubular junction. On that image, measure the distance along the path of the aortic root from the aortic annular plane, marked by the reformatting line, to the sinotubular junction (Figure CTA-6).

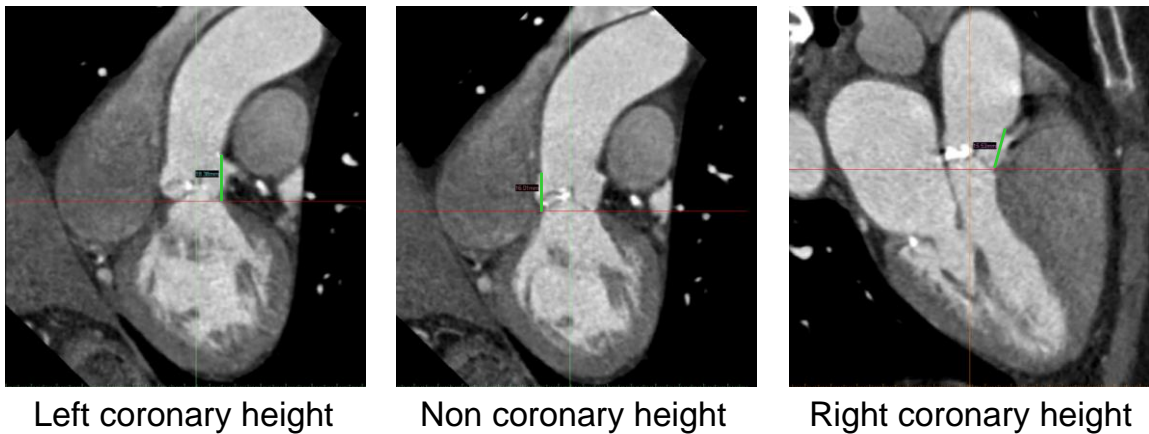

Figure CTA-6: Example of sinus of Valsalva heights.

Maximum Ascending Aorta Diameter

- Choose the double oblique axial image so that it is located at the level of the aortic annulus. The reformatting line representing the double oblique axial image should now be visible in the oblique coronal and oblique sagittal images at the level of the aortic annulus
- Choose the oblique coronal image that is in the center of the aortic root
- Measure a distance of 40mm from the line representing the aortic annular plane
- Center the images at this level, and reformat the images so that the double oblique is perpendicular to the ascending aorta at this level (Figure CTA-7)
- Measure the maximum diameter at this level (Figure CTA-7)

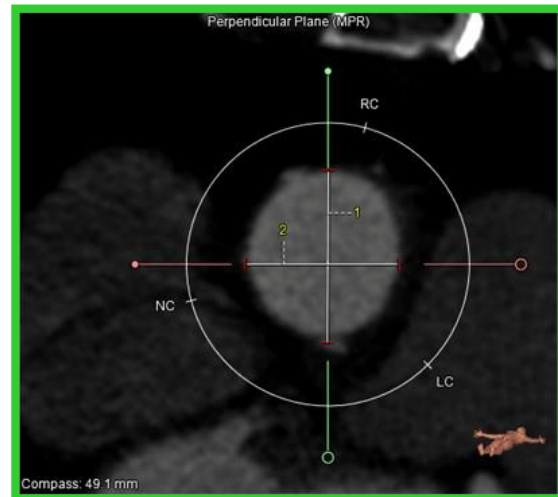
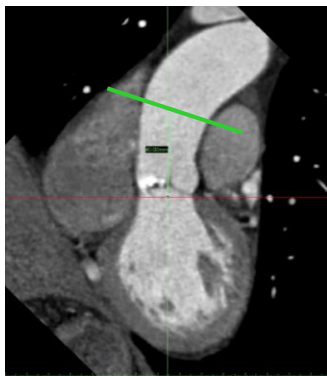

Figure CTA-7: Oblique coronal with measurement of 40mm above the aortic annulus (left) and double-oblique reformatted to be perpendicular to that location (right).

Aortic Root Angulation

- The aortic root angle measured in this study is the angle between the aortic annulus and the true axial plane of the patient
- To measure, use the standard coronal diastolic image, before any reformatting
- Scroll to the middle of the aortic root in these images (Figure CTA-8)
- Use the angle tool to draw a line first across the aortic annulus and second horizontal to the coronal image, which represents the axial plane of the patient. Start the angle measurement in the upper left of the patient, so that the angle is to the lower right of the patient (Figure CTA-8)

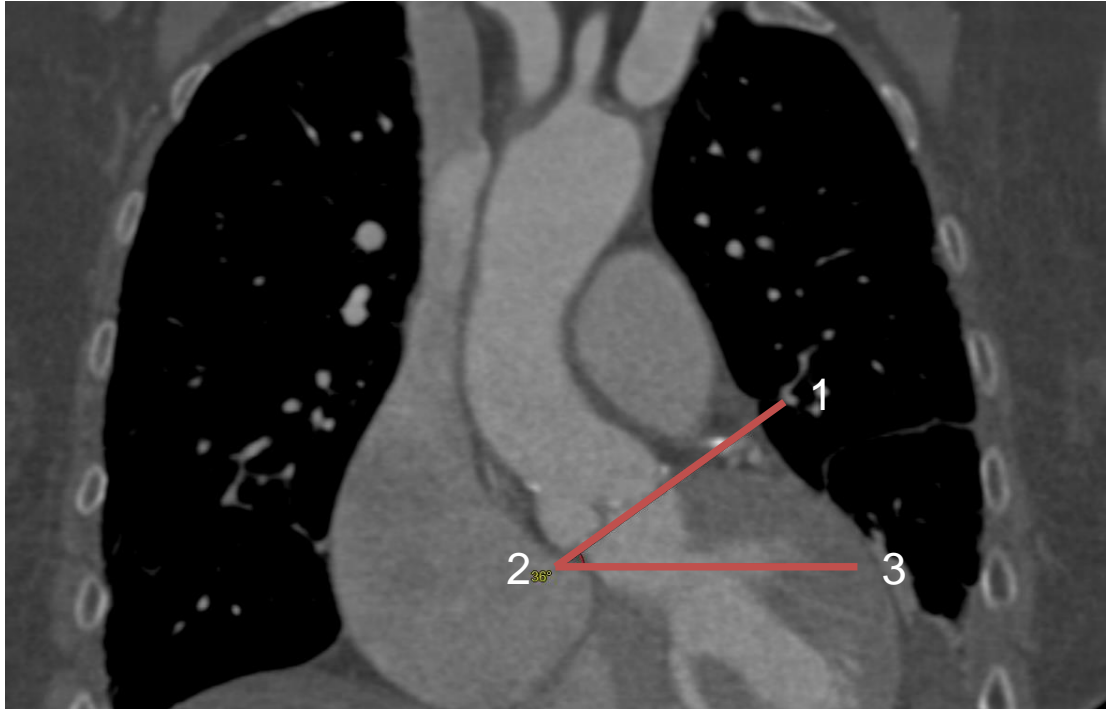

Figure CTA-8: Aortic root angulation measurement on the standard coronal image. Use the angle tool beginning at point 1, with point 2 on the lower right of the patient, and the final point on the lower left of the patient. The first line, between points 1 and 2 should be along the aortic annulus. The second line, between points 2 and 3, should be horizontal in the coronal image, which represents the axial plane of the patient.

Step 3: Access Vessel Measurements

Peripheral vessel measurements are made on non-gated CT and measured on images perpendicular to the vessel. The intent of these measurements is to determine the minimum diameters for the potential access routes. All vessel measurements should be completed on images that are perpendicular to the vessels of interest.

Minimum Abdominal Aortic Diameter

- Use a stretched vessel view to locate the minimum luminal abdominal aortic diameter
- Measure the minimum lumen diameter and a perpendicular diameter on the image orthogonal to the vessel at the minimum location (Figure CTA-9)

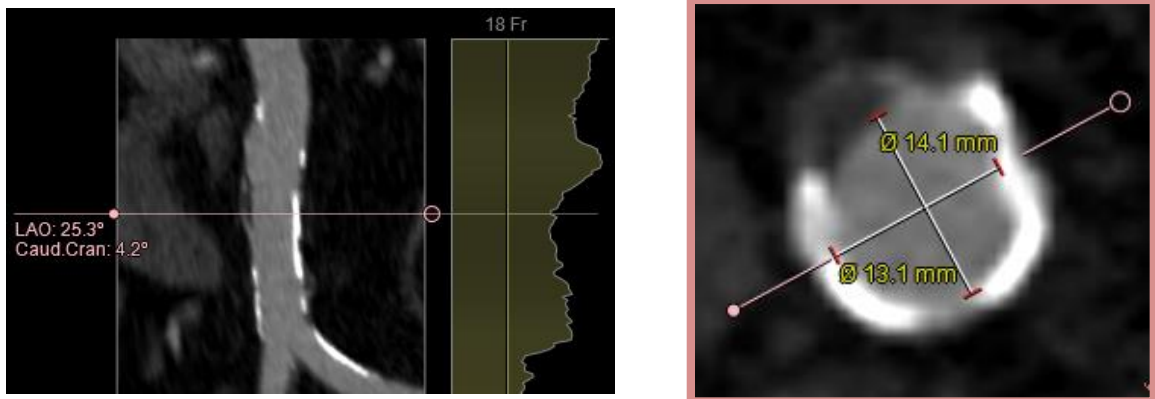

Figure CTA-9: Example of minimum abdominal aortic diameter. Stretched vessel (left), with the pink line at the location of the minimum luminal abdominal diameter. Orthogonal image (right), showing the minimum luminal diameter and the perpendicular diameter.

Peripheral Vessel Measurements

- These techniques are to be used for measurements on the following arteries:
 - Right and left femorals
 - Right and left common and external iliacs
 - If non-femoral access is planned – right and left subclavians
- Use a stretched vessel view to locate the minimum luminal diameter
- Measure the minimum lumen diameter and a perpendicular diameter on the image orthogonal to the vessel at the minimum location (Figure CTA-10)

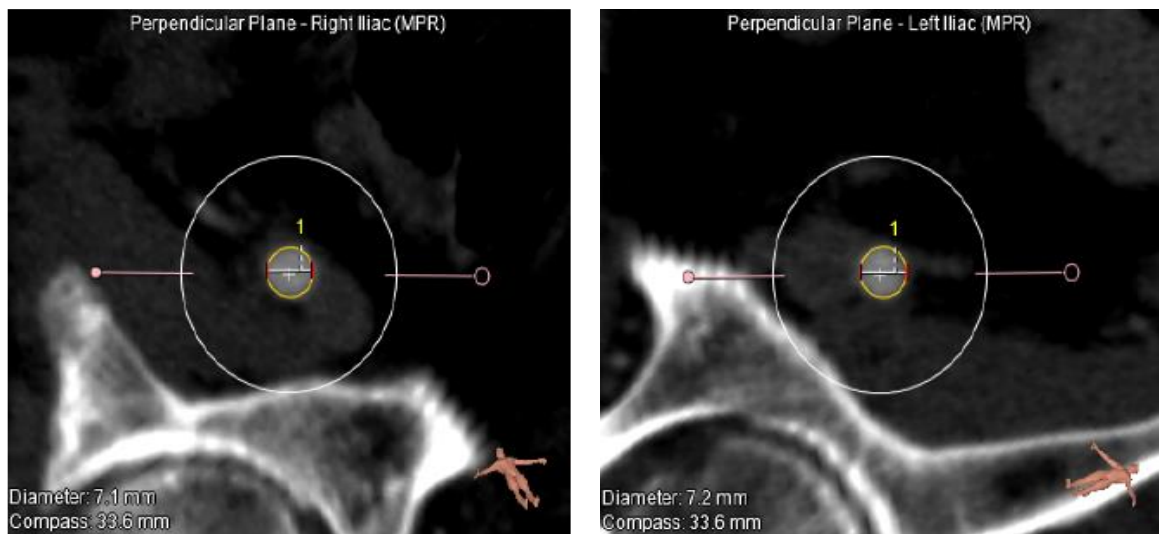

Figure CTA-10: Example of the peripheral vessels and measurements for the right (left) and left (right) iliac arteries.

Additional CT Measurements

- In the case of a thoracic aortic aneurysm, measure the maximum diameter in the aneurysm.
- To determine the maximum location, use similar methods to the other vessel measurements (stretched vessel view)
- Complete the measurement on the orthogonal images and report the maximum diameter

Prepare data for submission

- Data should be stored in DICOM 3.0 format
- If possible, de-identify all images prior to uploading
- Burn images to DICOM DVD/CD or upload to internal electronic records system
- Ensure all required images are included on DVD/CD or internal electronic records system for upload:
 - ECG-gated contrast enhanced aortic root. Upload on 4 time-points: 30% & 40% (systole) and 60% & 70% (diastole). If the system has “best-systolic” and “best-diastolic,” only upload those 2 phases.
 - Non ECG-gated contrast enhanced peripheral vessels – upload entire set.
 - Screenshots of all measurements
- Upload all images to InteleGRID (secure electronic system used for transferring images)

R.10 Interactive Voice/Web Response System (IXRS)

Medtronic will utilize an Interactive Voice/Web Response (IXRS) System to manage subject screen failures and randomization into the Medtronic CoreValve™ SURTAVI Trial.

The IXRS system will assign patients a Screening ID to be used for all patients that sign the Informed Consent Form and are considered for possible enrollment by the Heart Team. If a patient is screened and does not meet eligibility criteria, the IXRS system will capture the reason for screen failure and disposition of the patient (if known).

Upon meeting eligibility criteria, the IXRS system will randomize the patient and assign a Subject ID to be used in the Oracle Clinical Database upon enrollment.

The IXRS system will assign subjects within one of four groups:

- TAVI with planned PCI
- TAVI without planned PCI
- SAVR with planned CABG
- SAVR without planned CABG

Users can sign in to the Medtronic CoreValve™ SURTAVI Trial study web site by using the URL below and use the sign in box labeled "IVRS/IWRS Login":

www.bracketglobal.com/client-login

The first time a user accesses the study website, they will be prompted to update their password. The password must be at least 8 characters in length and contain at least 1 capital letter and 1 number or symbol.

Remember that the User ID and Password are private and should not be shared with other individuals.

For technical questions, contact UBC Technical Support at 888-794-0122 or at support@bracketglobal.com

R.11 Explanted Device/Pathology and Return Procedures

In the event of a device malfunction of the investigational device prior to or during implant, or in the event that a TAV device is explanted after implant (due to reintervention or autopsy), the TAV device and/or affected device components should be returned to Medtronic.

SHIPPING INSTRUCTIONS

System Malfunction (TAV Device, Delivery Catheter System (DCS) and/or Compression Loading System (CLS/LS) Before or During Procedure

1. Always retain original product packaging until the procedure is completed.
2. Place product back into original packaging if it was not clinically used (i.e. in contact with blood or body fluids)
3. If clinically used, use heart valve return kit to ship the valve or CLS/LS. Use a DCS return kit for the DCS, if applicable.

Explant of CoreValve at Reoperation

1. Photograph the TAV in situ (if possible).
2. If possible, indicate with a suture on the frame, the relation of the TAV device to the midpoint of the mitral valve.
3. Following explantation, rinse blood from the lumen with a physiologic solution (e.g. Ringer's lactate solution).
4. Do not disturb or alter the valve leaflets in any way (as possible).
5. Remove all packaging material and forms from kit. Temperature indicator should remain in box unless it has been activated. If it has been activated, discard noting that the kit is still usable.
6. Immerse the TAV and any surrounding tissue in the solution provided in the explant kit.
7. Place the jar into the yellow absorbent pouch and close, then into the zip lock bag and seal.

Explant of CoreValve at Autopsy

1. Remove all packaging material and forms from kit.
2. If possible, leave aortic root intact with an ample margin between the valve and descending aorta.
3. Whole hearts should be immersion fixed in formalin in the local autopsy suite or pathology lab for at least 24-48 hours prior to shipping. Note: hospitals or contract pathology labs should have formalin available for use.
4. Use the plastic container provided in the return kit for fixing the heart.
5. Before shipping, remove most of the formalin from the container and wrap the heart in the cloth specimen bag that is provided, which has been thoroughly soaked in formalin. Place the heart and specimen bag back into the container.
6. Label the outside of the container (lid and container) with the TAV device serial number, patient ID, center name and study name.
7. Seal the container tightly and wrap the container-lid interface with parafilm (if available).

All Explants>Returns

1. Complete the Product Experience Report (PER) form and email a copy to rs.structuralheartfieldassurance@medtronic.com to receive a PE number.
 - a. If an adverse event form has already been reported for this event and a PE number has already been issued via the AE, use the PE number from the AE correspondence. In this instance, sending the PER to field assurance to receive a PCR number is not required.
2. Note the PE number on the Product Experience Report and place the completed form and autopsy heart in the box.
3. Using the pre-paid/pre-printed form, ship by Federal Express or other overnight carrier if a form is not provided for your convenience. For further assistance, call the number below.

If a return kit is required, contact Customer Service:**1-800-556-4247****All return product should be sent to:**

Medtronic, Inc.

Attn: Explant Lab/ [PE #]

1851 E. Deere Ave.

Santa Ana, CA 92705-5720

USA

1-800-854-3570

R.12 Economic and Quality of Life Data Collection

R.12.1 R.12.1 Health Economic Data Collection

Throughout this trial, resource utilization data will be collected by the research coordinator along with clinical data using case report forms.

Prior to enrollment in the study, patients will be asked to provide the information and permission to obtain such billing records for the length of their follow-up period. All related data will be kept in a secure and confidential database.

R.12.2 Quality of Life Data Collection

The QoL questionnaires will be administered to all subjects in languages where translation is available. It is not a deviation if a subject does not complete a Quality of Life Questionnaire because a translation is not available in the subject's language.

All QoL assessments will be by written, self-administered questionnaires. Ample, uninterrupted time should be provided for the subject to complete the questionnaires. Every effort should be made to have the subject complete the questionnaire him or herself. If the subject is unable to complete the questionnaires, the caregiver may complete the questionnaires on their behalf.

R.12.2.1 Schedule of Assessments

Questionnaires are to be administered, per protocol:

- Baseline
- 30 days
- 3 months
- 6 months
- 12 months
- 18 months
- 24 months
- 3 years
- 4 years
- 5 years

Baseline Assessment:

Questionnaires may be administered any time after the subject has provided informed consent but should be collected prior to informing the subject of their treatment assignment.

3 month Assessment:

Questionnaire(s) should be administered via telephone.

- **EQ-5D** – collected in all participating geographies
- **SF-36** – collected is limited to subjects in:
 - Canada
 - Denmark
 - Netherlands
 - United Kingdom
 - United States

R.12.2.2 Questionnaires**Kansas City Cardiomyopathy Questionnaire (KCCQ)**

The Kansas City Cardiomyopathy Questionnaire (KCCQ) is a validated self-administered 23-item questionnaire that quantifies physical limitations, symptoms, self-efficacy, social interference and quality of life.

SF-36

QualityMetric's SF-36v2[®] Health Survey is a multi-purpose short-form that measures functional health and well-being from the patient's point of view.

EuroQoL EQ-5D

The EQ-5D is a measure of self-reported health outcomes that is applicable to a wide range of health conditions and treatments. It consists of two parts: a descriptive system (Part I) and a visual analogue scale (VAS) (Part II). Part I of the scale consists of 5 single-item dimensions including: mobility, self-care, usual activities, pain/discomfort, and anxiety/depression. Each dimension has a 3 point response scale designed to indicate the level of the problem. Part II uses a vertical graduated VAS (thermometer) to measure health status, ranging from worst imaginable health state to best imaginable health state.

R.13 Pacing Guidelines

Recommendations for pacing pre-, peri- and post-operatively are provided below (see also respective investigational device Instructions For Use). These are recommendations and final decisions should be made via clinical presentation and physician discretion. Programmed settings for temporary and permanent pacing are per subject condition and physician discretion.

Pre-operative Recommendations

- Ensure subject is informed about the placement of temporary pacing wires during the procedure and any additional associated risks.
- Ensure subject is informed about the potential for the placement of a permanent pacemaker and any additional associated risks.
- Obtain a baseline 12-lead ECG and assess for subject's conduction status
- **Subjects with a pre-existing permanent pacemaker only:** Conduct a full interrogation and AV conduction assessment. Print a copy of the interrogation and save the data on a diskette. Label the diskette with labels provided by Medtronic, including center name, subject ID, date and time of visit/interrogation and type of visit. Retain the printout and diskette in the subject's file for source verification.
 - **Recommended AV conduction assessment:**
 - Conduct an atrial threshold test with a long AV delay (e.g. 350ms) in DDD mode.
 - If the subject's ventricular rhythm doesn't come through within the 350 ms, the subject would be considered dependent on ventricular pacing.

Peri-operative Recommendations

- Prior to beginning the respective investigational device implant, place a temporary 4-5 Fr. balloon-tip pacing wire in a stable location within the right ventricular (a screw-tip wire may be used for more secure placement for subjects at high-risk for dislodgement, if necessary and experienced with implantation technique).
 - Whenever possible, use the upper torso venous system (e.g., jugular, sub-clavian) for temporary pacing wire access due to the recommendation to leave this system in for at least 48 hours post-procedure.
 - Use fluoroscopy to guide wire placement and stability.
 - Confirm sensing and capture
 - Program the backup pacing rate to minimize ventricular pacing (e.g. 30-40 bpm). If heart block develops, adjustment the rate accordingly.
- Rapid pacing during balloon valvuloplasty
 - Conduct a rapid pacing test prior to balloon valvuloplasty.
 - Successful test is defined as 1-to-1 pacing capture with an immediate drop in pressure and elimination of the systolic-diastolic waveform.

Post-operative Recommendations

- All subjects should stay on telemetry until discharge
- Maintain temporary pacing until at least 48 hours post-implant
 - Ensure a clean, sterile environment is maintained
- After 48 hours, obtain ECG and assess subject rhythm and conduction
 - Based on assessment, and with the consult of an electrophysiologist as needed, take one of the following actions:
 - Discontinue temporary pacing
 - Continue temporary pacing for another 24 hours (longer if needed) to make further assessments

- Place a permanent pacemaker according to ACC/AHA/HRS Guidelines for Device-Based Therapy of Cardiac Rhythm Abnormalities⁸(Class I or IIa for Acquired Atrioventricular Block in Adults or Permanent Pacing in Chronic Bifascicular Block)
 - Prior to the permanent pacemaker implantation, document the reason for the placement of the permanent pacemaker via a 12-lead ECG.
- For complete heart block, review subject medications. Consider withholding some medications to assess for subject's intrinsic rate and conduction. If heart block persists off medications, a permanent pacemaker should be considered.
- If a permanent pacemaker is required, a dual chamber system is recommended to optimize subject hemodynamics.
 - **Recommended AV conduction assessment:**
 - Conduct an atrial threshold test with a long AV delay (350ms) in DDD mode.
 - If the subject's ventricular rhythm doesn't come through within the 350 ms, the subject would be considered dependent on ventricular pacing.

⁸ ACC/AHA/HRS 2008 Guidelines for Device-Based Therapy of Cardiac Rhythm Abnormalities; J Am Coll Cardiol 2008; 51:2085–105; Circulation 2008;117:2820–40

Recommendations for Acquired Atrioventricular Block in Adults

Class I Permanent pacemaker implantation is indicated for:

- Third-degree and advanced second-degree atrioventricular (AV) block at any anatomic level associated with bradycardia with symptoms (including heart failure) or ventricular arrhythmias presumed to be due to AV block. (LOE: C)
- Third-degree and advanced second-degree AV block at any anatomic level associated with arrhythmias and other medical conditions that require drug therapy that results in symptomatic bradycardia. (LOE: C)
- Third-degree and advanced second-degree AV block at any anatomic level in awake, symptom-free patients in sinus rhythm, with documented periods of asystole greater than or equal to 3.0 seconds or any escape rate less than 40 bpm, or with an escape rhythm that is below the AV node. (LOE: C)
- Third-degree and advanced second-degree AV block at any anatomic level in awake, symptom-free patients with atrial fibrillation and bradycardia with 1 or more pauses of at least 5 seconds or longer. (LOE: C)
- Third-degree and advanced second-degree AV block at any anatomic level after catheter ablation of the AV junction. (LOE: C)
- Third-degree and advanced second-degree AV block at any anatomic level associated with postoperative AV block that is not expected to resolve after cardiac surgery. (LOE: C)
- Third-degree and advanced second-degree AV block at any anatomic level associated with neuromuscular diseases with AV block, such as myotonic muscular dystrophy, Kearns-Sayre syndrome, Erb dystrophy (limb-girdle muscular dystrophy), and peroneal muscular atrophy, with or without symptoms. (LOE: B)
- Second-degree AV block with associated symptomatic bradycardia regardless of type or site of block. (LOE: B)
- Asymptomatic persistent third-degree AV block at any anatomic site with average awake ventricular rates of 40 bpm or faster if cardiomegaly or left ventricular (LV) dysfunction is present or if the site of block is below the AV node. (LOE: B)
- Second- or third-degree AV block during exercise in the absence of myocardial ischemia. (LOE: C)

Class IIa Permanent pacemaker implantation is reasonable for:

- Persistent third-degree AV block with an escape rate greater than 40 bpm in asymptomatic adult patients without cardiomegaly. (LOE: C)
- Asymptomatic second-degree AV block at intra or infra-His levels found at electrophysiological study. (LOE: B)
- First- or second-degree AV block with symptoms similar to those of pacemaker syndrome or hemodynamic compromise. (LOE: B)
- Asymptomatic type II second-degree AV block with a narrow QRS. When type II second-degree AV block occurs with a wide QRS, including isolated right bundle-branch block, pacing becomes a Class I recommendation (see Section 2.1.3, "Chronic Bifascicular Block," in the full-text guidelines). (LOE: B)

Recommendations for Permanent Pacing in Chronic Bifascicular Block

Class I Permanent pacemaker implantation is indicated for:

1. Advanced second-degree AV block or intermittent third-degree AV block. (LOE: B)
2. Type II second-degree AV block. (LOE: B)
3. Alternating bundle-branch block. (LOE: C)

Class IIa Permanent pacemaker implantation is reasonable for:

- Syncope not demonstrated to be due to AV block when other likely causes have been excluded, specifically ventricular tachycardia (VT). (LOE: B)
- Incidental finding at electrophysiological study of a markedly prolonged HV interval (greater than or equal to 100 milliseconds) in asymptomatic patients. (LOE: B)
- Incidental finding at electrophysiological study of pacing-induced infra-His block that is not physiological. (LOE: B)

R.14 Six Minute Walk Test Instructions

American Thoracic Society

ATS Statement: Guidelines for the Six-Minute Walk Test

THIS OFFICIAL STATEMENT OF THE AMERICAN THORACIC SOCIETY WAS APPROVED BY THE ATS BOARD OF DIRECTORS MARCH 2002

CONTENTS

- Purpose and Scope
- Background
- Indications and Limitations
- Contraindications
- Safety Issues
- Technical Aspects of the 6-Minute Walk Test
- Required Equipment
- Patient Preparation
- Measurements
- Quality Assurance
- Interpretation
- References

PURPOSE AND SCOPE

This statement provides practical guidelines for the 6-minute walk test (6MWT). Specifically, it reviews indications, details factors that influence results, presents a brief step-by-step protocol, outlines safety measures, describes proper patient preparation and procedures, and offers guidelines for clinical interpretation of results. These recommendations are not intended to limit the use of alternative protocols for research studies. We do not discuss the general topic of clinical exercise testing.

As with other American Thoracic Society statements on pulmonary function testing, these guidelines come out of a consensus conference. Drafts were prepared by two members (P.L.E. and R.J.Z.) and were based on a comprehensive Medline literature search from 1970 through 2001, augmented by suggestions from other committee members. Each draft responded to comments from the working committee. The guidelines follow previously published methods as closely as possible and provide a rationale for each specific recommendation. The final recommendations represent a consensus of the committee. The committee recommends that these guidelines be reviewed in five years and in the meantime encourages further research in areas of controversy.

BACKGROUND

There are several modalities available for the objective evaluation of functional exercise capacity. Some provide a very complete assessment of all systems involved in exercise performance (high tech), whereas others provide basic information but are low tech and are simpler to perform. The modality used should be chosen based on the clinical question to be addressed and on available resources. The most popular clinical exercise tests in order of increasing complexity are stair climbing, a 6MWT, a shuttle-walk test, detection of exercise-induced asthma, a cardiac stress test (e.g., Bruce protocol), and a cardiopulmonary exercise test ([1](#), [2](#)). Other professional organizations have published standards for cardiac stress testing ([3](#), [4](#)).

Assessment of functional capacity has traditionally been done by merely asking patients the following: "How many flights of stairs can you climb or how many blocks can you walk?" However, patients vary in their recollection and may report overestimations or underestimations of their true functional capacity. Objective measurements are usually better than self-reports. In the early 1960s, Balke developed a simple test to evaluate the functional capacity by measuring the distance walked during a defined period of time ([5](#)). A 12-minute field performance test was then developed to evaluate the level of physical fitness of healthy individuals ([6](#)). The walking test was also adapted to assess disability in patients with chronic bronchitis ([7](#)). In an attempt to accommodate patients with respiratory disease for whom walking 12 minutes was too exhausting, a 6-minute walk was found to perform as well as the 12-minute walk ([8](#)). A recent review of functional walking tests concluded that

"the 6MWT is easy to administer, better tolerated, and more reflective of activities of daily living than the other walk tests" (9).

The 6MWT is a practical simple test that requires a 100-ft hallway but no exercise equipment or advanced training for technicians. Walking is an activity performed daily by all but the most severely impaired patients. This test measures the distance that a patient can quickly walk on a flat, hard surface in a period of 6 minutes (the 6MWD). It evaluates the global and integrated responses of all the systems involved during exercise, including the pulmonary and cardiovascular systems, systemic circulation, peripheral circulation, blood, neuromuscular units, and muscle metabolism. It does not provide specific information on the function of each of the different organs and systems involved in exercise or the mechanism of exercise limitation, as is possible with maximal cardiopulmonary exercise testing. The self-paced 6MWT assesses the submaximal level of functional capacity. Most patients do not achieve maximal exercise capacity during the 6MWT; instead, they choose their own intensity of exercise and are allowed to stop and rest during the test. However, because most activities of daily living are performed at submaximal levels of exertion, the 6MWD may better reflect the functional exercise level for daily physical activities.

INDICATIONS AND LIMITATIONS

The strongest indication for the 6MWT is for measuring the response to medical interventions in patients with moderate to severe heart or lung disease. The 6MWT has also been used as a one-time measure of functional status of patients, as well as a predictor of morbidity and mortality (see [Table 1](#) for a list of these indications). The fact that investigators have used the 6MWT in these settings does not prove that the test is clinically useful (or the best test) for determining functional capacity or changes in functional capacity due to an intervention in patients with these diseases. Further studies are necessary to determine the utility of the 6MWT in various clinical situations.

TABLE 1. Indications for the Six-Minute Walk Test

Pretreatment and post treatment comparisons

- Lung transplantation (9, 10)
- Lung resection (11)
- Lung volume reduction surgery (12, 13)
- Pulmonary rehabilitation (14, 15)
- COPD (16–18)
- Pulmonary hypertension
- Heart failure (19, 20)

Functional status (single measurement)

- COPD (21, 22)
- Cystic fibrosis (23, 24)
- Heart failure (25–27)
- Peripheral vascular disease (28, 29)
- Fibromyalgia (30)
- Older patients (31)

Predictor of morbidity and mortality

- Heart failure (32, 33)
- COPD (34, 35)
- Primary pulmonary hypertension (10, 36)

Definition of abbreviation: COPD = chronic obstructive pulmonary disease.

Formal cardiopulmonary exercise testing provides a global assessment of the exercise response, an objective determination of functional capacity and impairment, determination of the appropriate intensity needed to perform prolonged exercise, quantification of factors limiting exercise, and a definition of the underlying pathophysiologic mechanisms such as the contribution of different organ systems involved in exercise. The 6MWT does not determine peak oxygen uptake, diagnose the cause of dyspnea on exertion, or evaluate the causes or mechanisms of exercise limitation (1, 2). The information provided by a 6MWT should be considered complementary to cardiopulmonary exercise testing, not a replacement for it. Despite the difference between these two functional tests, some good correlations between them have been reported. For example, a significant correlation ($r = 0.73$) between 6MWD and peak oxygen uptake has been reported for patients with end-stage lung diseases (36).

In some clinical situations, the 6MWT provides information that may be a better index of the patient's ability to perform daily activities than is peak oxygen uptake; for example, 6MWD correlates better with formal measures of quality of life (37). Changes in 6MWD after therapeutic interventions correlate with subjective improvement in dyspnea (38, 39). The reproducibility of the 6MWD (with a coefficient of variation of approximately 8%) appears to be better than the reproducibility of 1-second forced expiratory volume in patients with chronic obstructive pulmonary disease (COPD) (8, 39–42). Questionnaire indices of functional status have a larger short-term variability (22–33%) than does the 6MWD (37).

The shuttle-walking test is similar to the 6MWT, but it uses an audio signal from a tape cassette to direct the walking pace of the patient back and forth on a 10-m course (43–45). The walking speed is increased every minute, and the test ends when the patient cannot reach the turnaround point within the required time. The exercise performed is similar to a symptom-limited, maximal, incremental treadmill test. An advantage of the shuttle walking test is that it has a better correlation with peak oxygen uptake than the 6MWD (46, 47). Disadvantages include less validation, less widespread use, and more potential for cardiovascular problems.

CONTRAINDICATIONS

Absolute contraindications for the 6MWT include the following: unstable angina during the previous month and myocardial infarction during the previous month. Relative contraindications include a resting heart rate of more than 120, a systolic blood pressure of more than 180 mm Hg, and a diastolic blood pressure of more than 100 mm Hg.

Patients with any of these findings should be referred to the physician ordering or supervising the test for individual clinical assessment and a decision about the conduct of the test. The results from a resting electrocardiogram done during the previous 6 months should also be reviewed before testing. Stable exertional angina is not an absolute contraindication for a 6MWT, but patients with these symptoms should perform the test after using their antiangina medication, and rescue nitrate medication should be readily available.

Rationale

Patients with the previously mentioned risk factors may be at increased risk for arrhythmias or cardiovascular collapse during testing. However, each patient determines the intensity of their exercise, and the test (without electrocardiogram monitoring) has been performed in thousands of older persons (31, 48) and thousands of patients with heart failure or cardiomyopathy (32, 49, 50) without serious adverse events. The contraindications listed previously here were used by study investigators based on their impressions of the general safety of the 6MWT and their desire to be prudent, but it is unknown whether adverse events would occur if such patients performed a 6MWT; they are, therefore, listed as relative contraindications.

SAFETY ISSUES

1. Testing should be performed in a location where a rapid, appropriate response to an emergency is possible. The appropriate location of a crash cart should be determined by the physician supervising the facility.
2. Supplies that must be available include oxygen, sublingual nitroglycerine, aspirin, and albuterol (metered dose inhaler or nebulizer). A telephone or other means should be in place to enable a call for help.
3. The technician should be certified in cardiopulmonary resuscitation with a minimum of Basic Life Support by an American Heart Association–approved cardiopulmonary resuscitation course. Advanced cardiac life support certification is desirable. Training, experience, and certification in related health care fields (registered nurse, registered respiratory therapist, certified pulmonary function technician, etc.) are also desirable. A certified individual should be readily available to respond if needed.
4. Physicians are not required to be present during all tests. The physician ordering the test or a supervising laboratory physician may decide whether physician attendance at a specific test is required.

5. If a patient is on chronic oxygen therapy, oxygen should be given at their standard rate or as directed by a physician or a protocol.

Reasons for immediately stopping a 6MWT include the following: (1) chest pain, (2) intolerable dyspnea, (3) leg cramps, (4) staggering, (5) diaphoresis, and (6) pale or ashen appearance.

Technicians must be trained to recognize these problems and the appropriate responses. If a test is stopped for any of these reasons, the patient should sit or lie supine as appropriate depending on the severity of the event and the technician's assessment of the severity of the event and the risk of syncope. The following should be obtained based on the judgment of the technician: blood pressure, pulse rate, oxygen saturation, and a physician evaluation. Oxygen should be administered as appropriate.

TECHNICAL ASPECTS OF THE 6MWT

Location

The 6MWT should be performed indoors, along a long, flat, straight, enclosed corridor with a hard surface that is seldom traveled. If the weather is comfortable, the test may be performed outdoors. The walking course must be 30 m in length. A 100-ft hallway is, therefore, required. The length of the corridor should be marked every 3 m. The turnaround points should be marked with a cone (such as an orange traffic cone). A starting line, which marks the beginning and end of each 60-m lap, should be marked on the floor using brightly colored tape.

Rationale

A shorter corridor requires patients to take more time to reverse directions more often, reducing the 6MWD. Most studies have used a 30-m corridor (51), but some have used 20- or 50-m corridors (52, 53). A recent multicenter study found no significant effect of the length of straight courses ranging from 50 to 164 ft, but patients walked farther on continuous (oval) tracks (mean 92 ft farther) (54).

The use of a treadmill to determine the 6MWD might save space and allow constant monitoring during the exercise, but the use of a treadmill for 6-minute walk testing is not recommended. Patients are unable to pace themselves on a treadmill. In one study of patients with severe lung disease, the mean distance walked on the treadmill during 6 minutes (with the speed adjusted by the patients) was shorter by a mean of 14% when compared with the standard 6MWD using a 100-ft hallway (55). The range of differences was wide, with patients walking between 400–1,300 ft on the treadmill who walked 1,200 ft in the hallway. Treadmill test results, therefore, are not interchangeable with corridor tests.

REQUIRED EQUIPMENT

1. Countdown timer (or stopwatch)
2. Mechanical lap counter
3. Two small cones to mark the turnaround points
4. A chair that can be easily moved along the walking course
5. Worksheets on a clipboard
6. A source of oxygen
7. Sphygmomanometer
8. Telephone
9. Automated electronic defibrillator

PATIENT PREPARATION

6. Comfortable clothing should be worn.
7. Appropriate shoes for walking should be worn.
8. Patients should use their usual walking aids during the test (cane, walker, etc.).
9. The patient's usual medical regimen should be continued.
10. A light meal is acceptable before early morning or early afternoon tests.
11. Patients should not have exercised vigorously within 2 hours of beginning the test.

MEASUREMENTS

1. Repeat testing should be performed about the same time of day to minimize intraday variability.
2. A "warm-up" period before the test should not be performed.
3. The patient should sit at rest in a chair, located near the starting position, for at least 10 minutes before the test starts. During this time, check for contraindications, measure pulse and blood pressure, and make sure that clothing and shoes are appropriate. Complete the first portion of the worksheet (see the [APPENDIX](#)).
4. Pulse oximetry is optional. If it is performed, measure and record baseline heart rate and oxygen saturation (SpO₂) and follow manufacturer's instructions to maximize the signal and to minimize motion artifact ([56](#)). Make sure the readings are stable before recording. Note pulse regularity and whether the oximeter signal quality is acceptable.

The rationale for measuring oxygen saturation is that although the distance is the primary outcome measure, improvement during serial evaluations may be manifest either by an increased distance or by reduced symptoms with the same distance walked ([38](#)). The SpO₂ should not be used for constant monitoring during the exercise. The technician must not walk with the patient to observe the SpO₂. If worn during the walk, the pulse oximeter must be lightweight (less than 2 pounds), battery powered, and held in place (perhaps by a "fanny pack") so that the patient does not have to hold or stabilize it and so that stride is not affected. Many pulse oximeters have considerable motion artifact that prevents accurate readings during the walk ([57](#)).

5. Have the patient stand and rate their baseline dyspnea and overall fatigue using the Borg scale (see [Table 2](#) for the Borg scale and instructions [\[58\]](#)).
6. Set the lap counter to zero and the timer to 6 minutes. Assemble all necessary equipment (lap counter, timer, clipboard, Borg Scale, worksheet) and move to the starting point.
7. Instruct the patient as follows:

"The object of this test is to walk as far as possible for 6 minutes. You will walk back and forth in this hallway. Six minutes is a long time to walk, so you will be exerting yourself. You will probably get out of breath or become exhausted. You are permitted to slow down, to stop, and to rest as necessary. You may lean against the wall while resting, but resume walking as soon as you are able.

You will be walking back and forth around the cones. You should pivot briskly around the cones and continue back the other way without hesitation. Now I'm going to show you. Please watch the way I turn without hesitation."

Demonstrate by walking one lap yourself. Walk and pivot around a cone briskly.

"Are you ready to do that? I am going to use this counter to keep track of the number of laps you complete. I will click it each time you turn around at this starting line. Remember that the object is to walk AS FAR AS POSSIBLE for 6 minutes, but don't run or jog.

Start now or whenever you are ready."

TABLE 2. The Borg scale

0	Nothing at all
0.5	Very, very slight (just noticeable)
1	Very slight
2	Slight (light)
3	Moderate
4	Somewhat severe
5	Severe (heavy)
6	
7	Very severe
8	
9	
10	Very, very severe (maximal)

This Borg scale should be printed on heavy paper (11 inches high and perhaps laminated) in 20-point type size. At the beginning of the 6-minute exercise, show the scale to the patient and ask the patient this: *"Please grade your level of shortness of breath using this scale."* Then ask this: *"Please grade your level of fatigue using this scale."* At the end of the exercise, remind the patient of the breathing number that they chose before the exercise and ask the patient to grade their breathing level again. Then ask the patient to grade their level of fatigue, after reminding them of their grade before the exercise.

8. Position the patient at the starting line. You should also stand near the starting line during the test. Do not walk with the patient. As soon as the patient starts to walk, start the timer
9. Do not talk to anyone during the walk. Use an even tone of voice when using the standard phrases of encouragement. Watch the patient. Do not get distracted and lose count of the laps. Each time the participant returns to the starting line, click the lap counter once (or mark the lap on the worksheet). Let the participant see you do it. Exaggerate the click using body language, like using a stopwatch at a race.

After the first minute, tell the patient the following (in even tones): *"You are doing well. You have 5 minutes to go."*

When the timer shows 4 minutes remaining, tell the patient the following: *"Keep up the good work. You have 4 minutes to go."*

When the timer shows 3 minutes remaining, tell the patient the following: *"You are doing well. You are halfway done."*

When the timer shows 2 minutes remaining, tell the patient the following: *"Keep up the good work. You have only 2 minutes left."*

When the timer shows only 1 minute remaining, tell the patient: *"You are doing well. You have only 1 minute to go."*

Do not use other words of encouragement (or body language to speed up).

If the patient stops walking during the test and needs a rest, say this: *"You can lean against the wall if you would like; then continue walking whenever you feel able."* Do not stop the timer. If the patient stops before the 6 minutes are up and refuses to continue (or you decide that they should not continue), wheel the chair over for the patient to sit on, discontinue the walk, and note on the worksheet the distance, the time stopped, and the reason for stopping prematurely.

When the timer is 15 seconds from completion, say this: *"In a moment I'm going to tell you to stop. When I do, just stop right where you are and I will come to you."*

When the timer rings (or buzzes), say this: *"Stop!"* Walk over to the patient. Consider taking the chair if they look exhausted. Mark the spot where they stopped by placing a bean bag or a piece of tape on the floor.

10. Post-test: Record the postwalk Borg dyspnea and fatigue levels and ask this: *"What, if anything, kept you from walking farther?"*

11. If using a pulse oximeter, measure SpO₂ and pulse rate from the oximeter and then remove the sensor.
12. Record the number of laps from the counter (or tick marks on the worksheet).
13. Record the additional distance covered (the number of meters in the final partial lap) using the markers on the wall as distance guides. Calculate the total distance walked, rounding to the nearest meter, and record it on the worksheet.
14. Congratulate the patient on good effort and offer a drink of water.

QUALITY ASSURANCE

Sources of Variability

There are many sources of 6MWD variability (see [Table 3](#)). The sources of variability caused by the test procedure itself should be controlled as much as possible. This is done by following the standards found in this document and by using a quality-assurance program.

TABLE 3. 6MWD Sources of Variability

Factors reducing the 6MWD
Shorter height
Older age
Higher body weight
Female sex
Impaired cognition
A shorter corridor (more turns)
Pulmonary disease (COPD, asthma, cystic fibrosis, interstitial lung disease)
Cardiovascular disease (angina, MI, CHF, stroke, TIA, PVD, AAI)
Musculoskeletal disorders (arthritis, ankle, knee, or hip injuries, muscle wasting, etc.)
Factors increasing the 6MWD
Taller height (longer legs)
Male sex
High motivation
A patient who was previously performed the test
Medication for a disabling disease taken just before the test
Oxygen supplementation in patients with exercise induced hypoxemia

Definition of abbreviations: COPD = chronic obstructive pulmonary disease; 6MWD = 6-minute walking distance.

Practice Tests

A practice test is not needed in most clinical settings but should be considered. If a practice test is done, wait for at least 1 hour before the second test and report the highest 6MWD as the patient's 6MWD baseline.

Rationale

The 6MWD is only slightly higher for a second 6MWT performed a day later. The mean reported increase ranges from 0 to 17% ([23](#), [27](#), [40](#), [41](#), [54](#), [59](#)). A multicenter study of 470 highly motivated patients with severe COPD performed two 6MWTs 1 day apart, and on average, the 6MWD was only 66 ft (5.8%) higher on the second day ([54](#)).

Performance (without an intervention) usually reaches a plateau after two tests done within a week ([8](#), [60](#)). The training effect may be due to improved coordination, finding optimal stride length, and overcoming anxiety. The possibility of a practice or training effect from tests repeated after more than a month has not been studied or reported; however, it is likely that the effect of training wears off (does not persist) after a few weeks.

Technician Training and Experience

Technicians who perform 6MWTs should be trained using the standard protocol and then supervised for several tests before performing them alone. They should also have completed cardiopulmonary resuscitation training.

Rationale

One multicenter study of older people found that after correction for many other factors, two of the technicians had mean 6MWDs that were approximately 7% lower than the other two sites (31).

Encouragement

Only the standardized phrases for encouragement (as specified previously here) must be used during the test.

Rationale

Encouragement significantly increases the distance walked (42). Reproducibility for tests with and without encouragement is similar. Some studies have used encouragement every 30 seconds, every minute, or every 2 minutes. We have chosen every minute and standard phrases. Some studies (53) have instructed patients to walk as fast as possible. Although larger mean 6MWDs may be obtained thereby, we recommend that such phrases not be used, as they emphasize initial speed at the expense of earlier fatigue and possible excessive cardiac stress in some patients with heart disease.

Supplemental Oxygen

If oxygen supplementation is needed during the walks and serial tests are planned (after an intervention other than oxygen therapy), then during all walks by that patient oxygen should be delivered in the same way with the same flow. If the flow must be increased during subsequent visits due to worsening gas exchange, this should be noted on the worksheet and considered during interpretation of the change noted in 6MWD. The type of oxygen delivery device should also be noted on the report: for instance, the patient carried liquid oxygen or pushed or pulled an oxygen tank, the delivery was pulsed or continuous, or a technician walked behind the patient with the oxygen source (not recommended). Measurements of pulse and SpO₂ should be made after waiting at least 10 minutes after any change in oxygen delivery.

Rationale

For patients with COPD or interstitial lung disease, oxygen supplementation increases the 6MWD (17, 59, 61). Carrying a portable gas container (but not using it for supplemental oxygen) reduced the mean 6MWD by 14% in one study of patients with severe respiratory disability, but using the container to deliver supplemental oxygen during the exercise increased the mean 6MWD by 20–36% (59).

Medications

The type of medication, dose, and number of hours taken before the test should be noted.

Rationale

Significant improvement in the distance walked, or the dyspnea scale, after administration of bronchodilators has been demonstrated in patients with COPD (62, 63), as well as cardiovascular medications in patients with heart failure (19).

INTERPRETATION

Most 6MWTs will be done before and after intervention, and the primary question to be answered after both tests have been completed is whether the patient has experienced a clinically significant improvement. With a good quality-assurance program, with patients tested by the same technician, and after one or two practice tests, short-term reproducibility of the 6MWD is excellent (36). It is not known whether it is best for clinical purposes to express change in 6MWD as (1) an absolute value, (2) a percentage change, or (3) a change in the percentage of predicted value. Until further research is available, we recommend that change in 6MWD be expressed as an absolute value (e.g., the patient walked 50 m farther).

A statistically significant mean increase in 6MWD in a group of study participants is often much less than a clinically significant increase in an individual patient. In one study of 112 patients (half of them women) with stable, severe COPD, the smallest difference in 6MWD that was associated with a noticeable clinical difference in the patients' perception of exercise performance was a mean of 54

m (95% confidence interval, 37–71 m) (64). This study suggests that for individual patients with COPD, an improvement of more than 70 m in the 6MWD after an intervention is necessary to be 95% confident that the improvement was significant. In an observational study of 45 older patients with heart failure, the smallest difference in 6MWD that was associated with a noticeable difference in their global rating of worsening was a mean of 43 m (20). The 6MWD was more responsive to deterioration than to improvement in heart failure symptoms.

Reported Mean Changes in 6MWD After Interventions

Supplemental oxygen (6 L/min) during exercise in patients with COPD or interstitial lung disease increased mean 6MWD by approximately 83 m (36%) in one study (59). Patients taking an inhaled corticosteroid experienced a mean 33 m (8%) increase in 6MWD in an international COPD study (16). Patients with COPD in a study of the effects of exercise and diaphragmatic strength training experienced a mean increase in 6MWD of 50 m (20%) (65). Lung volume reduction surgery in patients with very severe COPD has been reported to increase 6MWD by a mean of 55 m (20%) (13).

Cardiac rehabilitation in patients referred with various heart diseases increased 6MWD by a mean of 170 m (15%) in a recent study (66). In 25 older patients with heart failure, an angiotensin-converting enzyme inhibitor medication (50 mg captopril per day) improved 6MWD a mean of 64 m (39%) compared with a mean increase of only 8% in those receiving a placebo (19).

Interpreting Single Measurements of Functional Status

Optimal reference equations from healthy population-based samples using standardized 6MWT methods are not yet available. In one study, the median 6MWD was approximately 580 m for 117 healthy men and 500 m for 173 healthy women (48). A mean 6MWD of 630 m was reported by another study of 51 healthy older adults (53). Differences in the population sampled, type and frequency of encouragement, corridor length, and number of practice tests may account for reported differences in mean 6MWD in healthy persons. Age, height, weight, and sex independently affect the 6MWD in healthy adults; therefore, these factors should be taken into consideration when interpreting the results of single measurements made to determine functional status. We encourage investigators to publish reference equations for healthy persons using the previously mentioned standardized procedures.

A low 6MWD is nonspecific and nondiagnostic. When the 6MWD is reduced, a thorough search for the cause of the impairment is warranted. The following tests may then be helpful: pulmonary function, cardiac function, ankle–arm index, muscle strength, nutritional status, orthopedic function, and cognitive function.

Conclusions

The 6MWT is a useful measure of functional capacity targeted at people with at least moderately severe impairment. The test has been widely used for preoperative and postoperative evaluation and for measuring the response to therapeutic interventions for pulmonary and cardiac disease. These guidelines provide a standardized approach to performing the 6MWT. The committee hopes that these guidelines will encourage further research into the 6MWT and allow direct comparisons among different studies.

APPENDIX

The following elements should be present on the 6MWT worksheet and report:		
Lap counter: _____		
Patient name: _____ Patient ID# _____		
Walk # _____ Tech ID: _____ Date: _____		
Gender: M F Age: _____ Race: _____ Height: _____ft _____in, _____ meters		
Weight: _____ lbs, _____ kg Blood pressure: _____ / _____		
Medications taken before the test (dose and time): _____		
Supplemental oxygen during the test: No Yes, flow _____ L/min, type _____		
	Baseline	End of Test
Time	____:____	____:____
Heart Rate	_____	_____
Dyspnea	_____	_____ (Borg scale)
Fatigue	_____	_____ (Borg scale)
SpO ₂	_____ %	_____ %
Stopped or paused before 6 minutes? No Yes, reason: _____		
Other symptoms at end of exercise: angina dizziness hip, leg, or calf pain		
Number of laps: _____ (x60 meters) + final partial lap: _____ meters =		
Total distance walked in 6 minutes: _____ meters		
Predicted distance: _____ meters Percent predicted: _____%		
Tech comments:		
Interpretation (including comparison with a preintervention 6MWD):		

Acknowledgments

This statement was developed by the ATS Committee on Proficiency Standards for Clinical Pulmonary Function Laboratories.

Members of the committee are:

ROBERT O. CRAPO, M.D., *Chair* *
RICHARD CASABURI, PH.D, M.D.
ALLAN L. COATES, M.D.
PAUL L. ENRIGHT, M.D.*
NEIL R. MACINTYRE, M.D.
ROY T. MCKAY, PH.D.
DOUGLAS JOHNSON, M.D.
JACK S. WANGER, M.S.
R. JORGE ZEBALLOS, M.D.*

Ad Hoc Committee members are:

VERA BITTNER, M.D.
CARL MOTTRAM, R.R.T.

*Writing Committee Members

REFERENCES

1. Wasserman K, Hansen JE, Sue DY, Casaburi R, Whipp BJ. Principles of exercise testing and interpretation, 3rd edition. Philadelphia: Lippincott, Williams & Wilkins; 1999.
2. Weisman IM, Zeballos RJ. An integrated approach to the interpretation of cardiopulmonary exercise testing. *Clin Chest Med* 1994;15:421–445.
3. Fletcher GF, Balady G, Froelicher VF, Hartley LH, Haskell WL, Pollock ML. Exercise standards: a statement for healthcare professionals from the American Heart Association: writing group. *Circulation* 1995; 91:580–615.
4. Pina IL, Balady GJ, Hanson P, Labovitz AJ, Madonna DW, Myers J. Guidelines for clinical exercise testing laboratories: a statement for healthcare professionals from the Committee on Exercise and Cardiac Rehabilitation, American Heart Association. *Circulation* 1995;91:912–921.
5. Balke B. A simple field test for the assessment of physical fitness. *CARI Report* 1963;63:18.
6. Cooper KH. A means of assessing maximal oxygen intake: correlation between field and treadmill testing. *JAMA* 1968;203:201–204.
7. McGavin CR, Gupta SP, McHardy GJR. Twelve-minute walking test for assessing disability in chronic bronchitis. *BMJ* 1976;1:822–823.
8. Butland RJA, Pang J, Gross ER, Woodcock AA, Geddes DM. Two-, six-, and 12-minute walking tests in respiratory disease. *BMJ* 1982; 284:1607–1608.
9. Solway S, Brooks D, Lacasse Y, Thomas S. A qualitative systematic overview of the measurement properties of functional walk tests used in the cardiorespiratory domain. *Chest* 2001;119:256–270.
10. Kadikar A, Maurer J, Kesten S. The six-minute walk test: a guide to assessment for lung transplantation. *J Heart Lung Transplant* 1997;16: 313–319.
11. Holden DA, Rice TW, Stelmach K, Meeker DP. Exercise testing, 6 min walk, and stair climb in the evaluation of patients at high risk for pulmonary resection. *Chest* 1992;102:1774–1779.
12. Sciruba FC, Rogers RM, Keenan RJ, Slivka WA, Gorcsan J 3rd, Ferson PF, Holbert JM, Brown ML, Landreneau RJ. Improvement in pulmonary function and elastic recoil after lung-reduction surgery for diffuse emphysema. *N Engl J Med* 1996;334:1095–1099.
13. Criner GJ, Cordova FC, Furukawa S, Kuzma AM, Travaline JM, Leyenson V, O'Brien GM. Prospective randomized trial comparing bilateral lung volume reduction surgery to pulmonary rehabilitation in severe COPD. *Am J Respir Crit Care Med* 1999;160:2018–2027.
14. Sinclair DJM, Ingram CG. Controlled trial of supervised exercise training in chronic bronchitis. *BMJ* 1980;280:519–521.
15. Roomi J, Johnson MM, Waters K, Yohannes A, Helm A, Connolly MJ. Respiratory rehabilitation, exercise capacity and quality of life in chronic airways disease in old age. *Age Ageing* 1996;25:12–16.
16. Paggiaro PL, Dahle R, Bakran I, Frith L, Hollingworth K, Efthimiou J. Multicentre randomised placebo-controlled trial of inhaled fluticasone propionate in patients with COPD. *Lancet* 1998;351:773–780.
17. Leggett RJ, Flenley DC. Portable oxygen and exercise tolerance in patients with chronic hypoxic cor pulmonale. *BMJ* 1977;2:84–86.
18. Spence DPS, Hay JG, Carter J, Pearson MG, Calverley PMA. Oxygen desaturation and breathlessness during corridor walking in COPD: effect of oxitropium bromide. *Thorax* 1993;48:1145–1150.
19. DeBock V, Mets T, Romagnoli M, Derde MP. Captopril treatment of chronic heart failure in the very old. *J Gerontol* 1994;49:M148–M152.

20. O'Keefe ST, Lye M, Donnellan C, Carmichael DN. Reproducibility and responsiveness of quality of life assessment and six minute walk test in elderly heart failure patients. *Heart* 1998;80:377–382.
21. Bernstein ML, Despars JA, Singh NP, Avalos K, Stansbury DW, Light RW. Re-analysis of the 12 minute walk in patients with COPD. *Chest* 1994;105:163–167.
22. Hajiro T, Nishimura K, Tsukino M, Ikeda A, Koyama H, Izumi T. Analysis of clinical methods used to evaluate dyspnea in patients with COPD. *Am J Respir Crit Care Med* 1998;158:1185–1189.
23. Gulmans VAM, vanVeldhoven NHMJ, deMeer K, Helders PJM. The six-minute walking test in children with cystic fibrosis: reliability and validity. *Pediatr Pulmonol* 1996;22:85–89.
24. Nixon PA, Joswiak ML, Fricker FJ. A six-minute walk test for assessing exercise tolerance in severely ill children. *J Pediatr* 1996;129:362–366.
25. Bittner V. Six-minute walk test in patients with cardiac dysfunction. *Cardiologia* 1997;42:897–902.
26. Peeters P, Mets T. The 6 minute walk as an appropriate exercise test in elderly patients with chronic heart failure. *J Gerontol* 1996;51A: M147–M151.
27. Zugck C, Kruger C, Durr S, Gerber SH, Haunstetter A, Hornig K, Kubler W, Haass M. Is the 6-minute walk test a reliable substitute for peak oxygen uptake in patients with dilated cardiomyopathy? *Eur Heart J* 2000;21:540–549.
28. Montgomery PS, Gardner AW. The clinical utility of a six-minute walk test in peripheral arterial occlusive disease patients. *J Am Geriatr Soc* 1998;46:706–711.
29. Cahan MA, Montgomery P, Otis RB, Clancy R, Flinn W, Gardner A. The effect of cigarette smoking status on six-minute walk distance in patients with intermittent claudication. *Angiology* 1999;50:537–546.
30. King S, Wessel J, Bhambhani Y, Maikala R, Sholter D, Maksymowych W. Validity and reliability of the 6 minute walk in persons with fibromyalgia. *J Rheumatol* 1999;26:2233–2237.
31. Enright PL, McBurnie MA, Bittner V, Tracy RP, McNamara R, Newman AB, the Cardiovascular Health Study. The six minute walk test: a quick measure of functional status in elderly adults. *Chest* (In press)
32. Bittner V, Weiner DH, Yusuf S, Rogers WJ, McIntyre KM, Bangdiwala SI, Kronenberg MW, Kostis JB, Kohn RM, Guillolette M, *et al.* Prediction of mortality and morbidity with a 6-minute walk test in patients with left ventricular dysfunction. *JAMA* 1993;270:1702–1707.
33. Cahalin LP, Mathier MA, Semigran MJ, Dec GW, DiSalvo TG. The six-minute walk test predicts peak oxygen uptake and survival in patients with advanced heart failure. *Chest* 1996;110:325–332.
34. Cote CG, Celli BR. In patients with COPD, the 6 minute walking distance is a better predictor of health care utilization than FEV₁, blood gases, and dyspnea [abstract]. *Eur Respir J* 1998;383.
35. Kessler R, Faller M, Fourgaut G, Mennecier B, Weitzenblum E. Predictive factors of hospitalization for acute exacerbation in a series of 64 patients with chronic obstructive pulmonary disease. *Am J Respir Crit Care Med* 1999;159:158–164.
36. Cahalin L, Pappagianopoulos P, Prevost S, Wain J, Ginns L. The relationship of the 6-min walk test to maximal oxygen consumption in transplant candidates with end-stage lung disease. *Chest* 1995;108:452–459.
37. Guyatt GH, Thompson PJ, Berman LB, Sullivan MJ, Townsend M, Jones NL, Pugsley SO. How should we measure function in patients with chronic heart and lung disease? *J Chronic Dis* 1985;38:517–524.
38. Guyatt GH, Townsend M, Keller J, Singer J, Nogradi S. Measuring functional status in chronic lung disease: conclusions from a random control trial. *Respir Med* 1991;85(Suppl B):17–21.
39. Niederman MS, Clemente PH, Fein AM, Feinsilver SH, Robinson DA, Ilowite JS, Bernstein MG. Benefits of a multidisciplinary pulmonary rehabilitation program: improvements are independent of lung function. *Chest* 1991;99:798–804.
40. Nosedá A, Carpioux J, Prigogine T, Schmerber J. Lung function, maximum and submaximum exercise testing in COPD patients: reproducibility over a long interval. *Lung* 1989;167:247–257.
41. Knox AJ, Morrison JF, Muers MF. Reproducibility of walking test results in chronic obstructive airways disease. *Thorax* 1988;43:388–392.
42. Guyatt GH, Pugsley SO, Sullivan MJ, Thompson PJ, Berman LB, Jones NL, Fallen EL, Taylor DW. Effect of encouragement on walking test performance. *Thorax* 1984;39:818–822.
43. Leger LA. A maximal multistage 20-m shuttle run test to predict VO₂ max. *Eur J Appl Physiol* 1982;49:1–12.
44. Singh SJ, Morgan MDL, Scott S, Walters D, Hardman AE. Development of a shuttle walking test of disability in patients with chronic airways obstruction. *Thorax* 1992;47:1019–1024.
45. Revill SM, Morgan MDL, Singh SJ, Williams J, Hardman AE. The endurance shuttle walk: a new field test for the assessment of endurance capacity in chronic obstructive pulmonary disease. *Thorax* 1999;54:213–222.
46. Singh SJ, Morgan MDL, Hardman AE, Rowe C, Bardsley PA. Comparison of oxygen uptake during a conventional treadmill test and the shuttle walking test in chronic airflow limitation. *Eur Respir J* 1994;7: 2016–2020.
47. Morales FJ, Martínez A, Méndez M, Agarrado A, Ortega F, Fernández-Guerra J, Montemayor T, Burgos J. A shuttle walk test for assessment of functional capacity in chronic heart failure. *Am Heart J* 1999;138:292–298.
48. Enright PL, Sherrill DL. Reference equations for the six-minute walk in healthy adults. *Am J Respir Crit Care Med* 1998;158:1384–1387.

49. Barst RJ, Rubin LJ, McGoon MD, Caldwell EJ, Long WA, Levy PS. Survival in primary pulmonary hypertension with long-term continuous intravenous prostacyclin. *Ann Intern Med* 1994;121:409–415.
50. Miyamoto S, Nagaya N, Satoh T, Kyotani S, Sakamaki F, Fujita M, Nakanishi N, Miyatake K. Clinical correlates and prognostic significance of six-minute walk test in patients with primary pulmonary hypertension. *Am J Respir Crit Care Med* 2000;161:487–492.
51. Guyatt GH, Sullivan MJ, Thompson PJ, Fallen EL, Pugsley SO, Taylor DW, Berman LB. The 6-minute walk: a new measure of exercise capacity in patients with chronic heart failure. *Can Med Assoc J* 1985; 132:919–923.
52. Lipkin DP, Scrivin AJ, Crake T, Poole-Wilson PA. Six minute walking test for assessing exercise capacity in chronic heart failure. *BMJ* 1986; 292:653–655.
53. Troosters T, Gosselink R, Decramer M. Six minute walking distance in healthy elderly subjects. *Eur Respir J* 1999;14:270–274.
54. Weiss RA, *et al*. Six minute walk test in severe COPD: reliability and effect of walking course layout and length. Paper presented at ACCP Conference; September 2000; San Francisco.
55. Stevens D, Elpern E, Sharma K, Szidon P, Ankin M, Kesten S. Comparison of hallway and treadmill six-minute walk tests. *Am J Respir Crit Care Med* 1999;160:1540–1543.
56. Jensen LA, Onyskiw JE, Prasad NGN. Meta-analysis of arterial oxygen saturation monitoring by pulse oximetry in adults. *Heart Lung* 1998; 27:387–408.
57. Barthelemy JC, Geyssant A, Riffat J, Antoniadis A, Berruyer J, LaCour JR. Accuracy of pulse oximetry during moderate exercise: a comparative study. *Scand J Clin Lab Invest* 1990;50:533–539.
58. Borg GAV. Psycho-physical bases of perceived exertion. *Med Sci Sports Exerc* 1982;14:377–381.
59. Leach RM, Davidson AC, Chinn S, Twort CHC, Cameron IR, Batemen NT. Portable liquid oxygen and exercise ability in severe respiratory disability. *Thorax* 1992;47:781–789.
60. Mungall IPF, Hainsworth R. Assessment of respiratory function in patients with chronic obstructive airways disease. *Thorax* 1979;34:254–258.
61. Roberts CM, Bell J, Wedzicha JA. Comparison of the efficacy of a demand oxygen delivery system with continuous low flow oxygen in subjects with stable COPD and severe oxygen desaturation on walking. *Thorax* 1996;51:831–834.
62. Hay JG, Stone P, Carter J, Church S, Eyre-Brook A, Pearson MG, Woodcock AA, Calverley PM. Bronchodilator reversibility, exercise performance and breathlessness in stable chronic obstructive pulmonary disease. *Eur Respir J* 1992;5:659–664.
63. Grove A, Lipworth BJ, Reid P, Smith RP, Lamage L, Ingram CG, Jenkins RJ, Winter JH, Dhillon DP. Effects of regular salmeterol on lung function and exercise capacity in patients with COPD. *Thorax* 1996;51:689–693.
64. Redelmeier DA, Bayoumi AM, Goldstein RS, Guyatt GH. Interpreting small differences in functional status: The six minute walk test in chronic lung disease patients. *Am J Respir Crit Care Med* 1997;155:1278–1282.
65. Weiner P, Magadle R, Berar-Yanay N, Davidovich A, Weiner M. The cumulative effect of long-acting bronchodilators, exercise, and inspiratory muscle training on the perception of dyspnea in patients with advanced COPD. *Chest* 2000;118:672–678.
66. Bittner V, Sanderson B, Breland J, Adams C, Schuman C. Assessing functional capacity as an outcome in cardiac rehabilitation: role of the 6 minute walk test. *Clinical Exercise Physiology* 2000.

R.15 National Institute of Health Stroke Scale (NIHSS)

Administer stroke scale items in the order listed. Record performance in each category after each subscale exam. Do not go back and change scores. Follow directions provided for each exam technique. Scores should reflect what the patient does, not what the clinician thinks the patient can do. The clinician should record answers while administering the exam and work quickly. Except where indicated, the patient should not be coached (i.e., repeated requests to patient to make a special effort).

Instructions	Scale Definition	Score
<p>1a. Level of Consciousness: The investigator must choose a response if a full evaluation is prevented by such obstacles as an endotracheal tube, language barrier, orotracheal trauma/bandages. A 3 is scored only if the patient makes no movement (other than reflexive posturing) in response to noxious stimulation.</p>	<p>0 = Alert; keenly responsive.</p> <p>1 = Not alert; but arousable by minor stimulation to obey, answer, or respond.</p> <p>2 = Not alert; requires repeated stimulation to attend, or is obtunded and requires strong or painful stimulation to make movements (not stereotyped).</p> <p>3 = Responds only with reflex motor or autonomic effects or totally unresponsive, flaccid, and areflexic.</p>	_____
<p>1b. LOC Questions: The patient is asked the month and his/her age. The answer must be correct - there is no partial credit for being close. Aphasic and stuporous patients who do not comprehend the questions will score 2. Patients unable to speak because of endotracheal intubation, orotracheal trauma, severe dysarthria from any cause, language barrier, or any other problem not secondary to aphasia are given a 1. It is important that only the initial answer be graded and that the examiner not "help" the patient with verbal or non-verbal cues.</p>	<p>0 = Answers both questions correctly.</p> <p>1 = Answers one question correctly.</p> <p>2 = Answers neither question correctly.</p>	_____
<p>1c. LOC Commands: The patient is asked to open and close the eyes and then to grip and release the non-paretic hand. Substitute another one step command if the hands cannot be used. Credit is given if an unequivocal attempt is made but not completed due to weakness. If the patient does not respond to command, the task should be demonstrated to him or her (pantomime), and the result scored (i.e., follows none, one or two commands). Patients with trauma, amputation, or other physical impediments should be given suitable one-step commands. Only the first attempt is scored.</p>	<p>0 = Performs both tasks correctly.</p> <p>1 = Performs one task correctly.</p> <p>2 = Performs neither task correctly.</p>	_____

<p>2. Best Gaze: Only horizontal eye movements will be tested. Voluntary or reflexive (oculocephalic) eye movements will be scored, but caloric testing is not done. If the patient has a conjugate deviation of the eyes that can be overcome by voluntary or reflexive activity, the score will be 1. If a patient has an isolated peripheral nerve paresis (CN III, IV or VI), score a 1. Gaze is testable in all aphasic patients. Patients with ocular trauma, bandages, pre-existing blindness, or other disorder of visual acuity or fields should be tested with reflexive movements, and a choice made by the investigator. Establishing eye contact and then moving about the patient from side to side will occasionally clarify the presence of a partial gaze palsy.</p>	<p>0 = Normal. 1 = Partial gaze palsy; gaze is abnormal in one or both eyes, but forced deviation or total gaze paresis is not present. 2 = Forced deviation, or total gaze paresis not overcome by the oculocephalic maneuver.</p>	<p>_____</p>
<p>3. Visual: Visual fields (upper and lower quadrants) are tested by confrontation, using finger counting or visual threat, as appropriate. Patients may be encouraged, but if they look at the side of the moving fingers appropriately, this can be scored as normal. If there is unilateral blindness or enucleation, visual fields in the remaining eye are scored. Score 1 only if a clear-cut asymmetry, including quadrantanopia, is found. If patient is blind from any cause, score 3. Double simultaneous stimulation is performed at this point. If there is extinction, patient receives a 1, and the results are used to respond to item 11.</p>	<p>0 = No visual loss. 1 = Partial hemianopia. 2 = Complete hemianopia. 3 = Bilateral hemianopia (blind including cortical blindness).</p>	<p>_____</p>
<p>4. Facial Palsy: Ask – or use pantomime to encourage – the patient to show teeth or raise eyebrows and close eyes. Score symmetry of grimace in response to noxious stimuli in the poorly responsive or non-comprehending patient. If facial trauma/bandages, orotracheal tube, tape or other physical barriers obscure the face, these should be removed to the extent possible.</p>	<p>0 = Normal symmetrical movements. 1 = Minor paralysis (flattened nasolabial fold, asymmetry on smiling). 2 = Partial paralysis (total or near-total paralysis of lower face). 3 = Complete paralysis of one or both sides (absence of facial movement in the upper and lower face).</p>	<p>_____</p>
<p>5. Motor Arm: The limb is placed in the appropriate position: extend the arms (palms down) 90 degrees (if sitting) or 45 degrees (if supine). Drift is scored if the arm falls before 10 seconds. The aphasic patient is encouraged using urgency in the voice and pantomime, but not noxious stimulation. Each limb is tested in turn, beginning with the non-paretic arm. Only in the case of amputation or joint fusion at the shoulder, the examiner should record the score as untestable (UN), and clearly write the explanation for this choice.</p>	<p>0 = No drift; limb holds 90 (or 45) degrees for full 10 seconds. 1 = Drift; limb holds 90 (or 45) degrees, but drifts down before full 10 seconds; does not hit bed or other support. 2 = Some effort against gravity; limb cannot get to or maintain (if cued) 90 (or 45) degrees, drifts down to bed, but has some effort against gravity. 3 = No effort against gravity; limb falls. 4 = No movement. UN = Amputation or joint fusion, explain: _____ 5a. Left Arm 5b. Right Arm</p>	<p>_____ _____</p>

<p>6. Motor Leg: The limb is placed in the appropriate position: hold the leg at 30 degrees (always tested supine). Drift is scored if the leg falls before 5 seconds. The aphasic patient is encouraged using urgency in the voice and pantomime, but not noxious stimulation. Each limb is tested in turn, beginning with the non-paretic leg. Only in the case of amputation or joint fusion at the hip, the examiner should record the score as untestable (UN), and clearly write the explanation for this choice.</p>	<p>0 = No drift; leg holds 30-degree position for full 5 seconds. 1 = Drift; leg falls by the end of the 5-second period but does not hit bed. 2 = Some effort against gravity; leg falls to bed by 5 seconds, but has some effort against gravity. 3 = No effort against gravity; leg falls to bed immediately. 4 = No movement. UN = Amputation or joint fusion, explain: _____</p> <p style="text-align: right;">6a. Left Leg _____ 6b. Right _____</p>	
<p>7. Limb Ataxia: This item is aimed at finding evidence of a unilateral cerebellar lesion. Test with eyes open. In case of visual defect, ensure testing is done in intact visual field. The finger-nose-finger and heel-shin tests are performed on both sides, and ataxia is scored only if present out of proportion to weakness. Ataxia is absent in the patient who cannot understand or is paralyzed. Only in the case of amputation or joint fusion, the examiner should record the score as untestable (UN), and clearly write the explanation for this choice. In case of blindness, test by having the patient touch nose from extended arm position.</p>	<p>0 = Absent. 1 = Present in one limb. 2 = Present in two limbs. UN = Amputation or joint fusion, explain: _____</p>	
<p>8. Sensory: Sensation or grimace to pinprick when tested, or withdrawal from noxious stimulus in the obtunded or aphasic patient. Only sensory loss attributed to stroke is scored as abnormal and the examiner should test as many body areas (arms [not hands], legs, trunk, face) as needed to accurately check for hemisensory loss. A score of 2, "severe or total sensory loss," should only be given when a severe or total loss of sensation can be clearly demonstrated. Stuporous and aphasic patients will, therefore, probably score 1 or 0. The patient with brainstem stroke who has bilateral loss of sensation is scored 2. If the patient does not respond and is quadriplegic, score 2. Patients in a coma (item 1a=3) are automatically given a 2 on this item.</p>	<p>0 = Normal; no sensory loss. 1 = Mild-to-moderate sensory loss; patient feels pinprick is less sharp or is dull on the affected side; or there is a loss of superficial pain with pinprick, but patient is aware of being touched. 2 = Severe to total sensory loss; patient is not aware of being touched in the face, arm, and leg.</p>	

<p>9. Best Language: A great deal of information about comprehension will be obtained during the preceding sections of the examination. For this scale item, the patient is asked to describe what is happening in the attached picture, to name the items on the attached naming sheet and to read from the attached list of sentences. Comprehension is judged from responses here, as well as to all of the commands in the preceding general neurological exam. If visual loss interferes with the tests, ask the patient to identify objects placed in the hand, repeat, and produce speech. The intubated patient should be asked to write. The patient in a coma (item 1a=3) will automatically score 3 on this item. The examiner must choose a score for the patient with stupor or limited cooperation, but a score of 3 should be used only if the patient is mute and follows no one-step commands.</p>	<p>0 = No aphasia; normal.</p> <p>1 = Mild-to-moderate aphasia; some obvious loss of fluency or facility of comprehension, without significant limitation on ideas expressed or form of expression. Reduction of speech and/or comprehension, however, makes conversation about provided materials difficult or impossible. For example, in conversation about provided materials, examiner can identify picture or naming card content from patient's response.</p> <p>2 = Severe aphasia; all communication is through fragmentary expression; great need for inference, questioning, and guessing by the listener. Range of information that can be exchanged is limited; listener carries burden of communication. Examiner cannot identify materials provided from patient response.</p> <p>3 = Mute, global aphasia; no usable speech or auditory comprehension.</p>	<p style="text-align: center;">_____</p>
<p>10. Dysarthria: If patient is thought to be normal, an adequate sample of speech must be obtained by asking patient to read or repeat words from the attached list. If the patient has severe aphasia, the clarity of articulation of spontaneous speech can be rated. Only if the patient is intubated or has other physical barriers to producing speech, the examiner should record the score as untestable (UN), and clearly write an explanation for this choice. Do not tell the patient why he or she is being tested.</p>	<p>0 = Normal.</p> <p>1 = Mild-to-moderate dysarthria; patient slurs at least some words and, at worst, can be understood with some difficulty.</p> <p>2 = Severe dysarthria; patient's speech is so slurred as to be unintelligible in the absence of or out of proportion to any dysphasia, or is mute/anarthric.</p> <p>UN = Intubated or other physical barrier, explain: _____</p>	<p style="text-align: center;">_____</p>
<p>11. Extinction and Inattention (formerly Neglect): Sufficient information to identify neglect may be obtained during the prior testing. If the patient has a severe visual loss preventing visual double simultaneous stimulation, and the cutaneous stimuli are normal, the score is normal. If the patient has aphasia but does appear to attend to both sides, the score is normal. The presence of visual spatial neglect or anosagnosia may also be taken as evidence of abnormality. Since the abnormality is scored only if present, the item is never untestable.</p>	<p>0 = No abnormality.</p> <p>1 = Visual, tactile, auditory, spatial, or personal inattention or extinction to bilateral simultaneous stimulation in one of the sensory modalities.</p> <p>2 = Profound hemi-inattention or extinction to more than one modality; does not recognize own hand or orients to only one side of space.</p>	<p style="text-align: center;">_____</p>

R.16 Modified Rankin Scale (mRS) Instructions

Instructions:

- The mRS is to be determined after the NIHSS has been determined and graded and by the same rater.
- The determination of the scale should be made from 5 to 0, i.e., the order presented.
- The purpose of the mRS is to record whether the patient is dead, severely, moderately, or slightly disabled and if not dead or disabled, whether the patient is performing all usual activities without symptoms or not. Because subjects and family members may understate the severity of disability, it is important for the rating clinician to understand that the mRS is a clinical scale and not a patient-reported outcome. The rater may ask questions but must assess the disability whether or not in agreement with the subject or family.

5 Severe disability; someone needs to be available at all times; care may be provided by either a trained or an untrained caregiver.

Question: Does the person require constant care?

4 Moderately severe disability; need for assistance with some basic ADL, but not requiring constant care.

Question: Is assistance essential for eating, using the toilet, daily hygiene, or walking?

3 Moderate disability; need for assistance with some instrumental ADL but not basic ADL.

Question: Is assistance essential for preparing a simple meal, doing household chores, looking after money, shopping, or traveling locally?

2 Slight disability; limitations in participation in usual social roles, but independent for ADL.

Questions:

- Has there been a change in the person's ability to work or look after others if these were roles before stroke?
- Has there been a change in the person's ability to participate in previous social and leisure activities?
- Has the person had problems with relationships or become isolated?
- Do any of the following interfere with the subject's ability to perform all usual activities: difficulty reading or writing, difficulty speaking or finding the right word, problems with balance or coordination, visual problems, numbness (face, arms, legs, hands, feet), loss of movement (face, arms, legs, hands, feet), difficulty with swallowing, or other symptom resulting from stroke?

1 No significant disability; symptoms present but not other limitations.

Question: Does the subject have any symptoms that do not interfere with the performance of all usual activities?

0 No symptoms at all; no limitations and no symptoms.

Note: The above questions are a modification of the questions from **Wilson, et. al, Stroke. 2002:33:2243-2246** and are **modified here for the use in percutaneous heart valve trials** for the FDA Division of CV Devices.

R.17 Mini Mental State Exam (MMSE-2:SV)

Mini Mental Status Exam1: The MMSE-2 Standard Version should be used.

Procedure:

Administer the MMSE-2 exam utilizing the standardized worksheets provided.

<http://www.minimental.com/>

R.18 Additional Neurological Assessments

Visual Field Testing

Visual fields, (upper and lower quadrants) are tested by confrontation, using finger counting or visual threat as appropriate.

Visual fields may be impaired by lesions anywhere in the neural visual pathways, from the optic nerves to the occipital lobes.

- **Individual eyes:**

In direct confrontation, examiner should sit directly in front of the patient, at the same level and approximately one meter apart. Ask the patient to cover one eye and maintain a fixed gaze on the examiners eye or nose. The examiner brings a small target (e.g. a match or a finger) from the periphery of the subject's visual field into each of the 4 visual quadrants and requests that the patient indicate when they first visualize the object. Wiggling the target assists in the patients separating and defining it.

Repeat the testing for the other eye.

Any abnormalities in target detection should prompt detailed testing with more precise instruments.

- **Bilateral eyes:**

In the same position, and with the patients fixed gaze on the examiners nose or eyes, use finger counting or visual threat to identify any asymmetry in the visual field.

Gait Assessment

Not tested as part of the NIH Stroke Scale.

Ask the patient to walk down a straight hallway under observation, if ambulatory.

Note any apparent abnormalities of gait. (Ataxic, lateralized hemi-paretic, 'shuffling' or 'small-step' or other abnormality).

Hand Function

- **Motor assessment**

The extensors are weaker than the flexors in the upper extremities. Consequently, following a neurological event, the arm eventually assumes a flexed position. Therefore the biceps will be stronger than the triceps, the wrist and finger flexors stronger than the extensors. For this reason it is not a good idea to monitor for stroke progression by testing grip strength. Test finger extensor strength instead.

Muscle power is classically graded on a scale of 0 – 5, with 0 being no power and 5 being normal power. For the purposes of documenting subtleties in potential deficits, power in finger muscle groups should be documented on a 0 – 10 scale as follows.

Grade 0	No muscle contraction
Grade 2	Muscle contraction without joint movement
Grade 4	Partial movement with gravity eliminated
Grade 6	Movement against gravity
Grade 8	Movement against some resistance
Grade 10	Normal strength

(Use odd numbers to document when physical findings fall between grades).

- **Finger Abductors**

Instruct the patient to “Spread your fingers apart, push your index finger towards the other hand. Don’t let me push it back”. Push on the finger at the Proximal Interphalangeal (PIP) joint level.

- **Finger Adductors**

Ask patient to ‘grip a sheet of paper’ between their fingers. Try to pull the sheet away from them.

- **Finger Extensors**

Instruct the patient to “Keep your fingers out straight, and don’t let me bend them”. This is a test of extension at the metacarpophalangeal (MCP) joints. It is important to support the palm and apply pressure to the PIP joints, testing extension at only one set of joints, because extension at the PIP joints is performed by the small hand muscles.

- **Sensory Assessment**

In a seated position, ask the patient to place both hands on their lap with palms facing down. Instruct them to close their eyes, and using their index finger point to the position touched by the examiner on fingers of the opposite hand. Repeat for both hands.

This should be documented as: ‘normal sensation’ or ‘can feel but unable to localize’ or ‘no sensation’ for each hand.

Writing Evaluation

Ask the patient to write two sentences about a particular subject. (e.g. their hometown). There is no time limit, and patient can be given time prior to neurological examination as necessary.

Note the subject’s ‘use of paper’, including the position of writing. Also, note whether the written subject is appropriate to that asked, and the correctness of the grammar, spelling and syntax used.

Document as ‘fail’ or ‘pass’ or ‘subject unable to attempt test’ if patient is unable.

Drawing Assessment

The ‘clock-drawing’ test is used for screening for cognitive impairment and dementia, and as a measure of spatial dysfunction and neglect. Doing the test requires verbal understanding, memory and spatially coded knowledge in addition to constructive skills.

Constructional apraxia may occur with lesions in either the left or right parietal lobe, although it is more frequent after right parietal damage (visually dominant).

Clock drawing has been used as a diagnostic measure of unilateral spatial neglect, with neglect patients omitting numbers on one half, with or without transposition of the numbers from the neglect side to the other, or demonstrating inattention to parts of the spatial layout of numbers.

The test has a high correlation with the MMSE and other tests of cognitive dysfunction.

- Ask patient to draw the face of a clock and put the numbers in the correct position.
- Then ask patient to draw in the hands at a particular time (e.g., "twenty minutes after eight").
- There is no time limit.

One point will be assigned for each of the following items completed (draws closed circle, includes all 12 correct numbers, places numbers in correct positions, places hands in correct positions) for a total of four points.

R.19 Medtronic CoreValve™ Clinical Assessment Guidelines

Clinical Assessments will be collected to help assess the overall health and frailty¹ of study participants at the time of screening. These assessments include measures of nutrition, strength and balance, independence in average daily living, mental status, and medical comorbidities.

The following are guidelines provided for administering the strength and balance examination.

5-Meter Gait Speed: The Gait Test measures, in seconds, the time a person takes walk 5meters.

Procedure:

- Accompany the patient to the designated area, which should be well-lit, unobstructed, and contain clearly indicated markings at 0 and 5 meters
- Position the patient with his/her feet behind and just touching the 0-meter start line
- Instruct the patient to **“Walk at your comfortable pace”** until a few steps past the 5-meter mark (the patient should not start to slow down before the 5-meter mark)
- Begin each trial on the word **“Go”**
- Start the timer with the first footfall after the 0-meter line
- Stop the timer with the first footfall after the 5-meter line
- Repeat 3 times, allowing sufficient time for recuperation between trials

Note: Patient may use a walking aid (cane, walker). If the patient is receiving an IV drip, he/she should perform the test without the IV only if it can be interrupted temporarily without any potential risk to the patient, if not, then the patient may perform the test pushing the IV pole.

Grip strength test²: The grip strength test is used to determine the strength in each of the participant's hands.

Procedure:

- Equipment: Hand Dynamometer
- Illustrate the use of the instrument to the participant prior to testing.
- The participant should be in a seated position.
- Ask the participant to squeeze the dynamometer with as much force as possible, being careful to squeeze only once for each measurement.
- Three trials should be made for the right hand followed by three trials for left hand with a pause of about 10-20 seconds between each trial to avoid the effects of muscle fatigue.
- The highest reading for each hand should be reported on the case report form.

¹ Fried LP et al, (2001). Frailty in older adults: Evidence for a phenotype. *Journal of Gerontology: Medical Science*, 56A (3), M146-M156.

² Luna-Heredia E, Martin-Pena G, Ruiz-Galiana J. Handgrip dynamometry in healthy adults. *Clinical Nutrition* 2005; 24:250-258

R.20 Katz Index of Independence in Activities of Daily Living

Activities Points (1 or 0)	Independence (1 POINT) NO supervision, direction or personal assistance	Dependence (0 Points) WITH supervision, direction, personal assistance or total assistance
BATHING Points: _____	(1 POINT) Bathes self completely or needs help in bathing only a single part of the body such as the back, genital area or disabled extremity.	(0 POINTS) Needs help with bathing more than one part of the body, getting in or out of the tub or shower. Requires total bathing.
DRESSING Points: _____	(1 POINT) Gets clothes from closets and drawers and puts on clothes and outer garments complete with fasteners. May have help tying shoes.	0 POINTS) Needs help with dressing self or needs to be completely dressed.
TOILETING Points: _____	(1 POINT) Goes to toilet, gets on and off, arranges clothes, cleans genital area without help	(0 POINTS) Needs help transferring to the toilet, cleaning self or uses bedpan or commode.
TRANSFERRING Points: _____	(1 POINT) Moves in and out of bed or chair unassisted. Mechanical transferring aides are acceptable.	(0 POINTS) Needs help in moving from bed to chair or requires a complete transfer.
CONTINENCE Points: _____	(1 POINT) Exercises complete self-control over urination and defecation.	(0 POINTS) Is partially or totally incontinent of bowel or bladder.
FEEDING Points: _____	(1 POINT) Gets food from plate into mouth without help. Preparation of food may be done by another person.	(0 POINTS) Needs partial or total help with feeding or requires parenteral feeding.

TOTAL POINTS = _____
 6 = High (patient independent)
 0 = Low (patient very dependent)

Slightly adapted from Katz S., Down, T.D., Cash, H.R. et al. (1970)
 Progress in the Development of the Index of ADL. Gerontologist
 10:20-30. Copyright The Gerontological Society of America

**R.21 Investigator Brochure / Report of Prior Investigations for the
Investigational Devices**

The geography-specific Investigator Brochure for the Medtronic CoreValve™ System and Medtronic CoreValve™ Evolut™ R System will be provided separately, as applicable.

R.22 Investigational Devices Instructions For Use

The geography-specific Instructions For Use for the Medtronic CoreValve™ System and Medtronic CoreValve™ Evolut™ R System will be provided under separate cover.

R.23 Radiation Exposure and Data Collection

The SURTAVI protocol requires several tests and procedures that expose subjects to radiation (angiograms, arteriograms and fluoroscopy). These tests and procedures are essential to appropriate patient selection and proper deployment of the study valves.

Procedure	Interval
Multi-slice Computed Tomography (MSCT) Angiogram	Screening
Coronary arteriogram	Screening Index Procedure – TAVI only
Aorotogram	Index Procedure – TAVI only

The following describes radiation exposure data collection requirements as well as parameters for additional subject follow-up.

Follow-up and Data Collection

Data regarding subject radiation exposure will be collected at all protocol intervals where radiation test or procedures are required.

- Screening
- Index-Procedure (TAVI only)
 - Percutaneous Coronary Intervention (PCI) – if staged approach
- Reintervention (Valve related)

NOTE: Based on the protocol design, imaging required at screening may have been completed prior to the subject signing the informed consent form and data related to radiation exposure during the acquisition of the images may not be available. **Radiation exposure data missing from the subject record will not be considered a protocol deviation.**

Substantial Radiation Dose Level

For purposes of SURTAVI, substantial radiation dose level (SRDL) is defined as meeting/exceeding one of the following:

Dose Metric	SRDL
Total air kerma at IRP ($K_{a,r}$)	3 Gy
Kerma-area product (P_{ka})	250 Gy·cm ²
Fluoroscopy Time	60 min

In cases where SRDL is met or exceeded additional steps should be taken.

- Document the radiation dose the subject was exposed to in the medical record
- Include an explanation regarding the medical necessity
- Describe the planned follow-up
- Notify the subject and caregiver, if applicable
 - Instruct subject (and caregiver) to perform visual skin assessments at least once per week between in-clinic visits
 - If a hand-sized read area or rash is noted, contact the Investigator immediately to schedule a follow-up visit

To ensure signs and symptoms of radiation exposure are identified as soon as possible, subjects should have a routine visual skin assessment at the following protocol intervals:

- Baseline
- Immediate Post-Procedure – within 48 hours of TAVI
- Discharge
- 30-days

Additional follow-up should be scheduled at the Investigators discretion based on progression of symptoms, as applicable.

If skin changes are noted at any interval additional follow-up should be scheduled with a dermatologist, or physician with the appropriate training and expertise for diagnosis and treatment. Long-term follow-up should be conducted in accordance with local standard of care.

Skin assessment findings should be noted in the patient medical record and applicable adverse events should be reported.

Threshold for Radiation Dose Exposure

Chronology and Severity of Tissue Reactions From Single-Delivery Radiation Dose

Single site (Gy) acute skin dose	Prompt (<2 weeks)	Early (2–8 weeks)	Mid term (6–52 weeks)	Long term (<40 weeks)
	No observable effects expected			
2-5	Transient erythema	Epilation	Recovery from hair loss	None expected
5-10	Transient erythema	Erythema, epilation	Recovery; high doses cause prolonged erythema and permanent partial epilation	Recovery; higher dose cause dermal atrophy/induration
10-15	Transient erythema	Erythema, epilation; dry/moist desquamation	Prolonged erythema permanent epilation	Telangiectasia; dermal atrophy/induration
>15	Transient erythema; Very high dose causes moist desquamation edema/ulceration	Erythema, epilation	Dermal atrophy with secondary ulceration; atrophy/induration; High dose dermal necrosis surgical repair likely	Telangiectasia; dermal Late skin breakdown

Modified: Balter S. Fluoroscopically guided interventional procedure: A review of radiation effects on skin and hair. NCRP SC 2–3, Feb 2010.

List of Abbreviations

Abbreviation	Term
Gy	Gray
IRP	Interventional reference point
KAP	Kerma area product
PSD	Peak skin dose
SDRL	Substantial radiation dose level

References

Balter, S. Moses, J. Managing Patient Dose in Interventional Cardiology. *Catheterization and Cardiovascular Interventions* 2007; 70:244–249

Chambers, et al. Radiation Safety Program for the Cardiac Catheterization Laboratory. *Catheterization and Cardiovascular Interventions* 2011; 77:546–556

Hirshfield, et al. ACCF/AHA/HRS/SCAI Clinical Competence Statement on Physician Knowledge to Optimize Patient Safety and Image Quality in Fluoroscopically Guided Invasive Cardiovascular Procedures: A Report of the American College of Cardiology Foundation/American Heart Association/American College of Physicians Task Force on Clinical Competence and Training *Circulation* 2005, 111:511-532

R.24 SURTAVI Risk Model

Risk assessment is essential in the strategy to approach patients with valvular heart disease in general and AS in particular. Various risk models primarily focusing on short-term mortality have been validated for AS patients (30-38). Some were initially derived from a broader patient population undergoing any type of cardiac surgery, others were more explicitly tailored to patients with AS. Most notably, contemporary scoring models tend to be consistent in lower risk patients but diverge with increasing risk profile. This can be partly explained by the fact that these models were extracted from large databases where the average patient risk is fairly low. Therefore such models are less well validated for higher risk patients and expectedly perform less well in the “outlier” population currently considered for TAVI (39).

An in-depth reappraisal of existing scoring models reveals some concordant risk factors (e.g. age, gender) but also established risk factors that are clearly missing (e.g. mediastinal radiation, porcelain aorta and frailty) (40-42). Furthermore definitions of individual components are not uniform and do not correspond to current suggested guidelines/definitions by respective professional societies.

R.24.1 SURTAVI Risk Model Rationale

1. Joint database

Following the initial report by the Bern, Rotterdam collaboration (28) including 1122 patients with severe AS, four academic institutions in Bern, Rotterdam, Bad Nauheim and Munich have created a joint database on all consecutive patients with severe AS treated with either TAVI or SAVR between January 2006 and December 2009.

Preliminary analysis on 3688 patients has been performed, including 789 TAVI and 2899 SAVR patients.

The pre-specified primary outcome was all cause mortality at 1 year. Patients were actively followed up after the index procedure and their vital status confirmed by outpatient clinic visit, telephone contact, review of medical records or national civil registries.

2. Statistical methods

The propensity scores of SAVR patients were estimated using a probit model with all baseline characteristics as described above as independent variables. The propensity score is the probability that a patient would have been treated with SAVR given that patient's observed baseline characteristics. To ensure the quality of the matching using propensity scores the common support assumption was applied, using the Epanechnikov kernel probability density estimates. The IPT weighted multivariable analysis was used. The IPT weighted analyses used the inverse of the propensity score as weights in SAVR patients and the inverse of 1 minus the propensity score in TAVI patients. All analyses were based on logistic regression models on the 1 year mortality and were performed in the overall dataset and stratified according to presence or absence of sufficient overlap of propensity scores (propensity score <0.675 versus ≥0.675).

3. Type of patient (patient selection)

Preliminary analysis demonstrated a pre-dominance of patients with age >80 years old, and a logistic EuroSCORE <20% in the TAVI cohort (figure “scatterplot”). However, the majority of patients in the entire study population are between 65-and 83-years-old (figure “age distribution”).

**SURTA VI Clinical Investigation Plan - Appendix
(Surgical Replacement and Transcatheter Aortic Valve Implantation)**

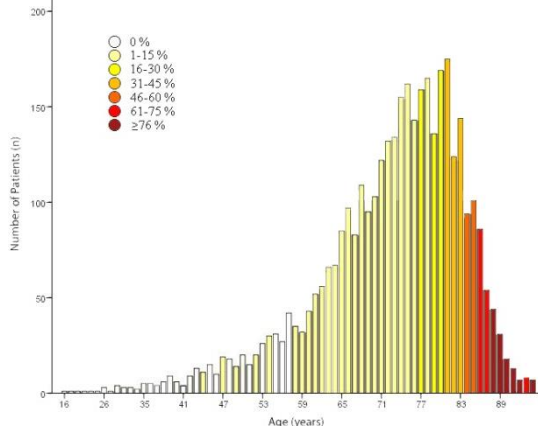

The distribution of age in patients treated for aortic stenosis. The color indicates the percentage of patients treated with TAVI in the corresponding age group

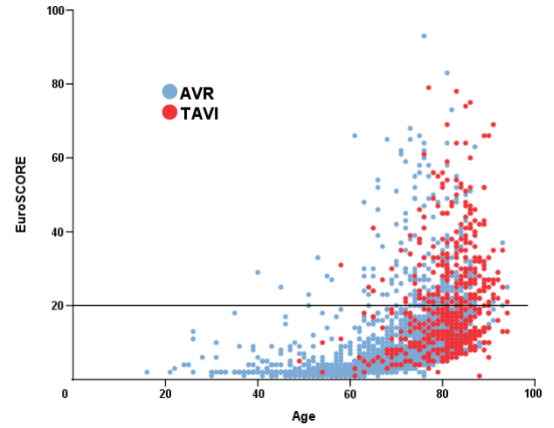

A scatterplot showing the age and corresponding EuroSCORE of patients treated for aortic stenosis. Indicated by colours are the treatment arms surgical aortic valve replacement and transcatheter aortic valve implantation. A previous commonly used EuroSCORE cut-off value of 20% is indicated in the graphic to show that many patients with lower scores are already treated by TAVI, but in lower ages this treatment remains limited due to the low EuroSCORE.

As it is well-known that both the STS score and EuroSCORE are suboptimal in operative risk assessment, these models are only used for descriptive purposes (39). Age is the predominant predictor of mortality in general, and after valve surgery in particular. Furthermore, the impact of other risk factors appears to be accentuated in an older age population.

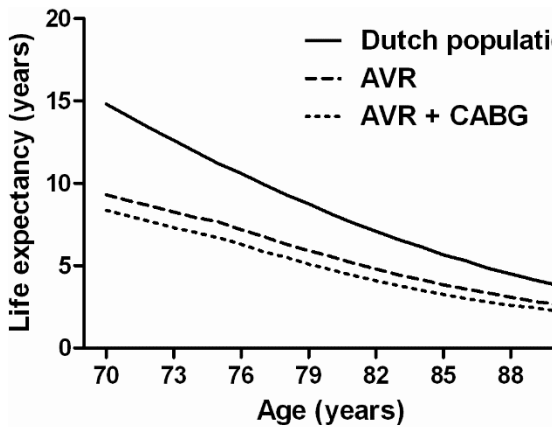

Survival curves of the general Dutch population (derived from death register); and patients undergoing an AVR (derived from meta-analysis data), or an AVR with the additional risk factor of coronary sclerosis (derived from meta-analysis data).

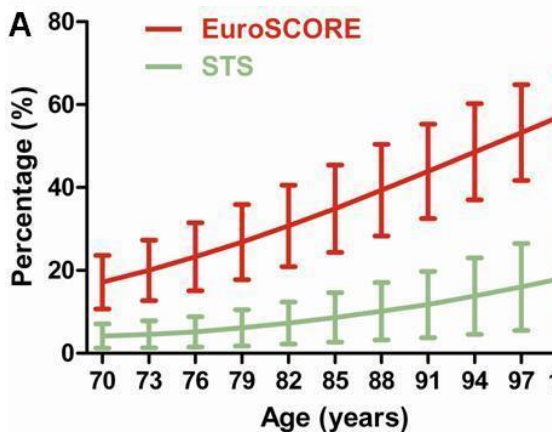

The range of both the EuroSCORE and STS score in a patient with 2 risk factors. The lower boundary indicates a score with risk factors that have little influence on the score, while the upper boundary indicates a score with risk factors that influence the score significantly

Therefore, we opt for a risk assessment based on age in combination with encoded co-morbidities selected from a pre-specified listing. Patients at intermediate risk are defined as age 70-74 years with 2 or 3 co-morbidities (cohort 1); age 75-79 years with 1 or 2 co-morbidities (cohort 2); and patients ≥80 years of age with ≤1 co-morbidities (cohort 3).

In-depth analysis and translation of the risk profile mentioned above to the STS score (table STS below):

- Cohort 1: range of 0.9% to 10.2% in males, and 1.4% to 14.8% in females
- Cohort 2: range of 1.2% to 8.5% in males, and 1.8% to 12.4% in females
- Cohort 3*: range of 1.7% to 8.9% in males, and 2.6% to 12.7% in females

Male		70 yr	73 yr	76 yr	79 yr	82 yr	85 yr	88 yr	91 yr
Risk factors	0	1.7	2.1	2.5	3.0
	1	1.2 - 3.6	1.4 - 4.3	1.7 - 5.2	2.1 - 6.2	2.5 - 7.4	3.0 - 8.9
	2	0.9 - 5.7	1.0 - 6.3	1.2 - 7.1	1.4 - 8.5
	3	1.1 - 9.3	1.2 - 10.2
Female		70 yr	73 yr	76 yr	79 yr	82 yr	85 yr	88 yr	91 yr
Risk factors	0	2.6	3.2	3.8	4.5
	1	1.8 - 5.4	2.2 - 6.5	2.6 - 7.7	3.2 - 9.2	3.8 - 10.9	4.5 - 12.7
	2	1.4 - 8.4	1.6 - 9.3	1.8 - 10.5	2.2 - 12.4
	3	1.7 - 13.5	1.9 - 14.8

STS score: ranges of scores are displayed as: score with least influential risk factors – score with most influential risk factors. *Upper age limit 91 years old

In-depth analysis and translation of the risk profile mentioned above to the logistic EuroSCORE (Table EuroSCORE below):

- Cohort 1: range of 9.1% to 42.3% in males, and 12.2% to 50.5% in females
- Cohort 2: range of 7.2% to 32.1% in males, and 9.8% to 39.6% in females
- Cohort 3*: range of 6.6% to 27.8% in males, and 9.0% to 34.9% in females

Male		70 yr	73 yr	76 yr	79 yr	82 yr	85 yr	88 yr	91 yr
Risk factors	0	6.6	8.0	9.6	11.4
	1	7.2 - 12.4	8.7 - 14.8	10.4 - 17.5	12.4 - 20.5	14.7 - 24.0	17.4 - 27.8
	2	9.1 - 20.6	10.9 - 24.0	13.0 - 27.9	15.4 - 32.1
	3	16.2 - 37.5	19.1 - 42.3
Female		70 yr	73 yr	76 yr	79 yr	82 yr	85 yr	88 yr	91 yr
Risk factors	0	9.0	10.7	12.8	15.2
	1	9.8 - 16.5	11.7 - 19.4	13.9 - 22.7	16.5 - 26.4	19.4 - 30.5	22.7 - 34.9
	2	12.2 - 26.5	14.5 - 30.6	17.2 - 35.0	20.2 - 39.6
	3	21.1 - 45.5	24.7 - 50.5

Euroscore: ranges of scores are displayed as: score with least influential risk factors – score with most influential risk factors. *Upper age limit 91 years old

4. Comparative patient outcome

One-year mortality amounts to 30% in the overall high-risk matched population with a logistic EuroSCORE of 15.8%. The hazard ratio of propensity matched patients between SAVR and TAVI is 0.97. This suggests equipoise for both treatment strategies and is the legitimation for a randomized trial in this intermediate risk AS population.

R.24.2 SURTA VI co-morbidity list

Methodology for identifying enlisted co-morbidities:

We first identified those components recurring in the previously published scoring models and looked for updated definitions by international professional societies. We then added missing risk factors, identified in the literature, which we felt, were essential. In addition, there exists an 'open box' to capture less prevalent and unanticipated risk factors (e.g. liver failure, mediastinal radiation, porcelain aorta, etc.)

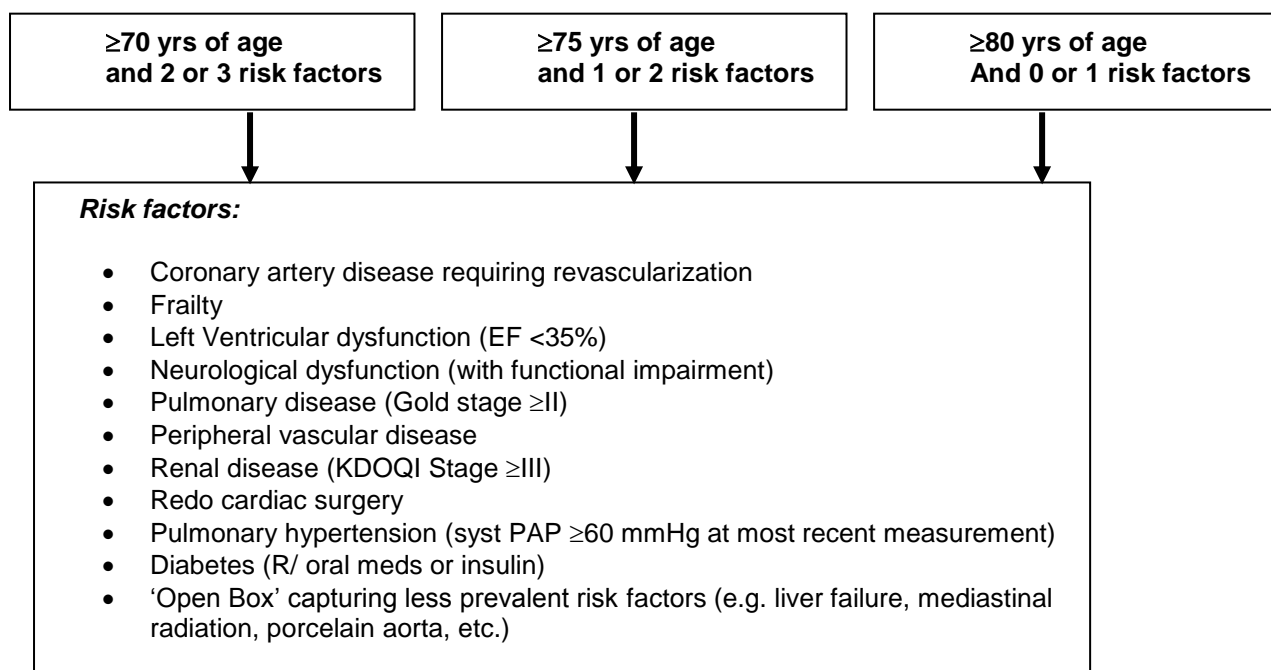

The above risk factors will guide the Heart Team in the selection of the treatment options but will not dictate patient allocation. The final decision treatment will be done by the local Heart Team.

1. **Significant concomitant Coronary Artery Disease:** defined as ≥70% stenosis by invasive coronary angiography because the combination of revascularization and aortic valve replacement reduces the rates of perioperative MI, perioperative mortality, late mortality and morbidity when compared with patients not undergoing simultaneous revascularization (ACC/AHA/ESC class IC recommendation)(6, 43, 44). Previous CABG or PCI is not considered to have considerable impact on short term outcome.
2. **Frailty:** in the absence of a generally accepted consensus definition Frailty is defined as suggested by Lee and co-workers by the presence of any 1 of the following⁽⁴⁰⁾:
 - Katz score(independence in Activities of Daily Living);
 - Ambulation (walking aid/assist?);
 - Diagnosis of (pre-)dementia.
3. **Left Ventricular dysfunction:** defined as EF < 35%, with respect to the pivotal position of this particular threshold in the heart failure population ⁽⁴⁵⁾.

4. Neurological dysfunction: Cerebro-Vascular Disease, documented by any one of the following: CVA (symptoms lasting >24 hours or imaging of an acute clinically relevant brain lesion in patients with rapidly vanishing symptoms); TIA (brief episode of neurological dysfunction caused by a focal disturbance of brain or retinal ischemia, with clinical symptoms with recovery within 24 hrs and without evidence of infarction); Non-invasive carotid test with > 60% diameter occlusion or prior carotid surgery or symptomatic carotid stenosis > 50%⁽⁴⁶⁻⁴⁹⁾. Does not include neurological disease processes such as metabolic and/or anoxic ischemic encephalopathy.
5. Pulmonary disease: COPD Gold Stage II: moderate COPD with worsening airflow limitation (FEV1/FVC <70%; 50% ≥ FEV1 <80% predicted), with shortness of breath typically developing on exertion⁽⁵⁰⁾.
6. Peripheral vascular disease: adapted from the STS risk model: Claudication, either with exertion or at rest; Amputation for arterial vascular insufficiency; Vascular reconstruction, bypass surgery, or percutaneous intervention to the extremities; Documented aortic aneurysm with or without repair; Positive non-invasive test (e.g., ankle brachial index ≤ 0.9, ultrasound, magnetic resonance or computed tomography imaging of > 50% diameter stenosis in any peripheral artery, i.e., renal, subclavian, femoral, iliac)
7. Renal disease: at least moderate chronic kidney disease with GFR < 60 mL/min according to the National Kidney Foundation kidney disease outcome quality initiative advisory board⁽⁵¹⁾.
8. Redo cardiac surgery
9. Pulmonary hypertension (> 60mmHg at most recent measurement)
10. Diabetes Mellitus on oral or insulin therapy.
11. OPEN BOX: e.g., extensive mediastinal radiation, chest wall deformity, Liver Failure Child-C

Patients available for screening

All patients

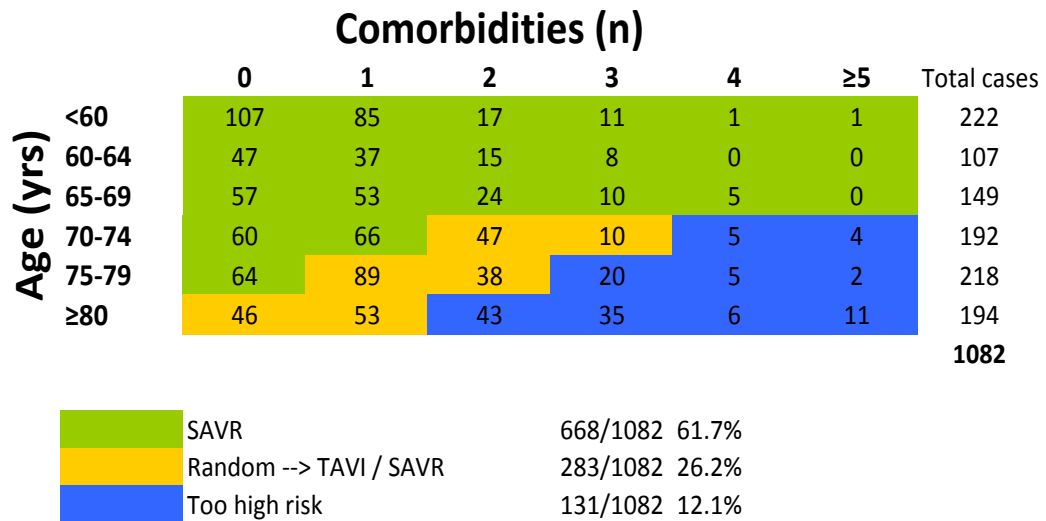

SAVR patients

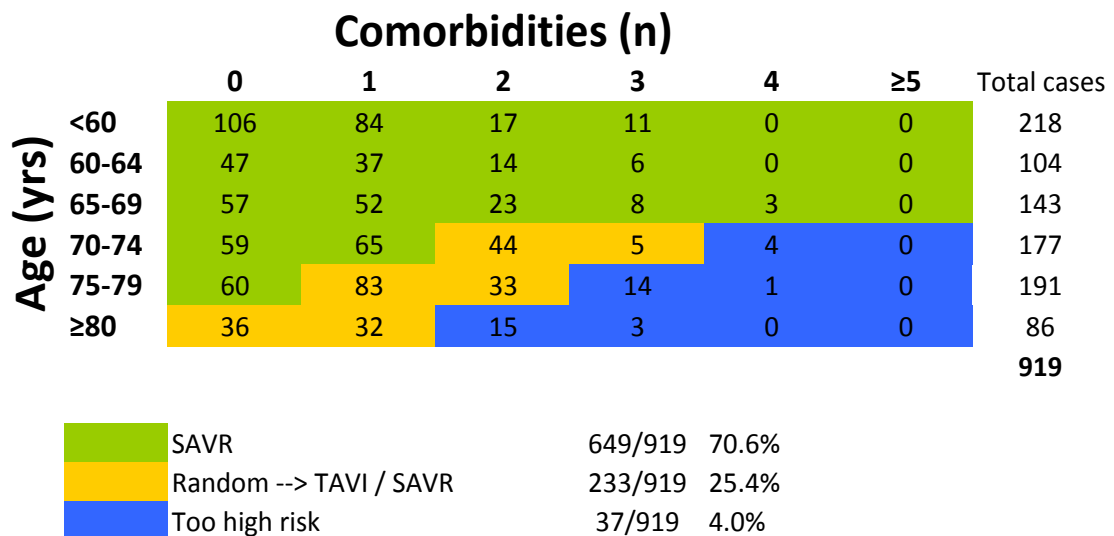

TAVI patients

		Comorbidities (n)						
		0	1	2	3	4	≥5	Total Cases
Age (yrs)	≤ 60	1	1	0	0	1	1	4
	60-64	0	0	1	2	0	0	3
	65-69	0	1	1	2	2	0	6
	70-74	1	1	3	5	1	4	15
	75-79	4	6	5	6	4	2	27
	≥ 80	10	21	28	32	6	11	108
							163	

	SAVR	19/163	11.7%
	Random --> TAVI / SAVR	50/163	30.7%
	Too high risk	94/163	57.7%

Distribution of age and comorbidities in patients with severe aortic stenosis in the Rotterdam practice. In each age group, patients are divided by the total number of comorbidities as previously defined.

Indicated in green are the patients that are too low risk for randomization (62%). Indicated by orange are patients that will be randomized in SURTAVI (26%). In blue are patients too high risk for randomization (12%). Therefore, it is estimated that every 1 in 4 patients meets the inclusion criteria for screening.

STS versus Euro Score

This table illustrates the relative impact of common co-morbidities in STS score (vertical axis) and Euroscore (horizontal axis) risk model. This present panel relates specifically of a male patient of 70 years old with 0, 1 or 2 risk factors.

The black line separates the score values of the two respective models: below the line relates to STS score, above to Euroscore.

The empty boxes indicate that the specific risk factor is not accounted for in the risk model, e.g. diabetes in Euroscore.

If this patient has no co-morbidity he would have an STS score of 0.9 and a Euroscore of 3 (see first square in upper left corner).

If this patient has a poor LVEF combined with peripheral vascular disease he would have a STS score of 1.5 and Euroscore of 15.5

Redo surgery is displayed as “first reoperation / second reoperation”, and COPD as “moderate / severe”. Values indicated as “score - score” correspond to the range of scores possible when combining all 4 risk factors (for instance ‘moderate COPD + 1st redo’ - ‘severe COPD + 2nd redo’)

DM = diabetes mellitus; PVD = peripheral vascular disease; CVD = cerebrovascular disease; LVEF = left ventricular ejection fraction; CAD = coronary artery disease; NYHA = New York Heart Association; COPD = chronic obstructive pulmonary disease; PH = pulmonary hypertension

		EUROSCORE												
		None	DM	PVD	CVD	Poor LVEF	CAD	NYHA III / IV	Redo Surgery	Renal Failure	COPD	Dialysis	PH	Neurologic Dysfunction
STS SCORE	None	0.9 3.0→	...	5.8	...	8.7	8.0	5.8	5.0	...	6.4	6.9
	DM	1.2	■
	PVD	1.2	1.5	■	...	15.5	14.3	10.5	9.1	...	11.7	12.5
	CVD	0.9	1.2	1.2	■
	Poor LVEF	1.2	1.5	1.5	1.2	■	20.6	15.4	13.5	...	17.0	18.1
	CAD	0.9	1.2	1.2	0.9	1.2	■
	NYHA III / IV	0.9 / 1.3	1.2 / 1.7	1.2 / 1.6	0.9 / 1.3	1.2 / 1.7	0.9 / 1.3	■
	Redo Surgery	1.5 / 1.8	1.9 / 2.2	1.9 / 2.2	1.5 / 1.8	2.0 / 2.3	1.5 / 1.8	1.5 - 2.5	■	14.3	12.4	...	15.7	16.8
	Renal Failure	1.8	2.3	2.2	1.8	2.3	1.8	1.8 / 2.5	2.9 / 3.4	■	9.1	...	11.6	12.4
	COPD	1.5 / 1.9	1.9 / 2.4	1.9 / 2.4	1.5 / 1.9	2.0 / 2.5	1.5 / 1.9	1.5 - 2.7	2.9 / 3.6	2.9 / 3.6	■	...	10.1	10.8
	Dialysis	2.9	3.6	3.5	2.9	3.7	2.9	2.9 / 4.0	4.6 / 5.3	2.9	4.5 / 5.7	■
	PH	■	13.7
	Neurologic Dysfunction	■

R.25 CMS Considerations for Coverage and Reimbursement – US ONLY

The SURTA VI protocol outlines the minimum requirements for trial participation, patient screening by the local Heart Team, and conduct of the TAVI procedure.

Within the United States, sites and Investigators should adhere to the following additional CMS requirements for coverage and reimbursementⁱ, as applicable to the Medicare patient population enrolled in the study:

Section C.4.2.1 Heart Team Composition

Local Heart Teams should be comprised of a multidisciplinary team qualified by education and experience to determine appropriate patient treatment.

Minimum Membership

- Interventional Cardiologist - ≥ 1 representative is required

-
- **Cardiac Surgeon - ≥ 2 representatives are required**

Recommended Membership

Additional members of the Heart Team should be included based on current standard practices and patient specific considerations, including but not limited to:

- Echocardiographer
- Anesthesiologist
- Cardiologist (general or referring physician)
- Geriatrician
- Neurologist or stroke specialist
- Radiologist or imaging specialist
- Heart Failure specialist
- Intesivist
- Nurse
- Social Worker

Section C.4.6.1 TAVI**TAVI Procedure**

- **Joint Participation**
 - The heart team's interventional cardiologist(s) and cardiac surgeon(s) must jointly participate in the intra-operative technical aspects of the TAVI procedure

i [http://www.cms.gov/medicare-coverage-database/details/nca-decision-memo.aspx?NCAId=257&ver=4&NcaName=Transcatheter+Aortic+Valve+Replacement+\(TAVR\)&bc=ACAAAAAAIAAA&](http://www.cms.gov/medicare-coverage-database/details/nca-decision-memo.aspx?NCAId=257&ver=4&NcaName=Transcatheter+Aortic+Valve+Replacement+(TAVR)&bc=ACAAAAAAIAAA&)

SURTA VI Trial – Clinical Investigation Plan Version Distribution

Version Date	Version	Description of Change	Rationale for Change	Geography Distribution
18-Nov-2011	3.0	Initial Release	NA	• Europe only
10-May-2012	4.0	<ul style="list-style-type: none"> • Inclusion/Exclusion Criteria updated • Device status updates: <ul style="list-style-type: none"> ○ Addition of 23mm PAV and applicable DCS ○ AOA CE mark status • Modification of statistical methods to relative risk design and addition of adaptive study design • Addition of Canada as a participating geography • Appendix updates: <ul style="list-style-type: none"> ○ Informed Consent templates ○ Clinical Assessments ○ Investigator Brochure ○ Instructions For Use ○ Radiation Exposure and Data Collection 	<ul style="list-style-type: none"> • Changes based on FDA pre-IDE feedback • Device status updates: <ul style="list-style-type: none"> ○ 23mm PAV and applicable DCS CE mark approval ○ AOA CE mark approval 	<ul style="list-style-type: none"> • Canada • Europe
23-Jul-2012	5.0	<ul style="list-style-type: none"> • Stroke classifications changed from major vs. minor to disabling vs. non-disabling • Inclusion/Exclusion Criteria updated • Additional neurological testing added (mRS) • Clarification of local Heart Team composition and decision making • Appendix updates: <ul style="list-style-type: none"> ○ CMS Requirements for Coverage and Reimbursement – US ONLY - <i>added</i> 	<ul style="list-style-type: none"> • Changes based on FDA IDE deficiencies • General updates and corrections 	<ul style="list-style-type: none"> • US only
07-Nov-2012	6.0	<ul style="list-style-type: none"> • Device status update – Canadian approval • Total number of investigational centers 	<ul style="list-style-type: none"> • Changes based on FDA recommendations • Publication of VARC-2 • General updates and 	<ul style="list-style-type: none"> • Canada • Europe • US – non-WIRB sites selected after

SURTA VI Trial – Clinical Investigation Plan Version Distribution

Version Date	Version	Description of Change	Rationale for Change	Geography Distribution
		<ul style="list-style-type: none"> increased • Inclusion criteria #3 updated • Roll-in subjects added • Definitions of terms updated in alignment with VARC-2 • Appendix updates: <ul style="list-style-type: none"> ○ Informed Consent templates ○ Echocardiography Acquisition Guidelines ○ Aortogram Acquisition Guidelines 	<ul style="list-style-type: none"> corrections 	<i>03-JAN-2013 only</i>
23-Jan-2013	7.0	<ul style="list-style-type: none"> • Device Description updated to include EnVeo™ DCS and next generation CLS • Appendix updates: <ul style="list-style-type: none"> ○ Informed Consent templates <ul style="list-style-type: none"> ▪ Europe ▪ Canada ▪ Canada, Roll-in ○ Echocardiography Acquisition Guidelines ○ Electrocardiogram (ECG) Submission 	<ul style="list-style-type: none"> • FDA IDE supplement to incorporate EnVeo/G5 and the next generation CLS in the United States • General updates and corrections 	<ul style="list-style-type: none"> • NA – OBSOLETE prior to distribution
10-Dec-2013	8.0	<ul style="list-style-type: none"> • Modification to Patient Population (re-defined Intermediate Risk) • Inclusion / Exclusion modifications and clarifications • Clarification of adverse event reporting requirements • All references to Percutaneous Aortic Valve (PAV) updated to Transcatheter Aortic Valve (TAV) • Addition of the next generation Compression Loading Systems • Appendix updates: <ul style="list-style-type: none"> ○ Informed Consent templates ○ Instructions for Use 	<ul style="list-style-type: none"> • General updates and corrections • Updated trial utilization of core laboratories 	<ul style="list-style-type: none"> • Canada • Europe

SURTA VI Trial – Clinical Investigation Plan Version Distribution

Version Date	Version	Description of Change	Rationale for Change	Geography Distribution
		<ul style="list-style-type: none"> ○ Investigator Brochure ○ Echocardiography Acquisition Guidelines ○ Electrocardiogram (ECG) Submission 		
08-May-2014	8.1	<ul style="list-style-type: none"> ● Inclusion criteria clarification 	<ul style="list-style-type: none"> ● Updated to include upper limit of risk classification 	<ul style="list-style-type: none"> ● US
14-Jan-2015	9.0	<ul style="list-style-type: none"> ● All references to Cardiovascular Department updated to Coronary and Structural Heart ● Addition of CoreValve Evolut R System ● All references to MCS TAVI updated to TAVI ● Appendix updates: <ul style="list-style-type: none"> ○ Informed Consent templates ○ Other Institutions ○ Instruction for Use ○ Investigator Brochure 	<ul style="list-style-type: none"> ● General updates and corrections ● Updated to include the use of CoreValve Evolut R System ● Updated change to Imaging Core Lab 	<ul style="list-style-type: none"> ● US
23-Mar-2015	10.0	<ul style="list-style-type: none"> ● Updated Device Approval Status ● Statistical Methods and Analysis: <ul style="list-style-type: none"> ○ Updated assumed event rates ○ Modified non-inferiority margin ○ Updated sample size look <ul style="list-style-type: none"> ▪ Updated maximum sample size from 3700 to 2000 ● Appendix updates: <ul style="list-style-type: none"> ○ Informed consent templates 	<ul style="list-style-type: none"> ● General updates and corrections ● Updated Statistical Methods and Analysis per agreement from FDA 	<ul style="list-style-type: none"> ● US
22-Nov-2015	11.0	<ul style="list-style-type: none"> ● Updated Device Approval Status ● Removed AR/AS/MR as SAEs in absence of clinical symptoms ● Statistical Methods and Analysis 	<ul style="list-style-type: none"> ● General updates and corrections ● Updated Statistical Methods and Analysis per agreement from FDA 	<ul style="list-style-type: none"> ● N/A – obsoleted prior to distribution
22-Nov-2015	11.1	<ul style="list-style-type: none"> ● All references to Cardiovascular Department 	<ul style="list-style-type: none"> ● General updates and corrections 	<ul style="list-style-type: none"> ● N/A – obsoleted prior to

SURTA VI Trial – Clinical Investigation Plan Version Distribution

Version Date	Version	Description of Change	Rationale for Change	Geography Distribution
		<ul style="list-style-type: none"> updated to Coronary and Structural Heart • All references to MCS TAVI updated to TAVI • Appendix updates: <ul style="list-style-type: none"> ○ Informed Consent templates ○ Other Institutions ○ Instruction for Use ○ Investigator Brochure • Updated Device Approval Status • Statistical Methods and Analysis: <ul style="list-style-type: none"> ○ Updated assumed event rates ○ Modified non-inferiority margin ○ Updated sample size look <ul style="list-style-type: none"> ▪ Updated maximum sample size from 3700 to 2000 • Appendix updates: <ul style="list-style-type: none"> ○ Informed consent templates • Updated Device Approval Status • Removed AR/AS/MR as SAEs in absence of clinical symptoms • Statistical Methods and Analysis 	<ul style="list-style-type: none"> • Updated change to Imaging Core Lab • General updates and corrections • Updated Statistical Methods and Analysis per agreement from FDA 	distribution
31-May-2016	12.0	<ul style="list-style-type: none"> • Updated Device Description • Removed moderate or severe mitral aortic regurgitation or stenosis as default SAEs in absence of clinical symptoms • Added section about Vigilance Reporting • Statistical Methods and Analysis • Investigational Device Accountability • Appendix Updates: <ul style="list-style-type: none"> ○ Informed consent 	<ul style="list-style-type: none"> • General updates and corrections • Updated Statistical Methods and Analysis 	<ul style="list-style-type: none"> • US only

SURTA VI Trial – Clinical Investigation Plan Version Distribution

Version Date	Version	Description of Change	Rationale for Change	Geography Distribution
		templates		
31-May-2016	12.1	<ul style="list-style-type: none"> • Updated Device Description • Removed moderate or severe mitral aortic regurgitation or stenosis as default SAEs in absence of clinical symptoms • Added section about Vigilance Reporting • Statistical Methods and Analysis • Investigational Device Accountability • Appendix Updates: <ul style="list-style-type: none"> ○ Informed consent templates 	<ul style="list-style-type: none"> • General updates and corrections • Updated Statistical Methods and Analysis 	<ul style="list-style-type: none"> • Canada • Europe
22-Nov-2015	Single Arm Addendum version 1.0	Initial release of addendum	N/A	<ul style="list-style-type: none"> • US only



SURTAVI

Surgical Replacement and Transcatheter Aortic Valve Iplantation

Clinical Investigation Plan

VERSION 12.1

31 May 2016

Sponsor:

Medtronic, Inc.
Clinical Research
Mailstop: MVS66
Mounds View South
8200 Coral Sea St NE
Mounds View, MN 55112 USA

Medtronic Bakken Research Center
Coronary and Structural Heart Department
Endepolsdomein 5
6229 GW Maastricht
The Netherlands

Contact Information Details*

Study Chair	<p>Prof. Patrick W. Serruys, MD, PhD (Study Chair) Professor of Medicine Erasmus Medical Center Dept. of Interventional Cardiology, Thoraxcenter P.O. Box 21253000 CC Rotterdam, The Netherlands</p> <p>Dr. Nicolas M. Van Mieghem, MD, PhD (Deputy Study Chair) Interventional Cardiologist Erasmus Medical Center Dept. of Interventional Cardiology, Thoraxcenter Room BD 171 's Gravendijkwal 230 3015 CE Rotterdam, The Netherlands</p>
Principal Investigators	<p>Prof. Stephan Windecker, MD, PhD Head of Interventional Cardiology Bern University Hospital Department of Cardiology Swiss Cardiovascular Center Bern Freiburgstrasse 4 CH-3010 Bern, Switzerland</p> <p>Prof. A. Pieter Kappetein, MD, PhD Cardio-Thoracic Surgeon Erasmus Medical Center Dept. of Thoracic Surgery Room BD 569 's Gravendijkwal 230 3015 CE Rotterdam, The Netherlands</p> <p>Prof. Rüdiger Lange, MD, PhD Direktor der Klinik für Herz- und Gefäßchirurgie Deutsches Herzzentrum München Lazarettstr. 36 80636 München, Germany</p> <p>Prof. Thomas Walther, MD, PhD Direktor der Abteilung Herzchirurgie Kerckhoff-Klinik Benekestr. 2-8 61231 Bad Nauheim; Germany</p> <p>Dr. Jeffrey J. Popma, MD Director, Interventional Cardiology Beth Israel Deaconess Medical Center 185 Pilgrim Rd. Boston, MA 02215 USA</p> <p>Dr. Michael J. Reardon, MD Professor, Cardiothoracic Surgery The Methodist Hospital 6550 Fannin St., Suite 1401 Houston, TX 77030 USA</p> <p>Dr. David H. Adams, MD Marie-Josée and Henry R. Kravis Professor and Chairman Department of Cardiothoracic Surgery The Mount Sinai Medical Center 1190 Fifth Avenue New York, NY 10029 USA</p>

Trial Oversight	<p>Mike Boulware Clinical Research Manager Medtronic Coronary and Structural Heart Phone: (763) 514.9826 Email: mike.j.boulware@medtronic.com</p> <p>Maarten Hollander – <i>EU</i> Clinical Research Manager Medtronic Bakken Research Center Phone: (+31-43) 3566864 Email: maarten.hollander@medtronic.com</p>
Sponsor	<p>Medtronic, Inc. Clinical Research Mailstop: MVS66 Mounds View South 8200 Coral Sea Street NE Mounds View, MN 55112 USA</p> <p>Medtronic Bakken Research Center Coronary and Structural Heart Department Endepolsdomein 5 6229 GW Maastricht The Netherlands</p>
Randomization System	Randomization (IXRS) information will be provided in the investigator site file

* Updated contact information will be provided as applicable. Additional information regarding contacts listed above available upon request.

CONFIDENTIAL and PROPRIETARY

This document contains confidential information and is solely the property of Medtronic, Inc. Acceptance of this document constitutes an agreement by the recipient that no unpublished information contained herein will be published or disclosed without the prior written approval of Medtronic, Inc. This document may be disclosed to the appropriate Institutional Review Board (IRB)/Ethics Committee (EC) with the stipulation that the IRB/EC treats the information contained herein as the confidential property of Medtronic, Inc.

TABLE OF CONTENTS

A	SYNOPSIS	8
B	PURPOSE	15
	B.1 Background	15
	B.2 Investigational Devices and Intended Use.....	17
	B.2.1 Device Description	17
	B.2.1.1 Medtronic CoreValve™ System	17
	B.2.2 Device Approval Status	18
	B.2.2.1 European Union	18
	B.2.2.2 United States	18
	B.2.2.3 Canada	18
	B.2.3 Intended Use of the Device / Indications for Use.....	19
	B.3 Trial Objectives	20
	B.3.1 Primary.....	20
	B.3.2 Secondary.....	20
	B.3.3 Exploratory.....	20
C	TRIAL PROTOCOL.....	21
	C.1 Ethics and Regulatory Compliance	21
	C.1.1 Applicable Regulations.....	21
	C.1.2 Institutional Review Board (IRB)/Medical Ethics Committee (MEC)	21
	C.1.3 Regulatory Submission	21
	C.1.4 Ethical Conduct of the Trial	22
	C.2 Trial Administration.....	22
	C.2.1 Steering Committee	22
	C.2.2 Publication Committee	22
	C.3 Methodology.....	23
	C.3.1 Purpose.....	23
	C.3.2 Patient Population	23
	C.3.3 Design.....	23
	C.3.4 Investigational Centers.....	23
	C.3.5 Number of Subjects.....	24
	C.3.6 Inclusion/Exclusion Criteria	24
	C.3.6.1 Inclusion Criteria	24
	C.3.6.2 Exclusion Criteria	24
	C.3.7 Informed Consent.....	27
	C.3.8 Revisions in Patient Information and Informed Consent Form.....	27
	C.3.9 Enrollment Flowchart for Randomization to TAVI or SAVR	28
	C.3.10 Trial Training.....	28
	C.4 Trial Procedures	29
	C.4.1 Screening Procedures.....	29
	C.4.2 Heart Team Procedures	31
	C.4.2.1 Heart Team Composition	31
	C.4.2.2 Heart Team Review and Decision.....	31
	C.4.3 Screening Committee.....	32
	C.4.4 Roll-in Subjects	32
	C.4.5 Enrollment and Randomization	32
	C.4.6 Baseline Assessments	33
	C.4.7 Transcatheter Aortic Valve Implant or Surgical Aortic Valve Replacement Procedure	34

C.4.7.1	TAVI.....	34
C.4.7.2	Surgical Aortic Valve Replacement.....	39
C.4.8	Assessments done at discharge (both SAVR and TAVI).....	43
C.4.9	Follow-Up Evaluations.....	44
C.4.9.1	30 Days	44
C.4.9.2	3 Months	45
C.4.9.3	6 Months	45
C.4.9.4	12 Months	45
C.4.9.5	18 Months	46
C.4.9.6	24 Months	46
C.4.9.7	3-5 Years	46
C.4.10	Echo Assessment	47
C.4.11	Neurologic Assessment	47
C.4.12	Angiographic and Computed Tomography Assessment	48
C.4.13	Data Collection	49
C.4.14	Unscheduled Follow-up Assessments	51
C.4.15	Missed Follow-up Visits	51
C.4.16	Investigational Product Accountability.....	51
C.4.17	Device Malfunction or Explant.....	51
C.4.18	Protocol Deviations	52
C.4.19	Subject Withdrawal or Discontinuation.....	53
C.4.20	Termination or Discontinuation of Trial.....	53
C.5	Adverse Events	54
C.5.1	Definitions	54
C.5.1.1	Adverse Event	54
C.5.1.2	Serious Adverse Event	54
C.5.1.3	Major Adverse Cardiovascular and Cerebrovascular Events	54
C.5.1.4	Major Adverse Event.....	55
C.5.1.5	Adverse Device Effect (ADE) or Device-Related Adverse Event.....	55
C.5.1.6	Serious Adverse Device Effects (SADEs)	55
C.5.1.7	Unanticipated Adverse Device Effect (UADE).....	55
C.5.1.8	Unanticipated Serious Adverse Device Effect (USADE)	56
C.5.1.9	Device Deficiency	56
C.5.1.10	Technical Observation	56
C.5.2	Reporting	56
C.5.2.1	Serious Adverse Events (SAEs)	56
C.5.2.2	Serious Adverse Device Effects.....	57
C.5.2.3	Unanticipated Adverse Device Effects (UADE or USADE).....	57
C.5.2.4	Device Deficiencies and Technical Observations.....	57
C.5.2.5	All Other Adverse Events	57
C.5.2.6	Anticipated Adverse Events	57
C.5.2.7	Deaths	59
C.5.2.8	Vigilance Reporting.....	59
C.5.3	Clinical Events Committee (CEC).....	59
C.5.4	Data Safety Monitoring Board (DSMB).....	59
C.6	Statistical Methods and Analysis	61
C.6.1	Statistical Considerations and Analysis.....	61
C.6.2	Reports	61
C.6.3	Description of Baseline Variables.....	61
C.6.4	Analysis Populations	61

C.6.4.1	Screening Population.....	61
C.6.4.2	Randomized Population.....	61
C.6.5	Primary Analysis	62
C.6.5.1	Hypothesis of Non-inferiority	62
C.6.5.2	Randomization, Sample Size and Analysis Plan.....	62
C.6.6	Missing Data and Planned Sensitivity Analyses (Primary Objective).....	63
C.6.7	Description of Performed Analysis, per population.....	63
C.6.7.1	Analysis of Screening Population.....	63
C.6.7.2	Analysis of ITT and mITT Populations	63
C.6.7.3	Analysis of Implanted Population	64
C.6.8	Secondary Endpoints	65
C.6.8.1	Secondary Endpoints Compared Between TAVI and SAVR.....	65
C.6.8.2	Secondary Endpoints Assessed for TAVI Only	69
C.6.9	Rationale for Selection of Trial Endpoints.....	69
C.6.10	Multiplicity Considerations.....	69
C.6.10.1	Secondary Endpoints Tested to Support Labeling Claims	70
C.6.11	Heterogeneity/Poolability	73
C.6.12	Additional Analysis.....	73
C.6.12.1	Pre-Defined Subgroups	73
C.6.12.2	Analysis of VARC Endpoints and Definitions	73
C.6.13	Health-Related Quality of Life (HRQoL) and Treatment Costs	74
C.6.13.1	Quality of Life.....	74
C.6.13.2	Economic Outcomes/Cost-Effectiveness	74
C.6.14	Use of Data for CE Mark.....	74
C.7	Data and Quality Management.....	75
C.7.1	Electronic Data Capture	75
C.7.2	Data Collection.....	75
C.7.3	Core Laboratories Procedures	75
C.7.4	Source Documents.....	75
C.7.5	Maintenance and Calibration.....	75
C.8	Records and Reports	76
C.8.1	Responsibilities of the Sponsor	76
C.8.2	Responsibilities of the Investigator	77
D	RISK / BENEFIT ANALYSIS	79
D.1	Methods to Minimize Risk	80
D.2	Potential Benefits	80
E	DESCRIPTION OF MEDTRONIC COREVALVE™ SYSTEM	81
E.1	Investigational Product Description	81
E.1.1	Medtronic CoreValve System.....	81
E.2	Investigational Device Ordering, Storage, and Disposition	85
F	MONITORING AND AUDITING	85
F.1	Monitoring	85
F.2	Auditing	85
G	LABELING.....	87
H	CONSENT MATERIALS	87
I	IRB/MEC INFORMATION	87
J	OTHER INSTITUTIONS	87
K	ADDITIONAL RECORDS AND REPORTS	87

L	REPORT OF PRIOR INVESTIGATIONS	87
M	PUBLICATION POLICY	88
N	AMENDMENTS TO THE CLINICAL INVESTIGATION PLAN	89
O	ABBREVIATIONS AND DEFINITIONS	91
	O.1 List of Abbreviations	91
	O.2 Definitions of Terms	94
P	TRIAL MANAGEMENT	111
	P.1 Miscellaneous	111
	P.1.1 Insurance	111
	P.1.2 Reimbursement.....	111
	P.1.3 Indemnification.....	111
	P.1.4 Subject confidentiality.....	111
Q	REFERENCES	112
R	APPENDICIES	118
	R.1 Sample Informed Consent	
	R.2 List of Participating Investigational Centers	
	R.3 Other Institutions	
	R.4 Additional Records and Reports	
	R.5 Sample Case Report Forms	
	R.6 Aortogram Acquisition Guidelines	
	R.7 Echocardiography Acquisition Guidelines	
	R.8 Electrocardiogram (ECG) Submission	
	R.9 Computed Tomography (CT) Angiography Acquisition Guidelines	
	R.10 Interactive Voice/Web Response System (IXRS)	
	R.11 Explanted Device/Pathology and Return Procedures	
	R.12 Economic and Quality of Life Data Collection	
	R.13 Pacing Guidelines	
	R.14 Six Minute Walk Test Instructions	
	R.15 National Institute of Health Stroke Scale (NIHSS)	
	R.16 Modified Rankin Scale (mRS) Instructions	
	R.17 Mini Mental State Exam (MMSE-2:SV)	
	R.18 Additional Neurological Assessments	
	R.19 Medtronic CoreValve™ Clinical Assessment Guidelines	
	R.20 Katz Index of Independence in Activities of Daily Living	
	R.21 Investigator Brochure / Report of Prior Investigations	
	R.22 Instructions For Use	
	R.23 Radiation Exposure and Data Collection	
	R.24 SURTAVI Risk Model	
	R.25 CMS Requirements for Coverage and Reimbursement – US ONLY	

A SYNOPSIS

Title of Trial:	Surgical Replacement and Transcatheter Aortic Valve Implantation (SURTAVI)
Name of Product:	Medtronic CoreValve™ System
Purpose:	The purpose of this trial is to investigate the safety and efficacy of transcatheter aortic valve implantation (TAVI) in patients with severe, symptomatic Aortic Stenosis (AS) at intermediate surgical risk by randomizing patients to either Surgical Aortic Valve Replacement (SAVR) or TAVI.
Design:	Subjects will be randomized on a 1:1 basis to either transcatheter aortic valve implant (TAVI) or to surgical aortic valve replacement (SAVR)
Primary Objective:	The primary objective of this trial is to evaluate in a prospective randomized fashion whether TAVI is non-inferior to SAVR with respect to composite endpoint of all-cause mortality and disabling stroke at 24 months in patients with symptomatic severe aortic stenosis and at intermediate surgical risk.
Secondary Objective:	The secondary objective of this trial is to assess differences in quality of life, clinical benefit (efficacy endpoints) and health economics in patients with symptomatic severe aortic stenosis and at intermediate risk treated with either Transcatheter Aortic Valve Implantation (TAVI) or Surgical Aortic Valve Replacement (SAVR).
Exploratory Objective:	An analysis will be conducted to determine if patients can be identified as intermediate risk for Transcatheter Aortic Valve Implantation (TAVI) based upon age and the presence of a defined list of co-morbidities commonly associated with patients undergoing TAVI procedures.
Primary Endpoint:	All-cause mortality or disabling stroke at 24 months
Secondary Endpoints:	<p>The following secondary endpoints will be compared between TAVI and SAVR subjects cohorts:</p> <ol style="list-style-type: none"> 1. Incidence of Major Adverse Cardiovascular and Cerebrovascular Events (MACCE)- at 30 days, 6 months, 12 months, 18 months, 24 months, and annually thereafter up to 5 years. MACCE is defined as a composite of: <ul style="list-style-type: none"> • All-cause death • Myocardial infarction (MI) • All stroke, and • Reintervention (defined as any cardiac surgery or percutaneous reintervention catheter procedure that repairs, otherwise alters or adjusts, or replaces a previously implanted valve) 2. The occurrence of individual MACCE components at 30 days, 6 months, 12 months, 18 months, 24 months, and annually thereafter up to 5 years. 3. Major Adverse Events (MAE) and individual components at 30 days, 6 months, 12 months, 18 months, 24 months, and annually thereafter up to 5 years.

	<p>4. Incidence of Early safety at 30 days defined as a composite of:</p> <ul style="list-style-type: none"> • All-cause mortality • All stroke (disabling and non-disabling) • Life-threatening bleeding • Acute kidney injury—Stage 2 or 3 (including renal replacement therapy) • Coronary artery obstruction requiring intervention • Major vascular complication • Valve-related dysfunction requiring repeat procedure (BAV, TAVI, or SAVR) • All-cause death <p>Early safety composite endpoint-incidence estimates will be provided for the two treatment groups at 30 days.</p> <p>5. Incidence of Clinical Efficacy (after 30 days) at 6 months, 12 months, 18 months, 24 months and annually thereafter up to 5 years. Clinical efficacy defined as a composite of:</p> <ul style="list-style-type: none"> • All-cause mortality • All stroke (disabling and non-disabling) • Requiring hospitalizations for valve-related symptoms or worsening congestive heart failure • NYHA class III or IV • Valve-related dysfunction (mean aortic valve gradient ≥ 20 mmHg, effective orifice area (EOA) $\leq 0.9-1.1$ cm² and/or doppler velocity index (DVI) < 0.35 m/s, AND/OR moderate or severe prosthetic valve regurgitation) <p>Clinical efficacy estimates will be provided for the two treatment groups at 6 months, 12 months, 18 months, 24 months and annually thereafter up to 5 years.</p> <p>6. Incidence of Time-Related Safety at 30 days, 6 months, 12 months, 18 months, 24 months and annually thereafter up to 5 years. Time-Related Safety defined as a composite of:</p> <ul style="list-style-type: none"> • Structural valve deterioration: <ul style="list-style-type: none"> ○ Valve-related dysfunction (mean aortic valve gradient ≥ 20 mmHg, EOA $\leq 0.9-1.1$ cm² and/or DVI < 0.35 m/s, AND/OR moderate or severe prosthetic valve regurgitation) ○ Requiring repeat procedure (TAVI or SAVR) • Prosthetic valve endocarditis • Prosthetic valve thrombosis • Thromboembolic events (eg. stroke) • VARC bleeding, unless clearly unrelated to valve therapy (eg. trauma) <p>Time related safety composite endpoint-incidence estimates will be provided for the two treatment groups at 30 days, 6 months, 12 months, 18 months, 24 months and annually thereafter up to 5 years.</p> <p>7. Conduction disturbance requiring permanent pacemaker implantation at 30 days, 6 months, 12 months, 18 months, 24 months, and annually thereafter up to 5 years.</p> <p>8. Change in NYHA class from baseline at 30 days, 6 months, 12 months, 18 months, 24 months, and</p>
--	--

	<p>annually thereafter up to 5 years.</p> <p>9. Change in distance walked during 6-minute walk test (6MWT) from baseline to 30 days, baseline to 12 months, and baseline to 24 months.</p> <p>10. Ratio of days alive out of hospital versus total days alive assessed at 12 months and 24 months follow-up.</p> <p>11. Quality of Life (QoL) change from baseline at 30 days, 3 months, 6 months, 12 months, 18 months, 24 months, and annually thereafter up to 5 years.</p> <p>12. Echocardiographic assessment of prosthetic valve performance at discharge, 6 months, 12 months, 24 months, and annually thereafter up to 5 years using the following measures:</p> <ul style="list-style-type: none"> • Transvalvular mean gradient • Effective orifice area • Degree of prosthetic aortic valve regurgitation (transvalvular and paravalvular). <p>13. Aortic valve disease related hospitalizations.</p> <p>14. Cardiovascular deaths and valve-related deaths.</p> <p>15. Strokes and TIAs.</p> <p>16. Peri-procedural neurological injury.</p> <p>17. Index procedure related MAEs.</p> <p>18. Length of index procedure hospital stay.</p> <p>19. Presence of atrial fibrillation at post-procedure, discharge, 30 days, 6 months, 12 months, 18 months, 24 months, and annually thereafter up to 5 years.</p> <p>The following secondary endpoints will be assessed for the TAVI cohort subjects only:</p> <p>20. Device success defined as follows:</p> <ul style="list-style-type: none"> • Absence of procedural mortality AND • Correct positioning of a single prosthetic heart valve into the proper anatomical location AND • Intended performance of the prosthetic heart valve (no prosthesis-patient mismatch and mean aortic valve gradient <20 mmHg or peak velocity <3 m/s, AND no moderate or severe prosthetic valve regurgitation) <ul style="list-style-type: none"> ○ Assessed acutely in resting state, either within 24-48 hours after the index procedure or before hospital discharge <p>21. Procedural success, defined as device success and absence of in-hospital MACCE.</p> <p>22. Evidence of prosthetic valve dysfunction at 30 days, 6 months, 12 months, 24 months, and annually thereafter up to 5 years.</p>
--	--

Trial Sites:	Up to 115 sites globally
Sample Size:	Approximately 1600 patients
Patient Population:	Patients who have symptomatic severe Aortic Stenosis who are determined by the Heart Team to be at intermediate surgical risk.
Inclusion Criteria:	<ol style="list-style-type: none"> 1. Subject must have co-morbidities such that Heart Team agrees predicted risk of operative mortality is $\geq 3\%$ and $< 15\%$ at 30 days (Intermediate Clinical Risk classification). Heart team evaluation of clinical surgical mortality risk for each patient includes the calculated STS score for predicted risk of surgical mortality augmented by consideration of the overall clinical status and co-morbidities unmeasured by the STS risk calculation; 2. Heart Team unanimously agree on treatment proposal and eligibility for randomization based on their clinical judgment (including anatomy assessment, risk factors, etc.); 3. Subject has severe aortic valve stenosis presenting with <ol style="list-style-type: none"> a) Critical aortic valve area defined as an initial aortic valve area of $\leq 1.0 \text{ cm}^2$ or aortic valve area index $< 0.6 \text{ cm}^2/\text{m}^2$ <p style="text-align: center;">AND</p> <ol style="list-style-type: none"> b) Mean gradient $> 40\text{mmHg}$ or $V_{\text{max}} > 4\text{m/sec}$ by resting echocardiogram or simultaneous pressure recordings at cardiac catheterization [or with dobutamine stress, if subject has a left ventricular ejection fraction (LVEF) $< 55\%$] or velocity ratio < 0.25; 4. Subject is symptomatic from his/her aortic valve stenosis, as demonstrated by New York Heart Association (NYHA) Functional Class II or greater; 5. Subject and the treating physician agree that the subject will return for all required post-procedure follow-up visits; 6. Subject meets the legal minimum age to provide informed consent based on local regulatory requirements.

Exclusion Criteria:	<ol style="list-style-type: none"> 1. Subject has refused surgical aortic valve replacement (SAVR) as a treatment option; 2. Any condition considered a contraindication for placement of a bioprosthetic valve (i.e. subject requires a mechanical valve); 3. A known hypersensitivity or contraindication to all anticoagulation/antiplatelet regimens (including inability to be anticoagulated for the index procedure), nitinol, or sensitivity to contrast media which cannot be adequately pre-medicated; 4. Blood dyscrasias as defined: leukopenia (WBC <1000mm³), thrombocytopenia (platelet count <50,000 cells/mm³), history of bleeding diathesis or coagulopathy; 5. Ongoing sepsis, including active endocarditis; 6. Any condition considered a contraindication to extracorporeal assistance; 7. Any percutaneous coronary or peripheral interventional procedure performed within 30 days prior to randomization (Subjects with recent placement of drug eluting stent(s) should be assessed for ability to safely proceed with SAVR within the protocol timeframe); 8. Symptomatic carotid or vertebral artery disease or successful treatment of carotid stenosis within six weeks of randomization; 9. Cardiogenic shock manifested by low cardiac output, vasopressor dependence, or mechanical hemodynamic support; 10. Recent (within 6 months of randomization) cerebrovascular accident (CVA) or transient ischemic attack (TIA); 11. Active gastrointestinal (GI) bleeding that would preclude anticoagulation; 12. Subject refuses a blood transfusion; 13. Severe dementia (resulting in either inability to provide informed consent for the trial/procedure, prevents independent lifestyle outside of a chronic care facility, or will fundamentally complicate rehabilitation from the procedure or compliance with follow-up visits); 14. Multivessel coronary artery disease with a Syntax score >22 and/or unprotected left main coronary artery (Syntax score calculation is not required for patients with history of previous revascularization if repeat revascularization is not planned); 15. Estimated life expectancy of less than 24 months due to associated non-cardiac co-morbid conditions; 16. Other medical, social, or psychological conditions that in the opinion of the Investigator precludes the subject from appropriate consent or adherence to the protocol required follow-up exams; 17. Currently participating in an investigational drug or another device trial (excluding registries);
---------------------	--

	<p>18. Evidence of an acute myocardial infarction ≤ 30 days before the index procedure;</p> <p>19. Need for emergency surgery for any reason;</p> <p>20. True porcelain aorta (i.e. Heart Team agrees the aorta is not clampable for SAVR);</p> <p>21. Extensive mediastinal radiation;</p> <p>22. Liver failure (Child-C);</p> <p>23. Reduced ventricular function with left ventricular ejection fraction (LVEF) $< 20\%$ as measured by resting echocardiogram;</p> <p>24. Uncontrolled atrial fibrillation (eg. resting heart rate > 120bpm);</p> <p>25. Pregnancy or intent to become pregnant prior to completion of all protocol follow-up requirements;</p> <p>26. End stage renal disease requiring chronic dialysis or creatinine clearance < 20 cc/min;</p> <p>27. Pulmonary Hypertension (systolic pressure > 80mmHg);</p> <p>28. Severe Chronic Obstructive Pulmonary Disease (COPD) demonstrated by Forced Expiratory Volume (FEV1) < 750cc;</p> <p>29. Frailty assessments identify:</p> <ul style="list-style-type: none"> • Subject is < 80 years of age and three or more of the following apply • Subject is ≥ 80 years of age and two or more of the following apply <ul style="list-style-type: none"> ○ Wheelchair bound ○ Resides in an institutional care facility (eg. nursing home, skilled care center) ○ Body Mass Index < 20kg/m² ○ Grip strength < 16kg ○ Katz Index score ≤ 4 ○ Albumin < 3.5 g/dL. <p>30. Marfan syndrome or other known connective tissue disease that would necessitate aortic root replacement/intervention.</p>
--	---

	<p>Anatomical Exclusion Criteria</p> <p>31. Native aortic annulus size <18 mm or >29 mm per the baseline diagnostic imaging;</p> <p>32. Pre-existing prosthetic heart valve in any position;</p> <p>33. Mixed aortic valve disease [aortic stenosis and aortic regurgitation with predominant aortic regurgitation (3-4+)];</p> <p>34. Severe mitral or severe tricuspid regurgitation;</p> <p>35. Severe mitral stenosis;</p> <p>36. Hypertrophic obstructive cardiomyopathy;</p> <p>37. Echocardiographic or Multislice Computed Tomography (MSCT) evidence of new or untreated intracardiac mass, thrombus or vegetation;</p> <p>38. Ascending aorta diameter greater than maximum diameter relative to the native aortic annulus size:</p> <table border="1" style="margin-left: auto; margin-right: auto;"> <thead> <tr> <th style="text-align: center;">Aortic Annulus Diameter</th> <th style="text-align: center;">Ascending Aorta Diameter</th> </tr> </thead> <tbody> <tr> <td style="text-align: center;">18 mm – 20 mm</td> <td style="text-align: center;">>34 mm</td> </tr> <tr> <td style="text-align: center;">20 mm – 23 mm</td> <td style="text-align: center;">>40 mm</td> </tr> <tr> <td style="text-align: center;">23 mm – 29 mm</td> <td style="text-align: center;">>43 mm</td> </tr> </tbody> </table> <p>39. Aortic root angulation (angle between plane of aortic valve annulus and horizontal plane/vertebrae)</p> <p style="margin-left: 20px;">a) Femoral and left subclavian/axillary access > 70°</p> <p style="text-align: center;">OR</p> <p style="margin-left: 20px;">b) Right subclavian/axillary access: Aortic root angulation > 30°;</p> <p>40. Congenital bicuspid or unicuspid valve verified by echocardiography;</p> <p>41. Sinus of Valsalva anatomy that would prevent adequate coronary perfusion.</p> <p>Vascular Exclusion Criteria</p> <p>42. Transarterial access not able to accommodate an 18Fr sheath.</p>	Aortic Annulus Diameter	Ascending Aorta Diameter	18 mm – 20 mm	>34 mm	20 mm – 23 mm	>40 mm	23 mm – 29 mm	>43 mm
Aortic Annulus Diameter	Ascending Aorta Diameter								
18 mm – 20 mm	>34 mm								
20 mm – 23 mm	>40 mm								
23 mm – 29 mm	>43 mm								
Enrollment Phase:	36 months								
Follow-up Evaluations:	Subjects will be followed through 5 years with assessments at 30 days, 3 months, 6 months, 12 months, 18 months, 24 months, and 3, 4, and 5 years post TAVI or post SAVR. The total trial duration is expected to be approximately 7 years.								

B PURPOSE

B.1 Background

Aortic valve stenosis (AS) is the most prevalent valve disorder in the adult population in developed countries affecting approximately 2% to 4% of people over 65 years of age (2, 3). This corresponds to approximately 3 million people with AS in Europe and approximately 1.5 million in the United States. One in five will eventually progress to symptomatic AS representing more than 900,000 patients in these two geographies.

Patients with severe AS face a grim prognosis once they become symptomatic. The landmark paper on symptomatic AS by Ross and Braunwald in 1968 highlighted this premise: median survival averages only 2, 3 and 5 years after symptom onset of angina, syncope and heart failure respectively(4). Furthermore mortality is already substantial in the months following the first symptoms (5). The dismal prognosis of patients with untreated severe, symptomatic aortic stenosis has been recently corroborated in the conservative treatment arm of the PARTNER B cohort. Both, the ESC and ACC/AHA cardiology societies have endorsed guidelines on valvular heart disease emphasizing the need for surgical aortic valve replacement (SAVR) once symptoms develop or in case of impaired LV function (Level of evidence grade 1)(6, 7, 8).

Physicians' preferences for lesser invasive strategies have fuelled the ongoing interest in developing minimally invasive transcatheter therapies. Alain Cribier pioneered the transcatheter aortic valve implantation (TAVI) technology and reported the first-in-man experience of TAVI in a patient with symptomatic AS who was deemed inoperable in 2002(10). Subsequent feasibility studies validated the proof of concept (11, 12). The Edwards-SAPIEN valve (Edwards Lifesciences, Irvine, CA, USA) and the Medtronic CoreValve system (Medtronic Corporation, Minneapolis, MN, USA) were the first two TAVI platforms with CE mark approval, followed by the Symetis Acurate (Symetis, Ecublens, Switzerland) and JenaValve (JenaValve, Munich, Germany). Numerous single-center and multi-center observational registries followed suggesting the safety and performance of the TAVI technology (13-17). The TAVI technology comes with its own specific complications (18), not necessarily overlapping with those of SAVR: vascular injury; stroke, cardiac injury such as heart block, coronary obstruction, and cardiac perforation; paravalvular leak; and valve misplacement. The non-uniformity in presenting respective data makes a comparison of results from different centers challenging (19, 20). The Valvular Academic Research Consortium (VARC), a FDA-endorsed collaboration between academic research organizations and professional societies in the United States and Europe is an initiative to generate a consensus statement on TAVI related definitions aiming to create order and uniformity making data more prone to analysis and comparison (21, 22).

Technical refinements and commercial entrepreneurship have made the technology accessible to many centers worldwide. This might pose future implications since few randomized trials with TAVI have been performed.

There are three types of medical practices. The first is the institution with on-site interventional cardiologic and cardiothoracic surgical activity and with close inter-disciplinary collaboration, where interventional cardiologists and cardiothoracic surgeons reach a consensus on which patients to select for a specific surgical or interventional treatment strategy (9). These centers would reasonably respect and adhere to CE mark labeling indications. Second, there are centers where interventional cardiologists and cardiothoracic surgeons do not often convene, and usually work as two separate departments. Finally, there are practices with an interventional cardiology program but without on-site cardiothoracic surgery, estimated to make up 37% of all PCI centers in the European Union. Expectedly, these kinds of organizations without intimate collaboration between cardiothoracic surgeons and interventional cardiologists will look to broaden their interventional activities with an attractive innovation like TAVI. A worldwide practice that is less controlled would potentially cloud the safety and efficacy profile of the procedure. This criticism by the medical community and health authorities could jeopardize future reimbursement policies (23, 24). The advent of randomized trial data is crucial and this next step in establishing a new treatment strategy should not be taken for granted as governmental authorities entitled to grant premarket approval to cardiovascular devices are under increased scrutiny and quality control (25).

After nearly a decade of worldwide mounting TAVI experience, the Cohort B arm of the much-anticipated PARTNER (Placement of AoRTic TraNscathetER Valve Trial) trial representing the first randomized data set, reported a dramatic 20% absolute reduction in mortality in favor of

TAVI compared to medical therapy in patients who, as determined by surgeons could not undergo conventional surgical valve replacement (26).

In the Cohort A of the PARTNER trial, patients for whom a surgeon and cardiologist concurred that the predicted risk of operative mortality was $\geq 15\%$ and/or with a minimum STS score of 10 were randomized to TAVI or SAVR. The trial completed its randomization in early 2009 and first data were presented at ACC in April 2011, reporting successful achievement of the primary endpoint (TAVR was non-inferior to AVR for all-cause mortality at 1 year).

At the PCR London Valves meeting in October 2010, it was reported that over 22000 patients had been treated with TAVI worldwide. To date over 45,000 Medtronic CoreValve System have been implanted worldwide (data on file with Medtronic). Inevitably, with increased operator experience and access to the device, physicians will shift their attention to younger patients with a less pronounced operative risk due to the decreased invasiveness of the TAVI procedure as compared with SAVR, coupled with the safety and performance observed in the PARTNER trial and other literature reports in the extreme and high risk populations. Similar to the coronary revascularization arena (27), the blending of surgical and interventional expertise has created unique interdisciplinary dynamics paving the way for a randomized trial comparing TAVI with SAVR in a surgical intermediate risk patient population.

It is in this spirit that the SURTAVI trial (SURgical and Transcatheter Aortic Valve Implantation) was conceived. The interdisciplinary approach and consensus of the Heart Team (the cardiothoracic surgeon, interventional cardiologist and other treating physicians if necessary) is crucial. This aspect of decision making cannot be over-emphasized and is essential for the quality of current medical practice in general and any planned randomized trial of TAVI versus SAVR in particular. The VARC publication (21, 22) on TAVI definitions and the accumulating TAVI expertise in Europe has created a unique momentum for such a randomized initiative complementary to the US Pivotal IDE randomized trial in AS patients with high operative risk.

For a new technology to be accepted as a new asset for treating symptomatic AS several essential questions need to be answered: is the technology effective? Which patients are likely to benefit (patient selection)? How does this new strategy compare with the alternatives? And what is the cost of the intervention relative to alternatives? The proof of concept has been validated. The innovative and less invasive transcatheter approach should be at least as effective and safe as conventional SAVR or have proof of superiority for both safety and efficacy compared to medical therapy.

The theoretical benefits of this transcatheter approach seem evident by avoiding the need of musculoskeletal incisions, cardioplegic arrest, aortic cross clamping, aortotomy, and full cardiopulmonary bypass. Ultimately the cost-effectiveness will determine whether the new treatment strategy is a valid option to be considered for reimbursement by governmental health institutions.

B.2 Investigational Devices and Intended Use

B.2.1 Device Description

B.2.1.1 Medtronic CoreValve™ System

The Medtronic CoreValve™ System consists of the following product elements:

- Transcatheter Aortic Valve Bioprosthesis (TAV): consisting of a multi-level self-expanding frame with porcine pericardial bioprosthesis. The bioprosthesis is processed with an anti-mineralization treatment of alpha-amino oleic acid (AOA) a compound derived from oleic acid, a naturally occurring long-chain fatty acid.
- Delivery Catheter System (DCS): designed to house the tissue valve prosthesis in the collapsed position for transcatheter delivery to the patient's aortic annulus.
- Compression Loading System (CLS): facilitates consistent and trauma-free manual loading of the TAV into the DCS.

The models to be used are:

- Transcatheter Aortic Valve Prosthesis (TAV) - Models MCS-P4-23-AOA, MCS-P4-23-AOA-US (23mm), MCS-P3-26-AOA, MCS-P3-26-AOA-US (26mm), MCS-P3-29-AOA, MCS-P3-29-AOA-US (29mm), and MCS-P3-31-AOA, MCS-P3-31-AOA-US (31mm)
- Delivery Catheter System (DCS) – AccuTrak®: DCS-C4-18FR, DCS-C4-18F-US, DCS-C4-18FR-23MM (US), and DCS-C4-18FR-23 (OUS)
- Compression Loading System (CLS) - Model CLS-3000-18FR, CLS4-18F, CLS-3000-18FR-US, and CLS4-18F-23

In the US, commercial devices, as referenced in the sections above and in Table 1, are approved for use in the clinical trial, as necessary, in the event that an investigational device is not available.

Also, any future approved (i.e. CE marked) models or device iterations may be used in the trial.

The TAV is adapted to a range of aortic annulus and ascending aorta diameters as shown in **Table 1**.

Table 1: Patient Anatomical Diameters

CoreValve™ Evolut™ Bioprosthesis		
Model	Aortic Annulus Diameter (range in mm)	Aortic Diameter at the Sino-tubular Junction (range in mm)
MCS-P4-23-AOA MCS-P4-23-AOA-US	18-20	≤34
CoreValve™ Bioprosthesis		
Model	Aortic Annulus Diameter (range in mm)	Aortic Diameter at the Sino-tubular Junction (range in mm)
MCS-P3-26-AOA MCS-P3-26-AOA-US	20-23	≤40
MCS-P3-29-AOA MCS-P3-29-AOA-US	23-27	≤43
MCS-P3-31-AOA MCS-P3-31-AOA-US	26-29	≤43

B.2.2 Device Approval Status

The approval status of the Medtronic CoreValve™ System is outlined in **Table 2** below. This table presents the current approval status for the CoreValve System where the clinical trial is conducted.

Table 2: Device Approval Status

Device Approval Status	United States	European Union	Canada
Medtronic CoreValve™ System			
TAV	Market Released	Market Released	26mm, 29mm, and 31mm - Market Released 23mm - Investigational
DCS	Market Released	Market Released	Market Released
CLS	Market Released	Market Released	Market Released

B.2.2.1 European Union

CoreValve

The notified body granted an approval for CE Marking for the 18Fr CoreValve ReValving™ System (renamed to “Medtronic CoreValve System” after acquisition from CoreValve Inc. by Medtronic Inc. on 9 April 2009) effective March 1, 2007. Model MCS-P3-640 (26mm) and MCS-P3-943 (29mm) received CE mark effective 2006) and MCS-P3-943 (31mm) received CE marked in July 2011. AOA treated valves (26mm, 29mm, and 31mm) received CE mark in March 2012. The AOA treated 23mm valve (MCS-P4-23-AOA) received CE mark in May 2012 (marketed as CoreValve™ Evolut™). The models to be used in this trial, listed in **Table 1**, are identical to the CE marked devices. The devices used in this trial will be used outside the current approved indication. The Medtronic CoreValve System is still under investigation for the intermediate risk indication.

The Delivery Catheter System (DCS) with AccuTrak® Stability Layer was designed to optimize the valve positioning and will be used in this trial. CE mark approval was received in July 2010. The Delivery System for 23mm TAV (DCS-C4-18FR-23) has a shortened capsule and plunger to house and deliver the 23 mm TAV. The DCS and CLS components used for this trial are the CE marked product.

B.2.2.2 United States

CoreValve

Medtronic submitted an Original IDE (G100012) to seek approval to initiate an Investigational Device Exemption for the Medtronic CoreValve System (size 26mm and 29mm). This trial was intended for use in subjects with severe symptomatic Aortic Stenosis (AS) necessitating aortic valve replacement in Extreme Risk and High Risk Patient Populations. This IDE was conditionally approved on October 13, 2010 and received full approval on November 10, 2011. Medtronic added an additional 31mm TAV size to the IDE via G100012/S24 followed by 23mm TAV via G100012/S31.

The FDA granted marketing approval of CoreValve for Extreme Risk patients on January 17, 2014 and High Risk patients on June 12, 2014. The devices used in this trial will be used outside the current approved indication. The models to be used in this trial, listed in **Table 1**, are identical to the FDA approved devices. FDA granted approval for the use of commercially labeled devices in the trial on August 6, 2014. The devices used in this trial will be used outside the current approved indication. The Medtronic CoreValve System is still under investigation for the intermediate risk indication.

B.2.2.3 Canada

CoreValve

The commercial application for the Medtronic CoreValve System (26mm and 29mm) was approved by Health Canada on August 2, 2012 and the 31mm on February 7, 2014. Medtronic

CoreValve System 23mm is available only via Special Access, which is considered investigational and may be used upon special access granted by Health Canada. The models to be used in this trial, listed in **Table 1**, are identical to the Health Canada approved and Special Access devices. The devices used in this trial will be used outside the current approved indication. The Medtronic CoreValve System is still under investigation for the intermediate risk indication.

B.2.3 Intended Use of the Device / Indications for Use

The Medtronic CoreValve™ System are intended/indicated for use in patients who have symptomatic severe aortic stenosis (AS) necessitating valve replacement and who are at intermediate surgical risk and presenting with anatomical dimensions as described in **Table 1**.

B.3 Trial Objectives

B.3.1 Primary

The primary objective of this trial is to evaluate in a prospective randomized fashion whether Transcatheter Aortic Valve Implantation (TAVI) is non-inferior to Surgical Aortic Valve Replacement (SAVR) with respect to the composite endpoint of all-cause mortality and disabling stroke at 24 months in patients with symptomatic severe aortic stenosis and at intermediate surgical risk.

B.3.2 Secondary

The secondary objective of this trial is to assess differences in quality of life, clinical benefit (efficacy endpoints) and health economics in patients with symptomatic severe aortic stenosis and at intermediate risk treated with either Transcatheter Aortic Valve Implantation (TAVI) or Surgical Aortic Valve Replacement (SAVR).

B.3.3 Exploratory

An analysis will be conducted to determine if patients can be identified as intermediate risk for Transcatheter Aortic Valve Implantation (TAVI) based upon age and the presence of a defined list of co-morbidities commonly associated with patients undergoing TAVI procedures. A complete discussion of this exploratory objective can be found in **Appendix R.24**.

C TRIAL PROTOCOL

C.1 Ethics and Regulatory Compliance

C.1.1 *Applicable Regulations*

This trial will be conducted in compliance with the protocol, the Sponsor's standard operating procedures and/or guidelines, the United States Food and Drug Administration (FDA) and local regulations where applicable, the International Conference on Harmonization (ICH) Good Clinical Practice (GCP) guidelines, ISO14155 (2011), and the Declaration of Helsinki (2008 and subsequent versions). Additionally, the Medical Device Directive (MEDDEV 2.7/3) will be followed for Investigator reporting of Serious Adverse Events (SAEs) to the sponsor.

C.1.2 *Institutional Review Board (IRB)/Medical Ethics Committee (MEC)*

The trial will be conducted in accordance with 21 CFR 56 Institutional Review Boards and/or local regulations for Medical Ethics Committee (MEC). The trial protocol and consent must be approved by the responsible Institutional Review Board (IRB) or MEC at each investigational site. Trial activities must not commence prior to receipt of documentation of IRB/MEC approval by the site and Medtronic. The Investigator and trial staff must comply with the requirements of their IRB/MEC.

Prior to enrolling subjects in this trial, each investigation site's IRB/MEC will be required to approve the current trial clinical investigation plan, the Patient Information and Informed Consent form, and any other written information to be provided to the subjects. In the US, Investigator must also utilize IRB approved Health Insurance Portability and Accountability Act (HIPAA) Authorization.

IRB/MEC approval of the clinical trial must be received in the form of a letter and provided to Medtronic before commencement of the trial at an investigation site. The approval letter must contain enough information to identify the version or date of the documents approved. In addition the approval letter needs to be accompanied by an IRB/MEC roster or letter of compliance, to allow verification that the investigator, other center trial staff, and/or Medtronic personnel are not members of the IRB/MEC. If they are members of the IRB/MEC, written documentation is required stating that he/she did not participate in the approval process. Investigators must inform Medtronic of any change in status of IRB/MEC approval once the investigation site has started enrolment.

C.1.3 *Regulatory Submission*

Prior to enrolling any patients in the trial, all local regulatory requirements must be fulfilled. Each trial site must have written documentation of site/investigator readiness, including but not limited to IRB/MEC approval of the current version of the Investigational Plan, Informed Consent form, a signed Investigator's Agreement, current investigator curriculum vitae, and documentation of training. The coordinating and principal investigators shall agree to this investigational plan and any amendments and indicate their approval by signing and dating the Investigator's Agreement.

Approval from the Regulatory Authorities, if applicable, is required prior to the first patient enrollment in a particular center. Medtronic will obtain a copy of the approval letter, directly from the Regulatory Authorities.

If any action is taken by an IRB/MEC with respect to the investigation, that information will be forwarded to Medtronic by the respective investigator.

Other documents that are referred to in this Clinical Investigation Plan are listed below and will be made available upon request:

- Monitoring Plan
- Data Management Plan
- Statistical Analysis Plan
- Patient Information and Informed Consent Form
- Case Report Forms

C.1.4 Ethical Conduct of the Trial

The trial will be conducted in accordance with the design and specific provisions of this protocol, in accordance with the ethical principles that have their origin in the Declaration of Helsinki, and that are consistent with Good Clinical Practice (GCP) and the applicable regulatory requirements.

The principles of the Declaration of Helsinki have all been implemented in this trial by means of the patient informed consent process, IRB/MEC approval, trial training, clinical trial registration, preclinical testing, risk benefit assessment, and publication policy.

The sponsor will avoid improper influence on, or inducement of the subject, monitor, and investigator(s) or other parties participating in, or contributing to, the clinical investigation by implementing the patient informed consent process, clinical investigation agreements, and IRB/MEC review and approval.

C.2 Trial Administration

C.2.1 Steering Committee

The Steering Committee will be an advisory body to Medtronic. Their roles and responsibilities may include, but are not limited to the following:

- Overall conduct of the study with regard to
 - Protocol development and implementation
 - Study progress
 - Patient safety
 - Data quality and integrity
- Quality performance at individual sites
 - The Steering Committee will support site investigators in resolving any clinical or procedural issues that may impact patient well-being or integrity of the study
 - Any site placed on probation for any reason may be terminated from the study after an appropriate review by the Steering Committee
- Review of all Data Safety Monitoring Board (DSMB) recommendations
- Assess requests for sub-studies
- Assist with Publication efforts by disseminating study information through appropriate scientific sessions and publications
 - All requests for abstract and manuscript preparation and submission require Steering Committee review and approval. All final decisions will be made by Medtronic; however, the recommendations made by the Steering Committee will be highly considered
- Participate in Investigator Meetings (and other study related meetings)
- Serve as a contact for other study investigators (providing peer consultation)

Prior to the onset of the trial, the Steering Committee will establish a charter. The Steering Committee charter will be approved by Medtronic and the Steering Committee members.

C.2.2 Publication Committee

The Publication Committee will review and approve publication ideas and facilitate submissions, including abstracts and manuscripts. The Publication Committee will consist of SURTAVI trial investigators (interventional cardiologists and cardiac surgeons) and Medtronic representatives.

The Publication Committee will be responsible for:

- Defining and refining the publication strategy
- Overseeing the development of manuscripts, abstracts, and presentations
- Identifying and appointing the manuscript/abstract first author(s)/writer(s)/presenters(s)
- Reviewing the publication

C.3 Methodology

C.3.1 Purpose

The purpose of this trial is to investigate the safety and efficacy of transcatheter aortic valve implantation (TAVI) in patients with severe, symptomatic Aortic Stenosis (AS) at intermediate surgical risk by randomizing patients to either Surgical Aortic Valve Replacement (SAVR) or TAVI. Data from this trial will be used to support regulatory applications in seeking approval for the Medtronic CoreValve System in the intermediate surgical risk population.

C.3.2 Patient Population

Patients who have symptomatic severe Aortic Stenosis who are determined by the Heart Team to be at intermediate surgical risk.

C.3.3 Design

This trial is designed as a prospective, multi-center, multi-national, randomized, interventional trial to investigate the safety and efficacy of transcatheter aortic valve implantation (TAVI) in patients with severe, symptomatic Aortic Stenosis (AS) at intermediate surgical risk.

Approximately 1600 subjects will be recruited in up to 115 investigational centers located in the United States, Canada and Europe. The trial may be expanded to include additional geographies based on enrollment rates and identification of qualified centers.

Subjects will be randomized on a 1:1 basis to either transcatheter aortic valve implant (TAVI) or to surgical aortic valve replacement (SAVR).

To avoid bias in the trial population the following measures have been taken:

- All sponsor and external trial personnel will be trained on the Clinical Investigation Plan (CIP) and related trial materials; and
- Subjects will be screened to confirm trial eligibility with defined inclusion/exclusion criteria prior to enrollment.

The total trial duration is expected to be approximately eight years.

C.3.4 Investigational Centers

Site distribution is anticipated to include up to 75 centers in the United States, 10 in Canada and 30 in Europe.

For this study, the following investigator/center selection minimum criteria are considered:

- Center must have sufficient patient population
- Each center's Implant Team (i.e. 1st and 2nd operators) must have completed at least 30 cumulative TAVI procedures
- There will be no other study ongoing during this study duration, which would prevent the center from meeting enrollment goals for SURTAVI or provide adequate staffing
- Investigator should have adequate staff that is accessible and has time to manage the study for 7 days per week, 24 hours per day
- Investigator, co-investigators, and study staff must be willing to provide his/her Curriculum Vitae
- Investigator and co-investigators must be willing to sign and comply with the protocol-specific Investigator Agreement
- Center must be willing to comply with the Clinical Investigation Plan and data requirements, including reporting Adverse Events
- Center has demonstrated experience with conducting clinical (device) trials that comply with applicable regulatory standards
- Center is willing to participate in follow-up of patients for 5 years
- Center has an internet connection with sufficient speed of data transfer

All investigators will be appropriately qualified practitioners legally entitled to practice, and experienced in the diagnosis and treatment of patients requiring an aortic valve treatment with a TAVI or SAVR.

For the purposes of the SURTAVI trial, it is imperative that Medtronic leverages highly qualified surgeons for the surgical aortic valve replacements (SAVR) that will occur as a part of the trial. The following minimum criteria will be used for all cardiac surgeons performing SAVRs in the SURTAVI trial:

- At least 5 years of experience post-residency
- At least 100 career aortic valve replacements post-residency
- At least 75 valve procedures in the last 3 years
- At least 35 surgical aortic valve replacements in the last 3 years
- At least 15 aortic valve replacements in the last year

C.3.5 *Number of Subjects*

Up to 2000 subjects will be randomized [1:1, TAVI: Surgical Aortic Valve Replacement (SAVR)]. The enrollment phase is anticipated to be approximately 36 months. Subjects will be followed through 5 years for assessment of long-term safety and efficacy endpoints. The total trial duration is expected to be approximately 8 years.

Enrollments shall not exceed 20% (approximately 400) of total randomized subjects at any individual site. Enrollment is competitive; therefore there is no set minimum number of subjects to be enrolled per site. Appropriate measures will be taken to monitor enrollment across geographies to ensure at least 40% of the total patient population is enrolled within the United States.

C.3.6 *Inclusion/Exclusion Criteria*

C.3.6.1 Inclusion Criteria

To participate in this trial, the subject must meet ALL of the following inclusion criteria.

1. Subject must have co-morbidities such that Heart Team agrees predicted risk of operative mortality is $\geq 3\%$ and $< 15\%$ at 30 days (Intermediate Clinical Risk classification). Heart team evaluation of clinical surgical mortality risk for each patient includes the calculated STS score for predicted risk of surgical mortality augmented by consideration of the overall clinical status and co-morbidities unmeasured by the STS risk calculation;
2. Heart Team unanimously agree on treatment proposal and eligibility for randomization based on their clinical judgment (including anatomy assessment, risk factors, etc.);
3. Subject has severe aortic stenosis presenting with:
 - a) Critical aortic valve area defined as an initial aortic valve area of $\leq 1.0 \text{ cm}^2$ or aortic valve area index $< 0.6 \text{ cm}^2/\text{m}^2$

AND

 - b) Mean gradient $> 40\text{mmHg}$ **or** $V_{\text{max}} > 4\text{m/sec}$ by resting echocardiogram or simultaneous pressure recordings at cardiac catheterization [or with dobutamine stress, if subject has a left ventricular ejection fraction (LVEF) $< 55\%$] **or** velocity ratio < 0.25 ;
4. Subject is symptomatic from his/her aortic valve stenosis, as demonstrated by New York Heart Association (NYHA) Functional Class II or greater;
5. Subject and the treating physician agree that the subject will return for all required post-procedure follow-up visits;
6. Subject meets the legal minimum age to provide informed consent based on local regulatory requirements.

C.3.6.2 Exclusion Criteria

Subjects are NOT eligible for trial participation if they meet ANY of the following exclusion criteria:

1. Subject has refused surgical aortic valve replacement (SAVR) as a treatment option;
2. Any condition considered a contraindication for placement of a bioprosthetic valve (i.e. subject requires a mechanical valve);

3. A known hypersensitivity or contraindication to all anticoagulation/antiplatelet regimens (or inability to be anticoagulated for the index procedure), nitinol, or sensitivity to contrast media which cannot be adequately pre-medicated;
4. Blood dyscrasias as defined: leukopenia (WBC <1000mm³), thrombocytopenia (platelet count <50,000 cells/mm³), history of bleeding diathesis or coagulopathy;
5. Ongoing sepsis, including active endocarditis;
6. Any condition considered a contraindication to extracorporeal assistance;
7. Any percutaneous coronary or peripheral interventional procedure performed within 30 days prior to randomization (Subjects with recent placement of drug eluting stent(s) should be assessed for ability to safely proceed with SAVR within the protocol timeframe);
8. Symptomatic carotid or vertebral artery disease or successful treatment of carotid stenosis within six weeks of randomization;
9. Cardiogenic shock manifested by low cardiac output, vasopressor dependence, or mechanical hemodynamic support;
10. Recent (within 6 months of randomization) cerebrovascular accident (CVA) or transient ischemic attack (TIA);
11. Active gastrointestinal (GI) bleeding that would preclude anticoagulation;
12. Subject refuses a blood transfusion;
13. Severe dementia (resulting in either inability to provide informed consent for the trial/procedure, prevents independent lifestyle outside of a chronic care facility, or will fundamentally complicate rehabilitation from the procedure or compliance with follow-up visits);
14. Multivessel coronary artery disease with a Syntax score >22 and/or unprotected left main coronary artery (Syntax score calculation is not required for patients with history of previous revascularization if repeat revascularization is not planned);
15. Estimated life expectancy of less than 24 months due to associated non-cardiac co-morbid conditions;
16. Other medical, social, or psychological conditions that in the opinion of the Investigator precludes the subject from appropriate consent or adherence to the protocol required follow-up exams;
17. Currently participating in an investigational drug or another device trial (excluding registries);
18. Evidence of an acute myocardial infarction ≤30 days before the index procedure;
19. Need for emergency surgery for any reason;
20. True porcelain aorta (i.e. Heart Team agrees the aorta is not clampable for SAVR);
21. Extensive mediastinal radiation;
22. Liver failure (Child-C);
23. Reduced ventricular function with left ventricular ejection fraction (LVEF) <20% as measured by resting echocardiogram;
24. Uncontrolled atrial fibrillation (eg. resting heart rate >120bpm);
25. Pregnancy or intent to become pregnant prior to completion of all protocol follow-up requirements;
26. End stage renal disease requiring chronic dialysis or creatinine clearance < 20 cc/min;
27. Pulmonary Hypertension (systolic pressure> 80mmHg);
28. Severe Chronic Obstructive Pulmonary Disease (COPD) demonstrated by Forced Expiratory Volume (FEV1) < 750cc;
29. Frailty assessments identify:
 - Subject is < 80 years of age and three or more of the following apply
 - Subject is ≥ 80 years of age and two or more of the following apply
 - Wheelchair bound
 - Resides in an institutional care facility (eg. nursing home, skilled care center)
 - Body Mass Index < 20 kg/m²
 - Grip strength <16 kg
 - Katz Index score ≤ 4

- o Albumin < 3.5 g/dL;
- 30. Marfan syndrome or other known connective tissue disease that would necessitate aortic root replacement/intervention.

Anatomical Exclusion Criteria

- 31. Native aortic annulus size <18 mm or >29 mm per the baseline diagnostic imaging;
- 32. Pre-existing prosthetic heart valve in any position;
- 33. Mixed aortic valve disease [aortic stenosis and aortic regurgitation with predominant aortic regurgitation (3-4+)];
- 34. Severe mitral or severe tricuspid regurgitation;
- 35. Severe mitral stenosis;
- 36. Hypertrophic obstructive cardiomyopathy;
- 37. Echocardiographic or Multislice Computed Tomography (MSCT) evidence of new or untreated intracardiac mass, thrombus or vegetation;
- 38. Ascending aorta diameter greater than maximum diameter relative to the native aortic annulus size:

Aortic Annulus Diameter	Ascending Aorta Diameter
18 mm – 20 mm	>34 mm
20 mm – 23 mm	>40 mm
23 mm – 29 mm	>43 mm

- 39. Aortic root angulation (angle between plane of aortic valve annulus and horizontal plane/vertebrae):
 - a) Femoral and left subclavian/axillary access > 70°
 - OR**
 - b) Right subclavian/axillary access: Aortic root angulation > 30°;
- 40. Congenital bicuspid or unicuspid valve verified by echocardiography;
- 41. Sinus of Valsalva anatomy that would prevent adequate coronary perfusion.

Vascular Exclusion Criteria

- 42. Transarterial access not able to accommodate an 18Fr sheath.

C.3.7 *Informed Consent*

The investigator must obtain written informed consent prior to subjecting the subject to any trial related activity.

Well in advance of the consent discussion, the subject should receive the MEC/IRB approved Patient Information and Informed Consent Form (ICF). During the consent discussion the investigator or his/her designee must fully inform the subject of all pertinent aspects of the trial including the approval of the MEC/IRB of the written Patient Information. If a subject is illiterate, an impartial witness must be present during the entire informed consent discussion. All items discussed in the Patient Information and the ICF must be explained. The language used shall be in the subject's native language, as non-technical as possible and must be understandable to the subject and the impartial witness, where applicable.

The subject must have ample time and opportunity to inquire about details of the trial, and to decide whether or not to participate in the clinical trial. All questions about the trial should be answered to the satisfaction of the subject.

Neither the investigator, nor the investigation site staff shall coerce or unduly influence a subject to participate or to continue to participate in the clinical trial. The informed consent process shall not appear to waive the subject's rights.

When the subject decides to participate in the clinical trial, the ICF must be signed and personally dated by the subject and investigator. If applicable, the witness shall also sign and personally date the consent form to attest that the information in the Patient Information and Informed Consent Form was accurately explained and clearly understood by the subject, and that informed consent was freely given.

Signing the ICF serves to document the written and verbal information that the Investigator or authorized delegate provides to the patient, the patient understanding of the information, and their agreement to participate. The Investigator or authorized delegate must document in the patient's medical records that the patient was consented and the date on which the consent was obtained. The original signed consent form will be retained in the patient's trial records. A copy of the informed consent will be provided to the patient and a copy placed in the patient's medical record.

Data relating to the trial might be made available to third parties (for example in case of an audit performed by regulatory authorities), provided the data are treated as confidential and that the subject's privacy is guaranteed. In the United States, "Protected Health Information" will be maintained in compliance with the Health Insurance Portability and Accountability Act of 1996 (HIPAA).

C.3.8 *Revisions in Patient Information and Informed Consent Form*

Medtronic will inform the investigators whenever information becomes available that may be relevant to the subject's continued participation in the trial. The revised information will be sent to the investigator for approval by the IRB/MEC. After approval by the IRB/MEC, a copy of this information must be provided to the participating subjects, and the informed consent process as described above needs to be repeated. The investigator or his/her designee should inform the subject in a timely manner.

C.3.9 Enrollment Flowchart for Randomization to TAVI or SAVR

Figure 1: Enrollment Flowchart

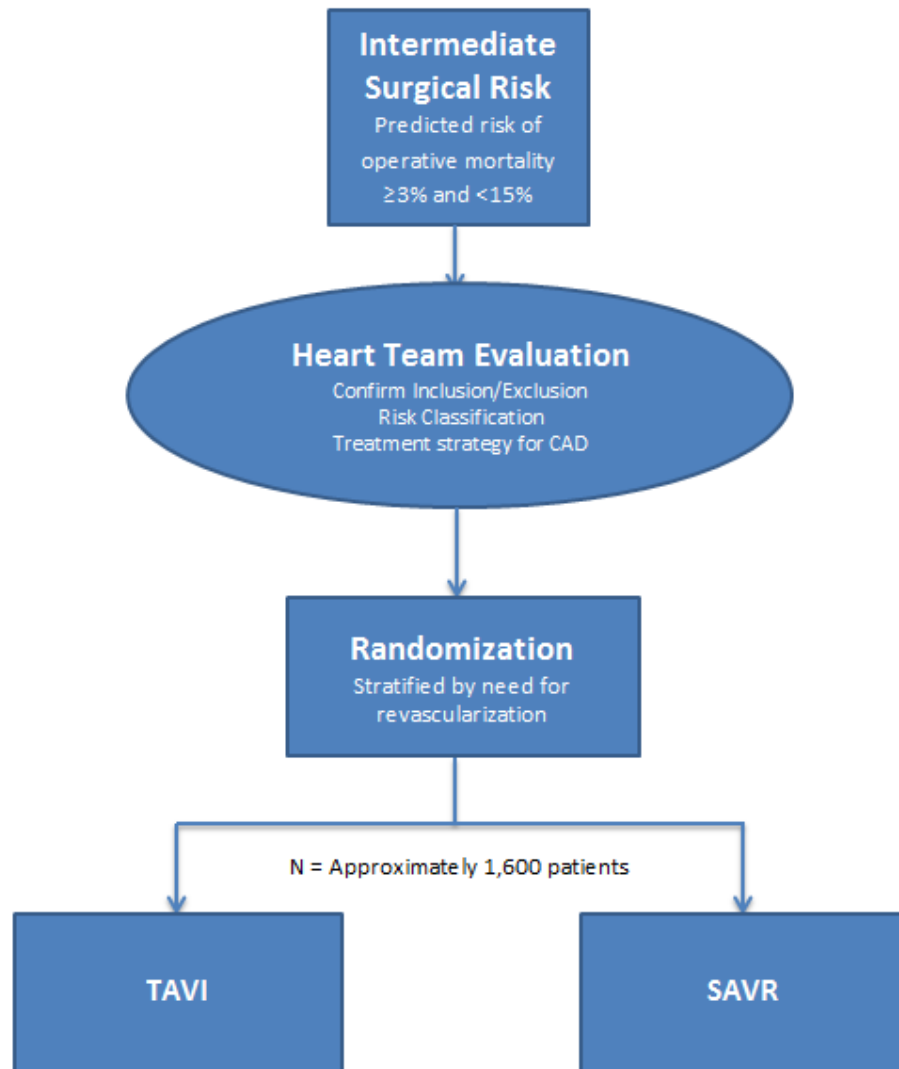

If the patient meets all of the inclusion criteria and none of the exclusion and Heart Team determines the patient is eligible for randomization in the SURTAVI trial, subjects will be randomized on a 1:1 basis to either TAVI or SAVR. Randomization will be stratified by the need for coronary revascularization. In case of required coronary revascularization, concomitant percutaneous coronary intervention (PCI) and TAVI is encouraged; however staging is left at the discretion of the operator. Coronary artery bypass graft (CABG) should be conducted during the index procedure.

C.3.10 Trial Training

Prior to investigational site activation or subsequent involvement in trial activities, Medtronic (or designee) will provide trial training relevant and pertinent to the involvement of personnel conducting trial activities, including investigator responsibilities, adverse event reporting as well as device training (if necessary, usage and handling of device under investigation). Training may be conducted via Site Initiation Visits, Investigator and Coordinator Meetings, and/or other media sessions. The sponsor will maintain documentation of attendance at each of these training opportunities, as applicable.

Additionally, Medtronic representative(s) may be present at each site's TAVI procedures as part of the ongoing training process.

C.4 Trial Procedures

C.4.1 Screening Procedures

Prior to any trial-specific tests or procedures, written informed consent must be obtained from the subject. Failure to obtain a signed and hand dated informed consent prior to the procedure constitutes a protocol violation, which is reportable to the IRB/MEC, the Food and Drug Administration (FDA), and other regulatory authorities as applicable.

All potential subjects for trial entry must be screened for eligibility. All patients with symptomatic severe AS that provide informed consent will be entered into the Electronic Data Capture (EDC) system and total number of patients screened will be counted. The reasons why a patient did not enter the Heart Team meeting will be collected (eg. patient does not meet inclusion criteria or meets an exclusion criteria) and, age, STS score, and available screening data.

Data readily available in the patient's medical record may be utilized to fulfill screening requirements and do not need to be repeated. If not previously completed, the following tests and procedures must be performed prior to randomization to verify eligibility. The recommended timeframe for these tests and procedures is within 30 days prior to submission to the Heart Team, unless otherwise specified.

- Demographics and Medical History
- Clinical Assessments – Refer to **Appendix R.19**
 - 5-Meter Gait Speed
 - Grip Strength
- Physical Examination including:
 - Vital signs, weight, height, and body surface area (BSA);
 - BSA will be calculated from height and weight by use of the formula by Dubois and Dubois ($BSA = 0.007184 \times \text{weight [kg]}^{0.425} \times \text{height [m]}^{0.725}$)
 - Major systems findings
- NYHA Classification
- Risk Assessments:
 - STS Risk Score – Dataset Version 2.73
 - Logistic EuroSCORE
 - EuroSCORE II
 - SYNTAX Score
 - Katz Index of Independence in Activities of Daily Living
- Co-morbidities
- Routine Laboratory Tests:
 - Complete Blood Count:
 - White Blood Count
 - Hematocrit
 - Hemoglobin
 - Platelet Count
 - Creatinine and Creatinine Clearance
 - Cardiac Enzymes (CK/CK-MB)
 - International Normalized Ratio (INR), if applicable
 - Activated Partial Thromboplastin Time (aPTT)
 - B-type Natriuretic Peptide (BNP) or NT-proBNP
 - Liver Panel:
 - ALT
 - AST
 - Albumin
 - Sodium
 - Potassium

- Transthoracic Echocardiogram (TTE)
 - Comprehensive transthoracic two-dimensional (2D) echocardiogram (TTE) is required within 365 days prior to review by the Heart Team to confirm diagnosis of severe aortic stenosis(AS) including:
 - Aortic valve area / indexed aortic valve area
 - Mean gradient / peak velocity / velocity ratio
 - If a historical TTE is used to confirm AS diagnosis a repeat TTE must be performed within 45 days prior to review by the Heart Team to:
 - Assess:
 - Aortic regurgitation
 - Mitral and tricuspid valve status (stenosis and regurgitation)
 - LVEF
 - Rule out:
 - New or recent MI
 - New or untreated intracardiac mass, thrombus or vegetation
 - Congenital bicuspid or unicuspid valve
 - If the patient recently underwent balloon aortic valvuloplasty (BAV), a TTE should be obtained post-BAV; within 45 days prior to review by the Heart Team to reconfirm all inclusion/exclusion echocardiographic parameters
 - Protocol required echocardiograms should be performed according to the Echocardiography Procedures found in **Appendix R.7**.
- Multi-Slice Computed Tomography (MSCT) Angiogram
 - Multi-Slice Computed Tomography (MSCT) angiograms with complete visualization of both iliacs, femorals and aorta (and subclavian/axillaries, if applicable), up to and including the aortic annulus. In the situation where subjects have compromised renal function that precludes contrast media, Magnetic Resonance (MR) imaging may be used as an alternative. MSCT angiograms should be performed according to the Computed Topography (CT) Angiography Acquisition Guidelines found in **Appendix R.9**. If the MSCT angiogram was conducted in the last 365 days and subject has not had a peripheral vascular intervention since the time of the image, a more recent exam is not required as long as visualization of both iliacs and femorals (and subclavian/axillaries, if applicable) to the aorta can be viewed. However, if the subject had a peripheral vascular intervention, the exam must be repeated after the intervention and within 90 days of review by the Heart Team.
- Coronary Arteriogram
 - Selective coronary arteriography to assess the presence and severity of coronary artery disease which should include angiograms of both coronary arteries and all bypass grafts (if applicable). If the coronary arteriogram has been performed within the last 365 days and the subject qualifies for the trial (no significant coronary artery disease), a more recent exam is not required. However, if the subject had evidence of significant coronary artery disease and/or received a coronary intervention, the exam must be repeated after the intervention and within 90 days of review by the Heart Team.
- 12-lead Electrocardiogram (ECG)

C.4.2 Heart Team Procedures

Each center will utilize a Heart Team to make determinations regarding eligibility of the prospective subject to be randomized in the SURTAVI trial.

C.4.2.1 Heart Team Composition

Local Heart Teams must be comprised of a multidisciplinary team qualified by education and experience to determine appropriate patient treatment.

Minimum Membership¹

- Interventional Cardiologist - ≥ 1 representative is required
- Cardiac Surgeon - ≥ 1 representative is required

Additional Membership Considerations

Additional members of the Heart Team should be included based on current standard practices and patient specific consideration, including but not limited to:

- Echocardiographer
- Anesthesiologist
- Cardiologist (general or referring physician)
- Geriatrician
- Neurologist or stroke specialist
- Radiologist or imaging specialist
- Heart Failure specialist
- Intensivist
- Nurse(s)
- Social Worker

C.4.2.2 Heart Team Review and Decision

Prior to determining if a patient is eligible for randomization the Heart Team will review each patient's screening data and confirm the following:

- STS risk calculation was properly performed
- Any additional risk factors not accounted for in the STS risk calculator that may increase the level of surgical risk:
 - Heart Team should consider the following potential incremental risks:
 - Age ≥ 75
 - BNP ≥ 550pg/mL or NT proBNP ≥ 3200pg/mL
 - Prior Stroke/TIA
 - FEV1 750-1000cc
 - Home / Supplemental oxygen
 - Nocturnal Bi-level Positive Airway Pressure
 - 5-Meter Gait Speed ≥ 6 seconds
 - Severe Diastolic Dysfunction (Grade III or IV)
 - Liver Disease (Child A or B)
 - Pulmonary Hypertension (systolic pressure 60-80mmHg)
 - Frailty (eg. BMI <21 kg/m², Albumin <3.5 g/dL, etc.)
 - Other risks, as deemed applicable
 - Confirm the incremental risk, as determined by the Heart Team, does not result in a risk definition higher than intermediate risk
- All inclusion criteria are met and none of the exclusion criteria

Both the reviewing Interventional Cardiologist and Cardiac Surgeon(s) must unanimously agree the patient has a predicted risk of operative mortality ≥ 3% and < 15% and appropriate for trial enrollment. The decision of the local Heart Team must be documented on the "Heart Team Decision" form and signed by the reviewing Interventional Cardiologist and Cardiac Surgeon(s).

¹ US only - Protocol criteria for Heart Team approval may not meet the minimum requirements outlined by Centers for Medicare and Medicaid Services (CMS) for reimbursement. Reference **Appendix R.25** for additional information.

C.4.3 Screening Committee

The Screening Committee will ensure appropriate and consistent patient selection across all sites. Prior to the onset of the trial, a charter will be drafted to that outline roles and responsibilities as well as describe the Screening Committee process.

Final decisions on patient eligibility will be made by the Screening Committee.

C.4.4 Roll-in Subjects

For participating centers who meet the requirement of 30 cumulative TAVI procedures but have no previous CoreValve experience (eg. Investigational centers where CoreValve is not commercially available and/or centers that did not participate in the US Pivotal Extreme/High Risk protocols) the first three successfully enrolled subjects will be considered “roll-in” subjects, will not be randomized, and will automatically be assigned to TAVI. A maximum of three successful roll-in subjects are allowed per center.

The purpose of the roll-in subjects is to provide investigators the time for training and familiarization with the investigational TAVI device. The Training and Education team will review recommendations made by Medtronic field support, Medtronic CoreValve Proctors and the Steering Committee for transition of sites from the roll-in phase to the randomization phase of enrollment after the first three subjects have been treated.

A subject will be considered a treated roll-in subject once the TAVI delivery catheter system (DCS) is introduced into the subject. A site must have three treated roll-in subjects before they can be evaluated to move into the randomization phase. The Training and Education team or designee will review and document their decisions based on the technique of the investigators, as well as the frequency, severity and nature of events in the roll-in subjects.

Roll-in subjects will complete in-clinic follow-up evaluations at the following time points post implant as subjects randomized to TAVI. However, the results for the roll-in population will be analyzed separately from the randomized population.

C.4.5 Enrollment and Randomization

Prior to randomization and enrollment of a subject, the following must occur:

- Confirm patient signed informed consent
- Confirm patient meets all of the inclusion and none of the exclusion criteria, including approval by the Heart Team

Subjects will be considered enrolled into the trial at the time of randomization² (i.e. time of treatment assignment). Randomization will occur only if the patient meets all inclusion criteria and does not meet any exclusion criteria and has been assessed by the Heart Team as being an appropriate candidate for randomization in the SURTAVI trial.

Due to the inclusion/exclusion criteria, not all patients that consent to the trial will be enrolled. All sites will be required to maintain a record of patients screened for the trial meeting general inclusion criteria who have signed the approved informed consent document. For subjects that do not meet trial criteria, the reason for not continuing in the trial must be documented and recorded in the EDC system. Patients consented but not randomized will be considered screen failures and no further trial-related follow-up will be required.

Subjects must have their TAVI or SAVR procedure no later than 30 days post-randomization.

Trial randomization will not be blinded. Once randomization is complete and a treatment arm is assigned, crossover from SAVR to TAVI treatment is not permitted. The sponsor will strictly monitor device dispensation to ensure that only those subjects randomized to the TAVI treatment arm receive the Medtronic CoreValve™ TAV.

Distribution of the subjects within the trial groups will be controlled at the implanting sites by means of central randomization using interactive voice/web randomization service (IXRS). The randomization scheme will be securely stored at the IXRS provider.

² Based on protocol design, the time of enrollment will be the same as randomization which is a deviation from ISO 14155 (2011).

Randomization with an assignment to the treatment arm or control arm (TAVI or SAVR) will be executed in a 1:1 ratio. Stratified randomization by investigational site and by the need for coronary revascularization will be used to ensure subjects will be allocated to each comparison group proportionately. Additionally, a blocked randomization scheme with random block sizes will be used within each stratum.

C.4.6 Baseline Assessments

The following baseline assessments should occur within 14 days prior to the index procedure.

- Physical examination
 - Vital signs
 - Major system findings
 - Skin assessment – refer to Radiation Exposure and Data Collection, **Appendix R.23**
- NYHA classification
- Concomitant medications
 - Use of relevant medications (diuretics, aspirin, anticoagulants, ACE-I, ARB, beta-blockers, statins and anti-platelets)
- Routine Laboratory Tests:
 - Complete Blood Count
 - White Blood Count
 - Hematocrit
 - Hemoglobin
 - Platelet Count
 - Creatinine and Creatinine Clearance
 - Cardiac Enzymes (CK/CK-MB)
 - International Normalized Ratio (INR), if applicable
 - Activated Partial Thromboplastin Time (aPTT)
 - B-type Natriuretic Peptide (BNP) or NT-proBNP
 - Liver Panel:
 - ALT
 - AST
 - Albumin
 - Sodium
 - Potassium
- Neurological Assessments:
 - National Institute of Health Stroke Scale (NIHSS)
 - Modified Rankin Score (mRS)
 - Mini-Mental State Exam (MMSE-2:SV)
 - Additional Neurological testing:
 - Visual Fields Testing
 - Gait Assessment
 - Hand Function
 - Writing Evaluation
 - Drawing Assessment
- 12-lead Electrocardiogram (ECG)
- 6 Minute Walk Test
- Quality of Life Questionnaires
 - Questionnaires may be administered any time after the subject has provided informed consent but should be collected prior to informing the subject of their treatment assignment
- Adverse Event Review

C.4.7 *Transcatheter Aortic Valve Implant or Surgical Aortic Valve Replacement Procedure*

C.4.7.1 TAVI

General Procedural Considerations

Transcatheter Aortic Valve Implantation (TAVI) requires meticulous preparation and typically a multi-disciplinary team approach involving among others, interventional cardiologists, cardiac imaging specialists, cardio-thoracic surgeons and anesthesiologists.

Within the United States, additional requirements apply for composition of the intra-operative team for TAVI procedures. Requirements are outlined in Appendix R.25.

In case of significant coronary artery disease that requires revascularization, the Heart Team will assess the feasibility of performing PCI simultaneously with the TAVI procedure based on the coronary lesion characteristics. When it is anticipated PCI can be performed in timely fashion with only a limited amount of additional contrast medium it is encouraged to perform PCI concomitant with the TAVI. When PCI is deemed challenging requiring relatively more time and contrast medium, staged PCI is recommended: TAVI will then be performed at least 7 days after PCI.

The implantation procedure itself takes place either in a catheterization laboratory with adequate hygiene precautions or ideally in a hybrid operating room equipped for state-of-the-art transcatheter and/or surgical procedures.

The execution of the TAVI involves an operating team typically consisting of 1 or 2 operators, an anesthesia team and at least 2 nurses/technicians. Medtronic representative(s) (eg. Therapy Development Specialists, proctors, etc.) may be present during TAVI procedures for training process, to perform valve loading or to provide general case support.

Both the dedicated “valve team” and the operators should have the expertise to select the appropriate access route and device size on a patient-per-patient basis.

All patients undergoing TAVI should be treated using the iliofemoral access route by default (first treatment strategy). Additional non-iliofemoral access routes will only be used in case iliofemoral access is not feasible. Alternative access is limited to subclavian and direct aortic.

The use of an embolic protection device during the TAVI procedure is not permitted.

Pre-Procedure

- Pre-medication recommendations:
 - If the subject is currently on warfarin therapy, or local equivalent, prior to the procedure:
 - Discontinue warfarin therapy 3 days prior to the procedure
 - Confirm that the INR < 1.8 prior to the procedure
 - Administer antiplatelet therapy:
 - Aspirin (75- 325 mg) daily **or**
 - Clopidogrel (75 mg) daily (or ticlopidine if clopidogrel is contraindicated) for 3 days prior to the procedure
 - If the subject is currently **not** on warfarin therapy prior to the procedure:
 - Aspirin (75-325 mg) on the day of the procedure **and**
 - Clopidogrel (300 mg)
 - Consider adjunctive proton pump inhibitors, H₂ antagonists or antacids
- Routine Laboratory Tests:
 - Complete Blood Count
 - White Blood Count
 - Hematocrit
 - Hemoglobin
 - Platelet Count
 - Creatinine and Creatinine Clearance
 - If the GFR < 60 cc/min, consider:
 - Fluid hydration on the day prior to the procedure
 - Discontinuation of NSAIDs and ACE inhibitors
 - Cardiac Enzymes (CK/CK-MB)
 - International Normalized Ratio (INR), if applicable
 - Activated Partial Thromboplastin Time (aPTT)
 - B-type Natriuretic Peptide (BNP) or NT-proBNP
 - Liver Panel:
 - ALT
 - AST
 - Albumin
 - Sodium
 - Potassium
- 12-lead Electrocardiogram (ECG)

TAVI Procedure

- *Medications*

One hour prior to the procedure, prophylactic antibiotic therapy of the Investigator's choice should be initiated:

 - Cefuroxime 750mg intravenous (IV) 1 hour pre-procedure, then 6 hours and 12 hours post-procedure
 - If allergic to Penicillin, prescribe Vancomycin 1g IV
 - Consider holding anti-hypertensives
- *Anesthesia and Procedural Set Up*
 - Establish a central venous line
 - Administer general anesthesia or conscious sedation per hospital protocol
 - Prior to beginning the investigational TAVI device system implant, place a temporary 4-5 Fr. balloon-tip pacing wire in a stable location within the right ventricular (a screw-tip wire may be used for more secure placement for subjects at high-risk for dislodgement, if necessary)
 - Whenever possible, use the upper torso venous system (eg. jugular, subclavian) for temporary pacing wire access
 - Use fluoroscopy to guide wire placement and stability
 - Confirm sensing and capture
 - Program the backup pacing rate to minimize ventricular pacing (eg. 30-40 bpm). If heart block develops, adjust the rate accordingly
 - Record ECG and angiogram during the procedure
- *Vascular Access*

- The primary access artery will be used to introduce the CoreValve device and the balloon catheter; the secondary access artery will be used to introduce the reference pigtail
- Insert a 6Fr introducer sheath into the secondary access artery
- Insert 18Fr introducer sheath into the primary access artery using hospital protocol (either percutaneously or surgical cut down)
- Administer anticoagulant therapy according to hospital protocol. If heparin is administered as an anticoagulant, check activated clotting time (ACT) at five minutes and monitor every 30-60 minutes after initial bolus of heparin
- Maintain ACT \geq 250 seconds
- Anticoagulant may be administered at any time prior to this point, but avoid delaying beyond this point
- *Crossing the native valve*
 - Advance the graduated pigtail catheter to the ascending aorta and position the distal tip in the noncoronary cusp of the native aortic valve
 - Identify the ideal annular viewing plane using contrast injections at various angiographic angles, preferably in the left anterior oblique (LAO) projection.
 - An aortogram with the three aortic cusps aligned in one (1) plane should be obtained in order to proceed with the procedure and guarantee an optimal working view for eventual implantation
 - Insert an angiographic catheter over a standard, J-tip guidewire into the primary access sheath and advance to the ascending aorta
 - Exchange the J-tip guidewire for a 0.035-in (0.889-mm) straight-tip guidewire. Advance the straight-tip guidewire across the native aortic valve into the left ventricle
 - After crossing the native aortic valve with the guidewire, advance the angiographic catheter into the left ventricle
 - Exchange the straight-tip guidewires for an exchange-length J-tip guidewire
 - Exchange the angiographic catheter for a 6Fr pigtail catheter
 - Remove the guidewire and connect the catheter to the transducer. Using both catheters, record the aortic pressure gradient
 - Using a right anterior oblique (RAO) projection, advance previously pigtail-shaped, 0.035-in (0.889-mm) high-support guidewire through the pigtail catheter and position in the apex of the left ventricle
 - Remove the pigtail catheter while maintaining guidewire position in the left ventricle
- *Rapid Pacing and Pre-dilatation of the Implant site*
 - Insert the valvuloplasty balloon through the 18Fr introducer sheath and advance it to the ascending aorta
 - Perform a rapid pacing test. A successful test is defined as 1-to-1 pacing capture with an immediate drop in pressure and elimination of the systolic-diastolic waveform
 - Reposition the angiographic equipment to the ideal viewing plane as previously described. Position the valvuloplasty balloon across the native valve, while maintaining strict fluoroscopic surveillance of the distal tip of the guidewire in the left ventricle (LV)
 - Perform BAV per hospital protocol and remove the valvuloplasty balloon while maintaining guidewire position across the native aortic valve
 - Balloon sizing directed to 1:1 sizing of the minimal annular diameter by computerized tomographic angiography (CTA) or echocardiogram with maximum 25 mm balloon
 - Perform full balloon expansion

- *Medtronic CoreValve™ Implantation*
 - Insert the device over the 0.035-in (0.889-mm) guidewire and advance it, while maintaining strict fluoroscopic surveillance of the guidewire in the LV
 - When crossing the aortic arch, control the guidewire preventing it from moving forward
 - Advance the device through the native valve. Perform an angiogram to confirm that the graduated pigtail catheter is in position within the noncoronary cusp of the aortic root, preferably in the shallow LAO projection
 - Use Fluoroscopy to identify the appropriate landmarks
 - Place the bioprosthesis within the aortic annulus. Optimal placement of the bioprosthesis is 4 mm - 6 mm below the annulus. The annulus is defined as the angiographic floor of the aortic root
 - After attaining optimal catheter position, slowly turn the micro knob and begin to deploy the bioprosthesis. As the inflow aspect of the bioprosthesis starts to flare outward, monitor bioprosthesis position under fluoroscopy
 - Caution: During implantation, if resistance to deployment is encountered (for example, the micro knob starts clicking or is tight or stuck), apply mild upward pressure to the macro slider while turning the micro knob. If the bioprosthesis still does not deploy, remove it from the patient and use another system
 - Perform an angiogram. Once annular contact is made, the bioprosthesis should not be advanced into a lower position
 - Continue deploying rapidly to the 2/3 deployment point; stop turning the micro knob
 - Perform an angiogram to assess the location of the bioprosthesis.
 - If the bioprosthesis is positioned low, carefully pull the DCS to reposition the bioprosthesis
 - Evaluate the valve position and valve function using hemodynamic, aortography, and possible echocardiography
 - When satisfactory position is achieved, continue to turn the micro knob until both frame loops disengage
 - Use orthogonal views under fluoroscopy to confirm that the frame loops have detached from the catheter tabs. If a frame loop is still attached to a catheter tab, under fluoroscopy, advance the catheter slightly and, if necessary, gently rotate the handle clockwise (<math><180^\circ</math>) and counterclockwise (<math><180^\circ</math>) to disengage the loop from the catheter tab
 - Withdraw the DCS carefully to the aorta avoiding contact with the inflow portion of the frame while maintaining guidewire position
- *Medtronic CoreValve™ Post Deployment*
 - Close the DCS capsule and remove the DCS through the 18Fr introducer sheath
 - Advance a 6Fr pigtail catheter over the guidewire into the left ventricle
 - Remove the guidewire and connect the pigtail catheter to the transducer
 - Using both pigtail catheters, record aortic pressure gradient
 - Withdraw 6Fr pigtail
 - Perform post-implant aortogram with the reference pigtail to assure coronary patency and assess aortic regurgitations. Aortogram Acquisition Guidelines are located in **Appendix R.6**
 - Remove the 18Fr introducer sheath and complete the puncture site closure per hospital protocol
 - Perform contrast angiography of the primary vessels to verify the absence of any vascular complications with the reference pigtail
 - Remove the reference pigtail catheter over a standard guidewire
 - Remove the 6Fr introducer and close the access site per hospital protocol

Ballooning as needed during the implant procedure is standard practice and should not be considered a reintervention.

Immediate Post-Procedure

The procedure is considered complete after final angiography has been performed, and the introducer/InLine sheath has been removed from the subject. Thereafter, if an introducer/InLine sheath is re-introduced, this is considered a repeat intervention, which must be documented on the reintervention Electronic Case Report Form (eCRF).

- Coronary Arteriogram
- Following the current recommendation all patients with prosthetic heart valves need endocarditis prophylaxis
- All patients should receive Deep Vein Thrombosis (DVT) prophylaxis with Heparin/Low Weight Molecular Heparin (LMWH) starting approximately 6 hours after TAVI if bleeding permits
- Anticoagulants should be discontinued per hospital standard
- Activated clotting time (ACT) should be monitored per hospital standards but recommendation is >250 seconds
- Cardiac Enzymes: CK within 8-12 hours post procedure and at any time when a clinical ischemic event is suspected.
 - CK-MB is required if CK is elevated $\geq 2X$ the laboratory upper limit of normal.
 - If a clinical event is confirmed, a total of 3 draws of cardiac enzymes within the first 24 hours (drawn approximately every 8 hours) following the clinical event should be obtained
- 12-lead Electrocardiogram (ECG) to be performed within 48 hours of procedure
- Abbreviated Neurological Assessment
 - National Institute of Health Stroke Scale (NIHSS) to be completed with 24 hours of procedure
- Transthoracic Echocardiogram (TTE)
 - Comprehensive transthoracic 2D echocardiogram (TTE) should be performed within 24-48 hours post-procedure or prior to discharge to assess device success. Echocardiograms will be performed according to Echocardiography Procedures found in **Appendix R.7**
- It is recommended that subjects are treated for a minimum of three months with dual anti-platelet medication
 - If the patient is on warfarin therapy post-procedure it is recommended that subjects are prescribed either daily:
 - Aspirin (75 to 325 mg) **or**
 - Clopidogrel (75 mg) (or ticlopidine, if clopidogrel is contraindicated) for at least three months following the procedure
 - If the patient will **not** be on warfarin therapy post-procedure it is recommended that subjects are prescribed daily:
 - Aspirin (75to 325 mg) **and**
 - Clopidogrel (75 mg) (or ticlopidine, if clopidogrel is contraindicated) for at least three months following the procedure
- Concomitant medications
- Adverse events review
 - Document all adverse events, including all unanticipated adverse device effects (UADE) or unanticipated serious adverse device effects (USADE), technical observations, reinterventions or repeat admissions to the catheterization suite and deaths
 - Any patient with evidence of a new neurological event should have a neurology consult and subsequently an imaging trial if deemed necessary by the neurologist or stroke specialist
 - Any patient exposed to substantial radiation dose levels, as outlined in **Appendix R.23**, should be assessed for skin reactions

Post-Procedure Pacing Guidelines

- All patients should stay on telemetry until discharge
- Maintain temporary pacing until at least 48 hours post-implant in Cardiovascular Intensive Care Unit (CV-ICU) or local equivalent
- After 48 hours, obtain ECG and assess patient rhythm and conduction
- Based on assessment, and with the consult of an electrophysiologist as needed, take one of the following actions:
 - Discontinue temporary pacing
 - Continue temporary pacing for another 24 hours (longer if needed) to make further assessments
 - Place a permanent pacemaker according to ACC/AHA/HRS Guidelines for Device-Based Therapy of Cardiac Rhythm Abnormalities (Class I or IIb for Acquired Atrioventricular Block in Adults or Permanent Pacing in Chronic Bifascicular Block) as outlined in **Appendix R.13**
 - Prior to the permanent pacemaker implantation, document the reason for the placement of the permanent pacemaker via a 12-lead ECG
 - For complete heart block, review patient medications
 - Consider withholding some medications to assess for patient's intrinsic rate and conduction
 - If heart block persists off medications, a permanent pacemaker should be considered
 - If a permanent pacemaker is required, a dual chamber system is recommended to optimize patient hemodynamics
 - For additional information refer to the Pacing Guidelines in **Appendix R.13**

C.4.7.2 Surgical Aortic Valve Replacement

Minimum Standards for Surgical Aortic Valve Replacement

Subjects randomized to SAVR should be treated according to the surgeon and hospital's standard practices. The surgeon or co-surgeon performing the SAVR must be a trial investigator for the site. The choice of surgical valve is left to the discretion of the investigator. **However, the use of a bioprosthetic valve is required.**

SAVR must be conducted as an isolated procedure with exception of subjects that have been randomized to SAVR with revascularization (eg. Aortic replacement or Maze procedures are not permitted). In cases of significant coronary artery disease that requires revascularization coronary artery bypass grafting (CABG) will be conducted concomitantly with SAVR.

Additional concomitant cardiac and non-cardiac procedures are not permitted with the exception of the procedures outlined under Additional Procedural Considerations.

General Procedural Considerations

One of the key requirements for good surgical outcome is an excellent collaboration of the dedicated multidisciplinary teams consisting of typically two cardiac surgeons with SAVR experience, a cardiac anesthesia team, an experienced cardio technician as well as at least two operation theater nurses.

Operation Theater

Surgical aortic valve replacement is to be performed in an operative theater with state-of-the-art technical equipment with certified sterility standards, adequate illumination, laminar flow, dedicated scrub nurses, and on site full technical support.

Perfusion

A dedicated, experienced perfusion team with greater than 75 Extracorporeal Circulation (ECC) runs per cardio technician per year who can perform all current cardioplegia strategies and is familiar with deep hypothermic circulatory arrest (DHCA) is recommended. The perfusion team should be capable of covering the full heart surgical spectrum including CABG, heart valve defect (HVD), Heart failure and assist devices, extracorporeal membrane oxygenation (ECMO) support, intra-aortic balloon pump (IABP), and cardiac transplant.

Pre-Procedure

- Pre-medication recommendations:
 - Discontinue warfarin therapy 3 days prior to the procedure, if applicable
 - Confirm that the INR < 1.8 prior to the procedure
 - Administer antiplatelet therapy, per local standards
 - Consider adjunctive proton pump inhibitors, H₂ receptor antagonists or antacids
- Routine Laboratory Tests:
 - Complete Blood Count
 - White Blood Count
 - Hematocrit
 - Hemoglobin
 - Platelet Count
 - Creatinine and Creatinine Clearance
 - If the GFR < 60 cc/min, consider:
 - Discontinuation of NSAIDs and ACE inhibitors
 - Cardiac Enzymes (CK/CK-MB)
 - International Normalized Ratio (INR), if applicable
 - Activated Partial Thromboplastin Time (aPTT)
 - B-type Natriuretic Peptide (BNP) or NT-proBNP
 - Liver Panel:
 - ALT
 - AST
 - Albumin
 - Sodium
 - Potassium
- 12-Lead Electrocardiogram
- One hour prior to the procedure, prophylactic antibiotic therapy of the Investigator's choice should be initiated:
 - Cefuroxime 750mg IV 1 hour pre-procedure, then 6 hours and 12 hours post-procedure
 - If allergic to Penicillin, prescribe Vancomycin 1g IV
 - Consider holding anti-hypertensives

Surgical Considerations

Surgical aortic valve replacement is typically performed with cardio-pulmonary bypass (CPB) on an arrested heart with a clamped aorta. Local practice and surgical standards should govern type of cardioplegia and the temperature/flow/pressure perfusion strategy as well as the activated clotting time used at either institution for safe CPB. Typically a minimum of 2 liters/m²/minute with a systemic arterial blood pressure of 60mmHg during CPB should be maintained and possibly increased in the elderly patients.

Cannulation for isolated SAVR CPB should be ascending aorta for arterial return unless there is ascending aortic arteriosclerosis or dilatation (>4cm in diameter), and right atrial for venous drainage. Embolic devices are not routinely used in SAVR.

Typical surgical workflow and general procedural recommendations

- *Procedural set-up and Anatomic Evaluation:*
 - The patient is prepared and draped
 - IV antibiotics should be administered following the local standard of care
 - Following the presternal skin incision the sternum is split
 - Prepare the mediastinum and open the pericardium
 - Inspect the ascending aorta for calcifications (including epiaortic scan if necessary)
 - Complete heparin application and arterial and venous cannulation
 - Initiate CPB, and at surgeons discretion, left heart venting via right upper pulmonary vein or pulmonary artery
 - Cross clamp the aorta and initiate cardioplegic arrest
 - Perform an aortotomy
 - Complete annular decalcification (the surgeon should take all possible means to prevent embolization of debris)

- *Prosthesis Specific Sizing:*
 - If the aortic annulus does not permit valve replacement with a patient matched valve diameter, the aortic annulus should be enlarged at the surgeon's discretion

- *Valve Preparation and Implantation:*
 - The valve prosthesis should be prepared following the manufacturer recommendations
 - After rinsing bioprosthetic valves should be kept wet throughout the procedure
 - Anchoring of the prosthesis with, for example, interrupted Teflon reinforced Tycron sutures or an equivalent technique is recommended
 - De-air and close the aortotomy
 - Insert temporary ventricular and atrial pacing wires and chest tubes
 - Wean from ECC hemostasis
 - Complete sternal wiring and layered closure

- *Additional Procedural Considerations:*
 - In case of concomitant significant subvalvular left ventricular outflow tract occlusion (LVOTO) then resection is recommended
 - If there is a significant patent foramen ovale (PFO) closure is recommended in cases of substantial right to left flow
 - It might be recommendable to apply CO₂ surgical field flooding to ease de-airing

- *Intraoperative Aortic Assessment*
 - Transesophageal echo (TEE) is recommended in all cases to additionally assess for aortic calcifications before manipulating the aorta. In case of doubt an Epiaortic scan might further help for surgical decision making
 - Additionally the TEE should be used to assess for subvalvular LVOTO and patent foramen ovale

- *Before Termination of Surgery Repeat Intraoperative TEE*
 - TEE is recommended to assess the postoperative SAVR result
 - Assessment should include aortic valve function, central or paravalvular leakage, valve gradient, exclude remaining LVOTO from subvalvular stenosis as well as ventricular function with special emphasis on new segmental wall function abnormalities.
 - Any regurgitation of more than trace should be critically evaluated and at surgeon's discretion the valve re-inspected and if necessary changed.

Immediate Post-Procedure

The procedure is considered complete at the time of skin closure. Immediately post-procedure the following tests and procedures must be performed and data collected:

- Cardiac Enzymes: CK within 8-12 hours post procedure and at any time when a clinical ischemic event is suspected.
 - CK-MB is required if CK is elevated >2X the laboratory upper limit of normal.
 - If a clinical event is confirmed, a total of 3 draws of cardiac enzymes within the first 24 hours (drawn approximately every 8 hours) following the clinical event should be obtained
- Concomitant Medications
- 12-lead Electrocardiogram (ECG) to be performed within 48 hours of procedure
- Abbreviated Neurological Assessment
 - National Institute of Health Stroke Scale (NIHSS) to be completed within 24 hours of procedure
- Transthoracic Echocardiogram (TTE)
 - Comprehensive transthoracic 2D echocardiogram (TTE) should be performed at least 24hours post-procedure but prior to discharge to assess device success (and no later than 7 days, whichever comes first)
 - Echocardiograms will be performed according to Echocardiography Procedures found in **Appendix R.7**
- Adverse Event review

Post-Procedural Medication

- It is recommended that subjects are treated with aspirin (75-325mg daily) for a minimum of three months
- If warfarin therapy is indicated (eg. A-fib): maintain therapeutic anticoagulation with Heparin or Low Molecular Weight Heparin until INR between 2 and 3 is reached after loading with warfarin
- The preoperative antibiotic therapy may be repeated within the next 6 to 12 hours
- All patients should receive DVT prophylaxis with Heparin/LMWH starting approximately 6 hours after SAVR if bleeding permits
- Following the current recommendation all patients with prosthetic heart valves need endocarditis prophylaxis

Post-Procedure Pacing Guidelines

- All patients should stay on telemetry until discharge
- Maintain temporary pacing until at least 48 hours post-implant in CV-ICU or local equivalent
- After 48 hours, obtain ECG and assess patient rhythm and conduction
- Based on assessment, and with the consult of an electrophysiologist as needed, take one of the following actions:
 - Discontinue temporary pacing
 - Continue temporary pacing for another 24 hours (longer if needed) to make further assessments
 - Place a permanent pacemaker according to ACC/AHA/HRS Guidelines for Device-Based Therapy of Cardiac Rhythm Abnormalities (Class I or IIb for Acquired Atrioventricular Block in Adults or Permanent Pacing in Chronic Bifascicular Block) as outlined in **Appendix R.13**
 - Prior to the permanent pacemaker implantation, document the reason for the placement of the permanent pacemaker via a 12-lead ECG
 - For complete heart block, review patient medications
 - Consider withholding some medications to assess for patient's intrinsic rate and conduction
 - If heart block persists off medications, a permanent pacemaker should be considered
 - If a permanent pacemaker is required, a dual chamber system is recommended to optimize patient hemodynamics
 - For additional information refer to the Pacing Guidelines in **Appendix R.13**

C.4.8 Assessments done at discharge (both SAVR and TAVI)

Prior to hospital discharge (or within 7 days post-index procedure, whichever occurs first) the following tests and procedures must be performed and data collected:

- Physical Examination
 - Vital signs
 - Major system findings
 - Skin Assessment – refer to Radiation Exposure and Data Collection, **Appendix R.23**
- Concomitant Medications
 - Use of relevant medications (diuretics, aspirin, anticoagulants, ACE-I, ARB, beta-blockers, statins and anti-platelets)
- Routine Laboratory Tests:
 - Complete Blood Count:
 - White Blood Count
 - Hematocrit
 - Hemoglobin
 - Platelet Count
 - Creatinine and Creatinine Clearance
 - Cardiac Enzymes (CK/CK-MB)
 - International Normalized Ratio (INR), if applicable
 - Activated Partial Thromboplastin Time (aPTT)
 - B-type Natriuretic Peptide (BNP) or NT-proBNP
 - Liver Panel:
 - ALT
 - AST
 - Albumin
 - Sodium
 - Potassium
- Neurological Assessments
 - National Institute of Health Stroke Scale (NIHSS)
 - Modified Rankin Score (mRS)
 - Mini-Mental State Exam (MMSE-2:SV)
 - Additional Neurological testing:
 - Visual Fields Testing
 - Gait Assessment
 - Hand Function
 - Writing Evaluation
 - Drawing Assessment
- Transthoracic Echocardiogram (TTE)
 - Comprehensive transthoracic 2D echocardiogram (TTE) should be performed at least 24hours post-procedure but prior to discharge to assess device success (and no later than 7 days, whichever comes first)
 - Echocardiograms will be performed according to Echocardiography Procedures found in **Appendix R.7**
- 12-lead Electrocardiogram
- Adverse Event review

C.4.9 Follow-Up Evaluations

All randomized subjects will undergo in-clinic follow-up evaluations at the following time points post implant.

All follow-up periods are defined as the number of days after the date of the index procedure (TAVI or SAVR).

Day 0 = day of index procedure (TAVI or SAVR):

- 30 days (- 7 days and + 14 days)
- 3 months (90 ± 14 days)
- 6 months (180 ± 30 days)
- 12 months (365 ± 30 days)
- 18 months (545 ± 60 days)
- 24 months (730 ± 60 days)
- 3 years (1080 ± 60 days)
- 4 years (1440 ± 60 days)
- 5 years (1800 ± 60 days)

All randomized subjects will complete long-term follow-up through at least 5 years. Based on clinical assessments or regulatory requirements, follow-up may be extended to up to 10 years post-index procedure. Upon completion of the final protocol visit (discontinuation) subject participation will be considered complete and the patient should then be followed per the local standard of care for their condition.

Note: For subjects where the Index Procedure is never attempted (eg. subject withdraws consent for the procedure but agrees to complete follow-up) follow-up intervals will be calculated from the 31st days post-randomization (i.e. the 1st day after the 30 day window from randomization to complete the Index Procedure).

C.4.9.1 30 Days

The following assessments will be conducted at the 30 day visit.

- Physical examination
 - Vital signs
 - Major system findings
 - Skin Assessment – refer to Radiation Exposure and Data Collection, **Appendix R.23**
- NYHA classification
- Concomitant Medications
 - Use of relevant medications (diuretics, aspirin, anticoagulants, ACE-I, ARB, beta-blockers, statins and anti-platelets)
- Routine Laboratory Tests:
 - Hemoglobin
 - Creatinine and Creatinine Clearance
- Abbreviated Neurological Assessment
 - National Institute of Health Stroke Scale (NIHSS)
- 12-lead Electrocardiogram
- 6 Minute Walk Test
- Quality of Life Questionnaires
- Adverse Event review

C.4.9.2 3 Months

The following assessments will be conducted **via telephone** at the 3 Month visit.

- Quality of Life Questionnaire
 - EQ-5D
 - SF-36 – in selected geographies. Refer to **Appendix R.12** for instructions on which geographies are required to collect the questionnaire

C.4.9.3 6 Months

The following assessments will be conducted at the 6 Month visit.

- Physical examination
 - Vital signs
 - Major system findings
- NYHA classification
- Concomitant Medications
 - Use of relevant medications (diuretics, aspirin, anticoagulants, ACE-I, ARB, beta-blockers, statins and anti-platelets)
- Abbreviated Neurological Assessment
 - National Institute of Health Stroke Scale (NIHSS)
- Transthoracic Echocardiogram (TTE)
- 12-lead Electrocardiogram
- Quality of Life Questionnaires
- Adverse Event Review

C.4.9.4 12 Months

The following assessments will be conducted at the 12 Month visit.

- Physical examination
 - Vital signs
 - Major system findings
- NYHA classification
- Concomitant Medications
 - Use of relevant medications (diuretics, aspirin, anticoagulants, ACE-I, ARB, beta-blockers, statins and anti-platelets)
- Neurological Assessments
 - National Institute of Health Stroke Scale (NIHSS)
 - Modified Rankin Score (mRS)
 - Mini-Mental State Exam (MMSE-2:SV)
 - Additional Neurological testing:
 - Visual Fields Testing
 - Gait Assessment
 - Hand Function
 - Writing Evaluation
 - Drawing Assessment
- Transthoracic Echocardiogram (TTE)
- 12-lead Electrocardiogram
- 6 Minute Walk Test
- Quality of Life Questionnaires
- Adverse Event review

C.4.9.5 18 Months

The following assessments will be conducted at the 18 Month visit.

- Physical examination
 - Vital signs
 - Major system findings
- NYHA classification
- Concomitant Medications
 - Use of relevant medications (diuretics, aspirin, anticoagulants, ACE-I, ARB, beta-blockers, statins and anti-platelets)
- Abbreviated Neurological Assessment
 - National Institute of Health Stroke Scale (NIHSS)
- 12-lead Electrocardiogram
- Quality of Life Questionnaires
- Adverse Event review

C.4.9.6 24 Months

The following assessments will be conducted at the 24 Month visit.

- Physical examination
 - Vital signs
 - Major system findings
- NYHA classification
- Concomitant medications
 - Use of relevant medications (diuretics, aspirin, anticoagulants, ACE-I, ARB, beta-blockers, statins and anti-platelets)
- Neurological Assessments
 - National Institute of Health Stroke Scale (NIHSS)
 - Modified Rankin Score (mRS)
 - Mini-Mental State Exam (MMSE-2:SV)
 - Additional Neurological testing:
 - Visual Fields Testing
 - Gait Assessment
 - Hand Function
 - Writing Evaluation
 - Drawing Assessment
- Transthoracic Echocardiogram (TTE)
- 12-lead Electrocardiogram
- 6 Minute Walk Test
- Quality of Life Questionnaires
- Adverse Event review

C.4.9.7 3-5 Years

The following assessments will be conducted at the 3, 4, and 5 year visits.

- Physical examination
 - Vital signs
 - Major system findings
- NYHA classification
- Abbreviated Neurological Assessment
 - National Institute of Health Stroke Scale (NIHSS)
- Transthoracic Echocardiogram (TTE)
- 12-lead Electrocardiogram
- Quality of Life Questionnaires
- Adverse Event review – refer to C.5.2 Reporting for AE reporting requirements post-24 Months

C.4.10 Echo Assessment

Echocardiography is the cornerstone of baseline and follow-up imaging. A comprehensive transthoracic echocardiogram (TTE) to assess the morphology and function of the respective heart chambers and valves is mandatory prior to implant. Calculation of LVEF by visual assessment, measurement of left ventricular end-diastolic volume and diameter and inter-ventricular septal thickness to characterize the left ventricle and transaortic jet velocity, mean transaortic gradient and aortic valve area by the continuity equation to illustrate AS severity are essential(1).

Echo assessment will be conducted by a core laboratory.

Sites should make every effort to utilize the same echo machine for all subjects at all required interval throughout the duration of the protocol.

C.4.11 Neurologic Assessment

The incidence of new clinically detectable neurological events or deficits, or any comparative change in indices of higher cognitive function following TAVI in the treatment of patients with symptomatic severe aortic stenosis is an important clinical endpoint. Therefore, a baseline and follow-up neurological examination by a qualified trial-trained neurologist or stroke specialist is mandatory and as outlined in section C.4.9 Follow-Up Evaluations. Abbreviated Neurological Assessments, requiring completion of only the NIHSS, may be conducted by certified site personnel.

If at any time there is change in a subject's NIHSS score of ≥ 4 further assessments should be conducted to identify potential adverse events and additional neurological evaluations should be conducted by a neurologist or stroke specialist, if a neurological event is suspected.

In case of a new neurological event, the diagnosis of stroke should be supported by complementary findings on neuro-imaging examination. The need for additional imaging is up to discretion of the Neurologist or Stroke Physician. Both diffusion-weighted Magnetic Resonance imaging and multi-slice Computed Tomography are valid neuro-imaging modalities (however CTA or MRA is preferred to CT or MRI), the selection of which will be left per institution's standard of care.

In addition to the neurological assessments at specified time periods, additional evaluations should be conducted, as follows during the course of the trial, if applicable:

- NIHSS:
 - For subjects with a new neurological event (stroke, TIA, or encephalopathy), additional NIHSS exams are to be performed at 30 days, and 3 months post-event
 - NIHSS also to be done within 24 hours of any aortic valve or ascending aortic intervention
 - Any patient with evidence of a new neurological event should have a neurology consult and an imaging study if deemed necessary
 - *NIHSS may be conducted by certified site personnel*
- Modified Rankin Scale
 - For subjects with new neurological event, assessment to be performed at 7 days or discharge (whichever occurs first), 30 days, and 3 months post-stroke
 - *All trial-required mRS testing should be conducted by a neurologist or stroke specialist*
- Mini Mental State Exam (MMSE-2:SV)
 - For subjects with a new neurological event assessments are to be performed at 30 days and 3 months post-stroke
 - *All trial-required MMSE testing should be conducted by a neurologist or stroke specialist*

Refer to the **Appendix R.18** for a description of the Additional Neurological Testing.

C.4.12 Angiographic and Computed Tomography Assessment

Complete angiographic (invasive or MSCT) assessment of the aortic bifurcation and ilio-femoral-arterial tree is mandatory prior to the Heart Team review.

An additional benefit of Multislice CT scan in the TAVI cohort is to obtain a thorough assessment of the anatomy of the left ventricular outflow tract (LVOT) up to the common femoral arteries.

MSCT also provides information on coronary and carotid anatomy, and might identify occult malignancy which is also valuable information in SAVR cohort.

The aortic valve calcification should be evaluated to determine grade of severity. With respect to the elliptical shape of the virtual aortic annulus, the axial plane where the 3 basal aortic leaflet attachments can be identified simultaneously is used for measuring the maximum and minimum annular diameter (most often corresponding to 2 orthogonal sagittal and coronal planes)(53).

Additionally the maximum diameters of the LVOT, sinuses of Valsalva and sinotubular junction are obtained. Maximum diameter, calcification and tortuosity of the ascending and descending thoracic aorta are evaluated. As for the iliofemoral tree, the minimal luminal diameter, plaque and calcification burden and tortuosity are assessed in order to judge transfemoral accessibility for the investigational TAVI device.

C.4.13 Data Collection

All scheduled testing and procedures to be conducted during the baseline, index procedure, and follow-up assessments are summarized in **Table 3**.

Table 3: Schedule of Assessments

Parameter	Screening	RANDOMIZATION	Baseline	Procedure	Discharge	30 days	3 Months	6 Months	12 Months	18 Months	24 Months	3 – 5 years
			(within 14 days of procedure)									
Informed consent (and in US HIPAA Authorization)	•											
Inclusion/Exclusion	•			•*								
Demographics and Medical history	•											
Physical Examination	•		•		•	•		•	•	•	•	•
Clinical Assessments	•											
NYHA Class	•		•			•		•	•	•	•	•
Risk Assessments: STS Risk Score, Logistic EuroSCORE, EuroSCORE II, SYNTAX Score, and Katz Index	•											
Co-morbidities	•											
Concomitant Medications ¹¹			•	•	•	•		•	•	•	•	
Routine Laboratory Tests	•		•	• ^{1,2}	•	• ³						
Neurological Assessments ⁷ (NIHSS, mRS, MMSE-2:SV and Additional Neurological Assessments) ⁹			•		•				•		•	
Abbreviated Neurological Assessment (NIHSS only)				• ⁸		•		•		•		•
Transthoracic Echocardiogram (TTE)	•			• ⁵				•	•		•	•
Computed Tomography (CT) Angiogram (MSCT required at screening) ⁶	•											
Coronary Arteriogram	•			(•)								
Aortogram				(•)								
12-lead Electrocardiogram	•		•	• ⁴	•	•		•	•	•	•	•
6 Minute Walk Test			•			•			•		•	
Quality of Life Questionnaires (EQ-5D, KCCQ, and SF-36)			• ¹²			•	• ¹³	•	•	•	•	•
Adverse Events			•	•	•	•		•	•	•	•	• ¹⁰

- * Document any changes to subject condition that affect inclusion/exclusion criteria, confirm the subject does not meet any exclusion criteria specific to the Index Procedure (eg. percutaneous coronary or peripheral intervention and evidence of an acute myocardial infarction which must not occur within 30 days prior to the index procedure)
- (•) TAVI subjects only (SAVR subjects will not have these assessments)
 - ¹ Laboratory test results must be performed pre-procedure and CK to be obtained within 8-12 hours post-procedure
 - ² Pre-procedure
 - ³ Only hemoglobin, creatinine and creatinine clearance are required to be collected
 - ⁴ Electrocardiogram within 48 hours post-procedure
 - ⁵ TTE to be completed at least 24hours post-procedure but prior to discharge (and no later than 7 days post procedure) to assess device success
 - ⁶ All subjects should have screening thoracic and abdominal CT angiograms with complete visualization of both iliacs, femorals, and aorta (and subclavian/axillaries, if applicable), up to and including the aortic annulus
 - ⁷ In addition to the protocol required assessment (NIHSS and MMSE); for subjects with neurological event or stroke, additional NIHSS and MMSE exams are to be performed at 30 days and 90 days post-event. mRS should be completed at 7 days post-event or discharge (whichever occurs first), 30 days, and 90 days post-event. NIHSS is also to be done within 24 hours of any aortic valve or ascending aortic intervention
 - ⁸ NIHSS to be done within 24 hours post- procedure
 - ⁹ Additional Neurological Assessments include: Visual Fields Testing, Gait Assessment, Hand Function, Writing Evaluation, and Drawing Assessment
 - ¹⁰ SAE, MAE, cardiovascular events, device-related events, including device-related technical observations, UADEs, USADEs, all stroke (CVAs), and death reports
 - ¹¹ Use of relevant medications (diuretics, aspirin, anticoagulants, ACE-I, ARB, beta-blockers, statins and anti-platelets)
 - ¹² Quality of Life Questionnaires collected at baseline may be administered any time after the subject has provided informed consent but should be collected prior to informing the subject of randomization assignment
 - ¹³ Quality of Life Questionnaire – EQ-5D to be administered via telephone. SF-36 will also be collected in selected geographies, refer to **Appendix R.12**

C.4.14 Unscheduled Follow-up Assessments

If a subject returns to the institution between their scheduled follow-up visits the visit will be treated as an unscheduled visit and the assessments completed at this visit will be done at the discretion of the investigator. eCRFs are provided for unscheduled visits.

C.4.15 Missed Follow-up Visits

Every effort should be made to ensure subjects return to the clinic for all protocol required follow-up. If the subject is unable to return for an in-person clinic visit, the Investigator, or designee, must document in the patient record the reason the subject was unable to complete the visit and, if applicable, follow the requirements for deviation reporting as outlined in Section C.4.18 Protocol Deviations.

The Investigator should also make every effort to contact the subject or subject's legal representative, within the visit window, to collect the subject's vital status as well as information related to potential adverse events, safety data, and hospitalizations.

C.4.16 Investigational Product Accountability

The Investigator is responsible for maintenance of the Device Accountability Log. The log must detail the product and lot numbers as well as the location and status of all investigational devices (including DCS,CLS/ LS components, where applicable) received by the hospital and/or Investigator. At the end of the clinical trial the Principal Investigator must sign the original log, as applicable.

This clinical trial will be conducted in some geographies where the TAV device or its components are commercially available. In these geographies, the device will be used outside the current approved indication; therefore the TAV will be labeled as investigational. Note, the DCS and CLS/LS components are identical to the CE marked CoreValve System and will be supplied within the approved commercial CE marked labeling. The Investigator must provide full accountability for each TAV from the time of receipt through disposition and/or return. Accountability for the each DCS and CLS/LS must include all dispositions within the clinical trial. In the US, commercially labeled devices may be used in the trial, as necessary in the event that the investigational device is not available. All commercial components must have full accountability for each component from the time of receipt through disposition and/or trial. In the event that a commercial device is used in a study subject, the device use will be documented in the Device Accountability Log.

In geographies where the device is not currently approved, the TAV, DCS, CLS/LS components will be labeled as investigational. The Investigator must provide full accountability for each TAV, DCS, and CLS/LS from the time of receipt through disposition.

At the end of the trial enrollment period, all remaining investigational product must be returned to Medtronic.

C.4.17 Device Malfunction or Explant

In the event of a device malfunction of the TAV device or its components prior to implant or in the event that a TAV is explanted after implant (due to reintervention or autopsy), the TAV and/or affected components should be returned to Medtronic to the following:

Medtronic, Inc.
Attn: Explant Lab [PE#]
1851 E. Deere Avenue
Santa Ana, CA 92705-5720

Additional details surrounding the device return process, including how to obtain the PE # (product experience number), are contained within the Medtronic explant kit and in **Appendix R.11**.

C.4.18 Protocol Deviations

A protocol deviation is defined as an event where the clinical investigator or site personnel did not conduct the trial according to the protocol or the Investigator agreement. Deviations will be reported regardless of whether medically justifiable, pre-approved by Medtronic, or taken to protect the patient in an emergency.

A protocol deviation form is to be completed for each trial protocol deviation, including, but not limited to:

- Failure to obtain informed consent
- Incorrect version of consent provided to patient
- Failure to obtain IRB/MEC protocol review and approval before starting the trial
- Enrollment of patient during an IRB/MEC approval lapse
- Clinical investigator exceeding enrollment limits specified by sponsor
- Patient did not meet inclusion/exclusion criteria
- Incorrectly performed testing
- Protocol-required testing and/or measurements not done or performed outside of window
- Source data permanently missing
- SAE, SADE, UADE or USADE not reported in the required timeframe

FDA regulations [21 CFR 812.140] require that the Investigator maintain accurate, complete, and current records, including documents showing the dates of and reasons for each deviation from the protocol. Relevant information for each deviation will be documented on a deviation form completed by site personnel and reviewed by the Investigator.

FDA regulations [21 CFR 812.150], ISO 14155 (2011), and local regulatory authorities (where applicable), require Investigators to obtain prior approval from the sponsor before initiating changes in or deviations from the protocol, except when necessary to protect the life or physical well-being of a patient in an emergency.

Prior approval by the sponsor is expected in those situations in which the Investigator anticipates, contemplates or makes a conscious decision to depart from procedures specified in the protocol. Prior approval is generally not expected in situations where unforeseen circumstances are beyond the Investigator's control, but is still considered a deviation (eg. a trial subject who fails to attend a scheduled follow-up visit, a trial subject too ill to perform a protocol-required test). To obtain approval, the Investigator must call or email and discuss the potential deviation with the Medtronic trial manager or designee prior to initiating any changes. If approval is granted, the Medtronic trial manager or designee will provide the applicable documentation to be maintained in the site files.

FDA regulations require the Investigator to notify the sponsor and the reviewing IRB/MEC within 5 working days of the following deviations [21 CFR 812.150]:

- a deviation from protocol to protect the life or physical wellbeing of a patient in an emergency
- failure to obtain an informed consent

Investigators or an authorized designee must notify Medtronic as soon as possible by calling the trial manager or designee and completing the protocol deviation form.

The Investigator is required to adhere to local IRB/MEC procedures for reporting deviations.

The DSMB may review protocol deviations to ensure compliance and overall trial integrity.

C.4.19 Subject Withdrawal or Discontinuation

All subjects will be encouraged to remain in the trial through the last follow-up visit at month 60. Subjects who discontinue participation prematurely after randomization will be included in the analysis of results (as appropriate) but they will not be replaced in the enrollment of total trial subjects. If a trial subject is discontinued from the trial early, the reason for discontinuation should be documented in the patient file and a Study Exit eCRF must be completed. If discontinuation is because of safety concerns or lack of effectiveness, the subject shall be asked to be followed for collection of ongoing safety data outside the clinical investigation.

The trial site and Sponsor will make every effort to have all subjects complete the follow up visit schedule. A subject will not be considered lost-to-follow-up unless all efforts to obtain compliance are unsuccessful. At a minimum, the effort to obtain follow-up information must include three attempts to make contact via telephone and if contact via phone is not successful, a traceable letter from the Investigator must be sent to the subject's last known address. Should both telephone and mail efforts to contact the subject be unsuccessful, the subject's primary physician should be contacted. Subjects will then be deemed lost to follow up. All contact efforts to obtain follow-up must be documented in both the subject's medical records and in the trial eCRFs.

If a subject officially withdraws from the trial but is willing to allow either regular vital status determinations for the trial or a one-time vital status determination, these are to be conducted per the follow-up visit schedule or only at the last planned follow-up visit, respectively, and may be conducted via telephone.

If a subject discontinues the trial at any time, is withdrawn from the trial early, or completes all protocol required follow-up they should then be followed per the local standard of care for their condition.

C.4.20 Termination or Discontinuation of Trial

Medtronic may decide to suspend or prematurely terminate the trial. If the trial is terminated prematurely or suspended, Medtronic shall promptly inform the clinical investigators of the termination or suspension and the reason(s) for this. The investigator shall then promptly inform the reviewing MEC/IRB.

Possible reasons for early trial termination include:

- Unanticipated Adverse Device Effect (UADE) or Unanticipated Serious Adverse Device Effect (USADE) presents an unreasonable risk to patients
- Recommendation from DSMB (eg. significant safety concerns, statistical futility)

If the trial is terminated early, the Sponsor will, as soon as possible, provide a written statement to the Investigators to enable prompt notification of the IRB/MECs. The Sponsor will also inform the FDA. If the trial enrollment is terminated early, the follow-up visits will continue for all enrolled subjects.

C.5 Adverse Events

C.5.1 Definitions

The definitions presented in this section allow for a clear understanding of adverse event data collection and subsequent analysis.

C.5.1.1 Adverse Event

An adverse event (AE) is any untoward medical occurrence, unintended disease or injury, or untoward clinical signs (including abnormal laboratory findings) in subjects, users or other persons, whether or not related to the investigational medical device.

NOTE 1: This definition includes events related to the investigational medical device or the comparator.

NOTE 2: This definition includes events related to the procedures involved.

NOTE 3: For users or other persons, this definition is restricted to events related to investigational medical devices.

The following events in **Table 4** are expected to occur with any surgical implant and therefore should not be reported as AEs, unless they occur outside of the stated timeframe:

Table 4: Expected Events

Description of the Event	Timeframe (hours) from Procedure
Anesthesia-related nausea and/or vomiting	24
Low-grade fever (<100°F or <37.8°C)	48
Back pain related to laying on the procedure table	72
Incisional pain (pain at access site)	72
Sleep problems or insomnia	72
Mild to moderate bruising or ecchymosis	168

C.5.1.2 Serious Adverse Event

A serious adverse event (SAE) is an event that:

- Led to death
- Led to serious deterioration in the health of the subject, that either resulted in:
 - a life threatening illness or injury, or
 - a permanent impairment of a body structure or a body function, or
 - inpatient or prolonged hospitalization, or
 - medical or surgical intervention to prevent life-threatening illness or injury or permanent impairment to a body structure of a body function
- Led to fetal distress, fetal death or a congenital anomaly or birth defect

NOTE: Planned hospitalization for a pre-existing condition, or a procedure required by the CIP, without serious deterioration in health, is not considered a serious adverse event.

In addition to above standard definition of SAE, the following events will also be defined as serious in the SURTAVI Trial, including events that do not meet the above criteria for SAE.

- Stage 2 and 3 acute renal injuries
- Life-threatening and Major bleeding events
- Any new or worsening LBBB or RBBB that requires the placement of a permanent pacemaker and/or surgical or invasive intervention
- All myocardial infarctions
- Disabling strokes
- Major vascular complications

Events that do not meet these criteria are considered non-serious.

C.5.1.3 Major Adverse Cardiovascular and Cerebrovascular Events

Major adverse cardiovascular and cerebrovascular events (MACCE) is defined as a composite of:

- All-cause death
- Myocardial infarction (MI)
- All stroke, and

- Reintervention (defined as any cardiac surgery or percutaneous reintervention catheter procedure that repairs, otherwise alters or adjusts, or replaces a previously implanted valve)

C.5.1.4 Major Adverse Event

Major adverse event (MAE) includes:

- MACCE
- Acute kidney Injury
- Cardiac tamponade
- Prosthetic valve dysfunction
- Cardiogenic shock
- Prosthetic valve endocarditis
- Life-threatening, disabling or major bleeding
- Major vascular complication
- Cardiac perforation
- Valve malpositioning

C.5.1.5 Adverse Device Effect (ADE) or Device-Related Adverse Event

An ADE is an adverse event related to the use of an investigational medical device. During this clinical investigation an event should be considered related to the device when it is the result of the Medtronic CoreValve™ System (MCS) System:

- The transcatheter aortic valve (TAV)
- The delivery catheter system (DCS)
- The compression loading system (CLS/LS)
- The implant procedure

An event should be considered not related to the device when it is the result of:

- A pre-existing medical condition
- A new illness, injury or condition
- Medication

NOTE 1: This definition includes adverse events resulting from insufficient or inadequate instructions for use deployment, implantation, installation, or operation, or any malfunction of the investigational medical device.

NOTE 2: This definition includes any event resulting from use error or from intentional misuse of the investigational medical device.

C.5.1.6 Serious Adverse Device Effects (SADEs)

Adverse device effect that has resulted in any of the consequences characteristic of a Serious Adverse Event.

C.5.1.7 Unanticipated Adverse Device Effect (UADE)

An unanticipated adverse device effect or UADE is defined as “any serious adverse effect on health or safety or any life-threatening problem or death caused by, or associated with, a device, if that effect, problem, or death was not previously identified in nature, severity, or degree of incidence in the protocol or application (including a supplementary plan or application), or any other unanticipated serious problem associated with the device that relates to the rights, safety, or welfare of subjects” [21 CFR 812.3 (s)].

Those known adverse events related to the device, procedure or therapy are listed in Section O and in the Risk/Benefit Analysis section (Section D) of this document.

C.5.1.8 Unanticipated Serious Adverse Device Effect (USADE)

Serious adverse device effect which by its nature, incidence, severity or outcome has not been identified in the current version of the risk analysis report.

NOTE: Anticipated serious adverse device effect (ASADE) is an effect, which by its nature, incidence, severity or outcome has been identified in the risk analysis report.

C.5.1.9 Device Deficiency

Inadequacy of a medical device with respect to its identity, quality, durability, reliability, safety or performance.

NOTE: Device deficiencies include malfunctions, use errors, and inadequate labeling.

C.5.1.10 Technical Observation

A technical observation is a defect, malfunction, or failure of any part of the TAV or its components. This may pertain to the device or system not functioning according to its design intent. Each technical observation (whether or not associated with any untoward medical occurrence in a subject) will be reported on the Adverse Event (AE) eCRF and tabulated as an AE.

C.5.2 Reporting

Investigators are required to keep records on “all relevant observations, including records concerning adverse device effects (whether anticipated or unanticipated)” [21 CFR 812.140; ISO 14155 (2011)]. Adverse event collection will begin from the point of trial enrollment to trial closure. All new or worsening (from baseline) adverse events and technical observations will be captured on the AE eCRF through the 24-month follow-up visit. It is the responsibility of the Investigator to assess the subject for adverse events and capture the required adverse event information on the AE eCRF.

Once a subject has completed their 24-month scheduled follow-up visit only serious adverse events, major adverse events, cardiovascular events, device-related adverse events, including device related technical observations, unanticipated adverse device effects (UADE) or unanticipated serious adverse device effects (USADE), all strokes (CVAs) and deaths will be required to be reported. Reference section C.5.1 Adverse Events for event definitions and criteria. Medtronic representatives or their designees will conduct monitoring visits to review source documentation and verify the complete and accurate capturing of adverse events.

The Investigator must also notify the responsible IRB/MEC regarding new and significant safety information and any event identified by Medtronic that requires expedited FDA, and/or local regulatory agency, reporting as serious, unexpected, and related to the investigational device. It is the responsibility of the investigator to ensure site specific IRB/MEC safety reporting requirements are met.

Medtronic Clinical will ensure all device-related adverse events and all procedure-related SAEs are processed according to internal policies and procedures. When necessary, Medtronic Field Assurance will respond to sites in writing with the findings related to the product experiences.

The general procedure for investigators reporting any adverse event is as follows:

- Report the event to Medtronic as soon as possible but no later than the timeframes outlined below. (At the time of Site Initiation, sites will be provided with the telephone and other applicable contact information of the appropriate Medtronic designee).
- Complete all sections of the Adverse Event eCRF.
- Each unique event/diagnosis must be documented separately.
- Documented pre-existing conditions are not considered to be reportable AEs unless there is a change in the nature or severity of the condition.
- The Adverse Event eCRF must be reviewed by the Investigator.

Reporting guidelines related to specific types of adverse events are outlined below.

C.5.2.1 Serious Adverse Events (SAEs)

The Investigator shall notify the sponsor immediately but not later than within 3 calendar days of first learning of any SAE using the EDC system [MEDDEV 2.7/3]. If necessary, the Investigator may be requested to provide copies of source documentation regarding the event (eg., physician/nurse notes or summaries). The Investigator should also notify their IRB/MEC and, if applicable, local regulatory agencies, per their requirements.

Medtronic will conduct an evaluation of the event and if it is determined by Medtronic to be a UADE or USADE, it will be reported as described in the following sections.

C.5.2.2 Serious Adverse Device Effects

The Investigator shall notify the sponsor immediately, but not later than within 3 calendar days of the first learning of any SADE.

C.5.2.3 Unanticipated Adverse Device Effects (UADE or USADE)

Investigators must report any (potential) unanticipated adverse device effects, or unanticipated serious device effects, to Medtronic and their IRB/MEC immediately but no later than 3 calendar days after first learning of the event [MEDDEV 2.7/3]. UADEs and USADEs should be reported immediately to Medtronic via telephone as well as on an eCRF. The Investigator should also notify their IRB/MEC and, if applicable, local regulatory agencies, per their requirements.

The Investigator should consider the device labeling and the Risk/Benefit Analysis section of this document (Section D) when determining whether an event is unanticipated or not.

If an event is determined by Medtronic to be a UADE or USADE, Medtronic will report the event to all investigators to enable reporting to their respective IRB/MECs. Medtronic will provide this notification within 10 working days after Medtronic first receives notice of the effect. [21 CFR 812.150]

If Medtronic and the DSMB determine that the event presents an unreasonable risk to the participating subjects, Medtronic must terminate all investigations or parts of investigations presenting the risk in the clinical trial 5 working days after making that determination and not later than 15 working days after Medtronic first receives notice of the effect. [21 CFR 812.46] Follow-up visits for enrolled subjects will continue according the schedule of assessments.

C.5.2.4 Device Deficiencies and Technical Observations

Device Deficiency information and Technical Observations will be collected throughout the trial and reported to Medtronic.

Device Deficiencies and Technical Observations should be reported on an Adverse Event eCRF.

Device deficiencies that did not lead to an Adverse Event but could have led to an SADE:

- a) if either suitable action had not been taken,
- b) if intervention had not been made, or
- c) if circumstances had been less fortunate,

require immediate reporting (see **Table 6**). Initial reporting may be done on the eCRF completing as much information as is available. The original completed eCRF must be submitted to Medtronic as soon as possible.

C.5.2.5 All Other Adverse Events

The Investigator shall notify the sponsor within 15 calendar days of first learning of any other AE using the EDC system. If necessary, the Investigator may be requested to provide copies of source documentation regarding the event (eg., physician/nurse notes or summaries).

C.5.2.6 Anticipated Adverse Events

Potential risks associated with TAVI device or its components may include, but are not limited to, the following:

- Death
- Cardiac arrest
- Coronary occlusion, obstruction, or vessel spasm (including acute coronary closure)
- Emergent surgery (eg., coronary artery bypass, heart valve replacement, valve explant)
- Multi-organ failure
- Heart failure
- Myocardial infarction
- Cardiogenic shock
- Respiratory insufficiency or respiratory failure

- Cardiovascular injury (including rupture, perforation, or dissection of vessels, ventricle, myocardium, or valvular structures that may require intervention)
- Perforation of the myocardium or a vessel
- Ascending aorta trauma
- Cardiac tamponade
- Cardiac failure or low cardiac output
- Prosthetic valve dysfunction including, but not limited to:
 - Fracture
 - Bending (out-of-round configuration) of the valve frame
 - Under-expansion of the valve frame
 - Calcification
 - Pannus, (wear, tear, prolapse, or retraction in the valve leaflets)
 - Poor valve coaptation
 - Suture breaks or disruption
 - Leaks
 - Mal-sizing (prosthesis-patient mismatch)
 - Malposition (either too high or too low)/malplacement
 - Regurgitation, stenosis
- Thrombosis/embolus (including valve thrombosis)
- Valve migration/valve embolization
- Ancillary device embolization
- Emergent percutaneous coronary intervention (PCI)
- Emergent balloon valvuloplasty
- Major or minor bleeding that may or may not require transfusion or intervention (including life-threatening or disabling bleeding)
- Allergic reaction to antiplatelet agents, contrast medium, or anesthesia
- Infection (including septicemia and endocarditis)
- Stroke, TIA, or other neurological deficits
- Permanent disability
- Renal insufficiency or renal failure (including acute kidney injury)
- Mitral valve regurgitation or injury
- Tissue erosion
- Vascular access related complications (eg., dissection, perforation, pain, bleeding, hematoma, pseudoaneurysm, irreversible nerve injury, compartment syndrome, arteriovenous fistula, stenosis)
- Conduction system disturbances (eg., atrioventricular node block, left-bundle branch block, asystole), which may require a permanent pacemaker
- Cardiac arrhythmias
- Encephalopathy
- Pulmonary edema
- Pericardial effusion
- Pleural effusion
- Myocardial ischemia
- Peripheral ischemia
- Bowel ischemia
- Heart murmur
- Hemolysis
- Cerebral infarction-asymptomatic
- Non-emergent reoperation
- Inflammation
- Fever
- Hypotension or hypertension

- Syncope
- Dyspnea
- Anemia
- Angina
- Abnormal lab values (including electrolyte imbalance)
- Exposure to radiation through fluoroscopy and angiography
- Delivery catheter malfunction resulting in need for additional re-crossing of the aortic valve and prolonged procedural time

C.5.2.7 Deaths

The Investigator shall notify Medtronic immediately but not later than within 3 calendar days of learning of a subject's death, whether or not the death is related to the investigational device. The Investigator should also notify his/her IRB/MEC and/or local regulatory agencies, if applicable, per their requirements. The Investigator should also attempt to determine, as conclusively as possible, whether such deaths are related to the investigational TAV device or its components. When an autopsy is conducted, a copy of the report should be provided to Medtronic. Medtronic will evaluate the event and if device-related and unexpected, the event will be reported as a UADE or USADE.

Any subject death will be reported on the Study Exit eCRF and accompanied by an Adverse Event eCRF identifying the cause of death.

C.5.2.8 Vigilance Reporting

A product complaint is defined as any written, electronic or oral communication that alleges deficiencies related to the identity, quality, durability, reliability, safety, effectiveness or performance of a medical device that has been placed on the market.

It is the responsibility of the investigator to report all product complaint(s) associated with a medical device distributed by Medtronic, regardless whether they are related to intended use, misuse or abuse of the product. Reporting must be done as soon as possible and without undue delay and via the regular channels for market released products. Note that although the reporting of product complaints is not part of the clinical study, all potential complaints that are collected as part of this study will be reviewed by the responsible person at Medtronic and, if applicable, reported to the designated complaint handling unit. Medtronic will ensure timely reporting to meet global regulatory requirements.

C.5.3 Clinical Events Committee (CEC)

An independent Clinical Events Committee (CEC) will review and adjudicate, at a minimum, all deaths and primary endpoint related adverse events. The CEC will consist of, at a minimum, interventional cardiologists and cardiac surgeons who are not participants in the trial. Additional specialist, such as neurologists, may also be selected as part of the CEC.

The purpose of the CEC is to conduct a medical review and classify/adjudicate, at a minimum, all deaths and/or clinical endpoints collected in the trial according to definitions and processes outlined in the Medtronic CoreValve™ SURTAVI Trial protocol and the CEC charter, which will be developed and approved by Medtronic and the CEC members.

All applicable events will be reviewed and adjudicated by a minimum of two CEC members. All other events will be reviewed and adjudicated by qualified internal Medtronic safety individual(s) to ensure they should not be adjudicated by the full CEC and that the events are appropriately classified by the investigator.

Prior to event adjudication, the CEC will draft a charter to establish explicit rules outlining the minimum amount of data required and the algorithm followed in order to classify/adjudicate a trial endpoint related clinical event. CEC decisions will be documented in meeting minutes, which will be maintained in the trial file.

C.5.4 Data Safety Monitoring Board (DSMB)

An independent, unblinded DSMB will be established and will be comprised of at least 3 experts, including a chairperson. The DSMB will have a minimum of one cardiac surgeon, one interventional cardiologist and one statistician, and will be independent of Medtronic and the trial

investigators. Investigators participating in the trial may participate in the meetings to offer clarification surrounding events, but will not have voting privileges. Medtronic personnel may facilitate the DSMB meeting but will not have voting privileges. The DSMB will meet (via teleconference or in person) prior to the first subject enrollment to establish procedures for DSMB review, chairman appointment and guidelines for trial recommendations. The full DSMB will meet on a periodic basis to perform a comprehensive data review and will meet more frequently when needed. Primary and safety-related secondary endpoints may also be reviewed at these meetings. Meetings will consist of both open and closed sessions.

The DSMB will also perform a supplemental review of, at a minimum, all serious adverse events and deaths and any other data requested by the DSMB on a more frequent periodic basis to ensure patient safety. DSMB members will review the report, and when necessary provide recommendations about the conduct of the trial and/or request a full DSMB meeting.

A DSMB charter will be developed and approved by Medtronic and the DSMB members. The committee will outline the criteria for both the full DSMB meeting and supplemental DSMB reviews within the DSMB charter.

Following each full DSMB meeting, the board will report to Medtronic in writing and may recommend changes in the conduct of the trial. These DSMB recommendations may include recommendations on trial status such as continuing the trial without modifications, continuing the trial with modifications, stopping the enrollment in the trial or a specific trial arm, or recommendations about trial conduct including recommendations around enrollment or protocol deviations.

In the case of UADEs or USADEs, if Medtronic and the DSMB determine that the event presents an unreasonable risk to the participating subjects, Medtronic must terminate the clinical trial within 5 working days after making that determination and not later than 15 working days after Medtronic first receives notice of the effect. [21 CFR 812.46]. All clinical sites will be notified of this action.

The DSMB may call additional meetings if, at any time, there is concern about any aspect of the trial. All data presented at the meetings will be considered confidential and returned to the trial statistician at the closure of the DSMB meeting.

Additional details about the DSMB are outlined in the DSMB charter.

C.6 Statistical Methods and Analysis

C.6.1 Statistical Considerations and Analysis

This section describes the statistical considerations and analysis plans for the SURTAVI trial. The statistical analysis will be performed by the statistics department of Medtronic. As primary analysis all randomized subjects will be analyzed following the modified intention to treat (mITT) approach; ie. analyses will be conducted on the cohort of subjects who undergo an attempted trial treatment, analyzed according to the randomized assignment. A secondary analysis of key objectives will be performed according to the therapy actually received.

Roll-in subjects will not be included in the primary or secondary analysis; however, the data will be summarized separately with descriptive statistics.

All follow-up periods are defined as the number of days after the procedure date.

C.6.2 Reports

Medtronic is responsible for the reports cited in **Table 5** (Sponsor Reporting Responsibilities). These reports are subject to regulatory retention and inspection requirements. In addition to the reports listed in **Table 5**, FDA, Competent Authorities, and local regulatory agencies, where applicable, or the reviewing IRB/MEC may request reports pertaining to any aspect of the clinical trial.

C.6.3 Description of Baseline Variables

Baseline demographic and clinical variables will be summarized for each of the treatment groups for the intention-to-treat (ITT), modified intent-to-treat (mITT), and implanted populations. All continuous variables will be summarized as means, medians, standard deviations, interquartile ranges, minima and maxima and compared between treatment groups using a Bayesian analog of a two-sample t-test or the non-parametric Wilcoxon rank-sum test. Categorical variables will be summarized as frequencies and percentages and compared between treatment groups using a Bayesian version of a comparison of proportions.

C.6.4 Analysis Populations

C.6.4.1 Screening Population

All patients with symptomatic severe AS who provide informed consent will be considered screened and all available data will be entered into the EDC system.

C.6.4.2 Randomized Population

If the patient signs informed consent, meets all inclusion and none of the exclusion criteria, and the Heart Team determines the patient is suitable for randomization in the trial, then the subject is reviewed by the SURTAVI Screening Committee. If the subject is approved by the Screening Committee and the subject is enrolled/randomized to either TAVI or SAVR the subject is added to the randomized population. Within the randomized population three sub-populations are distinguished:

- Intention to treat (ITT) population - Subjects are reported according to the randomized assignment, SAVR or TAVI, regardless of what, if any, therapy was actually received
- Modified intention to treat (mITT) population - Randomized subjects in whom a procedure is attempted. Subjects who undergo an attempted trial treatment are reported according to the randomized assignment, SAVR or TAVI, regardless of what, if any, therapy was actually received. A procedure attempt is defined as when the subject is brought into the procedure room and any of the following have occurred: anesthesia administered, vascular line placed, TEE placed or any monitoring line placed
- Implanted population - population includes the mITT subjects who are actually implanted with either the investigational TAVI device or a surgical valve. Depending on context, subjects may be analyzed according to randomized treatment assignment or treatment actually received.

The primary analysis for the primary objective and most secondary objectives will use the mITT population. At the conclusion of the trial, an analysis using the ITT population will also be presented.

C.6.5 Primary Analysis

The primary endpoint of all-cause mortality or disabling stroke at 24 months will be evaluated using the absolute difference of the TAVI rate and the SAVR rate for all-cause mortality or disabling stroke during a fixed follow-up of 24 months' time. The hypothesis test is designed to show non-inferiority of TAVI to SAVR for the primary endpoint.

C.6.5.1 Hypothesis of Non-inferiority

The primary objective is to establish that TAVI is non-inferior to SAVR for the primary endpoint. The hypothesis of interest is:

$$H: \pi_T < \pi_C + \delta$$

where π_T and π_C denote binary rates of all-cause mortality or disabling stroke during a fixed follow-up of 24 months for the treatment (TAVI) and control (SAVR) groups, and $\delta = 0.07$. This trial is designed using Bayesian statistical techniques. TAVI will be declared to be non-inferior to SAVR if it can be established that the posterior probability $\Pr(H_{\delta=0.07} | \text{data}) > \Psi$, where Ψ is a pre-specified threshold value. If, in addition, it can be shown that $\Pr(H_A: \pi_T < \pi_C + \delta | \text{data}) > \Psi_{\text{SUP}}$, TAVI will be declared to be superior to SAVR. The values chosen for Ψ and Ψ_{SUP} are described below.

C.6.5.2 Randomization, Sample Size and Analysis Plan

Randomization will follow a 1:1 (treatment:control) allocation ratio and be stratified by site and need for revascularization, using a blocked randomization scheme with blocks of randomly varying sizes. The sample size for the mITT population is 1600 subjects.

Sample Size Justification

The assumed values $\pi_T = \pi_C = 0.17$ are based on the data published by Iturra et al³ and CoreValve US Pivotal High Risk study results. As reported in the Iturra paper, the incidence of all-cause mortality at 30 days was 2.8% and the late all-cause mortality Kaplan-Meier rate at 24 months was 12.1%. The overall 24-month all-cause mortality rate was approximately 15%. STS score reported in the Iturra paper (5.6 ± 1.1 , $n=502$) was similar to the STS score for subjects currently enrolled in the SURTAVI study⁴ (5.6 ± 1.4 , $n=654$), and it is believed that the 24-month all-cause mortality rate in SURTAVI will be approximately 15% at 24 months. The major stroke rate was 3.2% for subjects who survived to 1 year in the CoreValve Pivotal High Risk study. The High Risk study enrolled a higher-risk population than SURTAVI, therefore, the major stroke rate in the High Risk study is adjusted downward, and it is believed the disabling stroke rate at 24 months would be approximately 2% in the SURTAVI study. Overall, the estimation of the all-cause mortality or disabling stroke rate at 24 months is 17%.

Although the pre-specified analysis methods are Bayesian, the sample size is guided by a standard frequentist non-inferiority power analysis. Under the assumptions of $\pi_T = \pi_C = 0.17$, non-inferiority margin $\delta=0.07$, 1:1 randomization, $\alpha=0.05$, and power = 95%, the method of Farrington and Manning⁵ as implemented in PASS 2008⁶ indicates that the required sample size for a single-look analysis is 1258. To allow for up to 6% dropout, 1339 subjects must be accrued. Furthermore, to compensate for power lost in a two-look group sequential analysis plan using Pocock-type alpha spending, the sample size would have to be increased by about 12.5%⁷. This leads to an estimated sample size of 1531. Thus a sample size of 1600 mITT subjects should provide ample power for establishing non-inferiority in the primary hypothesis test.

Analysis Plan

An interim analysis (timed to occur when 1400 mITT subjects have reached 12 months) for the purpose of declaring an early win will be conducted. At this analysis, $\Pr(H_{\delta=0.07} | \text{data}) > \Psi$,

³ Iturra SA, Suri RM, Greason KL, et al. The Journal of thoracic and cardiovascular surgery 2014;147:127-132.

⁴ Medtronic CoreValve SURTAVI Trial 2014 FDA Annual Progress Report;

⁵ Farrington, C. P. and Manning, G. 1990. 'Test Statistics and Sample Size Formulae for Comparative Binomial Trials with Null

⁶ Hintze, J. (2004). NCSS and PASS, Number Cruncher Statistical Systems. Kaysville UT. www.ncss.com

⁷ Jennison C and Turnbull BW, Group Sequential Methods with Applications to Clinical Trials. Boca Raton: Chapman & Hall, 2000, p 27

non-inferiority will be declared at this time, and a regulatory submission will follow. Alternatively, if $P(H_{\delta=0.07} | \text{data}) \leq \Psi$, all mITT subjects will be followed to 24 months, when a final analysis will occur. At the final analysis, the standard for trial success will again be $P(H_{\delta=0.07} | \text{data}) > \Psi$. These two analyses are termed "Win Looks."

If, at the early (interim) "Win Look," non-inferiority is established, a test of superiority will immediately follow. If $P(H_{\delta=0} | \text{data}) > \Psi_{\text{SUP}}$, superiority will be established at this time. However, if $P(H_{\delta=0} | \text{data}) \leq \Psi_{\text{SUP}}$, subjects will continue to be followed and analyzed according to the same analysis plan. At the final "Win" analysis, if $P(H_{\delta=0} | \text{data}) > \Psi_{\text{SUP}}$, a delayed determination of superiority will be made.

The statistical approach for these analyses is Bayesian. The prior distributions for π_T and π_C in these calculations are Beta (1,1). The threshold Ψ is designated to be 0.971 for non-inferiority testing and $\Psi_{\text{SUP}} = 0.989$ for superiority testing; these values are selected by trial-and-error to achieve a type I error (under simulation) of at most 0.05 for non-inferiority testing and at most 0.025 for superiority testing. Of note, establishing $P(H_{\delta=0} | \text{data}) > \Psi_{\text{SUP}}$ means that superiority has been established to a standard equivalent to a nominal significance level of 0.025 (1-sided), but this does not automatically mean that a labeling claim of superiority is supported. See "Multiplicity Considerations" (Section C.12) for additional requirements regarding labeling claims on secondary objectives.

Further details of planned analyses are provided in the SAP.

C.6.6 Missing Data and Planned Sensitivity Analyses (Primary Objective)

Every effort will be undertaken to minimize missing data. However, some missing data is inevitable, and the trial is designed with the expectation that there may be up to 6% of primary data missing at 24 months. The reasons for missing data will be described in detail and evaluated for assessment of possible bias. The distribution of prognostic factors between patients with data and those without data will be examined to evaluate any potential sources of bias.

C.6.7 Description of Performed Analysis, per population

Any deviations from this section and/or the Statistical Analysis Plan will be described and justified in the Final Report or justified in a protocol amendment, as appropriate.

C.6.7.1 Analysis of Screening Population

For the screening population only descriptive statistical analysis will be performed, on variables that are captured in the EDC system.

C.6.7.2 Analysis of ITT and mITT Populations

For the subjects in the randomized population the primary analysis of the primary endpoint and inferential statistics for the following secondary endpoints will be performed on the ITT and mITT populations:

- Major adverse cardiovascular and cerebrovascular events (MACCE)
- Individual MACCE components
- Major adverse events (MAE)
- Conduction disturbance requiring permanent pacemaker implantation
- NYHA
- Six-minute walk test
- Ratio of days alive out of hospital versus total days alive
- Quality of life
- Echocardiographic assessment of valve performance
- Aortic valve disease-related hospitalizations
- Cardiovascular deaths and valve-related deaths
- Strokes and TIAs
- Per-procedural neurological injury

- Index procedure-related MAEs
- Length of index procedure hospital stay
- Device success
- Procedure success

C.6.7.3 Analysis of Implanted Population

The endpoints listed in C.6.7.2 will also be performed on the implanted population. Additionally, the implanted population will be used for analyzing the primary endpoint, secondary endpoint of prosthetic valve dysfunction, and echocardiographic assessment of valve performance.

C.6.8 Secondary Endpoints

C.6.8.1 Secondary Endpoints Compared Between TAVI and SAVR

1. Incidence of Major Adverse Cardiovascular and Cerebrovascular Events (MACCE) at 30 days, 6 months, 12 months, 18 months, 24 months, and annually thereafter up to 5 years. MACCE is defined as a composite of:

- All-cause death
- Myocardial infarction (MI)
- All stroke, and
- Reintervention (defined as any cardiac surgery or percutaneous reintervention catheter procedure that repairs, otherwise alters or adjusts, or replaces a previously implanted valve)

MACCE-incidence estimates will be provided for the two treatment groups at 30 days, 6 months, 12 months, 18 months, 24 months, and annually thereafter up to 5 years. The statistical method will be the Bayesian version of a comparison of proportions (with predictions).

Additionally, incidence of MACCE will be compared at 30 days or hospital discharge, whichever is later. The statistical method will be the Bayesian version of a comparison of proportions.

2. The occurrence of individual MACCE components at 30 days, 6 months, 12 months, 18 months, 24 months, and annually thereafter up to 5 years.

MACCE components will be summarized and their incidence estimates provided at 30 days, 6 months, 12 months, 18 months, 24 months, and annually thereafter up to 5 years. The statistical method will be the Bayesian version of a comparison of proportions (with predictions).

3. Major Adverse Events (MAE) and individual components at 30 days, 6 months, 12 months, 18 months, 24 months, and annually thereafter up to 5 years.

MAE events and individual components will be summarized and the incidence of MAEs will be provided at 30 days, 6 months, 12 months, 18 months, 24 months, and annually thereafter up to 5 years. The statistical method will be the Bayesian version of a comparison of proportions (with predictions).

Additionally, incidence of major vascular complications and incidence of major or life-threatening bleeding events at 30 days or hospital discharge, whichever is longer, will also be compared using the Bayesian version of a comparison of proportions.

4. Incidence of Early safety at 30 days defined as a composite of:

- All-cause mortality
- All stroke (disabling and non-disabling)
- Life-threatening bleeding
- Acute kidney injury—Stage 2 or 3 (including renal replacement therapy)
- Coronary artery obstruction requiring intervention
- Major vascular complication
- Valve-related dysfunction requiring repeat procedure (BAV, TAVI, or SAVR)
- All-cause death

Early safety composite endpoint-incidence estimates will be provided for the two treatment groups at 30 days. The statistical method will be the Bayesian version of a comparison of proportions.

5. Incidence of Clinical Efficacy (after 30 days) at 6 months, 12 months, 18 months, 24 months and annually thereafter up to 5 years. Clinical efficacy defined as a composite of:
- All-cause mortality
 - All stroke (disabling and non-disabling)
 - Requiring hospitalizations for valve-related symptoms or worsening congestive heart failure
 - NYHA class III or IV
 - Valve-related dysfunction (mean aortic valve gradient ≥ 20 mmHg, EOA ≤ 0.9 - 1.1 cm² and/or DVI < 0.35 m/s, AND/OR moderate or severe prosthetic valve regurgitation*)

Clinical efficacy estimates will be provided for the two treatment groups at 6 months, 12 months, 18 months, 24 months and annually thereafter up to 5 years. The statistical method will be the Bayesian version of a comparison of proportions (with predictions).

*Refers to VARC-2 definitions

6. Incidence of Time-Related Safety at 30 days, 6 months, 12 months, 18 months, 24 months and annually thereafter up to 5 years. Time-Related Safety defined as a composite of:
- Structural valve deterioration:
 - Valve-related dysfunction (mean aortic valve gradient ≥ 20 mmHg, EOA ≤ 0.9 - 1.1 cm² and/or DVI < 0.35 m/s, AND/OR moderate or severe prosthetic valve regurgitation*)
 - Requiring repeat procedure (TAVI or SAVR)
 - Prosthetic valve endocarditis
 - Prosthetic valve thrombosis
 - Thromboembolic events (eg. stroke)
 - VARC bleeding, unless clearly unrelated to valve therapy (eg. trauma)

Time related safety composite endpoint-incidence estimates will be provided for the two treatment groups at 30 days, 6 months, 12 months, 18 months, 24 months and annually thereafter up to 5 years. The statistical method will be the Bayesian version of a comparison of proportions (with predictions).

*Refers to VARC-2 definitions

7. Conduction disturbance requiring permanent pacemaker implantation at 30 days, 6 months, 12 months, 18 months, 24 months, and annually thereafter up to 5 years.
- The incidence of conduction disturbance requiring permanent pacemaker implantation will be provided at 30 days, 6 months, 12 months, 18 months, 24 months, and annually thereafter up to 5 years, separately for new onset and pre-existing conduction disturbance. The statistical method will be the Bayesian version of a comparison of proportions (with predictions).
8. Change in NYHA class from baseline at 30 days, 6 months, 12 months, 18 months, 24 months, and annually thereafter up to 5 years.
- For each subject with paired data, the number of classes changed from baseline (-3, -2, -1, 0, 1, 2, or 3) will be calculated at 30 days, 6 months, 12 months, 18 months, 24 months, and annually thereafter up to 5 years. The endpoint will be evaluated between groups using a Bayesian version of a t-test.
9. Change in distance walked during 6-minute walk test (6MWT) from baseline to 30 days, baseline to 12 months, and baseline to 24 months.

All subjects who are able to perform the six-minute walk evaluation at the time of the follow-up visit will be included in the analysis.

The endpoint will be evaluated using a Bayesian version of a t-test.

10. Ratio of days alive out of hospital versus total days alive assessed at 12 months and 24 months follow-up.

The proportion of post procedure days alive out of hospital against total days alive will be compared between groups at 12 and 24 months. The numerator will be the number of days alive out of hospital, and the denominator will be the number of post procedure days alive as of the last follow-up date. All hospitalizations will be included in this analysis, including hospitalization for device implant.

In addition, days alive out of hospital will be compared between groups at 12 months and 24 months.

The endpoint will be evaluated using a Bayesian version of a t-test.

11. Quality of Life (QoL) change from baseline at 30 days, 3 months, 6 months, 12 months, 18 months, 24 months, and annually thereafter up to 5 years.

The Kansas City Cardiomyopathy Questionnaire (KCCQ), SF-36, and EuroQoL (EQ-5D) will be assessed at baseline, 30 days, 6 months, 12 months, 18 months, 24 months, and annually thereafter up to 5 years. SF-36 and EQ-5D will also be assessed at 3 months. All subjects completing the questionnaires will be evaluated and the reasons for missing data will be provided.

The endpoint will be evaluated using a Bayesian version of a t-test.

12. Echocardiographic assessment of prosthetic valve performance at discharge, 6 months, 12 months, 24 months, and annually thereafter up to 5 years using the following measures:

- transvalvular mean gradient
- effective orifice area
- degree of prosthetic aortic valve regurgitation (including transvalvular and paravalvular)

The four echocardiographic measurements will be evaluated at discharge, 6 months, 12 months, 24 months, and annually thereafter up to 5 years. All implanted subjects undergoing echocardiography procedures will be evaluated.

Continuous measures will be evaluated using a Bayesian version of a two-sample t-test. Categorical variables will be evaluated using Bayesian version of a comparison of polytomous outcomes.

Additionally, incidence of moderate/severe aortic insufficiency at discharge will be compared between groups using the Bayesian version of a comparison of proportions.

13. Aortic valve disease related hospitalizations

The number of subjects re-hospitalized after the initial index procedure will be compared at 30 days, 6 months, 12 months, 18 months, 24 months, and annually thereafter up to 5 years.

Incidence of recurrent hospitalization will be provided at 30 days, 6 months, 12 months, 18 months, 24 months, and annually thereafter up to 5 years. The statistical method will be the Bayesian version of a comparison of proportions (with predictions).

14. Cardiovascular deaths and valve-related deaths

The number of subjects experiencing cardiovascular deaths and valve-related deaths at 30 days, 6 months, 12 months, 18 months, 24 months, and annually thereafter up to 5 years. Incidences will be compared between groups. The statistical method will be the Bayesian version of a comparison of proportions (with predictions).

15. Strokes and TIAs

The number of subjects with strokes (of any severity) and TIAs at 30 days, 6 months, 12 months, 18 months, 24 months, and annually thereafter up to 5 years. A separate analysis will be performed for each of the following:

- a composite of all strokes and TIAs
- disabling strokes only
- non-disabling strokes only
- TIAs only

The statistical method will be the Bayesian version of a comparison of proportions (with predictions).

Additionally, incidence of all strokes at 30 days or hospital discharge, whichever is longer, will be compared between groups using the Bayesian version of a comparison of proportions.

16. Peri-procedural Neurological Injury (Stroke, TIA, Encephalopathy)

For each treatment group, the proportion of subjects with a neurologic injury (stroke, TIA, or encephalopathy) at discharge or at 7 days post-index procedure (whichever occurs first) will be calculated. The numerator will be the number of subjects with a neurologic injury (stroke, TIA, or encephalopathy) at discharge or at 7 days post-index procedure (whichever occurs first), and the denominator will be the number of subjects in that treatment group. Results will also be presented separately for disabling stroke, non-disabling stroke, TIA, and encephalopathy. Proportions will be compared between groups using Bayesian version of a comparison of proportions.

17. Index procedure related MAEs

Index procedure-related MAE events will be summarized and event rates will be provided at 30 days. The numerator will be the number of procedure-related MAE events experienced by the end of the 30-day follow-up visit, and the denominator will be the number of subjects evaluated at the 30-day follow-up visit (or a later follow-up) plus the number of subjects not evaluated but who experienced a procedure-related MAE event prior to the end of the follow-up visit window.

The endpoint is descriptive and no statistical hypothesis test will be performed.

18. Length of index procedure hospital stay

The length of TAVI or SAVR hospital stay will be summarized for all subjects undergoing a trial procedure.

The endpoint will be evaluated between groups using a Bayesian version of a t-test.

19. Presence of atrial fibrillation at post-procedure, discharge, 30 days, 6 months, 12 months, 18 months, 24 months, and annually thereafter up to 5 years.

The statistical method will be the Bayesian version of a comparison of proportions (with predictions).

C.6.8.2 Secondary Endpoints Assessed for TAVI Only

The following secondary endpoints will be assessed for the TAVI cohort subjects only:

20. Device success defined as follows:

- Absence of procedural mortality AND
- Correct positioning of a single prosthetic heart valve into the proper anatomical location AND
- Intended performance of the prosthetic heart valve (no prosthesis-patient mismatch and mean aortic valve gradient <20 mmHg or peak velocity <3 m/s, AND no moderate or severe prosthetic valve regurgitation*)
 - Assessed acutely in a resting state, either within 24-48 hours after the index procedure or before hospital discharge

*Refers to VARC-2 definitions

Device success, as defined above, will be calculated for all subjects undergoing the TAVI procedure.

The endpoint is descriptive and no statistical hypothesis test will be performed.

21. Procedural success, defined as device success and absence of in-hospital MACCE.

Procedural success, as defined above, will be calculated for all randomized subjects undergoing the TAVI procedure.

The endpoint is descriptive and no statistical hypothesis test will be performed.

22. Evidence of prosthetic valve dysfunction at 30 days, 6 months, 12 months, 24 months, and annually thereafter up to 5 years.

The number of subjects with evidence of prosthetic valve dysfunction will be evaluated at 30 days, 6 months, 12 months, 18 months, 24 months, and annually thereafter up to 5 years. Point estimates and 95% BCIs for each time point will be presented using methods described below in the Bayesian version of a comparison of proportions (with predictions).

23. Resheath and Recapture (combined) success rate.

The success rate will be analyzed for all subjects in whom the resheath or recapture feature is attempted. The number and percentage of successful resheath or recapture attempts combined will be calculated. Separate resheathing and recapturing success rates will also be calculated.

The endpoint is descriptive and no statistical hypothesis test will be performed.

C.6.9 Rationale for Selection of Trial Endpoints

Trial endpoints were selected with following considerations:

- Clinically relevant and address important safety and performance aspects of the investigational TAVI device
- Objectively defined and measurable in the majority of subjects
- Consistent with current recommendations for endpoints in TAVI clinical studies and VARC-2

C.6.10 Multiplicity Considerations

It is recognized that with a multiplicity of tests comes inflation in the chance of a false finding of superiority or non-inferiority. Therefore, for the purpose of seeking approved labeling claims on designated secondary objectives, the following standard will be used: If the primary objective demonstrates non-inferiority, claims will be sought for selected secondary non-inferiority and superiority objectives and for superiority on the primary objective metric. These will be tested via a hierarchical (sequential) testing order that preserves the overall study-wise type I error rate at the level of 0.05, while requiring all non-inferiority tests to meet a nominal type I error rate of 0.05 and all superiority tests to meet a nominal type I error rate of 0.025. The testing order is specified below. The following objectives are tested in order, and testing continues if and only if all previous objectives have met their designated success criterion.

1. Primary endpoint (non-inferiority)

2. Transvalvular mean gradient at 12 months (non-inferiority)
3. Effective orifice area at 12 months (non-inferiority)
4. Change in NYHA classification from baseline to 12 months (non-inferiority)
5. Change in KCCQ score from baseline to 30 days (non-inferiority)

All of the above are non-inferiority tests and are tested with a type I error standard of 0.05. If all of the above tests meet their success criterion, the type I error rate of 0.05 that is passed on from the above tests will be split equally (using a Bonferroni justification) between the following parallel subfamilies, so that each subfamily is tested using a type I error rate of 0.025:

Subfamily #1: Primary endpoint (superiority)

Subfamily #2: Secondary (superiority) objectives #5–#18 as enumerated below, tested in ordered sequence such that all α is passed on to subsequent tests if a test criterion is met, while all testing stops if a test criterion is not met. This procedure controls the type I error rate of this subfamily at the level 0.025.

It is not necessary to “pass” all objectives in one subfamily in order to test the objective(s) in the other subfamily. For the purposes of seeking claims, these objectives will only be evaluated once, at the same time as non-inferiority of the primary objective is established. The only exception to this is the primary endpoint superiority test, which carries the possibility of a delayed determination of superiority (as described in Section 4.2.1) and may thus meet its success criterion at a different time.

The remaining secondary objectives may be of interest for scientific or financial reasons but will not be the basis for supporting labeling claims; they are thus outside of the hierarchical testing procedure. Similarly, for those objectives that test non-inferiority, if non-inferiority is established, a test of superiority will also be conducted, but unless specifically itemized in the list, such superiority testing is not part of the hierarchical testing procedure; these superiority tests may be of interest for scientific or financial reasons but will not be the basis for supporting labeling claims.

C.6.10.1 Secondary Endpoints Tested to Support Labeling Claims

The following secondary endpoints will be tested, in order, to support labeling claims:

1. Transvalvular mean gradient at 12 months (non-inferiority): TAVI vs. SAVR (secondary objective #12). The hypothesis of interest is

$$H: \mu_{TAVI} < \mu_{SAVR} + 5$$

where μ_{TAVI} and μ_{SAVR} denote the average mean gradient from at 12 months, measured in mmHg. This objective will be evaluated using a Bayesian version of a two-sample t-test (see Section C.11). The posterior probability $P(H | \text{data})$ will be calculated and compared to a threshold of 0.95.

2. Effective orifice area at 12 months (non-inferiority): TAVI vs. SAVR (secondary objective #12). The hypothesis of interest is

$$H: \mu_{TAVI} > \mu_{SAVR} - 0.1$$

where μ_{TAVI} and μ_{SAVR} denote the mean effective orifice area at 12 months, measured in cm^2 . This objective will be evaluated using a Bayesian version of a two-sample t-test (see Section C.11). The posterior probability $P(H | \text{data})$ will be calculated and compared to a threshold of 0.95.

3. Change in NYHA classification from baseline to 12 months (non-inferiority): TAVI vs. SAVR (secondary objective #8). The hypothesis of interest is

$$H: \mu_{TAVI} > \mu_{SAVR} - 0.375$$

where μ_{TAVI} and μ_{SAVR} denote the mean number of classification improvements in NYHA from baseline to 12 months. For subjects with NYHA categories at both baseline and 12

month visit, the NYHA classification improvements will be calculated as $NYHA_{baseline} - NYHA_{12month}$. This objective will be evaluated using a Bayesian version of a two-sample t-test (see Section C.11). The posterior probability $P(H | data)$ will be calculated and compared to a threshold of 0.95.

4. Change in Kansas City Cardiomyopathy Questionnaire (KCCQ) score from baseline to 30 days (non-inferiority): TAVI vs. SAVR (secondary objective #11). The hypothesis of interest is

$$H: \mu_{TAVI} > \mu_{SAVR} - 5$$

where μ_{TAVI} and μ_{SAVR} denote the mean improvements in the KCCQ score from baseline to 30 days. For subjects with KCCQ score at both baseline and 30 days, the improvement in KCCQ will be calculated as $KCCQ_{30day} - KCCQ_{baseline}$. This objective will be evaluated using a Bayesian version of a two-sample t-test (see Section C.11). The posterior probability $P(H | data)$ will be calculated and compared to a threshold of 0.95.

5. Length of index procedure hospital stay after TAVI vs. SAVR (secondary objective #18). The hypothesis of interest is

$$H: \mu_{TAVI} < \mu_{SAVR}$$

where μ_{TAVI} and μ_{SAVR} denote the mean length of index hospital stay. This objective will be evaluated using a Bayesian version of a two-sample t-test (see Section C.11). The posterior probability $P(H | data)$ will be calculated and compared to a threshold of 0.975.

6. Transvalvular mean gradient at 12 months (superiority): TAVI vs. SAVR (secondary objective #12). The hypothesis of interest is

$$H: \mu_{TAVI} < \mu_{SAVR}$$

where μ_{TAVI} and μ_{SAVR} denote the average mean gradient from at 12 months, measured in mmHg. This objective will be evaluated using a Bayesian version of a two-sample t-test (see Section C.11). The posterior probability $P(H | data)$ will be calculated and compared to a threshold of 0.975.

7. Effective orifice area at 12 months (superiority): TAVI vs. SAVR (secondary objective #12). The hypothesis of interest is

$$H: \mu_{TAVI} > \mu_{SAVR}$$

where μ_{TAVI} and μ_{SAVR} denote the mean effective orifice area at 12 months, measured in cm^2 . This objective will be evaluated using a Bayesian version of a two-sample t-test (see Section C.11). The posterior probability $P(H | data)$ will be calculated and compared to a threshold of 0.975.

8. Change in Kansas City Cardiomyopathy Questionnaire (KCCQ) score from baseline to 30 days (superiority): TAVI vs. SAVR (secondary objective #11). The hypothesis of interest is

$$H: \mu_{TAVI} > \mu_{SAVR}$$

where μ_{TAVI} and μ_{SAVR} denote the mean improvements in the KCCQ score from baseline to 30 days. For subjects with KCCQ score at both baseline and 30 days, the improvement in KCCQ will be calculated as $KCCQ_{30day} - KCCQ_{baseline}$. This objective will be evaluated using a Bayesian version of a two-sample t-test (see Section C.11). The posterior probability $P(H | data)$ will be calculated and compared to a threshold of 0.975.

9. Days alive out of the hospital at 12 months after TAVI vs. SAVR (secondary objective #10). The hypothesis of interest is

$$H: \mu_{TAVI} > \mu_{SAVR}$$

where μ_{TAVI} and μ_{SAVR} denote the mean number of days alive out of the hospital at 12 months. This objective will be evaluated using a Bayesian version of a two-sample t-test (see Section C.11). The posterior probability $P(H | data)$ will be calculated and compared to a threshold of 0.975.

10. Days alive out of the hospital at 24 months after TAVI vs. SAVR (secondary objective #10). The hypothesis of interest is

$$H: \mu_{TAVI} > \mu_{SAVR}$$

where μ_{TAVI} and μ_{SAVR} denote the mean number of days alive out of the hospital at 24 months. This objective will be evaluated using a Bayesian version of a two-sample t-test (see Section C.11). The posterior probability $P(H | \text{data})$ will be calculated and compared to a threshold of 0.975.

11. Change in SF-36 Physical Summary Scale from baseline to 3 months: TAVI vs. SAVR (secondary objective #11). The hypothesis of interest is

$$H: \mu_{TAVI} > \mu_{SAVR}$$

where μ_{TAVI} and μ_{SAVR} denote the mean improvements in the SF-36 Physical Summary Scale from baseline to 3 months. This objective will be evaluated using a Bayesian version of a two-sample t-test (see Section C.11). The posterior probability $P(H | \text{data})$ will be calculated and compared to a threshold of 0.975.

12. Change in EQ-5D from baseline to 3 months: TAVI vs. SAVR (secondary objective #11). The hypothesis of interest is

$$H: \mu_{TAVI} > \mu_{SAVR}$$

where μ_{TAVI} and μ_{SAVR} denote the mean improvements in the EQ-5D from baseline to 3 months. This objective will be evaluated using a Bayesian version of a two-sample t-test (see Section C.11). The posterior probability $P(H | \text{data})$ will be calculated and compared to a threshold of 0.975.

13. Incidence of MACCE at 30 days or hospital discharge, whichever is longer: TAVI vs. SAVR (secondary objective #1). The hypothesis of interest is

$$H: \pi_{TAVI} < \pi_{SAVR}$$

where π_{TAVI} and π_{SAVR} denote the binary rate of MACCE at 30 days or hospital discharge (if longer). The posterior probability $P(H | \text{data})$ will be calculated and compared to a threshold of 0.975. The statistical method will be the Bayesian version of a comparison of proportions (see Section C.11).

14. Incidence of major vascular complications at 30 days or hospital discharge, whichever is longer: TAVI vs. SAVR (secondary objective #3). The hypothesis of interest is

$$H: \pi_{TAVI} < \pi_{SAVR}$$

where π_{TAVI} and π_{SAVR} denote the binary rate of major vascular complications at 30 days or hospital discharge (if longer). The posterior probability $P(H | \text{data})$ will be calculated and compared to a threshold of 0.975. The statistical method will be the Bayesian version of a comparison of proportions (see Section C.11).

15. Incidence of major or life-threatening bleeding event at 30 days or hospital discharge, whichever is longer: TAVI vs. SAVR (secondary objective #3). The hypothesis of interest is

$$H: \pi_{TAVI} < \pi_{SAVR}$$

where π_{TAVI} and π_{SAVR} denote the binary rate of major or life-threatening bleeding events at 30 days or hospital discharge (if longer). The posterior probability $P(H | \text{data})$ will be calculated and compared to a threshold of 0.975. The statistical method will be the Bayesian version of a comparison of proportions (see Section C.11).

16. Incidence of all strokes at 30 days or hospital discharge, whichever is longer: TAVI vs. SAVR (secondary objective #15). The hypothesis of interest is

$$H: \pi_{TAVI} < \pi_{SAVR}$$

where π_{TAVI} and π_{SAVR} denote the binary rate of strokes at 30 days or hospital discharge (if longer). The posterior probability $P(H | \text{data})$ will be calculated and compared to a threshold of 0.975. The statistical method will be the Bayesian version of a comparison of proportions (see Section C.11).

17. Incidence of moderate/severe aortic insufficiency after TAVI vs. SAVR (secondary objective #12). The hypothesis of interest is

$$H: \pi_{TAVI} < \pi_{SAVR}$$

where π_{TAVI} and π_{SAVR} denote the proportion of subjects with moderate/severe aortic insufficiency at the discharge echo. The posterior probability $P(H | \text{data})$ will be calculated and compared to a threshold of 0.975. The statistical method will be the Bayesian version of a comparison of proportions (see Section C.11).

18. New pacemaker implant rate for TAVI at 30 days or hospital discharge, whichever is longer (secondary objective #7). The hypothesis of interest is

$$H: \pi_{TAVI} < 30\%$$

where π_{TAVI} denote the binary rate of new pacemaker implants for TAVI at 30 days or hospital the discharge (if longer). The posterior probability $P(H | \text{data})$ will be calculated and compared to a threshold of 0.975. The statistical method will be the Bayesian version of a comparison of proportions (see Section C.11).

Other than the hierarchical testing procedure described above, no further multiplicity adjustments will be made in the analyses of the secondary endpoints. Summary data from other secondary objectives, such as device success and procedural success from secondary objectives #20 and #21, respectively, may be provided in the device labeling. However, no claims of statistical significance or other statistical inference will be made.

C.6.11 Heterogeneity/Poolability

A poolability analysis among investigational centers, access site (ilio-femoral or non-ilio-femoral), need for revascularization, and primary baseline demographics will be performed for the primary endpoint and will be described in the SAP. In particular, the primary endpoint and key secondary endpoints such as MACCE and MAE incidence will be examined for differences in outcome between genders, need for revascularization, and between access routes. Additionally, tests for these outcomes will be performed to evaluate potential interactions between treatment and gender and between treatments and need for revascularization and between treatment and access site.

C.6.12 Additional Analysis

C.6.12.1 Pre-Defined Subgroups

The following sub-groups will be analysed for publication purposes:

- Diabetes Mellitus (yes, no)
- Age [< 65 years of age (ie. Medicare population), $65-70$ years of age, $71-74$ years of age, $75-79$ years of age and ≥ 80 years of age]
- Gender (male, female)
- STS score
- Presence of co-morbidities
- Need for coronary revascularization

A test for interaction between the treatment effect (SAVR versus TAVI) and the subgroup variable will be performed.

These comparisons are not powered, and will be for exploratory purposes only, not to be used to support labeling claims.

C.6.12.2 Analysis of VARC Endpoints and Definitions

Endpoints

Device success will be calculated per the definition outlined in O.2 as well as using the VARC-I definition, as appropriate.

Definitions

Events with definitions modified in revisions to VARC will be analyzed per both the definition outlined in O.2 and VARC-I. Applicable terms include:

- Acute Kidney Injury
- Bleeding

- Death
- Device Migration/ Valve Embolism
- Device Malplacement
- Myocardial Infarction
- Prosthetic Valve Dysfunction
- Stroke and TIA
- Vascular Complications

C.6.13 Health-Related Quality of Life (HRQoL) and Treatment Costs

Health-related quality of life (HRQoL) and treatment costs will be assessed alongside the core clinical trial to evaluate the impact of the TAVI and SAVR strategies on a range of relevant quality of life (QoL) domains and also to evaluate the cost-effectiveness of the two treatment strategies.

C.6.13.1 Quality of Life

Health Related Quality of Life (HRQoL) and functional status will be assessed using a combination of generic and disease-specific measures selected to cover a broad range of health domains that may be affected by severe aortic stenosis disease, its treatment, and its complications: the Medical Outcomes Study 36-item Short Form (SF-36), the Kansas City Cardiomyopathy Questionnaire (KCCQ), and the EuroQoL Five Dimensions (EQ-5D). All patients will complete standardized, written questionnaires at baseline (prior to subject being informed of randomization), 30 days, 6 months, 12 months, 18 months, 24 months and annually thereafter up to 5 years. At 3 months subjects will also be contacted via telephone to complete the EQ-5D, in select geographies SF-36 will also be collected. Additional information regarding the HRQoL assessments and administration is located in **Appendix R.12** Economic and Quality of Life Data Collection.

C.6.13.2 Economic Outcomes/Cost-Effectiveness

Data on resource utilization will be collected for the index hospitalization and through long-term follow-up for all enrolled subjects. These resource items will include number and duration in-patient stays in hospital by type of unit (eg. intensive care, high-dependency care and standard ward care); number of clinic visits (by type of physician); and details of the main procedure undertaken. As part of the trial analysis, resource use estimates will be presented by randomized group (eg. mean per patient plus standard deviation). This data, together with the EQ-5D data will provide an important input into cost effectiveness analysis. However, as such analysis is likely to be based on a modeling framework, to include evidence from a number of sources (eg. a meta-analysis of other TAVI trials) and to vary according to the jurisdiction of interest, it is appropriate to detail the methods in separate protocols and analysis plans.

C.6.14 Use of Data for CE Mark

Data from the TAVI arm may be utilized to seek CE Mark approval for the Intermediate Risk indication prior to trial completion. This is expected to include the experience of approximately the first 100 TAVI subjects out to 30 days. This analysis will not impact the Type I error rate of this trial as there will not be an early analysis of control (randomized) data, and no decisions to alter the pivotal trial are allowed based on this analysis. This data will not be made public and a limited number of personnel will have access to the results.

C.7 Data and Quality Management

C.7.1 Electronic Data Capture

Medtronic will use the Oracle Clinical Remote Data Capture database system for data collection. Oracle is a secure, password-protected, Part 11 compliant database which is backed up regularly (at a minimum once daily).

C.7.2 Data Collection

The investigator must ensure accuracy, completeness and timeliness of the data reported in the EDC system and in all other required reports. Data reported on the eCRFs which are derived from source documents must be consistent with the source documents or the discrepancies need to be justified in a documented rationale, signed and dated by the (principal) investigator, to be filed in the subject file.

Required data will be recorded on the eCRFs by authorized site personnel as indicated on the Delegation of Authority Log. The eCRFs must be completed and/or updated to reflect the latest observations on the subjects participating in the trial.

The investigator (or approved sub-investigator) will electronically sign the appropriate pages of each eCRF.

The EDC system maintains an audit trail on entries, changes or corrections in CRFs. If a person only authorized to complete CRFs makes changes to an already signed CRF, the investigator shall re-sign this CRF.

The sponsor and/or assigned designee will be responsible for the processing and quality control of the data. Data management will be done according to Medtronic SOPs and the applicable Data Management Plan. All trial-related documents must be retained for a period of at least 2 years after the last approval of a marketing application and until there are no pending or contemplated marketing applications in an ICH region, or at least 2 years have elapsed since the formal discontinuation of clinical development of the investigational device. Medtronic will inform the investigator/institution when these documents are no longer required to be retained.

No trial document or image should be destroyed without prior written agreement between the Sponsor and the investigator. Should the investigator wish to assign the trial records to another party or move them to another location, advance written notice should be given to the Sponsor.

Copies of the eCRFs to be used are included in **Appendix R.5**.

C.7.3 Core Laboratories Procedures

Data from the core lab will be transferred to Medtronic and stored in the Oracle Clinical Remote Data Capture system as described in the Medtronic CoreValve™ SURTAVI Trial Data Management Plan.

C.7.4 Source Documents

Source documentation is defined as the first time the data appear and may include all clinical records, hospital records, surgery reports, autopsy reports, and any other material that contains original information used for trial data collection or adverse event reporting. Where copies of the original source document as well as print outs of original electronic source documents are retained, these shall be signed and dated by a member of the investigation site team with a statement that it is a true reproduction of the original source document. No eCRFs may serve as source documents.

Source documentation may vary from site to site. The source documents must be retained by the investigational site for a period of 2 years after trial conclusion and made available for monitoring or auditing by the sponsor's representative or representatives of the FDA, IRB/MEC, and other applicable regulatory agencies. The Investigator must ensure the availability of source documents from which the information on the eCRFs was derived.

C.7.5 Maintenance and Calibration

Sites should perform regular maintenance and calibration of all equipment relevant to protocol required assessments. Maintenance and calibration should be conducted per local standards and ensure proper documentation must be on file for routine monitoring and audit, as applicable.

C.8 Records and Reports

C.8.1 Responsibilities of the Sponsor

The Sponsor must maintain the following records, at a minimum:

- All essential correspondence related to the clinical trial
- Signed Investigator Agreement
- Curriculum vitae for each Investigator
- Records of device shipment and disposition (shipping receipts, material destruction records, etc.)
- Adverse event information
- Complaint documentation
- All data forms, prepared and signed by the Investigators and received source documentation and core lab reports
- Protocol and report of prior investigations
- Site monitoring reports
- Financial disclosure information

The Sponsor is responsible for the preparation of, the accuracy of the data contained in, the review of and the submission of the reports listed in **Table 5**.

Table 5: Sponsor Reporting Responsibilities

Report	Submit to	Description
Unanticipated Adverse (Serious) Device Effects (UADE or USADE)	IRB/MEC, Investigators, FDA, and local regulatory agencies, where applicable	Medtronic will report on any confirmed unanticipated adverse device effect evaluation as soon as possible but no later than within 10 working days after first receiving notice of the effect. (21 CFR 812.150) and in compliance with local regulatory requirements, as applicable.
Withdrawal of IRB/MEC approval	IRB/MEC, Investigators, FDA, and local regulatory agencies, where applicable	Notification, when appropriate, will be made within 5 working days after Medtronic receives notice of withdrawal of IRB/MEC approval.
Withdrawal of FDA approval	IRB/MEC, Investigators	Notification will be made within 5 working days after Medtronic receives notice of withdrawal of FDA approval.
Current Investigator List	FDA and local regulatory agencies, where applicable	Medtronic will submit a current list of the names and addresses of all participating Investigators at six-month intervals, beginning six months after FDA approval of IDE.
Progress Report	IRB/MEC, Investigators, FDA	A progress report will be submitted at least yearly.
Recall and Device Disposition	IRB/MEC, Investigators, FDA, and local regulatory agencies, where applicable	Notification will be made within 30 working days of Medtronic's request that an Investigator return, repair or otherwise dispose of any devices. Such notification will state why the request was made.
Final Report	IRB/MEC, Investigators, FDA	Notification will be made within 30 working days of the completion or termination of the investigation. A final report will be submitted within six months after trial completion or termination.

Report	Submit to	Description
Failure to obtain Informed Consent	FDA	Notification will be made within 5 working days after Medtronic's receipt of such notification indicating Informed Consent was not obtained.
Emergency Deviations from Investigational Plan	FDA and local regulatory agencies, where applicable	Notification will be made within 5 working days after Medtronic learns of an emergency deviation from the Investigational Plan where the deviation was made to protect the life or physical wellbeing of a subject.

C.8.2 Responsibilities of the Investigator

The Investigator is responsible for the preparation, review, signature, and retention of the records listed below:

- All essential correspondence that pertains to the investigation
- Device use/disposition records
- Records of each subject's case history and exposure to the device. Case histories include the CRFs and supporting data (source documentation), including, for example:
 - Signed and dated consent forms
 - Medical records, including, for example, progress notes of the physicians, the subject's hospital chart(s) and the nurses' notes
 - All adverse event information
 - A record of the exposure of each subject to the investigational device (eg., date of implant procedure and follow-up assessment dates)
 - Documentation of any deviation from the protocol, including the date and the rationale for such deviation
- Screening Logs, Enrollment Logs and Patient Identification Logs
- Signed Investigator Agreement, curriculum vitae and training records
- Protocol and any amendments
- IRB/MEC approval documentation, and where applicable, other local regulatory approvals

The Investigator may withdraw from responsibility to maintain records by transferring custody to another person, who will accept responsibility for record and report maintenance.

The Investigator is responsible for the preparation, review, signature, and submission of the reports listed below in. These are also subject to inspection by government agencies and must be retained as specified above.

Table 6: Investigator Reporting Responsibilities

Report	Submitted to	Description
Unanticipated Adverse (Serious) Device Effects (UADE or USADE)	Sponsor, IRB/MEC, and local regulatory agencies, where applicable	UADEs and USADEs should be reported immediately via telephone as well as on an eCRF. UADEs and USADEs must be submitted as soon as possible, but in no event later than 3 calendar days after the Investigator first learns of the effect.
Serious Adverse Events and Deaths	Sponsor, and local regulatory agencies, where applicable	The Investigator shall notify the sponsor immediately (i.e. within 3 calendar days of first learning of any SAE) [MEDDEV 2.7/3].
Withdrawal of IRB/MEC approval	Sponsor	The Investigator must report a withdrawal of the reviewing IRB/MEC, approval within 5 working days.
Progress Report	Sponsor, IRB/MEC	The Investigator must submit a progress report on an annual basis if the trial lasts longer than one year.
Failure to obtain Informed Consent	Sponsor, IRB/MEC	The Investigator must make notification within 5 working days after device implant.
Final Report	Sponsor, IRB/MEC	This report must be submitted within 3 months after termination or completion of the investigation.
Deviations from Investigational Plan (CFR 812.150)		
Emergency Use	Sponsor, IRB/MEC	Notification must be made within 5 working days of the occurrence of an emergency deviation made to protect the life or physical well-being of a subject.
Planned deviation	Sponsor, IRB/MEC, FDA	If the deviation affects scientific soundness of the trial or the rights, safety, or welfare of the subject and is not an emergency, prior approval must be obtained from Medtronic, the reviewing IRB/MEC, and FDA.
Other Deviations	Sponsor	Deviations that are beyond the control of the investigator (such as patient who fails to return to follow-up visit) or deviations that do not affect the scientific soundness of the trial or the rights, safety, or welfare of the subject and are not an emergency, should be submitted as they are identified by the site or Medtronic staff.

D RISK / BENEFIT ANALYSIS

There are risks for participants in this trial. However, it should be noted that most of the risks of trial participation are not materially different than those entailed by an individual who undergoes the same treatment outside of the context of this trial.

Known adverse events that may result from TAVI include but may not be limited to:

- Death
- Cardiac arrest
- Coronary occlusion, obstruction, or vessel spasm (including acute coronary closure)
- Emergent surgery (eg., coronary artery bypass, heart valve replacement, valve explant)
- Multi-organ failure
- Heart failure
- Myocardial infarction
- Cardiogenic shock
- Respiratory insufficiency or respiratory failure
- Cardiovascular injury (including rupture, perforation, or dissection of vessels, ventricle, myocardium, or valvular structures that may require intervention)
- Perforation of the myocardium or a vessel
- Ascending aorta trauma
- Cardiac tamponade
- Cardiac failure or low cardiac output
- Prosthetic valve dysfunction including, but not limited to:
 - Fracture
 - Bending (out-of-round configuration) of the valve frame
 - Under-expansion of the valve frame
 - Calcification
 - Pannus, (wear, tear, prolapse, or retraction in the valve leaflets)
 - Poor valve coaptation
 - Suture breaks or disruption
 - Leaks
 - Mal-sizing (prosthesis-patient mismatch)
 - Malposition (either too high or too low)/malplacement
 - Regurgitation, stenosis
- Thrombosis/embolus (including valve thrombosis)
- Valve migration/valve embolization
- Ancillary device embolization
- Emergent percutaneous coronary intervention (PCI)
- Emergent balloon valvuloplasty
- Major or minor bleeding that may or may not require transfusion or intervention (including life-threatening or disabling bleeding)
- Allergic reaction to antiplatelet agents, contrast medium, or anesthesia
- Infection (including septicemia and endocarditis)
- Stroke, TIA, or other neurological deficits
- Permanent disability
- Renal insufficiency or renal failure (including acute kidney injury)
- Mitral valve regurgitation or injury
- Tissue erosion
- Vascular access related complications (eg., dissection, perforation, pain, bleeding, hematoma, pseudoaneurysm, irreversible nerve injury, compartment syndrome, arteriovenous fistula, stenosis)
- Conduction system disturbances (eg., atrioventricular node block, left-bundle branch block, asystole), which may require a permanent pacemaker
- Cardiac arrhythmias

- Encephalopathy
- Pulmonary edema
- Pericardial effusion
- Pleural effusion
- Myocardial ischemia
- Peripheral ischemia
- Bowel ischemia
- Heart murmur
- Hemolysis
- Cerebral infarction-asymptomatic
- Non-emergent reoperation
- Inflammation
- Fever
- Hypotension or hypertension
- Syncope
- Dyspnea
- Anemia
- Angina
- Abnormal lab values (including electrolyte imbalance)
- Exposure to radiation through fluoroscopy and angiography
- Delivery catheter malfunction resulting in need for additional re-crossing of the aortic valve and prolonged procedural time

Additional information regarding risk analysis is located in the Investigator Brochures (**Appendix R.21**).

D.1 Methods to Minimize Risk

The investigational plan is specifically designed to manage and minimize risks through careful patient selection, thorough training of investigators, adherence to the pre-determined time points to assess subject clinical status and regular clinical monitoring visits by Sponsor appointed monitoring personnel.

In addition, an independent Data Safety Monitoring Board will monitor safety of the subjects throughout the trial.

D.2 Potential Benefits

Patients treated with TAVI may experience improvement in quality of life, morbidity and mortality compared to traditional open-heart aortic valve replacement. Potential benefits include, but are not limited to, absence of open-heart surgery-related risks, reduced procedure time, reduced anesthesia procedure time, shorter hospital stay and earlier return to normal activities than after open-heart aortic valve replacement.

There is no direct benefit associated to participation in this trial, but the information obtained during this trial will be used scientifically. The results of this trial can help physicians understand the implications of transcatheter treatment of patients with intermediate risk for surgery.

E DESCRIPTION OF MEDTRONIC COREVALVE™ SYSTEM

E.1 Investigational Product Description

E.1.1 Medtronic CoreValve System

The Medtronic CoreValve™ System (MCS) consists of 3 components: the Transcatheter Aortic Valve Bioprosthesis (TAV) in

Figure 2 below, the Delivery Catheter System (DCS) in **Figure 3** and **Figure 4**, and the Compression Loading System (CLS) in **Figure 5** and **Figure 6**.

Transcatheter Aortic Valve Bioprosthesis

Figure 2: Transcatheter Aortic Valve (TAV)

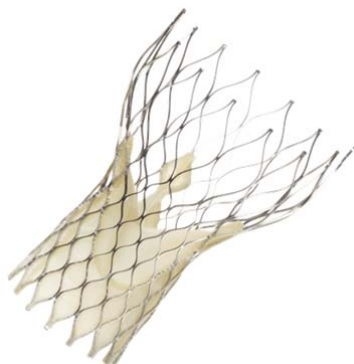

The TAV is manufactured by suturing valve leaflets and a skirt, made from a single layer of porcine pericardium, into a tri-leaflet configuration. The TAV is designed to replace the native aortic heart valve without open heart surgery and without concomitant surgical removal of the failed native valve.

The bioprosthesis is processed with an antimineralization treatment of alpha-amino oleic acid (AOA) a compound derived from oleic acid, a naturally occurring long-chain fatty acid.

The self-expanding multi-level frame is made of Nitinol and is radiopaque.

The TAV is available for a range of aortic annulus and ascending aortic diameters as shown in **Table 7** below.

Table 7: Medtronic CoreValve System Patient Anatomical Diameters

CoreValve™ Evolut™ Bioprosthesis			
Model	Size (mm)	Aortic Annulus Diameter (range in mm)	Ascending Aortic Diameter (mm)
MCS-P4-23-AOA MCS-P4-23-AOA-US	23	18-20	≤34
CoreValve™ Bioprosthesis			
Model	Size (mm)	Aortic Annulus Diameter (range in mm)	Ascending Aortic Diameter (mm)
MCS-P3-26-AOA MCS-P3-26-AOA-US	26	20-23	≤40
MCS-P3-29-AOA MCS-P3-29-AOA-US	29	23-27	≤43

MCS-P3-31-AOA MCS-P3-31-AOA-US	31	26-29	≤43
-----------------------------------	----	-------	-----

Delivery Catheter System

The AccuTrak[®] DCS (DCS-C4-18FR and DCS-C4-18FR-US) is compatible with a 0.889-mm (0.035-in) guidewire. The working length of the AccuTrak[®] DCS is 112.5 cm. It incorporates a protective deployment sheath that houses and deploys the TAV. The AccuTrak[®] DCS can be used to house and deliver all commercially available sizes of the TAV (26mm, 29mm, and 31mm TAV). The outer diameter of the DCS is 12Fr, the stability layer is 15Fr and the outer diameter of the valve capsule is 18 Fr.

Figure 3: Delivery Catheter System (DCS)

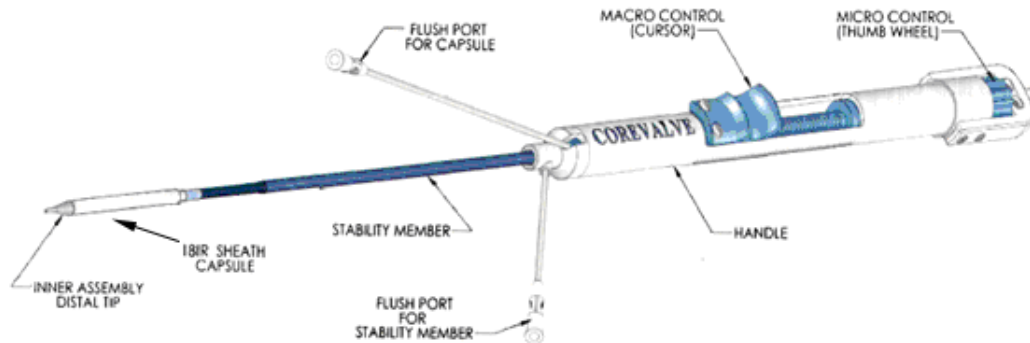

A new Delivery Catheter System (DCS-C4-18FR-23MM and DCS-C4-18F-23US) will be used to deploy 23mm Transcatheter Aortic Valve (TAV). The DCS-C4-18FR-23MM and DCS-C4-18FR-23 and DCS-C4-18FR- has a shortened Capsule and Plunger (5mm) for delivery of the 23mm TAV but the working length of the new AccuTrak[™] DCS is 112.5 cm similar to DCS-C4-18FR used to deploy other TAV sizes.

Figure 4: Design Changes for Delivery Catheter System (DCS) specific to 23mm

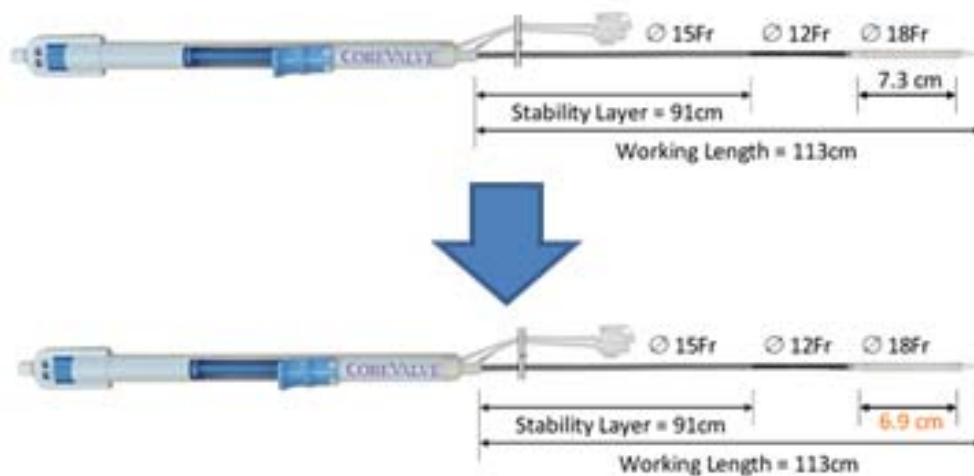

The AccuTrak[®] DCS features an integrated handle designed to provide the user with accurate and controlled deployment. After the DCS is placed in the vicinity of the aortic annulus, the user retracts the deployment sheath, thereby deploying the TAV to the desired location. In use, the deployment sheath can be partially pulled back to evaluate the TAV location prior to fully releasing the TAV. In this way, the user can make slight adjustments to the TAV location if needed prior to release.

Compression Loading Systems

The CLS (Model CLS-3000-18FR and CLS-3000-18FR-US) and next generation CLS (Model CLS4-18F and Model CLS4-18F-23) is a system of reduction cones and tubing, which is designed to gradually reduce the diameter of the TAV to an optimal diameter to facilitate manual loading of the TAV into the deployment sheath capsule of the DCS.

The CLS is comprised of the following elements:

- inflow cone
- inflow tube (straight tube)
- outflow cap
- outflow cone
- outflow tube (tube with flared ends)

Figure 5: Compression Loading System (CLS) (Model CLS-3000-18 FR and CLS-3000-18FR-US)

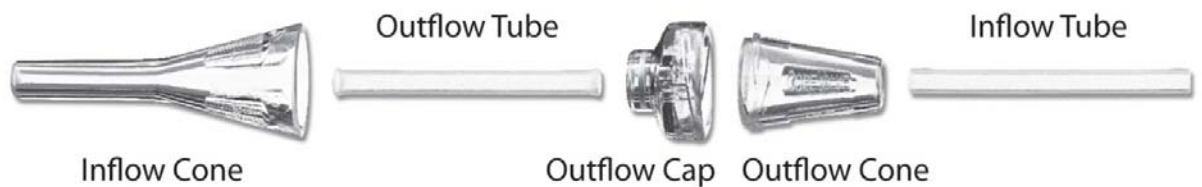
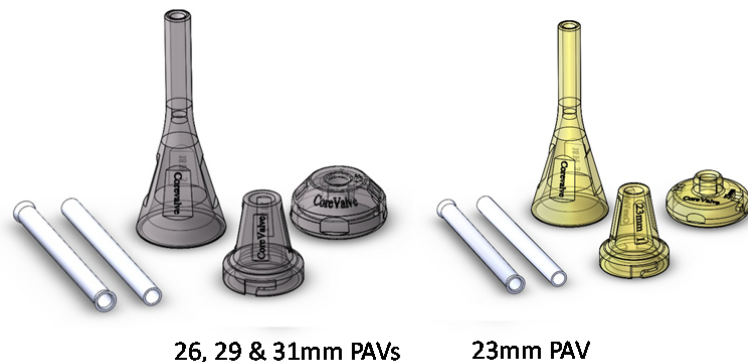

Figure 6: Compression Loading System (CLS) Models CLS4-18F-C and CLS-3000-18FR-US (left) and CLS4-18F-23-C (right)



The inflow cone, outflow cone, and outflow cap components of the next generation CLS models are tinted, and the locking mechanism has been modified from the previous generation. The purpose and function of all CLS models is the same, but the next generation includes 2 models, one intended for use with the 23mm TAV (CLS4-18F-23-C), which has an orange tint, and another model intended for 26 mm, 29 mm & 31mm TAVs (CLS4-18F-C and CLS-3000-18FR-US), which has a blue tint.

E.2 Investigational Device Ordering, Storage, and Disposition

The TAV and all required delivery components will be ordered through Medtronic. Medtronic will only allow shipment of investigational devices to the hospital or investigator when the Clinical Research Specialist has declared the investigation site ready to start the trial.

Devices will be shipped to sites as needed based on subject enrollment/randomization and procedures scheduled. Only one device should be used per patient, unless in case of device malfunctions or in case of complications. Sites will be supplied with sufficient device stock to complete scheduled procedures. Upon completion of scheduled procedures all unused devices must be returned to Medtronic. Instructions for device return are outlined on the Device Accountability Log. In the US, commercial devices, as referenced in Table 1, are approved for use in the clinical trial, as necessary, in the event that an investigational device is not available.

Investigational devices must be stored in a secured area. The method of storage shall prevent the use of investigational devices outside the applications as mentioned in this Clinical Investigation Plan. In addition, all information for the use, storage and handling of the investigational device as indicated in the Investigator's Brochure, must be taken into account.

Instructions for Use and storage recommendations are outlined in **Appendix R.22**.

F MONITORING AND AUDITING

F.1 Monitoring

The investigational site will be monitored to ensure compliance with the trial protocol, adherence to applicable regulations, and accuracy of trial data. Monitoring visits will be conducted primarily to ensure the safety and wellbeing of the subjects is preserved. Monitoring visits will also be used to verify that trial data submitted on case report forms are complete and accurate with respect to the subject records and to verify device accountability.

The Investigator(s), his/her delegate(s) and the study coordinator(s) shall be accessible to during monitoring. Accessibility is of particular importance for reviewing data in the eCRF.

Site personnel will complete eCRFs following each subject visit. Trial data submitted will be reviewed against patient charts and other sources containing original records of patient data. Source document verification will be conducted via a risk based approach as outlined in the Monitoring Plan.

The responsible individual for this trial is included on the title page of the CIP.

The progress of the trial will be monitored by:

- On-site review, as deemed appropriate by the sponsor
- Telephone communications between the site personnel (eg., Investigator, Trial Coordinator) and trial monitors
- Review of eCRFs and the associated clinical records
- Review of regulatory documents

Upon trial completion Site Closeout Visits will be conducted, as outlined in the Monitoring Plan.

Monitoring and monitoring oversight will be provided by Medtronic Coronary and Structural Heart (Mounds View, MN, USA, and Maastricht, the Netherlands). Representatives of Medtronic (i.e. contractors and designees) may also act as the trial monitors to the site. Medtronic will maintain an updated list of applicable representative and provide a copy to sites upon request.

Prior to the first site activation a monitoring plan will be established outlining the above activities, as well as trial materials to be supplied to sites, the process for corrective and preventive actions and Investigator disqualification procedures.

F.2 Auditing

Medtronic may conduct audits at participating clinical sites. The purpose of an audit is to verify the performance of the monitoring process and the trial conduct, independently of the personnel directly involved in the trial. Regulatory bodies, such as the Food and Drug Administration, may

also perform inspections at participating sites. The investigator and/or institution shall permit Medtronic and regulatory bodies direct access to source data and documents.

G LABELING

In Europe, the TAV component labeling will not carry the CE mark and the labeling will state for “clinical study purposes only” in accordance with ISO14155. The Investigational Instructions for Use (IFU) and labeling is supplied in English (and the local language, if required) with the TAV component and this will also not carry the CE mark. The DCS and CLS components are identical to the CE marked CoreValve System and will be supplied with the approved commercial CE marked labeling.

In the United States and other geographies, where TAV is not currently approved, the TAV, DCS and CLS will be labeled as Investigational.

Instructions for Use and additional labeling are attached in **Appendix R.22**.

H CONSENT MATERIALS

The template consents for the trial are attached in **Appendix R.1**.

I IRB/MEC INFORMATION

IRB/MEC information is attached in **Appendix R.2**.

J OTHER INSTITUTIONS

Information regarding other institutions involved in this trial is located in **Appendix R.3**.

K ADDITIONAL RECORDS AND REPORTS

Information regarding additional Records and Reports can be in found in **Appendix R.4**.

L REPORT OF PRIOR INVESTIGATIONS

The Report of Prior Investigations (RPI) is attached in the Investigator Brochure in **Appendix R.21**.

M PUBLICATION POLICY

Medtronic, as the Sponsor of this trial, recognizing the seminal importance of this investigation, is committed to the widespread dissemination of all primary and secondary endpoint results. A publication plan will be implemented and followed. At the conclusion of the trial, a multisite abstract reporting the primary results will be prepared by the Principal Investigators (in collaboration with others including but not limited to the Steering Committee, directors of the core laboratories, CEC, and Lead Investigators from high enrolling sites) and presented at an annual scientific meeting (eg., Transcatheter Cardiovascular Therapeutics, EuroPCR, the American Heart Association, or the American College of Cardiology). A multisite publication will similarly be prepared for publication in a reputable scientific journal. The publication of the principal results from any single site experience within the trial is not allowed until both the preparation and publication of the multisite results, and then only with written permission from Medtronic.

Following analysis and presentation of the primary endpoint results, active participation of all committee members, Investigators from high enrolling sites, and core laboratory personnel will be solicited for data analysis and abstract and manuscript preparation. Submission of all abstracts and publications regarding the primary endpoint and secondary endpoints from the trial requires approval by Medtronic and the Publications Committee.

A separate publication plan will provide detailed information about the publication committee, authorship, publication proposals, and requests for data.

N AMENDMENTS TO THE CLINICAL INVESTIGATION PLAN

All amendments to the CIP shall be agreed between the sponsor and the clinical investigator(s). The investigator may propose appropriate modification(s) of the Clinical Investigation Plan or investigational device or investigational device use. Medtronic will review this proposal and decide whether the modification(s) will be implemented.

Medtronic will submit any significant amendment to the Clinical Investigation Plan, including a justification for this amendment, to the appropriate regulatory authorities and to the investigators to obtain approval from their IRB/MEC. The investigator will only implement the amendment after approval of the IRB/MEC, regulatory authority and sponsor.

Amendments will be recorded with a justification for the amendments in Table 8 below:

Table 8: Clinical Investigation Plan Change History

Version	Description of Change	Rationale for Change
3.0	Initial Release	NA
4.0	<ul style="list-style-type: none"> • Inclusion/Exclusion Criteria updated • Device status updates: <ul style="list-style-type: none"> ○ Addition of 23mm PAV and applicable DCS ○ AOA CE mark status • Modification of statistical methods to relative risk design and addition of adaptive trial design • Addition of Canada as a participating geography • Appendix updates: <ul style="list-style-type: none"> ○ Informed Consent templates ○ Clinical Assessments ○ Investigator Brochure ○ Instructions For Use ○ Radiation Exposure and Data Collection 	<ul style="list-style-type: none"> • Changes based on FDA pre-IDE feedback • Device status updates: <ul style="list-style-type: none"> ○ 23mm PAV and applicable DCS CE mark approval ○ AOA CE mark approval
5.0	<ul style="list-style-type: none"> • Stroke classifications changed from major vs. minor to disabling vs. non-disabling • Inclusion/Exclusion Criteria updated • Additional neurological testing added (mRS) • Clarification of local Heart Team composition and decision making • Appendix updates: <ul style="list-style-type: none"> ○ CMS Requirements for Coverage and Reimbursement – US ONLY – <i>added</i> 	<ul style="list-style-type: none"> • Changes based on FDA IDE deficiencies • General updates and corrections
6.0	<ul style="list-style-type: none"> • Device status update – Canadian approval • Total number of investigational centers increased • Inclusion criteria #3 updated • Roll-in subjects added • Definitions of terms updated in alignment with VARC-2 • Appendix updates: <ul style="list-style-type: none"> ○ Informed Consent templates ○ Echocardiography Acquisition Guidelines 	<ul style="list-style-type: none"> • Changes based on FDA recommendations • Publication of VARC-2 • General updates and corrections

Version	Description of Change	Rationale for Change
	<ul style="list-style-type: none"> o Aortogram Acquisition Guidelines 	
7.0 <i>OBSOLETE</i> prior to distribution	<ul style="list-style-type: none"> • Device Description updated to include EnVeo™ DCS and next generation CLS 	<ul style="list-style-type: none"> • FDA IDE supplement to incorporate EnVeo/G5 and the next generation CLS in the United States
8.0	<ul style="list-style-type: none"> • Modification to Patient Population (re-defined Intermediate Risk) • Inclusion / Exclusion modifications and clarifications • Clarification of adverse event reporting requirements • All references to Percutaneous Aortic Valve (PAV) updated to Transcatheter Aortic Valve (TAV) • Addition of the next regeneration Compression Loading Systems • Appendix updates: <ul style="list-style-type: none"> o Informed Consent templates o Instructions for Use o Investigator Brochure o Echocardiography Acquisition Guidelines o Electrocardiogram (ECG) Submission 	<ul style="list-style-type: none"> • General updates and corrections • Updated trial utilization of core laboratories
8.1	<ul style="list-style-type: none"> • Inclusion criteria clarification 	<ul style="list-style-type: none"> • Updated to include upper limit of risk classification
9.0	<ul style="list-style-type: none"> • All references to Cardiovascular Department updated to Coronary and Structural Heart • All references to MCS TAVI updated to TAVI • Appendix updates: <ul style="list-style-type: none"> o Informed Consent templates o Other Institutions o Instruction for Use o Investigator Brochure 	<ul style="list-style-type: none"> • General updates and corrections • Updated change to Imaging Core Lab
10.0	<ul style="list-style-type: none"> • Updated Device Approval Status • Statistical Methods and Analysis: <ul style="list-style-type: none"> o Updated assumed event rates o Modified non-inferiority margin o Updated sample size look <ul style="list-style-type: none"> ▪ Updated maximum sample size from 3700 to 2000 • Appendix updates: <ul style="list-style-type: none"> o Informed consent templates 	<ul style="list-style-type: none"> • General updates and corrections • Updated Statistical Methods and Analysis per agreement from FDA
11.1 <i>OBSOLETE</i> prior to distribution	<ul style="list-style-type: none"> • Updated Device Approval Status • Removed AR/AS/MR as SAEs in absence of clinical symptoms • Statistical Methods and Analysis 	<ul style="list-style-type: none"> • General updates and corrections • Updated Statistical Methods and Analysis per agreement from FDA
12.1	<ul style="list-style-type: none"> • Update Device Description • Removed moderate or severe mitral or aortic regurgitation or stenosis as a default SAEs in absence of clinical symptoms • Added section about Vigilance Reporting • Investigational Device Accountability • Statistical Methods and Analysis • Appendix updates: <ul style="list-style-type: none"> o Informed consent templates 	<ul style="list-style-type: none"> • General updates and corrections • Updated Statistical Methods and Analysis

O ABBREVIATIONS AND DEFINITIONS

O.1 List of Abbreviations

Please refer to **Table 9** below for a list of abbreviations for use in the SURTAVI trial.

Table 9: List of Abbreviations

Abbreviation	Term
2D	Two Dimensional
6MWT	Six Minute Walk Test
AE	Adverse Event
ACT	Active Clotting Time
ADE	Adverse Device Effect
AF	Atrial Fibrillation
AOA	Alpha-amino Oleic Acid
aPTT	Activated Partial Thromboplastin Time
AR	Aortic Regurgitation
AS	Aortic Stenosis
AVR	Aortic Valve Replacement
BAV	Balloon Aortic Valvuloplasty
BNP	B-type Natriuretic Peptide
BPM	Beats Per Minute
BP	Blood Pressure
BSA	Body Surface Area
CA	Competent Authority
CE	European Conformity
CEC	Clinical Events Committee
CFR	U.S. Code of Federal Regulations
CIP	Clinical Investigation Plan
CLS	Compression Loading System
CMS	Centers for Medicare and Medicaid Services
CRF	Case Report Form
CRO	Contract Research Organization
CT	Computed Tomography
CTA	Computerized tomographic angiography
CVA	Cerebrovascular Accident
CV-ICU	Cardiovascular Intensive Care Unit
DCS	Delivery Catheter System
DHCA	Deep Hypothermic Circulatory Arrest
DSMB	Data Safety Monitoring Board
DVI	Doppler Velocity Index

Abbreviation	Term
DVT	Deep Vein Thrombosis
ECC	Extracorporeal Circulation
ECG	Electrocardiogram
ECMO	Extracorporeal Membrane Oxygenation
eCRF	Electronic Case Report Form
EDC	Electronic Data Capture
EOA	Effective Orifice Area
EQ-5D	EuroQoL Five Dimensions
EuroSCORE	European System for Cardiac Operative Risk Evaluation
FDA	U.S. Food and Drug Administration
Fr	French
GCP	Good Clinical Practice
GI	Gastrointestinal
HVD	Heart Valve Dysfunction
HIPAA	Health Insurance Portability and Accountability Act
HR	Heart Rate
IABP	Intra-Aortic Balloon Pump
ICF	Informed Consent Form
IDE	Investigational Device Exemption
IFU	Instructions for use
INR	International Normalized Ratio
IRB	Institutional Review Board
ITT	Intent-to-treat
IV	Intravenous
IXRS	Interactive Voice/Web Response System
KCCQ	Kansas City Cardiomyopathy Questionnaire
LA	Left Atrial/Atrium
LAO	Left Anterior Oblique
LBBB	Left Bundle Branch Block
LMWH	Low Molecular Weight Heparin
LVEF	Left Ventricular Ejection Fraction
LVOT	Left Ventricular Outflow Tract
LVOTO	Left Ventricular Outflow Tract Occlusion
MACCE	Major Adverse Cardiovascular and Cerebrovascular Event
MAE	Major Adverse Event
MCS	Medtronic CoreValve™ System
MEC	Medical Ethics Committee
MI	Myocardial Infarction
MMSE-2:SV	Mini Mental State Exam

Abbreviation	Term
NIHSS	National Institute of Health Stroke Scale
mRS	Modified Rankin Score
NYHA	New York Heart Association
PCI	Percutaneous Coronary Intervention
PE	Product Experience
PPM	Patient Prosthesis Mismatch
QoL	Quality of Life
RAO	Right Anterior Oblique
RBBB	Right Bundle Branch Block
SAE	Serious Adverse Event
SADE	Serious Adverse Device Effect
SAP	Statistical Analysis Plan
SAVR	Surgical Aortic Valve Replacement
SF-36	Short Form (36) Health Survey
SOP	Standard Operating Procedures
STS	Society of Thoracic Surgeons
TAV	Transcatheter Aortic Valve
TAVI	Transcatheter Aortic Valve Implant
TEE	Transesophageal Echocardiography
TIA	Transient Ischemic Attack
TTE	Transthoracic Echocardiography
UADE	Unanticipated Adverse Device Effect
USADE	Unanticipated Serious Adverse Device Effect

O.2 Definitions of Terms

ACUTE KIDNEY INJURY

Acute Kidney Injury will be defined according to the Valve Academic Research Consortium (VARC)-2; Updated Standardized Endpoint Definitions for Transcatheter Aortic Valve Implantation (TAVI); 2012-10-09.

Acute Kidney Injury (AKIN Classification)	
Stages	Change in Serum Creatinine (up to 7 days post-index procedure) compared to Baseline
Stage 1	Increase in serum creatinine to 150-199% (1.5-1.9 x increase compared with baseline) OR increase of ≥ 0.3 mg/dl (≥ 26.4 μ mol/L) OR urine output < 0.5 ml/kg/hour for > 6 but < 12 hours
Stage 2*	Increase in serum creatinine to 200-299% (> 2.0 - 2.9 x increase compared with baseline) OR urine output < 0.5 ml/kg/hour for > 12 but < 24 hours
Stage 3**	Increase in serum creatinine to $\geq 300\%$ (> 3 x increase compared with baseline) OR serum creatinine of > 4.0 mg/d (≥ 354 μ mol/L) with an acute increase of at least 0.5 mg/dl (44 μ mol/L) OR urine output < 0.3 ml/kg/hour for > 24 hours OR anuria for > 12 hours
<p>* Stage 2 and 3 acute renal injuries will be considered to be serious adverse events.</p> <p>** Patients receiving renal replacement therapy are considered to meet Stage 3 criteria irrespective of other criteria</p>	

ACUTE VESSEL OCCLUSION

The state of complete luminal obstruction with no antegrade blood flow.

ADVERSE EVENT (AE)

An adverse event is any untoward medical occurrence, unintended disease or injury, or untoward clinical signs (including abnormal laboratory findings) in subjects, users or other persons, whether or not related to the investigational medical device.

NOTE 1: This definition includes events related to the investigational medical device or the comparator.

NOTE 2: This definition includes events related to the procedures involved.

NOTE 3: For users or other persons, this definition is restricted to events related to investigational medical devices.

ADVERSE DEVICE EFFECT (ADE)

Adverse event related to the use of an investigational medical device

NOTE 1: This definition includes adverse events resulting from insufficient or inadequate instructions for use, deployment, implantation, installation, or operation, or any malfunction of the investigational medical device.

NOTE 2: This definition includes any event resulting from use error or from intentional misuse of the investigational medical device

AORTIC DISSECTION

Intimal tear resulting in blood splitting the aortic media and producing a false lumen that can progress in an antegrade or retrograde direction. Aortic dissection is further classified using Stanford classification (Types A and B) depending on whether ascending or descending aorta involved) or DeBakey classification (Types I, II and III) as shown below.

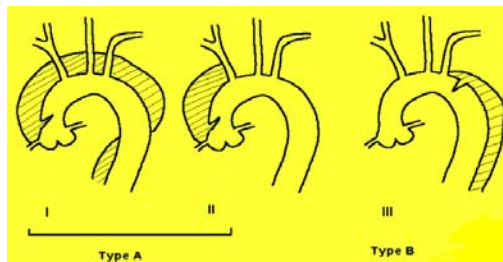

AORTIC REGURGITATION (AR)

Aortic valve incompetence resulting in backward flow of blood. **Reference Appendix R.7 Echocardiography Acquisition Guidelines** for additional information regarding assessment of aortic regurgitation.

AORTIC STENOSIS (AS)

A narrowing, stiffening or stricture of the aortic valve.

Aortic stenosis of the native valve (i.e. inclusion criteria) will be defined based on the 2008 Focused Update Incorporated Into the ACC/AHA 2006 Guidelines for the Management of Patients With Valvular Heart Disease (published in the October 2008 issues of Journal of the American College of Cardiology and Circulation)

Aortic Stenosis			
Indicator	Mild	Moderate	Severe
Jet velocity (m/s)	Less than 3.0	3.0-4.0	Greater than 4.0
Mean gradient (mmHg)	Less than 25	25-40	Greater than 40
Valve area (cm ²)	Greater than 1.5	1.0-1.5	Less than 1.0
Valve area index (cm ² /m ²)			Less than 0.6

Stenosis of trial valve will be defined based on the definition of the Valve Academic Research Consortium (VARC)-2 Updated Standardized Endpoint Definitions for Consensus Report for Transcatheter Aortic Valve Implantation (TAVI); 2012-10-09. **See Prosthetic Valve Dysfunction – Prosthetic Aortic Valve Stenosis.**

ARRHYTHMIA

Any variation from the normal rhythm of the heartbeat, including sinus arrhythmia, premature beat, heart block, atrial fibrillation, atrial flutter and tachycardia.

- Major Arrhythmias: Complete heart block, ventricular tachycardia and ventricular fibrillation
- Serious Arrhythmias: Any arrhythmia requiring surgical or invasive intervention or DC cardioversion

ATRIAL FIBRILLATION

Atrial fibrillation will be classified according to the International Consensus on Nomenclature and Classification of Atrial Fibrillation; A Collaborative Project of the Working Group on Arrhythmias and the Working Group on Cardiac Pacing of the European Society of Cardiology and the North American Society of Pacing and Electrophysiology, Europace 2003, Vol 5.

- **Paroxysmal:** spontaneous termination within 7 days and most often <48 hours
- **Persistent:** is not self-terminating; lasts longer than 7 days; or prior cardioversion
- **Permanent (accepted):** does not terminate, or terminated but relapsed; no cardioversion attempt

BLEEDING EVENT

Bleeding event will be defined according to the Valve Academic Research Consortium (VARC)-2; Updated Standardized Endpoint Definitions for Transcatheter Aortic Valve Implantation (TAVI); 2012-10-09.

Life-threatening or Disabling Bleeding
<ul style="list-style-type: none"> • Fatal bleeding (<i>BARC type 5</i>) OR • Bleeding in a critical area or organ, such as intracranial, intraspinal, intraocular, or pericardial necessitating pericardiocentesis, or intramuscular with compartment syndrome (<i>BARC type 3b</i>) OR • Bleeding causing hypovolemic shock or severe hypotension requiring vasopressors or surgery OR • Overt source of bleeding with drop in hemoglobin of ≥ 5 g/dL or whole blood or packed red blood cells (RBC) transfusion ≥ 4 units* (<i>BARC type 3b</i>)
Major Bleeding (<i>BARC type 3a</i>)
<ul style="list-style-type: none"> • Overt bleeding either associated with a drop in the hemoglobin level of at least 3.0g/dL or requiring transfusion of 2-3 units of whole blood/RBC, or causing hospitalization or permanent injury or requiring surgery AND • Does not meet criteria of life-threatening or disabling bleeding
Minor Bleeding (<i>BARC type 2 or 3a, depending on severity</i>)
<ul style="list-style-type: none"> • Any bleeding worthy of clinical mention (eg. access site hematoma) that does not qualify as life-threatening, disabling or major

* Given one unit of packed RBC typically will raise blood hemoglobin concentration by 1g/dL, an estimated decrease in hemoglobin will be calculated.
BARC = Bleeding Academic Research Consortium

Life-threatening and Major bleeding events are considered to be serious.

BUNDLE BRANCH BLOCK

ACC/AHA/HRS 2006 Key Data Elements and Definitions for Electrophysiological Studies and Procedures; A Report of the American College of Cardiology/ American Heart Association Task Force on Clinical Data Standards (ACC/AHA/HRS Writing Committee to Develop Data Standards on Electrophysiology), JACC, Vol. 48, No. 11, 2006.

Left Bundle Branch Block (LBBB)

- QRS duration 120 ms or longer
- Delayed onset of intrinsicoid deflection in I, V5, and V6 ≥ 60 ms
- Broad and notched or slurred R waves in I, aVL, V5, and V6
- rS or QS complexes in right precordial leads
- ST-segment and T waves in opposite polarity to the major QRS deflection

Right Bundle Branch Block (RBBB)

- QRS duration ≥ 120 ms
- rsR \equiv or rSR \equiv complexes in V1 and V2
- Delayed onset of intrinsicoid deflection in V1 and V2 ≥ 50 ms
- Broad, slurred S wave in I, V5,

Any new or worsening LBBB or RBBB that requires the placement of a permanent pacemaker and/or other surgical or invasive intervention will be considered to be serious.

CARDIAC PERFORATION

A laceration or tearing of the walls of the ventricles or atria of the heart, of the interatrial or interventricular septum, of the papillary muscles or chordae tendineae or of the one of the valves of the heart.

Cardiac perforation events will be classified into additional subgroups according to the Valve Academic Research Consortium (VARC)-2; Updated Standardized Endpoint Definitions for Transcatheter Aortic Valve Implantation (TAVI); 2012-10-09

Mitral valve apparatus damage or dysfunction

Angiographic or echocardiographic evidence of new damage (chordae papillary muscle, or to the leaflet) to the mitral valve apparatus or dysfunction (eg. opening restrictions due to the THV) of the mitral valve during or after the TAVI procedure.

Ventricular septal perforation

Angiographic or echocardiographic evidence of a new septal perforation during or after the TAVI procedure.

CARDIAC TAMPONADE

Clinical syndrome caused by the accumulation of fluid in the pericardial space, resulting in reduced ventricular filling and subsequent hemodynamic compromise.

CARDIOGENIC SHOCK

Patient was, at the time of procedure, in a clinical state of hypoperfusion sustained for greater than 30 minutes, according to either of the following criteria:

1. Systolic BP < 80 and/or Cardiac Index < 1.8 despite maximal treatment; or
2. IV inotropes and/or IABP necessary to maintain Systolic BP > 80 and/or CI > 1.8

CHRONIC RENAL INSUFFICIENCY

Kidney damage or glomerular filtration rate (GFR) <60 mL/min/1.73 m² for or ≥3 months. Kidney damage is defined as pathologic abnormalities or markers of damage, including abnormalities in blood or urine test or imaging studies.

CONDUCTION DISTURBANCE REQUIRING PERMANENT PACEMAKER IMPLANTATION

ACC/AHA 2006 Guidelines for the Management of Patients with Valvular Heart Disease (published in the August 1, 2006, issues of Journal of the American College of Cardiology and Circulation)

Any disturbance in the cardiac electrical conduction system that meets the American College of Cardiology (ACC)/American Heart Association (AHA)/ Heart Rhythm Society (HRS) Class I or IIa Guidelines for Device-Based Therapy of Cardiac Rhythm Abnormalities for Acquired Atrioventricular Block in Adults or Permanent Pacing in Chronic Bifascicular Block.

CONVERSION TO OPEN HEART SURGERY

Valve Academic Research Consortium (VARC)-2; Updated Standardized Endpoint Definitions for Transcatheter Aortic Valve Implantation (TAVI); 2012-10-09.

Conversion to open sternotomy during the TAVI procedure secondary to any procedure-related complications.

CORONARY OBSTRUCTION

Valve Academic Research Consortium (VARC)-2; Updated Standardized Endpoint Definitions for Transcatheter Aortic Valve Implantation (TAVI); 2012-10-09.

Angiographic or echocardiographic evidence of a new, partial or complete, obstruction of a coronary ostium, either by the valve prosthesis itself, the native leaflets, calcifications, or dissection, occurring during or after the TAVI procedure.

DEVICE DEFICIENCY

Inadequacy of a medical device with respect to its identity, quality, durability, reliability, safety or performance

NOTE: Device deficiencies include malfunctions, use errors, and inadequate labeling.

DEVICE RELATED

Events that occur as the direct result of the Medtronic CoreValve™ System (MCS) as it relates to delivery, placement, efficacy or durability; these may involve the implanted device or the delivery system components.

DEVICE RELATED COMPLICATIONS

Complications associated with the device as it relates to delivery, placement, efficacy or durability; these may involve the implanted device or the delivery system.

EMBOLISM

Free flowing blood clot or lesion material that is located in the systemic or pulmonary circulation that occurs in the absence of infection after the immediate perioperative period. Embolism may be manifested by a neurological event or a noncerebral embolic event.

ENCEPHALOPATHY

Altered mental state (eg., seizures, delirium, confusion, hallucinations, dementia, coma, psychiatric episode, etc.).

ENDOCARDITIS

Implanted valve endocarditis: Any infection involving an implanted valve. The diagnosis of *operated valvular endocarditis* is based on one of the following criteria:

- re-operation with evidence of abscess, paravalvular leak, pus, or vegetation confirmed as secondary to infection by histological or bacteriologic studies;
- autopsy findings of abscess, pus, or vegetation involving a replaced valve; or
- in the absence of reoperation or autopsy, meeting of the Duke Criteria for endocarditis.

Infective endocarditis is diagnosed based on Duke Criteria and necessitates 2 major criteria, or 1 major and 3 minor criteria, or 5 minor criteria

Major criteria 1: Positive blood culture for infective endocarditis

Typical microorganism consistent with infective endocarditis from 2 separate blood cultures, as noted below:

- Viridans streptococci, *Streptococcus bovis*, or HACEK group (*Haemophilus. Actinobacillus actinomycetemcomitans, Cardiobacterium hominis, Eikenella corrodens, Kingella* or
- Community-acquired *Staphylococcus aureus* or enterococci, in the absence of a primary focus

-OR-

Microorganisms consistent with infective endocarditis from persistently positive blood cultures defined as:

- Two positive cultures of blood samples drawn >12 hours apart, or
- All of 3 or a majority of 4 separate cultures of blood (with first and last sample drawn 1 hour apart)

Major criteria 2: Evidence of endocardial involvement

Positive echocardiogram for infective endocarditis defined as:

- oscillating intracardiac mass on valve or supporting structures, in the path of regurgitant jets, or on implanted material in the absence of an alternative anatomic explanation, or
- abscess, or
- new partial dehiscence of prosthetic valve

-OR-

- New valvular regurgitation (worsening or changing of pre-existing murmur not sufficient)

Minor criteria 1: Predisposition: predisposing heart condition or intravenous drug use

Minor criteria 2: Fever: temperature > 38.0° C (100.4° F)

Minor criteria 3: Vascular phenomena: major arterial emboli, septic pulmonary infarcts, mycotic aneurysm, intracranial hemorrhage, conjunctival hemorrhages, and Janeway lesions

Minor criteria 4: Immunologic phenomena: glomerulonephritis, Osler's nodes, Roth spots, and rheumatoid factor

Minor criteria 5: Microbiological evidence: positive blood culture but does not meet a major criterion as noted above or serological evidence of active infection with organism consistent with infective endocarditis

Minor criteria 6: Echocardiographic findings: consistent with infective endocarditis but do not meet a major criterion as noted above

EXPLANT

Removal of the investigational valve implant for any reason, including post-mortem.

HEMOLYSIS

A plasma free hemoglobin value > 40 mg/dL is considered to be hemolysis and a reportable adverse event.

- **Major hemolysis:** A plasma free hemoglobin value > 40 mg/dL that requires intervention (i.e. iron replacement, blood transfusion, folic acid administration, corticosteroids, Intravenous immunoglobulin G (IVIG) and/or surgery). Major hemolysis events will be considered to be serious adverse events.
- **Minor hemolysis:** A plasma free hemoglobin value > 40 mg/dL that does not require intervention.

INFECTION

Elevated body temperature (fever), and White Blood Count (WBC) > 12,000/ml, and Significant leftward shift on Differential.

MAJOR ADVERSE CARDIOVASCULAR AND CEREBROVASCULAR EVENTS (MACCE)

Defined as a composite rate of

- all-cause death
- myocardial infarction (MI)
- all stroke, and
- reintervention (defined as any cardiac surgery or percutaneous reintervention catheter procedure that repairs, otherwise alters or adjusts, or replaces a previously implanted valve)

MAJOR ADVERSE EVENT (MAE)

Major Adverse events include the following:

- MACCE
- Acute kidney Injury
- Cardiac tamponade
- Prosthetic valve dysfunction
- Cardiogenic shock
- Prosthetic valve endocarditis
- Life-threatening, disabling or major bleeding
- Major vascular complication
- Cardiac Perforation
- Valve malpositioning

MITRAL REGURGITATION

Mitral valve incompetence resulting in backward flow of blood.

2008 Focused Update Incorporated into the ACC/AHA 2006 Guidelines for the Management of Patients with Valvular Heart Disease (published in the October 2008 issues of Journal of the American College of Cardiology and Circulation)

Classification of the Severity of Valve Disease in Adults			
Mitral Regurgitation			
	Mild	Moderate	Severe
Qualitative Angiographic grade Color Doppler jet area	1+ Small, central jet, < 4cm ² or <20% LA area)	2+ Signs of > mild present but no criteria for severe MR	3-4+ Vena contracta with > 0.7cm with large central MR jet (area >40% of LA area) or with a wall-impinging jet of any size, swirling in LA
Doppler vena contracta width (cm)	< 0.3	0.3-0.69	≥ 0.70
Quantitative (cath or echo) Regurgitant volume (mL per beat)	< 30	30-59	≥ 60
Regurgitant fraction (%)	< 30	30-49	≥ 50
Regurgitant orifice area (cm ²)	< 0.20	0.29 – 0.39	≥ 0.40
Additional essential criteria Left atrial size Left ventricular size			Enlarged Enlarged

MITRAL STENOSIS

A narrowing, stiffening or stricture of the mitral valve.

2008 Focused Update Incorporated into the ACC/AHA 2006 Guidelines for the Management of Patients with Valvular Heart Disease (published in the October 2008 issues of Journal of the American College of Cardiology and Circulation)

Mitral Stenosis			
	Mild	Moderate	Severe
Mean Gradient (mmHg)	Less than 5	5-10	Greater than 10
Pulmonary artery systolic pressure (mmHg)	Less than 30	30-50	Greater than 50
Valve area (cm ²)	Greater than 1.5	1.0-1.5	Less than 1.0

MORTALITY

A serious adverse event that is classified by the following:

All-cause mortality: All deaths from any cause after a valve intervention. This includes all cardiovascular and non-cardiovascular deaths.

Cardiovascular mortality:

Cardiovascular death will be defined according to the Valve Academic Research Consortium (VARC)-2; Updated Standardized Endpoint Definitions for Transcatheter Aortic Valve Implantation (TAVI); 2012-10-09.

A death meeting any one of the following criteria:

- Death due to proximate cardiac cause (eg. myocardial infarction, cardiac tamponade, worsening heart failure)
- Death caused by non-coronary vascular conditions such as neurological events, pulmonary embolism, ruptured aortic aneurysm, dissecting aneurysm, or other vascular disease
- All procedure-related deaths, including those related to a complication of the procedure or treatment for a complication of the procedure
- All valve-related deaths including structural or non-structural valve dysfunction or other valve-related adverse events
- Sudden or unwitnessed death
- Death of unknown cause

Non-cardiovascular mortality: Any death in which primary cause of death is clearly related to another condition (eg. trauma, cancer, suicide)

NOTE: All deaths are considered cardiac unless an unequivocal non-cardiac cause can be established. Specifically, any unexpected death even in subjects with coexisting potentially fatal non-cardiac disease (eg. cancer, infection) should be classified as cardiac.

MYOCARDIAL INFARCTION (MI)

Myocardial infarction will be defined according to the Valve Academic Research Consortium (VARC)-2; Updated Standardized Endpoint Definitions for Transcatheter Aortic Valve Implantation (TAVI); 2012-10-09.

Peri-Procedural MI (<72 hours after the index procedure)
<ol style="list-style-type: none"> 1. New ischemic symptoms (eg. chest pain or shortness of breath), or new ischemic signs (eg. ventricular arrhythmias, new or worsening heart failure, new ST-segment changes, hemodynamic instability, new pathological Q-waves in at least two continuous leads, imaging evidence of new loss of viable myocardium or new wall motion abnormality) AND 2. Elevated cardiac biomarkers (preferably CK-MB) within 72 hours after the index procedure, consisting of two or more post-procedure samples with a peak value exceeding 15x the upper reference limit (URL) for troponin or 5x for CK-MB. If cardiac biomarkers are increased at baseline (>99th percentile), a further increase in at least 50% post-procedure is required AND the peak value must exceed the previously stated limit

Spontaneous MI (> 72 hours after the index procedure)
<p>Any one of the following criteria:</p> <ol style="list-style-type: none"> 1. Detection of rise and/or fall of cardiac biomarkers (preferably troponin) with at least one value above the 99th percentile URL, together with evidence of myocardial ischemia with at least one of the following: <ul style="list-style-type: none"> • Symptoms of ischemia • ECG changes indicative of new ischemia [new ST-T changes or new left bundle branch block (LBBB)]; • New pathological Q waves in at least two contiguous leads; • Imaging evidence of new loss of viable myocardium or new regional wall motion abnormality 2. Sudden, unexpected cardiac death, involving cardiac arrest, often with symptoms suggestive of myocardial ischemia, and accompanied by presumably new ST elevation, or new LBBB, and/or evidence of fresh thrombus by coronary angiography and/or at autopsy, but death occurring before blood samples could be obtained, or at a time before the appearance of cardiac biomarkers in the blood. 3. Pathological findings of an acute myocardial infarction.

All myocardial infarctions will be considered serious adverse events.

NEUROLOGICAL EVENT

Any central, new neurological deficit, whether temporary or permanent and whether focal or global, that occurs after the subject emerges from anesthesia.

NEW YORK HEART ASSOCIATION CLASSIFICATION (NYHA)

Classification system for defining cardiac disease and related functional limitations into four broad categorizations:

Class I	Subject with cardiac disease but without resulting limitations of physical activity. Ordinary physical activity does not cause undue fatigue, palpitation, dyspnea, or anginal pain.
Class II	Subjects with cardiac disease resulting in slight limitation of physical activity. They are comfortable at rest. Ordinary physical activity results in fatigue, palpitation, dyspnea, or anginal pain.
Class III	Subjects with cardiac disease resulting in marked limitation of physical activity. They are comfortable at rest. Less than ordinary physical activity causes fatigue, palpitation, dyspnea, or anginal pain.
Class IV	Subjects with cardiac disease resulting in inability to carry on any physical activity without discomfort. Symptoms of cardiac insufficiency or of the anginal syndrome may be present even at rest. If any physical activity is undertaken, discomfort is increased.

PARAVALVULAR AORTIC REGURGITATION

Leakage due to a separation of the prosthetic valve from the annulus. Diagnosis of paravalvular leak may be obtained from echocardiogram; however definitive diagnosis is obtained at reoperation, explant, or autopsy.

(Refer to the definition of Aortic Regurgitation for additional paravalvular leak severity criteria)

PATIENT PROSTHESIS MISMATCH (PPM)

Patient prosthesis mismatch (PPM) is defined under the definition of Prosthetic Valve Dysfunction according to the Valve Academic Research Consortium (VARC)-2 Updated Standardized Endpoint Definitions for Consensus Report for Transcatheter Aortic Valve Implantation (TAVI); 2012-10-09

Reference prosthetic valve dysfunction.

PERMANENT PACEMAKER IMPLANTATION

Implantation of permanent pacemaker after the index procedure due to occurrence of conduction disturbances.

- **Procedure-related:** Permanent Pacemaker is implanted in subjects with new onset conduction disturbances or worsening of existing conduction disturbances
- **Not related to procedure:** Permanent Pacemaker is implanted in subjects with known conduction disturbances that did not advance after the index procedure.

PROCEDURE RELATED COMPLICATIONS

Complications associated with any part of the vascular access procedure, associated treatments or necessary secondary interventions that do not necessarily involve the device. This includes morbidity associated with either pre-medication, or anesthesia, or other adjunct to the surgical procedure. Other technical errors including inappropriate patient selection, inappropriate operator techniques, measurements, or judgment that do not involve the device itself are also included.

PROCEDURAL SUCCESS

Defined as device success without occurrence of in-hospital MACCE.

PROCEDURE-RELATED EVENTS

All events occurring during or as a direct result of the index procedure.

All events that occur before extubation and/or before access site closure are classified as procedure-related regardless of event timing.

PROSTHETIC VALVE DYSFUNCTION

Prosthetic Valve Dysfunction will be defined according to the Valve Academic Research Consortium (VARC)-2 Updated Standardized Endpoint Definitions for Consensus Report for Transcatheter Aortic Valve Implantation (TAVI); 2012-10-09

Failure modes of prosthetic valve dysfunction include, but are not limited to, the following:

- Aortic Stenosis

- Stent creep
- Pannus
- Calcification
- Support structure deformation (out-of-round configuration), under-expansion, fracture, or trauma (cardio-pulmonary resuscitation, blunt chest trauma)
- Mal-sizing [prosthesis-patient mismatch(PPM)]
- Endocarditis
- Prosthetic valve thrombosis
- Native leaflet prolapse impeding prosthetic leaflet motion
- Aortic Regurgitation
 - Pannus
 - Calcification
 - Support structure deformation (out-of-round configuration), recoil, under-expansion, fracture, insufficient radial strength, or trauma (cardio-pulmonary resuscitation, blunt chest trauma)
 - Endocarditis
 - Prosthetic valve thrombosis
 - Mal-position (too high, too low)
 - Acute mal-coaptation
 - Leaflet wear, tear/perforation, prolapse or retraction
 - Suture breakage or disruption
 - Native leaflet prolapse impeding prosthetic leaflet motion

Prosthetic valve dysfunction will be considered serious when it meets the definition of a serious adverse event (SAE).

Prosthetic valve dysfunction			
Prosthetic aortic valve stenosis*			
	Normal	Mild Stenosis	Moderate/Severe Stenosis
Quantitative Parameters (Flow-dependent)†			
Peak velocity	<3 m/s	3-4 m/s	>4 m/s
Mean gradient	<20 mmHg	20-40 mmHg	>40 mmHg
Quantitative Parameters (Flow-independent)			
Doppler velocity index‡	>0.35	0.35-0.25	<0.25
Effective orifice area†	>1.1 cm ²	1.1-0.8 cm ²	<0.8 cm ²
Effective orifice area§	>0.9 cm ²	0.9-0.6 cm ²	<0.6 cm ²
Prosthesis-patient mismatch (PPM)			
	Insignificant	Moderate	Severe
Indexed effective orifice area**	>0.85 cm ² /m ²	0.85-0.65 cm ² /m ²	<0.65 cm ² /m ²
Indexed effective orifice area††	>0.70 cm ² /m ²	0.70-0.60 cm ² /m ²	<0.60 cm ² /m ²
Prosthetic aortic valve regurgitation			
	Mild	Moderate	Severe
Semi-quantitative Parameters			
Diastolic flow reversal in the descending aorta—PW	Absent or brief early diastolic	Intermediate	Prominent, holodiastolic
Circumferential extent of prosthetic valve paravalvular regurgitation (%)‡‡	<10%	10-29%	≥30%
Quantitative Parameters‡			
Regurgitant volume (ml/beat)	<30 ml	30-59 ml	≥60 ml
Regurgitant fraction (%)	<30%	30-49%	≥50%
EROA (cm ²)	<0.10 cm ²	0.10-0.29 cm ²	≥0.30 cm ²

*In conditions of normal or near normal stroke volume (50–70 mL)

†These parameters are more affected by flow, including concomitant aortic regurgitation

‡For LVOT >2.5 cm, significant stenosis criteria is <0.20

†Use in setting of BSA ≥1.6 cm² (note: dependent on the size of the valve and the size of the native annulus)

§Use in setting of BSA <1.6 cm²

**Use in setting of BMI <30 kg/cm²

††Use in setting of BMI ≥30 kg/cm²

‡‡Not well-validated and may overestimate severity compared to quantitative Doppler

Moderate or severe AS and AR will be considered a serious adverse event when the dysfunction is accompanied with clinical sequelae at the time of the event detection, and the clinical sequelae are chronologically and physiologically associated with the dysfunction.

RECURRENT HOSPITALIZATION

Recurrent hospitalization is defined as a non-elective hospital admission for signs and symptoms related to aortic valve disease (as described below), as well as complications related to aortic valve procedures including neurological events, infection, additional procedures (eg. implant of permanent pacemaker), and renal failure. For the purposes of the protocol a hospitalization is an admission that results in at least a one night stay (i.e., one midnight/change in calendar day).

Overnight stays at nursing home facilities, extended care facilities, or emergency room visits that do not result in an in-patient admission do not meet the protocol definition of recurrent hospitalization. Patients with signs and symptoms related to aortic valve disease (as described below) who are hospitalized for less than one night or who are treated and released from the emergency department or an outpatient clinic [including treatment for intravenous heart failure therapy (eg., inotropes, diuretics, and/or vasodilators)], does not meet the protocol definition of as recurrent hospitalizations.

Aortic valve disease will be evaluated using documented evidence of the following signs and symptoms. An independent Clinical Events Committee (CEC) will review all available source documentation for all hospitalizations to determine if they are aortic valve disease hospitalizations. The CEC adjudication will be used for final analysis.

Signs and Symptoms of Aortic Valve Disease	
Sign/Symptom	Definition
Aortic Valve Dysfunction	
Shortness of breath/dyspnea	A feeling of difficult or labored breathing that is out of proportion to the patient's level of physical activity
Exercise intolerance	A condition where the patient is unable to do physical exercise at the level or for the duration that would be expected of someone in his/her general physical condition, or experiences unusually severe post-exercise pain, fatigue, or other negative effects
Dizziness/syncope	Lightheadness or unsteadiness of gait or a partial or complete loss of consciousness with interruption of awareness of oneself and ones surroundings
Chest pain	Discomfort and soreness in and around the chest
Worsening Heart Failure	
Volume Overload	
Orthopnea	Dyspnea in which the person can breathe comfortably only when standing or sitting erect
Paroxysmal nocturnal dyspnea	Acute dyspnea caused by the lung congestion and edema that results from partial heart failure and occurring suddenly at night, usually an hour or two after the individual has fallen asleep.
Jugular venous distension	With the patient is positioned under 45°, and the filling level of the jugular vein determined. An abnormal response is more than 3 centimeters above the sternal angle.
Hepatomegaly	Palpation of the edge of the liver below the edge of the ribs without inspiration
Peripheral edema	Swelling of tissues, usually in the lower limbs, due to the accumulation of fluids.
Pulmonary rales	Small clicking, bubbling, or rattling sounds in the lung associated with inspiration
Abdominal-jugular reflux	An elevation of venous pressure visible in the jugular veins and measurable in the veins of the arm, produced in active or impending congestive heart failure by firm pressure with the flat hand over the abdomen.
Radiographic evidence of pulmonary edema	NA
Elevated B-type natriuretic peptide level	NA
Hypoperfusion	
Narrow pulse pressure	Pulse pressure < 30 mmHg
Hypotension	Systolic BP < 90 systolic
Renal or hepatic dysfunction	<ul style="list-style-type: none"> •Rise in baseline creatinine by 25% •Increase in LFT (SGOT, SGPT) > 2 times normal
Low serum sodium concentration	Serum sodium < 130 mEq/dL

REINTERVENTION

Any surgical or percutaneous interventional catheter procedure that repairs, otherwise alters or adjusts, or replaces a previously implanted valve. In addition to surgical reoperations, balloon dilatation, interventional manipulation, repositioning, or retrieval, and other catheter-based interventions for valve-related complications are also considered *reinterventions*. Reintervention is further subdivided into *surgical* and *percutaneous*.

RESPIRATORY INSUFFICIENCY

Post-bronchodilator forced expiratory volume in one second (FEV1)/forced vital capacity (FVC) ratio [FEV1/FVC] less than 70%.

Post-bronchodilator FEV1 less than 80% predicted, with or without chronic symptoms (i.e., cough or sputum production).

RESPIRATORY FAILURE

The need for ventilatory support for > 72 hours associated with an inability to wean from the respirator for any reason.

RIGHT VENTRICULAR INSUFFICIENCY

Defined as sequelae of right ventricular failure including the following:

- Significantly decreased right ventricular systolic and/or diastolic function
- Tricuspid valvular regurgitation secondary to elevated pressure

Clinical symptoms to include:

- Hepatic congestion
- Ascites
- Anasarca
- Presence of “hepato-jugular reflux”
- Edema

SERIOUS ADVERSE DEVICE EFFECT (SADE)

Adverse device effect that has resulted in any of the consequences characteristic of a Serious Adverse Event

SERIOUS ADVERSE EVENT (SAE)

A serious adverse event (SAE) is an event that:

- Led to death,
- Led to serious deterioration in health of the subject, that either resulted in:
 - a life threatening illness or injury, or
 - a permanent impairment of a body structure or a body function, or
 - in-patient or prolonged hospitalization, or
 - medical or surgical intervention to prevent a life-threatening illness or injury or permanent impairment to a body structure or a body function
- Led to fetal distress, fetal death or a congenital abnormality or birth defect

NOTE: Planned hospitalization for pre-existing condition, or a procedure required by per protocol, without serious deterioration in health, is not considered a serious adverse event.

Events that do not meet these criteria are considered non-serious.

STROKE and TIA

Stroke and TIA will be defined according to the Valve Academic Research Consortium (VARC)-2; Updated Standardized Endpoint Definitions for Transcatheter Aortic Valve Implantation (TAVI); 2012-10-09 and the FDA's Current Thinking Regarding Neurological Assessments for Transcatheter Valve Trials (July 25, 2011).

Diagnostic Criteria
<ul style="list-style-type: none"> • Acute episode of a focal or global neurological deficit with at least one of the following: change in level of consciousness, hemiplegia, hemiparesis, numbness or sensory loss affecting one side of the body, dysphasia or aphasia, hemianopia, amaurosis fugax, or other neurological signs or symptoms consistent with stroke • Stroke: duration of a focal or global neurological deficit \geq 24 hours; OR $<$ 24 hours available neuroimaging documents a new hemorrhage or infarct; OR the neurologic deficit results in death • TIA: duration of a focal or global neurological deficit $<$24 hours, any variable neuroimaging does not demonstrate a new hemorrhage or infarct • No other readily identifiable non-stroke cause for the clinical presentations (eg. brain tumor, trauma, infection, hypoglycemia, peripheral lesion, pharmacological influences) to be determined by or in conjunction with designated neurologist* • Confirmation of the diagnosis by at least one of the following: <ul style="list-style-type: none"> ○ Neurology or neurosurgical specialist ○ Neuroimaging procedure (CT scan or brain MRI), but stroke be diagnosed on clinical grounds alone
Stroke Classification
<ul style="list-style-type: none"> • Ischemic: an acute episode of focal cerebral, spinal or retinal dysfunctions caused by infarction of the central nervous system tissue • Hemorrhagic: an acute episode of focal cerebral, spinal or spinal dysfunctions caused by intraparenchymal, intraventricular, or subarachnoid hemorrhage
Stroke Definitions
<ul style="list-style-type: none"> • Disabling stroke: an mRS score of 2 or more at 90 days and an increase in at least one mRS category from an individual's pre-stroke baseline • Non-disabling stroke: an mRS score of $<$ 2 at 90 days or one that does not result in an increase in at least one mRS category from an individual's pre-stroke baseline

* Patients with non-focal global encephalopathy will not be reported as a stroke without unequivocal evidence based upon neuroimaging studies

+ Modified Rankin score assessments should be made by qualified individuals according to certification process.

Clinically important disabilities (disabling strokes) will be considered to be serious adverse events.

TAV-in-TAV DEPLOYMENT

Valve malpositioning will be defined according to the Valve Academic Research Consortium (VARC) -2; Updated Standardized Endpoint Definitions for Transcatheter Aortic Valve Implantation (TAVI); 2012-10-09.

An additional valve prosthesis is implanted within a previously implanted prosthesis because of suboptimal device position and/or function, during or after the index procedure.

TECHNICAL OBSERVATION

A defect, malfunction, or failure of any part of the Medtronic CoreValve™ System. This may pertain to the device or delivery and/or loading system not functioning according to its design intent.

TRICUSPID REGURGITATION

2008 Focused Update Incorporated into the ACC/AHA 2006 Guidelines for the Management of Patients with Valvular Heart Disease (published in the October 2008 issues of Journal of the American College of Cardiology and Circulation)

Severe tricuspid regurgitation: vena contracta width greater than 0.7cm and systolic reversal in hepatic veins.

UNANTICIPATED SERIOUS ADVERSE DEVICE EFFECT (USADE)

Serious adverse device effect which by its nature, incidence, severity or outcome has not been identified in the current version of the risk analysis report

NOTE: Anticipated serious adverse device effect (ASADE) is an effect which by its nature, incidence, severity or outcome has been identified in the risk analysis report.

UNPLANNED USE OF CARDIOPULMONARY BYPASS (CPB)

Valve Academic Research Consortium (VARC)-2; Updated Standardized Endpoint Definitions for Transcatheter Aortic Valve Implantation (TAVI); 2012-10-09.

Unplanned use of CPB for hemodynamic support at any time during the TAVI procedure.

VALVE THROMBOSIS

Any thrombus not caused by infection attached to or near the trial valve that occludes part of the blood flow path, interferes with valve function, or is sufficiently large to warrant treatment. Valve thrombus found at autopsy in a subject whose cause of death was not valve-related or found at operation for an unrelated indication should also be counted as *valve thrombosis*.

VALVE MALPOSITIONING

Valve malpositioning will be defined according to the Valve Academic Research Consortium (VARC))-2; Updated Standardized Endpoint Definitions for Transcatheter Aortic Valve Implantation (TAVI); 2012-10-09.

Valve migration

After initial correct positioning, the valve prosthesis moves upward or downward, within the aortic annulus from its initial position, with or without consequences

Valve embolization

The valve prosthesis moves during or after deployment such that it loses contact with the aortic annulus

Ectopic valve deployment

Permanent deployment of the valve prosthesis in a location other than the aortic root

VASCULAR COMPLICATIONS

Vascular Complications will be defined according to the Valve Academic Research Consortium (VARC) -2; Updated Standardized Endpoint Definitions for Transcatheter Aortic Valve Implantation (TAVI); 2012-10-09.

Vascular Access Site and Access Related Complications
Major Vascular Complications
<ul style="list-style-type: none"> • Any aortic dissection, aortic rupture, annulus rupture, left ventricle perforation, or new apical aneurysm/pseudo-aneurysm OR • Access site or access-related vascular injury (dissection, stenosis, perforation, rupture, arterio-venous fistula, pseudoaneurysm, hematoma, irreversible nerve injury, compartment syndrome, percutaneous closure device failure) leading to death, life-threatening or major bleeding*, visceral ischemia or neurological impairment OR • Distal embolization (non-cerebral) from a vascular source requiring surgery or resulting in amputation or irreversible end-organ damage OR • The use of unplanned endovascular or surgical intervention associated with death, major bleeding, visceral ischaemia or neurological impairment OR • Any new ipsilateral lower extremity ischemia documented by patient symptoms, physical exam, and/or decreased or absent blood flow on lower extremity angiogram OR • Surgery for access site-related nerve injury OR • Permanent access site-related nerve injury
Minor Vascular Complications
<ul style="list-style-type: none"> • Access site or access-related vascular injury (dissection, stenosis, perforation, rupture, arterio-venous fistula, pseudoaneurysms, hematomas, percutaneous closure device failure) not leading to death, life-threatening or major bleeding*, visceral ischemia or neurological impairment OR • Distal embolization treated with embolectomy and/or thrombectomy and not resulting in amputation or irreversible end-organ damage OR • Any unplanned endovascular stenting or unplanned surgical intervention not meeting the criteria for a major vascular complication OR • Vascular repair or the need for vascular repair (via surgery, ultrasound-guided compression, transcatheter embolization, or stent-graft)
Percutaneous closure device failure
<ul style="list-style-type: none"> • Failure of a closure device to achieve hemostasis at the arteriotomy site leading to alternative treatment (other than manual compression or adjunctive endovascular ballooning)

Major vascular complications will be considered to be serious adverse events.

*Refers to VARC bleeding definitions.

P TRIAL MANAGEMENT

P.1 Miscellaneous

P.1.1 Insurance

The Medtronic Bakken Research Center B.V. is a wholly owned subsidiary of Medtronic Inc., which as the parent company of such entity maintains appropriate clinical trial liability insurance coverage as required under applicable laws and regulations and will comply with applicable law and custom concerning specific insurance coverage. If required, a Clinical Trial Insurance statement/certificate will be provided to the IRB/MEC.

P.1.2 Reimbursement

Trial reimbursement is outlined in the Clinical Trial Agreement.

P.1.3 Indemnification

Indemnification will be done according to local laws.

P.1.4 Subject confidentiality

At all times throughout the trial confidentiality shall be observed by all parties involved. All information and data sent to parties involved in trial conduct concerning patients or their participation in this trial will be considered confidential. The patient identification number is to be recorded on all trial documents and will link the trial documents to the patient's name and medical record at the investigator's site. To maintain confidentiality, the patient's name or any other personal identifiers should not be recorded on any trial document other than the informed consent form.

Q REFERENCES

1. Baumgartner H, Hung J, Bermejo J, Chambers JB, Evangelista A, Griffin BP, Jung B, Otto CM, Pellikka PA, Quinones M. Echocardiographic assessment of valve stenosis: EAE/ASE recommendations for clinical practice. *J Am Soc Echocardiogr* 2009; 22(1):1-23; quiz 101-102.
2. Jung B, Baron G, Butchart EG, Delahaye F, Gohlke-Barwolf C, Levang OW, Tornos P, Vanoverschelde JL, Vermeer F, Boersma E, Ravaut P, Vahanian A. A prospective survey of patients with valvular heart disease in Europe: The Euro Heart Survey on Valvular Heart Disease. *Eur Heart J* 2003; 24(13):1231-1243.
3. Supino PG, Borer JS, Preibisz J, Bornstein A. The epidemiology of valvular heart disease: a growing public health problem. *Heart Fail Clin* 2006; 2(4):379-393.
4. Ross J, Jr., Braunwald E. Aortic stenosis. *Circulation* 1968; 38(1 Suppl):61-67.
5. Rosenhek R, Zilberszac R, Schemper M, Czerny M, Mundigler G, Graf S, Bergler-Klein J, Grimm M, Gabriel H, Maurer G. Natural history of very severe aortic stenosis. *Circulation*; 121(1):151-156.
6. Bonow RO, Carabello BA, Chatterjee K, de Leon AC, Jr., Faxon DP, Freed MD, Gaasch WH, Lytle BW, Nishimura RA, O'Gara PT, O'Rourke RA, Otto CM, Shah PM, Shanewise JS. 2008 Focused update incorporated into the ACC/AHA 2006 guidelines for the management of patients with valvular heart disease: a report of the American College of Cardiology/American Heart Association Task Force on Practice Guidelines (Writing Committee to Revise the 1998 Guidelines for the Management of Patients With Valvular Heart Disease): endorsed by the Society of Cardiovascular Anesthesiologists, Society for Cardiovascular Angiography and Interventions, and Society of Thoracic Surgeons. *Circulation* 2008; 118(15):e523-661.
7. Vahanian A, Baumgartner H, Bax J, Butchart E, Dion R, Filippatos G, Flachskampf F, Hall R, Jung B, Kasprzak J, Nataf P, Tornos P, Torracca L, Wenink A. Guidelines on the management of valvular heart disease: The Task Force on the Management of Valvular Heart Disease of the European Society of Cardiology. *Eur Heart J* 2007; 28(2):230-268.
8. Jung B, Cachier A, Baron G, Messika-Zeitoun D, Delahaye F, Tornos P, Gohlke-Barwolf C, Boersma E, Ravaut P, Vahanian A. Decision-making in elderly patients with severe aortic stenosis: why are so many denied surgery? *Eur Heart J* 2005; 26(24):2714-2720.
9. Serruys PW. Keynote address--EuroPCR 2008, Barcelona, May 14th, 2008. Transcatheter aortic valve implantation: state of the art. *EuroIntervention* 2009; 4(5):558-565.
10. Cribier A, Eltchaninoff H, Bash A, Borenstein N, Tron C, Bauer F, Derumeaux G, Anselme F, Laborde F, Leon MB. Percutaneous transcatheter implantation of an aortic valve prosthesis for calcific aortic stenosis: first human case description. *Circulation* 2002; 106(24):3006-3008.
11. Webb JG, Pasupati S, Humphries K, Thompson C, Altwegg L, Moss R, Sinhal A, Carere RG, Munt B, Ricci D, Ye J, Cheung A, Lichtenstein SV. Percutaneous transarterial aortic valve replacement in selected high-risk patients with aortic stenosis. *Circulation* 2007; 116(7):755-763.
12. Grube E, Laborde JC, Gerckens U, Felderhoff T, Sauren B, Buellesfeld L, Mueller R, Menichelli M, Schmidt T, Zickmann B, Iversen S, Stone GW. Percutaneous implantation of the CoreValve self-expanding valve prosthesis in high-risk patients with aortic valve disease: the Siegburg first-in-man study. *Circulation* 2006; 114(15):1616-1624.
13. Piazza N, Grube E, Gerckens U, den Heijer P, Linke A, Luha O, Ramondo A, Ussia G, Wenaweser P, Windecker S, Laborde JC, de Jaegere P, Serruys PW. Procedural and 30-day outcomes following transcatheter aortic valve implantation using the third generation (18 Fr) corevalve revalving system: results from the multicentre, expanded evaluation registry 1-year following CE mark approval. *EuroIntervention* 2008; 4(2):242-249.
14. Bleiziffer S, Ruge H, Mazzitelli D, Hutter A, Opitz A, Bauernschmitt R, Lange R. Survival after transapical and transfemoral aortic valve implantation: talking about two different patient populations. *J Thorac Cardiovasc Surg* 2009; 138(5):1073-1080.
15. Webb JG, Altwegg L, Boone RH, Cheung A, Ye J, Lichtenstein S, Lee M, Masson JB, Thompson C, Moss R, Carere R, Munt B, Nietlispach F, Humphries K. Transcatheter aortic valve implantation: impact on clinical and valve-related outcomes. *Circulation* 2009; 119(23):3009-3016.

16. Thomas M, Schymik G, Walther T, Himbert D, Lefevre T, Treede H, Eggebrecht H, Rubino P, Michev I, Lange R, Anderson WN, Wendler O. Thirty-Day Results of the SAPIEN Aortic Bioprosthesis European Outcome (SOURCE) Registry. A European Registry of Transcatheter Aortic Valve Implantation Using the Edwards SAPIEN Valve. *Circulation*.
17. Gerckens U, Latsios G, Mueller R, Buellfeld L, John D, Yucel S, Sauren B, Felderhof T, Iversen S, Grube E. Procedural and mid-term results in patients with aortic stenosis treated with implantation of 2 (in-series) CoreValve prostheses in 1 procedure. *JACC Cardiovasc Interv*; 3(2):244-250.
18. Masson JB, Kovac J, Schuler G, Ye J, Cheung A, Kapadia S, Tuzcu ME, Kodali S, Leon MB, Webb JG. Transcatheter aortic valve implantation: review of the nature, management, and avoidance of procedural complications. *JACC Cardiovasc Interv* 2009; 2(9):811-820.
19. Piazza N, Cutlip DE, Onuma Y, Kappetein AP, de Jaegere P, Serruys PW. Clinical endpoints in transcatheter aortic valve implantation: a call to ARC for standardised definitions. *EuroIntervention* 2009; 5(1):29-31.
20. Thomas M, Wendler O. Transcatheter aortic valve implantation (TAVI): how to interpret the data and what data is required? *EuroIntervention* 2009; 5(1):25-27.
21. Leon MB, Piazza N, Nikolsky E, Blackstone EH, Cutlip DE, Kappetein AP, Krucoff MW, Mack MM, R., Miller C, Morel M, Petersen JP, J.J., Takkenberg JJM, Vahanian A, van Es G, Vranckx P, Smith C, Webb JG, Mohr F, Windecker S, Serruys PW. Standardized endpoint definitions for Transcatheter Aortic Valve Implantation Clinical Trials: a consensus report from the Valve Academic Research Consortium. *J Am Coll Cardiol* 2011.
22. Leon MB, Piazza N, Nikolsky E, Blackstone EH, Cutlip DE, Kappetein AP, Krucoff MW, Mack MM, R., Miller C, Morel M, Petersen JP, J.J., Takkenberg JJM, Vahanian A, van Es G, Vranckx P, Smith C, Webb JG, Mohr F, Windecker S, Serruys PW. Standardized endpoint definitions for Transcatheter Aortic Valve Implantation Clinical Trials: a consensus report from the Valve Academic Research Consortium. *European Heart Journal* 2011.
23. Van Brabandt H, Neyt M. Safety of percutaneous aortic valve insertion. A systematic review. *BMC Cardiovasc Disord* 2009; 9:45.
24. Van Brabandt H, Neyt M. What is the evidence in favor of percutaneous aortic valve insertion? *Am J Cardiol* 2009; 103(4):575.
25. Dhruva SS, Bero LA, Redberg RF. Strength of study evidence examined by the FDA in premarket approval of cardiovascular devices. *JAMA* 2009; 302(24):2679-2685.
26. Leon MB, Smith CR, Mack M, Miller DC, Moses JW, Svensson LG, Tuzcu EM, Webb JG, Fontana GP, Makkar RR, Brown DL, Block PC, Guyton RA, Pichard AD, Bavaria JE, Herrmann HC, Douglas PS, Petersen JL, Akin JJ, Anderson WN, Wang D, Pocock S. Transcatheter aortic-valve implantation for aortic stenosis in patients who cannot undergo surgery. *N Engl J Med*; 363(17):1597-1607.
27. Serruys PW, Morice MC, Kappetein AP, Colombo A, Holmes DR, Mack MJ, Stahle E, Feldman TE, van den Brand M, Bass EJ, Van Dyck N, Leadley K, Dawkins KD, Mohr FW. Percutaneous coronary intervention versus coronary-artery bypass grafting for severe coronary artery disease. *N Engl J Med* 2009; 360(10):961-972.
28. Piazza N, van Gameren M, Juni P, Wenaweser P, Carrel T, Onuma Y, Gahl B, Hellige G, Otten A, Kappetein AP, Takkenberg JJ, van Domburg R, de Jaegere P, Serruys PW, Windecker S. A comparison of patient characteristics and 30-day mortality outcomes after transcatheter aortic valve implantation and surgical aortic valve replacement for the treatment of aortic stenosis: a two-centre study. *EuroIntervention* 2009; 5(5):580-588.
29. Ong AT, Serruys PW, Mohr FW, Morice MC, Kappetein AP, Holmes DR, Jr., Mack MJ, van den Brand M, Morel MA, van Es GA, Kleijne J, Koglin J, Russell ME. The SYNergy between percutaneous coronary intervention with TAXus and cardiac surgery (SYNTAX) study: design, rationale, and run-in phase. *Am Heart J* 2006; 151(6):1194-1204.
30. Roques F, Nashef SA, Michel P, Gauducheau E, de Vincentiis C, Baudet E, Cortina J, David M, Faichney A, Gabrielle F, Gams E, Harjula A, Jones MT, Pintor PP, Salamon R, Thulin L. Risk factors and outcome in European cardiac surgery: analysis of the EuroSCORE multinational database of 19030 patients. *Eur J Cardiothorac Surg* 1999; 15(6):816-822; discussion 822-813.
31. Shahian DM, O'Brien SM, Filardo G, Ferraris VA, Haan CK, Rich JB, Normand SL, DeLong ER, Shewan CM, Dokholyan RS, Peterson ED, Edwards FH, Anderson RP. The Society of Thoracic Surgeons 2008 cardiac surgery risk models: part 3--valve plus coronary artery bypass grafting surgery. *Ann Thorac Surg* 2009; 88(1 Suppl):S43-62.
32. Jin R, Grunkemeier GL, Starr A. Validation and refinement of mortality risk models for heart valve surgery. *Ann Thorac Surg* 2005; 80(2):471-479.

33. Edwards FH, Peterson ED, Coombs LP, DeLong ER, Jamieson WR, Shroyer ALW, Grover FL. Prediction of operative mortality after valve replacement surgery. *J Am Coll Cardiol* 2001; 37(3):885-892.
34. Hannan EL, Wu C, Bennett EV, Carlson RE, Culliford AT, Gold JP, Higgins RS, Smith CR, Jones RH. Risk index for predicting in-hospital mortality for cardiac valve surgery. *Ann Thorac Surg* 2007; 83(3):921-929.
35. Gardner SC, Grunwald GK, Rumsfeld JS, Cleveland JC, Jr., Schooley LM, Gao D, Grover FL, McDonald GO, Shroyer AL. Comparison of short-term mortality risk factors for valve replacement versus coronary artery bypass graft surgery. *Ann Thorac Surg* 2004; 77(2):549-556.
36. Dewey TM, Brown D, Ryan WH, Herbert MA, Prince SL, Mack MJ. Reliability of risk algorithms in predicting early and late operative outcomes in high-risk patients undergoing aortic valve replacement. *J Thorac Cardiovasc Surg* 2008; 135(1):180-187.
37. Nowicki ER, Birkmeyer NJ, Weintraub RW, Leavitt BJ, Sanders JH, Dacey LJ, Clough RA, Quinn RD, Charlesworth DC, Sisto DA, Uhlig PN, Olmstead EM, O'Connor GT. Multivariable prediction of in-hospital mortality associated with aortic and mitral valve surgery in Northern New England. *Ann Thorac Surg* 2004; 77(6):1966-1977.
38. van Gameren M, Kappetein AP, Steyerberg EW, Venema AC, Berenschot EA, Hannan EL, Bogers AJ, Takkenberg JJ. Do we need separate risk stratification models for hospital mortality after heart valve surgery? *Ann Thorac Surg* 2008; 85(3):921-930.
39. van Gameren M, Piazza N, Bogers AJ, Takkenberg JJ, Kappetein AP. How to assess risks of valve surgery: quality, implementation and future of risk models. *Heart* 2009; 95(23):1958-1963.
40. Lee DH, Buth KJ, Martin BJ, Yip AM, Hirsch GM. Frail patients are at increased risk for mortality and prolonged institutional care after cardiac surgery. *Circulation*; 121(8):973-978.
41. Chang AS, Smedira NG, Chang CL, Benavides MM, Myhre U, Feng J, Blackstone EH, Lytle BW. Cardiac surgery after mediastinal radiation: extent of exposure influences outcome. *J Thorac Cardiovasc Surg* 2007; 133(2):404-413.
42. Girardi LN, Krieger KH, Mack CA, Isom OW. No-clamp technique for valve repair or replacement in patients with a porcelain aorta. *Ann Thorac Surg* 2005; 80(5):1688-1692.
43. Wijns W, Kolh P, Danchin N, Di Mario C, Falk V, Folliguet T, Garg S, Huber K, James S, Knuuti J, Lopez-Sendon J, Marco J, Menicanti L, Ostojic M, Piepoli MF, Pirllet C, Pomar JL, Reifart N, Ribichini FL, Schalij MJ, Sergeant P, Serruys PW, Silber S, Sousa Uva M, Taggart D, Vahanian A, Auricchio A, Bax J, Ceconi C, Dean V, Filippatos G, Funck-Brentano C, Hobbs R, Kearney P, McDonagh T, Popescu BA, Reiner Z, Sechtem U, Sirnes PA, Tendera M, Vardas PE, Widimsky P, Alfieri O, Dunning J, Elia S, Kappetein P, Lockowandt U, Sarris G, Vouhe P, von Segesser L, Agewall S, Aladashvili A, Alexopoulos D, Antunes MJ, Atalar E, Brutel de la Riviere A, Doganov A, Eha J, Fajadet J, Ferreira R, Garot J, Halcox J, Hasin Y, Janssens S, Kervinen K, Laufer G, Legrand V, Nashef SA, Neumann FJ, Niemela K, Nihoyannopoulos P, Noc M, Piek JJ, Pirk J, Rozenman Y, Sabate M, Starc R, Thielmann M, Wheatley DJ, Windecker S, Zembala M. Guidelines on myocardial revascularization: The Task Force on Myocardial Revascularization of the European Society of Cardiology (ESC) and the European Association for Cardio-Thoracic Surgery (EACTS). *Eur Heart J*; 31(20):2501-2555.
44. Lund O, Nielsen TT, Pilegaard HK, Magnussen K, Knudsen MA. The influence of coronary artery disease and bypass grafting on early and late survival after valve replacement for aortic stenosis. *J Thorac Cardiovasc Surg* 1990; 100(3):327-337.
45. Dickstein K, Vardas PE, Auricchio A, Daubert JC, Linde C, McMurray J, Ponikowski P, Priori SG, Sutton R, van Veldhuisen DJ, Vahanian A, Bax J, Ceconi C, Dean V, Filippatos G, Funck-Brentano C, Hobbs R, Kearney P, McDonagh T, Popescu BA, Reiner Z, Sechtem U, Sirnes PA, Tendera M, Vardas P, Widimsky P, Anker SD, Blanc JJ, Gasparini M, Hoes AW, Israel CW, Kalarus Z, Merkely B, Swedberg K, Camm AJ. 2010 Focused Update of ESC Guidelines on device therapy in heart failure: an update of the 2008 ESC Guidelines for the diagnosis and treatment of acute and chronic heart failure and the 2007 ESC guidelines for cardiac and resynchronization therapy. Developed with the special contribution of the Heart Failure Association and the European Heart Rhythm Association. *Eur Heart J*; 31(21):2677-2687.

46. Goldstein LB, Adams R, Alberts MJ, Appel LJ, Brass LM, Bushnell CD, Culebras A, DeGraba TJ, Gorelick PB, Guyton JR, Hart RG, Howard G, Kelly-Hayes M, Nixon JV, Sacco RL. Primary prevention of ischemic stroke: a guideline from the American Heart Association/American Stroke Association Stroke Council: cosponsored by the Atherosclerotic Peripheral Vascular Disease Interdisciplinary Working Group; Cardiovascular Nursing Council; Clinical Cardiology Council; Nutrition, Physical Activity, and Metabolism Council; and the Quality of Care and Outcomes Research Interdisciplinary Working Group. *Circulation* 2006; 113(24):e873-923.
47. Sacco RL, Adams R, Albers G, Alberts MJ, Benavente O, Furie K, Goldstein LB, Gorelick P, Halperin J, Harbaugh R, Johnston SC, Katzan I, Kelly-Hayes M, Kenton EJ, Marks M, Schwamm LH, Tomsick T. Guidelines for prevention of stroke in patients with ischemic stroke or transient ischemic attack: a statement for healthcare professionals from the American Heart Association/American Stroke Association Council on Stroke: co-sponsored by the Council on Cardiovascular Radiology and Intervention: the American Academy of Neurology affirms the value of this guideline. *Circulation* 2006; 113(10):e409-449.
48. Adams RJ, Albers G, Alberts MJ, Benavente O, Furie K, Goldstein LB, Gorelick P, Halperin J, Harbaugh R, Johnston SC, Katzan I, Kelly-Hayes M, Kenton EJ, Marks M, Sacco RL, Schwamm LH. Update to the AHA/ASA recommendations for the prevention of stroke in patients with stroke and transient ischemic attack. *Stroke* 2008; 39(5):1647-1652.
49. O'Brien SM, Shahian DM, Filardo G, Ferraris VA, Haan CK, Rich JB, Normand SL, DeLong ER, Shewan CM, Dokholyan RS, Peterson ED, Edwards FH, Anderson RP. The Society of Thoracic Surgeons 2008 cardiac surgery risk models: part 2--isolated valve surgery. *Ann Thorac Surg* 2009; 88(1 Suppl):S23-42.
50. Pauwels RA, Buist AS, Calverley PM, Jenkins CR, Hurd SS. Global strategy for the diagnosis, management, and prevention of chronic obstructive pulmonary disease. NHLBI/WHO Global Initiative for Chronic Obstructive Lung Disease (GOLD) Workshop summary. *Am J Respir Crit Care Med* 2001; 163(5):1256-1276.
51. Levey AS, Coresh J, Balk E, Kausz AT, Levin A, Steffes MW, Hogg RJ, Perrone RD, Lau J, Eknoyan G. National Kidney Foundation practice guidelines for chronic kidney disease: evaluation, classification, and stratification. *Ann Intern Med* 2003; 139(2):137-147.
52. Zoghbi WA, Chambers JB, Dumesnil JG, Foster E, Gottdiener JS, Grayburn PA, Khandheria BK, Levine RA, Marx GR, Miller FA, Jr., Nakatani S, Quinones MA, Rakowski H, Rodriguez LL, Swaminathan M, Waggoner AD, Weissman NJ, Zabalgoitia M. Recommendations for evaluation of prosthetic valves with echocardiography and doppler ultrasound: a report From the American Society of Echocardiography's Guidelines and Standards Committee and the Task Force on Prosthetic Valves, developed in conjunction with the American College of Cardiology Cardiovascular Imaging Committee, Cardiac Imaging Committee of the American Heart Association, the European Association of Echocardiography, a registered branch of the European Society of Cardiology, the Japanese Society of Echocardiography and the Canadian Society of Echocardiography, endorsed by the American College of Cardiology Foundation, American Heart Association, European Association of Echocardiography, a registered branch of the European Society of Cardiology, the Japanese Society of Echocardiography, and Canadian Society of Echocardiography. *J Am Soc Echocardiogr* 2009; 22(9):975-1014; quiz 1082-1014.
53. Schultz CJ, Moelker A, Piazza N, Tzikas A, Otten A, Nuis RJ, Neefjes LA, van Geuns RJ, de Feyter P, Krestin G, Serruys PW, de Jaegere PP. Three dimensional evaluation of the aortic annulus using multislice computer tomography: are manufacturer's guidelines for sizing for percutaneous aortic valve replacement helpful? *Eur Heart J*; 31(7):849-856.



SURTAVI

Surgical Replacement and Transcatheter Aortic Valve Iplantation

Appendix

VERSION 12.1
31 May 2016

Sponsor:

Medtronic, Inc.
Clinical Research
Mailstop: MVS66
Mounds View South
8200 Coral Sea St NE
Mounds View, MN 55112 USA

Medtronic Bakken Research Center
Coronary and Structural Heart Department
Endepolsdomein 5
6229 GW Maastricht
The Netherlands

TABLE OF CONTENTS

R	APPENDICES	118
R.1	Sample Informed Consent	118
R.1.1	United States	119
R.1.2	United States – Roll-in Subjects	134
R.1.3	Europe	147
R.1.4	Canada	160
R.1.4	Canada – Roll-in Subjects	176
R.2	List of Participating Investigational Centers	192
R.3	Other Institutions	193
R.4	Additional Records and Reports	194
R.5	Sample Case Report Forms	195
R.6	Aortogram Acquisition Guidelines	196
R.7	Echocardiography Acquisition Guidelines	198
R.8	Electrocardiogram (ECG) Submission	219
R.9	Computed Tomography (CT) Angiography Acquisition Guidelines	220
R.10	Interactive Voice/Web Response System (IXRS)	232
R.11	Explanted Device/Pathology and Return Procedures	233
R.12	Economic and Quality of Life Data Collection	235
R.12.1	Health Economic Data Collection	235
R.12.2	Quality of Life Data Collection	235
R.12.2.1	Schedule of Assessments	235
R.12.2.2	Questionnaires	236
R.13	Pacing Guidelines	237
R.14	Six Minute Walk Test Instructions	241
R.15	National Institute of Health Stroke Scale (NIHSS)	254
R.16	Modified Rankin Scale (mRS) Instructions	258
R.17	Mini Mental State Exam (MMSE-2:SV)	259
R.18	Additional Neurological Assessments	260
R.19	Medtronic CoreValve™ Clinical Assessment Guidelines	262
R.20	Katz Index of Independence in Activities of Daily Living	263
R.21	Investigator Brochure / Report of Prior Investigations for the Investigational Devices	264
R.22	Investigational Devices Instructions For Use	265
R.23	Radiation Exposure and Data Collection	266
R.24	SURTAVI Risk Model	269
R.24.1	SURTAVI Risk Model Rationale	269
R.24.2	SURTAVI co-morbidity list	272
R.25	CMS Considerations for Coverage and Reimbursement – US ONLY	277

R.1 Sample Informed Consent

Attached are the informed consent form templates:

- United States
- United States - *Roll-in Subjects*
- Europe
- Canada
- Canada – *Roll-in Subjects*

R.1.1 United States

INFORMED CONSENT FORM**Medtronic CoreValve™ SURTAVI Trial**

You are being asked to read this form so that you understand this research study and how you might take part in it. By signing this form, you will show that you understand and that you agree to take part in this research study. Your signature on this form is required before you can take part in this research study.

BACKGROUND

You are being asked to take part in a research study entitled “*Medtronic CoreValve™ SURTAVI Trial*” because you have a disease of your aortic valve. This disease is called aortic stenosis.

The aortic valve is one of the four heart valves that control the flow of blood into and out of the heart. The aortic valve lets oxygen-containing blood to be pumped out of the heart, from the left ventricle (main pumping chamber of the heart) into the aorta (main artery delivering blood to the body). If the valve becomes abnormally narrow through a process of thickening and stiffening (aortic stenosis) the heart must work harder to pump the same amount of blood with each beat.

As the heart works harder, the heart muscle thickens (hypertrophy), and the heart chamber (ventricle) may become larger (dilate). Open-heart surgery to replace the diseased aortic valve is the standard treatment.

As an alternative to open heart surgery, the Medtronic CoreValve™ System has been developed to replace a diseased aortic heart valve without the need for open heart surgery. This system allows the percutaneous aortic valve (study valve) to be implanted (inserted) through a long, thin flexible tube that is inserted through an incision in the skin and threaded through the bloodstream (percutaneous).

A description of this clinical trial will be available on <http://www.ClinicalTrials.gov>, as required by U.S. Law. This website will not include information that can identify you. At most, the website will include a summary of the results. You can search this website at any time.

You are being asked to participate in this study because doctors have determined your aortic valve is no longer working properly. However, your doctors have also decided that your risk of experiencing major problems while undergoing open-heart surgery is moderate due to medical reasons or anatomical reasons (relating to how and where your heart, aortic valve and blood vessels are placed within your body). This means that you doctor believes your health is acceptable for open-heart surgery, but there are still a risk of potential problems.

PURPOSE OF THE STUDY

The purpose of this clinical study is to determine if replacing the aortic valve without open-heart surgery is as safe as or safer than open-heart surgery in patients with similar medical conditions as you.

The study valve is considered an “investigational device”, which means that clinical studies are required to determine if it is safe and provides clinical benefit. Medtronic, Inc. is sponsoring this study to obtain data on the safety and performance of the investigational device. The Medtronic CoreValve™ System includes the valve described below and two parts that help load and deliver the valves correctly.

This study will involve approximately 1600 subjects at up to 115 hospitals in the United States and around the world, and is anticipated to take approximately 8 years to complete. Your participation in

this study is expected to last approximately five years from the day you are enrolled in the study. Annual follow-up may be extended to up to 10 years after the implant procedure.

STUDY DEVICES

The study valve is made from animal tissue attached to a metal frame.

The study valve is designed to be implanted (inserted) using a delivery system catheter (long, thin flexible tube) to replace your diseased aortic heart valve without open-heart surgery. Once it is implanted, CoreValve™ study valves acts in the same method of the native valve.

The Medtronic CoreValve system is approved by the US Food & Drug Administration (FDA) since 2014 and it has been approved in other parts of the world since 2006. It has been implanted in over 45,000 patients. The Medtronic CoreValve™ System is currently approved for use in Europe, South America, and parts of Asia.



PROCEDURES TO BE FOLLOWED

If you agree to be in this study, and after you have signed this informed consent form, data such as your age, gender, medical history and medication use will be recorded. You will undergo the following tests:

- Physical examination
- Computed tomography (CT) - a scan performed using an x-ray machine, which is linked to a computer to take pictures of your body. Sometimes a CT will require the use of a type of dye that makes the kidneys work harder and may be harmful to the kidneys. You may have an MRI in place of a CT scan if your doctor believes your kidneys are not working well enough for you to have a CT scan. MRI stands for magnetic resonance imaging and is a test that uses a strong magnet and a complex computer system to produce detailed images of your internal organs and soft body tissues.
- Blood tests (about 2 tablespoons)
- Echocardiography [transthoracic echocardiogram (TTE)] - a test that uses sound waves to take pictures of your heart and measure the degree of narrowing of your aortic valve; a probe with gel is placed on the outside of your chest to take pictures of your heart
- Electrocardiogram (ECG) - a test that records electrical impulses of your heart; patches are placed on the outside of your chest
- Heart catheterization/angiography - a test that takes pictures of your heart and blood vessels; a special dye is injected through long, flexible tubes into the coronary arteries (vessels delivering blood to the heart) and bypass grafts if you have them

If you are of child-bearing potential, we will ask you to take a pregnancy test. If you are pregnant, you will not be able to participate in this study.

These procedures and tests are standard procedures and are not experimental. If you have already had any of these tests performed before, they may to be used for the study if your study doctor determines they don't need to be repeated for study purposes.

The results from your exams and tests will be reviewed by your doctor and a committee of study doctors who will determine if you are eligible to be in the study.

Your study doctor and the committee may determine after reviewing your test results that you are not eligible to be in the study and/or it will not be possible to implant the study valve. If so, you will not be allowed to participate in the study.

If your doctor and the committee decide you are eligible to be in the study your treatment will be determined in a way similar to flipping a coin, called randomization. You will be assigned to one of two groups. One group will receive a transcatheter aortic valve implant (TAVI), the other group will receive open-heart surgical aortic valve replacement (SAVR). On average, one out of every two participants will receive TAVI. The other participants will receive SAVR. You will not be able to choose your treatment assignment.

Your enrollment in the study will begin once you sign this consent and you are assigned to your treatment group.

If you are enrolled in the study, you will be required to have the following additional tests completed within 14 days prior to the procedure (TAVI or SAVR):

- Physical exam, including a determination of neurological (brain) status where you will be asked to answer a series of questions and perform a series of tasks such as writing and drawing
- Blood tests (about 2 tablespoons)
- Walking test – a test that records your breathing, heart rate, and how you feel after 6 minutes of walking
- Electrocardiogram (ECG) - a test that records electrical impulses of your heart; patches are placed on the outside of your chest

You will also be asked to complete surveys about the quality of your life and your ability to do normal daily activities, called Quality of Life Questionnaires (QOL).

Your personal physician will be informed about your participation in this clinical study.

If you are assigned to the TAVI group:

The study valve is an experimental valve which means you can only receive the valve if you are part of this study.

Before the TAVI procedure, it will be strongly recommended that you take blood thinning medications, used to prevent your blood from clotting (thickening). These medications will be described to you by your study doctor. You may be advised to continue these medications for at least three months following your procedure.

Before the procedure you will be given an antibiotic (a medicine that kills bacteria or germs) to decrease your chance of developing an infection. Your study doctor will choose the antibiotic that he or she thinks is best suited for you and decide whether you need additional medication.

You will also have blood tests (about 2 tablespoons) and an ECG before the procedure.

Immediately prior to the procedure, you will receive medications to make you more relaxed and comfortable during the procedure. Your study doctor may decide that general anesthesia is necessary, meaning you need to be put to sleep for the procedure. Your doctor will inform you of this need before the procedure. Additionally, if your study doctor decides that it is necessary during the procedure, you will be put under general anesthesia at that time.

Your study doctor will decide what locations are best for inserting the long, thin flexible tubes required for TAVI and getting all of the pictures that are necessary. These pictures are described in the next paragraphs. Additionally, your study doctor will decide if performing a surgical incision to any of the site(s) is necessary.

During the procedure you may have a transesophageal echocardiogram which is also called a TEE. This test uses sound waves to take a closer look at the inside structures of the heart. If your doctor decides these pictures are necessary, to perform the test you will swallow a thin flexible tube with a special tip. This tube sits in the esophagus (the tube that connects the mouth to the stomach). The special tip of the tube sends out sound waves (ultrasound) that echo within the chest wall. The esophagus is located behind the heart so these echoes are picked up and create a picture of the heart that is displayed on a video monitor. The pictures will allow your study doctor to take a closer look at your valve.

You will have a temporary pacemaker put in place during the TAVI procedure. A temporary pacemaker is a thin wire inserted through your skin and into one of your veins and threaded through your vein into the right side of your heart. The wire is attached to a battery operated device outside of your body. This temporary pacemaker will help keep your heart rate (speed) and rhythm steady. This temporary pacemaker will not be removed for at least 48 hours after your TAVI procedure.

After your study doctor has taken a good look at your valve, a balloon valvuloplasty will be performed. Balloon valvuloplasty is a procedure used to widen a stiff or narrowed heart valve. A wire and a thin tube are guided by x-rays through the heart and positioned through the diseased heart valve. A balloon is placed over the wire and inflated, enlarging the opening through the diseased valve allowing the study valve to be placed.

Your doctor will then implant (insert) the study valve through the long, thin flexible tube that is inserted through an incision in the skin and threaded through the bloodstream. TAVI is performed using x-ray machines which will allow your doctor to see the study valve, your blood vessels and heart. The study valve will be guided through your blood vessels to your existing aortic valve and then the study valve will be placed over your existing valve.

During the TAVI procedure, your doctor will perform angiography (x-ray pictures) and ECGs (recordings of the electrical impulses of your heart through patches placed on the chest) to observe your heart function and make sure that the study valve fits and works properly.

Doctors from other hospitals who have experience with the TAVI procedure may assist your study doctor with the procedure. Medtronic staff may assist the physician in the loading of the study valve.

If you are assigned to the SAVR group:

Open heart surgery, surgical repair and/or replacement of your aortic valve, are not experimental procedures.

If you are assigned to the SAVR group, your doctors will replace your diseased aortic valve through open heart surgery. During surgery, you are asleep under general anesthesia. SAVR often requires a median sternotomy, where the bone in the center of the chest (sternum) is split down the middle. The chest is then opened to provide your doctor with access to the heart and chest cavity, in order to replace your aortic valve. Your surgery is performed while the function of your heart is taken over by a heart lung machine (called CPB for cardiopulmonary bypass).

You may have a TEE (a thin tube sits in the esophagus and sends out sound waves to create a picture of your heart) and a temporary pacemaker (thin wire threaded through your vein to right side of heart to keep your heart rate and rhythm steady) during the procedure.

Your doctor may remove any tissue and calcium deposits that are interfering with the normal function of the valve. Your damaged valve may be completely removed. The new valve will be sewn into the space where your own valve used to be. After your doctor makes sure your valve is

working properly, blood flow will be restored to your heart and the incisions will be closed. You will also have blood drawn for testing before and after the procedure.

If your doctor is unable to implant (insert) the study valve in you during the TAVI or SAVR procedure, you will still be considered enrolled in the study and will need to return to the clinic for the required follow-up visits as described in the “Follow-up Visits after TAVI and SAVR” section.

After TAVI and SAVR Procedure:

After the TAVI and SAVR procedure, your study doctors will continue to monitor your progress and recovery.

You will have the following tests performed within the two days following the procedure and before you are discharged from the hospital:

- Determination of neurological (brain) status where you will be asked to answer a series of questions and perform a series of tasks
- Blood tests (about 2 tablespoons)
- Echocardiogram (TTE)
- ECG

Follow-up Visits after TAVI and SAVR:

You will need to return to the clinic for required follow-up visits at 30 days, 6 months, 12 months (1 year), 18 months, 24 months (2 years), and 3, 4, and 5 years after the procedure. Most of the follow-up tests and examinations are routine, not experimental. Each visit will take about 1 ½ to 2 hours.

Your evaluations at 30 days, 6 and 18 months will include:

- Physical examination, including a determination of neurological (brain) status where you will be asked to answer a series of questions and perform a series of tasks
- You will be asked about your health since the last follow-up visit
- Quality of Life Questionnaires
- ECG
- Blood tests (about 2 tablespoons) – 30 day visit only
- Walking test – 30 day visit only
- Echocardiogram (TTE) – 6 month visit only

Your evaluation at 12 months, 24 months, and 3, 4, 5 years will include:

- Physical examination, including a determination of neurological (brain) status where you will be asked to answer a series of questions and perform a series of tasks
- You will be asked about your health since the last clinic visit
- Blood tests (about 2 tablespoons)
- Echocardiogram (TTE)
- Quality of Life Questionnaires
- ECG
- Walking test – 12 and 24 months visits only

In addition to the in-clinic follow-up visits, at 3 months you will be contacted via phone to complete a Quality of Life Questionnaire.

If, during the 5 years of follow-up, you have additional heart surgeries or cath lab procedures to work on or replace your aortic valve or study valve, you will be asked to answer questions and perform activities that will help the study doctors and nurses to determine your neurological (brain) status within 24 hours after each additional procedure.

If you have a stroke, have been inform by a doctor that you experienced a stroke, or experience any of the following symptoms, notify Dr. Principal Investigator at xxx-xxx-xxxx as soon as possible: sudden numbness, tingling, loss of movement (especially on 1 side of the body), vision changes, confusion or trouble understanding simple statements, severe headaches, or seizures. Any of these symptoms could indicate that you are having problems with your neurological (brain) function. If a doctor confirms that you had a stroke, you will be asked to come to the clinical to have tests performed to determine your neurological (brain) status where you will be asked to answer a series of questions and perform a series of tasks. These tests will be performed at 7 days, 30 days and 3 months after you have any of these symptoms.

If you have any other problems or complications, are seen by any other doctors for problems, or are hospitalized during your participation in this study you should immediately notify Dr. Principal Investigator at xxx-xxx-xxxx.

If the study valve is removed for any reason, we will request that it be returned to Medtronic for additional analysis. Your study doctor will determine if you will need to have another valve implanted.

In the event of your death, we will request an autopsy. We will also request that either the whole heart and valve or just the valve are removed and returned to Medtronic for additional analysis.

The autopsy and the removal of the heart and/or valve would be done to provide additional information about the research and the investigational valve.

Your family and your "legally authorized representatives", have the right to refuse the autopsy and refuse the request to remove the heart and/or valve even if you sign this consent form.

TAVI

Potential risks associated with the implantation of the study valve may include, but are not limited to, the following:

- **Death**
- **Cardiac arrest** – heart stops beating and blood flow through the body is interrupted or stopped
- **Coronary occlusion, obstruction, or vessel spasm (including acute coronary closure)** – blockage or closure of an artery that supplies the heart with blood
- **Emergent surgery**
 - Coronary artery bypass – (CABG) a surgery where the chest is opened to place new vessels around the existing blocked vessels of the heart to improve blood supply to the heart.
 - Heart valve replacement – replacing the existing heart valve with a new heart valve
 - Valve explant – the removal of the existing valve
- **Multi-organ failure** – more than one organ of the body not functioning correctly
- **Heart failure** – heart does not pump blood to the body
- **Myocardial infarction** - decreased blood flow to the heart causing death of heart muscle cells
- **Cardiogenic shock** – failure of the heart to pump enough blood to the body organs
- **Respiratory insufficiency or respiratory failure** – not enough oxygen or not able to supply oxygen to the body
- **Cardiovascular injury (including rupture, perforation, or dissection of vessels, ventricle, myocardium, or valvular structures that may require intervention)**
- **Perforation of the myocardium or a vessel** – a hole in the heart muscle or a blood vessel
- **Ascending aorta trauma** – injury to the large blood vessel leading blood away from the heart
- **Cardiac tamponade** – the constriction or inability of the heart to pump due to buildup of blood or fluid around the lining of the heart
- **Cardiac failure or low cardiac output**
- **Prosthetic valve dysfunction including, but not limited to:**
 - Fracture (break) in the valve frame
 - Bending of the valve frame
 - The valve frame does not open (expand) all the way
 - Calcification (build-up of calcium on the valve)
 - Pannus – the formation of scar tissue that may cover or block the valve from functioning normally
 - Wear, tear or movement forward (prolapse) or backward (retraction) from the normal position of the valve leaflets
 - The valve leaflets do not close together
 - A break in the stitches (sutures) of the valve frame or leaflets
 - Leakage through or around the valve or valve frame
 - Incorrect size of the valve implanted
 - Incorrect position of the valve, either too high or too low
 - Regurgitation – backward flow of blood through the valve
 - Stenosis – narrowing of the opening of the valve

- **Thrombosis/embolus (including valve thrombosis)** - an abnormal particle (air, blood clots) floating in the blood stream or attached to an object, including the valve
- **Valve migration/valve embolization** – upward or downward movement of the device from where it was originally placed
- **Ancillary device embolization** – a broken piece of the tube that delivers the valve floating in the blood stream
- **Emergent percutaneous coronary intervention (PCI)** – a procedure through the vessels inside the body and heart used to treat or open narrowed vessels of the heart
- **Emergent balloon valvuloplasty** (balloon valvuloplasty during the TAVI procedure is expected) – a procedure through the vessels inside the body and heart in which a narrowed heart valve is stretched open by a balloon
- **Bleeding that may or may not require transfusion or intervention**
- **Allergic reaction to:**
 - Antiplatelet agents (blood thinning medication)
 - Contrast medium (dye used to see vessels with x-ray), or
 - Anesthesia (medication used to put you to sleep during the procedure)
- **Infection (including septicemia and endocarditis)** – an abnormal growth of germs in the body or body part
- **Stroke, TIA, or other neurological deficits** – decreased blood flow to the brain causing death of brain cells
- **Permanent disability** – injury that does not allow that impairs normal/previous physical or mental function
- **Renal insufficiency or renal failure (including acute kidney injury)** – failure of the kidneys to work correctly
- **Mitral valve regurgitation or injury** – a leaking valve between the left upper (left atrium) and left lower (left ventricle) parts of the heart where blood flows backward through the valve or damage to the valve that may cause it to not function correctly
- **Tissue erosion** – damage to the tissue of the heart or blood vessels that could result in a tear or hole
- **Vascular access related complications, such as:**
 - Dissection - a tear in a blood vessel
 - Perforation – puncture of a blood vessel
 - Pain
 - Bleeding
 - Hematoma –blood collecting under the skin
 - Pseudoaneurysm - blood collecting on the outside of a vessel wall causing a balloon-like widening
 - Irreversible nerve damage – permanent damage to nerves
 - Compartment syndrome – squeezing of nerves and muscles in a closed space that could cause muscle or nerve damage
 - Arteriovenous fistula – abnormal connection between an artery vessel that takes blood away from the heart and a vein vessel that takes blood to the heart
 - Stenosis – narrowing of a vessel (artery)
- **Cardiac arrhythmias**
 - Disturbances in the electrical system of the heart that may result in the permanent placement of a device (pacemaker) that delivers electrical impulses to the heart to help your heart beat normally

- Atrio-ventricular node block – a block in the electrical path from the top part of the heart (atria) to the bottom part of the heart (ventricle)
- Bundle branch block – a delay or block in the electrical path in the bottom part of the heart (ventricle)
- Asystole – when the heart stops beating
- Ventricular arrhythmias – abnormal fast or slow heart beats in the lower part of the heart (ventricles)
- **Encephalopathy** – altered mental state
- **Pulmonary edema** – fluid build-up in or in the space around the lungs
- **Pericardial effusion** – fluid around the heart
- **Pleural effusion** – fluid build-up in the space around the lungs that makes breathing difficult
- **Myocardial ischemia** – reduced or interrupted blood supply to the heart
- **Peripheral ischemia** – reduced or interrupted blood supply to arms and legs
- **Bowel ischemia** – decrease blood supply to the intestines
- **Heart murmur** – an extra or unusual sound hear during a heartbeat
- **Hemolysis** – break down of blood cells
- **Cerebral infarction-asymptomatic** – silent stroke
- **Non-emergent reoperation**
- **Inflammation** – swelling of tissue
- **Fever** – increase in body temperature
- **Hypotension or hypertension** – low or high blood pressure
- **Syncope** – fainting
- **Dyspnea** – shortness of breath
- **Anemia** – not enough oxygen carrying cells in the blood
- **Angina** – chest pain
- **Abnormal lab values (including electrolyte imbalance)** – changes in blood test results
- **Exposure to radiation through fluoroscopy and angiography**
- **Delivery catheter malfunction resulting in need for additional re-crossing of the aortic valve and prolonged procedural time**

There may also be additional risks, discomforts, or side effects that are not yet known.

SAVR

Although SAVR is not experimental there are potential risks associated with the procedure. These risks are the same even if you undergo the SAVR procedure and you decide not to participate in this study. Some of these risks include, but may not be limited to the following:

- Obstruction of blood flow to the heart (angina) resulting in damage to the heart tissue
- (myocardial infarction/heart attack)
- Abnormal heart beat (cardiac arrhythmia and dysrhythmia)
- Blood leaking around the outside of the prosthetic valve (paravalvular leak) or any
- Problem with the valve that causes leaking of blood after the valve has closed (transvalvular leak).
- Damage to red blood cells (hemolysis) that can result in anemia (decreased red blood cells)
- Death

- Inflammation of the lining of the heart (endocarditis)
- Heart failure
- Any problem with the prosthetic valve that causes narrowing of the valve opening (stenosis)
- Blood clots that develop in the heart or on the replacement valve. These clots may break loose and travel through the bloodstream (thromboembolism). This problem may cause stroke (decrease blood flow to the brain causing damage to the brain) or heart attack
- Failure of the valve to open and close properly

If you become pregnant there may be risks, discomforts, or side effects to you and the embryo/fetus that are not yet known. Please notify your study doctor as soon as possible to discuss any of these potential risks.

RADIATION EXPOSURE RISKS

Some of the tests and procedures that are part of this study require exposure to radiation (x-rays). These tests or treatments involve a small amount of radiation. To give you an idea about how much radiation you will get, in the following descriptions the radiation is compared to the amounts that people are exposed to in daily life. There is radiation that naturally occurs from space and from rocks in the soil. This natural radiation is greater at higher altitudes.

CT of Chest and Abdomen and Coronary Angiography

The radiation exposure received from the screening tests (CTA of abdomen and thorax and coronary angiogram) is approximately 10 times the radiation exposure received in one year from background radiation (naturally occurring radiation you are exposed to everyday). The exposure is less than the radiation exposure limit an occupational worker is allowed to receive in one year.

Valve implantation

The estimated radiation exposure for the valve procedure is approximately 10-15 times the amount of radiation exposure received in one year from background radiation (naturally occurring radiation you are exposed to everyday). The exposure is approximately the amount an occupational worker is allowed to receive in one year.

There are additional risks or side effects from being exposed to x-rays. Most side effects do not occur often and resolve without major problems. It is possible that skin reddening or other alterations to the skin's appearance may occur if you are exposed to enough radiation during the procedure or if you have recently had another cardiac angiogram. You should contact your doctor in the event that you observe this. If you have a reaction to the x-rays you may need to have extra follow-up visits with your doctor to watch your recovery more closely.

Your doctor will explain to you how many x-rays you will receive, what x-rays are part of your normal care and what, if any, are extra for the study.

POSSIBLE BENEFITS

The possible benefits you may receive from participating in this research are that you may be able to receive a new heart valve without having open-heart surgery. Another possible benefit is that your new valve may work better than the way your diseased valve currently works. This may improve how you feel and may improve your daily activity.

Your participation in this research may improve procedures that may guide the future treatment of heart surgery, by using procedures that are less invasive, meaning less cutting, entering or breaking through the body, which may benefit others in the future. However, there is no guarantee that you will benefit from being in this research.

ALTERNATIVE TREATMENTS

The current long-term effective treatment for severe aortic stenosis is open heart surgery to replace the aortic valve. For patients who are at high risk for open heart surgery, other treatment options

include percutaneous (through an artery in the groin) aortic valve implantation, or medical management to relieve symptoms, which may include balloon valvuloplasty. Ask your study doctor about other treatment options you may have.

IF PROBLEMS DEVELOP

If you believe that you have been injured as a result of your participation in the study, you should notify Dr. Principal Investigator at xxx-xxx-xxxx as soon as possible or in serious cases, go to the emergency room.

Immediate necessary medical care is available at [Name of institution(s)] in the event that you are injured as a result of your participation in this research study.

If you are assigned to the TAVI group

Immediate necessary medical care is available at [name of institution] in the event that you are injured as a result of your participation in this research study.

For those patients receiving the investigational device and the TAVI procedure,

Medtronic has agreed to pay back [name of institutions that are parties to the CTA] for the costs of medical or surgical care they provide for any serious and unanticipated illness or injury under the following conditions:

- The illness or injury must be related to a defect or malfunction of the investigational device or in the TAVI procedure as described in the Protocol, and not related to procedures that are routine standard of care.
- The illness or injury cannot be caused by (a) the negligence or intentional misconduct of the study staff or [name of institutions that are parties to the CTA]; (b) because the study staff or [name of institution(s)] that are parties to the CTA] did not follow the protocol for the study; or (c) the natural progression of your illness.
- The illness or injury must have happened before the study closes (last patient is seen for the 5 year follow-up visit) at this [Name of institution(s)].
- [Name of institution(s) that are parties to the CTA] must notify Medtronic within one year of the date the study closes at all study sites or before the study closes at this site, whichever is earlier.

Subject to the above conditions, Medtronic will pay back the costs that are not covered by your health insurance or Medicare. The amount Medtronic will pay back is the amount Medicare pays [name of institution(s) that are parties to the CTA] plus 10%.

If you are assigned to the SAVR group

In the event of physical injury or physical illness related to a procedure required for the SAVR group, no monetary compensation or subsidized (paid) will be provided. Medical treatment will be routinely provided to you by any person involved in this study including the study doctors, or the hospital. Any immediate medical treatment, however, that may be necessary will be provided.

By agreeing to the above, you do not waive any of your legal rights which you otherwise would have as a research subject, nor do you release the study sponsor (Medtronic, Inc.), study doctors, or the hospital from liability for negligence.

PAYMENT FOR PARTICIPATION IN THE STUDY

You will not be paid to take part in the study. However, you may be reimbursed for local mileage and parking expenses directly related to any study related visits. Your study doctor or research coordinator will tell you how to get reimbursement.

There is no monetary advantage to the study doctor for participation in this study.

MEDICAL EXPENSES

Your private or public health insurance company (for example Medicare) will be billed for the valve procedure and the cardiac catheterization and other procedures that are required by the study and you will be responsible for paying for any co-payment, co-insurance or deductible. It is possible that your private or public health insurance will not pay for some or all of the procedures, including the valve procedure or the cardiac catheterization procedure because you are participating in this study. Any costs not covered by your public or private insurance will be your responsibility. You should discuss the estimate of these costs with your study doctor. You will not be charged for the cost of collecting the data for this study and other clinic visits and diagnostic tests done solely for the purposes of this study.

BASIS OF PARTICIPATION

Your participation in this study is voluntary. If you refuse to be in this study there will be no penalty or loss of benefits to which you are otherwise entitled. You may withdraw from the study at any time and will not lose your benefits or be treated any differently as a result of withdrawing from the study. Any new findings (decisions or conclusions) that may influence your willingness to participate will be provided to you. If you decide to leave the study before it is finished, please tell one of the persons listed in the section below “Obtaining Additional Information”. It may be requested that, if you withdraw, you return to your study doctor for a final visit.

The study doctor may end your participation in the study at any time if:

- He or she determines it is not in the best interest of your health
- The study doctor loses contact with you and you do not return for your study visits as scheduled
- You refuse to allow the use of private health information during the course of the study

The study doctor will make the decision and let you know if it is not possible for you to continue in the study.

You may be removed from the study without your consent if the sponsor (Medtronic, Inc.) ends the study. If this happens, you will be notified and the reasons will be explained to you. Your physician will continue to provide the appropriate medical therapy.

PERMISSION FOR ACCESS TO AND USE OF HEALTH INFORMATION

This section governs how your health information will be used and shared by the study doctors during and after the study. The health information that may be used and shared includes all information collected during the study and any health information in your medical records that is relevant to the study.

1. PROVIDERS’ DISCLOSURE OF HEALTH INFORMATION IN YOUR RECORDS

You agree to permit [hospital and/or clinic], your doctors, and your other health care providers (“Providers”) to share health information in your medical records with [investigator(s)] and [his/her/his/her/its] staff (“Researchers”). You agree to permit Providers to share your health information:

- With the Researchers;
- With the study sponsor, Medtronic, Inc. and its agents and contractors (together “Medtronic”);
- As required by law;
 - With government organizations and review boards required to watch over the safety and effectiveness of medical products and therapies and the conduct of research; and
 - With other persons who are required to watch over the safety and effectiveness of medical products and therapies and the conduct of research.

2. RESEARCHER’S USE AND DISCLOSURE OF YOUR HEALTH INFORMATION

You agree to permit the Researchers to use and share your health information:

- Among themselves to conduct the study;
- With other researchers in the study to conduct the study;
- With Medtronic;
- With government organizations and review boards required to watch over the safety and effectiveness of medical products and therapies and the conduct of research; and
- With other persons who are required to watch over the safety and effectiveness of medical products and therapies and the conduct of research.

Once Providers or Researchers have shared your health information with a third party, the information may be subject to further sharing by the third party. Federal privacy laws may no longer protect it from further sharing.

While the study is in progress, you will not be allowed to see your health information that is created or collected for the study. After the study is finished, you may see this information as described in the [hospital/clinical trial site]'s Notice of Information practices.

This permission to share your health information does not have an ending date. You do not have to give this permission, but if you do not, you will not be allowed to be in the study. You may change your mind and take back this permission to use your health information at any time. To take back this permission, you must write to [name and contact information]. If you take back this permission, you cannot continue in the study. Even if you take back this permission, Medtronic and Researchers may continue to use and share the health information already received as described in this informed consent

Economic Study

This study contains a health economics review that will be done to compare the in-hospital, 12 month and 24 month follow-up medical care resource utilization and cost for patients in each of the treatment groups. As part of this study, you may be asked to sign a separate document that gives us your permission to review your billing information sent directly from the Medicare system in order to evaluate medical cost data. This information will be kept strictly confidential and be used solely to assess the medical expenses which occur as a direct result of participating in the Medtronic CoreValve™ SURTAVI Trial.

Quality of Life Questionnaire

Medtronic CoreValve™ SURTAVI Trial will also contain a quality of life study. As part of this study, your research coordinator will have you or your legal representative complete a questionnaire called a Quality of Life Questionnaire. You will need to complete this questionnaire when you are enrolled in the study and 1 month, 3 months, 6 months, 12 months, 18 months, 2 years, 3 years, 4 years and 5 years after your study procedure.

OBTAINING ADDITIONAL INFORMATION

You are encouraged and have the right to ask questions at any time concerning potential and/or known risks of this study. The study doctor will inform you of any new significant information, when it becomes available, which may affect your willingness to continue to participate in this study. If you have any questions about this study or if you experience any health problems, you should contact Dr. Principal Investigator at xxx-xxx-xxxx.

If you have questions about your rights as a participant in this study, you should contact the chairman of the Institutional Review Board at xxx-xxx-xxxx.

MEDTRONIC'S USE AND DISCLOSURE OF YOUR HEALTH INFORMATION

This section describes what Medtronic as study sponsor will do with the study data, including your health information received during the study.

Medtronic will keep your health information confidential in keeping with all applicable laws and regulations. Medtronic may use your health information to conduct this study. Medtronic may use your health information for other purposes, such as:

- Watch over and improve the performance of its device;
- New medical research;
- Proposals for making new medical products or procedures; and
- Other business purposes.

Any reports or publications about the study or any other research will not include your name or a description of you. Any records identifying you will not be made publically available. Information received during the study will not be used to market to you; your name will not be placed on any mailing lists or sold to anyone for marketing purposes.

The US Food and Drug Administration's regulations, as well as other applicable laws, control Medtronic's work in developing and assuring the safety and quality performance of its medical devices. Medtronic may disclose your health information to the FDA, as well as to other US and foreign government authorities responsible for assuring the safety of medical devices. Medtronic also may disclose your health information to institutional review boards and other persons who are required to watch over the safety and effectiveness of medical products and therapies and the conduct of research. You agree to allow Medtronic to use study data in these ways. You also agree to allow FDA and other governmental authorities to inspect your health information.

PRIMARY CARE PHYSICIAN / SPECIALIST NOTIFICATION OPTION

Please indicate below whether you would like us to notify your primary care physician or your specialist of your participation in this study.

(Initial only one box).

Yes, I want the study doctor to inform my primary care physician/specialist of my participation in this study

No. I do not want the study doctor to inform my primary care physician/specialist of my participation in this study.

I do not have a primary care physician/specialist.

The study doctor is my primary care physician/specialist.

CONSENT

I confirm that:

- I have read the informed consent form of this study and my physician has answered all my questions regarding the study.
- I had sufficient time to consider my participation into this study, I am aware that participation into this study is completely voluntary, and I agree to follow the instructions from the investigator.
- I realize that I may decide to refuse participation or stop participation at any time without penalty and without affecting the quality of my health care or the relationship with my physician.
- I understand and agree that personal information about me will be collected from my medical records, used and processed (manually and by computer) by the manufacturer of a medical device used in my treatment or any other designated party that is involved in the study (e.g. hospital, physician, regulatory authorities, ethics committees).
- I understand and agree that representatives from Medtronic, regulatory authorities and the Institutional Review Board will be granted direct access to my medical records.
- I understand and agree that the physician(s) / hospital will release the relevant personal information about me for the purpose of the clinical investigation.
- I fully understand there is limited experience with this device in humans and that its safety and effectiveness have not been established and there are risks of serious complications associated with this study.
- I also understand that the doctors might determine after I give consent that it is not possible to implant the study valve.

I hereby give my consent to participate in the “*Medtronic CoreValve™ SURTAVI Trial*”. I have been given a copy of this consent form, and am also aware that the investigator will keep a copy in his or her files.

Patient Name (please print)

Patient Signature

Date (MM/DD/YYYY)

Statement from Person Obtaining Consent

I certify that I have explained the nature of the device and the study to the above-named person. I have also explained the contents of this informed consent form to the above-named person. I have asked whether or not there are any questions. I have answered any questions that were raised by this person.

Person Obtaining Consent Name (please print)

Signature of Person Obtaining Consent

Date (MM/DD/YYYY)

R.1.2 United States – Roll-in Subjects

INFORMED CONSENT FORM

FOR ROLL-IN SUBJECTS

Medtronic CoreValve™ SURTAVI Trial

You are being asked to read this form so that you understand this research study and how you might take part in it. By signing this form, you will show that you understand and that you agree to take part in this research study. Your signature on this form is required before you can take part in this research study.

BACKGROUND

You are being asked to take part in a research study entitled “*Medtronic CoreValve™ SURTAVI Trial*” because you have a disease of your aortic valve. This disease is called aortic stenosis.

The aortic valve is one of the four heart valves that control the flow of blood into and out of the heart. The aortic valve lets oxygen-containing blood to be pumped out of the heart, from the left ventricle (main pumping chamber of the heart) into the aorta (main artery delivering blood to the body). If the valve becomes abnormally narrow through a process of thickening and stiffening (aortic stenosis) the heart must work harder to pump the same amount of blood with each beat.

As the heart works harder, the heart muscle thickens (hypertrophy), and the heart chamber (ventricle) may become larger (dilate). Open-heart surgery to replace the diseased aortic valve is the standard treatment.

As an alternative to open heart surgery, the Medtronic CoreValve™ System has been developed to replace a diseased aortic heart valve without the need for open heart surgery. This system allows the percutaneous aortic valve (study valve) to be implanted (inserted) through a long, thin flexible tube that is inserted through an incision in the skin and threaded through the bloodstream (percutaneous).

A description of this clinical trial will be available on <http://www.ClinicalTrials.gov>, as required by U.S. Law. This website will not include information that can identify you. At most, the website will include a summary of the results. You can search this website at any time.

You are being asked to participate in this study because doctors have determined your aortic valve is no longer working properly. However, your doctors have also decided that your risk of experiencing major problems while undergoing open-heart surgery is moderate due to medical reasons or anatomical reasons (relating to how and where your heart, aortic valve and blood vessels are placed within your body). This means that you doctor believes your health is acceptable for open-heart surgery, but there are still a risk of potential problems.

PURPOSE OF THE STUDY

The purpose of this clinical study is to determine if replacing the aortic valve without open-heart surgery is as safe as or safer than open-heart surgery in patients with similar medical conditions as you.

The study valve is considered an “investigational device”, which means that clinical studies are required to determine if it is safe and provides clinical benefit. Medtronic, Inc. is sponsoring this study to obtain data on the safety and performance of the investigational device. The Medtronic CoreValve™ System includes the valve described below and two parts that help load and deliver the valves correctly.

This study will involve approximately 1600 subjects at up to 115 hospitals in the United States and around the world, and is anticipated to take approximately 8 years to complete. Your participation in this study is expected to last approximately five years from the day you are enrolled in the study. Annual follow-up may be extended to up to 10 years after the implant procedure.

STUDY DEVICES

The study valve are made from animal tissue attached to a metal frame.

The study valve is designed to be implanted (inserted) using a delivery system catheter (long, thin flexible tube) to replace your diseased aortic heart valve without open-heart surgery. Once it is implanted, CoreValve™ study valves acts in the same method of the native valve.

The Medtronic CoreValve system is approved by the US Food & Drug Administration (FDA) since 2014 and it has been approved in other parts of the world since 2006. It has been implanted in over 45,000 patients. The Medtronic CoreValve™ System is currently approved for use in Europe, South America, and parts of Asia.

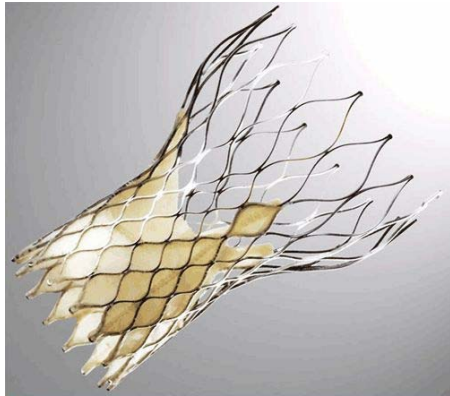

PROCEDURES TO BE FOLLOWED

If you agree to be in this study, and after you have signed this informed consent form, data such as your age, gender, medical history and medication use will be recorded. You will undergo the following tests:

- Physical examination
- Computed tomography (CT) - a scan performed using an x-ray machine, which is linked to a computer to take pictures of your body. Sometimes a CT will require the use of a type of dye that makes the kidneys work harder and may be harmful to the kidneys. You may have an MRI in place of a CT scan if your doctor believes your kidneys are not working well enough for you to have a CT scan. MRI stands for magnetic resonance imaging and is a test that uses a strong magnet and a complex computer system to produce detailed images of your internal organs and soft body tissues.
- Blood tests (about 2 tablespoons)
- Echocardiography (transthoracic echocardiogram (TTE)) - a test that uses sound waves to take pictures of your heart and measure the degree of narrowing of your aortic valve; a probe with gel is placed on the outside of your chest to take pictures of your heart
- Electrocardiogram (ECG) - a test that records electrical impulses of your heart; patches are placed on the outside of your chest
- Heart catheterization/angiography - a test that takes pictures of your heart and blood vessels; a special dye is injected through long, flexible tubes into the coronary arteries (vessels delivering blood to the heart) and bypass grafts if you have them

If you are of child-bearing potential, we will ask you to take a pregnancy test. If you are pregnant, you will not be able to participate in this study.

These procedures and tests are standard procedures and are not experimental. If you have already had any of these tests performed before, they may to be used for the study if your study doctor determines they don't need to be repeated for study purposes.

The results from your exams and tests will be reviewed by your doctor and a committee of study doctors who will determine if you are eligible to be in the study.

Your study doctor and the committee may determine after reviewing your test results that you are not eligible to be in the study and/or it will not be possible to implant the study valve. If so, you will not be allowed to participate in the study.

If your doctor and the committee decide you are eligible to be in the study, you will be one of the first three (3) patients at this hospital to be enrolled in this study. You will receive a transcatheter aortic valve implant (TAVI).

Your enrollment in the study will begin once you sign this consent and you are assigned to the roll-in treatment group. If you are enrolled in the study, you will be required to have the following additional tests completed within 14 days prior to the procedure (TAVI):

- Physical exam, including a determination of neurological (brain) status where you will be asked to answer a series of questions and perform a series of tasks such as writing and drawing
- Blood tests (about 2 tablespoons)
- Walking test – a test that records your breathing, heart rate, and how you feel after 6 minutes of walking
- Electrocardiogram (ECG) - a test that records electrical impulses of your heart; patches are placed on the outside of your chest

You will also be asked to complete surveys about the quality of your life and your ability to do normal daily activities, called Quality of Life Questionnaires (QOL).

TAVI Procedure:

The study valve is an experimental valve which means you can only receive the valve if you are part of this study.

Before the TAVI procedure, it will be strongly recommended that you take blood thinning medications, used to prevent your blood from clotting (thickening). These medications will be described to you by your study doctor. You may be advised to continue these medications for at least three months following your procedure.

Before the procedure you will be given an antibiotic (a medicine that kills bacteria or germs) to decrease your chance of developing an infection. Your study doctor will choose the antibiotic that he or she thinks is best suited for you and decide whether you need additional medication.

You will also have blood tests (about 2 tablespoons) and an ECG before the procedure.

Immediately prior to the procedure, you will receive medications to make you more relaxed and comfortable during the procedure. Your study doctor may decide that general anesthesia is necessary, meaning you need to be put to sleep for the procedure. Your doctor will inform you of this need before the procedure. Additionally, if your study doctor decides that it is necessary during the procedure, you will be put under general anesthesia at that time.

Your study doctor will decide what locations are best for inserting the long, thin flexible tubes required for TAVI and getting all of the pictures that are necessary. These pictures are described in the next paragraphs. Additionally, your study doctor will decide if performing a surgical incision to any of the site(s) is necessary.

During the procedure you may have a transesophageal echocardiogram which is also called a TEE. This test uses sound waves to take a closer look at the inside structures of the heart. If your doctor decides this picture is necessary, to perform the test you will swallow a thin flexible tube with a special tip. This tube sits in the esophagus (the tube that connects the mouth to the stomach). The special tip of the tube sends out sound waves (ultrasound) that echo within the chest wall. The esophagus is located behind the heart so these echoes are picked up and create a picture of the heart that is displayed on a video monitor. The pictures will allow your study doctor to take a closer look at your valve.

You will have a temporary pacemaker put in place during the TAVI procedure. A temporary pacemaker is a thin wire inserted through your skin and into one of your veins and threaded through your vein into the right side of your heart. The wire is attached to a battery operated device outside of your body. This temporary pacemaker will help keep your heart rate (speed) and rhythm steady. This temporary pacemaker will not be removed for at least 48 hours after your TAVI procedure.

After your study doctor has taken a good look at your valve, a balloon valvuloplasty will be performed. Balloon valvuloplasty is a procedure used to widen a stiff or narrowed heart valve. A wire and a thin tube are guided by x-rays through the heart and positioned through the diseased heart valve. A balloon is placed over the wire and inflated, enlarging the opening through the diseased valve allowing the study valve to be placed.

Your doctor will then implant (insert) the study valve through the long, thin flexible tube that is inserted through an incision in the skin and threaded through the bloodstream. TAVI is performed using x-ray machines which will allow your doctor to see the study valve, your blood vessels and heart. The study valve will be guided through your blood vessels to your existing aortic valve and then the study valve will be placed over your existing valve.

During the TAVI procedure, your doctor will perform angiography (x-ray pictures) and ECGs (recordings of the electrical impulses of your heart through patches placed on the chest) to observe your heart function and make sure that the study valve fits and works properly.

Doctors from other hospitals who have experience with the TAVI procedure may assist your study doctor with the procedure. Medtronic staff may assist the physician in the loading of the study valve.

AFTER TAVI PROCEDURE:

After the TAVI procedure, your study doctors will continue to monitor your progress and recovery. You will have the following tests performed within the two days following the procedure and before you are discharged from the hospital:

- Determination of neurological (brain) status where you will be asked to answer a series of questions and perform a series of tasks
- Blood tests (about 2 tablespoons)
- Echocardiogram (TTE)
- ECG

FOLLOW-UP VISITS AFTER TAVI PROCEDURE:

You will need to return to the clinic for required follow-up visits at 30 days, 6 months, 12 months (1 year), 18 months, 24 months (2 years), and 3, 4, and 5 years after the procedure. Most of the follow-up tests and examinations are routine, not experimental. Each visit will take about 1 ½ to 2 hours.

Your evaluations at 30 days, 6 and 18 months will include:

- Physical examination, including a determination of neurological (brain) status where you will be asked to answer a series of questions and perform a series of tasks
- You will be asked about your health since the last follow-up visit
- Quality of Life Questionnaires
- ECG
- Blood tests (about 2 tablespoons) – 30 day visit only
- Walking test – 30 day visit only
- Echocardiogram (TTE) – 6 month visit only

Your evaluation at 12 months, 24 months, and 3, 4, 5 years will include:

- Physical examination, including a determination of neurological (brain) status where you will be asked to answer a series of questions and perform a series of tasks
- You will be asked about your health since the last clinic visit

- Blood tests (about 2 tablespoons)
- Echocardiogram (TTE)
- Quality of Life Questionnaires
- ECG
- Walking test – 12 and 24 months visits only

In addition to the in-clinic follow-up visits, at 3 months you will be contacted via phone to complete a Quality of Life Questionnaire.

If, during the 5 years of follow-up, you have additional heart surgeries or cath lab procedures to work on or replace your aortic valve or study valve, you will be asked to answer questions and perform activities that will help the study doctors and nurses to determine your neurological (brain) status within 24 hours after each additional procedure.

If you have a stroke, have been inform by a doctor that you experienced a stroke, or experience any of the following symptoms, notify Dr. **Principal Investigator** at xxx-xxx-xxxx as soon as possible: sudden numbness, tingling, loss of movement (especially on 1 side of the body), vision changes, confusion or trouble understanding simple statements, severe headaches, or seizures. Any of these symptoms could indicate that you are having problems with your neurological (brain) function. If a doctor confirms that you had a stroke, you will be asked to come to the clinical to have tests performed to determine your neurological (brain) status where you will be asked to answer a series of questions and perform a series of tasks. These tests will be performed at 7 days, 30 days and 3 months after you have any of these symptoms.

If you have any other problems or complications, are seen by any other doctors for problems, or are hospitalized during your participation in this study you should immediately notify Dr. **Principal Investigator** at xxx-xxx-xxxx.

If the study valve is removed for any reason, we will request that it be returned to Medtronic for additional analysis. Your study doctor will determine if you will need to have another valve implanted.

In the event of your death, we will request an autopsy. We will also request that either the whole heart and valve or just the valve are removed and returned to Medtronic for additional analysis.

The autopsy and the removal of the heart and/or valve would be done to provide additional information about the research and the investigational valve.

Your family and your "legally authorized representatives", have the right to refuse the autopsy and refuse the request to remove the heart and/or valve even if you sign this consent form.

POSSIBLE RISKS AND DISCOMFORTS

Potential risks associated with the implantation of the study valve may include, but are not limited to, the following:

- **Death**
- **Cardiac arrest** –heart stops beating and blood flow through the body is interrupted or stopped
- **Coronary occlusion, obstruction, or vessel spasm (including acute coronary closure)** – blockage or closure of an artery that supplies the heart with blood
- **Emergent surgery**
 - Coronary artery bypass – (CABG) a surgery where the chest is opened to place new vessels around the existing blocked vessels of the heart to improve blood supply to the heart.
 - Heart valve replacement – replacing the existing heart valve with a new heart valve
 - Valve explant – the removal of the existing valve
- **Multi-organ failure** – more than one organ of the body not functioning correctly
- **Heart failure** – heart does not pump blood to the body

- **Myocardial infarction** - decreased blood flow to the heart causing death of heart muscle cells
- **Cardiogenic shock** – failure of the heart to pump enough blood to the body organs
- **Respiratory insufficiency or respiratory failure** – not enough oxygen or not able to supply oxygen to the body
- **Cardiovascular injury (including rupture, perforation, or dissection of vessels, ventricle, myocardium, or valvular structures that may require intervention)**
- **Perforation of the myocardium or a vessel** – a hole in the heart muscle or a blood vessel
- **Ascending aorta trauma** – injury to the large blood vessel leading blood away from the heart
- **Cardiac tamponade** – the constriction or inability of the heart to pump due to buildup of blood or fluid around the lining of the heart
- **Cardiac failure or low cardiac output**
- **Prosthetic valve dysfunction including, but not limited to:**
 - Fracture (break) in the valve frame
 - Bending of the valve frame
 - The valve frame does not open (expand) all the way
 - Calcification (build-up of calcium on the valve)
 - Pannus – the formation of scar tissue that may cover or block the valve from functioning normally
 - Wear, tear or movement forward (prolapse) or backward (retraction) from the normal position of the valve leaflets
 - The valve leaflets do not close together
 - A break in the stitches (sutures) of the valve frame or leaflets
 - Leakage through or around the valve or valve frame
 - Incorrect size of the valve implanted
 - Incorrect position of the valve, either too high or too low
 - Regurgitation – backward flow of blood through the valve
 - Stenosis – narrowing of the opening of the valve
- **Thrombosis/embolus (including valve thrombosis)** - an abnormal particle (air, blood clots) floating in the blood stream or attached to an object, including the valve
- **Valve migration/valve embolization** – upward or downward movement of the device from where it was originally placed
- **Ancillary device embolization** – a broken piece of the tube that delivers the valve floating in the blood stream
- **Emergent percutaneous coronary intervention (PCI)** – a procedure through the vessels inside the body and heart used to treat or open narrowed vessels of the heart
- **Emergent balloon valvuloplasty** (balloon valvuloplasty during the TAVI procedure is expected) – a procedure through the vessels inside the body and heart in which a narrowed heart valve is stretched open by a balloon
- **Bleeding that may or may not require transfusion or intervention**
- **Allergic reaction to:**
 - Antiplatelet agents (blood thinning medication)
 - Contrast medium (dye used to see vessels with x-ray), or
 - Anesthesia (medication used to put you to sleep during the procedure)
- **Infection (including septicemia and endocarditis)** – an abnormal growth of germs in the body or body part
- **Stroke, TIA, or other neurological deficits** – decreased blood flow to the brain causing death of brain cells

- **Permanent disability** – injury that does not allow that impairs normal/previous physical or mental function
- **Renal insufficiency or renal failure (including acute kidney injury)** – failure of the kidneys to work correctly
- **Mitral valve regurgitation or injury** – a leaking valve between the left upper (left atrium) and left lower (left ventricle) parts of the heart where blood flows backward through the valve or damage to the valve that may cause it to not function correctly
- **Tissue erosion** – damage to the tissue of the heart or blood vessels that could result in a tear or hole
- **Vascular access related complications, such as:**
 - Dissection - a tear in a blood vessel
 - Perforation – puncture of a blood vessel
 - Pain
 - Bleeding
 - Hematoma –blood collecting under the skin
 - Pseudoaneurysm - blood collecting on the outside of a vessel wall causing a balloon-like widening
 - Irreversible nerve damage – permanent damage to nerves
 - Compartment syndrome – squeezing of nerves and muscles in a closed space that could cause muscle or nerve damage
 - Arteriovenous fistula – abnormal connection between an artery vessel that takes blood away from the heart and a vein vessel that takes blood to the heart
 - Stenosis – narrowing of a vessel (artery)
- **Cardiac arrhythmias**
 - Disturbances in the electrical system of the heart that may result in the permanent placement of a device (pacemaker) that delivers electrical impulses to the heart to help your heart beat normally
 - Atrio-ventricular node block – a block in the electrical path from the top part of the heart (atria) to the bottom part of the heart (ventricle)
 - Bundle branch block – a delay or block in the electrical path in the bottom part of the heart (ventricle)
 - Asystole – when the heart stops beating
 - Ventricular arrhythmias – abnormal fast or slow heart beats in the lower part of the heart (ventricles)
- **Encephalopathy** – altered mental state
- **Pulmonary edema** – fluid build-up in or in the space around the lungs
- **Pericardial effusion** – fluid around the heart
- **Pleural effusion** – fluid build-up in the space around the lungs that makes breathing difficult
- **Myocardial ischemia** – reduced or interrupted blood supply to the heart
- **Peripheral ischemia** – reduced or interrupted blood supply to arms and legs
- **Bowel ischemia** – decrease blood supply to the intestines
- **Heart murmur** – an extra or unusual sound hear during a heartbeat
- **Hemolysis** – break down of blood cells
- **Cerebral infarction-asymptomatic** – silent stroke
- **Non-emergent reoperation**
- **Inflammation** – swelling of tissue
- **Fever** – increase in body temperature
- **Hypotension or hypertension** – low or high blood pressure

- **Syncope** – fainting
- **Dyspnea** – shortness of breath
- **Anemia** – not enough oxygen carrying cells in the blood
- **Angina** – chest pain
- **Abnormal lab values (including electrolyte imbalance)** – changes in blood test results
- **Exposure to radiation through fluoroscopy and angiography**
- **Delivery catheter malfunction resulting in need for additional re-crossing of the aortic valve and prolonged procedural time**

There may also be additional risks, discomforts, or side effects that are not yet known. If you become pregnant there maybe risks, discomforts, or side effects to you and the embryo/fetus that are not yet known. Please notify your study doctor as soon as possible to discuss any of these potential risks.

RADIATION EXPOSURE RISKS

Some of the test and procedures that are part of this study require exposure to radiation (x-rays). These tests or treatments involve a small amount of radiation. To give you an idea about how much radiation you will get, in the following descriptions the radiation is compared to the amounts that people are exposed to in daily life. There is radiation that naturally occurs from space and from rocks in the soil. This natural radiation is greater at higher altitudes.

CT of Chest and Abdomen and Coronary Angiography

The radiation exposure received from the screening tests (CTA of abdomen and thorax and coronary angiogram) is approximately 10 times the radiation exposure received in one year from background radiation (naturally occurring radiation you are exposed to everyday). The exposure is less than the radiation exposure limit an occupational worker is allowed to receive in one year.

Valve implantation

The estimated radiation exposure for the valve procedure is approximately 10-15 times the amount of radiation exposure received in one year from background radiation (naturally occurring radiation you are exposed to everyday). The exposure is approximately the amount an occupational worker is allowed to receive in one year.

There are additional risks or side effects from being exposed to x-rays. Most side effects do not occur often and resolve without major problems. It is possible that skin reddening or other alterations to the skin's appearance may occur if you are exposed to enough radiation during the procedure or if you have recently had another cardiac angiogram. You should contact your doctor in the event that you observe this. If you have a reaction to the x-rays you may need to have extra follow-up visits with your doctor to watch your recovery more closely.

Your doctor will explain to you how many x-rays you will receive, what x-rays are part of your normal care and what, if any, are extra for the study.

POSSIBLE BENEFITS

The possible benefits you may receive from participating in this research are that you may be able to receive a new heart valve without having open-heart surgery. Another possible benefit is that your new valve may work better than the way your diseased valve currently works. This may improve how you feel and may improve your daily activity.

Your participation in this research may improve procedures that may guide the future treatment of heart surgery, by using procedures that are less invasive, meaning less cutting, entering or breaking through the body, which may benefit others in the future. However, there is no guarantee that you will benefit from being in this research.

ALTERNATIVE TREATMENTS

The current long-term effective treatment for severe aortic stenosis is open heart surgery to replace the aortic valve. For patients who are at high risk for open heart surgery, other treatment options include percutaneous (through an artery in the groin) aortic valve implantation, or medical management to relieve symptoms, which may include balloon valvuloplasty. Ask your study doctor about other treatment options you may have.

IF PROBLEMS DEVELOP

If you believe that you have been injured as a result of your participation in the study, you should notify Dr. Principal Investigator at xxx-xxx-xxxx as soon as possible or in serious cases, go to the emergency room.

Immediate necessary medical care is available at [Name of institution(s)] in the event that you are injured as a result of your participation in this research study

Medtronic has agreed to pay back [name of institutions that are parties to the CTA] for the costs of medical or surgical care they provide for any serious and unanticipated illness or injury under the following conditions:

- The illness or injury must be related to a defect or malfunction of the investigational device or in the TAVI procedure as described in the Protocol, and not related to procedures that are routine standard of care.
- The illness or injury cannot be caused by (a) the negligence or intentional misconduct of the study staff or [name of institutions that are parties to the CTA]; (b) because the study staff or [name of institution(s)] that are parties to the CTA did not follow the protocol for the study; or (c) the natural progression of your illness.
- The illness or injury must have happened before the study closes (last patient is seen for the 5 year follow-up visit) at this [Name of institution(s)].
- [Name of institution(s) that are parties to the CTA] must notify Medtronic within one year of the date the study closes at all study sites or before the study closes at this site, whichever is earlier.

Subject to the above conditions, Medtronic will pay back the costs that are not covered by your health insurance or Medicare. The amount Medtronic will pay back is the amount Medicare pays [name of institution(s) that are parties to the CTA] plus 10%.

PAYMENT FOR PARTICIPATION IN THE STUDY

You will not be paid to take part in the study. However, you may be reimbursed for local mileage and parking expenses directly related to any study related visits. Your study doctor or research coordinator will tell you how to get reimbursement.

There is no monetary advantage to the study doctor for participation in this study.

MEDICAL EXPENSES

Your private or public health insurance company (for example Medicare) will be billed for the valve procedure and the cardiac catheterization and other procedures that are required by the study and you will be responsible for paying for any co-payment, co-insurance or deductible. It is possible that your private or public health insurance will not pay for some or all of the procedures, including the valve procedure or the cardiac catheterization procedure because you are participating in this study. Any costs not covered by your public or private insurance will be your responsibility. You should discuss the estimate of these costs with your study doctor. You will not be charged for the cost of collecting the data for this study and other clinic visits and diagnostic tests done solely for the purposes of this study.

BASIS OF PARTICIPATION

Your participation in this study is voluntary. If you refuse to be in this study there will be no penalty or loss of benefits to which you are otherwise entitled. You may withdraw from the study at any time and will not lose your benefits or be treated any differently as a result of withdrawing from the study. Any new findings (decisions or conclusions) that may influence your willingness to

participate will be provided to you. If you decide to leave the study before it is finished, please tell one of the persons listed in the section below "Obtaining Additional Information". It may be requested that, if you withdraw, you return to your study doctor for a final visit.

The study doctor may end your participation in the study at any time if:

- He or she determines it is not in the best interest of your health
- The study doctor loses contact with you and you do not return for your study visits as scheduled
- You refuse to allow the use of private health information during the course of the study

The study doctor will make the decision and let you know if it is not possible for you to continue in the study.

You may be removed from the study without your consent if the sponsor (Medtronic, Inc.) ends the study. If this happens, you will be notified and the reasons will be explained to you. Your physician will continue to provide the appropriate medical therapy.

PERMISSION FOR ACCESS TO AND USE OF HEALTH INFORMATION

This section governs how your health information will be used and shared by the study doctors during and after the study. The health information that may be used and shared includes all information collected during the study and any health information in your medical records that is relevant to the study.

1. PROVIDERS' DISCLOSURE OF HEALTH INFORMATION IN YOUR RECORDS

You agree to permit [hospital and/or clinic], your doctors, and your other health care providers ("Providers") to share health information in your medical records with [investigator(s)] and [his/her/his/her/its] staff ("Researchers"). You agree to permit Providers to share your health information:

- With the Researchers;
- With the study sponsor, Medtronic, Inc. and its agents and contractors (together "Medtronic");
- As required by law;
 - With government organizations and review boards required to watch over the safety and effectiveness of medical products and therapies and the conduct of research; and
 - With other persons who are required to watch over the safety and effectiveness of medical products and therapies and the conduct of research.

2. RESEARCHER'S USE AND DISCLOSURE OF YOUR HEALTH INFORMATION

You agree to permit the Researchers to use and share your health information:

- Among themselves to conduct the study;
- With other researchers in the study to conduct the study;
- With Medtronic;
- With government organizations and review boards required to watch over the safety and effectiveness of medical products and therapies and the conduct of research; and
- With other persons who are required to watch over the safety and effectiveness of medical products and therapies and the conduct of research.

Once Providers or Researchers have shared your health information with a third party, the information may be subject to further sharing by the third party. Federal privacy laws may no longer protect it from further sharing.

While the study is in progress, you will not be allowed to see your health information that is created or collected for the study. After the study is finished, you may see this information as described in the [hospital/clinical trial site]'s Notice of Information practices.

This permission to share your health information does not have an ending date. You do not have to give this permission, but if you do not, you will not be allowed to be in the study. You may change your mind and take back this permission to use your health information at any time. To take back this permission, you must write to [name and contact information]. If you take back this permission, you cannot continue in the study. Even if you take back this permission, Medtronic and Researchers may continue to use and share the health information already received as described in this informed consent

Economic Study

This study contains a health economics review that will be done to compare the in-hospital, 12 month and 24 month follow-up medical care resource utilization and cost for patients in each of the treatment groups. As part of this study, you may be asked to sign a separate document that gives us your permission to review your billing information sent directly from the Medicare system in order to evaluate medical cost data. This information will be kept strictly confidential and be used solely to assess the medical expenses which occur as a direct result of participating in the Medtronic CoreValve™ SURTAVI Trial.

Quality of Life Questionnaire

Medtronic CoreValve™ SURTAVI Trial will also contain a quality of life study. As part of this study, your research coordinator will have you or your legal representative complete a questionnaire called a Quality of Life Questionnaire. You will need to complete this questionnaire when you are enrolled in the study and 1 month, 3 months, 6 months, 12 months, 18 months, 2 years, 3 years, 4 years and 5 years after your study procedure.

OBTAINING ADDITIONAL INFORMATION

You are encouraged and have the right to ask questions at any time concerning potential and/or known risks of this study. The study doctor will inform you of any new significant information, when it becomes available, which may affect your willingness to continue to participate in this study. If you have any questions about this study or if you experience any health problems, you should contact Dr. Principal Investigator at xxx-xxx-xxxx.

If you have questions about your rights as a participant in this study, you should contact the chairman of the Institutional Review Board at xxx-xxx-xxxx.

MEDTRONIC'S USE AND DISCLOSURE OF YOUR HEALTH INFORMATION

This section describes what Medtronic as study sponsor will do with the study data, including your health information received during the study.

Medtronic will keep your health information confidential in keeping with all applicable laws and regulations. Medtronic may use your health information to conduct this study. Medtronic may use your health information for other purposes, such as:

- Watch over and improve the performance of its device;
- New medical research;
- Proposals for making new medical products or procedures; and
- Other business purposes.

Any reports or publications about the study or any other research will not include your name or a description of you. Any records identifying you will not be made publically available. Information received during the study will not be used to market to you; your name will not be placed on any mailing lists or sold to anyone for marketing purposes.

The US Food and Drug Administration's regulations, as well as other applicable laws, control Medtronic's work in developing and assuring the safety and quality performance of its medical devices. Medtronic may disclose your health information to the FDA, as well as to other US and foreign government authorities responsible for assuring the safety of medical devices. Medtronic also may disclose your health information to institutional review boards and other persons who are required to watch over the safety and effectiveness of medical products and therapies and the conduct of research. You agree to allow Medtronic to use study data in these ways. You also agree to allow FDA and other governmental authorities to inspect your health information.

PRIMARY CARE PHYSICIAN / SPECIALIST NOTIFICATION OPTION

Please indicate below whether you would like us to notify your primary care physician or your specialist of your participation in this study.

(Initial only one box).

Yes, I want the study doctor to inform my primary care physician/specialist of my participation in this study

No. I do not want the study doctor to inform my primary care physician/specialist of my participation in this study.

I do not have a primary care physician/specialist.

The study doctor is my primary care physician/specialist.

CONSENT

I confirm that:

- I have read the informed consent form of this study and my physician has answered all my questions regarding the study.
- I had sufficient time to consider my participation into this study, I am aware that participation into this study is completely voluntary, and I agree to follow the instructions from the investigator.
- I realize that I may decide to refuse participation or stop participation at any time without penalty and without affecting the quality of my health care or the relationship with my physician.
- I understand and agree that personal information about me will be collected from my medical records, used and processed (manually and by computer) by the manufacturer of a medical device used in my treatment or any other designated party that is involved in the study (e.g. hospital, physician, regulatory authorities, ethics committees).
- I understand and agree that representatives from Medtronic, regulatory authorities and the Institutional Review Board will be granted direct access to my medical records.
- I understand and agree that the physician(s) / hospital will release the relevant personal information about me for the purpose of the clinical investigation.
- I fully understand there is limited experience with this device in humans and that its safety and effectiveness have not been established and there are risks of serious complications associated with this study.
- I also understand that the doctors might determine after I give consent that it is not possible to implant the study valve.

I hereby give my consent to participate in the “*Medtronic CoreValve™ SURTAVI Trial*”. I have been given a copy of this consent form, and am also aware that the investigator will keep a copy in his or her files.

Patient Name (please print)

Patient Signature

Date (MM/DD/YYYY)

Statement from Person Obtaining Consent

I certify that I have explained the nature of the device and the study to the above-named person. I have also explained the contents of this informed consent form to the above-named person. I have asked whether or not there are any questions. I have answered any questions that were raised by this person.

Person Obtaining Consent Name (please print)

Signature of Person Obtaining Consent

Date (MM/DD/YYYY)

R.1.3 Europe

PATIENT INFORMED CONSENT FORM - INFORMATION SHEET

Medtronic CoreValve™ SURTAVI Trial

You are being asked to read this form so that you understand this clinical study and how you might take part in it. By signing this form, you will show that you understand and that you agree to take part in this clinical study. Your signature on this form is required before you can take part in this clinical study.

Background

You are being asked to take part in a clinical study entitled “*The Medtronic CoreValve™ SURTAVI Trial*” because you have a disease of your aortic valve. This disease is called aortic stenosis.

The aortic valve is one of the four heart valves that control the flow of blood into and out of the heart. The aortic valve lets oxygen-containing blood to be pumped out of the heart, from the lower chamber of the heart (ventricle) into the main artery delivering blood to the body (aorta). If the valve becomes abnormally narrow through a process of thickening and stiffening (aortic stenosis), then the heart must work harder to pump the same amount of blood with each beat. As the heart works harder, the heart muscle thickens (hypertrophy), and the lower chamber (ventricle) may become larger (dilate). Open-heart surgery to replace the diseased aortic valve is the standard treatment. For some patients, the risk of experiencing major problems during open-heart surgery is greater because of other health problems.

As an alternative to open-heart surgery, the Medtronic CoreValve™ System has been developed to replace a diseased aortic heart valve without the need for open-heart surgery. This system allows the percutaneous aortic valve (study valve) to be implanted (inserted) through a long, thin flexible tube that is inserted through an incision in the skin and threaded through the bloodstream (percutaneous).

You are being asked to participate in this study because doctors have determined your aortic valve is no longer working properly. However, your doctors have also decided that your risk of experiencing major problems while undergoing open-heart surgery is moderate due to medical reasons or anatomical reasons (relating to how and where your heart, aortic valve and blood vessels are placed within your body). This means that your doctor believes your health is acceptable for open-heart surgery, but there is still a risk of potential problems.

Purpose of the Study

The purpose of this clinical study is to determine if replacing the aortic valve without open-heart surgery is as safe as or safer than open-heart surgery in patients with similar medical conditions as you.

The Medtronic CoreValve™ System is considered an “investigational device” by the United States Food and Drug Administration (FDA) which means that clinical studies are required to determine if it is safe and provides clinical benefit. Medtronic, Inc. is sponsoring this study to obtain data on the safety and performance of the investigational device and its delivery system to gain FDA approval.

The study will involve approximately 1600 patients and is being conducted at up to 115 hospitals in Europe, Canada and the United States and around the world. It is anticipated to take approximately eight years to complete. Your participation in this study is expected to last approximately five years from the day you are enrolled. Annual follow-up may be extended to up to 10 years after the implant procedure.

As a participant in the study, you have certain responsibilities. You have the responsibility to be truthful regarding your health and medication history.

You are expected to return to your study doctor’s office for the study visits. The evaluations performed at these visits are a component of the study. They are important for data collection and for monitoring that the investigational device is working properly. These evaluations will take place at baseline, implant procedure, discharge, and follow-up visits (30 days, 6, 12, 18, 24, 36, 48, and 60 months). You should not take part in this study if you will not be available for the study visits.

You also have the responsibility to report any injuries, hospitalizations, emergency room visits or other medical visits, symptoms or complaints to the study doctor or study nurse as soon as possible.

Study Device

The study valve is made from animal tissue attached to a metal frame. The study valve is designed to be implanted (inserted) using a delivery system catheter (long, thin flexible tube) to replace your diseased aortic heart valve without open-heart surgery. Once it is implanted, CoreValve™ study valve acts in the same method of the native valve.



The Medtronic CoreValve™ system was CE marked in 2006 and has been implanted in over 45,000 patients. The CoreValve™ being implanted in this study is identical to the valve that was CE marked in 2006 with the exception of adding a coating, but is being used outside the current approved patient population that is approved under the current CE mark. This coating is designed to help the study valve last longer (i.e. function as it is supposed to) and to help keep the study valve from becoming calcified like your native valve did. The coating received CE mark in March 2012.

Procedures to Be Followed

- If you agree to be in this study, and after you have signed this informed consent form, data such as your age, gender, ethnic origin, medical history and medication use will be recorded. You will undergo the following tests to determine if you are suitable for receiving the investigational device:
- Transthoracic echocardiography (TTE): a test that uses sound waves to take pictures of your heart and measure the degree of narrowing of your aortic valve; a probe is placed on the outside of your chest to take pictures of your heart
- Computed Tomography (CT): a scan performed using an x-ray machine, which is linked to a computer to take pictures of your heart and aortic valve
- If your doctor decides it is unsafe for you to have a CT scan, you will have a Magnetic Resonance Imaging (MRI) test. MRI is a scan that uses the magnetic properties of your tissues to take pictures of your heart. For the MRI test, you will lie on a special exam table while the pictures are taken.
- Blood tests: about two tablespoons
- An electrocardiogram (ECG): a test that records electrical impulses of your heart; patches are placed on the outside of your chest
- A physical examination
- Heart catheterization/angiography - a test that takes pictures of your heart and blood vessels; a special dye is injected through long, flexible tubes into: the coronary arteries (vessels delivering blood to the heart) and bypass grafts if you have them

If you are of child-bearing potential, we will ask you to take a pregnancy test. If you are pregnant, you will not be able to participate in this study.

All of these procedures and tests are standard procedures for patients with aortic valve disease, and are not experimental. If you have already had any of these tests performed before, they may be used for the study if your study doctor determines they do not need to be repeated for study purposes.

The results from your exams and tests will be reviewed by your doctor and a committee of study doctors who will determine if you are eligible to be in the study.

Your study doctor and the committee may determine after reviewing your test results that you are not eligible to be in the study and/or it will not be possible to implant the study valve. If so, you will not be allowed to participate in the study.

If your doctors and the committee decide you are eligible to be in the study, your treatment will be determined in a way similar to flipping a coin, called randomization. You will be assigned to one of two groups. One group will receive a transcatheter aortic valve implant (TAVI), the other group will have an open-heart surgical aortic valve replacement (SAVR). One out of every two participants will receive TAVI. The other participants will receive SAVR. You will not be able to choose your treatment assignment.

Your enrollment in the study will begin once you sign this consent and you are assigned to your treatment group. If you are enrolled in the study; you will be required to have the following additional tests completed within 14 days prior to the procedure (TAVI or SAVR):

- Physical exam, including a determination of neurological (brain) status where you will be asked to answer a series of questions and perform a series of tasks
- Blood tests (about two tablespoons)
- Six-Minute walking test – a test that records your breathing, heart rate, and how you feel
- Electrocardiogram (ECG) - a test that records electrical impulses of your heart; patches are placed on the outside of your chest

You will also be asked to complete surveys about the quality of your life and your ability to do normal daily activities, called Quality of Life (QOL) Questionnaires.

If you are assigned to the TAVI group:

Before the TAVI procedure, it will be strongly recommended that you take blood thinning medications, used to prevent your blood from clotting (thickening). These medications will be described to you by your study doctor. You may be advised to continue taking blood thinning medications for at least three months following your procedure.

Before the procedure you will be given a medicine that kills bacteria or germs (antibiotic) to decrease your chance of developing an infection. Your study doctor will choose the antibiotic that he or she thinks is best suited for you and decide whether you need additional medication.

You will also have blood tests (about two tablespoons) and an ECG before the procedure.

Immediately prior to the procedure, you will receive medications to make you more relaxed and comfortable during the procedure. Your study doctor may decide that general anesthesia is necessary, meaning you need to be put to sleep for the procedure. Your doctor will inform you of this need before the procedure. Additionally, if your study doctor decides that it is necessary during the procedure, you will be put under general anesthesia at that time.

Your study doctor will decide what areas are best for inserting the long, thin flexible tubes required for TAVI and getting all of the pictures that are necessary. These pictures are described in the next paragraphs. Additionally, your study doctor will decide if performing a surgical incision to any of the area(s) is necessary.

During the procedure, you may have a transesophageal echocardiogram which is also called a TEE. This test uses sound waves to take a closer look at the inside structures of the heart. If your doctor decides this picture is necessary, to perform the test, you will swallow a thin flexible tube with a special tip. This tube sits in the tube that connects the mouth to the stomach (esophagus). The special tip of the tube sends out sound waves (ultrasound) that echo within the chest wall. The esophagus is located behind the heart so these echoes are picked up and create a picture of the heart that is displayed on a video monitor. The pictures will allow your study doctor to take a closer look at your valve.

You will have a temporary pacemaker put in place during the TAVI procedure. A temporary pacemaker is a thin wire inserted through your skin and into one of your veins. It is then threaded through your vein into the right side of your heart. The wire is attached to a battery-operated device that is outside of your body. This temporary pacemaker will help keep your heart rate and beat steady. This temporary pacemaker will not be removed for at least 48 hours after your TAVI procedure.

After your study doctor has taken a good look at your valve, a balloon valvuloplasty will be performed. This is a procedure used to widen a hard or thin heart valve. A wire and a thin tube are guided by x-rays through the heart and positioned through the diseased heart valve. A balloon is placed over the wire and inflated, enlarging the opening through the diseased valve allowing the study valve to be placed.

Your doctor will then insert the study valve through the long, thin flexible tube that is inserted through an incision in the skin and threaded through the bloodstream. TAVI is performed using x-ray machines which will allow your doctor to see the study valve, your blood vessels and heart. The study valve will be guided through your blood vessels to your existing aortic valve and then the study valve will be placed over your existing valve.

During the TAVI procedure, your doctor will perform x-ray pictures (angiogram) and recordings of the electrical impulses of your heart through patches placed on the chest (ECG) to observe your heart function and make sure that the study valve fits and works properly.

Doctors from other hospitals who have experience with the TAVI procedure may assist your study doctor with the procedure. Medtronic staff may assist the physician in the loading of the study valve.

If you are assigned to the SAVR group:

If you are assigned to the SAVR group, your doctors will replace your diseased aortic valve through open-heart surgery. During surgery, you are asleep under general anesthesia. SAVR often requires a median sternotomy, where the bone in the center of the chest (sternum) is split down the middle. The chest is then opened to provide your doctor with access to the heart and chest cavity, in order to replace your aortic valve. Your surgery is performed while the function of your heart is taken over by a heart lung machine (called CPB for cardiopulmonary bypass).

You may have a TEE (a thin tube sits in the esophagus and sends out sound waves to create a picture of your heart) and a temporary pacemaker (thin wire threaded through your vein to right side of heart to keep your heart rate and rhythm steady) during the procedure.

Your doctor may remove any tissue and calcium deposits that are interfering with the normal function of the valve. Your damaged valve may be completely removed. The new valve will be sewn into the space where your own valve used to be. After your doctor makes sure your valve is working properly, blood flow will be restored to your heart and the incisions will be closed. You will also have blood drawn for testing before and after the procedure.

After TAVI and SAVR Procedure:

After your TAVI and SAVR procedure, your study doctors will continue to monitor your progress and recovery.

You will have the following tests performed within the two days following your TAVI procedure and before you leave the hospital:

- Determination of neurological (brain) status where you will be asked to answer a series of questions and perform a series of tasks
- Blood tests (about two tablespoons)
- Echocardiogram (TTE)
- ECG

Follow-up Visits after TAVI and SAVR:

You will need to return to the clinic for required follow-up visits at 30 days, 6 months, 12 months, 18 months, 24 months (3 years) and 3, 4, and 5 years after the procedure. The follow-up tests and

examinations are not experimental and most are performed on a routine basis. Each visit will take about 1 ½ to 2 hours.

Your evaluations at 30 days, 6 and 18 months will include:

- Physical examination, including a determination of neurological (brain) status where you will be asked to answer a series of questions and perform a series of tasks
- You will be asked about your health since the last follow-up visit
- Blood tests (about two tablespoons) – 30 day visit only
- Quality of Life (QoL) Questionnaires
- ECG
- Six-Minute walking test – 30 day visit only
- Echocardiogram (TTE) – 6 month visit only

Your evaluation at 12, 24, 36, 48 and 60 months will include:

- Physical examination, including a determination of neurological (brain) status where you will be asked to answer a series of questions and perform a series of tasks
- You will be asked about your health since the last follow-up visit
- Echocardiogram (TTE)
- QoL Questionnaires
- ECG
- Six-Minute walking test – 12 and 24 months visit only

In addition to the in-clinic follow-up visits, at 3 months you will be contacted via phone to complete a Quality of Life Questionnaire.

If the study doctor is unable to implant the study valve, you will still be followed for safety and will need to return to the clinic for the required follow-up visits as described above.

If, during the 5 years of follow-up, you have additional heart surgeries or cath lab procedures to work on or replace your aortic valve or study valve, you will be asked to answer questions and perform activities that will help the study doctors and nurses to determine your neurological (brain) status within 24 hours after each additional procedure.

If you have a stroke, have been informed by a doctor that you experienced a stroke, experience any of the following symptoms, notify your study doctor at xxx-xxx-xxxx as soon as possible: sudden numbness, tingling on, loss of movement (occurring on one side of the body), sudden vision changes, confusion or trouble understanding simple statements, unable to speak, severe headaches, or seizures. Any of these symptoms could indicate that you are having problems with your neurological (brain) function. You will be asked to come to the clinical to have tests performed to determine your neurological (brain) status where you will be asked to answer a series of questions and perform a series of tasks. These tests will be performed at 7 days, 30 days and 3 months after you have any of these symptoms.

If you have any other problems or complications, are seen by any other doctors for problems, or are hospitalized during your participation in this study you should immediately notify Dr. **Principal Investigator** at xxx-xxx-xxxx.

If the study valve is removed for any reason, we will request that it be returned to Medtronic for additional analysis. The study doctor will determine if you will need to have another valve implanted.

In the event of your death and an autopsy is performed, the study doctor will ask your family or "legally authorized representatives" for either the whole heart and valve or just the valve are removed and returned to Medtronic for additional analysis.

The autopsy and the removal of the heart and/or valve would be done to provide additional information about the research and the investigational valve.

Your family and your "legally authorized representatives", have the right to refuse the autopsy and refuse the request to remove the heart and/or valve even if you sign this consent form.

POSSIBLE RISKS AND DISCOMFORTS

TAVI

Potential risks associated with the implantation of the study valve may include, but are not limited to, the following:

- **Death**
- **Cardiac arrest** – heart stops beating and blood flow through the body is interrupted or stopped
- **Coronary occlusion, obstruction, or vessel spasm (including acute coronary closure)** – blockage or closure of an artery that supplies the heart with blood
- **Emergent surgery**
 - Coronary artery bypass – (CABG) a surgery where the chest is opened to place new vessels around the existing blocked vessels of the heart to improve blood supply to the heart.
 - Heart valve replacement – replacing the existing heart valve with a new heart valve
 - Valve explant – the removal of the existing valve
- **Multi-organ failure** – more than one organ of the body not functioning correctly
- **Heart failure** – heart does not pump blood to the body
- **Myocardial infarction** - decreased blood flow to the heart causing death of heart muscle cells
- **Cardiogenic shock** – failure of the heart to pump enough blood to the body organs
- **Respiratory insufficiency or respiratory failure** – not enough oxygen or not able to supply oxygen to the body
- **Cardiovascular injury (including rupture, perforation, or dissection of vessels, ventricle, myocardium, or valvular structures that may require intervention)**
- **Perforation of the myocardium or a vessel** – a hole in the heart muscle or a blood vessel
- **Ascending aorta trauma** – injury to the large blood vessel leading blood away from the heart
- **Cardiac tamponade** – the constriction or inability of the heart to pump due to buildup of blood or fluid around the lining of the heart
- **Cardiac failure or low cardiac output**
- **Prosthetic valve dysfunction including, but not limited to:**
 - Fracture (break) in the valve frame
 - Bending of the valve frame
 - The valve frame does not open (expand) all the way
 - Calcification (build-up of calcium on the valve)
 - Pannus – the formation of scar tissue that may cover or block the valve from functioning normally
 - Wear, tear or movement forward (prolapse) or backward (retraction) from the normal position of the valve leaflets
 - The valve leaflets do not close together
 - A break in the stitches (sutures) of the valve frame or leaflets
 - Leakage through or around the valve or valve frame
 - Incorrect size of the valve implanted
 - Incorrect position of the valve, either too high or too low
 - Regurgitation – backward flow of blood through the valve
 - Stenosis – narrowing of the opening of the valve
- **Thrombosis/embolus (including valve thrombosis)** - an abnormal particle (air, blood clots) floating in the blood stream or attached to an object, including the valve
- **Valve migration/valve embolization** – upward or downward movement of the device from where it was originally placed

- **Ancillary device embolization** – a broken piece of the tube that delivers the valve floating in the blood stream
- **Emergent percutaneous coronary intervention (PCI)** – a procedure through the vessels inside the body and heart used to treat or open narrowed vessels of the heart
- **Emergent balloon valvuloplasty** (balloon valvuloplasty during the TAVI procedure is expected) – a procedure through the vessels inside the body and heart in which a narrowed heart valve is stretched open by a balloon
- **Bleeding that may or may not require transfusion or intervention**
- **Allergic reaction to:**
 - Antiplatelet agents (blood thinning medication)
 - Contrast medium (dye used to see vessels with x-ray), or
 - Anesthesia (medication used to put you to sleep during the procedure)
- **Infection (including septicemia and endocarditis)** – an abnormal growth of germs in the body or body part
- **Stroke, TIA, or other neurological deficits** – decreased blood flow to the brain causing death of brain cells
- **Permanent disability** – injury that does not allow that impairs normal/previous physical or mental function
- **Renal insufficiency or renal failure (including acute kidney injury)** – failure of the kidneys to work correctly
- **Mitral valve regurgitation or injury** – a leaking valve between the left upper (left atrium) and left lower (left ventricle) parts of the heart where blood flows backward through the valve or damage to the valve that may cause it to not function correctly
- **Tissue erosion** – damage to the tissue of the heart or blood vessels that could result in a tear or hole
- **Vascular access related complications, such as:**
 - Dissection - a tear in a blood vessel
 - Perforation – puncture of a blood vessel
 - Pain
 - Bleeding
 - Hematoma –blood collecting under the skin
 - Pseudoaneurysm - blood collecting on the outside of a vessel wall causing a balloon-like widening
 - Irreversible nerve damage – permanent damage to nerves
 - Compartment syndrome – squeezing of nerves and muscles in a closed space that could cause muscle or nerve damage
 - Arteriovenous fistula – abnormal connection between an artery vessel that takes blood away from the heart and a vein vessel that takes blood to the heart
 - Stenosis – narrowing of a vessel (artery)
- **Cardiac arrhythmias**
 - Disturbances in the electrical system of the heart that may result in the permanent placement of a device (pacemaker) that delivers electrical impulses to the heart to help your heart beat normally
 - Atrio-ventricular node block – a block in the electrical path from the top part of the heart (atria) to the bottom part of the heart (ventricle)
 - Bundle branch block – a delay or block in the electrical path in the bottom part of the heart (ventricle)
 - Asystole – when the heart stops beating

- Ventricular arrhythmias – abnormal fast or slow heart beats in the lower part of the heart (ventricles)
- **Encephalopathy** – altered mental state
- **Pulmonary edema** – fluid build-up in or in the space around the lungs
- **Pericardial effusion** – fluid around the heart
- **Pleural effusion** – fluid build-up in the space around the lungs that makes breathing difficult
- **Myocardial ischemia** – reduced or interrupted blood supply to the heart
- **Peripheral ischemia** – reduced or interrupted blood supply to arms and legs
- **Bowel ischemia** – decrease blood supply to the intestines
- **Heart murmur** – an extra or unusual sound hear during a heartbeat
- **Hemolysis** – break down of blood cells
- **Cerebral infarction-asymptomatic** – silent stroke
- **Non-emergent reoperation**
- **Inflammation** – swelling of tissue
- **Fever** – increase in body temperature
- **Hypotension or hypertension** – low or high blood pressure
- **Syncope** – fainting
- **Dyspnea** – shortness of breath
- **Anemia** – not enough oxygen carrying cells in the blood
- **Angina** – chest pain
- **Abnormal lab values (including electrolyte imbalance)** – changes in blood test results
- **Exposure to radiation through fluoroscopy and angiography**
- **Delivery catheter malfunction resulting in need for additional re-crossing of the aortic valve and prolonged procedural time**

There may also be additional risks, discomforts, or side effects that are not yet known.

SAVR

Although SAVR is not experimental there are potential risks associated with the procedure. These risks are the same even if you undergo the SAVR procedure and you decide not to participate in this study. Some of these risks include, but may not be limited to the following:

- Obstruction of blood flow to the heart (angina) resulting in damage to the heart tissue (myocardial infarction/heart attack)
- Abnormal heart beat (cardiac arrhythmia and dysrhythmia)
- Blood leaking around the outside of the prosthetic valve (paravalvular leak) or any problem with the valve that causes leaking of blood after the valve has closed (transvalvular leak).
- Damage to red blood cells (hemolysis) that can result in anemia (decreased red blood cells)
- Death
- Inflammation of the lining of the heart (endocarditis)
- Heart failure
- Any problem with the prosthetic valve that causes narrowing of the valve opening (stenosis)
- Blood clots that develop in the heart or on the replacement valve. These clots may break loose and travel through the bloodstream (thromboembolism). This problem may cause stroke (decrease blood flow to the brain causing damage to the brain) or heart attack.
- Failure of the valve to open and close properly

If you are or you become pregnant, there may be risks, discomforts or side effects to you and your unborn child that are not yet known.

Some possible inconveniences may include, but is not limited to the following:

- Transportation to and from the clinic for follow-up visits
- Parking
- Follow-up visit scheduling

There may be other discomforts and risks related to the device and/or this study that are not foreseen at this time.

RADIATION EXPOSURE RISKS

Some of the test and procedures that are part of this study require exposure to radiation (x-rays). These tests or treatments involve a small amount of radiation. To give you an idea about how much radiation you will get, in the following descriptions the radiation is compared to the amounts that people are exposed to in daily life. There is radiation that naturally occurs from space and from rocks in the soil. This natural radiation is greater at higher altitudes.

CT of Chest and Abdomen and Coronary Angiography

The radiation exposure received from the screening tests (CTA of abdomen and thorax and coronary angiogram) is approximately 10 times the radiation exposure received in one year from background radiation (naturally occurring radiation you are exposed to everyday). The exposure is less than the radiation exposure limit an occupational worker is allowed to receive in one year.

Valve implantation

The estimated radiation exposure for the valve procedure is approximately 10-15 times the amount of radiation exposure received in one year from background radiation (naturally occurring radiation you are exposed to everyday). The exposure is approximately the amount an occupational worker is allowed to receive in one year.

There are additional risks or side effects from being exposed to x-rays. Most side effects do not occur often and resolve without major problems. It is possible that skin reddening or other alterations to the skin's appearance may occur if you are exposed to enough radiation during the procedure or if you have recently had another cardiac angiogram. You should contact your doctor in the event that you observe this. If you have a reaction to the x-rays you may need to have extra follow-up visits with your doctor to watch your recovery more closely.

Your doctor will explain to you how many x-rays you will receive, what x-rays are part of your normal care and what, if any, are extra for the study.

Potential Benefits for You

The possible benefits you may receive from participating in this clinical study are that you may be able to receive a new heart valve without having open-heart surgery. Another possible benefit is that your new study valve may work better than the way your diseased valve currently works. This may improve how you feel and may improve your daily activity. However, there is no guarantee that you will benefit from being in this clinical study.

Potential Benefits for Other Patients

Your participation in this clinical study may improve procedures that may guide the future treatment of aortic stenosis, by using procedures that are less invasive (meaning less cutting, entering or breaking through the body), which may benefit others in the future.

Alternative Therapy

The current long-term effective treatment for severe aortic stenosis is open heart surgery to replace the aortic valve. For patients who are at high risk for open heart surgery, other treatment options include percutaneous (through an artery in the groin) aortic valve implantation, or medical management to relieve symptoms, which may include balloon valvuloplasty. Ask your study doctor about other treatment options you may have and their related benefits and risks.

Compensation for Illness or Injury

If you are physically injured as a result of your participation in this study, reasonable and appropriate medical treatment will be provided to you free of charge by the study sponsor, if such treatment is not already covered by your medical insurance.

Medtronic maintains appropriate clinical trial liability insurance coverage as required under applicable laws and regulations and will comply with applicable local law and custom concerning specific insurance coverage. If required, a Clinical Trial insurance statement/certificate will be provided to your Institution's Ethics Committee.

Compensation and Additional Costs

You will not receive any compensation for your participation in this study (including follow up). There is no monetary advantage to the study doctor for participation in this study.

You may request for reimbursement for costs associated with travel expenses for the purpose of the follow-up visits.

Role of the Sponsor's Representative

Your study doctor will delegate study activities not only to other study personnel (both doctors and study nurses), but also sponsor representatives. These study activities may include support during the procedure and supporting during data collection throughout the study. These activities are performed under supervision of the study doctor and will not bias the data integrity in any way.

Use of Personal Data/Confidentiality

Your participation in this study is entirely confidential.

While participating in this study the following personal data will be collected:

- medical and health data from your medical records
- data on your ethnic origins

(Hereinafter "personal data")

Representatives of the institution or hospital in which you are treated, including your physician(s) who conduct(s) the study, the monitor(s) on behalf of the study sponsor and other designated parties that are involved in the study (for example third party data processors) have direct access to your personal data. Furthermore, representatives of national, European or other international regulatory bodies, members of the ethics committees or any other public authority may be granted direct access to your personal data in order to comply with legal and regulatory requirements. If it is necessary, your personal data may also be transferred to the above-mentioned parties, which are located in the country in which you are treated and in member states of the European Economic Area but maybe also in countries where the European Directive on Data Protection does not apply.

For conducting the study your personal data will be transferred to and processed by Medtronic (meaning the Medtronic, Inc. as well as all affiliates of this group of companies) or a third party designated by Medtronic – but solely in a key coded form, unless it may be impossible to make it anonymous, for instance, where your name cannot be removed from the data carrier, such as x-ray, angiogram or echocardiography. This means that these data will be transferred to a Medtronic entity or a third party designated by Medtronic which is located in the country where you are treated, in a member state of the European Economic Area but maybe also in the United States or another country where the European Directive on Data Protection does not apply.

Medtronic, or a third party designated by Medtronic, will process these data manually or by computer, including the use of internet or cloud computing.

Your personal data are collected for medical research purposes, to gather information on the device and its performance during and after this study and may be used for obtaining assessments for approvals for the device, additional scientific research, educational purposes and publications as well as for future health studies.

Study results may be published without disclosing your name or any other identifying characteristics. In all cases, your personal data will be handled at all times in accordance with appropriate confidentiality standards and all applicable data protection and privacy laws.

You are entitled to access the personal data collected about you and to have inaccuracies corrected.

If you agree upon, your personal physician will be informed about your participation in the study.

Voluntary Participation

Your participation in this study is entirely voluntary. You are free to refuse participation and you are free to discontinue participation in the study at any time without fear of penalty or loss of medical care. In addition, you will be notified in written form of any significant new findings that may develop during the course of the study or the reasons for any amendment to the study protocol which may relate to your willingness to continue your participation.

Your physician, Medtronic, the Ethics Committee or the Competent Authority may decide to terminate your participation in the study at any time without your prior consent. If this happens you will be notified and the reasons explained to you.

Medtronic can also suspend or terminate the study at any time without your prior consent. If this happens, you will be notified and the reasons will be explained to you. Your physician will continue to provide the appropriate medical treatment.

If you discontinue your participation or if the study sponsor decides to terminate your participation in the study all your personal data collected for the study can still be used by the study sponsor unless you object and ask for deletion of the data.

Questions

In case of any question, you can contact one of the following people:

Questions about the study:

Questions in the event of illness or injury:

Questions about patient rights:

PATIENT INFORMED CONSENT FORM - SIGNATURE SHEET
Medtronic CoreValve™ SURTAVI Trial

I have read the patient information of this study and my physician has answered all my questions regarding the study.

I had sufficient time to consider my participation into this study, I am aware that participation into this study is completely voluntary, and I agree to follow the instructions from the investigator.

I realize that I may decide to refuse participation or stop participation at any time without penalty and without affecting the quality of my health care or the relationship with my physician.

I understand and agree that personal data about me will be collected and used for the purpose of the study. For conducting the study these data will be transferred to and processed by Medtronic or third parties designated by Medtronic as described in the section 'use of personal data/confidentiality.'

I understand and agree that representatives from Medtronic, regulatory authorities and the Ethics Committee will be granted direct access to my medical records.

I understand and agree that the physician(s) / hospital will release the relevant personal information about me for the purpose of the study.

I understand that I am entitled to access the personal information collected about me and to have inaccuracies corrected.

I have received a copy of the Patient Information and hereby I agree to participate voluntarily in and comply with this study.

You may agree or disagree that your personal physician is informed on your participation in this study.

Please, check **one** option below indicating your choice:

! must be checked by patient

- I agree that my personal physician is informed about my participation in this study.
 I disagree that my personal physician is informed about my participation in this study.

I agree to participate in this study and I have consented before the initiation of any study specific procedures.

Patient:

Name

Signature

Date (dd MMM yyyy)

Must be written by patient

Must be written by patient

Study Doctor or designated person by Study Doctor:

I have conducted the informed consent discussion.

Only persons officially trained and authorized on the delegated task list are allowed to sign off

Name

Signature

Date (dd MMM yyyy)

If patient is unable to read:

I have attended the entire informed consent discussion. I attest that the information in the consent form and any other written information was accurately explained to, and apparently understood by, the patient. Informed consent was freely given by the patient.

Impartial Witness:

Name

Signature

Date (dd MMM yyyy)

Section should be filled in by impartial witness

R.1.4 Canada

INFORMED CONSENT FORM

Medtronic CoreValve™ SURTAVI Trial

You are being asked to read this form so that you understand this research study and how you might take part in it. By signing this form, you will show that you understand and that you agree to take part in this research study. Your signature on this form is required before you can take part in this research study.

BACKGROUND

You have been invited to participate in this research project because you have aortic stenosis (a disease of one of your heart valves). Before deciding to participate in the study you should be familiar with its requirements, risks and benefits. This document provides information about the study. It may contain words you do not fully understand. Please read it carefully and ask the study staff any questions you may have. They will discuss the study with you in detail. If you decide to participate, you will be asked to sign this form and a copy will be given to you.

The aortic valve is one of the four heart valves that control the flow of blood into and out of the heart. The aortic valve lets oxygen-containing blood to be pumped out of the heart, from the left ventricle (main pumping chamber of the heart) into the aorta (main artery delivering blood to the body). If the valve becomes abnormally narrow through a process of thickening and stiffening (aortic stenosis) the heart must work harder to pump the same amount of blood with each beat.

As the heart works harder, the heart muscle thickens (hypertrophy), and the heart chamber (ventricle) may become larger (dilate). Open-heart surgery to replace the diseased aortic valve is usually the standard treatment.

As an alternative to open heart surgery, the Medtronic CoreValve™ System has been developed to replace a diseased aortic heart valve without the need for open heart surgery. A description of the valves is included under the section **Study Devices**.

A description of this clinical trial will be available on <http://www.ClinicalTrials.gov>. This website will not include information that can identify you. At most, the website will include a summary of the results. You can search this website at any time.

You are being asked to participate in this study because doctors have determined your aortic valve is no longer working the way it should. However, your doctors have also decided that your risk of experiencing major problems while having open-heart surgery is moderate. This means that your doctor believes your health is good enough for open-heart surgery, but there is still a risk of potential problems.

PURPOSE OF THE STUDY

The purpose of this clinical study is to figure out if replacing the aortic valve without open-heart surgery is as safe as or safer than open-heart surgery in patients with similar medical conditions as you.

The study valve is considered an “investigational device”, which means that Health Canada has not yet approved it to be used for standard of care purposes and is only allowed to be used for the study. Medtronic, Inc. is sponsoring this study to obtain data on the safety and performance of the investigational device. The Medtronic CoreValve™ System includes the valve described below and two parts that help load and deliver the valves correctly.

This study will involve approximately 1600 subjects at up to 115 hospitals in the United States, Canada and around the world, and is anticipated to take approximately 8 years to complete. Your participation in this study is expected to last approximately five years from the day you are enrolled in the study. Annual follow-up may be extended to up to 10 years after the implant procedure.

STUDY DEVICES

The study valve is made from animal tissue attached to a metal frame.

The study valve is designed to be inserted using a long, thin flexible tube (delivery system) to replace your diseased aortic heart valve through an incision in the skin and threaded through the bloodstream (percutaneous) and without open-heart surgery. Once it is implanted, CoreValve™ study valve acts in the same method of the native valve.

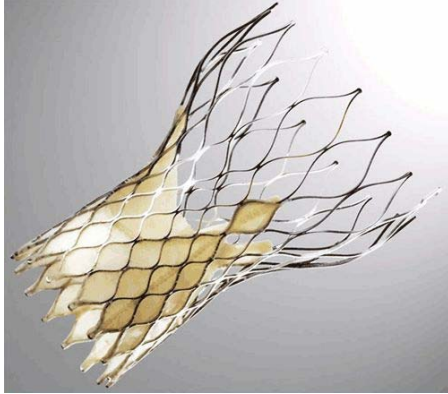

Although the Medtronic CoreValve™ system is not approved by the US Food & Drug Administration (FDA), or Health Canada, it has been approved in other parts of the world since 2006 and has been implanted in over 45,000 patients.

The Medtronic CoreValve™ System is currently approved for use in Europe, South America, and parts of Asia.

PROCEDURES TO BE FOLLOWED

If you agree to be in this study, and after you have signed this informed consent form, information such as your age, gender, medical history and medication use will be recorded. You will have the following tests:

- Physical examination
- Computed tomography (CT) - a scan performed using an x-ray machine that takes pictures of your body. Sometimes a CT will require the use of a type of dye that makes the kidneys work harder and may be harmful to the kidneys. You may have an MRI in place of a CT scan if your doctor believes your kidneys are not working well enough for you to have a CT scan. MRI stands for magnetic resonance imaging and is a test that also takes pictures of your internal organs.
- Blood tests (about 2 tablespoons). These tests include the following:
 - Complete blood count - counting the amount of white and red blood cells you have
 - Blood chemistry – tests to make sure your liver and kidneys are working as they should as well as make sure other minerals (enzymes) in your blood are normal
 - Creatinine and Creatinine clearance - tests to make sure your kidneys are functioning as they should
 - Cardiac Enzymes (CK/CK-MB) – test to make sure you have not had heart attack or other heart problems
 - International Normalized Ratio – only if you are taking a medicine called coumadin or warfarin. The test shows how fast your blood clots and if your medication dosage is working
 - Activated Partial Thromboplastin Time – test to determine the thickness of your blood

- B-Type Natriuretic Peptide (BNP) or NT-proBNP – tests that show if your heart is working harder than normal to pump blood through your body
- Echocardiography (transthoracic echocardiogram (TTE)) - a test that uses sound waves to take pictures of your heart and measure the degree of narrowing of your aortic valve; a probe with gel is placed on the outside of your chest to take pictures of your heart
- Electrocardiogram (ECG) - a test that records electrical impulses of your heart; patches are placed on the outside of your chest
- Heart catheterization/angiography - a test that takes pictures of your heart and blood vessels; a special dye is injected through long, flexible tubes into the coronary arteries (vessels delivering blood to the heart) and bypass grafts if you have them

These procedures and tests are standard procedures required for the treatment of your disease and are not experimental. If you have already had any of these tests performed before, they may be used for the study if your study doctor determines they don't need to be repeated for study purposes. The results from your exams and tests will be reviewed by your doctors who will determine if you are eligible to be in the study.

The results from your exams and tests will be reviewed by your doctor and a committee of study doctors who will determine if you are eligible to be in the study.

Your study doctor and the committee may determine after reviewing your test results that you are not eligible to be in the study and/or it will not be possible to implant the study valve. If so, you will not be allowed to participate in the study.

If your doctors and the committee decide you are eligible to be in the study, your treatment will be determined in a way similar to flipping a coin, called randomization. You will be assigned to one of two groups. One group will receive a transcatheter aortic valve implant (TAVI); the other group will receive an open-heart surgical aortic valve replacement (SAVR). On average, one out of every two participants will receive TAVI. The other participants will receive SAVR. You will not be able to choose your treatment assignment.

You will be considered enrolled in the study once you are assigned to a treatment group.

If you are enrolled in the study, you will be required to have the following additional tests (for study purposes only) completed within 14 days prior to the procedure (TAVI or SAVR):

- Physical exam, including determining your neurological (brain) status where you will be asked to answer a some questions and perform some tasks such as writing and drawing
- Blood tests (about 2 tablespoons) These tests include the following:
 - Complete blood count - counting the amount of white and red blood cells you have
 - Blood chemistry – tests to make sure your liver and kidneys are working as they should as well as make sure other minerals (enzymes) in your blood are normal
 - Creatinine and Creatinine clearance - tests to make sure your kidneys are functioning as they should
 - Cardiac Enzymes (CK/CK-MB) – test to make sure you have no had heart attack or other heart problems
 - International Normalized Ratio – only if you are taking a medicine called coumadin or warfarin. The test shows how fast your blood clots and if your medication dosage is working
 - Activated Partial Thromboplastin Time – test to determine the thickness of your blood
 - B-Type Natriuretic Peptide (BNP) or NT-proBNP – tests that show if your heart is working harder than normal to pump blood through your body
- Walking test – a test that records your breathing, heart rate, and how you feel after 6 minutes of walking
- Electrocardiogram (ECG) - a test that records electrical impulses of your heart; patches are placed on the outside of your chest

You will also be asked to complete surveys about the quality of your life and your ability to do normal daily activities, called Quality of Life Questionnaires (QOL). Completing the questionnaires should take about 10-15 minutes each.

Your personal physician will be informed about your participation in this clinical study.

If you are assigned to the TAVI group:

The study valve is an experimental valve which means you can only receive the valve if you are part of this study.

Before the TAVI procedure, it will be strongly recommended that you take blood thinning medications, used to prevent your blood from clotting (thickening). These medications will be described to you by your study doctor. You may be advised to continue these medications for at least three months after your procedure.

Before the procedure you will be given an antibiotic (a medicine that kills bacteria or germs) to decrease your chance of developing an infection. Your study doctor will choose the antibiotic that he or she thinks is best suited for you and decide whether you need additional medication.

You will also have blood tests (about 2 tablespoons) and an ECG before the procedure.

Immediately prior to the procedure, you will receive medications to make you more relaxed and comfortable during the procedure. Your study doctor may decide that general anesthesia is necessary, meaning you need to be put to sleep for the procedure. Your doctor will inform you of this need before the procedure. Additionally, if your study doctor decides that it is necessary during the procedure, you will be put under general anesthesia at that time.

Your study doctor will decide what locations are best for inserting the long, thin flexible tubes required for TAVI and getting all of the pictures that are necessary. These pictures are described in the next paragraphs.

During the procedure, one of the pictures that may be needed is a transesophageal echocardiogram which is also called a TEE. This test uses sound waves to take a closer look at the inside structures of the heart. If your doctor decides this picture is necessary, to perform the test you will swallow a thin flexible tube with a special tip. This tube sits in the esophagus (the tube that connects the mouth to the stomach). The special tip of the tube sends out sound waves (ultrasound) that echo within the chest wall. The esophagus is located behind the heart so these echoes are picked up and create a picture of the heart that is displayed on a video monitor. The pictures will allow your study doctor to take a closer look at your valve.

You will have a temporary pacemaker put in your heart during the TAVI procedure. A temporary pacemaker is a thin wire inserted through your skin and into one of your veins and threaded through your vein into the right side of your heart. The wire is attached to a battery operated device outside of your body. This temporary pacemaker will help keep your heart rate (speed) and rhythm steady. This temporary pacemaker will not be removed for at least 48 hours after your TAVI procedure.

After your study doctor has taken a good look at your valve, a balloon valvuloplasty will be performed. Balloon valvuloplasty is a procedure used to widen a stiff or narrowed heart valve. A wire and a thin tube are guided by x-rays through the heart and positioned through the diseased heart valve. A balloon is placed over the wire and inflated, making the opening bigger through the diseased valve allowing the study valve to be placed.

Your doctor will then implant (insert) the study valve through the long, thin flexible tube that is inserted through an incision in the skin and threaded through the bloodstream. TAVI is performed using x-ray machines which will allow your doctor to see the study valve, your blood vessels and heart. The study valve will be guided through your blood vessels and then it will be placed over your existing aortic valve.

During the TAVI procedure, your doctor will perform angiography (x-ray pictures) and ECGs (recordings of the electrical impulses of your heart through patches placed on the chest) to observe your heart function and make sure that the study valve fits and works properly.

Doctors from other hospitals who have experience with the TAVI procedure may assist your study doctor with the procedure. Medtronic staff may assist the physician in the loading of the study valve onto the tube that helps deliver the valve to the heart.

If you are assigned to the SAVR group:

Open heart surgery, surgical repair and/or replacement of your aortic valve, are not experimental procedure; meaning you could have this procedure if you did not take part in this study.

If you are assigned to the SAVR group, your doctors will replace your diseased aortic valve through open heart surgery. During surgery, you are asleep under general anesthesia. SAVR often requires the bone in the center of the chest (sternum) to be split down the middle. The chest is then opened to provide your doctor with access to the heart and chest cavity, in order to replace your aortic valve. Your surgery is performed while the function of your heart is taken over by a heart lung machine (called CPB for cardiopulmonary bypass).

You may have a TEE (a thin tube that sits in the esophagus and sends out sounds waves to create a picture of your heart) and a temporary pacemaker (thin wire threaded through your vein to right side of heart to keep your heart rate and rhythm steady) during the procedure.

Your doctor may remove any tissue and calcium deposits (extra calcium that has collected on the valve) that are interfering with the normal function of the valve. Your damaged valve may be completely removed. The new valve will be sewn into the space where your own valve used to be. After your doctor makes sure your valve is working properly, blood flow will be returned to your heart and the incisions will be closed. You will also have blood drawn for testing before and after the procedure.

If your doctor is unable to implant (insert) the a valve in you during the TAVI or SAVR procedure, you will still be considered enrolled in the study and will need to return to the clinic for the required follow-up visits as described in the "Follow-up Visits after TAVI and SAVR" section.

After TAVI and SAVR Procedure:

After the TAVI and SAVR procedure, your study doctors will continue to monitor your progress and recovery.

You will have the following tests performed within the two days following the procedure and before you are discharged from the hospital:

- Physical exam, including determining your neurological (brain) status where you will be asked to answer a some questions and perform some tasks such as writing and drawing
- Blood tests (about 2 tablespoons) These tests include the following:
 - Complete blood count - counting the amount of white and red blood cells you have
 - Blood chemistry – tests to make sure your liver and kidneys are working as they should as well as make sure other minerals (enzymes) in your blood are normal
 - Creatinine and Creatinine clearance - tests to make sure your kidneys are functioning as they should
 - Cardiac Enzymes (CK/CK-MB) – test to make sure you have no had heart attack or other heart problems
 - International Normalized Ratio – only if you are taking a medicine called coumadin or warfarin. The test shows how fast your blood clots and if your medication dosage is working
 - Activated Partial Thromboplastin Time – test to determine the thickness of your blood
 - B-Type Natriuretic Peptide (BNP) or NT-proBNP – tests that show if your heart is working harder than normal to pump blood through your body
- Echocardiogram (TTE)
- ECG

Follow-up Visits after TAVI and SAVR:

You will need to return to the clinic for required follow-up visits at 30 days, 6 months, 12 months (1 year), 18 months, 24 months (2 years), and 3, 4, and 5 years after the procedure. Most of the follow-up tests and examinations are routine, not experimental. Each visit will take about 1 ½ to 2 hours.

Your evaluations at 30 days, 6 and 18 months will include:

- Physical exam, including determining your neurological (brain) status where you will be asked to answer a some questions and perform some tasks such as writing and drawing
- You will be asked about your health since the last follow-up visit
- Quality of Life Questionnaires
- ECG
- Blood tests (about 2 tablespoons) – 30 day visit only
 - Hemoglobin – test how much of a protein that carries oxygen to your body's organs and tissues and transports carbon dioxide from your organs and tissues back to your lungs you have in your blood
 - Creatinine and Creatinine clearance - tests to make sure your kidneys are functioning as they should
- Walking test – 30 day visit only
- Echocardiogram (TTE) – 6 month visit only

Your evaluation at 12 months, 24 months, and 3, 4, 5 years will include:

- Physical exam, including determining your neurological (brain) status where you will be asked to answer a some questions and perform some tasks such as writing and drawing
- You will be asked about your health since the last clinic visit
- Blood tests (about 2 tablespoons)
- Echocardiogram (TTE)
- Quality of Life Questionnaires
- ECG
- Walking test – 12 and 24 months visits only

In addition to the in-clinic follow-up visits, at 3 months you will be contacted by phone, by someone from your clinic, to complete a Quality of Life Questionnaire.

If, during the 5 years of follow-up you have additional heart surgeries or cath lab procedures to work on or replace your aortic valve or study valve, you will be asked to answer questions and perform activities that will help the study doctors and nurses to determine your neurological (brain) status within 24 hours after each additional procedure.

If you have a stroke, have been informed by a doctor that you experienced a stroke, or experience any of the following symptoms, notify Dr. Principal Investigator at xxx-xxx-xxxx as soon as possible: sudden numbness, tingling, loss of movement (especially on 1 side of the body), vision changes, confusion or trouble understanding simple statements, severe headaches, or seizures. Any of these symptoms could indicate that you are having problems with your neurological (brain) function. If a doctor confirms that you had a stroke, you will be asked to come to the clinical to have tests performed to determine your neurological (brain) status where you will be asked to answer a series of questions and perform a series of tasks. These tests will be performed at 7 days, 30 days and 3 months after you have any of these symptoms.

If you have any other problems or complications, are seen by any other doctors for problems, or are hospitalized during your participation in this study you should immediately notify Dr. Principal Investigator at xxx-xxx-xxxx.

If the study valve is removed for any reason, we will request that it be returned to Medtronic for additional analysis. Your study doctor will determine if you will need to have another valve implanted.

In the event of your death, we would like to do an autopsy. We will ask that either your whole heart and valve or just the valve are removed and returned to Medtronic for additional analysis.

The autopsy and the removal of the heart and/or valve would be done to provide additional information about the research and the study valve.

Your family and your "legally authorized representatives", has the right to refuse the autopsy and refuse the request to remove the heart and/or valve even if you sign this consent form. You may still participate in this study if you do not want to have an autopsy done.

POSSIBLE RISKS AND DISCOMFORTS

TAVI

Potential risks associated with the implantation of the study valve may include, but are not limited to, the following:

- **Death**
- **Cardiac arrest** – heart stops beating and blood flow through the body is interrupted or stopped
- **Coronary occlusion, obstruction, or vessel spasm (including acute coronary closure)** – blockage or closure of an artery that supplies the heart with blood
- **Emergent surgery**
 - Coronary artery bypass – (CABG) a surgery where the chest is opened to place new vessels around the existing blocked vessels of the heart to improve blood supply to the heart.
 - Heart valve replacement – replacing the existing heart valve with a new heart valve
 - Valve explant – the removal of the existing valve
- **Multi-organ failure** – more than one organ of the body not functioning correctly
- **Heart failure** – heart does not pump blood to the body
- **Myocardial infarction** - decreased blood flow to the heart causing death of heart muscle cells
- **Cardiogenic shock** – failure of the heart to pump enough blood to the body organs
- **Respiratory insufficiency or respiratory failure** – not enough oxygen or not able to supply oxygen to the body
- **Cardiovascular injury (including rupture, perforation, or dissection of vessels, ventricle, myocardium, or valvular structures that may require intervention)**
- **Perforation of the myocardium or a vessel** – a hole in the heart muscle or a blood vessel
- **Ascending aorta trauma** – injury to the large blood vessel leading blood away from the heart
- **Cardiac tamponade** – the constriction or inability of the heart to pump due to buildup of blood or fluid around the lining of the heart
- **Cardiac failure or low cardiac output**
- **Prosthetic valve dysfunction including, but not limited to:**
 - Fracture (break) in the valve frame
 - Bending of the valve frame
 - The valve frame does not open (expand) all the way
 - Calcification (build-up of calcium on the valve)
 - Pannus – the formation of scar tissue that may cover or block the valve from functioning normally
 - Wear, tear or movement forward (prolapse) or backward (retraction) from the normal position of the valve leaflets
 - The valve leaflets do not close together
 - A break in the stitches (sutures) of the valve frame or leaflets

- Leakage through or around the valve or valve frame
- Incorrect size of the valve implanted
- Incorrect position of the valve, either too high or too low
- Regurgitation – backward flow of blood through the valve
- Stenosis – narrowing of the opening of the valve
- **Thrombosis/embolus (including valve thrombosis)** - an abnormal particle (air, blood clots) floating in the blood stream or attached to an object, including the valve
- **Valve migration/valve embolization** – upward or downward movement of the device from where it was originally placed
- **Ancillary device embolization** – a broken piece of the tube that delivers the valve floating in the blood stream
- **Emergent percutaneous coronary intervention (PCI)** – a procedure through the vessels inside the body and heart used to treat or open narrowed vessels of the heart
- **Emergent balloon valvuloplasty** (balloon valvuloplasty during the TAVI procedure is expected) – a procedure through the vessels inside the body and heart in which a narrowed heart valve is stretched open by a balloon
- **Bleeding that may or may not require transfusion or intervention**
- **Allergic reaction to:**
 - Antiplatelet agents (blood thinning medication)
 - Contrast medium (dye used to see vessels with x-ray), or
 - Anesthesia (medication used to put you to sleep during the procedure)
- **Infection (including septicemia and endocarditis)** – an abnormal growth of germs in the body or body part
- **Stroke, TIA, or other neurological deficits** – decreased blood flow to the brain causing death of brain cells
- **Permanent disability** – injury that does not allow that impairs normal/previous physical or mental function
- **Renal insufficiency or renal failure (including acute kidney injury)** – failure of the kidneys to work correctly
- **Mitral valve regurgitation or injury** – a leaking valve between the left upper (left atrium) and left lower (left ventricle) parts of the heart where blood flows backward through the valve or damage to the valve that may cause it to not function correctly
- **Tissue erosion** – damage to the tissue of the heart or blood vessels that could result in a tear or hole
- **Vascular access related complications, such as:**
 - Dissection - a tear in a blood vessel
 - Perforation – puncture of a blood vessel
 - Pain
 - Bleeding
 - Hematoma –blood collecting under the skin
 - Pseudoaneurysm - blood collecting on the outside of a vessel wall causing a balloon-like widening
 - Irreversible nerve damage – permanent damage to nerves
 - Compartment syndrome – squeezing of nerves and muscles in a closed space that could cause muscle or nerve damage
 - Arteriovenous fistula – abnormal connection between an artery vessel that takes blood away from the heart and a vein vessel that takes blood to the heart
 - Stenosis – narrowing of a vessel (artery)
- **Cardiac arrhythmias**

- Disturbances in the electrical system of the heart that may result in the permanent placement of a device (pacemaker) that delivers electrical impulses to the heart to help your heart beat normally
- Atrio-ventricular node block – a block in the electrical path from the top part of the heart (atria) to the bottom part of the heart (ventricle)
- Bundle branch block – a delay or block in the electrical path in the bottom part of the heart (ventricle)
- Asystole – when the heart stops beating
- Ventricular arrhythmias – abnormal fast or slow heart beats in the lower part of the heart (ventricles)
- **Encephalopathy** – altered mental state
- **Pulmonary edema** – fluid build-up in or in the space around the lungs
- **Pericardial effusion** – fluid around the heart
- **Pleural effusion** – fluid build-up in the space around the lungs that makes breathing difficult
- **Myocardial ischemia** – reduced or interrupted blood supply to the heart
- **Peripheral ischemia** – reduced or interrupted blood supply to arms and legs
- **Bowel ischemia** – decrease blood supply to the intestines
- **Heart murmur** – an extra or unusual sound hear during a heartbeat
- **Hemolysis** – break down of blood cells
- **Cerebral infarction-asymptomatic** – silent stroke
- **Non-emergent reoperation**
- **Inflammation** – swelling of tissue
- **Fever** – increase in body temperature
- **Hypotension or hypertension** – low or high blood pressure
- **Syncope** – fainting
- **Dyspnea** – shortness of breath
- **Anemia** – not enough oxygen carrying cells in the blood
- **Angina** – chest pain
- **Abnormal lab values (including electrolyte imbalance)** – changes in blood test results
- **Exposure to radiation through fluoroscopy and angiography**
- **Delivery catheter malfunction resulting in need for additional re-crossing of the aortic valve and prolonged procedural time**

There may also be additional risks, discomforts, or side effects that are not yet known.

SAVR

Although SAVR is not experimental there are potential risks associated with this procedure and any surgery. These risks are the same even if you undergo the SAVR procedure and you decide not to participate in this study. Your study doctor will explain these risks to you and you will be asked to sign a separate surgical informed consent.

If you become pregnant there may be risks, discomforts, or side effects to you and the embryo/fetus that are not yet known. Please notify your study doctor as soon as possible to discuss any of these potential risks.

RADIATION EXPOSURE RISKS

Some of the test and procedures that are part of this study require exposure to radiation (x-rays). These tests or treatments involve a small amount of radiation. To give you an idea about how much radiation you will get, in the following descriptions the radiation is compare to the amounts

that people are exposed to in daily life. There is radiation that naturally occurs from space and from rocks in the soil. This natural radiation is greater at higher altitudes.

CT of Chest and Abdomen and Coronary Angiography

The radiation exposure received from the screening tests (CTA of abdomen and thorax and coronary angiogram) is approximately 10 times the radiation exposure received in one year from background radiation (naturally occurring radiation you are exposed to everyday). The exposure is less than the radiation exposure limit an occupational worker is allowed to receive in one year.

Valve implantation

The estimated radiation exposure for the valve procedure is approximately 10-15 times the amount of radiation exposure received in one year from background radiation (naturally occurring radiation you are exposed to everyday). The exposure is approximately the amount an occupational worker is allowed to receive in one year.

There are additional risks or side effects from being exposed to x-rays. Most side effects do not occur often and resolve without major problems. It is possible that skin reddening or other alterations to the skin's appearance may occur if you are exposed to enough radiation during the procedure or if you have recently had another cardiac angiogram. You should contact your doctor in the event that you observe this. If you have a reaction to the x-rays you may need to have extra follow-up visits with your doctor to watch your recovery more closely.

Your doctor will explain to you how many x-rays you will receive, what x-rays are part of your normal care and what, if any, are extra for the study.

POSSIBLE BENEFITS

The possible benefits you may receive from participating in this research are that you may be able to receive a new heart valve without having open-heart surgery.

Your participation in this research may improve procedures that may guide the future treatment of heart surgery, by using procedures that are less invasive, meaning less cutting, entering or breaking through the body, which may benefit others in the future. However, there is no guarantee that you will benefit from being in this research.

ALTERNATIVE TREATMENTS

The current long-term effective treatment for severe aortic stenosis is open heart surgery to replace the aortic valve. For patients who are at high risk for open heart surgery, other treatment options include percutaneous (through an artery in the groin) aortic valve implantation, or medical management to relieve symptoms, which may include balloon valvuloplasty. Ask your study doctor about other treatment options you may have.

IF PROBLEMS DEVELOP

If you believe that you have been injured as a result of your participation in the study, you should notify Dr. Principal Investigator at xxx-xxx-xxxx as soon as possible or in serious cases, go to the emergency room.

Immediate necessary medical care is available at [Name of institution(s)] in the event that you are injured as a result of your participation in this research study

If you are assigned to the TAVI group

For those patients receiving the investigational device and the TAVI procedure,

Medtronic has agreed to pay back [name of institutions that are parties to the CTA] for the costs of reasonable medical or surgical care they provide for any serious and unanticipated illness or injury under the following conditions:

- The illness or injury must be directly related to a defect or malfunction of the investigational device or in the TAVI procedure as described in the Protocol, and not related to procedures that are routine standard of care.
- The illness or injury cannot be caused (a) by the negligence or intentional misconduct of the study staff or [name of institutions that are parties to the CTA]; (b) because the study staff or

[name of institution(s)] that are parties to the CTA] did not follow the protocol for the study; or (c) by the natural progression of your illness.

- The illness or injury must have happened before the study closes (last patient is seen for the 5 year follow-up visit) at this [Name of institution(s)].
- [Name of institution(s) that are parties to the CTA] must notify Medtronic of the illness or injury within one year of the date the study closes at all study sites or before the study closes at this site, whichever is earlier.

Subject to the above conditions, Medtronic will pay back the costs that are not covered by your applicable provincial health insurance or third party insurer. The amount Medtronic will pay back is the applicable provincial health insurance plan rate.

If you are assigned to the SAVR group

In the event of physical injury or physical illness related to a procedure required for the SAVR group, no monetary compensation or subsidy (payment) will be provided. Medical treatment will be routinely provided to you through your regular provincial health insurance plan.

By agreeing to the above, you do not waive any of your legal rights which you otherwise would have as a research subject, nor do you release the study sponsor (Medtronic, Inc.), study doctors, or the hospital from liability for negligence.

PAYMENT FOR PARTICIPATION IN THE STUDY

You will not be paid to take part in the study. However, you may be reimbursed for local mileage and parking expenses directly related to any study-only related visits. Your study doctor or research coordinator will tell you how to get reimbursement.

There is no monetary advantage to the study doctor for participation in this study. Your participation in this study may contribute to the development of commercial products from which Medtronic may receive economic benefit. Medtronic is paying the study site for the work involved in collecting study data and managing the study at this site.

MEDICAL EXPENSES

All necessary medical procedures should be covered by Provincial Health Insurance Plan.

BASIS OF PARTICIPATION

Your participation in this study is voluntary. If you refuse to be in this study there will be no penalty or loss of benefits to which you are otherwise entitled. You may withdraw from the study at any time and will not lose your benefits or be treated any differently as a result of withdrawing from the study. Any new findings (decisions or conclusions) that may influence your willingness to participate will be provided to you. If you decide to leave the study before it is finished, please tell one of the persons listed in the section below "Obtaining Additional Information". It may be requested that, if you withdraw, you return to your study doctor for a final visit.

The study doctor may end your participation in the study at any time if:

- He or she determines it is not in the best interest of your health
- The study doctor loses contact with you and you do not return for your study visits as scheduled
- You refuse to allow the use of private health information during the course of the study

The study doctor will make the decision and let you know if it is not possible for you to continue in the study.

You may be removed from the study without your consent if the sponsor (Medtronic, Inc.) ends the study. If this happens, you will be notified and the reasons will be explained to you. Your physician will continue to provide the appropriate medical care.

What are my responsibilities as a research subject?

As a subject in a research study, it is important that you:

- Be truthful about your health and medication history;
- Return to the office for the study visits that the physician has scheduled with you;
- Call the study doctor's office to reschedule a missed visit as soon as possible;
- Report any injuries, hospitalizations, emergency room visits, symptoms or complaints to the study doctor or nurse as soon as possible.

PERMISSION FOR ACCESS TO AND USE OF HEALTH INFORMATION

While you take part in this research study, the researcher in charge and study staff will collect and take down information about you in a file. Only information necessary for the research study will be collected.

The information in your file could include your past and present medical history, information about your way of life and test results from exams and procedures done during this study. Your file could also contain other information, such as your name, sex, date of birth and ethnic origin.

All the information collected about you during the study will remain confidential as the law demands. To protect your privacy, your information will be identified with numbers and or letters. Only the researcher in charge of the study knows the numbers and or letters that link them to you.

The study researcher will send the research study information collected about you to the sponsor or sponsor representatives. This information does not include your name or address.

The sponsor will use the information collected about you only to reach the study goals as they are explained in this Informed Consent Form.

The information collected about you can be shared by itself, or together with other information collected from other studies with government groups in Canada or in other countries, or with the people that do business with the study's sponsor Medtronic. This means that your study information could be sent to other countries. The sponsor must respect applicable Canadian privacy laws and those in all the countries where your study information will be sent. Your study information will be kept for at least 25 years by the researcher in charge of the study and by the sponsor.

The study information may help the government approve the sale of the study device. The study information may also be used for other reasons related to the study or to help develop future studies.

The study information could be printed in medical journals or shared with other people at scientific meetings, but, it will be impossible to identify you.

To make sure the study is being done properly; your research study file as well as your medical file could be checked by a person authorized by the Research Ethics Board of the [Name of hospital or clinic(s)], or by the institution, by a person authorized by special people or groups (Health Canada) as well as by the sponsor's representatives. These people and groups are obliged to respect your privacy.

For your safety and to be able to reach you quickly, your family name, first name, how to contact you and the date you started and ended the study will be kept for one year after the study ends in a separate list kept by the researcher in charge of the study or by the institution.

You have the right to look at your study file in order to check the information gathered about you and to correct it, if necessary, as long as the study researcher or the institution keeps this information. However, you may only have access to certain information once the study has ended so that the quality of the research study is protected.

Economic Study

This study contains a health economics review that will be done to compare the in-hospital, follow-up medical care resource utilization and cost for patients in each of the treatment groups. You may also be asked to sign a separate document that gives us your permission to review your billing information sent directly from your payer in order to evaluate medical cost data. This information

will be kept strictly confidential and be used solely to assess the medical expenses which occur as a direct result of participating in the Medtronic CoreValve™ SURTAVI Trial.

Quality of Life Questionnaire

Medtronic CoreValve™ SURTAVI Trial will also contain a quality of life study. As part of this study, your research coordinator will have you or your caregiver complete a questionnaire called a Quality of Life Questionnaire. You will need to complete this questionnaire when you are enrolled in the study and 1 month, 3 months, 6 months, 12 months, 18 months, 2 years, 3 years, 4 years and 5 years after your study procedure.

OBTAINING ADDITIONAL INFORMATION

You are encouraged and have the right to ask questions at any time concerning potential and/or known risks of this study. The study doctor will inform you of any new significant information, when it becomes available, which may affect your willingness to continue to participate in this study. If you have any questions about this study or if you experience any health problems, you should contact Dr. Principal Investigator at xxx-xxx-xxxx.

If you have questions about your rights as a participant in this study, you should contact the chairman of the Institutional Review Board at xxx-xxx-xxxx.

MEDTRONIC'S USE AND DISCLOSURE OF YOUR HEALTH INFORMATION

This section describes what Medtronic as study sponsor will do with the study data, including your health information received during the study.

Medtronic will keep your health information confidential in keeping with all applicable laws and regulations. Medtronic may use your health information to conduct this study. Medtronic may use your health information for other purposes, such as:

- Watch over and improve the performance of its device;
- New medical research;
- Proposals for making new medical products or procedures; and
- Other business purposes.

Any reports or publications about the study or any other research will not include your name or a description of you. Any records identifying you will not be made publically available. Information received during the study will not be used to market to you; your name will not be placed on any mailing lists or sold to anyone for marketing purposes.

The United States Food and Drug Administration's (FDA) and Health Canada's regulations, as well as other applicable laws, control Medtronic's work in developing and assuring the safety and quality performance of its medical devices. Medtronic may disclose your health information to the FDA, Health Canada, as well as to other U.S. and foreign government authorities responsible for assuring the safety of medical devices. Medtronic also may disclose your health information to research ethics boards and other persons who are required to watch over the safety and effectiveness of medical products and therapies and the conduct of research. In addition, Medtronic representatives or delegates of Medtronic may inspect/monitor your medical records during the course of the clinical study in order to ensure compliance with the study protocol and study procedures. You agree to allow Medtronic to use study data in these ways. You also agree to allow Health Canada, the FDA and other governmental authorities to inspect your health information.

You may change your mind and take back this permission to use your health information at any time. To take back this permission, you must write to [name and contact information]. If you take back this permission, you cannot continue in the study. Even if you take back this permission, Medtronic and Researchers may continue to use and share the health information already received as described in this Informed consent.

PRIMARY CARE PHYSICIAN / SPECIALIST NOTIFICATION OPTION

Please indicate below whether you would like us to notify your primary care physician or your specialist of your participation in this study.

(Initial only one box).

Yes, I want the study doctor to inform my primary care physician/specialist of my participation in this study

No. I do not want the study doctor to inform my primary care physician/specialist of my participation in this study.

I do not have a primary care physician/specialist.

The study doctor is my primary care physician/specialist.

**INFORMED CONSENT FOR THE MEDTRONIC
SURTAVI TRIAL**

PATIENT INFORMED CONSENT FORM SIGNATURE SHEET

I confirm that:

- I have read the informed consent form of this study and my physician has answered all my questions regarding the study.
- I had sufficient time to consider my participation into this study, I am aware that participation into this study is completely voluntary, and I agree to follow the instructions from the investigator.
- I realize that I may decide to refuse participation or stop participation at any time without penalty and without affecting the quality of my health care or the relationship with my physician.
- I understand and agree that personal information about me will be collected from my medical records, used and processed (manually and by computer) by the manufacturer of a medical device used in my treatment or any other designated party that is involved in the study (e.g. hospital, physician, regulatory authorities, ethics committees).
- I understand and agree that representatives from Medtronic, regulatory authorities and the Institutional Review Board will be granted direct access to my medical records.
- I understand and agree that the physician(s) / hospital will release the relevant personal information about me for the purpose of the clinical investigation.
- I understand that I am entitled to access the personal information collected about me and to have inaccuracies corrected.
- I fully understand there is limited experience with this device in humans and that its safety and effectiveness have not been established and there are risks of serious complications associated with this study.
- I also understand that the doctors might determine after I give consent that it is not possible to implant the study valve.

Signature of the subject or subject's legally authorized representative

I hereby give my consent to participate in the "*Medtronic CoreValve™ SURTAVI Trial*". I have been given a copy of this consent form, and am also aware that the investigator will keep a copy in his or her files.

<hr/> Printed name of subject	
<hr/> Signature of subject	<hr/> Date (must be written in by subject)

Signature of a witness in the event that the subject or subject's legally authorized representative is unable to read or write

<hr/> Printed name of witness (if applicable)	
<hr/> Signature of witness (if applicable)	<hr/> Date (must be written in by witness)

Signature of the principal investigator or authorized designee for conducting the informed consent process

<ul style="list-style-type: none">• I certify that I have explained the nature of the device and the study to the above-named person.• I have also explained the contents of this informed consent form to the above-named person. I have asked whether or not there are any questions. I have answered any questions that were raised by this person. <hr/> Printed name of principal investigator or authorized designee for conducting the informed consent process	
<hr/> Signature of principal investigator or authorized designee	<hr/> Date (must be written in by principal investigator or authorized designee)

R.1.4 Canada – Roll-in Subjects

INFORMED CONSENT FORM

FOR ROLL-IN SUBJECTS

Medtronic CoreValve™ SURTAVI Trial

You are being asked to read this form so that you understand this research study and how you might take part in it. By signing this form, you will show that you understand and that you agree to take part in this research study. Your signature on this form is required before you can take part in this research study.

BACKGROUND

You have been invited to participate in this research project because you have aortic stenosis (a disease of one of your heart valves). Before deciding to participate in the study you should be familiar with its requirements, risks and benefits. This document provides information about the study. It may contain words you do not fully understand. Please read it carefully and ask the study staff any questions you may have. They will discuss the study with you in detail. If you decide to participate, you will be asked to sign this form and a copy will be given to you.

The aortic valve is one of the four heart valves that control the flow of blood into and out of the heart. The aortic valve lets oxygen-containing blood to be pumped out of the heart, from the left ventricle (main pumping chamber of the heart) into the aorta (main artery delivering blood to the body). If the valve becomes abnormally narrow through a process of thickening and stiffening (aortic stenosis) the heart must work harder to pump the same amount of blood with each beat.

As the heart works harder, the heart muscle thickens (hypertrophy), and the heart chamber (ventricle) may become larger (dilate). Open-heart surgery to replace the diseased aortic valve is usually the standard treatment.

As an alternative to open heart surgery, the Medtronic CoreValve™ System has been developed to replace a diseased aortic heart valve without the need for open heart surgery. A description of the study valve is included under the section **Study Device**.

A description of this clinical trial will be available on <http://www.ClinicalTrials.gov>. This website will not include information that can identify you. At most, the website will include a summary of the results. You can search this website at any time.

You are being asked to participate in this study because doctors have determined your aortic valve is no longer working the way it should. However, your doctors have also decided that your risk of experiencing major problems while having open-heart surgery is moderate. This means that you doctor believes your health is good enough for open-heart surgery, but there is still a risk of potential problems.

PURPOSE OF THE STUDY

The purpose of this clinical study is to figure out if replacing the aortic valve without open-heart surgery is as safe as or safer than open-heart surgery in patients with similar medical conditions as you.

The study valve is considered an “investigational device”, which means that Health Canada has not yet approved it to be used for standard of care purposes and is only allowed to be used for the study. Medtronic, Inc. is sponsoring this study to obtain data on the safety and performance of the investigational device. The Medtronic CoreValve™ System includes the valve described below and two parts that help load and deliver the valves correctly.

This study will involve up to 2000 subjects at up to 115 hospitals in the United States, Canada and around the world, and is anticipated to take approximately 8 years to complete. Your participation in this study is expected to last approximately five years from the day you are

enrolled in the study. Annual follow-up may be extended to up to 10 years after the implant procedure.

STUDY DEVICES

The study valve is made from animal tissue attached to a metal frame.

The study valve is designed to be inserted using a long, thin flexible tube (delivery system) to replace your diseased aortic heart valve through an incision in the skin and threaded through the bloodstream (percutaneous) and without open-heart surgery. Once it is implanted, CoreValve™ study valves acts in the same method of the native valve.

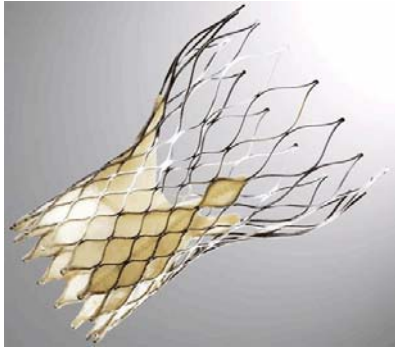

Although the Medtronic CoreValve™ system is not approved by the US Food & Drug Administration (FDA), or Health Canada, it has been approved in other parts of the world since 2006 and has been implanted in over 45,000 patients.

The Medtronic CoreValve™ System is currently approved for use in Europe, South America, and parts of Asia.

PROCEDURES TO BE FOLLOWED

If you agree to be in this study, and after you have signed this informed consent form, information such as your age, gender, medical history and medication use will be recorded. You will have the following tests:

- Physical examination
- Computed tomography (CT) - a scan performed using an x-ray machine that takes pictures of your body. Sometimes a CT will require the use of a type of dye that makes the kidneys work harder and may be harmful to the kidneys. You may have an MRI in place of a CT scan if your doctor believes your kidneys are not working well enough for you to have a CT scan. MRI stands for magnetic resonance imaging and is a test that also takes pictures of your internal organs.
- Blood tests (about 2 tablespoons). These tests include the following:
 - Complete blood count - counting the amount of white and red blood cells you have
 - Blood chemistry – tests to make sure your liver and kidneys are working as they should as well as make sure other minerals (enzymes) in your blood are normal
 - Creatinine and Creatinine clearance - tests to make sure your kidneys are functioning as they should
 - Cardiac Enzymes (CK/CK-MB) – test to make sure you have not had heart attack or other heart problems
 - International Normalized Ratio – only if you are taking a medicine called coumadin or warfarin. The test shows how fast your blood clots and if your medication dosage is working
 - Activated Partial Thromboplastin Time – test to determine the thickness of your blood

- B-Type Natriuretic Peptide (BNP) or NT-proBNP – tests that show if your heart is working harder than normal to pump blood through your body
- Echocardiography (transthoracic echocardiogram (TTE)) - a test that uses sound waves to take pictures of your heart and measure the degree of narrowing of your aortic valve; a probe with gel is placed on the outside of your chest to take pictures of your heart
- Electrocardiogram (ECG) - a test that records electrical impulses of your heart; patches are placed on the outside of your chest
- Heart catheterization/angiography - a test that takes pictures of your heart and blood vessels; a special dye is injected through long, flexible tubes into the coronary arteries (vessels delivering blood to the heart) and bypass grafts if you have them

These procedures and tests are standard procedures required for the treatment of your disease and are not experimental. If you have already had any of these tests performed before, they may be used for the study if your study doctor determines they don't need to be repeated for study purposes.

The results from your exams and tests will be reviewed by your doctor and a committee of study doctors who will determine if you are eligible to be in the study.

Your study doctor and the committee may determine after reviewing your test results that you are not eligible to be in the study and/or it will not be possible to implant the study valve. If so, you will not be allowed to participate in the study.

If your doctor and the committee decide you are eligible to be in the study, you will be one of the first three (3) patients at this hospital to be enrolled in this study. You will receive a transcatheter aortic valve implant (TAVI).

Your enrollment in the study will begin once you sign this consent and you are assigned to the roll-in treatment group. If you are enrolled in the study, you will be required to have the following additional tests (for study purposes only) completed within 14 days prior to the procedure (TAVI):

- Physical exam, including determining your neurological (brain) status where you will be asked to answer a some questions and perform some tasks such as writing and drawing
- Blood tests (about 2 tablespoons) These tests include the following:
 - Complete blood count - counting the amount of white and red blood cells you have
 - Blood chemistry – tests to make sure your liver and kidneys are working as they should as well as make sure other minerals (enzymes) in your blood are normal
 - Creatinine and Creatinine clearance - tests to make sure your kidneys are functioning as they should
 - Cardiac Enzymes (CK/CK-MB) – test to make sure you have no had heart attack or other heart problems
 - International Normalized Ratio – only if you are taking a medicine called coumadin or warfarin. The test shows how fast your blood clots and if your medication dosage is working
 - Activated Partial Thromboplastin Time – test to determine the thickness of your blood
 - B-Type Natriuretic Peptide (BNP) or NT-proBNP – tests that show if your heart is working harder than normal to pump blood through your body
- Walking test – a test that records your breathing, heart rate, and how you feel after 6 minutes of walking
- Electrocardiogram (ECG) - a test that records electrical impulses of your heart; patches are placed on the outside of your chest

You will also be asked to complete surveys about the quality of your life and your ability to do normal daily activities, called Quality of Life Questionnaires (QOL). Completing the questionnaires should take about 10-15 minutes each.

Your personal physician will be informed about your participation in this clinical study.

TAVI PROCEDURE:

The study valve is an experimental valve which means you can only receive the valve if you are part of this study.

Before the TAVI procedure, it will be strongly recommended that you take blood thinning medications, used to prevent your blood from clotting (thickening). These medications will be described to you by your study doctor. You may be advised to continue these medications for at least three months after your procedure.

Before the procedure you will be given an antibiotic (a medicine that kills bacteria or germs) to decrease your chance of developing an infection. Your study doctor will choose the antibiotic that he or she thinks is best suited for you and decide whether you need additional medication.

You will also have blood tests (about 2 tablespoons) and an ECG before the procedure.

Immediately prior to the procedure, you will receive medications to make you more relaxed and comfortable during the procedure. Your study doctor may decide that general anesthesia is necessary, meaning you need to be put to sleep for the procedure. Your doctor will inform you of this need before the procedure. Additionally, if your study doctor decides that it is necessary during the procedure, you will be put under general anesthesia at that time.

Your study doctor will decide what locations are best for inserting the long, thin flexible tubes required for TAVI and getting all of the pictures that are necessary.

During the procedure you may have a transesophageal echocardiogram which is also called a TEE. This test uses sound waves to take a closer look at the inside structures of the heart. To perform the test you will swallow a thin flexible tube with a special tip. This tube sits in the esophagus (the tube that connects the mouth to the stomach). The special tip of the tube sends out sound waves (ultrasound) that echo within the chest wall. The esophagus is located behind the heart so these echoes are picked up and create a picture of the heart that is displayed on a video monitor. The pictures will allow your study doctor to take a closer look at your valve.

You will have a temporary pacemaker put in your heart during the TAVI procedure. A temporary pacemaker is a thin wire inserted through your skin and into one of your veins and threaded through your vein into the right side of your heart. The wire is attached to a battery operated device outside of your body. This temporary pacemaker will help keep your heart rate (speed) and rhythm steady. This temporary pacemaker will not be removed for at least 48 hours after your TAVI procedure.

After your study doctor has taken a good look at your valve, a balloon valvuloplasty will be performed. Balloon valvuloplasty is a procedure used to widen a stiff or narrowed heart valve. A wire and a thin tube are guided by x-rays through the heart and positioned through the diseased heart valve. A balloon is placed over the wire and inflated, making the opening bigger through the diseased valve allowing the study valve to be placed.

Your doctor will then implant (insert) the study valve through the long, thin flexible tube that is inserted through an incision in the skin and threaded through the bloodstream. TAVI is performed using x-ray machines which will allow your doctor to see the study valve, your blood vessels and heart. The study valve will be guided through your blood vessels and then it will be placed over your existing aortic valve.

During the TAVI procedure, your doctor will perform angiography (x-ray pictures) and ECGs (recordings of the electrical impulses of your heart through patches placed on the chest) to observe your heart function and make sure that the study valve fits and works properly.

Doctors from other hospitals who have experience with the TAVI procedure may assist your study doctor with the procedure. Medtronic staff may assist the physician in the loading of the study valve.

AFTER TAVI PROCEDURE:

After the TAVI procedure, your study doctors will continue to monitor your progress and recovery.

You will have the following tests performed within the two days following the procedure and before you are discharged from the hospital:

- Physical exam, including determining your neurological (brain) status where you will be asked to answer a some questions and perform some tasks such as writing and drawing
- Blood tests (about 2 tablespoons) These tests include the following:
 - Complete blood count - counting the amount of white and red blood cells you have
 - Blood chemistry – tests to make sure your liver and kidneys are working as they should as well as make sure other minerals (enzymes) in your blood are normal
 - Creatinine and Creatinine clearance - tests to make sure your kidneys are functioning as they should
 - Cardiac Enzymes (CK/CK-MB) – test to make sure you have no had heart attack or other heart problems
 - International Normalized Ratio – only if you are taking a medicine called coumadin or warfarin. The test shows how fast your blood clots and if your medication dosage is working
 - Activated Partial Thromboplastin Time – test to determine the thickness of your blood
 - B-Type Natriuretic Peptide (BNP) or NT-proBNP – tests that show if your heart is working harder than normal to pump blood through your body
- Echocardiogram (TTE)
- ECG

FOLLOW-UP VISITS AFTER TAVI:

You will need to return to the clinic for required follow-up visits at 30 days, 6 months, 12 months (1 year), 18 months, 24 months (2 years), and 3, 4, and 5 years after the procedure. Most of the follow-up tests and examinations are routine, not experimental. Each visit will take about 1 ½ to 2 hours.

Your evaluations at 30 days, 6 and 18 months will include:

- Physical exam, including determining your neurological (brain) status where you will be asked to answer a some questions and perform some tasks such as writing and drawing
- You will be asked about your health since the last follow-up visit
- Quality of Life Questionnaires
- ECG
- Blood tests (about 2 tablespoons) – 30 day visit only
 - Hemoglobin – test how much of a protein that carries oxygen to your body's organs and tissues and transports carbon dioxide from your organs and tissues back to your lungs you have in your blood
 - Creatinine and Creatinine clearance - tests to make sure your kidneys are functioning as they should
- Walking test – 30 day visit only
- Echocardiogram (TTE) – 6 month visit only

Your evaluation at 12 months, 24 months, and 3, 4, 5 years will include:

- Physical exam, including determining your neurological (brain) status where you will be asked to answer a some questions and perform some tasks such as writing and drawing
- You will be asked about your health since the last clinic visit
- Blood tests (about 2 tablespoons)
- Echocardiogram (TTE)
- Quality of Life Questionnaires
- ECG
- Walking test – 12 and 24 months visits only

In addition to the in-clinic follow-up visits, at 3 months you will be contacted by phone, by someone from your clinic, to complete a Quality of Life Questionnaire.

If, during the 5 years of follow-up, you have had additional heart surgeries or cath lab procedures to work on or replace your aortic valve or study valve, you will be asked to answer questions and perform activities that will help the study doctors and nurses to determine your neurological (brain) status within 24 hours after each additional procedure.

If you have a stroke, have been informed by a doctor that you experienced a stroke, or experience any of the following symptoms, notify Dr. Principal Investigator at xxx-xxx-xxxx as soon as possible: sudden numbness, tingling, loss of movement (especially on 1 side of the body), vision changes, confusion or trouble understanding simple statements, severe headaches, or seizures. Any of these symptoms could indicate that you are having problems with your neurological (brain) function. If a doctor confirms that you had a stroke, you will be asked to come to the clinical to have tests performed to determine your neurological (brain) status where you will be asked to answer a series of questions and perform a series of tasks. These tests will be performed at 7 days, 30 days and 3 months after you have any of these symptoms.

If you have any other problems or complications, are seen by any other doctors for problems, or are hospitalized during your participation in this study you should immediately notify Dr. Principal Investigator at xxx-xxx-xxxx.

If the study valve is removed for any reason, we will request that it be returned to Medtronic for additional analysis. Your study doctor will determine if you will need to have another valve implanted.

In the event of your death, we would like to do an autopsy. We will ask that either your whole heart and valve or just the valve are removed and returned to Medtronic for additional analysis.

The autopsy and the removal of the heart and/or valve would be done to provide additional information about the research and the study valve.

Your family and your "legally authorized representatives", has the right to refuse the autopsy and refuse the request to remove the heart and/or valve even if you sign this consent form. You may still participate in this study if you do not want to have an autopsy done.

POSSIBLE RISKS AND DISCOMFORTS

Potential risks associated with the implantation of the study valve may include, but are not limited to, the following:

- **Death**
- **Cardiac arrest** – heart stops beating and blood flow through the body is interrupted or stopped
- **Coronary occlusion, obstruction, or vessel spasm (including acute coronary closure)** – blockage or closure of an artery that supplies the heart with blood
- **Emergent surgery**
 - Coronary artery bypass – (CABG) a surgery where the chest is opened to place new vessels around the existing blocked vessels of the heart to improve blood supply to the heart.
 - Heart valve replacement – replacing the existing heart valve with a new heart valve
 - Valve explant – the removal of the existing valve
- **Multi-organ failure** – more than one organ of the body not functioning correctly
- **Heart failure** – heart does not pump blood to the body
- **Myocardial infarction** - decreased blood flow to the heart causing death of heart muscle cells
- **Cardiogenic shock** – failure of the heart to pump enough blood to the body organs
- **Respiratory insufficiency or respiratory failure** – not enough oxygen or not able to supply oxygen to the body

- **Cardiovascular injury (including rupture, perforation, or dissection of vessels, ventricle, myocardium, or valvular structures that may require intervention)**
- **Perforation of the myocardium or a vessel** – a hole in the heart muscle or a blood vessel
- **Ascending aorta trauma** – injury to the large blood vessel leading blood away from the heart
- **Cardiac tamponade** – the constriction or inability of the heart to pump due to buildup of blood or fluid around the lining of the heart
- **Cardiac failure or low cardiac output**
- **Prosthetic valve dysfunction including, but not limited to:**
 - Fracture (break) in the valve frame
 - Bending of the valve frame
 - The valve frame does not open (expand) all the way
 - Calcification (build-up of calcium on the valve)
 - Pannus – the formation of scar tissue that may cover or block the valve from functioning normally
 - Wear, tear or movement forward (prolapse) or backward (retraction) from the normal position of the valve leaflets
 - The valve leaflets do not close together
 - A break in the stitches (sutures) of the valve frame or leaflets
 - Leakage through or around the valve or valve frame
 - Incorrect size of the valve implanted
 - Incorrect position of the valve, either too high or too low
 - Regurgitation – backward flow of blood through the valve
 - Stenosis – narrowing of the opening of the valve
- **Thrombosis/embolus (including valve thrombosis)** - an abnormal particle (air, blood clots) floating in the blood stream or attached to an object, including the valve
- **Valve migration/valve embolization** – upward or downward movement of the device from where it was originally placed
- **Ancillary device embolization** – a broken piece of the tube that delivers the valve floating in the blood stream
- **Emergent percutaneous coronary intervention (PCI)** – a procedure through the vessels inside the body and heart used to treat or open narrowed vessels of the heart
- **Emergent balloon valvuloplasty** (balloon valvuloplasty during the TAVI procedure is expected) – a procedure through the vessels inside the body and heart in which a narrowed heart valve is stretched open by a balloon
- **Bleeding that may or may not require transfusion or intervention**
- **Allergic reaction to:**
 - Antiplatelet agents (blood thinning medication)
 - Contrast medium (dye used to see vessels with x-ray), or
 - Anesthesia (medication used to put you to sleep during the procedure)
- **Infection (including septicemia and endocarditis)** – an abnormal growth of germs in the body or body part
- **Stroke, TIA, or other neurological deficits** – decreased blood flow to the brain causing death of brain cells
- **Permanent disability** – injury that does not allow that impairs normal/previous physical or mental function
- **Renal insufficiency or renal failure (including acute kidney injury)** – failure of the kidneys to work correctly

- **Mitral valve regurgitation or injury** – a leaking valve between the left upper (left atrium) and left lower (left ventricle) parts of the heart where blood flows backward through the valve or damage to the valve that may cause it to not function correctly
- **Tissue erosion** – damage to the tissue of the heart or blood vessels that could result in a tear or hole
- **Vascular access related complications, such as:**
 - Dissection - a tear in a blood vessel
 - Perforation – puncture of a blood vessel
 - Pain
 - Bleeding
 - Hematoma –blood collecting under the skin
 - Pseudoaneurysm - blood collecting on the outside of a vessel wall causing a balloon-like widening
 - Irreversible nerve damage – permanent damage to nerves
 - Compartment syndrome – squeezing of nerves and muscles in a closed space that could cause muscle or nerve damage
 - Arteriovenous fistula – abnormal connection between an artery vessel that takes blood away from the heart and a vein vessel that takes blood to the heart
 - Stenosis – narrowing of a vessel (artery)
- **Cardiac arrhythmias**
 - Disturbances in the electrical system of the heart that may result in the permanent placement of a device (pacemaker) that delivers electrical impulses to the heart to help your heart beat normally
 - Atrio-ventricular node block – a block in the electrical path from the top part of the heart (atria) to the bottom part of the heart (ventricle)
 - Bundle branch block – a delay or block in the electrical path in the bottom part of the heart (ventricle)
 - Asystole – when the heart stops beating
 - Ventricular arrhythmias – abnormal fast or slow heart beats in the lower part of the heart (ventricles)
- **Encephalopathy** – altered mental state
- **Pulmonary edema** – fluid build-up in or in the space around the lungs
- **Pericardial effusion** – fluid around the heart
- **Pleural effusion** – fluid build-up in the space around the lungs that makes breathing difficult
- **Myocardial ischemia** – reduced or interrupted blood supply to the heart
- **Peripheral ischemia** – reduced or interrupted blood supply to arms and legs
- **Bowel ischemia** – decrease blood supply to the intestines
- **Heart murmur** – an extra or unusual sound hear during a heartbeat
- **Hemolysis** – break down of blood cells
- **Cerebral infarction-asymptomatic** – silent stroke
- **Non-emergent reoperation**
- **Inflammation** – swelling of tissue
- **Fever** – increase in body temperature
- **Hypotension or hypertension** – low or high blood pressure
- **Syncope** – fainting
- **Dyspnea** – shortness of breath
- **Anemia** – not enough oxygen carrying cells in the blood

- **Angina** – chest pain
- **Abnormal lab values (including electrolyte imbalance)** – changes in blood test results
- **Exposure to radiation through fluoroscopy and angiography**
- **Delivery catheter malfunction resulting in need for additional re-crossing of the aortic valve and prolonged procedural time**

There may also be additional risks, discomforts, or side effects that are not yet known. If you become pregnant there maybe risks, discomforts, or side effects to you and the embryo/fetus that are not yet known. Please notify your study doctor as soon as possible to discuss any of these potential risks.

RADIATION EXPOSURE RISKS

Some of the test and procedures that are part of this study require exposure to radiation (x-rays). These tests or treatments involve a small amount of radiation. To give you an idea about how much radiation you will get, in the following descriptions the radiation is compared to the amounts that people are exposed to in daily life. There is radiation that naturally occurs from space and from rocks in the soil. This natural radiation is greater at higher altitudes.

CT of Chest and Abdomen and Coronary Angiography

The radiation exposure received from the screening tests (CTA of abdomen and thorax and coronary angiogram) is approximately 10 times the radiation exposure received in one year from background radiation (naturally occurring radiation you are exposed to everyday). The exposure is less than the radiation exposure limit an occupational worker is allowed to receive in one year.

Valve implantation

The estimated radiation exposure for the valve procedure is approximately 10-15 times the amount of radiation exposure received in one year from background radiation (naturally occurring radiation you are exposed to everyday). The exposure is approximately the amount an occupational worker is allowed to receive in one year.

There are additional risks or side effects from being exposed to x-rays. Most side effects do not occur often and resolve without major problems. It is possible that skin reddening or other alterations to the skin's appearance may occur if you are exposed to enough radiation during the procedure or if you have recently had another cardiac angiogram. You should contact your doctor in the event that you observe this. If you have a reaction to the x-rays you may need to have extra follow-up visits with your doctor to watch your recovery more closely.

Your doctor will explain to you how many x-rays you will receive, what x-rays are part of your normal care and what, if any, are extra for the study.

POSSIBLE BENEFITS

The possible benefits you may receive from participating in this research are that you may be able to receive a new heart valve without having open-heart surgery.

Your participation in this research may improve procedures that may guide the future treatment of heart surgery, by using procedures that are less invasive, meaning less cutting, entering or breaking through the body, which may benefit others in the future. However, there is no guarantee that you will benefit from being in this research.

ALTERNATIVE TREATMENTS

The current long-term effective treatment for severe aortic stenosis is open heart surgery to replace the aortic valve. For patients who are at high risk for open heart surgery, other treatment options include percutaneous (through an artery in the groin) aortic valve implantation, or medical management to relieve symptoms, which may include balloon valvuloplasty. Ask your study doctor about other treatment options you may have.

IF PROBLEMS DEVELOP

If you believe that you have been injured as a result of your participation in the study, you should notify Dr. Principal Investigator at xxx-xxx-xxxx as soon as possible or in serious cases, go to the emergency room.

Immediate necessary medical care is available at [Name of institution(s)] in the event that you are injured as a result of your participation in this research study.

Medtronic has agreed to pay back [name of institutions that are parties to the CTA] for the costs of reasonable medical or surgical care they provide for any serious and unanticipated illness or injury under the following conditions:

- The illness or injury must be directly related to a defect or malfunction of the investigational device or in the TAVI procedure as described in the Protocol, and not related to procedures that are routine standard of care.
- The illness or injury cannot be caused (a) by the negligence or intentional misconduct of the study staff or [name of institutions that are parties to the CTA]; (b) because the study staff or [name of institution(s)] that are parties to the CTA] did not follow the protocol for the study; or (c) by the natural progression of your illness.
- The illness or injury must have happened before the study closes (last patient is seen for the 5 year follow-up visit) at this [Name of institution(s)].
- [Name of institution(s) that are parties to the CTA] must notify Medtronic of the illness or injury within one year of the date the study closes at all study sites or before the study closes at this site, whichever is earlier.

Subject to the above conditions, Medtronic will pay back the costs that are not covered by your applicable provincial health insurance or third party insurer. The amount Medtronic will pay back is the applicable provincial health insurance plan rate.

PAYMENT FOR PARTICIPATION IN THE STUDY

You will not be paid to take part in the study. However, you may be reimbursed for local mileage and parking expenses directly related to any study-only related visits. Your study doctor or research coordinator will tell you how to get reimbursement.

There is no monetary advantage to the study doctor for participation in this study. Your participation in this study may contribute to the development of commercial products from which Medtronic may receive economic benefit. Medtronic is paying the study site for the work involved in collecting study data and managing the study at this site.

MEDICAL EXPENSES

All necessary medical procedures should be covered by Provincial Health Insurance Plan.

BASIS OF PARTICIPATION

Your participation in this study is voluntary. If you refuse to be in this study there will be no penalty or loss of benefits to which you are otherwise entitled. You may withdraw from the study at any time and will not lose your benefits or be treated any differently as a result of withdrawing from the study. Any new findings (decisions or conclusions) that may influence your willingness to participate will be provided to you. If you decide to leave the study before it is finished, please tell one of the persons listed in the section below "Obtaining Additional Information". It may be requested that, if you withdraw, you return to your study doctor for a final visit.

The study doctor may end your participation in the study at any time if:

- He or she determines it is not in the best interest of your health
- The study doctor loses contact with you and you do not return for your study visits as scheduled
- You refuse to allow the use of private health information during the course of the study

The study doctor will make the decision and let you know if it is not possible for you to continue in the study.

You may be removed from the study without your consent if the sponsor (Medtronic, Inc.) ends the study. If this happens, you will be notified and the reasons will be explained to you. Your physician will continue to provide the appropriate medical care.

What are my responsibilities as a research subject?

As a subject in a research study, it is important that you:

- Be truthful about your health and medication history;
- Return to the office for the study visits that the physician has scheduled with you;
- Call the study doctor's office to reschedule a missed visit as soon as possible;
- Report any injuries, hospitalizations, emergency room visits, symptoms or complaints to the study doctor or nurse as soon as possible.

PERMISSION FOR ACCESS TO AND USE OF HEALTH INFORMATION

While you take part in this research study, the researcher in charge and study staff will collect and take down information about you in a file. Only information necessary for the research study will be collected.

The information in your file could include your past and present medical history, information about your way of life and test results from exams and procedures done during this study. Your file could also contain other information, such as your name, sex, date of birth and ethnic origin.

All the information collected about you during the study will remain confidential as the law demands. To protect your privacy, your information will be identified with numbers and or letters. Only the researcher in charge of the study knows the numbers and or letters that link them to you.

The study researcher will send the research study information collected about you to the sponsor or sponsor representatives. This information does not include your name or address.

The sponsor will use the information collected about you only to reach the study goals as they are explained in this Informed and Consent Form.

The information collected about you can be shared by itself, or together with other information collected from other studies with government groups in Canada or in other countries, or with the people that do business with the study's sponsor Medtronic. This means that your study information could be sent to other countries. The sponsor must respect applicable Canadian privacy laws and those in all the countries where your study information will be sent. Your study information will be kept for at least 25 years by the researcher in charge of the study and by the sponsor.

The study information may help the government approve the sale of the study device. The study information may also be used for other reasons related to the study or to help develop future studies.

The study information could be printed in medical journals or shared with other people at scientific meetings, but, it will be impossible to identify you.

To make sure the study is being done properly; your research study file as well as your medical file could be checked by a person authorized by the Research Ethics Board of the [Name of hospital or clinic(s)], or by the institution, by a person authorized by special people or groups (Health Canada) as well as by the sponsor's representatives. These people and groups are obliged to respect your privacy.

For your safety and to be able to reach you quickly, your family name, first name, how to contact you and the date you started and ended the study will be kept for one year after the study ends in a separate list kept by the researcher in charge of the study or by the institution.

You have the right to look at your study file in order to check the information gathered about you and to correct it, if necessary, as long as the study researcher or the institution keeps this information. However, you may only have access to certain information once the study has ended so that the quality of the research study is protected.

Economic Study

This study contains a health economics review that will be done to compare the in-hospital, follow-up medical care resource utilization and cost for patients in each of the treatment groups. You may also be asked to sign a separate document that gives us your permission to review your billing information sent directly from your payer in order to evaluate medical cost data. This information will be kept strictly confidential and be used solely to assess the medical expenses which occur as a direct result of participating in the Medtronic CoreValve™ SURTA VI Trial.

Quality of Life Questionnaire

Medtronic CoreValve™ SURTA VI Trial will also contain a quality of life study. As part of this study, your research coordinator will have you or your caregiver complete a questionnaire called a Quality of Life Questionnaire. You will need to complete this questionnaire when you are enrolled in the study and 1 month, 3 months, 6 months, 12 months, 18 months, 2 years, 3 years, 4 years and 5 years after your study procedure.

OBTAINING ADDITIONAL INFORMATION

You are encouraged and have the right to ask questions at any time concerning potential and/or known risks of this study. The study doctor will inform you of any new significant information, when it becomes available, which may affect your willingness to continue to participate in this study. If you have any questions about this study or if you experience any health problems, you should contact Dr. **Principal Investigator** at xxx-xxx-xxxx.

If you have questions about your rights as a participant in this study, you should contact the chairman of the Institutional Review Board at xxx-xxx-xxxx.

MEDTRONIC'S USE AND DISCLOSURE OF YOUR HEALTH INFORMATION

This section describes what Medtronic as study sponsor will do with the study data, including your health information received during the study.

Medtronic will keep your health information confidential in keeping with all applicable laws and regulations. Medtronic may use your health information to conduct this study. Medtronic may use your health information for other purposes, such as:

- Watch over and improve the performance of its device;
- New medical research;
- Proposals for making new medical products or procedures; and
- Other business purposes.

Any reports or publications about the study or any other research will not include your name or a description of you. Any records identifying you will not be made publically available. Information received during the study will not be used to market to you; your name will not be placed on any mailing lists or sold to anyone for marketing purposes.

The United States Food and Drug Administration's (FDA) and Health Canada's regulations, as well as other applicable laws, control Medtronic's work in developing and assuring the safety and quality performance of its medical devices. Medtronic may disclose your health information to the FDA, Health Canada, as well as to other U.S. and foreign government authorities responsible for assuring the safety of medical devices. Medtronic also may disclose your health information to research ethics boards and other persons who are required to watch over the safety and effectiveness of medical products and therapies and the conduct of research. In addition, Medtronic representatives or delegates of Medtronic may inspect/monitor your medical records during the course of the clinical study in order to ensure compliance with the study protocol and study procedures. You agree to allow Medtronic to use study data in these ways. You also agree to allow Health Canada, the FDA and other governmental authorities to inspect your health information.

You may change your mind and take back this permission to use your health information at any time. To take back this permission, you must write to [name and contact information]. If you take back this permission, you cannot continue in the study. Even if you take back this permission,

Medtronic and Researchers may continue to use and share the health information already received as described in this Informed consent.

PRIMARY CARE PHYSICIAN / SPECIALIST NOTIFICATION OPTION

Please indicate below whether you would like us to notify your primary care physician or your specialist of your participation in this study.

(Initial only one box).

Yes, I want the study doctor to inform my primary care physician/specialist of my participation in this study

No. I do not want the study doctor to inform my primary care physician/specialist of my participation in this study.

I do not have a primary care physician/specialist.

The study doctor is my primary care physician/specialist.

**INFORMED CONSENT FOR THE MEDTRONIC
SURTAVI TRIAL**

PATIENT INFORMED CONSENT FORM SIGNATURE SHEET

I confirm that:

- I have read the informed consent form of this study and my physician has answered all my questions regarding the study.
- I had sufficient time to consider my participation into this study, I am aware that participation into this study is completely voluntary, and I agree to follow the instructions from the investigator.
- I realize that I may decide to refuse participation or stop participation at any time without penalty and without affecting the quality of my health care or the relationship with my physician.
- I understand and agree that personal information about me will be collected from my medical records, used and processed (manually and by computer) by the manufacturer of a medical device used in my treatment or any other designated party that is involved in the study (e.g. hospital, physician, regulatory authorities, ethics committees).
- I understand and agree that representatives from Medtronic, regulatory authorities and the Institutional Review Board will be granted direct access to my medical records.
- I understand and agree that the physician(s) / hospital will release the relevant personal information about me for the purpose of the clinical investigation.
- I understand that I am entitled to access the personal information collected about me and to have inaccuracies corrected.
- I fully understand there is limited experience with this device in humans and that its safety and effectiveness have not been established and there are risks of serious complications associated with this study.
- I also understand that the doctors might determine after I give consent that it is not possible to implant the study valve.

Signature of the subject or subject's legally authorized representative

I hereby give my consent to participate in the "*Medtronic CoreValve™ SURTAVI Trial*". I have been given a copy of this consent form, and am also aware that the investigator will keep a copy in his or her files.

<hr style="border: none; border-top: 1px solid black; margin-bottom: 5px;"/>	
Printed name of subject	
<hr style="border: none; border-top: 1px solid black; margin-bottom: 5px;"/>	<hr style="border: none; border-top: 1px solid black; margin-bottom: 5px;"/>
Signature of subject	Date (must be written in by subject)

Signature of a witness in the event that the subject or subject's legally authorized representative is unable to read or write

<p>_____</p> <p>Printed name of witness (if applicable)</p>	
<p>_____</p> <p>Signature of witness (if applicable)</p>	<p>_____</p> <p>Date (must be written in by witness)</p>

Signature of the principal investigator or authorized designee for conducting the informed consent process

<ul style="list-style-type: none">• I certify that I have explained the nature of the device and the study to the above-named person.• I have also explained the contents of this informed consent form to the above-named person. I have asked whether or not there are any questions. I have answered any questions that were raised by this person. <p>_____</p> <p>Printed name of principal investigator or authorized designee for conducting the informed consent process</p>	
<p>_____</p> <p>Signature of principal investigator or authorized designee</p>	<p>_____</p> <p>Date (must be written in by principal investigator or authorized designee)</p>

R.2 List of Participating Investigational Centers

The list of participating Investigational Centers will be provided under separate cover.

R.3 Other Institutions

The following institutions/organizations will participate in the Medtronic CoreValve SURTAVI Trial. An updated list of "Other Institutions" will be provided in progress reports and/or upon request.

Clinical Events Committee (CEC) / Data Safety Monitoring Committee (DSMB):

Cardialysis
Westblaak 92
3012 KM Rotterdam
The Netherlands

Explanted Device/Pathology Core Lab:

CVPath Institute, Inc.
19 Firstfield Road
Gaithersburg, MD 20878

Imaging Core Lab:

Mayo Clinic
200 First Street SW
Rochester, MN 55905

InteleGRID™ (imaging sharing network):

Intelemage, LLC
5400 Kennedy Ave
Cincinnati, OH 45213

Interactive Voice/Web Response System (IXRS):

United BioSource Corporation (UBC)
303 2nd Street, Suite 700
7th Floor South Tower
San Francisco, CA 94107

R.4 Additional Records and Reports

No additional records and/or reports, other than those previously described in this investigational plan or required by FDA, will be maintained for this clinical investigation.

R.5 Sample Case Report Forms

Sample Case Report Forms (CRFs) will be provided under separate cover.

R.6 Aortogram Acquisition Guidelines

The purpose of the acquisition guidelines is to increase consistency and effectiveness in reviewing the procedural aortograms.

1. Required aortogram:

- Index Procedure –TAVI

2. Required cine runs:

- Pre-procedure aortogram in a projection with 3 aortic cusps aligned (for comparison of final aortogram with pre-procedure aortogram)
- Final aortogram at least 10 minutes after TAVI implantation in the exact same projection as the pre-procedure aortogram (in order to measure depth of implantation and assess grade of aortic regurgitation)

NOTE: If the apex is not clearly visible in the final projection and in case of adequate renal function, in order to assess grade of AR, perform an additional final aortogram in RAO 30° with visualization of the left ventricle in long axis, including the apex.

3. Guidelines on how final aortogram after deployment of the valve should be performed:

- Use at least 20 ml of contrast, with an injection rate of 20 ml/sec
- Position the pigtail catheter in the upper third part of the frame
- Preferably use non-diluted contrast. 50%-diluted contrast is acceptable in case of renal insufficiency
- Use the angiographic projection with the three aortic cusps aligned in 1 plane:
 - Whenever available this optimal projection can be suggested by baseline MSCT exam
 - Pragmatic approach might be to use a shallow LAO or RAO projection, and adjust in a cranial or caudal position respectively to approach the optimal projection
- Confirm visualization of the left ventricular apex on the final aortogram
- Perform the final aortogram at least 10 minutes after deployment of the investigational TAVI device; include a time indication on the aortogram
- Use marker pigtail or provide the French-size of the pigtail catheter for calibration purpose

4. General imaging and recording procedures:

- Use a fixed table system and biplane x-ray equipment, if available
- Recommended resolution: 1024 x 1024 pixels
- Preferred acquisition speed: 25 frames/second
- One single cine run should have a duration of at least 5 heart beats
- The digital clock should be activated
- The maximum magnification factor should be applied during cine run without losing the image of the entire frame
- There should be no overlap of the frame with other catheters or electrodes
- Foreshortening of the frame should be avoided as much as possible
- Upload all images to InteleGRID (secure electronic system used for transferring images)

5. Core lab analysis:

The procedural aortograms may be analyzed by a core laboratory. Analysis would include:

- Grade of aortic regurgitation
- Depth of implantation

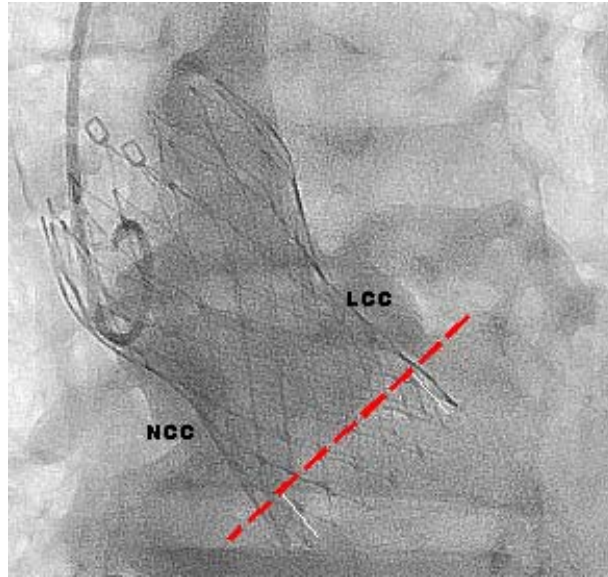

Figure 1: Example of depth of implantation measurement.

R.7 Echocardiography Acquisition Guidelines

1. Scope of the document

These guidelines aim to increase consistency and effectiveness in collection and adjudication of echocardiography data of selected candidates for the SURTAVI trial. Optimal image acquisition, storage, and transmission will be described.

2. Protocol required echocardiograms

Transthoracic echocardiography is required at the following intervals:

Screening	- 45 days of Heart Team review
Post-Procedure OR Discharge	Between 24hrs post-procedure and hospital discharge (but no later than 7 days from post Index Procedure)
6 months	± 30 days
12 months	± 30 days
24 months	± 60 days
3,4,5 years	± 60 days

3. Four general rules for echocardiography recordings

3.1 Rule #1 for overall recordings: adhere STRICTLY to the PROTOCOL regarding:

- **number** and **order** of recordings as listed on the Table
- **do not perform measurements** on the echo recordings, except screening echo to be submitted for screening committee review (see measurements noted in section 4)
- at end of echo exam, export all required recordings in **DICOM** format and upload it to InteGRID
- only one **certified** echocardiographer (+ 1 replacement) is allowed to participate in the study, he/she should print his/her name, fill in contact details and sign the transmittal form

3.2 Rule #2 for Doppler recordings:

- Unless stated otherwise, all pulsed-wave and continuous-wave Doppler signals should be recorded at a **sweep speed of 50-100 mm/sec** (recording must contain minimum of three heartbeats) with optimized gain and filter setting, baseline position, and velocity range.

3.3 Rule #3 for apical 2D views (4-, 5-, 2-, and 3-Chamber views)

- pay attention to ultrasound sector **depth** and **gain** settings
- the aortic valve should be out of scan plane in the 4-CH view
- please avoid patient or transducer **motion** and record during **quite respiration** unless stated otherwise
- make sure the **entire LV myocardium** (including epicardium and apex) is recorded in the scan sector in particular at end-diastole
- make sure **Frame Rate** is more than 30Hz for 2D grey-scale and around 20Hz for colour Doppler aortic regurgitation

3.4 Rule #4 for EF calculation (apical 4-, 2-, and 3-Chamber views focused on LV)

- Record **3 runs** (run 1: 3 beats, run 2: 3 beats, run 3: 10 beats)

4. Data requirements

Participating centers in the SURTAVI study should obtain the appropriate Doppler and echocardiography recordings to document the following variables.

- Aortic annulus long-axis diameter in mid-systole (screening/baseline only)*
- LVOT long axis diameter in mid-systole
- Sinus of Valsalva diameter (SOV) at end diastole (screening/baseline only)*
- Sino-tubular junction diameter (STJ) at end diastole (screening/baseline only)*
- Sinus of Valsalva height (SOVH) at end-diastole (screening/baseline only)*
- Max aortic valve velocity (V2) by CW Doppler
- Velocity time integral (VTI) across aortic valve by CW Doppler
- Mean gradient across aortic valve (MGV2) by CW Doppler*
- Peak LVOT velocity (V1) by PW Doppler
- Velocity Ratio (V1 / V2)
- Velocity time integral (VTI) of LVOT velocity by PW Doppler
- Mean LVOT gradient (MGV1) by PW Doppler
- Doppler Velocity Index (DVI) = VTI_{LVOT} / VTI_{Ao}
- Grade of aortic transvalvular regurgitation
- Grade of aortic paravalvular regurgitation
- Grade of mitral regurgitation
- PISA for MR (optional)
- Max tricuspid regurgitant (TR) jet velocity (if TR is present)
- Left ventricular (LV) end-diastolic diameter (LVEDD)
- Left ventricular (LV) end-systolic diameter (LVESD)
- Interventricular septal thickness at end diastole
- Left ventricular posterior wall thickness at end diastole
- Left atrial diameter (AP linear dimension) at end systole
- Left ventricular ejection fraction by visual estimate
- Heart rate from Doppler signal
- Mitral inflow "A" velocity
- Mitral inflow "E" velocity
- Mitral inflow E-wave deceleration time
- Mitral annular tissue Doppler systolic velocity (septal and lateral)
- Mitral annular tissue Doppler early diastolic velocity (septal and lateral)
- Mitral annular tissue Doppler late diastolic velocity (septal and lateral)

Procedures for acquiring aortic root measurements and key hemodynamic variables are described in the following sections. For Doppler velocities, the values reported should represent the average of measurements from at least three cardiac cycles for patients in sinus rhythm, and the average of measurements from five cardiac cycles for patients not in sinus rhythm. For aortic valve, TR jet, and tissue Doppler velocities, the reported values should represent the average of the highest velocities obtained from the same transducer position.

* Screening/baseline measurements should be noted on the echo submitted for Screening Committee review.

5. Table 1. list of echo recordings (views)

- Please include all LV walls including epicardium are within the scan sector
- Please enter patient's height, weight, and blood pressure during echo acquisition
- Please optimize frame rate of 2D colour Doppler around 20 Hz if possible
- Shift the colour flow zero baseline downwards or upwards in the regurgitant jet direction in the left PLAX view depending on the jet orientation and upwards in the apical view
- Record frozen images & cine loops in the following order:

A: From parasternal long-axis window

1. 2D greyscale standard view
2. 2D Colour Doppler of mitral regurgitation (MR)
3. 2D Colour Doppler of aortic (or prosthetic) regurgitation (AR)
4. If AR is present, **ZOOM** & narrow sector with focus on vena contracta of regurgitant jet
5. If AR is present, **ZOOM** & narrow sector, shift Nyquist 35-40 for PISA measurements
6. 2D greyscale **ZOOM** for LV outflow tract diameter (LVOT) (**3 recordings**)
7. 2D greyscale **ZOOM** at an intercostal space higher for aortic root / aortic prosthesis

B: From parasternal short-axis window (use same depth setting)

8. 2D greyscale LV at mitral valve level
9. 2D greyscale LV at papillary muscle level
10. 2D greyscale-guided M-mode at LV minor axis (LV dimensions, avoid papillary muscles)
11. 2D greyscale LV at apical level: *lower your transducer position by 1 or 2 intercostal spaces and record the LV as circular as possible, just proximal to the level with end-systolic LV luminal obliteration*
12. 2D greyscale aortic valve level (post TAVI the native annulus is usually identified by maximal calcification)
13. 2D greyscale-guided M-mode of left atrial & aortic dimensions
14. 2D Colour Doppler of AR: *in post-TAVI start scanning from highest position and record first visible AR jet, scan more downwards and try to pick up additional jets – confirm origin of AR jets from PLAX*
15. 2D greyscale **ZOOM** & focussed on RV outflow tract (RVOT) – pulmonic valve should be visible
16. 2D Colour Doppler of pulmonary regurgitation (PR)
17. If PR is present, CWD of PR jet (include both systolic & diastolic signals)
18. PWD of RVOT velocity (within 0.5 -1cm below the pulmonic valve) (frozen image)

C: From special parasternal long-axis window (RV inflow)

19. 2D Colour Doppler of tricuspid regurgitation (TR)
20. If TR is present, CWD of TR jet (frozen image)

D: From the apical 4-Chamber window

21. 2D greyscale standard view
22. 2D Colour Doppler of MR
23. If MR is present, ZOOM & narrow sector, shift Nyquist 35-40 for PISA measurements
24. If MR is present, CWD of MR jet (frozen image)
25. 2D Colour Doppler of TR
26. If TR is present, CWD of TR jet (frozen image)

27. PWD of transmitral flow at mitral valve tips – at a sweep speed of 50-100 mm/s (frozen image)
28. Tissue Doppler of the septal mitral annulus – (frozen image)
29. Tissue Doppler of the lateral mitral annulus – (frozen image)
30. Tissue Doppler of RV free wall (frozen image)
31. M-mode tricuspid annular plane systolic excursion (TAPSE) – (frozen image)
32. 2D greyscale focussed on LV with decreased depth – three recordings: 3 beats, 3 beats, 10 beats)

E: Apical 5-chamber window

33. 2D greyscale standard view
34. 2D Colour Doppler of AR
35. If AR is present, ZOOM & narrow sector, shift Nyquist 35-40 for PISA measurements
36. If AR is present, CWD of AR jet (frozen image)
37. CWD of aortic forward flow (frozen image)
38. PWD LVOT in native aortic valve: within 0.5 - 1cm below native aortic valve
39. PWD LVOT in Core Valve, two recordings: immediately below and inside the inflow region of the stent

F: Apical 2-Chamber window

40. 2D greyscale standard view
41. 2D greyscale focussed on LV with decreased depth – three recordings: 3 beats, 3 beats, 10 beats)

G: Apical 3-chamber window

42. 2D greyscale standard view
43. 2D Colour Doppler of MR
44. If MR is present, use ZOOM & narrow sector – shift Nyquist 35-40 for PISA measurements
45. If MR is present, CWD of MR jet (frozen image)
46. 2D Colour Doppler of AR
47. If AR is present, CWD of AR jet (frozen image)
48. If AR is present, use ZOOM & narrow sector– shift Nyquist 35-40 for PISA measurements
49. CWD of aortic forward flow (frozen image)
50. PWD LVOT in native aortic valve: within 0.5 - 1cm below native aortic valve
51. PWD LVOT in Core Valve, two recordings: immediately below and inside the inflow region of the stent
52. 2D greyscale focussed on LV with decreased depth – three recordings: 3 beats, 3 beats, 10 beats)

H: special recordings

53. Suprasternal PWD of descending aorta diastolic flow (frozen image)
54. Subcostal PWD of abdominal aortic diastolic flow (frozen image)
55. CWD right parasternal aortic forward flow (frozen image)
56. 2D greyscale inferior vena cava – **sniff test for changes in IVC diameter**
57. Optional – biplane imaging at LVOT long-axis for measurement of LVOT area in SAX
58. Optional – 3D full volume acquisition of parasternal long-axis view focus LVOT and aortic root
59. Optional – 3D apical full volume acquisition (single beat or 7 beats)
60. Optional – 3D Colour Doppler from apical view – region of interest aortic valve for AR

6. Detailed instructions for acquisition of SURTAVI echocardiography recordings

6.1 Quality control of the investigational site (initial site validation)

- The 1st subject with an echo examination submitted will be reviewed to assess the quality of the recording and the transmission and most importantly the ADHERENCE to the PROTOCOL.
- A "Core Laboratory Pre-Analysis" Report will be provided to the site

6.2 Guidelines for study object confidentiality

- **NO patients' information should be present** on the echocardiogram.
- Site-Patient identification: study subjects are to be identified by a specific study identification number as supplied by the sponsor.
- The following items should be entered in the patient identification section of ultrasound system and should be clearly shown on all digital cine loops or still frames.
 - Site-subject ID (XXXXX-YYYY)
 - date of exam and
 - study interval
- To ensure adherence to the USA HIPAA (Health Insurance Portability and Accountability Act of 1996) guidelines for study subject confidentiality, no study subject names or other Protected Health Information (date of birth, hospital record number, etc.) should be displayed.

6.3 Submission

- Upload all study echocardiograms to InteleGRID (secure electronic system used for transferring images)

6.4 Further inquiries:

- For any questions, contact your monitor or Medtronic Clinical Research Specialist

7. Technical guidelines: how to optimize the echocardiography images

7.1 General recording recommendations

- Ensure ultrasound machines are maintained as instructed by the manufacture
- Ensure calibration of distance, velocity and time on each image
- Keep persistence and smoothing off

7.2 ECG gating

- All cine-loops and still frames must clearly display a single lead electrocardiographic recording in which P-, QRS-, and T-waves (but in particular the R wave) are clearly identifiable

7.3 Number of recorded heart cycles

- In sinus rhythm, record three continuous beats for all cine-loops and still frames, unless indicated otherwise.
- In the presence of irregular/non-sinus rhythm, record 5-10 continuous beats.
- Try to exclude premature beats.

7.4 Effects of respiration and timing of recordings

- During all recordings, respiration should be quiet.
- Tissue Doppler measurements should be recorded after non-forced end-expiration

7.5 Two-dimensional echocardiography general settings

- Use harmonic-imaging mode with maximized (mechanical index >1) power output
- Gain (and time-gain compensation (TGC)) settings should be adjusted to eliminate background noise and to allow for a clear blood-tissue border.
- An optimal gain setting consists of a left ventricular cavity with minimal (but not completely absent) noise
- The greyscale / dynamic range should be adjusted to provide an image with marked contrast between light and dark areas
- The focus point should be set at the middle of the region of interest
- Depth settings should be minimized (do not display structures outside the region of interest)

7.6 (Tissue) Doppler settings

- Use a display speed of 50 to 100 mm/sec and a sample volume length of 3-4 mm (in extremely low heart rates use a speed of 150 mm/sec).
- For mitral E-wave deceleration, time one recording is needed at a sweep speed of 150 mm/s
- Adjust gain, filter settings, position and velocity range to maximize the velocity excursion
- Minimize the angle between the direction of motion of the investigated structure or flow and the Doppler beam
- Transmitral flow should be assessed at the tips of the mitral valve
- Annotate the tissue Doppler recordings

7.7 Colour Doppler settings

- Minimize the colour sector and use a velocity range of approximately ± 60 cm/sec

7.8 Parasternal long-axis view

- Minimize the angle between the left ventricle and aorta (the inferolateral wall should be as perpendicular as possible to the transducer) the anteroseptal wall is visualized at the same distance from the transducer as the anterior wall of the ascending aorta

7.9 Apical two and four-chamber view

- The left ventricular apex should be visible in the top of the sector
- The aortic valve should be out of the image plane
- Maximize the internal long-axis of the left ventricle (avoid foreshortening) by looking for a window one intercostal space lower (in particular when the left ventricle does not appear ellipsoid)

- To ensure that the proper rotation has been made for a two-chamber view, the transducer is angled posteriorly to intersect both papillary muscles symmetrically. Then the transducer is angled slightly anteriorly so that neither papillary muscle is seen in its long axis in this view

7.10 Special considerations for aortic regurgitation by colour flow imaging¹⁻³

In addition to the abovementioned recommendations:

- Standardize the machine settings for all examinations. Keep the Frame Rate around 20 Hz when recording colour Doppler aortic regurgitation
- Colour gain should be set step by step just below the appearance of colour noise artefacts
- For Vena contracta: use a parasternal long-axis view in ZOOM mode with minimal colour sector size and imaging depth to maximize lateral and temporal resolution
- For PISA: Shift the colour flow zero baseline downwards or upwards in the regurgitant jet direction in the left PLAX view depending on the jet orientation and upwards in the apical view)

7.10 Subcostal window

In order to provide optimal image acquisition from subcostal window, the following steps are required:

- The knee-flexed position relaxes the upper abdominal muscles and thereby improves visualization
- From the subcostal four-chamber view, anti-clockwise rotation of the transducer permits visualization and pulsed Doppler examination of the upper abdominal aorta

8. Measurements of aortic root geometry⁴

The following measurements of the aortic root are obtained from the parasternal long-axis view (screening/baseline exams only):

- **Aortic annulus long axis diameter.** The aortic annulus long axis diameter is measured perpendicular to the long axis of the root, measured between the endothelial point that trisects the posterior aortic wall, non-coronary cusp hinge and anterior mitral leaflet hinge (posterior hinge point), and the point that bisects the septal endocardium and the right coronary cusp hinge (anterior hinge point). Measurements should be made at mid-systole and inclusive of cusp calcifications (Figure 1). To accurately incorporate cusp calcification for aortic annulus sizing, measure from the white-black interfaces of the posterior and anterior aortic cusp hinge points and add 2 mm to the measurement.
- **Sinus of Valsalva diameter (SoV).** The SoV diameter is perpendicular to the long axis of the root and typically parallel to the aortic valve annulus. It is the widest intra-luminal distance within the sinuses (measured at end-diastole from inner edge to inner edge, Figure 2, A).
- **Sino-tubular junction diameter (STJ).** The STJ diameter is the intra-luminal diameter parallel to the SoV diameter, where the sinuses narrow and join the ascending aorta (measured at end-diastole from inner edge to inner edge, Figure 2, B).
- **Sinus of Valsalva height (SoVH).** The SoVH is the distance between the STJ and the aortic annulus long-annulus diameter (measured at end-diastole, Figure 3).

Note: *Measurements should be noted on images submitted for Screening Committee review*

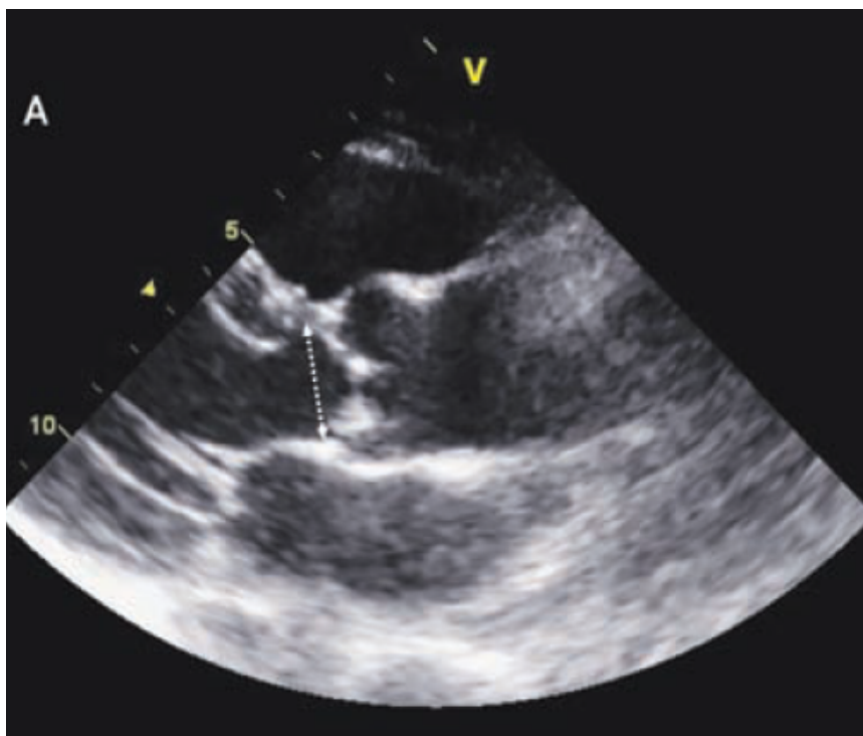

Figure 1. Examples of measurement of the aortic annulus long axis diameter

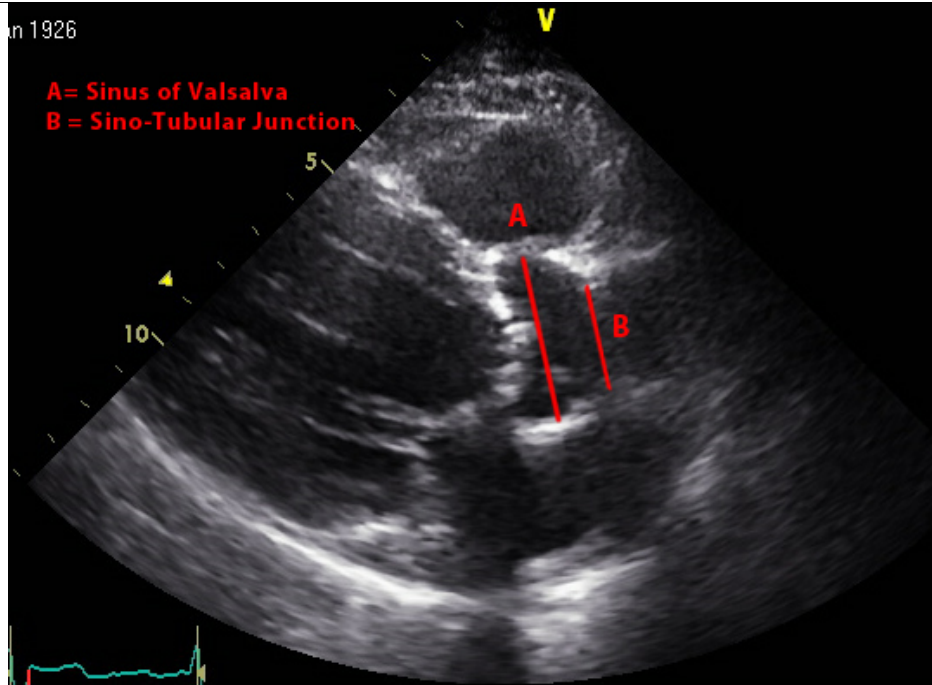

Figure 2. Example of measurement of the Sinus of Valsalva (A) and Sino-Tubular Junction (B) diameters

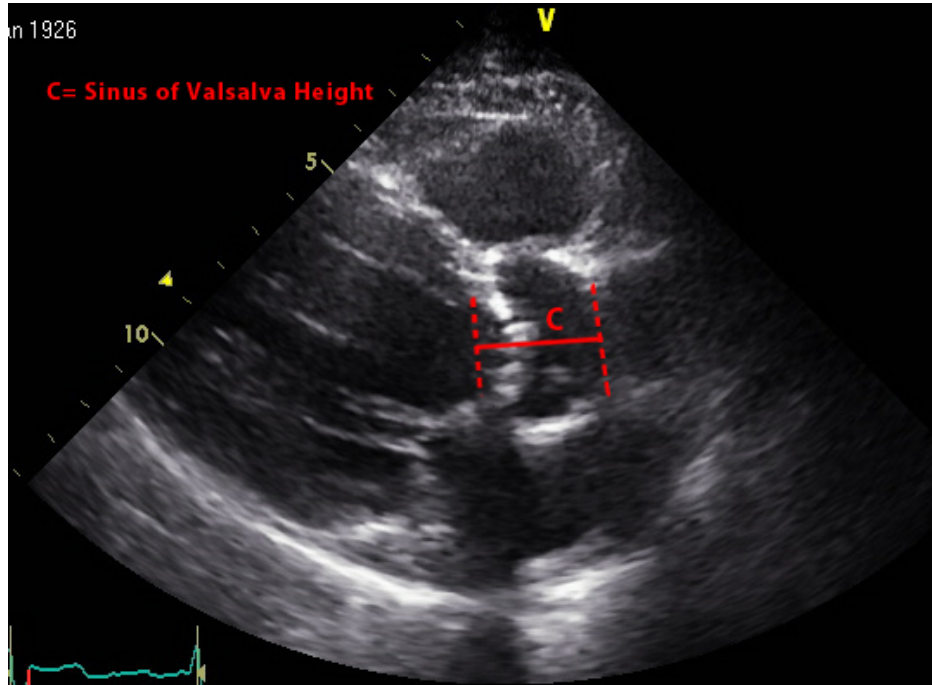

Figure 3. Example of measurement of the Sinus of Valsalva Height (C)

9. Measurement of Left Ventricular Outflow Tract (LVOT) Diameter

The LVOT long axis diameter is measured in the parasternal long-axis view at early to mid systole. The optimal imaging plane is through the long axis of the aorta; therefore, the anterior and posterior walls of the aortic root should be parallel with the maximal aortic diameter.

For native aortic valves, the LVOT long axis diameter is measured from the white-black interface of the septal endocardium to the anterior mitral leaflet, parallel to the aortic valve plane and within 0.5 cm - 1 cm of the valve orifice (Figure 4)¹. Following implantation of the CoreValve device, the LVOT diameters and the LVOT area are measured immediately proximal to the inflow aspect of the stent (Figure 5).

Note: For optimal results, LVOT diameter is averaged from 3 measurements from 3 consecutive high quality 2D ZOOM views.

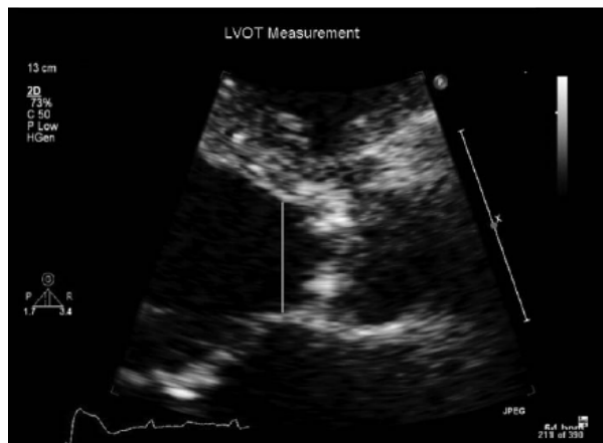

Figure 4. TTE mid-systolic frame showing measurement of LVOT diameter for derivation of native aortic valve area.

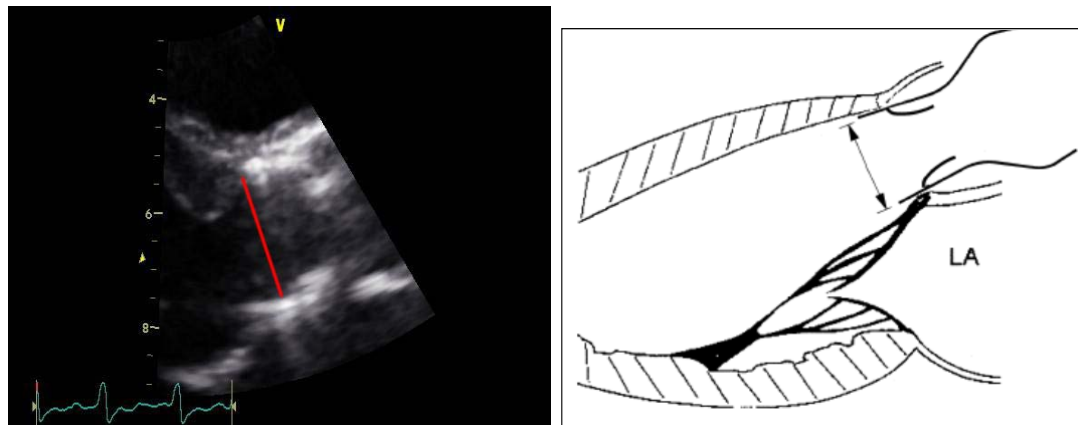

Figure 5. Cursor placement for measurement of LVOT diameter for derivation of prosthetic effective orifice area

10. Measurement of LVOT Velocity⁵

LVOT velocity is recorded with PW Doppler from the apical transducer position, either in the apical long-axis view or in the anteriorly angulated four-chamber view or “five-chamber view.” The PW sample volume is positioned just proximal to the aortic valve, with care to avoid the zone of pre-valve acceleration. The recommended procedure is to initially place the sample volume within the aortic valve leaflets (prosthetic or native), and then gradually move it apically until a clear spectral waveform is observed with a well-defined peak and minimal spectral broadening (Figure 6). No opening click should be seen. The optimal sample volume placement is usually between 0.5 and 1.0 cm upstream from the valve annulus.² Post implantation, the sample volume should be placed at the entrance of the inlet of the TAV prosthesis.

11. Measurement of Aortic Valve Velocity⁵

The aortic valve velocity and VTI should be interrogated with CW Doppler from all transducer positions (apical, right parasternal, suprasternal notch, left supraclavicular, subcostal). The position that provides the highest velocity is used for measurements. A smooth velocity curve with a clear outer edge and maximal velocity should be recorded. The maximal velocity is measured at the outer edge of the dark signal; fine linear signals at the peak should not be included in measurements. The outer edge of the dark “envelope” of the velocity curve is traced to provide both the VTI for the continuity equation and the mean gradient (Figure 7).¹

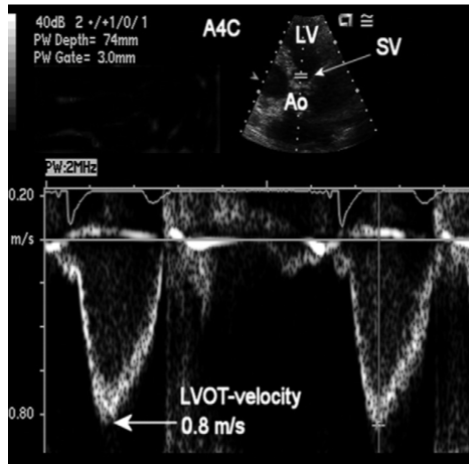

Figure 6. An optimal LVOT signal shows a smooth velocity curve with a narrow velocity range at each time point.

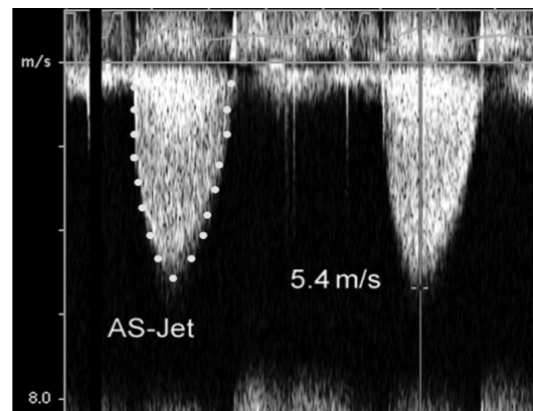

Figure 7. CW Doppler of severe AS jet showing measurement of maximal velocity and tracing of the Velocity curve to calculate mean gradient.

Note: Velocity tracings should be noted on images submitted for Screening Committee review

Note: Fine linear signals at peak velocity should not be included in the velocity tracings!

12. Assessment of Aortic Regurgitation^{6,7}

- **Use all echo modalities:** An integrated exam approach using colour flow, pulsed-wave (PW), and continuous-wave (CW) Doppler is used to assess the severity of transvalvular and paravalvular regurgitation.
- **Use four views:** Colour flow Doppler imaging should be performed from the parasternal long and short-axis views, and the apical long-axis and apical 5-chamber views. A recording of the aortic regurgitant signal should be obtained with CW Doppler. If the degree of aortic regurgitation appears more than mild by visual estimate, the velocity in the proximal descending aorta and the abdominal aorta should be recorded with PW Doppler.
- **Severity:** The degree of transvalvular and paravalvular AR will be graded as none, trace, mild, moderate, and severe based on the analysis of the parameters shown in Table 2a.^{3,4}
 - The category of “trace” is used in cases where regurgitation is barely detectable by colour Doppler.
 - Regurgitant signals observed to originate within the stent will be considered transvalvular, and regurgitant signals observed to originate outside the stent will be considered paravalvular.
- Paravalvular regurgitant jets will be characterized by the extent of the aortic regurgitant jet relative to the short axis circumference of the aortic valve (Table 2a- Valve Academic Research Consortium (VARC) Consensus Report for Transcatheter Aortic Valve Implantation (TAVI) and Table 2b. Updated standardized endpoint definitions for transcatheter aortic valve implantation: the VARC-2 consensus document, and Table 3a and b -2008 Focused Update Incorporated Into the ACC/AHA 2006 Guidelines for the Management of Patients With Valvular Heart Disease (published in the October 2008 issues of Journal of the American College of Cardiology and Circulation).

Table 2a. Parameters for evaluation of the severity of aortic regurgitation^{1, 6, 8}

Prosthetic Aortic Valve Regurgitation Criteria (Central and Paravalvular)			
Parameter	Mild	Moderate	Severe
Valve Structure and Motion Mechanical or bioprosthesis	Usually normal	Usually abnormal†	Usually abnormal†
Structural parameters Left ventricular size	Normal ‡	Normal/ mildly dilated ‡	Dilated
Doppler parameters (qualitative or semi quantitative) Jet width in central jets (% LVO diameter): colour* Jet density: CW Doppler Jet deceleration rate (PHT [†] , ms): CW Doppler** LV outflow vs. pulmonary flow: PW Doppler Diastolic: flow reversal in the descending aorta PW Doppler Circumferential extent of paraprosthetic AR (%)	Narrow (≤25%) Incomplete or faint Slow (>500) Slightly increased Absent or brief early diastolic <10	Intermediate (26-64%) Dense Variable (200-500) Intermediate Intermediate 10-20	Large (≥65%) Dense Steep (<200) Greatly Increased Prominent, Holodiastolic >20
Doppler parameters (quantitative) Regurgitant volume (mL/beat) Regurgitant fraction (%)	<30 <30	30-59 30-50	>60 >50

* Parameter applicable to central jets and is less accurate in eccentric jets

** Influenced by left ventricular compliance

AR=aortic regurgitation; CW= continuous wave; LVO= left ventricular outflow; PW= pulsed wave

† PHT is shortened with increasing LV diastolic pressure and vasodilator therapy, and may be lengthened in chronic adaptation to severe aortic regurgitation. As such, PH, in contrast to the other parameters, does not reflect the volumetric severity of aortic regurgitation, but rather its hemodynamic impact. Therefore, in the setting of acute paravalvular or transvalvular leaks, intermediate values between 200 and 500 ms should not be used to classify the degree of regurgitation.

‡ Abnormal mechanical valves, for example, immobile occluder (valvular regurgitation), dehiscence or rocking (paravalvular regurgitation); abnormal biologic valves, for example, leaflet thickening or prolapse (valvular), dehiscence or rocking (paravalvular regurgitation).

‡ Applies to chronic, late postoperative AR in the absence of other etiologies.

Table 2b. VARC-2 criteria for evaluation of the prosthetic valve dysfunction

Prosthetic valve dysfunction			
Prosthetic aortic valve stenosis*			
	Normal	Mild Stenosis	Moderate/Severe Stenosis
Quantitative Parameters (Flow-dependent)†			
Peak velocity	<3 m/s	3-4 m/s	>4 m/s
Mean gradient	<20 mmHg	20-40 mmHg	>40 mmHg
Quantitative Parameters (Flow-independent)			
Doppler velocity index‡	>0.35	0.35-0.25	<0.25
Effective orifice area¶	>1.1 cm ²	1.1-0.8 cm ²	<0.8 cm ²
Effective orifice area§	>0.9 cm ²	0.9-0.6 cm ²	<0.6 cm ²
Prosthesis-patient mismatch (PPM)			
	Insignificant	Moderate	Severe
Indexed effective orifice area**	>0.85 cm ² /m ²	0.85-0.65 cm ² /m ²	<0.65 cm ² /m ²
Indexed effective orifice area††	>0.70 cm ² /m ²	0.70-0.60 cm ² /m ²	<0.60 cm ² /m ²
Prosthetic aortic valve regurgitation			
	Mild	Moderate	Severe
Semi-quantitative Parameters			
Diastolic flow reversal in the descending aorta—PW	Absent or brief early diastolic	Intermediate	Prominent, holodiastolic
Circumferential extent of prosthetic valve paravalvular regurgitation (%)¶¶	<10%	10-29%	≥30%
Quantitative Parameters‡			
Regurgitant volume (ml/beat)	<30 ml	30-59 ml	≥60 ml
Regurgitant fraction (%)	<30%	30-49%	≥50%
EROA (cm ²)	<0.10 cm ²	0.10-0.29 cm ²	≥0.30 cm ²

*In conditions of normal or near normal stroke volume (50–70 mL)

†These parameters are more affected by flow, including concomitant aortic regurgitation

‡For LVOT >2.5 cm, significant stenosis criteria is <0.20

¶Use in setting of BSA ≥1.6 cm² (note: dependent on the size of the valve and the size of the native annulus)

§Use in setting of BSA <1.6 cm²

**Use in setting of BMI <30 kg/cm²

††Use in setting of BMI ≥30 kg/cm²

¶¶Not well-validated and may overestimate severity compared to quantitative Doppler

From the publication entitled "Updated standardized endpoint definitions for transcatheter aortic valve implantation: the valve academic research consortium-2 consensus document. Kappetein AP, et al. J Am Coll Cardiol. 2012 Oct 9;60(15):1438-54."

Table 3a. Parameters for evaluation of the severity of aortic regurgitation

Classification of the Severity of Valve Disease in Adults with Aortic Regurgitation			
	Mild	Moderate	Severe
Qualitative			
Angiographic grade Color Doppler jet width Doppler vena contracta width (cm)	1+ Central jet, width less 25% of LVOT Less than 0.3	2+ Greater than mild but no signs of AR 0.3-0.6	3-4+ Central jet, width greater than 65% LVOT Greater than 0.6
Quantitative (cath or echo)			
Regurgitant volume (mL per beat) Regurgitant fraction (%) Regurgitant orifice area (cm ²)	< 30 < 30 < 0.10	30-59 30-49 0.10-0.29	≥ 60 ≥ 50 ≥ 0.30
Additional essential criteria			
Left ventricular size			Increased

13. Assessment of Mitral Regurgitation^{2, 8}

Colour flow Doppler imaging of the left atrium should be performed from the parasternal long-axis view, and from the apical four, two, and long axis views. Mitral regurgitant signals should be recorded with CW Doppler using a velocity scale that allows assessment of the density, shape, duration, and peak velocity of the mitral regurgitant signal. If the severity appears moderate or greater by visual assessment, pulmonary vein velocities should be recorded with PW Doppler to assess for the presence of systolic flow reversal. Grading of the severity of mitral regurgitation should be integrative using the parameters in Table 3b.⁴

Table 3b. Classification of the Severity of Valve Disease in Adults Mitral Regurgitation

Classification of the Severity of Valve Disease in Adults Mitral Regurgitation			
	Mild	Moderate	Severe
Qualitative			
Angiographic grade Colour Doppler jet area Doppler vena contracta width (cm)	1+ Small, central jet, < 4cm ² or <20% LA area)	2+ Signs of > mild present but no criteria for severe MR 0.3-0.69	3-4+ Vena contracta with > 0.7cm with large central MR jet (area >40% of LA area) or with a wall- impinging jet of any size, swirling in LA ≥ 0.70
Quantitative (cath or echo)			
Regurgitant volume (mL per beat) Regurgitant fraction (%) Regurgitant orifice area (cm ²)	< 30 < 30 < 0.20	30-59 30-49 0.29 – 0.39	≥ 60 ≥ 50 ≥ 0.40
Additional essential criteria			
Left atrial size Left ventricular size			Enlarged Enlarged

14. Assessment of Left Ventricular Function and Left Atrial Size⁹

M-mode recordings of the left ventricle and left atrium should be obtained using 2-D guided beam alignment (Figures 7 and 8). Left ventricular chamber dimensions and wall thicknesses will be measured from 2D parasternal long axis views and should be utilized preferentially if M-mode images are suboptimal. Chamber dimensions are measured using the American Society of Echocardiography (ASE) measurement convention.⁵ In addition, standard 2-D views of the left ventricle should be obtained from parasternal and apical transducer positions for visual estimation and quantitative assessment of left ventricular ejection fraction by visual estimate.

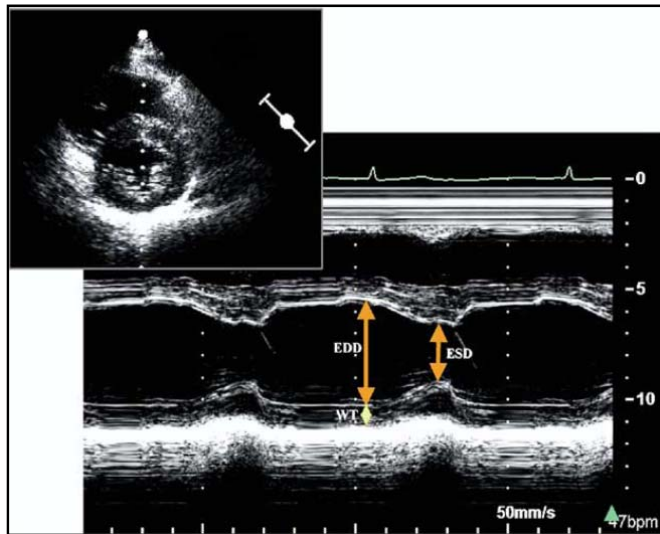

Figure 7. Measurement of left ventricular end-diastolic diameter (EDD) and end-systolic (ESD) from 2-D guided m-mode to optimize medial-lateral beam orientation.

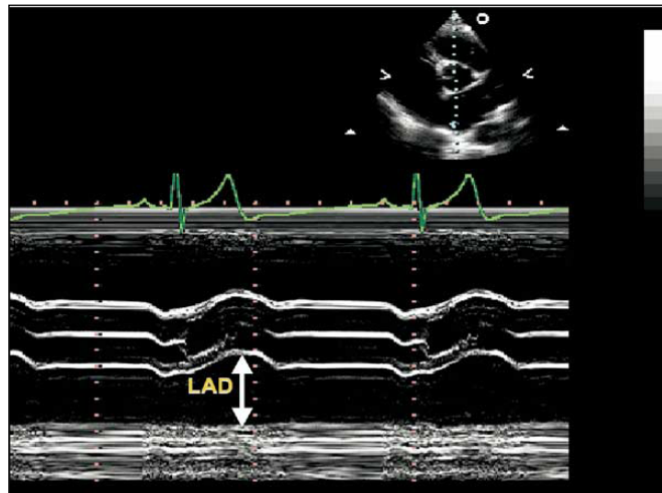

Figure 8. Measurement of left atrial diameter (LAD) by 2-D guided m-mode at end-systole.

15. Acquisition of Mitral Inflow Velocities

A spectral Doppler recording of mitral inflow velocities should be obtained with PW Doppler in the apical 4-chamber view, using a 1 to 3 mm sample volume placed between the mitral leaflet tips during diastole (Figure 9). The spectral gain and wall filter settings should be optimized to clearly display the onset and cessation of left ventricular inflow.⁶

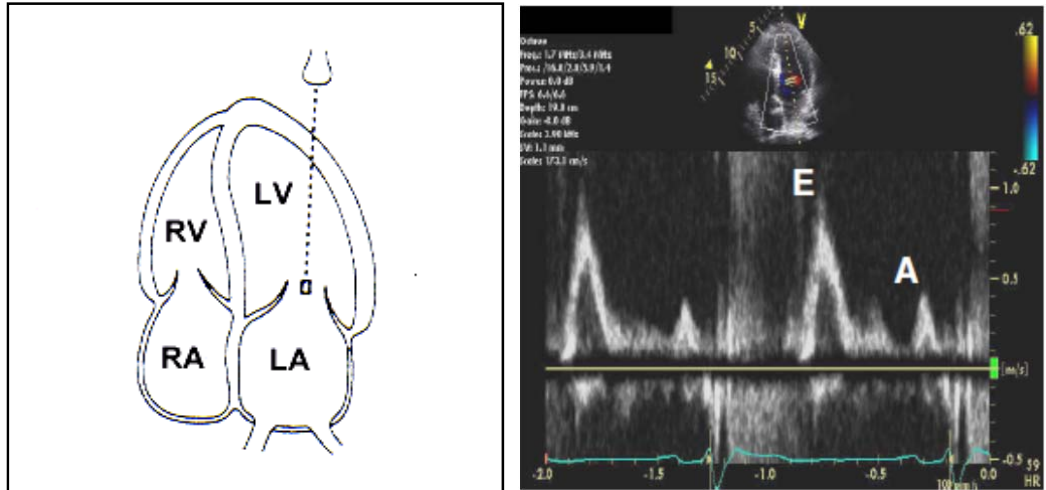

Figure 9. Positioning of the sample volume for recording of mitral inflow velocities.

16. Acquisition of Mitral Annular Tissue Doppler Velocities

Mitral annular velocities should be obtained from the lateral and septal aspects of the mitral annulus using PW tissue Doppler performed in the apical 4-chamber view. The sample volume should be positioned at or 1 cm within the septal and lateral insertion sites of the mitral leaflets and adjusted as necessary (usually 5 to 10 mm) to cover the longitudinal excursion of the mitral annulus in both systole and diastole. Minimal angulations (<20 degrees) should be present between the ultrasound beam and the plane of cardiac motion.⁶ The Doppler gain should be minimized to prevent “blooming” of the signal to facilitate accurate measurement of the annular velocities.

17. Assessment of Device Migration

CoreValve device placement site and migration will be assessed from the parasternal long axis view at each follow up point and compared to the initial post-procedural echo. A zoomed image of the left ventricular outflow tract including the anterior mitral leaflet and the anterior aortic wall should be included at each follow up echo. The location of the device will be determined by measurement of the distance from the proximal edge of the left ventricular outflow tract anteriorly, to the edge of the CoreValve device (Figure 10). Optimal placement of the valve should be within the left ventricular outflow tract just below the aortic annulus (Figure 11).

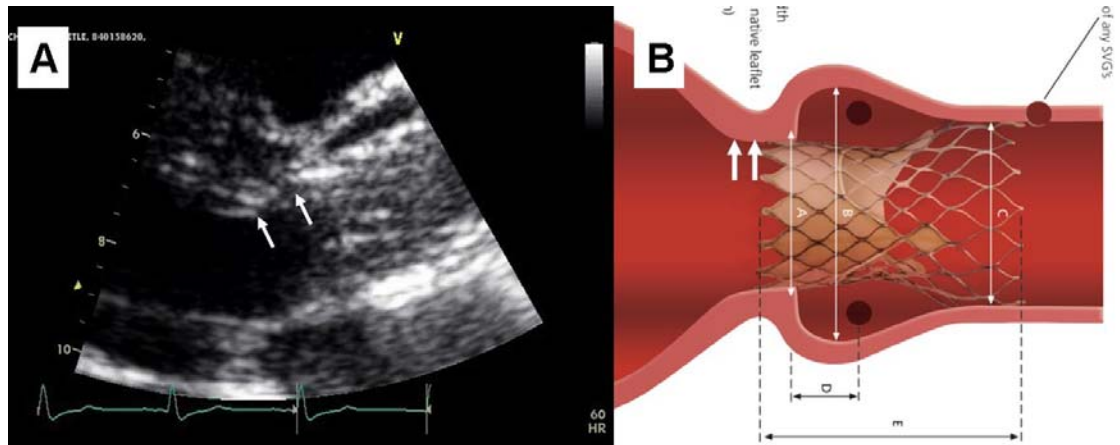

Figure 10. Zoomed view of the left ventricular outflow tract (panel A) and schematic (panel B). Measurement of the distance from the proximal edge of the anterior aspect of the left ventricular outflow tract to the edge of the CoreValve device (arrows).

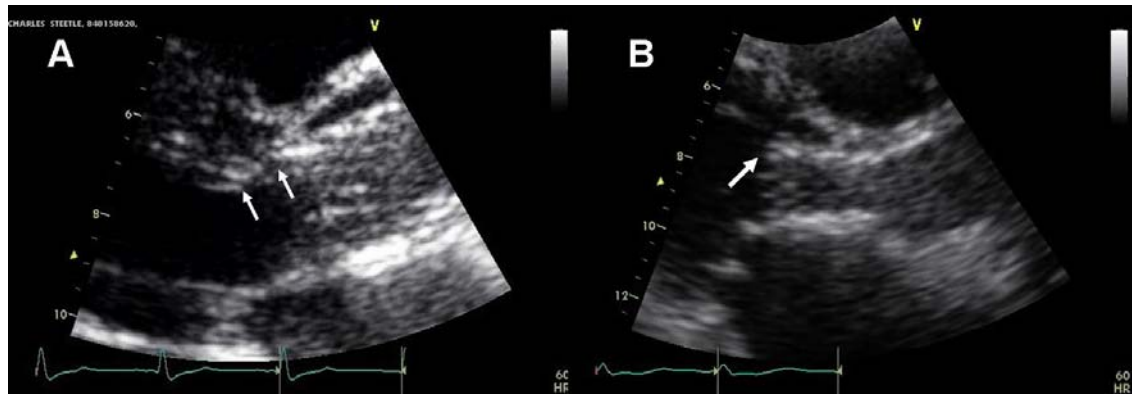

Figure 11. Zoomed view of the left ventricular outflow tract. Panel A. Optimal device placement of the CoreValve device within the left ventricular outflow tract with the proximal edge of the device just below the aortic annulus. Panel B. Low placement of the CoreValve device extends beyond the left ventricular outflow tract into the left ventricular chamber, encroaching on anterior mitral valve leaflet.

18. Echo Core Lab Analysis^{5,7}

Data generated by the Echo Core Lab will be the primary data used for analysis and reporting. Qualitative assessment of valvular regurgitation will be performed using the criteria previously described in sections 8 and 9 of this Appendix. The Echo Core Lab will report the following variables:

- Aortic annulus long-axis diameter in mid-systole (screening/baseline only)
- LVOT long axis diameter in mid-systole
- Sinus of Valsalva diameter (SOV) at end diastole (screening/baseline only)
- Sino-tubular junction diameter (STJ) at end diastole (screening/baseline only)
- Sinus of Valsalva height (SOVH) at end-diastole (screening/baseline only)
- Device location and migration
- Max aortic valve velocity (V2) by CW Doppler
- Velocity time integral (VTI) across aortic valve by CW Doppler
- Mean gradient across aortic valve (MGV2) by CW Doppler
- Peak LVOT velocity (V1) by PW Doppler
- Velocity Ratio (V1 / V2)
- Velocity time integral (VTI) of LVOT velocity by PW Doppler
- Mean LVOT gradient (MGV1) by PW Doppler
- Doppler Velocity Index (DVI)
- Grade of aortic transvalvular regurgitation
- Grade of aortic paravalvular regurgitation
- Grade of mitral regurgitation
- ERO for MR (if available)
- Max tricuspid regurgitant (TR) jet velocity (if TR is present)
- Left ventricular (LV) end-diastolic diameter (LVEDD)
- Left ventricular (LV) end-systolic diameter (LVESD)
- Interventricular septal thickness at end diastole
- Left ventricular posterior wall thickness at end diastole
- Left atrial diameter (AP linear dimension) at systole
- Left ventricular ejection fraction by visual estimate
- Heart rate
- Mitral inflow "A" velocity
- Mitral inflow "E" velocity
- Mitral inflow deceleration time
- Mitral annular tissue Doppler systolic (s) velocity (septal and lateral)
- Mitral annular tissue Doppler early diastolic (e') velocity (septal and lateral)
- Mitral annular tissue Doppler late diastolic (a') velocity (septal and lateral)

In addition, the following variables will be derived by the central database from the appropriate measurements reported by the Echo Core Lab⁵:

- **Mean Transvalvular Gradient (Mean ΔP) Across the Prosthetic Valve in mmHg**
 $Mean \Delta P = MG_{V_2} - MG_{V_1}$
 Where: MG_{V_2} is the mean pressure gradient across the prosthesis in mmHg, and MG_{V_1} is the mean pressure gradient from the left ventricular outflow tract in mmHg
- **Peak Pressure Gradient (Peak ΔP) Across the Aortic Prosthetic Valve in mmHg**
 $Peak \Delta P = 4 \times (V_2^2 - V_1^2)$
 Where: V_2 is the peak velocity across the prosthesis in m/sec, and V_1 is the peak velocity from the left ventricular outflow tract in m/sec
- **Effective Orifice Area (EOA) in cm^2**
 $EOA = LVOT \text{ Long Axis diameter}^2 \times 0.785 \times (VTI_{V_1}/VTI_{V_2})$
 Where: VTI_{V_1} is the velocity time integral of the left ventricular outflow tract in cm, and VTI_{V_2} is the velocity time integral of the aortic prosthesis in cm. Alternatively, using velocity instead of VTI for simplification:
 $AVA = \pi(\text{radius of LVOT})^2 \times V_{LVOT}/V_{max}$
 Where V_{max} is the maximum flow velocity across aortic valve, V_{LVOT} is the maximum velocity across the LVOT.
- **Effective Orifice Area Index (EOAI) in cm^2/m^2**
 $EOAI = EOA/BSA$
 Where: EOA is the effective orifice area in cm^2 , and BSA is the body surface area in m^2
- **Doppler Velocity Index = Velocity Time Integral Ratio (VTI Ratio)**
 $DVI = VTI \text{ Ratio} = VTI_{V_1}/VTI_{V_2}$
 Where: VTI_{V_1} is the velocity time integral of the left ventricular outflow tract in cm, and VTI_{V_2} is the time velocity integral of the prosthetic aortic valve in cm
- **Stroke Volume (SV) in ml/beat**
 $SV = LVOT \text{ long axis diameter}^2 \times 0.785 \times VTI_{V_1}$
 Where: VTI_{V_1} is the velocity time integral from the left ventricular outflow tract in cm
- **Cardiac Output (CO) in l/min**
 $CO = (SV \times HR)/1000$
 Where: SV is the stroke volume in ml/beat, and HR is the heart rate in beats per minute
- **Left Ventricular Mass (LVM) in grams**
 $LVM = 0.83 \times [(LVEDD + LVPW + IVS)^3 - (LVEDD)^3] + 0.6$
 Where: LVEDD is the left ventricular end-diastolic diameter in cm, LVPW is the left ventricular posterior wall thickness at end diastole in cm, and IVS is the interventricular wall thickness at end diastole in cm.
- **Left Ventricular Mass Index (LVMI) in g/m^2 body surface area**
 $LVMI = LVM/BSA$
 Where: LVM is left ventricular mass in g, and BSA is body surface area in m^2
- **Fractional Shortening (FS) in %**
 $FS = [(LVEDD - LVESD)/LVEDD] \times 100$
 Where: LVEDD is left ventricular end-diastolic diameter in cm, and LVESD is left ventricular end-systolic diameter in cm
- **Estimated Right Ventricular Systolic Pressure (RVSP) in mmHg**
 $RVSP = (4 \times MV_{TR \text{ jet}}^2) + 10$
 Where: $MV_{TR \text{ jet}}$ is the max velocity of the tricuspid regurgitant jet, and 10 = the assumed mean right atrial pressure in mmHg

- **Aortic Regurgitant volume (ml/beat) and fraction (%)**

The regurgitant volume across the aortic valve may be calculated as the difference between the LVOT volume and the transmitral volume, assuming there is no significant mitral regurgitation

$RV = \text{Total stroke volume} - \text{forward stroke volume}$

$RV = SV_{AV} - SV_{MV}$

$RF = [RV/SV] \times 100$

$SV_{AV} = 0.785 \times (LVOT)^2 \times VTI_{LVOT}$ (by Pulsed-wave Doppler)

$SV_{MV} = 0.785 \times (D_{MV})^2 \times VTI_{MV}$ (by Pulsed-wave Doppler)

Where: SV is stroke volume in mL, AV is aortic valve and MV is mitral valve

- **Regurgitant Orifice Area (EROA)**

The regurgitant orifice area or EROA represents the average size of the defect in the aortic valve during diastole and is proportional to regurgitant severity.

The regurgitant orifice area may be calculated as the regurgitant volume multiplied by the VTI of the continuous wave Doppler jet

$EROA_{AV} = RV / VTI_{AR_{jet}}$ (by Continuous-wave Doppler)

19. Echocardiography References

1. Zoghbi WA, Chambers JB, Dumesnil JG, Foster E, Gottdiener JS, Grayburn PA, Khandheria BK, Levine RA, Marx GR, Miller FA, Jr., Nakatani S, Quinones MA, Rakowski H, Rodriguez LL, Swaminathan M, Waggoner AD, Weissman NJ, Zabalgoitia M. Recommendations for evaluation of prosthetic valves with echocardiography and doppler ultrasound: A report from the american society of echocardiography's guidelines and standards committee and the task force on prosthetic valves, developed in conjunction with the american college of cardiology cardiovascular imaging committee, cardiac imaging committee of the american heart association, the european association of echocardiography, a registered branch of the european society of cardiology, the japanese society of echocardiography, and canadian society of echocardiography. *J Am Soc Echocardiogr.* 2009;22:975-1014; quiz 1082-1014.
2. Lancellotti P, Moura L, Pierard LA, Agricola E, Popescu BA, Tribouilloy C, Hagendorff A, Monin JL, Badano L, Zamorano JL. European association of echocardiography recommendations for the assessment of valvular regurgitation. Part 2: Mitral and tricuspid regurgitation (native valve disease). *Eur J Echocardiogr.* 2010;11:307-332.
3. Lancellotti P, Tribouilloy C, Hagendorff A, Moura L, Popescu BA, Agricola E, Monin JL, Pierard LA, Badano L, Zamorano JL. European association of echocardiography recommendations for the assessment of valvular regurgitation. Part 1: Aortic and pulmonary regurgitation (native valve disease). *Eur J Echocardiogr.* 2010;11:223-244.
4. Evangelista A, Flachskampf FA, Erbel R, Antonini-Canterin F, Vlachopoulos C, Rocchi G, Sicari R, Nihoyannopoulos P, Zamorano J, Pepi M, Breithardt OA, Plonska-Gosciniak E. Echocardiography in aortic diseases: Eae recommendations for clinical practice. *Eur J Echocardiogr.* 2010;11:645-658.
5. Baumgartner H, Hung J, Bermejo J, Chambers JB, Evangelista A, Griffin BP, Jung B, Otto CM, Pellikka PA, Quinones M. Echocardiographic assessment of valve stenosis: Eae/ase recommendations for clinical practice. *J Am Soc Echocardiogr.* 2009;22:1-23; quiz 101-102.
6. Zoghbi WA. New recommendations for evaluation of prosthetic valves with echocardiography and doppler ultrasound. *Methodist Debaquey Cardiovasc J.* 2010;6:20-26.
7. Chambers J, Shah PM. Recommendations for the echocardiographic assessment of replacement heart valves. *J Heart Valve Dis.* 1995;4:9-13.
8. Leon MB, Piazza N, Nikolsky E, Blackstone EH, Cutlip DE, Kappetein AP, Krucoff MW, Mack M, Mehran R, Miller C, Morel MA, Petersen J, Popma JJ, Takkenberg JJ, Vahanian A, van Es GA, Vranckx P, Webb JG, Windecker S, Serruys PW. Standardized endpoint definitions for transcatheter aortic valve implantation clinical trials: A consensus report from the valve academic research consortium. *Eur Heart J.* 2011;32:205-217.
9. Lang RM, Bierig M, Devereux RB, Flachskampf FA, Foster E, Pellikka PA, Picard MH, Roman MJ, Seward J, Shanewise JS, Solomon SD, Spencer KT, Sutton MS, Stewart WJ. Recommendations for chamber quantification: A report from the american society of echocardiography's guidelines and standards committee and the chamber quantification writing group, developed in conjunction with the european association of echocardiography, a branch of the european society of cardiology. *J Am Soc Echocardiogr.* 2005;18:1440-1463.
10. Updated standardized endpoint definitions for transcatheter aortic valve implantation: the valve academic research consortium-2 consensus document. Kappetein AP, Head SJ, Génèreux P, Piazza N, van Mieghem NM, Blackstone EH, Brott TG, Cohen DJ, Cutlip DE, van Es GA, Hahn RT, Kirtane AJ, Krucoff MW, Kodali S, Mack MJ, Mehran R, Rodés-Cabau J, Vranckx P, Webb JG, Windecker S, Serruys PW, Leon MB. *J Am Coll Cardiol.* 2012 Oct 9;60(15):1438-54. doi: 10.1016/j.jacc.2012.09.001"

R.8 Electrocardiogram (ECG) Submission

The standard 12 lead ECG will be utilized as a diagnostic and prognostic tool in patients participating in this study.

Acquisition:

1. Standard 12-lead ECGs must be obtained (with the exception of implant procedure)
2. ECG should be conducted with the subject at rest
3. ECGs should be provided on a single page printout (i.e. lead strips are not acceptable) using standard amplification of 1mV/cm and paper speed of 25mm/sec (50mm/sec is strongly discouraged)
4. Visible lead annotation
5. More than 1 normal beat per lead. No average ECGs
6. ECG without Pace-Maker beats is preferred

Labeling:

7. Protect subject confidentiality. Effectively block out any subject confidential information recorded on the ECG
8. ECG labels are to be placed on top of the tracing, being careful not to obstruct any of the lead recordings
9. Labels with Study name will be provided by Medtronic and shall be filled out completely, including
 - a) Site number
 - b) Subject identification number
 - c) ECG date and time
 - d) Applicable visit/interval (i.e. screening, Discharge)
10. Incomplete labeling will result in the generation of a data clarification query and untimely interpretation of the tracing

Submission:

11. Original ECGs are strongly encouraged but high quality photocopies with good visible gridline are accepted
12. Submission of all ECGs within appropriate timeframe is imperative
13. Upload all ECGs to InteleGRID (secure electronic system used for transferring images)

R.9 Computed Tomography (CT) Angiography Acquisition Guidelines

Background

Cardiac Multislice Computed Tomographic Angiography (Cardiac MSCT Angiography) is intended to evaluate aortic valve anatomy, aortic root dimensions for device sizing, and assessment of peripheral vessel dimensions and anatomy. This appendix is meant as a guideline to help with the proper acquisition of the images necessary for assessment of the above mentioned items. The primary objective should be to acquire the highest resolution images and perform the correct measurements, as specified below, by tailoring the acquisition to your particular hardware and experience.

Equipment Requirements

- Multi-detector CT scanner (64-slice minimum) with ECG-gating capability
 - The scans acquired and submitted for analysis of the aortic root MUST be ECG-gated
 - Non-gated scans in areas with cardiac motion lead to measurement inaccuracy and therefore incomplete information for device selection
 - Peripheral vessel image acquisition may be non-gated
- Ability to electronically transfer the imaging data via secure network (InteleGRID)

Scans Acquired

- Chest Topogram
- ECG-gated contrast enhanced aortic root*
- Non ECG-gated contrast enhanced peripheral vessels*

*Sub-millimeter slice thickness is required

Scanning Procedures

The scan protocol is similar to a CT coronary angiogram. The aim is to get adequate contrast in the region of interest which includes: endo-luminal surface for visualization of left heart, aorta, and peripheral access vessels (i.e., femorals and subclavians, when necessary). Temporal resolution should be optimized to reduce motion artifact. Spatial resolution should be as high as possible (goal is smallest isotropic voxel size).

Step 1: Patient preparation

- Administer medication per institution standard practice for CT scanning (suggest avoid sublingual nitrate, avoid or caution with B-blockers)
- Attach ECG electrodes for gating of scan (suggest: avoiding large respiratory muscles as these may introduce ECG-artifact). Verify quality and stability of ECG tracing on scanner console during an inspiratory breath hold
- Prepare large intravenous line (i.e., 18 or 20 gauge) for administration of contrast media
- Instruct patient to lie still during scan, even if they experience warmth or tingling due to the injection of contrast
- Instruct patient in practice breath-hold at end-inspiration for 10-15 seconds (duration required will depend on specific scanner performance). Assess heart rate variability during breath-hold. If heart rate is >65 bpm or unstable, consider cautious titration of beta-blockers

Step 2: Chest Topogram

- Acquire a chest topogram for use in planning the following imaging protocol



Figure CTA-1: Example image of chest topogram

Step 3: ECG-gated contrast enhanced scan of aortic root

The aim of this scan is to assess the aortic root and valve anatomy. Ensure the required scan parameters are used; these are listed below in Table 1. The following parameters are crucial to the optimum required scan:

- The recommended coverage area is from superior to the aortic arch to inferior to the cardiac apex. The minimum required coverage area is from 50mm above the aortic annulus to the inferior border of the heart. Coverage less than this will not allow for proper assessment of the patients anatomic suitability
- The scan requires dynamic 4D acquisition using retrospective ECG-gating
- The required detector collimation is 0.4-0.625mm
- The required slice thickness is $\leq 0.8\text{mm}$
- The recommended slice overlap is 0.4mm

Contrast Enhanced Scan Execution

- Prepare iodinated contrast injection apparatus (recommendations in scan parameters are provided in Table 1)
- Set up scan parameters per the table below
- Instruct patient to lie still during scan, even if they experience warmth or tingling due to the injection of contrast
- Initiate contrast injection
- When contrast reaches threshold at bolus-tracking location, instruct patient to hold breath at end-inspiration, then initiate main scan protocol
- At completion of scan verify scan is of adequate quality
- Record amount of contrast given. Note: this is not on the CRF, but is recommended in this patient population
- Record heart rate average and range. Note: this is not on the CRF, but is recommended for explanation of image quality issues

Post-processing

- Verify heart rate ECG triggers are at consistent place in cardiac cycle, edit if necessary. Additional editing/removal of arrhythmias may be performed
- Reconstruct at multiple phases (10 increments of 10%), with ≤ 0.8 mm slice thickness. If the system has the capability, also reconstruct a “best systolic” and “best diastolic” phase. If image quality of the aortic root is not good in the end systolic phase the phase with the best image quality may be selected instead

Table 1. Recommended Scan Parameters

	Recommended Parameters
IV injection with iodine contrast	80-100 (320mg/ml or higher), modify per patient as appropriate
Injection rate	4-6 mL/sec
Bolus tracking, delay	Delay time calculated using protocol for current scanner (bolus tracking or similar) with peak of contrast concentration in the ascending aorta during acquisition. Bolus tracking is the preferred method.
ECG Leads	Required
ECG-gating	Retrospective (Prospective may be used in centers with much experience of the technique and in patients with stable heart rate)
Scan direction	Cranial-caudal
Scan coverage	From above the aortic arch to past the cardiac apex
Detector collimation	0.4 – 0.625 mm
Pitch	0.2–0.43 adapted to the heart rate
Dose modulation	Modulation and full current between 30 and 80% of the cardiac cycle (or no modulation i.e. full dose throughout)
Slice thickness	0.8mm
Slice overlap	0.4mm
Reconstruction kernel	Medium Smooth
Post-processing	Use single segmental reconstruction algorithm that minimizes motion artifact. Reconstruct at multiple phases (10 minimum, 20 preferred, increments of 5-10%). Reconstructed slice thickness 0.75-1mm.

Step 4: Non ECG-gated contrast enhanced scan of vessels

The aim of this scan is to assess the peripheral access vessels and abdominal aorta for suitability for the procedure.

- Standard radiology CT angiography protocol should be used.
- Can be non ECG-gated
- Contrast Volume: 40-50 cc, Injection rate: 4 cc/sec. Modify per patient as necessary to acquire good quality images
- Delay time calculated using protocol for current scanner (bolus tracking, etc) with peak of contrast concentration in the abdominal aorta and iliac arteries
- Suggested coverage areas:
 - Femoral access only screening: abdominal aorta above celiac artery and down to the femoral head. Use this option there if you are confident that femoral access will be suitable for this patient
 - Subclavian access only screening: above the subclavian arteries and down to mid-thorax. Use this option if prior information (i.e., CT scan) exists which demonstrates that femoral access will not be possible in this patient
 - Combined access screening: above the subclavian arteries and down to the femoral head. This is the recommended option. An additional option for subclavian screening is to include the subclavian vessels in the ECG-gated portion and use femoral only screening for the rest of the vessels
- Source data reconstructed using sub-millimeter slice thickness

Aortic Root and Peripheral Vessel Measurements

CT measurements are conducted in different parts of the cardiac cycle to correlate most closely with corresponding echo measurements

- Systole for aortic annulus measurements
- Diastole for sinus of Valsalva diameters, sinus of Valsalva heights, maximum ascending aorta diameter, and aortic root angulation

Table 2: Required CT Measurements

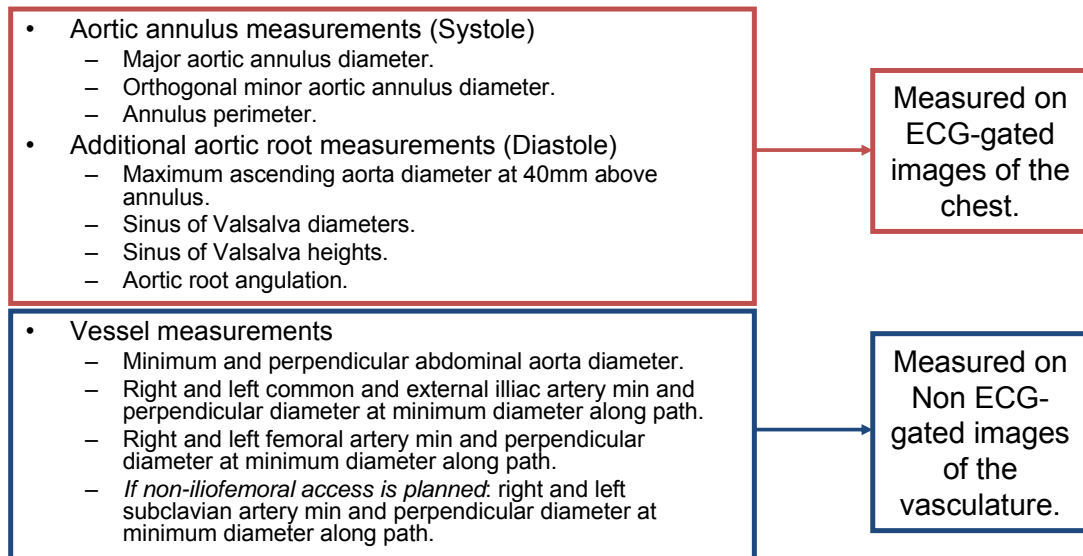

Proper Aortic Annulus Measurements

The aortic annulus is not co-planar with the planes of the body (i.e., axial, sagittal, or coronal). Therefore, multi-planar reformatting of the CT images to create a double-oblique axial image is required for annulus measurements. This reformatting is critical; if the plane is not correctly aligned, it may be going through the sinuses or the LVOT. This can lead to improper device selection.

The methods described here for measurement of the aortic annulus (virtual basal ring) are similar to those reported in Schultz et al. EuroIntervention Supplement (2010) Volume 6 (Supplement G) G6-G13.

Step 1: Reformatting of Images

- Center image cross-hairs on aortic root in all windows where it is visible. Lock cross-hairs so they remain orthogonal for all steps
- In the coronal window, rotate cross-hairs (horizontal line) counter-clockwise to align with virtual basal plane, as shown in Figure CTA-2 (upper left panel)
- In the sagittal window, the horizontal line has to be rotated clockwise or counter-clockwise to align with virtual basal plane, as shown in Figure CTA-2 (lower left panel)
- On the newly defined double-oblique axial image, scroll up and down through the aortic root until the most caudal attachment points of the three native leaflets come into view (indicated by arrowheads in Figure CTA-3 below). If one of the leaflets comes into view at a more cranial or caudal slice, adjust the coronal or sagittal cross-hairs until all three leaflets come into view on the same axial slice

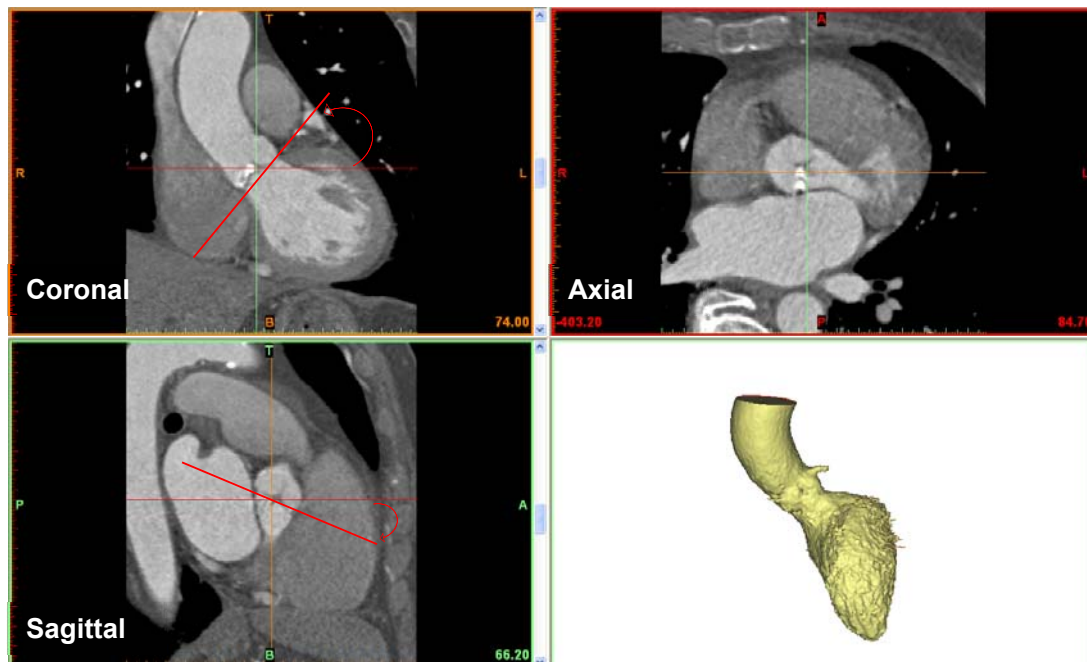

Figure CTA-2: Example images in original orientation (axial, coronal and sagittal). Red curved arrow and line indicate adjustment of coronal and sagittal planes to align with aortic basal annulus.

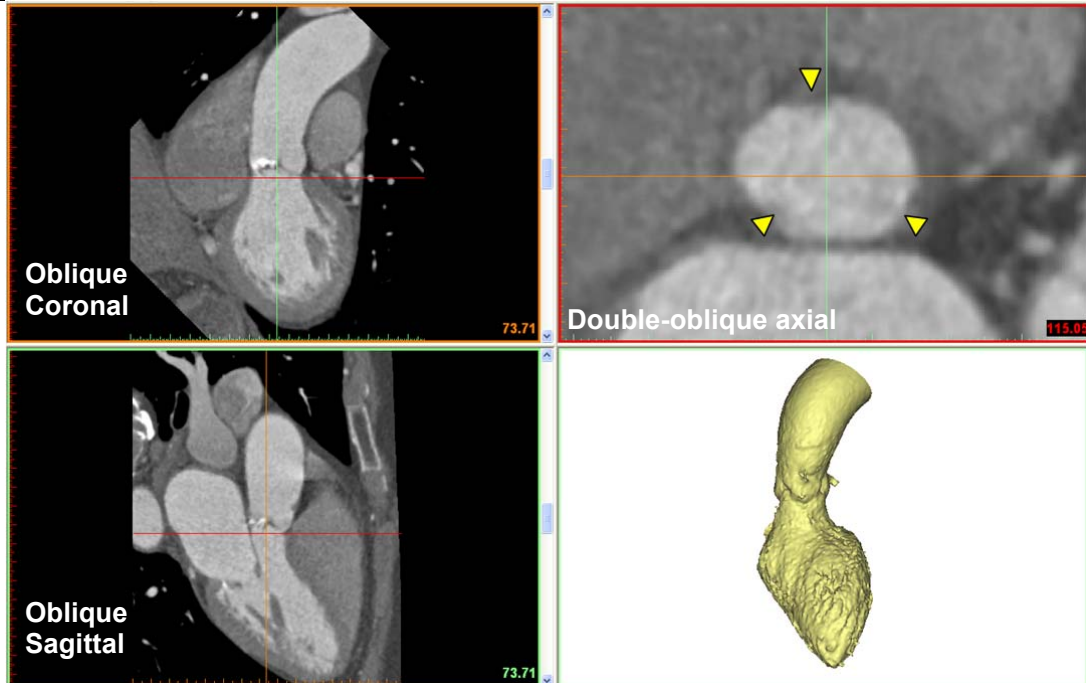

Figure CTA-3: Example images of reformatted oblique coronal (upper left), oblique sagittal (lower left), double oblique axial (upper right) and 3D reconstruction lower right. Yellow arrowheads indicate most caudal attachment of three leaflets of aortic valve.

- For confirmation of the correct aortic annulus plane, scroll through the double oblique axial images starting in the mid sinus and ending at the level of the aortic annulus. The sinuses should appear to be relatively the same size at the level of the mid-sinus and the leaflets should all disappear equally at the level of the annulus

Step 2: Aortic Root Measurements

Aortic Annulus Measurements

- Choose the cleanest systolic images for the aortic annulus measurements
- Aortic annulus measurements should be completed on the properly reformatted double-oblique axial image at aortic annulus level
- Trace the perimeter of the basal annulus (Figure CTA-4, left). Place cross-hairs at center of basal annulus, create major diameter through the center, create minor diameter defined as perpendicular to major and through center (Figure CTA-4, right). Record perimeter, major and minor diameter measurements on the screening worksheet

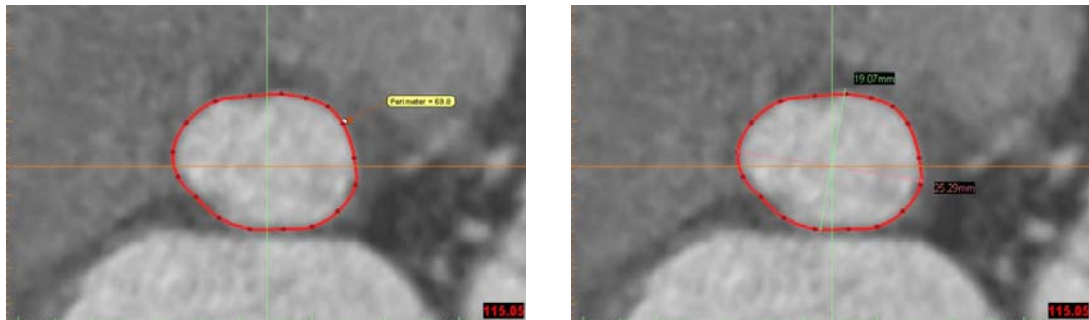

Figure CTA-4: Example of perimeter measurement (left) and major and minor diameter measurements (right).

Additional Aortic Root Measurements

- Choose the best diastolic images for measurement of sinus of Valsalva diameters, sinus of Valsalva heights, maximum ascending aorta diameter (40 mm from annulus), and aortic root angulation. Sinus of Valsalva diameters, heights, and maximum ascending aorta diameter should be completed on reformatted images using the same reformatting technique as used for the aortic annulus measurements

Sinus of Valsalva Diameters

- Select the double oblique axial image where the widest portion of the three sinuses is visible
- Measure a diameter from each commissure through the center of the root to the opposite sinus. Complete for all three sinuses (Figure CTA-5)

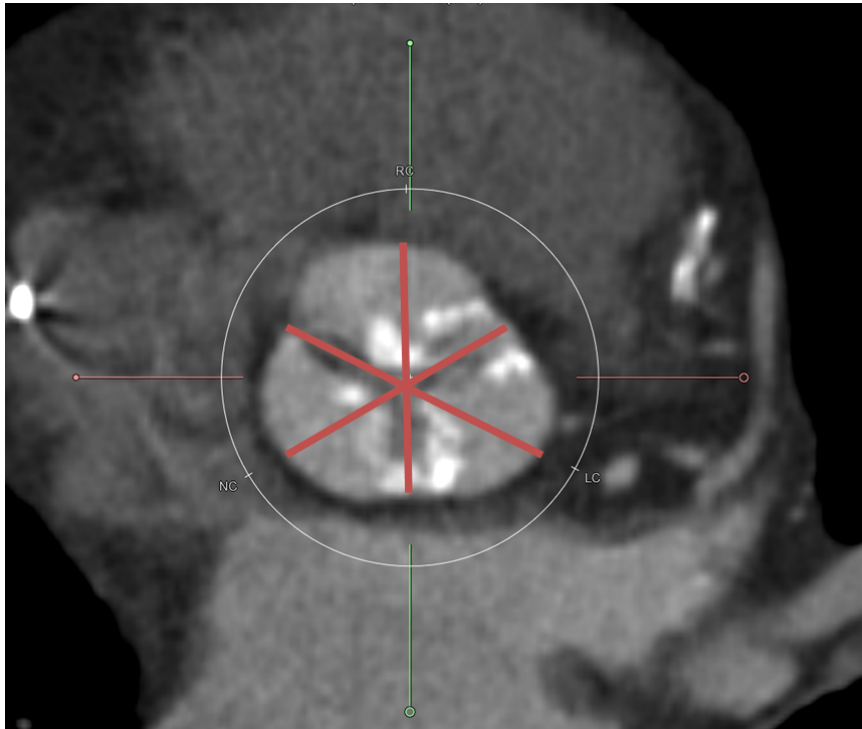

Figure CTA-5: Example of sinus of Valsalva diameters.

Sinus of Valsalva Heights

- The sinotubular junction is typically not co-planar with the aortic annulus. Therefore, a sinus of Valsalva height must be measured for each of the three sinuses. This height is defined as the distance between the aortic annular plane and the tallest point in the sinus
- Choose the double oblique axial image so that it is located at the level of the aortic annulus. The reformatting line representing the double oblique axial image should now be visible in the oblique coronal and oblique sagittal images at the level of the aortic annulus
- For the left coronary and non-coronary heights, use the oblique coronal image. For the right coronary height, use the oblique sagittal image
- To complete the measurement, scroll through the oblique coronal or sagittal image (depending on which sinus you are measuring) and locate the heights location of the sinotubular junction. On that image, measure the distance along the path of the aortic root from the aortic annular plane, marked by the reformatting line, to the sinotubular junction (Figure CTA-6).

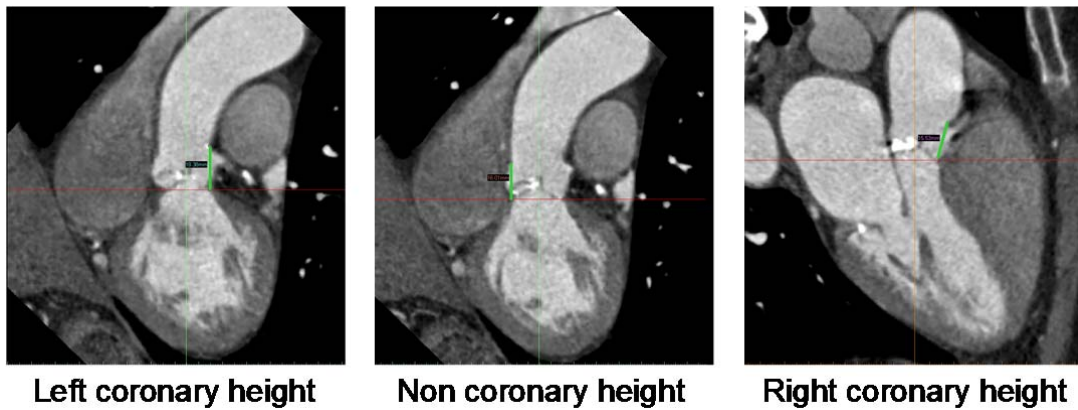

Figure CTA-6: Example of sinus of Valsalva heights.

Maximum Ascending Aorta Diameter

- Choose the double oblique axial image so that it is located at the level of the aortic annulus. The reformatting line representing the double oblique axial image should now be visible in the oblique coronal and oblique sagittal images at the level of the aortic annulus
- Choose the oblique coronal image that is in the center of the aortic root
- Measure a distance of 40mm from the line representing the aortic annular plane
- Center the images at this level, and reformat the images so that the double oblique is perpendicular to the ascending aorta at this level (Figure CTA-7)
- Measure the maximum diameter at this level (Figure CTA-7)

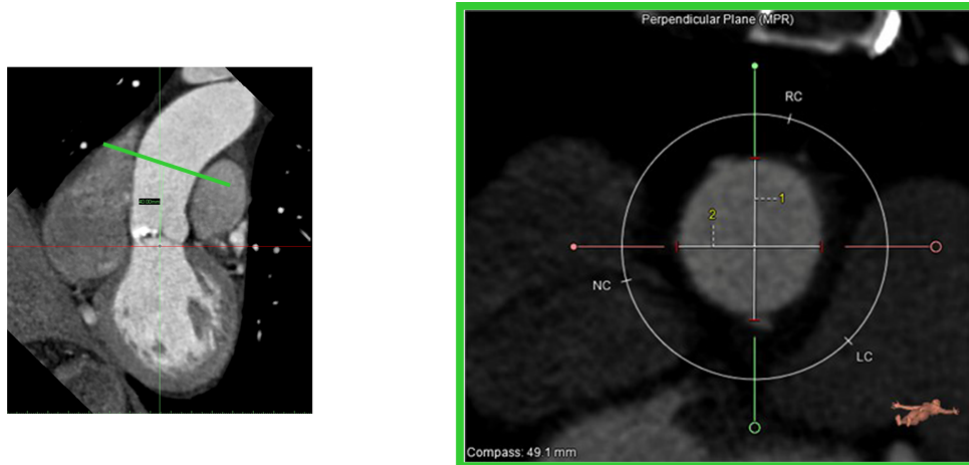

Figure CTA-7: Oblique coronal with measurement of 40mm above the aortic annulus (left) and double-oblique reformatted to be perpendicular to that location (right).

Aortic Root Angulation

- The aortic root angle measured in this study is the angle between the aortic annulus and the true axial plane of the patient
- To measure, use the standard coronal diastolic image, before any reformatting
- Scroll to the middle of the aortic root in these images (Figure CTA-8)
- Use the angle tool to draw a line first across the aortic annulus and second horizontal to the coronal image, which represents the axial plane of the patient. Start the angle measurement in the upper left of the patient, so that the angle is to the lower right of the patient (Figure CTA-8)

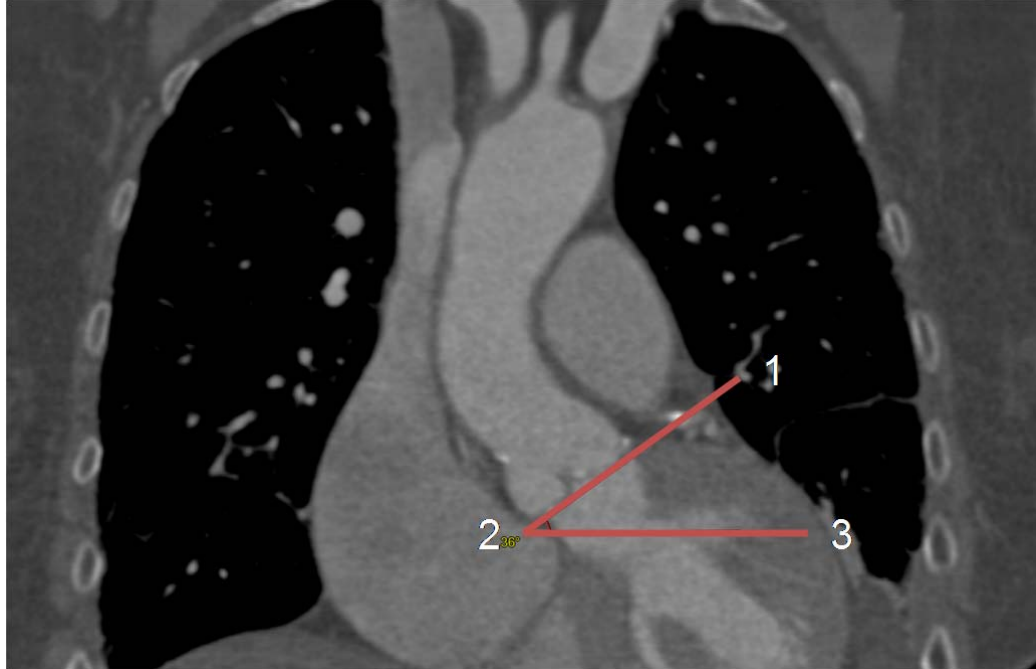

Figure CTA-8: Aortic root angulation measurement on the standard coronal image. Use the angle tool beginning at point 1, with point 2 on the lower right of the patient, and the final point on the lower left of the patient. The first line, between points 1 and 2 should be along the aortic annulus. The second line, between points 2 and 3, should be horizontal in the coronal image, which represents the axial plane of the patient.

Step 3: Access Vessel Measurements

Peripheral vessel measurements are made on non-gated CT and measured on images perpendicular to the vessel. The intent of these measurements is to determine the minimum diameters for the potential access routes. All vessel measurements should be completed on images that are perpendicular to the vessels of interest.

Minimum Abdominal Aortic Diameter

- Use a stretched vessel view to locate the minimum luminal abdominal aortic diameter
- Measure the minimum lumen diameter and a perpendicular diameter on the image orthogonal to the vessel at the minimum location (Figure CTA-9)

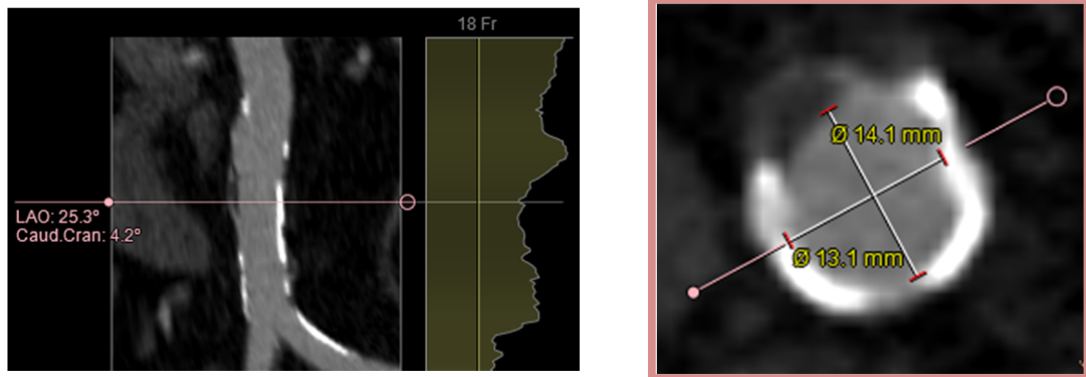

Figure CTA-9: Example of minimum abdominal aortic diameter. Stretched vessel (left), with the pink line at the location of the minimum luminal abdominal diameter. Orthogonal image (right), showing the minimum luminal diameter and the perpendicular diameter.

Peripheral Vessel Measurements

- These techniques are to be used for measurements on the following arteries:
 - Right and left femorals
 - Right and left common and external iliacs
 - If non-femoral access is planned – right and left subclavians
- Use a stretched vessel view to locate the minimum luminal diameter
- Measure the minimum lumen diameter and a perpendicular diameter on the image orthogonal to the vessel at the minimum location (Figure CTA-10)

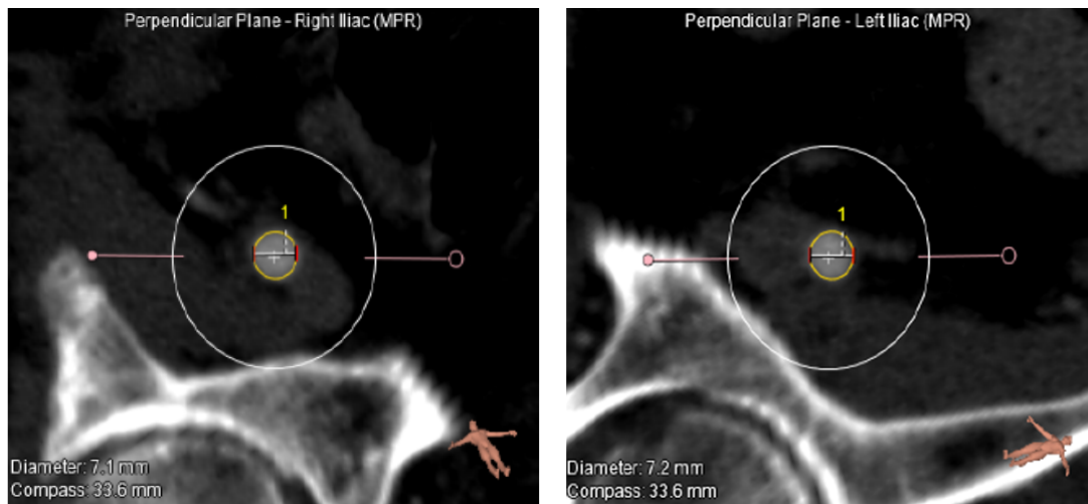

Figure CTA-10: Example of the peripheral vessels and measurements for the right (left) and left (right) iliac arteries.

Additional CT Measurements

- In the case of a thoracic aortic aneurysm, measure the maximum diameter in the aneurysm.
- To determine the maximum location, use similar methods to the other vessel measurements (stretched vessel view)
- Complete the measurement on the orthogonal images and report the maximum diameter

Prepare data for submission

- Data should be stored in DICOM 3.0 format
- If possible, de-identify all images prior to uploading
- Burn images to DICOM DVD/CD or upload to internal electronic records system
- Ensure all required images are included on DVD/CD or internal electronic records system for upload:
 - ECG-gated contrast enhanced aortic root. Upload on 4 time-points: 30% & 40% (systole) and 60% & 70% (diastole). If the system has “best-systolic” and “best-diastolic,” only upload those 2 phases.
 - Non ECG-gated contrast enhanced peripheral vessels – upload entire set.
 - Screenshots of all measurements
- Upload all images to InteleGRID (secure electronic system used for transferring images)

R.10 Interactive Voice/Web Response System (IXRS)

Medtronic will utilize an Interactive Voice/Web Response (IXRS) System to manage subject screen failures and randomization into the Medtronic CoreValve™ SURTAVI Trial.

The IXRS system will assign patients a Screening ID to be used for all patients that sign the Informed Consent Form and are considered for possible enrollment by the Heart Team. If a patient is screened and does not meet eligibility criteria, the IXRS system will capture the reason for screen failure and disposition of the patient (if known).

Upon meeting eligibility criteria, the IXRS system will randomize the patient and assign a Subject ID to be used in the Oracle Clinical Database upon enrollment.

The IXRS system will assign subjects within one of four groups:

- TAVI with planned PCI
- TAVI without planned PCI
- SAVR with planned CABG
- SAVR without planned CABG

Users can sign in to the Medtronic CoreValve™ SURTAVI Trial study web site by using the URL below and use the sign in box labeled "IVRS/IWRS Login":

www.bracketglobal.com/client-login

The first time a user accesses the study website, they will be prompted to update their password. The password must be at least 8 characters in length and contain at least 1 capital letter and 1 number or symbol.

Remember that the User ID and Password are private and should not be shared with other individuals.

For technical questions, contact UBC Technical Support at 888-794-0122 or at support@bracketglobal.com

R.11 Explanted Device/Pathology and Return Procedures

In the event of a device malfunction of the investigational device prior to or during implant, or in the event that a TAV device is explanted after implant (due to reintervention or autopsy), the TAV device and/or affected device components should be returned to Medtronic.

SHIPPING INSTRUCTIONS

System Malfunction (TAV Device, Delivery Catheter System (DCS) and/or Compression Loading System (CLS/LS) Before or During Procedure

1. Always retain original product packaging until the procedure is completed.
2. Place product back into original packaging if it was not clinically used (i.e. in contact with blood or body fluids)
3. If clinically used, use heart valve return kit to ship the valve or CLS/LS. Use a DCS return kit for the DCS, if applicable.

Explant of CoreValve at Reoperation

1. Photograph the TAV in situ (if possible).
2. If possible, indicate with a suture on the frame, the relation of the TAV device to the midpoint of the mitral valve.
3. Following explantation, rinse blood from the lumen with a physiologic solution (e.g. Ringer's lactate solution).
4. Do not disturb or alter the valve leaflets in any way (as possible).
5. Remove all packaging material and forms from kit. Temperature indicator should remain in box unless it has been activated. If it has been activated, discard noting that the kit is still usable.
6. Immerse the TAV and any surrounding tissue in the solution provided in the explant kit.
7. Place the jar into the yellow absorbent pouch and close, then into the zip lock bag and seal.

Explant of CoreValve at Autopsy

1. Remove all packaging material and forms from kit.
2. If possible, leave aortic root intact with an ample margin between the valve and descending aorta.
3. Whole hearts should be immersion fixed in formalin in the local autopsy suite or pathology lab for at least 24-48 hours prior to shipping. Note: hospitals or contract pathology labs should have formalin available for use.
4. Use the plastic container provided in the return kit for fixing the heart.
5. Before shipping, remove most of the formalin from the container and wrap the heart in the cloth specimen bag that is provided, which has been thoroughly soaked in formalin. Place the heart and specimen bag back into the container.
6. Label the outside of the container (lid and container) with the TAV device serial number, patient ID, center name and study name.
7. Seal the container tightly and wrap the container-lid interface with parafilm (if available).

All Explants>Returns

1. Complete the Product Experience Report (PER) form and email a copy to rs.structuralheartfieldassurance@medtronic.com to receive a PE number.
 - a. If an adverse event form has already been reported for this event and a PE number has already been issued via the AE, use the PE number from the AE correspondence. In this instance, sending the PER to field assurance to receive a PCR number is not required.
2. Note the PE number on the Product Experience Report and place the completed form and autopsy heart in the box.
3. Using the pre-paid/pre-printed form, ship by Federal Express or other overnight carrier if a form is not provided for your convenience. For further assistance, call the number below.

If a return kit is required, contact Customer Service:

1-800-556-4247

All return product should be sent to:

Medtronic, Inc.

Attn: Explant Lab/ [PE #]

1851 E. Deere Ave.

Santa Ana, CA 92705-5720

USA

1-800-854-3570

R.12 Economic and Quality of Life Data Collection

R.12.1 Health Economic Data Collection

Throughout this trial, resource utilization data will be collected by the research coordinator along with clinical data using case report forms.

Prior to enrollment in the study, patients will be asked to provide the information and permission to obtain such billing records for the length of their follow-up period. All related data will be kept in a secure and confidential database.

R.12.2 Quality of Life Data Collection

The QoL questionnaires will be administered to all subjects in languages where translation is available. It is not a deviation if a subject does not complete a Quality of Life Questionnaire because a translation is not available in the subject's language.

All QoL assessments will be by written, self-administered questionnaires. Ample, uninterrupted time should be provided for the subject to complete the questionnaires. Every effort should be made to have the subject complete the questionnaire him or herself. If the subject is unable to complete the questionnaires, the caregiver may complete the questionnaires on their behalf.

R.12.2.1 Schedule of Assessments

Questionnaires are to be administered, per protocol:

- Baseline
- 30 days
- 3 months
- 6 months
- 12 months
- 18 months
- 24 months
- 3 years
- 4 years
- 5 years

Baseline Assessment:

Questionnaires may be administered any time after the subject has provided informed consent but should be collected prior to informing the subject of their treatment assignment.

3 month Assessment:

Questionnaire(s) should be administered via telephone.

- **EQ-5D** – collected in all participating geographies
- **SF-36** – collected is limited to subjects in:
 - Canada
 - Denmark
 - Netherlands
 - United Kingdom
 - United States

R.12.2.2 Questionnaires

Kansas City Cardiomyopathy Questionnaire (KCCQ)

The Kansas City Cardiomyopathy Questionnaire (KCCQ) is a validated self-administered 23-item questionnaire that quantifies physical limitations, symptoms, self-efficacy, social interference and quality of life.

SF-36

QualityMetric's SF-36v2[®] Health Survey is a multi-purpose short-form that measures functional health and well-being from the patient's point of view.

EuroQoL EQ-5D

The EQ-5D is a measure of self-reported health outcomes that is applicable to a wide range of health conditions and treatments. It consists of two parts: a descriptive system (Part I) and a visual analogue scale (VAS) (Part II). Part I of the scale consists of 5 single-item dimensions including: mobility, self-care, usual activities, pain/discomfort, and anxiety/depression. Each dimension has a 3 point response scale designed to indicate the level of the problem. Part II uses a vertical graduated VAS (thermometer) to measure health status, ranging from worst imaginable health state to best imaginable health state.

R.13 Pacing Guidelines

Recommendations for pacing pre-, peri- and post-operatively are provided below (see also respective investigational device Instructions For Use). These are recommendations and final decisions should be made via clinical presentation and physician discretion. Programmed settings for temporary and permanent pacing are per subject condition and physician discretion.

Pre-operative Recommendations

- Ensure subject is informed about the placement of temporary pacing wires during the procedure and any additional associated risks.
- Ensure subject is informed about the potential for the placement of a permanent pacemaker and any additional associated risks.
- Obtain a baseline 12-lead ECG and assess for subject's conduction status
- **Subjects with a pre-existing permanent pacemaker only:** Conduct a full interrogation and AV conduction assessment. Print a copy of the interrogation and save the data on a diskette. Label the diskette with labels provided by Medtronic, including center name, subject ID, date and time of visit/interrogation and type of visit. Retain the printout and diskette in the subject's file for source verification.
 - **Recommended AV conduction assessment:**
 - Conduct an atrial threshold test with a long AV delay (e.g. 350ms) in DDD mode.
 - If the subject's ventricular rhythm doesn't come through within the 350 ms, the subject would be considered dependent on ventricular pacing.

Peri-operative Recommendations

- Prior to beginning the respective investigational device implant, place a temporary 4-5 Fr. balloon-tip pacing wire in a stable location within the right ventricular (a screw-tip wire may be used for more secure placement for subjects at high-risk for dislodgement, if necessary and experienced with implantation technique).
 - Whenever possible, use the upper torso venous system (e.g., jugular, sub-clavian) for temporary pacing wire access due to the recommendation to leave this system in for at least 48 hours post-procedure.
 - Use fluoroscopy to guide wire placement and stability.
 - Confirm sensing and capture
 - Program the backup pacing rate to minimize ventricular pacing (e.g. 30-40 bpm). If heart block develops, adjustment the rate accordingly.
- Rapid pacing during balloon valvuloplasty
 - Conduct a rapid pacing test prior to balloon valvuloplasty.
 - Successful test is defined as 1-to-1 pacing capture with an immediate drop in pressure and elimination of the systolic-diastolic waveform.

Post-operative Recommendations

- All subjects should stay on telemetry until discharge
- Maintain temporary pacing until at least 48 hours post-implant
 - Ensure a clean, sterile environment is maintained
- After 48 hours, obtain ECG and assess subject rhythm and conduction
 - Based on assessment, and with the consult of an electrophysiologist as needed, take one of the following actions:
 - Discontinue temporary pacing
 - Continue temporary pacing for another 24 hours (longer if needed) to make further assessments

- Place a permanent pacemaker according to ACC/AHA/HRS Guidelines for Device-Based Therapy of Cardiac Rhythm Abnormalities¹ (Class I or IIa for Acquired Atrioventricular Block in Adults or Permanent Pacing in Chronic Bifascicular Block)
 - Prior to the permanent pacemaker implantation, document the reason for the placement of the permanent pacemaker via a 12-lead ECG.
- For complete heart block, review subject medications. Consider withholding some medications to assess for subject's intrinsic rate and conduction. If heart block persists off medications, a permanent pacemaker should be considered.
- If a permanent pacemaker is required, a dual chamber system is recommended to optimize subject hemodynamics.
 - **Recommended AV conduction assessment:**
 - Conduct an atrial threshold test with a long AV delay (350ms) in DDD mode.
 - If the subject's ventricular rhythm doesn't come through within the 350 ms, the subject would be considered dependent on ventricular pacing.

¹ ACC/AHA/HRS 2008 Guidelines for Device-Based Therapy of Cardiac Rhythm Abnormalities: J Am Coll Cardiol 2008; 51:2085–105; Circulation 2008;117:2820–40

Recommendations for Acquired Atrioventricular Block in Adults

Class I Permanent pacemaker implantation is indicated for:

- Third-degree and advanced second-degree atrioventricular (AV) block at any anatomic level associated with bradycardia with symptoms (including heart failure) or ventricular arrhythmias presumed to be due to AV block. (LOE: C)
- Third-degree and advanced second-degree AV block at any anatomic level associated with arrhythmias and other medical conditions that require drug therapy that results in symptomatic bradycardia. (LOE: C)
- Third-degree and advanced second-degree AV block at any anatomic level in awake, symptom-free patients in sinus rhythm, with documented periods of asystole greater than or equal to 3.0 seconds or any escape rate less than 40 bpm, or with an escape rhythm that is below the AV node. (LOE: C)
- Third-degree and advanced second-degree AV block at any anatomic level in awake, symptom-free patients with atrial fibrillation and bradycardia with 1 or more pauses of at least 5 seconds or longer. (LOE: C)
- Third-degree and advanced second-degree AV block at any anatomic level after catheter ablation of the AV junction. (LOE: C)
- Third-degree and advanced second-degree AV block at any anatomic level associated with postoperative AV block that is not expected to resolve after cardiac surgery. (LOE: C)
- Third-degree and advanced second-degree AV block at any anatomic level associated with neuromuscular diseases with AV block, such as myotonic muscular dystrophy, Kearns-Sayre syndrome, Erb dystrophy (limb-girdle muscular dystrophy), and peroneal muscular atrophy, with or without symptoms. (LOE: B)
- Second-degree AV block with associated symptomatic bradycardia regardless of type or site of block. (LOE: B)
- Asymptomatic persistent third-degree AV block at any anatomic site with average awake ventricular rates of 40 bpm or faster if cardiomegaly or left ventricular (LV) dysfunction is present or if the site of block is below the AV node. (LOE: B)
- Second- or third-degree AV block during exercise in the absence of myocardial ischemia. (LOE: C)

Class IIa Permanent pacemaker implantation is reasonable for:

- Persistent third-degree AV block with an escape rate greater than 40 bpm in asymptomatic adult patients without cardiomegaly. (LOE: C)
- Asymptomatic second-degree AV block at intra or infra-His levels found at electrophysiological study. (LOE: B)
- First- or second-degree AV block with symptoms similar to those of pacemaker syndrome or hemodynamic compromise. (LOE: B)
- Asymptomatic type II second-degree AV block with a narrow QRS. When type II second-degree AV block occurs with a wide QRS, including isolated right bundle-branch block, pacing becomes a Class I recommendation (see Section 2.1.3, "Chronic Bifascicular Block," in the full-text guidelines). (LOE: B)

Recommendations for Permanent Pacing in Chronic Bifascicular Block

Class I Permanent pacemaker implantation is indicated for:

1. Advanced second-degree AV block or intermittent third-degree AV block. (LOE: B)
2. Type II second-degree AV block. (LOE: B)
3. Alternating bundle-branch block. (LOE: C)

Class IIa Permanent pacemaker implantation is reasonable for:

- Syncope not demonstrated to be due to AV block when other likely causes have been excluded, specifically ventricular tachycardia (VT). (LOE: B)
- Incidental finding at electrophysiological study of a markedly prolonged HV interval (greater than or equal to 100 milliseconds) in asymptomatic patients. (LOE: B)
- Incidental finding at electrophysiological study of pacing-induced infra-His block that is not physiological. (LOE: B)

R.14 Six Minute Walk Test Instructions

American Thoracic Society

ATS Statement: Guidelines for the Six-Minute Walk Test

THIS OFFICIAL STATEMENT OF THE AMERICAN THORACIC SOCIETY WAS APPROVED BY THE ATS BOARD OF DIRECTORS MARCH 2002

CONTENTS

- Purpose and Scope
- Background
- Indications and Limitations
- Contraindications
- Safety Issues
- Technical Aspects of the 6-Minute Walk Test
- Required Equipment
- Patient Preparation
- Measurements
- Quality Assurance
- Interpretation
- References

PURPOSE AND SCOPE

This statement provides practical guidelines for the 6-minute walk test (6MWT). Specifically, it reviews indications, details factors that influence results, presents a brief step-by-step protocol, outlines safety measures, describes proper patient preparation and procedures, and offers guidelines for clinical interpretation of results. These recommendations are not intended to limit the use of alternative protocols for research studies. We do not discuss the general topic of clinical exercise testing.

As with other American Thoracic Society statements on pulmonary function testing, these guidelines come out of a consensus conference. Drafts were prepared by two members (P.L.E. and R.J.Z.) and were based on a comprehensive Medline literature search from 1970 through 2001, augmented by suggestions from other committee members. Each draft responded to comments from the working committee. The guidelines follow previously published methods as closely as possible and provide a rationale for each specific recommendation. The final recommendations represent a consensus of the committee. The committee recommends that these guidelines be reviewed in five years and in the meantime encourages further research in areas of controversy.

BACKGROUND

There are several modalities available for the objective evaluation of functional exercise capacity. Some provide a very complete assessment of all systems involved in exercise performance (high tech), whereas others provide basic information but are low tech and are simpler to perform. The modality used should be chosen based on the clinical question to be addressed and on available resources. The most popular clinical exercise tests in order of increasing complexity are stair climbing, a 6MWT, a shuttle-walk test, detection of exercise-induced asthma, a cardiac stress test (e.g., Bruce protocol), and a cardiopulmonary exercise test (1, 2). Other professional organizations have published standards for cardiac stress testing (3, 4).

Assessment of functional capacity has traditionally been done by merely asking patients the following: "How many flights of stairs can you climb or how many blocks can you walk?" However, patients vary in their recollection and may report overestimations or underestimations of their true functional capacity. Objective measurements are usually better than self-reports. In the early 1960s, Balke developed a simple test to evaluate the functional capacity by measuring the distance walked during a defined period of time (5). A 12-minute field performance test was then developed to evaluate the level of physical fitness of healthy individuals (6). The walking test was also adapted to assess disability in patients with chronic bronchitis (7). In an attempt to accommodate patients with respiratory disease for whom walking 12 minutes was too exhausting, a 6-minute walk was found to perform as well as the 12-minute walk (8). A recent review of functional walking tests concluded that

"the 6MWT is easy to administer, better tolerated, and more reflective of activities of daily living than the other walk tests" (9).

The 6MWT is a practical simple test that requires a 100-ft hallway but no exercise equipment or advanced training for technicians. Walking is an activity performed daily by all but the most severely impaired patients. This test measures the distance that a patient can quickly walk on a flat, hard surface in a period of 6 minutes (the 6MWD). It evaluates the global and integrated responses of all the systems involved during exercise, including the pulmonary and cardiovascular systems, systemic circulation, peripheral circulation, blood, neuromuscular units, and muscle metabolism. It does not provide specific information on the function of each of the different organs and systems involved in exercise or the mechanism of exercise limitation, as is possible with maximal cardiopulmonary exercise testing. The self-paced 6MWT assesses the submaximal level of functional capacity. Most patients do not achieve maximal exercise capacity during the 6MWT; instead, they choose their own intensity of exercise and are allowed to stop and rest during the test. However, because most activities of daily living are performed at submaximal levels of exertion, the 6MWD may better reflect the functional exercise level for daily physical activities.

INDICATIONS AND LIMITATIONS

The strongest indication for the 6MWT is for measuring the response to medical interventions in patients with moderate to severe heart or lung disease. The 6MWT has also been used as a one-time measure of functional status of patients, as well as a predictor of morbidity and mortality (see Table 1 for a list of these indications). The fact that investigators have used the 6MWT in these settings does not prove that the test is clinically useful (or the best test) for determining functional capacity or changes in functional capacity due to an intervention in patients with these diseases. Further studies are necessary to determine the utility of the 6MWT in various clinical situations.

TABLE 1. Indications for the Six-Minute Walk Test

Pretreatment and post treatment comparisons

- Lung transplantation (9, 10)
- Lung resection (11)
- Lung volume reduction surgery (12, 13)
- Pulmonary rehabilitation (14, 15)
- COPD (16–18)
- Pulmonary hypertension
- Heart failure (19, 20)

Functional status (single measurement)

- COPD (21, 22)
- Cystic fibrosis (23, 24)
- Heart failure (25–27)
- Peripheral vascular disease (28, 29)
- Fibromyalgia (30)
- Older patients (31)

Predictor of morbidity and mortality

- Heart failure (32, 33)
- COPD (34, 35)
- Primary pulmonary hypertension (10, 36)

Definition of abbreviation: COPD = chronic obstructive pulmonary disease.

Formal cardiopulmonary exercise testing provides a global assessment of the exercise response, an objective determination of functional capacity and impairment, determination of the appropriate intensity needed to perform prolonged exercise, quantification of factors limiting exercise, and a definition of the underlying pathophysiologic mechanisms such as the contribution of different organ systems involved in exercise. The 6MWT does not determine peak oxygen uptake, diagnose the cause of dyspnea on exertion, or evaluate the causes or mechanisms of exercise limitation (1, 2). The information provided by a 6MWT should be considered complementary to cardiopulmonary exercise testing, not a replacement for it. Despite the difference between these two functional tests, some good correlations between them have been reported. For example, a significant correlation ($r = 0.73$) between 6MWD and peak oxygen uptake has been reported for patients with end-stage lung diseases (36).

In some clinical situations, the 6MWT provides information that may be a better index of the patient's ability to perform daily activities than is peak oxygen uptake; for example, 6MWD correlates better with formal measures of quality of life (37). Changes in 6MWD after therapeutic interventions correlate with subjective improvement in dyspnea (38, 39). The reproducibility of the 6MWD (with a coefficient of variation of approximately 8%) appears to be better than the reproducibility of 1-second forced expiratory volume in patients with chronic obstructive pulmonary disease (COPD) (8, 39–42). Questionnaire indices of functional status have a larger short-term variability (22–33%) than does the 6MWD (37).

The shuttle-walking test is similar to the 6MWT, but it uses an audio signal from a tape cassette to direct the walking pace of the patient back and forth on a 10-m course (43–45). The walking speed is increased every minute, and the test ends when the patient cannot reach the turnaround point within the required time. The exercise performed is similar to a symptom-limited, maximal, incremental treadmill test. An advantage of the shuttle walking test is that it has a better correlation with peak oxygen uptake than the 6MWD (46, 47). Disadvantages include less validation, less widespread use, and more potential for cardiovascular problems.

CONTRAINDICATIONS

Absolute contraindications for the 6MWT include the following: unstable angina during the previous month and myocardial infarction during the previous month. Relative contraindications include a resting heart rate of more than 120, a systolic blood pressure of more than 180 mm Hg, and a diastolic blood pressure of more than 100 mm Hg.

Patients with any of these findings should be referred to the physician ordering or supervising the test for individual clinical assessment and a decision about the conduct of the test. The results from a resting electrocardiogram done during the previous 6 months should also be reviewed before testing. Stable exertional angina is not an absolute contraindication for a 6MWT, but patients with these symptoms should perform the test after using their antiangina medication, and rescue nitrate medication should be readily available.

Rationale

Patients with the previously mentioned risk factors may be at increased risk for arrhythmias or cardiovascular collapse during testing. However, each patient determines the intensity of their exercise, and the test (without electrocardiogram monitoring) has been performed in thousands of older persons (31, 48) and thousands of patients with heart failure or cardiomyopathy (32, 49, 50) without serious adverse events. The contraindications listed previously here were used by study investigators based on their impressions of the general safety of the 6MWT and their desire to be prudent, but it is unknown whether adverse events would occur if such patients performed a 6MWT; they are, therefore, listed as relative contraindications.

SAFETY ISSUES

1. Testing should be performed in a location where a rapid, appropriate response to an emergency is possible. The appropriate location of a crash cart should be determined by the physician supervising the facility.
2. Supplies that must be available include oxygen, sublingual nitroglycerine, aspirin, and albuterol (metered dose inhaler or nebulizer). A telephone or other means should be in place to enable a call for help.
3. The technician should be certified in cardiopulmonary resuscitation with a minimum of Basic Life Support by an American Heart Association–approved cardiopulmonary resuscitation course. Advanced cardiac life support certification is desirable. Training, experience, and certification in related health care fields (registered nurse, registered respiratory therapist, certified pulmonary function technician, etc.) are also desirable. A certified individual should be readily available to respond if needed.
4. Physicians are not required to be present during all tests. The physician ordering the test or a supervising laboratory physician may decide whether physician attendance at a specific test is required.

5. If a patient is on chronic oxygen therapy, oxygen should be given at their standard rate or as directed by a physician or a protocol.

Reasons for immediately stopping a 6MWT include the following: (1) chest pain, (2) intolerable dyspnea, (3) leg cramps, (4) staggering, (5) diaphoresis, and (6) pale or ashen appearance.

Technicians must be trained to recognize these problems and the appropriate responses. If a test is stopped for any of these reasons, the patient should sit or lie supine as appropriate depending on the severity of the event and the technician's assessment of the severity of the event and the risk of syncope. The following should be obtained based on the judgment of the technician: blood pressure, pulse rate, oxygen saturation, and a physician evaluation. Oxygen should be administered as appropriate.

TECHNICAL ASPECTS OF THE 6MWT

Location

The 6MWT should be performed indoors, along a long, flat, straight, enclosed corridor with a hard surface that is seldom traveled. If the weather is comfortable, the test may be performed outdoors. The walking course must be 30 m in length. A 100-ft hallway is, therefore, required. The length of the corridor should be marked every 3 m. The turnaround points should be marked with a cone (such as an orange traffic cone). A starting line, which marks the beginning and end of each 60-m lap, should be marked on the floor using brightly colored tape.

Rationale

A shorter corridor requires patients to take more time to reverse directions more often, reducing the 6MWD. Most studies have used a 30-m corridor (51), but some have used 20- or 50-m corridors (52, 53). A recent multicenter study found no significant effect of the length of straight courses ranging from 50 to 164 ft, but patients walked farther on continuous (oval) tracks (mean 92 ft farther) (54).

The use of a treadmill to determine the 6MWD might save space and allow constant monitoring during the exercise, but the use of a treadmill for 6-minute walk testing is not recommended. Patients are unable to pace themselves on a treadmill. In one study of patients with severe lung disease, the mean distance walked on the treadmill during 6 minutes (with the speed adjusted by the patients) was shorter by a mean of 14% when compared with the standard 6MWD using a 100-ft hallway (55). The range of differences was wide, with patients walking between 400–1,300 ft on the treadmill who walked 1,200 ft in the hallway. Treadmill test results, therefore, are not interchangeable with corridor tests.

REQUIRED EQUIPMENT

1. Countdown timer (or stopwatch)
2. Mechanical lap counter
3. Two small cones to mark the turnaround points
4. A chair that can be easily moved along the walking course
5. Worksheets on a clipboard
6. A source of oxygen
7. Sphygmomanometer
8. Telephone
9. Automated electronic defibrillator

PATIENT PREPARATION

6. Comfortable clothing should be worn.
7. Appropriate shoes for walking should be worn.
8. Patients should use their usual walking aids during the test (cane, walker, etc.).
9. The patient's usual medical regimen should be continued.
10. A light meal is acceptable before early morning or early afternoon tests.
11. Patients should not have exercised vigorously within 2 hours of beginning the test.

MEASUREMENTS

1. Repeat testing should be performed about the same time of day to minimize intraday variability.
2. A "warm-up" period before the test should not be performed.
3. The patient should sit at rest in a chair, located near the starting position, for at least 10 minutes before the test starts. During this time, check for contraindications, measure pulse and blood pressure, and make sure that clothing and shoes are appropriate. Complete the first portion of the worksheet (see the [APPENDIX](#)).
4. Pulse oximetry is optional. If it is performed, measure and record baseline heart rate and oxygen saturation (SpO₂) and follow manufacturer's instructions to maximize the signal and to minimize motion artifact ([56](#)). Make sure the readings are stable before recording. Note pulse regularity and whether the oximeter signal quality is acceptable.

The rationale for measuring oxygen saturation is that although the distance is the primary outcome measure, improvement during serial evaluations may be manifest either by an increased distance or by reduced symptoms with the same distance walked ([38](#)). The SpO₂ should not be used for constant monitoring during the exercise. The technician must not walk with the patient to observe the SpO₂. If worn during the walk, the pulse oximeter must be lightweight (less than 2 pounds), battery powered, and held in place (perhaps by a "fanny pack") so that the patient does not have to hold or stabilize it and so that stride is not affected. Many pulse oximeters have considerable motion artifact that prevents accurate readings during the walk ([57](#)).

5. Have the patient stand and rate their baseline dyspnea and overall fatigue using the Borg scale (see [Table 2](#) for the Borg scale and instructions [[58](#)]).
6. Set the lap counter to zero and the timer to 6 minutes. Assemble all necessary equipment (lap counter, timer, clipboard, Borg Scale, worksheet) and move to the starting point.
7. Instruct the patient as follows:

"The object of this test is to walk as far as possible for 6 minutes. You will walk back and forth in this hallway. Six minutes is a long time to walk, so you will be exerting yourself. You will probably get out of breath or become exhausted. You are permitted to slow down, to stop, and to rest as necessary. You may lean against the wall while resting, but resume walking as soon as you are able.

You will be walking back and forth around the cones. You should pivot briskly around the cones and continue back the other way without hesitation. Now I'm going to show you. Please watch the way I turn without hesitation."

Demonstrate by walking one lap yourself. Walk and pivot around a cone briskly.

"Are you ready to do that? I am going to use this counter to keep track of the number of laps you complete. I will click it each time you turn around at this starting line. Remember that the object is to walk AS FAR AS POSSIBLE for 6 minutes, but don't run or jog.

Start now or whenever you are ready."

TABLE 2. The Borg scale

0	Nothing at all
0.5	Very, very slight (just noticeable)
1	Very slight
2	Slight (light)
3	Moderate
4	Somewhat severe
5	Severe (heavy)
6	
7	Very severe
8	
9	
10	Very, very severe (maximal)

This Borg scale should be printed on heavy paper (11 inches high and perhaps laminated) in 20-point type size. At the beginning of the 6-minute exercise, show the scale to the patient and ask the patient this: *"Please grade your level of shortness of breath using this scale."* Then ask this: *"Please grade your level of fatigue using this scale."* At the end of the exercise, remind the patient of the breathing number that they chose before the exercise and ask the patient to grade their breathing level again. Then ask the patient to grade their level of fatigue, after reminding them of their grade before the exercise.

8. Position the patient at the starting line. You should also stand near the starting line during the test. Do not walk with the patient. As soon as the patient starts to walk, start the timer
9. Do not talk to anyone during the walk. Use an even tone of voice when using the standard phrases of encouragement. Watch the patient. Do not get distracted and lose count of the laps. Each time the participant returns to the starting line, click the lap counter once (or mark the lap on the worksheet). Let the participant see you do it. Exaggerate the click using body language, like using a stopwatch at a race.

After the first minute, tell the patient the following (in even tones): *"You are doing well. You have 5 minutes to go."*

When the timer shows 4 minutes remaining, tell the patient the following: *"Keep up the good work. You have 4 minutes to go."*

When the timer shows 3 minutes remaining, tell the patient the following: *"You are doing well. You are halfway done."*

When the timer shows 2 minutes remaining, tell the patient the following: *"Keep up the good work. You have only 2 minutes left."*

When the timer shows only 1 minute remaining, tell the patient: *"You are doing well. You have only 1 minute to go."*

Do not use other words of encouragement (or body language to speed up).

If the patient stops walking during the test and needs a rest, say this: *"You can lean against the wall if you would like; then continue walking whenever you feel able."* Do not stop the timer. If the patient stops before the 6 minutes are up and refuses to continue (or you decide that they should not continue), wheel the chair over for the patient to sit on, discontinue the walk, and note on the worksheet the distance, the time stopped, and the reason for stopping prematurely.

When the timer is 15 seconds from completion, say this: *"In a moment I'm going to tell you to stop. When I do, just stop right where you are and I will come to you."*

When the timer rings (or buzzes), say this: *"Stop!"* Walk over to the patient. Consider taking the chair if they look exhausted. Mark the spot where they stopped by placing a bean bag or a piece of tape on the floor.

10. Post-test: Record the postwalk Borg dyspnea and fatigue levels and ask this: *"What, if anything, kept you from walking farther?"*

11. If using a pulse oximeter, measure SpO₂ and pulse rate from the oximeter and then remove the sensor.
12. Record the number of laps from the counter (or tick marks on the worksheet).
13. Record the additional distance covered (the number of meters in the final partial lap) using the markers on the wall as distance guides. Calculate the total distance walked, rounding to the nearest meter, and record it on the worksheet.
14. Congratulate the patient on good effort and offer a drink of water.

QUALITY ASSURANCE

Sources of Variability

There are many sources of 6MWD variability (see [Table 3](#)). The sources of variability caused by the test procedure itself should be controlled as much as possible. This is done by following the standards found in this document and by using a quality-assurance program.

TABLE 3. 6MWD Sources of Variability

Factors reducing the 6MWD
Shorter height
Older age
Higher body weight
Female sex
Impaired cognition
A shorter corridor (more turns)
Pulmonary disease (COPD, asthma, cystic fibrosis, interstitial lung disease)
Cardiovascular disease (angina, MI, CHF, stroke, TIA, PVD, AAI)
Musculoskeletal disorders (arthritis, ankle, knee, or hip injuries, muscle wasting, etc.)
Factors increasing the 6MWD
Taller height (longer legs)
Male sex
High motivation
A patient who was previously performed the test
Medication for a disabling disease taken just before the test
Oxygen supplementation in patients with exercise induced hypoxemia

Definition of abbreviations: COPD = chronic obstructive pulmonary disease; 6MWD = 6-minute walking distance.

Practice Tests

A practice test is not needed in most clinical settings but should be considered. If a practice test is done, wait for at least 1 hour before the second test and report the highest 6MWD as the patient's 6MWD baseline.

Rationale

The 6MWD is only slightly higher for a second 6MWT performed a day later. The mean reported increase ranges from 0 to 17% ([23](#), [27](#), [40](#), [41](#), [54](#), [59](#)). A multicenter study of 470 highly motivated patients with severe COPD performed two 6MWTs 1 day apart, and on average, the 6MWD was only 66 ft (5.8%) higher on the second day ([54](#)).

Performance (without an intervention) usually reaches a plateau after two tests done within a week ([8](#), [60](#)). The training effect may be due to improved coordination, finding optimal stride length, and overcoming anxiety. The possibility of a practice or training effect from tests repeated after more than a month has not been studied or reported; however, it is likely that the effect of training wears off (does not persist) after a few weeks.

Technician Training and Experience

Technicians who perform 6MWTs should be trained using the standard protocol and then supervised for several tests before performing them alone. They should also have completed cardiopulmonary resuscitation training.

Rationale

One multicenter study of older people found that after correction for many other factors, two of the technicians had mean 6MWDs that were approximately 7% lower than the other two sites (31).

Encouragement

Only the standardized phrases for encouragement (as specified previously here) must be used during the test.

Rationale

Encouragement significantly increases the distance walked (42). Reproducibility for tests with and without encouragement is similar. Some studies have used encouragement every 30 seconds, every minute, or every 2 minutes. We have chosen every minute and standard phrases. Some studies (53) have instructed patients to walk as fast as possible. Although larger mean 6MWDs may be obtained thereby, we recommend that such phrases not be used, as they emphasize initial speed at the expense of earlier fatigue and possible excessive cardiac stress in some patients with heart disease.

Supplemental Oxygen

If oxygen supplementation is needed during the walks and serial tests are planned (after an intervention other than oxygen therapy), then during all walks by that patient oxygen should be delivered in the same way with the same flow. If the flow must be increased during subsequent visits due to worsening gas exchange, this should be noted on the worksheet and considered during interpretation of the change noted in 6MWD. The type of oxygen delivery device should also be noted on the report: for instance, the patient carried liquid oxygen or pushed or pulled an oxygen tank, the delivery was pulsed or continuous, or a technician walked behind the patient with the oxygen source (not recommended). Measurements of pulse and SpO₂ should be made after waiting at least 10 minutes after any change in oxygen delivery.

Rationale

For patients with COPD or interstitial lung disease, oxygen supplementation increases the 6MWD (17, 59, 61). Carrying a portable gas container (but not using it for supplemental oxygen) reduced the mean 6MWD by 14% in one study of patients with severe respiratory disability, but using the container to deliver supplemental oxygen during the exercise increased the mean 6MWD by 20–36% (59).

Medications

The type of medication, dose, and number of hours taken before the test should be noted.

Rationale

Significant improvement in the distance walked, or the dyspnea scale, after administration of bronchodilators has been demonstrated in patients with COPD (62, 63), as well as cardiovascular medications in patients with heart failure (19).

INTERPRETATION

Most 6MWTs will be done before and after intervention, and the primary question to be answered after both tests have been completed is whether the patient has experienced a clinically significant improvement. With a good quality-assurance program, with patients tested by the same technician, and after one or two practice tests, short-term reproducibility of the 6MWD is excellent (36). It is not known whether it is best for clinical purposes to express change in 6MWD as (1) an absolute value, (2) a percentage change, or (3) a change in the percentage of predicted value. Until further research is available, we recommend that change in 6MWD be expressed as an absolute value (e.g., the patient walked 50 m farther).

A statistically significant mean increase in 6MWD in a group of study participants is often much less than a clinically significant increase in an individual patient. In one study of 112 patients (half of them women) with stable, severe COPD, the smallest difference in 6MWD that was associated with a noticeable clinical difference in the patients' perception of exercise performance was a mean of 54

m (95% confidence interval, 37–71 m) (64). This study suggests that for individual patients with COPD, an improvement of more than 70 m in the 6MWD after an intervention is necessary to be 95% confident that the improvement was significant. In an observational study of 45 older patients with heart failure, the smallest difference in 6MWD that was associated with a noticeable difference in their global rating of worsening was a mean of 43 m (20). The 6MWD was more responsive to deterioration than to improvement in heart failure symptoms.

Reported Mean Changes in 6MWD After Interventions

Supplemental oxygen (6 L/min) during exercise in patients with COPD or interstitial lung disease increased mean 6MWD by approximately 83 m (36%) in one study (59). Patients taking an inhaled corticosteroid experienced a mean 33 m (8%) increase in 6MWD in an international COPD study (16). Patients with COPD in a study of the effects of exercise and diaphragmatic strength training experienced a mean increase in 6MWD of 50 m (20%) (65). Lung volume reduction surgery in patients with very severe COPD has been reported to increase 6MWD by a mean of 55 m (20%) (13).

Cardiac rehabilitation in patients referred with various heart diseases increased 6MWD by a mean of 170 m (15%) in a recent study (66). In 25 older patients with heart failure, an angiotensin-converting enzyme inhibitor medication (50 mg captopril per day) improved 6MWD a mean of 64 m (39%) compared with a mean increase of only 8% in those receiving a placebo (19).

Interpreting Single Measurements of Functional Status

Optimal reference equations from healthy population-based samples using standardized 6MWT methods are not yet available. In one study, the median 6MWD was approximately 580 m for 117 healthy men and 500 m for 173 healthy women (48). A mean 6MWD of 630 m was reported by another study of 51 healthy older adults (53). Differences in the population sampled, type and frequency of encouragement, corridor length, and number of practice tests may account for reported differences in mean 6MWD in healthy persons. Age, height, weight, and sex independently affect the 6MWD in healthy adults; therefore, these factors should be taken into consideration when interpreting the results of single measurements made to determine functional status. We encourage investigators to publish reference equations for healthy persons using the previously mentioned standardized procedures.

A low 6MWD is nonspecific and nondiagnostic. When the 6MWD is reduced, a thorough search for the cause of the impairment is warranted. The following tests may then be helpful: pulmonary function, cardiac function, ankle–arm index, muscle strength, nutritional status, orthopedic function, and cognitive function.

Conclusions

The 6MWT is a useful measure of functional capacity targeted at people with at least moderately severe impairment. The test has been widely used for preoperative and postoperative evaluation and for measuring the response to therapeutic interventions for pulmonary and cardiac disease. These guidelines provide a standardized approach to performing the 6MWT. The committee hopes that these guidelines will encourage further research into the 6MWT and allow direct comparisons among different studies.

APPENDIX

The following elements should be present on the 6MWT worksheet and report:

Lap counter: _____

Patient name: _____ Patient ID# _____

Walk # _____ Tech ID: _____ Date: _____

Gender: M F Age: _____ Race: _____ Height: _____ ft _____ in, _____ meters

Weight: _____ lbs, _____ kg Blood pressure: _____ / _____

Medications taken before the test (dose and time): _____

Supplemental oxygen during the test: No Yes, flow _____ L/min, type _____

	Baseline	End of Test
Time	____:____	____:____
Heart Rate	_____	_____
Dyspnea	_____	_____ (Borg scale)
Fatigue	_____	_____ (Borg scale)
SpO ₂	_____ %	_____ %

Stopped or paused before 6 minutes? No Yes, reason: _____

Other symptoms at end of exercise: angina dizziness hip, leg, or calf pain

Number of laps: _____ (x60 meters) + final partial lap: _____ meters =

Total distance walked in 6 minutes: _____ meters

Predicted distance: _____ meters Percent predicted: _____ %

Tech comments:

Interpretation (including comparison with a preintervention 6MWD):

Acknowledgments

This statement was developed by the ATS Committee on Proficiency Standards for Clinical Pulmonary Function Laboratories.

Members of the committee are:

ROBERT O. CRAPO, M.D., *Chair* *
RICHARD CASABURI, PH.D, M.D.
ALLAN L. COATES, M.D.
PAUL L. ENRIGHT, M.D.*
NEIL R. MACINTYRE, M.D.
ROY T. MCKAY, PH.D.
DOUGLAS JOHNSON, M.D.
JACK S. WANGER, M.S.
R. JORGE ZEBALLOS, M.D.*

Ad Hoc Committee members are:

VERA BITTNER, M.D.
CARL MOTTRAM, R.R.T.

*Writing Committee Members

REFERENCES

1. Wasserman K, Hansen JE, Sue DY, Casaburi R, Whipp BJ. Principles of exercise testing and interpretation, 3rd edition. Philadelphia: Lippincott, Williams & Wilkins; 1999.
2. Weisman IM, Zeballos RJ. An integrated approach to the interpretation of cardiopulmonary exercise testing. *Clin Chest Med* 1994;15:421–445.
3. Fletcher GF, Balady G, Froelicher VF, Hartley LH, Haskell WL, Pollock ML. Exercise standards: a statement for healthcare professionals from the American Heart Association: writing group. *Circulation* 1995; 91:580–615.
4. Pina IL, Balady GJ, Hanson P, Labovitz AJ, Madonna DW, Myers J. Guidelines for clinical exercise testing laboratories: a statement for healthcare professionals from the Committee on Exercise and Cardiac Rehabilitation, American Heart Association. *Circulation* 1995;91:912–921.
5. Balke B. A simple field test for the assessment of physical fitness. *CARI Report* 1963;63:18.
6. Cooper KH. A means of assessing maximal oxygen intake: correlation between field and treadmill testing. *JAMA* 1968;203:201–204.
7. McGavin CR, Gupta SP, McHardy GJR. Twelve-minute walking test for assessing disability in chronic bronchitis. *BMJ* 1976;1:822–823.
8. Butland RJA, Pang J, Gross ER, Woodcock AA, Geddes DM. Two-, six-, and 12-minute walking tests in respiratory disease. *BMJ* 1982; 284:1607–1608.
9. Solway S, Brooks D, Lacasse Y, Thomas S. A qualitative systematic overview of the measurement properties of functional walk tests used in the cardiorespiratory domain. *Chest* 2001;119:256–270.
10. Kadikar A, Maurer J, Kesten S. The six-minute walk test: a guide to assessment for lung transplantation. *J Heart Lung Transplant* 1997;16: 313–319.
11. Holden DA, Rice TW, Stelmach K, Meeker DP. Exercise testing, 6 min walk, and stair climb in the evaluation of patients at high risk for pulmonary resection. *Chest* 1992;102:1774–1779.
12. Sciruba FC, Rogers RM, Keenan RJ, Slivka WA, Gorcsan J 3rd, Ferson PF, Holbert JM, Brown ML, Landreneau RJ. Improvement in pulmonary function and elastic recoil after lung-reduction surgery for diffuse emphysema. *N Engl J Med* 1996;334:1095–1099.
13. Criner GJ, Cordova FC, Furukawa S, Kuzma AM, Travaline JM, Leyenson V, O'Brien GM. Prospective randomized trial comparing bilateral lung volume reduction surgery to pulmonary rehabilitation in severe COPD. *Am J Respir Crit Care Med* 1999;160:2018–2027.
14. Sinclair DJM, Ingram CG. Controlled trial of supervised exercise training in chronic bronchitis. *BMJ* 1980;280:519–521.
15. Roomi J, Johnson MM, Waters K, Yohannes A, Helm A, Connolly MJ. Respiratory rehabilitation, exercise capacity and quality of life in chronic airways disease in old age. *Age Ageing* 1996;25:12–16.
16. Paggiaro PL, Dahle R, Bakran I, Frith L, Hollingworth K, Efthimiou J. Multicentre randomised placebo-controlled trial of inhaled fluticasone propionate in patients with COPD. *Lancet* 1998;351:773–780.
17. Leggett RJ, Flenley DC. Portable oxygen and exercise tolerance in patients with chronic hypoxic cor pulmonale. *BMJ* 1977;2:84–86.
18. Spence DPS, Hay JG, Carter J, Pearson MG, Calverley PMA. Oxygen desaturation and breathlessness during corridor walking in COPD: effect of oxitropium bromide. *Thorax* 1993;48:1145–1150.
19. DeBock V, Mets T, Romagnoli M, Derde MP. Captopril treatment of chronic heart failure in the very old. *J Gerontol* 1994;49:M148–M152.

20. O'Keeffe ST, Lye M, Donnellan C, Carmichael DN. Reproducibility and responsiveness of quality of life assessment and six minute walk test in elderly heart failure patients. *Heart* 1998;80:377–382.
21. Bernstein ML, Despars JA, Singh NP, Avalos K, Stansbury DW, Light RW. Re-analysis of the 12 minute walk in patients with COPD. *Chest* 1994;105:163–167.
22. Hajiro T, Nishimura K, Tsukino M, Ikeda A, Koyama H, Izumi T. Analysis of clinical methods used to evaluate dyspnea in patients with COPD. *Am J Respir Crit Care Med* 1998;158:1185–1189.
23. Gulmans VAM, vanVeldhoven NHMJ, deMeer K, Helder PJM. The six-minute walking test in children with cystic fibrosis: reliability and validity. *Pediatr Pulmonol* 1996;22:85–89.
24. Nixon PA, Joswiak ML, Fricker FJ. A six-minute walk test for assessing exercise tolerance in severely ill children. *J Pediatr* 1996;129:362–366.
25. Bittner V. Six-minute walk test in patients with cardiac dysfunction. *Cardiologia* 1997;42:897–902.
26. Peeters P, Mets T. The 6 minute walk as an appropriate exercise test in elderly patients with chronic heart failure. *J Gerontol* 1996;51A: M147–M151.
27. Zugck C, Kruger C, Durr S, Gerber SH, Haunstetter A, Hornig K, Kubler W, Haass M. Is the 6-minute walk test a reliable substitute for peak oxygen uptake in patients with dilated cardiomyopathy? *Eur Heart J* 2000;21:540–549.
28. Montgomery PS, Gardner AW. The clinical utility of a six-minute walk test in peripheral arterial occlusive disease patients. *J Am Geriatr Soc* 1998;46:706–711.
29. Cahan MA, Montgomery P, Otis RB, Clancy R, Flinn W, Gardner A. The effect of cigarette smoking status on six-minute walk distance in patients with intermittent claudication. *Angiology* 1999;50:537–546.
30. King S, Wessel J, Bhambhani Y, Maikala R, Sholter D, Maksymowych W. Validity and reliability of the 6 minute walk in persons with fibromyalgia. *J Rheumatol* 1999;26:2233–2237.
31. Enright PL, McBurnie MA, Bittner V, Tracy RP, McNamara R, Newman AB, the Cardiovascular Health Study. The six minute walk test: a quick measure of functional status in elderly adults. *Chest* (In press)
32. Bittner V, Weiner DH, Yusuf S, Rogers WJ, McIntyre KM, Bangdiwala SI, Kronenberg MW, Kostis JB, Kohn RM, Guillothe M, et al. Prediction of mortality and morbidity with a 6-minute walk test in patients with left ventricular dysfunction. *JAMA* 1993;270:1702–1707.
33. Cahalin LP, Mathier MA, Semigran MJ, Dec GW, DiSalvo TG. The six-minute walk test predicts peak oxygen uptake and survival in patients with advanced heart failure. *Chest* 1996;110:325–332.
34. Cote CG, Celli BR. In patients with COPD, the 6 minute walking distance is a better predictor of health care utilization than FEV1, blood gases, and dyspnea [abstract]. *Eur Respir J* 1998;383.
35. Kessler R, Faller M, Fourgaut G, Mennecier B, Weitzenblum E. Predictive factors of hospitalization for acute exacerbation in a series of 64 patients with chronic obstructive pulmonary disease. *Am J Respir Crit Care Med* 1999;159:158–164.
36. Cahalin L, Pappagianopoulos P, Prevost S, Wain J, Ginns L. The relationship of the 6-min walk test to maximal oxygen consumption in transplant candidates with end-stage lung disease. *Chest* 1995;108:452–459.
37. Guyatt GH, Thompson PJ, Berman LB, Sullivan MJ, Townsend M, Jones NL, Pugsley SO. How should we measure function in patients with chronic heart and lung disease? *J Chronic Dis* 1985;38:517–524.
38. Guyatt GH, Townsend M, Keller J, Singer J, Nogradi S. Measuring functional status in chronic lung disease: conclusions from a random control trial. *Respir Med* 1991;85(Suppl B):17–21.
39. Niederman MS, Clemente PH, Fein AM, Feinsilver SH, Robinson DA, Ilowite JS, Bernstein MG. Benefits of a multidisciplinary pulmonary rehabilitation program: improvements are independent of lung function. *Chest* 1991;99:798–804.
40. Noseda A, Carpiaux J, Prigogine T, Schmerber J. Lung function, maximum and submaximum exercise testing in COPD patients: reproducibility over a long interval. *Lung* 1989;167:247–257.
41. Knox AJ, Morrison JF, Muers MF. Reproducibility of walking test results in chronic obstructive airways disease. *Thorax* 1988;43:388–392.
42. Guyatt GH, Pugsley SO, Sullivan MJ, Thompson PJ, Berman LB, Jones NL, Fallen EL, Taylor DW. Effect of encouragement on walking test performance. *Thorax* 1984;39:818–822.
43. Leger LA. A maximal multistage 20-m shuttle run test to predict VO2 max. *Eur J Appl Physiol* 1982;49:1–12.
44. Singh SJ, Morgan MDL, Scott S, Walters D, Hardman AE. Development of a shuttle walking test of disability in patients with chronic airways obstruction. *Thorax* 1992;47:1019–1024.
45. Revill SM, Morgan MDL, Singh SJ, Williams J, Hardman AE. The endurance shuttle walk: a new field test for the assessment of endurance capacity in chronic obstructive pulmonary disease. *Thorax* 1999;54:213–222.
46. Singh SJ, Morgan MDL, Hardman AE, Rowe C, Bardsley PA. Comparison of oxygen uptake during a conventional treadmill test and the shuttle walking test in chronic airflow limitation. *Eur Respir J* 1994;7: 2016–2020.
47. Morales FJ, Martinez A, Mendez M, Agarrado A, Ortega F, Fernandez-Guerra J, Montemayor T, Burgos J. A shuttle walk test for assessment of functional capacity in chronic heart failure. *Am Heart J* 1999;138:292–298.
48. Enright PL, Sherrill DL. Reference equations for the six-minute walk in healthy adults. *Am J Respir Crit Care Med* 1998;158:1384–1387.

49. Barst RJ, Rubin LJ, McGoon MD, Caldwell EJ, Long WA, Levy PS. Survival in primary pulmonary hypertension with long-term continuous intravenous prostacyclin. *Ann Intern Med* 1994;121:409–415.
50. Miyamoto S, Nagaya N, Satoh T, Kyotani S, Sakamaki F, Fujita M, Nakanishi N, Miyatake K. Clinical correlates and prognostic significance of six-minute walk test in patients with primary pulmonary hypertension. *Am J Respir Crit Care Med* 2000;161:487–492.
51. Guyatt GH, Sullivan MJ, Thompson PJ, Fallen EL, Pugsley SO, Taylor DW, Berman LB. The 6-minute walk: a new measure of exercise capacity in patients with chronic heart failure. *Can Med Assoc J* 1985;132:919–923.
52. Lipkin DP, Scrivin AJ, Crake T, Poole-Wilson PA. Six minute walking test for assessing exercise capacity in chronic heart failure. *BMJ* 1986; 292:653–655.
53. Troosters T, Gosselink R, Decramer M. Six minute walking distance in healthy elderly subjects. *Eur Respir J* 1999;14:270–274.
54. Weiss RA, *et al.* Six minute walk test in severe COPD: reliability and effect of walking course layout and length. Paper presented at ACCP Conference; September 2000; San Francisco.
55. Stevens D, Elpern E, Sharma K, Szidon P, Ankin M, Kesten S. Comparison of hallway and treadmill six-minute walk tests. *Am J Respir Crit Care Med* 1999;160:1540–1543.
56. Jensen LA, Onyskiw JE, Prasad NGN. Meta-analysis of arterial oxygen saturation monitoring by pulse oximetry in adults. *Heart Lung* 1998; 27:387–408.
57. Barthelemy JC, Geysant A, Riffat J, Antoniadis A, Berruyer J, LaCour JR. Accuracy of pulse oximetry during moderate exercise: a comparative study. *Scand J Clin Lab Invest* 1990;50:533–539.
58. Borg GAV. Psycho-physical bases of perceived exertion. *Med Sci Sports Exerc* 1982;14:377–381.
59. Leach RM, Davidson AC, Chinn S, Twort CHC, Cameron IR, Batemen NT. Portable liquid oxygen and exercise ability in severe respiratory disability. *Thorax* 1992;47:781–789.
60. Mungall IPF, Hainsworth R. Assessment of respiratory function in patients with chronic obstructive airways disease. *Thorax* 1979;34:254–258.
61. Roberts CM, Bell J, Wedzicha JA. Comparison of the efficacy of a demand oxygen delivery system with continuous low flow oxygen in subjects with stable COPD and severe oxygen desaturation on walking. *Thorax* 1996;51:831–834.
62. Hay JG, Stone P, Carter J, Church S, Eyre-Brook A, Pearson MG, Woodcock AA, Calverley PM. Bronchodilator reversibility, exercise performance and breathlessness in stable chronic obstructive pulmonary disease. *Eur Respir J* 1992;5:659–664.
63. Grove A, Lipworth BJ, Reid P, Smith RP, Lamage L, Ingram CG, Jenkins RJ, Winter JH, Dhillon DP. Effects of regular salmeterol on lung function and exercise capacity in patients with COPD. *Thorax* 1996;51:689–693.
64. Redelmeier DA, Bayoumi AM, Goldstein RS, Guyatt GH. Interpreting small differences in functional status: The six minute walk test in chronic lung disease patients. *Am J Respir Crit Care Med* 1997;155:1278–1282.
65. Weiner P, Magadle R, Berar-Yanay N, Davidovich A, Weiner M. The cumulative effect of long-acting bronchodilators, exercise, and inspiratory muscle training on the perception of dyspnea in patients with advanced COPD. *Chest* 2000;118:672–678.
66. Bittner V, Sanderson B, Breland J, Adams C, Schuman C. Assessing functional capacity as an outcome in cardiac rehabilitation: role of the 6 minute walk test. *Clinical Exercise Physiology* 2000.

R.15 National Institute of Health Stroke Scale (NIHSS)

Administer stroke scale items in the order listed. Record performance in each category after each subscale exam. Do not go back and change scores. Follow directions provided for each exam technique. Scores should reflect what the patient does, not what the clinician thinks the patient can do. The clinician should record answers while administering the exam and work quickly. Except where indicated, the patient should not be coached (i.e., repeated requests to patient to make a special effort).

Instructions	Scale Definition	Score
<p>1a. Level of Consciousness: The investigator must choose a response if a full evaluation is prevented by such obstacles as an endotracheal tube, language barrier, orotracheal trauma/bandages. A 3 is scored only if the patient makes no movement (other than reflexive posturing) in response to noxious stimulation.</p>	<p>0 = Alert; keenly responsive.</p> <p>1 = Not alert; but arousable by minor stimulation to obey, answer, or respond.</p> <p>2 = Not alert; requires repeated stimulation to attend, or is obtunded and requires strong or painful stimulation to make movements (not stereotyped).</p> <p>3 = Responds only with reflex motor or autonomic effects or totally unresponsive, flaccid, and areflexic.</p>	_____
<p>1b. LOC Questions: The patient is asked the month and his/her age. The answer must be correct - there is no partial credit for being close. Aphasic and stuporous patients who do not comprehend the questions will score 2. Patients unable to speak because of endotracheal intubation, orotracheal trauma, severe dysarthria from any cause, language barrier, or any other problem not secondary to aphasia are given a 1. It is important that only the initial answer be graded and that the examiner not "help" the patient with verbal or non-verbal cues.</p>	<p>0 = Answers both questions correctly.</p> <p>1 = Answers one question correctly.</p> <p>2 = Answers neither question correctly.</p>	_____
<p>1c. LOC Commands: The patient is asked to open and close the eyes and then to grip and release the non-paretic hand. Substitute another one step command if the hands cannot be used. Credit is given if an unequivocal attempt is made but not completed due to weakness. If the patient does not respond to command, the task should be demonstrated to him or her (pantomime), and the result scored (i.e., follows none, one or two commands). Patients with trauma, amputation, or other physical impediments should be given suitable one-step commands. Only the first attempt is scored.</p>	<p>0 = Performs both tasks correctly.</p> <p>1 = Performs one task correctly.</p> <p>2 = Performs neither task correctly.</p>	_____

<p>2. Best Gaze: Only horizontal eye movements will be tested. Voluntary or reflexive (oculocephalic) eye movements will be scored, but calorific testing is not done. If the patient has a conjugate deviation of the eyes that can be overcome by voluntary or reflexive activity, the score will be 1. If a patient has an isolated peripheral nerve paresis (CN III, IV or VI), score a 1. Gaze is testable in all aphasic patients. Patients with ocular trauma, bandages, pre-existing blindness, or other disorder of visual acuity or fields should be tested with reflexive movements, and a choice made by the investigator. Establishing eye contact and then moving about the patient from side to side will occasionally clarify the presence of a partial gaze palsy.</p>	<p>0 = Normal. 1 = Partial gaze palsy; gaze is abnormal in one or both eyes, but forced deviation or total gaze paresis is not present. 2 = Forced deviation, or total gaze paresis not overcome by the oculocephalic maneuver.</p>	<p align="center">_____</p>
<p>3. Visual: Visual fields (upper and lower quadrants) are tested by confrontation, using finger counting or visual threat, as appropriate. Patients may be encouraged, but if they look at the side of the moving fingers appropriately, this can be scored as normal. If there is unilateral blindness or enucleation, visual fields in the remaining eye are scored. Score 1 only if a clear-cut asymmetry, including quadrantanopia, is found. If patient is blind from any cause, score 3. Double simultaneous stimulation is performed at this point. If there is extinction, patient receives a 1, and the results are used to respond to item 11.</p>	<p>0 = No visual loss. 1 = Partial hemianopia. 2 = Complete hemianopia. 3 = Bilateral hemianopia (blind including cortical blindness).</p>	<p align="center">_____</p>
<p>4. Facial Palsy: Ask – or use pantomime to encourage – the patient to show teeth or raise eyebrows and close eyes. Score symmetry of grimace in response to noxious stimuli in the poorly responsive or non-comprehending patient. If facial trauma/bandages, orotracheal tube, tape or other physical barriers obscure the face, these should be removed to the extent possible.</p>	<p>0 = Normal symmetrical movements. 1 = Minor paralysis (flattened nasolabial fold, asymmetry on smiling). 2 = Partial paralysis (total or near-total paralysis of lower face). 3 = Complete paralysis of one or both sides (absence of facial movement in the upper and lower face).</p>	<p align="center">_____</p>
<p>5. Motor Arm: The limb is placed in the appropriate position: extend the arms (palms down) 90 degrees (if sitting) or 45 degrees (if supine). Drift is scored if the arm falls before 10 seconds. The aphasic patient is encouraged using urgency in the voice and pantomime, but not noxious stimulation. Each limb is tested in turn, beginning with the non-paretic arm. Only in the case of amputation or joint fusion at the shoulder, the examiner should record the score as untestable (UN), and clearly write the explanation for this choice.</p>	<p>0 = No drift; limb holds 90 (or 45) degrees for full 10 seconds. 1 = Drift; limb holds 90 (or 45) degrees, but drifts down before full 10 seconds; does not hit bed or other support. 2 = Some effort against gravity; limb cannot get to or maintain (if cued) 90 (or 45) degrees, drifts down to bed, but has some effort against gravity. 3 = No effort against gravity; limb falls. 4 = No movement. UN = Amputation or joint fusion, explain: _____ 5a. Left Arm 5b. Right Arm</p>	<p align="center">_____ _____</p>

<p>6. Motor Leg: The limb is placed in the appropriate position: hold the leg at 30 degrees (always tested supine). Drift is scored if the leg falls before 5 seconds. The aphasic patient is encouraged using urgency in the voice and pantomime, but not noxious stimulation. Each limb is tested in turn, beginning with the non-paretic leg. Only in the case of amputation or joint fusion at the hip, the examiner should record the score as untestable (UN), and clearly write the explanation for this choice.</p>	<p>0 = No drift; leg holds 30-degree position for full 5 seconds. 1 = Drift; leg falls by the end of the 5-second period but does not hit bed. 2 = Some effort against gravity; leg falls to bed by 5 seconds, but has some effort against gravity. 3 = No effort against gravity; leg falls to bed immediately. 4 = No movement. UN = Amputation or joint fusion, explain: _____ 6a. Left Leg _____ 6b. Right _____</p>	
<p>7. Limb Ataxia: This item is aimed at finding evidence of a unilateral cerebellar lesion. Test with eyes open. In case of visual defect, ensure testing is done in intact visual field. The finger-nose-finger and heel-shin tests are performed on both sides, and ataxia is scored only if present out of proportion to weakness. Ataxia is absent in the patient who cannot understand or is paralyzed. Only in the case of amputation or joint fusion, the examiner should record the score as untestable (UN), and clearly write the explanation for this choice. In case of blindness, test by having the patient touch nose from extended arm position.</p>	<p>0 = Absent. 1 = Present in one limb. 2 = Present in two limbs. UN = Amputation or joint fusion, explain: _____</p>	
<p>8. Sensory: Sensation or grimace to pinprick when tested, or withdrawal from noxious stimulus in the obtunded or aphasic patient. Only sensory loss attributed to stroke is scored as abnormal and the examiner should test as many body areas (arms [not hands], legs, trunk, face) as needed to accurately check for hemisensory loss. A score of 2, "severe or total sensory loss," should only be given when a severe or total loss of sensation can be clearly demonstrated. Stuporous and aphasic patients will, therefore, probably score 1 or 0. The patient with brainstem stroke who has bilateral loss of sensation is scored 2. If the patient does not respond and is quadriplegic, score 2. Patients in a coma (item 1a=3) are automatically given a 2 on this item.</p>	<p>0 = Normal; no sensory loss. 1 = Mild-to-moderate sensory loss; patient feels pinprick is less sharp or is dull on the affected side; or there is a loss of superficial pain with pinprick, but patient is aware of being touched. 2 = Severe to total sensory loss; patient is not aware of being touched in the face, arm, and leg.</p>	

<p>9. Best Language: A great deal of information about comprehension will be obtained during the preceding sections of the examination. For this scale item, the patient is asked to describe what is happening in the attached picture, to name the items on the attached naming sheet and to read from the attached list of sentences. Comprehension is judged from responses here, as well as to all of the commands in the preceding general neurological exam. If visual loss interferes with the tests, ask the patient to identify objects placed in the hand, repeat, and produce speech. The intubated patient should be asked to write. The patient in a coma (item 1a=3) will automatically score 3 on this item. The examiner must choose a score for the patient with stupor or limited cooperation, but a score of 3 should be used only if the patient is mute and follows no one-step commands.</p>	<p>0 = No aphasia; normal.</p> <p>1 = Mild-to-moderate aphasia; some obvious loss of fluency or facility of comprehension, without significant limitation on ideas expressed or form of expression. Reduction of speech and/or comprehension, however, makes conversation about provided materials difficult or impossible. For example, in conversation about provided materials, examiner can identify picture or naming card content from patient's response.</p> <p>2 = Severe aphasia; all communication is through fragmentary expression; great need for inference, questioning, and guessing by the listener. Range of information that can be exchanged is limited; listener carries burden of communication. Examiner cannot identify materials provided from patient response.</p> <p>3 = Mute, global aphasia; no usable speech or auditory comprehension.</p>	<p align="center">_____</p>
<p>10. Dysarthria: If patient is thought to be normal, an adequate sample of speech must be obtained by asking patient to read or repeat words from the attached list. If the patient has severe aphasia, the clarity of articulation of spontaneous speech can be rated. Only if the patient is intubated or has other physical barriers to producing speech, the examiner should record the score as untestable (UN), and clearly write an explanation for this choice. Do not tell the patient why he or she is being tested.</p>	<p>0 = Normal.</p> <p>1 = Mild-to-moderate dysarthria; patient slurs at least some words and, at worst, can be understood with some difficulty.</p> <p>2 = Severe dysarthria; patient's speech is so slurred as to be unintelligible in the absence of or out of proportion to any dysphasia, or is mute/anarthric.</p> <p>UN = Intubated or other physical barrier, explain: _____</p>	<p align="center">_____</p>
<p>11. Extinction and Inattention (formerly Neglect): Sufficient information to identify neglect may be obtained during the prior testing. If the patient has a severe visual loss preventing visual double simultaneous stimulation, and the cutaneous stimuli are normal, the score is normal. If the patient has aphasia but does appear to attend to both sides, the score is normal. The presence of visual spatial neglect or anosagnosia may also be taken as evidence of abnormality. Since the abnormality is scored only if present, the item is never untestable.</p>	<p>0 = No abnormality.</p> <p>1 = Visual, tactile, auditory, spatial, or personal inattention or extinction to bilateral simultaneous stimulation in one of the sensory modalities.</p> <p>2 = Profound hemi-inattention or extinction to more than one modality; does not recognize own hand or orients to only one side of space.</p>	<p align="center">_____</p>

R.16 Modified Rankin Scale (mRS) Instructions

Instructions:

- The mRS is to be determined after the NIHSS has been determined and graded and by the same rater.
- The determination of the scale should be made from 5 to 0, i.e., the order presented.
- The purpose of the mRS is to record whether the patient is dead, severely, moderately, or slightly disabled and if not dead or disabled, whether the patient is performing all usual activities without symptoms or not. Because subjects and family members may understate the severity of disability, it is important for the rating clinician to understand that the mRS is a clinical scale and not a patient-reported outcome. The rater may ask questions but must assess the disability whether or not in agreement with the subject or family.

5 Severe disability; someone needs to be available at all times; care may be provided by either a trained or an untrained caregiver.

Question: Does the person require constant care?

4 Moderately severe disability; need for assistance with some basic ADL, but not requiring constant care.

Question: Is assistance essential for eating, using the toilet, daily hygiene, or walking?

3 Moderate disability; need for assistance with some instrumental ADL but not basic ADL.

Question: Is assistance essential for preparing a simple meal, doing household chores, looking after money, shopping, or traveling locally?

2 Slight disability; limitations in participation in usual social roles, but independent for ADL.

Questions:

- Has there been a change in the person's ability to work or look after others if these were roles before stroke?
- Has there been a change in the person's ability to participate in previous social and leisure activities?
- Has the person had problems with relationships or become isolated?
- Do any of the following interfere with the subject's ability to perform all usual activities: difficulty reading or writing, difficulty speaking or finding the right word, problems with balance or coordination, visual problems, numbness (face, arms, legs, hands, feet), loss of movement (face, arms, legs, hands, feet), difficulty with swallowing, or other symptom resulting from stroke?

1 No significant disability; symptoms present but not other limitations.

Question: Does the subject have any symptoms that do not interfere with the performance of all usual activities?

0 No symptoms at all; no limitations and no symptoms.

Note: The above questions are a modification of the questions from **Wilson, et. al, Stroke. 2002;33:2243-2246** and are **modified here for the use in percutaneous heart valve trials** for the FDA Division of CV Devices.

R.17 Mini Mental State Exam (MMSE-2:SV)

Mini Mental Status Exam1: The MMSE-2 Standard Version should be used.

Procedure:

Administer the MMSE-2 exam utilizing the standardized worksheets provided.

<http://www.minimental.com/>

R.18 Additional Neurological Assessments

Visual Field Testing

Visual fields, (upper and lower quadrants) are tested by confrontation, using finger counting or visual threat as appropriate.

Visual fields may be impaired by lesions anywhere in the neural visual pathways, from the optic nerves to the occipital lobes.

- **Individual eyes:**

In direct confrontation, examiner should sit directly in front of the patient, at the same level and approximately one meter apart. Ask the patient to cover one eye and maintain a fixed gaze on the examiners eye or nose. The examiner brings a small target (e.g. a match or a finger) from the periphery of the subject's visual field into each of the 4 visual quadrants and requests that the patient indicate when they first visualize the object. Wiggling the target assists in the patients separating and defining it.

Repeat the testing for the other eye.

Any abnormalities in target detection should prompt detailed testing with more precise instruments.

- **Bilateral eyes:**

In the same position, and with the patients fixed gaze on the examiners nose or eyes, use finger counting or visual threat to identify any asymmetry in the visual field.

Gait Assessment

Not tested as part of the NIH Stroke Scale.

Ask the patient to walk down a straight hallway under observation, if ambulatory.

Note any apparent abnormalities of gait. (Ataxic, lateralized hemi-paretic, 'shuffling' or 'small-step' or other abnormality).

Hand Function

- **Motor assessment**

The extensors are weaker than the flexors in the upper extremities. Consequently, following a neurological event, the arm eventually assumes a flexed position. Therefore the biceps will be stronger than the triceps, the wrist and finger flexors stronger than the extensors. For this reason it is not a good idea to monitor for stroke progression by testing grip strength. Test finger extensor strength instead.

Muscle power is classically graded on a scale of 0 – 5, with 0 being no power and 5 being normal power. For the purposes of documenting subtleties in potential deficits, power in finger muscle groups should be documented on a 0 – 10 scale as follows.

Grade 0	No muscle contraction
Grade 2	Muscle contraction without joint movement
Grade 4	Partial movement with gravity eliminated
Grade 6	Movement against gravity
Grade 8	Movement against some resistance
Grade 10	Normal strength

(Use odd numbers to document when physical findings fall between grades).

- **Finger Abductors**

Instruct the patient to “Spread your fingers apart, push your index finger towards the other hand. Don’t let me push it back”. Push on the finger at the Proximal Interphalangeal (PIP) joint level.

- **Finger Adductors**

Ask patient to ‘grip a sheet of paper’ between their fingers. Try to pull the sheet away from them.

- **Finger Extensors**

Instruct the patient to “Keep your fingers out straight, and don’t let me bend them”. This is a test of extension at the metacarpophalangeal (MCP) joints. It is important to support the palm and apply pressure to the PIP joints, testing extension at only one set of joints, because extension at the PIP joints is performed by the small hand muscles.

- **Sensory Assessment**

In a seated position, ask the patient to place both hands on their lap with palms facing down. Instruct them to close their eyes, and using their index finger point to the position touched by the examiner on fingers of the opposite hand. Repeat for both hands.

This should be documented as: ‘normal sensation’ or ‘can feel but unable to localize’ or ‘no sensation’ for each hand.

Writing Evaluation

Ask the patient to write two sentences about a particular subject. (e.g. their hometown). There is no time limit, and patient can be given time prior to neurological examination as necessary.

Note the subject’s ‘use of paper’, including the position of writing. Also, note whether the written subject is appropriate to that asked, and the correctness of the grammar, spelling and syntax used.

Document as ‘fail’ or ‘pass’ or ‘subject unable to attempt test’ if patient is unable.

Drawing Assessment

The ‘clock-drawing’ test is used for screening for cognitive impairment and dementia, and as a measure of spatial dysfunction and neglect. Doing the test requires verbal understanding, memory and spatially coded knowledge in addition to constructive skills.

Constructional apraxia may occur with lesions in either the left or right parietal lobe, although it is more frequent after right parietal damage (visually dominant).

Clock drawing has been used as a diagnostic measure of unilateral spatial neglect, with neglect patients omitting numbers on one half, with or without transposition of the numbers from the neglect side to the other, or demonstrating inattention to parts of the spatial layout of numbers.

The test has a high correlation with the MMSE and other tests of cognitive dysfunction.

- Ask patient to draw the face of a clock and put the numbers in the correct position.
- Then ask patient to draw in the hands at a particular time (e.g., “twenty minutes after eight”).
- There is no time limit.

One point will be assigned for each of the following items completed (draws closed circle, includes all 12 correct numbers, places numbers in correct positions, places hands in correct positions) for a total of four points.

R.19 Medtronic CoreValve™ Clinical Assessment Guidelines

Clinical Assessments will be collected to help assess the overall health and frailty¹ of study participants at the time of screening. These assessments include measures of nutrition, strength and balance, independence in average daily living, mental status, and medical comorbidities.

The following are guidelines provided for administering the strength and balance examination.

5-Meter Gait Speed: The Gait Test measures, in seconds, the time a person takes walk 5meters.

Procedure:

- Accompany the patient to the designated area, which should be well-lit, unobstructed, and contain clearly indicated markings at 0 and 5 meters
- Position the patient with his/her feet behind and just touching the 0-meter start line
- Instruct the patient to “**Walk at your comfortable pace**” until a few steps past the 5-meter mark (the patient should not start to slow down before the 5-meter mark)
- Begin each trial on the word “**Go**”
- Start the timer with the first footfall after the 0-meter line
- Stop the timer with the first footfall after the 5-meter line
- Repeat 3 times, allowing sufficient time for recuperation between trials

Note: Patient may use a walking aid (cane, walker). If the patient is receiving an IV drip, he/she should perform the test without the IV only if it can be interrupted temporarily without any potential risk to the patient, if not, then the patient may perform the test pushing the IV pole.

Grip strength test²: The grip strength test is used to determine the strength in each of the participant's hands.

Procedure:

- Equipment: Hand Dynamometer
- Illustrate the use of the instrument to the participant prior to testing.
- The participant should be in a seated position.
- Ask the participant to squeeze the dynamometer with as much force as possible, being careful to squeeze only once for each measurement.
- Three trials should be made for the right hand followed by three trials for left hand with a pause of about 10-20 seconds between each trial to avoid the effects of muscle fatigue.
- The highest reading for each hand should be reported on the case report form.

¹ Fried LP et al. (2001). Frailty in older adults: Evidence for a phenotype. *Journal of Gerontology: Medical Science*, 56A (3), M146-M156.

² Luna-Heredia E, Martin-Pena G, Ruiz-Galiana J. Handgrip dynamometry in healthy adults. *Clinical Nutrition* 2005; 24:250-258

R.20 Katz Index of Independence in Activities of Daily Living

Activities Points (1 or 0)	Independence (1 POINT) NO supervision, direction or personal assistance	Dependence (0 Points) WITH supervision, direction, personal assistance or total assistance
BATHING Points: _____	(1 POINT) Bathes self completely or needs help in bathing only a single part of the body such as the back, genital area or disabled extremity.	(0 POINTS) Needs help with bathing more than one part of the body, getting in or out of the tub or shower. Requires total bathing.
DRESSING Points: _____	(1 POINT) Gets clothes from closets and drawers and puts on clothes and outer garments complete with fasteners. May have help tying shoes.	0 POINTS) Needs help with dressing self or needs to be completely dressed.
TOILETING Points: _____	(1 POINT) Goes to toilet, gets on and off, arranges clothes, cleans genital area without help	(0 POINTS) Needs help transferring to the toilet, cleaning self or uses bedpan or commode.
TRANSFERRING Points: _____	(1 POINT) Moves in and out of bed or chair unassisted. Mechanical transferring aides are acceptable.	(0 POINTS) Needs help in moving from bed to chair or requires a complete transfer.
CONTINENCE Points: _____	(1 POINT) Exercises complete self-control over urination and defecation.	(0 POINTS) Is partially or totally incontinent of bowel or bladder.
FEEDING Points: _____	(1 POINT) Gets food from plate into mouth without help. Preparation of food may be done by another person.	(0 POINTS) Needs partial or total help with feeding or requires parenteral feeding.

TOTAL POINTS = _____
 6 = High (patient independent)
 0 = Low (patient very dependent)

Slightly adapted from Katz S., Down, T.D., Cash, H.R. et al. (1970)
 Progress in the Development of the Index of ADL. Gerontologist
 10:20-30. Copyright The Gerontological Society of America

R.21 Investigator Brochure / Report of Prior Investigations for the Investigational Devices

The geography-specific Investigator Brochure for the Medtronic CoreValve™ System will be provided separately, as applicable.

R.22 Investigational Devices Instructions For Use

The geography-specific Instructions For Use for the Medtronic CoreValve™ System will be provided under separate cover.

R.23 Radiation Exposure and Data Collection

The SURTAVI protocol requires several tests and procedures that expose subjects to radiation (angiograms, arteriograms and fluoroscopy). These tests and procedures are essential to appropriate patient selection and proper deployment of the study valves.

Procedure	Interval
Multi-slice Computed Tomography (MSCT) Angiogram	Screening
Coronary arteriogram	Screening Index Procedure – TAVI only
Aorotogram	Index Procedure – TAVI only

The following describes radiation exposure data collection requirements as well as parameters for additional subject follow-up.

Follow-up and Data Collection

Data regarding subject radiation exposure will be collected at all protocol intervals where radiation test or procedures are required.

- Screening
- Index-Procedure (TAVI only)
 - Percutaneous Coronary Intervention (PCI) – if staged approach
- Reintervention (Valve related)

NOTE: Based on the protocol design, imaging required at screening may have been completed prior to the subject signing the informed consent form and data related to radiation exposure during the acquisition of the images may not be available. **Radiation exposure data missing from the subject record will not be considered a protocol deviation.**

Substantial Radiation Dose Level

For purposes of SURTAVI, substantial radiation dose level (SRDL) is defined as meeting/exceeding one of the following:

Dose Metric	SRDL
Total air kerma at IRP ($K_{a,r}$)	3 Gy
Kerma-area product (P_{ka})	250 Gy·cm ²
Fluoroscopy Time	60 min

In cases where SRDL is met or exceeded additional steps should be taken.

- Document the radiation dose the subject was exposed to in the medical record
- Include an explanation regarding the medical necessity
- Describe the planned follow-up
- Notify the subject and caregiver, if applicable
 - Instruct subject (and caregiver) to perform visual skin assessments at least once per week between in-clinic visits
 - If a hand-sized red area or rash is noted, contact the Investigator immediately to schedule a follow-up visit

To ensure signs and symptoms of radiation exposure are identified as soon as possible, subjects should have a routine visual skin assessment at the following protocol intervals:

- Baseline
- Immediate Post-Procedure – within 48 hours of TAVI
- Discharge
- 30-days

Additional follow-up should be scheduled at the Investigators discretion based on progression of symptoms, as applicable.

If skin changes are noted at any interval additional follow-up should be scheduled with a dermatologist, or physician with the appropriate training and expertise for diagnosis and treatment. Long-term follow-up should be conducted in accordance with local standard of care.

Skin assessment findings should be noted in the patient medical record and applicable adverse events should be reported.

Threshold for Radiation Dose Exposure

Chronology and Severity of Tissue Reactions From Single-Delivery Radiation Dose

Single site (Gy) acute skin dose	Prompt (<2 weeks)	Early (2–8 weeks)	Mid term (6–52 weeks)	Long term (<40 weeks)
	No observable effects expected			
2-5	Transient erythema	Epilation	Recovery from hair loss	None expected
5-10	Transient erythema	Erythema, epilation	Recovery; high doses cause prolonged erythema and permanent partial epilation	Recovery; higher dose cause dermal atrophy/induration
10-15	Transient erythema	Erythema, epilation; dry/moist desquamation	Prolonged erythema permanent epilation	Telangiectasia; dermal atrophy/induration
>15	Transient erythema; Very high dose causes moist desquamation edema/ulceration	Erythema, epilation	Dermal atrophy with secondary ulceration; atrophy/induration; High dose dermal necrosis surgical repair likely	Telangiectasia; dermal Late skin breakdown

Modified: Balter S. Fluoroscopically guided interventional procedure: A review of radiation effects on skin and hair. NCRP SC 2–3, Feb 2010.

List of Abbreviations

Abbreviation	Term
Gy	Gray
IRP	Interventional reference point
KAP	Kerma area product
PSD	Peak skin dose
SDRL	Substantial radiation dose level

References

Balter, S. Moses, J. Managing Patient Dose in Interventional Cardiology. *Catheterization and Cardiovascular Interventions* 2007; 70:244–249

Chambers, et al. Radiation Safety Program for the Cardiac Catheterization Laboratory. *Catheterization and Cardiovascular Interventions* 2011; 77:546–556

Hirshfield, et al. ACCF/AHA/HRS/SCAI Clinical Competence Statement on Physician Knowledge to Optimize Patient Safety and Image Quality in Fluoroscopically Guided Invasive Cardiovascular Procedures: A Report of the American College of Cardiology Foundation/American Heart Association/American College of Physicians Task Force on Clinical Competence and Training *Circulation* 2005, 111:511-532

R.24 SURTAVI Risk Model

Risk assessment is essential in the strategy to approach patients with valvular heart disease in general and AS in particular. Various risk models primarily focusing on short-term mortality have been validated for AS patients (30-38). Some were initially derived from a broader patient population undergoing any type of cardiac surgery, others were more explicitly tailored to patients with AS. Most notably, contemporary scoring models tend to be consistent in lower risk patients but diverge with increasing risk profile. This can be partly explained by the fact that these models were extracted from large databases where the average patient risk is fairly low. Therefore such models are less well validated for higher risk patients and expectedly perform less well in the “outlier” population currently considered for TAVI (39).

An in-depth reappraisal of existing scoring models reveals some concordant risk factors (e.g. age, gender) but also established risk factors that are clearly missing (e.g. mediastinal radiation, porcelain aorta and frailty) (40-42). Furthermore definitions of individual components are not uniform and do not correspond to current suggested guidelines/definitions by respective professional societies.

R.24.1 SURTAVI Risk Model Rationale

1. Joint database

Following the initial report by the Bern, Rotterdam collaboration (28) including 1122 patients with severe AS, four academic institutions in Bern, Rotterdam, Bad Nauheim and Munich have created a joint database on all consecutive patients with severe AS treated with either TAVI or SAVR between January 2006 and December 2009.

Preliminary analysis on 3688 patients has been performed, including 789 TAVI and 2899 SAVR patients.

The pre-specified primary outcome was all cause mortality at 1 year. Patients were actively followed up after the index procedure and their vital status confirmed by outpatient clinic visit, telephone contact, review of medical records or national civil registries.

2. Statistical methods

The propensity scores of SAVR patients were estimated using a probit model with all baseline characteristics as described above as independent variables. The propensity score is the probability that a patient would have been treated with SAVR given that patient's observed baseline characteristics. To ensure the quality of the matching using propensity scores the common support assumption was applied, using the Epanechnikov kernel probability density estimates. The IPT weighted multivariable analysis was used. The IPT weighted analyses used the inverse of the propensity score as weights in SAVR patients and the inverse of 1 minus the propensity score in TAVI patients. All analyses were based on logistic regression models on the 1 year mortality and were performed in the overall dataset and stratified according to presence or absence of sufficient overlap of propensity scores (propensity score <0.675 versus ≥0.675).

3. Type of patient (patient selection)

Preliminary analysis demonstrated a pre-dominance of patients with age >80 years old, and a logistic EuroSCORE <20% in the TAVI cohort (figure “scatterplot”). However, the majority of patients in the entire study population are between 65-and 83-years-old (figure “age distribution”).

**SURTAVI Clinical Investigation Plan - Appendix
(Surgical Replacement and Transcatheter Aortic Valve Implantation)**

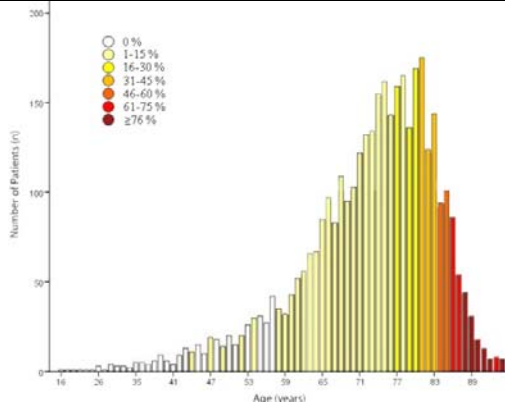

The distribution of age in patients treated for aortic stenosis. The color indicates the percentage of patients treated with TAVI in the corresponding age group

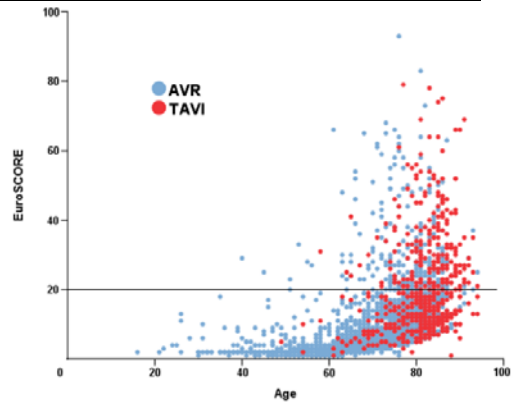

A scatterplot showing the age and corresponding EuroSCORE of patients treated for aortic stenosis. Indicated by colours are the treatment arms surgical aortic valve replacement and transcatheter aortic valve implantation. A previous commonly used EuroSCORE cut-off value of 20% is indicated in the graphic to show that many patients with lower scores are already treated by TAVI, but in lower ages this treatment remains limited due to the low EuroSCORE.

As it is well-known that both the STS score and EuroSCORE are suboptimal in operative risk assessment, these models are only used for descriptive purposes (39). Age is the predominant predictor of mortality in general, and after valve surgery in particular. Furthermore, the impact of other risk factors appears to be accentuated in an older age population.

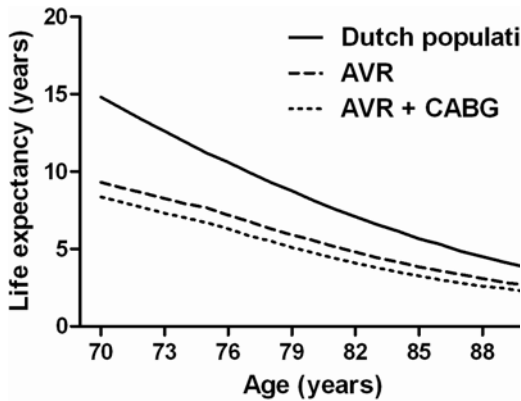

Survival curves of the general Dutch population (derived from death register); and patients undergoing an AVR (derived from meta-analysis data), or an AVR with the additional risk factor of coronary sclerosis (derived from meta-analysis data).

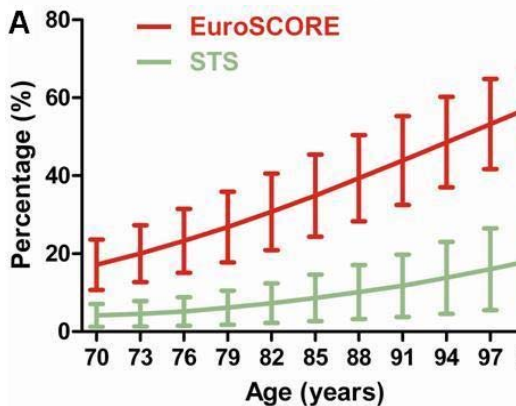

The range of both the EuroSCORE and STS score in a patient with 2 risk factors. The lower boundary indicates a score with risk factors that have little influence on the score, while the upper boundary indicates a score with risk factors that influence the score significantly

Therefore, we opt for a risk assessment based on age in combination with encoded co-morbidities selected from a pre-specified listing. Patients at intermediate risk are defined as age 70-74 years with 2 or 3 co-morbidities (cohort 1); age 75-79 years with 1 or 2 co-morbidities (cohort 2); and patients ≥80 years of age with ≤1 co-morbidities (cohort 3).

In-depth analysis and translation of the risk profile mentioned above to the STS score (table STS below):

- Cohort 1: range of 0.9% to 10.2% in males, and 1.4% to 14.8% in females
- Cohort 2: range of 1.2% to 8.5% in males, and 1.8% to 12.4% in females
- Cohort 3*: range of 1.7% to 8.9% in males, and 2.6% to 12.7% in females

Male		70 yr	73 yr	76 yr	79 yr	82 yr	85 yr	88 yr	91 yr
Risk factors	0	1.7	2.1	2.5	3.0
	1	1.2 - 3.6	1.4 - 4.3	1.7 - 5.2	2.1 - 6.2	2.5 - 7.4	3.0 - 8.9
	2	0.9 - 5.7	1.0 - 6.3	1.2 - 7.1	1.4 - 8.5
	3	1.1 - 9.3	1.2 - 10.2
Female		70 yr	73 yr	76 yr	79 yr	82 yr	85 yr	88 yr	91 yr
Risk factors	0	2.6	3.2	3.8	4.5
	1	1.8 - 5.4	2.2 - 6.5	2.6 - 7.7	3.2 - 9.2	3.8 - 10.9	4.5 - 12.7
	2	1.4 - 8.4	1.6 - 9.3	1.8 - 10.5	2.2 - 12.4
	3	1.7 - 13.5	1.9 - 14.8

STS score: ranges of scores are displayed as: score with least influential risk factors – score with most influential risk factors. *Upper age limit 91 years old

In-depth analysis and translation of the risk profile mentioned above to the logistic EuroSCORE (Table EuroSCORE below):

- Cohort 1: range of 9.1% to 42.3% in males, and 12.2% to 50.5% in females
- Cohort 2: range of 7.2% to 32.1% in males, and 9.8% to 39.6% in females
- Cohort 3*: range of 6.6% to 27.8% in males, and 9.0% to 34.9% in females

Male		70 yr	73 yr	76 yr	79 yr	82 yr	85 yr	88 yr	91 yr
Risk factors	0	6.6	8.0	9.6	11.4
	1	7.2 - 12.4	8.7 - 14.8	10.4 - 17.5	12.4 - 20.5	14.7 - 24.0	17.4 - 27.8
	2	9.1 - 20.6	10.9 - 24.0	13.0 - 27.9	15.4 - 32.1
	3	16.2 - 37.5	19.1 - 42.3
Female		70 yr	73 yr	76 yr	79 yr	82 yr	85 yr	88 yr	91 yr
Risk factors	0	9.0	10.7	12.8	15.2
	1	9.8 - 16.5	11.7 - 19.4	13.9 - 22.7	16.5 - 26.4	19.4 - 30.5	22.7 - 34.9
	2	12.2 - 26.5	14.5 - 30.6	17.2 - 35.0	20.2 - 39.6
	3	21.1 - 45.5	24.7 - 50.5

Euroscore: ranges of scores are displayed as: score with least influential risk factors – score with most influential risk factors. *Upper age limit 91 years old

4. Comparative patient outcome

One-year mortality amounts to 30% in the overall high-risk matched population with a logistic EuroSCORE of 15.8%. The hazard ratio of propensity matched patients between SAVR and TAVI is 0.97. This suggests equipoise for both treatment strategies and is the legitimation for a randomized trial in this intermediate risk AS population.

R.24.2 SURTAVI co-morbidity list

Methodology for identifying enlisted co-morbidities:

We first identified those components recurring in the previously published scoring models and looked for updated definitions by international professional societies. We then added missing risk factors, identified in the literature, which we felt, were essential. In addition, there exists an 'open box' to capture less prevalent and unanticipated risk factors (e.g. liver failure, mediastinal radiation, porcelain aorta, etc.)

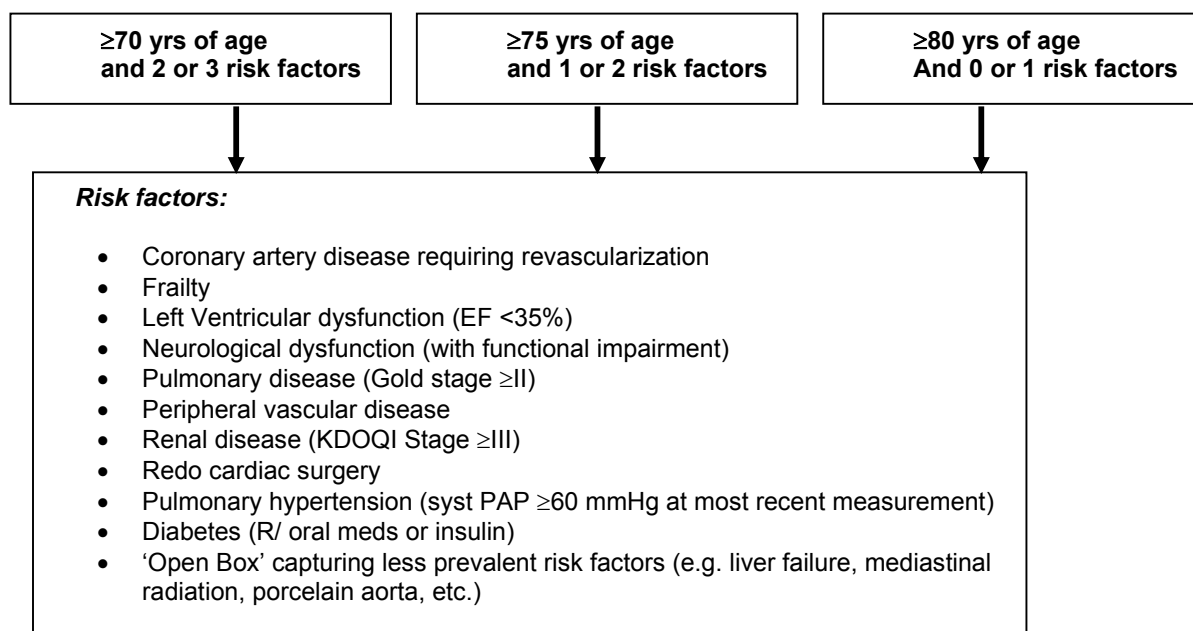

The above risk factors will guide the Heart Team in the selection of the treatment options but will not dictate patient allocation. The final decision treatment will be done by the local Heart Team.

1. Significant concomitant Coronary Artery Disease: defined as ≥70% stenosis by invasive coronary angiography because the combination of revascularization and aortic valve replacement reduces the rates of perioperative MI, perioperative mortality, late mortality and morbidity when compared with patients not undergoing simultaneous revascularization (ACC/AHA/ESC class IC recommendation)(6, 43, 44). Previous CABG or PCI is not considered to have considerable impact on short term outcome.
2. Frailty: in the absence of a generally accepted consensus definition Frailty is defined as suggested by Lee and co-workers by the presence of any 1 of the following⁽⁴⁰⁾:
 - Katz score(independence in Activities of Daily Living);
 - Ambulation (walking aid/assist?);
 - Diagnosis of (pre-)dementia.
3. Left Ventricular dysfunction: defined as EF < 35%, with respect to the pivotal position of this particular threshold in the heart failure population⁽⁴⁵⁾.

4. Neurological dysfunction: Cerebro-Vascular Disease, documented by any one of the following: CVA (symptoms lasting >24 hours or imaging of an acute clinically relevant brain lesion in patients with rapidly vanishing symptoms); TIA (brief episode of neurological dysfunction caused by a focal disturbance of brain or retinal ischemia, with clinical symptoms with recovery within 24 hrs and without evidence of infarction); Non-invasive carotid test with > 60% diameter occlusion or prior carotid surgery or symptomatic carotid stenosis > 50%⁽⁴⁶⁻⁴⁹⁾. Does not include neurological disease processes such as metabolic and/or anoxic ischemic encephalopathy.
5. Pulmonary disease: COPD Gold Stage II: moderate COPD with worsening airflow limitation (FEV1/FVC <70%; 50% ≥ FEV1 <80% predicted), with shortness of breath typically developing on exertion⁽⁵⁰⁾.
6. Peripheral vascular disease: adapted from the STS risk model: Claudication, either with exertion or at rest; Amputation for arterial vascular insufficiency; Vascular reconstruction, bypass surgery, or percutaneous intervention to the extremities; Documented aortic aneurysm with or without repair; Positive non-invasive test (e.g., ankle brachial index ≤ 0.9, ultrasound, magnetic resonance or computed tomography imaging of > 50% diameter stenosis in any peripheral artery, i.e., renal, subclavian, femoral, iliac)
7. Renal disease: at least moderate chronic kidney disease with GFR < 60 mL/min according to the National Kidney Foundation kidney disease outcome quality initiative advisory board⁽⁵¹⁾.
8. Redo cardiac surgery
9. Pulmonary hypertension (> 60mmHg at most recent measurement)
10. Diabetes Mellitus on oral or insulin therapy.
11. OPEN BOX: e.g., extensive mediastinal radiation, chest wall deformity, Liver Failure Child-C

Patients available for screening



All patients

		Comorbidities (n)						Total cases
		0	1	2	3	4	≥5	
Age (yrs)	<60	107	85	17	11	1	1	222
	60-64	47	37	15	8	0	0	107
	65-69	57	53	24	10	5	0	149
	70-74	60	66	47	10	5	4	192
	75-79	64	89	38	20	5	2	218
	≥80	46	53	43	35	6	11	194
							1082	

	SAVR	668/1082	61.7%
	Random --> TAVI / SAVR	283/1082	26.2%
	Too high risk	131/1082	12.1%

SAVR patients

		Comorbidities (n)						Total cases
		0	1	2	3	4	≥5	
Age (yrs)	<60	106	84	17	11	0	0	218
	60-64	47	37	14	6	0	0	104
	65-69	57	52	23	8	3	0	143
	70-74	59	65	44	5	4	0	177
	75-79	60	83	33	14	1	0	191
	≥80	36	32	15	3	0	0	86
							919	

	SAVR	649/919	70.6%
	Random --> TAVI / SAVR	233/919	25.4%
	Too high risk	37/919	4.0%

TAVI patients

		Comorbidities (n)						
		0	1	2	3	4	≥5	Total Cases
Age (yrs)	≤ 60	1	1	0	0	1	1	4
	60-64	0	0	1	2	0	0	3
	65-69	0	1	1	2	2	0	6
	70-74	1	1	3	5	1	4	15
	75-79	4	6	5	6	4	2	27
	≥ 80	10	21	28	32	6	11	108
							163	

	SAVR	19/163	11.7%
	Random --> TAVI / SAVR	50/163	30.7%
	Too high risk	94/163	57.7%

Distribution of age and comorbidities in patients with severe aortic stenosis in the Rotterdam practice. In each age group, patients are divided by the total number of comorbidities as previously defined.

Indicated in green are the patients that are too low risk for randomization (62%). Indicated by orange are patients that will be randomized in SURTAVI (26%). In blue are patients too high risk for randomization (12%). Therefore, it is estimated that every 1 in 4 patients meets the inclusion criteria for screening.

STS versus Euro Score

This table illustrates the relative impact of common co-morbidities in STS score (vertical axis) and Euroscore (horizontal axis) risk model. This present panel relates specifically of a male patient of 70 years old with 0, 1 or 2 risk factors.

The black line separates the score values of the two respective models: below the line relates to STS score, above to Euroscore.

The empty boxes indicate that the specific risk factor is not accounted for in the risk model, e.g. diabetes in Euroscore.

If this patient has no co-morbidity he would have an STS score of 0.9 and a Euroscore of 3 (see first square in upper left corner).

If this patient has a poor LVEF combined with peripheral vascular disease he would have a STS score of 1.5 and Euroscore of 15.5

Redo surgery is displayed as “first reoperation / second reoperation”, and COPD as “moderate / severe”. Values indicated as “score - score” correspond to the range of scores possible when combining all 4 risk factors (for instance ‘moderate COPD + 1st redo’ - ‘severe COPD + 2nd redo’)

DM = diabetes mellitus; PVD = peripheral vascular disease; CVD = cerebrovascular disease; LVEF = left ventricular ejection fraction; CAD = coronary artery disease; NYHA = New York Heart Association; COPD = chronic obstructive pulmonary disease; PH = pulmonary hypertension

		EUROSCORE												
		None	DM	PVD	CVD	Poor LVEF	CAD	NYHA III / IV	Redo Surgery	Renal Failure	COPD	Dialysis	PH	Neurologic Dysfunction
STS SCORE	None	0.9 3.0	...	5.8	...	8.7	8.0	5.8	5.0	...	6.4	6.9
	DM	1.2
	PVD	1.2	1.5	15.5	14.3	10.5	9.1	...	11.7	12.5
	CVD	0.9	1.2	1.2
	Poor LVEF	1.2	1.5	1.5	1.2	20.6	15.4	13.5	...	17.0	18.1
	CAD	0.9	1.2	1.2	0.9	1.2
	NYHA III / IV	0.9 / 1.3	1.2 / 1.7	1.2 / 1.6	0.9 / 1.3	1.2 / 1.7	0.9 / 1.3
	Redo Surgery	1.5 / 1.8	1.9 / 2.2	1.9 / 2.2	1.5 / 1.8	2.0 / 2.3	1.5 / 1.8	1.5 - 2.5	...	14.3	12.4	...	15.7	16.8
	Renal Failure	1.8	2.3	2.2	1.8	2.3	1.8	1.8 / 2.5	2.9 / 3.4	...	9.1	...	11.6	12.4
	COPD	1.5 / 1.9	1.9 / 2.4	1.9 / 2.4	1.5 / 1.9	2.0 / 2.5	1.5 / 1.9	1.5 - 2.7	2.9 / 3.6	2.9 / 3.6	10.1	10.8
	Dialysis	2.9	3.6	3.5	2.9	3.7	2.9	2.9 / 4.0	4.6 / 5.3	2.9	4.5 / 5.7
	PH	13.7
	Neurologic Dysfunction

R.25 CMS Considerations for Coverage and Reimbursement – US ONLY

The SURTAVI protocol outlines the minimum requirements for trial participation, patient screening by the local Heart Team, and conduct of the TAVI procedure.

Within the United States, sites and Investigators should adhere to the following additional CMS requirements for coverage and reimbursementⁱ, as applicable to the Medicare patient population enrolled in the study:

Section C.4.2.1 Heart Team Composition

Local Heart Teams should be comprised of a multidisciplinary team qualified by education and experience to determine appropriate patient treatment.

Minimum Membership

- Interventional Cardiologist - ≥ 1 representative is required
- **Cardiac Surgeon - ≥ 2 representatives are required**

Recommended Membership

Additional members of the Heart Team should be included based on current standard practices and patient specific considerations, including but not limited to:

- Echocardiographer
- Anesthesiologist
- Cardiologist (general or referring physician)
- Geriatrician
- Neurologist or stroke specialist
- Radiologist or imaging specialist
- Heart Failure specialist
- Intensivist
- Nurse
- Social Worker

Section C.4.6.1 TAVI

TAVI Procedure

- **Joint Participation**
 - The heart team's interventional cardiologist(s) and cardiac surgeon(s) must jointly participate in the intra-operative technical aspects of the TAVI procedure

ⁱ [http://www.cms.gov/medicare-coverage-database/details/nca-decision-memo.aspx?NCAId=257&ver=4&NcaName=Transcatheter+Aortic+Valve+Replacement+\(TAVR\)&bc=ACAAAAAIAA&A&](http://www.cms.gov/medicare-coverage-database/details/nca-decision-memo.aspx?NCAId=257&ver=4&NcaName=Transcatheter+Aortic+Valve+Replacement+(TAVR)&bc=ACAAAAAIAA&A&)

CardioVascular Structural Heart Clinical Department

SURTAVI

STATISTICAL ANALYSIS PLAN

Revision 1A

16-May-2012

Surgical Replacement and Transcatheter Aortic Valve Iplantation
Version 4.0, 10-May-2012

Prepared by:
Sharla Chenoweth, MS
Sr. Principal Statistician

Bayesian Design by:
Andrew S Mugglin, PHD
Paradigm Biostatistics, LLC

Table of Contents

A	PURPOSE OF SAP	4
B	RATIONALE FOR STUDY DESIGN	4
C	STATISTICAL METHODS AND ANALYSIS	4
C.1	Statistical considerations and analysis.....	4
C.2	Description of Baseline Variables.....	4
C.3	Analysis Populations	5
C.3.1	Screening population.....	5
C.3.2	Randomized population.....	5
C.4	Primary analysis	5
C.4.1	Hypothesis of non-inferiority.....	5
C.4.2	Randomization, Sample Size, and Analysis Plan	5
C.5	Predictions.....	7
C.5.1	Prior Distributions for Transition Probabilities	9
C.6	Operating Characteristics	11
C.7	Simulation Details and Design Sensitivity	11
C.7.1	LTFU/Data Missingness	12
C.7.2	Control Arm Event Rate	12
C.7.3	Rate of Enrollment.....	13
C.7.4	Temporal Correlation.....	13
C.7.5	Type I Errors.....	16
C.8	Missing Data and Planned Sensitivity Analyses (Primary Objective).....	16
C.9	Description of performed analysis, per population	17
C.9.1	Analysis of screening population.....	17
C.9.2	Analysis of mITT population	17
C.9.3	Analysis of implanted population.....	17
C.10	Secondary Endpoints	18
C.11	Analysis Methods for Secondary Objectives	21
C.11.1	Discrete (Dichotomous) Data: Bayesian Version of a Comparison of Proportions	21
C.11.2	Discrete (Polytomous) Data: Bayesian Version of a Comparison of Proportions.....	21
C.11.3	Discrete (Dichotomous) Data: Bayesian Comparison of Proportions (with Predictions)	21
C.11.4	Continuous Data: Bayesian version of a t-test.	22

C.11.5	Continuous Data (Distribution-free, Superiority): Bayesian Version of a Wilcoxon Rank-Sum Test.....	22
C.12	Multiplicity Considerations	23
C.12.1	Ordered List of Secondary Objectives to be Tested To Support Labeling Claims.....	23
C.13	Heterogeneity/Poolability	24
C.13.1	Geography Poolability Analysis	25
C.13.2	Site Poolability Analysis	25
C.14	Pre-Defined Subgroups	26
C.14.1	Health-Related Quality of Life (HRQoL) and Treatment Costs.....	26
C.14.2	Quality of Life	26
C.15	Economic Outcomes/Cost-Effectiveness	27
C.16	Use of Data for CE Mark	27
D	REVISION PROCESS	27
E	DISTRIBUTION	27

A PURPOSE OF SAP

This Statistical Analysis Plan has been designed to document, before data are analyzed, the rationale for the study design, and the planned analyses that will be included in study reports. The design and analyses are consistent with the objectives of the Clinical Investigational Plan (CIP).

B RATIONALE FOR STUDY DESIGN

The purpose of this study is to evaluate the safety and efficacy of the Medtronic CoreValve® System in the treatment of symptomatic severe aortic stenosis in subjects who have a predicted intermediate (STS 4-10) for aortic valve surgery. Intermediate risk surgical subjects will be randomized to receive either transcatheter aortic valve implant (TAVI) with the Medtronic CoreValve® System (MCS) or surgical aortic valve replacement (SAVR) in a 1:1 ratio.

This statistical analysis plan is developed based on the Clinical Investigational Plan Version 4.0.

C STATISTICAL METHODS AND ANALYSIS

The SURTAVI study is a multicenter, multinational, prospective, adaptive, 1:1 randomized study designed to demonstrate non-inferiority (to within a relative margin of 20%) of TAVI to SAVR with the Medtronic CoreValve® System, as measured by a composite of all-cause death and major stroke incidence at 24 months. The study is designed to adaptively determine sample size. Once the sample size (N) becomes known, study success will be evaluated at an interim analysis that is timed to occur 12 months later (with the expectation that all subjects will have at least 12 months of follow-up); if necessary, study success will again be evaluated when all subjects have reached 24 months.

A study report will be prepared for submission to FDA at the time study success criteria have been met, for the purpose of seeking marketing approval. After all subjects have completed all protocol-specified follow-up, a final clinical report including updated long-term safety data will be prepared and submitted.

Any deviations from this section and/or the Statistical Analysis Plan will be described and justified in the Final Report, as appropriate.

C.1 Statistical considerations and analysis

This section describes the statistical considerations and analysis plans for the SURTAVI trial. The statistical analysis will be performed by the statistics department of Medtronic. As primary analysis, all randomized subjects will be analyzed following the modified intention to treat (mITT) approach; i.e., analyses will be conducted on the cohort of subjects who undergo an attempted study treatment, analyzed according to the randomized assignment. A secondary analysis of key objectives will be performed according to the therapy actually received. All follow-up periods are defined as the number of days after the procedure date.

C.2 Description of Baseline Variables

Baseline demographic and clinical variables will be summarized for each of the treatment groups for the randomized, modified intent-to-treat (mITT), and implanted populations (as-treated). All continuous variables will be summarized as means, medians, standard deviations and interquartile ranges and compared between treatment groups using a Bayesian analog of a two-sample t-test or the non-parametric Wilcoxon rank-sum test. Categorical variables will be summarized as frequencies and percentages and compared between treatment groups using a Bayesian version of a comparison of proportions.

C.3 Analysis Populations

C.3.1 Screening population

All patients with symptomatic severe AS that provide informed consent will be considered screened and all available data will be entered into the EDC system.

C.3.2 Randomized population

If the patient signs informed consent, meets all inclusion and none of the exclusion criteria, and Heart Team determines the patient is suitable for randomization in the trial, the patient is added to the randomized population once the treatment assignment is made. Within the randomized population three subpopulations are distinguished:

- The intention to treat (ITT) population, - Patients are reported according to the randomized assignment, SAVR or TAVI, regardless of what, if any, therapy was actually received.
- The modified intention to treat (mITT) population – Patients who undergo an attempted study treatment are reported according to the randomized assignment, SAVR or TAVI, regardless of what, if any, therapy was actually received. A procedure attempt is defined as when the subject is brought into the procedure room and any of the following have occurred: anesthesia administered, vascular line placed, TEE placed or any monitoring line placed.
- The implanted population: This population includes the mITT patients who are actually implanted with either the CoreValve device or a surgical valve. Depending on context, subjects may be analyzed according to randomized treatment assignment or treatment actually received.

The primary objective and most secondary objectives will be evaluated using the mITT population.

C.4 Primary analysis

The primary endpoint of all-cause mortality or major stroke at 24 months will be evaluated using the relative risk of the TAVI rate and the SAVR rate for all-cause mortality or major stroke during a fixed follow-up of 24 months' time. The hypothesis test is designed to show non-inferiority of TAVI to SAVR for the primary endpoint.

C.4.1 Hypothesis of non-inferiority

The primary objective is to establish that TAVI is non-inferior to SAVR for the primary endpoint. The hypothesis of interest is:

$$H: \pi_T / \pi_C < 1 + \delta$$

where π_T and π_C denote binary rates of all-cause mortality or major stroke during a fixed follow-up of 24 months for the treatment (TAVI) and control (SAVR) groups, for a population with an STS score in the range 4-10. This study is designed using Bayesian statistical techniques. TAVI will be declared to be non-inferior to SAVR if it can be established that the posterior probability $\Pr(H_{\delta=0.20} | \text{data}) > \Psi$, where Ψ is a pre-specified threshold value. If, in addition, it can be shown that $\Pr(H_{\delta=0} | \text{data}) > \Psi$, TAVI will be declared to be superior to SAVR. The value chosen for Ψ is described below.

C.4.2 Randomization, Sample Size, and Analysis Plan

Randomization will follow a 1:1 (treatment:control) allocation ratio and be stratified by site and need for revascularization, using a blocked randomization scheme with blocks of randomly varying sizes. This study is designed to adaptively determine the proper sample size. Possible sample sizes are 1000, 1500, 2000, 2500, 3000, and 3700 (maximum). Once the final sample

size has been determined, an interim analysis (timed to occur 12 months later) will be conducted for the purpose of possibly passing the primary objective early. If the criterion for passing the primary objective is not met at that time, follow-up will continue until all subjects have reached 24 months, and a final analysis will occur.

C.4.2.1 Determination of Sample Size

The sample size is guided by a standard frequentist non-inferiority power analysis. Under the assumptions of $\pi_T = \pi_C = 0.25$, $\delta=0.2$, 1:1 randomization, $\alpha= 0.05$, and power = 80%, the method of Farrington and Manning¹ as implemented in PASS 2005² indicates that the required sample size for a single-look analysis is 2240. To allow for up to 6% dropout, 2383 subjects must be accrued. Furthermore, to compensate for power lost in a two-look group sequential analysis plan using Pocock-type alpha spending, the sample size would have to be increased by about 12.5%^{3,4}. This leads to an estimated sample size of 2680.

The assumed values $\pi_T = \pi_C = 0.25$ are based on the PARTNER Cohort A results⁵, the Kaplan-Meier estimate at one-year follow-up for SAVR was 28.0%. This trial however had a higher-risk population than SURTAVI. Therefore, the PARTNER A rate is adjusted downwards and a two-year follow-up period instead of a one-year follow-up period is used. The resulting 25% should be a conservative estimation of the 24 month SURTAVI rate. Uncertainty in these event rates motivates the use of a design where the sample size can be determined adaptively. If $\pi_T = \pi_C = 0.30$, calculations similar to the above yield a required sample size of 2088; while if $\pi_T = \pi_C = 0.20$, a size of 3574 is required. Of course, if $\pi_T \neq \pi_C$, more or fewer subjects may be required. This uncertainty motivates an adaptive design with possible sample sizes of 1000, 1500, 2000, 2500, 3000, 3700. It is intended that the design will achieve at least 80% power for $\pi_T = \pi_C = 0.25$ and $\pi_T = \pi_C = 0.30$ and at least 75% power for $\pi_T = \pi_C = 0.20$, while allowing early stopping of subject accrual (for either evidence of efficacy or futility) and an interim analysis for a possible "early win."

This study is designed using Bayesian statistical techniques. The sample size determination algorithm is as follows. At a pre-defined analysis time (e.g., when $N=N_i$ subjects have been accrued; $N_i = 1000, 1500, 2000, 2500, \text{ or } 3000$), two predictive probabilities are calculated:

- $PP_{win} = \text{Pr}(\text{Eventual Win} \mid \text{Data}, N=N_i \text{ is the final sample size})$
- $PP_{fut} = \text{Pr}(\text{Eventual Win} \mid \text{Data}, N=3700 \text{ is the final sample size})$

If PP_{win} exceeds a suitably high threshold W_i , subject accrual will stop because final success looks probable. On the other hand, if PP_{fut} is less than a suitably low threshold F_i , subject accrual will stop and futility will be declared. If neither of these conditions obtains, enrollment will continue to the next larger sample size. These analyses are termed "Sample Size Looks." Thresholds W_i and F_i are listed in Table 1. Further detail on the calculation of these predictive probabilities is given in Section A.1.5 Predictions.

¹ Farrington, C. P. and Manning, G. 1990. "Test Statistics and Sample Size Formulae for Comparative Binomial Trials with Null

² Hintze, J. (2004). NCSS and PASS, Number Cruncher Statistical Systems. Kaysville UT. www.ncss.com

³ Hintze, J. (2004). NCSS and PASS, Number Cruncher Statistical Systems. Kaysville UT. www.ncss.com

⁴ Jennison C and Turnbull BW, Group Sequential Methods with Applications to Clinical Trials. Boca Raton: Chapman & Hall, 2000, p 27

⁵ Smith C, et al for PARTNER Trial Investigators, Transcatheter versus Surgical Aortic-Valve Replacement in High-Risk Patients, N Engl J Med 2011; 364:2187-98

Table 1: Thresholds for stopping enrollment for reasons of futility or probable eventual success for each of the 5 interim sample size determination analyses

Sample Size Determination Analysis (i)	Sample Size (N _i)	Threshold for Stopping for Futility (F _i)	Threshold for Stopping for Likely Future Win (W _i)
1	1000	0.05	0.85
2	1500	0.05	0.85
3	2000	0.10	0.85
4	2500	0.10	0.85
5	3000	0.10	0.85

Once subject accrual has stopped, an interim analysis (timed to occur 12 months after the last subject is accrued) for the purpose of declaring an early win will occur. At this analysis, if $P(H_{\delta=0.20} | \text{data}) > \Psi$, non-inferiority will be declared at this time, and a regulatory submission will follow. On the other hand, if $P(H_{\delta=0.20} | \text{data}) \leq \Psi$, all subjects will be followed to 24 months, when a final analysis will occur. At the final analysis, the standard for trial success will again be $P(H_{\delta=0.20} | \text{data}) > \Psi$. These two analyses are termed "Win Looks."

If, at the first (interim) "Win Look," non-inferiority is established, a test of superiority will immediately follow. If $P(H_{\delta=0} | \text{data}) > \Psi$, superiority will be claimed at this time. However, if $P(H_{\delta=0} | \text{data}) \leq \Psi$, subjects will continue to be followed and analyzed according to the same analysis plan. At the final "Win" analysis, if $P(H_{\delta=0} | \text{data}) > \Psi$, a delayed determination of superiority will be claimed.

The statistical approach for these analyses is Bayesian. The prior distributions for π_T and π_C in these calculations are Beta(1,1). The threshold Ψ is designated to be 0.972; this value is selected by trial-and-error to achieve a type I error (under simulation) of at most 0.05.

C.5 Predictions

Outcomes at 24-month are binary and are denoted "E" (for having experienced an Event) or "N" (for not having experienced an event). Predicted values of 24-month outcomes for those subjects who have not yet yielded 24-month outcomes will be based on intermediate outcomes observed at 1 month, 6 months, 12 months, and 18 months. These intermediate outcomes are:

- "E" -- subject has had a known primary event (death or major stroke) at the time point in question
- "P" -- subject is known to have had a "possible primary event" at the time point in question. "Possible primary events" are adverse events that may later be determined to be Major Strokes. This determination takes 90 days, by definition. For example, a subject may have a stroke at month 5 which cannot be known to be a Major Stroke until Month 8. At Month 6, such a subject is in the "P" state.
- "N" -- subject has not had a primary event or a "possible primary event" at the time point in question.

Subjects without 24-month outcome data will thus be considered to be in one of 26 states (13 for each treatment group). The 13 states are:

- no interim data
- E or P or N at 1 month, no subsequent data
- E or P or N at 6 months, no subsequent data
- E or P or N at 12 months, no subsequent data
- E or P or N at 18 months, no subsequent data

Subjects in the "E" state at an interim analysis can be imputed to be "E" at 24 months, with certainty. For each of the remaining 18 states (9 for each treatment group), the probability of becoming an "E" at 24 months is modeled via a Beta(a,b) prior distribution which is updated to

a Beta($a+X$, $b+Y$) distribution, based on the number X and Y of subjects who went on from that state to become 24-month "E" and "N" subjects, respectively. For example, if, in the treatment group at an interim analysis time point, it is known that 10 of 30 subjects had previously gone from the "N at 18 months" state to the "E at 24 months" state, then the transition probability from the 18-month "N" state to the 24-month "E" state will be modeled as Beta($a+10$, $b+20$). At an interim analysis time point, any treatment-group subjects residing in the "N-at-18-month-but-without-24-month-data" state will have their 24-month outcome predicted on the basis of this Beta($a+10$, $b+20$) distribution. Similar statements can be made about each of the possible transitions. As data are accrued in this study, the Beta distributions used for prediction are updated accordingly. Figure 1 graphically depicts the various possible states and transitions from them to the final state, for a generic treatment group. For clarity, the lines connecting the interim "E" state to the 24-month "E" state have been omitted. The numerical example above would apply to transition #9 in the Figure 1.

Figure 1 Graphical depiction of transitions from interim states (E = Event, P = Possible Event, N = No Event, Start) to 24-month outcome. Each transition is assigned a separate Beta(a,b) prior distribution which is updated as data are gathered.

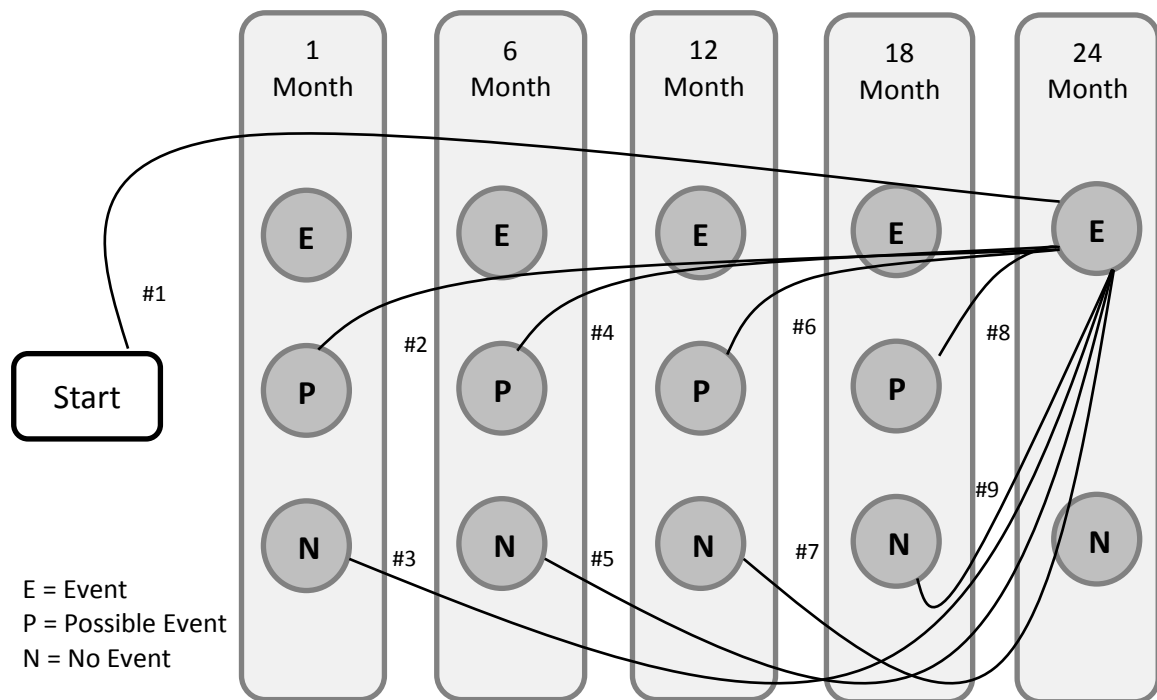

By predicting 24-month outcomes for each of these states, and combining with the data from subjects with known 24-month outcomes, a **posterior probability of non-inferiority** is calculated; it is based on observed 24-month data and also a predictive model that employs interim outcomes and the relationship between those interim outcomes and their corresponding final outcomes that is *learned during the current trial*. This is accomplished in Monte Carlo fashion. With any one imputation of incomplete data, we calculate the posterior probability $\Pr(H_{\delta=\delta^*} | \text{Observed 24-month Data, Imputed 24-month Data})$, and store it. By iterating this process and averaging these posterior probabilities, we are essentially integrating them over the predictive distribution of imputed data. This resulting quantity we have denoted as $\Pr(H_{\delta=\delta^*} | \text{Data})$. The model is very similar to that employed in Lipscomb et al.⁶ The chief differences are that this model incorporates interim outcomes at other time points (e.g., 1 month, 6 months,

⁶ Lipscomb B, Ma G, Berry D, "Bayesian predictions of final outcomes: regulatory approval of a spinal implant," *Clinical Trials*, Vol. 2, No. 4, 325-333 (2005)

18 months rather than just 12 months), and the model also considers trichotomous rather than dichotomous interim states.

The **predictive probability of eventual trial success** can be calculated in a similar manner. With any one imputation of incomplete data, we calculate the posterior probability $\Pr(H_{\delta=\delta^*} \mid \text{Observed 24-month Data, Imputed 24-month Data})$ and record whether this value exceeds the threshold Ψ . By iterating this process and reporting the proportion of times that Ψ is exceeded, we obtain an estimate of the predictive probability of eventual trial success (meaning a trial that results in a conclusion of non-inferiority).

In this trial, predictive probabilities of eventual success are used in the determination of sample size (i.e., analyses in the adaptive portion of the trial, or “Sample Size Looks”). Posterior probabilities are used for the determination of non-inferiority (i.e., analyses in the evaluation portion of the trial, or “Win Looks”).

C.5.1 Prior Distributions for Transition Probabilities

The transitions of Figure 1 are assigned individual Beta(a,b) prior distributions. For “sample size looks,” the values of a and b are tabulated in Table 2 and graphically depicted in Figure 2 (for the treatment group) and Figure 3 (for the control group). These values represent the trial sponsor’s knowledge and belief about the relationship of the various interim states to the final state. At the times when sample size decisions must be made, the number of subjects who have completed 24 months (and thus provide information on the transition probabilities) will generally be insufficient to make good sample size decisions without including some additional information. Therefore, in all Sample Size Looks, the transitions are given informative priors, as tabulated in Table 2. However, for all Win Looks, only flat priors ($a = b = 1$) for the transitions will be used.

Table 2. Parameters for Prior Distributions of the Transition Probabilities used in the determination of sample size. For all "Win" analyses, a and b are set to 1.

	Treatment Group		Control Group	
	a	b	a	b
Transition #1 (Start to E24)	21.117	61.695	21.117	61.695
Transition #2 (P1 to E24)	32.699	28.496	30.703	25.998
Transition #3 (N1 to E24)	22.633	91.792	21.206	83.650
Transition #4 (P6 to E24)	33.675	32.662	31.623	29.835
Transition #5 (N6 to E24)	23.027	129.623	21.583	118.269
Transition #6 (P12 to E24)	34.933	37.780	32.827	34.574
Transition #7 (N12 to E24)	23.853	212.300	22.370	194.040
Transition #8 (P18 to E24)	46.744	50.190	44.237	46.438
Transition #9 (N18 to E24)	26.346	528.664	24.725	484.423

Figure 2: Prior Distributions of the Transition Probabilities used in the determination of sample size (Treatment Group)

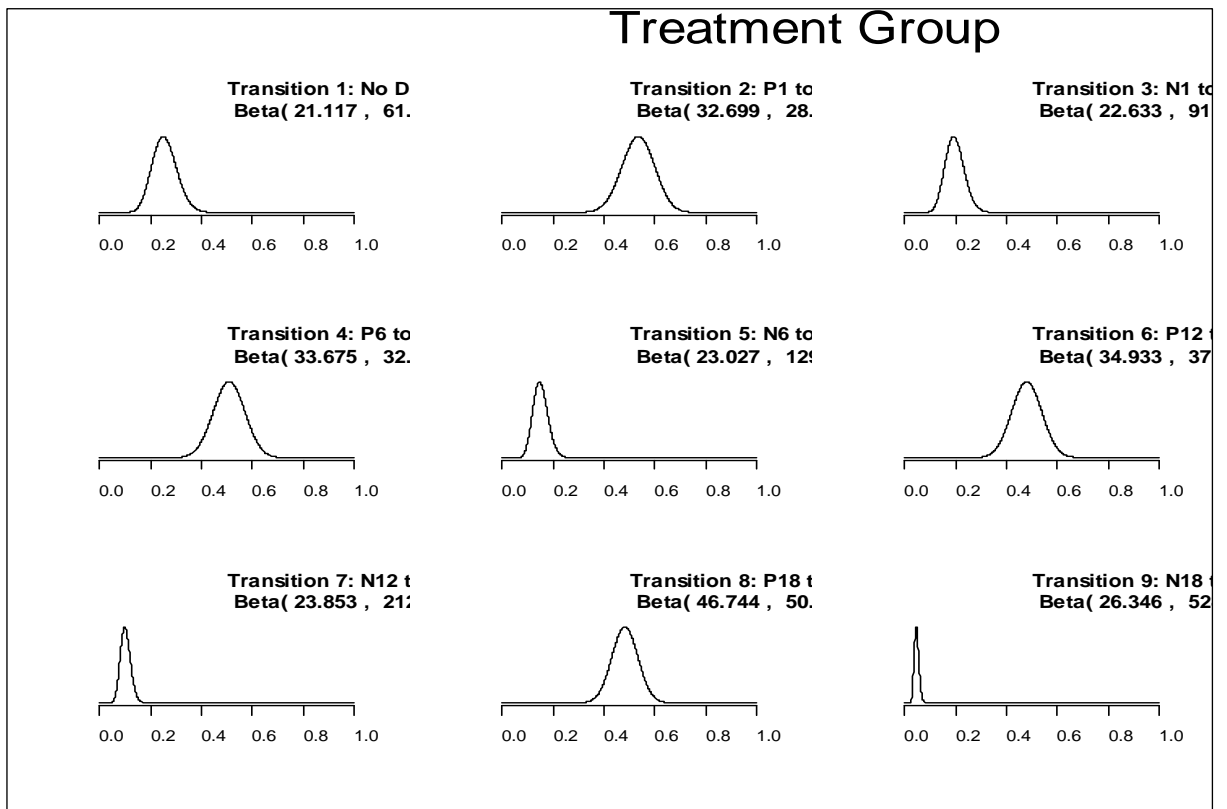
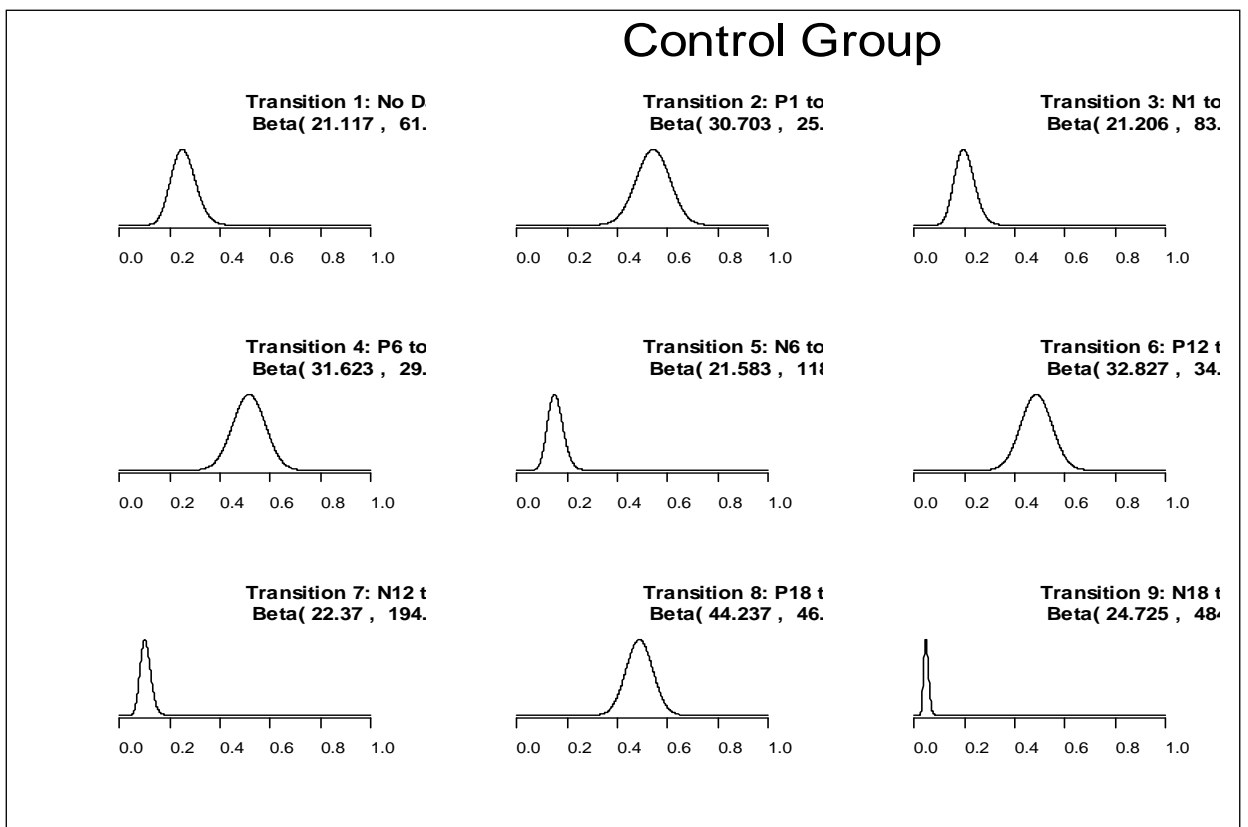

Figure 3: Prior Distributions of the Transition Probabilities used in the determination of sample size (Control Group)



C.6 Operating Characteristics

The design described above has been subjected to intensive simulations in order to evaluate its anticipated performance in practice. In the simulation, the proportion of simulated trials that result in a declaration of non-inferiority is the estimated power when $\pi_T / \pi_C < 1.2$ and the estimated type I error rate when $\pi_T / \pi_C \geq 1.2$. The estimated operating characteristics are based on 10000 simulated trials per scenario, with predictions (for each transition at each interim analysis of each of the 10000 trials) based on 5000 draws from the relevant transition probability distribution.

Table 3 displays the operating characteristics and summarizes the performance of the adaptive sample size determination algorithm under various assumed values of π_C and π_T/π_C . The column "Overall Power" is the proportion of trials that resulted in a declaration of non-inferiority (NI). The column "Early Win, Late Win" indicates at which of the two "win analyses" the "win" occurred; i.e., a trial that passed the primary objective at the interim "win" analysis would appear as an "Early Win" in the upper number, while a trial that did not pass until the final analysis would appear in the lower number as a "late win." The column "Average N" shows the average sample size attained for that row. The probability of attaining any of the allowed sample sizes (1000, 1500, 2000, 2500, 3000, 3700) is then displayed; the upper number indicates the proportion that stopped at that size because the results were promising, while the lower number indicates the proportion that stopped at that size for futility. The last column shows the proportion of trials that went to the maximum sample size of 3700.

Table 3: Operating characteristics of the design when $\pi_C = 0.25$, from a simulation of 10,000 simulated trials per line. Interpretations of column headings are given in the narrative

$\pi_C = 0.25$				Probability of Achieving Sample Size N					
π_T/π_C	Power	Early Win, Late Win	Average N	N=1000 (Promise, Futile)	N=1500 (Promise, Futile)	N=2000 (Promise, Futile)	N=2500 (Promise, Futile)	N=3000 (Promise, Futile)	N=3700
1.3	0.001	0.001 0.000	2854.9	0.000 0.000	0.000 0.000	0.001 0.004	0.004 0.483	0.002 0.360	0.147
1.2	0.041	0.031 0.010	3112.3	0.000 0.000	0.000 0.000	0.008 0.001	0.031 0.256	0.019 0.306	0.379
1.1	0.373	0.307 0.066	3205.2	0.000 0.000	0.004 0.000	0.040 0.000	0.127 0.093	0.089 0.129	0.517
1.0	0.858	0.781 0.077	2917.7	0.001 0.000	0.021 0.000	0.146 0.000	0.259 0.025	0.180 0.026	0.342
0.9	0.989	0.965 0.024	2446.4	0.004 0.000	0.080 0.000	0.331 0.000	0.323 0.004	0.156 0.002	0.099

In Table 3, the type I error rate (when $\pi_T/\pi_C = 1.2$) is 0.041. In this scenario, the trial went to its maximum size of N=3700 37.9% of the time, often stopping enrollment sooner for futility (0.001 + 0.256 + 0.306 = 0.563), and only rarely stopping enrollment early for promising trend (0.008 + 0.031 + 0.019 = 0.058). Those trials that either stopped early for promising trend or went to the maximum of 3700 were tested for an "early win" twelve months after enrollment stop, with 3.1% (of the 10,000) winning early and an additional 1.0% winning at the final analysis (for a total type 1 error rate of 0.041). When $\pi_T/\pi_C = 1.0$, the estimated power is 85.8%; the trial stopped enrolling for promising trend at N=2000 14.6% percent of the time, at N=2500 25.9% of the time, and at N=3000 18% of the time; the maximum of N=3700 occurred 34.2% of the time. The proportion of trials that passed at the interim "win" analysis was 78.1%, while an additional 7.7% passed the primary objective at the final "win" analysis. The average of the sample sizes (across the 10,000 simulated trials) was 2917.7 subjects.

C.7 Simulation Details and Design Sensitivity

In order to generate data for the operating characteristics simulations described above, several additional assumptions about the data mechanism had to be made. These assumptions are

intrinsic to the generation of artificial data in the simulation exercise but are *not* part of the analysis that is conducted on any data (real or simulated). This section describes these assumptions and also the sensitivity of the design to these assumptions.

C.7.1 LTFU/Data Missingness

Simulations were conducted under the assumption of 6% missingness over the 24-month study period. With each simulated trial, each subject was designated to be "lost" with probability 0.06; thus the exact number of subjects lost from one simulated trial to the next varied, though it was always approximately 6%. Furthermore, those subjects designated to "drop" were assumed to have dropped out uniformly in time, so that each of these subjects was dropped by 18 months with probability 18/24, each of those was in turn dropped by 12 months with probability 12/18, and so on. Marginally, the probability of being lost at 12 months was thus $0.06 \times 18/24 \times 12/18 = 0.03$, and similar statements can be made about each time point. Dropout was thus uniform in time over the 24-month study period. Artificial patients, once lost, did not return to the analysis for subsequent visits.

C.7.2 Control Arm Event Rate

A stated assumption made in the operating characteristics as displayed in Table 3 is that the control arm event rate is $\pi_C = 0.25$. Alternative scenarios were simulated in which the control arm event rate was instead 30% and 20%. The results of these simulations are provided below in Table 4. It is evident that the type I error is < 0.05 . Power is $> 95\%$ when $\pi_T/\pi_C = 1.0$ and $\pi_C = 0.30$ and $> 75\%$ when $\pi_T/\pi_C = 1.0$ and $\pi_C = 0.20$. Average sample size is smaller when $\pi_C = 0.30$.

Table 4: Operating characteristics of the design under differing control arm event rate assumptions. 10,000 simulated trials per line, with predictions based on 5000 imputations. Column interpretations are the same as in Table 3

$\pi_C = 0.30$				Probability of Achieving Sample Size N					
π_T/π_C	Power	Early Win, Late Win	Average N	N=1000 (Promise, Futile)	N=1500 (Promise, Futile)	N=2000 (Promise, Futile)	N=2500 (Promise, Futile)	N=3000 (Promise, Futile)	N=3700
1.3	0.001	0.001 0.000	2809.9	0.000 0.000	0.000 0.000	0.001 0.009	0.004 0.525	0.001 0.341	0.120
1.2	0.040	0.032 0.008	3106.2	0.000 0.000	0.000 0.000	0.009 0.002	0.026 0.268	0.019 0.298	0.378
1.1	0.443	0.368 0.075	3170.1	0.001 0.000	0.005 0.000	0.054 0.000	0.143 0.086	0.104 0.110	0.497
1.0	0.915	0.852 0.063	2763.0	0.004 0.000	0.039 0.000	0.196 0.000	0.292 0.016	0.181 0.016	0.256
0.9	0.997	0.972 0.025	2249.5	0.013 0.000	0.147 0.000	0.391 0.000	0.294 0.002	0.106 0.001	0.048
$\pi_C = 0.20$				Probability of Achieving Sample Size N					
π_T/π_C	Power	Early Win, Late Win	Average N	N=1000 (Promise, Futile)	N=1500 (Promise, Futile)	N=2000 (Promise, Futile)	N=2500 (Promise, Futile)	N=3000 (Promise, Futile)	N=3700
1.3	0.002	0.001 0.000	2913.4	0.000 0.000	0.000 0.000	0.001 0.001	0.005 0.422	0.003 0.382	0.185
1.2	0.039	0.032 0.007	3141.4	0.000 0.000	0.000 0.000	0.007 0.000	0.030 0.234	0.017 0.309	0.402
1.1	0.308	0.251 0.057	3250.4	0.000 0.000	0.002 0.000	0.031 0.000	0.098 0.097	0.074 0.154	0.544
1.0	0.769	0.685 0.084	3056.8	0.000 0.000	0.007 0.000	0.104 0.000	0.222 0.033	0.164 0.041	0.428
0.9	0.972	0.934 0.039	2678.8	0.000 0.000	0.032 0.000	0.236 0.000	0.334 0.007	0.191 0.006	0.193

C.7.3 Rate of Enrollment

The speed at which subjects are recruited into the trial is another important assumption embedded within the simulations to determine operating characteristics. It is anticipated that this study will enroll approximately 100 subjects per month, after a ramp-up period of about 12 months. Specifically, the monthly accrual in the simulation is 8, 16, 24, 32, 40, 48, 56, 64, 72, 80, 88, 100 for the first 12 months, and 100/month thereafter until accrual is complete. This is the accrual rate used in the generation of Table 3 and Table 4. Table 5 illustrates how the study design performs if enrollment is faster or slower than this expectation.

The slow speed assumes that 50 subjects are accrued per month and that the ramp-up period takes 15 months. (Monthly accrual = 3, 6, 9, 12, 15, 18, 22, 25, 28, 31, 34, 38, 42, 46, 50 for the first 15 months, and 50/month thereafter.) The fast speed assumes 120 subjects are accrued per month and ramp-up is completed in only 8 months (15, 30, 45, 60, 75, 90, 105, 120, and 120/month thereafter).

The results in Table 5 demonstrate that type I error is controlled at < 0.05 as the rate of enrollment varies. Power is in the range 84% - 89% for the cases where $\pi_T/\pi_C = 1.0$, though it is evident that sample size tends to be much smaller when the enrollment is slow.

Table 5: Operating characteristics of the design under differing assumptions about accrual rate. 10,000 simulated trials per line, with predictions based on 5000 imputations. Column meanings are the same as in Table 3

$\pi_C = 0.25$, Slow Enrollment				Probability of Achieving Sample Size N					
π_T/π_C	Power	Early Win, Late Win	Average N	N=1000 (Promise, Futile)	N=1500 (Promise, Futile)	N=2000 (Promise, Futile)	N=2500 (Promise, Futile)	N=3000 (Promise, Futile)	N=3700
1.3	0.002	0.001 0.000	2026.2	0.001 0.000	0.002 0.275	0.001 0.501	0.000 0.144	0.000 0.052	0.024
1.2	0.045	0.038 0.007	2439.8	0.004 0.000	0.017 0.116	0.013 0.353	0.006 0.198	0.005 0.122	0.165
1.1	0.373	0.334 0.039	2765.4	0.014 0.000	0.077 0.040	0.070 0.138	0.061 0.098	0.053 0.083	0.366
1.0	0.845	0.803 0.042	2399.8	0.050 0.000	0.224 0.010	0.192 0.026	0.145 0.019	0.105 0.013	0.216
0.9	0.984	0.963 0.021	1800.0	0.134 0.000	0.433 0.001	0.242 0.002	0.108 0.001	0.049 0.000	0.028
$\pi_C = 0.25$, Fast Enrollment				Probability of Achieving Sample Size N					
π_T/π_C	Power	Early Win, Late Win	Average N	N=1000 (Promise, Futile)	N=1500 (Promise, Futile)	N=2000 (Promise, Futile)	N=2500 (Promise, Futile)	N=3000 (Promise, Futile)	N=3700
1.3	0.001	0.000 0.000	3291.2	0.000 0.000	0.000 0.000	0.000 0.000	0.000 0.001	0.006 0.576	0.417
1.2	0.042	0.032 0.009	3457.0	0.000 0.000	0.000 0.000	0.001 0.000	0.005 0.000	0.041 0.294	0.659
1.1	0.384	0.305 0.079	3469.7	0.000 0.000	0.001 0.000	0.008 0.000	0.034 0.000	0.146 0.102	0.709
1.0	0.888	0.803 0.086	3169.0	0.000 0.000	0.009 0.000	0.052 0.000	0.167 0.000	0.294 0.024	0.454
0.9	0.994	0.964 0.030	2725.5	0.001 0.000	0.033 0.000	0.184 0.000	0.328 0.000	0.272 0.003	0.179

C.7.4 Temporal Correlation

For simulation, patient-level data with realistic temporal correlation had to be generated. For each treatment group, a "skeleton" of probabilities for the various state transitions was constructed, as shown below in Table 6. For example, a subject in the Treatment group could

become an "E" at 1 month with probability 0.05, a "P" at 1 month with probability 0.06, and an "N" at 1 month with probability $1 - 0.05 - 0.06 = 0.89$. If a subject is "E" at 1 month (denoted "E1" in the table), that subject becomes an "E" at 6 months with probability 1 (since subjects who have had an event by 1 month necessarily will have had that event by 6 months. If a subject is "P" at 1 month, that subject becomes an "E" at 6 months with probability 0.45, a "P" at 6 months with probability 0.05, and an N at 6 months with probability 0.50. Taken as a whole, the treatment "skeleton" of probabilities implies a 24-month marginal event rate of 26.9%, while the control "skeleton" of probabilities implies a 24-month marginal event rate of 26.3%; the serial correlation implied by the skeleton is the sponsor's best estimate of what will actually occur in the trial. (Shaded cells in the table are uniquely determined by the immediately preceding cells, a consequence of the fact that probabilities conditioned on the same event must sum to one.)

Table 6: Probability "Skeletons" for State Transitions used in Generating Temporally Correlated Data

State Transition	Probability		State Transition	Probability	
	Treatment Group	Control Group		Treatment Group	Control Group
Start → E1	0.05	0.06	N6 → E12	0.05	0.05
Start → P1	0.06	0.02	N6 → P12	0.02	0.02
Start → N1	0.89	0.92	N6 → N12	0.93	0.93
E1 → E6	1.00	1.00	E12 → E18	1.00	1.00
P1 → E6	0.45	0.45	P12 → E18	0.45	0.45
P1 → P6	0.05	0.05	P12 → P18	0.05	0.05
P1 → N6	0.50	0.50	P12 → N18	0.50	0.50
N1 → E6	0.05	0.05	N12 → E18	0.05	0.05
N1 → P6	0.02	0.02	N12 → P18	0.02	0.02
N1 → N6	0.93	0.93	N12 → N18	0.93	0.93
E6 → E12	1.00	1.00	E18 → E24	1.00	1.00
P6 → E12	0.45	0.45	P18 → E24	0.50	0.50
P6 → P12	0.05	0.05	P18 → N24	0.50	0.50
P6 → N12	0.50	0.50	N18 → E24	0.05	0.05
			N18 → N24	0.95	0.95

In the course of simulating multiple data scenarios, it is necessary to generate data with specific 24-month target event rates for both the Treatment and Control groups. To do this, the "skeleton" values of Table 6 are adjusted as follows. First, the probabilities in all unshaded cells that are not already 1.00 by construction are transformed to the logit scale; then a common value ϵ is added to each logit-transformed probability before transforming the sum back to the probability scale. By algebraically expressing the 24-month event rate in terms of the foregoing modified skeletal probabilities and subsequently solving for ϵ , a suitable adjustment to the skeletal state transition probabilities is found that sets the 24-month event rate equal to the desired target value π (e.g., $\pi = 0.25$) while approximately maintaining the serial correlation of the original skeleton. This is accomplished separately for the two treatment groups.

This mechanism of generating temporally correlated data represents the sponsor's best knowledge and belief about the data that will actually arise in the prospective clinical trial. All operating characteristics in Table 3, Table 4, and Table 5 are generated with this method.

This mechanism only applies to the *generation of artificial* data in the simulation; it is not used at all in the analysis of data (real or simulated). If this data generation model does not adequately reflect the true pattern of serial correlation, the analysis model will nonetheless be tasked with recognizing this and causing the design to respond appropriately. In order to evaluate the robustness of the analysis model and sampling plan to the pattern of serial correlation, a simulation was conducted wherein the study design was presented with data

simulated at the extremes of complete temporal correlation and complete temporal independence.

"Complete Temporal Correlation" is a scenario in which knowing the 1-month outcome for a subject is the same as knowing the 24-month outcome. This is accomplished by setting all interim outcomes (e.g., 1-month, 6-month, etc.) to be equal to the 24-month "E" or "N" outcomes (except for those patients lost to follow-up in the simulation). The study design is expected to react appropriately and much sooner when presented with this pattern of data. "Complete Temporal Independence" is a scenario where knowing the interim outcomes for a subject gives no information about what that subject will be at 24 months. To accomplish this, no patient can be an "E" prior to 24 months (else there would be serial correlation), and subject outcomes at interim time points are set to be "P" or "N" with probability P(E24), independently at each time point.

Table 7 displays operating characteristics generated under the Complete Temporal Correlation and Complete Temporal Independence patterns. As expected, the design reacts quicker (i.e., with smaller sample size) when the data are completely correlated. While neither scenario is particularly realistic, it is important that the observed Type I errors are < 0.05 in both cases.

Table 7: Operating characteristics of the design under alternative assumptions about temporal correlation. 10,000 simulated trials per line, with predictions based on 5000 imputations. Column meanings are the same as in Table 2

Complete Temporal Correlation $\pi_c = 0.25$, Expected Enrollment Rate				Probability of Achieving Sample Size N					
π_T/π_c	Power	Early Win, Late Win	Average N	N=1000 (Promise, Futile)	N=1500 (Promise, Futile)	N=2000 (Promise, Futile)	N=2500 (Promise, Futile)	N=3000 (Promise, Futile)	N=3700
1.3	0.002	0.002 0.000	2723.8	0.001 0.000	0.000 0.000	0.001 0.008	0.000 0.598	0.000 0.343	0.048
1.2	0.046	0.044 0.002	3040.2	0.006 0.000	0.009 0.000	0.013 0.001	0.006 0.267	0.004 0.388	0.307
1.1	0.401	0.391 0.010	3052.9	0.040 0.000	0.071 0.000	0.076 0.000	0.051 0.052	0.051 0.136	0.524
1.0	0.895	0.872 0.023	2226.3	0.162 0.000	0.225 0.000	0.194 0.000	0.115 0.004	0.084 0.012	0.203
0.9	0.996	0.966 0.031	1485.8	0.416 0.000	0.344 0.000	0.151 0.000	0.052 0.000	0.022 0.000	0.015
Complete Temporal Independence $\pi_c = 0.25$, Expected Enrollment Rate				Probability of Achieving Sample Size N					
π_T/π_c	Power	Early Win, Late Win	Average N	N=1000 (Promise, Futile)	N=1500 (Promise, Futile)	N=2000 (Promise, Futile)	N=2500 (Promise, Futile)	N=3000 (Promise, Futile)	N=3700
1.3	0.002	0.002 0.000	3012.9	0.000 0.000	0.000 0.000	0.000 0.001	0.021 0.339	0.012 0.350	0.277
1.2	0.047	0.036 0.011	3187.5	0.000 0.000	0.000 0.000	0.004 0.000	0.067 0.188	0.048 0.238	0.455
1.1	0.362	0.251 0.111	3201.1	0.000 0.000	0.000 0.000	0.024 0.000	0.167 0.079	0.121 0.111	0.498
1.0	0.818	0.657 0.161	2995.5	0.000 0.000	0.000 0.000	0.093 0.000	0.289 0.031	0.197 0.032	0.357
0.9	0.970	0.867 0.104	2621.9	0.000 0.000	0.011 0.000	0.263 0.000	0.385 0.008	0.184 0.006	0.142

C.7.5 Type I Errors

To study all combinations of enrollment rate, control success rate, and serial correlation would require $3 \times 3 \times 3 = 27$ tables similar to Table 3. Rather than present all of these, Table 8 provides a comprehensive summary of all type I error rates observed through repeated trial simulations under the varying conditions described above. Each cell is based on 10,000 simulated clinical trials, with predictions based on 5,000 draws from each of the predictive model transition distributions. Under all scenarios, type I error is controlled. There is no evidence that type I error exceeds 0.05. Even the few scenarios with observed type I error greater than 0.05 (e.g., the maximum of 0.0527) could easily result from a simulation of size 10,000 with underlying true rate = 0.05: a 95% probability interval calculated as $0.05 \pm 1.96 \sqrt{(0.05 \times 0.95 / 10000)}$ would range from 0.0457 to 0.0543, so a value as high as 0.0527 is entirely expected and constitutes no evidence of a type I error inflation.

Table 8: Simulated Type I error rates given varied correlation structures, accrual rates, and control event rates. 10,000 simulated trials per line, with predictions based on 5,000 imputations

			Control Event Rate		
			0.20	0.25	0.30
Complete Temporal Correlation	Enrollment Rate	Slow	0.0477	0.0438	0.0505
		Expected	0.0412	0.0486	0.0516
		Fast	0.0431	0.0527	0.0518
Expected Temporal Correlation		Slow	0.0434	0.0459	0.0441
		Expected	0.0414	0.0413	0.0418
		Fast	0.0396	0.0391	0.0417
Complete Temporal Independence		Slow	0.0474	0.0473	0.0478
		Expected	0.0434	0.0485	0.0503
		Fast	0.0505	0.0483	0.0456

C.8 Missing Data and Planned Sensitivity Analyses (Primary Objective)

Every effort will be undertaken to minimize missing data. However, some missingness is inevitable, and the study is designed with the expectation that there may be up to 6% missing primary data at 24 months. The reasons for missing data will be described in detail and evaluated for assessment of possible bias. The distribution of prognostic factors between patients with data and those without data will be examined to evaluate any potential sources of bias.

By design, the analysis of the primary objective (at both interim time points) will predict 24-month outcomes for any subjects without measured 24-month outcomes, based on transitions from interim states and the experience of those who went on from those states to provide complete 24-month data. This is true whether the missing 24-month outcomes are due to being enrolled later in the trial (as happens for many subjects at the interim "win" analyses) or some other cause, such as loss to follow-up (which will likely apply at both the interim and final "win" analyses). Several additional analyses are planned to be conducted (at the conclusion of the trial) that will explore the sensitivity of the main conclusions to the predictions for subjects whose missing 24-month outcomes cannot be explained by simply being enrolled late (i.e., subjects who are known to be lost to follow-up or whose 24-month visit window has closed without a measured outcome). In these analyses and for such subjects, 24-month outcomes will be imputed according to the model described below.

As with the primary analysis, any such subject will be viewed as belonging to one of several interim states. These are the same states used in the primary analysis (e.g., "E" or "P" or "N" at 6 months, etc.)

For each of these states, the probability of becoming a composite success at 24 months will be modeled via a logistic formulation. Based on the number of subjects who went on from that state to become 24-month "E" and "N" subjects, respectively, a logistic regression of the following form will be fit:

$$\text{logit}(p) = \beta_0$$

where the parameter β_0 will be assigned a vague $N(0,10^2)$ distribution. The posterior distribution for β_0 will then be shifted by a biasing constant γ and will be back-transformed to the probability scale as:

$$p^* = \text{logit}^{-1}(\beta_0 + \gamma)$$

The 24-month outcome for any subject belonging to this state but lost thereafter will be imputed based on this distribution of p^* . The case $\gamma = 0$ contains no bias and corresponds essentially to the primary analysis.

By varying γ , the impact of a biasing influence on the study results can be examined. The values $\gamma = +\infty$ and $\gamma = -\infty$ correspond to setting all such observations to be "E" or "N." The impact of various values of γ (including $+\infty$ and $-\infty$) will be examined and presented in a sensitivity analysis, representing both positive and negative biases for the two groups.

Further analyses will explore the sensitivity of efficacy to the imputation model. Specifically, one analysis will present posterior probabilities of non-inferiority/superiority without the use of prediction (i.e., completers only). Another will present the results of a tipping point analysis.

C.9 Description of performed analysis, per population

C.9.1 Analysis of screening population

For the screening population only descriptive statistical analysis will be performed, on variables that are captured in the EDC system.

C.9.2 Analysis of mITT population

For the patients in the randomized population the primary analysis of the primary endpoint and inferential statistics for the following secondary endpoints will be performed on an mITT basis:

- Major adverse cardiovascular and cerebrovascular events (MACCE)
- Individual MACCE components
- Major adverse events (MAE)
- Conduction disturbance requiring permanent pacemaker implantation
- NYHA
- Six-minute walk test
- Ratio of days alive out of hospital versus total days alive
- Quality of life
- Echocardiographic assessment of valve performance
- Aortic valve disease-related hospitalizations
- Cardiovascular deaths and valve-related deaths
- Strokes and TIAs
- Peri-procedural neurological injury
- Index procedure-related MAEs
- Length of index procedure hospital stay
- Device success
- Procedure success

C.9.3 Analysis of implanted population

The implanted population will be used for analyzing the secondary endpoint of prosthetic valve dysfunction. An additional analysis of the primary endpoint and of the secondary endpoint of echocardiographic assessment of valve performance will also be performed on the implanted population.

C.10 Secondary Endpoints

The following secondary endpoints will be compared between MCS TAVI and SAVR subject cohorts using the appropriate Bayesian version of analysis for comparing proportions and continuous variables as described below:

1. Incidence of Major Adverse Cardiovascular and Cerebrovascular Events (MACCE) at 30 days, 6 months, 12 months, 18 months, 24 months, and annually thereafter up to 5 years. MACCE is defined as a composite of:
 - All-cause death
 - Myocardial infarction (MI)
 - All stroke, and
 - Reintervention (defined as any cardiac surgery or percutaneous reintervention catheter procedure that repairs, otherwise alters or adjusts, or replaces a previously implanted valve)

MACCE-incidence estimates will be provided for the two treatment groups at 30 days, 6 months, 12 months, 18 months, 24 months, and annually thereafter up to 5 years. The statistical method will be the Bayesian version of a comparison of proportions (with predictions).

Additionally, incidence of MACCE will be compared at 30 days or hospital discharge, whichever is later. The statistical method will be the Bayesian version of a comparison of proportions.

2. The occurrence of individual MACCE components at 30 days, 6 months, 12 months, 18 months, 24 months, and annually thereafter up to 5 years.

MACCE components will be summarized and their incidence estimates provided at 30 days, 6 months, 12 months, 18 months, 24 months, and annually thereafter up to 5 years. The statistical method will be the Bayesian version of a comparison of proportions (with predictions).

3. Major Adverse Events (MAE) at 30 days, 6 months, 12 months, 18 months, 24 months, and annually thereafter up to 5 years.

MAE events will be summarized and the incidence of MAEs will be provided at 30 days, 6 months, 12 months, 18 months, 24 months, and annually thereafter up to 5 years. The statistical method will be the Bayesian version of a comparison of proportions (with predictions).

4. Conduction disturbance requiring permanent pacemaker implantation at 30 days, 6 months, 12 months, 18 months, 24 months, and annually thereafter up to 5 years.

The incidence of conduction disturbance requiring permanent pacemaker implantation will be provided at 30 days, 6 months, 12 months, 18 months, 24 months, and annually thereafter up to 5 years, separately for new onset and pre-existing conduction disturbance. The statistical method will be the Bayesian version of a comparison of proportions (with predictions).

5. Change in NYHA class from baseline at 30 days, 6 months, 12 months, 18 months, 24 months, and annually thereafter up to 5 years.

For each subject with paired data, the number of classes changed from baseline (-3, -2, -1, 0, 1, 2, or 3) will be calculated at 30 days, 6 months, 12 months, 18 months, 24 months, and annually thereafter up to 5 years. The endpoint will be evaluated using a Bayesian version of a t-test (or Wilcoxon test, as appropriate).

6. Change in distance walked during 6-minute walk test (6MWT) from baseline to 30 days, baseline to 12 months, and baseline to 24 months.

All subjects who are able to perform the six-minute walk evaluation; and those subjects who are unable to perform the walk evaluation due to heart failure symptoms at the time of the follow-up visit will be included in the analysis.

The endpoint will be evaluated using a Bayesian version of a t-test (or Wilcoxon test, as appropriate).

7. Ratio of days alive out of hospital versus total days alive assessed at 12 months and 24 months follow-up.

The proportion of post randomization days alive out of hospital against total days alive will be compared between groups at 12 and 24 months. The numerator will be the number of days alive out of hospital, and the denominator will be the number of days alive as of the follow-up visit date. All hospitalizations will be included in this analysis, including hospitalization for device implant.

The endpoint will be evaluated using a Bayesian version of a t-test (or Wilcoxon test, as appropriate).

8. Quality of Life (QoL) change from baseline at 30 days, 3 months, 6 months, 12 months, 18 months, 24 months, and annually thereafter up to 5 years.

The Kansas City Cardiomyopathy Questionnaire (KCCQ), SF-36, and EuroQoL will be assessed at baseline, 30 days, 6 months, 12 months, 18 months, 24 months, and annually thereafter up to 5 years. SF-36 and EuroQoL will also be assessed at 3 months. All subjects completing the questionnaires will be evaluated and the reasons for missing data will be provided.

The endpoint will be evaluated using a Bayesian version of a t-test (or Wilcoxon test, as appropriate).

9. Echocardiographic assessment of prosthetic valve performance at discharge, 6 months, 12 months, 24 months, and annually thereafter up to 5 years using the following measures:

- transvalvular mean gradient
- effective orifice area
- degree of prosthetic aortic valve regurgitation (transvalvular and paravalvular)

The four echocardiographic measurements will be evaluated at discharge, 6 months, 12 months, 24 months, and annually thereafter up to 5 years. All randomized subjects undergoing echocardiography procedures will be evaluated.

Continuous measures will be evaluated using a Bayesian version of a two-sample t-test or the Wilcoxon rank-sum test, as appropriate. Categorical variables will be evaluated using Bayesian version of a comparison of polytomous outcomes.

10. Aortic valve disease related hospitalizations

The number of subjects re-hospitalized after the initial index procedure will be compared at 30 days, 6 months, 12 months, 18 months, 24 months, and annually thereafter up to 5 years.

Incidence of re-hospitalization will be provided at 30 days, 6 months, 12 months, 18 months, 24 months, and annually thereafter up to 5 years. The statistical method will be the Bayesian version of a comparison of proportions (with predictions).

11. Cardiovascular deaths and valve-related deaths

The number of cardiovascular deaths and valve-related deaths at 30 days, 6 months, 12 months, 18 months, 24 months, and annually thereafter up to 5 years. Incidences will be compared between groups. The statistical method will be the Bayesian version of a comparison of proportions (with predictions).

12. Strokes and TIAs

The number of subjects with strokes (of any severity) and TIAs at 30 days, 6 months, 12 months, 18 months, 24 months, and annually thereafter up to 5 years. A separate analysis will be performed for each of the following:

- a composite of all strokes and TIAs
- major strokes only
- minor strokes only
- TIAs only

The statistical method will be the Bayesian version of a comparison of proportions (with predictions).

13. Peri-procedural Neurological Injury (Stroke, TIA, Encephalopathy)

For each treatment group, the proportion of subjects with a neurologic injury (stroke, TIA, or encephalopathy) at discharge or at 7 days post-index procedure (whichever occurs first) will be calculated. The numerator will be the number of subjects with a neurologic injury (stroke, TIA, or encephalopathy) at discharge or at 7 days post-index procedure (whichever occurs first), and the denominator will be the number of subjects in that treatment group. Results will also be presented separately for major stroke, minor stroke, TIA, and encephalopathy. Proportions will be compared between groups using Bayesian version of a comparison of proportions.

14. Index procedure related MAEs

Index procedure-related MAE events will be summarized and event rates will be provided at 30 days. The numerator will be the number of procedure-related MAE events experienced by the end of the follow-up visit, and the denominator will be the number of subjects evaluated at the follow-up visit plus the number of subjects not evaluated but who experienced a procedure-related MAE event prior to the end of the follow-up visit window.

The endpoint is descriptive and no statistical hypothesis test will be performed.

15. Length of index procedure hospital stay

The length of TAVI or SAVR hospital stay will be summarized for all subjects undergoing a study procedure.

Descriptive statistics will be provided. The endpoint is descriptive and no statistical hypothesis test will be performed.

The following secondary endpoints will be assessed for the MCS TAVI cohort subjects only:

16. Device success defined as follows:

- successful vascular access, delivery and deployment of the device, and successful retrieval of the delivery system,
- correct position of the device in the proper anatomical location (placement in the annulus with no impedance on device function),
- Intended performance of the prosthetic valve (aortic valve area $> 1.2 \text{ cm}^2$ (by echocardiography using the continuity equation) and mean aortic valve gradient $< 20 \text{ mmHg}$ or peak velocity $< 3 \text{ m/sec}$, without moderate or severe prosthetic valve AR)
 - assessed acutely in a resting state, either within 24-48 hours after the index procedure or before hospital discharge
- Only one valve implanted in the proper anatomical location

Device success, as defined above, will be calculated for all subjects undergoing the TAVI procedure.

The endpoint is descriptive and no statistical hypothesis test will be performed.

17. Procedural success, defined as device success and absence of in-hospital MACCE.

Procedure success, as defined above, will be calculated for all randomized subjects undergoing the TAVI procedure.

The endpoint is descriptive and no statistical hypothesis test will be performed.

18. Evidence of prosthetic valve dysfunction at 30 days, 6 months, 12 months, 18 months, 24 months, and annually thereafter up to 5 years.

The number of subjects with evidence of prosthetic valve dysfunction will be evaluated at 30 days, 6 months, 12 months, 18 months, 24 months, and annually thereafter up to 5 years.

Point estimates and 95% BCIs for each time point will be presented using methods described below in the Bayesian version of a comparison of proportions (with predictions); only analyses relevant to a single cohort will be used.

C.11 Analysis Methods for Secondary Objectives

As indicated below, flat or diffuse prior distributions have been identified for all secondary objective analyses.

C.11.1 Discrete (Dichotomous) Data: Bayesian Version of a Comparison of Proportions

Given proportions p_t and p_c for a dichotomous outcome, let each be assigned a flat Beta(1, 1) prior. Then the posterior distributions for p_t and p_c follow Beta($1+Y_t, 1+N_t-Y_t$) and Beta($1+Y_c, 1+N_c-Y_c$) distributions, respectively, where Y_t and Y_c represent the number of “successes” and N_t and N_c represent the number of “tries” (e.g., subjects) in their respective treatment groups. The distribution of the difference $p_t - p_c$ can be easily estimated by drawing a large number of observations (e.g., 100,000) from each Beta posterior, and subtracting. The posterior probability $P(p_t / p_c < \theta \mid \text{data})$ is estimated as the proportion of these observations where the ratio is less than θ . A 95% equal-tail Bayesian credible interval can be calculated from the 2.5th and 97.5th percentiles of the sampled distribution of p_t / p_c . Similarly, the posterior probability $P(p_t - p_c < \delta \mid \text{data})$ is estimated as the proportion of these observations where the difference is less than δ . A 95% equal-tail Bayesian credible interval can be calculated from the 2.5th and 97.5th percentiles of the sampled distribution of $p_t - p_c$ or p_t / p_c , as appropriate. Credible intervals for p_t and p_c can be individually calculated as the 2.5th and 97.5th percentiles from their respective (beta) posterior distributions.

C.11.2 Discrete (Polytomous) Data: Bayesian Version of a Comparison of Proportions

Given the vectors \mathbf{p}_t and \mathbf{p}_c of k -variate proportions for a polytomous outcome, let each be assigned a flat Dirichlet($\mathbf{1}$) prior. The Dirichlet distribution is the multidimensional analog of the Beta distribution. After observing multinomial count data \mathbf{Y}_t and \mathbf{Y}_c , the posterior distributions of \mathbf{p}_t and \mathbf{p}_c follow Dirichlet($\mathbf{1}+\mathbf{Y}_t$) and Dirichlet($\mathbf{1}+\mathbf{Y}_c$) distributions, respectively. The distribution of the difference $\mathbf{p}_t - \mathbf{p}_c$ (or ratio) can be easily estimated by drawing a large number of observations (e.g., 100,000) from each Dirichlet posterior, and subtracting (or dividing). The marginal posterior probability $\Pr(p_t^{(i)} - p_c^{(i)} > \delta \mid \text{data})$ for the i^{th} component of $(\mathbf{p}_t - \mathbf{p}_c)$ is estimated as the proportion of these observations where the difference exceeds δ . A 95% Bayesian equal-tail credible interval can be calculated from the 2.5th and 97.5th percentiles of the sampled distribution of $p_t^{(i)} - p_c^{(i)}$. Posterior probabilities of ratios are similarly calculated from the sampled distribution of $p_t^{(i)} / p_c^{(i)}$.

C.11.3 Discrete (Dichotomous) Data: Bayesian Comparison of Proportions (with Predictions)

The analysis above under “Bayesian Version of a Comparison of Proportions” applies only to subjects with observed data at the time point of interest (e.g., the 24-month visit). A modification is required in order to take into account subjects with partial follow-up, as will be the case if non-inferiority is demonstrated for the primary objective at the interim analysis time point.

The modeling is analogous to the predictions in the Primary Objective. Subjects without outcome data for the time point of interest T_0 will be considered to be in intermediate states that are analogous to those used in the primary objective. If $T_0 = 24$ months, subjects without 24-month outcome data will be considered to be in one of 26 states (13 for each treatment group). The 13 states are:

- no interim data
- E or P or N at 1 month, no subsequent data
- E or P or N at 6 months, no subsequent data

- E or P or N at 12 months, no subsequent data
- E or P or N at 18 months, no subsequent data

If T_0 is later (e.g., 3 years), there is one more set of 3 interim states (E or P or N at 24 months). If the time point of interest is sooner (e.g., 12 months), only the first few bullets above (measured at time points prior to T_0) would apply.

As with the primary objective analysis, subjects in the "E" state at interim time points can be imputed to be "E" at T_0 , with certainty. For each of the remaining interim states (separately by treatment group), the probability of becoming an "E" at 24 months is modeled via a Beta(1,1) prior distribution which is updated to a Beta(1+X, 1+Y) distribution, based on the number X and Y of subjects who went on from that state to become 24-month "E" and "N" subjects, respectively.

Predicting 2-year outcomes for each of these states, and combining with the data from subjects with known 2-year outcomes, a posterior probability of non-inferiority (or superiority) is calculated; it is based on observed 2-year data and also a predictive model that employs interim outcomes and the relationship between those interim outcomes and their corresponding final outcomes that is learned during the current trial.

Inference proceeds from a sampled version of the posterior distribution of $[p_t - p_c]$ or $[p_t / p_c]$, as appropriate, that incorporates both the observed and predicted values at T_0 . With any one imputation of incomplete data, we draw and store a sample from the posterior distribution $[p_t - p_c \mid \text{Observed 2-year data, Imputed 2-year data}]$. By iterating this process we create a sampled version of the $[p_t - p_c]$ posterior distribution that accounts for uncertainty in the prediction. The probability of superiority is then estimated by the proportion of these stored values wherein $p_t > p_c$. By identifying the 2.5th and 97.5th percentiles of the combined stored samples, a 95% credible interval that accounts for uncertainty in the predicted values is obtained. Analogous techniques are used if the quantity of interest is the ratio p_t / p_c .

In this analysis, all prior distributions (i.e., those for p_t and p_c as well as for all transition probability distributions) and Beta(1,1).

C.11.4 Continuous Data: Bayesian version of a t-test.

Assuming that the quantity of interest Y follows a $N(\mu, \sigma^2)$ distribution, and placing a uniform prior distribution on $(\mu, \log(\sigma))$, the posterior distribution of μ has the form²⁷

$$\left[\frac{\mu - \bar{y}}{s / \sqrt{n}} \mid Y \right] \sim t_{n-1}$$

Employing this for both μ_t and μ_c , the distribution of $(\mu_t - \mu_c)$ can be estimated in Monte Carlo fashion by drawing a large number of observations (e.g., 25000) from a t_{n-1} distribution for $n = n_t$ and $n = n_c$, back-transforming these observations to the μ_t and μ_c -scales, and subtracting. The posterior probability $P(\mu_t - \mu_c > \delta \mid \text{data})$ is estimated as the proportion of observed values of $(\mu_t - \mu_c)$ that exceed δ . A 95% equal-tail Bayesian credible interval can be calculated from the 2.5th and 97.5th percentiles of the sampled distribution of $\mu_t - \mu_c$.

C.11.5 Continuous Data (Distribution-free, Superiority): Bayesian Version of a Wilcoxon Rank-Sum Test

For this test, data are ranked. Analogous to the Wilcoxon Rank-Sum test, observations in each group are replaced by their ranks in the combined order statistic. Then the two groups of rank-transformed data are compared via the Bayesian version of a t-test, above. It has

been shown that conducting a two-sample t-test on rank-transformed data is approximately equivalent to the Wilcoxon Rank-Sum test^{7,8}.

Non-inferiority can be evaluated by first subtracting a margin (δ) from each observation in one treatment group prior to the rank transformation.

C.12 Multiplicity Considerations

It is recognized that with a multiplicity of tests comes an inflation in the chance of a false finding of superiority or non-inferiority. Therefore, for the purpose of seeking approved labeling claims on designated secondary objectives, the following standard will be used. If the primary objective demonstrates non-inferiority, claims will be sought at the same time for the subset of secondary objectives enumerated below. These will be tested via a hierarchical testing procedure in the order specified below: objectives are tested in order and continue so long as all previous objectives have met their designated success criterion. Once one objective fails to meet its success criterion, tests further down the list do not occur.

For those objectives in the list that test non-inferiority, if non-inferiority is established using this procedure, a test of superiority will also be conducted. Such superiority testing is not part of the hierarchical testing procedure; it is not necessary for superiority to be established on a non-inferiority objective in order to "pass" the stated objectives further down the list.

Since, for all secondary objectives, the prior distributions are flat or nearly flat, virtually all information in the model is contained within the likelihood. Therefore, a rule that determines $P(H | \text{data}) > \theta$ must induce a "critical value" in the data space that is approximately equal to the critical value defined by a $(1-\theta)$ -level significance test in the setting of a standard frequentist hypothesis test, and the type 1 error of each secondary objective analysis must therefore approximate the quantity $1 - \theta$. This is consistent with the statement of Gelman et al. that "[i]n various simple one-sided hypothesis tests, conventional p-values may correspond with posterior probabilities, under noninformative prior distributions"⁹ and the statement of Albert that "a Bayesian probability of a hypothesis is equal to the p-value for one-sided testing problems when a vague prior distribution is placed on the parameter"¹⁰. It follows that frequentist methods that control type 1 errors among multiple objectives must apply, at least approximately, to posterior probabilities in an analogous fashion.

For the purposes of seeking claims, these objectives will only be evaluated once, at the same time as non-inferiority of the primary objective is established.

The remaining secondary objectives may be of interest for scientific or financial reasons but will not be the basis for supporting labeling claims.

C.12.1 Ordered List of Secondary Objectives to be Tested To Support Labeling Claims

1. Change in transvalvular mean gradient from baseline to 12 months: MCS TAVI vs. SAVR (secondary objective #9). The hypothesis of interest is

$$H: \mu_{\text{MCS TAVI}} > \mu_{\text{SAVR}} - 15$$

where $\mu_{\text{MCS TAVI}}$ and μ_{SAVR} denote the mean improvements in mean gradient from baseline to 12 months, measured in mmHg. The posterior probability $P(H | \text{data})$ will be calculated and compared to a threshold of 0.95.

7 Berry D & Lindgren B, *Statistics: Theory and Methods*, 2ed. Belmont, CA: Duxbury, 1996, p 505.

8 Conover WJ & Iman RL, "Rank transformations as a bridge between parametric and nonparametric statistics," *American Statistician* 35 (1981), 124-129.

⁹ Gelman A, Carlin JB, Stern HS, Rubin DB, *Bayesian Data Analysis*, 1st ed. London: Chapman & Hall, 1995, p. 69.

¹⁰ Albert J, *Bayesian Computation with R*, 1st ed. New York: Springer, 2007.

2. Change in effective orifice area from baseline to 12 months: MCS TAVI vs. SAVR (secondary objective #9). The hypothesis of interest is

$$H: \mu_{\text{MCS TAVI}} > \mu_{\text{SAVR}} - 0.375$$

where $\mu_{\text{MCS TAVI}}$ and μ_{SAVR} denote the mean improvements in effective orifice area from baseline to 12 months, measured in cm^2 . The posterior probability $P(H \mid \text{data})$ will be calculated and compared to a threshold of 0.95.

3. Change in NYHA classification from baseline to 12 months: MCS TAVI vs. SAVR (secondary objective #5). The hypothesis of interest is

$$H: \mu_{\text{MCS TAVI}} > \mu_{\text{SAVR}} - 0.375$$

where $\mu_{\text{MCS TAVI}}$ and μ_{SAVR} denote the mean number of classification improvements in NYHA from baseline to 12 months. The posterior probability $P(H \mid \text{data})$ will be calculated and compared to a threshold of 0.95.

4. Change in Kansas City Cardiomyopathy Questionnaire (KCCQ) score from baseline to 12 months: MCS TAVI vs. SAVR (secondary objective #8). The hypothesis of interest is

$$H: \mu_{\text{MCS TAVI}} > \mu_{\text{SAVR}} - 5$$

where $\mu_{\text{MCS TAVI}}$ and μ_{SAVR} denote the mean improvements in the KCCQ score from baseline to 12 months. The posterior probability $P(H \mid \text{data})$ will be calculated and compared to a threshold of 0.95.

5. TAVI with the Medtronic CoreValve® System is superior to SAVR in binary rate of MACCE at 30 days or hospital discharge, whichever is longer (secondary objective #1). The hypothesis of interest is

$$H: \pi_{\text{MCS TAVI}} < \pi_{\text{SAVR}}$$

where $\pi_{\text{MCS TAVI}}$ and π_{SAVR} denote the binary rate of MACCE at 30 days or hospital discharge (if longer). The posterior probability $P(H \mid \text{data})$ will be calculated and compared to a threshold of 0.95.

6. Change in SF-36 Physical Summary Scale from baseline to 30 days: TAVI vs. SAVR (secondary objective #8). The hypothesis of interest is

$$H: \mu_{\text{MCS TAVI}} > \mu_{\text{SAVR}}$$

where $\mu_{\text{MCS TAVI}}$ and μ_{SAVR} denote the mean improvements in the SF-36 Physical Summary Scale from baseline to 30 days. The posterior probability $P(H \mid \text{data})$ will be calculated and compared to a threshold of 0.975.

Other than the hierarchical testing procedure described above, no further multiplicity adjustments will be made in the analyses of the secondary endpoints. Summary data from other secondary objectives, such as device success and procedural success from secondary objectives #16 and #17, respectively, may be provided in the device labeling. However, no claims of statistical significance or other statistical inference will be made.

C.13 Heterogeneity/Poolability

A poolability analysis among investigational centers, access site (ilio-femoral or non-ilio-femoral), need for revascularization, and primary baseline demographics will be performed for the primary endpoint. In particular, the primary endpoint and key secondary endpoints such as MACCE and MAE incidence will be examined for differences in outcome between genders, need for revascularization, and between access sites. Additionally, tests for these outcomes will be performed to evaluate potential interactions between treatment and gender and between treatments and need for revascularization and between treatment and access site.

C.13.1 Geography Poolability Analysis

C.13.1.1 Primary Endpoint by Geography

The interaction between geography (Europe and North America) and treatment on the probability of death or major stroke will be compared using a logistic regression model. This analysis will be performed on the modified intent-to-treat (mITT) population, for subjects whose status at 24 months is known. If the resulting p-value is ≤ 0.15 , further exploratory analysis will attempt to identify covariates that may explain treatment effect differences between the regions. Otherwise, the data will be considered to be poolable across geographies.

C.13.1.2 Univariate Covariate Analysis

If in the analysis of primary endpoint by geography, the resulting p-value is ≤ 0.15 then the following baseline characteristics will be examined individually as potential predictors of death or major stroke using logistic regression models:

- Gender
- Age
- Baseline NYHA
- STS score
- Baseline LVEF
- Hypertension
- Diabetes
- Coronary artery disease
- Prior stroke
- Prior MI
- Prior PI

C.13.1.3 Multivariate Analysis

If in the analysis of primary endpoint by geography, the resulting p-value ≤ 0.15 then the covariates with p-value ≤ 0.20 from the Univariate Covariate Analysis will be included along with geography in a logistic regression model. If this multivariate regression does not result in a significant (p-value ≤ 0.15) geography by treatment interaction after adjustment for these baseline factors, then outcome results will again be considered poolable across geographies. If geography by treatment interaction is still significant (p-value ≤ 0.15) after adjustment for these factors, results will be presented by geography and the clinical significance of these differences will be assessed.

If it is determined that data is not poolable by geography, then a random-effects model for the primary endpoint that includes geography as a random effect will be provided.

C.13.2 Site Poolability Analysis

If the geographic regions Europe and North America are considered to be poolable, then the Site Poolability Analysis will be performed on all sites, for patients with an STS score between 4-10. The geographic region (Europe, United States,) is not taken into account.

Should, however, the geographic regions Europe and North America not be considered to be poolable, then for both of these regions a separate poolability analysis will take place. Per region the STS 4-10 population will be analyzed.

C.13.2.1 Pooling of Small Sites

With up to 75 sites expected to participate in the study, this leads to an average of 33 subjects per site.

Sites should contribute both at least 5 treatment and at least 5 control subjects to the mITT population. If this is not the case, the site is considered a "small site"; small sites will be ordered by the date of first enrollment in the mITT population. Starting with the first "small site", a pseudo-site will be created by adding subjects from successive "small sites". Once the number

of subjects (treatment and control subject together) reaches or exceeds the size of the median enrollment (treatment and control subject together) of the “large sites”, then a second pseudo-site will be created, beginning with the next site not already included in the first pseudo-site. Additional pseudo-sites, if needed, would be created in the same manner.

If the geographic regions Europe and North America are considered to be poolable then the pseudo-sites can consist of small sites of both geographics regions. If however the regions are not considered to be poolable, then specific Europe pseudo-sites and North America pseudo-sites need to be created. A separate site poolability analysis will be performed for Europe sites and for North American sites.

C.13.2.2 Primary Endpoint by Site

The interaction between site or pseudosite and treatment on the probability of death or major stroke will be compared using a logistic regression model. This analysis will be performed on the mITT population for subjects whose status at 24 months is known. If the resulting p-value is ≤ 0.15 , further exploratory analysis will attempt to identify covariates that may explain treatment effect differences among the sites, beginning in the next section. Otherwise, the data will be considered to be poolable across study sites.

C.13.2.3 Multivariate Analysis

If in the analysis for Primary Endpoint by Site, the resulting p-value ≤ 0.15 then the covariates with p-value ≤ 0.20 from Univariate Covariate Analysis will be included along with site in a logistic regression model. If this multivariate regression does not result in a significant (p-value ≤ 0.15) site by treatment interaction after adjustment for these baseline factors, then outcome results will again be considered poolable across study sites. If site by treatment interaction is still significant (p-value ≤ 0.15) after adjustment for these factors, results will be presented by site and the clinical significance of these differences will be assessed.

C.14 Pre-Defined Subgroups

The following sub-groups will be analyzed for publication purposes:

- Diabetes Mellitus (yes, no)
- Age (<70 years of age, 70-74 years of age, 75-79 years of age and ≥ 80 years of age)
- Sex (male, female)
- Presence of co-morbidities
- Need for coronary revascularization

A test for interaction between the treatment effect (SAVR versus TAVI) and the subgroup variable will be performed.

These comparisons are not powered, and will be for exploratory purposes only, not to be used to support labeling claims.

C.14.1 Health-Related Quality of Life (HRQoL) and Treatment Costs

Health-related quality of life (HRQoL) and treatment costs will be assessed alongside the core clinical trial to evaluate the impact of the TAVI and SAVR strategies on a range of relevant quality of life (QoL) domains and also to evaluate the cost-effectiveness of the two treatment strategies.

C.14.2 Quality of Life

Health Related Quality of Life (HRQoL) and functional status will be assessed using a combination of generic and disease-specific measures selected to cover a broad range of health domains that may be affected by severe aortic stenosis disease, its treatment, and its complications: the Medical Outcomes Study 36-item Short Form (SF-36), the Kansas City Cardiomyopathy Questionnaire (KCCQ), and the EuroQoL Five Dimensions (EQ-5D). All subjects will complete standardized, written questionnaires at baseline (prior to subject being informed of randomization), 30 days, 6 months, 12 months, 18 months, 24 months and annually

thereafter up to 5 years. At 3 months subjects will also be contacted via telephone to complete the EQ-5D, in select geographies SF-36 will also be collected Economic Outcomes/Cost-Effectiveness.

C.15 Economic Outcomes/Cost-Effectiveness

Data on resource utilization will be collected for the index hospitalization and through long-term follow-up for all enrolled subjects. These resource items will include number and duration in-patient stays in hospital by type of unit (e.g. intensive care, high-dependency care and standard ward care); number of clinic visits (by type of physician); and details of the main procedure undertaken. As part of the trial analysis, resource use estimates will be presented by randomized group (e.g. mean per patient plus standard deviation). This data, together with the EQ-5D data will provide an important input into cost effectiveness analysis. However, as such analysis is likely to be based on a modeling framework, to include evidence from a number of sources (e.g. a meta-analysis of other TAVI trials) and to vary according to the jurisdiction of interest, it is appropriate to detail the methods in separate protocols and analysis plans.

C.16 Use of Data for CE Mark

Data from the MCS TAVI arm may be utilized to seek CE Mark approval for the Intermediate Risk indication prior to study completion. This is expected to include the experience of approximately the first 150 TAVI subjects out to 1 year. This analysis will not impact the Type I error rate of this study as there will not be an early analysis of control (randomized) data, and no decisions to alter the pivotal trial are allowed based on this analysis. This data will not be made public and a limited number of personnel will have access to the results.

D REVISION PROCESS

The study statistician will be responsible for the execution of this statistical analysis plan, including any revisions and obtaining of appropriate approvals.

E DISTRIBUTION

The study statistician will be responsible for execution of this statistical analysis plan and distribution of revisions to the appropriate clinical staff.

Coronary and Structural Heart Clinical Department

SURTAVI

STATISTICAL ANALYSIS PLAN

Revision 6

31-May-2016

Surgical Replacement and Transcatheter Aortic Valve Implantation
Version 12.0, 31-May-2016

Prepared by:
Yanping Chang, MS
Sr. Principal Statistician

Bayesian Design by:
Andrew S Mugglin, PhD
Paradigm Biostatistics, LLC

Anna McGlothlin, PhD
Berry Consultants, LLC

Table of Contents

A	PURPOSE OF SAP	4
B	RATIONALE FOR STUDY DESIGN	4
C	STATISTICAL METHODS AND ANALYSIS	4
C.1	Statistical considerations and analysis	4
C.2	Description of Baseline Variables	4
C.3	Analysis Populations	5
C.3.1	Screening population.....	5
C.3.2	Randomized population.....	5
C.4	Primary analysis	5
C.4.1	Hypothesis of non-inferiority	5
C.4.2	Randomization, Sample Size, and Analysis Plan	6
C.5	Predictions	8
C.5.1	Prior Distributions for Transition Probabilities	10
C.6	Operating Characteristics	12
C.7	Simulation Details and Design Sensitivity	13
C.7.1	LTFU/Data Missingness	13
C.7.2	Control Arm Event Rate	14
C.7.3	Rate of Accrual.....	14
C.7.4	Temporal Correlation.....	17
C.7.5	Type I Errors.....	19
C.8	Missing Data and Planned Sensitivity Analyses (Primary Objective).....	21
C.9	Description of Performed Analysis, per Population	22
C.9.1	Analysis of screening population.....	22
C.9.2	Analysis of ITT and mITT Populations	22
C.9.3	Analysis of implanted population.....	22
C.10	Secondary Endpoints	22
C.11	Analysis Methods for Secondary Objectives	27
C.11.1	Discrete (Dichotomous) Data: Bayesian Version of a Comparison of Proportions	27
C.11.2	Discrete (Polytomous) Data: Bayesian Version of a Comparison of Proportions.....	27
C.11.3	Discrete (Dichotomous) Data: Bayesian Comparison of Proportions (with Predictions)	28
C.11.4	Continuous Data: Bayesian version of a t-test.	28

C.11.5	Continuous Data (Distribution-free, Superiority): Bayesian Version of a Wilcoxon Rank-Sum Test.....	29
C.12	Multiplicity Considerations	29
C.12.1	Ordered List of Secondary Objectives to be Tested To Support Labeling Claims.....	30
C.13	Heterogeneity/Poolability	33
C.13.1	Geography Poolability Analysis	34
C.13.2	Site Poolability Analysis	35
C.14	Additional Analysis	35
C.14.1	Pre-Defined Subgroups	35
C.14.2	Analysis of VARC Endpoints and Definitions.....	36
C.14.3	Health-Related Quality of Life (HRQoL) and Treatment Costs.....	36
C.14.4	Quality of Life	36
C.15	Economic Outcomes/Cost-Effectiveness	36
C.16	Use of Data for CE Mark	37
D	REVISION PROCESS	38
E	DISTRIBUTION	38
F	REVISION HISTORY.....	39
G	APPENDIX	41
G.1	Sample Size Determination Algorithm.....	41
G.2	Reasonableness of Priors	41
G.3	Derivation of the Informative Priors	42
G.4	Justifying the Skeletons.....	44
G.5	Appropriateness of Imputing Missing Data.....	45
G.6	Type I Errors for the Primary Endpoint Superiority Testing.....	45

A PURPOSE OF SAP

This Statistical Analysis Plan has been designed to document, before data are analyzed, the rationale for the study design, and the planned analyses that will be included in study reports. The design and analyses are consistent with the objectives of the Clinical Investigational Plan (CIP).

B RATIONALE FOR STUDY DESIGN

The purpose of this trial is to evaluate the safety and efficacy of transcatheter aortic valve implantation (TAVI) in the treatment of symptomatic severe aortic stenosis (AS) in subjects who are determined by the Heart Team to be at intermediate surgical risk. Subjects will be randomized to receive either transcatheter aortic valve implant (TAVI) or surgical aortic valve replacement (SAVR) in a 1:1 ratio.

This statistical analysis plan is developed based on the Clinical Investigational Plan (CIP) Version 12.0.

C STATISTICAL METHODS AND ANALYSIS

The SURTAVI trial is a multicenter, multinational, prospective, adaptive, 1:1 randomized study designed to demonstrate non-inferiority (to within an absolute margin of 0.07) of TAVI to SAVR, as measured by a composite of all-cause death or disabling stroke incidence at 24 months. Study success will be evaluated at an interim analysis that is timed to occur when 1400 subjects who undergo an attempted study treatment have reached 12 months; if necessary, study success will again be evaluated when all subjects have reached 24 months.

A study report will be prepared for submission to FDA at the time study success criteria have been met, for the purpose of seeking marketing approval. After all subjects have completed all protocol-specified follow-up, a final clinical report including updated long-term safety data will be prepared and submitted.

Roll-in subjects (refer to CIP section C.4.4) will not be included in the primary or secondary analysis; however, the data will be summarized separately with descriptive statistics.

Any deviations from this section and/or the Statistical Analysis Plan will be described and justified in the Final Report, as appropriate.

C.1 Statistical considerations and analysis

This section describes the statistical considerations and analysis plans for the SURTAVI trial. The statistical analysis will be performed by the statistics department of Medtronic. As primary analysis, all randomized subjects will be analyzed following the modified intention to treat (mITT) approach; ie., analyses will be conducted on the cohort of subjects who undergo an attempted study treatment, analyzed according to the randomized assignment. A secondary analysis of key objectives will be performed according to the therapy actually received. All follow-up periods are defined as the number of days after the procedure date.

C.2 Description of Baseline Variables

Baseline demographic and clinical variables will be summarized for each of the treatment groups for the intention-to-treat (ITT), modified intent-to-treat (mITT), and implanted populations. All continuous variables will be summarized as means, medians, standard deviations, interquartile ranges, minima and maxima and compared between treatment groups using a Bayesian analog of a two-sample t-test or the non-parametric Wilcoxon rank-sum test. Categorical variables will be summarized as frequencies and percentages and compared between treatment groups using a Bayesian version of a comparison of proportions.

C.3 Analysis Populations

C.3.1 Screening population

All patients with symptomatic severe AS who provide informed consent will be considered screened and all available data will be entered into the Electronic Data Capture (EDC) system.

C.3.2 Randomized population

If the patient signs informed consent, meets all inclusion and none of the exclusion criteria, and the Heart Team determines the patient is suitable for randomization in the trial, then the subject is reviewed by the SURTAVI Screening Committee. If the subject is approved by the Screening Committee and the subject is enrolled/randomized to either TAVI or SAVR the subject is added to the randomized population. Within the randomized population three subpopulations are distinguished:

- The intention-to-treat (ITT) population: Subjects are reported according to the randomized assignment, SAVR or TAVI, regardless of what, if any, therapy was actually received.
- The modified intention-to-treat (mITT) population: Randomized subjects in whom a procedure is attempted. Patients who undergo an attempted trial treatment are reported according to the randomized assignment, SAVR or TAVI, regardless of what, if any, therapy was actually received. A procedure attempt is defined as when the subject is brought into the procedure room and any of the following have occurred: anesthesia administered, vascular line placed, TEE placed or any monitoring line placed. In the database, attempted procedure is defined by a non-missing procedure date.
- The implanted population: This population includes the mITT subjects who are actually implanted with either the TAVI device or a surgical valve. Depending on context, subjects may be analyzed according to randomized treatment assignment or treatment actually received.

The primary analysis for the primary objective and most secondary objectives will use the mITT population. At the conclusion of the trial, an analysis using the ITT population will also be presented.

C.4 Primary analysis

The primary endpoint of all-cause mortality or disabling stroke at 24 months will be evaluated using the absolute difference of the TAVI rate and the SAVR rate for all-cause mortality or disabling stroke during a fixed follow-up of 24 months' time. The hypothesis test is designed to show non-inferiority of TAVI to SAVR for the primary endpoint.

C.4.1 Hypothesis of non-inferiority

The primary objective is to establish that TAVI is non-inferior to SAVR for the primary endpoint. The hypothesis of interest is:

$$H_A: \pi_T < \pi_C + \delta$$

where π_T and π_C denote binary rates of all-cause mortality or disabling stroke during a fixed follow-up of 24 months for the treatment (TAVI) and control (SAVR) groups, and $\delta = 0.07$. This study is designed using Bayesian statistical techniques. TAVI will be declared to be non-inferior to SAVR if it can be established that the posterior probability $\Pr(H_{A, \delta=0.07} | \text{data}) > \Psi$, where Ψ is a pre-specified threshold value. If, in addition, it can be shown that $\Pr(H_A: \pi_T < \pi_C + 0 | \text{data}) > \Psi_{\text{SUP}}$, TAVI will be declared to be superior to SAVR. The values chosen for Ψ and Ψ_{SUP} are described below.

C.4.1.1 Non-inferiority Margin

The $\delta = 0.07$ non-inferiority margin is considered clinically relevant and is consistent with the FDA Draft Guidance for Industry Non-inferiority Clinical Trials (March 2010). As stated in the guidance, M1 is the entire effect of the active control assumed to be present in the non-inferiority study; M2 is the largest clinically acceptable difference (degree of inferiority) of the test drug (or investigational device) compared to active control. Active control is SAVR in the study.

Medical management and SAVR historical data¹ are summarized in the following table. The estimated SAVR 2 year all-cause mortality or stroke rate in high risk population is 38.8% (using the higher upper bound of Partner A² and Pivotal High Risk³). The historical SAVR treatment effect over standard therapy (M1) can be calculated as 19.1% (=57.9%-38.8%). To preserve 50% M1, a NI margin of 7% is specified based on clinical judgment.

Table 1: Medical Management and SAVR Data from Literature

Study	24 Month All-cause Mortality or Stroke/Major Stroke* Kaplan-Meier Rate	95% Exact Confidence Interval
Medical Management Data		
Partner B	68.0% (117/179)	(57.9%, 72.3%)
SAVR Data		
Partner A	34.2% (104/313)	(28.0%, 38.8%)
Pivotal High Risk	32.5% (113/359)	(26.7%, 36.6%)

*24 month all-cause mortality or stroke for Partner A and B studies; 24 month all-cause mortality or major stroke for Pivotal High Risk study

C.4.2 Randomization, Sample Size, and Analysis Plan

Randomization will follow a 1:1 (treatment:control) allocation ratio and be stratified by site and need for revascularization, using a blocked randomization scheme with blocks of randomly varying sizes. The sample size for the mITT population is 1600 subjects.

C.4.2.1 Sample Size Justification

Although the pre-specified analysis methods are Bayesian, the sample size is guided by a standard frequentist non-inferiority power analysis. Under the assumptions of $\pi_T = \pi_C = 0.17$, non-inferiority margin $\delta = 0.07$, 1:1 randomization, $\alpha = 0.05$, and power = 95%, the method of Farrington and Manning⁴ as implemented in PASS 2008⁵ indicates that the required sample size for a single-look analysis is 1258. To allow for up to 6% dropout, 1339 subjects must be accrued. Furthermore, to compensate for power lost in a two-look group sequential analysis plan using Pocock-type alpha spending, the sample size would have to be increased by about

¹ Raj R. Makkar, Gregory P. Fontana, et al. Transcatheter Aortic-Valve Replacement for Inoperable Severe Aortic Stenosis, N Engl J Med 2012; 366:1696-1704
² Kodali SK, Williams MR, et al. Two-year outcomes after transcatheter or surgical aortic-valve replacement, N Engl J Med 2012; 366:1686-1695
³ Michael J. Reardon, David H. Adams, et al. 2-Year outcomes in patients undergoing surgical or self-expanding transcatheter aortic valve placement, JACC 2015; 66:113-21
⁴ Farrington, C. P. and Manning, G. 1990. 'Test Statistics and Sample Size Formulae for Comparative Binomial Trials with Null
⁵ Hintze, J. (2004). NCSS and PASS, Number Cruncher Statistical Systems. Kaysville UT. www.ncss.com

12.5%⁶. This leads to an estimated sample size of 1531. Thus a sample size of 1600 mITT subjects should provide ample power for establishing non-inferiority in the primary hypothesis test.

The assumed values $\pi_T = \pi_C = 0.17$ are based on the data published by Iturra et al.⁷ and CoreValve US Pivotal High Risk study results. As reported in the Iturra paper, the incidence of all-cause mortality at 30 days was 2.8% and the late all-cause mortality Kaplan-Meier rate at 24 months was 12.1%. The overall 24-month all-cause mortality rate was approximately 15%. STS score reported in the Iturra paper (5.6 ± 1.1 , $n=502$) was similar to the STS score for subjects currently enrolled in the SURTAVI study (5.6 ± 1.4 , $n=654$)⁸, and it is believed that the 24-month all-cause mortality rate in SURTAVI will be approximately 15% at 24 months. The major stroke rate was 3.2% for subjects who survived to 1 year in the CoreValve Pivotal High Risk study. The High Risk study enrolled a higher-risk population than SURTAVI, therefore, the major stroke rate in the High Risk study is adjusted downward, and it is believed the disabling stroke rate at 24 months would be approximately 2% in the SURTAVI study. Overall, the estimation of all-cause mortality or disabling stroke rate is 17% at 24 months.

C.4.2.2 Analysis Plan

The sample size look analysis (timed when 1400 subjects had entered the mITT population) occurred prior to the change of margin; the conclusion of this analysis was that 1400 would be inadequate to establish non-inferiority (using $\delta = 0.05$) and that subject accrual should continue (refer to Appendix G.1 for sample size determination algorithm). With the re-design accompanying the change of margin, an interim analysis (timed to occur when 1400 mITT subjects have reached 12 months) for the purpose of declaring an early win will occur and all enrolled mITT subjects will be included in the analysis. At this analysis, if $P(H_{\delta=0.07} | \text{data}) > \Psi$, non-inferiority will be declared at this time, and a regulatory submission will follow. On the other hand, if $P(H_{\delta=0.07} | \text{data}) \leq \Psi$, all mITT subjects will be followed to 24 months, when a final analysis will occur. At the final analysis, the standard for trial success will again be $P(H_{\delta=0.07} | \text{data}) > \Psi$. These two analyses are termed “Win Looks”.

If, at the early interim “Win Look,” non-inferiority is established, a test of superiority will immediately follow. If $P(H_{\delta=0} | \text{data}) > \Psi_{\text{SUP}}$, superiority will be established at this time. However, if $P(H_{\delta=0} | \text{data}) \leq \Psi_{\text{SUP}}$, subjects will continue to be followed and analyzed according to the same analysis plan (i.e., with one more possible “Win” analysis when all mITT subjects have reached 24 months). At the final “Win” analysis, if $P(H_{\delta=0} | \text{data}) > \Psi_{\text{SUP}}$, a delayed determination of superiority will be made.

The statistical approach for these analyses is Bayesian. The prior distributions for π_T and π_C in these calculations are Beta(1,1). The threshold Ψ is designated to be 0.971 for non-inferiority testing and $\Psi_{\text{SUP}} = 0.989$ for superiority testing; these values were selected by trial-and-error to achieve a type I error (under extensive simulation) of at most 0.05 for non-inferiority testing and at most 0.025 for superiority testing under the design with $\delta = 0.05$ margin. These same thresholds are retained in the current study design. Control of type I error using these thresholds is described in detail in “Type I Errors” (Section C.7.5). Of note, establishing $P(H_{\delta=0} | \text{data}) > \Psi_{\text{SUP}}$ means that superiority has been established to a standard equivalent to a nominal significance level of 0.025 (1-sided), but this does not automatically mean that a labeling claim of superiority is supported. See “Multiplicity Considerations” (Section C.12) for additional requirements regarding labeling claims on secondary objectives.

⁶ Jennison C and Turnbull BW, Group Sequential Methods with Applications to Clinical Trials. Boca Raton: Chapman & Hall, 2000, p 27

⁷ Iturra SA, Suri RM, Greason KL, et al. The Journal of thoracic and cardiovascular surgery 2014;147:127-132.

⁸ Medtronic CoreValve SURTAVI Trial 2014 FDA Annual Progress Report.

C.5 Predictions

Outcomes at 24-month are binary and are denoted "E" (for having experienced an Event) or "N" (for not having experienced an event). Predicted values of 24-month outcomes for those subjects who have not yet yielded 24-month outcomes will be based on intermediate outcomes observed at 1 month, 6 months, 12 months, and 18 months. These intermediate outcomes are:

- "E" -- subject has had a known primary event (death or disabling stroke) at the time point in question
- "P" -- subject is known to have had a "possible primary event" at the time point in question. "Possible primary events" are adverse events that may later be determined to be Disabling Strokes. This determination takes 90 days, by definition. For example, a subject may have a stroke at month 5 which cannot be known to be a Disabling Stroke until Month 8. At Month 6, such a subject is in the "P" state.
- "N" -- subject has not had a primary event or a "possible primary event" at the time point in question.

Subjects without 24-month outcome data will thus be considered to be in one of 26 states (13 for each treatment group). The 13 states are:

- no interim data
- E or P or N at 1 month, no subsequent data
- E or P or N at 6 months, no subsequent data
- E or P or N at 12 months, no subsequent data
- E or P or N at 18 months, no subsequent data

Subjects in the "E" state at an interim analysis can be imputed to be "E" at 24 months, with certainty. For each of the remaining 18 states (9 for each treatment group), the probability of becoming an "E" at 24 months is modeled via a Beta(a,b) prior distribution which is updated to a Beta(a+X, b+Y) distribution, based on the number X and Y of subjects who went on from that state to become 24-month "E" and "N" subjects, respectively. For example, if, in the treatment group at an interim analysis time point, it is known that 10 of 30 subjects had previously gone from the "N at 18 months" state to the "E at 24 months" state, then the transition probability from the 18-month "N" state to the 24-month "E" state will be modeled as Beta(a+10, b+20). At an interim analysis time point, any treatment-group subjects residing in the "N-at-18-month-but-without-24-month-data" state will have their 24-month outcome predicted on the basis of this Beta(a+10, b+20) distribution. Similar statements can be made about each of the possible transitions. As data are accrued in this study, the Beta distributions used for prediction are updated accordingly. Figure 1 graphically depicts the various possible states and transitions from them to the final state, for a generic treatment group. For clarity, the lines connecting the interim "E" state to the 24-month "E" state have been omitted. The numerical example above would apply to transition #9 in the Figure 1.

Figure 1 Graphical depiction of transitions from interim states (E = Event, P = Possible Event, N = No Event, Start) to 24-month outcome. Each transition is assigned a separate Beta(a,b) prior distribution which is updated as data are gathered.

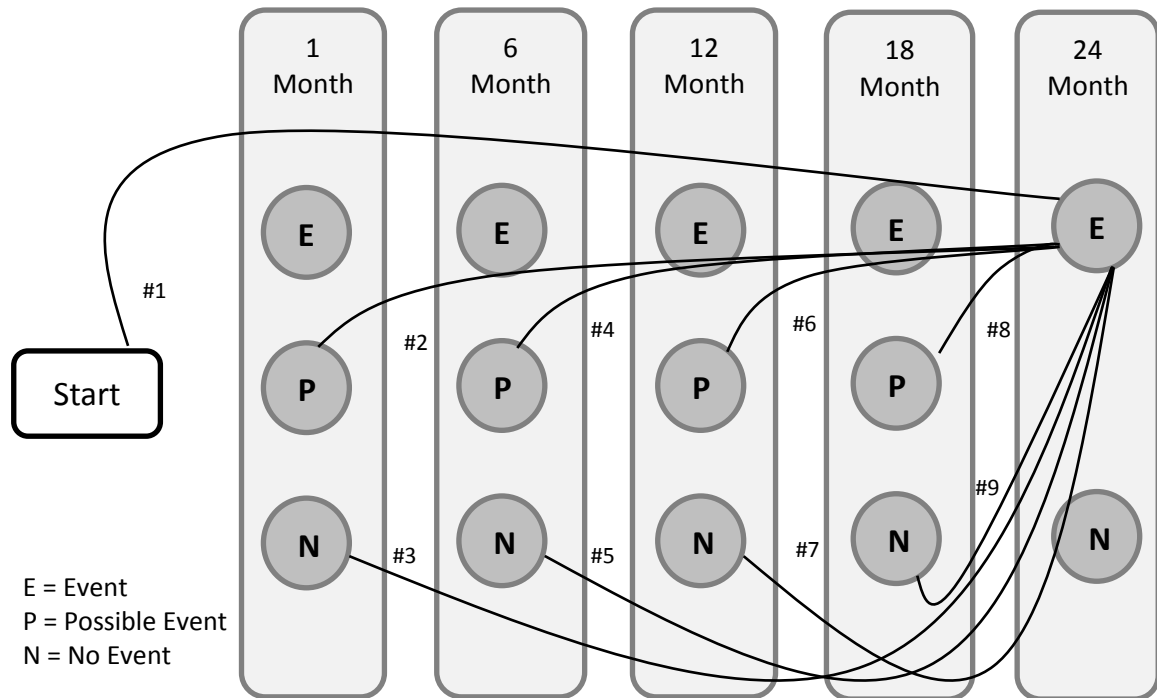

By predicting 24-month outcomes for each of these states, and combining with the data from subjects with known 24-month outcomes, a **posterior probability of non-inferiority** is calculated; it is based on observed 24-month data and also a predictive model that employs interim outcomes and the relationship between those interim outcomes and their corresponding final outcomes that is *learned during the current trial*. This is accomplished in Monte Carlo fashion. With any one imputation of incomplete data, we calculate the posterior probability $\Pr(H_{\delta=\delta^*} \mid \text{Observed 24-month Data, Imputed 24-month Data})$, and store it. By iterating this process and averaging these posterior probabilities, we are essentially integrating them over the predictive distribution of imputed data. This resulting quantity we have denoted as $\Pr(H_{\delta=\delta^*} \mid \text{Data})$. The model is very similar to that employed in Lipscomb et al.⁹ The chief differences are that this model incorporates interim outcomes at other time points (eg., 1 month, 6 months, 18 months rather than just 12 months), and the model also considers trichotomous rather than dichotomous interim states.

The **predictive probability of eventual trial success** can be calculated in a similar manner. With any one imputation of incomplete data, we calculate the posterior probability $\Pr(H_{\delta=\delta^*} \mid \text{Observed 24-month Data, Imputed 24-month Data})$ and record whether this value exceeds the threshold Ψ . By iterating this process and reporting the proportion of times that Ψ is exceeded, we obtain an estimate of the predictive probability of eventual trial success (meaning a trial that results in a conclusion of non-inferiority with the designated sample size).

In this trial, predictive probabilities of eventual success are used in the 1400-subject sample size analysis. Posterior probabilities are used for the determination of non-inferiority (ie., analyses in the evaluation portion of the trial or "Win Looks").

In any analysis conducted for the purpose of determining whether the primary endpoint has passed (ie, any "Win" analysis), no subject can be a "P" at 24 months. Whether a stroke

⁹ Lipscomb B, Ma G, Berry D, "Bayesian predictions of final outcomes: regulatory approval of a spinal implant," *Clinical Trials*, Vol. 2, No. 4, 325-333 (2005)

qualifies as a disabling stroke (primary endpoint) is accomplished via the Modified Rankin Score (mRS), which may take up to 3 months after the stroke's onset to determine, but all P's at 24 months will be converted to E's or N's. If at the precise time of a Win analysis there are any subjects who are still "P" at 24 months, Medtronic will wait until all such determinations and conversions are made before submitting the results, and thus there can be no P's at 24 months.

Sample Size Determination analysis is similar but with one small difference. If, at the precise time of a Sample Size Determination analysis, there are any subjects who are still "P" at 24 months, Medtronic may proceed with the Sample Size Determination analysis, treating each P in the TAVI or SAVR group as an E or an N in four separate analyses:

- each P in the SAVR group as an N and each P in the TAVI group as an E
- each P in the SAVR group as an N and each P in the TAVI group as an N
- each P in the SAVR group as an E and each P in the TAVI group as an E
- each P in the SAVR group as an E and each P in the TAVI group as an N

If the results of these analyses all imply the same decision about whether to stop enrolling, Medtronic will follow that decision. If the results imply differing decisions about whether to stop enrolling, no decision will be made until all 24-month P's have been resolved and converted to E's or N's.

C.5.1 Prior Distributions for Transition Probabilities

The transitions of Figure 1 are assigned individual Beta(a,b) prior distributions. For the 1400 sample size look analysis, the values of a and b are tabulated in Table 2 and graphically depicted in Figure 2 (for the treatment group) and Figure 3 (for the control group). These values represent the trial sponsor's knowledge and belief about the relationship of the various interim states to the final state. At the times when sample size decisions must be made, the number of subjects who have completed 24 months (and thus provide information on the transition probabilities) will generally be insufficient to make good sample size decisions without including some additional information. Therefore, in the 1400 Sample Size Look analysis, the transitions are given informative priors, as tabulated in Table 2 and displayed graphically in Figure 2 and Figure 3 (further rationale for the choice of these prior distributions is given in Appendix G.1 and G.2). However, for all Win Looks, only flat priors ($a = b = 1$) for the transitions will be used.

Table 2. Parameters for Prior Distributions of the Transition Probabilities used in the determination of sample size. For all "Win" analyses, a and b are set to 1.

	Treatment Group		Control Group	
	a	b	A	b
Transition #1 (Start to E24)	7.35	41.65	7.35	41.651
Transition #2 (P1 to E24)	8.538	21.273	8.554	23.942
Transition #3 (N1 to E24)	7.639	50.038	7.745	53.642
Transition #4 (P6 to E24)	8.736	24.537	8.735	27.49
Transition #5 (N6 to E24)	7.739	67.557	7.819	76.512
Transition #6 (P12 to E24)	8.983	28.795	8.961	32.089
Transition #7 (N12 to E24)	7.89	101.736	7.959	114.768
Transition #8 (P18 to E24)	9.491	34.896	9.416	38.505
Transition #9 (N18 to E24)	8.218	197.452	8.263	221.227

Figure 2: Prior Distributions of the Transition Probabilities used in the determination of sample size (Treatment Group)

Treatment Group

Transition 1: No Data to E24
Beta(7.35 , 41.65)

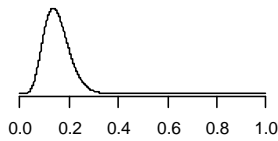

Transition 2: P1 to E24
Beta(8.538 , 21.273)

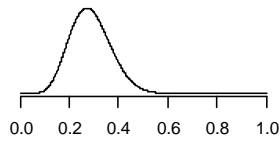

Transition 3: N1 to E24
Beta(7.639 , 50.038)

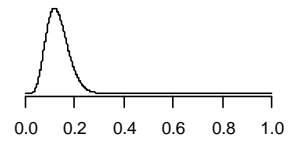

Transition 4: P6 to E24
Beta(8.736 , 24.537)

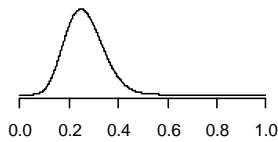

Transition 5: N6 to E24
Beta(7.739 , 67.557)

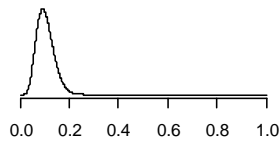

Transition 6: P12 to E24
Beta(8.983 , 28.795)

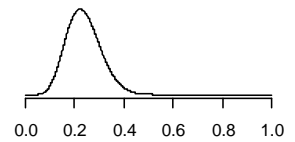

Transition 7: N12 to E24
Beta(7.89 , 101.736)

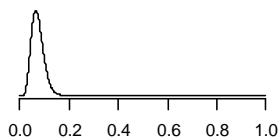

Transition 8: P18 to E24
Beta(9.491 , 34.896)

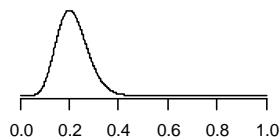

Transition 9: N18 to E24
Beta(8.218 , 197.452)

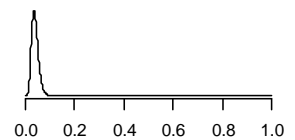
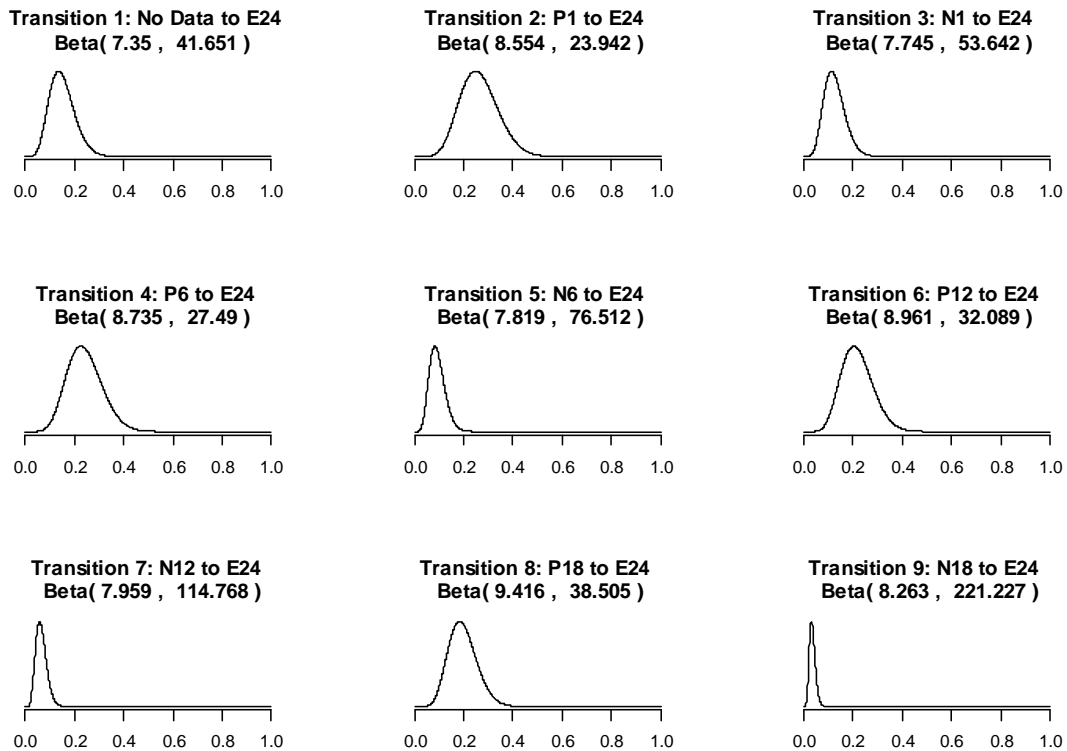

Figure 3: Prior Distributions of the Transition Probabilities used in the determination of sample size (Control Group)

Control Group



C.6 Operating Characteristics

The design described above has been subjected to intensive simulations in order to evaluate its anticipated performance in practice. In this section, we summarize the simulations of the design, which has one sample size look analysis (using $\delta = 0.05$) when 1400 subjects had entered the mITT population, one "Early Win" analysis (using $\delta = 0.07$) when 1400 mITT subjects have reached 12 months, and a final analysis (using $\delta = 0.07$) when the maximum sample size $N=1600$ mITT subjects have reached 24 months.

In the simulation, the proportion of simulated trials that result in a declaration of non-inferiority is the estimated power when $\pi_T - \pi_C < 0.07$ and the estimated type I error rate when $\pi_T - \pi_C \geq 0.07$. The estimated operating characteristics are based on 10000 simulated trials per scenario, with predictions (for each transition at each interim analysis of each of the 10000 trials) based on 5000 draws from the relevant transition probability distribution.

Table 3 displays the operating characteristics and summarizes the performance of the adaptive sample size determination algorithm under various assumed values of π_C and difference of $\pi_T - \pi_C$. The column "Overall Power" is the proportion of trials that resulted in a declaration of non-inferiority (NI). The column "Early Win, Late Win" indicates at which of the two "win analyses" the "win" occurred; ie., a trial that passed the primary objective at the interim "win" analysis would appear as an "Early Win" in the upper number, while a trial that did not pass until the final analysis would appear in the lower number as a "late win." The column "Average N" shows the average sample size attained for that row. The probability of attaining any of the allowed sample sizes (1400, 1600) is then displayed; the upper number indicates the proportion that stopped at that size because the results were promising, while the lower number indicates the proportion that stopped at that size for futility. The last column shows the proportion of trials that went to the maximum sample size of 1600.

Table 3: Operating characteristics of the design when $\pi_C = 0.17$, from a simulation of 10,000 simulated trials per line. Interpretations of column headings are given in the narrative

$\pi_C = 0.17$				Probability of Achieving Sample Size N	
Diff ($\pi_T - \pi_C$)	Power	Early Win, Late Win	Average N	N=1400 (Promise, Futile)	N=1600
-0.025	0.9954	0.9909 0.0045	1446.8	0.7615 0.0043	0.2342
0	0.9402	0.8896 0.0506	1509.1	0.4146 0.0401	0.5453
0.025	0.6410	0.5338 0.1072	1536.1	0.1425 0.1768	0.6807
0.05	0.1974	0.1505 0.0469	1506.5	0.0268 0.4406	0.5326
0.07	0.0409	0.0329 0.0080	1465.0	0.0050 0.6700	0.3250
0.075	0.0218	0.0158 0.0060	1454.3	0.0033 0.7253	0.2714

In Table 3, the type I error rate (when $\pi_T - \pi_C = 0.07$) is 0.0409. In this scenario, the trial went to its maximum size of N=1600 32.50% of the time, often stopping accrual sooner for futility (0.6700), and only rarely stopping accrual early for promising trend (0.0050). Those trials that either stopped early for promising trend or went to the maximum of 1600 were tested for an "early win" twelve months after accrual stops, with 3.29% (of the 10,000) winning early and an additional 0.80% winning at the final analysis (for a total type 1 error rate of 0.0409). When $\pi_T - \pi_C = 0$, the estimated power is 94.02%; the trial stopped accruing for promising trend at N=1400 41.46% of the time; the maximum of N=1600 occurred 54.53% of the time. The proportion of trials that passed at the interim "win" analysis was 88.96%, while an additional 5.06% passed the primary objective at the final "win" analysis. The average of the sample sizes (across the 10,000 simulated trials) was 1509.1 subjects, which is an average of some trials that stop accrual at N=1400 and some that stop at N=1600.

C.7 Simulation Details and Design Sensitivity

In order to generate data for the operating characteristics simulations described above, several additional assumptions about the data mechanism had to be made. These assumptions are intrinsic to the generation of artificial data in the simulation exercise but are *not* part of the analysis that is conducted on any data (real or simulated). This section describes these assumptions and also the sensitivity of the design to these assumptions.

C.7.1 LTFU/Data Missingness

Simulations were conducted under the assumption of 6% missingness over the 24-month study period. With each simulated trial, each subject was designated to be "lost" with probability 0.06; thus the exact number of subjects lost from one simulated trial to the next varied, though it was always approximately 6%. Furthermore, those subjects designated to "drop" were assumed to have dropped out uniformly in time, so that each of these subjects was dropped by 18 months with probability 18/24, each of those was in turn dropped by 12 months with probability 12/18, and so on. Marginally, the probability of being lost at 12 months was thus $0.06 \times 18/24 \times 12/18 = 0.03$, and similar statements can be made about each time point. Dropout was thus uniform in time over the 24-month study period. Artificial subjects, once lost, did not return to the analysis for subsequent visits.

C.7.2 Control Arm Event Rate

A stated assumption made in the operating characteristics as displayed in Table 3 is that the control arm event rate is $\pi_C = 0.17$. Alternative scenarios were simulated in which the control arm event rate was instead 12% and 22%. The results of these simulations are provided below in Table 4. It is evident that the type I error is < 0.05 . Power is $> 95\%$ when $\pi_T - \pi_C = 0$ and $\pi_C = 0.12$ and $> 80\%$ when $\pi_T - \pi_C = 0$ and $\pi_C = 0.22$.

Table 4: Operating characteristics of the design under differing control arm event rate assumptions. 10,000 simulated trials per line, with predictions based on 5000 imputations. Column interpretations are the same as in Table 3

$\pi_C = 0.12$				Probability of Achieving Sample Size N	
Diff ($\pi_T - \pi_C$)	Power	Early Win, Late Win	Average N	N=1400 (Promise, Futile)	N=1600
-0.025	0.9994	0.9989 0.0005	1424.8	0.8753 0.0006	0.1241
0	0.9778	0.9549 0.0229	1493.2	0.5177 0.0163	0.4660
0.025	0.7455	0.6417 0.1038	1540.1	0.1713 0.1283	0.7004
0.05	0.2443	0.1857 0.0586	1512.9	0.0284 0.4069	0.5467
0.07	0.0407	0.0311 0.0096	1463.3	0.0055 0.6781	0.3164
0.075	0.0243	0.0192 0.0051	1454.1	0.0028 0.7265	0.2707
$\pi_C = 0.22$				Probability of Achieving Sample Size N	
Diff ($\pi_T - \pi_C$)	Power	Early Win, Late Win	Average N	N=1400 (Promise, Futile)	N=1600
-0.025	0.9872	0.9752 0.0120	1464.4	0.6670 0.0108	0.3222
0	0.8971	0.8277 0.0694	1517.7	0.3519 0.0598	0.5883
0.025	0.4702	0.4702 0.1071	1535.7	0.1188 0.2029	0.6783
0.05	0.1861	0.1424 0.0437	1503.6	0.0260 0.4558	0.5182
0.07	0.0388	0.0305 0.0083	1463.2	0.0053 0.6787	0.3160
0.075	0.0270	0.0204 0.0066	1454.7	0.0044 0.7219	0.2737

C.7.3 Rate of Accrual

The speed at which subjects are recruited into the trial is another important assumption embedded within the simulations to determine operating characteristics. SURTAVI started to enroll subjects in June 2012. The enrollment was slow in the first 2 years. Therefore, in simulation of operating characteristics, the monthly accrual totals over the first 21 months were set to approximate the actual number of monthly implants, as follows: 7 in the first month, 2 in the second month, followed by 4, 7, 17, 21, 24, 31, 29, 28, 32, 32, 31, 34, 44, 42, 40, 39, 33, 36, 43. Beginning in Month 22, the assumed accrual is 45 subjects per month for the duration of the trial. This is the accrual rate used in the generation of Table 3 and Table 4.

Table 5 illustrates how the study design performs if accrual is faster or slower than this expectation. The slow speed assumes that 30 subjects are accrued per month after the first 22 months of accrual, and the fast speed assumes a steady set of 60 subjects per month (after the first 22 months).

The results in Table 5 demonstrate that type I error is controlled at < 0.05 as the rate of accrual varies. Power is approximately 94% for the cases where $\pi_T - \pi_C = 0$, and type 1 error is < 0.05 , though sample size tends to be smaller when accrual is slow.

Table 5: Operating characteristics of the design under differing assumptions about accrual rate. 10,000 simulated trials per line, with predictions based on 5000 imputations. Column meanings are the same as in Table 3

$\pi_C = 0.17$, slow accrual				Probability of Achieving Sample Size N	
Diff ($\pi_T - \pi_C$)	Power	Early Win, Late Win	Average N	N=1400 (Promise, Futile)	N=16000
-0.025	0.9981	0.9971 0.0010	1427.0	0.8631 0.0018	0.1351
0	0.9435	0.9086 0.0349	1493.8	0.4944 0.0364	0.4692
0.025	0.6473	0.5666 0.0807	1527.6	0.1467 0.2152	0.6381
0.05	0.2042	0.1671 0.0371	1481.1	0.0228 0.5718	0.4054
0.07	0.0407	0.0320 0.0087	1436.7	0.0024 0.8142	0.1834
0.075	0.0263	0.0210 0.0053	1428.0	0.0017 0.8582	0.1401
$\pi_C = 0.17$, fast accrual				Probability of Achieving Sample Size N	
Diff ($\pi_T - \pi_C$)	Power	Early Win, Late Win	Average N	N=1400 (Promise, Futile)	N=1600
-0.025	0.9926	0.9844 0.0082	1468.3	0.6518 0.0069	0.3413
0	0.9363	0.8616 0.0747	1523.2	0.3472 0.0369	0.6159
0.025	0.6488	0.5078 0.1410	1545.2	0.1349 0.1393	0.7258
0.05	0.2173	0.1529 0.0644	1528.1	0.0365 0.3228	0.6407
0.07	0.0437	0.0317 0.0120	1493.6	0.0097 0.5224	0.4679
0.075	0.0299	0.0229 0.0070	1485.7	0.0068 0.5646	0.4286

C.7.3.1 Subject Follow-up for 'Early Win' Analysis

The Early Win analysis occurs when 1400 mITT subject have reached 12 months, assuming that accrual did not stop for futility. Thus it is expected that approximately 1400 subjects will have 12 month follow-up at this analysis, except for perhaps 3% lost-to-follow-up during this 12 months, and perhaps a little variability due to the follow-up visit window. The number of subjects who have reached 24 months as of this analysis varies primarily with accrual rate. The table below displays the probable counts of 24-month observations at the early win analysis .

Table 6: Probable counts of subjects with 24-month outcomes at the Early Win analysis, for various accrual rates

Accrual Rate		
Expected	Slow	Fast
808	978	639

The percentage of subjects with 12-month and 24-month observations will depend on whether the trial stopped accrual at N=1400 or continued to N=1600, which in turn depends on factors such as the event rates and the treatment effect size. The expected counts of subjects accrued and subjects with 12- and 24-month outcomes at the Early Win analysis are shown in Table 7.

Table 7: Expected counts and proportions of subjects with 24-month outcomes, for various accrual rates and treatment effect sizes, as assessed by simulation.

	π_C	$\pi_t - \pi_C$	N Accrued	N at 12 Month	N at 24 Month	% at 24 Month
Slow Accrual	0.12	-0.025	1409.9	1358.0	976.5	69.3%
		0.000	1473.5	1358.0	976.7	66.6%
		0.025	1556.4	1358.1	976.6	62.9%
		0.050	1589.9	1358.1	976.4	61.5%
		0.070	1597.5	1357.8	975.3	61.1%
		0.075	1598.2	1358.1	975.5	61.0%
	0.17	-0.025	1427.1	1358.0	976.9	68.6%
		0.000	1497.4	1358.0	976.6	65.5%
		0.025	1562.6	1358.0	976.3	62.7%
		0.050	1589.4	1358.1	976.4	61.5%
		0.070	1597.4	1358.1	975.6	61.1%
		0.075	1597.6	1358.0	976.1	61.1%
	0.22	-0.025	1442.1	1358.0	976.6	67.9%
		0.000	1510.8	1358.0	976.1	64.9%
		0.025	1563.4	1358.1	976.7	62.6%
		0.050	1590.4	1358.1	976.1	61.4%
		0.070	1597.4	1358.1	976.1	61.1%
		0.075	1597.9	1357.8	976.0	61.1%
Expected Accrual	0.12	-0.025	1424.8	1358.0	807.5	56.8%
		0.000	1494.7	1358.1	807.3	54.2%
		0.025	1560.7	1358.0	807.3	51.9%
		0.050	1590.4	1358.0	807.0	50.8%
		0.070	1596.6	1357.9	806.9	50.6%
		0.075	1598.0	1358.0	806.9	50.5%
	0.17	-0.025	1447.0	1358.0	807.4	56.0%
		0.000	1513.6	1358.0	807.6	53.6%
		0.025	1565.4	1357.9	807.2	51.7%
		0.050	1590.4	1357.9	806.9	50.8%
		0.070	1597.0	1358.1	806.1	50.5%
		0.075	1597.6	1357.8	805.8	50.4%
	0.22	-0.025	1465.1	1358.0	807.7	55.3%
		0.000	1525.1	1358.0	807.2	53.1%
		0.025	1570.2	1358.0	807.2	51.5%
		0.050	1590.4	1357.9	807.1	50.8%
		0.070	1596.7	1358.0	806.3	50.5%
		0.075	1596.8	1358.1	806.0	50.5%

	π_C	$\pi_t - \pi_C$	N Accrued	N at 12 Month	N at 24 Month	% at 24 Month
Fast Accrual	0.12	-0.025	1445.4	1358.0	638.3	44.3%
		0.000	1510.9	1357.9	637.8	42.4%
		0.025	1566.5	1358.0	638.6	40.9%
		0.050	1590.1	1357.9	637.9	40.2%
		0.070	1597.3	1357.8	636.7	39.9%
		0.075	1597.3	1358.0	636.6	39.9%
	0.17	-0.025	1468.7	1358.1	638.0	43.6%
		0.000	1527.9	1358.0	638.5	42.0%
		0.025	1568.7	1358.1	637.2	40.7%
		0.050	1589.2	1358.0	638.2	40.2%
		0.070	1595.9	1358.2	637.0	39.9%
		0.075	1596.9	1358.1	637.3	39.9%
	0.22	-0.025	1486.8	1357.9	638.4	43.1%
		0.000	1538.3	1358.0	638.4	41.7%
		0.025	1571.6	1358.0	638.7	40.7%
		0.050	1590.3	1358.0	637.9	40.1%
		0.070	1596.2	1358.0	637.4	39.9%
		0.075	1596.8	1358.1	636.8	39.9%

C.7.4 Temporal Correlation

For simulation, patient-level data with realistic temporal correlation had to be generated. For each treatment group, a "skeleton" of probabilities for the various state transitions was constructed, as shown below in Table 8. For example, a subject in the Treatment group could become an "E" at 1 month with probability 0.02, a "P" at 1 month with probability 0.03, and an "N" at 1 month with probability $1 - 0.02 - 0.03 = 0.95$. If a subject is "E" at 1 month (denoted "E1" in the table), that subject becomes an "E" at 6 months with probability 1 (since subjects who have had an event by 1 month necessarily will have had that event by 6 months). If a subject is "P" at 1 month, that subject becomes an "E" at 6 months with probability 0.25, a "P" at 6 months with probability 0.01, and an N at 6 months with probability 0.74. Taken as a whole, the treatment "skeleton" of probabilities implies a 24-month marginal event rate of 18.7%, while the control "skeleton" of probabilities implies a 24-month marginal event rate of 20.7%; the serial correlation implied by the skeleton is the sponsor's best estimate of what will actually occur in the trial. (Shaded cells in the table are uniquely determined by the immediately preceding cells, a consequence of the fact that probabilities conditioned on the same event must sum to one.)

Table 8: Probability "Skeletons" for State Transitions used in Generating Temporally Correlated Data

Status	TAVI	SAVR	Status	TAVI	SAVR
Treated → 1 Month			6 Month → 12 Month		
P(E1)	0.02	0.03	P(E12 N6)	0.04	0.04
P(P1)	0.03	0.05	P(P12 N6)	0.01	0.01
P(N1)	0.95	0.92	P(N12 N6)	0.95	0.95
1 Month → 6 Month			12 Month → 18 Month		
P(E6 E1)	1.00	1.00	P(E18 E12)	1.00	1.00
P(E6 P1)	0.25	0.25	P(E18 P12)	0.25	0.25
P(P6 P1)	0.01	0.01	P(P18 P12)	0.01	0.01
P(N6 P1)	0.74	0.74	P(N18 P12)	0.74	0.74
P(E6 N1)	0.04	0.05	P(E18 N12)	0.04	0.04
P(P6 N1)	0.01	0.01	P(P18 N12)	0.01	0.01
P(N6 N1)	0.95	0.94	P(N18 N12)	0.95	0.95

Status	TAVI	SAVR	Status	TAVI	SAVR
6 Month → 12 Month			18 Month → 24 Month		
P(E12 E6)	1.00	1.00	P(E24 E18)	1.00	1.00
P(E12 P6)	0.25	0.25	P(E24 P18)	0.26	0.26
P(P12 P6)	0.01	0.01	P(N24 P18)	0.74	0.74
P(N12 P6)	0.74	0.74	P(E24 N18)	0.05	0.05
			P(N24 N18)	0.95	0.95

Estimated probability of subject's status at a specified follow-up given the subject's status at previous follow-up visit

E=Event experienced (either death or major stroke)

P=Potential major stroke experienced (severity not known until 90 day MRS)

N=No event experience

In the course of simulating multiple data scenarios, it is necessary to generate data with specific 24-month target event rates for both the Treatment and Control groups. To do this, the "skeleton" values of Table 8 are adjusted as follows. First, the probabilities in all unshaded cells that are not already 1.00 by construction are transformed to the logit scale; then a common value ϵ is added to each logit-transformed probability before transforming the sum back to the probability scale. By algebraically expressing the 24-month event rate in terms of the foregoing modified skeletal probabilities and subsequently solving for ϵ , a suitable adjustment to the skeletal state transition probabilities is found that sets the 24-month event rate equal to the desired target value π (eg., $\pi = 0.17$) while approximately maintaining the serial correlation of the original skeleton. This is accomplished separately for the two treatment groups.

This mechanism of generating temporally correlated data represents the sponsor's best knowledge and belief about the data that will actually arise in the prospective clinical trial. All operating characteristics in Table 3, Table 4, and Table 5 are generated with this method.

This mechanism only applies to the *generation of artificial* data in the simulation; it is not used at all in the analysis of data (real or simulated). If this data generation model does not adequately reflect the true pattern of serial correlation, the analysis model will nonetheless be tasked with recognizing this and causing the design to respond appropriately. In order to evaluate the robustness of the analysis model and sampling plan to the pattern of serial correlation, a simulation was conducted wherein the study design was presented with data simulated at the extremes of complete temporal correlation and complete temporal independence.

"Complete Temporal Correlation" is a scenario in which knowing the 1-month outcome for a subject is the same as knowing the 24-month outcome. This is accomplished by setting all interim outcomes (eg., 1-month, 6-month, etc.) to be equal to the 24-month "E" or "N" outcomes (except for those patients lost to follow-up in the simulation). The study design is expected to react appropriately and much sooner when presented with this pattern of data. "Complete Temporal Independence" is a scenario where knowing the interim outcomes for a subject gives no information about what that subject will be at 24 months. To accomplish this, no patient can be an "E" prior to 24 months (else there would be serial correlation), and subject outcomes at interim time points are set to be "P" or "N" with probability $P(E24)$, independently at each time point.

Table 9 displays operating characteristics generated under the Complete Temporal Correlation and Complete Temporal Independence patterns. As expected, the design reacts quicker (ie., with smaller sample size and higher chance of early win) when the data are completely correlated. While neither scenario is particularly realistic, it is important that the observed Type I errors are < 0.05 in both cases and the powers are acceptable.

Table 9: Operating characteristics of the design under alternative assumptions about temporal correlation. 10,000 simulated trials per line, with predictions based on 5000 imputations. Column meanings are the same as in Table 3

Complete Temporal Correlation $\pi_c = 0.17$, Expected Accrual Rate				Probability of Achieving Sample Size N	
Diff ($\pi_T - \pi_C$)	Power	Early Win, Late Win	Average N	N=1400 (Promise, Futile)	N=1600
-0.025	0.9990	0.9989 0.0001	1416.7	0.9157 0.0007	0.0836
0	0.9589	0.9575 0.0014	1487.7	0.5413 0.0204	0.4383
0.025	0.6496	0.6404 0.0092	1539.2	0.1274 0.1768	0.6958
0.05	0.1826	0.1757 0.0069	1487.9	0.0102 0.5504	0.4394
0.07	0.0278	0.0266 0.0012	1434.1	0.0010 0.8286	0.1704
0.075	0.0145	0.0134 0.0011	1425.9	0.0002 0.8704	0.1294
Complete Temporal Independence $\pi_c = 0.17$, Expected Accrual Rate				Probability of Achieving Sample Size N	
Diff ($\pi_T - \pi_C$)	Power	Early Win, Late Win	Average N	N=1400 (Promise, Futile)	N=1600
-0.025	0.9914	0.9701 0.0213	1469.8	0.6431 0.0081	0.3488
0	0.9283	0.8048 0.1235	1512.9	0.3905 0.0449	0.5646
0.025	0.6446	0.4591 0.1855	1534.0	0.1878 0.1424	0.6698
0.05	0.2230	0.1530 0.0700	1521.0	0.0719 0.3233	0.6048
0.07	0.0516	0.0384 0.0132	1494.9	0.0248 0.5008	0.4744
0.075	0.0391	0.0301 0.0090	1487.6	0.0213 0.5406	0.4381

C.7.5 Type I Errors

To study all combinations of accrual rate, control success rate, and serial correlation would require $3 \times 3 \times 3 = 27$ tables similar to Table 3. Rather than present all of these, we instead provide a comprehensive summary of all type I error rates observed through repeated trial simulations under the varying conditions described above. For reference, Table 10 shows the type I error rates for the previous trial design (non-inferiority margin $\delta = 0.05$, sample size of either $N=1400$, $N=1700$, $N=2000$, and Early Win analysis 12 months after stopping accrual). Each cell is based on 10,000 simulated clinical trials, with predictions based on 5,000 draws from each of the predictive model transition distributions. Under all scenarios, type I error is controlled. There is no evidence that type I error exceeds 0.05. Even the few scenarios with observed type I error greater than 0.05 (eg., the maximum of 0.0524) could easily result from a simulation of size 10,000 with underlying true rate = 0.05: a 95% probability interval calculated as $0.05 \pm 1.96 \sqrt{(0.05 \times 0.95 / 10000)}$ would range from 0.0457 to 0.0543, so a value as high as 0.0524 is entirely expected and constitutes no evidence of a type I error inflation.

Similarly, Table 11 shows the type I error rate for the same design, but changing only the non-inferiority margin from $\delta = 0.05$ to $\delta = 0.07$. This table was produced under the assumption that

the underlying true treatment rate is 0.07 higher than the control rate. The type I error rate remains in a similar range to the previous design, though the error rate is occasionally above 0.05 for the scenario of complete temporal independence, especially combined with the fast accrual profile. However, the assumption of complete temporal independence (with all events happening between 18 and 24 months) is not realistic, and the fast accrual scenario is faster than the known accrual rate that has been observed in the ongoing trial.

Finally, Table 12 shows the type I error rate for the current design which uses $\delta = 0.05$ for the sample size analysis at N=1400 enrolled, $\delta = 0.07$ for the Early Win interim analysis when 1400 mITT subjects have reached 12 months, and the final Win analysis when N=1600 have reached 24 months. Again, the implausible scenario of complete temporal independence combined with fast accrual shows the highest type I error rates. For the expected temporal correlation profile, type I error rates remain well below the nominal rate of 0.05.

Type I error rates for the superiority testing are described in Appendix G.5.

Table 10: Simulated Type I error rates for the previous trial design with non-inferiority margin 0.05, given varied correlation structures, accrual rates, and control event rates. 10,000 simulated trials per line, with predictions based on 5,000 imputations

			Control Event Rate		
			0.12	0.17	0.22
Complete Temporal Correlation	Accrual Rate	Slow	0.0364	0.0349	0.0370
		Expected	0.0313	0.0331	0.0356
		Fast	0.0338	0.0309	0.0325
Expected Temporal Correlation		Slow	0.0469	0.0424	0.0419
		Expected	0.0442	0.0433	0.0475
		Fast	0.0421	0.0488	0.0411
Complete Temporal Independence		Slow	0.0507	0.0483	0.0455
		Expected	0.0506	0.0476	0.0524
		Fast	0.0520	0.0501	0.0498

Table 11: Simulated Type I error rates for the previous trial design with non-inferiority margin 0.07, given varied correlation structures, accrual rates, and control event rates. 10,000 simulated trials per line, with predictions based on 5,000 imputations

			Control Event Rate		
			0.12	0.17	0.22
Complete Temporal Correlation	Accrual Rate	Slow	0.0370	0.0363	0.0406
		Expected	0.0354	0.0335	0.0340
		Fast	0.0330	0.0274	0.0332
Expected Temporal Correlation		Slow	0.0418	0.0401	0.0420
		Expected	0.0409	0.0413	0.0436
		Fast	0.0447	0.0430	0.0430
Complete Temporal Independence		Slow	0.0451	0.0502	0.0475
		Expected	0.0531	0.0530	0.0502
		Fast	0.0555	0.0552	0.0537

Table 12: Simulated Type I error rates for the current trial design (with non-inferiority margin $\delta = 0.07$ for “Win” analyses but $\delta = 0.05$ for the sample size assessment at N=1400), given varied correlation structures, accrual rates, and control event rates. 10,000 simulated trials per line, with predictions based on 5,000 imputations

			Control Event Rate		
			0.12	0.17	0.22
Complete Temporal Correlation	Accrual Rate	Slow	0.0259	0.0304	0.0302
		Expected	0.0275	0.0278	0.0295
		Fast	0.0305	0.0298	0.0292
Expected Temporal Correlation		Slow	0.0396	0.0407	0.0381
		Expected	0.0407	0.0409	0.0388
		Fast	0.0441	0.0437	0.0461
Complete Temporal Independence		Slow	0.0453	0.0488	0.0447
		Expected	0.0546	0.0516	0.0534
		Fast	0.0618	0.0638	0.0621

C.8 Missing Data and Planned Sensitivity Analyses (Primary Objective)

Every effort will be undertaken to minimize missing data. However, some missingness is inevitable, and the study is designed with the expectation that there may be up to 6% missing primary data at 24 months. The reasons for missing data will be described in detail and evaluated for assessment of possible bias. The distribution of prognostic factors between patients with data and those without data will be examined to evaluate any potential sources of bias.

By design, the analysis of the primary objective (at both interim time points) will predict 24-month outcomes for any subjects without measured 24-month outcomes, based on transitions from interim states and the experience of those who went on from those states to provide complete 24-month data. This is true whether the missing 24-month outcomes are due to being accrued later in the trial (as happens for many subjects at the interim "win" analyses) or some other cause, such as loss to follow-up (which will likely apply at both the interim and final "win" analyses). Several additional analyses are planned to be conducted (at the conclusion of the trial) that will explore the sensitivity of the main conclusions to the predictions for subjects whose missing 24-month outcomes cannot be explained by simply being accrued late (ie., subjects who are known to be lost to follow-up or whose 24-month visit window has closed without a measured outcome). In these analyses and for such subjects, 24-month outcomes will be imputed according to the model described below.

As with the primary analysis, any such subject will be viewed as belonging to one of several interim states. These are the same states used in the primary analysis (eg., "E" or "P" or "N" at 6 months, etc.)

For each of these states, the probability of becoming a composite success at 24 months will be modeled via a logistic formulation. Based on the number of subjects who went on from that state to become 24-month "E" and "N" subjects, respectively, a logistic regression of the following form will be fit:

$$\text{logit}(p) = \beta_0$$

where the parameter β_0 will be assigned a vague $N(0,10^2)$ distribution. The posterior distribution for β_0 will then be shifted by a biasing constant γ and will be back-transformed to the probability scale as:

$$p^* = \text{logit}^{-1}(\beta_0 + \gamma)$$

The 24-month outcome for any subject belonging to this state but lost thereafter will be imputed based on this distribution of p^* . The case $\gamma = 0$ contains no bias and corresponds essentially to the primary analysis.

By varying γ , the impact of a biasing influence on the study results can be examined. The values $\gamma = +\infty$ and $\gamma = -\infty$ correspond to setting all such observations to be "E" or "N." The impact of various values of γ (including $+\infty$ and $-\infty$) will be examined and presented in a sensitivity analysis, representing both positive and negative biases for the two groups.

Further analyses will explore the sensitivity of efficacy to the imputation model. Specifically, one analysis will present posterior probabilities of non-inferiority/superiority without the use of prediction (ie., completers only). Another will present the results of a tipping point analysis.

C.9 Description of Performed Analysis, per Population

C.9.1 Analysis of screening population

For the screening population only descriptive statistical analysis will be performed, on variables that are captured in the EDC system.

C.9.2 Analysis of ITT and mITT Populations

For the subjects in the randomized population the primary analysis of the primary endpoint and inferential statistics for the following secondary endpoints will be performed on the ITT and mITT populations:

- Major adverse cardiovascular and cerebrovascular events (MACCE)
- Individual MACCE components
- Major adverse events (MAE)
- Conduction disturbance requiring permanent pacemaker implantation
- NYHA
- Six-minute walk test
- Ratio of days alive out of hospital versus total days alive
- Quality of life
- Echocardiographic assessment of valve performance
- Aortic valve disease-related hospitalizations
- Cardiovascular deaths and valve-related deaths
- Strokes and TIAs
- Peri-procedural neurological injury
- Index procedure-related MAEs
- Length of index procedure hospital stay
- Device success
- Procedure success

C.9.3 Analysis of implanted population

The endpoints listed in C.9.2 will also be performed on the implanted population. Additionally, the implanted population will be used for analyzing the primary endpoint, secondary endpoint of prosthetic valve dysfunction, and echocardiographic assessment of valve performance.

C.10 Secondary Endpoints

The following secondary endpoints will be compared between TAVI and SAVR subject cohorts using the appropriate Bayesian version of analysis for comparing proportions and continuous variables as described below:

1. Incidence of Major Adverse Cardiovascular and Cerebrovascular Events (MACCE) at 30 days, 6 months, 12 months, 18 months, 24 months, and annually thereafter up to 5 years. MACCE is defined as a composite of:

- All-cause death
- Myocardial infarction (MI)
- All stroke, and
- Reintervention (defined as any cardiac surgery or percutaneous reintervention catheter procedure that repairs, otherwise alters or adjusts, or replaces a previously implanted valve)

MACCE-incidence estimates will be provided for the two treatment groups at 30 days, 6 months, 12 months, 18 months, 24 months, and annually thereafter up to 5 years. The statistical method will be the Bayesian version of a comparison of proportions (with predictions).

Additionally, incidence of MACCE will be compared at 30 days or hospital discharge, whichever is later. The statistical method will be the Bayesian version of a comparison of proportions

2. The occurrence of individual MACCE components at 30 days, 6 months, 12 months, 18 months, 24 months, and annually thereafter up to 5 years.

MACCE components will be summarized and their incidence estimates provided at 30 days, 6 months, 12 months, 18 months, 24 months, and annually thereafter up to 5 years. The statistical method will be the Bayesian version of a comparison of proportions (with predictions).

3. Major Adverse Events (MAE) and individual components of MAE at 30 days, 6 months, 12 months, 18 months, 24 months, and annually thereafter up to 5 years.

Major adverse event (MAE) includes:

- MACCE
- Acute kidney Injury
- Cardiac tamponade
- Prosthetic valve dysfunction – including moderate or severe aortic regurgitation
- Cardiogenic shock
- Prosthetic valve endocarditis
- Life-threatening, disabling or major bleeding
- Major vascular complication
- Cardiac perforation
- Valve malpositioning

MAE events and individual components of MAE will be summarized and the incidence of MAEs will be provided at 30 days, 6 months, 12 months, 18 months, 24 months, and annually thereafter up to 5 years. The statistical method will be the Bayesian version of a comparison of proportions (with predictions).

Additionally, incidence of major vascular complications and incidence of major or life-threatening bleeding events at 30 days or hospital discharge, whichever is longer, will also be compared using the Bayesian version of a comparison of proportions.

4. Incidence of Early safety at 30 days defined as a composite of:

- All-cause mortality
- All stroke (disabling and non-disabling)
- Life-threatening bleeding
- Acute kidney injury—Stage 2 or 3 (including renal replacement therapy)
- Coronary artery obstruction requiring intervention
- Major vascular complication
- Valve-related dysfunction requiring repeat procedure (BAV, TAVI, or SAVR)
- All-cause death

Early safety composite endpoint-incidence estimates will be provided for the two treatment groups at 30 days. The statistical method will be the Bayesian version of a comparison of proportions.

5. Incidence of Clinical Efficacy (after 30 days) at 6 months, 12 months, 18 months, 24 months and annually thereafter up to 5 years. Clinical efficacy defined as a composite of:
- All-cause mortality
 - All stroke (disabling and non-disabling)
 - Requiring hospitalizations for valve-related symptoms or worsening congestive heart failure
 - NYHA class III or IV
 - Valve-related dysfunction (mean aortic valve gradient ≥ 20 mmHg, EOA ≤ 0.9 - 1.1 cm² and/or DVI < 0.35 m/s, AND/OR moderate or severe prosthetic valve regurgitation*)

Clinical efficacy estimates will be provided for the two treatment groups at 6 months, 12 months, 18 months, 24 months and annually thereafter up to 5 years. The statistical method will be the Bayesian version of a comparison of proportions (with predictions).

*Refers to VARC-2 definitions

6. Incidence of Time-Related Safety at 30 days, 6 months, 12 months, 18 months, 24 months and annually thereafter up to 5 years. Time-Related Safety defined as a composite of:
- Structural valve deterioration:
 - Valve-related dysfunction (mean aortic valve gradient ≥ 20 mmHg, EOA ≤ 0.9 - 1.1 cm² and/or DVI < 0.35 m/s, AND/OR moderate or severe prosthetic valve regurgitation*)
 - Requiring repeat procedure (TAVI or SAVR)
 - Prosthetic valve endocarditis
 - Prosthetic valve thrombosis
 - Thromboembolic events (e.g. stroke)
 - VARC bleeding, unless clearly unrelated to valve therapy (e.g. trauma)

Time related safety composite endpoint-incidence estimates will be provided for the two treatment groups at 30 days, 6 months, 12 months, 18 months, 24 months and annually thereafter up to 5 years. The statistical method will be the Bayesian version of a comparison of proportions (with predictions).

*Refers to VARC-2 definitions

7. Conduction disturbance requiring permanent pacemaker implantation at 30 days, 6 months, 12 months, 18 months, 24 months, and annually thereafter up to 5 years.

The incidence of conduction disturbance requiring permanent pacemaker implantation will be provided at 30 days, 6 months, 12 months, 18 months, 24 months, and annually thereafter up to 5 years, separately for new onset and pre-existing conduction disturbance. The statistical method will be the Bayesian version of a comparison of proportions (with predictions).

8. Change in NYHA class from baseline at 30 days, 6 months, 12 months, 18 months, 24 months, and annually thereafter up to 5 years.

NYHA classifications will be summarized with frequencies and percentages at baseline, 30 days, 6 months, 12 months, 18 months, 24 months, and annually through five years. Change in NYHA classification from baseline will be summarized both with frequencies and percentages and as continuous data at 30 days, 6 months, 12 months, 18 months, 24 months and annually through five years.

For each subject with paired data, the number of classes changed from baseline (-3, -2, -1, 0, 1, 2, or 3) will be calculated at 30 days, 6 months, 12 months, 18 months, 24 months, and annually thereafter up to 5 years. For each treatment group, a Bayesian version of a paired t-test will be performed to evaluate change from baseline at 30 days, 6 months, 12 months, 18 months, 24 months, and annually through five years. The endpoint will be evaluated between groups using a Bayesian version of a t-test.

9. Change in distance walked during 6-minute walk test (6MWT) from baseline to 30 days, baseline to 12 months, and baseline to 24 months.

All subjects who are able to perform the six-minute walk evaluation at the time of the follow-up visit will be included in the analysis.

The endpoint will be evaluated using a Bayesian version of a t-test.

10. Ratio of days alive out of hospital versus total days alive assessed at 12 months and 24 months follow-up.

The proportion of post-procedure days alive out of hospital against total days alive will be compared between groups at 12 and 24 months. The numerator will be the number of days alive out of hospital, and the denominator will be the number of post-procedure days alive as of the last follow-up date. All hospitalizations will be included in this analysis, including hospitalization for device implant.

In addition, days alive out of hospital will be compared between groups at 12 months and 24 months.

The endpoint will be evaluated using a Bayesian version of a t-test.

11. Quality of Life (QoL) change from baseline at 30 days, 3 months, 6 months, 12 months, 18 months, 24 months, and annually thereafter up to 5 years.

The Kansas City Cardiomyopathy Questionnaire (KCCQ), SF-36, and EuroQoL will be assessed at baseline, 30 days, 6 months, 12 months, 18 months, 24 months, and annually thereafter up to 5 years. SF-36 and EuroQoL will also be assessed at 3 months. All subjects completing the questionnaires will be evaluated and the reasons for missing data will be provided.

The endpoint will be evaluated using a Bayesian version of a t-test.

12. Echocardiographic assessment of prosthetic valve performance at discharge, 6 months, 12 months, 24 months, and annually thereafter up to 5 years using the following measures:

- transvalvular mean gradient
- effective orifice area
- degree of prosthetic aortic valve regurgitation (including transvalvular and paravalvular)

The four echocardiographic measurements will be evaluated at discharge, 6 months, 12 months, 24 months, and annually thereafter up to 5 years. All implanted subjects undergoing echocardiography procedures will be evaluated.

Continuous measures will be evaluated using a Bayesian version of a two-sample t-test. Categorical variables will be evaluated using Bayesian version of a comparison of polytomous outcomes.

Additionally, incidence of moderate/severe aortic insufficiency at discharge will be compared between groups using the Bayesian version of a comparison of proportions.

13. Aortic valve disease related hospitalizations

The number of subjects re-hospitalized after the initial index procedure will be compared at 30 days, 6 months, 12 months, 18 months, 24 months, and annually thereafter up to 5 years.

Incidence of recurrent hospitalization will be provided at 30 days, 6 months, 12 months, 18 months, 24 months, and annually thereafter up to 5 years. The statistical method will be the Bayesian version of a comparison of proportions (with predictions).

14. Cardiovascular deaths and valve-related deaths

The number of subjects experiencing cardiovascular deaths and valve-related deaths at 30 days, 6 months, 12 months, 18 months, 24 months, and annually thereafter up to 5 years. Incidences will be compared between groups. The statistical method will be the Bayesian version of a comparison of proportions (with predictions).

15. Strokes and TIAs

The number of subjects with strokes (of any severity) and TIAs at 30 days, 6 months, 12 months, 18 months, 24 months, and annually thereafter up to 5 years. A separate analysis will be performed for each of the following:

- a composite of all strokes and TIAs
- disabling strokes only
- non-disabling strokes only
- TIAs only

The statistical method will be the Bayesian version of a comparison of proportions (with predictions).

Additionally, incidence of all strokes at 30 days or hospital discharge, whichever is longer, will be compared between groups using the Bayesian version of a comparison of proportions.

16. Peri-procedural Neurological Injury (Stroke, TIA, Encephalopathy)

For each treatment group, the proportion of subjects with a neurologic injury (stroke, TIA, or encephalopathy) at discharge or at 7 days post-index procedure (whichever occurs first) will be calculated. The numerator will be the number of subjects with a neurologic injury (stroke, TIA, or encephalopathy) at discharge or at 7 days post-index procedure (whichever occurs first), and the denominator will be the number of subjects in that treatment group. Results will also be presented separately for disabling stroke, non-disabling stroke, TIA, and encephalopathy. Proportions will be compared between groups using Bayesian version of a comparison of proportions.

17. Index procedure related MAEs

Index procedure-related MAE events will be summarized and event rates will be provided at 30 days. The numerator will be the number of procedure-related MAE events experienced by the end of the 30-day follow-up visit, and the denominator will be the number of subjects evaluated at the 30-day follow-up visit (or a later follow-up) plus the number of subjects not evaluated but who experienced a procedure-related MAE event prior to the end of the follow-up visit window.

Additionally, the percentage of subjects with a procedure-related MAE will be calculated in the same way, but allowing no more than one MAE per subject. The endpoint is descriptive and no statistical hypothesis test will be performed.

18. Length of index procedure hospital stay

The length of TAVI or SAVR hospital stay will be summarized for all subjects undergoing a study procedure.

The endpoint will be evaluated between groups using a Bayesian version of a t-test.

19. Presence of atrial fibrillation at post-procedure, discharge, 30 days, 6 months, 12 months, 18 months, 24 months, and annually thereafter up to 5 years.

The statistical method will be the Bayesian version of a comparison of proportions (with predictions).

The following secondary endpoints will be assessed for the TAVI cohort subjects only:

20. Device success defined as follows:

- Absence of procedural mortality AND
- Correct positioning of a single prosthetic heart valve into the proper anatomical location AND
- Intended performance of the prosthetic heart valve (no prosthesis-patient mismatch and mean aortic valve gradient <20 mmHg or peak velocity <3 m/s, AND no moderate or severe prosthetic valve regurgitation*)
 - assessed acutely in a resting state, either within 24-48 hours after the index procedure or before hospital discharge

*Refers to VARC-2 definitions

Device success, as defined above, will be calculated for all subjects undergoing the TAVI procedure.

The endpoint is descriptive and no statistical hypothesis test will be performed.

21. Procedural success, defined as device success and absence of in-hospital MACCE.
- Procedural success, as defined above, will be calculated for all randomized subjects undergoing the TAVI procedure.
- The endpoint is descriptive and no statistical hypothesis test will be performed.
22. Evidence of prosthetic valve dysfunction at 30 days, 6 months, 12 months, 24 months, and annually thereafter up to 5 years.
- The number of subjects with evidence of prosthetic valve dysfunction will be evaluated at 30 days, 6 months, 12 months, 18 months, 24 months, and annually thereafter up to 5 years.
- Point estimates and 95% BCIs for each time point will be presented using methods described below in the Bayesian version of a comparison of proportions (with predictions).
23. Resheath and Recapture (combined) success rate.
- The success rate will be analyzed for all subjects in whom the resheath or recapture feature is attempted. The number and percentage of successful resheath or recapture attempts combined will be calculated. Separate resheathing and recapturing success rates will also be calculated.
- The endpoint is descriptive and no statistical hypothesis test will be performed.
- Resheath and recapture success, as defined above, will be calculated for all subjects undergoing the TAVI procedure with Evolut R.

C.11 Analysis Methods for Secondary Objectives

As indicated below, flat or diffuse prior distributions have been identified for all secondary objective analyses.

C.11.1 Discrete (Dichotomous) Data: Bayesian Version of a Comparison of Proportions

Given proportions p_t and p_c for a dichotomous outcome, let each be assigned a flat Beta(1, 1) prior. Then the posterior distributions for p_t and p_c follow Beta($1+Y_t, 1+N_t-Y_t$) and Beta($1+Y_c, 1+N_c-Y_c$) distributions, respectively, where Y_t and Y_c represent the number of “successes” and N_t and N_c represent the number of “tries” (e.g., subjects) in their respective treatment groups. The distribution of the difference $p_t - p_c$ can be easily estimated by drawing a large number of observations (e.g., 100,000) from each Beta posterior, and subtracting. The posterior probability $P(p_t / p_c < \theta \mid \text{data})$ is estimated as the proportion of these observations where the ratio is less than θ . Similarly, the posterior probability $P(p_t - p_c < \delta \mid \text{data})$ is estimated as the proportion of these observations where the difference is less than δ . A 95% equal-tail Bayesian credible interval can be calculated from the 2.5th and 97.5th percentiles of the sampled distribution of $p_t - p_c$ or p_t / p_c , as appropriate. Credible intervals for p_t and p_c can be individually calculated as the 2.5th and 97.5th percentiles from their respective (beta) posterior distributions.

C.11.2 Discrete (Polytomous) Data: Bayesian Version of a Comparison of Proportions

Given the vectors \mathbf{p}_t and \mathbf{p}_c of k -variate proportions for a polytomous outcome, let each be assigned a flat Dirichlet($\mathbf{1}$) prior. The Dirichlet distribution is the multidimensional analog of the Beta distribution. After observing multinomial count data \mathbf{Y}_t and \mathbf{Y}_c , the posterior distributions of \mathbf{p}_t and \mathbf{p}_c follow Dirichlet($\mathbf{1}+\mathbf{Y}_t$) and Dirichlet($\mathbf{1}+\mathbf{Y}_c$) distributions, respectively. The distribution of the difference $\mathbf{p}_t - \mathbf{p}_c$ (or ratio) can be easily estimated by drawing a large number of observations (eg, 100,000) from each Dirichlet posterior, and subtracting (or dividing). The marginal posterior probability $\Pr(p_t^{(i)} - p_c^{(i)} > \delta \mid \text{data})$ for the i^{th} component of $(\mathbf{p}_t - \mathbf{p}_c)$ is estimated as the proportion of these observations where the difference exceeds δ . A 95% Bayesian equal-tail credible interval can be calculated from the 2.5th and 97.5th percentiles of the sampled distribution of $p_t^{(i)} - p_c^{(i)}$. Posterior probabilities of ratios are similarly calculated from the sampled distribution of $p_t^{(i)} / p_c^{(i)}$.

C.11.3 Discrete (Dichotomous) Data: Bayesian Comparison of Proportions (with Predictions)

The analysis above under “Bayesian Version of a Comparison of Proportions” applies only to subjects with observed data at the time point of interest (eg, the 24-month visit). A modification is required in order to take into account subjects with partial follow-up, as will be the case if non-inferiority is demonstrated for the primary objective at the interim analysis time point.

The modeling is analogous to the predictions in the Primary Objective. Subjects without outcome data for the time point of interest T_0 will be considered to be in intermediate states that are analogous to those used in the primary objective. If $T_0 = 24$ months, subjects without 24-month outcome data will be considered to be in one of 26 states (13 for each treatment group). The 13 states are:

- no interim data
- E or P or N at 1 month, no subsequent data
- E or P or N at 6 months, no subsequent data
- E or P or N at 12 months, no subsequent data
- E or P or N at 18 months, no subsequent data

If T_0 is later (eg, 3 years), there is one more set of 3 interim states (E or P or N at 24 months). If the time point of interest is sooner (eg, 12 months), only the first few bullets above (measured at time points prior to T_0) would apply.

As with the primary objective analysis, subjects in the "E" state at interim time points can be imputed to be "E" at T_0 , with certainty. For each of the remaining interim states (separately by treatment group), the probability of becoming an "E" at 24 months is modeled via a Beta(1,1) prior distribution which is updated to a Beta(1+X, 1+Y) distribution, based on the number X and Y of subjects who went on from that state to become 24-month "E" and "N" subjects, respectively.

Predicting 2-year outcomes for each of these states, and combining with the data from subjects with known 2-year outcomes, a posterior probability of non-inferiority (or superiority) is calculated; it is based on observed 2-year data and also a predictive model that employs interim outcomes and the relationship between those interim outcomes and their corresponding final outcomes that is learned during the current trial.

Inference proceeds from a sampled version of the posterior distribution of $[p_t - p_c]$ or $[p_t / p_c]$, as appropriate, that incorporates both the observed and predicted values at T_0 . With any one imputation of incomplete data, we draw and store a sample from the posterior distribution $[p_t - p_c | \text{Observed 2-year data, Imputed 2-year data}]$. By iterating this process we create a sampled version of the $[p_t - p_c]$ posterior distribution that accounts for uncertainty in the prediction. The probability of superiority is then estimated by the proportion of these stored values wherein $p_t > p_c$. By identifying the 2.5th and 97.5th percentiles of the combined stored samples, a 95% credible interval that accounts for uncertainty in the predicted values is obtained. Analogous techniques are used if the quantity of interest is the ratio p_t / p_c .

In this analysis, all prior distributions (i.e., those for p_t and p_c as well as for all transition probability distributions) are Beta(1,1).

C.11.4 Continuous Data: Bayesian version of a t-test.

Assuming that the quantity of interest Y follows a $N(\mu, \sigma^2)$ distribution, and placing a uniform prior distribution on $(\mu, \log(\sigma))$, the posterior distribution of μ has the form²⁷

$$\left[\frac{\mu - \bar{y}}{s/\sqrt{n}} \mid Y \right] \sim t_{n-1}$$

Employing this for both μ_t and μ_c , the distribution of $(\mu_t - \mu_c)$ can be estimated in Monte Carlo fashion by drawing a large number of observations (eg, 25000) from a t_{n-1} distribution for $n = n_t$ and $n = n_c$, back-transforming these observations to the μ_r and μ_c -scales, and subtracting. The posterior probability $P(\mu_t - \mu_c > \delta \mid \text{data})$ is estimated as the proportion of observed values of $(\mu_t - \mu_c)$ that exceed δ . A 95% equal-tail Bayesian credible interval can be calculated from the 2.5th and 97.5th percentiles of the sampled distribution of $\mu_t - \mu_c$. Credible intervals for μ_t and μ_c can be individually calculated as the 2.5th and 97.5th percentiles from their respective (scaled t) posterior distributions.

C.11.5 Continuous Data (Distribution-free, Superiority): Bayesian Version of a Wilcoxon Rank-Sum Test

For this test, data are ranked. Analogous to the Wilcoxon Rank-Sum test, observations in each group are replaced by their ranks in the combined order statistic. Then the two groups of rank-transformed data are compared via the Bayesian version of a t-test, above. It has been shown that conducting a two-sample t-test on rank-transformed data is approximately equivalent to the Wilcoxon Rank-Sum test^{10,11}.

Non-inferiority can be evaluated by first subtracting a margin (δ) from each observation in one treatment group prior to the rank transformation.

C.12 Multiplicity Considerations

It is recognized that with a multiplicity of tests comes an inflation in the chance of a false finding of superiority or non-inferiority. Therefore, for the purpose of seeking approved labeling claims on designated secondary objectives, the following standard will be used: If the primary objective demonstrates non-inferiority, claims will be sought for selected secondary non-inferiority and superiority objectives and for superiority on the primary objective metric. These will be tested via a hierarchical (sequential) testing order that preserves the overall study-wise type I error rate at the level of 0.05, while requiring all non-inferiority tests to meet a nominal type I error rate of 0.05 and all superiority tests to meet a nominal type I error rate of 0.025. The testing order is specified below. The following objectives are tested in order, and testing continues if and only if all previous objectives have met their designated success criterion.

1. Primary endpoint (non-inferiority)
2. Transvalvular mean gradient at 12 months (non-inferiority)
3. Effective orifice area at 12 months (non-inferiority)
4. Change in NYHA classification from baseline to 12 months (non-inferiority)
5. Change in KCCQ score from baseline to 30 days (non-inferiority)

All of the above are non-inferiority tests and are tested with a type I error standard of 0.05. If all of the above tests meet their success criterion, the type I error rate of 0.05 that is passed on from the above tests will be split equally (using a Bonferroni justification) between the following parallel subfamilies, so that each subfamily is tested using a type I error rate of 0.025:

¹⁰ Berry D & Lindgren B, *Statistics: Theory and Methods*, 2ed. Belmont, CA: Duxbury, 1996, p 505.

¹¹ Conover WJ & Iman RL, "Rank transformations as a bridge between parametric and nonparametric statistics," *American Statistician* 35 (1981), 124-129.

Subfamily #1: Primary endpoint (superiority)

Subfamily #2: Secondary (superiority) objectives #5–#18 as enumerated below, tested in ordered sequence such that all α is passed on to subsequent tests if a test criterion is met, while all testing stops if a test criterion is not met. This procedure controls the type I error rate of this subfamily at the level 0.025.

It is not necessary to “pass” all objectives in one subfamily in order to test the objective(s) in the other subfamily.

Since, for all secondary objectives, the prior distributions are flat or nearly flat, virtually all information in the model is contained within the likelihood. Therefore, a rule that determines $P(H | \text{data}) > \theta$ must induce a “critical value” in the data space that is approximately equal to the critical value defined by a $(1-\theta)$ -level significance test in the setting of a standard frequentist hypothesis test, and the type 1 error of each secondary objective analysis must therefore approximate the quantity $1 - \theta$. This is consistent with the statement of Gelman et al. that “[i]n various simple one-sided hypothesis tests, conventional p-values may correspond with posterior probabilities, under noninformative prior distributions”¹² and the statement of Albert that “a Bayesian probability of a hypothesis is equal to the p-value for one-sided testing problems when a vague prior distribution is placed on the parameter”¹³. It follows that frequentist methods that control type 1 errors among multiple objectives must apply, at least approximately, to posterior probabilities in an analogous fashion.

For the purposes of seeking claims, these objectives will only be evaluated once, at the same time as non-inferiority of the primary objective is established. The only exception to this is the primary endpoint superiority test, which carries the possibility of a delayed determination of superiority (as described in Section 4.2.1 and Appendix G.5 of this SAP document) and may thus meet its success criterion at a different time.

The remaining secondary objectives may be of interest for scientific or financial reasons but will not be the basis for supporting labeling claims; they are thus outside of the hierarchical testing procedure. Similarly, for those objectives that test non-inferiority, if non-inferiority is established, a test of superiority will also be conducted, but unless specifically itemized in the list, such superiority testing is not part of the hierarchical testing procedure; these superiority tests may be of interest for scientific or financial reasons but will not be the basis for supporting labeling claims.

C.12.1 Ordered List of Secondary Objectives to be Tested To Support Labeling Claims

1. Transvalvular mean gradient at 12 months (non-inferiority): TAVI vs. SAVR (secondary objective #12). The hypothesis of interest is

$$H: \mu_{\text{TAVI}} < \mu_{\text{SAVR}} + 5$$

where μ_{TAVI} and μ_{SAVR} denote the average mean gradient at 12 months, measured in mmHg. This objective will be evaluated using a Bayesian version of a two-sample t-test (see Section C.11). The posterior probability $P(H | \text{data})$ will be calculated and compared to a threshold of 0.95.

Rationale for Delta: A difference less than 5 mmHg for mean gradient is not considered clinically relevant for the SURTAVI Steering Committee.

¹² Gelman A, Carlin JB, Stern HS, Rubin DB, *Bayesian Data Analysis*, 1st ed. London: Chapman & Hall, 1995, p. 69.

¹³ Albert J, *Bayesian Computation with R*, 1st ed. New York: Springer, 2007.

- Effective orifice area at 12 months (non-inferiority): TAVI vs. SAVR (secondary objective #12). The hypothesis of interest is

$$H: \mu_{TAVI} > \mu_{SAVR} - 0.1$$

where μ_{TAVI} and μ_{SAVR} denote the mean effective orifice area at 12 months, measured in cm^2 . This objective will be evaluated using a Bayesian version of a two-sample t-test (see Section C.11). The posterior probability $P(H | \text{data})$ will be calculated and compared to a threshold of 0.95.

Rationale for Delta: A difference less than 0.1 cm^2 for effective orifice area is not considered clinically relevant for the SURTAVI Steering Committee.

- Change in NYHA classification from baseline to 12 months (non-inferiority): TAVI vs. SAVR (secondary objective #8). The hypothesis of interest is

$$H: \mu_{TAVI} > \mu_{SAVR} - 0.375$$

where μ_{TAVI} and μ_{SAVR} denote the mean number of classification improvements in NYHA from baseline to 12 months. For subjects with NYHA categories at both baseline and 12 month visit, the NYHA classification improvements will be calculated as $\text{NYHA}_{\text{baseline}} - \text{NYHA}_{12\text{month}}$. The objective will be evaluated using a Bayesian version of a two-sample t-test (see Section C.11). The posterior probability $P(H | \text{data})$ will be calculated and compared to a threshold of 0.95.

Rationale for Delta: A difference less than 0.375 for NYHA classification is not considered clinically relevant for the SURTAVI Steering Committee.

- Change in Kansas City Cardiomyopathy Questionnaire (KCCQ) score from baseline to 30 days (non-inferiority): TAVI vs. SAVR (secondary objective #11). The hypothesis of interest is

$$H: \mu_{TAVI} > \mu_{SAVR} - 5$$

where μ_{TAVI} and μ_{SAVR} denote the mean improvements in the KCCQ score from baseline to 30 days. For subjects with KCCQ score at both baseline and 30 days, the improvement in KCCQ will be calculated as $\text{KCCQ}_{30\text{day}} - \text{KCCQ}_{\text{baseline}}$. The objective will be evaluated using a Bayesian version of a two-sample t-test (see Section C.11). The posterior probability $P(H | \text{data})$ will be calculated and compared to a threshold of 0.95.

Rationale for Delta: A 5 point improvement or decrease in KCCQ is the minimum difference that is clinically relevant. (Spertus J, et al, "Monitoring clinical changes in patients with heart failure: A comparison of methods," American Heart Journal 2005;150:710-715.)

- Length of index procedure hospital stay after TAVI vs. SAVR (secondary objective #18). The hypothesis of interest is

$$H: \mu_{TAVI} < \mu_{SAVR}$$

where μ_{TAVI} and μ_{SAVR} denote the mean length of index hospital stay. The objective will be evaluated using a Bayesian version of a two-sample t-test (see Section C.11). The posterior probability $P(H | \text{data})$ will be calculated and compared to a threshold of 0.975.

- Transvalvular mean gradient at 12 months (superiority): TAVI vs. SAVR (secondary objective #12). The hypothesis of interest is

$$H: \mu_{TAVI} < \mu_{SAVR}$$

where μ_{TAVI} and μ_{SAVR} denote the average mean gradient at 12 months, measured in mmHg. This objective will be evaluated using a Bayesian version of a two-sample t-test (see Section C.11). The posterior probability $P(H | \text{data})$ will be calculated and compared to a threshold of 0.975.

- Effective orifice area at 12 months (superiority): TAVI vs. SAVR (secondary objective #12). The hypothesis of interest is

$$H: \mu_{TAVI} > \mu_{SAVR}$$

where μ_{TAVI} and μ_{SAVR} denote the mean effective orifice area at 12 months, measured in cm^2 . This objective will be evaluated using a Bayesian version of a two-sample t-test (see Section C.11). The posterior probability $P(H | \text{data})$ will be calculated and compared to a threshold of 0.975.

8. Change in Kansas City Cardiomyopathy Questionnaire (KCCQ) score from baseline to 30 days (superiority): TAVI vs. SAVR (secondary objective #11). The hypothesis of interest is

$$H: \mu_{TAVI} > \mu_{SAVR}$$

where μ_{TAVI} and μ_{SAVR} denote the mean improvements in the KCCQ score from baseline to 30 days. For subjects with KCCQ score at both baseline and 30 days, the improvement in KCCQ will be calculated as $KCCQ_{30\text{day}} - KCCQ_{\text{baseline}}$. The objective will be evaluated using a Bayesian version of a two-sample t-test (see Section C.11). The posterior probability $P(H | \text{data})$ will be calculated and compared to a threshold of 0.975.

9. Days alive out of the hospital at 12 months after TAVI vs. SAVR (secondary objective #10). The hypothesis of interest is

$$H: \mu_{TAVI} > \mu_{SAVR}$$

where μ_{TAVI} and μ_{SAVR} denote the mean number of days alive out of the hospital at 12 months. The objective will be evaluated using a Bayesian version of a two-sample t-test (see Section C.11). The posterior probability $P(H | \text{data})$ will be calculated and compared to a threshold of 0.975.

10. Days alive out of the hospital at 24 months after TAVI vs. SAVR (secondary objective #10). The hypothesis of interest is

$$H: \mu_{TAVI} > \mu_{SAVR}$$

where μ_{TAVI} and μ_{SAVR} denote the mean number of days alive out of the hospital at 24 months. The objective will be evaluated using a Bayesian version of a two-sample t-test (see Section C.11). The posterior probability $P(H | \text{data})$ will be calculated and compared to a threshold of 0.975.

11. Change in SF-36 Physical Summary Scale from baseline to 3 months: TAVI vs. SAVR (secondary objective #11). The hypothesis of interest is

$$H: \mu_{TAVI} > \mu_{SAVR}$$

where μ_{TAVI} and μ_{SAVR} denote the mean improvements in the SF-36 Physical Summary Scale from baseline to 3 months. The objective will be evaluated using a Bayesian version of a two-sample t-test (see Section C.11). The posterior probability $P(H | \text{data})$ will be calculated and compared to a threshold of 0.975.

12. Change in EQ-5D from baseline to 3 months: TAVI vs. SAVR (secondary objective #11). The hypothesis of interest is

$$H: \mu_{TAVI} > \mu_{SAVR}$$

where μ_{TAVI} and μ_{SAVR} denote the mean improvements in the EQ-5D from baseline to 3 months. The objective will be evaluated using a Bayesian version of a two-sample t-test (see Section C.11). The posterior probability $P(H | \text{data})$ will be calculated and compared to a threshold of 0.975.

13. Incidence of MACCE at 30 days or hospital discharge, whichever is longer: TAVI vs. SAVR (secondary objective #1). The hypothesis of interest is

$$H: \pi_{TAVI} < \pi_{SAVR}$$

where π_{TAVI} and π_{SAVR} denote the binary rate of MACCE at 30 days or hospital discharge (if longer). The posterior probability $P(H | \text{data})$ will be calculated and compared to a threshold

of 0.975. The statistical method will be the Bayesian version of a comparison of proportions (see Section C.11).

14. Incidence of major vascular complication at 30 days or hospital discharge, whichever is longer: TAVI vs. SAVR (secondary objective #3). The hypothesis of interest is

$$H: \pi_{TAVI} < \pi_{SAVR}$$

where π_{TAVI} and π_{SAVR} denote the binary rate of major vascular complications at 30 days or hospital discharge (if longer). The posterior probability $P(H | \text{data})$ will be calculated and compared to a threshold of 0.975. The statistical method will be the Bayesian version of a comparison of proportions (see Section C.11).

15. Incidence of major or life-threatening bleeding events at 30 days or hospital discharge, whichever is longer: TAVI vs. SAVR (secondary objective #3). The hypothesis of interest is

$$H: \pi_{TAVI} < \pi_{SAVR}$$

where π_{TAVI} and π_{SAVR} denote the binary rate of major or life-threatening bleeding events at 30 days or hospital discharge (if longer). The posterior probability $P(H | \text{data})$ will be calculated and compared to a threshold of 0.975. The statistical method will be the Bayesian version of a comparison of proportions (see Section C.11).

16. Incidence of all strokes at 30 days or hospital discharge, whichever is longer: TAVI vs. SAVR (secondary objective #15). The hypothesis of interest is

$$H: \pi_{TAVI} < \pi_{SAVR}$$

where π_{TAVI} and π_{SAVR} denote the binary rate of all strokes at 30 days or hospital discharge (if longer). The posterior probability $P(H | \text{data})$ will be calculated and compared to a threshold of 0.975. The statistical method will be the Bayesian version of a comparison of proportions (see Section C.11).

17. Incidence of moderate/severe aortic insufficiency after TAVI vs. SAVR (secondary objective #12). The hypothesis of interest is

$$H: \pi_{TAVI} < \pi_{SAVR}$$

where π_{TAVI} and π_{SAVR} denote the proportion of subjects with moderate/severe aortic insufficiency at the discharge echo. The posterior probability $P(H | \text{data})$ will be calculated and compared to a threshold of 0.975. The statistical method will be the Bayesian version of a comparison of proportions (see Section C.11).

18. New pacemaker implant rate for TAVI at 30 days or hospital discharge, whichever is longer (secondary objective #7). The hypothesis of interest is

$$H: \pi_{TAVI} < 30\%$$

where π_{TAVI} denote the binary rate of new pacemaker implants for TAVI at 30 days or hospital discharge (if longer). The posterior probability $P(H | \text{data})$ will be calculated and compared to a threshold of 0.975. The statistical method will be the Bayesian version of a comparison of proportions (see Section C.11).

Other than the hierarchical testing procedure described above, no further multiplicity adjustments will be made in the analyses of the secondary endpoints. Summary data from other secondary objectives, such as device success and procedural success from secondary objectives #20 and #21, respectively, may be provided in the device labeling. However, no claims of statistical significance or other statistical inference will be made.

C.13 Heterogeneity/Poolability

A poolability analysis among investigational centers, access site (iliofemoral or non-iliofemoral), need for revascularization, and primary baseline demographics will be performed for the

primary endpoint. In particular, the primary endpoint and key secondary endpoints such as MACCE and MAE incidence will be examined for differences in outcome between genders, need for revascularization, and between access sites. Additionally, tests for these outcomes will be performed to evaluate potential interactions between treatment and gender and between treatments and need for revascularization and between treatment and access site.

C.13.1 Geography Poolability Analysis

Poolability analyses may be conducted either with frequentist or Bayesian statistical methods. The analysis descriptions below are written with the language of frequentist methods. If Bayesian methods are used, analogous models will be employed, with non-informative prior distributions, and statements below such as "significant at the 0.15 level" can be understood to mean if the 85% equal-tailed Bayesian credible interval (BCI) for the parameter of interest excludes 0."

C.13.1.1 Primary Endpoint by Geography

The interaction between geography (Europe and North America) and treatment on the probability of death or disabling stroke will be compared using a logistic regression model. This analysis will be performed on the modified intent-to-treat (mITT) population, for subjects whose status at 24 months is known. If the resulting test is significant at the 0.15 level, further exploratory analysis will attempt to identify covariates that may explain treatment effect differences between the regions. Otherwise, the data will be considered to be poolable across geographies.

C.13.1.2 Univariate Covariate Analysis

If in the analysis of primary endpoint by geography, the resulting p-value is ≤ 0.15 then the following baseline characteristics will be examined individually as potential predictors of death or disabling stroke using logistic regression models:

- Gender
- Age
- Baseline NYHA
- STS score
- Baseline LVEF
- Hypertension
- Diabetes
- Coronary artery disease
- Prior stroke
- Prior MI
- Prior PI

C.13.1.3 Multivariate Analysis

If in the analysis of primary endpoint by geography, with a 0.15 significant level, and the covariates with a 0.20 significant level from the Univariate Covariate Analysis will be included along with geography in a logistic regression model. If this multivariate regression does not result in a significant (level 0.15) geography by treatment interaction after adjustment for these baseline factors, then outcome results will again be considered poolable across geographies. If geography by treatment interaction is still significant (level 0.15) after adjustment for these factors, results will be presented by geography and the clinical significance of these differences will be assessed.

If it is determined the data is not poolable across geographies, then a random-effects model for the primary endpoint that includes geography as a random effect will be provided.

C.13.2 Site Poolability Analysis

If the geographic regions Europe and North America are considered to be poolable, then the Site Poolability Analysis will be performed on all sites, for subjects. The geographic regions (Europe, United States, Canada) is not taken into account.

Should, however, the geographic regions Europe and North America not be considered to be poolable, then for both of these regions a separate poolability analysis will take place.

C.13.2.1 Pooling of Small Sites

Sites should contribute both at least 5 treatment and at least 5 control subjects to the mITT population. If this is not the case, the site is considered a “small site”; small sites will be ordered by the date of first enrollment in the mITT population. Starting with the first “small site”, a pseudo-site will be created by adding subjects from successive “small sites”. Once the number of subjects (treatment and control subject together) reaches or exceeds the size of the median enrollment (treatment and control subject together) of the “large sites”, then a second pseudo-site will be created, beginning with the next site not already included in the first pseudo-site. Additional pseudo-sites, if needed, would be created in the same manner.

If the geographic regions Europe and North America are considered to be poolable then the pseudo-sites can consist of small sites of both geographic regions. If however the regions are not considered to be poolable, then specific Europe pseudo-sites and North America pseudo-sites need to be created. A separate site poolability analysis will be performed for Europe sites and for North American sites.

C.13.2.2 Primary Endpoint by Site

The interaction between site or pseudosite and treatment on the probability of death or disabling stroke will be compared using a logistic regression model. This analysis will be performed on the mITT population for subjects whose status at 24 months is known. If the resulting test is significant at the 0.15 level, further exploratory analysis will be conducted. One analysis will implement a random-effects model for the primary endpoint that includes site as a random effect. Another analysis will attempt to identify covariates that may explain treatment effect differences among the sites, beginning in the next section. Otherwise, the data will be considered to be poolable across study sites.

C.13.2.3 Multivariate Analysis

If in the analysis for Primary Endpoint by Site, the resulting test is significant at the 0.15 level then the covariates significant at the 0.20 level from Univariate Covariate Analysis will be included along with site in a logistic regression model. If this multivariate regression does not result in a significant (level 0.15) site by treatment interaction after adjustment for these baseline factors, then outcome results will again be considered poolable across study sites. If site by treatment interaction is still significant (level 0.15) after adjustment for these factors, results will be presented by site and the clinical significance of these differences will be assessed.

C.14 Additional Analysis

C.14.1 Pre-Defined Subgroups

The following sub-groups will be analyzed for publication purposes:

- Diabetes Mellitus (yes, no)
- Age ([< 65 years of age (i.e. Medicare population), 65-70 years of age, 70-74 years of age, 75-79 years of age and ≥80 years of age)
- Gender (male, female)
- STS score
- Presence of co-morbidities

- Need for coronary revascularization

A test for interaction between the treatment effect (SAVR versus TAVI) and the subgroup variable will be performed.

These comparisons are not powered, and will be for exploratory purposes only, not to be used to support labeling claims.

C.14.2 Analysis of VARC Endpoints and Definitions

C.14.2.1 Endpoints:

Device success will be calculated per the definition outlined in the SURTAVI protocol Section O.2 Definitions of Terms as well as using the VARC-I definition, as appropriate.

C.14.2.2 Definitions

Events with definitions modified in revisions to VARC will be analyzed per both the definition outlined in the SURTAVI protocol Section O.2 Definitions of Terms and VARC-I definitions. Applicable terms include:

- Acute Kidney Injury
- Bleeding
- Death
- Device Migration/ Valve Embolism
- Device Malplacement
- Myocardial Infarction
- Prosthetic Valve Dysfunction
- Stroke and TIA
- Vascular Complications

C.14.3 Health-Related Quality of Life (HRQoL) and Treatment Costs

Health-related quality of life (HRQoL) and treatment costs will be assessed alongside the core clinical trial to evaluate the impact of the TAVI and SAVR strategies on a range of relevant quality of life (QoL) domains and also to evaluate the cost-effectiveness of the two treatment strategies.

C.14.4 Quality of Life

Health Related Quality of Life (HRQoL) and functional status will be assessed using a combination of generic and disease-specific measures selected to cover a broad range of health domains that may be affected by severe aortic stenosis disease, its treatment, and its complications: the Medical Outcomes Study 36-item Short Form (SF-36), the Kansas City Cardiomyopathy Questionnaire (KCCQ), and the EuroQoL Five Dimensions (EQ-5D). All subjects will complete standardized, written questionnaires at baseline (prior to subject being informed of randomization), 30 days, 6 months, 12 months, 18 months, 24 months and annually thereafter up to 5 years. At 3 months subjects will also be contacted via telephone to complete the EQ-5D, in select geographies SF-36 will also be collected Economic Outcomes/Cost-Effectiveness.

C.15 Economic Outcomes/Cost-Effectiveness

Data on resource utilization will be collected for the index hospitalization and through long-term follow-up for all enrolled subjects. These resource items will include number and duration in-patient stays in hospital by type of unit (eg, intensive care, high-dependency care and standard ward care); number of clinic visits (by type of physician); and details of the main procedure undertaken. As part of the trial analysis, resource use estimates will be presented by randomized group (eg, mean per subject plus standard deviation). These data, together with the EQ-5D data will provide an important input into cost effectiveness analysis. However, as such analysis is likely to be based on a modeling framework, to include evidence from a number of sources (eg, a meta-analysis of other TAVI trials) and to vary according to the

jurisdiction of interest, it is appropriate to detail the methods in separate protocols and analysis plans.

C.16 Use of Data for CE Mark

Data from the TAVI arm may be utilized to seek CE Mark approval for the Intermediate Risk indication prior to study completion. This is expected to include the experience of approximately the first 100 TAVI subjects out to 30 days. This analysis will not impact the Type I error rate of this study as there will not be an early analysis of control (randomized) data, and no decisions to alter the pivotal trial are allowed based on this analysis. This data will not be made public and a limited number of personnel will have access to the results.

D REVISION PROCESS

The study statistician will be responsible for the execution of this statistical analysis plan, including any revisions and obtaining of appropriate approvals.

E DISTRIBUTION

The study statistician will be responsible for execution of this statistical analysis plan and distribution of revisions to the appropriate clinical staff.

F REVISION HISTORY

Version	Date	Author	Summary of Changes
1.0	16-May-2012	Sharla Chenoweth	Initial Release
2.0	26-Aug-2012	Sharla Chenoweth	Incorporate recommended changes from FDA: perform analysis on ITT, mITT, and implanted populations Incorporate Medtronic responses to FDA regarding justification
3.0	27-Nov-2012	Sharla Chenoweth	Incorporate recommended changes from FDA Update secondary endpoints to correspond to VARC II definitions
4.0	25-Feb-2015	Yanping Chang	Incorporate study re-design changes: <ul style="list-style-type: none"> • Modify non-inferiority to absolute 5% • Adjust assumed event rate to 17% • Adjust final sample size to N=2000 • Modify Sample Size Looks to N=1400 and 1700 <p>Add #24 secondary endpoint resheath and recapture (combined) success rate</p> <p>Modify the hypothesis testing from superiority to non-inferiority for #3 hierarchical testing NYHA change from baseline to 12 months</p> <p>Version control (footer) corrected to internal document control requirements</p>
5.0	28-OCT-2015	Yanping Chang	Incorporate recommendations from FDA: Add primary endpoint superiority testing threshold and type I error rate table for the primary endpoint superiority testing All OC tables for non-inferiority testing of the primary objective have been updated because of the re-run of the simulation to incorporate superiority testing at the level 0.025 ($\Psi^{\text{sup}} = 0.989$). Add more scenarios treating P as an N or an E for sample size determination analyses Modify hierarchical testing procedure by adding the primary endpoint superiority testing and the superiority testing for the following secondary endpoints to the testing order: <ul style="list-style-type: none"> • Transvalvular mean gradient at 12 months • Effective orifice area at 12 months • Change in Kansas City Cardiomyopathy Questionnaire (KCCQ) score from baseline to 30 days
6.0	31-May-2016		Incorporate study design changes: <ul style="list-style-type: none"> • Modify non-inferiority margin to

			<p>absolute $\delta = 0.07$</p> <ul style="list-style-type: none"> Adjust maximum sample size to $N=1600$. This trial was previously designed using a non-inferiority margin (δ) of 0.05, and an adaptive analysis plan wherein the sample size was chosen from possible values of 1400, 1700, and 2000, based on evidence available at interim analyses. After the 1400-subject sample size interim analysis, the margin was changed to $\delta = 0.07$. The resulting increase in study power obviated the need for adaptively determining sample size, and the accrued sample size at the time of this change (approximately 1600 mITT subjects) was determined to sufficiently power the study. Modify the previous study design. Current design has one sample size look analysis (using $\delta = 0.05$) when 1400 subjects have entered the mITT population, one "Early Win" analysis (using $\delta = 0.07$) when 1400 mITT subjects have reached 12 months, and a final analysis (using $\delta = 0.07$) when all mITT subjects have reached 24 months.
--	--	--	--

G APPENDIX

G.1 Sample Size Determination Algorithm

The sample size determination algorithm is as follows. At a pre-defined analysis time (eg., when $N=N_i$ subjects have been accrued; $N_i = 1400$, or 1700 for the previous design), two predictive probabilities are calculated:

- $PP_{win} = \Pr(\text{Eventual Win} \mid \text{Data}, N=N_i \text{ is the final sample size})$
- $PP_{fut} = \Pr(\text{Eventual Win} \mid \text{Data}, N=2000 \text{ is the final sample size})$

Although the current design has a maximum sample size of $N=1600$, the predictive probability calculation retains $N=2000$ from the previous design.

If PP_{win} exceeds a suitably high threshold W_i , subject accrual will stop because final success looks probable. On the other hand, if PP_{fut} is less than a suitably low threshold F_i , subject accrual will stop and futility will be declared. If neither of these conditions obtains, accrual will continue to the next larger sample size. These analyses are termed "Sample Size Looks." Thresholds W_i and F_i are listed in Table 13 (Note that the second row, $N=1700$ is no longer applicable for the current design)**Error! Reference source not found..** Further detail on the calculation of these predictive probabilities is given in Section C.5 Predictions.

Table 13: Thresholds for stopping accrual for reasons of futility or probable eventual success for each of the 2 interim sample size determination analyses

Sample Size Determination Analysis (i)	Sample Size (N_i)	Threshold for Stopping for Futility (F_i)	Threshold for Stopping for Likely Future Win (W_i)
1	1400	0.05	0.80
2	1700	0.10	0.80

For all Sample Size Looks, informative priors for the transitions are tabulated in Table 2 and displayed graphically in Figures 2 and 3. Further rationale for the choice of these prior distributions is given in appendix G.2 and G.3. Appendix G.4 provides skeletons justification and Appendix G.5 summarizes the appropriateness of imputing missing data in the analysis.

G.2 Reasonableness of Priors

Consider the following desirable features:

- Transition #1 represents the probability of a subject having an event somewhere between initial implant and 24 months, and this is expected to be approximately 17%, with some uncertainty over the range 7%-23%. The estimated 24 month SURTAVI rate is 17%. Uncertainty in this rate is exactly the motivation for using an adaptive study design. This expected value and uncertainty are both captured nicely in this distribution.
- Transition #9 is fairly narrow, with dominant support centered close to 5% and ranging up to 10%. This represents the belief that if a subject is event-free at 18 months, the likelihood of that subject having an event prior to 24 months is low.
- Transitions 1, 3, 5, 7 represent a progression of the notion in transition #9. The distribution of Transition #7 is somewhat wider and shifted somewhat higher than that of Transition #9, reflecting the fact that subjects who are event-free at 12 months have

more time to have an event than does a subject who is event-free at 18 months. Similar statements can be made about Transitions 5, 3, and 1.

- Transitions 2, 4, 6, and 8 all address the probability that a subject with a "Possible Event" at some time point will end up in the "Event" state at 24 months. It is expected that "possible events" will be classified as disabling strokes with probability about 0.25, and all of these distributions are centered at approximately 0.25, with some spread in support ranging from about 10% to 40%, with slightly more precision in the later transitions (e.g., Transition #8) than the earlier ones (e.g., Transition #2). Even if a subject in a "Possible Event" state has that possible event classified as "not a disabling stroke", it is still possible that such a subject will end up as an "Event" at 24 months because of a subsequent stroke or death, and thus the mean of the Transition #2 distribution is slightly higher than the mean of Transition #8, reflecting the increased time in which such a subsequent event could occur.

It is also important to recognize that, during the course of the trial, these priors are modified by the accruing data via Bayes' theorem, and thus at later analyses, when substantial 24-month data are available, the impact of these priors is diminished. Most importantly, all decisions for a "Win" will not use these informative distributions, but rather will use flat priors.

G.3 Derivation of the Informative Priors

To understand the derivation of the prior distributions assigned to the model transition probabilities, it is helpful first to consider how subjects traverse the study period. In Figure 1, consider that a subject begins in the "Start" state and moves to one of the states (gray circles E, P, or N) at 1 month, and then again to a state (gray circle E, P, or N) at 6 months, and again at 12 and 18 months, and finally ending in either the E or N state at 24 months. Suppose that each one of these "state transitions" has a known probability of occurrence. These "state transitions" arise from consecutive time points and are generally not the transitions that are part of the analysis model; the "model transitions" are generally from non-consecutive time points, such as $P(E_{24}|P_1)$ or $P(E_{24}|N_6)$, which are indicated as the curved lines in Figure 1. However, probability values for the state transitions uniquely determine the probability values of the model transitions, and by understanding or making sensible assumptions about the state transitions, sensible model transitions will result. It is generally easier to think about state transitions than model transitions, and that was the approach taken here.

The consecutive-visit state transitions is exactly the process that is used to generate artificial data for the simulation. Section C.7 Simulation Details and Design Sensitivity describe the mechanism for generating artificial data with sensible temporal correlation. This starts with a "skeleton" of state transition probabilities (see Table 8). Consider that a subject must traverse the study period by following a particular path, such as Non-Event at 1, 6, and 12 months and then a Possible Event at 18 and finally an Event at 24 months. The probability of a randomly chosen subject following this particular path would be

$$P(N_1) \times P(N_6|N_1) \times P(N_{12}|N_6) \times P(P_{18}|N_{12}) \times P(E_{24}|P_{18}).$$

By summing such probabilities over all possible paths, these transition probabilities induce marginal probabilities at each time point (such as $P(E_1)$, $P(E_6)$, $P(E_{12})$, $P(E_{18})$, and $P(E_{24})$). Similarly, these skeletal probabilities also induce probabilities for the model transitions (e.g., $P(E_{24}|P_1)$ or $P(E_{24}|N_{12})$).

The process of generating data for the simulation entailed starting with the skeleton of probabilities and adjusting it to achieve specific target values of $P(E_{24})$. This process is described in Section C.7.4 Temporal Correlation. For example, if the target value of $P(E_{24})$ in the treatment group is to be 0.20, then the value $\varepsilon = 0.07012076$ is applied to the skeleton probabilities for the treatment group to result in a transformed vector of "state transition" probabilities as shown in Table 14 **Error! Reference source not found.**. These state transition probabilities induce the values for marginal probabilities and model transition probabilities also shown in Table 14 **Error! Reference source not found.**

Table 14. Induced Probabilities when the Target Value $P(E24) = 0.20$

State Transitions (Consecutive Time Points)	P(E1)	P(P1)	P(N1)	P(E6 E1)	P(E6 P1)	P(P6 P1)
	0.0214	0.0321	0.9465	1.0000	0.2634	0.0107
	P(N6 P1)	P(E6 N1)	P(P6 N1)	P(N6 N1)	P(E12 E6)	P(E12 P6)
	0.7259	0.0428	0.0107	0.9465	1.0000	0.2634
	P(P12 P6)	P(N12 P6)	P(E12 N6)	P(P12 N6)	P(N12 N6)	P(E18 E12)
	0.0107	0.7259	0.0428	0.0107	0.9465	1.0000
	P(E18 P12)	P(P18 P12)	P(N18 P12)	P(E18 N12)	P(P18 N12)	P(N18 N12)
	0.2634	0.0107	0.7259	0.0428	0.0107	0.9465
P(E24 E18)	P(E24 P18)	P(N24 P18)	P(E24 N18)	P(N24 N18)		
1.0000	0.2737	0.7263	0.0534	0.9466		
Marginal Probabilities	P(E1)	P(P1)	P(N1)	P(E6)	P(P6)	P(N6)
	0.0214	0.0321	0.9465	0.0704	0.0105	0.9191
	P(E12)	P(P12)	P(N12)	P(E18)	P(P18)	P(N18)
	0.1125	0.0100	0.8776	0.1526	0.0095	0.8379
P(E24)	P(N24)					
0.2000	0.8000					
Model Transitions	#1	#2	#3	#4	#5	#6
	0.2000	0.3666	0.1762	0.3365	0.1372	0.3051
	#7	#8	#9			
	0.0963	0.2737	0.0534			

The target values of most interest in our simulation range from a low of 0.07 to a high of 0.23. By iterating this process over target values ranging from 0.07 to 0.23, a vector of model transition probabilities is created for each of the model transitions, and the means and variances of these vectors are used to create Beta prior distributions that match those means and variances. As an example, consider $P(E24|P18)$, which is Model Transition #8 and also happens to be one of the State Transitions. As the target value of $P(E24)$ varies from 0.07 to 0.23, this transition takes on the probabilities shown in Table 15. The mean and standard deviation of these 16 values are 0.2138192 and 0.06058585, respectively, and a Beta distribution that matches that mean and standard deviation is $\text{Beta}(9.491, 34.896)$, which is thus the specified prior distribution for Transition #8 (treatment group), as shown in Figure 2.

Table 15. Induced Probabilities of $P(E24|P18)$ [Transition #8] as the Target $P(E24)$ is varied from 0.07 to 0.23

Target $P(E24)$	0.07	0.08	0.09	0.10	0.11	0.12	0.13	0.14
$P(E24 P18)$	0.1119	0.1262	0.1401	0.1537	0.1669	0.1799	0.1925	0.2049
Target $P(E24)$	0.15	0.16	0.17	0.18	0.19	0.20	0.21	0.22
$P(E24 P18)$	0.2169	0.2288	0.2404	0.2517	0.2628	0.2737	0.2844	0.2949
Target $P(E24)$	0.23							
$P(E24 P18)$	0.3052							

It is not a theoretical requirement that the prior distributions be consistent with the data that will be presented to the model during simulation (or during the actual trial). For trial design, however, it seems most logical to tune the model to perform well for the data that are actually expected to arise, and these priors are specifically chosen to do that. It is recognized that the actual data may or may not be consistent with the assumptions used in creating these priors, and for that reason the protocol includes a study of sensitivity to this temporal correlation (by examining the impact of total temporal correlation and total temporal independence in Section C.7.4 Temporal Correlation). The design is quite robust, as seen in Table 4.

G.4 Justifying the Skeletons

This section describes the rationale for the probability skeletons shown in Table 8.

Data published by Iturra et al.¹⁴ and CoreValve US Pivotal High Risk study results are presented in Figure 4.

Figure 4: Mortality or Major Stroke rate from Literature and CoreValve US Pivotal High Risk Study

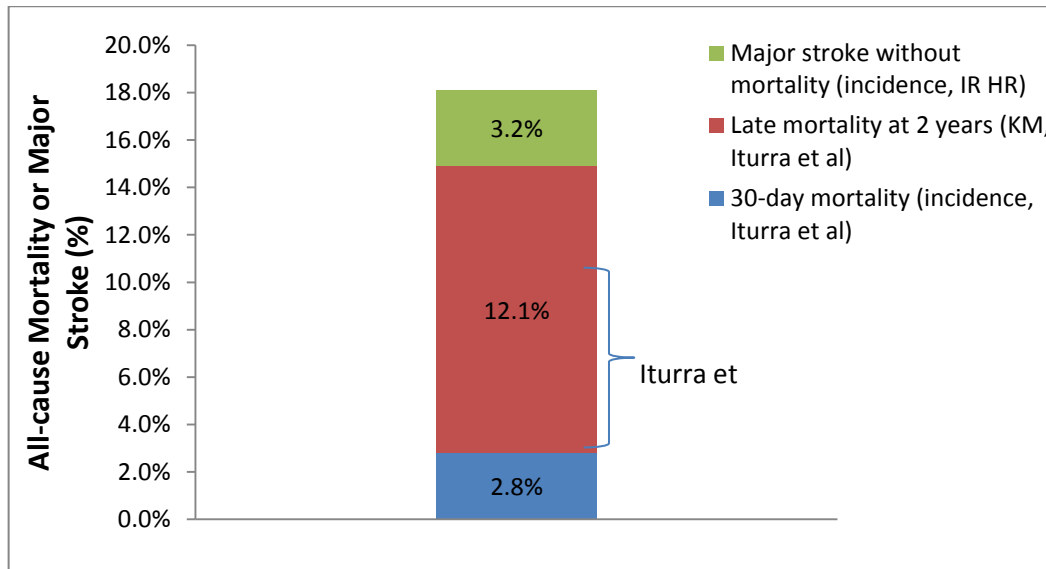

As reported in the Iturra paper, the incidence of all-cause mortality at 30 day was 2.8% and late all-cause mortality Kaplan-Meier rate at 24 months was 12.1%. The major stroke rate was 3.2% for subjects who survived to 1 year in the CoreValve Pivotal High Risk study. The High Risk study had a higher-risk population than SURTAVI, therefore, the major stroke rate in the High Risk study is adjusted downwards and a two-year follow-up period instead of a one-year follow-up period is used. Overall, the estimation of the 24 months all-cause mortality or disabling stroke rate range of 17%-21% should be a close estimation of the 2 year rate in SURTAVI.

A set of inclusion and exclusion criteria were developed to identify subjects at intermediate risk for SAVR from the High Risk cohort. A total of 444 subjects from this US Pivotal Trial met these criteria, and received an attempted procedure, and are presented as the intermediate risk (IR) cohort. Table 16 summarizes the all-cause mortality and all stroke rate for those subjects.

Table 16. All-Cause Mortality and All Stroke Data for IR Cohort of the High Risk Study

	IR TAVI N=239			IR SAVR N=205		
	# Subjects with Events	Binomial %	Kaplan-Meier %	# Subjects with Events	Binomial %	Kaplan-Meier %
All-Cause Mortality						
30 Day	5	2.1	2.1	8	3.9	3.9
1 Year	26	10.9	11.0	27	13.2	13.3
All Stroke						
30 Day	9	3.8	3.8	12	5.9	5.9

¹⁴ Iturra SA, Suri RM, Greason KL, et al. The Journal of thoracic and cardiovascular surgery 2014;147:127-132.

1 Year	14	5.9	6.0	22	10.7	11.4
--------	----	-----	-----	----	------	------

The skeleton in Table 8 was developed to have a probability for all-cause mortality or disabling stroke at 24 months to be between 18%-21% for each treatment arm. As shown in the Table 16, the SAVR cohort is expected to have a slightly higher all-cause mortality rate and all stroke rate at 1 month than TAVI. The probability of a stroke being classified as disabling in literature is a wide range of approximately 40%-70%, however, it was observed to be 11.4% (95% CI 3.2%-26.7%) in this IR cohort. Therefore the estimated probability of 25% is chosen. After 6 months, it is assumed that the rate of all-cause death and disabling stroke will be similar and remain constant for each treatment arm.

G.5 Appropriateness of Imputing Missing Data

The appropriateness of predicting/imputing missing data is justifiable on the basis of several important considerations:

1. The FDA guidance on Bayesian statistics discusses the use of predicting/imputing missing data. See "Guidance for the Use of Bayesian Statistics in Medical Device Clinical Trials," Sections 5.4 "Predictive Probabilities" and Section 5.5 "Interim Analyses."
2. There is precedent. For example, the INTERFIX PMA documentation that is referenced in the FDA guidance: Summary of Safety and Effectiveness for PMA P970015 at <http://www.accessdata.fda.gov/scripts/cdrh/cfdocs/cfTopic/pma/pma.cfm?num=p970015>. As an example from the field of cardiology, see Wilber et al., "Comparison of Antiarrhythmic Drug Therapy and Radiofrequency Catheter Ablation in Patients With Paroxysmal Atrial Fibrillation: A Randomized Controlled Trial," JAMA, January 27, 2010—Vol 303, No. 4, pp 333-340, and especially the statistical methods in the third column of page 335.
3. At any analysis (interim or final, sample size or "win" determination), ignoring subjects with incomplete follow-up leads to biased estimates of the event rate. Consider two hypothetical subjects (A and B), one of which (A) will be LTFU at 11 months and the other (B) at 13 months, so neither will finish the trial. Now suppose each die at 12 months. We will know about B's death but not about A's death, so a simple proportion of events at 24 months will include B in the numerator, but whether or not to include A in the denominator is disputable. To include A in the denominator as a non-death when there has only been 11 months of known follow-up is to assume that A will not have an event in the remaining 13 months, which in this case is patently false and would lead to an underestimate of the true event rate. To exclude A and any other subjects with only 11 months of follow-up would lead to an over-estimate of the true event rate. Either way, the event rate estimate is biased. The only sensible approach is to somehow account for partial follow-up by giving "partial credit" to these patients. Survival analysis techniques with explicit censoring mechanisms do this automatically and explicitly, and this is non-controversial. But that is not the only way to accomplish this goal. Important considerations in why the proposed method was chosen over survival analysis are (a) the fact that outcomes known at interim time points are not binary (event/no event) but rather ternary (event, possible disabling stroke, no event), (b) the fact that the focus of interest is an event rate at a specific time point (24 months), while most survival analysis techniques tend to compare hazards over all follow-up time, and (c) the fact that Bayesian survival analysis methods are generally more computationally burdensome than binomial and betabinomial calculations, a non-trivial consideration when faced with the task of extensive simulation.
4. The partial follow-up and interim outcomes are part of the body of evidence. Outcomes at interim time points such as 12 months are important in their own right and also predictive of the 24-month outcomes. The quality of the prediction is learned in this very trial, so to analyze completers only is to ignore important evidence in the decision process.

G.6 Type I Errors for the Primary Endpoint Superiority Testing

There are three possible time points where testing primary endpoint superiority could occur:

- Simultaneous to demonstrating non-inferiority at the first (interim) "Win Look."

- Simultaneous to demonstrating non-inferiority at the final “Win Look,” in the event that non-inferiority is not established at the first (interim) Win Look.
- All mITT subjects have reached 24 months, in the event that non-inferiority but not superiority is established at the first (interim) Win Look. (SAP Section C.4.2.1 terms this a “delayed determination of superiority.”)

Simulations were conducted to assess the type I error rate for the primary endpoint superiority testing under the previous trial design, and it was found that, in order to control the type I error rate at ≤ 0.025 , the posterior threshold Ψ_{SUP} for declaring superiority must be higher than the posterior threshold Ψ used for the primary endpoint non-inferiority testing. The threshold value Ψ_{SUP} is designated to be 0.989 in order to control type I error at a level ≤ 0.025 for superiority. The current design retains the same threshold. Table 17 summarizes all type I errors observed through repeated trial simulations under the varying conditions of accrual rate, control success rate, and serial correlation that were described in the SAP section C.7. As with the simulations assessing non-inferiority, each cell of the table is based on 10,000 simulated clinical trials, with predictions based on 5,000 draws from each of the predictive model transition distributions. Under all scenarios, type I error is controlled at ≤ 0.025 . There is no evidence that the type I error exceeds 0.025. Even in the scenario with observed type I error greater than 0.025 (eg., 0.0275) could easily result from a simulation of size 10,000 with underlying true rate = 0.025: a 95% probability interval calculated as $0.025 \pm 1.96 \sqrt{(0.025 \times 0.975 / 10000)}$ would range from 0.0219 to 0.0281, so a value as high as 0.0275 is entirely expected and constitutes no evidence of a type I error inflation.

Table 17: Simulated Type I error rates given varied correlation structures, accrual rates, and control event rates. 10,000 simulated trials per cell, with predictions based on 5,000 imputations for the primary endpoint superiority testing

			Control Event Rate		
			0.12	0.17	0.22
Complete Temporal Correlation	Accrual Rate	Slow	0.0118	0.0123	0.0118
		Expected	0.0154	0.0135	0.0124
		Fast	0.0110	0.0133	0.0108
Expected Temporal Correlation	Accrual Rate	Slow	0.0149	0.0120	0.0147
		Expected	0.0164	0.0163	0.0200
		Fast	0.0175	0.0176	0.0173
Complete Temporal Independence	Accrual Rate	Slow	0.0172	0.0188	0.0169
		Expected	0.0206	0.0202	0.0215
		Fast	0.0252	0.0275	0.0258

SURTA VI SAP summary of changes

Design Element	V1 (CIP V4)	V2 (CIP V5)	V3 (CIP V6)	V4 (CIP V10)	V5 (CIP V11)	V6 (CIP V12)
Noninferiority (NI) margin	20% relative NI margin $H_A: \pi_T / \pi_C < 1 + 0.2$	No Change	No Change	5% absolute NI margin $H_A: \pi_T < \pi_C + 0.05$	No Change	7% absolute NI margin $H_A: \pi_T < \pi_C + 0.07$
Design	Bayesian Adaptive with one early win analysis with prediction of missing outcomes	No Change	No Change	Bayesian, Adaptive <ul style="list-style-type: none"> • Maximum N=2000 • Early Win Analysis (12 months after enrollment stop) • Final Analysis (all subjects through 24 months) 	No Change	Bayesian <ul style="list-style-type: none"> • Maximum N≈1600 • Early Win Analysis (12 months after N=1400 accrued) • Final Analysis (all subjects through 24 months; N≈1600)
Assumed 2 yr event rate	25%	No Change	No Change	17%	No change	No Change
Sample size	3700	No Change	No Change	2000	No Change	
Sample size looks	first look at 1000 then at 1500, 2000, 2500 and 3000 patients	First look at 1500 then 2000, 2500, 3000 patients	No Change	First look at 1400 patients, then 1700	No Change	1400 patients with 12 month follow-up; Final all patients through 24 months
Secondary endpoint		19 (added AF)	22 (added three VARC II composite endpoints)	No Change	No Change	No Change

Hierarchical testing	<p>6 endpoints</p> <ul style="list-style-type: none"> • MGV • EOA • NYHA • KCCQ • MACCE • SF-36 	<p>8</p> <p>Added:</p> <ul style="list-style-type: none"> • Length of stay • Major bleeding at 30 days) 	<p>15</p> <p>Added:</p> <ul style="list-style-type: none"> • Days alive out of hospital at 1 year • Days alive out of hospital at 2 year • EQ-5D • Major vascular complication • All stroke • Moderate/severe AR • PPI <p>Modified:</p> <ul style="list-style-type: none"> • Major bleeding to major or life-threatening bleeding. 	<p>15</p> <p>Modified NYHA from superiority to NI testing</p>	<p>18</p> <p>Added superiority testing for</p> <ul style="list-style-type: none"> • MGV • EOA • KCCQ 	No Change
Other		ITT, IMP for primary and most secondary endpoints		Inclusion criteria changed from STS 4-8% to 30-day predictive mortality risk [3, 15)%	Added primary endpoint superiority testing threshold	