

Fig. 1**A.** CRISPR-cas9 sgRNA 1 sequence:**AATGTGTACATAACTCCCGCAGG**

CRISPR-cas9 sgRNA 3 sequence:

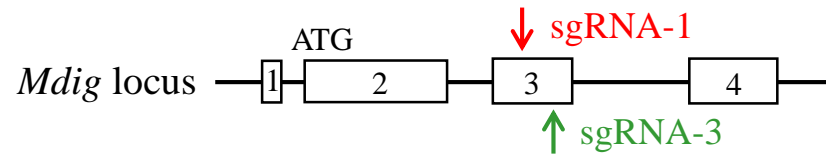
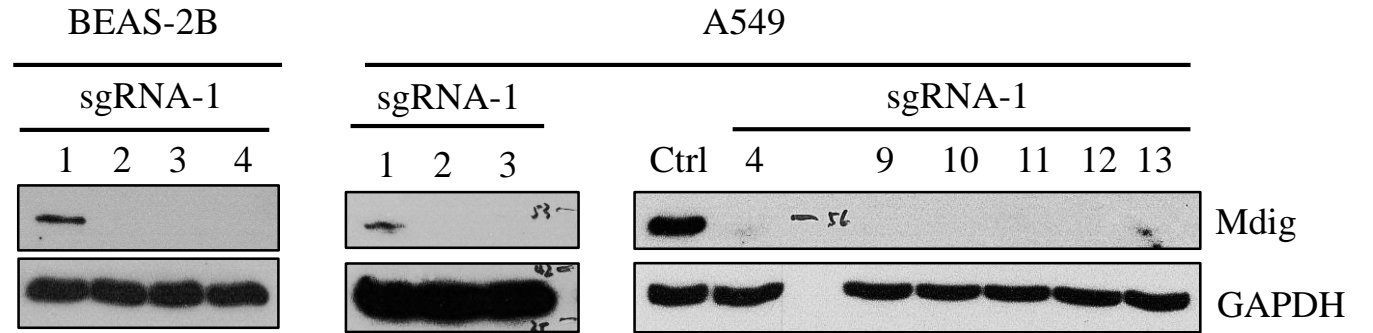
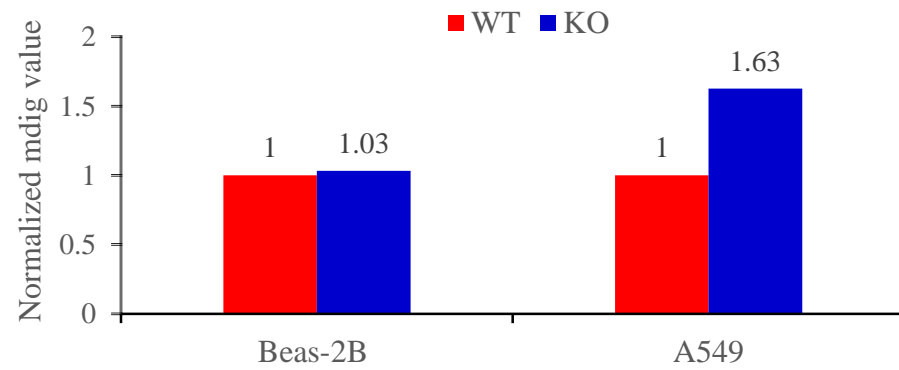
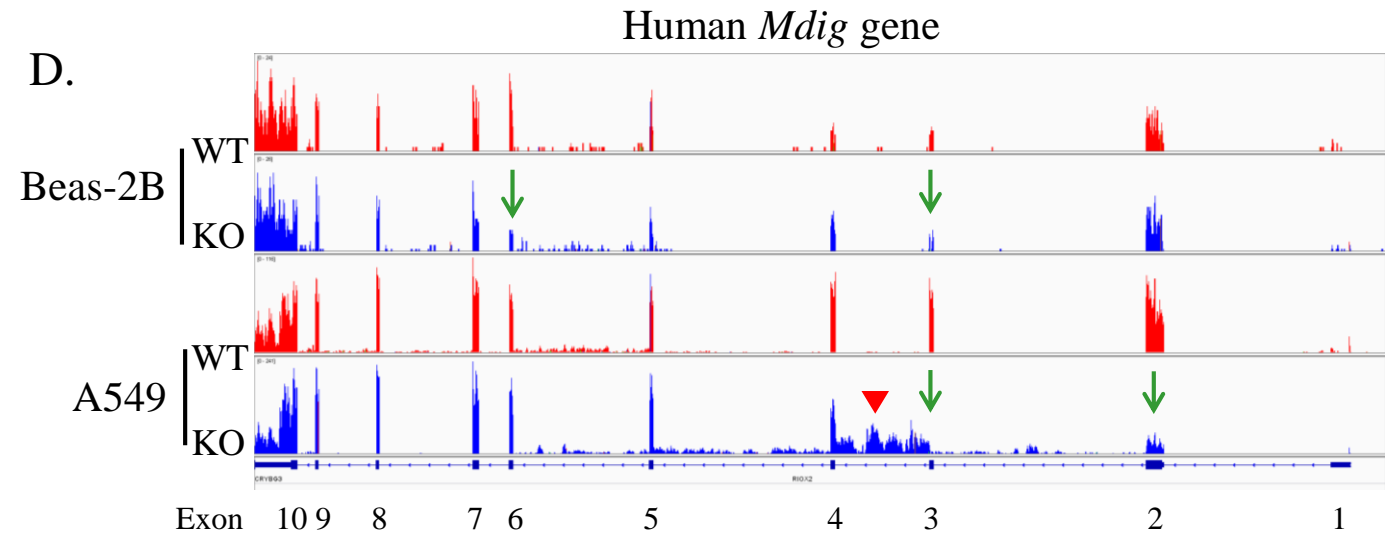
CATCATCATAATGGGGCGGCAGG**B.****C.****D.**

Fig. 2

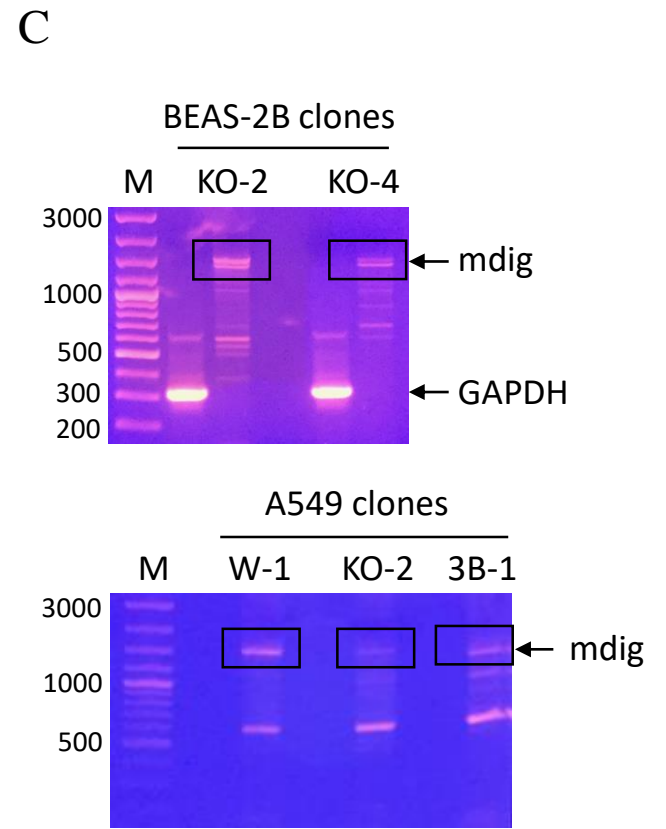
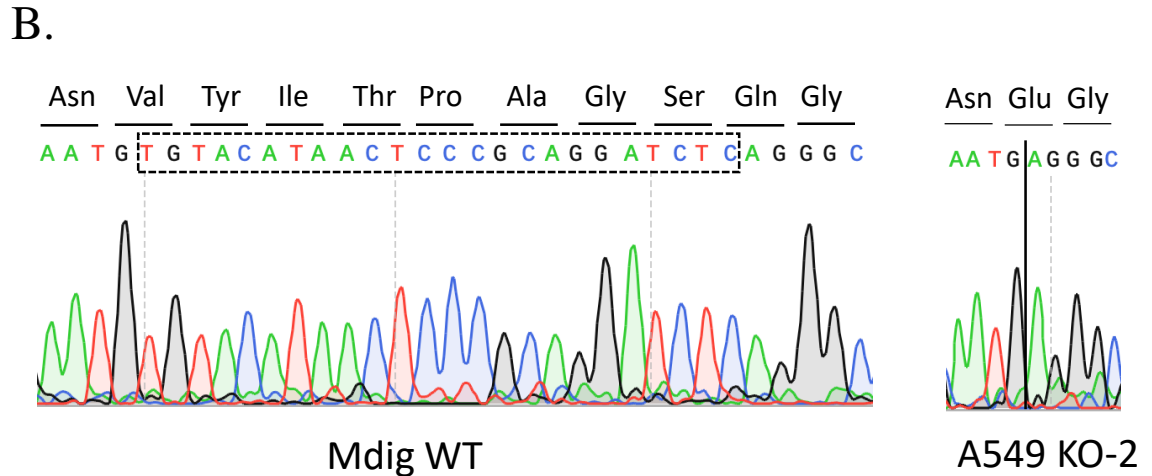
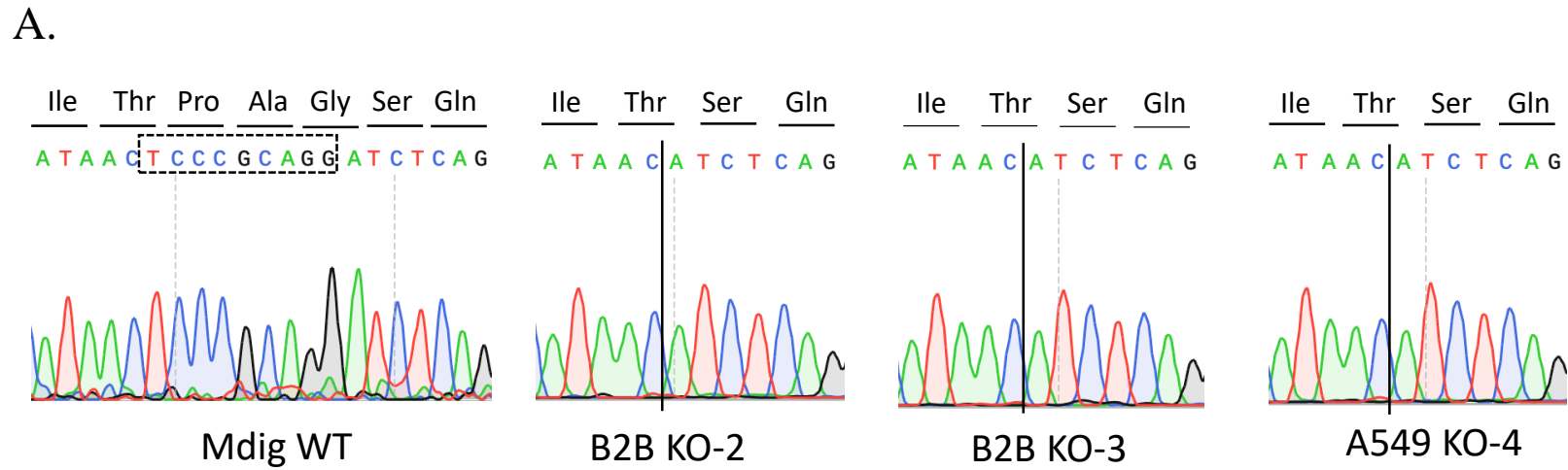
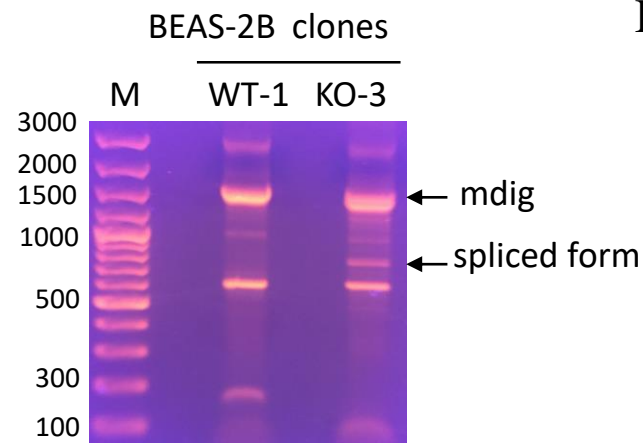


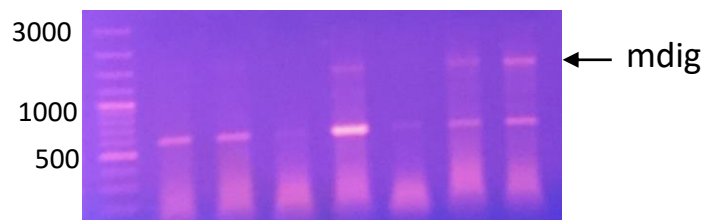
Fig. 3

A.



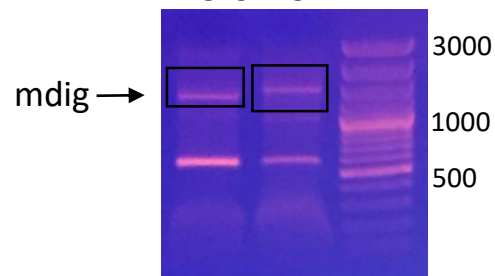
A549 clones

3B-1 3B-2

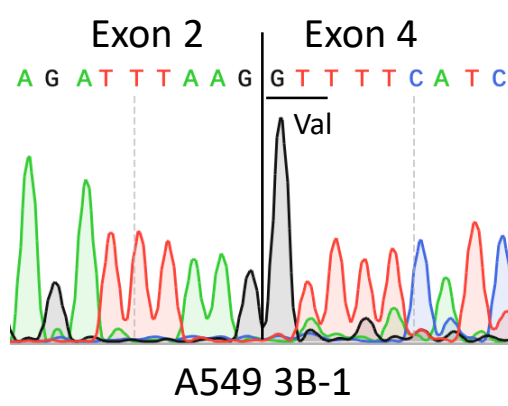
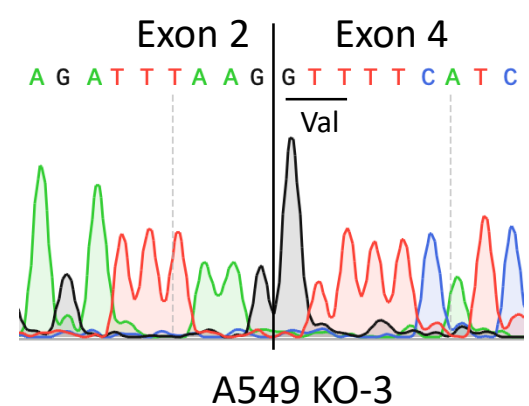
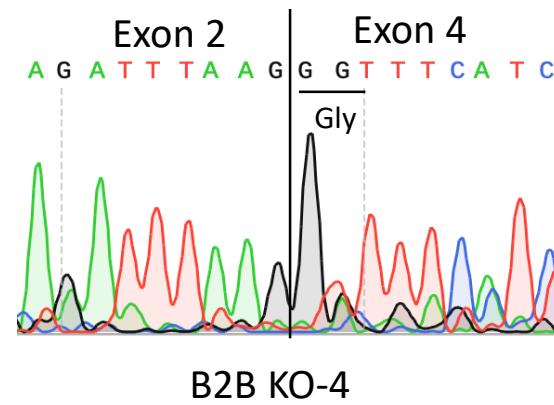
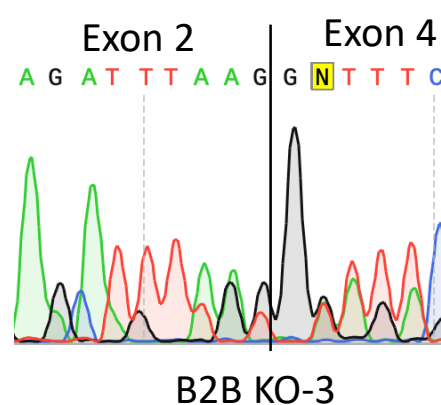
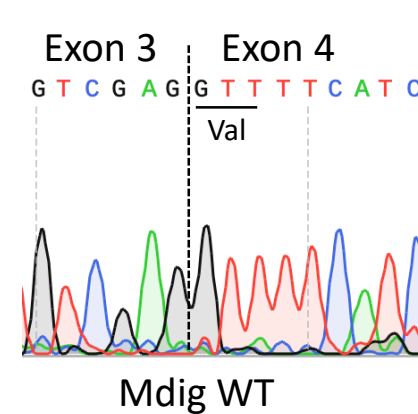
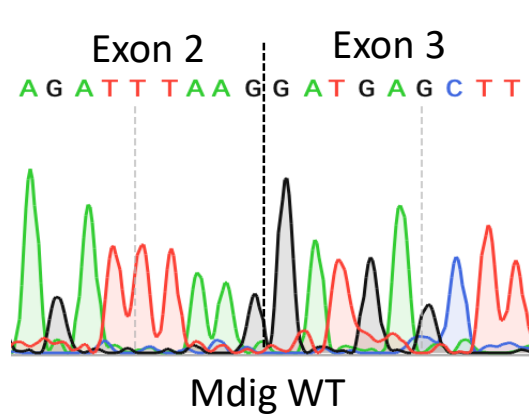


A549 clones

KO-3 KO-4 M



B.



C.

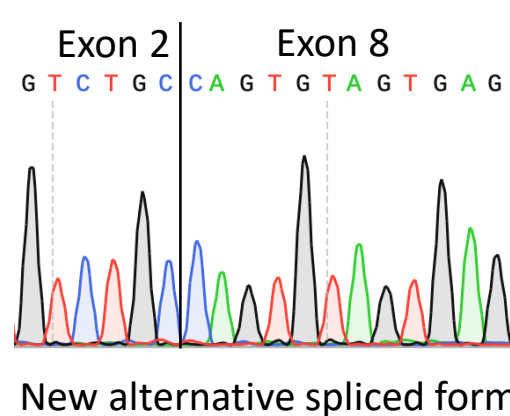
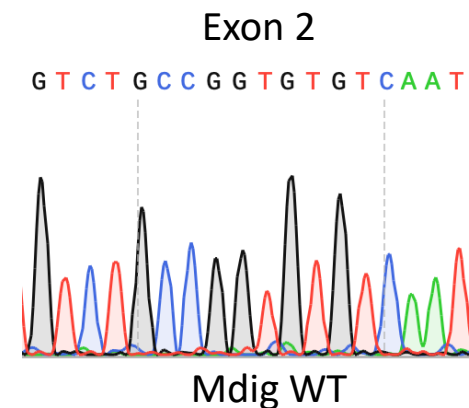
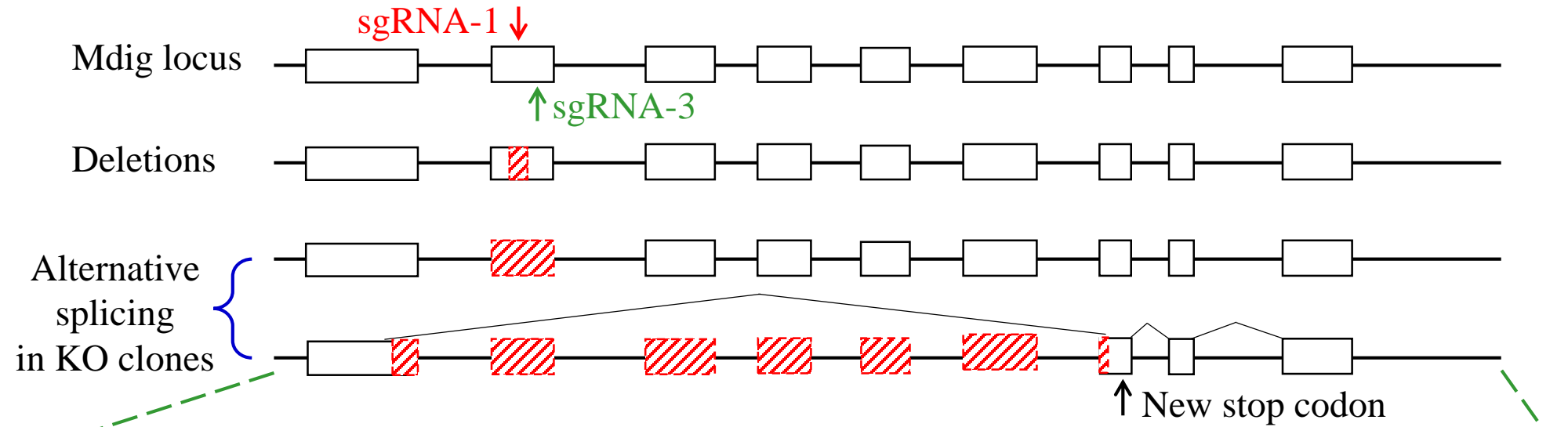


Fig. 4

A.



B.

WT MPKKAKPTGSGKEEGPAPCKQMKLEAAGGPSALNFDSPSSLFESLISPIKTETFFKEFWEQKPLLIQRDD
KO MPKKAKPTGSGKEEGPAPCKQMKLEAAGGPSALNFDSPSSLFESLISPIKTETFFKEFWEQKPLLIQRDD
 PALATYYGSLFKLTDLKSLSRGMYYGRDVNVCRCVNGKKKVLNKDGKAHFLQLRKDFDQKRATIQFHQP
 PALATYYGSLFKLTDLKSLSRGMYYGRDVNVC-----
 QRFKDELWRIQEKLECYFGSLVGSNVYITPAGSQGLPPHYDDVEVFILQLEGEKHWRLYHPTVPLAREYS

 E G

 VEAERIGRPVHEFMLKPGDLLYFPRGTIHQADTPAGLAHSTHVTISTYQNNSWGDFLLDTISGLVFDTA

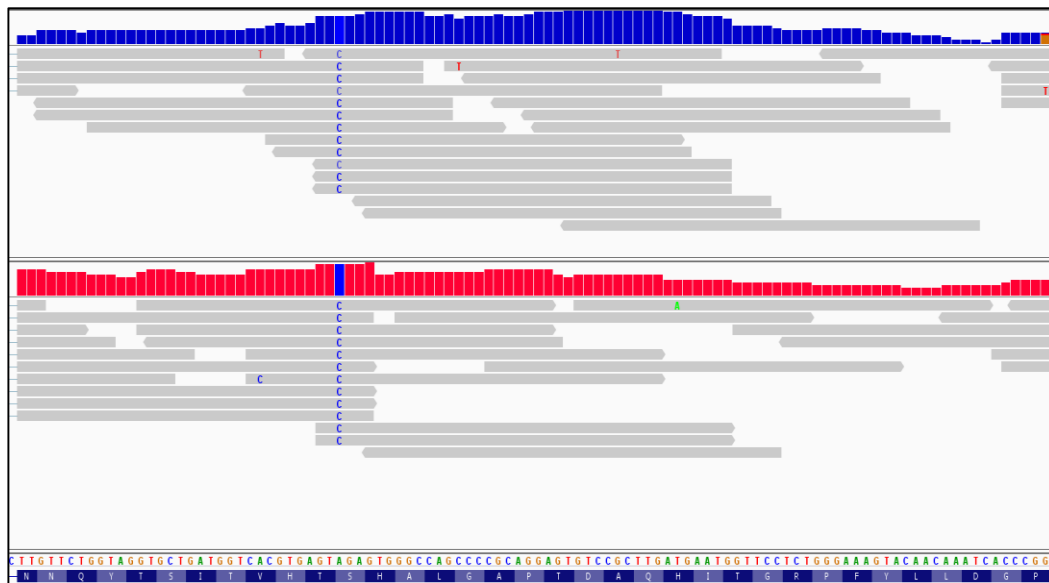
 KEDVELRTGIPRQLLLQVESTTVATRRLSGFLRTLADRLEGTKELLSSDMKKDFIMHRLPPYSAGDGAEL

 STPGGKLPRLDS**VVRLQFK**DHIVLTVLPDQDQSDEAQEKMVYIYHSLKNSRETHMMGNEEETEFHGLRFP

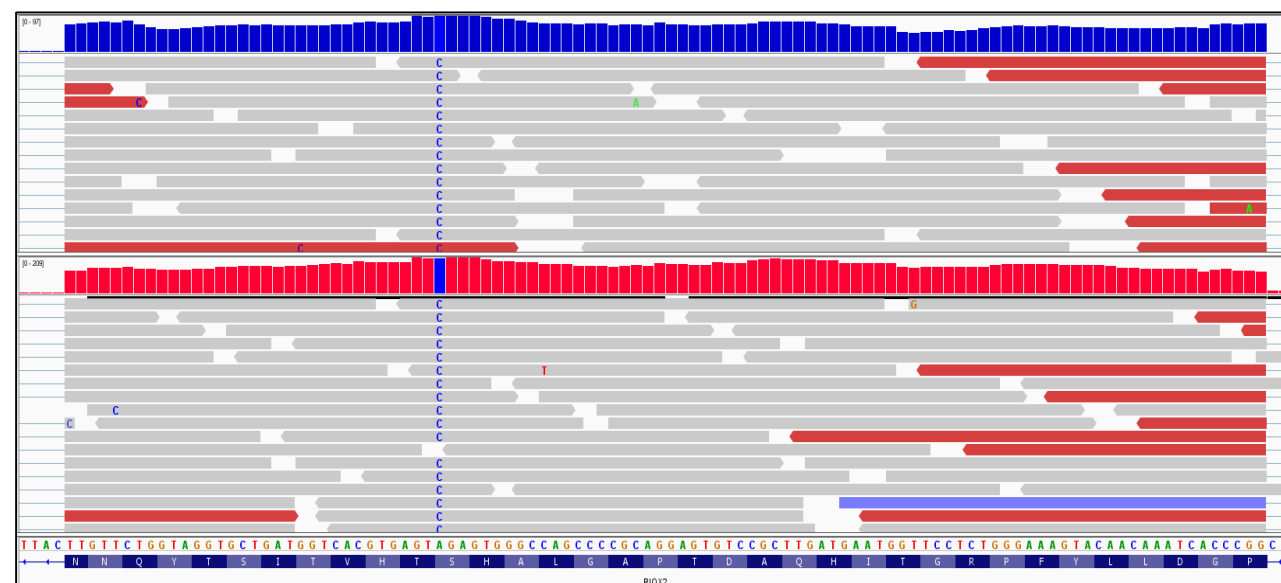
 -----QCSETAV* 109
 LSHLDALKQIWNSPAISVKDLKLTDEEKESLVLSLWTECLIQVV 465

Fig. 5

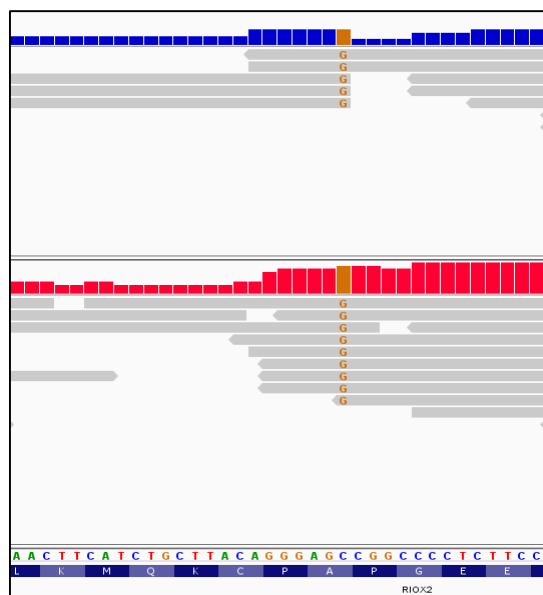
A. BEAS-2B Exon 5 A to C (NM_032778, 1330T to G)



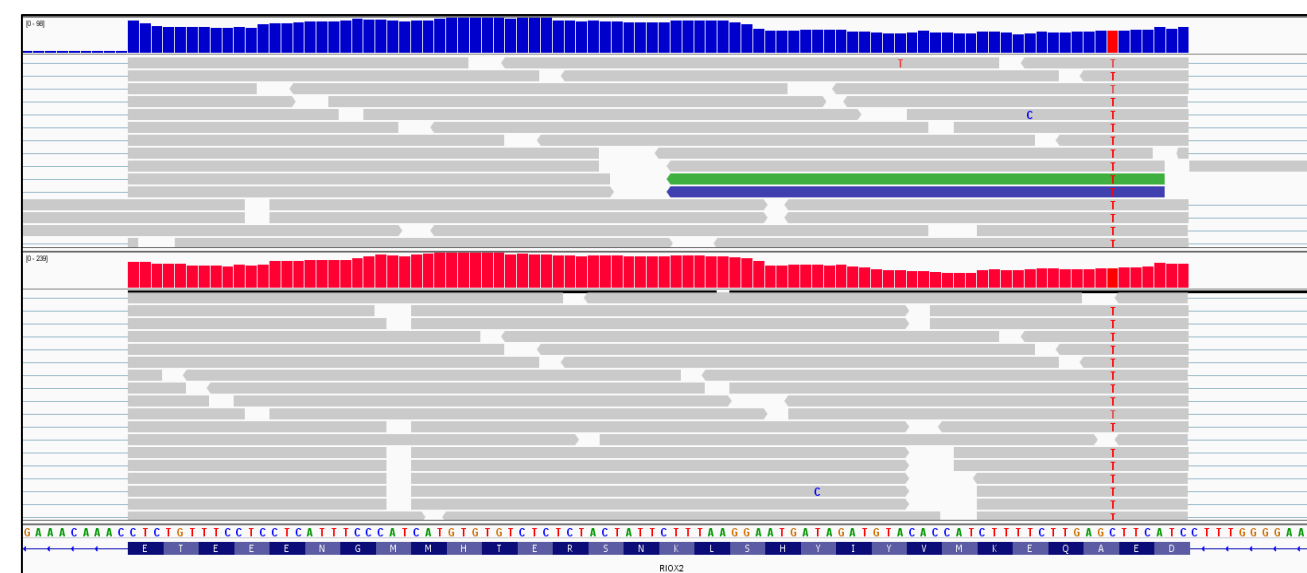
B. A549 Exon 5 A to C (NM_032778, 1330T to G)



C. BEAS-2B Exon 2 C to G (NM_032778, 626G to C)



D. A549 Exon 9 C to T (NM_032778 1730G to A)



sFig 1

BEAS-2B

A549

