

# FIGURE S1

## A *Tbl1xr1* locus (*Tbl1xr1*-D370Y mouse model):

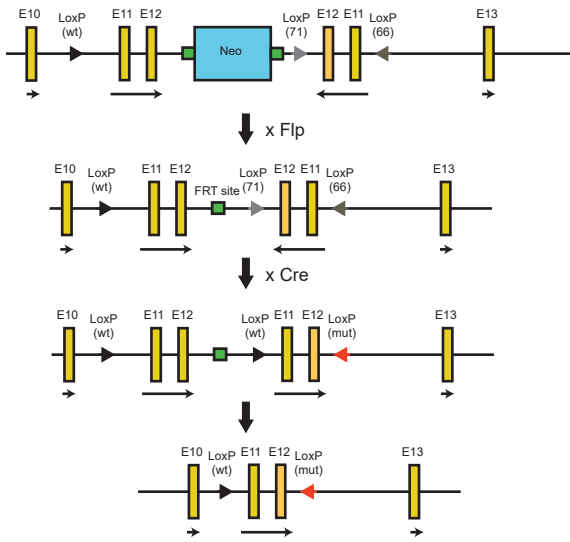

## F *Tbl1xr1* locus (*Tbl1xr1*-KO mouse model):

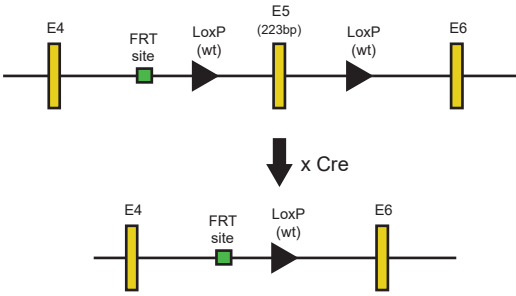

## B *Tbl1xr1* locus genotyping:

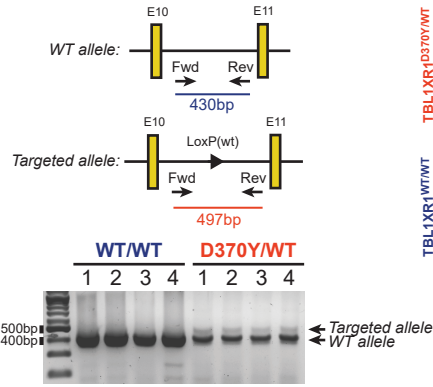

## D Sorted GCB (B220+FAS+GL7+)

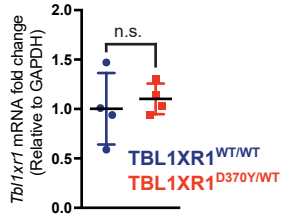

## C Sorted GCB (B220+FAS+GL7+)

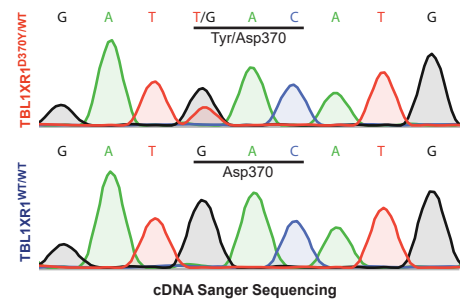

## E Sorted GCB (B220+FAS+GL7+)

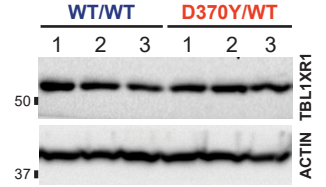

## H Sorted GCB (B220+FAS+GL7+)

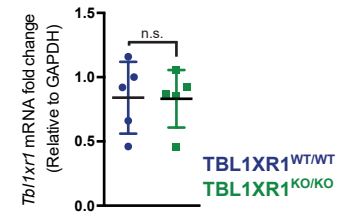

## I Sorted GCB (B220+FAS+GL7+)

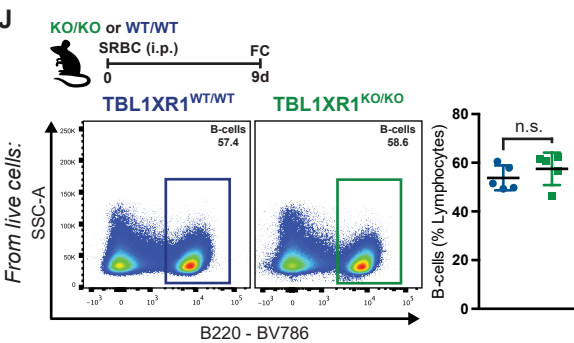
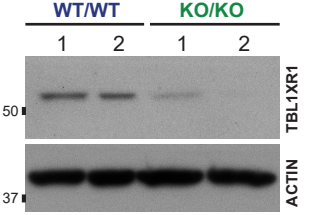

## K From B-cells:

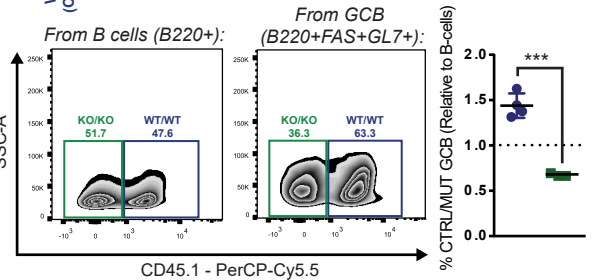
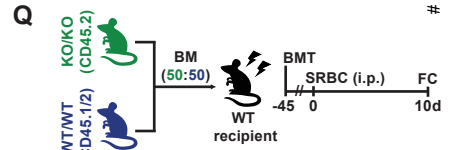
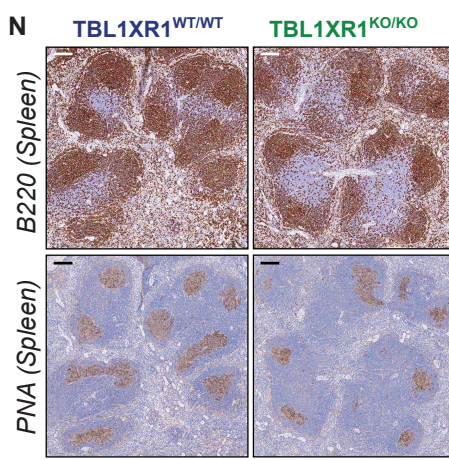
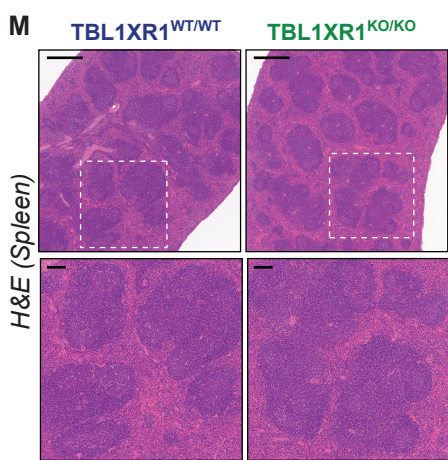
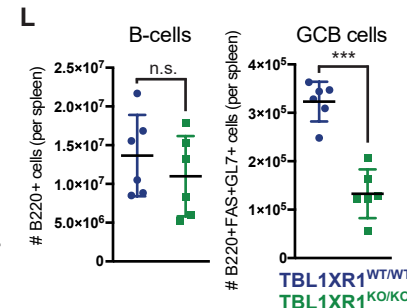
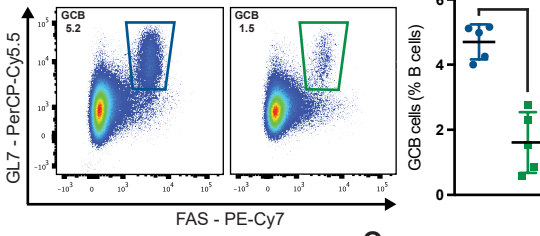

## R KO/KO or WT/WT

