

Estrogens and Congeners from Spent Hops (*Humulus lupulus* L.)

*Lucas R. Chadwick, Dejan Nikolic, Joanna E. Burdette, Cassia R. Overk, Judy L. Bolton, Richard B. van Breemen, Roland Fröhlich,¹ Harry H. S. Fong, Norman R. Farnsworth, and Guido F. Pauli**

UIC/NIH Center for Botanical Dietary Supplements Research, Department of Medicinal Chemistry and Pharmacognosy, College of Pharmacy, University of Illinois at Chicago, Chicago, IL 60612; and ¹ Organisch-Chemisches Institut, Westfälische Wilhelms-Universität, D-48149, Münster, Germany

*gfp@uic.edu

Supplementary data

Figures from Chadwick, *Estrogens and congeners from spent hops*, Ph.D. dissertation, University of Illinois at Chicago, 2004.

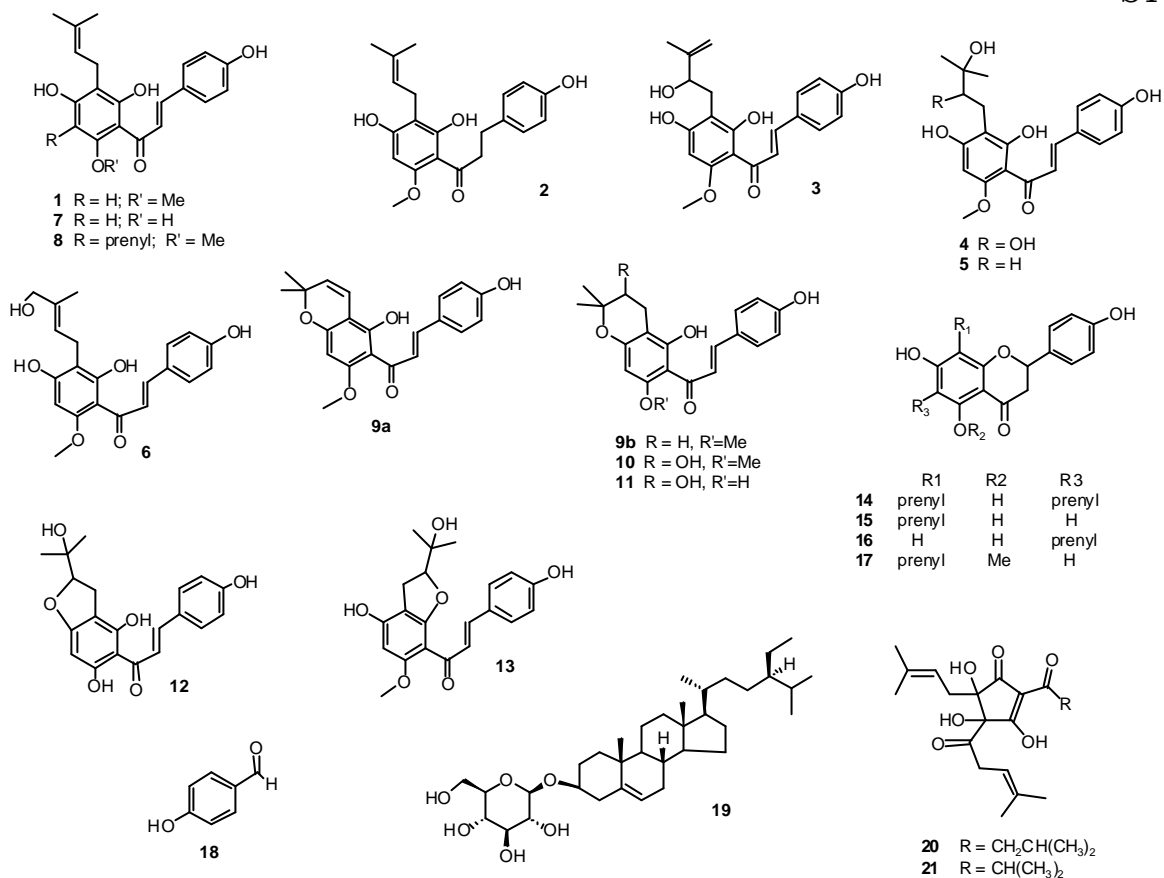

yield (%)

1	xanthohumol	0.4
2	a,b-dihydroxanthohumol	0.00048
3	xanthohumol D	0.0019
4	xanthohumol G	0.00036
5	xanthohumol H	0.00026
6	5"-hydroxyxanthohumol	0.00015
7	desmethylxanthohumol	0.00056
8	diprenylxanthohumol	0.0019
9a	xanthohumol C	0.0016
9b	1",2"-dihydroxanthohumol C	0.0002
10	xanthohumol B	0.00085
11	desmethylxanthohumol B	0.00051
12	desmethylxanthohumol J	0.00034
13	xanthohumol I	0.00051
14	6,8-diprenylnaringenin	0.0016
15	8-prenylnaringenin	0.00034
16	6-prenylnaringenin	0.0039
17	isoxanthohumol	0.0011
18	4-hydroxybenzaldehyde	0.00093
19	sitosterol-3-O-β-glucopyranoside	0.0031
20	humulinone	0.00087
21	cohumulinone	0.00058

642 g *Humulus lupulus* var. *Nugget*;
post-supercritical CO₂ extraction - "spent pellets"

S2

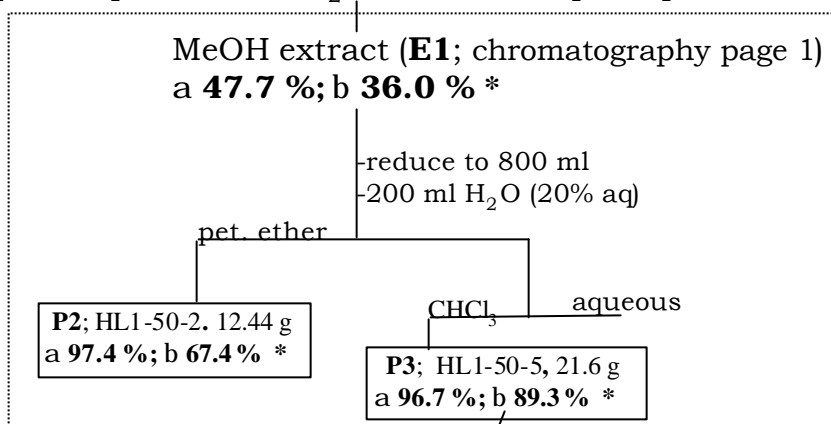

VLC of P3 (chromatography page 1)

Fraction	F1	F2	F3
Gradient ^{§1}	1/0/0	6/4/0	46/54/0
mass (g)	4.5	2.8	6.5 ?
α%**	70.1	87.7	78.7
β%**	80.8	81.2	50.3

VLC of F1 (chromatography page 2)

Fraction F1-	1	2	3A	3B	4	5	6	7
% MeOH ^{§2}	0	1.0	1.4	1.8	2.0	2.0	2.8	10
Mass (mg)	894	481	218	1170	1171	845	608	532
***Ishi %	3	0	11	36	42	87	95	100

VLC of F2 (chromatography page 3)

Fraction F2-	1	2	3	4	5	6	7	8	9
% MeOH ^{§2}	0	1.0	1.33	2.0	2.33	3.0	3.67	4.67	10
Mass (mg)	31	139	864	351	434	329	250	73	227
***Ishi %	2	1	0	21	16	100	56	19	15

VLC of F3 (chromatography page 4)

Fraction F3-	1	2a	2b	3a	3b	3c	4a	4b	5	6	7	8	9	10
% MeOH ^{§2}	0	5	5	5	6	6	6	7	7	9	12	12	14	40
Mass (mg)	125	508	465	347	259	289	786	220	635	765	242	470	868	195
***Ishi %	0	28*		20*			27*		4	5	1	4	1	1

*2a,2b combined for bioassay; * 4a,4b combined for bioassay
* 3a,3b,3c combined for bioassay

Fractionation of spent Nugget hops. Bioassay data are from Bolton *et al.* (BCP2)

*For the MeOH extract and crude partitions, bioassay numbers are percent inhibition of ³H E2 binding to given ER at **200** µg/ml. **For **F1**, **F2**, and **F3**, bioassay numbers are at a test concentration of **50** µg/ml. ***For subfractions of **F1**, **F2**, and **F3**: Bioassay numbers represent % alk. phos. induction (relative to 2 nM estradiol) in Ishikawa cells treated with given sample at a concentration of 1 µg/ml. §For VLC **Gradients**, numbers represent solvent composition at **start** of given fraction. §¹(VLC of P3): pet. ether / EtOAc / MeOH; §²(VLC of F1, F2, and F3): % MeOH in CHCl₃.

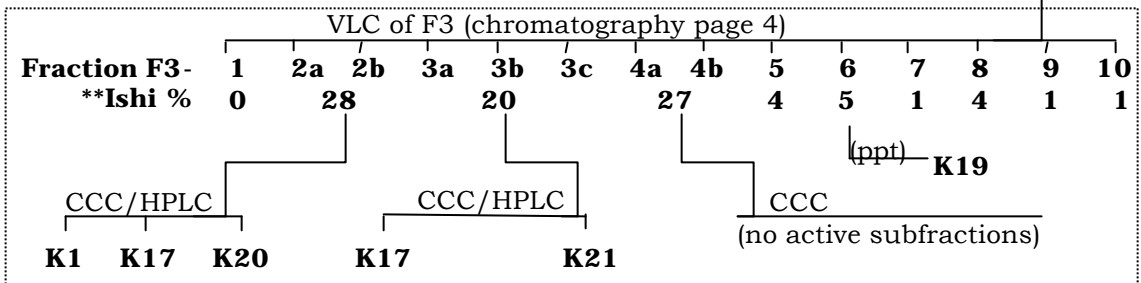
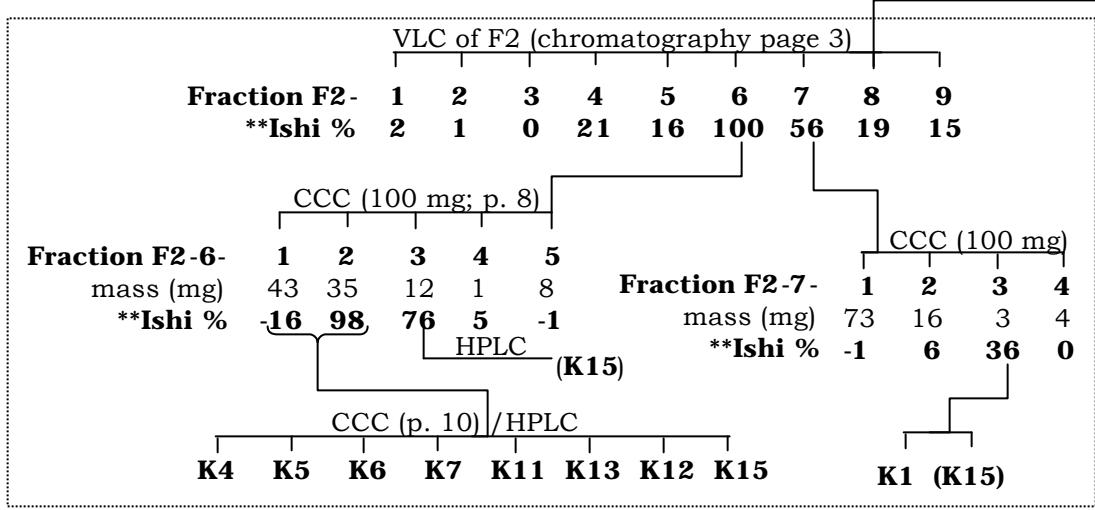
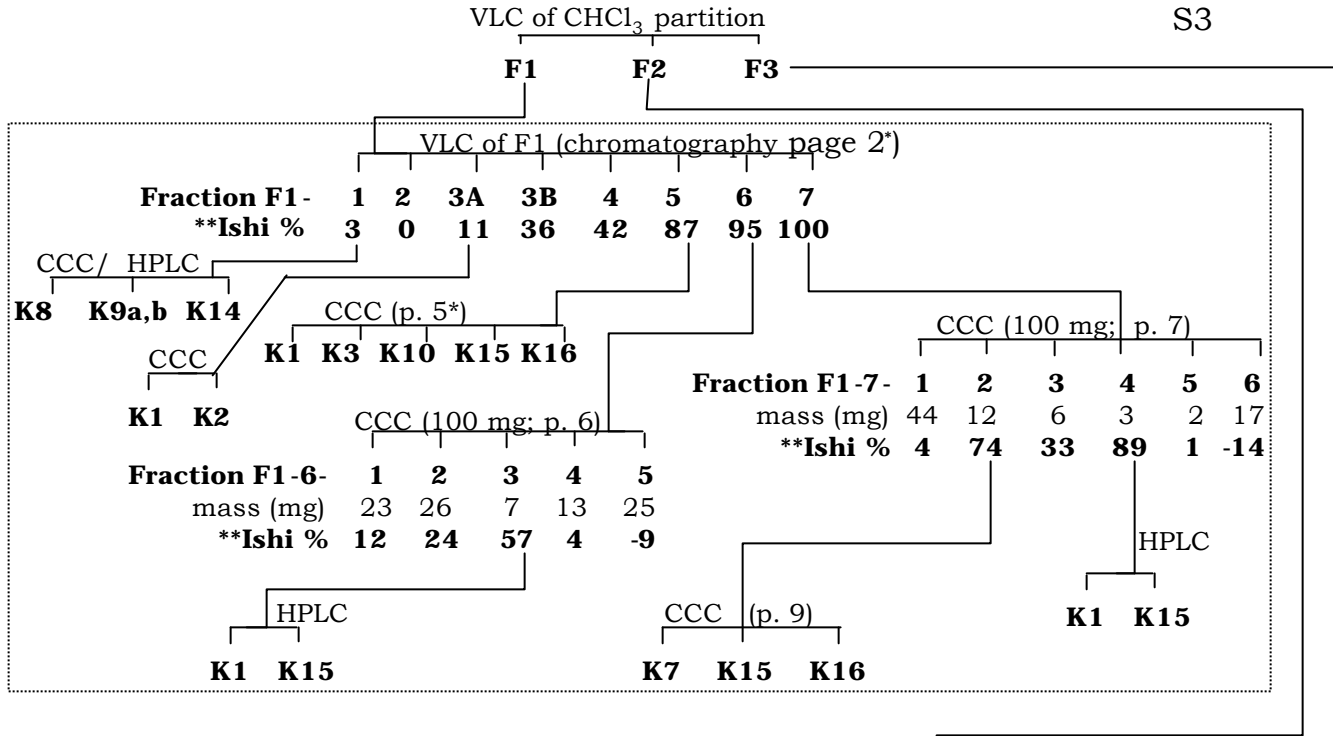

Fractionation of spent Nugget hops (continued). *Page numbers refer to chromatography section immediately following this figure. **Bioassay numbers represent % alk. phos. induction (relative to 2 nM estradiol) in Ishikawa cells treated with given sample at a concentration of 1 µg/ml. Prior to testing, the CCC fractions had been left in MeOH solution at room temperature for ca. 1 week.

642 g *Humulus lupulus* L. var. *Nugget*;
post-supercritical CO₂ extraction - "spent pellets"

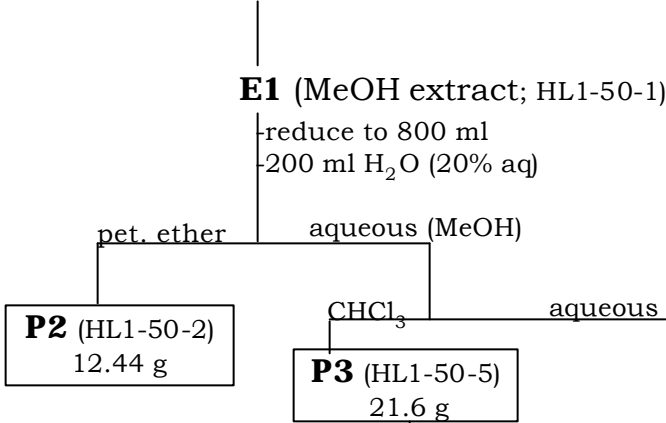
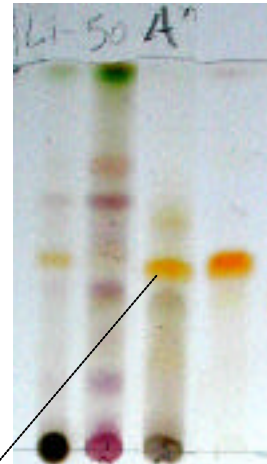

E1 P2 P3 K1

VLC of P3

20.0 g sample / 500 g Si gel
Pet. Ether → EtOAc gradient;
48- 500 ml fractions collected;
combined to three pooled fractions:
f13-f29=F1; f30-f40=F2; f41-f51=F3

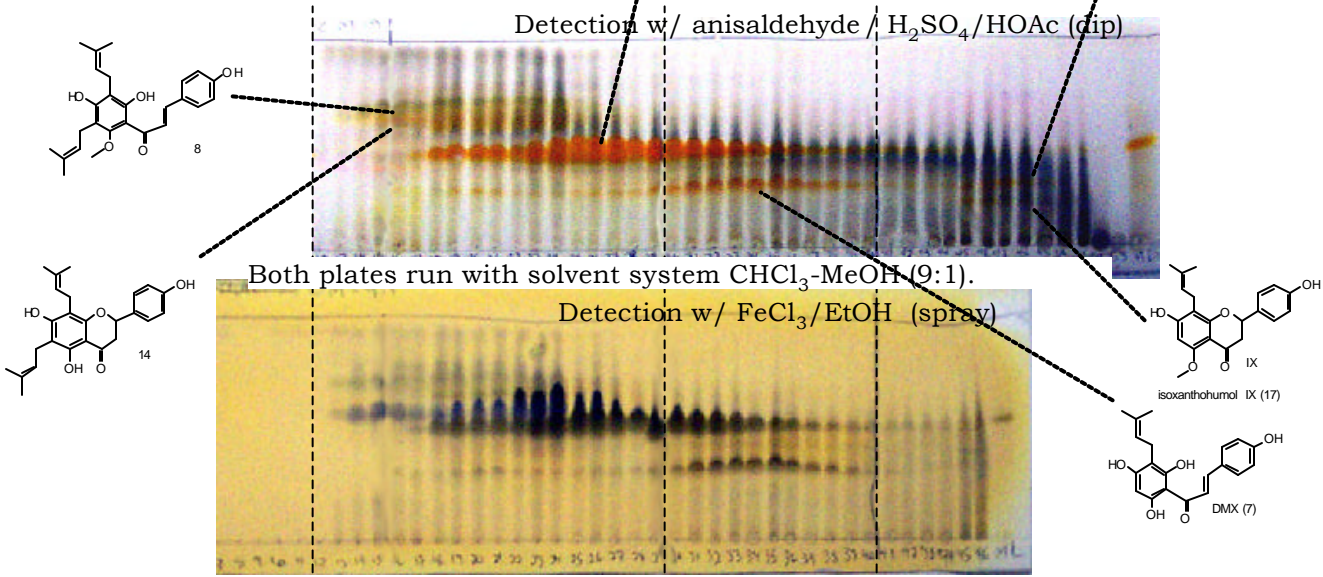
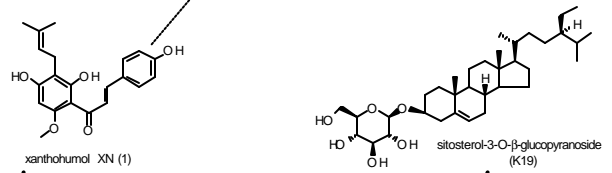

see chromatography page	2				3				4							
%EtOAc (Pet. eth).	22	26	30	34	38	40	40	40	40	40	42	46	50	54	60	100
% MeOH (EtOAc)	0 10 20 50 80 100															
combined F#	F1				F2				F3							
mass (g)	6.6				2.8				6.5							
ERα binding	70.1%				87.7%				78.7							
ERβ binding	80.8%				81.2%				50.3%							

*ER binding values at 50 µg/ml relative to 2nM estradiol.

Chromatography page 1. Bulk partitioning and VLC of chloroform partition **P3**.

F1 (see previous page)
Si gel VLC; CHCl₃→MeOH gradient

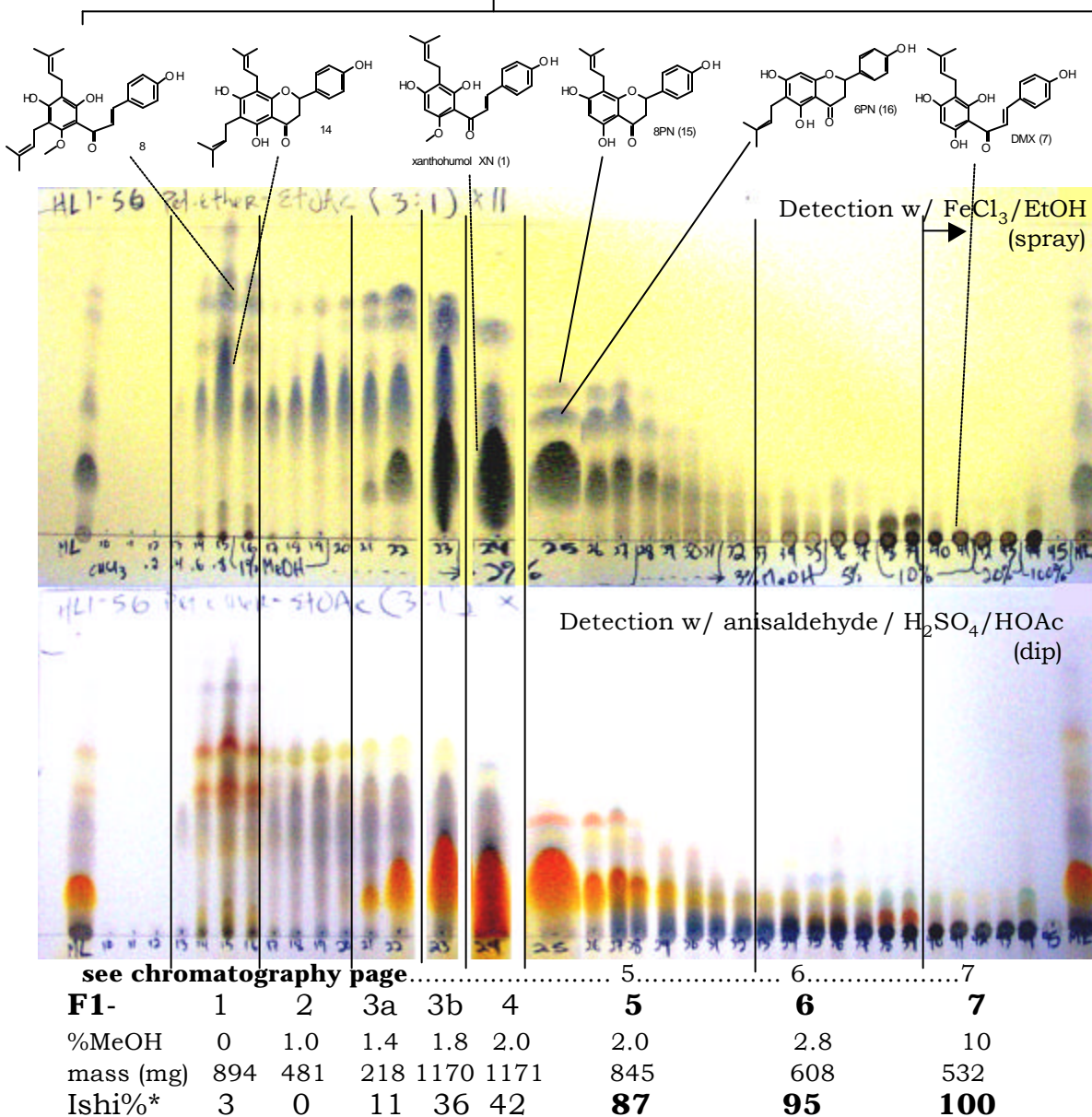

Chromatography page 2. 2nd chromatographic step: VLC of **F1**. Both plates run with TLC solvent system: Petroleum ether-EtOAc (3:1); plates run once, then allowed to dry, then run a second time before spraying/dipping. *Alkaline phosphatase induction in Ishikawa cells relative to 2 nm estradiol, due to test substance (combined fraction as indicated by vertical lines) at 1 µg/ml. Regarding use of the anisaldehyde reagent, if the plates are scanned and digitally filtered (eg. photoshop autolevels) after dipping, but *before* heating, vivid red/orange/yellow colors are observed for **K1-K17**. Upon heating, the colors will change. Overheating will cause many spots to fade.

F2 (see chromatography page 1)
Si gel VLC; CHCl₃→MeOH gradient

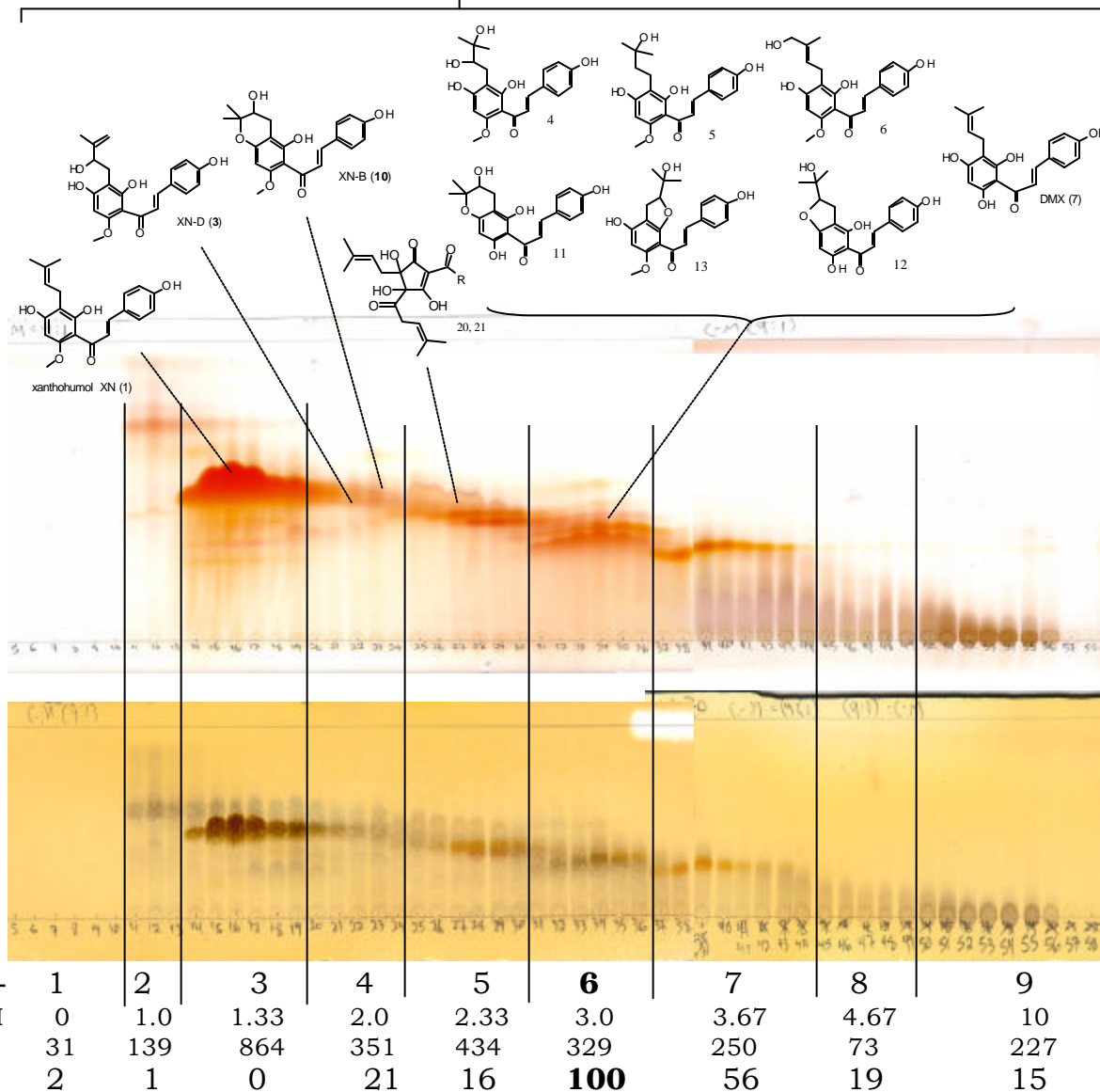

K4-7,11,13-16

(see chromatography pages 8,10)

Chromatography page 3. 2nd chromatographic step: VLC of **F2**. *alkaline phosphatase induction in Ishikawa cells, due to test substance at 1 µg/ml. Above: Detection with anisaldehyde / H₂SO₄/HOAc (dip). Below: Detection with FeCl₃/EtOH (spray). Both plates run w/ same TLC solvent system: CHCl₃-MeOH (9:1).

F3 (see chromatography page 1)
Si gel VLC; CHCl₃→MeOH gradient

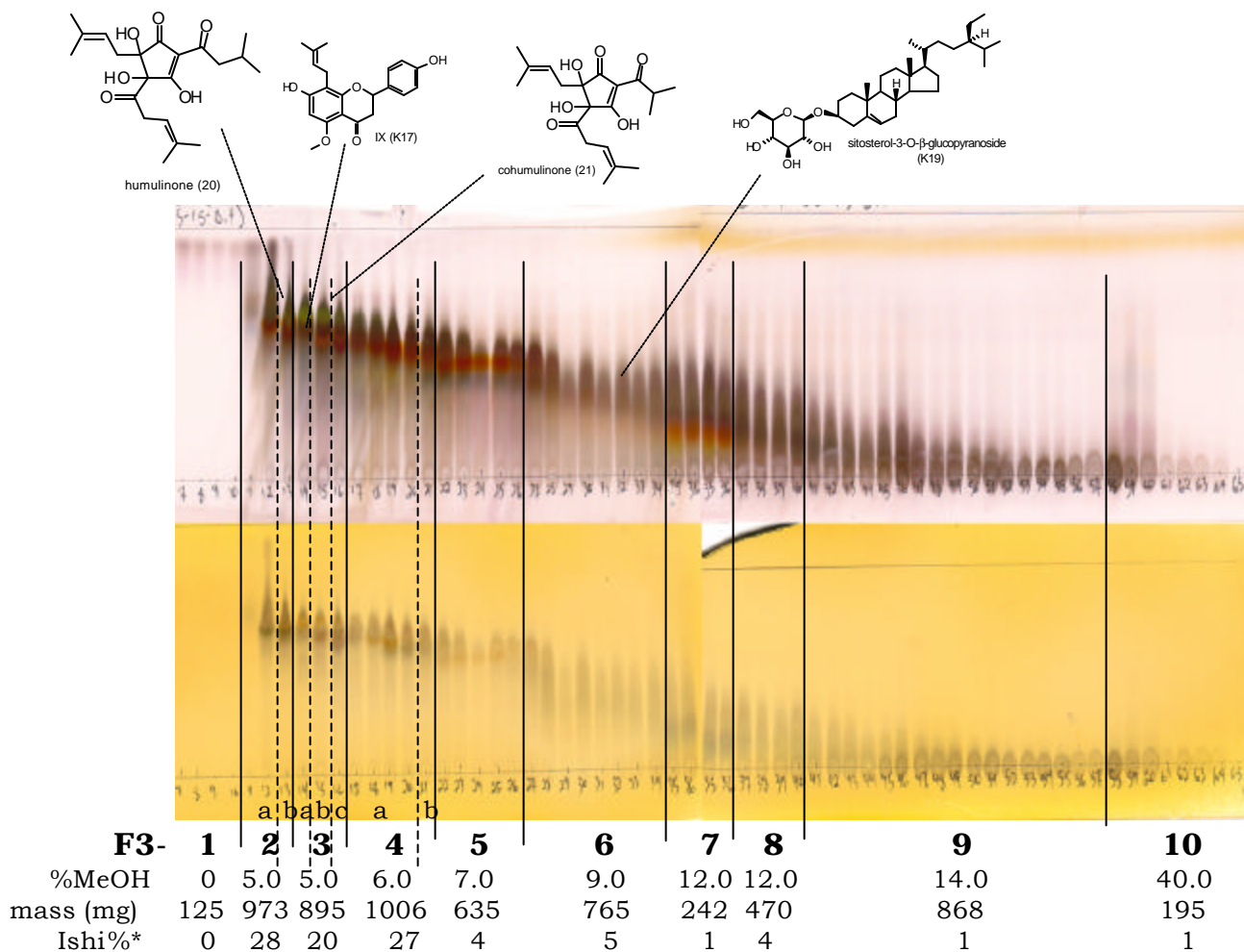

Chromatography page 4. 2nd chromatographic step: VLC of **F3**. *alkaline phosphatase induction in Ishikawa cells, due to test substance at 1 µg/ml. Above: Detection with anisaldehyde/ H₂SO₄/HOAc (dip). Below: Detection with FeCl₃/EtOH (spray). Both plates run w/ same TLC solvent system: CHCl₃-MeOH-H₂O (85:15:0.4)

F1-5 (see chromatography page 2)
CCC (545 mg) PEMW = 5/5/6/4

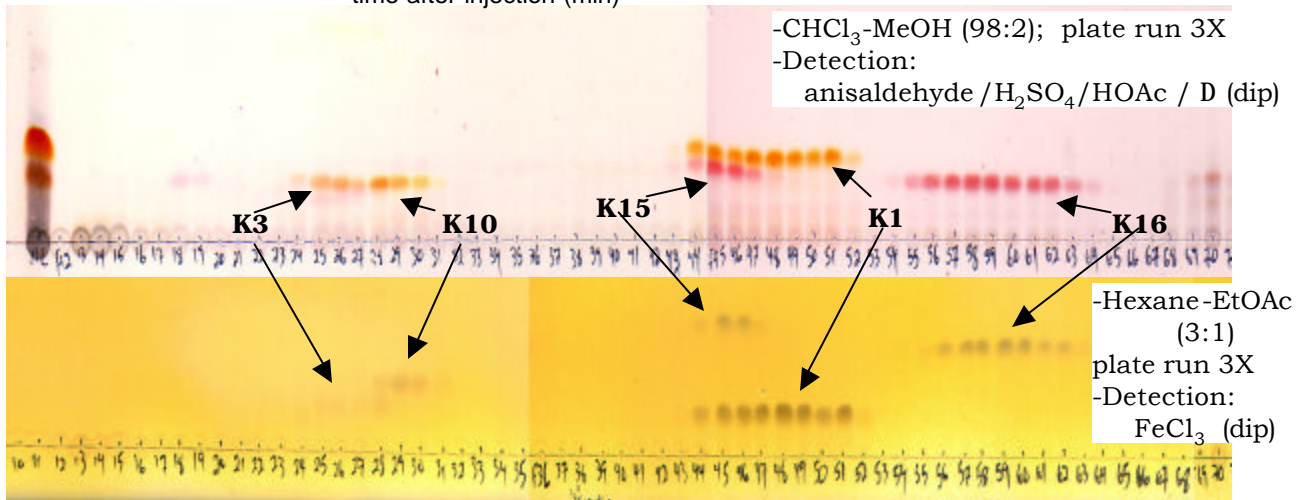
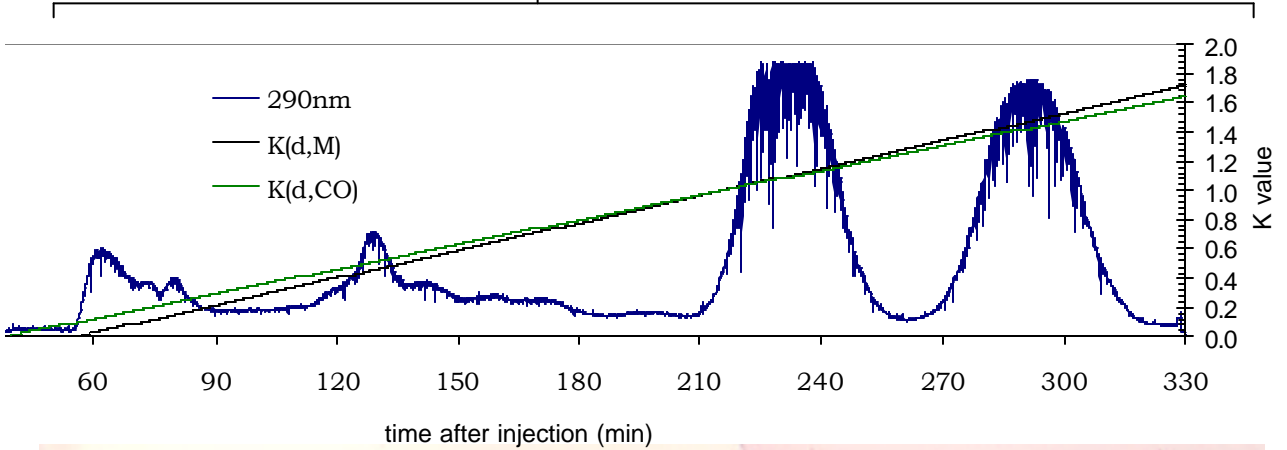

CC(C)=C/C=C/C1=C(O)C(OC)=C(O)C1
 XND (3)

CC(C)(O)C/C=C/C1=C(O)C(OC)=C(O)C1
 XNB (10)

CC(C)=C/C=C/C1=C(O)C(OC)=C(O)C1
 8PN (15)

CC(C)=C/C=C/C1=C(O)C(OC)=C(O)C1
 XN (1)

CC(C)=C/C=C/C1=C(O)C(OC)=C(O)C1
 6PN (16)

-SP fractions = column (continued from above)

Chromatography page 5. 3rd chromatographic step: CCC of F1-5.

F1-6 (see chromatography page 2)
CCC (100 mg) HEMW = 6/4/6/4

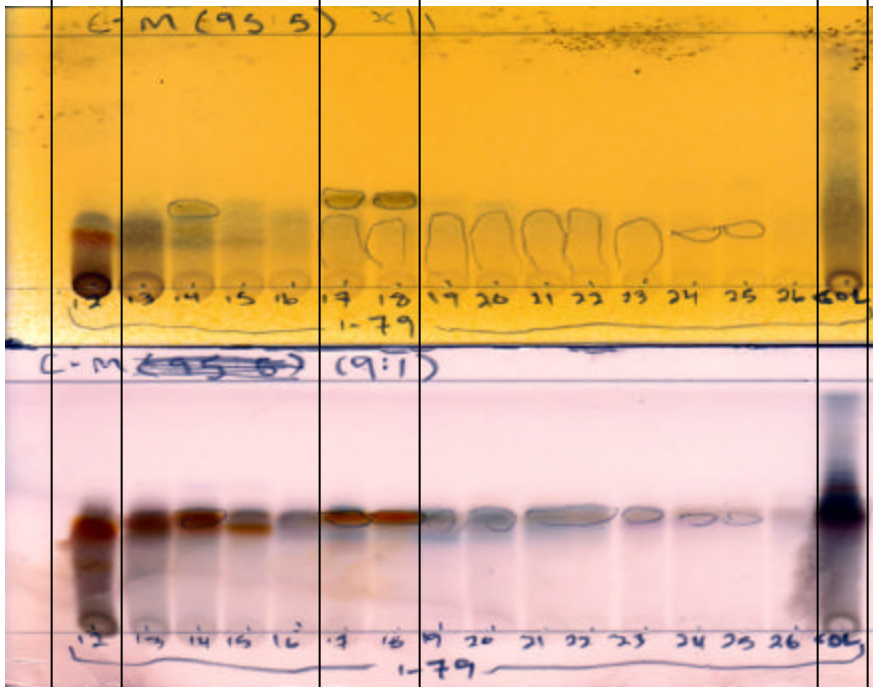
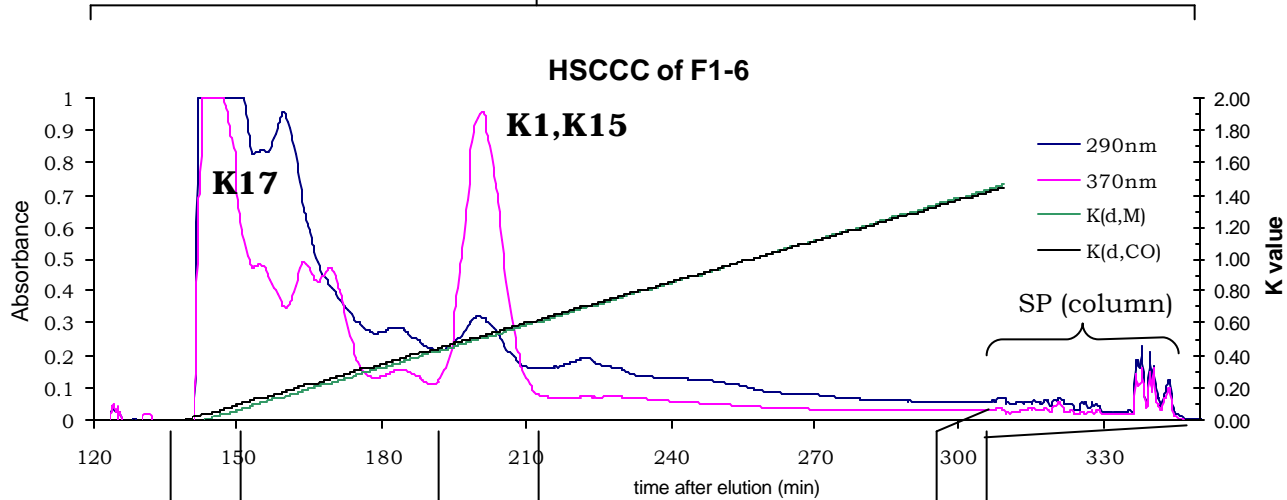

F1-6-	1	2	3	4	5
Mass (mg)	23	25.9	7.1	13.4	25
%Ishi	12	24	57	4	-9

Chromatography page 6. 3rd chromatographic step: CCC of **F1-6**. Selective removal of 8PN from active silica gel fractions. *alkaline phosphatase induction in Ishikawa cells, due to test substance at 1 $\mu\text{g/ml}$.

F1-7 (see chromatography page 2)
CCC (100 mg): HEMW = 6/4/6/4

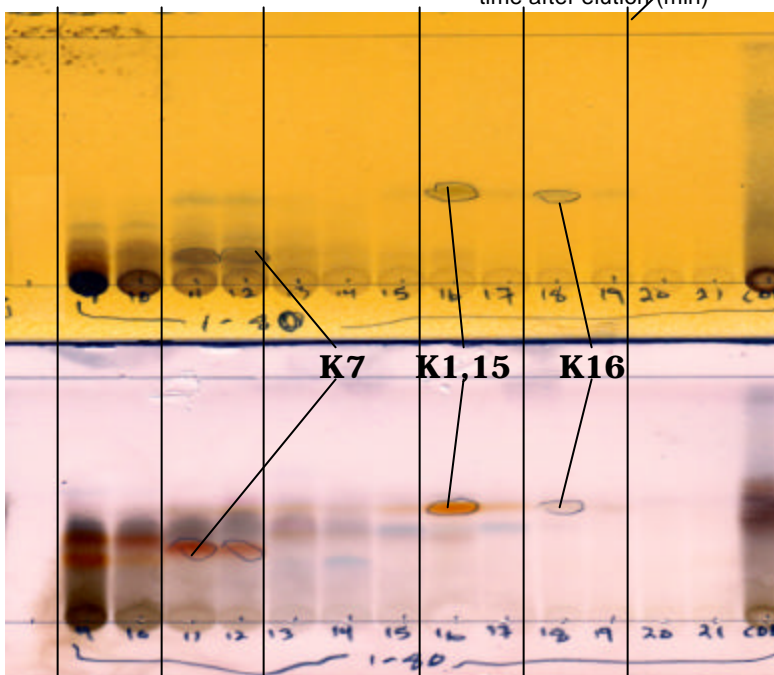
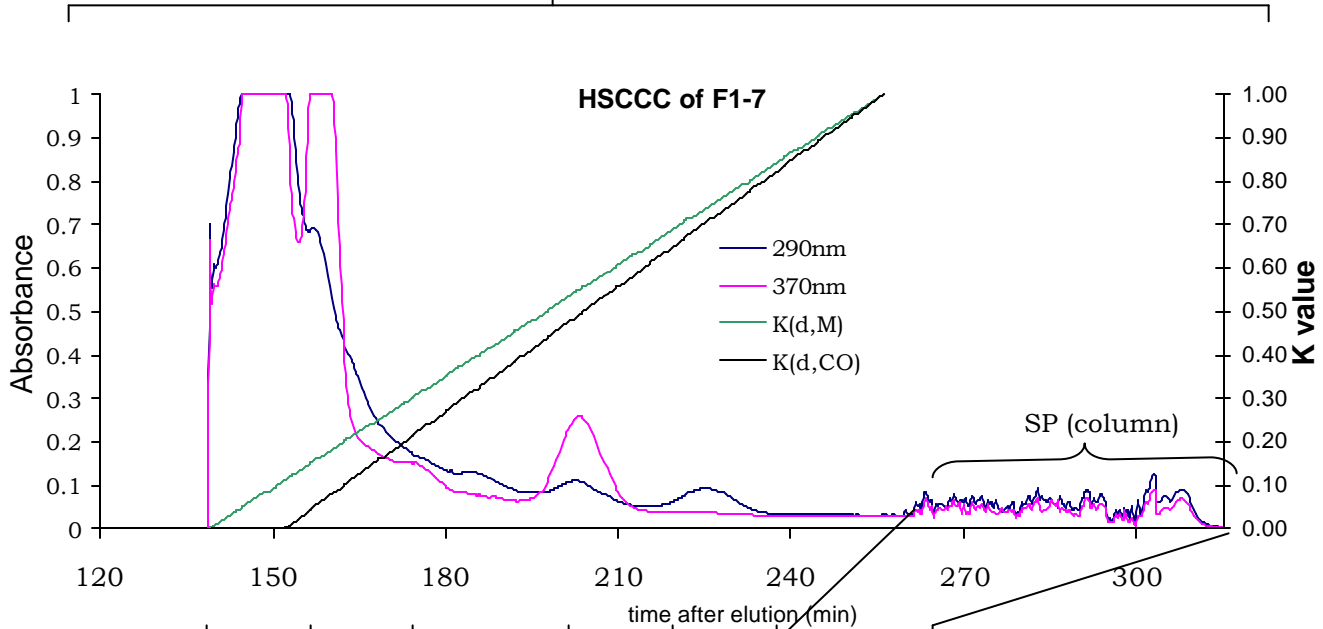

CHCl₃-MeOH (95:5);
 plate run 2X; detection
 with FeCl₃ (3% EtOH)

CHCl₃-MeOH (9:1);
 detection with
 anisaldehyde-H₂SO₄-
 HOAc (1:1:48)/Δ.

see chrom. page.....9	1	2	3	4	5	6
F1-7-						
Mass (mg)	43.9	12.1	5.9	2.8	1.7	16.7
%Ishi	4	74	33	89	1	-14

Chromatography page 7. 3rd chromatographic step: CCC of F1-7. Selective removal of 8PN from active silica gel fractions (continued). *alkaline phosphatase induction in Ishikawa cells, due to test substance at 1 µg/ml.

F2-6 (see chromatography page 3)
CCC (100 mg): HEMW = 6/4/6/4

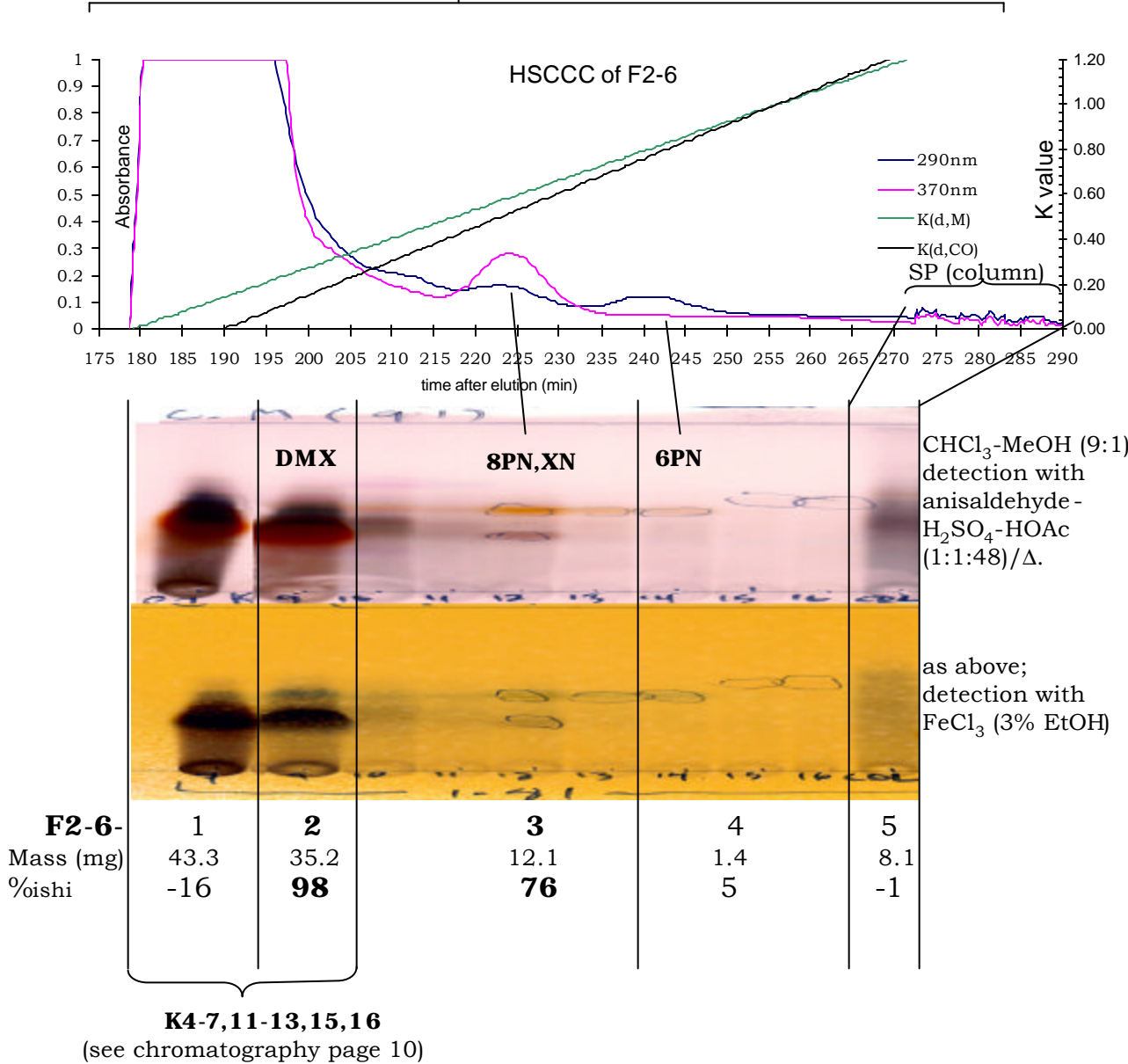

Chromatography page 8. 3rd chromatographic step: CCC of **F2-6**. Selective removal of 8PN from active silica gel fractions (continued). *alkaline phosphatase induction in Ishikawa cells, due to test substance at 1 µg/ml.

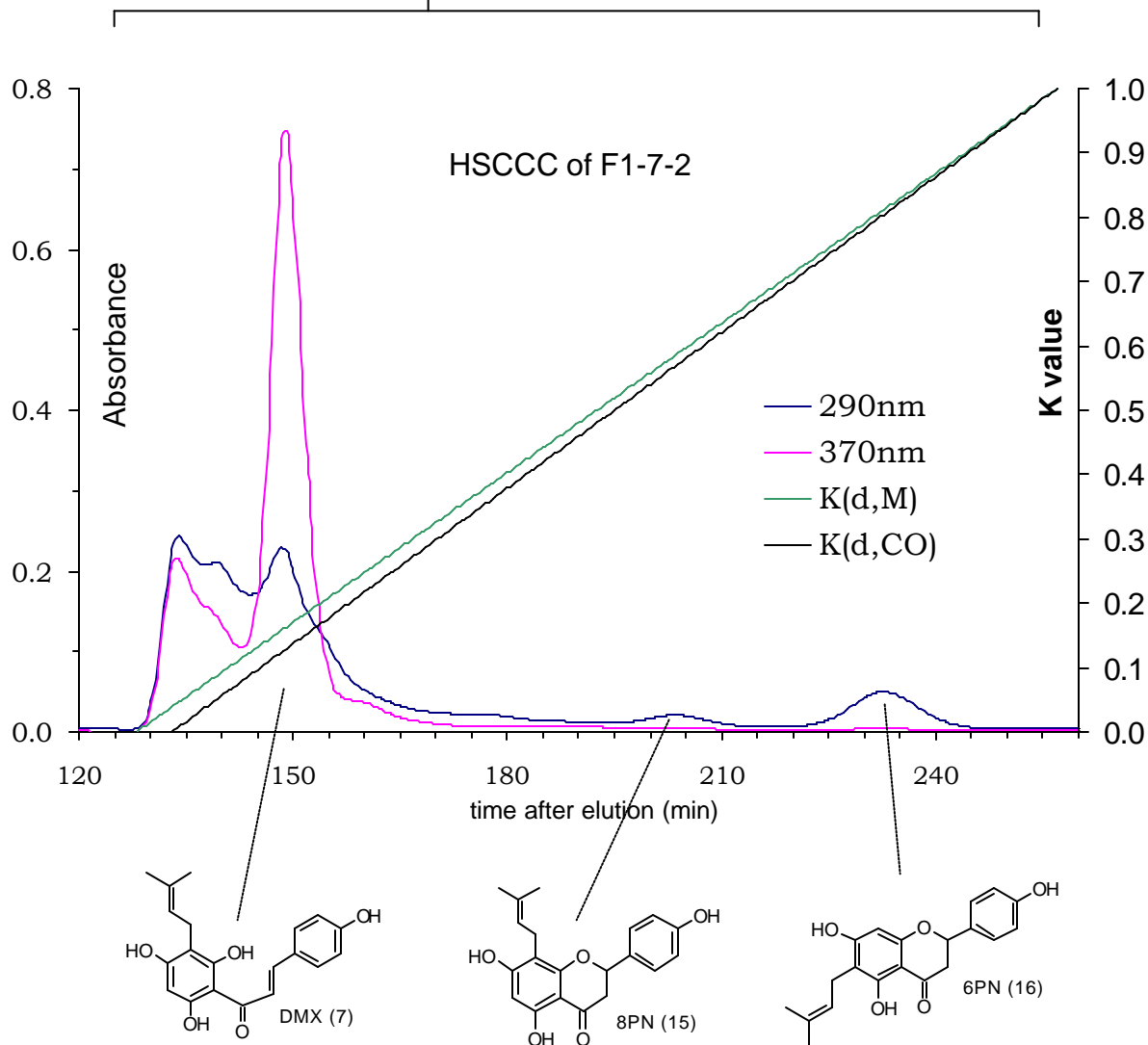
F1-7-2 (see chromatography page 7)**(12 mg):****CCC HEMW = 6/4/6/4**

Chromatography page 9. 4th chromatographic step: CCC of **F1-7-2**. The parent fraction was produced using the same solvent system as above. This figure illustrates a caveat associated with high-throughput CCC of natural mixtures, when it comes to possible reactivity of compounds. According to the above calculations, and given that $0.1 < K_p < 0.4$ for the parent fraction, the sample should have eluted entirely ca. 160 minutes after injection. All analytes with $K_p > 0.5$ in the above solvent system **were** removed from this sample in the previous chromatographic step. The peaks corresponding to 8PN and 6PN above are due to the isomerization of DMX in the sample **after** the previous chromatographic step. Without considering the possibility of artefact formation, it could be calculated that similar fractions could be injected ca. 120 minutes apart, without overlap. The injection of another sample 120 minutes after the one shown above, however, could have resulted in a confounding situation regarding bioassay-guided fractionation.

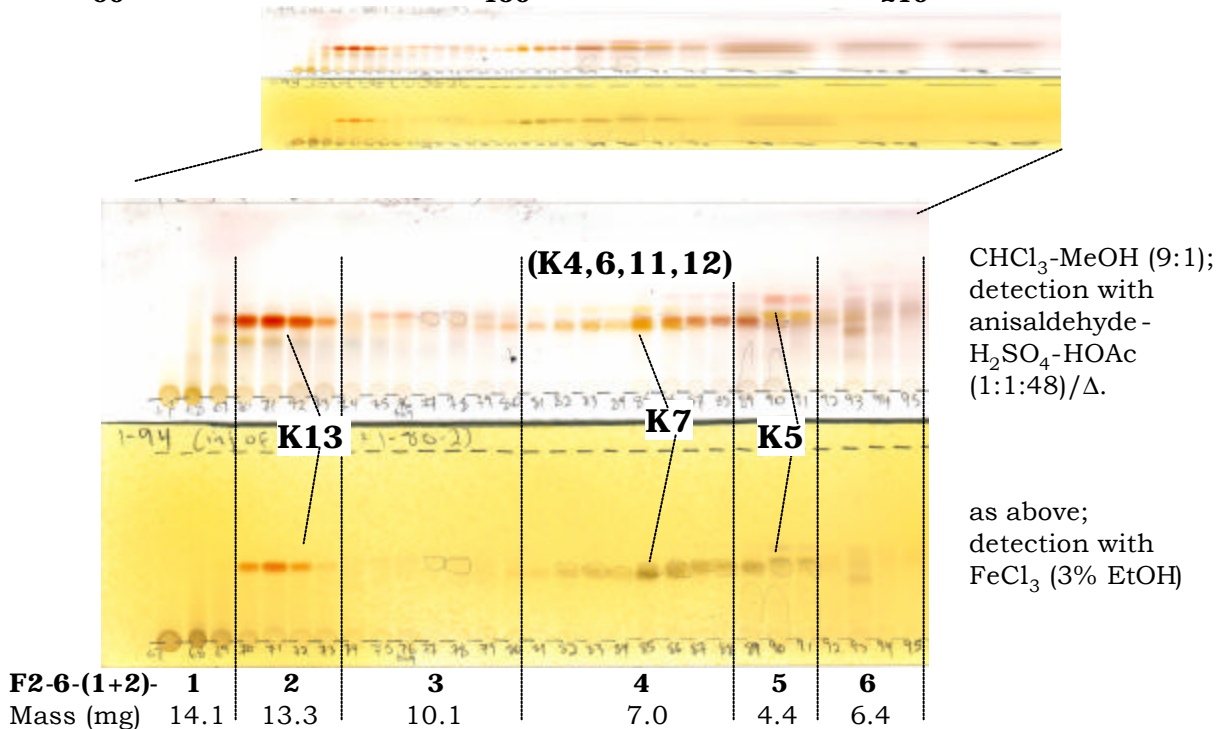
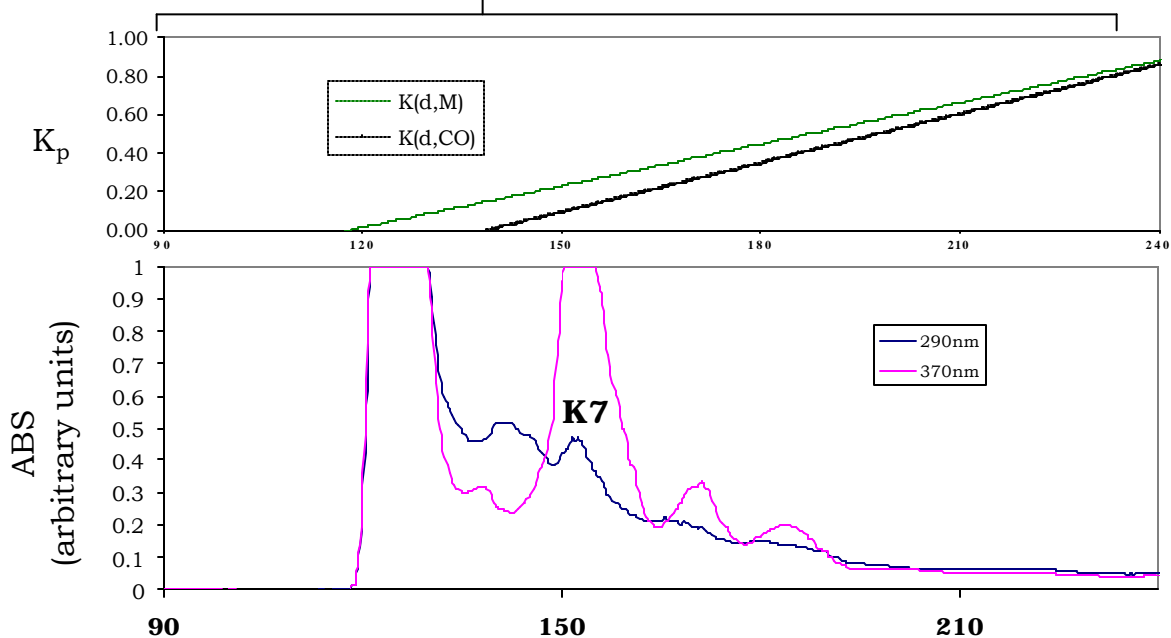
F2-6-(1+2) (see chromatography page 8)**0 $K_p(SS+1)$ ≤ 0.15 combined (78 mg):****CCC HEMW = 5/5/5/5 = SS-0**

Chromatography page 10. 4th chromatographic step: The HEMWat 5-5-5-5 solvent system (SS-0) used here is more polar than the 6-4-6-4 system (SS+1), which was used to produce the parent fraction. The preceding CCC step “primed” the above sample (chromatography page 8; fractions with $0 < K_p(SS+1) < 0.15$) such that it could be chromatographed without the need to empty the SP contents, leaving the CCC instrument ready for a subsequent injection (notwithstanding the caveat highlighted in the preceding figure).

1H	ppm	mult (J)	integ
H3(a)	7.81	dt (15.6, 0.2, 0.2)	1H
H2(b)	7.69	dt (15.6, 0.7, 0.4)	1H
H2',6'	7.51	dddd (8.5, 2.3, 0.7, 0.4, 0.2)	2H
H3',5'	6.83	dddd (8.5, 2.3, 0.4, 0.4, 0.2)	2H
H6	6.07	s	1H
5-OMe	3.92	s	3H
H2''	3.56	dd (10.0, 2.6)	1H
H1''a	2.61	dd (14.3, 10.0)	1H
H1''b	3.03	dd (14.3, 2.6)	1H
Me-4,5''	1.25	s	6H

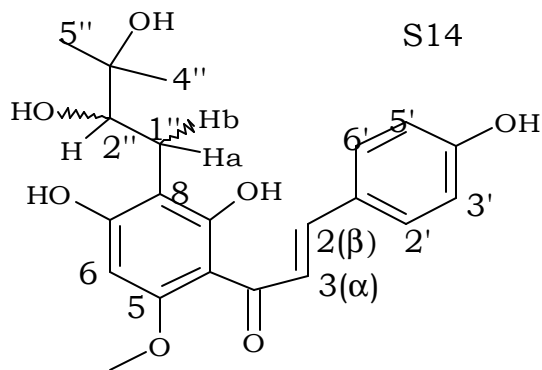

(4) Xanthohumol G
 $C_{21}H_{24}O_7$ MW = 388.14

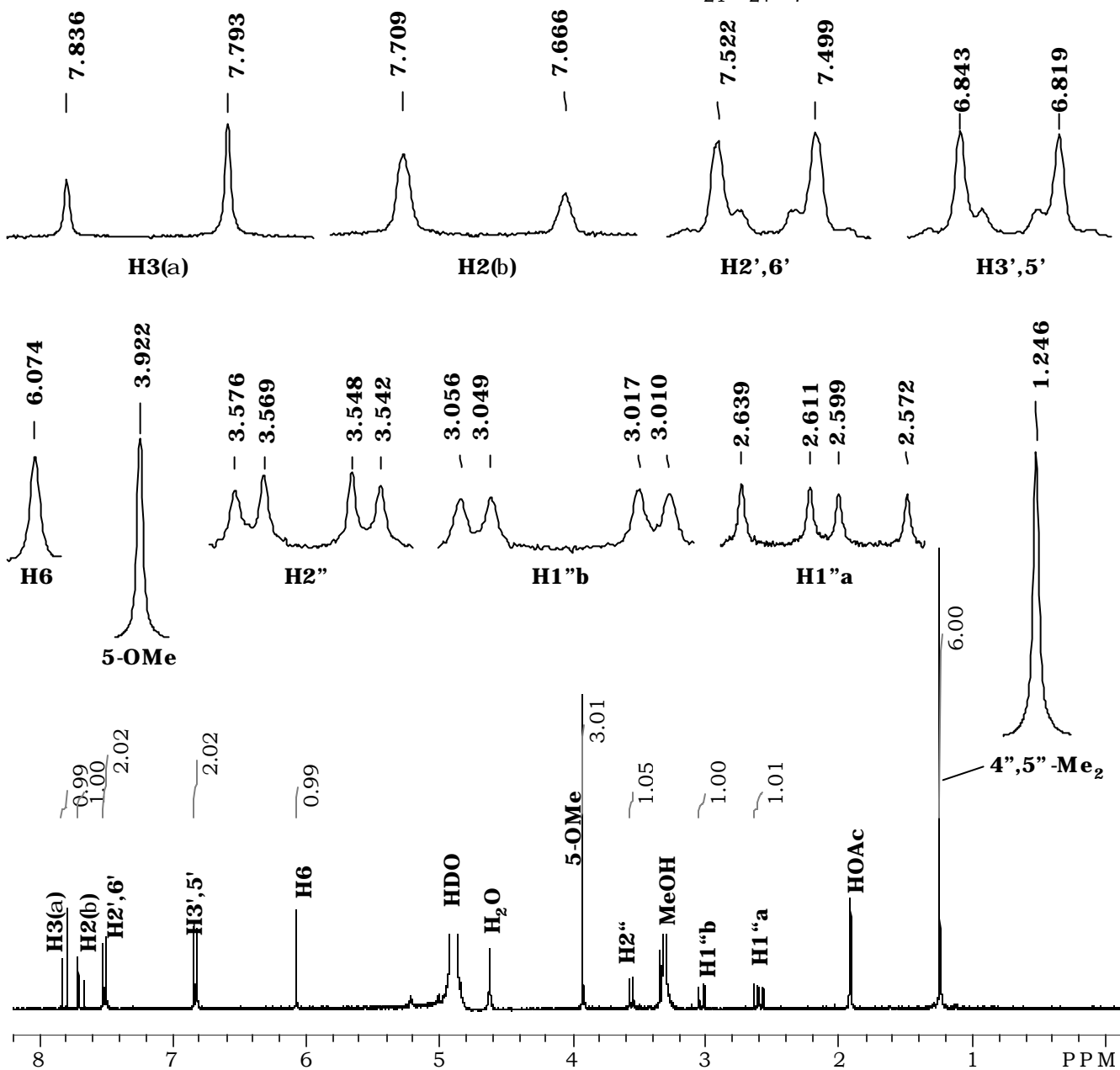

xanthohumol G (**4**) 500 MHz 1H NMR spectrum taken in $MeOH-d_4$

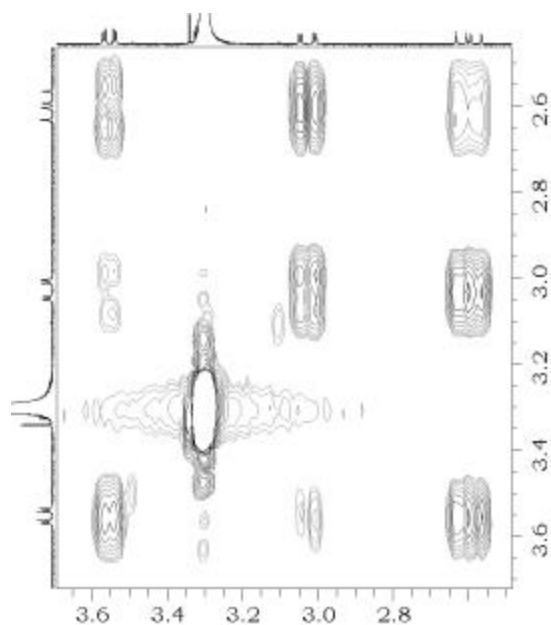
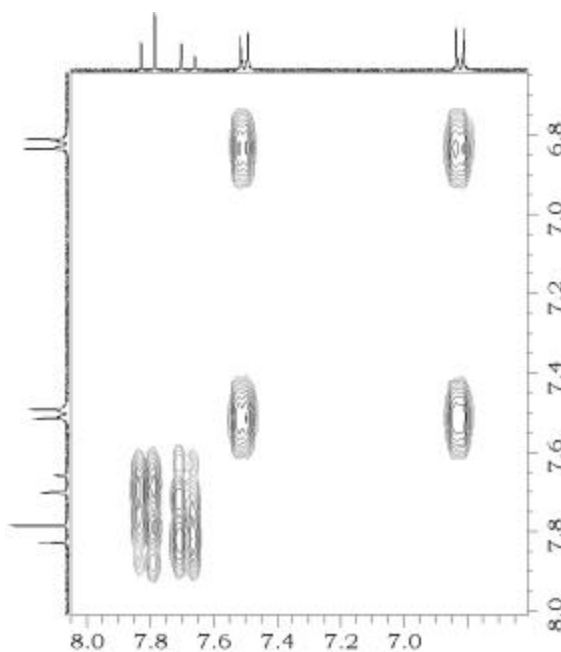
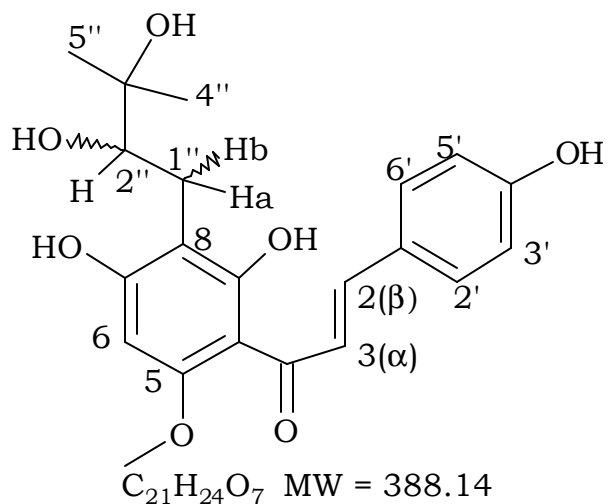
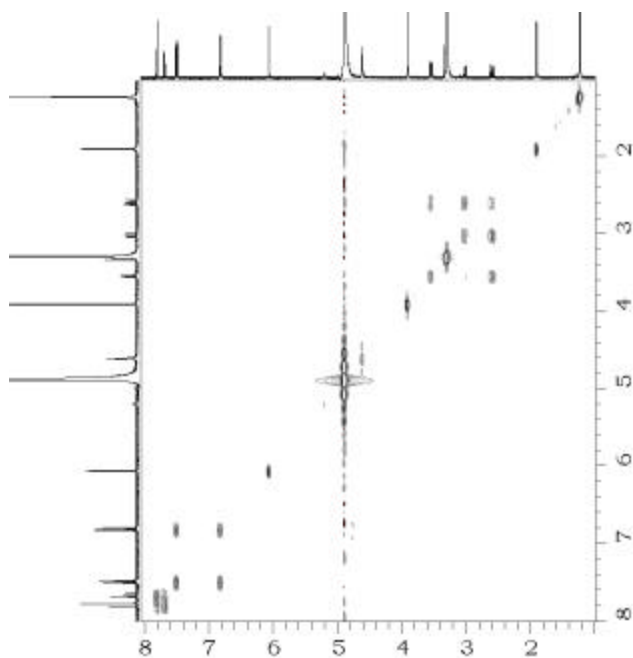

xanthohumol G (**4**) 360 MHz COSY spectrum.

¹³ C	ppm	HMQC	HMBC
C4	194.8 b		H α ,H β
C7	167.5 b		H6
C8a	167.5 b		H1''b
C5	163.06		5-O-Me; H6
C4'	161.5 b		H2',6'; H3',5'
C2(b)	143.31	(x)	H2',6'; H α
C2',6'	131.27	X	H2',6' ; H β ;
C1'	128.55		H3',5'; H α
C3(a)	125.91	X	H β
C3',5'	116.95	X	H3',5'
C4a	108.6 b		H1''b
C8	107.0 b		H6
C6	93.084	X	
C2''	80.583	(x)	Me-4'',5''; H1''a
C3''	74.077		Me-4'',5''
5-OMe	56.207	X	
MeOH	49.1		"doublet"
C4'',5''	25.944		Me-4'',5''
C1''	25.293		
TMS	0		

125 MHz ¹³C NMR spectral assignments.
b = signal estimated from HMBC correlation

UV spectrum of compound **4**

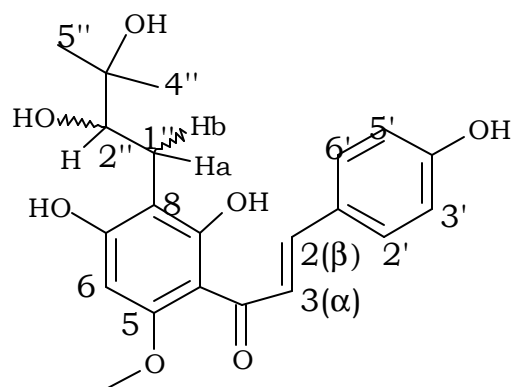

(4) "Xanthohumol G"
C₂₁H₂₄O₇ MW = 388.145

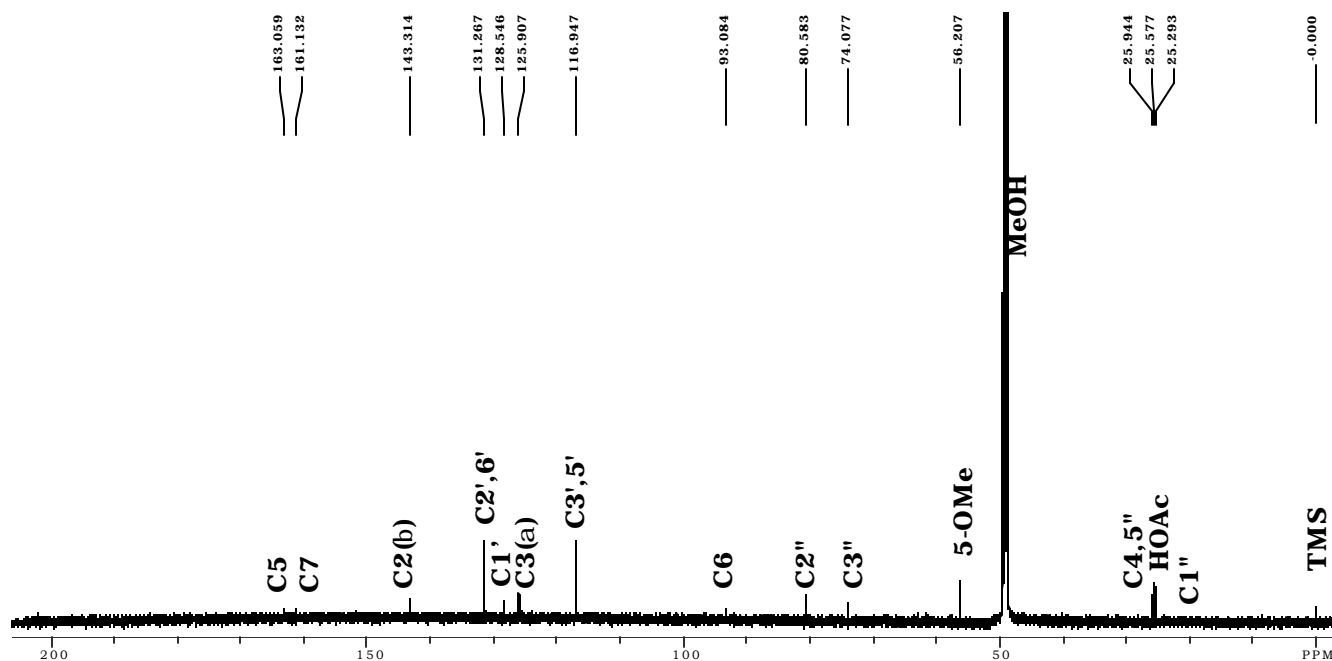

xanthohumol G (**4**) ¹³C 125 MHz spectrum in MeOH-d₄; 0.4 mg; ns = 45k; t=33.5 hr

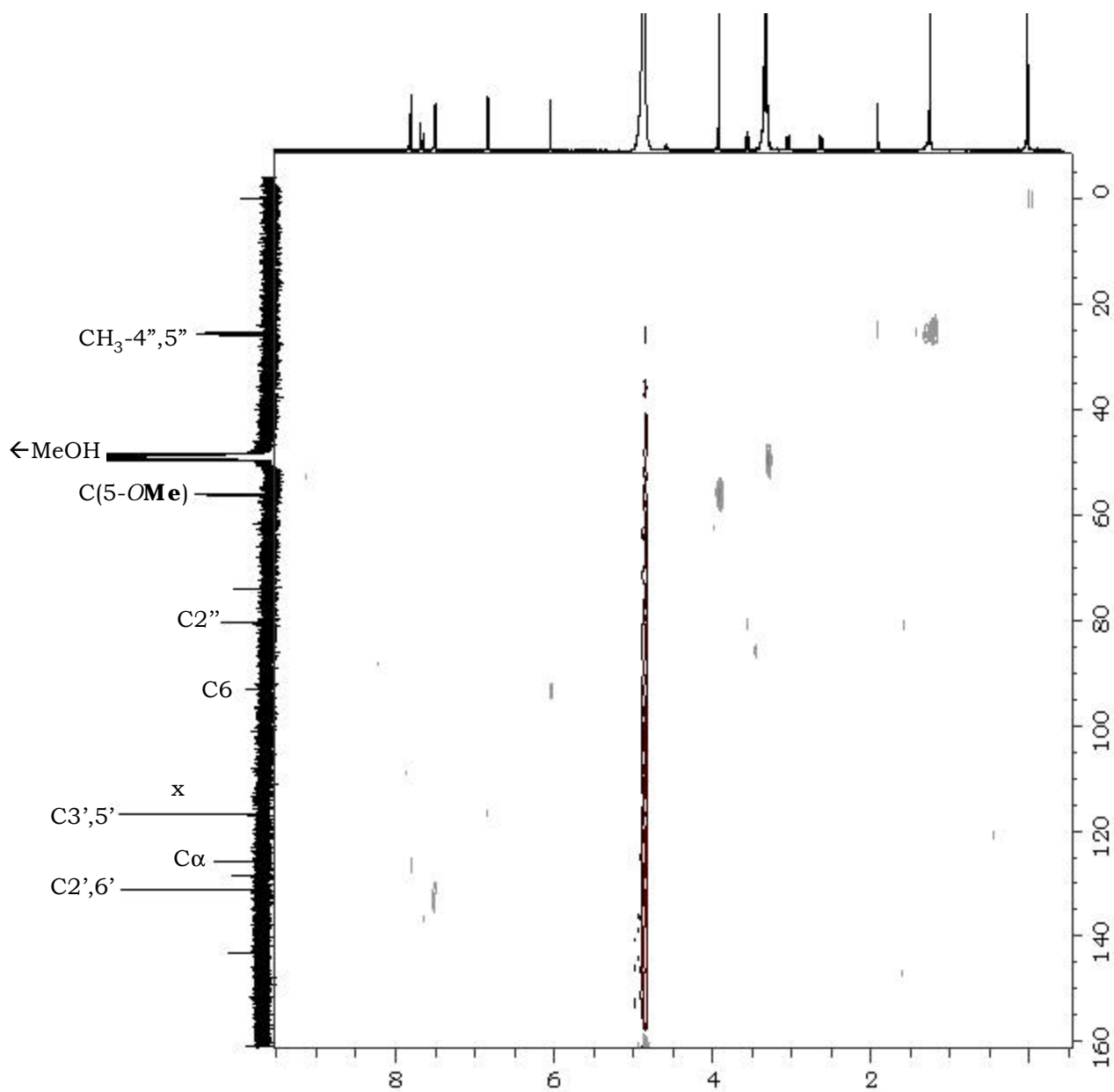

xanthohumol G (**4**) 500 MHz HMQC spectrum; 0.4 mg; ns = 64; t = 5 hr

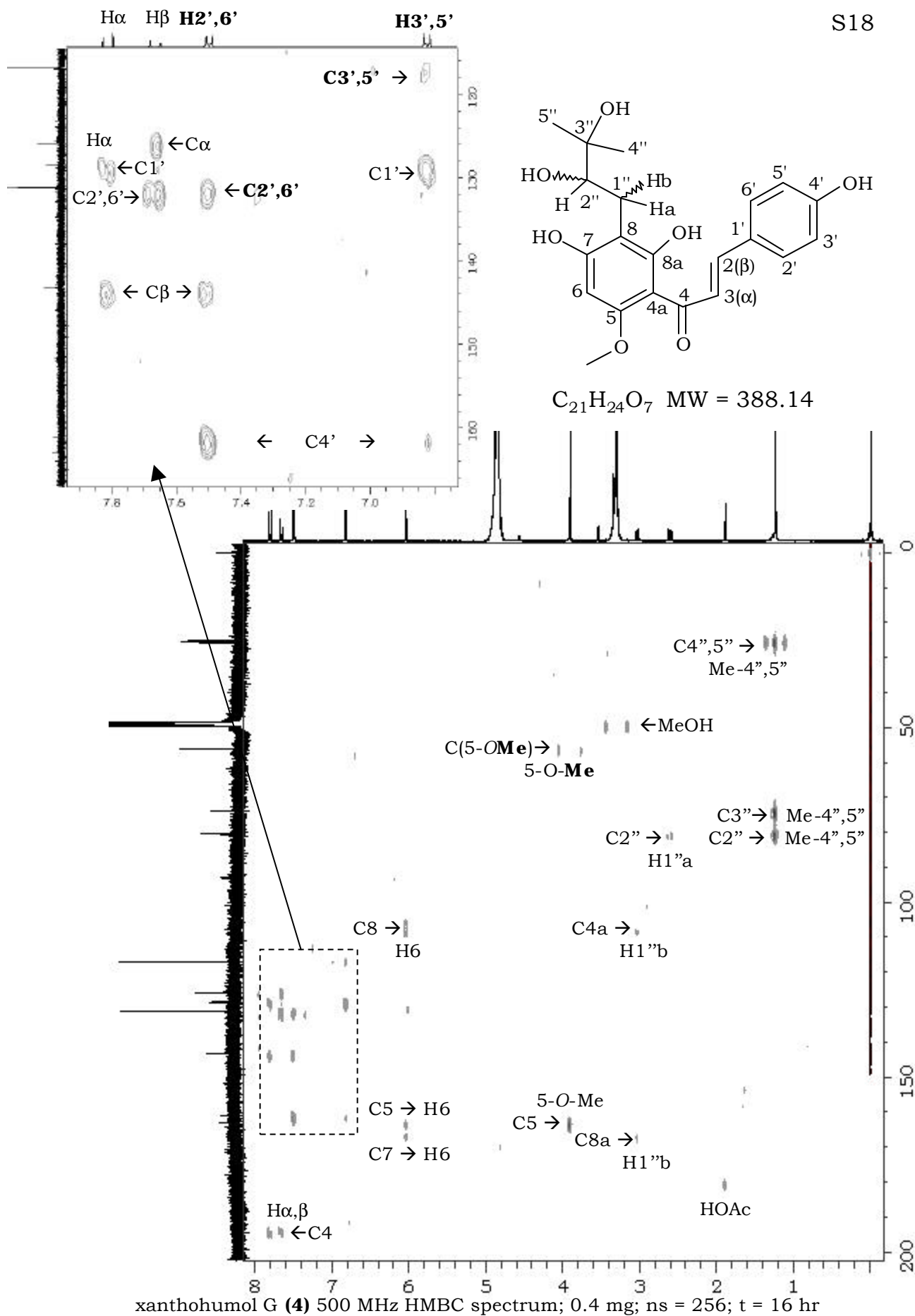

1H	ppm	mult (J)	integ
H3(a)	7.81	dt (15.6, 0.1, 0.1)	1H
H2(b)	7.67	dt (15.6, 0.5, 0.4)	1H
H2',6'	7.50	dddd (8.5, 2.3, 0.5, 0.4, 0.1)	2H
H3',5'	6.82	dddd (8.5, 2.3, 0.4, 0.4, 0.1)	2H
H6	6.02	s	1H
5-OMe	3.91	s	3H
H1''	2.62	ddd (18.0, 11.9, 4.9)	1H
H2''	1.64	ddd (18.0, 11.9, 4.9)	1H
Me-4'',5''	1.24	s	6H

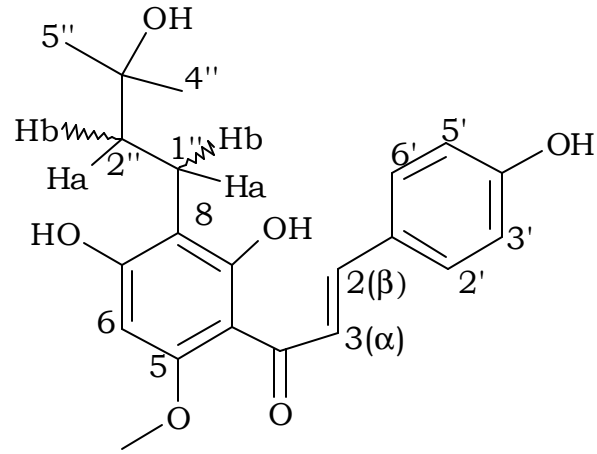

$C_{21}H_{24}O_6$ MW = 372.150

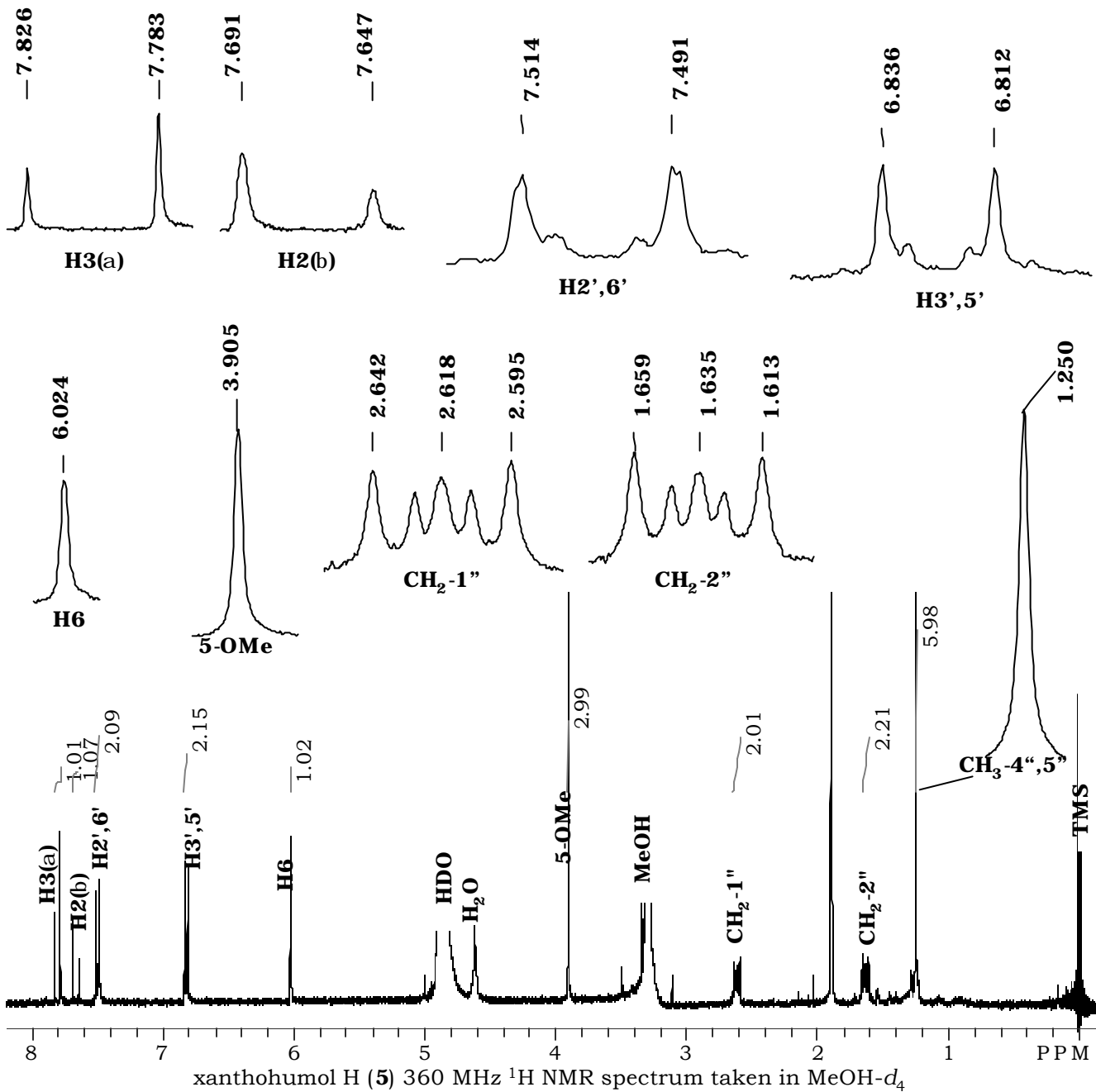

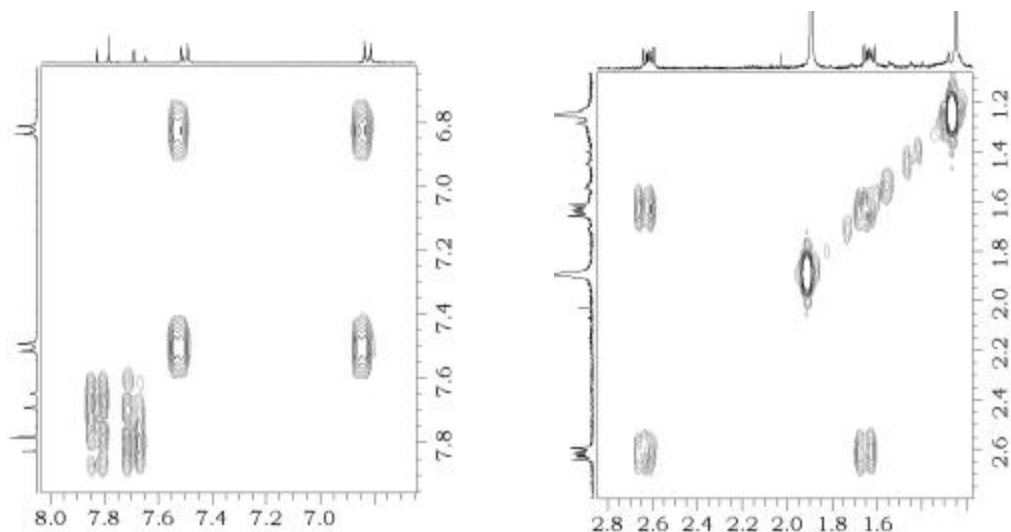
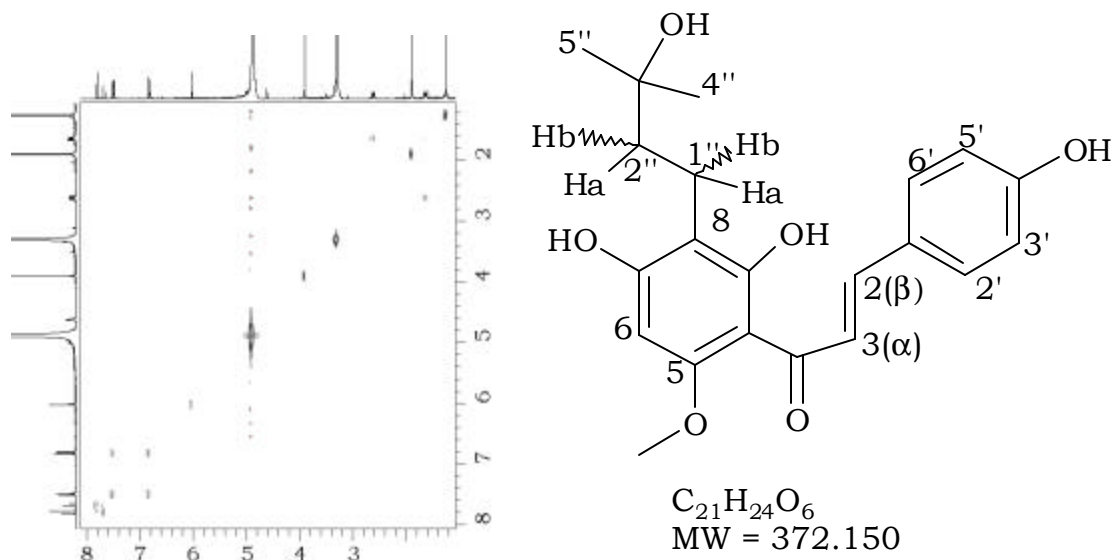

xanthohumol H (**5**) 360 MHz **COSY** spectrum in MeOH- d_4 .

1H	ppm	mult (J)	integ
H3(a)	7.80	dt (15.5, 0.1, 0.1)	1H
H2(b)	7.67	dt (15.5, 0.5, 0.3)	1H
H2',6'	7.50	dddd (8.5, 2.3, 0.5, 0.4, 0.1)	2H
H3',5'	6.81	dddd (8.5, 2.3, 0.4, 0.3, 0.1)	2H
H6	6.02	s	1H
H2''	5.49	ddqt (7.2, 7.2, 1.5, 0.5)	1H
5-OMe	3.90	s	1H
CH2-5''	3.89	dddq* (1.2, 1.0, 1.0, 0.5)	2H
Me-4''	1.81	dtdd (1.5, 1.0, 0.4, 0.4)	3H
CH2-1''	(3.31)	COSY; buried under MeOH	-

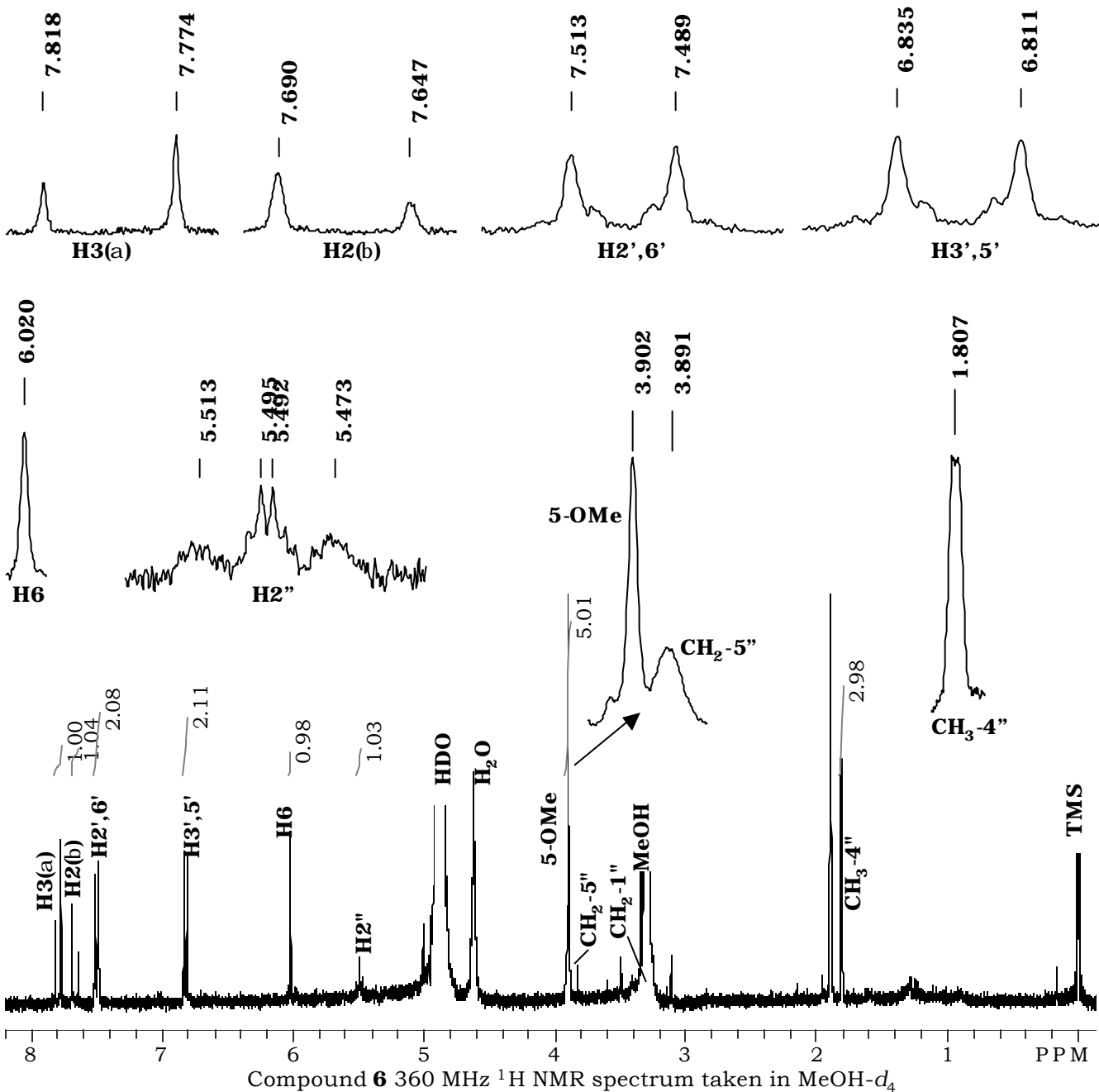
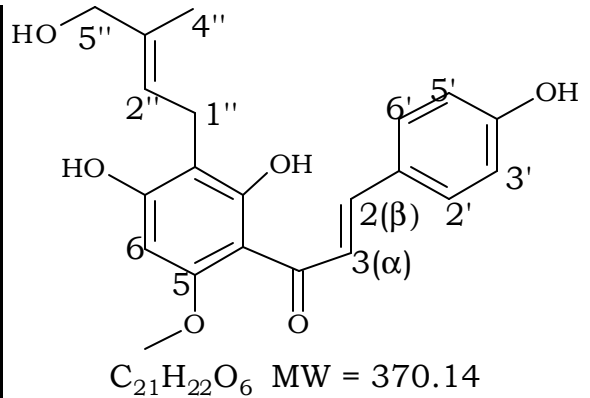

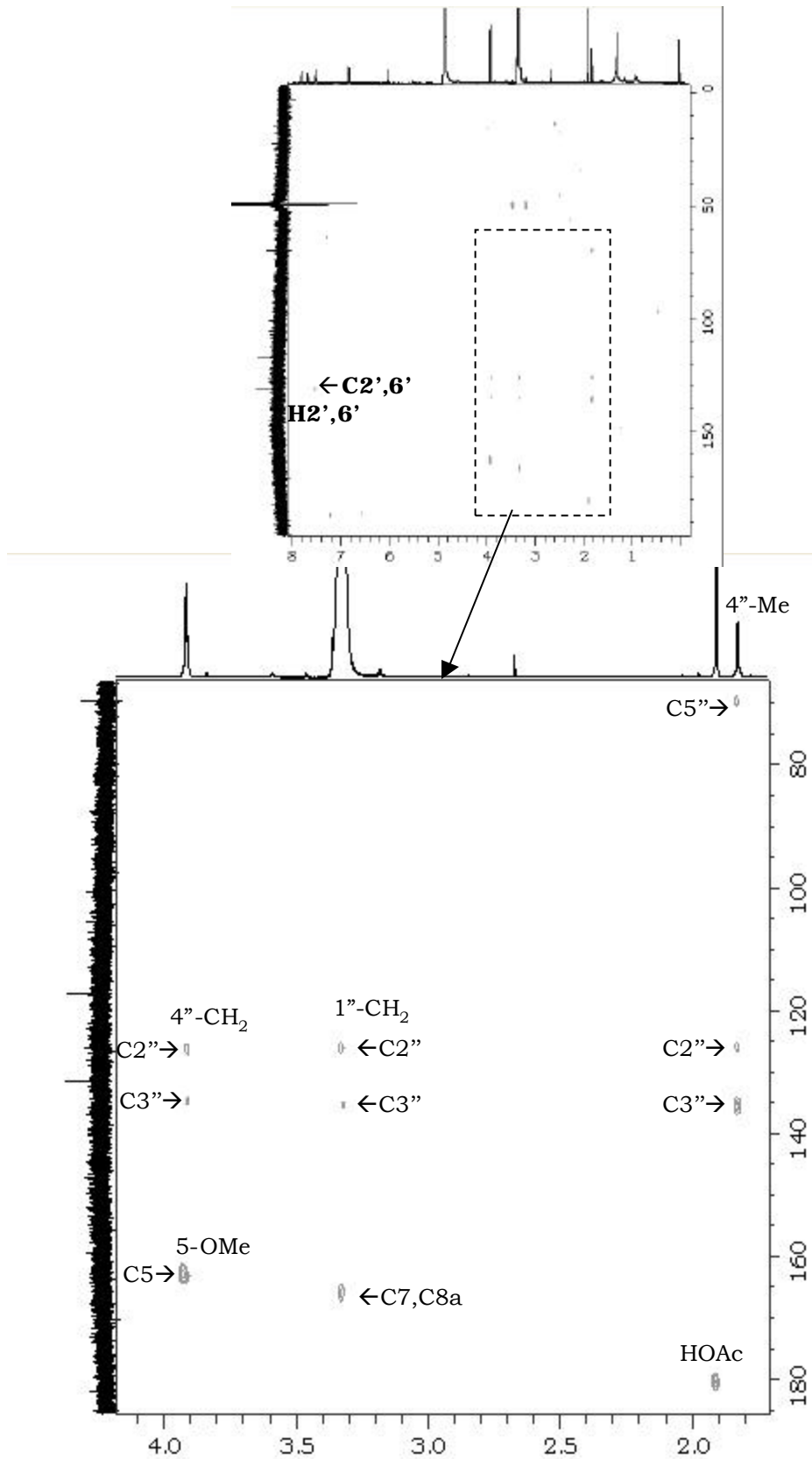
$C_{21}H_{22}O_6$ MW = 370.14

Compound **6** 500 MHz HMBC spectrum in MeOH- d_4 ns = 160; experiment = 10 hr.

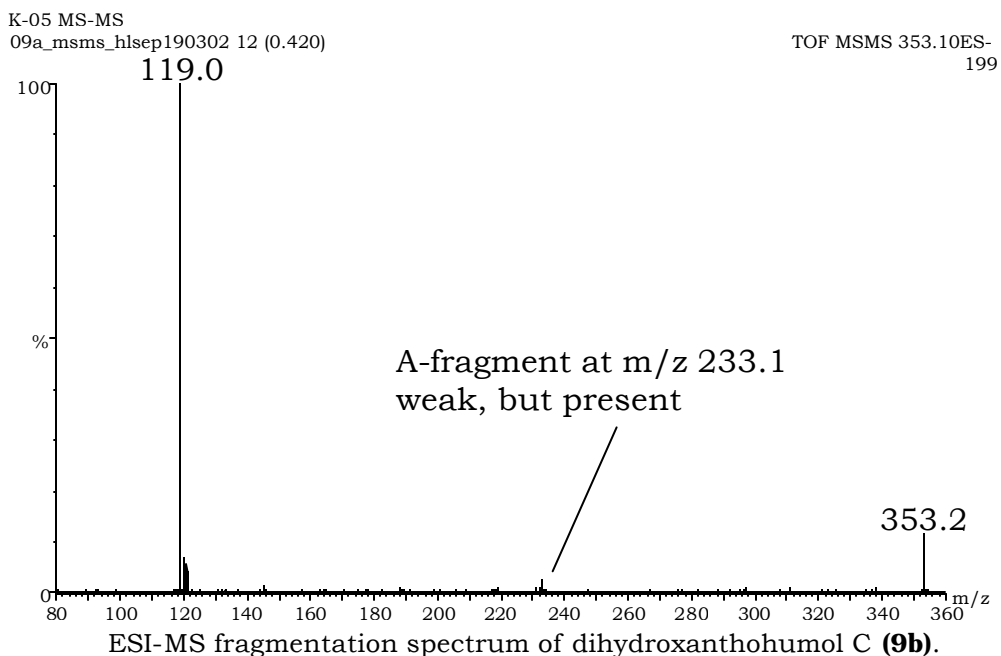

	ppm	mult (J)	integ
H3(a)	7.77	dt (15.6, 0.2, 0.2)	1H
H2(b)	7.70	dt (15.5, 0.6, 0.5)	1H
H2',6'	7.51	dddd (8.5, 2.3, 0.6, 0.4, 0)	2H
H3',5'	6.83	dddd (8.5, 2.3, 0.5, 0.4, 0)	2H
H1''	6.62	br-d (10.0)	1H
H6	6.03	s	1H
H2''	5.52	dd (10.0, 0.4) (see COSY)	3H
5-OMe	3.94	s	1H
Me-4'',5''	1.43	s	6H

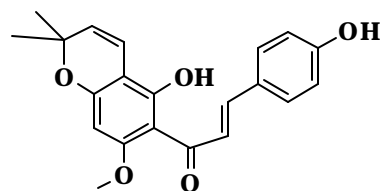

(**9a**) xanthohumol C
C₂₁H₂₀O₅ MW = 352.13

	ppm	mult (J)	integ
H3(a)	7.81	dt* (15.6, 0.2, 0.2)	-
H2(b)	7.69	dt* (15.6, 0.6, 0.5)	-
H2',6'	[7.5]	[dddd]	-
H3',5'	[6.8]	[dddd]	-
H6	5.95	s	(0.15H)
H1''	2.59	t (6.8)	(0.3H)
5-OMe	3.90	s	(0.45H)
H2''	1.81	t (6.8)	(0.3H)
Me-4'',5''	1.34	s	(1H)

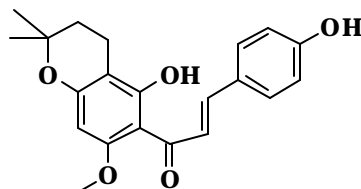

(**9b**) 1'',2''-dihydroxanthohumol C
C₂₁H₂₂O₅ MW = 354.14

Assignments for xanthohumol C (**9a**) and partial assignments for dihydroxanthohumol C (**9b**) from 360 MHz ¹H NMR spectrum of the mixture in MeOH-d₄.

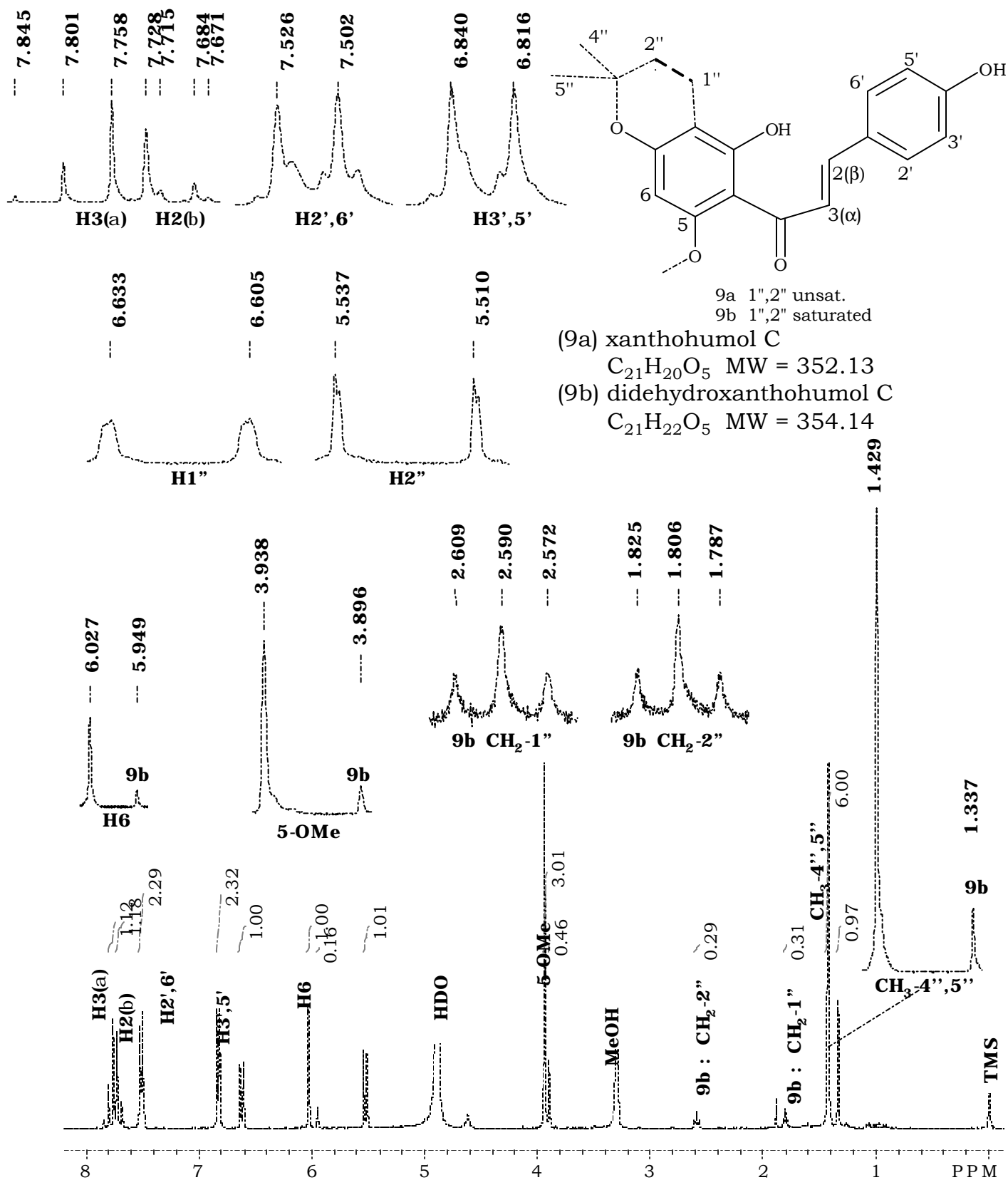

xanthohumol C (9a) and dihydroxanthohumol C (9b) ¹H NMR spectrum of a ca. 6:1 mixture in MeOH-*d*₄

(9a) xanthohumol C ($C_{21}H_{20}O_5$)
 (9b) dihydroxanthohumol C ($C_{21}H_{22}O_5$)

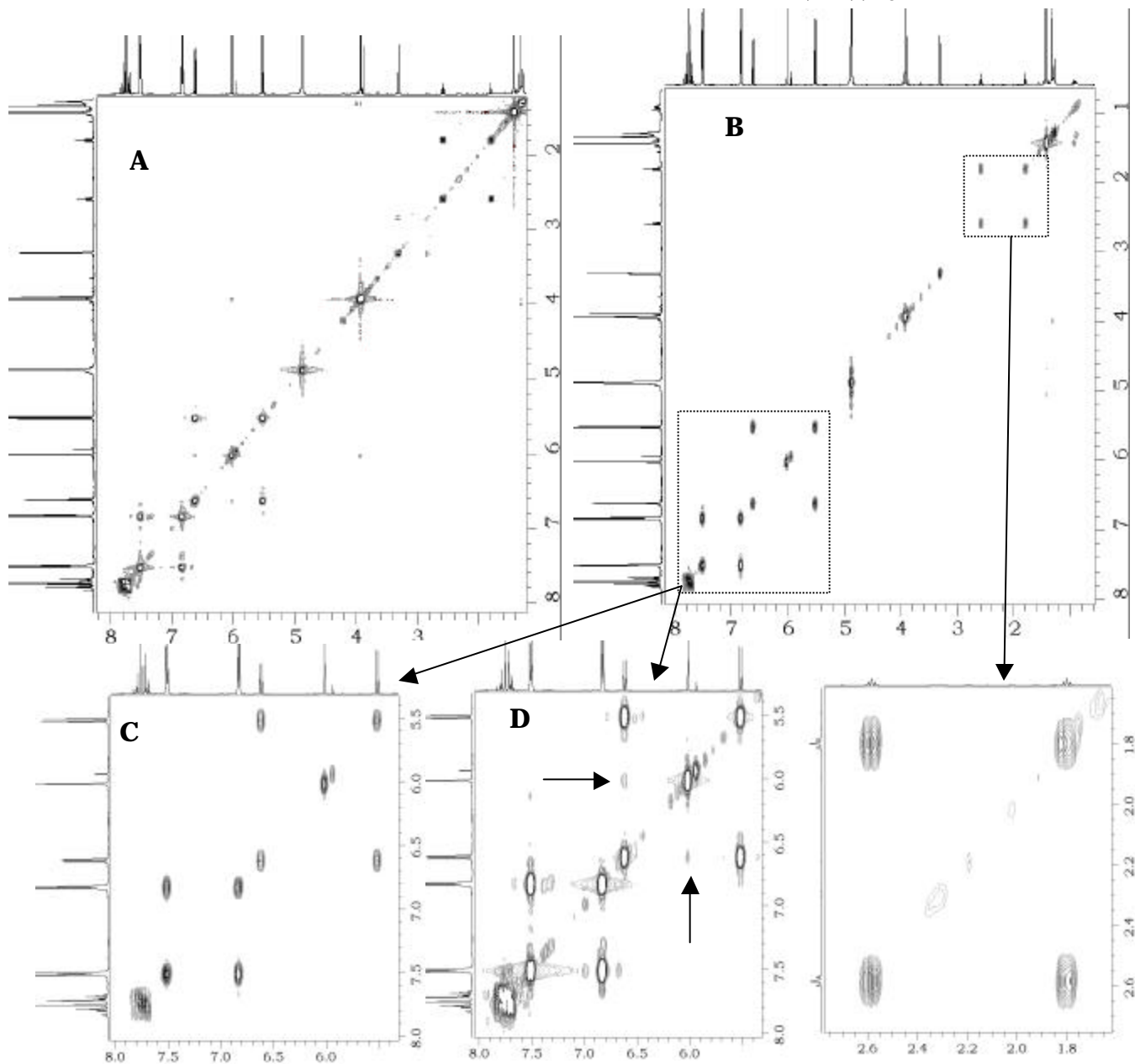

Symmetrized (A) unsymmetrized (B) $^1\text{COSY}$ 360 MHz NMR spectrum in $\text{MeOH-}d_4$ of the ca. 6:1 mixture of xanthohumol C (**9a**) and dihydroxanthohumol C (**9b**) When the spectrum is plotted at a high intensity (D, compared to C), crosspeaks between H6 and H1' become visible, as indicated by the arrows in panel D. If this is not an artefact, it is noted that no splitting of the H6 signal could be observed in the ^1H spectrum.

(9a) C₂₁H₂₀O₅(9b) C₂₁H₂₂O₅

09a

13C	ppm	HMQC	HMBC
C4	194.28		H6;H α ;H β ;
C5	164.18		H6; 5-O-Me
C8a	162.1 b		H1''
C4'	162.00		H3',5'
C7	161.19		H6; H1''
C2(b)	144.15	X	H2',6'; H α
C2',6'	131.36	X	H2',6' ; H3',5'
C1'	128.31		H3',5'
C3(a)	125.38	X	H β ;
C3',5'	116.93	X	H3',5' ;H2',6'
C2''	116.9 q	X	
C1''	107.02		H6
C8	103.95		H1''; H6; H2''
C6	93.04	X	5-O-Me
C3''	79.17		H1'';H2'';Me4'',5''
5-OMe	56.55	X	?d, J=49Hz?
C4'',5''	28.63	X	H1'';H2''

09b

13C	ppm	HMQC	HMBC
C4	194.4 b		H6
C5	163.07		5-O-Me
C4'	162.00		
C7	161.59		H6; H1''
C8a	161.31		H1''
C2(b)	143.73		
C2',6'	131.46		
C1'	128.41		
C3(a)	125.61		
C3',5'	116.10		
C8	103.60		H1''; H6; H2''
C6	92.79	X	
C3''	77.11		H1'';H2'';Me4'',5''
5-OMe	56.27	(x)	
C2''	33.10		H1'';Me4'',5''
C4'',5''	26.99	(x)	H2'', Me4'',5''
C1''	17.14		H2''

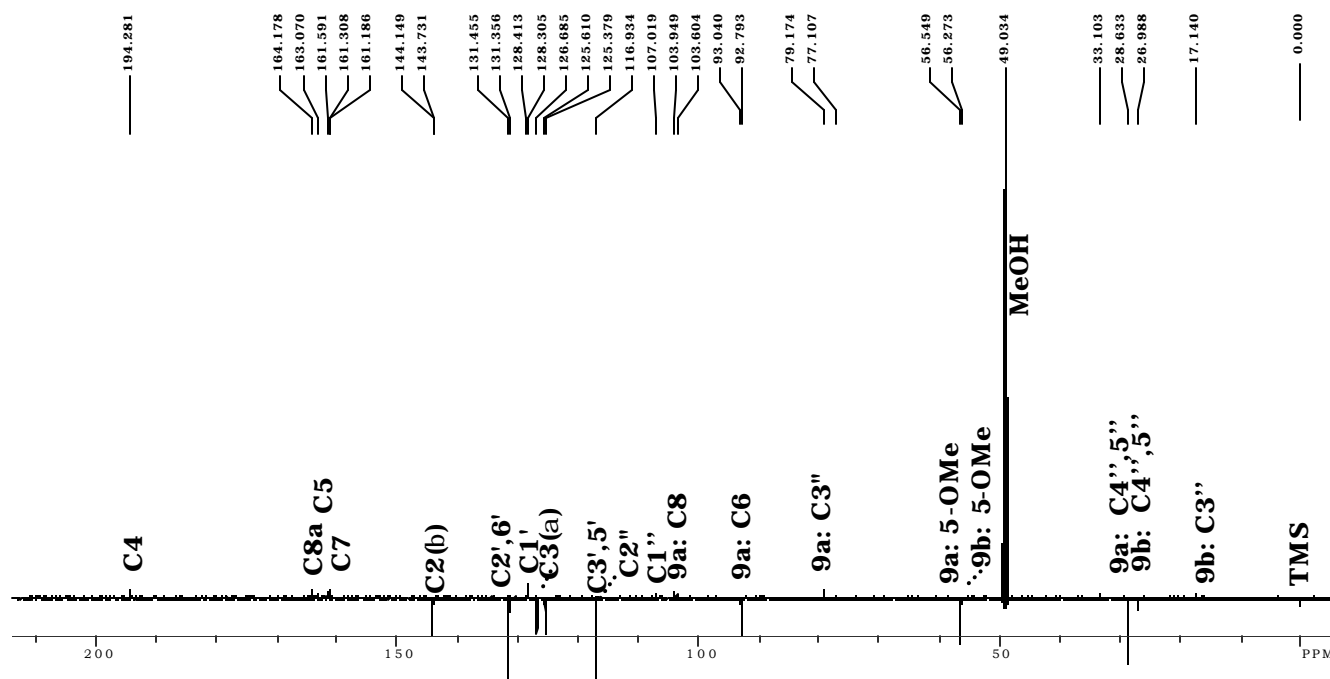
xanthohumol C (**9a**)-dihydroxanthohumol C (**9b**) (ca. 6:1)125 MHz APT spectrum in MeOH-d₄.

(9a) $C_{21}H_{20}O_5$

(9b) $C_{21}H_{22}O_5$

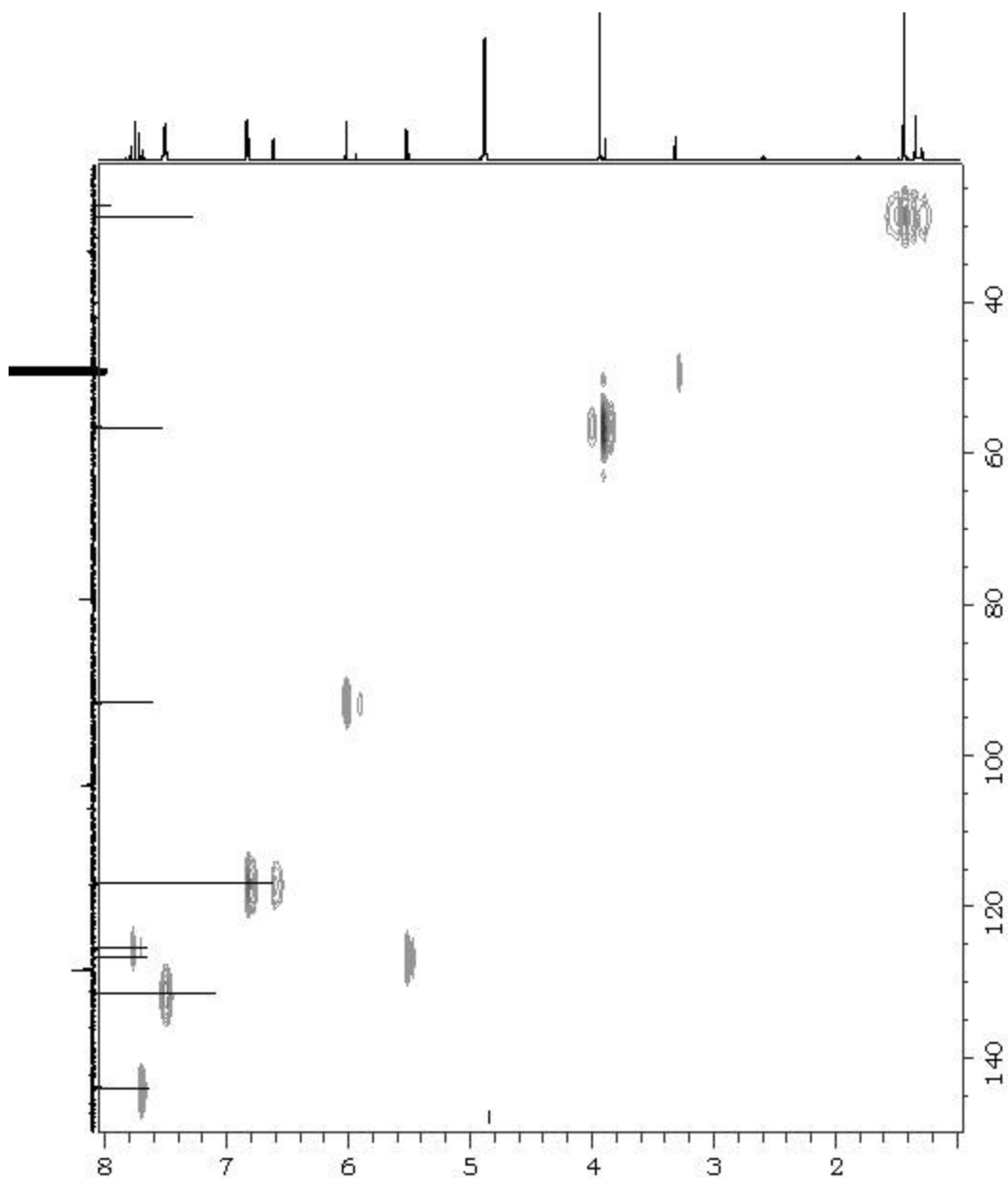

xanthohumol C (**9a**)-dihydroxanthohumol C (**9b**) (ca. 6:1) 500 MHz HMQC spectrum in $MeOH-d_4$.

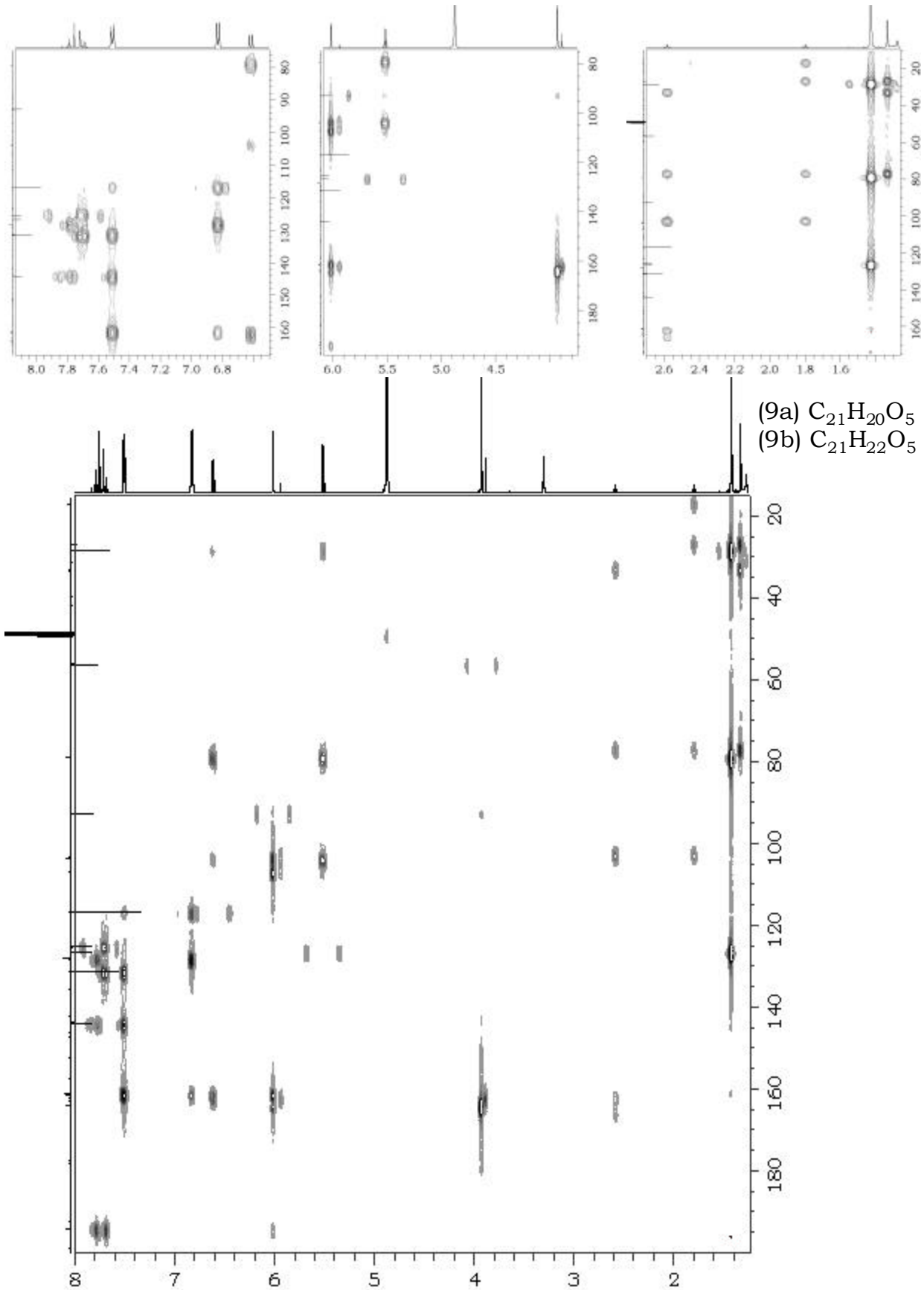

xanthohumol C (**9a**)-dihydroxanthohumol C (**9b**) (ca. 6:1) 500 MHz HMBC spectrum in MeOH- d_4 (below) and enlargements of key regions (above)

1H	ppm	mult (J)	integ
H3(a)	7.94	dt (15.5, 0.1, 0.1)	1H
H2(b)	7.63	dt (15.5, 0.5, 0.4)	1H
H2',6'	7.50	dddd (8.5, 2.3, 0.5, 0.4, 0.1)	2H
H3',5'	6.83	dddd (8.5, 2.3, 0.4, 0.4, 0.1)	2H
H6	5.93	s	1H
H2''	3.79	dd (6.8, 5.5)	1H
H1''a	2.85	dd (16.9, 5.5)	1H
H1''b	2.51	dd (16.9, 6.9)	1H
Me-5''	1.45	s	3H
Me-4''	1.39	s	3H

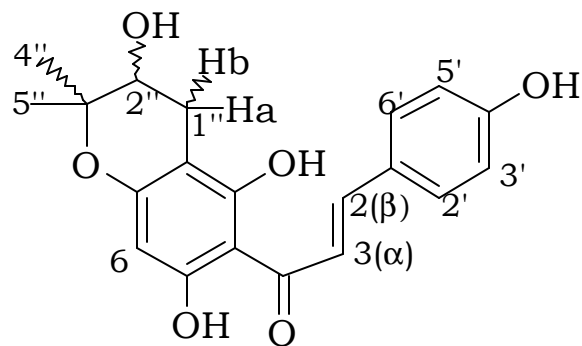

(11) “desmethylxanthohumol B”
 $C_{20}H_{20}O_6$ MW = 356.14

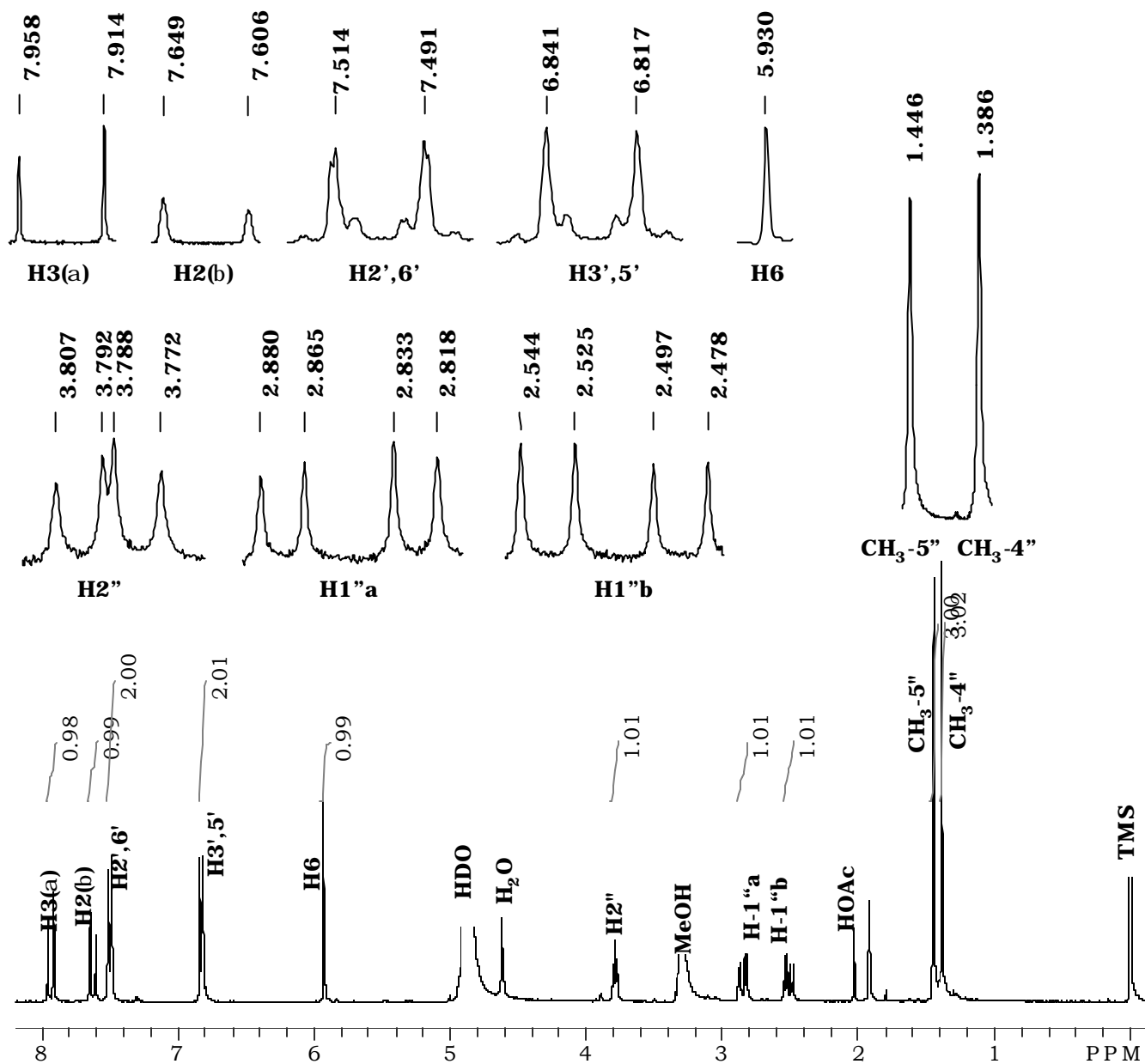

(11) DMX-B $C_{20}H_{20}O_6$
MW = 356.14

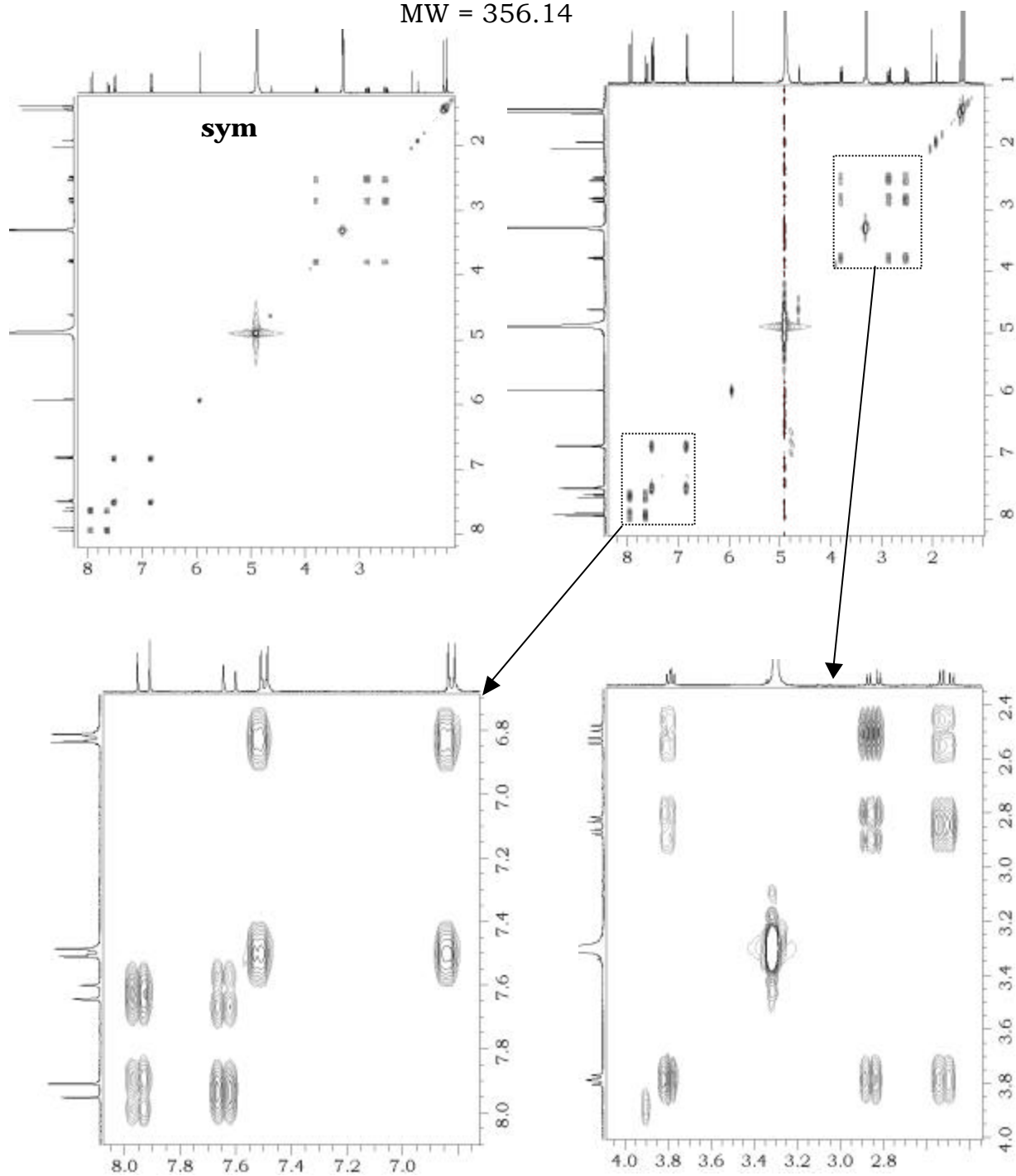

DMX-B (**11**) symmetrized (above left) and unsymmetrized (above right) 360 MHz COSY spectrum in $MeOH-d_4$; Enlargments of the indicated regions of the unsymmetrized are shown below.

(11) DMX-B C₂₀H₂₀O₆
MW = 356.14

¹³ C	ppm	HMQC	HMBC
C2(b)	142.964	X	H2',6'
C3(a)	126.121	X	
C4	194.20		H α , H β
C4a	106.2 b		H6
C5	166.696		(H6)
C6	96.192	X	
C7	164.288		(H6)
C8	100.874		H1''b; H6
C8a	157.166		
C1'	128.521		H3',5'; H α
C2',6'	131.179	X	H2',6'; H β
C3',5'	116.921	X	H3',5'
C4'	161.11		H2',6'; H3',5'
C1''	26.822	X	
C2''	69.495	X	H1''b; Me4'',5'';
C3''	79.652		Me4'',5'';
C4''	21.528	X	Me-5''
C5''	25.936	X	Me-4''
MeOH	49.03	X	
TMS	0.00		

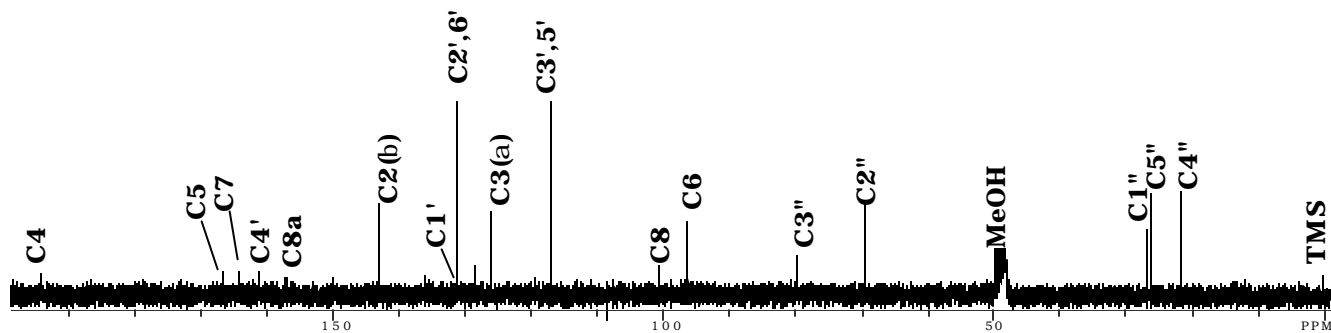
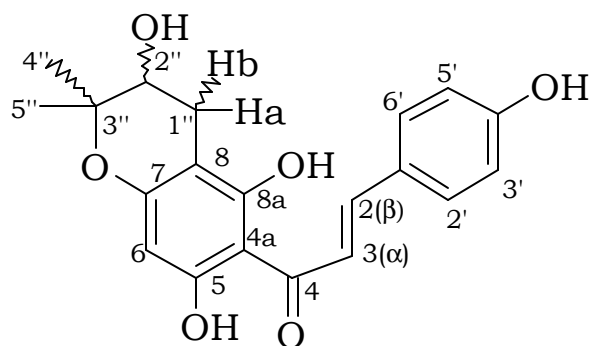

DMX-B (**11**) 90 MHz ¹³C spectrum in MeOH-d₄.

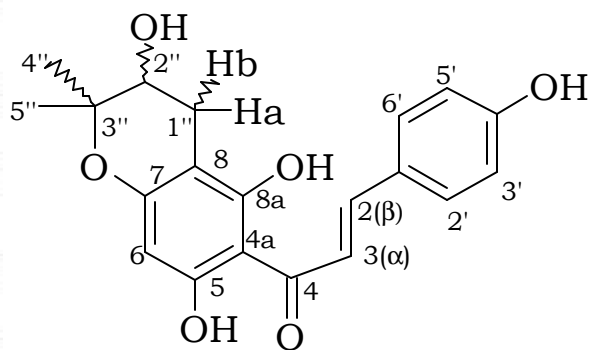
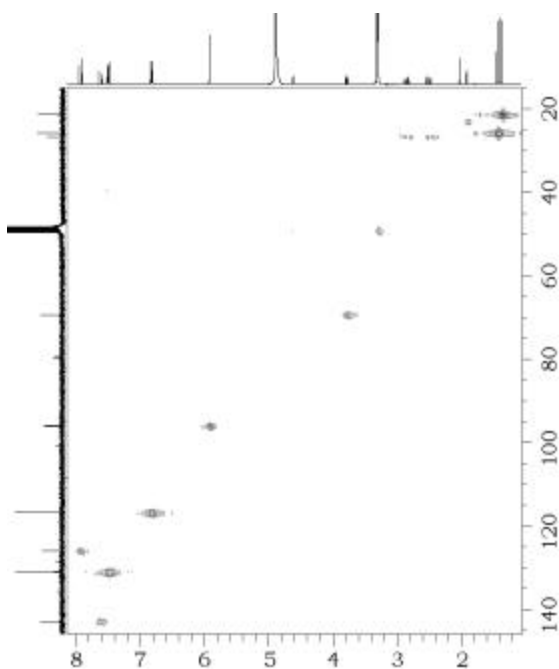

(11) DMX-B $C_{20}H_{20}O_6$
MW = 356.14

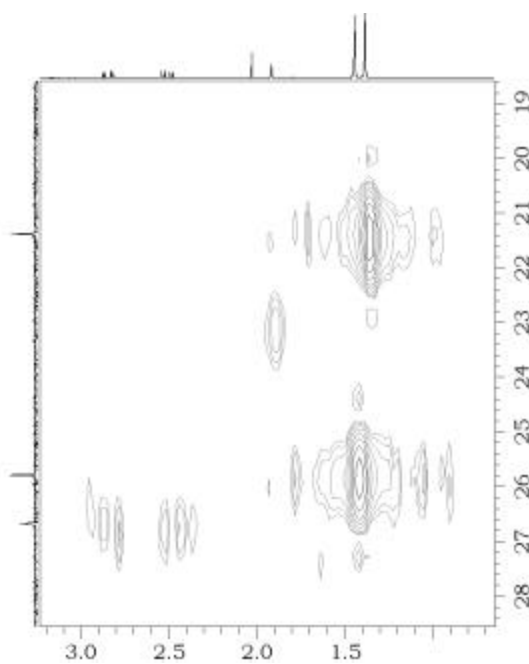
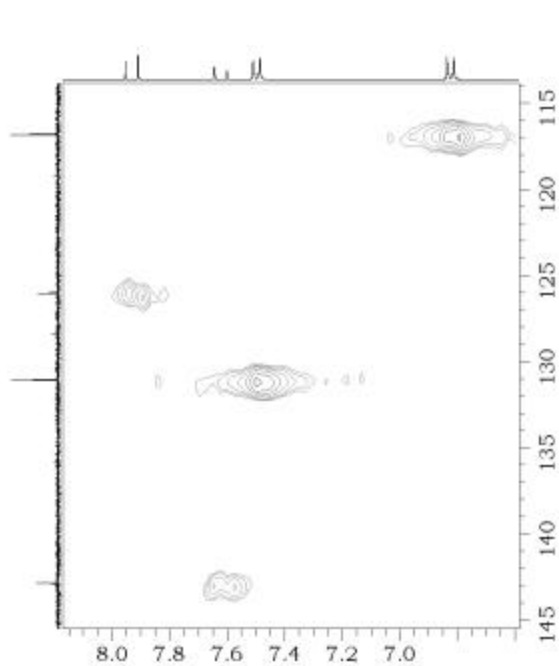

DMX-B (**11**) 360 MHz 1H NMR spectrum in $MeOH-d_4$; Enlargements of selected regions are shown above.

(11) DMX-B $C_{20}H_{20}O_6$
MW = 356.14

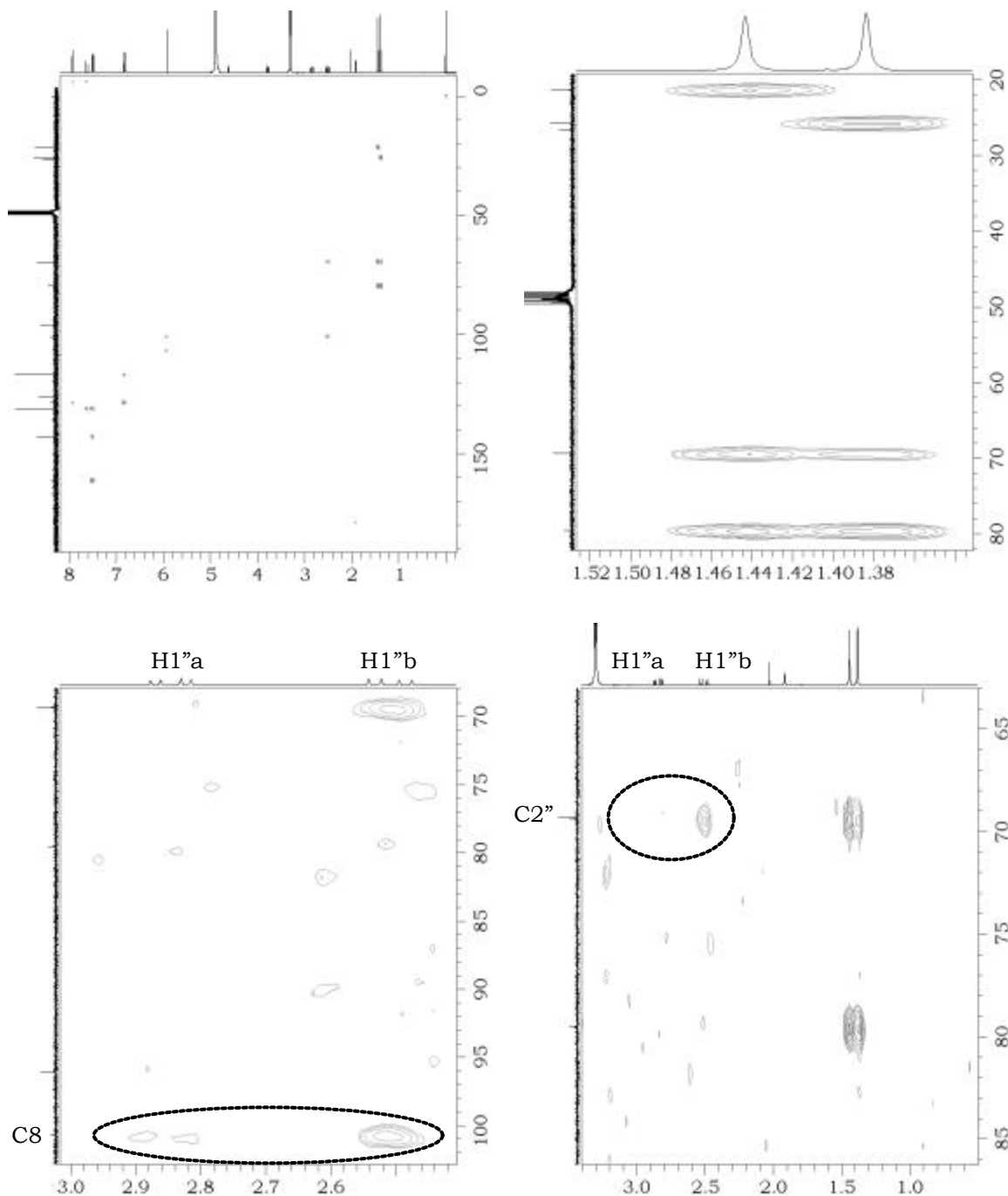

DMX-B (**11**) 360 MHz HMBC spectrum in MeOH- d_4 ; Enlargements of selected regions are shown above. Note that the peaks correlating to $2J$ coupling with C2'' and C8 are much more intense in each case with H1''b (eclipsing hydroxyl group) than with H1''a.

1H	ppm	mult (J)	integ
H3(a)	8.06	dt (15.5, 0.1, 0.1)	1H
H2(b)	7.73	dt (15.5, 0.5, 0.4)	1H
H2',6'	7.54	dddd (8.5, 2.3, 0.5, 0.4, 0.1)	2H
H3',5'	6.81	dddd (8.5, 2.3, 0.4, 0.4, 0.1)	2H
H6	5.83	s	1H
H2''	4.83	dd (9.6, 8.7)	1H
H1''a	3.04	dd (16.0, 8.7)	1H
H1''b	3.03	dd (16.0, 9.6)	1H
Me-4''	1.41	s	3H
Me-5''	1.30	s	3H

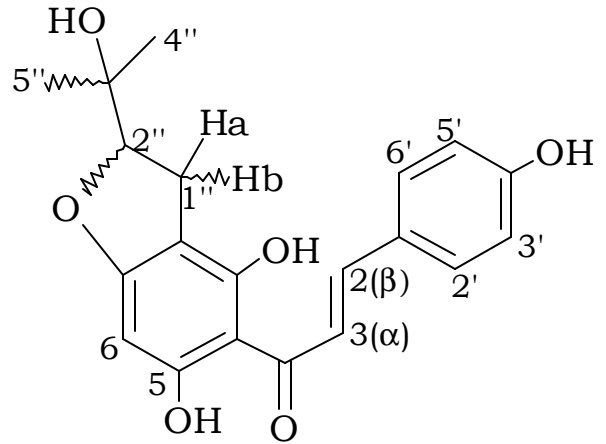
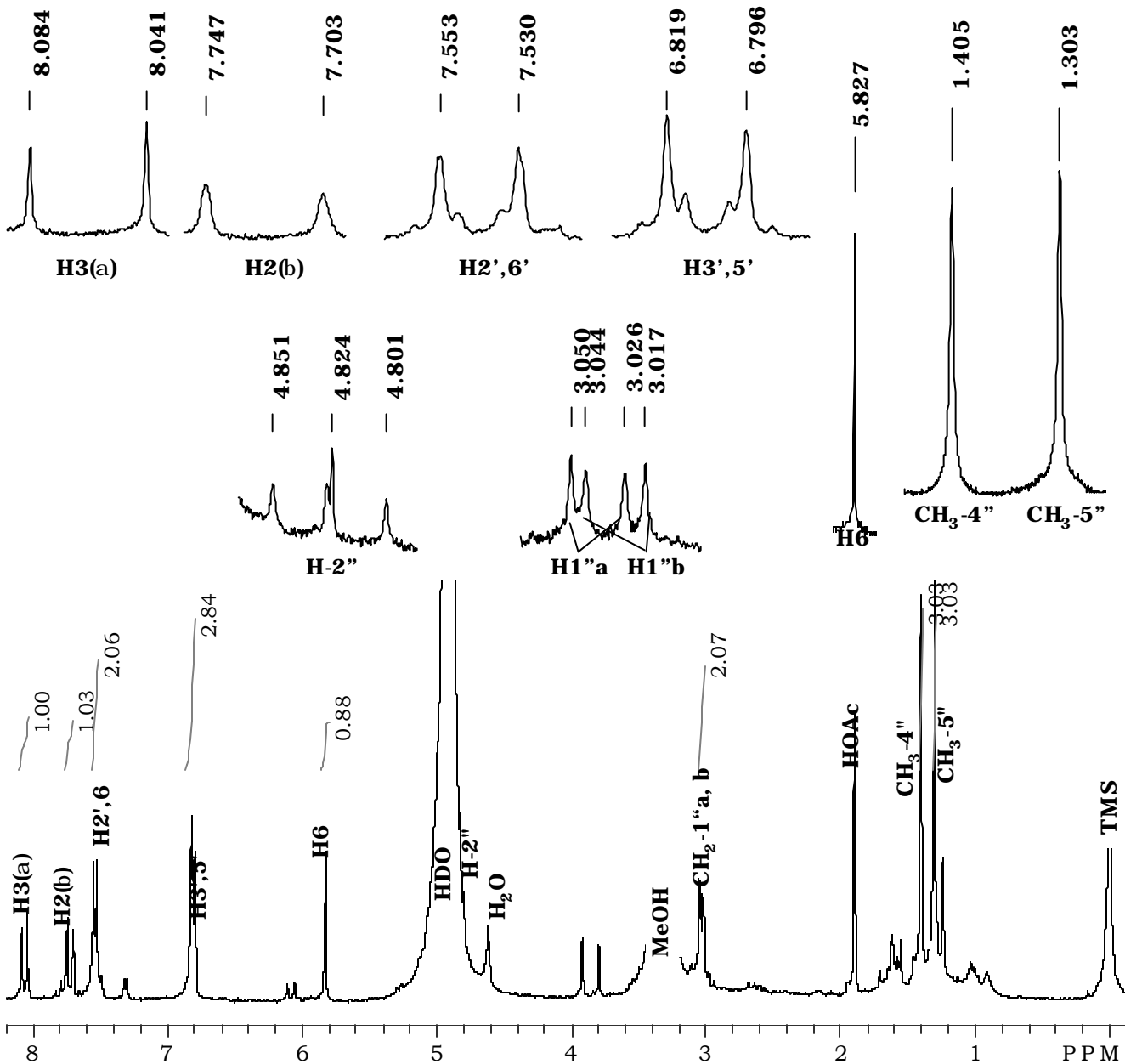
(12) DMX-J C₂₀H₂₀O₆desmethylxanthohumol J (12) 360 MHz ¹H NMR spectrum taken in MeOH-*d*₄

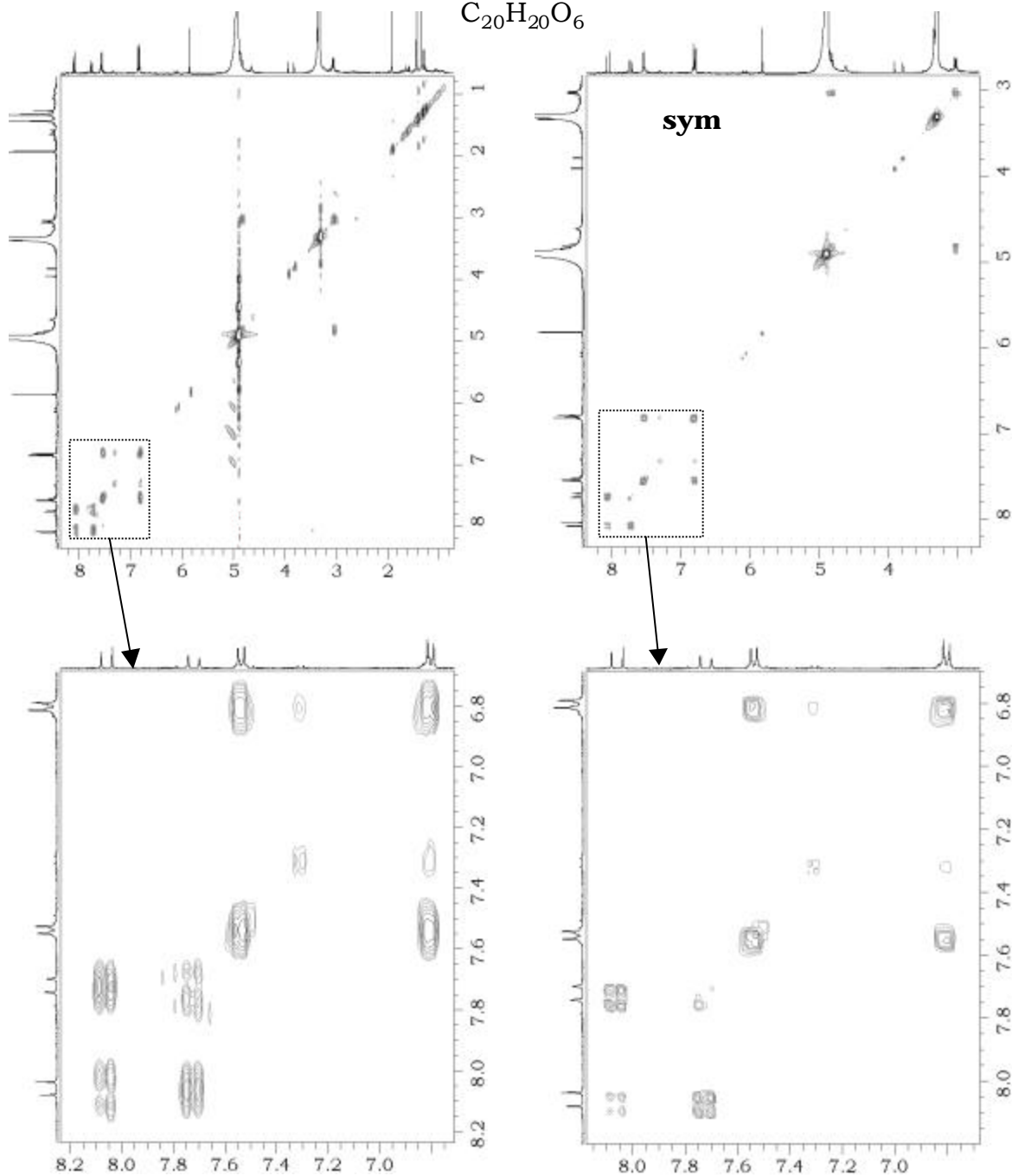
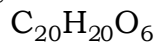
desmethylxanthohumol J (**12**)

desmethylxanthohumol J (**12**) 360 MHz COSY spectrum in MeOH- d_4 with enlargement of B-ring spin system. Due to excessive noise, symmetrized spectra are shown on the right.

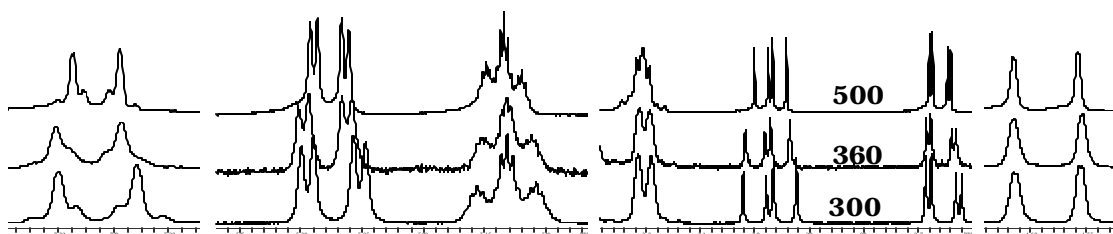

Comparison of ¹H NMR spectra for isoxanthohumol **17** taken on 500, 360, and 300 MHz instruments. Optimization of tuning and shimming parameters has a much more profound effect on spectral quality than does spectrometer frequency.

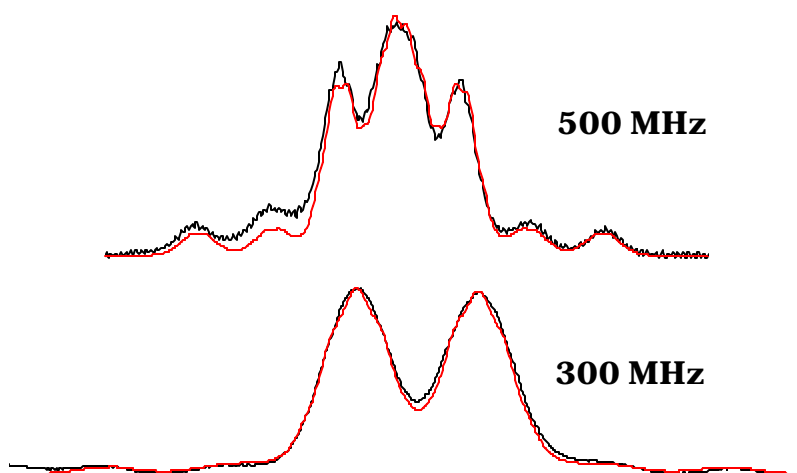

Enlargement of simulated (red) and experimental (black) spectra of isoxanthohumol **17** H1'' methylene peak at 500 MHz (above) and 300 MHz (below). In the present work, the H1'' methylene signals of prenyl units at the 8-position on a flavanone nucleus were the only observed peaks where spectrometer frequency showed a profound effect on the peak shape. Note that the only parameter difference among the simulated spectra shown above is the spectrometer frequency. Chemical shifts (relative to TMS) of spectra collected at different times and on different instruments were within 0.01 ppm in every case.

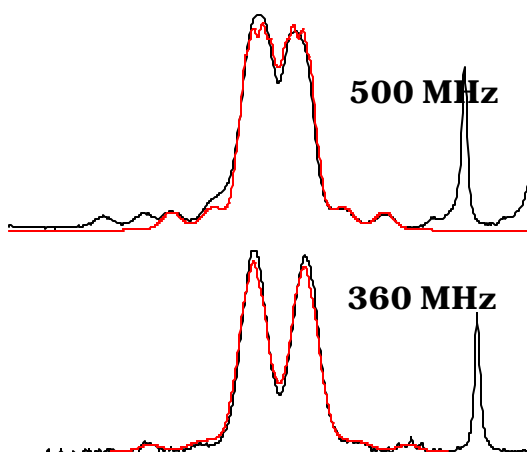

Comparison of experimental and simulated H1'' peaks of 8-prenylnaringenin **15** at 500 MHz (above) and 360 MHz (below). Essentially the same effect of spectrometer frequency is seen in the 5-O-Me derivative isoxanthohumol **17** (above).

F1-2 (see Chromatography page 2)
CCC (100.8 mg) HEMW = 6/4/6/4

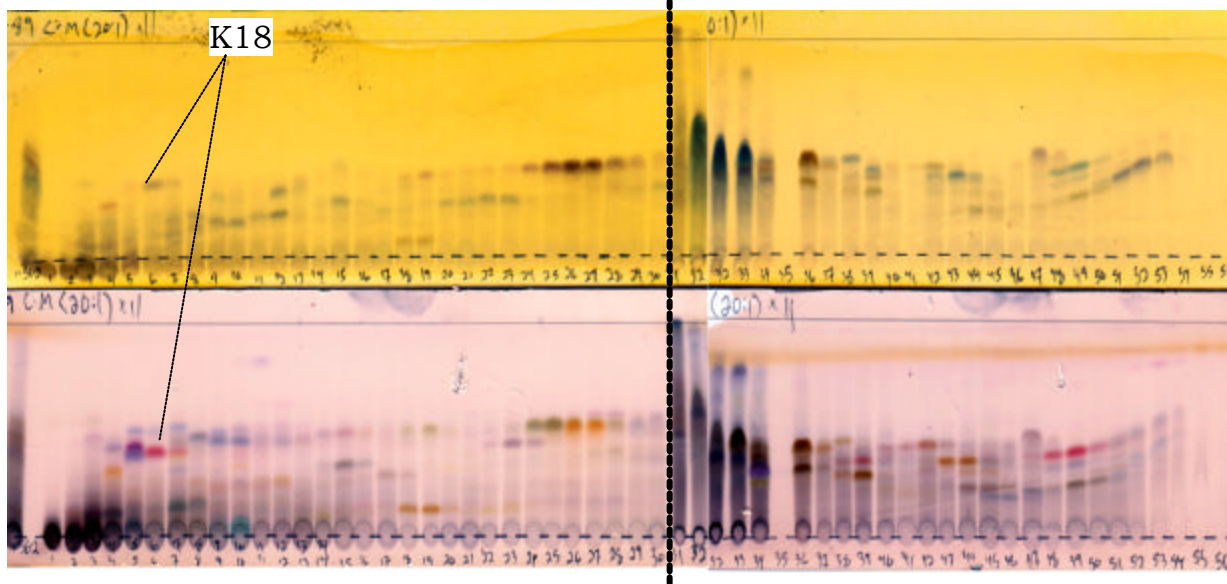
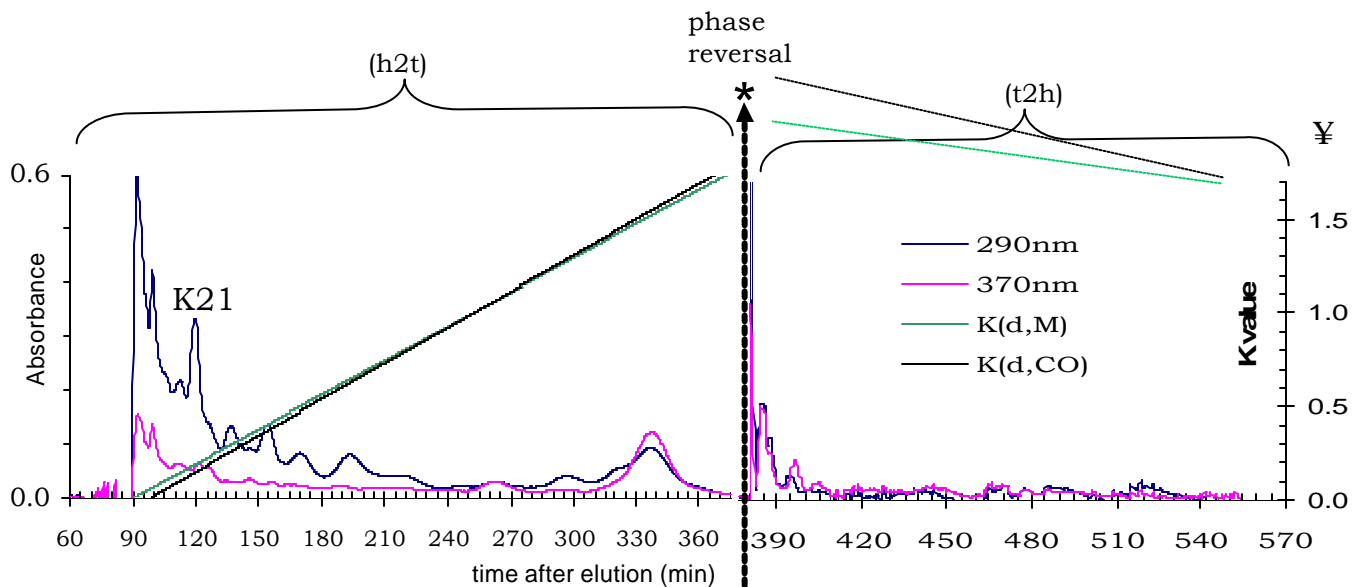

Above: CHCl_3 -MeOH (95:5); plate run 2X; detection with FeCl_3 (3% EtOH).

Below: as above; detection with anisaldehyde- H_2SO_4 -HOAc (1:1:48)/ Δ .

Example of phase reversal in countercurrent chromatography. As indicated by the asterisk(*), after ca. 6 hr of operating in descending mode (reverse phase; head-to-tail), the apparatus was switched to ascending mode (normal phase; tail-to-head). The entire range of partition coefficients was chromatographed in 1 day, from 0 to ca. 1.7 and then, after phase reversal, from ∞ back down to 1.7. All things considered, the method used above is preferred for chromatographing “unprimed” extracts or fractions. Suggestion: for routine operation, reverse elution precisely when $t_r = t_1$.

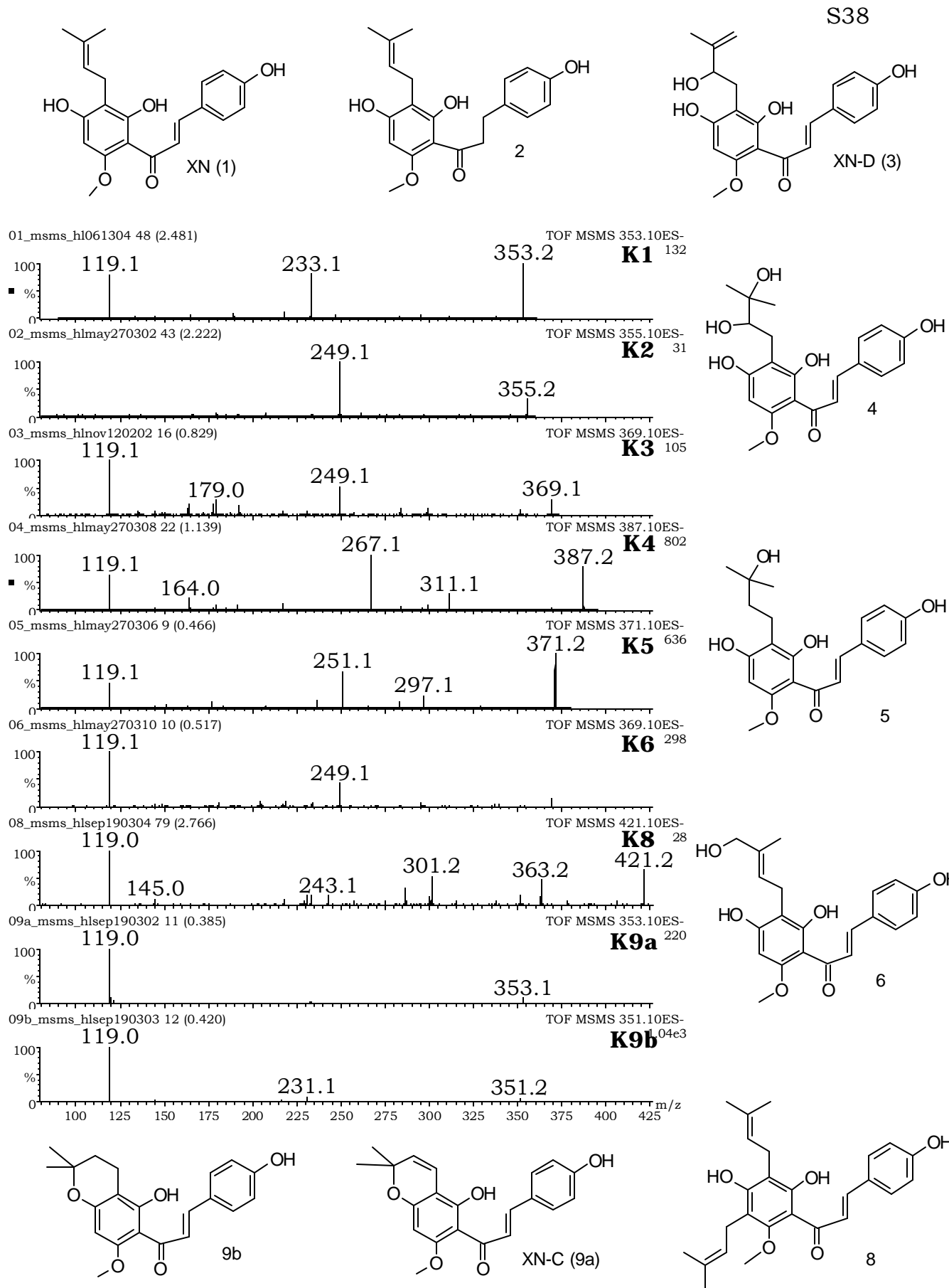

Negative ion ESI fragmentation spectra for compounds 1-9b.

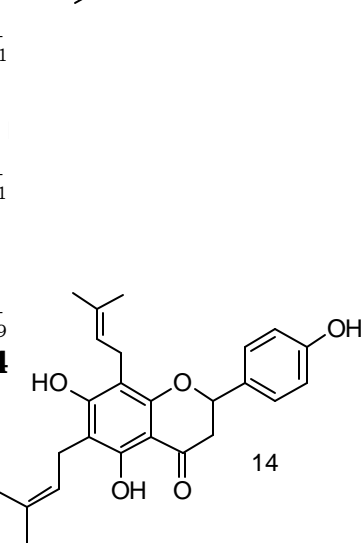
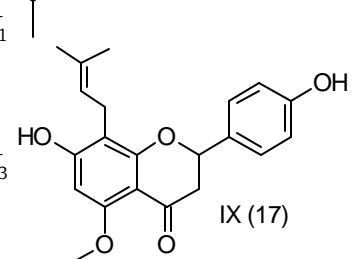
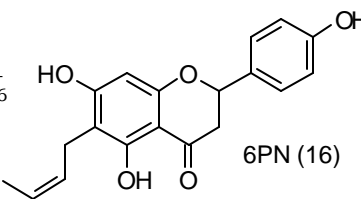
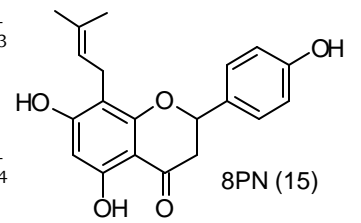
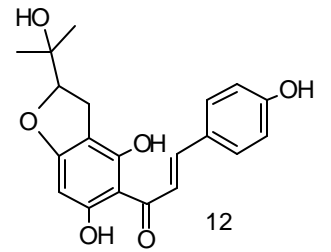
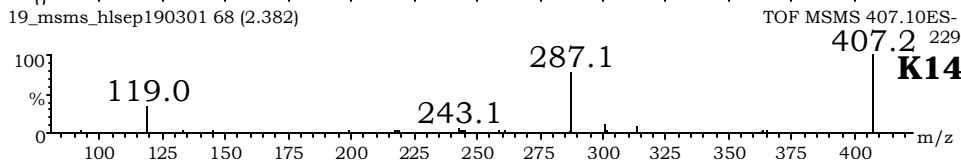
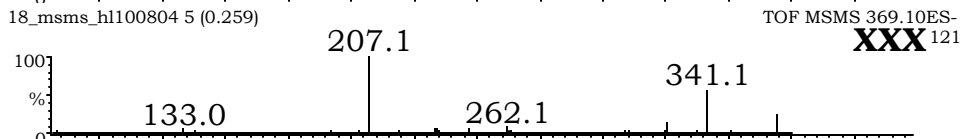
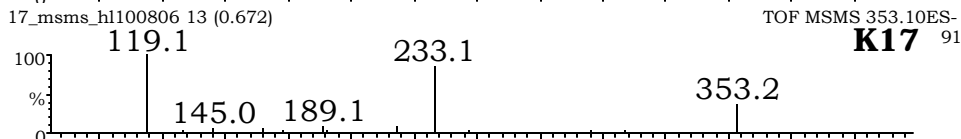
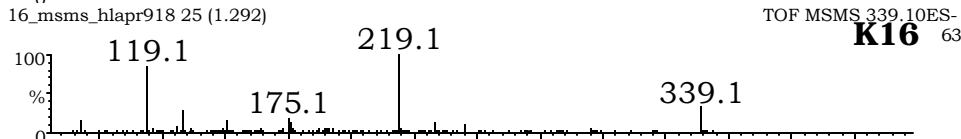
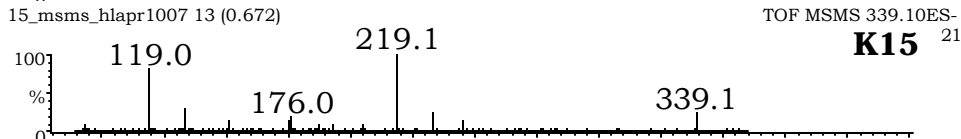
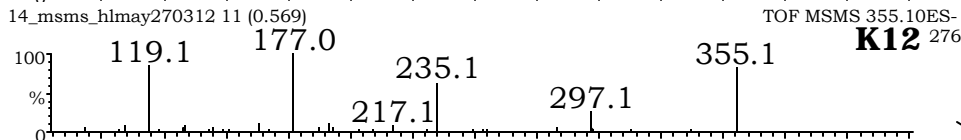
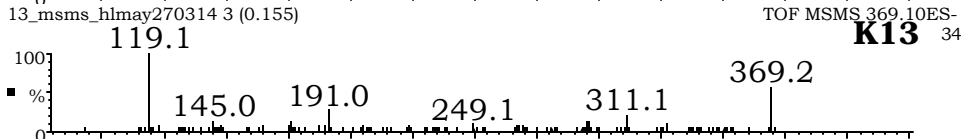
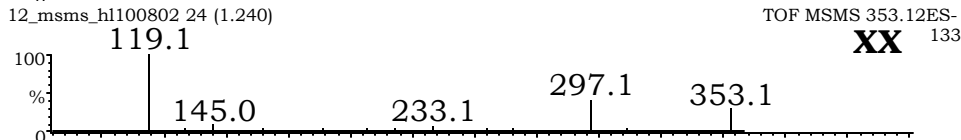
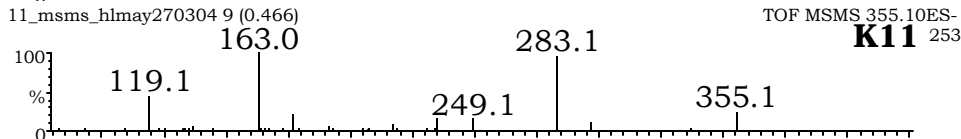
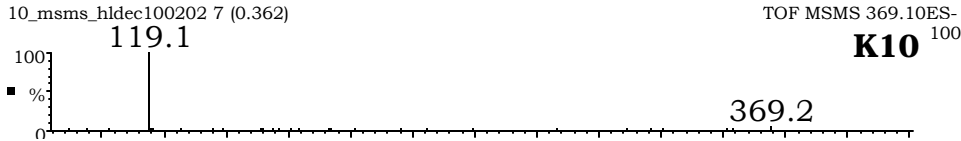
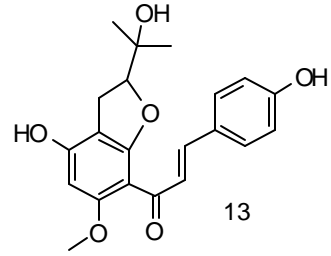
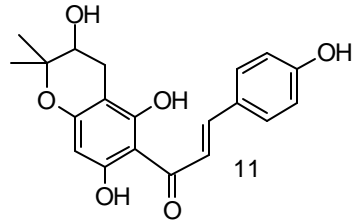
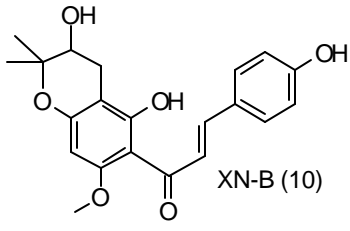

Negative ion ESI-MS² spectra for compounds 10-19.

1H	ppm	mult (J)	integ
H3(a)	7.79	dt (15.5, 0.1, 0.1)	1H
H2(b)	7.67	dt (15.5, 0.6, 0.4)	1H
H2',6'	7.49	dddd (8.5, 2.3, 0.6, 0.4 0.1)	2H
H3',5'	6.82	dddd (8.5, 2.3, 0.4, 0.4, 0.1)	2H
H6	6.02	s	1H
H2''	5.20	ddq (7.2, 7.2, 1.5, 1.2)	1H
5-OMe	3.90	s	3H
CH2-1''	3.23	ddq* (appear as br-d w/ J 7.2)	2H
Me-4''	1.76	dddq (1.5, 0.4, 0.4, 0.3)	3H
Me-5''	1.65	dddq (1.3, 1.3, 1.2, 0.3)	3H

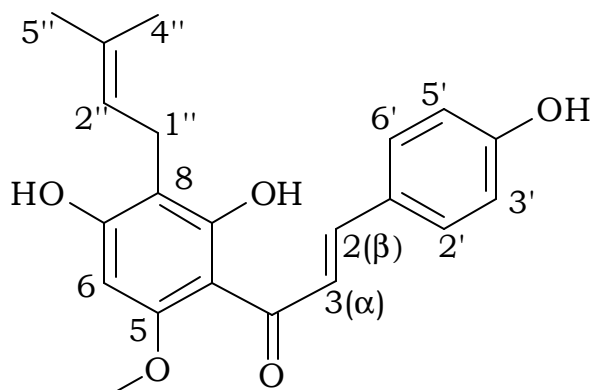

(1) Xanthohumol
 $C_{21}H_{22}O_5$ MW = 354.139

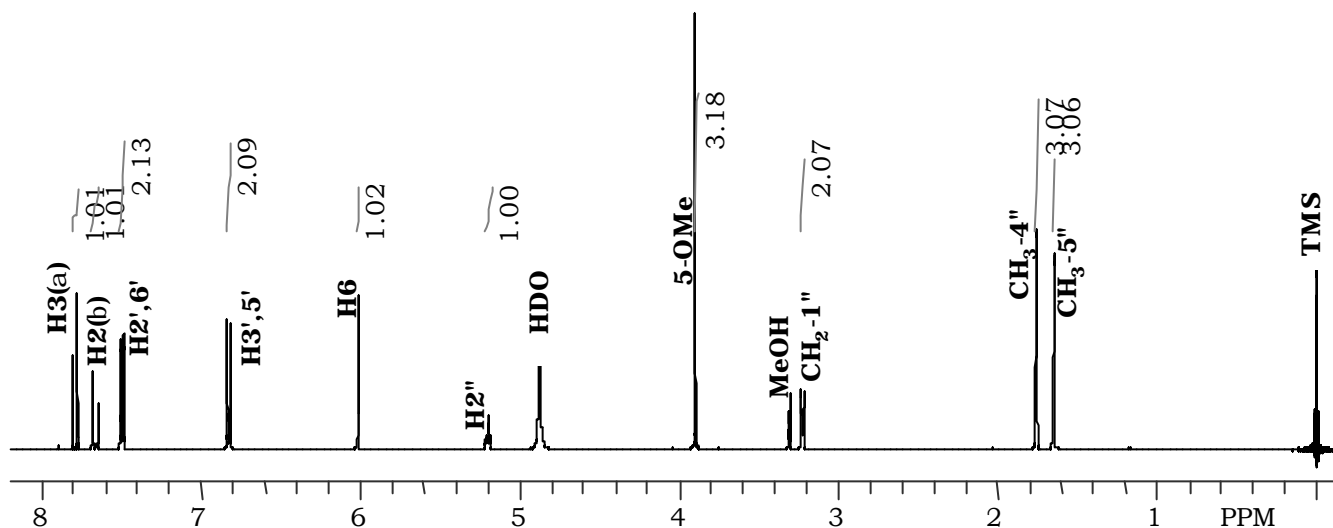
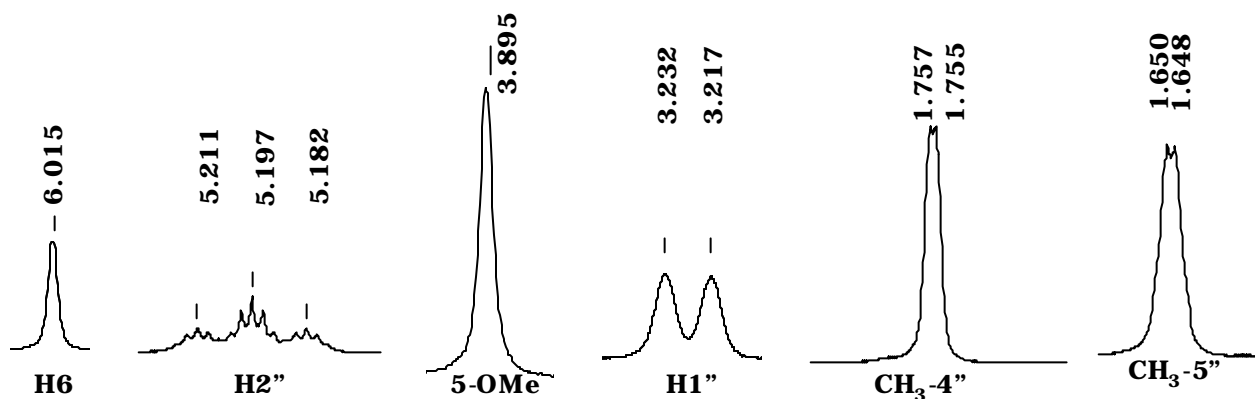
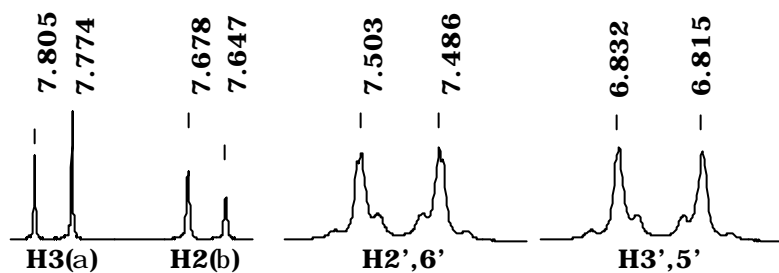

xanthohumol (**1**) 500 MHz 1H NMR spectrum taken in $MeOH-d_4$

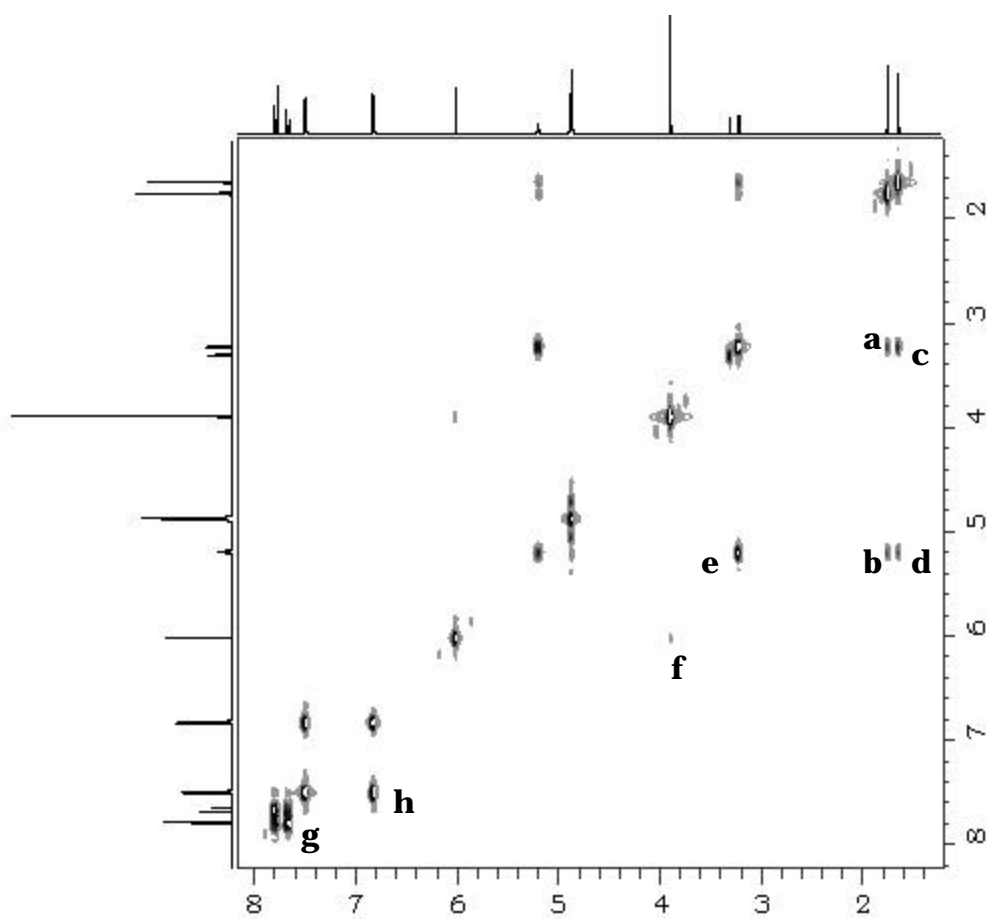
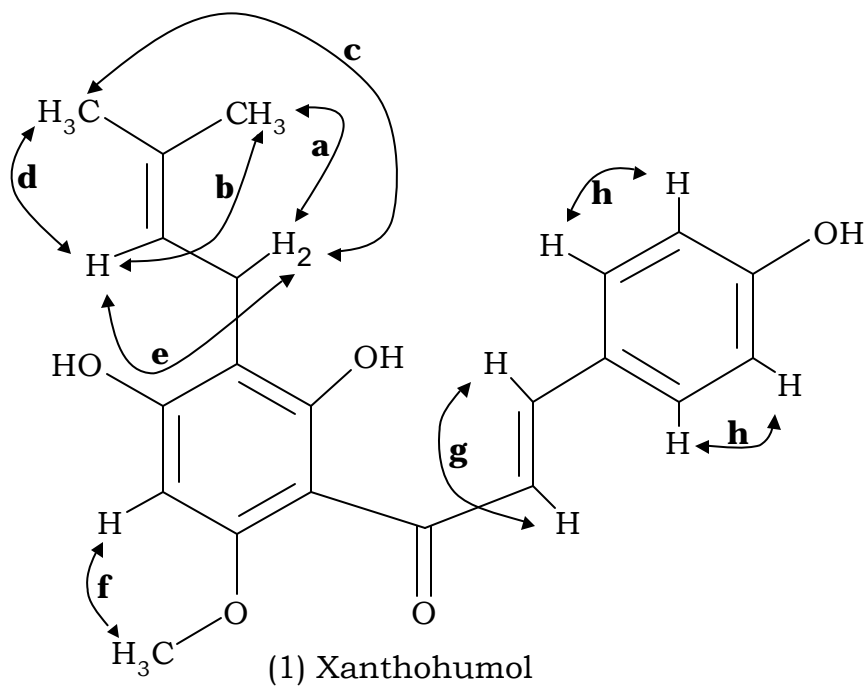

500 MHz COSY spectrum of xanthohumol **1** in MeOH-*d*₄

¹³ C	ppm	HMQC	HMBC
C4	194.1		H3(α);H2(β)
C8a	166.2		H1''
C7	163.7		H6,H1''
C5	162.4		5-OMe; H6
C4'	161.1		H3',5'; 2',6'
C2(b)	143.3	x	H3(α);H2',6'
C3''	131.4		H4'',5''
C2',6'	131.3	x	H2(β); H2',6'
C1'	128.5		H3(α),H3',5'
C3(a)	125.9	x	H2(β)
C2''	124.3	x	H1''; Me-4'',5''
C3',5'	116.9	x	H2',6'; H3',5'
C8	109.4		H6,H1''
C4a	106.5		H6
C6	91.6	x	
5-OMe	56.2	x	
MeOH	49.0		
C4''	26.0	x	CH3-5''
C1''	22.3	x	
C5''	17.9	x	CH3-4''
TMS	0.0		

125 MHz ¹³C NMR spectrum taken in MeOD-d₃.

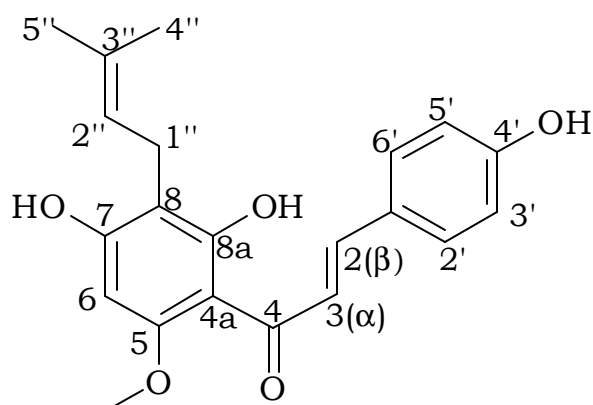
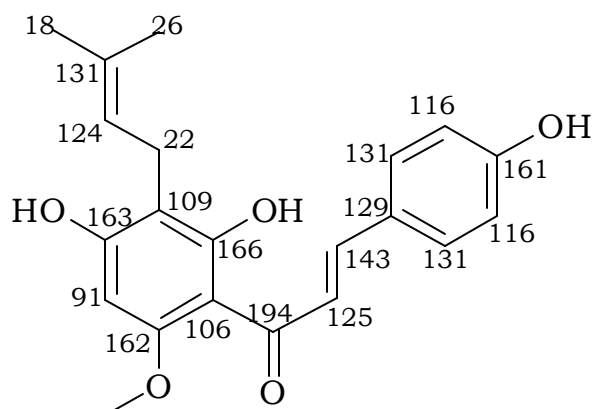

(1) Xanthohumol

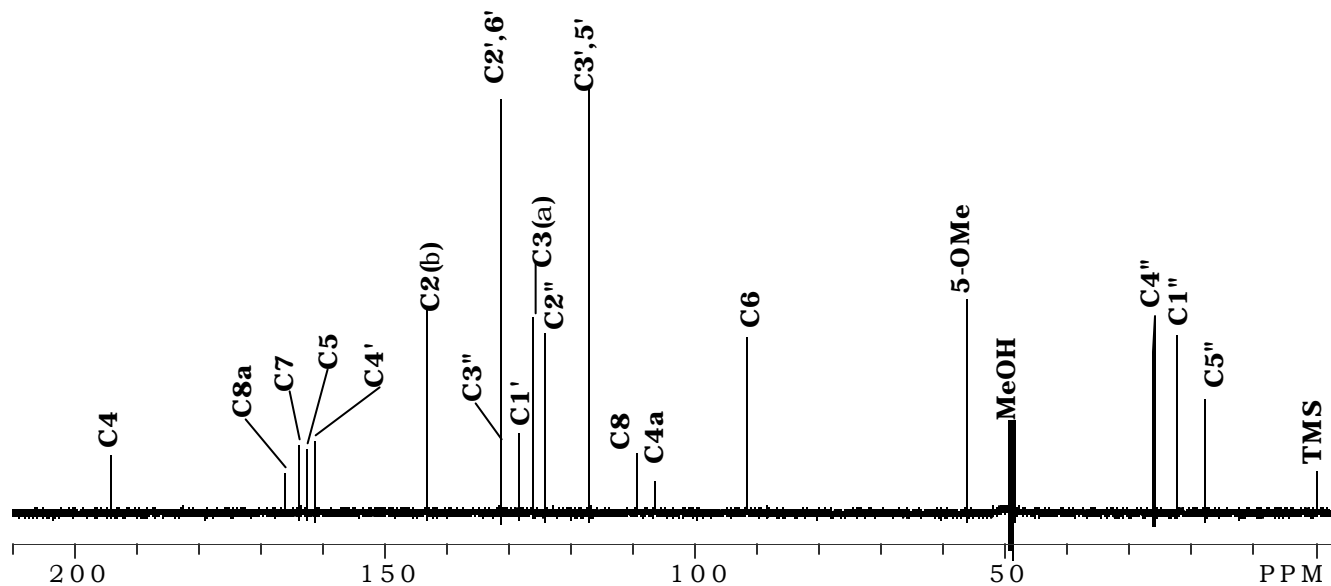

500 MHz ¹³C spectrum of xanthohumol **1** in MeOH-d₄

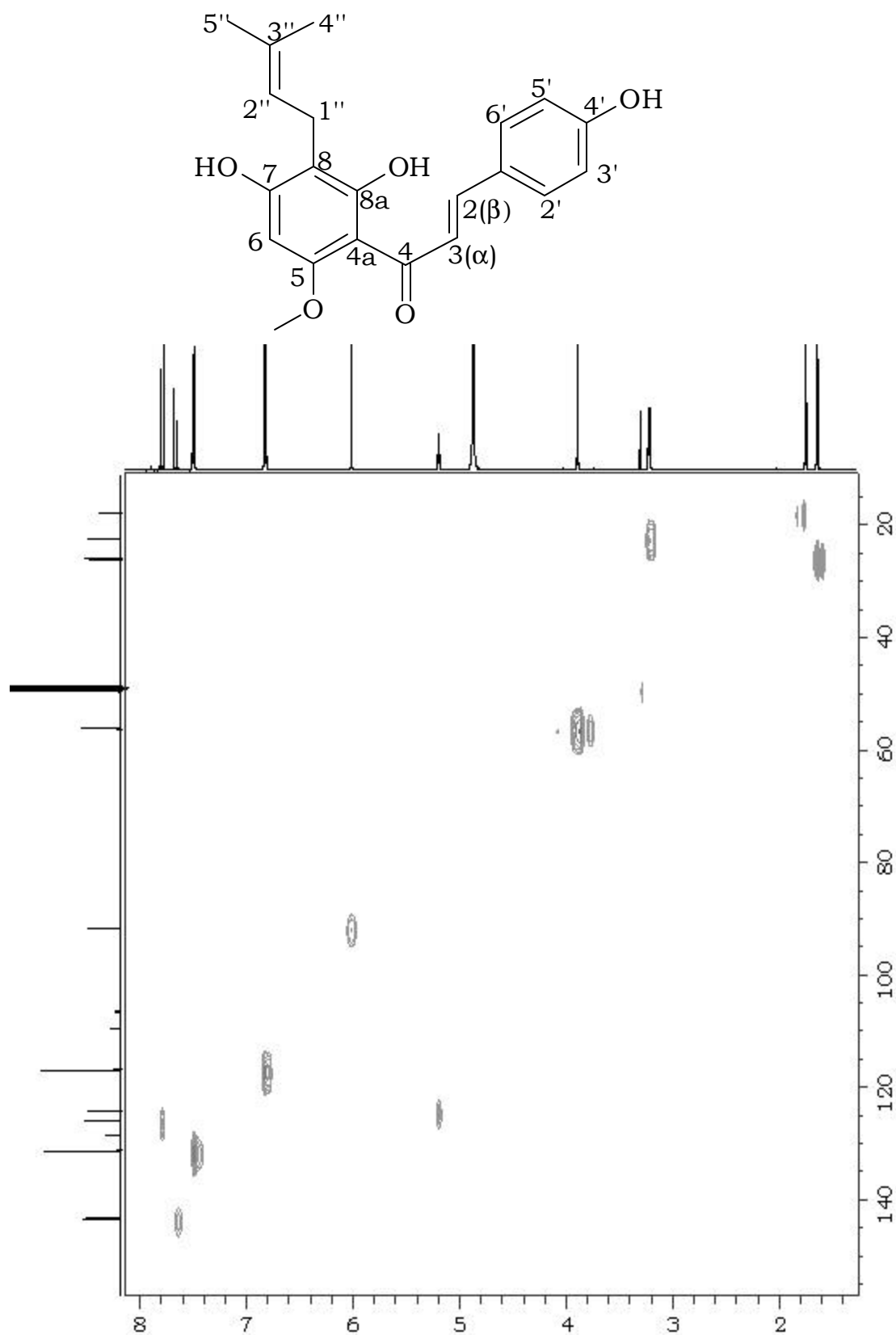
500 MHz HMQC spectrum of xanthohumol (**1**) taken in MeOH-*d*₄

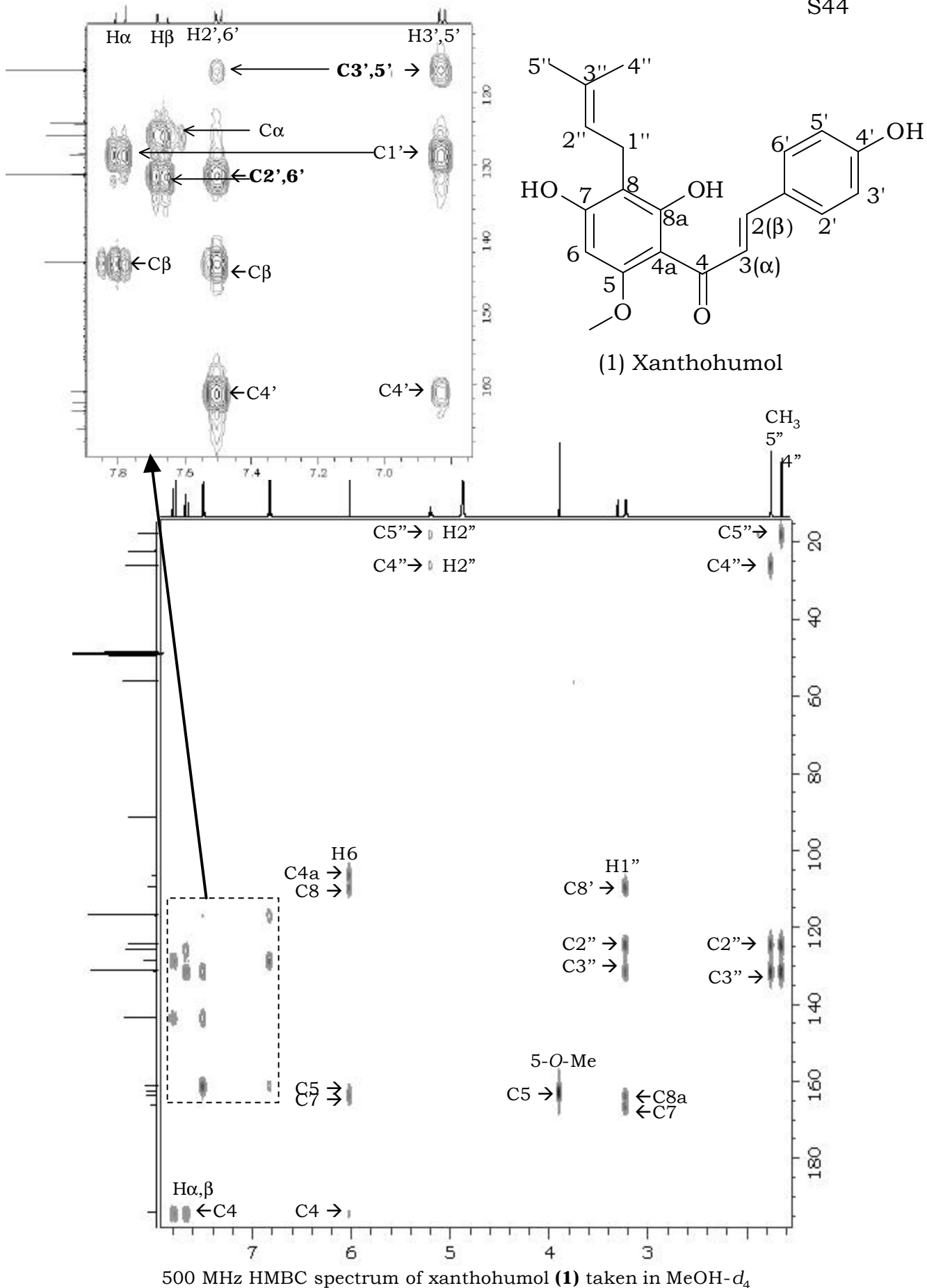

	ppm	mult (J)	integ
H2',6'	7.03	ddtd (8.5, 2.3, 0.5, 0.4)	2H
H3',5'	6.69	ddtd (8.5, 2.3, 0.5, 0.4)	2H
H6	5.98	s	1H
H2''	5.17	ddqq (7.2, 7.2, 1.5, 1.2)	1H
5-OMe	3.82	s	3H
CH2-1''	3.20	ddqq* (overlaps w/ H3)	2H
CH2-3(a)	3.19	ddd (13.8, 8.0, 8.0)	2H
CH2-2(b)	2.83	dddtt (13.8, 8.0, 9.0, 0.5)	2H
Me-4''	1.74	dddq (1.5, 0.4, 0.4, 0.3)	3H
Me-5''	1.64	dddq (1.3, 1.3, 1.2, 0.3)	3H

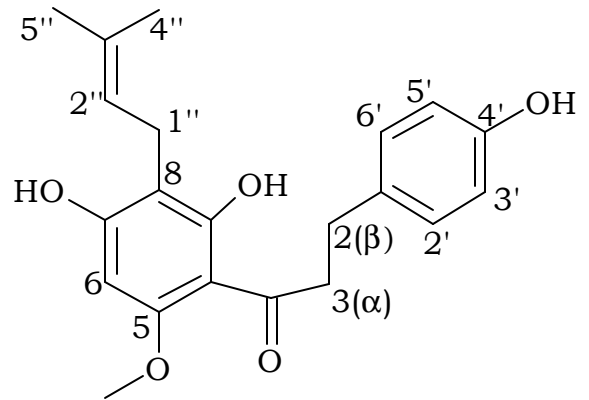

(2) dihydroxanthohumol

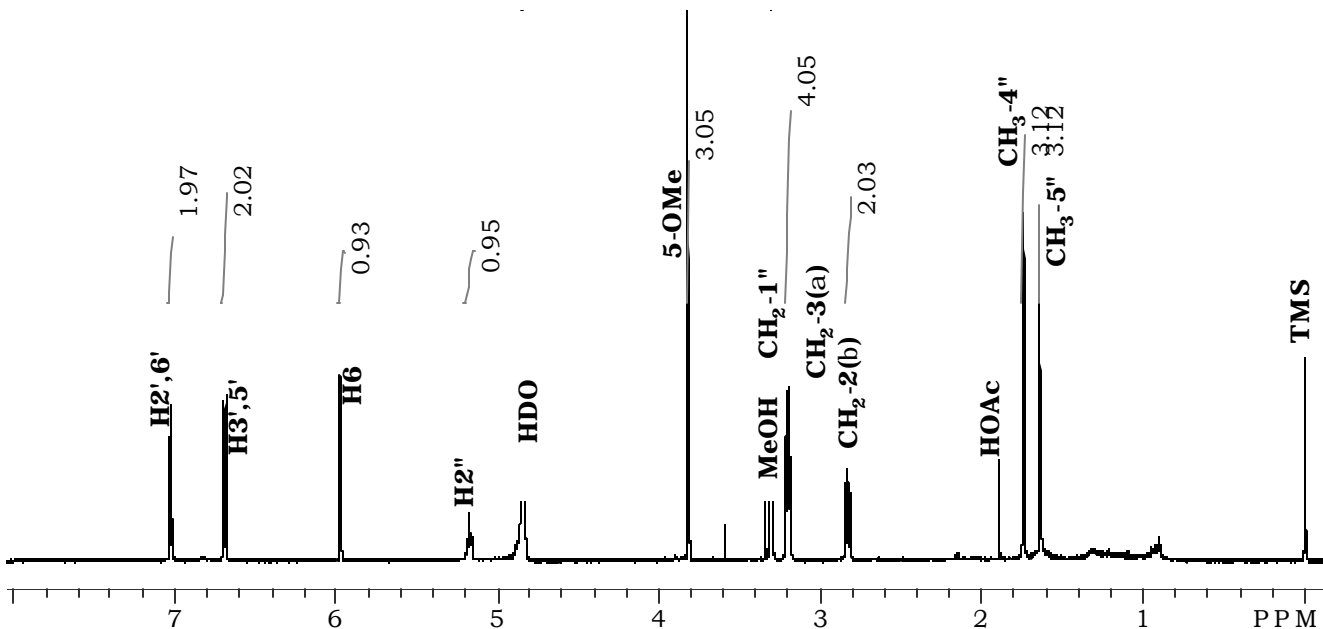
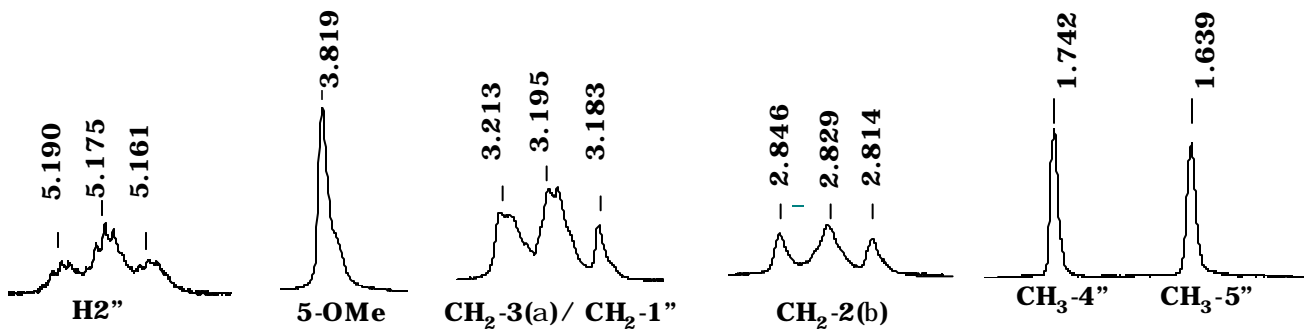
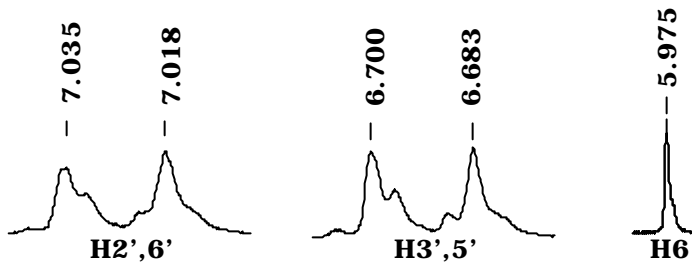
C₂₁H₂₄O₅ MW = 356.16 α,β -dihydroxanthohumol (**2**) 500 MHz ¹H NMR spectrum taken in MeOH-*d*₄

1H	ppm	mult (J)	integ
H3(a)	7.79	dt (15.5, 0.1, 0.1)	1H
H2(b)	7.68	dt (15.5, 0.5, 0.3)	1H
H2',6'	7.50	dddd (8.5, 2.3, 0.5, 0.4, 0.1)	2H
H3',5'	6.83	dddd (8.5, 2.3, 0.4, 0.3, 0.1)	2H
H6	6.03	s	1H
H4"a	4.79	ddq (2.1, 1.0, 0.8)	1H
H4"b	4.70	dqd (2.1, 1.5, 0.3)	1H
H2"	4.33	dddq (7.5, 5.5, 1.0, 0.4, 0.3)	1H
5-OMe	3.90	s	3H
H1"a	2.96	dd (13.6, 5.5)	1H
H1"b	2.78	dd (13.6, 7.5)	1H
Me-5"	1.80	ddd (1.5, 0.8, 0.3)	3H

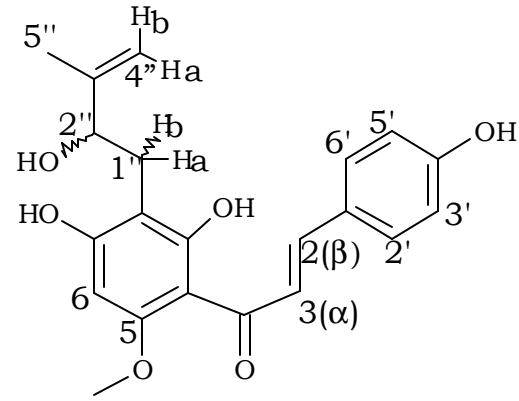

(3) Xanthohumol D

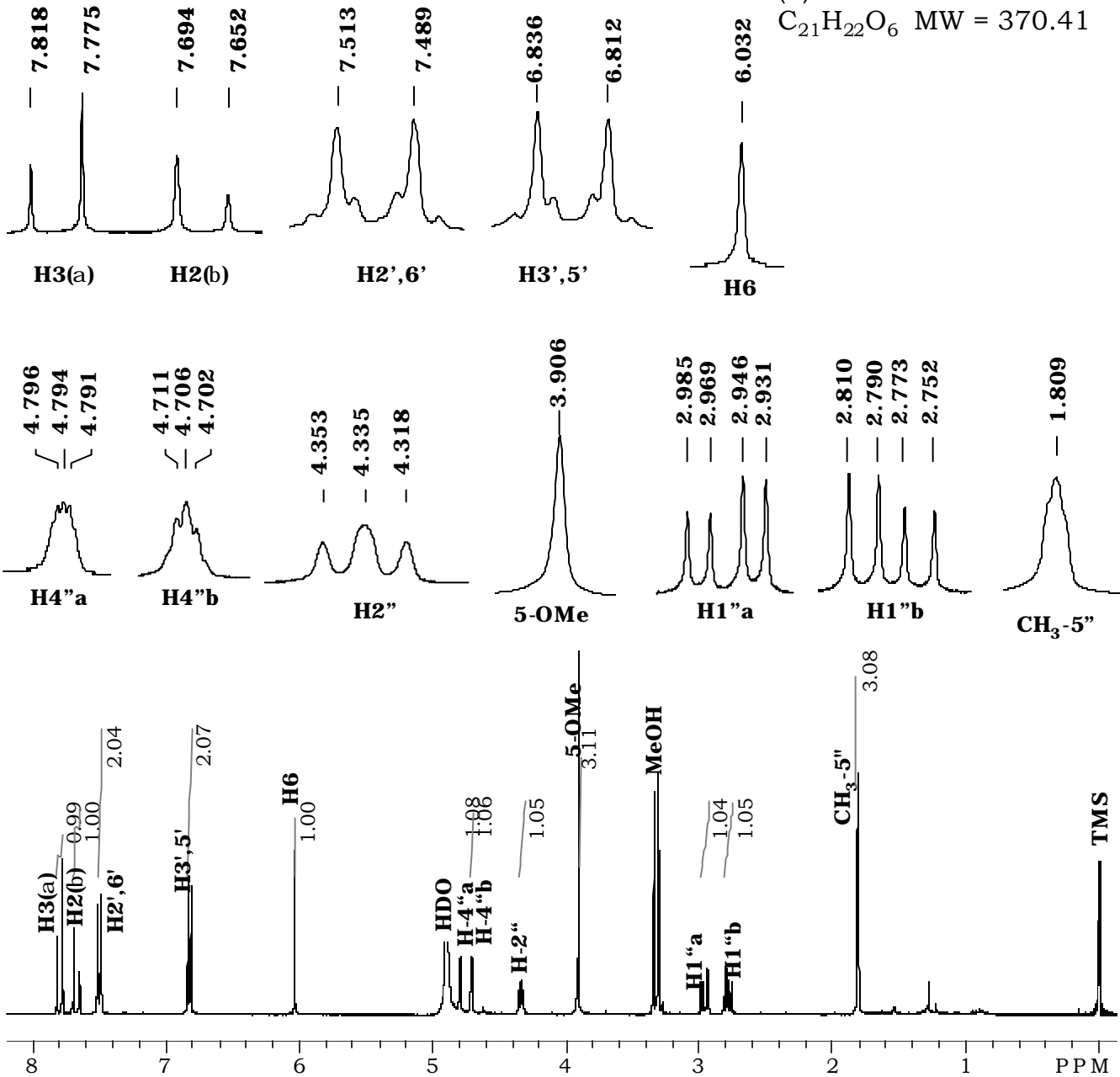
C₂₁H₂₂O₆ MW = 370.41xanthohumol D (3) 360 MHz ¹H NMR spectrum taken in MeOH-d₄

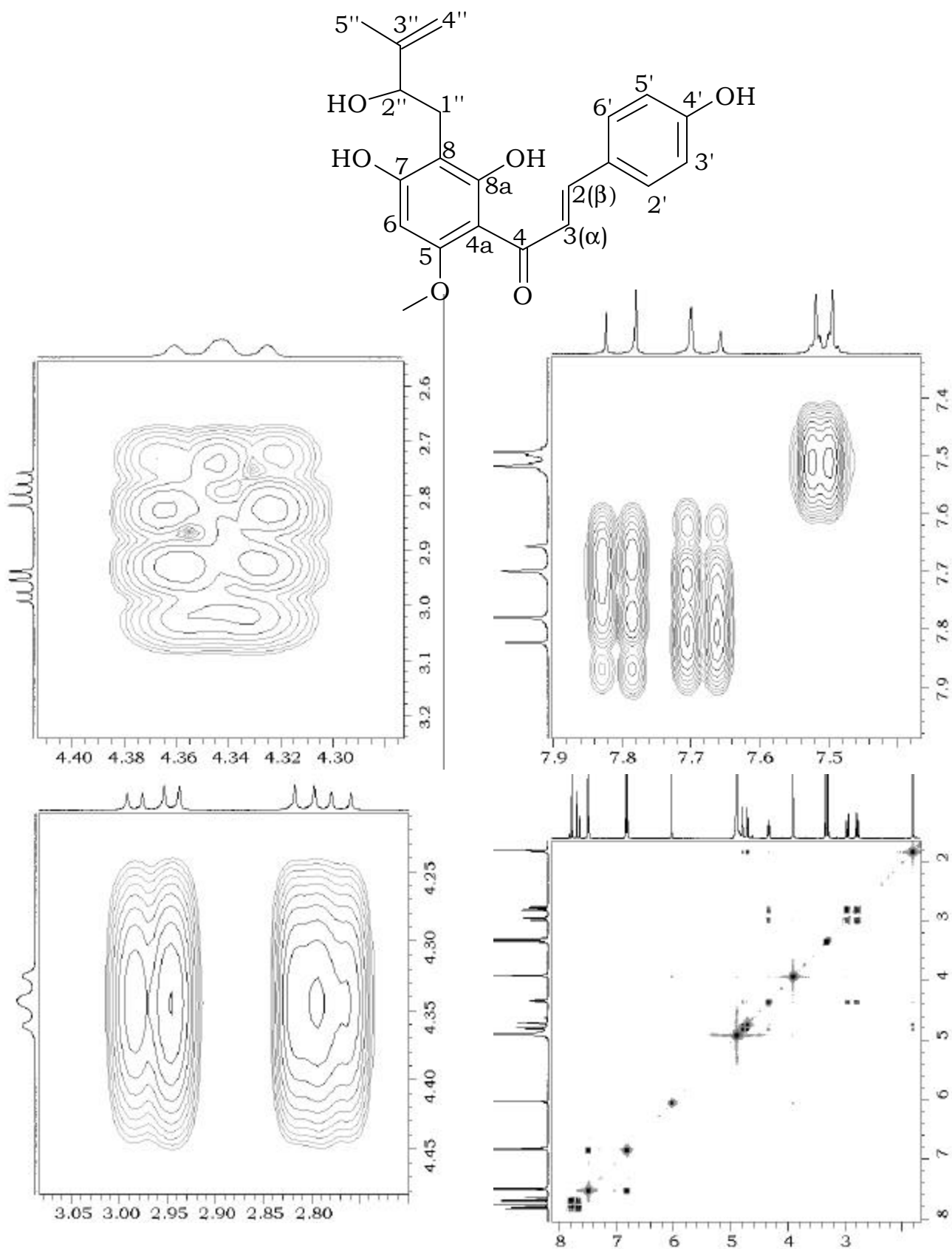

xanthohumol D (**3**) 360 MHz COSY spectrum taken in MeOH- d_4

13C	ppm	HMQC	HMBC
C2(b)	143.5	x	H3(α);H2',6'
C3(a)	128.4	x	H3(a) ;H2(β);H3',5'
C4	194.1		H3(α);H2(β), H6
C4a	106.4		H6
C5	162.9		H6;5-OMe
C6	92.1	x	
C7	164.9		H6;H1''a,b
C8	106.7		H6;H1''a,b;H2''
C8a	166.7		H1''a,b
C1'	125.8		H2(β)
C2',6'	131.3	x	H2(β); H2',6'
C3',5'	116.9	x	H2',6'; H3',5'
C4'	161.1		H2',6';H3',5'
C1''	29.8	x	H2''
C2''	76.7	x	H4''a,b;H1''a,b;Me-5''
C3''	148.8		H2'', 1''a,b, Me-5''
C4''	110.9	x	H2'', Me-5''
C5''	17.9	x	H4''a,b;H2''
5-OMe	56.2	x	
MeOH	49.0		
TMS	0.0		

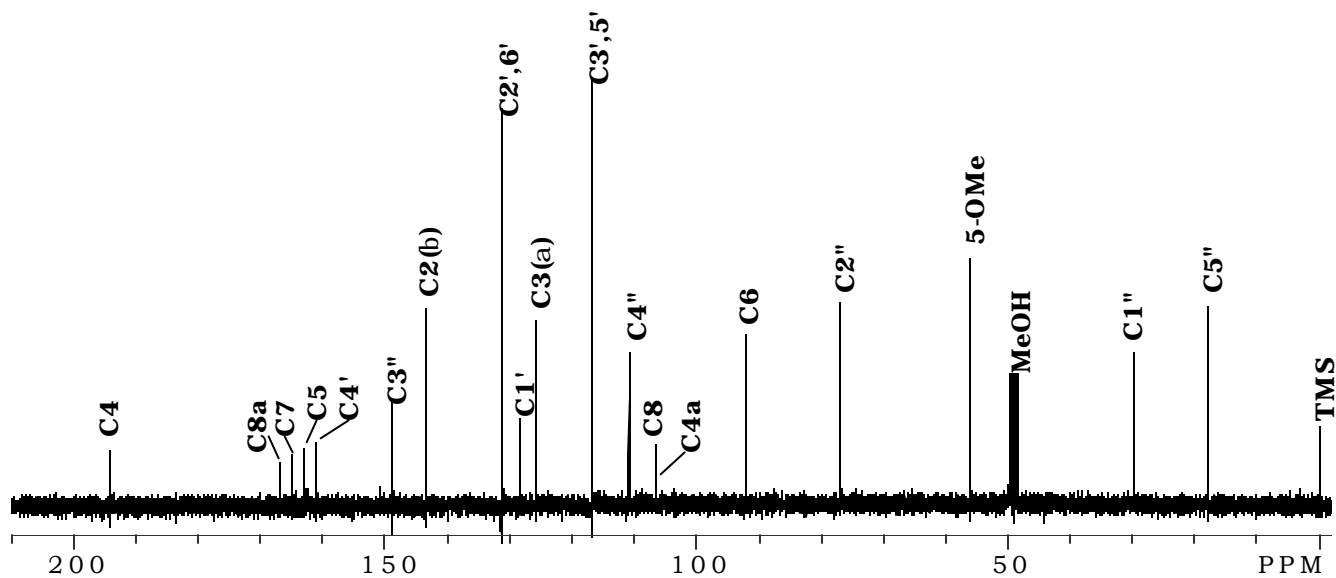
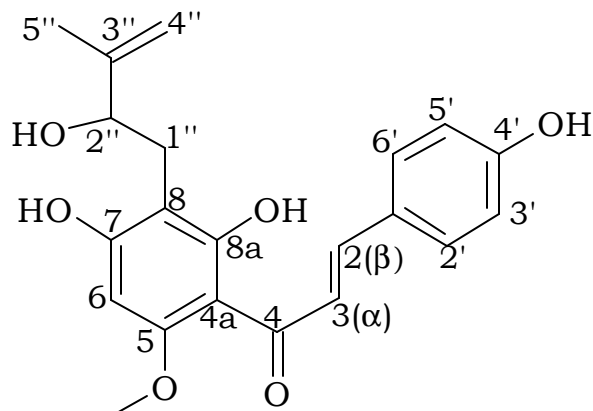
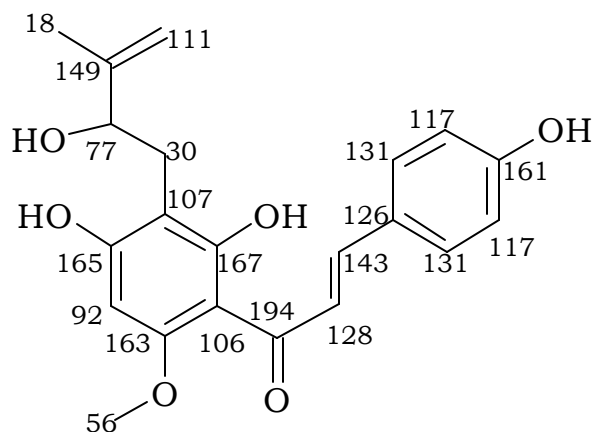

Xanthohumol D (3) 90 MHz ^{13}C NMR spectrum taken in $\text{MeOH-}d_4$.

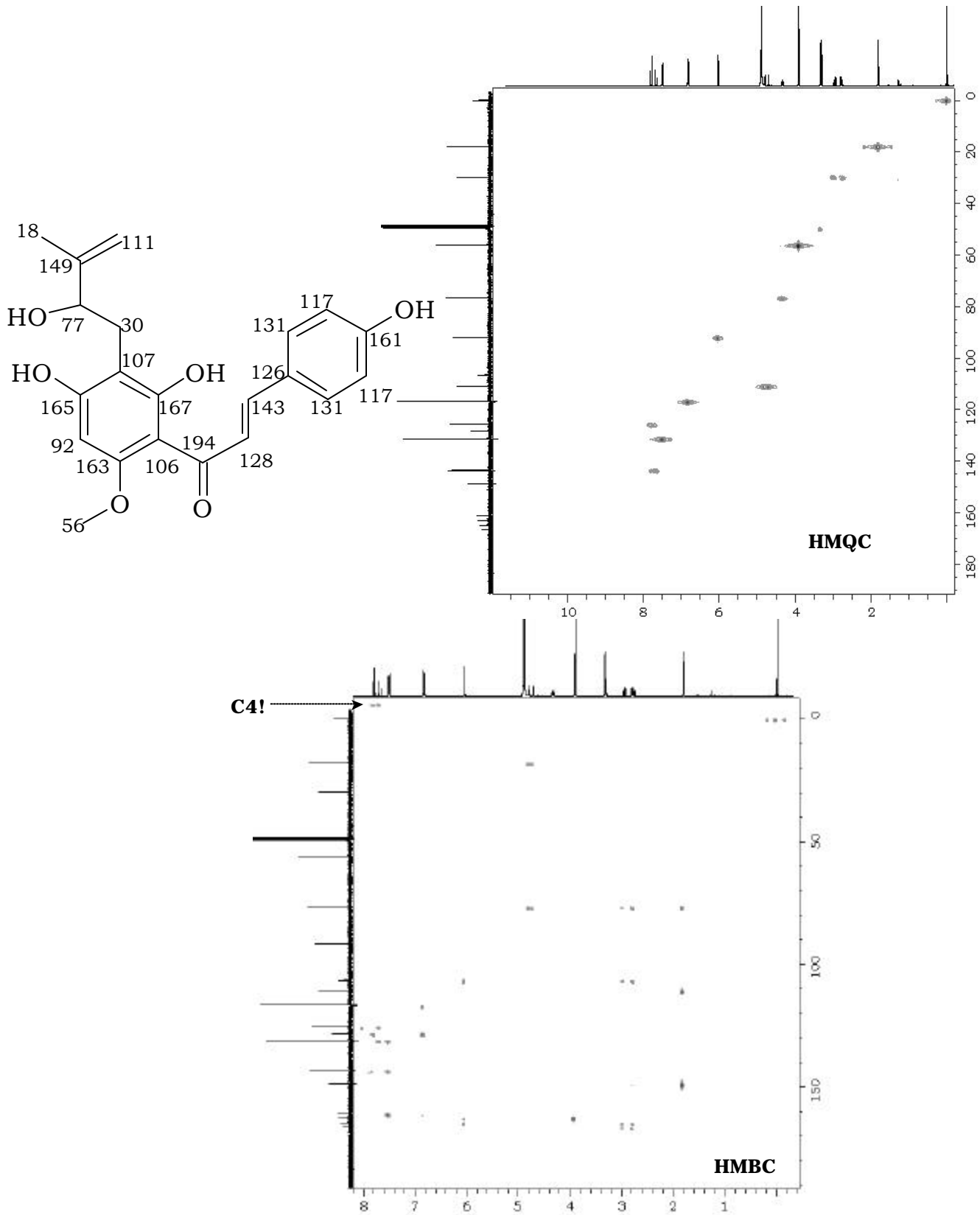

Xanthohumol D (3) ^1H - ^{13}C J coupling: HMBC and HMQC experiments (360 MHz spectra)

1H	ppm	mult (J)	integ
H3(a)	7.99	dt ^t * (15.6, 0.1, 0.1)	1H
H2(b)	7.74	dt ^t (15.6, 0.5, 0.3)	1H
H2',6'	7.49	dddd (8.5, 2.3, 0.5, 0.4, 0.3)	2H
H3',5'	6.82	dddd (8.5, 2.3, 0.4, 0.3, 0.1)	2H
H6	5.85	s	1H
H2''	5.25	ddq ^q (7.2, 7.2, 1.5, 1.2)	1H
CH₂-1''	3.29	ddq ^q (appear as br-d w/ J 7.2)	2H
Me-4''	1.80	ddd ^q (1.5, 0.4, 0.4, 0.3)	3H
Me-5''	1.71	ddd ^q * (1.3, 1.3, 1.2, 0.3)	3H

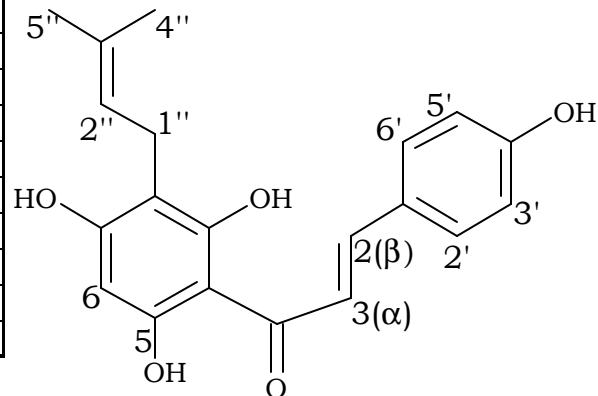

(7) desmethylxanthohumol
 $C_{20}H_{20}O_5$ MW = 340.14

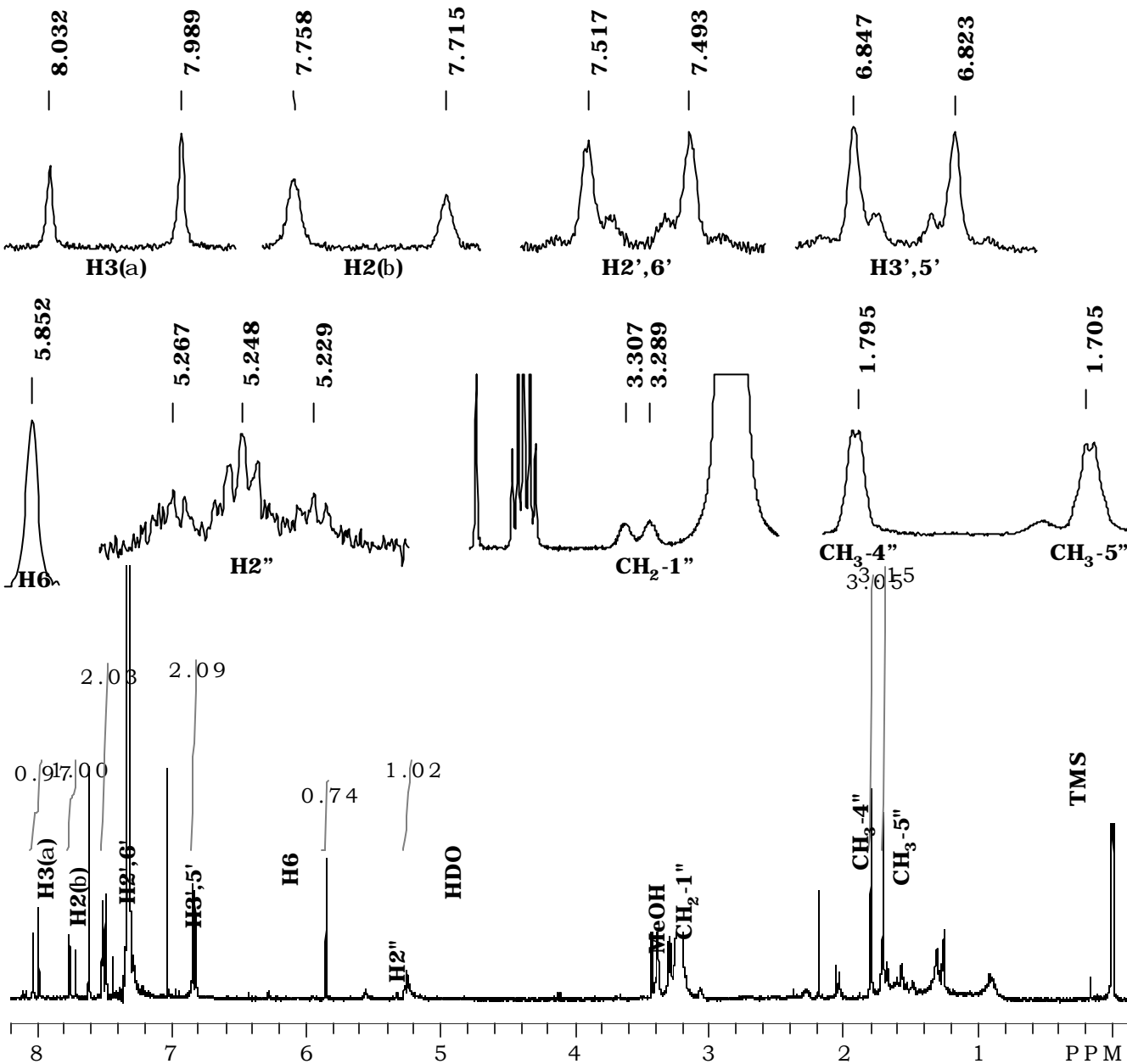

DMX (7) 360 MHz ¹H NMR spectrum taken in CDCl₃-MeOH-*d*₄ (20:1)

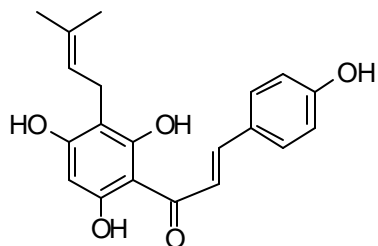

(7) desmethylxanthohumol
 $C_{20}H_{20}O_5$

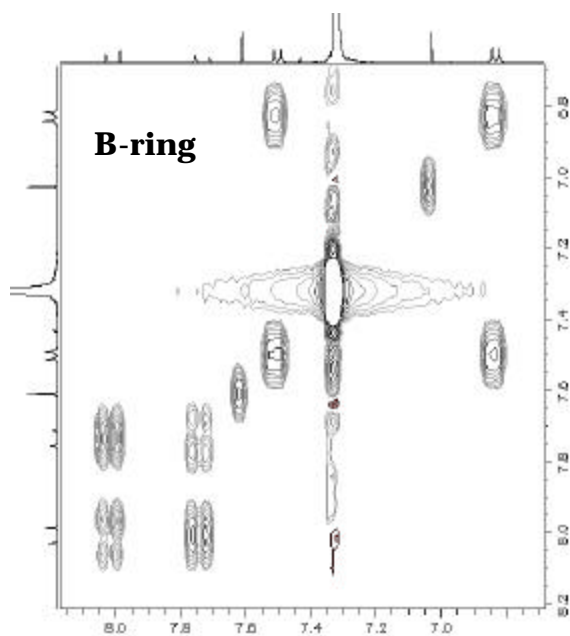
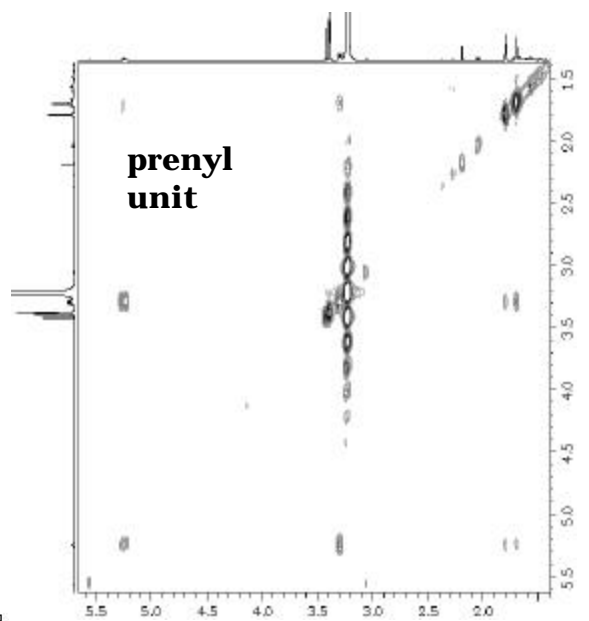
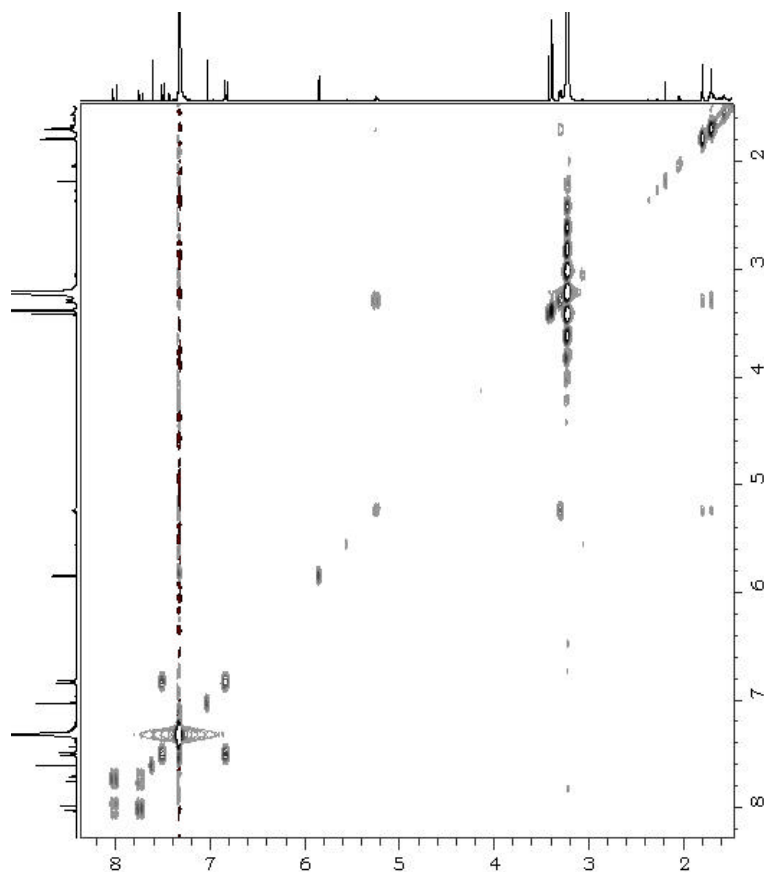

DMX (7) 360 MHz 1H - 1H COSY NMR spectrum taken in $CDCl_3$ -MeOH- d_4 (20:1)

1H	ppm	mult (J)	integ
H3(a)	7.83	dt (15.5, 0.1, 0.1)	1H
H2(b)	7.78	dt (15.5, 0.6, 0.3)	1H
H2',6'	7.53	dddd (8.5, 2.3, 0.6, 0.4)	2H
H3',5'	6.84	dddd (8.5, 2.3, 0.4, 0.3)	2H
H2'',2'''	5.17	m* (over-lapped ddqqs)	2H
5-OMe	3.62	s	3H
CH2-1''	3.33	COSY; buried under Me	-
CH2-1'''	3.31	COSY; buried under Me	-
CH3-4''	1.80	dddq (1.5, 0.4, 0.4, 0.3)	3H
CH3-4'''	1.78	dddq (1.5, 0.4, 0.4, 0.3)	3H
CH3-5''	1.70	dddq (1.3, 1.3, 1.2, 0.3)	3H

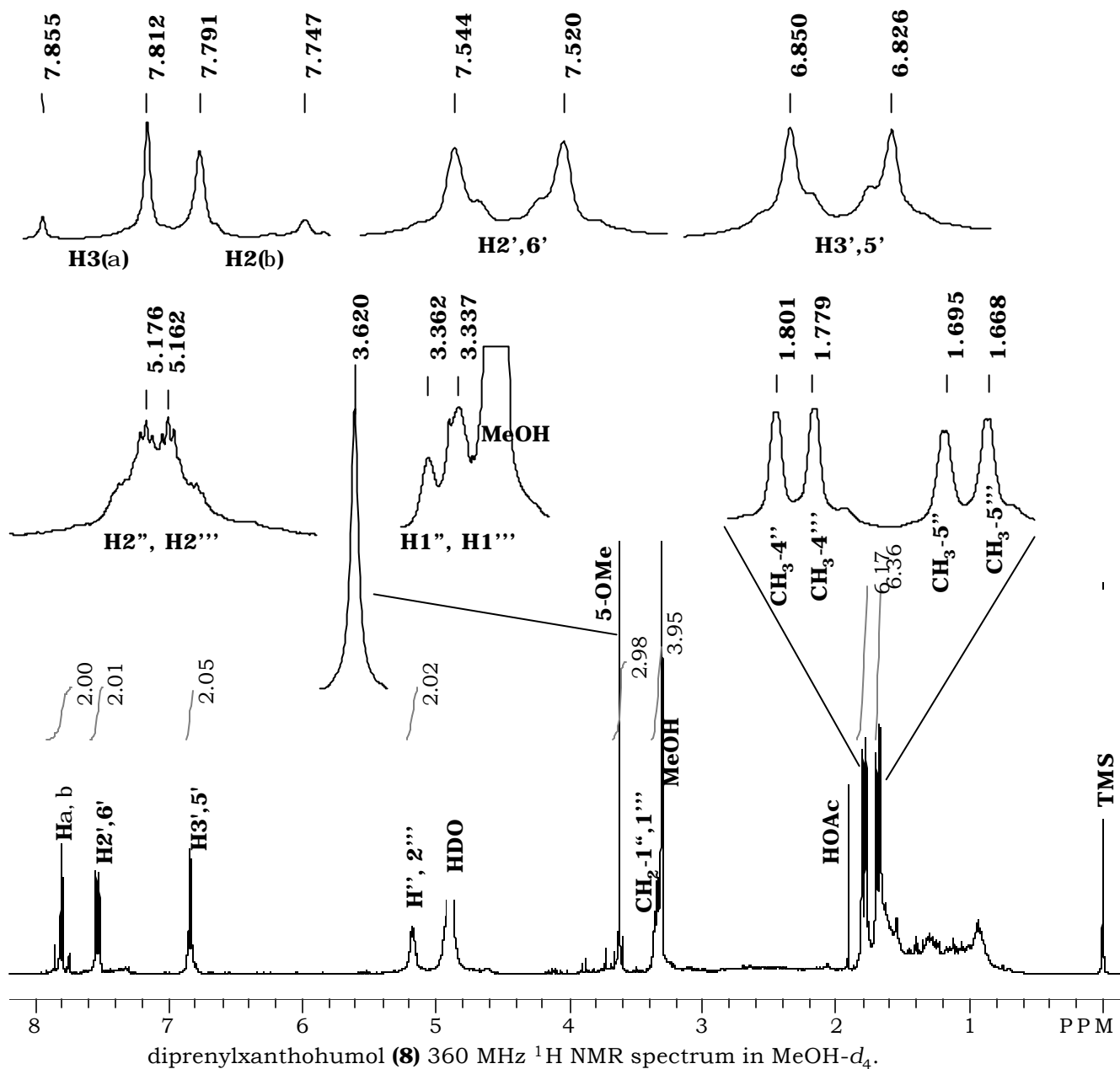
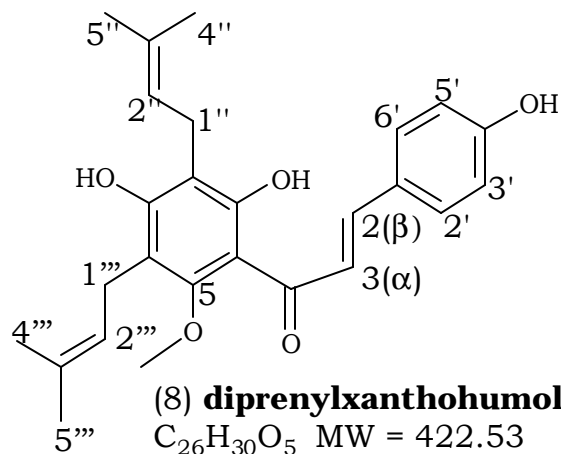

1H	ppm	mult (J)	integ
H3(a)	7.82	dt (15.5, 0.2, 0.1)	1H
H2(b)	7.70	dt (15.5, 0.5, 0.4)	1H
H2',6'	7.51	dddd (8.5, 2.3, 0.5, 0.4, 0.2)	2H
H3',5'	6.83	dddd (8.5, 2.3, 0.4, 0.4, 0.1)	2H
H6	5.99	s	1H
H2''	3.77	dd (7.0, 5.4)	1H
5-OMe	3.90	s	3H
H1''a	2.85	dd (16.8, 5.4)	1H
H1''b	2.52	dd (16.8, 7.0)	1H
Me-5''	1.35	s	3H
Me-4''	1.29	s	3H

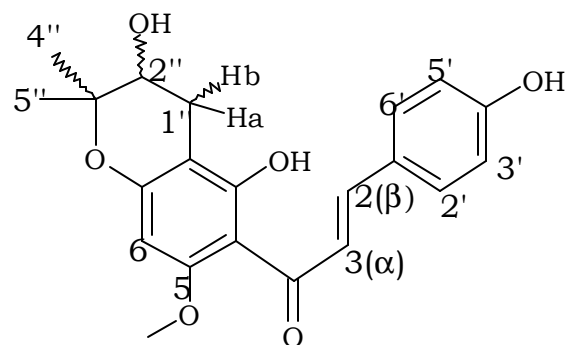

(10) Xanthohumol B
 $C_{21}H_{22}O_6$ MW = 370.14

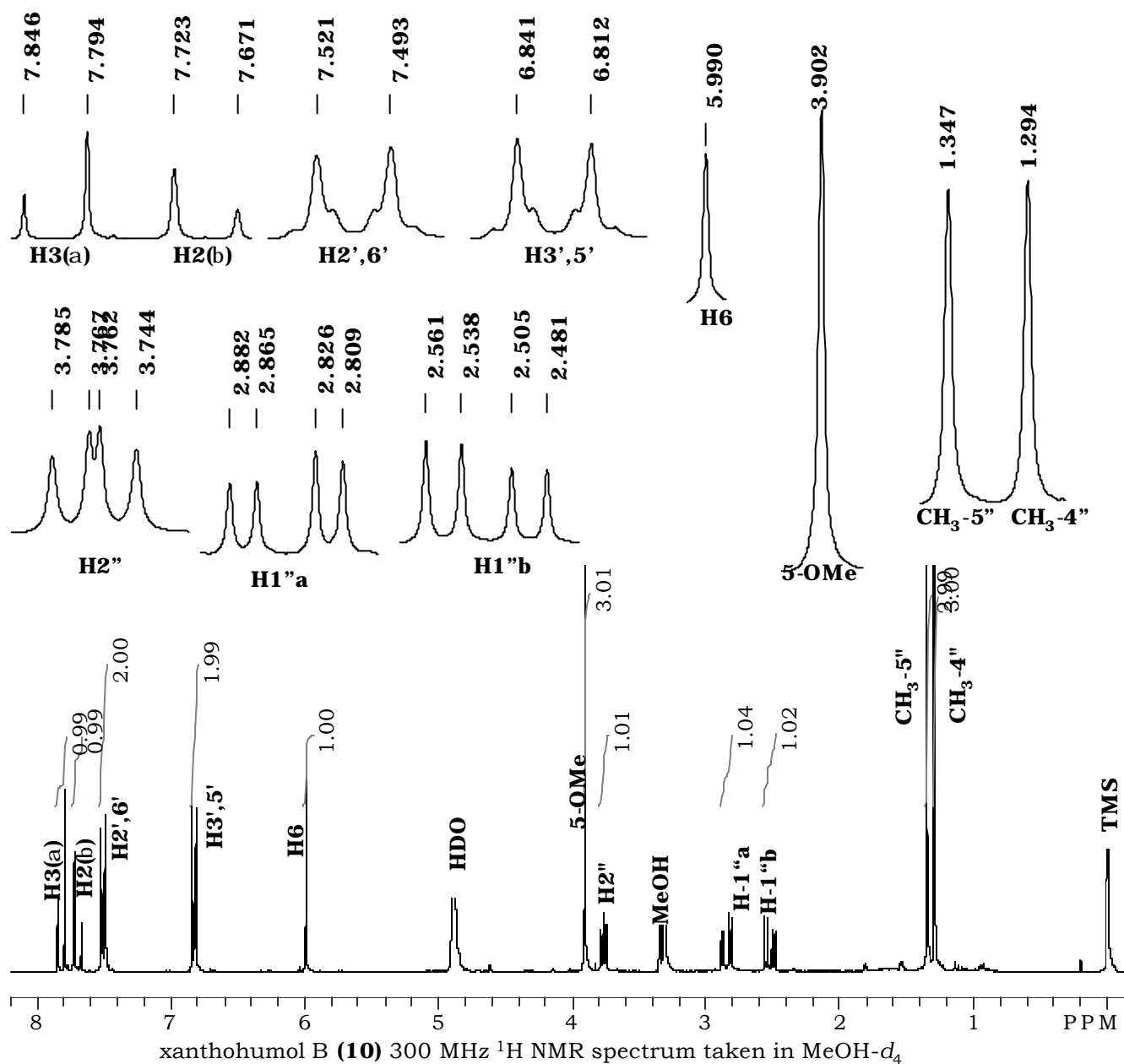

1H	ppm	mult (J)	integ
H3(a)	7.13	dt (15.8, 0.2, 0.1)	1H
H2(b)	7.49	dt (15.8, 0.5, 0.4)	1H
H2',6'	7.49	dddd (8.5, 2.3, 0.5, 0.4, 0.2)	2H
H3',5'	6.81	dddd (8.4, 2.3, 0.4, 0.4, 0.1)	2H
H6	6.11	s	1H
H2''	4.67	dd (9.5, 8.5)	1H
5-OMe	3.77	s	3H
H1''a	3.03	dd (16.0, 8.5)	1H
H1''b	3.02	dd (16.0, 9.5)	1H
Me-4''	1.27	s	3H
Me-5''	1.18	s	3H

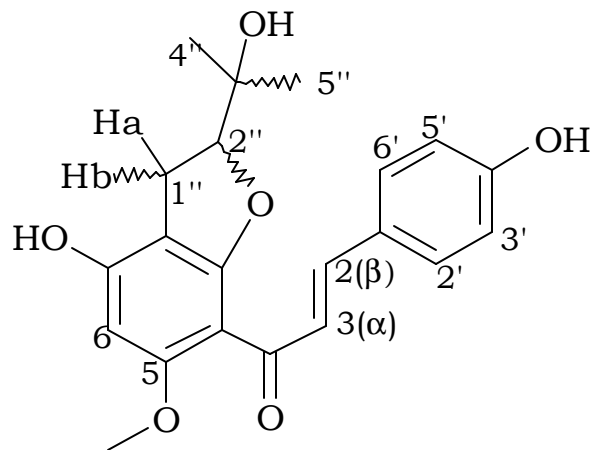

(**13**) (E)-2''-(2''-hydroxyisopropyl)-dihydrofuran [2'',3'':2',3']-4'-hydroxy-5-methoxychalcone ("Xanthohumol I")

$C_{21}H_{22}O_6$ MW = 370.14

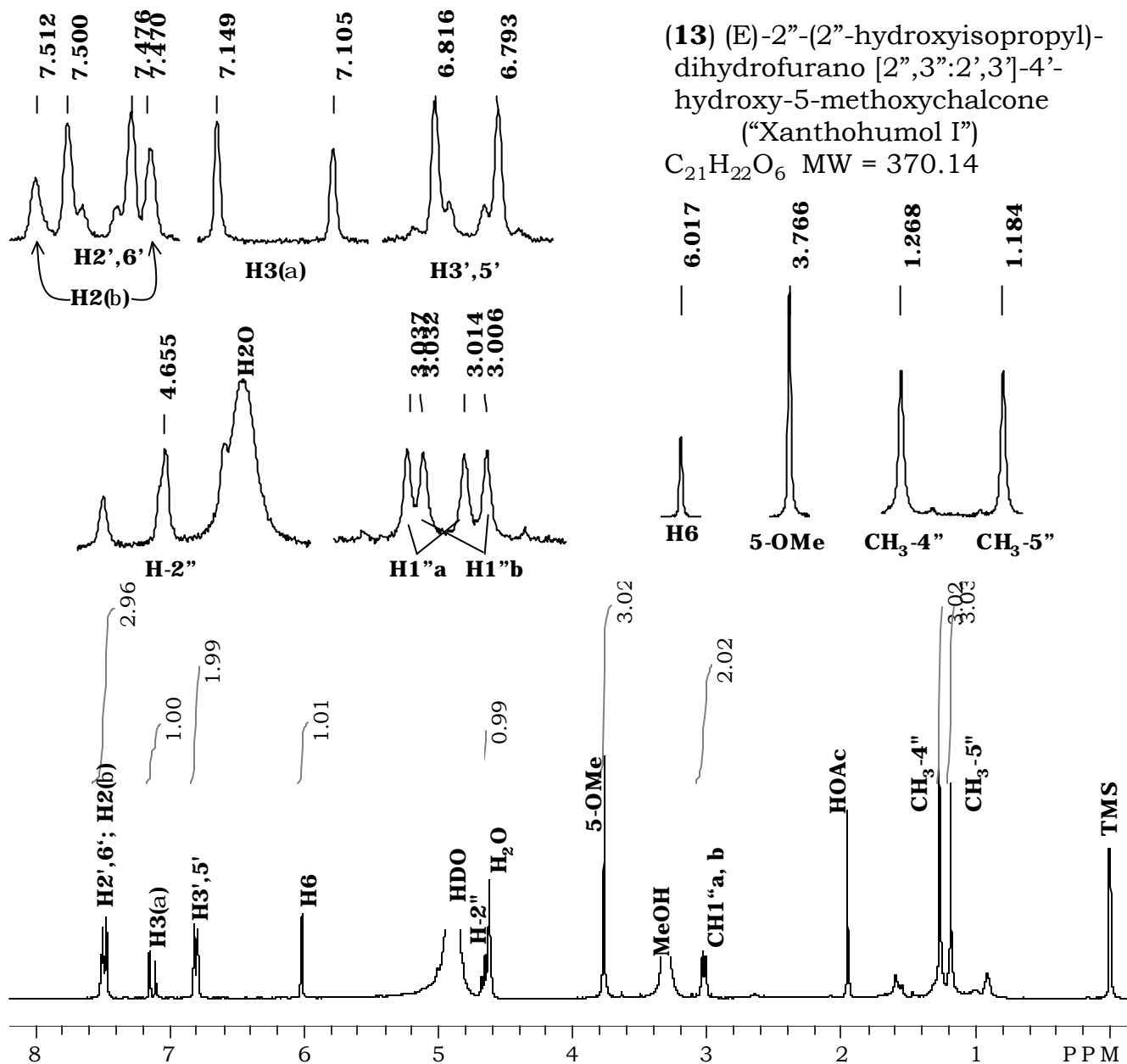

xanthohumol I (**13**) 360 MHz 1H NMR spectrum in $MeOH-d_4$

(“Xanthohumol I”)
 $C_{21}H_{22}O_6$ MW = 370.14

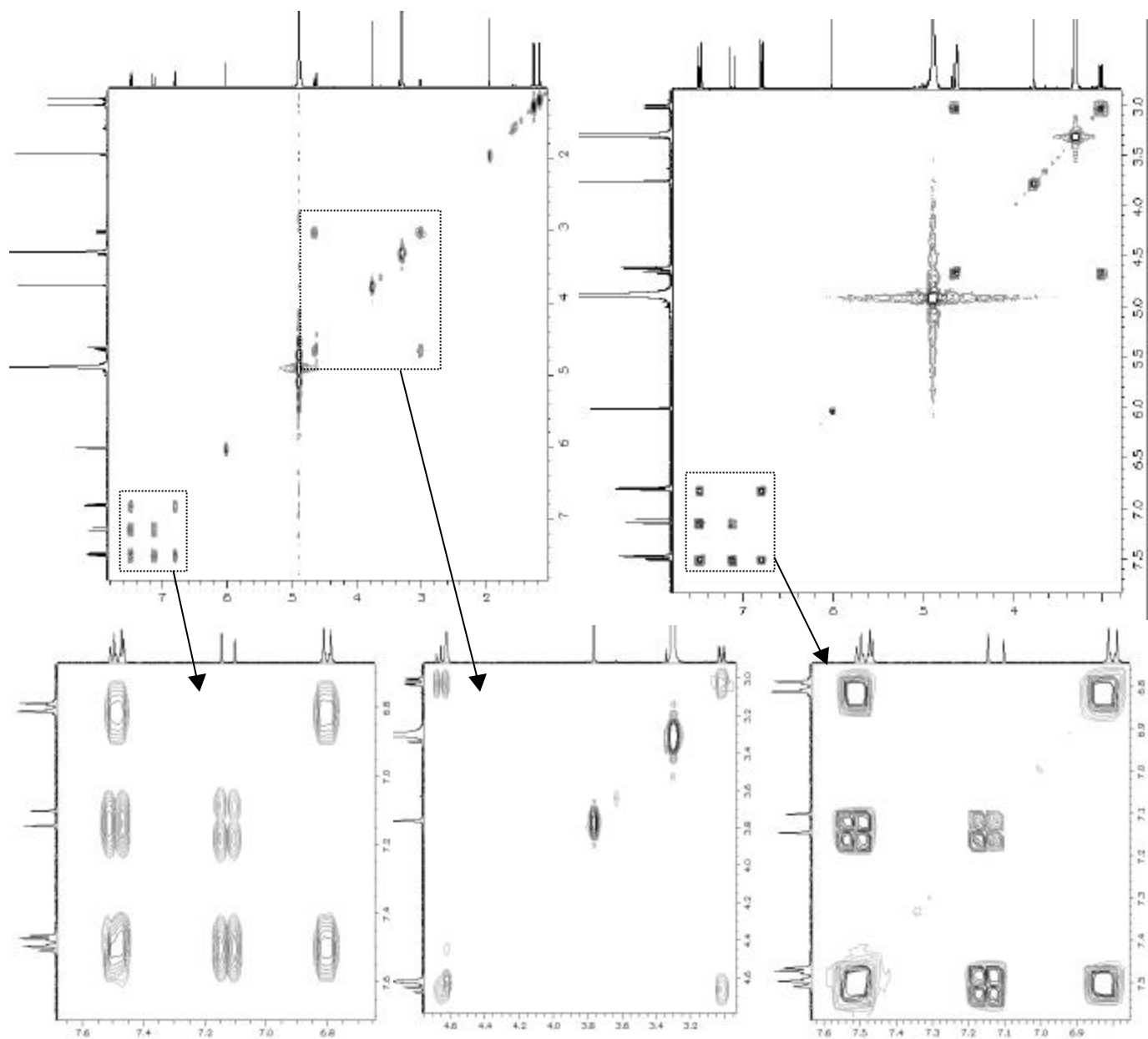

XN-I (**13**) symmetrized (above right) and unsymmetrized (above left) 360 MHz COSY spectrum in MeOH-*d*₄ with enlargements of indicated regions below

1H	ppm	mult (J)	integ
H2',6'	7.32	dddd (8.5, 2.3, 0.6, 0.4)	2H
H3',5'	6.81	dddd (8.5, 2.3, 0.4, 0.3)	2H
H6	5.86	s	1H
H2	5.28	ddtt (12.8, 3.1, 0.6, 0.3)	1H
H2''	5.14	ddqq (7.2, 7.2, 1.5, 1.2)	1H
CH2-1''a	3.18	ddqq* (13.8, 7.2, 1.3, 0.4)	1H
CH2-1''b	3.16	(*appear as br-d @ 300 MHz)	1H
H3a	3.04	dd (17.0, 12.8)	1H
H3b	2.67	dd (17.0, 3.1)	1H
Me-5''	1.61	dddq (1.3, 1.3, 1.2, 0.3)	3H

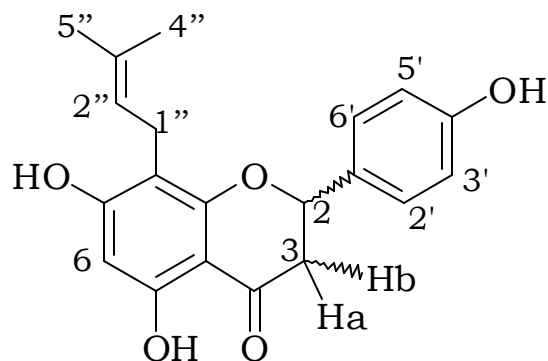

(15) 8-prenylnaringenin
 $C_{20}H_{20}O_5$ MW = 340.13

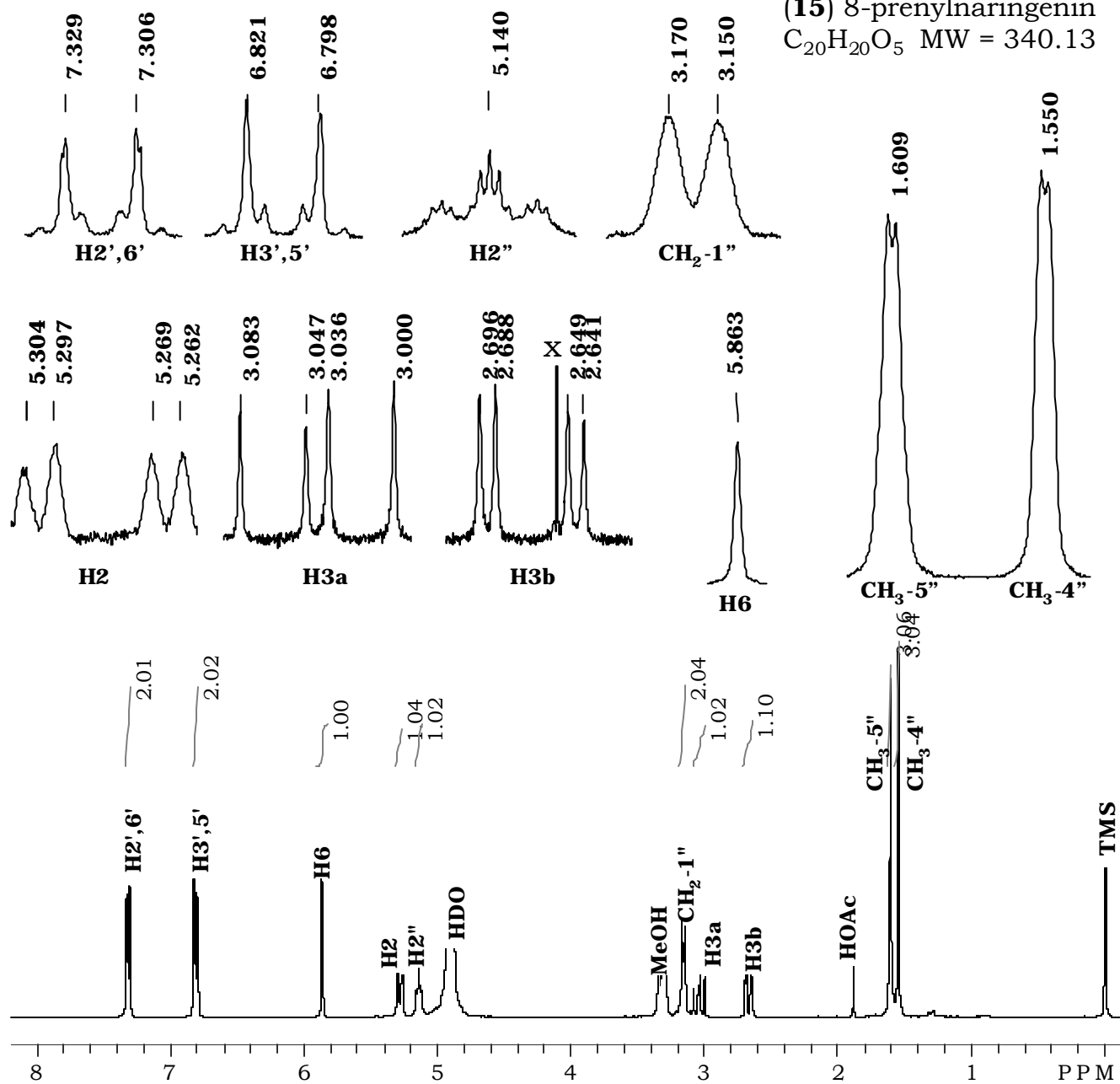

8-prenylnaringenin (**15**) 500 MHz 1H NMR spectrum taken in MeOH- d_4

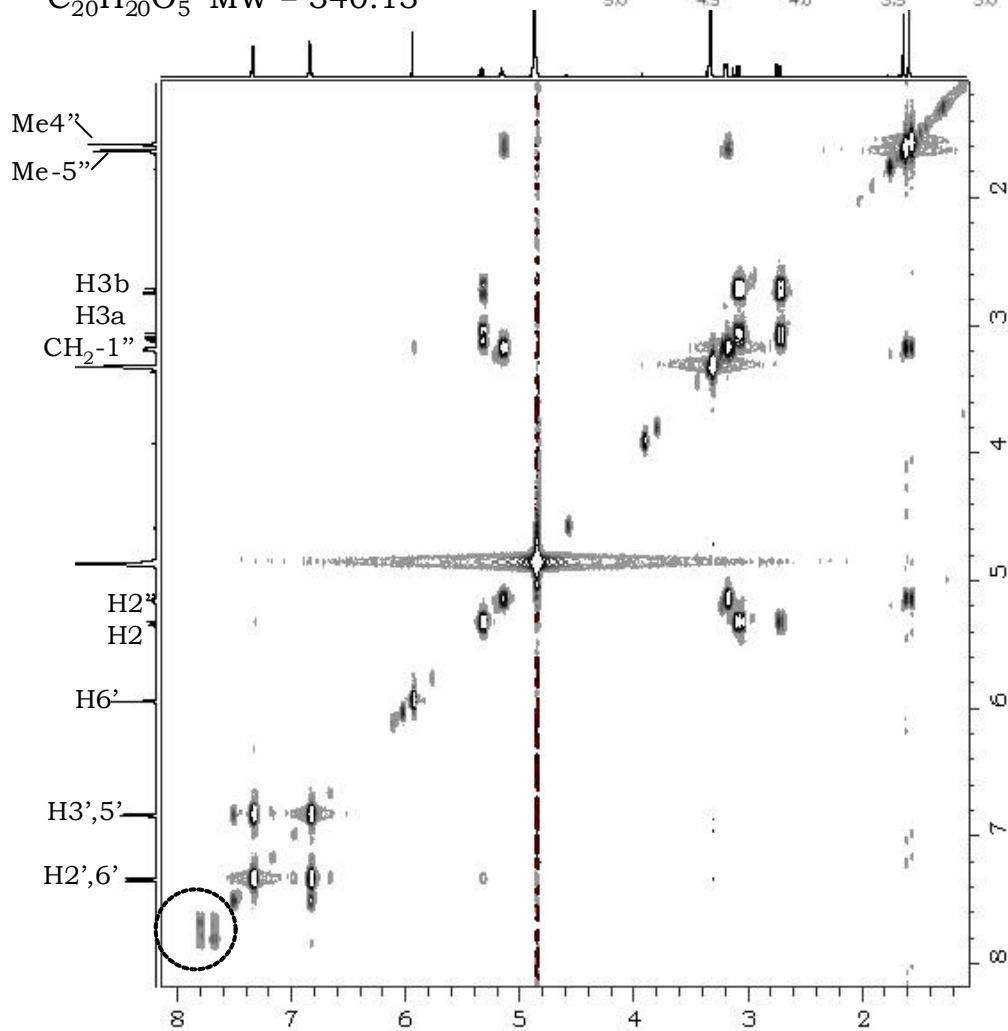
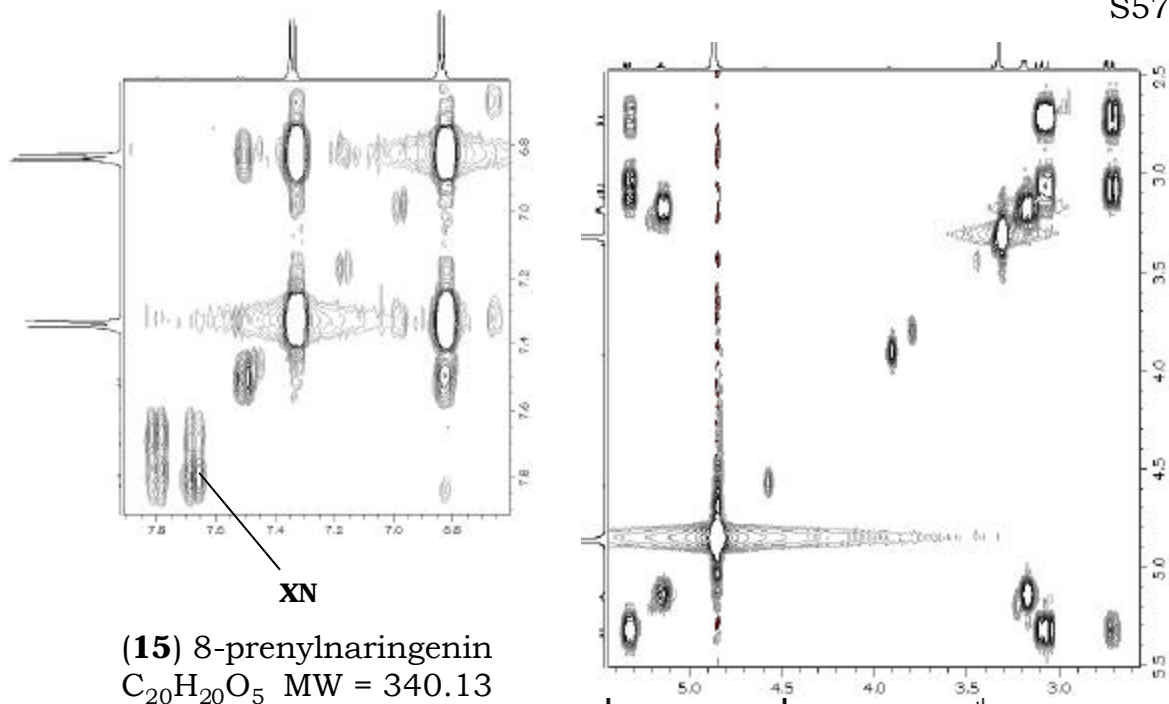

8-prenylnaringenin (**15**) COSY 360 MHz spectrum in MeOH-*d*₄. Note α,β crosspeaks due to ca. 1% impurity of xanthohumol (**1**; circled). As with 6PN, a crosspeak is observed between H2 and H2',6'.

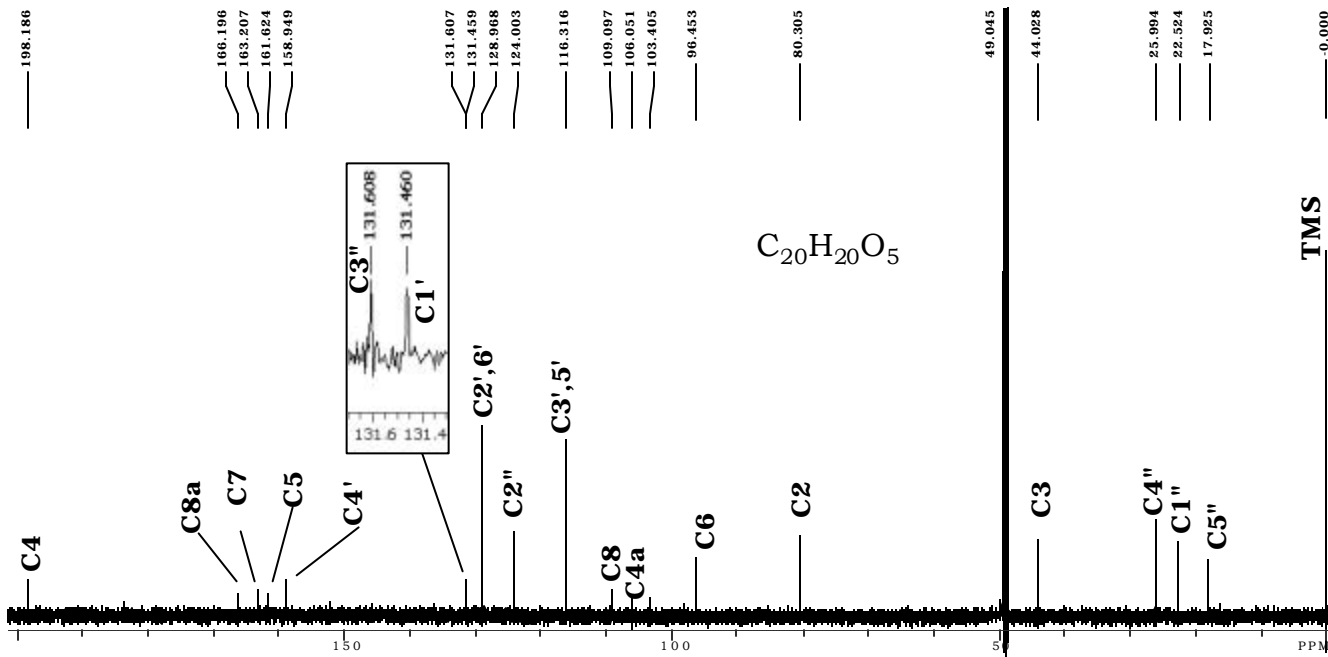
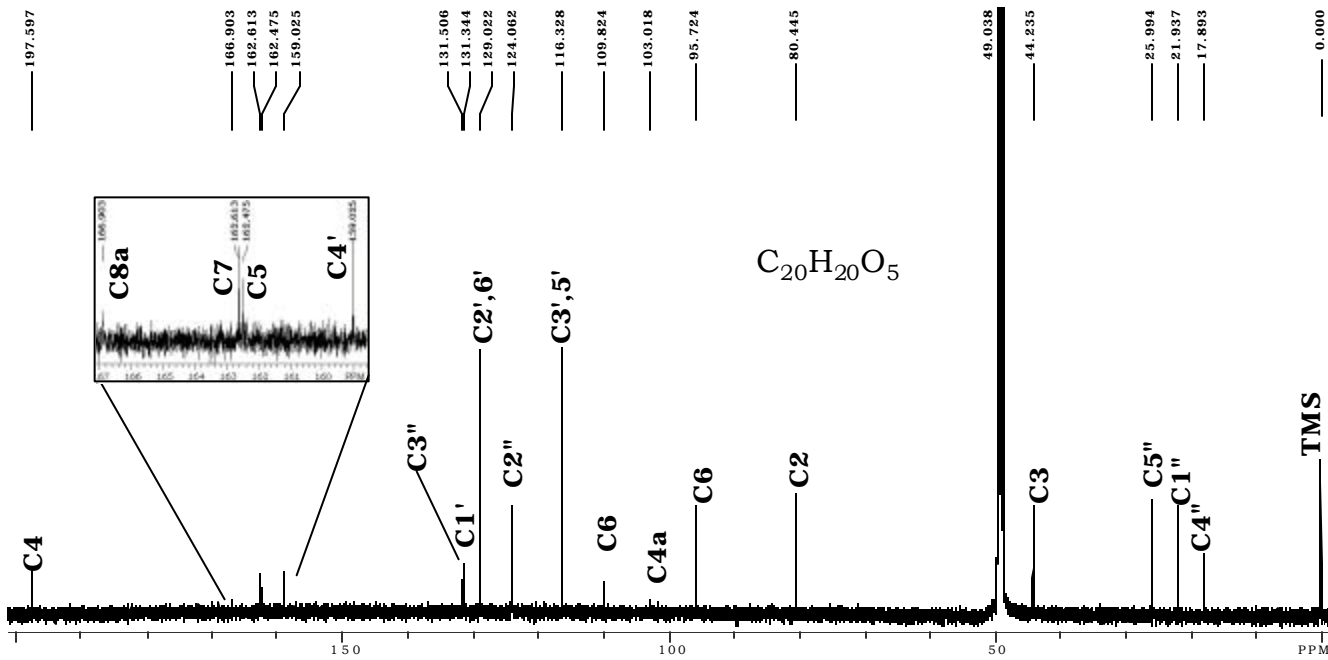

8-prenylnaringenin (**15**; above) and 6-prenylnaringenin (**16**; below) 500 MHz ^{13}C NMR spectra in MeOH- d_4 .

¹ H	ppm	mult (J)	integ
H2',6'	7.31	dddd (8.5, 2.3, 0.6, 0.4)	2H
H3',5'	6.81	dddd (8.5, 2.3, 0.4, 0.3)	2H
H8	5.93	s	1H
H2	5.29	ddtt (12.8, 3.1, 0.6, 0.3)	1H
H2''	5.18	ddqq (7.2, 7.2, 1.5, 1.2)	1H
CH2-1''	3.20	ddqq* (appear as br-d)	2H
H3a	3.10	dd (17.0, 12.8)	1H
H3b	2.67	dd (17.0, 3.1)	1H
Me-4''	1.75	dddq (1.5, 0.4, 0.4, 0.3)	3H
Me-5''	1.65	dddq (1.3, 1.3, 1.2, 0.3)	3H

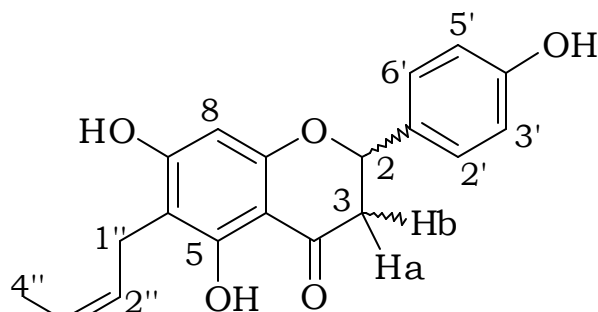

(16) 6-prenylnaringenin
 $C_{20}H_{20}O_5$ MW = 340.13

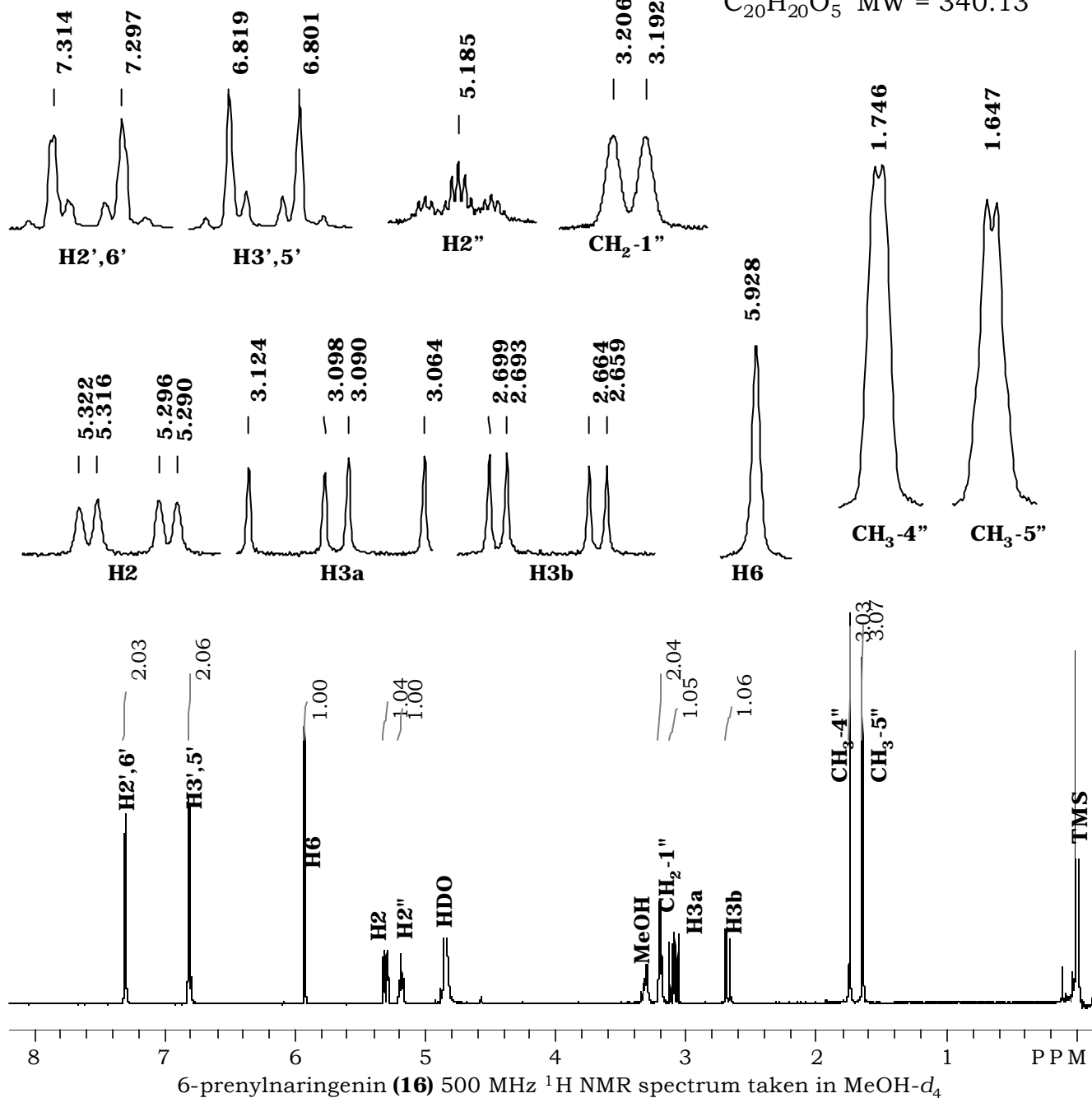

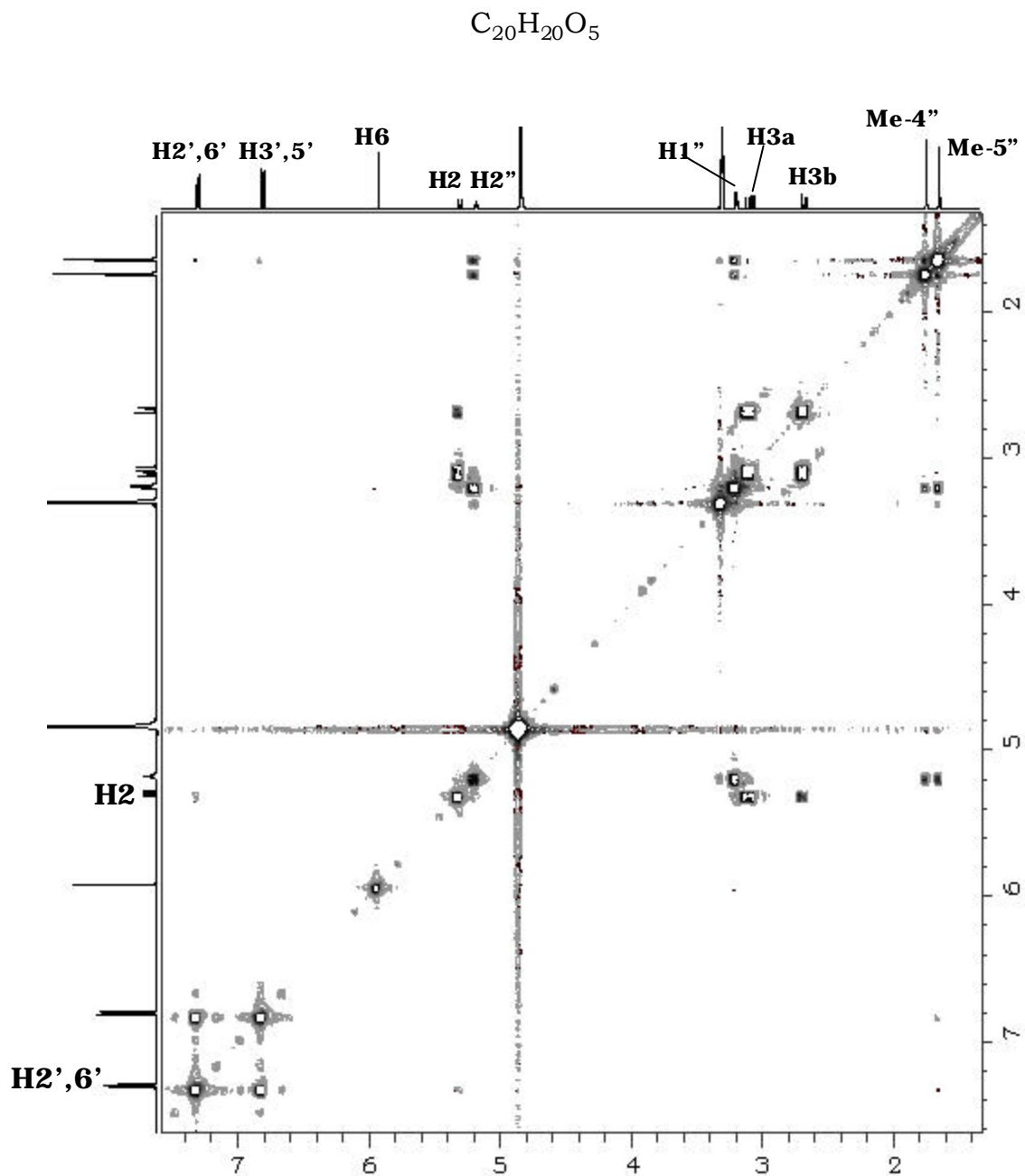

6-prenylnaringenin (**16**) symmetrized COSY 500 MHz NMR spectrum taken in $MeOH-d_4$. Note H_2 - $H_{2',6'}$ crosspeak.

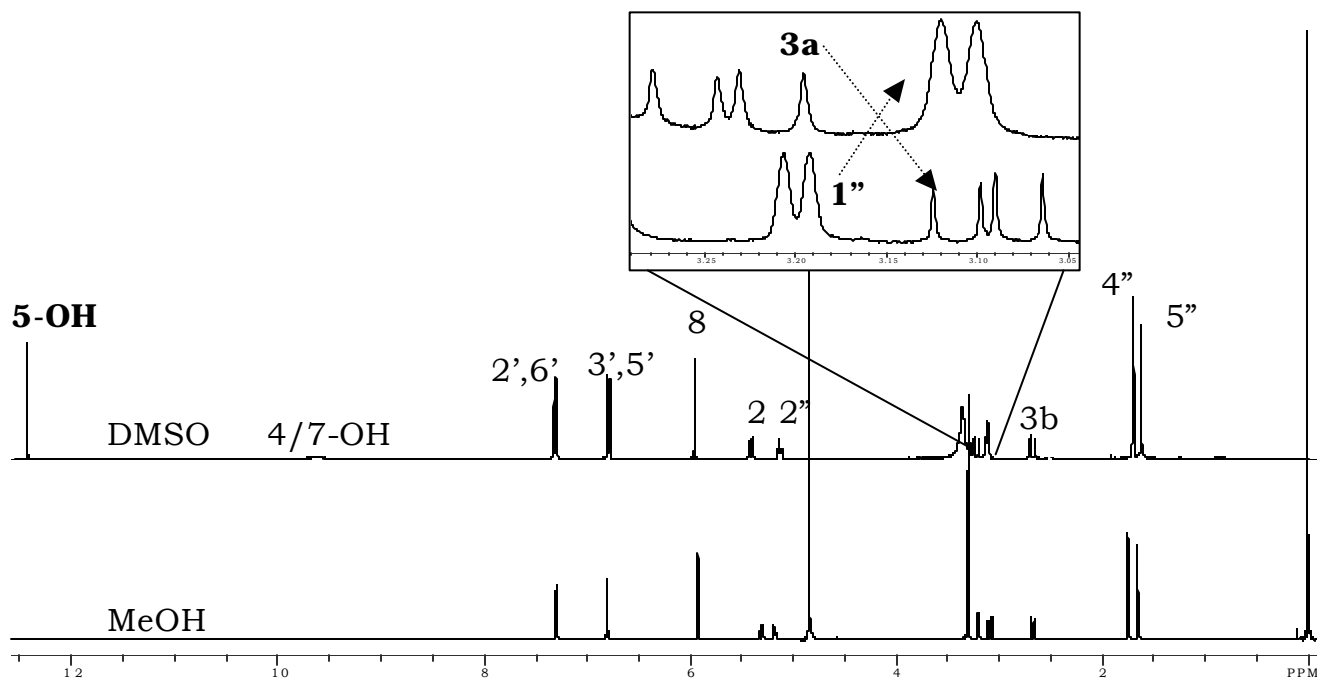

Comparison of ^1H NMR spectra of 6PN (**16**) collected in $\text{DMSO-}d_6$ (above) and $\text{MeOH-}d_4$ (below). The most significant difference observed was the relative chemical shifts of H3a and $\text{CH}_2\text{-1''}$ (inset above).

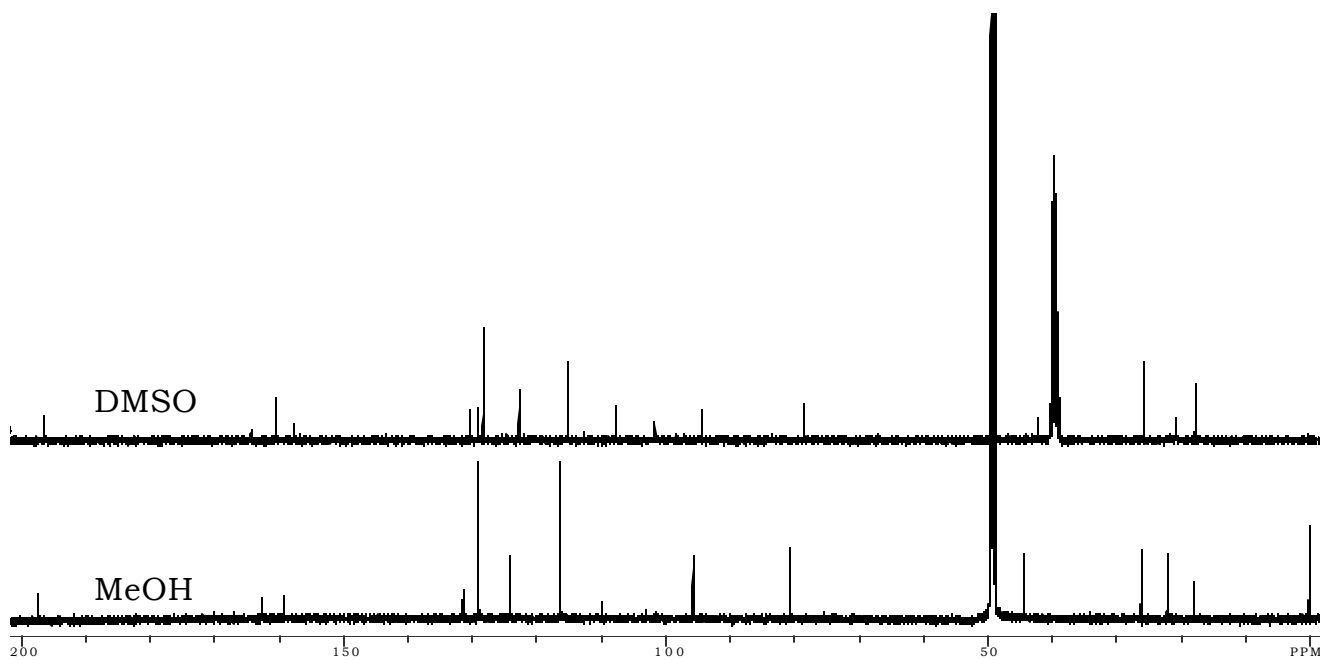

Comparison of ^{13}C NMR spectra of 6PN collected in $\text{DMSO-}d_6$ (above) and $\text{MeOH-}d_4$ (below).

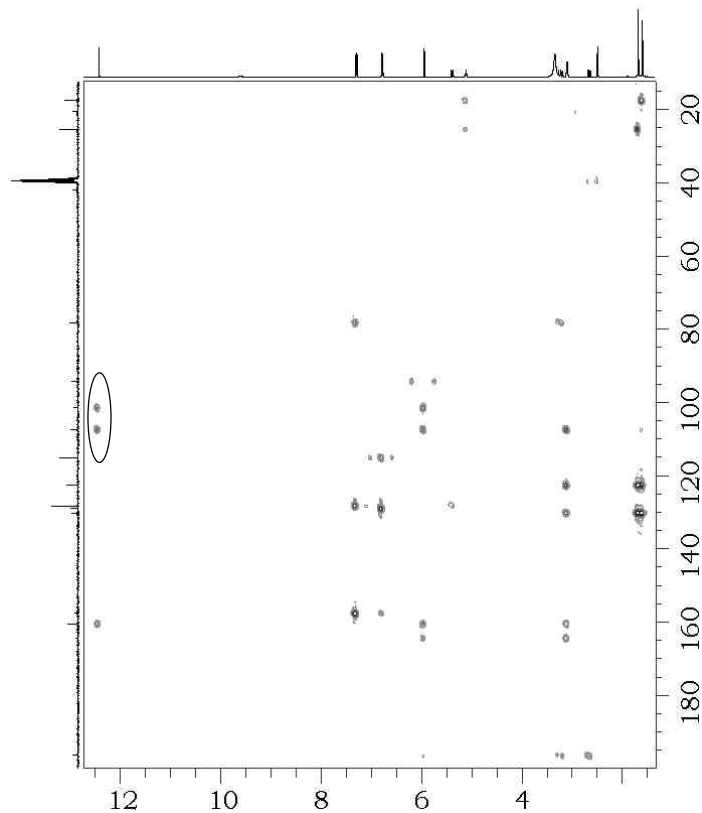

Figure 63 HMBC spectrum of 6-prenylaringenin **16** in DMSO- d_6 .

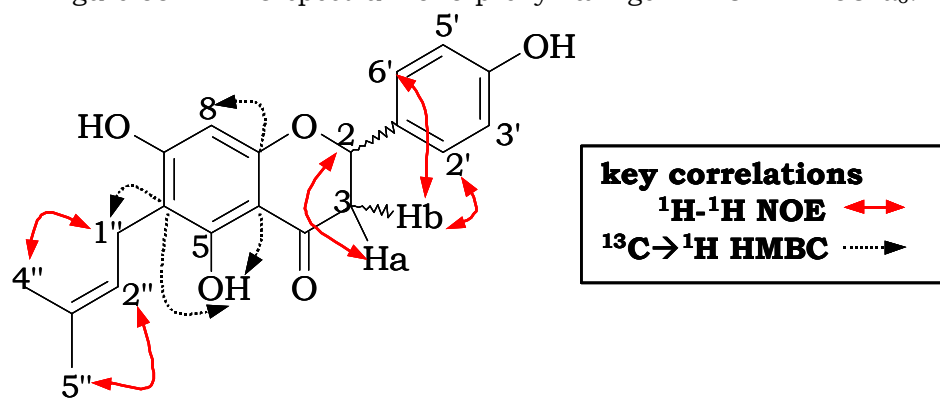
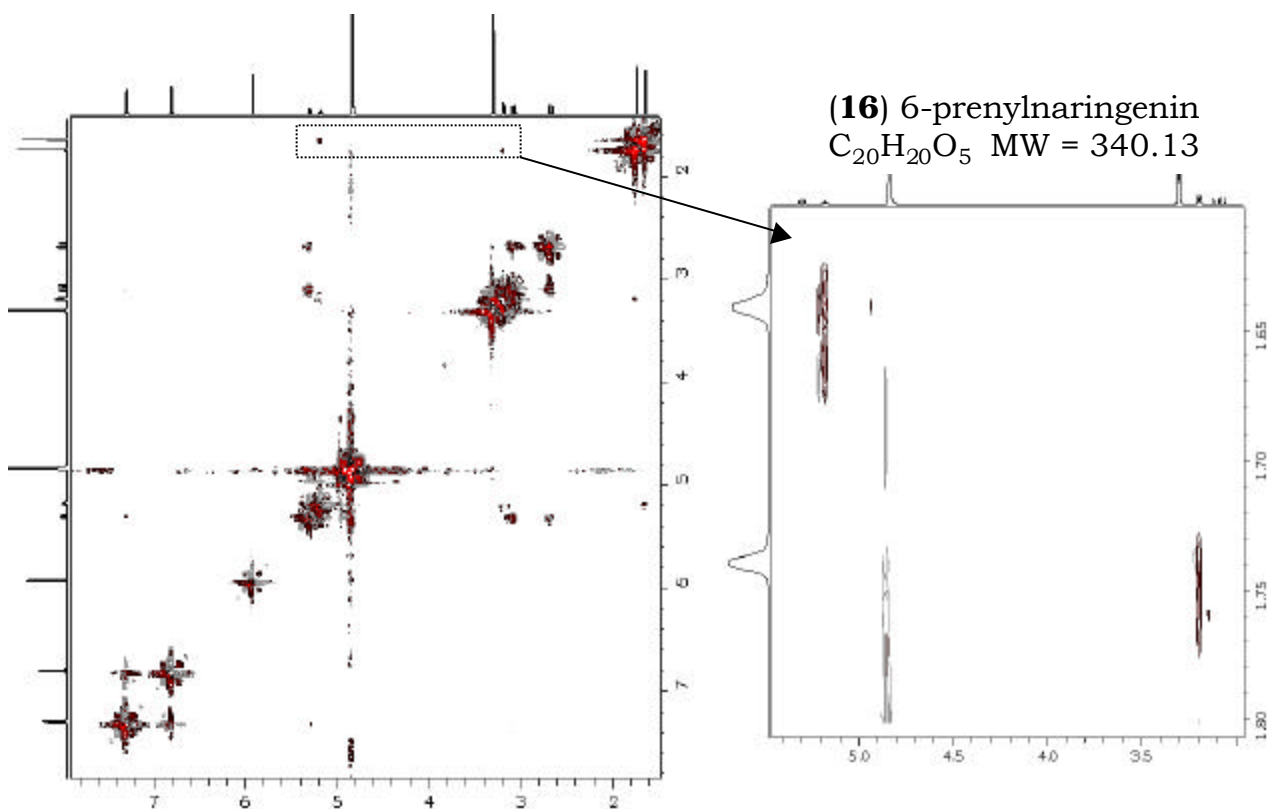
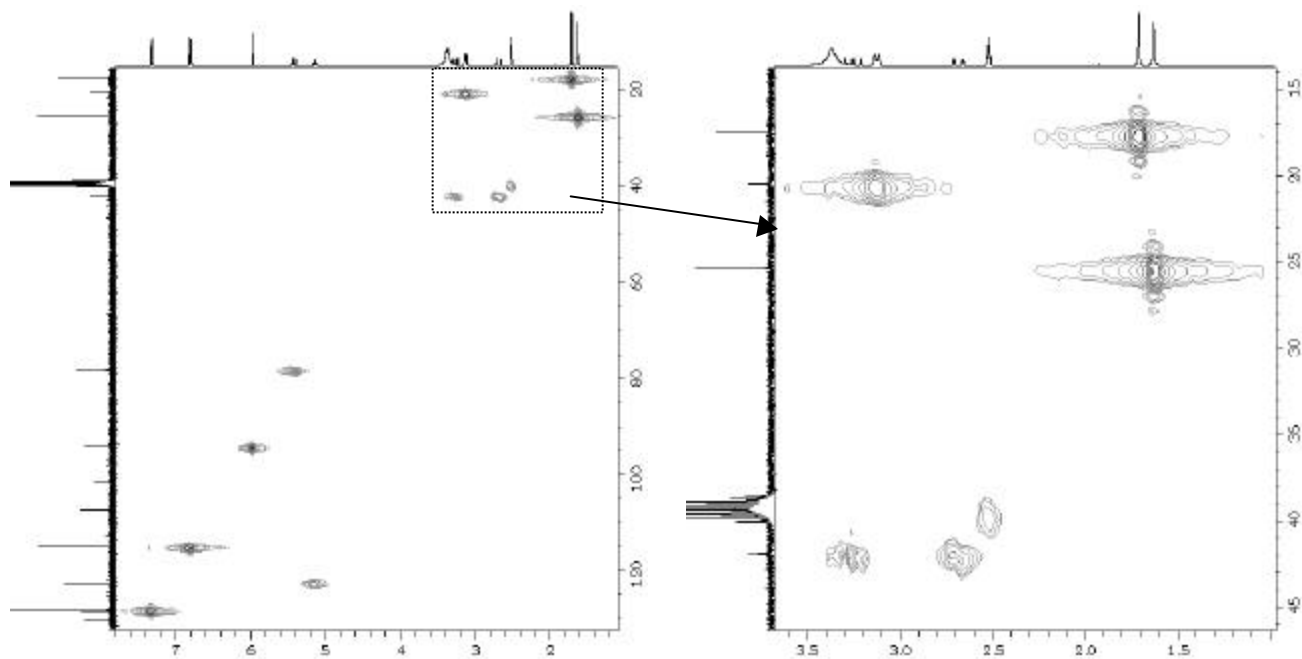

Figure 64 Key 2D NMR correlations in 6-prenylaringenin **16**



6-prenylnaringenin (16) 2D 360 MHz NOESY spectrum in $MeOH-d_4$. The key NOE correlations for the assignment of the prenyl methyl groups are shown in the enlargement (right).



1H	ppm	mult (J)	integ
H2',6'	7.31	dddd (8.5, 2.3, 0.6, 0.4)	2H
H3',5'	6.81	dddd (8.5, 2.3, 0.4, 0.3)	2H
H6	6.11	s	1H
H2	5.28	ddtt (12.8, 3.1, 0.6, 0.2)	1H
H2''	5.13	ddqq (7.2, 7.2, 1.5, 1.2)	1H
5-O-Me	3.79	s	3H
H1''a	3.21	ddqq (13.8, 7.2, 1.3, 0.4)	1H
H1''b	3.19	ddqq (13.8, 7.2, 1.3, 0.4)	1H
H3a	2.97	dd (16.7, 12.8)	1H
H3b	2.66	dd (16.7, 3.1)	1H
Me-5''	1.61	dddq (1.3, 1.3, 1.2, 0.3)	3H
Me-4''	1.56	dddq (1.5, 0.4, 0.4, 0.3)	3H

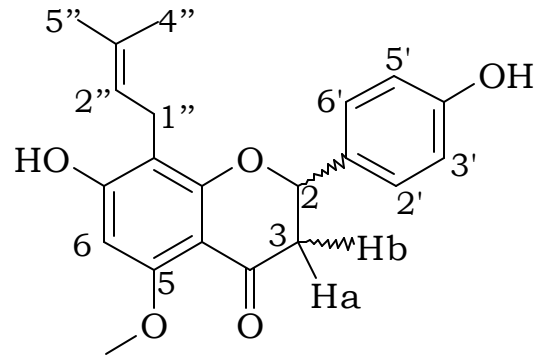

(17) Isoxanthohumol
 (5-*O*-methyl-8-prenylnaringenin)
 $C_{21}H_{22}O_5$ MW = 354.14

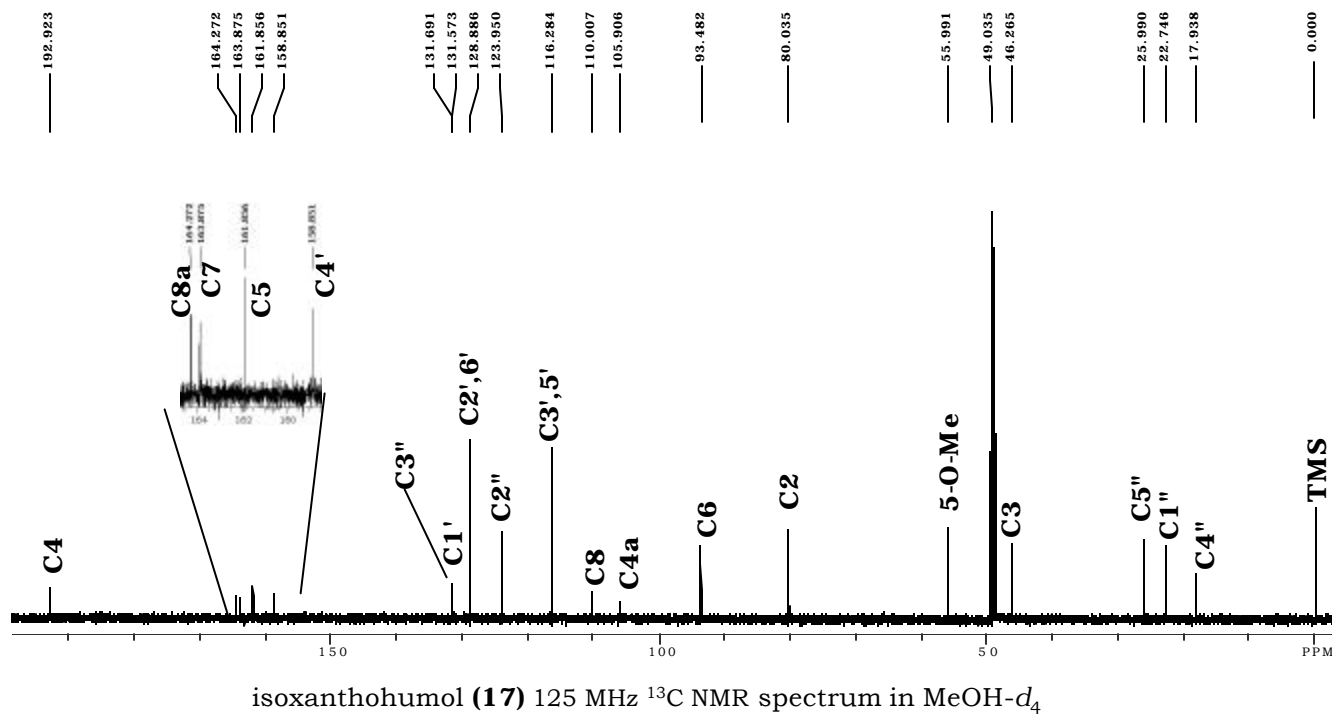

¹³ C	ppm	HMQC	HMBC
C2	80.035	X	
C3	46.265	X	
C4	192.92		H3a,b
C4a	105.906		H6
C5	161.86		5-O-Me
5-OMe	55.991	X	
C6	93.482	X	
C7	163.88		H6
C8	110.007		H6; H1''
C8a	164.27		H1''
C1'	131.57		H3',5'
C2',6'	128.89	X	
C3',5'	116.28	X	
C4'	158.85		H2',6'; H3',5'
C1''	22.746	X	
C2''	123.95	X	
C3''	131.69		H1'', Me-4'',5''
C5''	25.99	X	
C4''	17.938	X	
MeOH	49.04		
TMS	0.00		

(17) Isoxanthohumol C₂₁H₂₂O₅

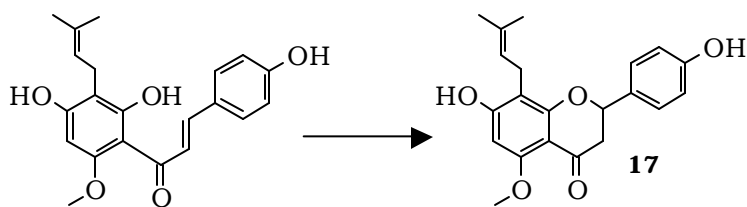
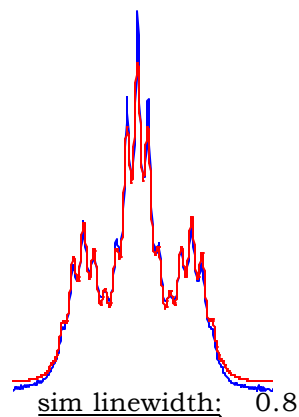
Chalcone **K1**Flavanone **K17**

δ 5.20, ddqq
($J = 7.2, 7.2, 1.5, 1.2$)

H2''

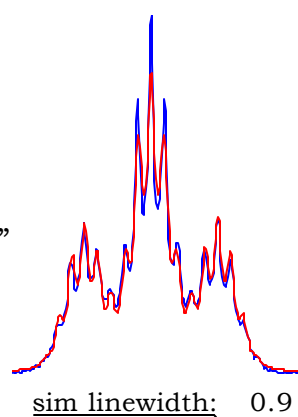

δ 5.13, ddqq
($J = 7.2, 7.2, 1.5, 1.2$)

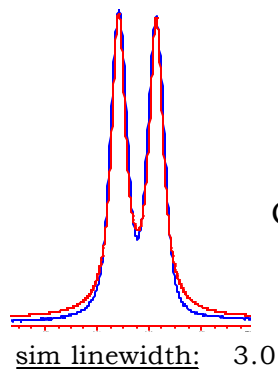

δ 3.22, 2H, ddqq
($J = *$)

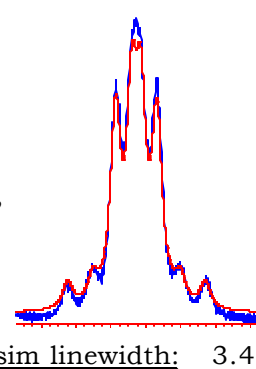
CH₂-1''

H''a: δ 3.22, ddqq
($J = 13.8, 7.2, 1.3, 0.4$)
H''b: δ 3.19, ddqq
($J = 13.8, 7.2, 1.3, 0.4$)

Effect of isomerization on the NMR spectra of the prenyl unit in XN/IX. Upon cyclization to the flavanone, the induced chirality does not effect the shape of peak H2''. However, a $\Delta\delta$ (δ -splitting) of the H1'' methylene signals in the flavanone is observed. The effect is seen more clearly at higher magnetic fields. Show above are simulated and experimental 500 MHz spectra. *By deduction, is the same as for IX (13.8 7.2, 1.3, 0.4 Hz), but this peak was not resolved in experiments conducted at ambient temperature.

1H	ppm	mult (J)	integ
H2',6'	7.32	dddd (8.5, 2.3, 0.6, 0.4)	2H
H3',5'	6.81	dddd (8.5, 2.3, 0.4, 0.3)	2H
H2	5.28	ddtt (12.8, 3.1, 0.6, 0.3)	1H
H2'''	5.15	ddqq (7.2, 7.2, 1.5, 1.2)	1H
H2''	5.11	ddqq (7.2, 7.2, 1.5, 1.2)	1H
CH2-1'''	3.26	(appear as br-d w/ J 7.2)	2H
CH2-1''	3.22	(appear as br-d w/ J 7.2)	2H
H3a	3.08	dd (17.0, 12.8)	1H
H3b	2.70	dd (17.0, 3.1)	1H
Me-4'''	1.76	dddq (1.5, 0.4, 0.4, 0.3)	3H
Me-5'''	1.66	dddq (1.3, 1.3, 1.2, 0.3)	3H
Me-5''	1.62	dddq (1.3, 1.3, 1.2, 0.3)	3H
Me-4''	1.56	dddq (1.5, 0.4, 0.4, 0.3)	3H

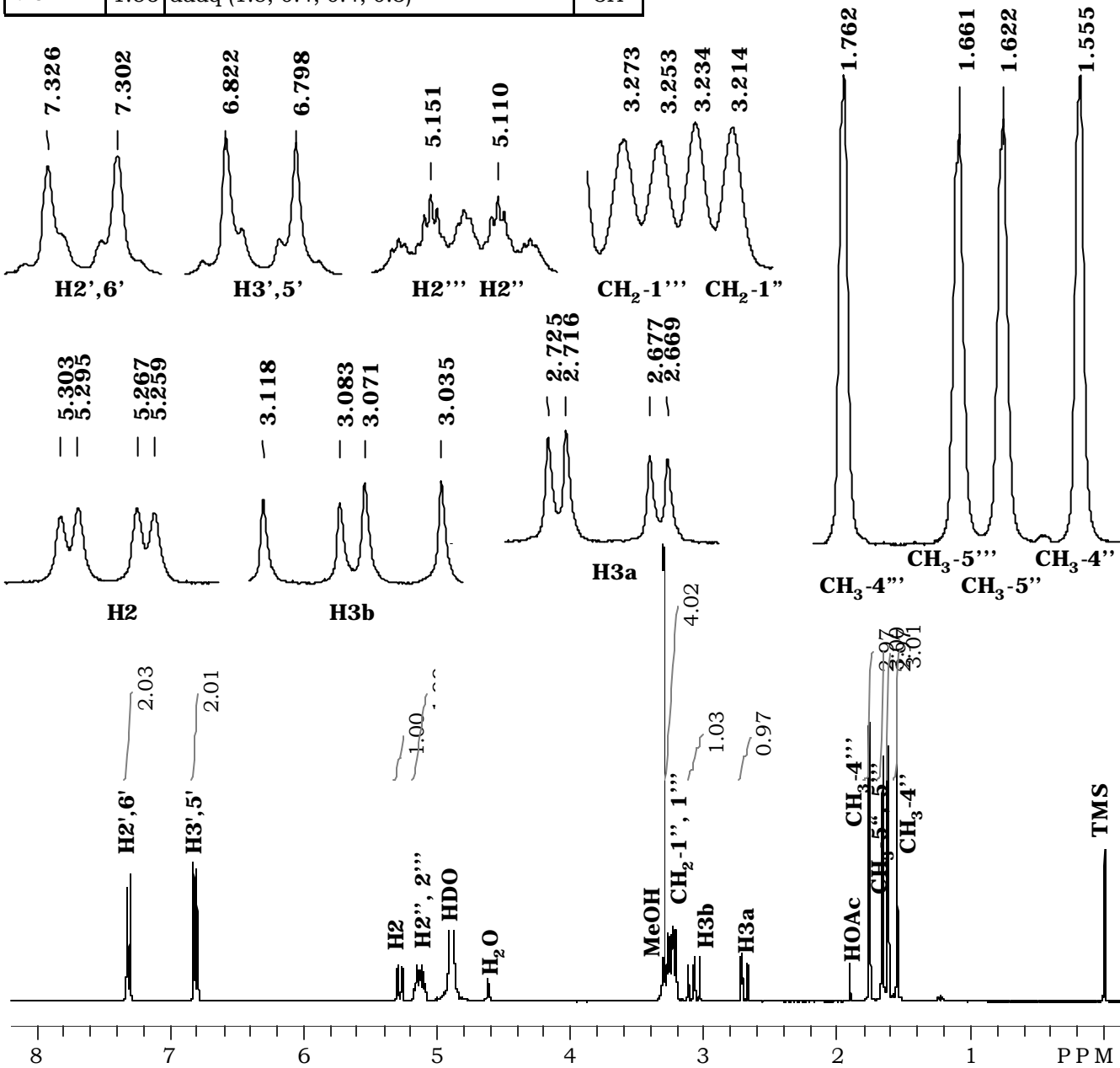
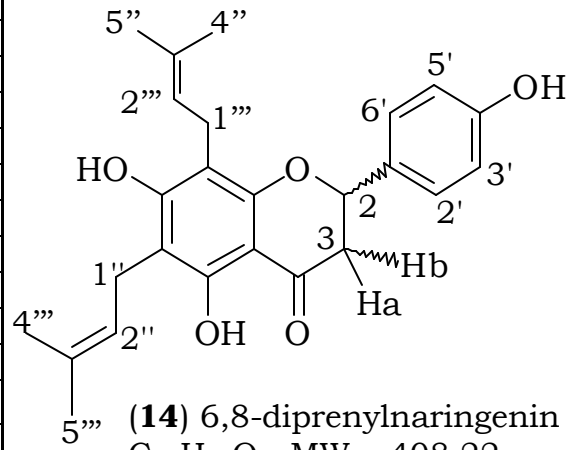

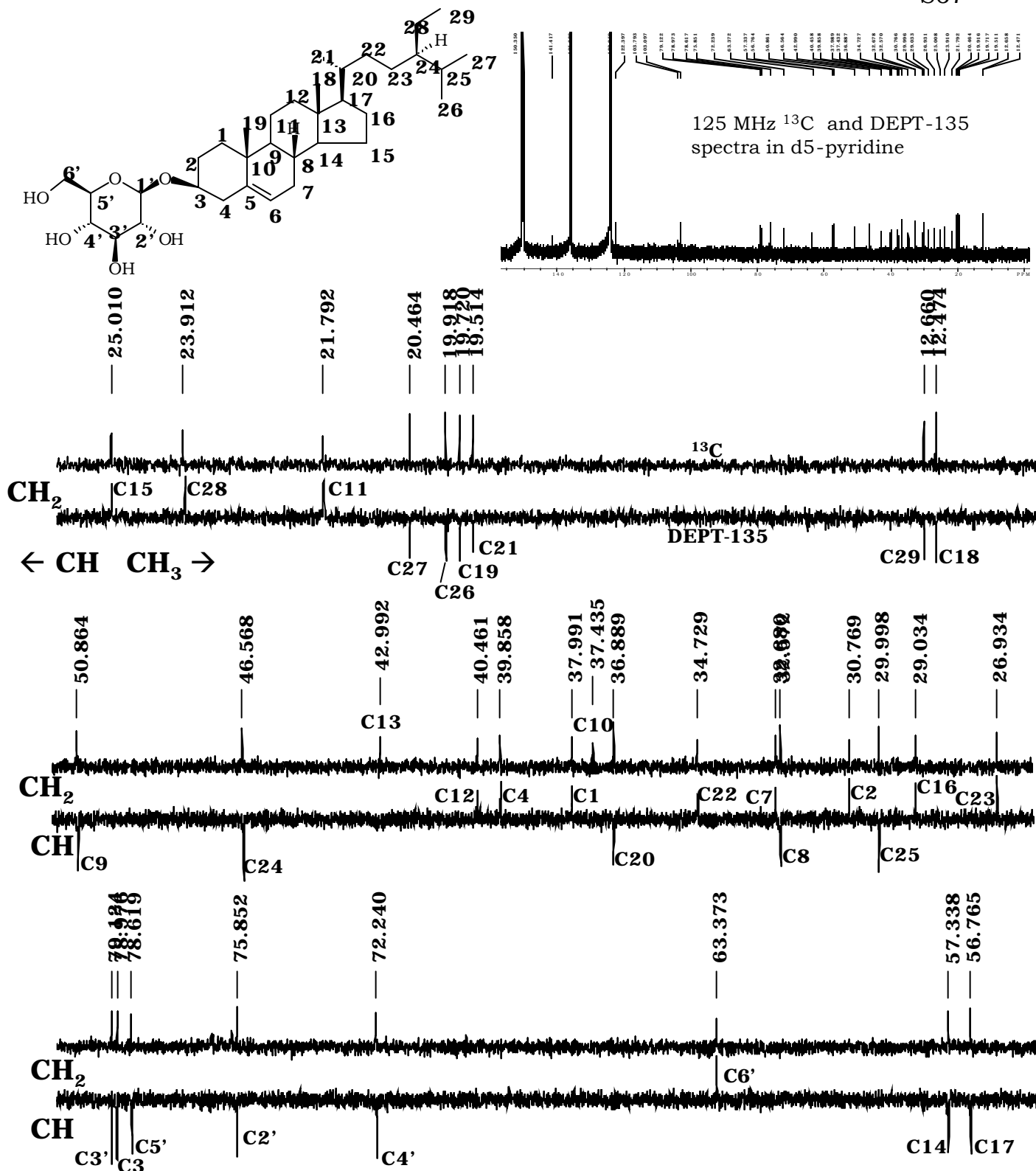

Assigned ^{13}C and DEPT-135 spectra of sitosterol-3-O- β -glucopyranoside **19**. The chemical shift values obtained in the present work agree precisely with values reported in the literature.

C	ppm	--> HMQC*	--> COSY
C			
5	141.417	-	-
10	37.43	-	-
13	42.99	-	-
CH			
3	78.97	3.97 m	
6	122.397	5.36, m (8.8)	H4b, 7a, 7b
8	32.57	- (ca. 1.38)	H7a, 7b
9	50.86	0.906 m	H11a
14	57.34	0.881 m	
17	56.76	1.13 m	
20	36.89	1.39 m	Me-21
24	46.56	1.00 m	H28a
25	30.00	1.69 m	Me26,29
1'	103.097	5.08 (d, 7.7)	H2'
2'	75.85	4.087 (dd 7.7, 9.2)	H1',3'
3'	79.12	4.323 (dd 9.2, 8.9)	H2',4'
4'	72.24	4.307 (9.0, 8.5)	H3',5'
5'	78.617	4.012 ddd (9.0, 5.4,	H4',6'a,6'b
CH2			
6'	63.37	4.442 (dd 11.8, 5.4)	H5',6'b
6'b		4.591 (dd 11.8, 2.1)	H5',6'a
1	37.99	1.75 m	H2a,1b
1b		0.98 m	H1a, H2a
2	30.77	2.16 m (23.1 Hz)	H3,1a,1b
2b		1.75 m	H3
4	39.86	2.75 ddm (13.1, 3.3,	H2a, 3, 4b
4b		2.50 ddm (12.6, ...)	H6,3,4a,7a,7b
7	32.68	1.93 m	H6,7b
7b		(COSY: 1.55)	H6
11	21.79	1.44 m	12a,9
11b		1.32 m	12a
12	40.458	1.99 ddd (12.8, 3.0,	H12b,11a,11b
12b		1.06 m	H12a
15	25.01	1.55 m	H15b
15b		1.06 m	H15a
16	29.03	1.85 m	H16b
16b		(1.25)	H16a
22	34.73	1.37 m	H23
22b		1.11 m	H23
23	26.93	1.26 m	H22
23b		1.26 m	H22
28	23.91	1.57 m	H28b
28b		1.06 m	H28a
CH3			
18	12.471	0.67 s	
19	19.72	0.95 s	
21	19.51	1.00 d (6.3)	H20,
26	19.92	0.88 d (10.0)	
27	20.46	0.89 d (10.0)	
29	12.66	0.91 t (7.5)	

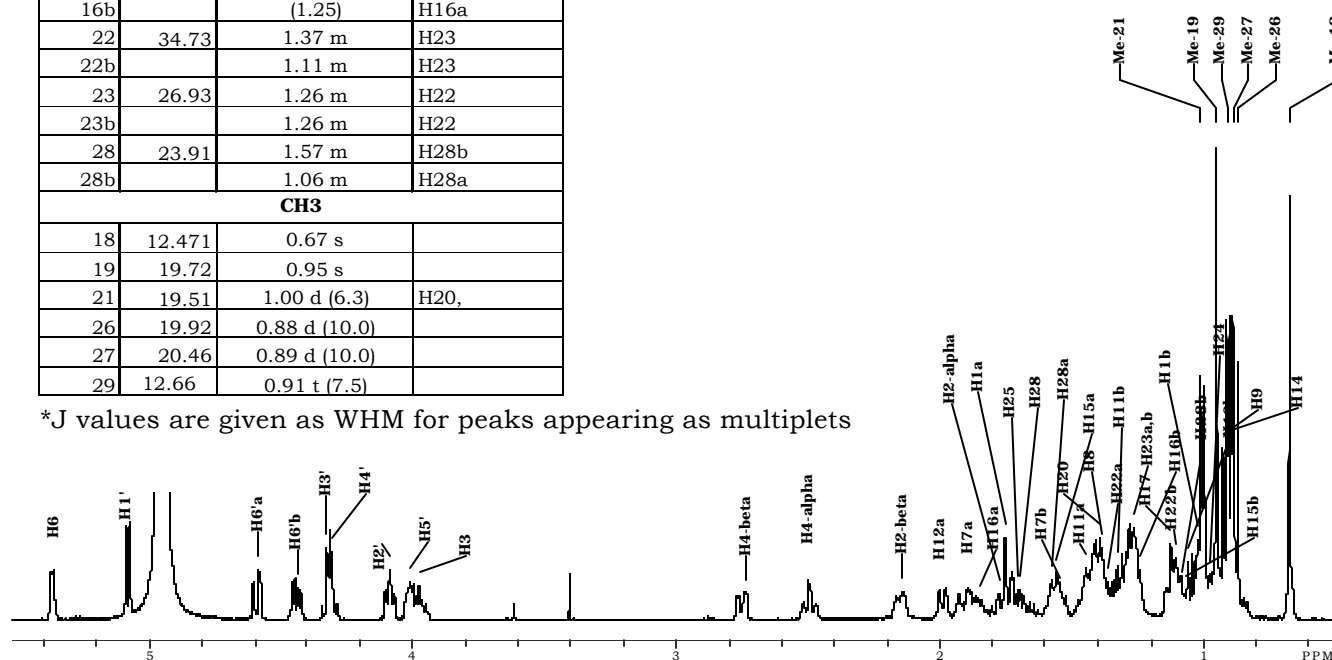
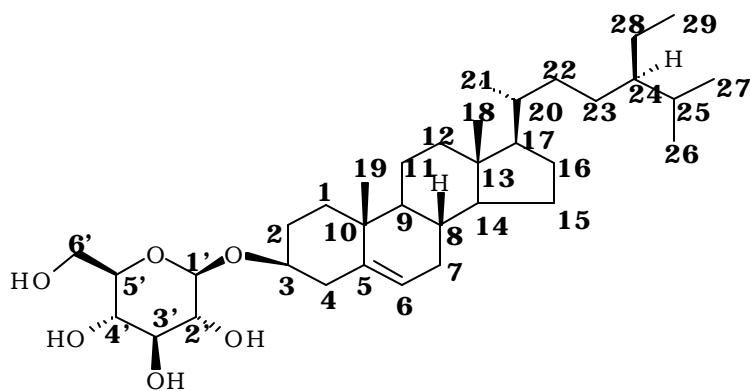

*J values are given as WHM for peaks appearing as multiplets

500 MHz ^1H NMR spectrum of sitosterol-3-O- β -glucopyranoside **19** in pyridine- d_5

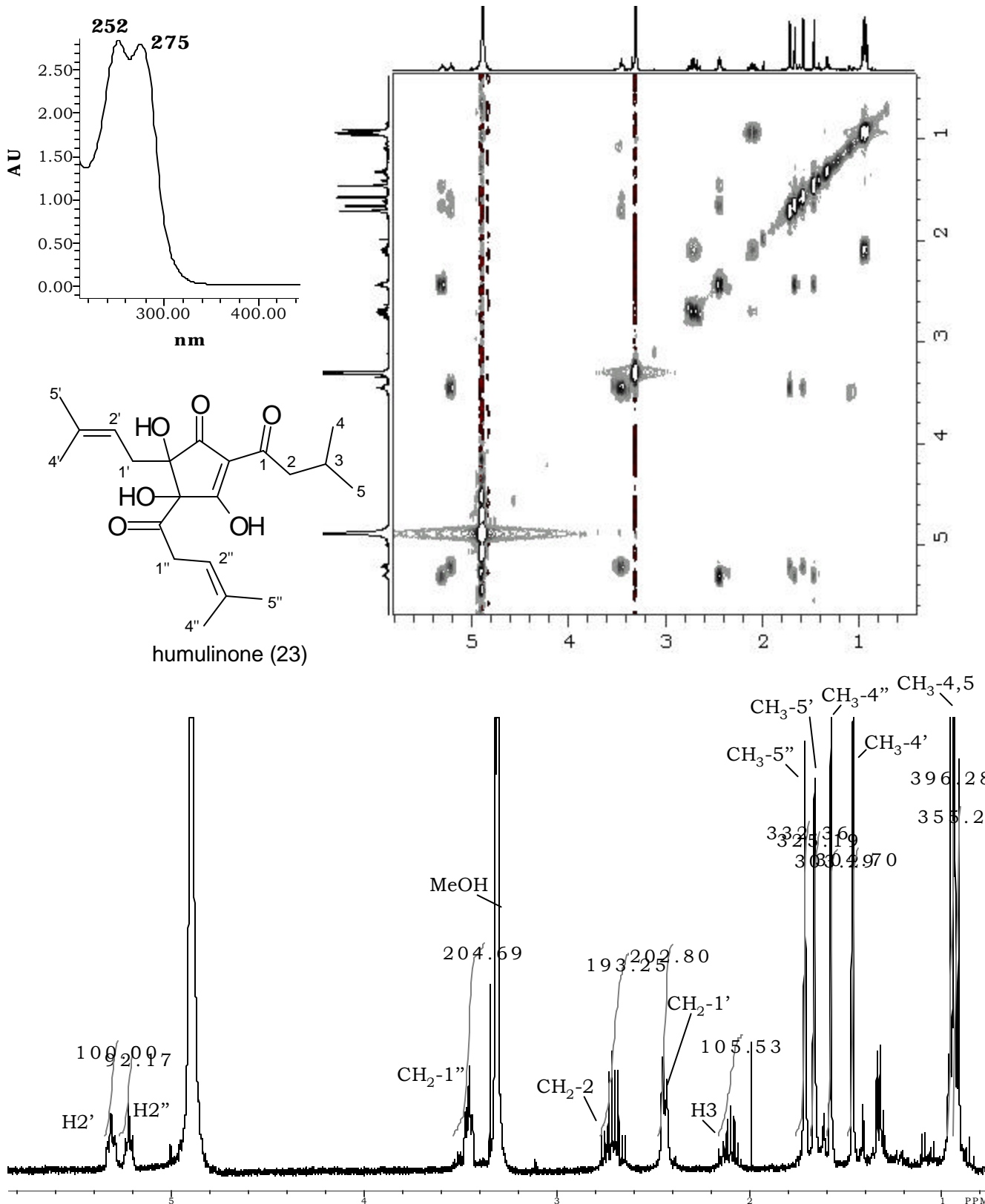
UV, ¹H NMR and COSY spectra of humulinone **20**

HLLC 49-84 or K48

hlmay270317 42 (2.177)

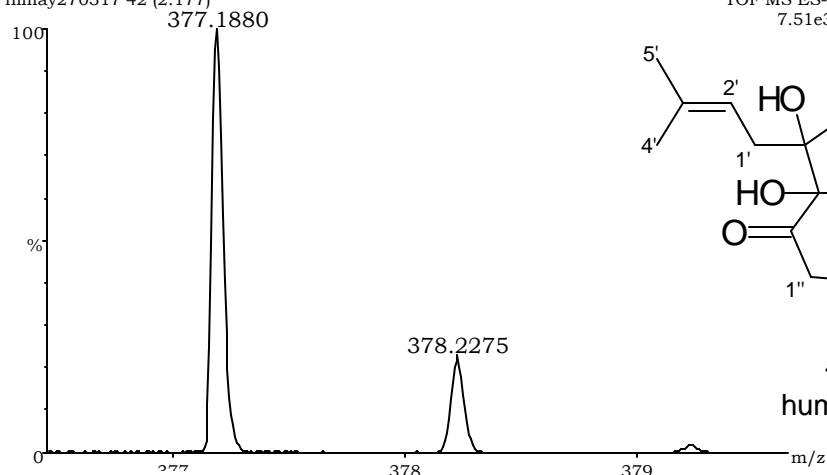
**HLLC 49-84 or K48**

hlmay270317 42 (2.177)

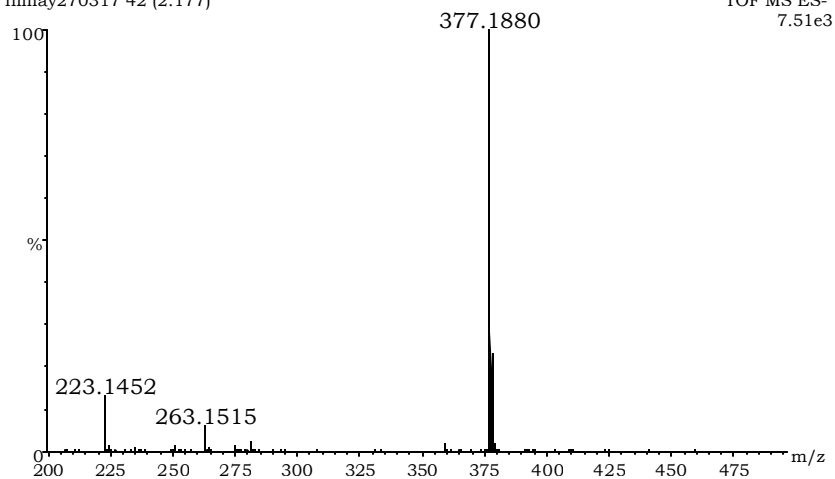
**HLLC 49-84 or K48 MS/MS at 25 ev**

hlmay270318 17 (0.880)

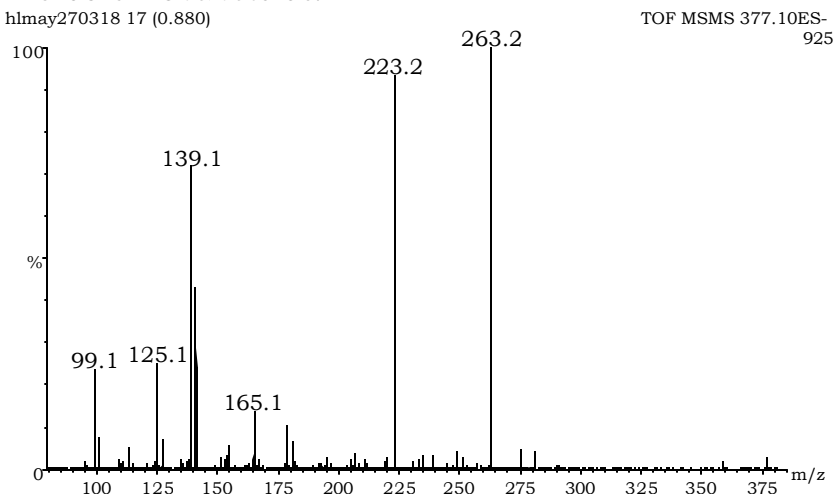

ESI spectra of compound humulinone (**23**). Above, enlargement of $[M-H]^-$ region. middle, 200-500 AMU scan of sample. below, MS² fragmentation.

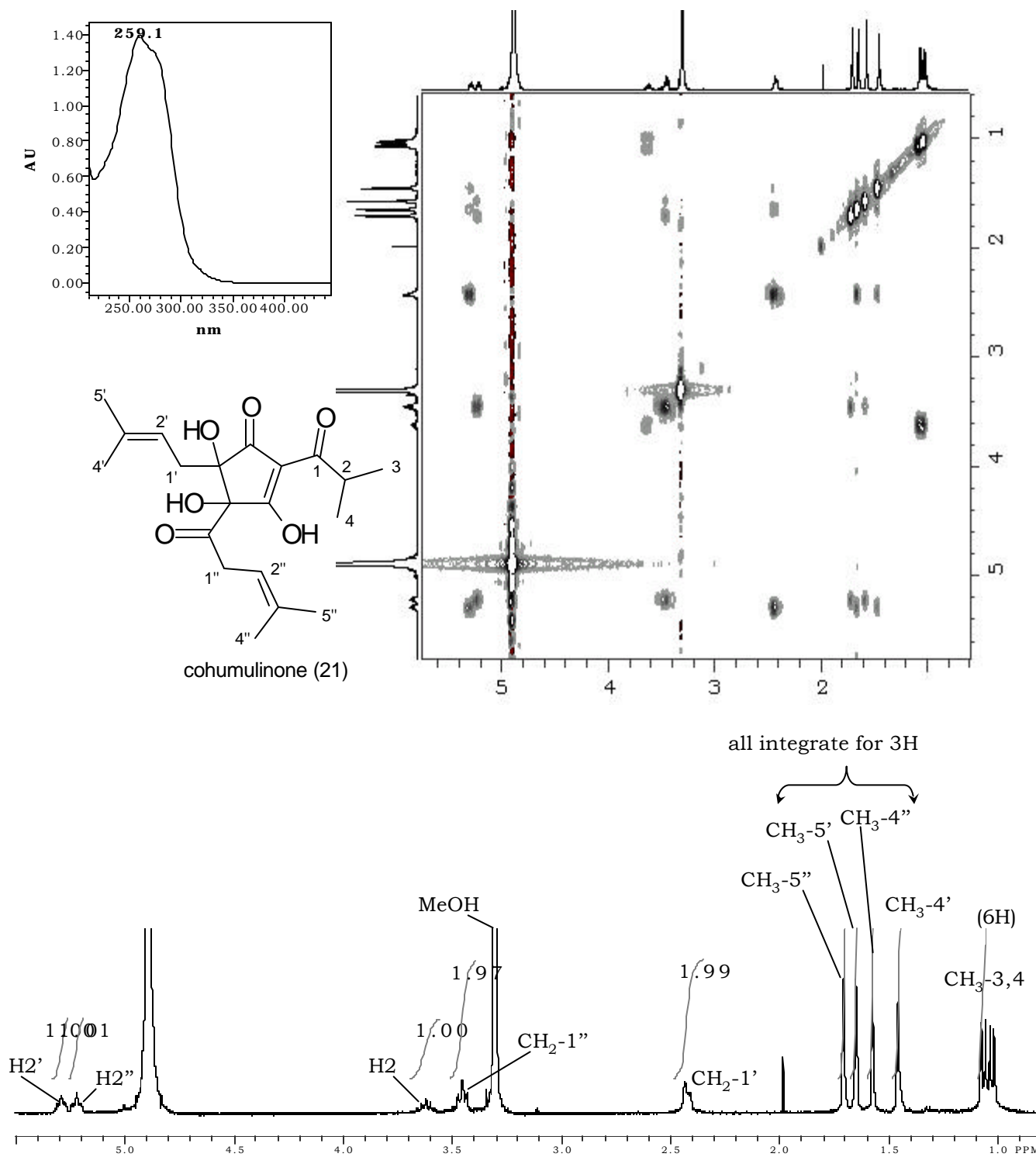
UV, ¹H NMR and COSY spectra of cohumulone **21**.

HLLC 49-110 or K49

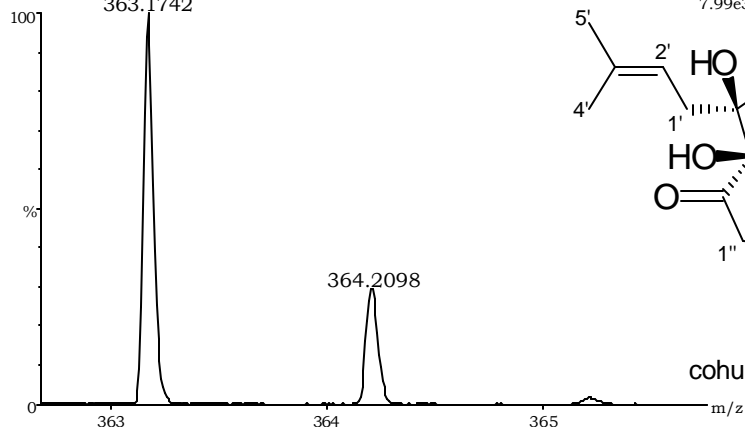
hlmay270319 52 (2.691)
363.1742

HLLC 49-110 or K49

hlmay270319 52 (2.691)

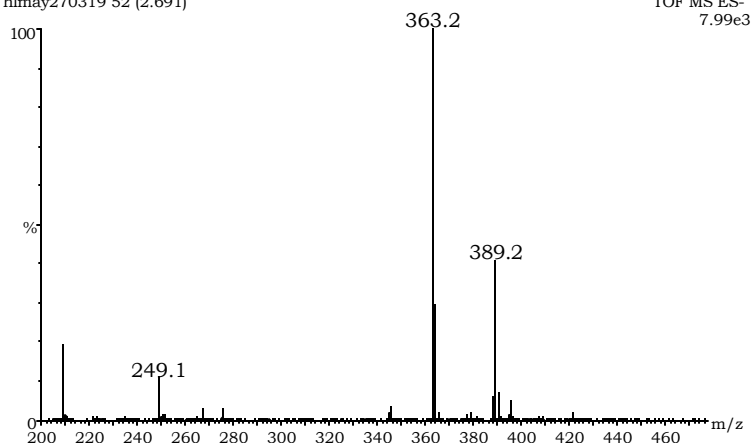

HLLC 49-110 or K49 MS/MS at 25 eV

hlmay270320 3 (0.155)

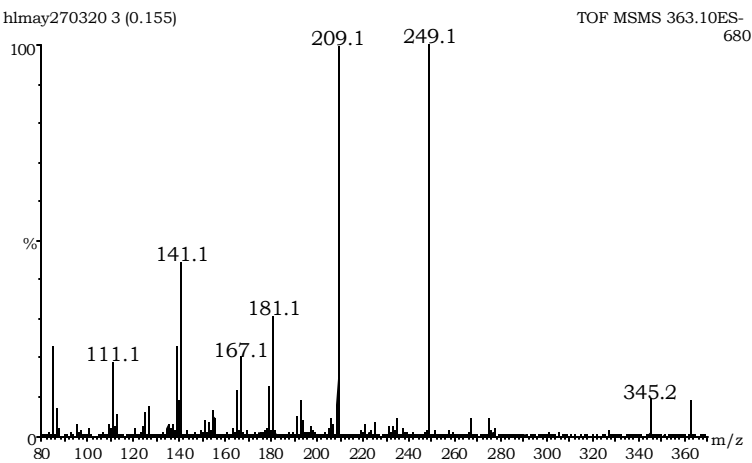

ESI spectra of cohumulone (**21**). Above, enlargement of $[M-H]^-$ region. middle, 200-500 AMU scan of sample. below, MS^2 fragmentation.

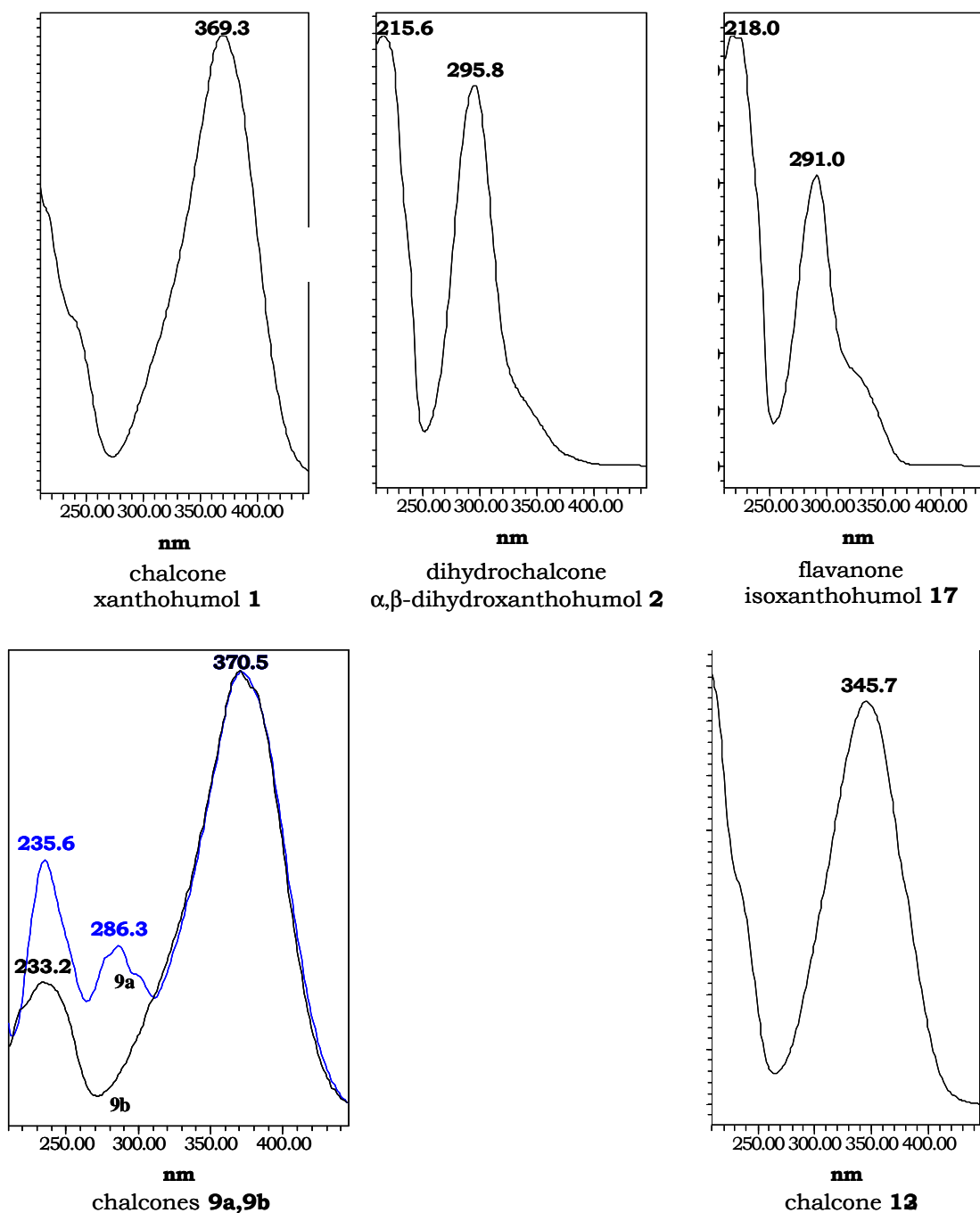
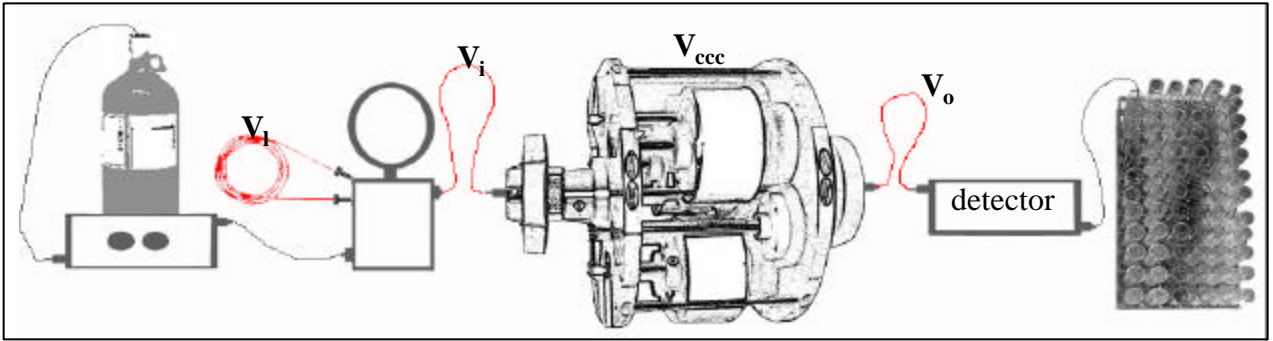

Figure 77 Comparison of UV spectra for chalcones and flavanones from hops. All UV spectra for chalcones with a free 5' or 8a- hydroxy group and no additional elements of saturation (**3-6,8,9b-11,14**) were essentially the same as for XN 1. The spectra of the flavanones **15,16** were indistinguishable from that of IX 17.



(carry-over method)

$$K_{CO} \equiv \frac{V_R - V_m}{V_S}$$

Carry-over method with dead-volume correction ($K_{D,CO}$)

$$K_{CO} = \frac{f(t_r) - V_m}{V_{CCC} - V_m}$$

$$K_{D,CO} = \frac{t_r - t_{0,CO}}{t_{1,d,D} - t_{0,CO}}$$

 V_{ccc} = **volume of CCC column** V_m = **mobile phase volume** t_r = **retention time of analyte** f = **flow rate** $t_{0,CO} \equiv V_{0,CO}/f$ $V_{0,CO} = V_m + V_{d,D}$ $t_1 = V_{0,CO} / \text{flow} = \text{retention time of analyte w/ } K=1$ $t_{1,d,D} \equiv t_1 + t_{d,D}$ $V_{d,D} = V_i/2 + V_{f,D}$ $V_{f,D} \equiv V_i + V_o$ $t_{d,D} = V_{d,D} / f$ V_1 = **sample loop volume** V_i = **dead volume between loop and column** V_o = **dead volume between column and detector**

(marker method)

$$K_M \equiv \frac{t_R - t_{0,M}}{V_{ccc}/\text{flow} - t_{0,M}}$$

Marker method with dead-volume correction ($K_{D,M}$)

$$K_M = \frac{t_R - t_{0,M}}{V_{ccc}/f - t_{0,M}}$$

$$K_{D,M} = \frac{t_R - t_{0,M}}{t_{1,d,D} - t_{0,M}}$$

 V_1 = **sample loop volume** V_i = **volume between loop and column** V_{ccc} = **volume of CCC column** V_o = **volume between column and detector** t_r = **retention time of analyte** $t_{0,M} \equiv \text{retention time of unretained marker}$ f = **flow rate** $t_{1,d,D} = t_1 + t_{d,D}$ $t_1 = V_{ccc}/\text{flow} = \text{retention time of analyte w/ } K=1$ $t_{d,D} = V_{d,D} / f$ $V_{d,D} = V_i/2 + V_{f,D}$ $V_{f,D} \equiv V_i + V_o$

Determination of partition coefficients by CCC. Experimentally defined variables used in calculation of corresponding K_p value in **bold** font; formulas are from Dr. W. D. Conway, "Extra-column Dead Volume in Countercurrent Chromatography (CCC)" poster #158 at ASP Meeting #44, Chapel Hill, NC, July 12-16, 2003 (and references therein).

254 nm

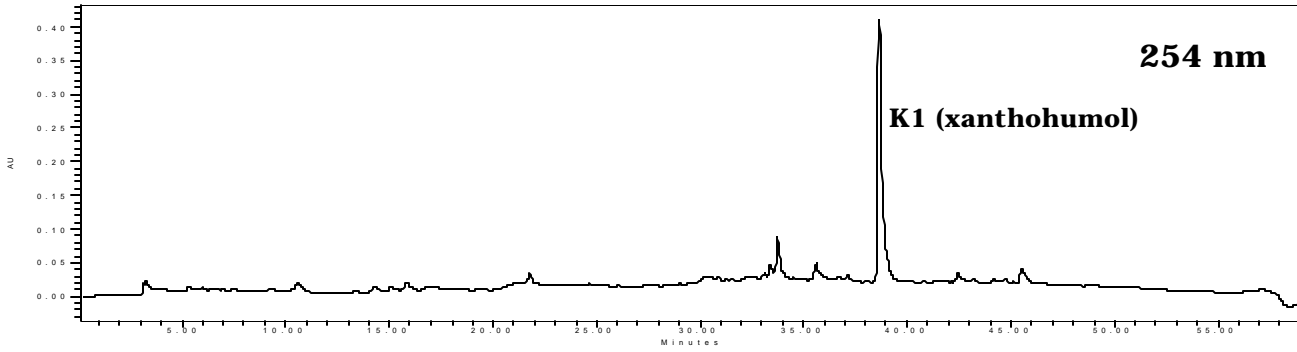

270 nm

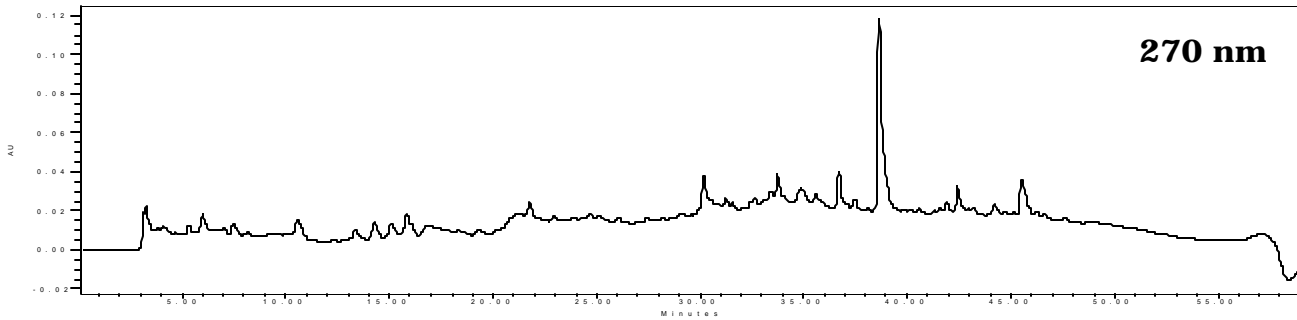

290 nm

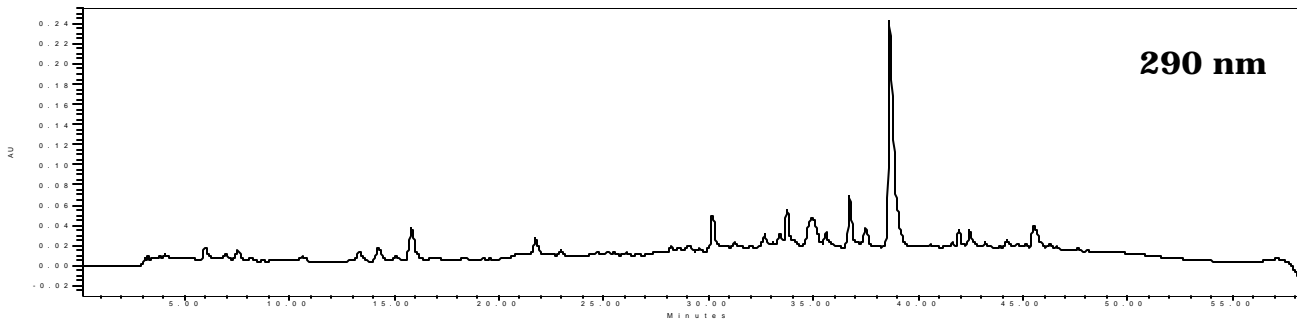

370 nm

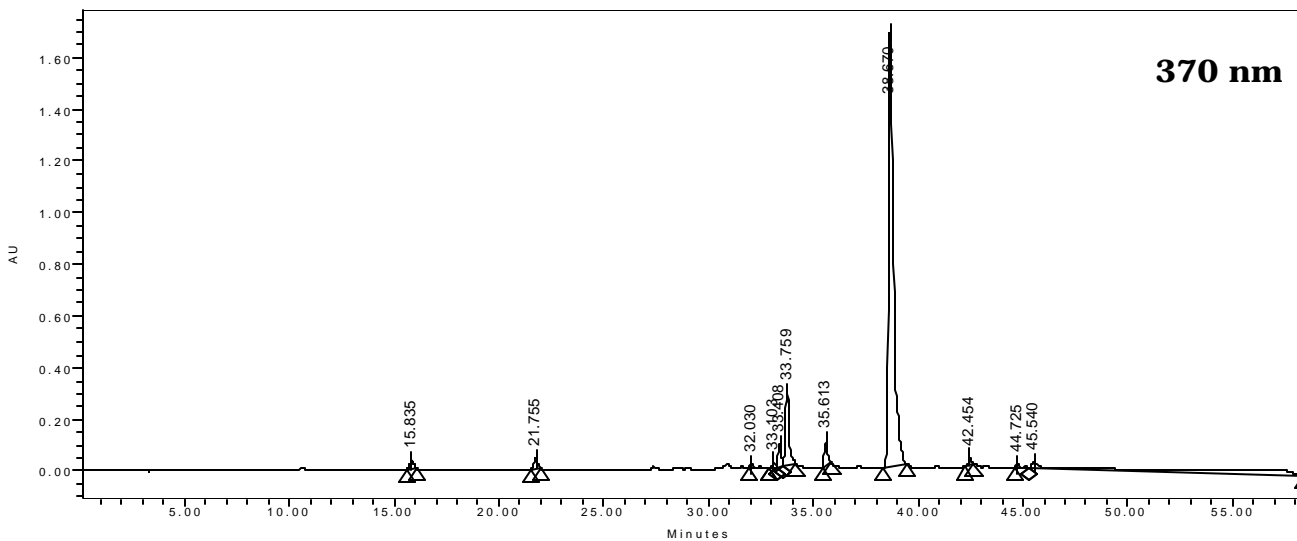

HPLC chromatogram of chloroform partition **P3** extracted at various wavelengths. As measured by UV, even at its absorbance minimum (270 nm), xanthohumol is the major component of this crude partition of spent hops.