

CYTOKINE RECEPTOR INTERACTION

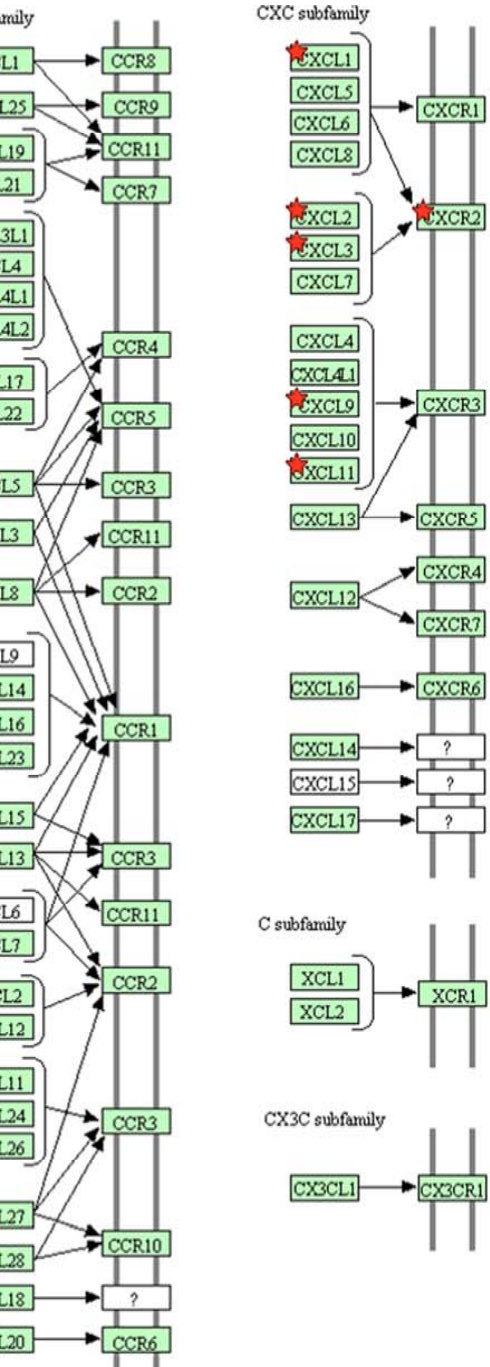

The class I helical cytokines  
γ-chain utilising

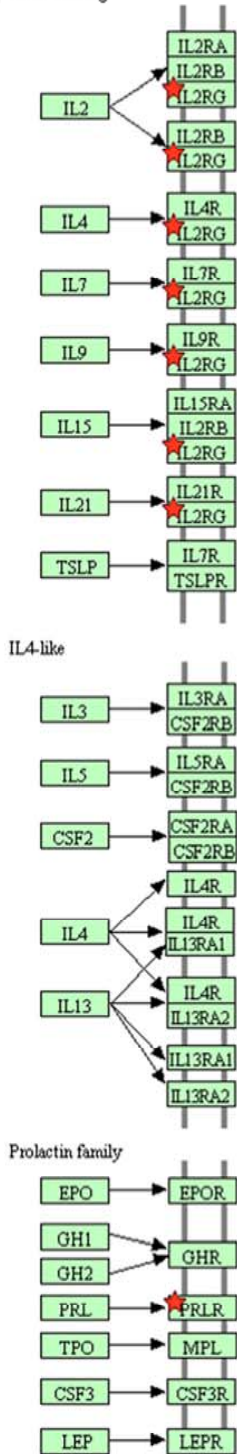

The class II helical cytokines

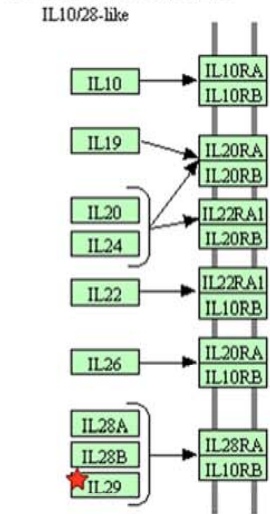

IL6/12-like

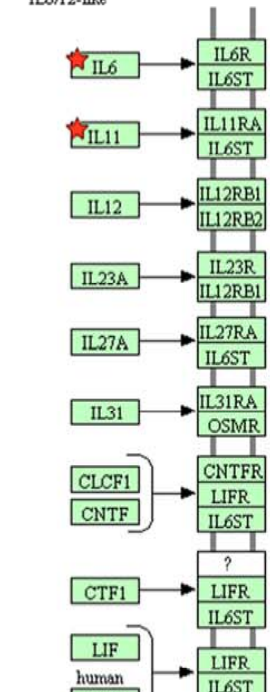

Interferon family

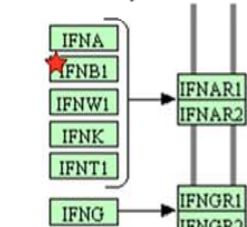

IL1-like cytokines

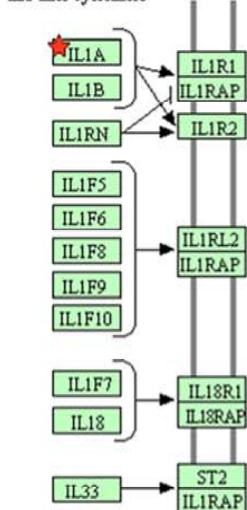

IL17-like cytokines

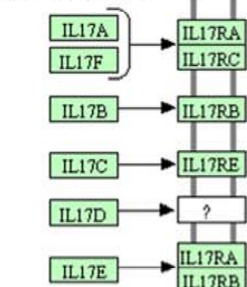

Non-classified

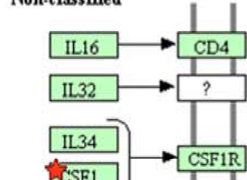

TNF Family

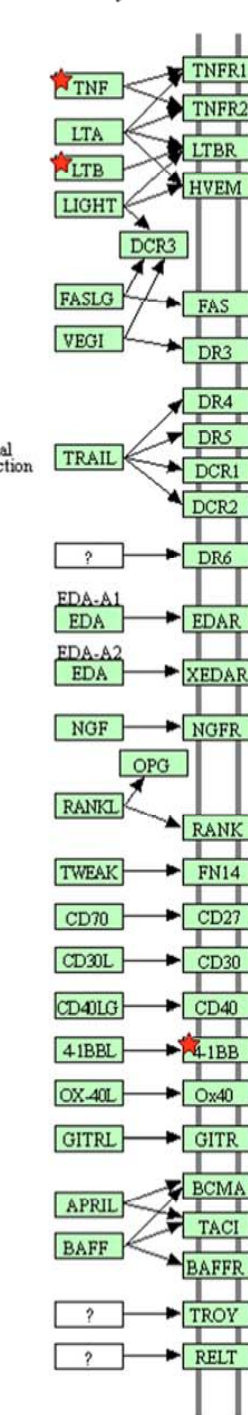

TGF-β family

