

No coding regions due to antisense transcription.

**SUPPORTING READ COUNT**

Split reads in IL7 = 0

Split reads in AC083837.1 = 1

Discordant mates = 1

Sample # SRR5120911

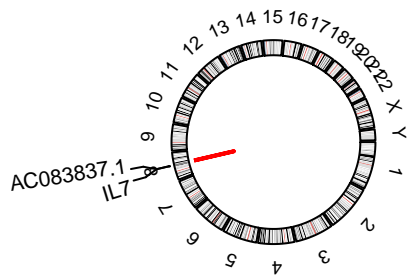
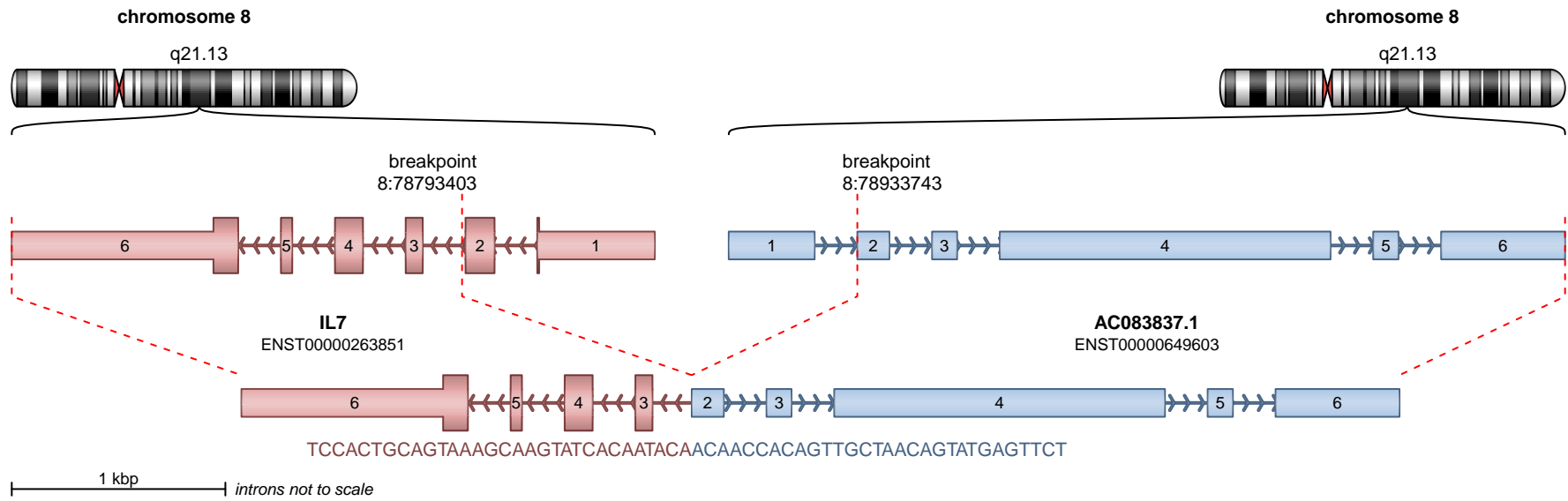

No coding regions due to antisense transcription.

**SUPPORTING READ COUNT**

Split reads in IL7 = 1  
 Split reads in AC083837.1 = 0  
 Discordant mates = 1

Sample # SRR5120918

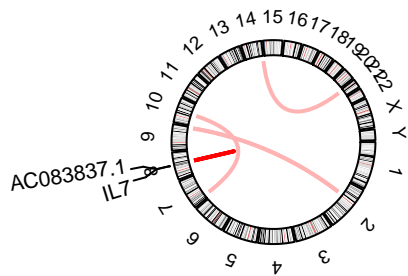
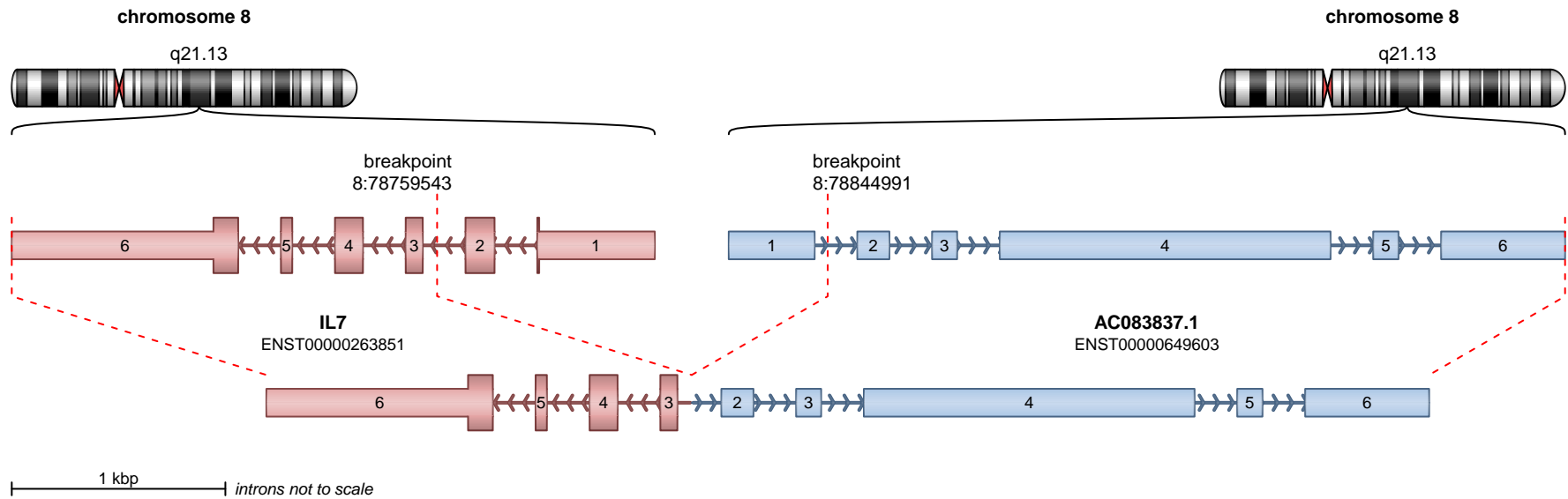

No coding regions due to antisense transcription.

**SUPPORTING READ COUNT**

Split reads in IL7 = 0  
 Split reads in AC083837.1 = 0  
 Discordant mates = 15

Sample # SRR5642422

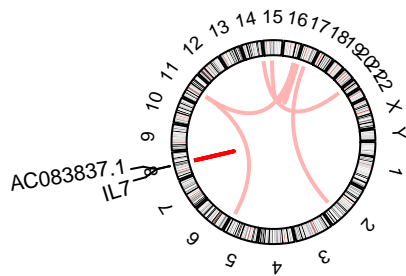
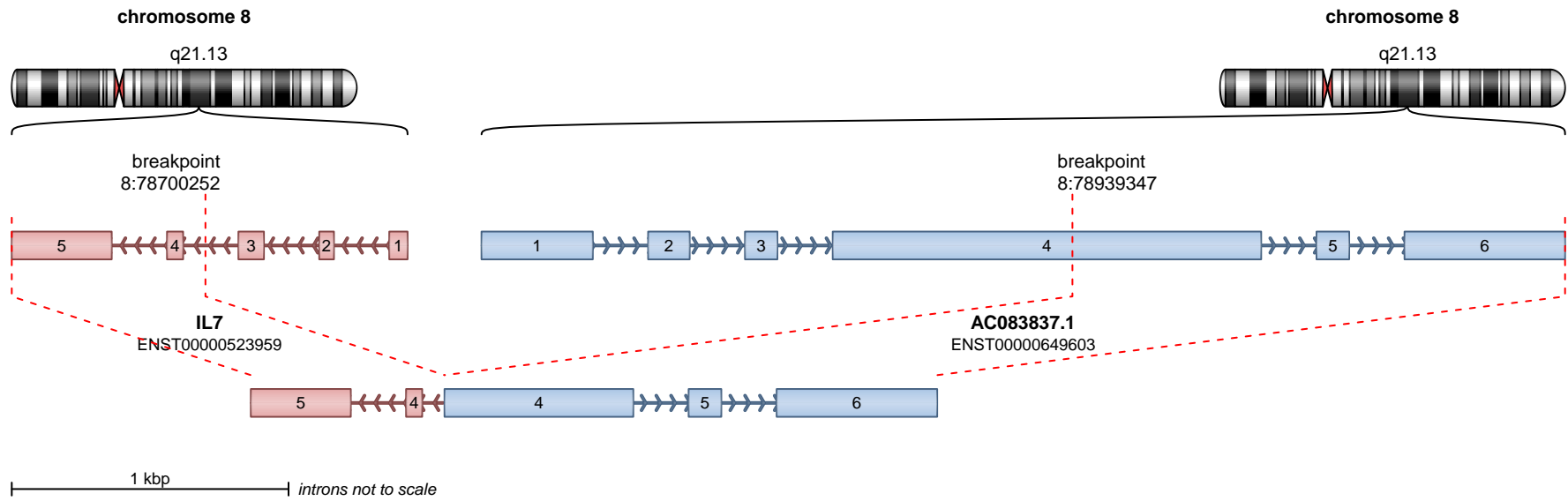

Genes are not protein-coding.

**SUPPORTING READ COUNT**

Split reads in IL7 = 0  
 Split reads in AC083837.1 = 0  
 Discordant mates = 6

Sample # SRR5642424

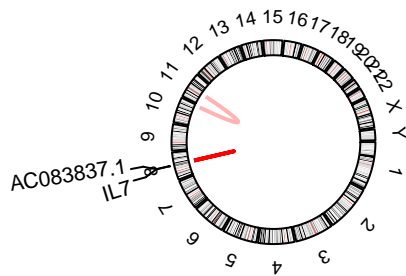
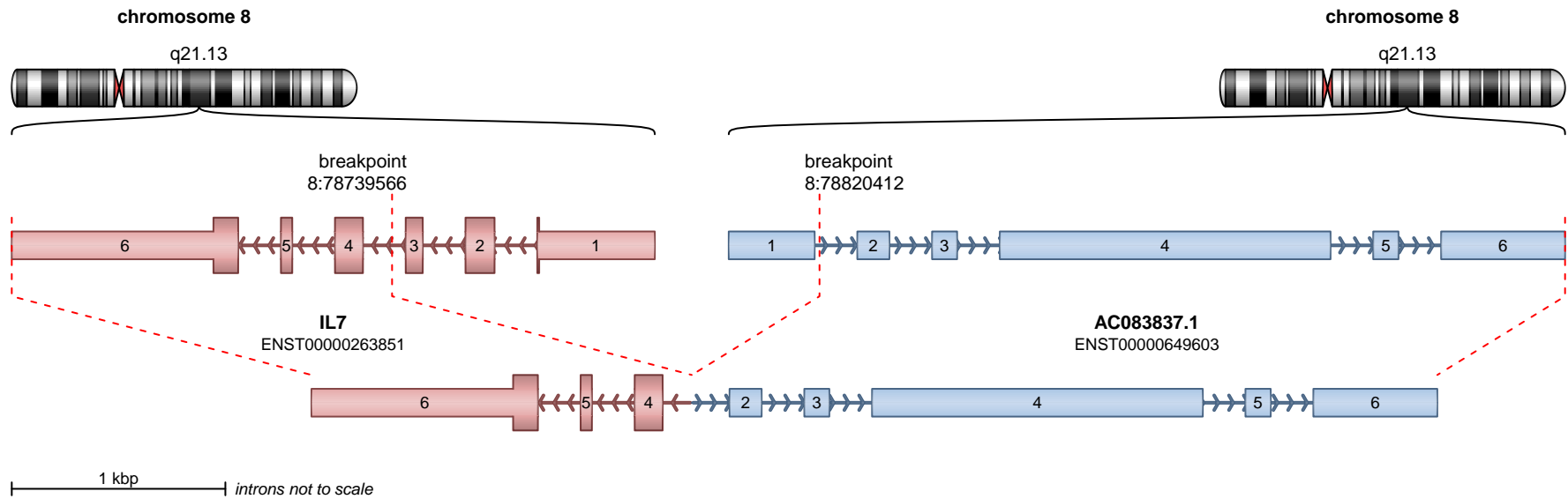

No coding regions due to antisense transcription.

**SUPPORTING READ COUNT**

Split reads in IL7 = 0  
 Split reads in AC083837.1 = 0  
 Discordant mates = 12

Sample # SRR5642427

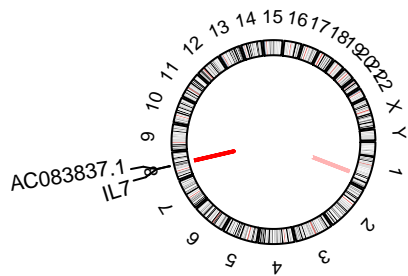
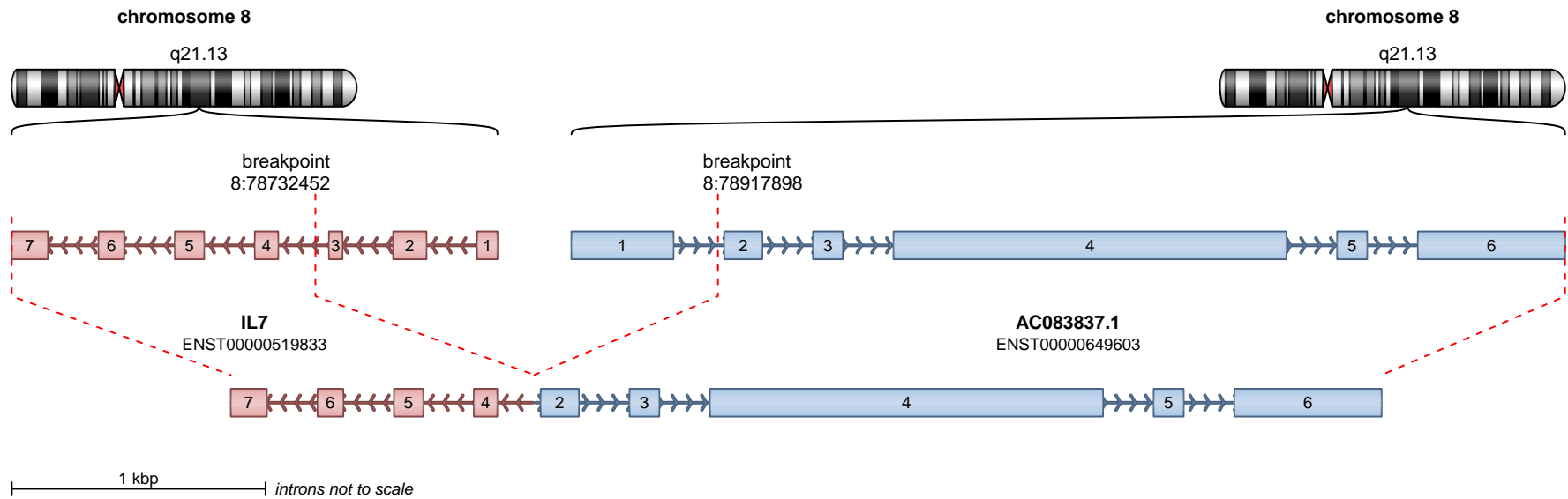

Genes are not protein-coding.

**SUPPORTING READ COUNT**

Split reads in IL7 = 0  
 Split reads in AC083837.1 = 0  
 Discordant mates = 12

Sample # SRR5642428

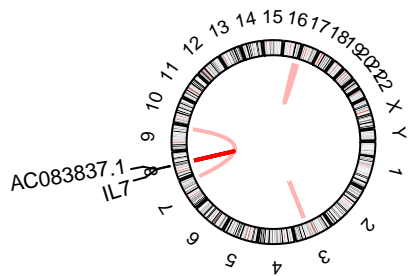
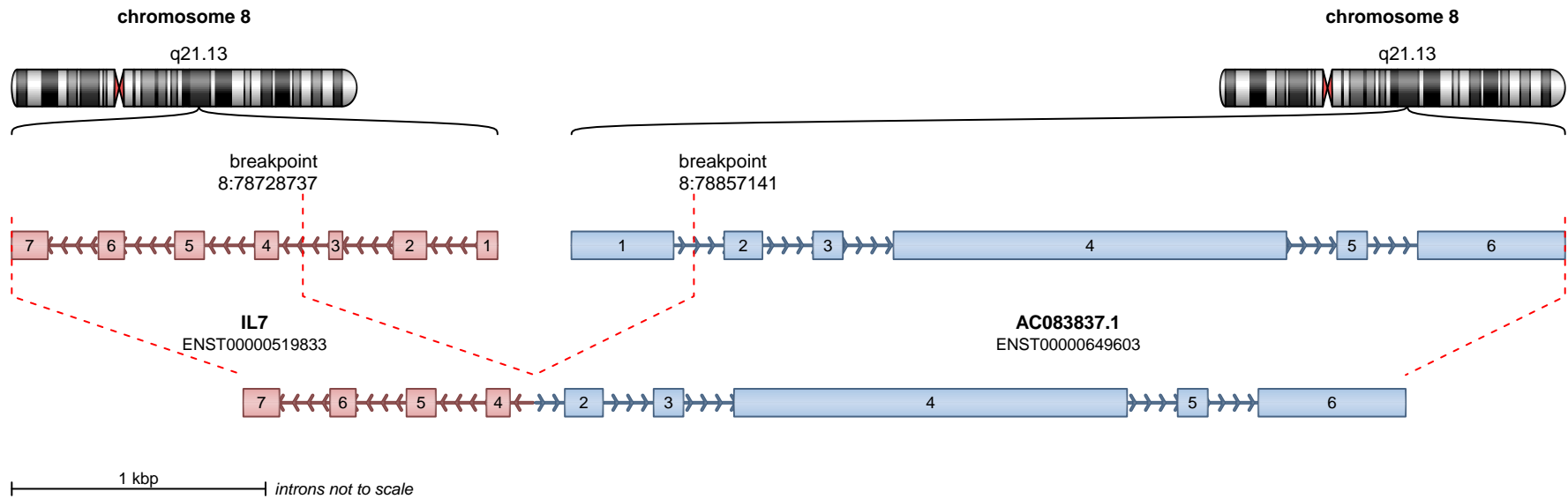

Genes are not protein-coding.

**SUPPORTING READ COUNT**

Split reads in IL7 = 0

Split reads in AC083837.1 = 0

Discordant mates = 7

Sample # SRR5642431

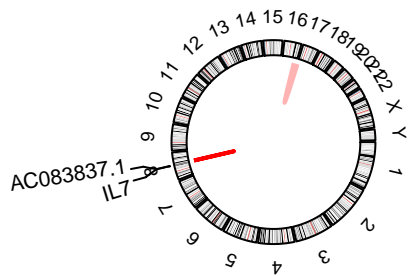
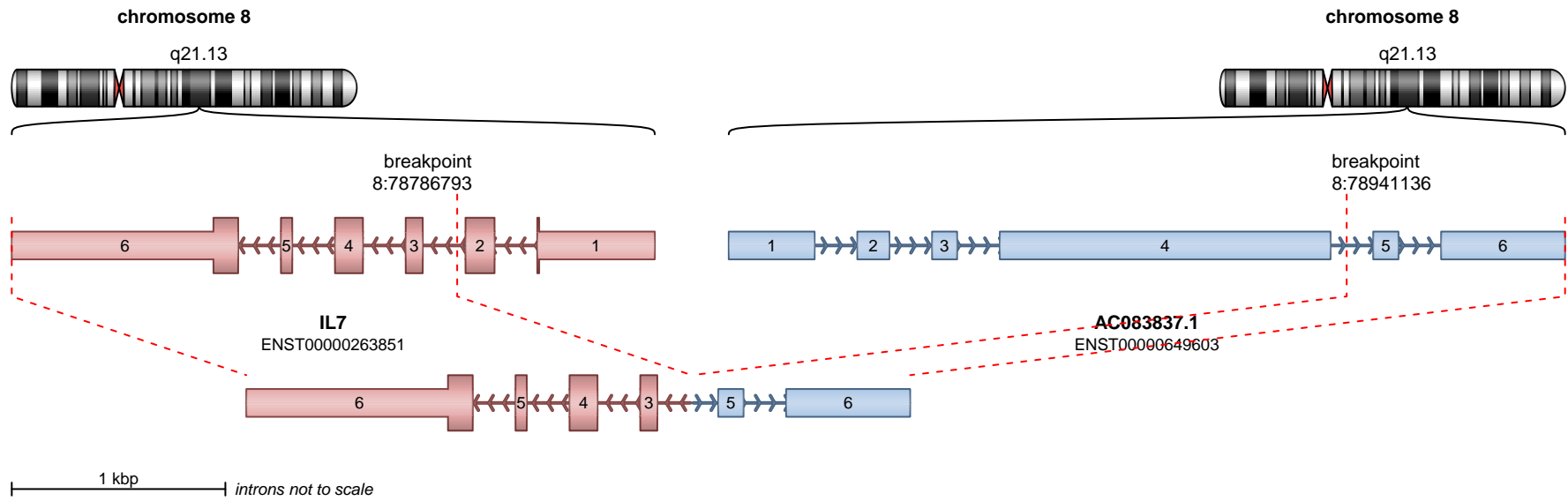

No coding regions due to antisense transcription.

**SUPPORTING READ COUNT**

Split reads in IL7 = 0  
 Split reads in AC083837.1 = 0  
 Discordant mates = 12

Sample # SRR5642434