

Supplemental Figure. S17: MS2 spectra for single peptide identifications and phospho STY

RO-QC-160121_ZackD_SS_Set_01_Fraction 7132 FTMS; HCl 80.52 485.27 SRSF4

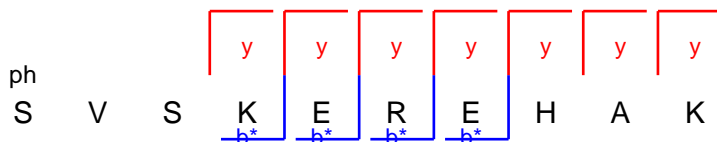

RO-QC-160121_ZackD_SS_Set_01_Fraction 7306 FTMS; HCl 92.06 696.36 TLK1

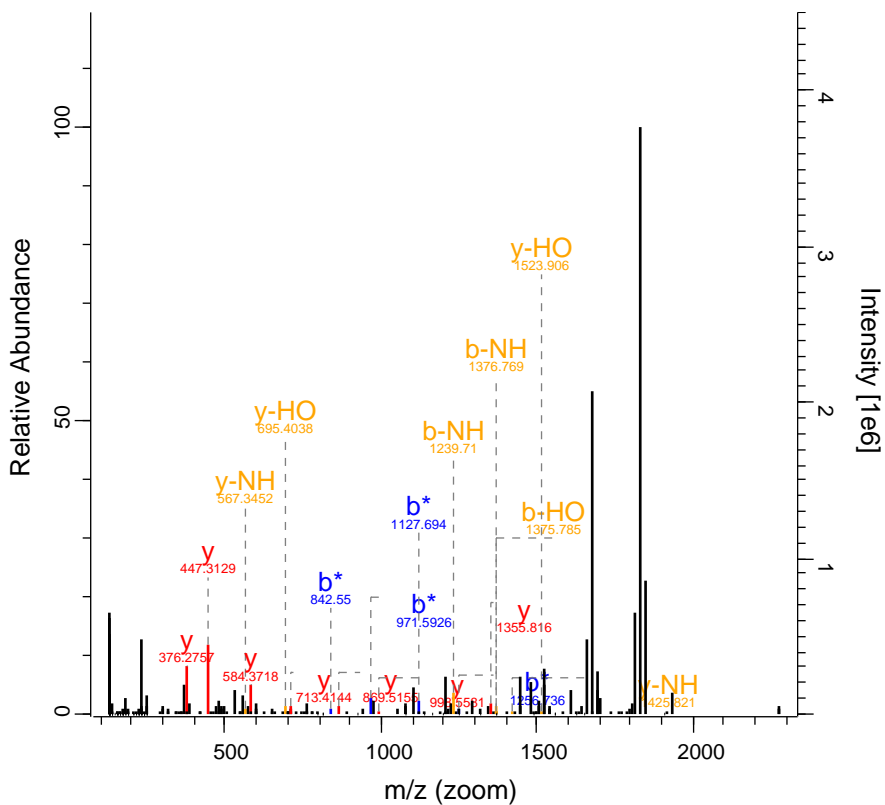
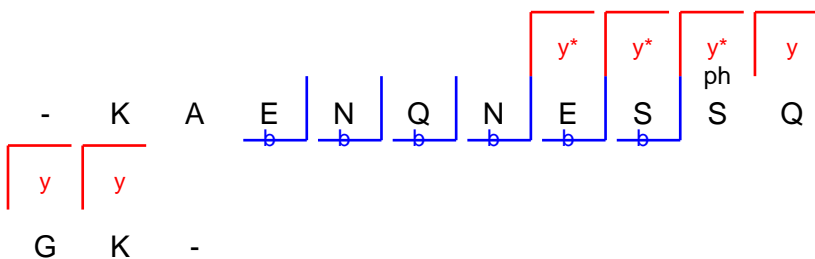
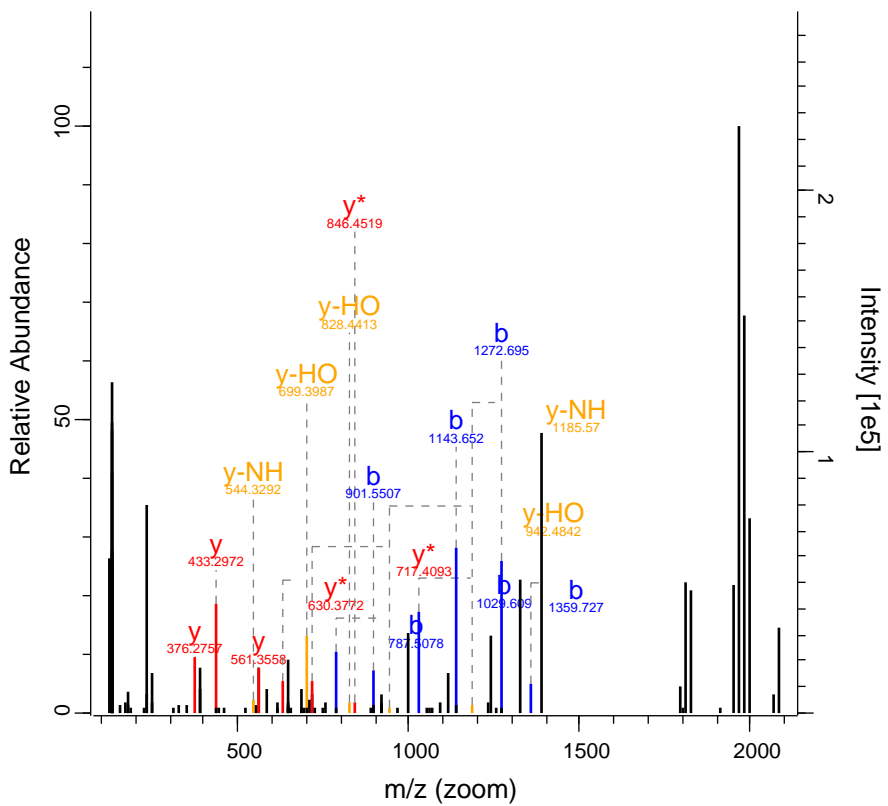

G K -

RO-QC-160121_ZackD_SS_Set_01_Fraction 7333 FTMS; HCl 40.35 486.6 MEFV

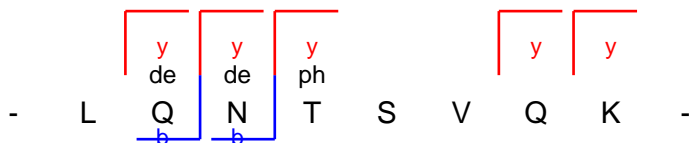
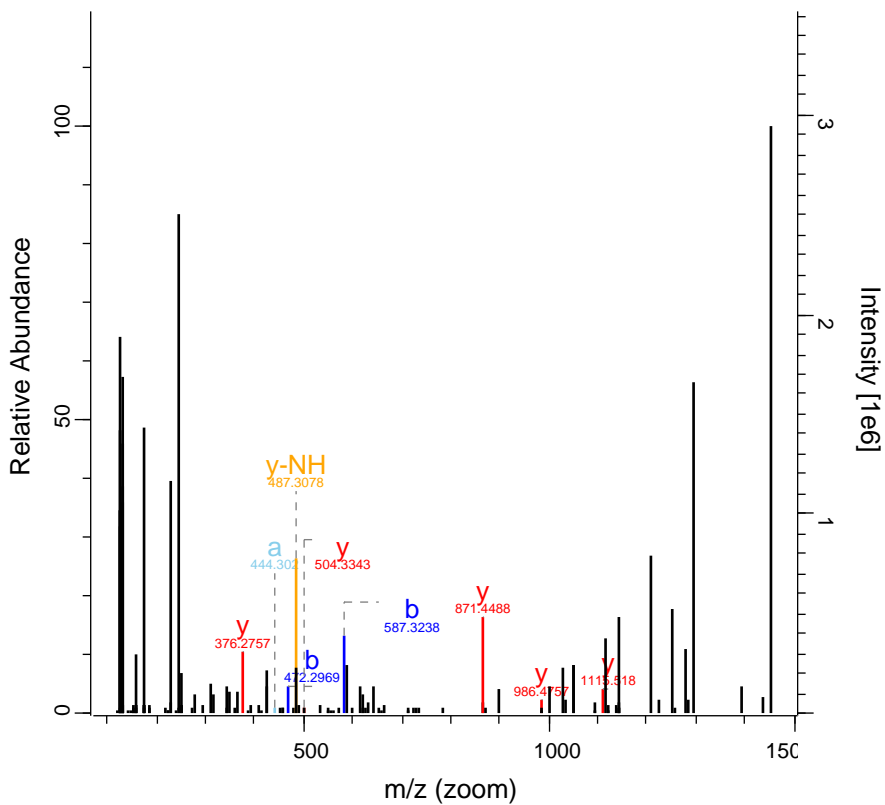

RO-QC-160121_ZackD_SS_Set_01_Fraction 8128 FTMS; HCl 59.73 723.73 PPIG

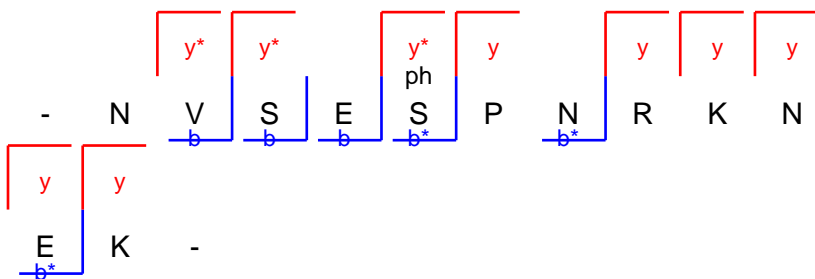
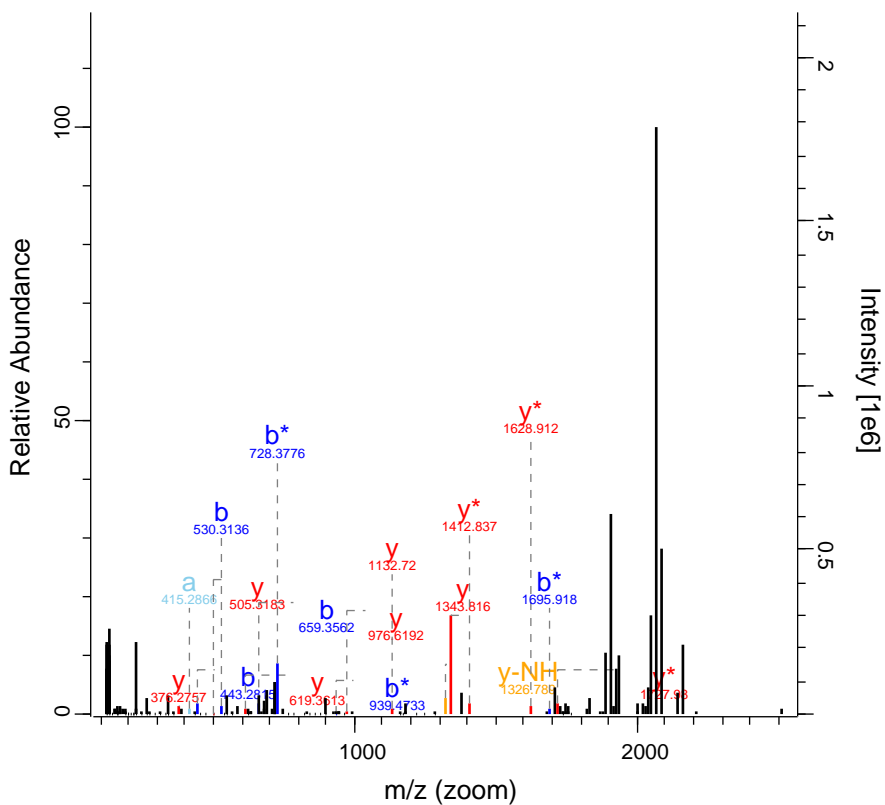

RO-QC-160121_ZackD_SS_Set_01_Fraction 8937 FTMS; HCl 95.36 496.6 LMNA

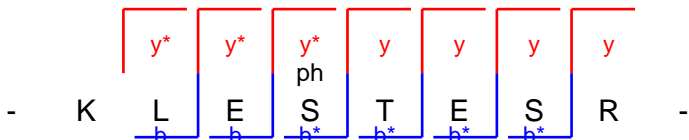
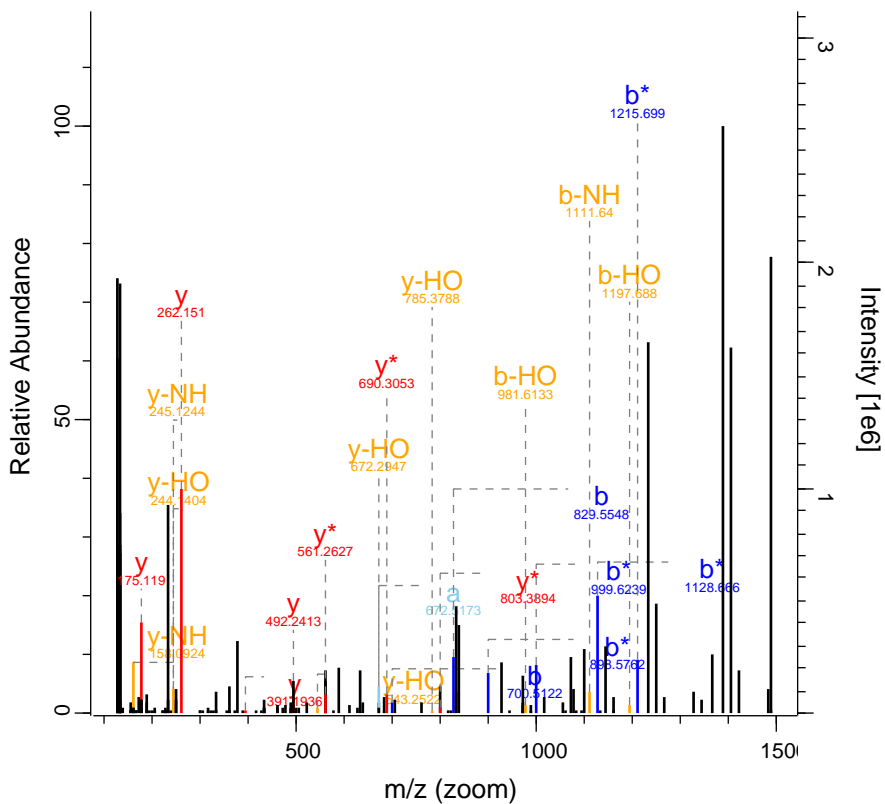

RO-QC-160121_ZackD_SS_Set_01_Fraction 9165 FTMS; HCl 47.07 776.86 CCNL1

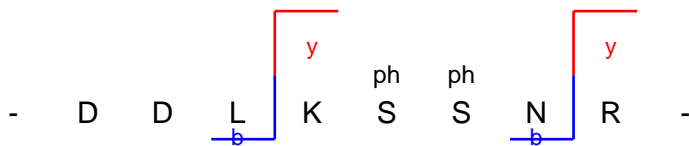
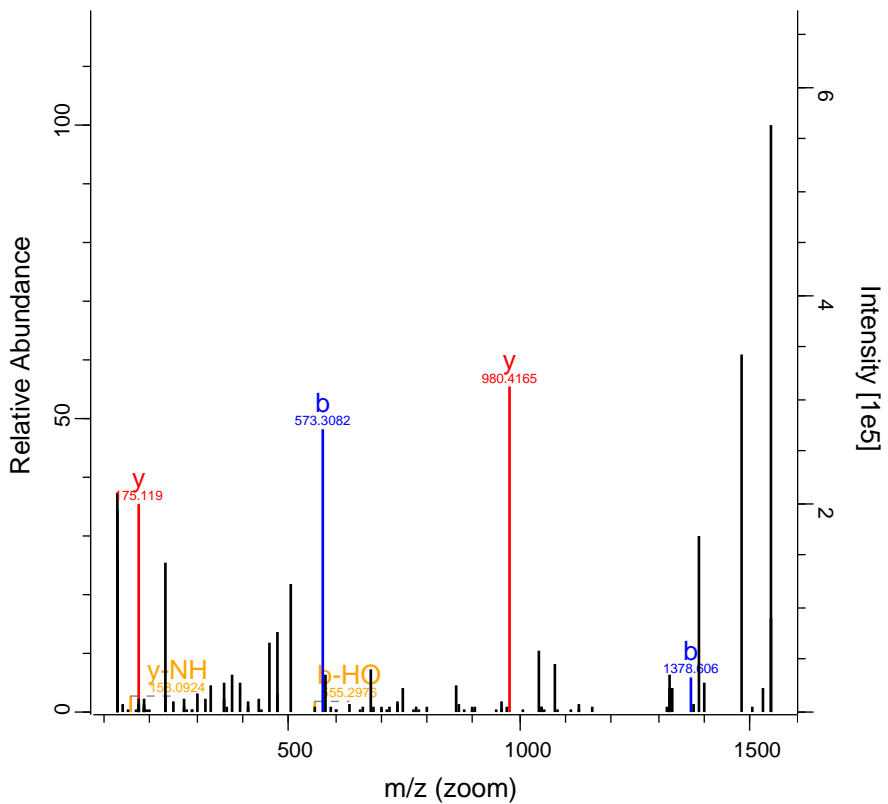

RO-QC-160121_ZackD_SS_Set_01_Fraction 9449 FTMS; HCl 72.43 671.35 AKAP8L

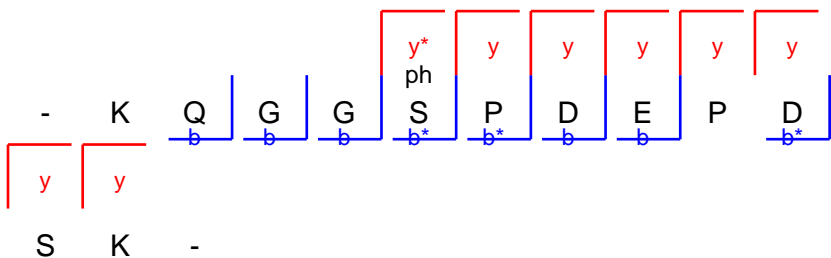
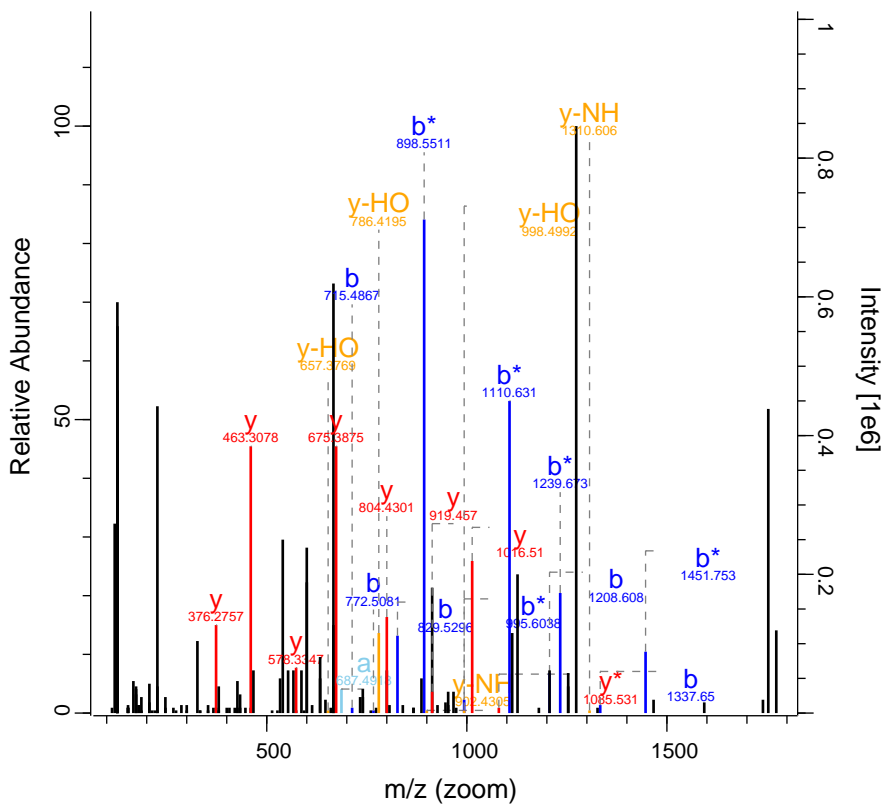

RO-QC-160121_ZackD_SS_Set_01_Fraction 9784 FTMS; HCl 52.58 527.62 TCOF1

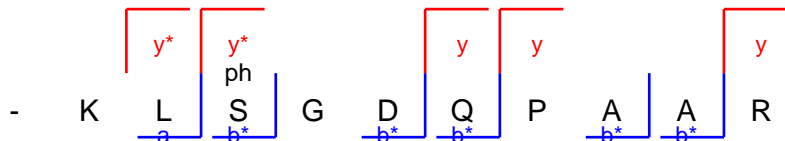
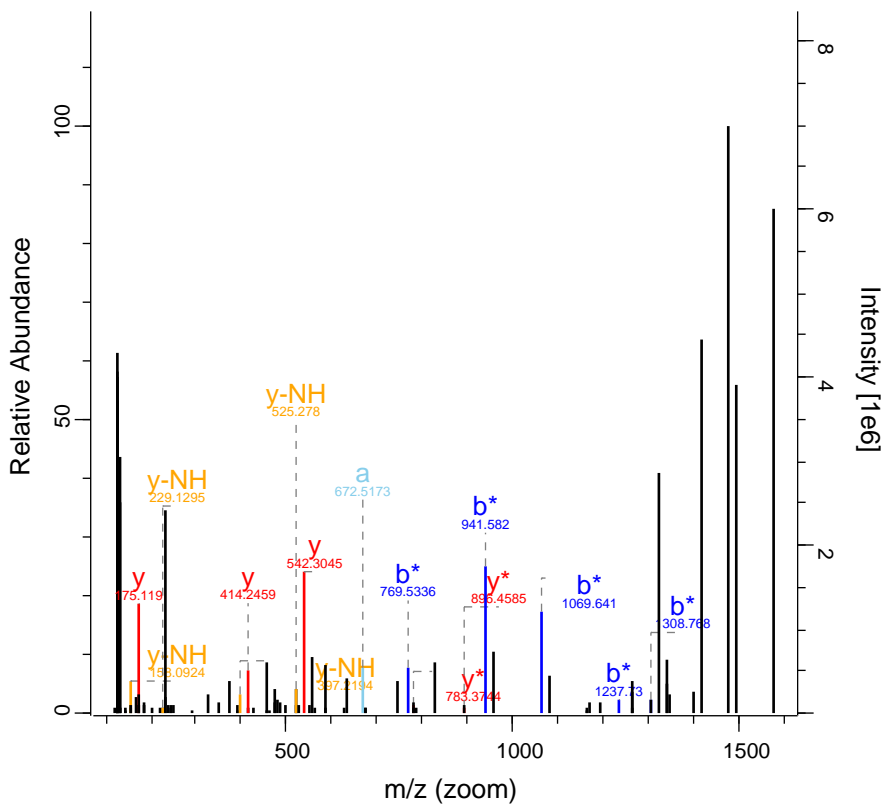

RO-QC-160121_ZackD_SS_Set_01_Fraction11053 FTMS; HCl 101.64 551.7 MARCKS

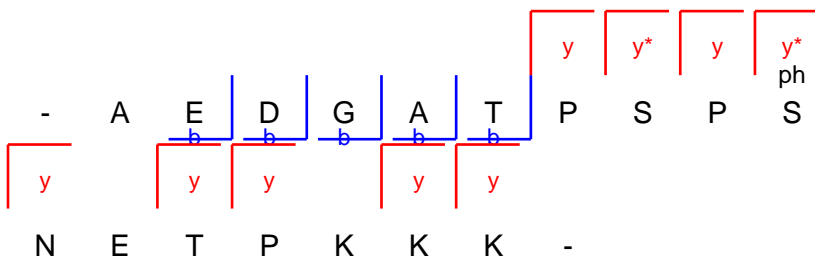
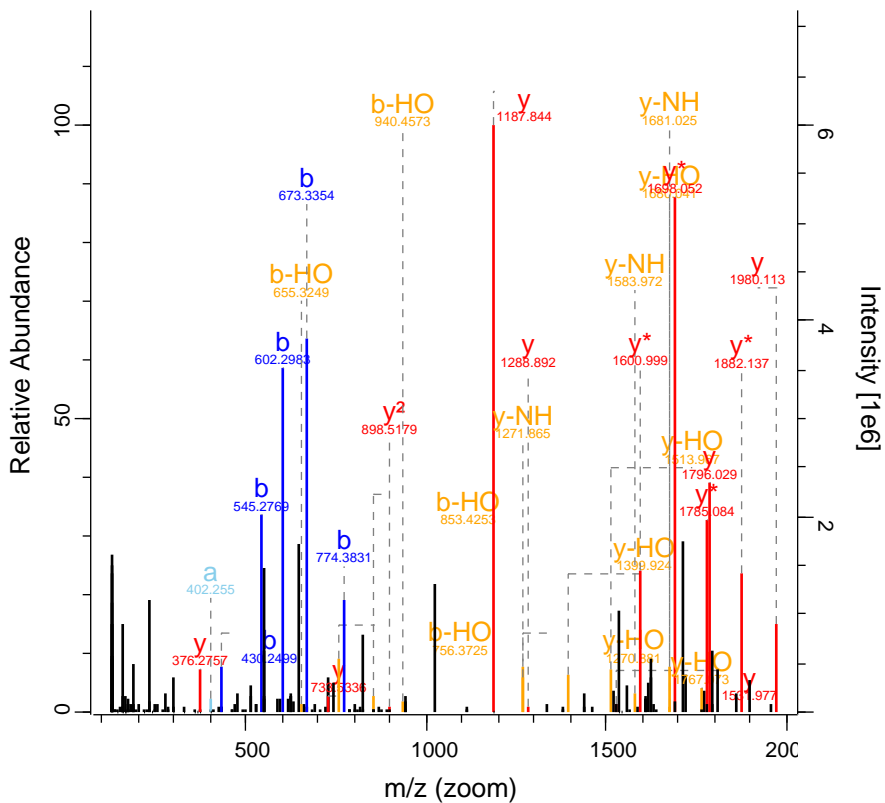

RO-QC-160121_ZackD_SS_Set_01_Fraction 12721 FTMS; HC 66.83 845.12 SRRM2

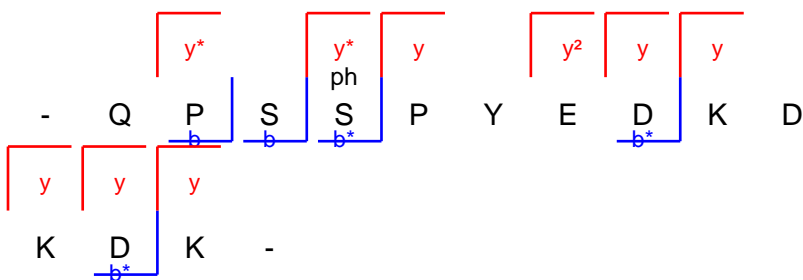
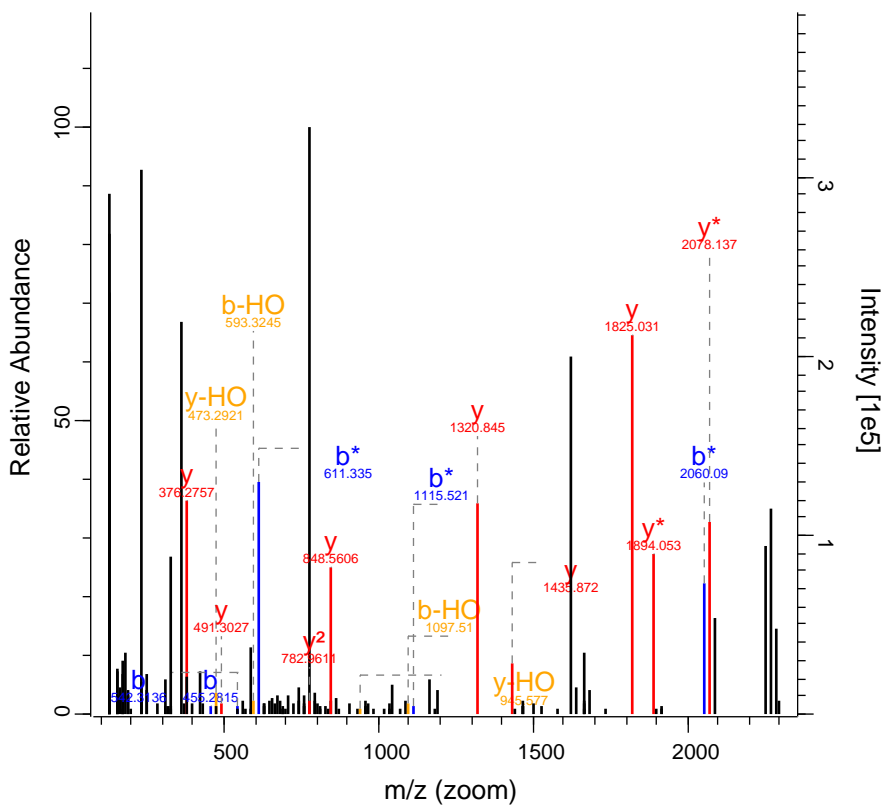

RO-QC-160121_ZackD_SS_Set_01_Fraction1 13054 FTMS; HCl 91.86 878.9 FNBP4

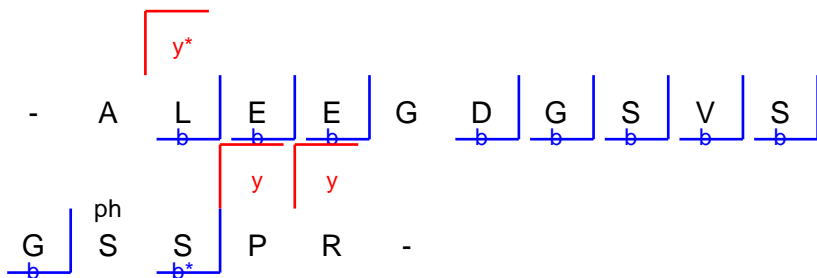
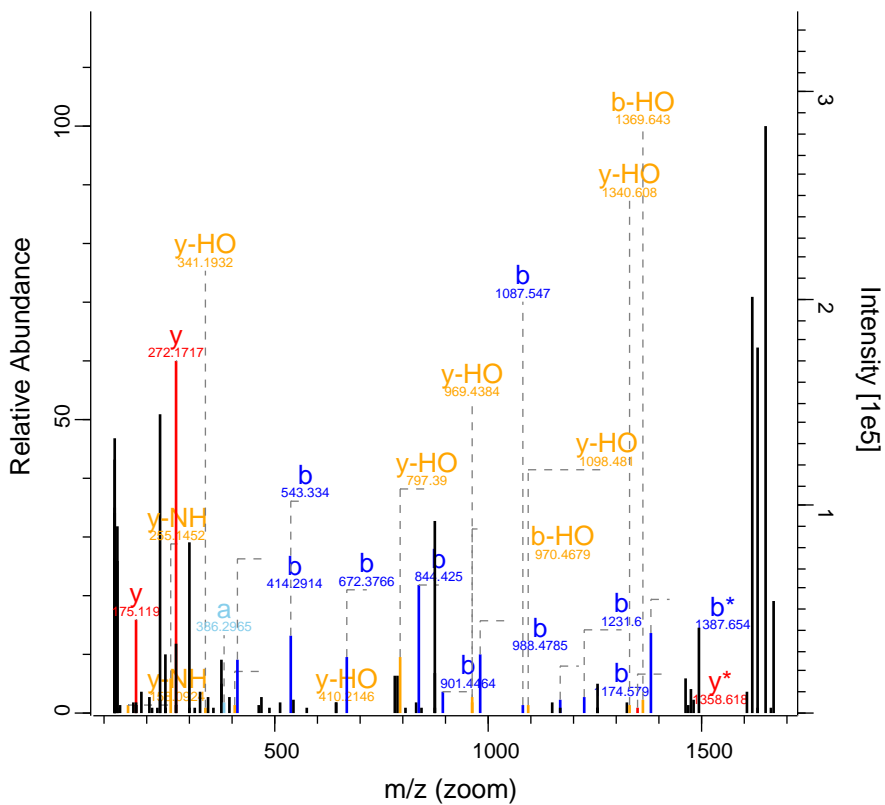

RO-QC-160121_ZackD_SS_Set_01_Fraction 14462 FTMS; HC 66.02 715.37 LEO1

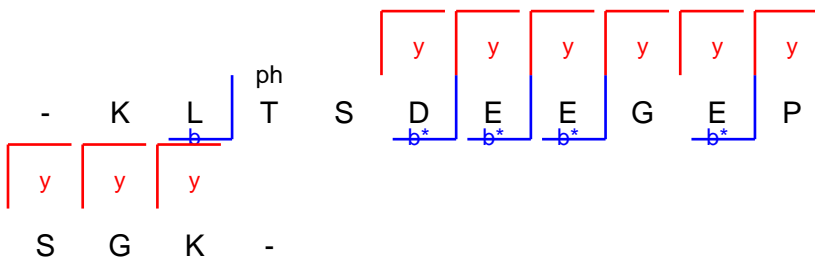
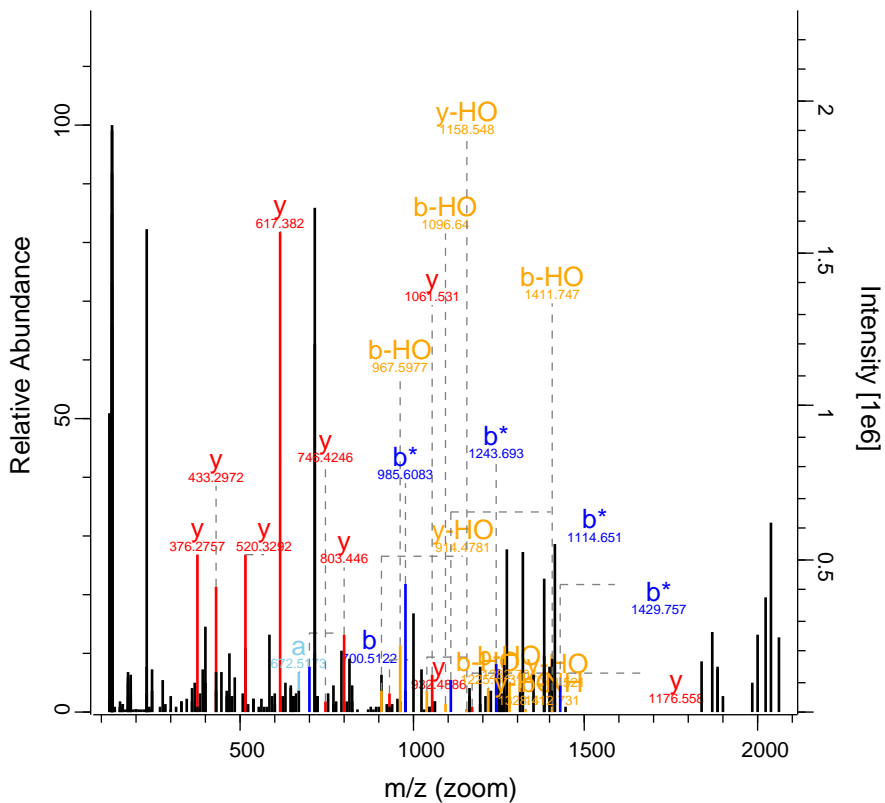

RO-QC-160121_ZackD_SS_Set_01_Fractio 14560 FTMS; HC 134.25 846.91 ERCC5

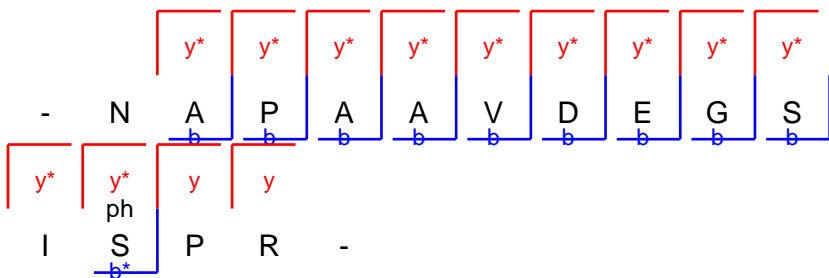
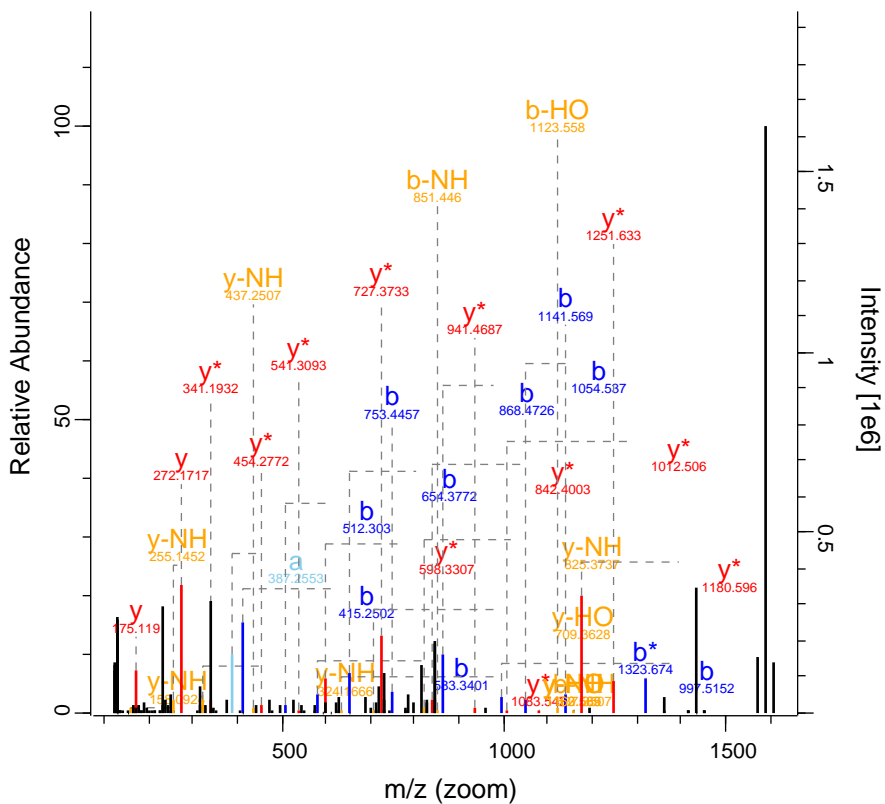

RO-QC-160121_ZackD_SS_Set_01_Fractio 14683 FTMS; HC 132.14 835.39 PPAN

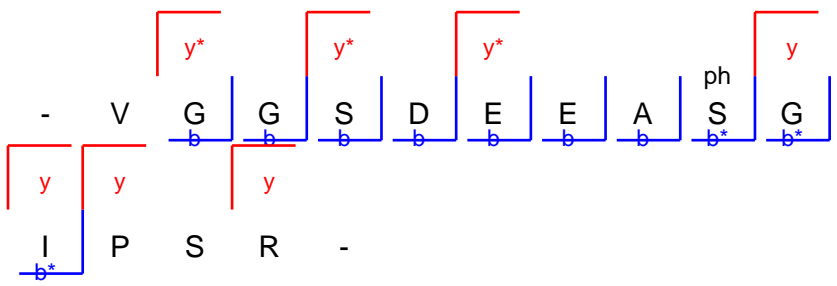
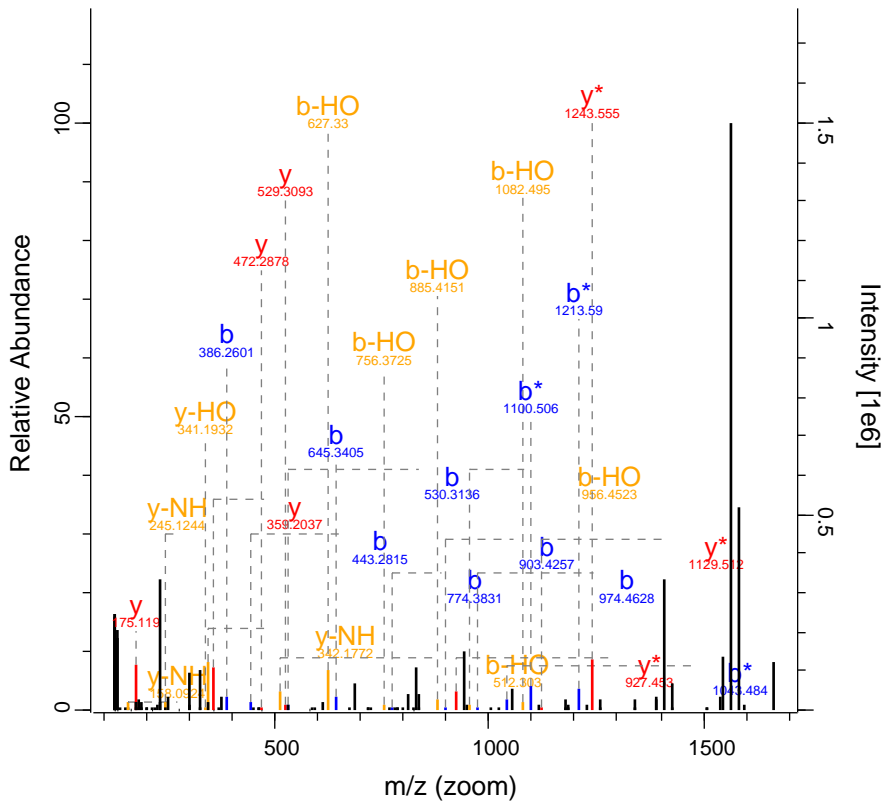

RO-QC-160121_ZackD_SS_Set_01_Fractic 14897 FTMS; HC 198.48 1032.87 AKAP2

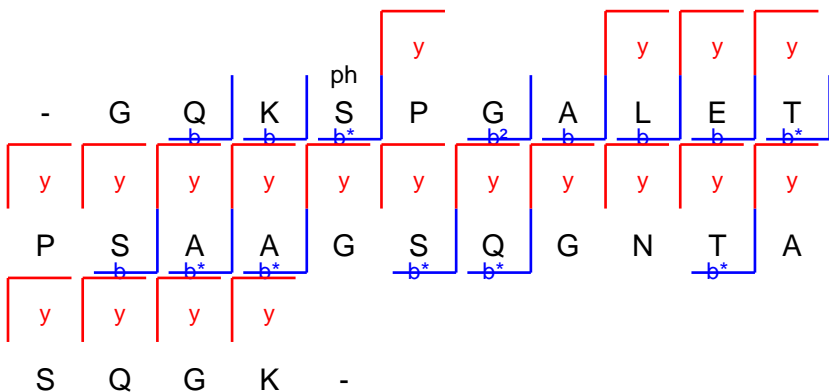
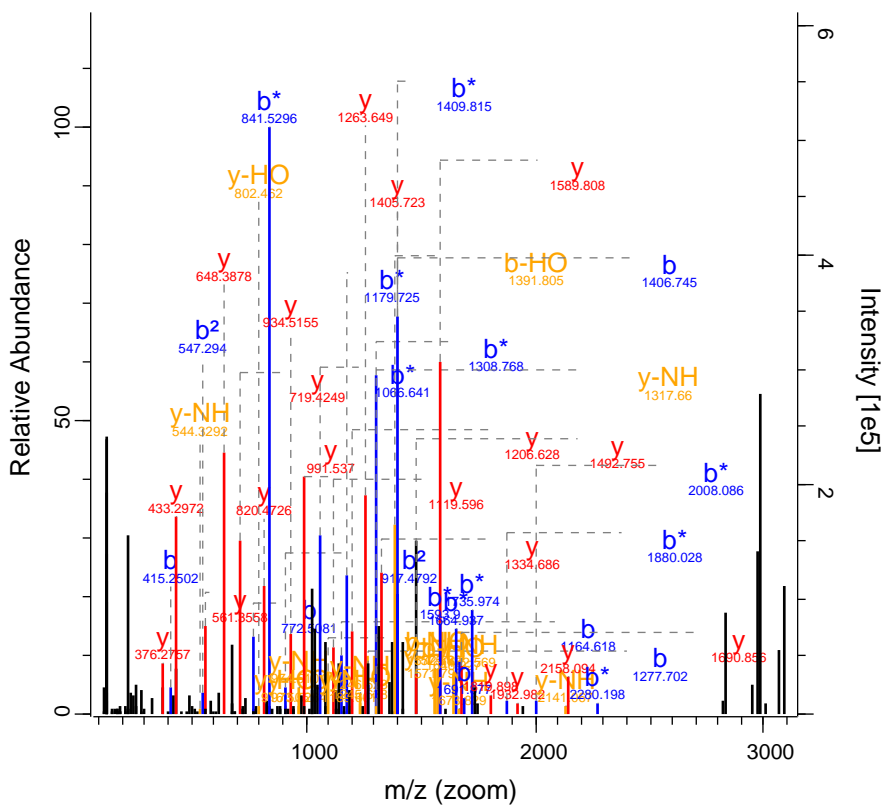

RO-QC-160121_ZackD_SS_Set_01_Fractic 15640 FTMS; HC 71.56 1231.05 TINAG

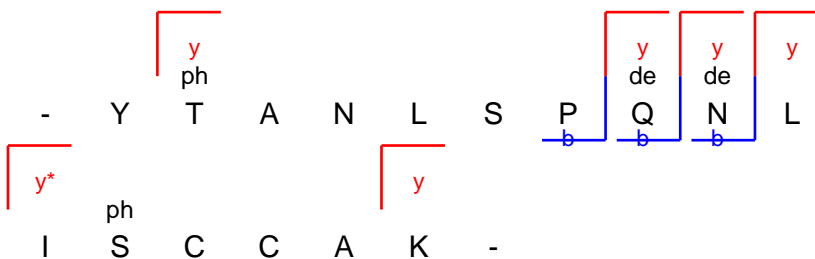
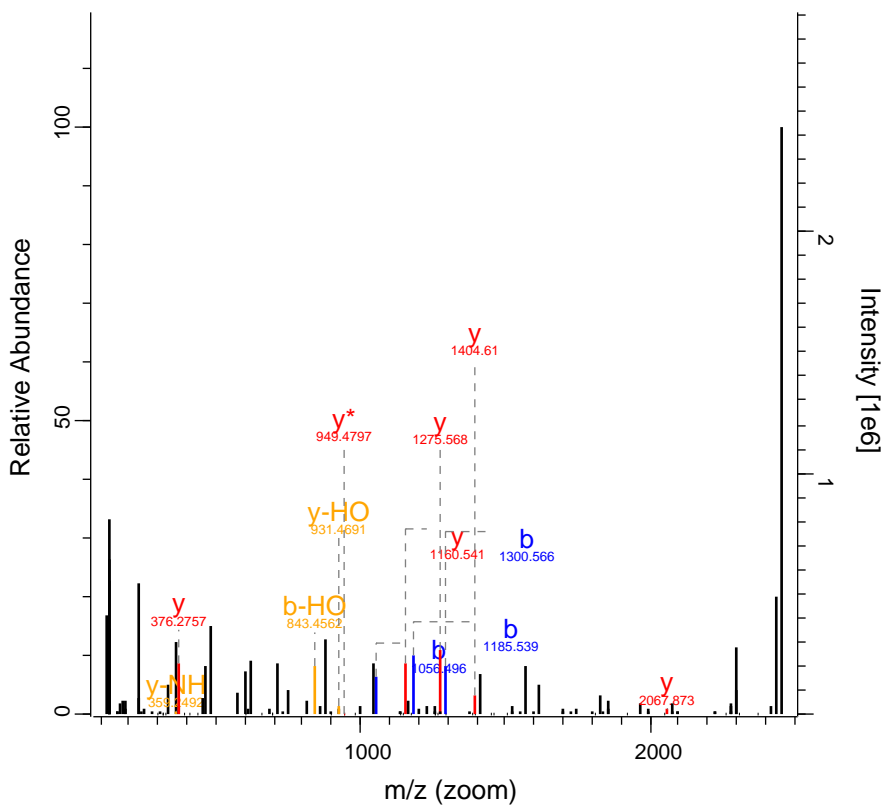

I S C C A K -

RO-QC-160121_ZackD_SS_Set_01_Fractic 15851 FTMS; HC 89.66 1118.04 NUMA1

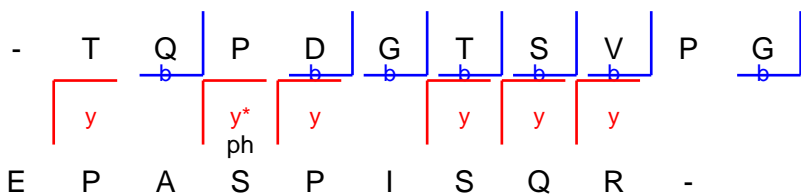
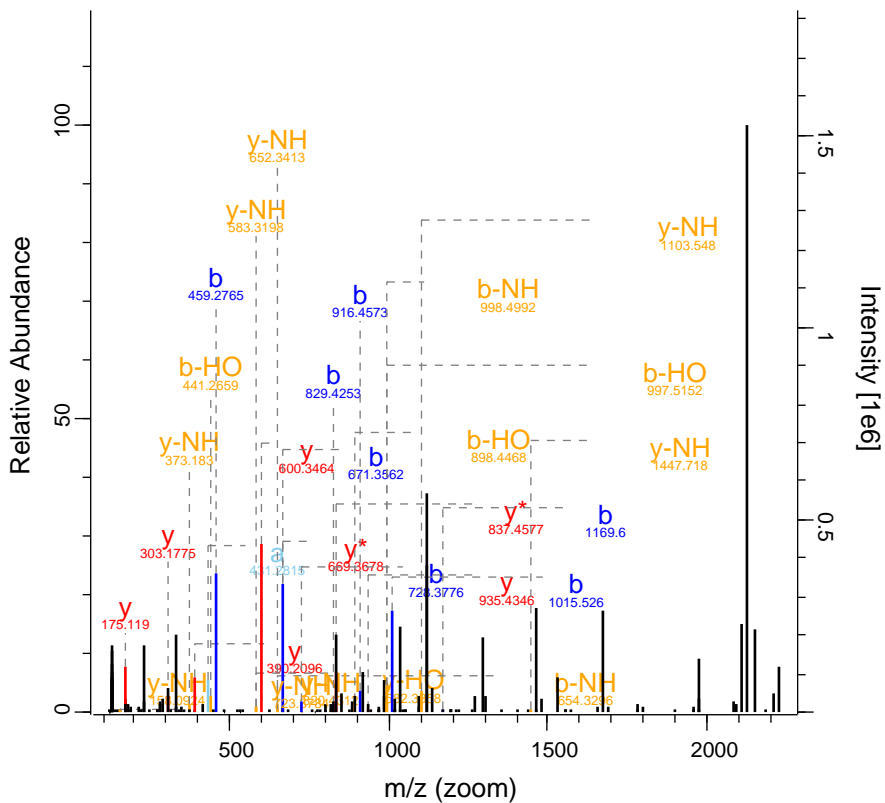

RO-QC-160121_ZackD_SS_Set_01_Fraction 18941 FTMS; HC 41.24 515.78 MMRN1

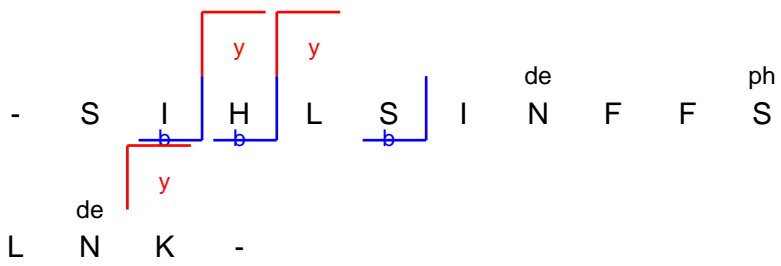
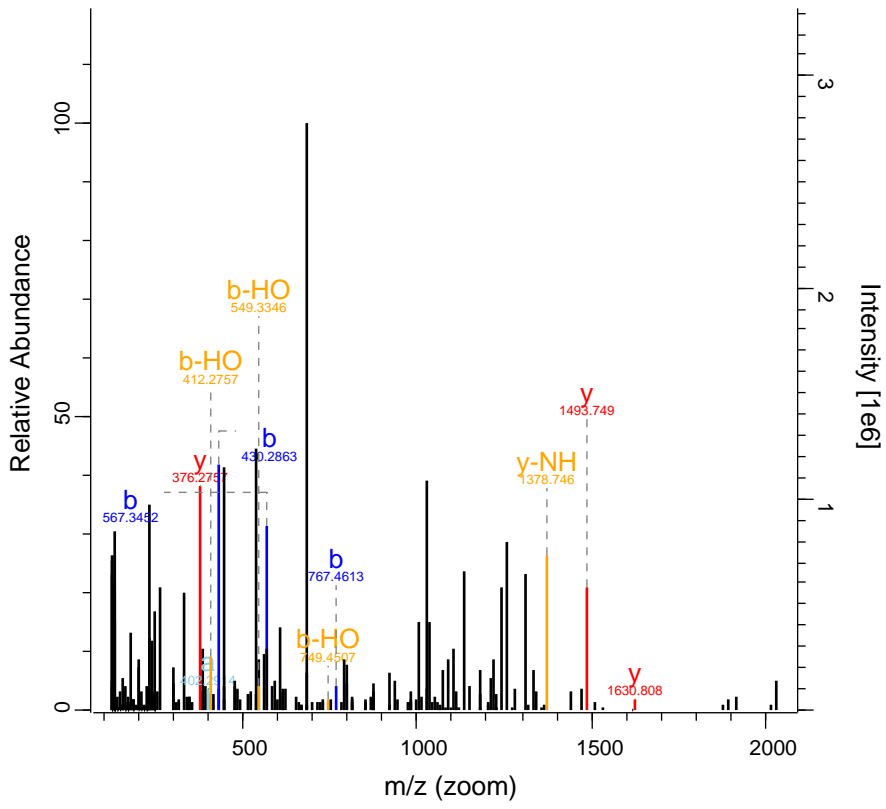

RO-QC-160121_ZackD_SS_Set_01_Fractio 18974 FTMS; HC 188.69 783.74 FLNA

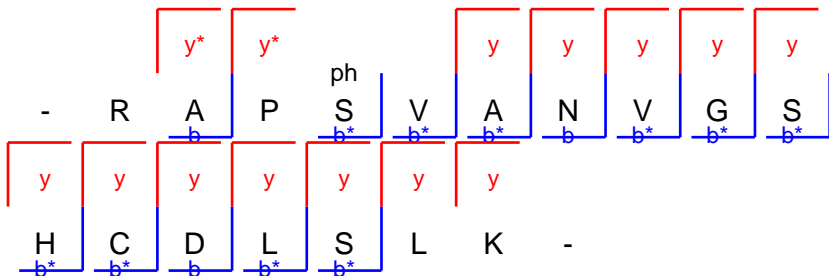
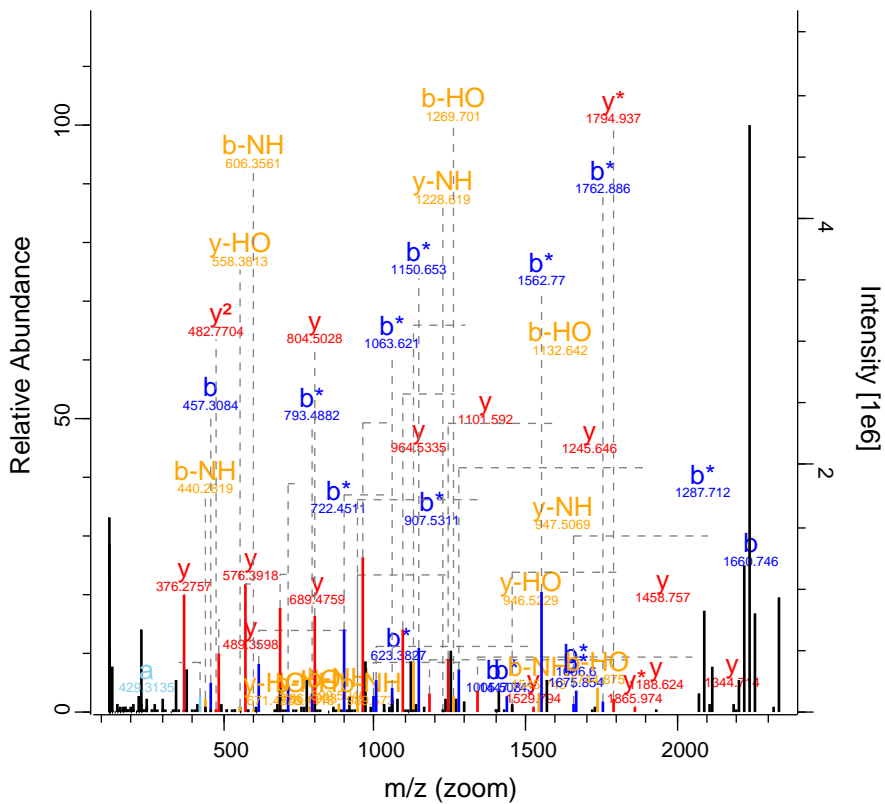

RO-QC-160121_ZackD_SS_Set_01_Fractio 19644 FTMS; HC 113.31 988.17 TANC1

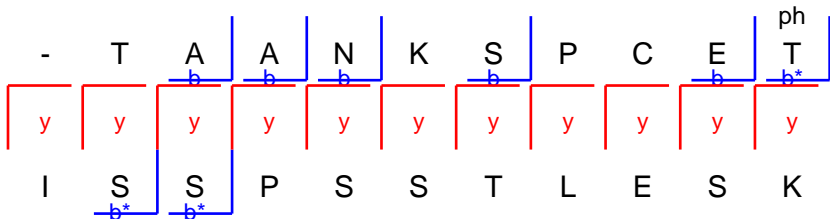
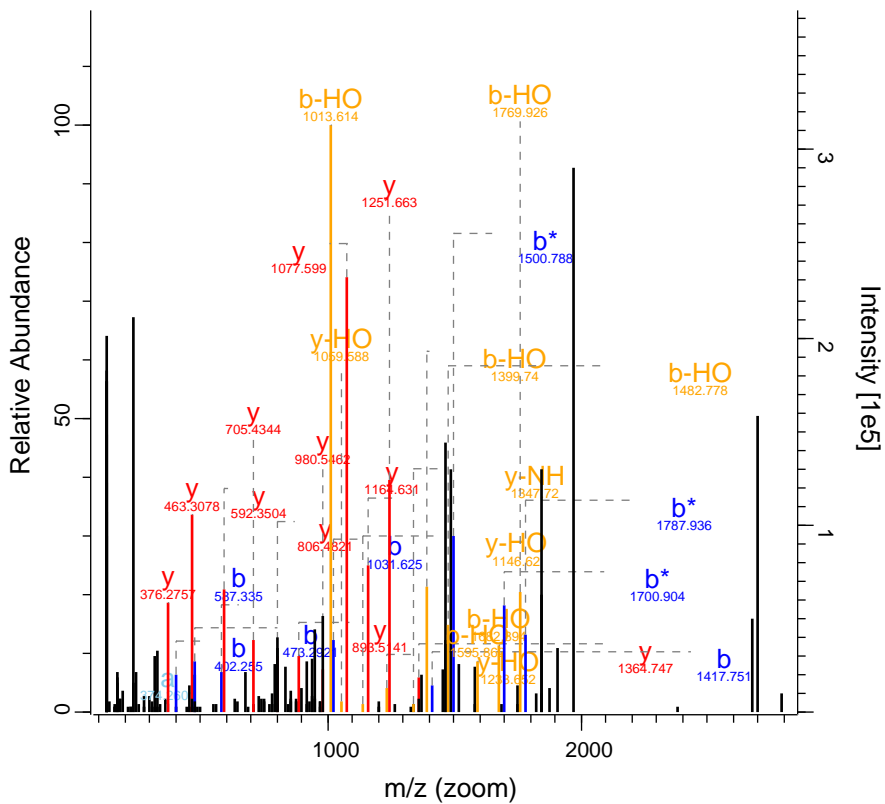

RO-QC-160121_ZackD_SS_Set_01_Fractio 19849 FTMS; HC 120.85 838.79 AHNAK

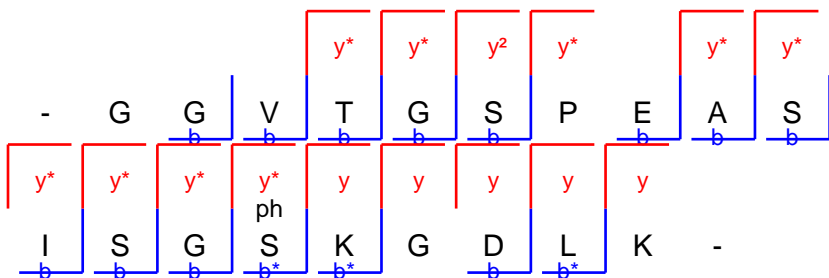
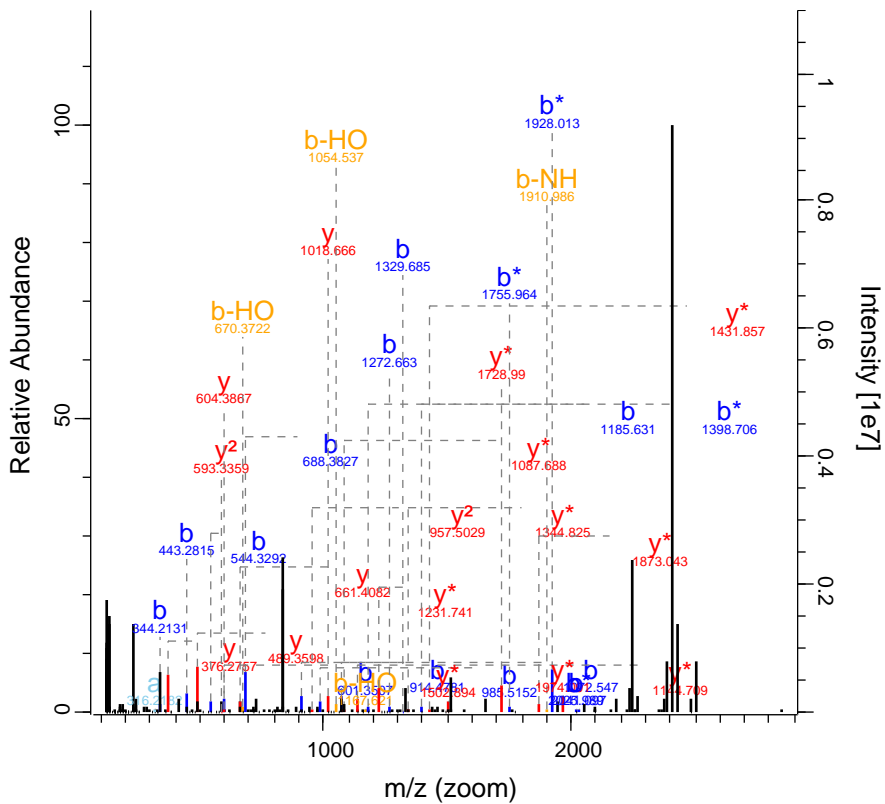

RO-QC-160121_ZackD_SS_Set_01_Fraction 20167 FTMS; HC 99.6 766.41 DIP2C

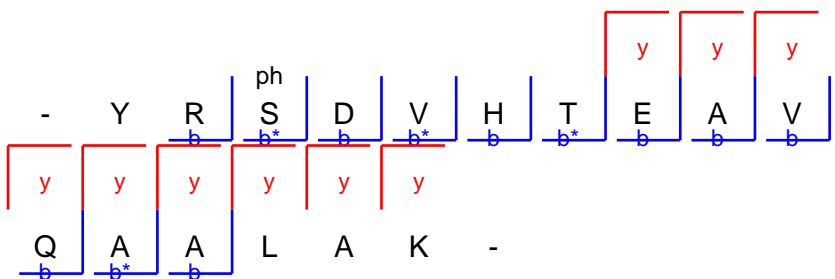
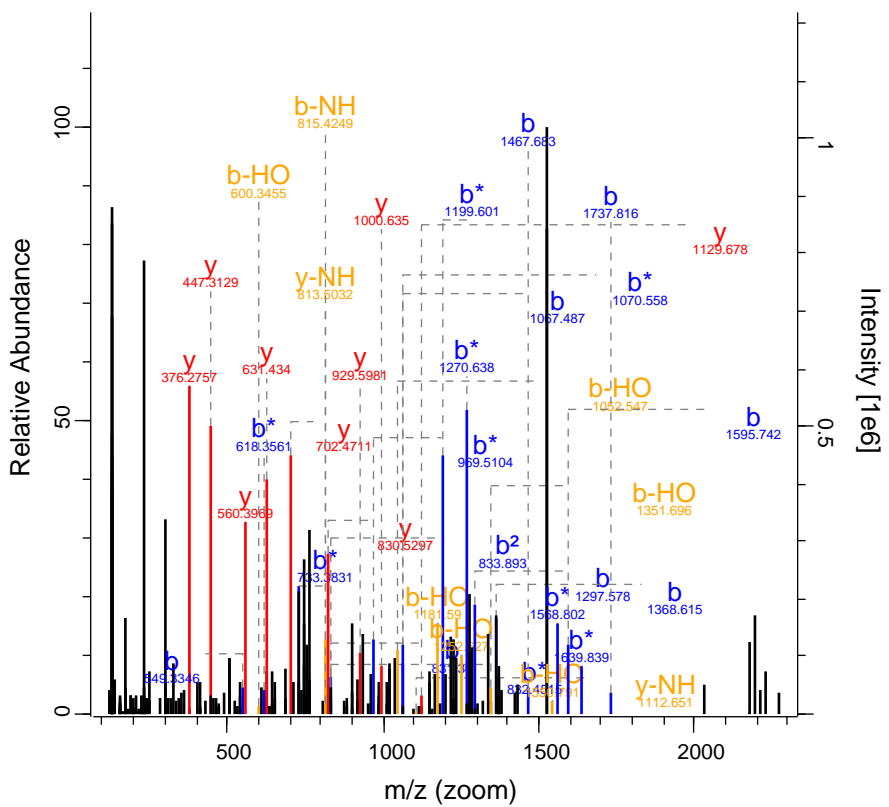

RO-QC-160121_ZackD_SS_Set_01_Fractio 20858 FTMS; HC 123.09 933.74 CDK13

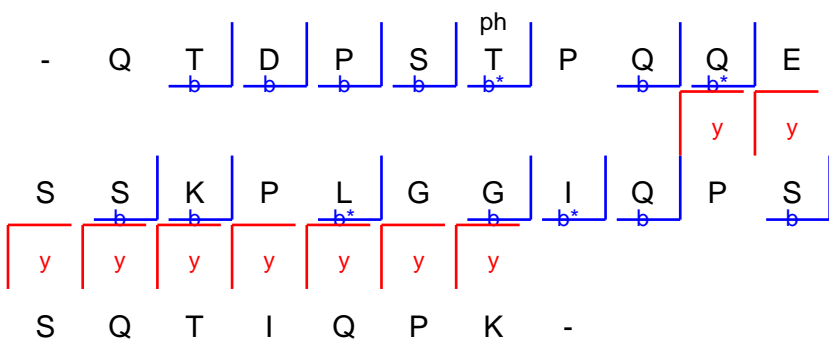
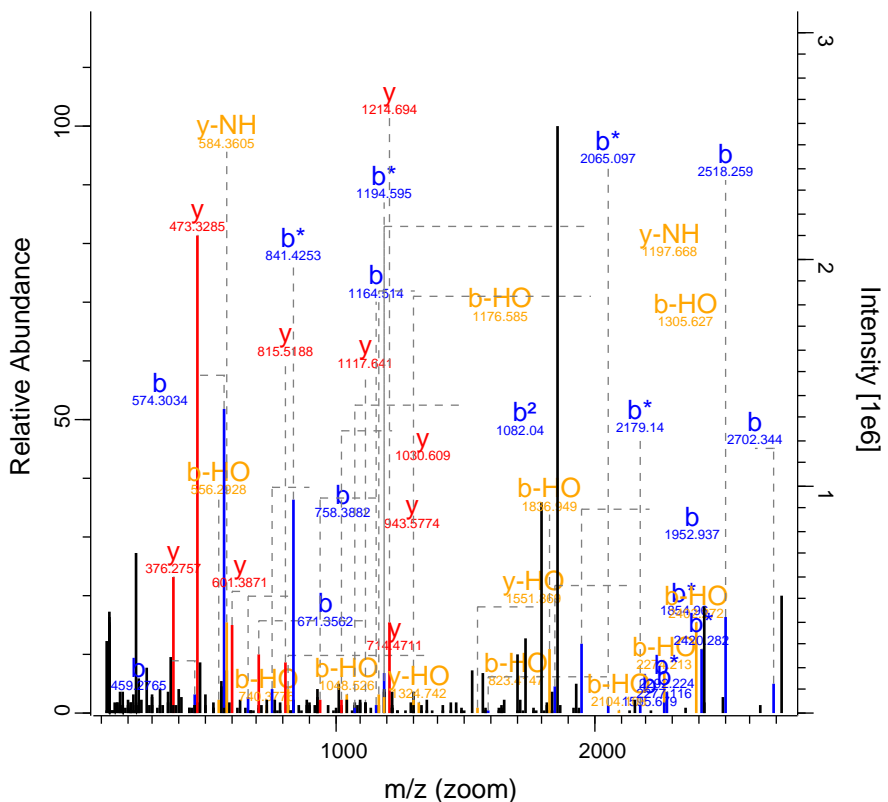

RO-QC-160121_ZackD_SS_Set_01_Fraction 21834 FTMS; HC 60.03 827.81 LARP1

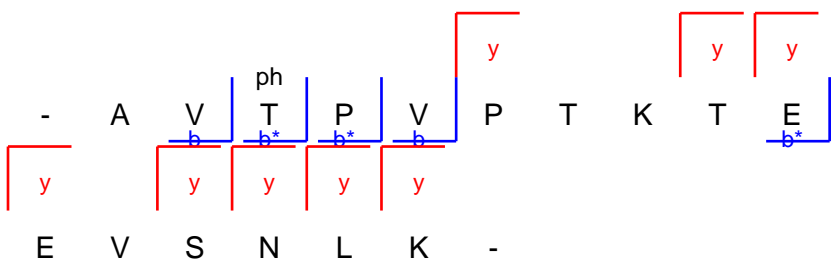
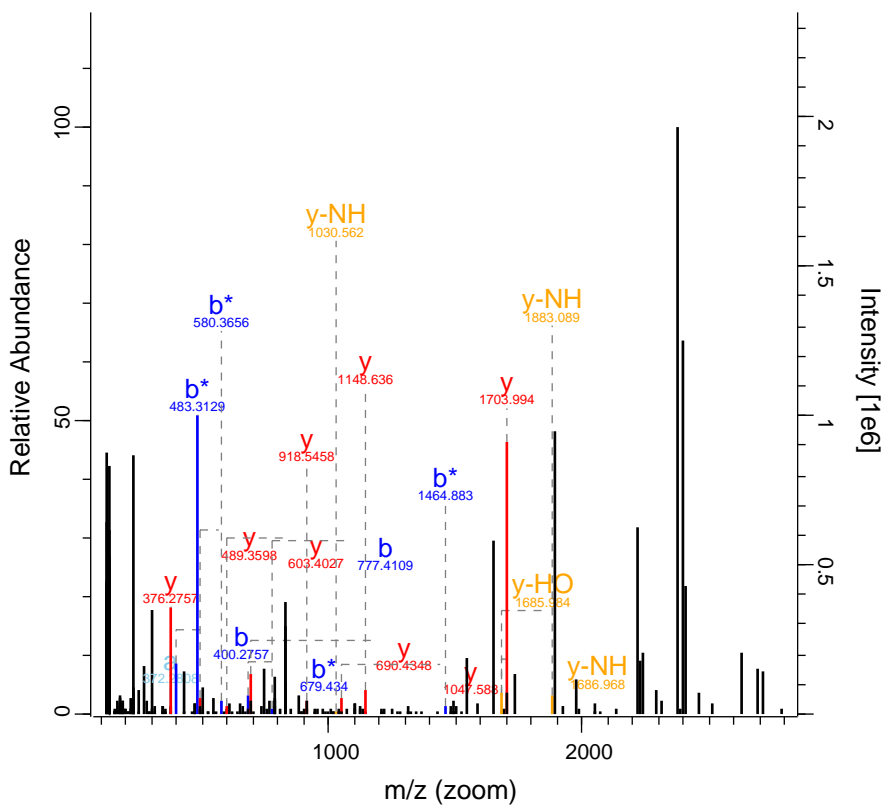

RO-QC-160121_ZackD_SS_Set_01_Fraction21971 FTMS; HC 74.77 601.01 RAB31L1

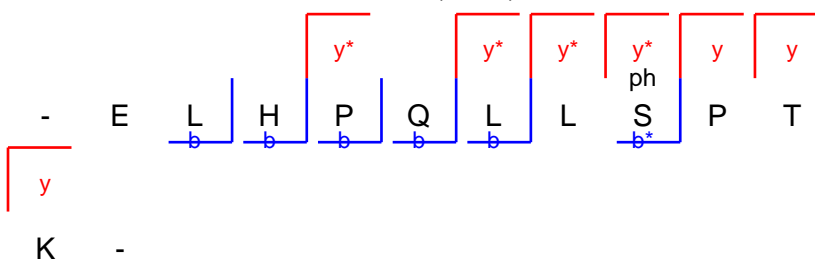
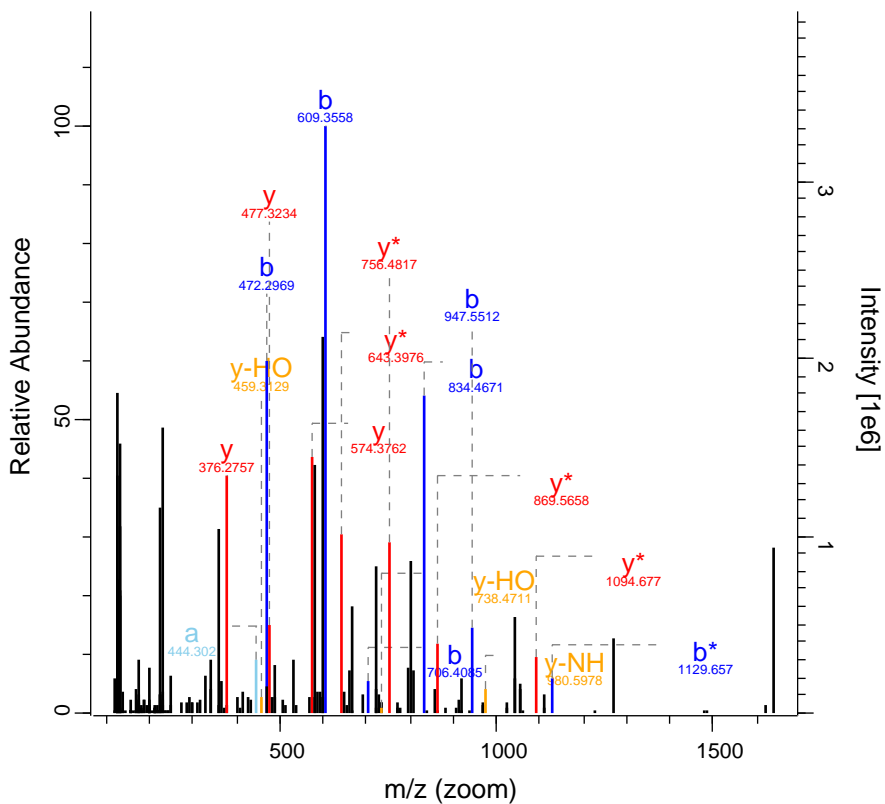

K -

RO-QC-160121_ZackD_SS_Set_01_Fraction 22135 FTMS; HC 45.26 597.28 ERMP1

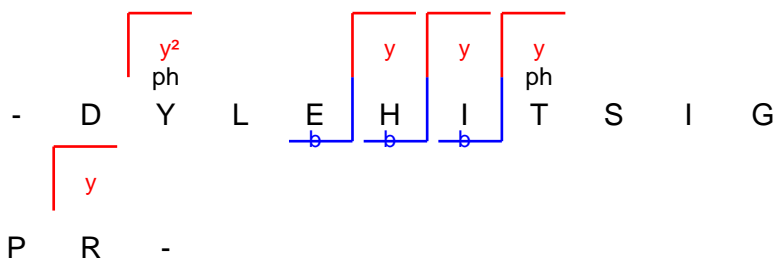
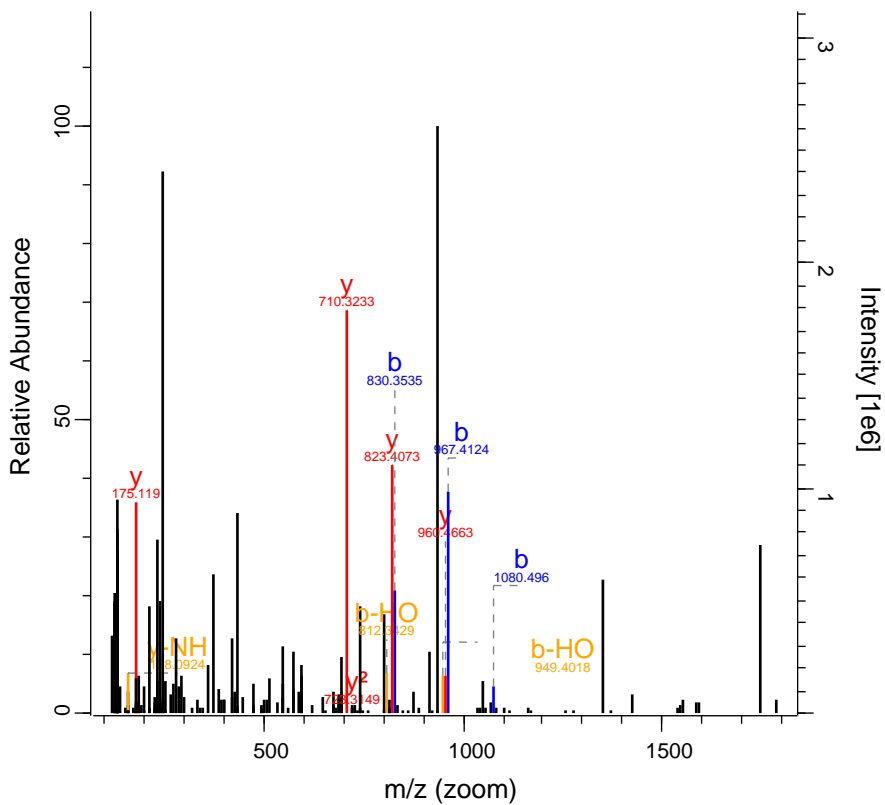

RO-QC-160121_ZackD_SS_Set_01_Fraction 22662 FTMS; HC 64.65 922.98 CLIP1

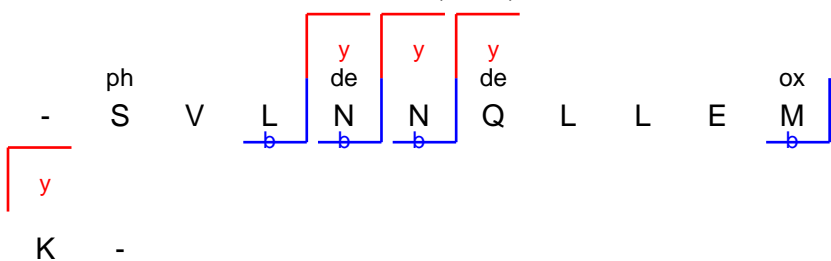
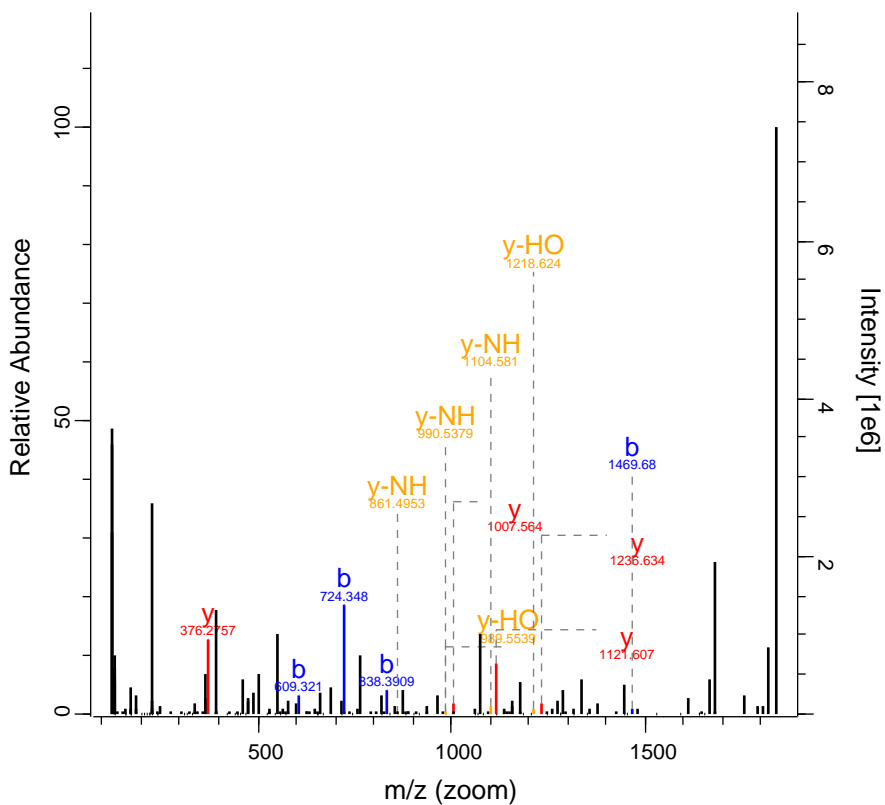

RO-QC-160121_ZackD_SS_Set_01_Fractic 23158 FTMS; HC 55.57 1193.16 SETD1A

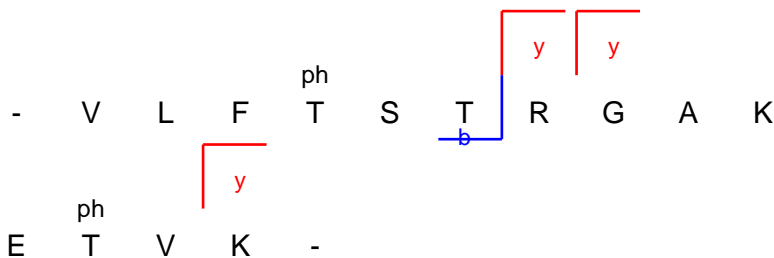
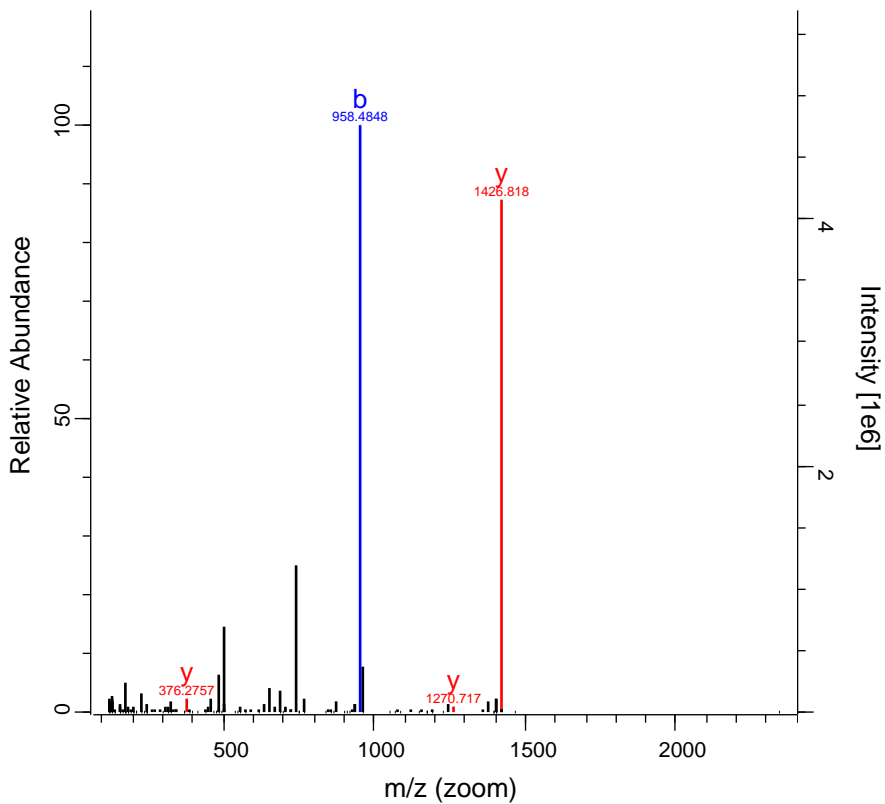

RO-QC-160121_ZackD_SS_Set_01_Fractio 23406 FTMS; HC 103.68 787.12 PCBP1

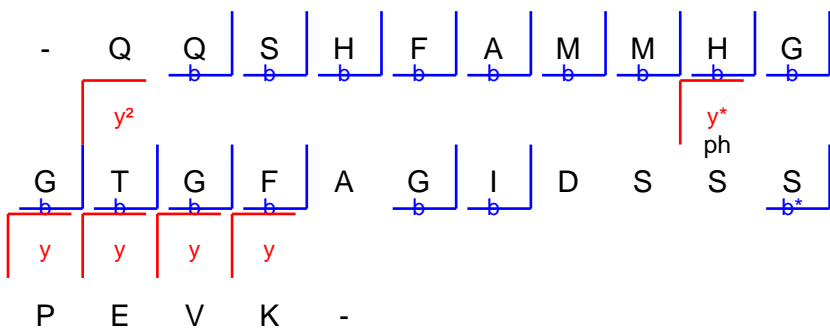
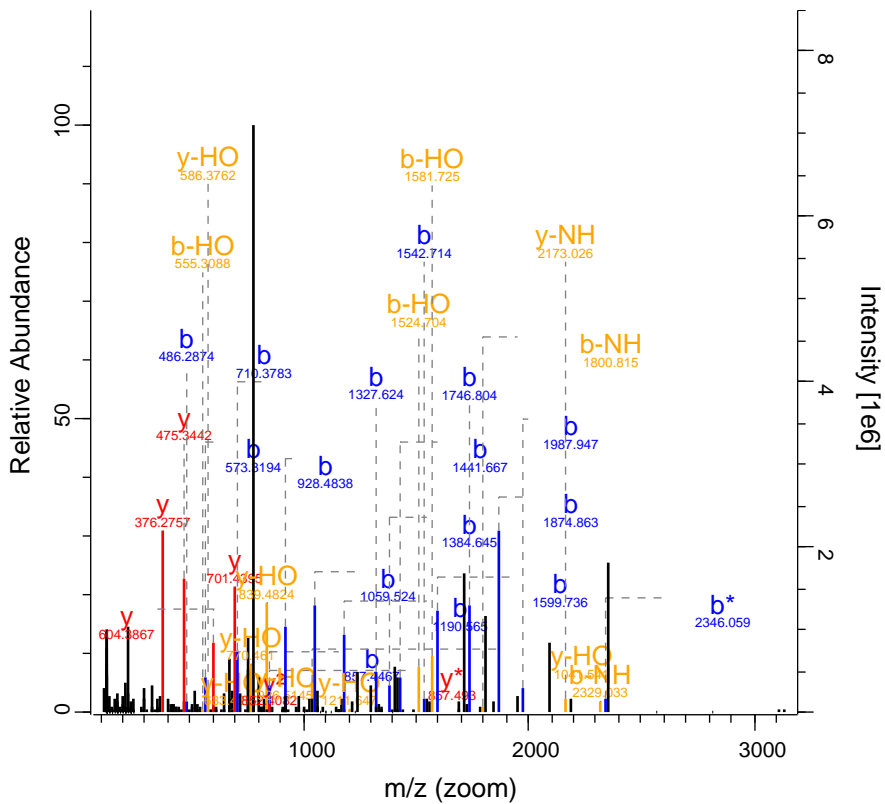

RO-QC-160121_ZackD_SS_Set_01_Fractic 23428 FTMS; HC 113.37 1049.16 PCBP1

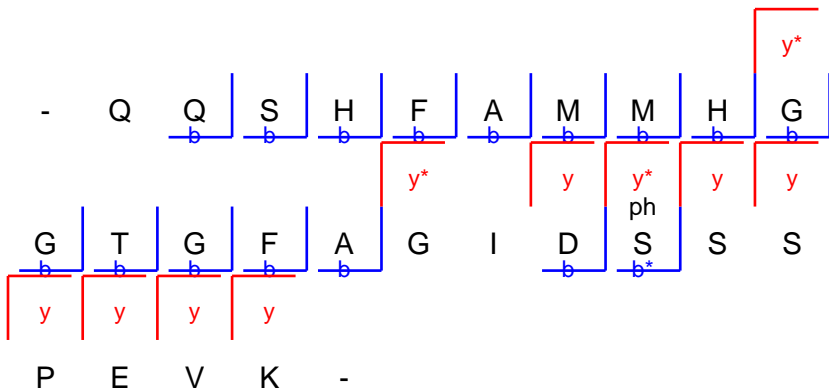
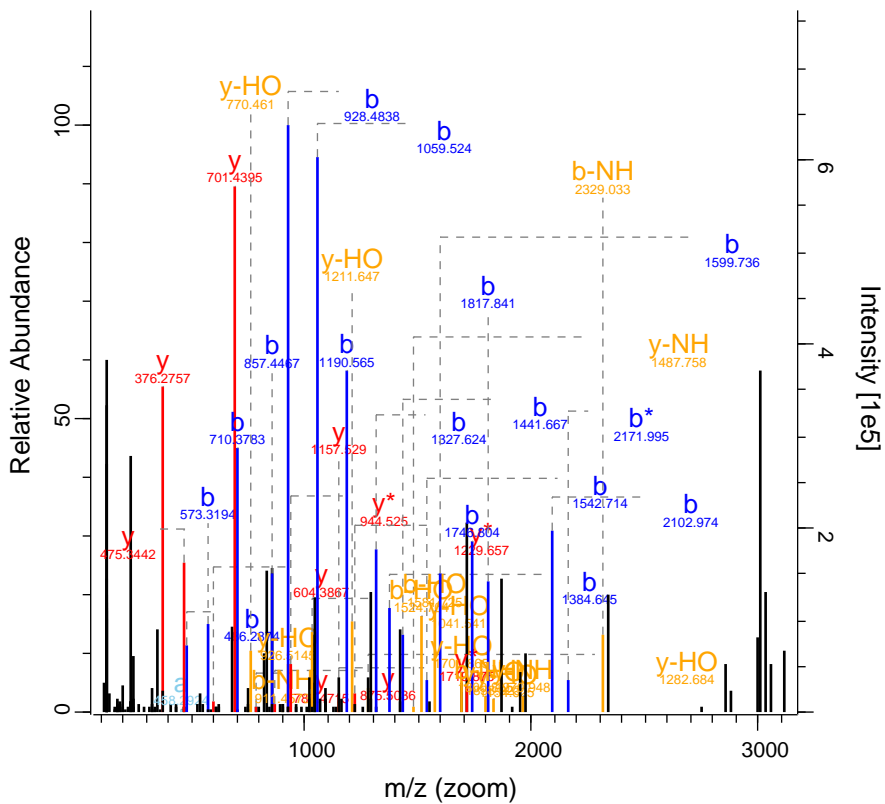

RO-QC-160121_ZackD_SS_Set_01_Fraction 24027 FTMS; HC 51.04 823.43 ZC3HC1

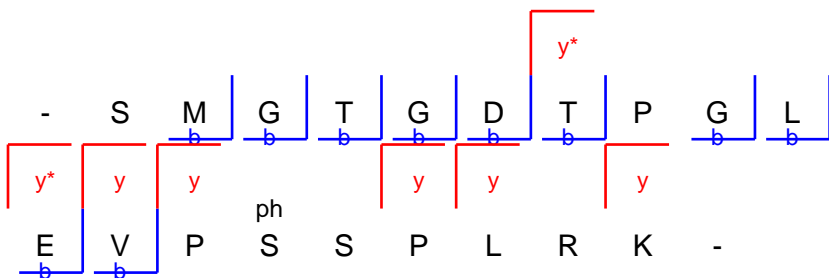
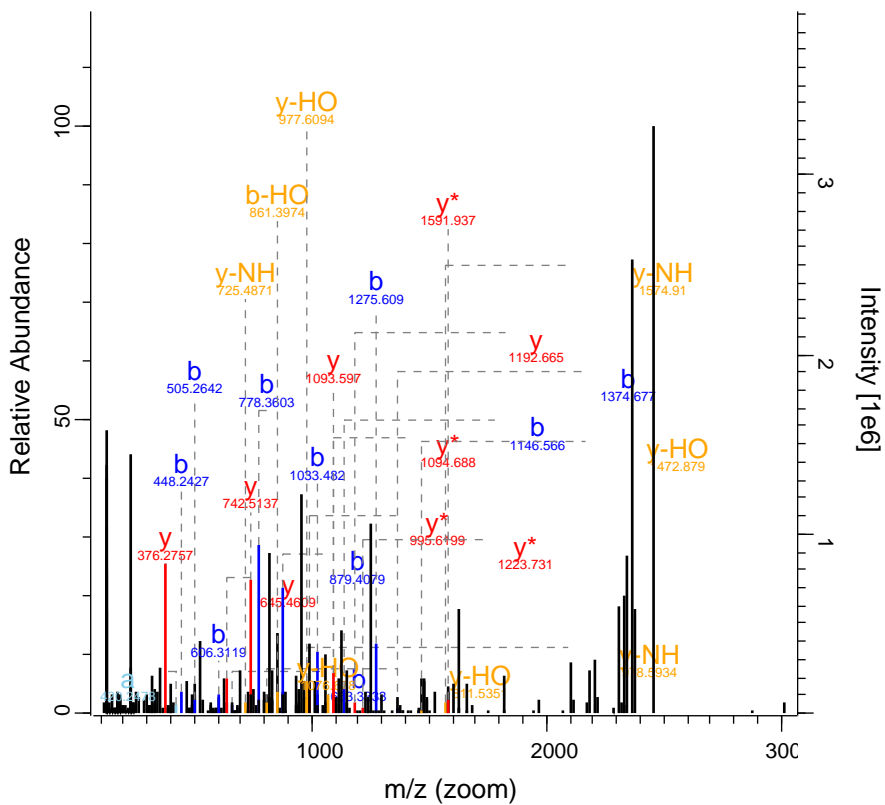

RO-QC-160121_ZackD_SS_Set_01_Fraction 27150 FTMS; HC 49.63 696.03 RASEF

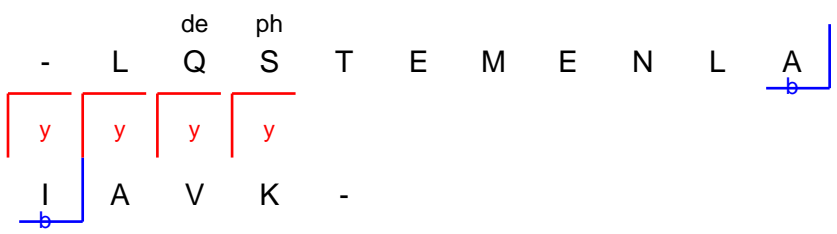
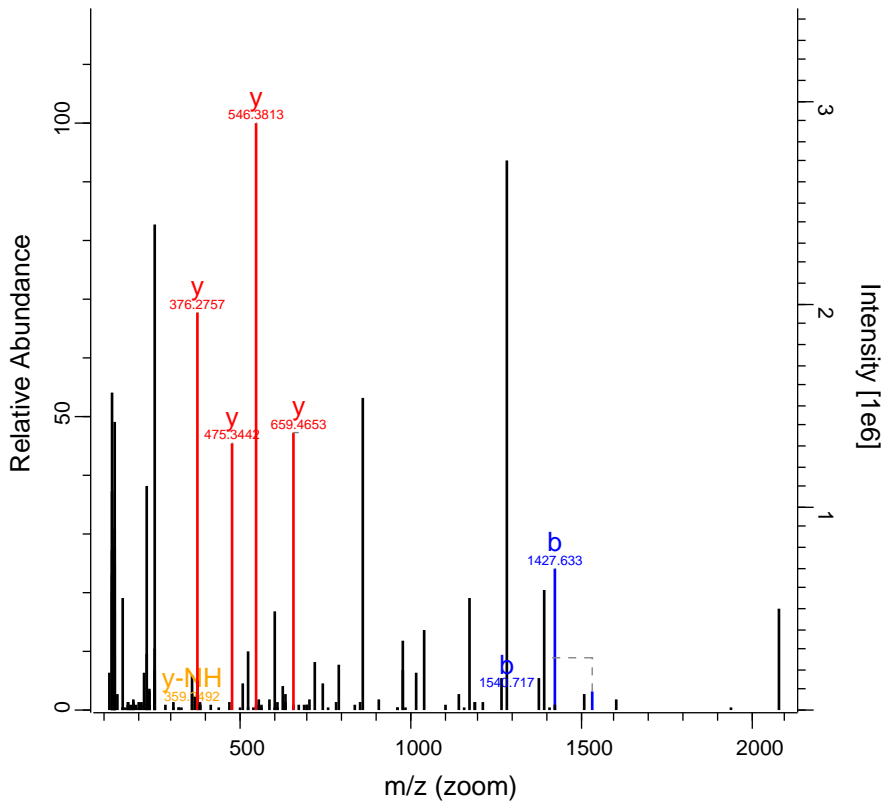

RO-QC-160121_ZackD_SS_Set_01_Fractio 27316 FTMS; HC 194.27 838.19 NEXN

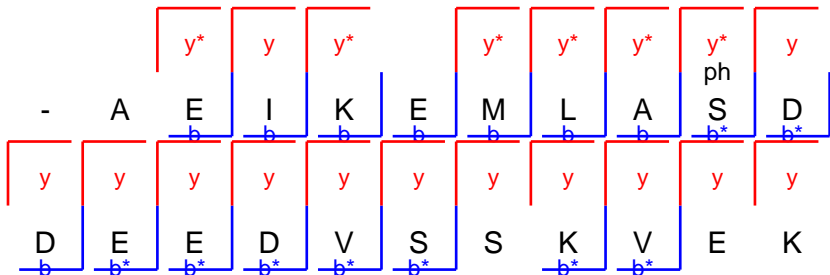
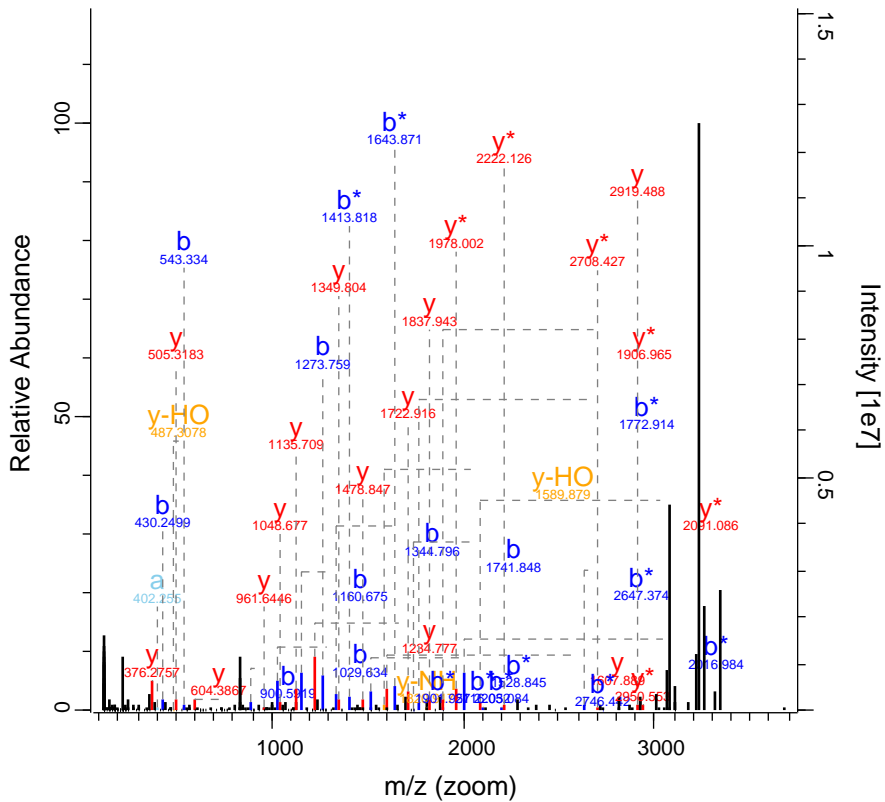

RO-QC-160121_ZackD_SS_Set_01_Fracti 29170 FTMS; HC 112.72 1075.54 RRAGC;RRAG

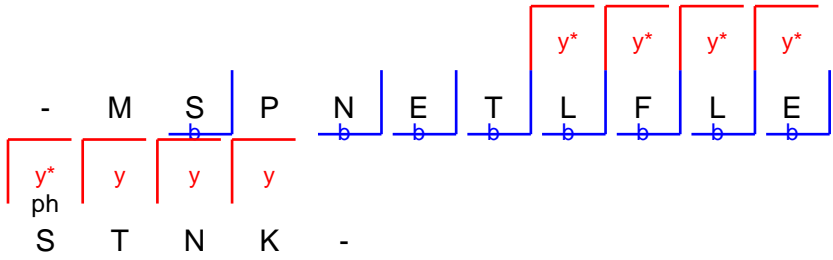
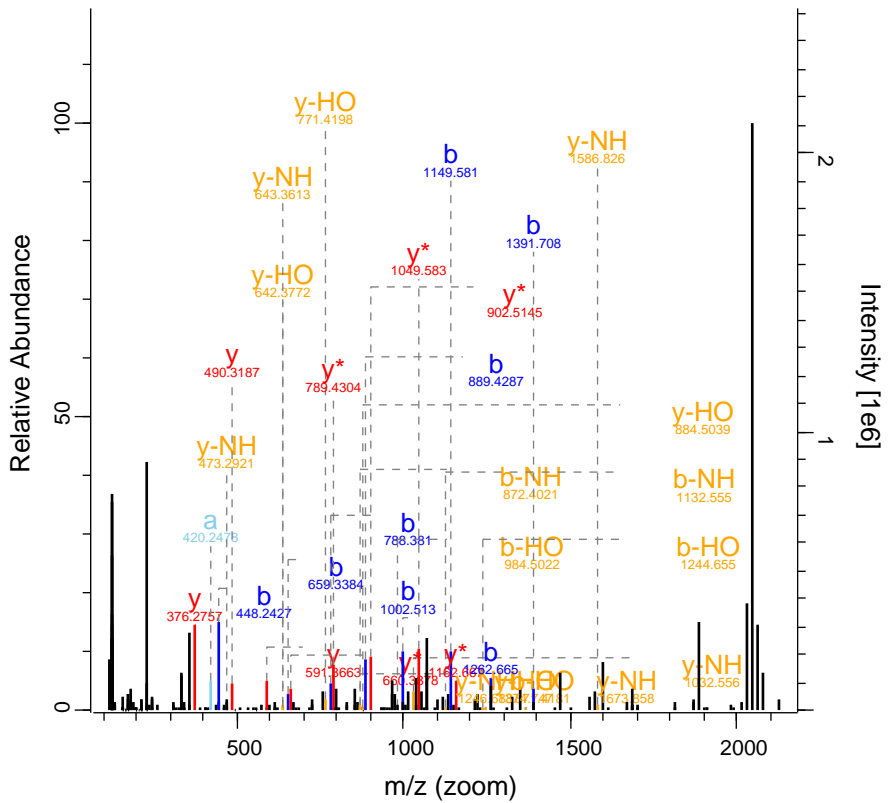

RO-QC-160121_ZackD_SS_Set_01_Fractic 31117 FTMS; HC 186.7 1098.04 G3BP1

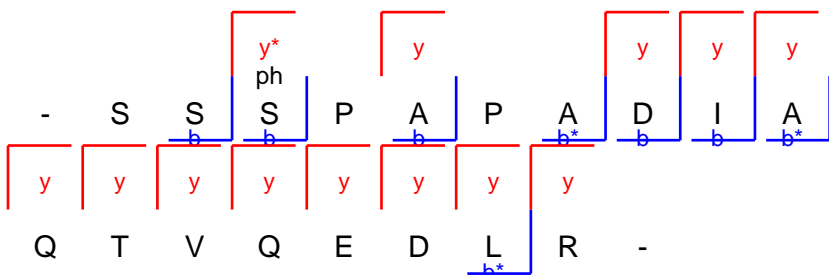
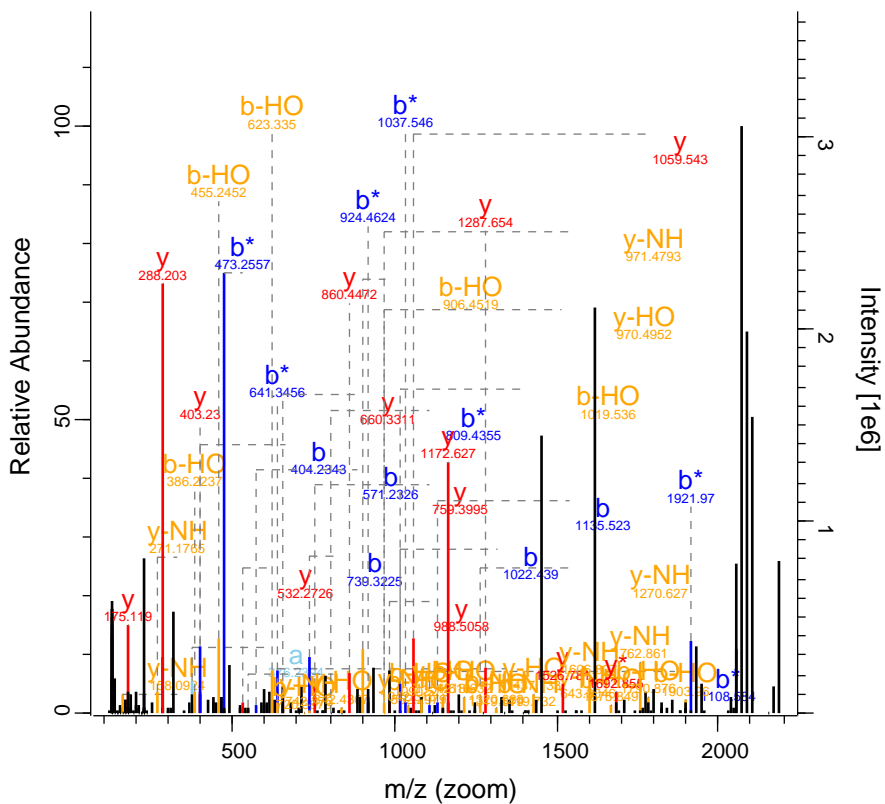

RO-QC-160121_ZackD_SS_Set_01_Fractic 31638 FTMS; HC 120.47 1020.53 MAP1A

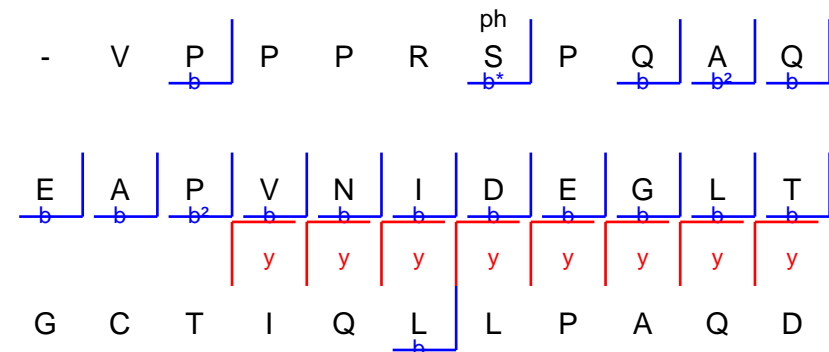
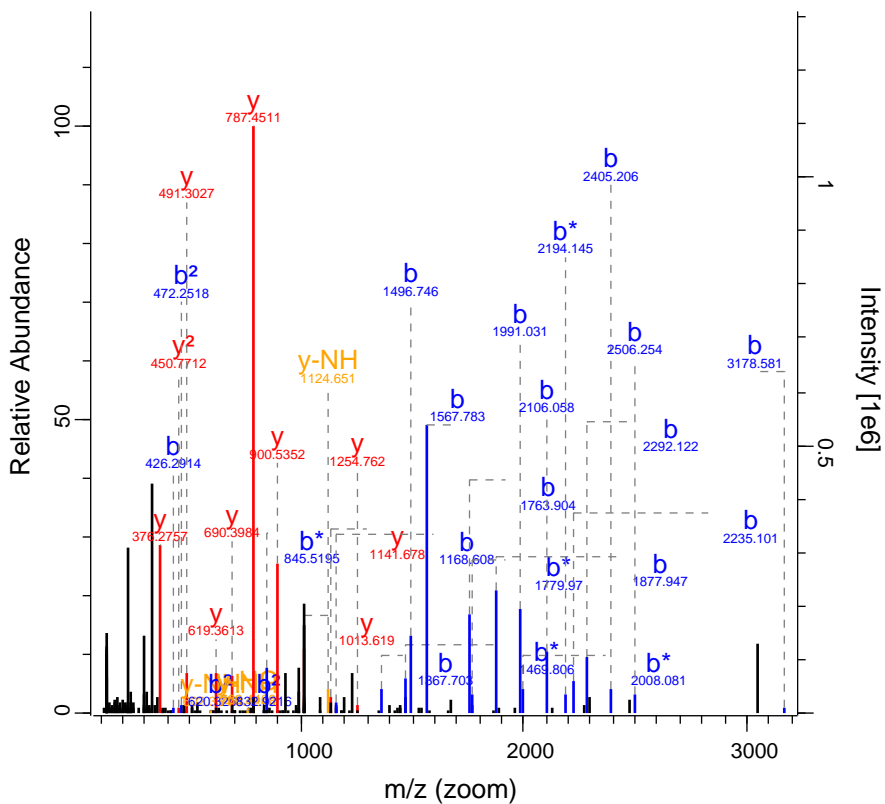

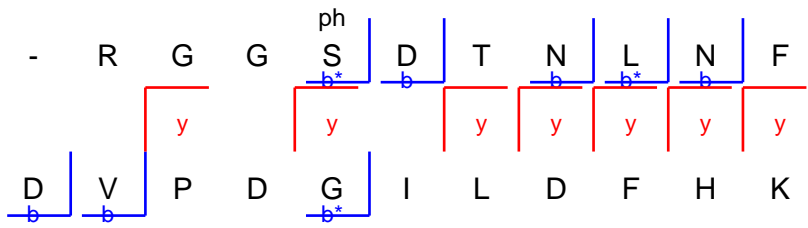
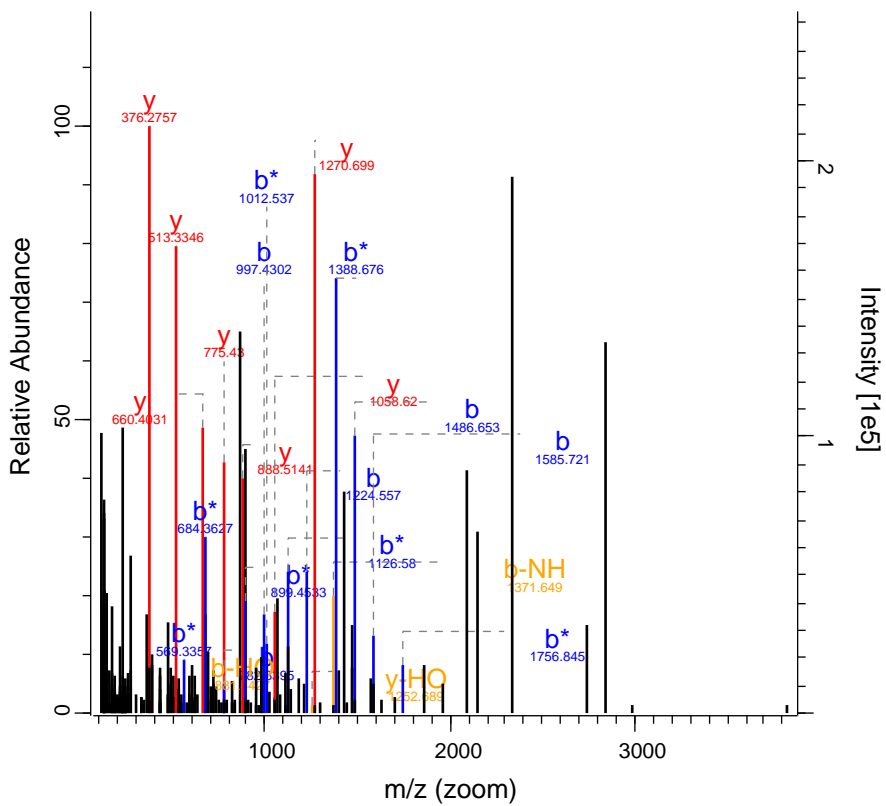

RO-QC-160121_ZackD_SS_Set_01_Fractic 32515 FTMS; HC 68.15 1021.54 HUWE1

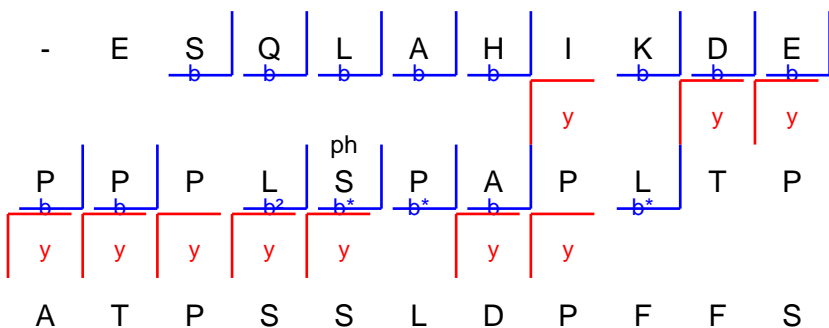
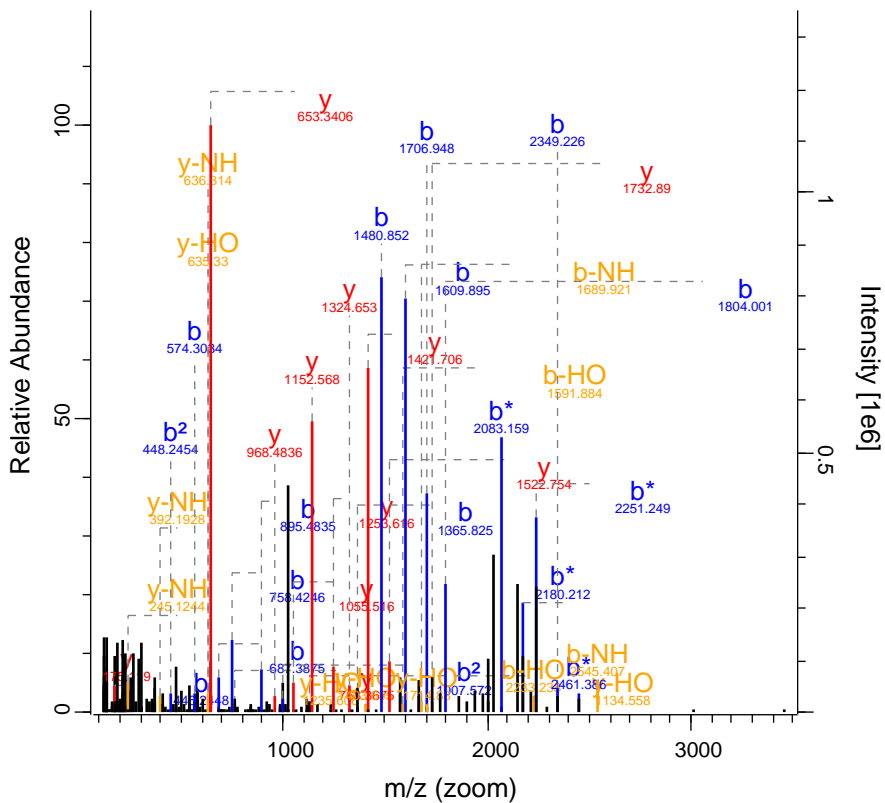

RO-QC-160121_ZackD_SS_Set_01_Fractic 32550 FTMS; HC 46.97 1034.51 KIAA1191

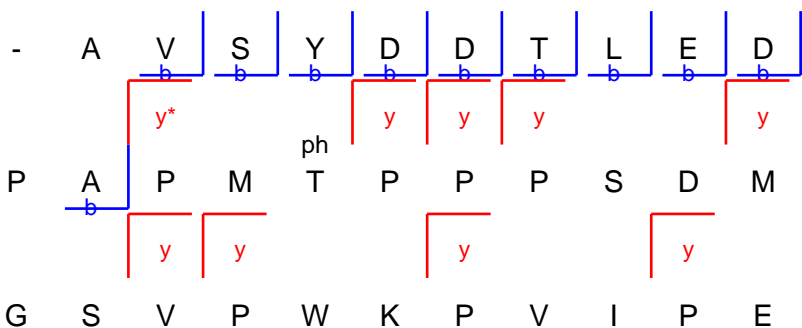
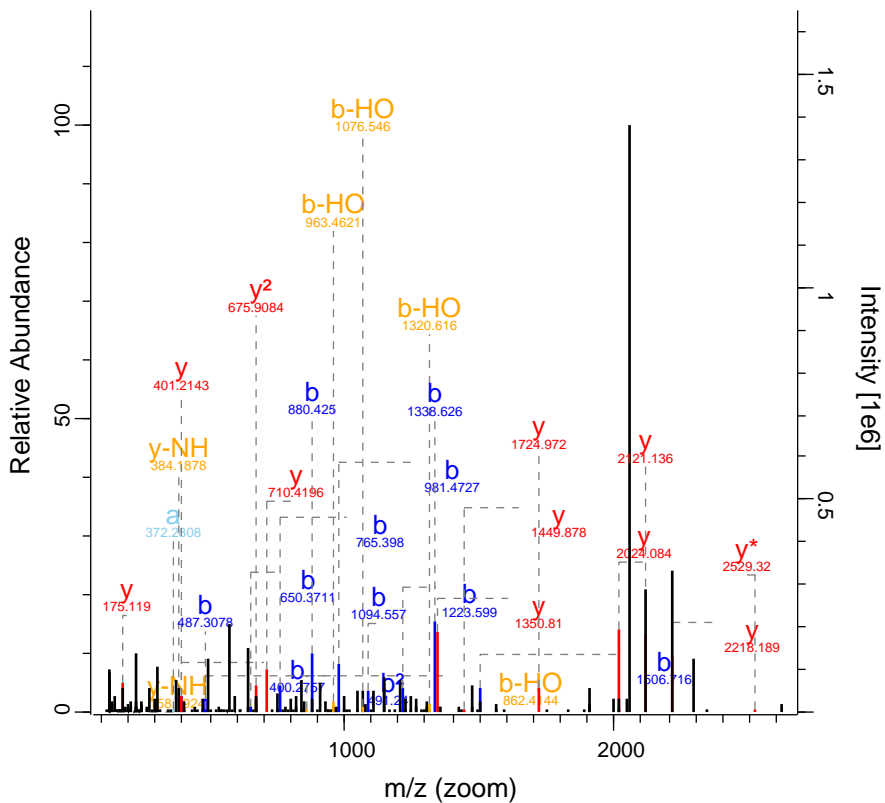

RO-QC-160121_ZackD_SS_Set_01_Fractic 32670 FTMS; HC 208.15 1070.53 TMEM230

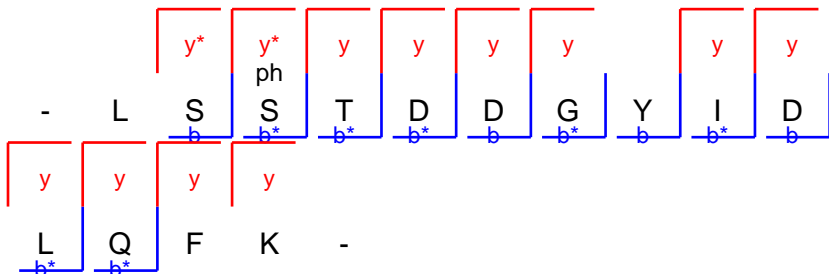
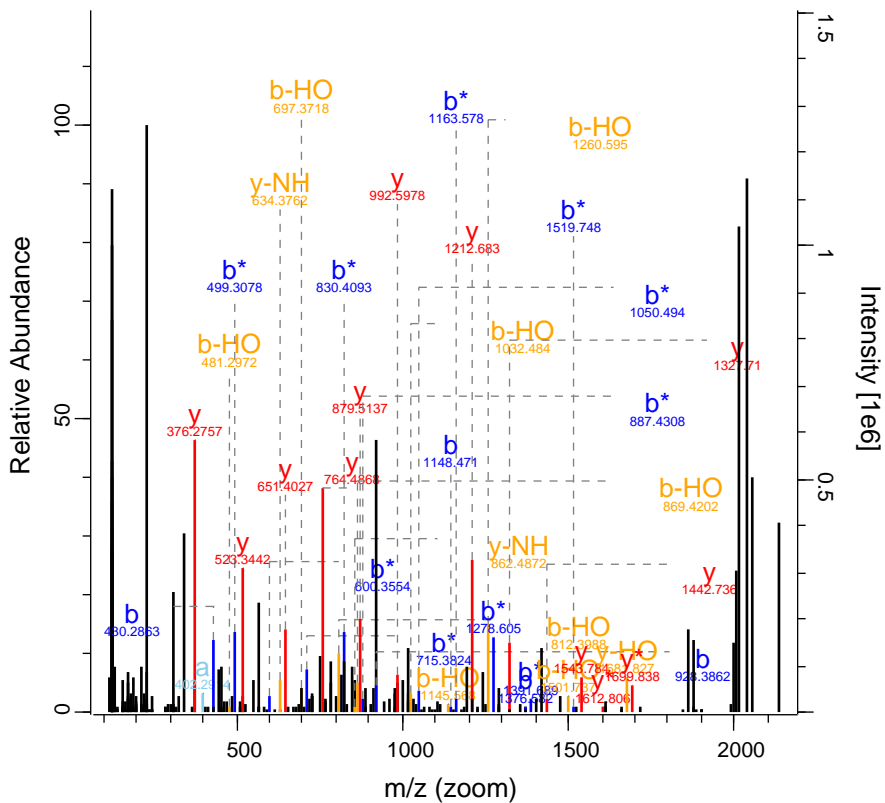

RO-QC-160121_ZackD_SS_Set_01_Fraction33022 FTMS; HC 148.7 869.93 TOP2B

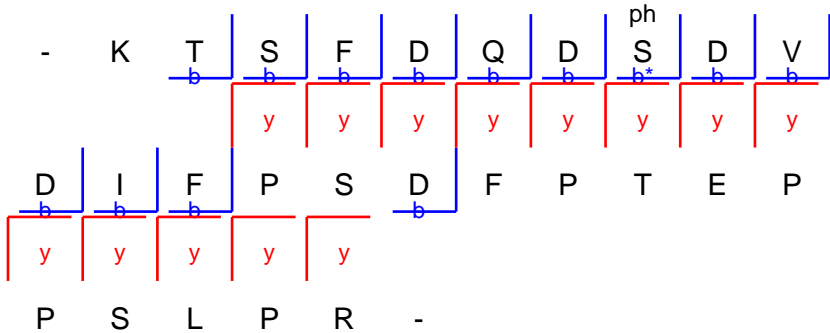
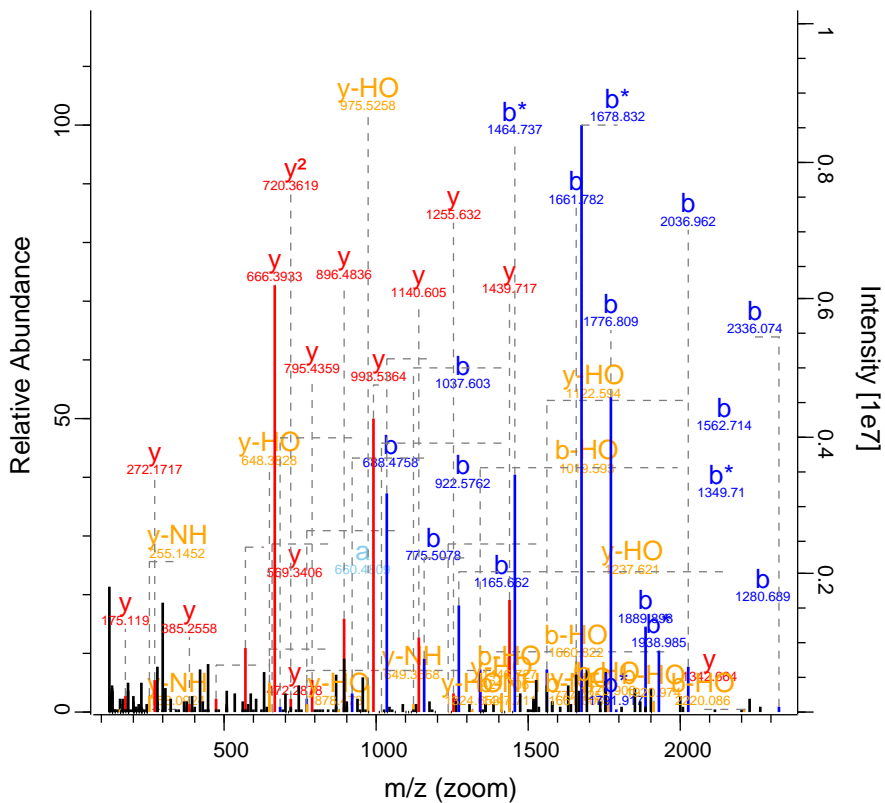

RO-QC-160121_ZackD_SS_Set_01_Fraction 33237 FTMS; HC 53.33 759.04 PLCXD3

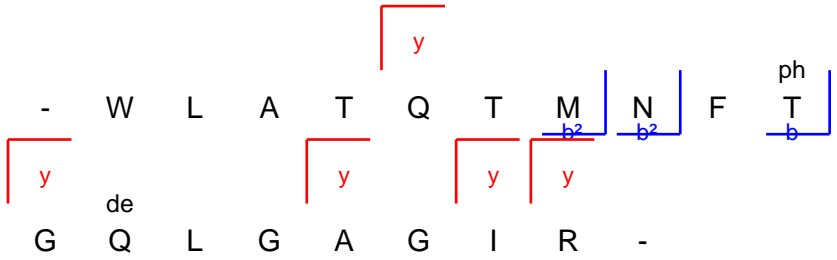
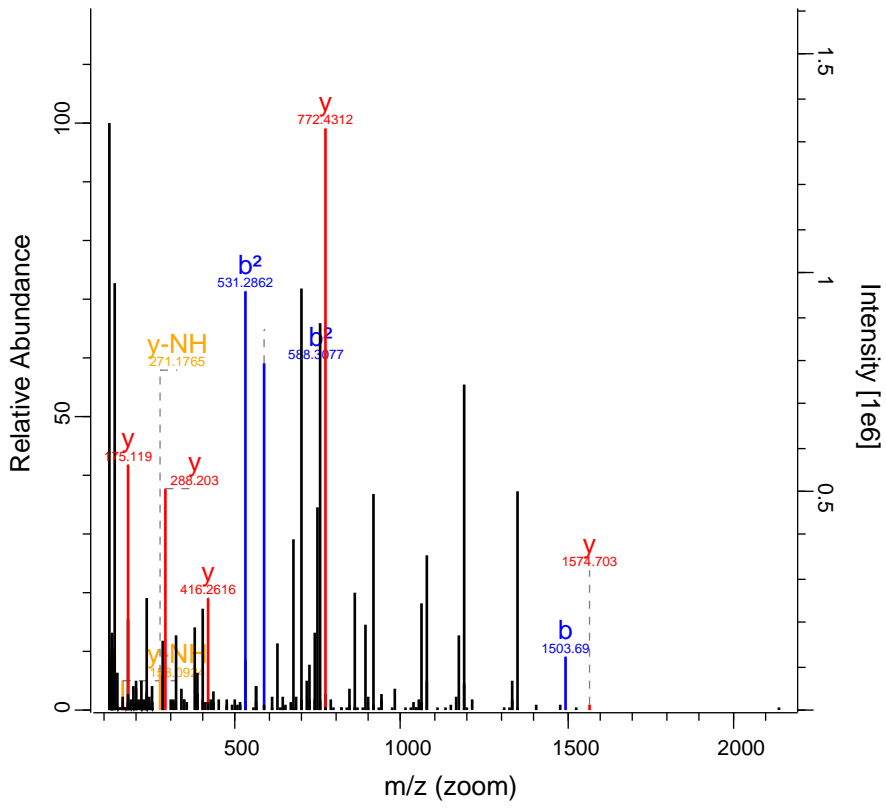

RO-QC-160121_ZackD_SS_Set_01_Fractic 33685 FTMS; HC 92.49 1000.85 SMAP2

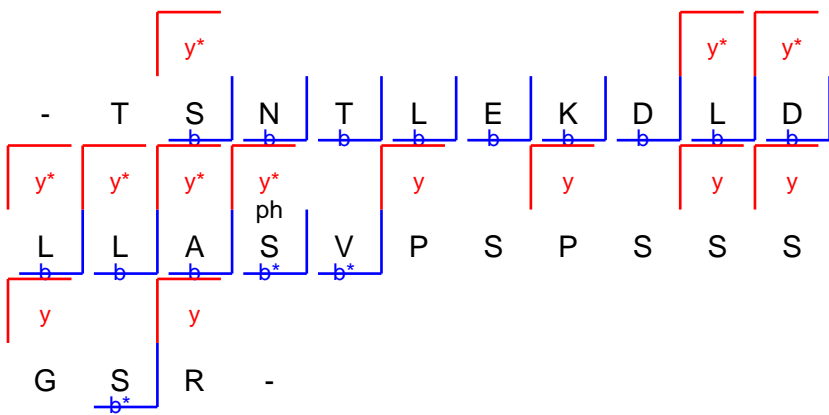
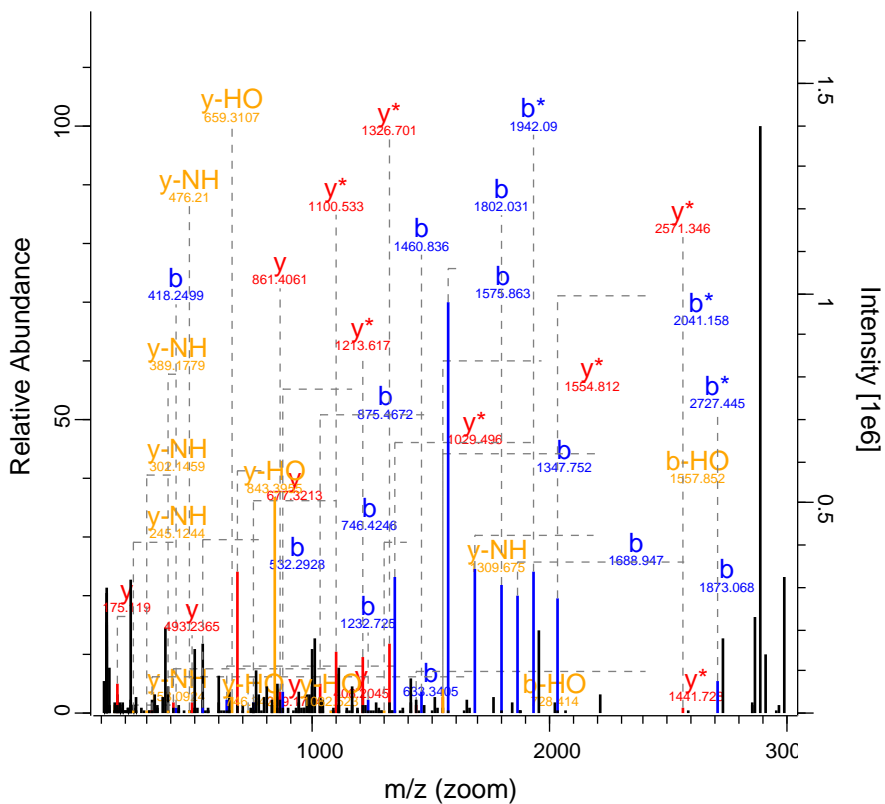

RO-QC-160121_ZackD_SS_Set_01_Fraction 33950 FTMS; HC 61.96 838.94 PARP4

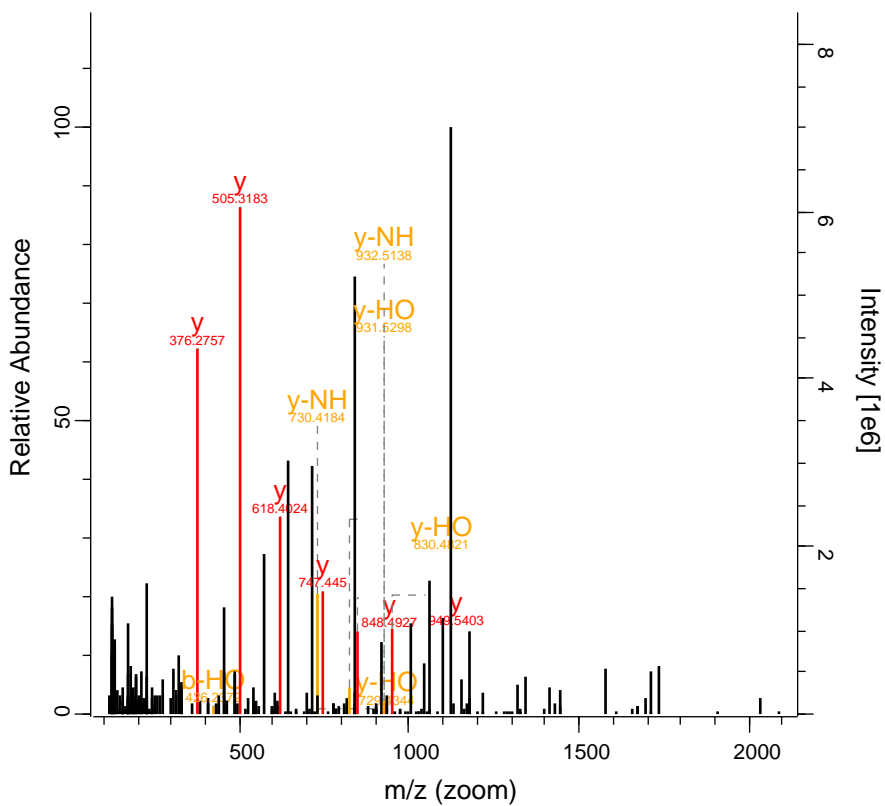

ph

- T M V S T T E L Q K

-

RO-QC-160121_ZackD_SS_Set_01_Fractic 34058 FTMS; HC 56.23 1339.18 C17orf104

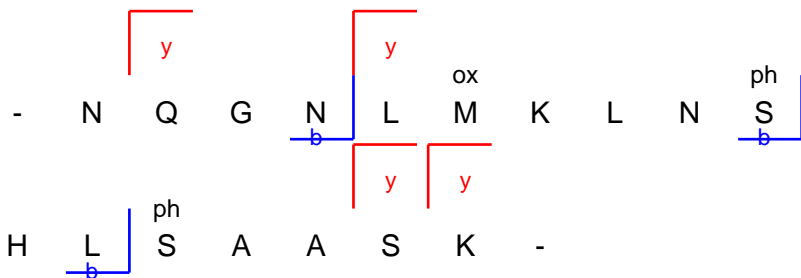
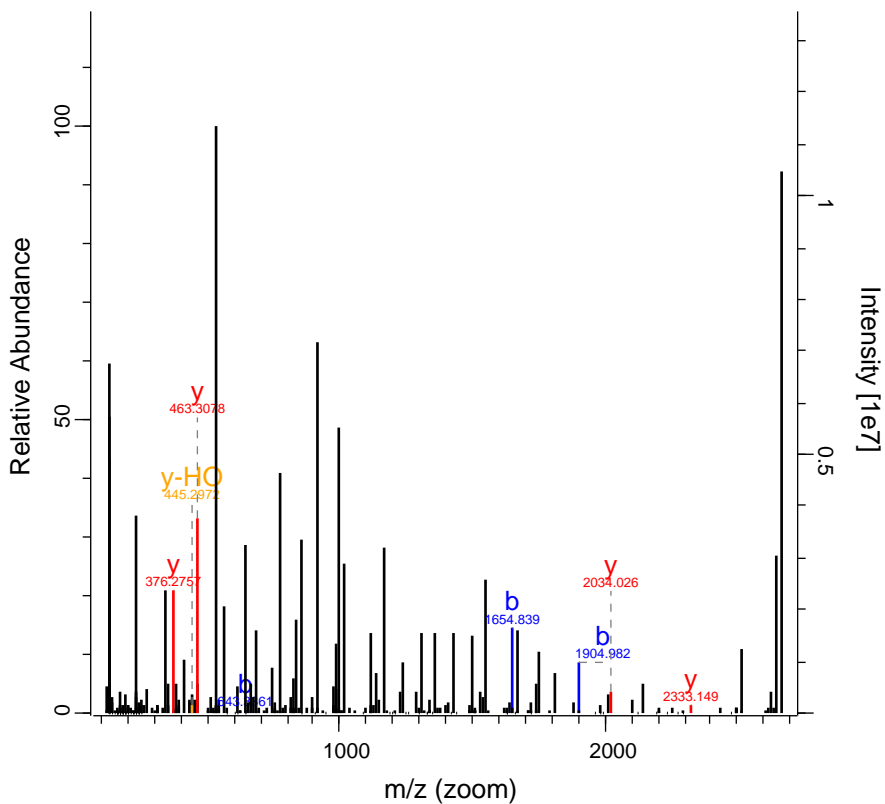

RO-QC-160121_ZackD_SS_Set_01_Fraction 34388 FTMS; HC 88.33 870.09 TOM1

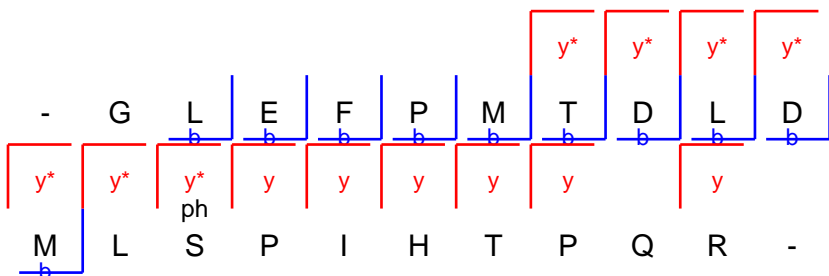
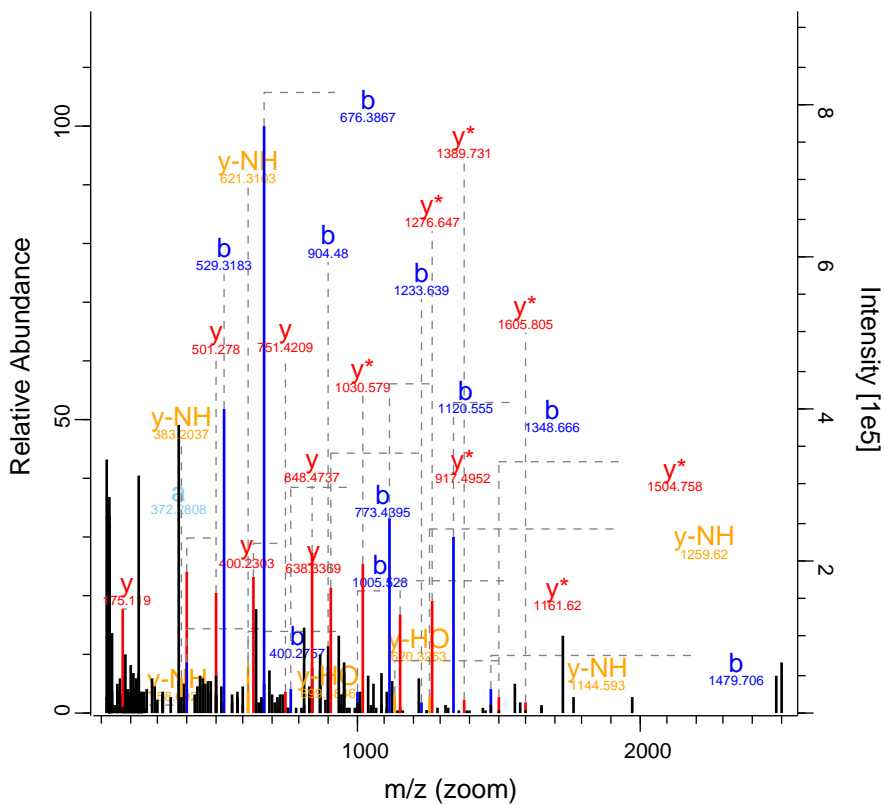

RO-QC-160121_ZackD_SS_Set_01_Fractio 34635 FTMS; HC 147.11 928.12 WRAP53

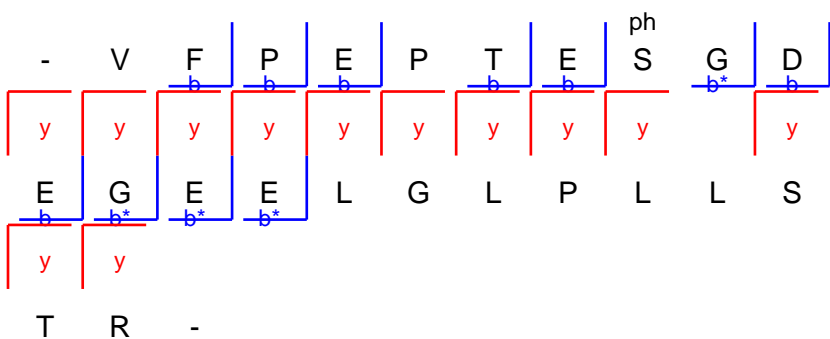
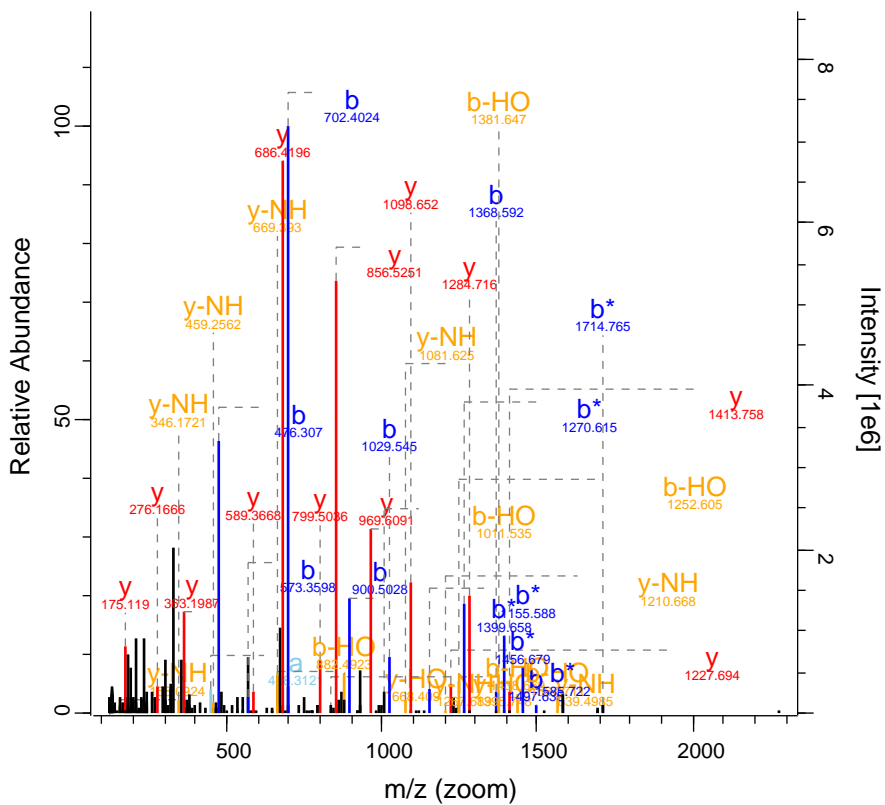

RO-QC-160121_ZackD_SS_Set_01_Fraction 5250 FTMS; HCl 54.28 498.78 PLEKHA7

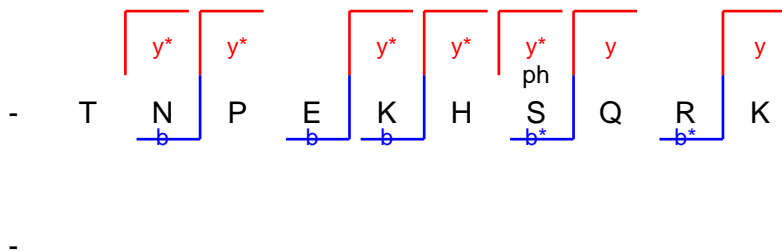
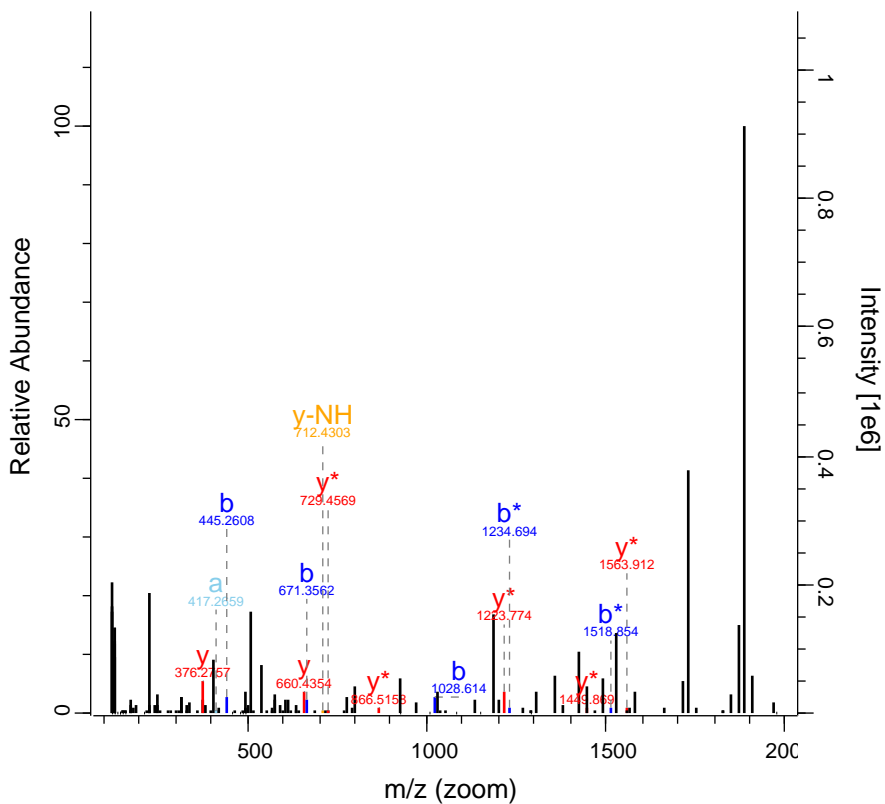

RO-QC-160121_ZackD_SS_Set_01_Fraction 5640 FTMS; HC 105.46 685.83 AAK1

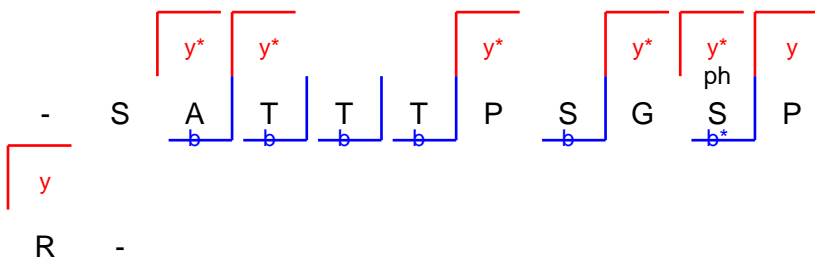
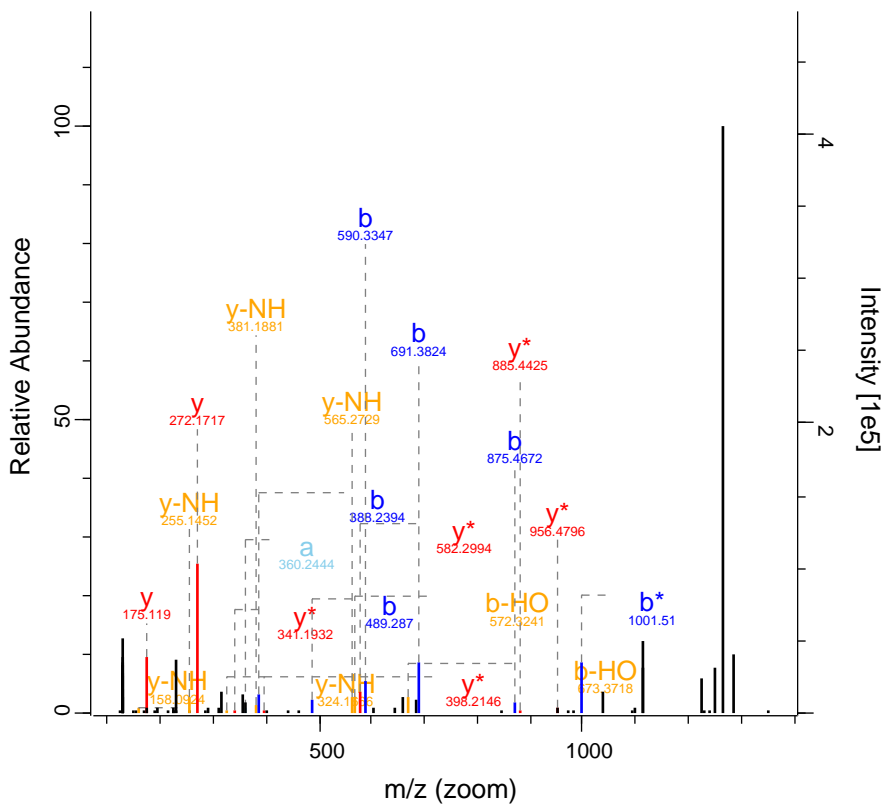

RO-QC-160121_ZackD_SS_Set_01_Fraction 6719 FTMS; HC 147.52 791.38 WWP2

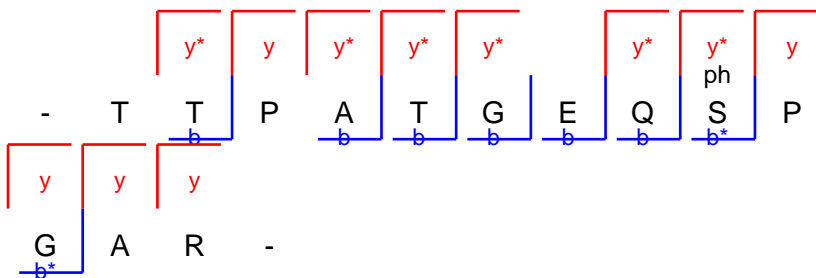
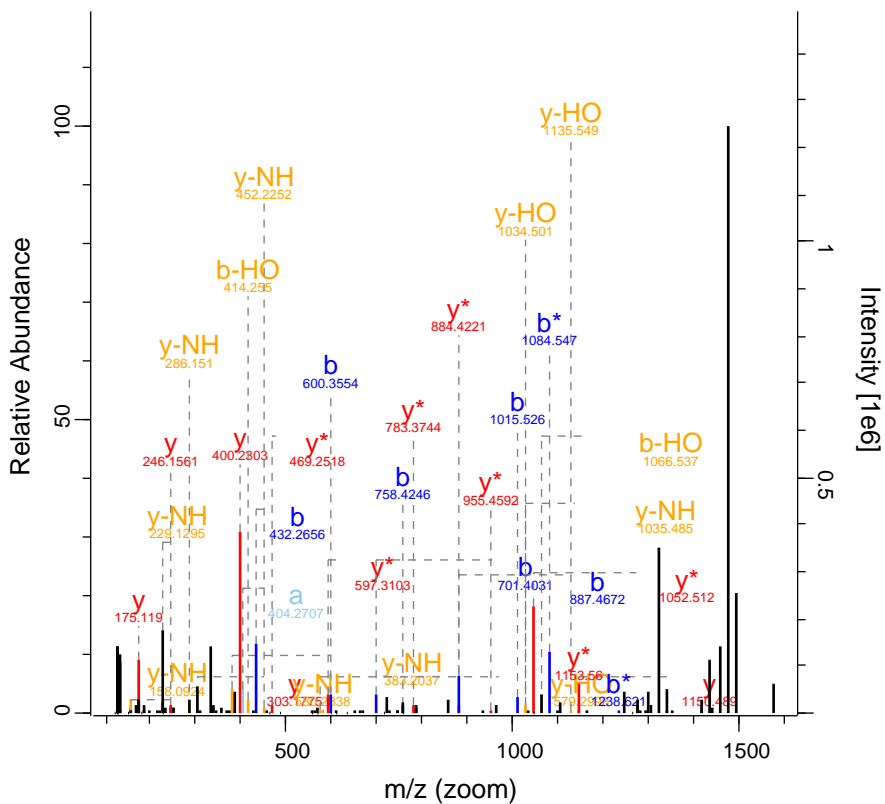

RO-QC-160121_ZackD_SS_Set_01_Fraction 6786 FTMS; HCl 94.19 638.35 HMGN3

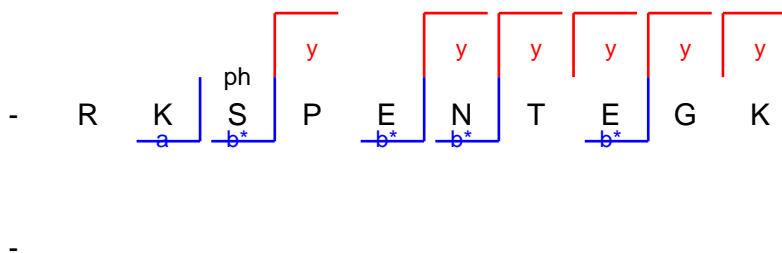
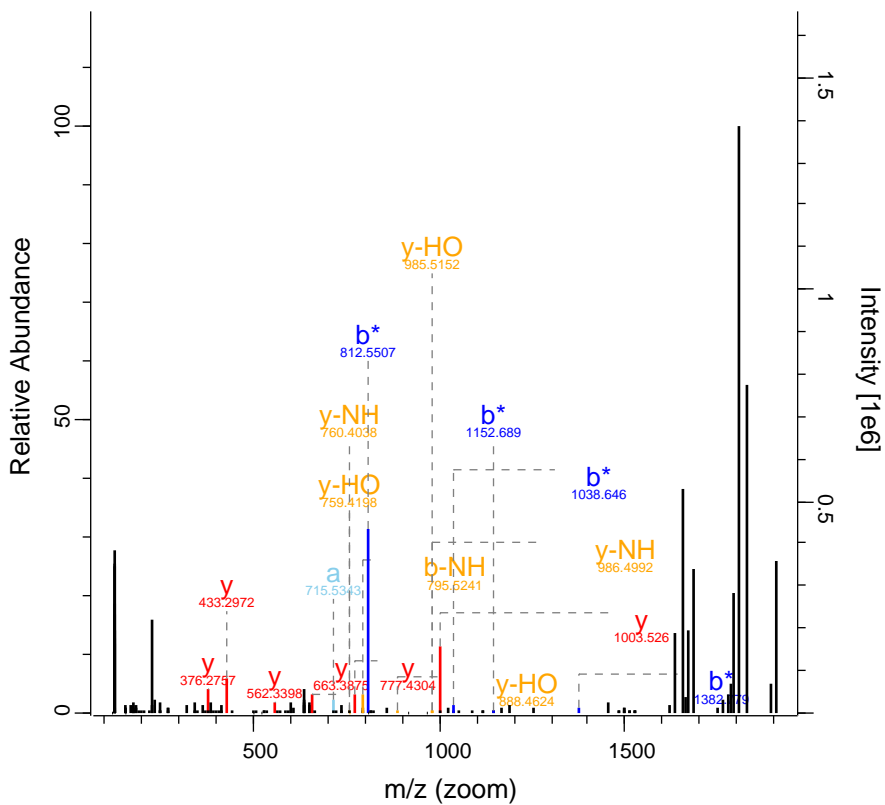

RO-QC-160121_ZackD_SS_Set_01_Fraction 10107 FTMS; HC 77.89 491.79 STMN1

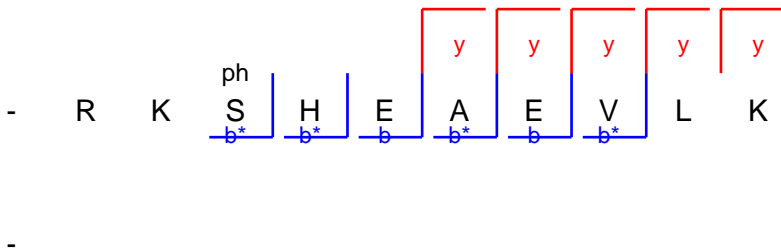
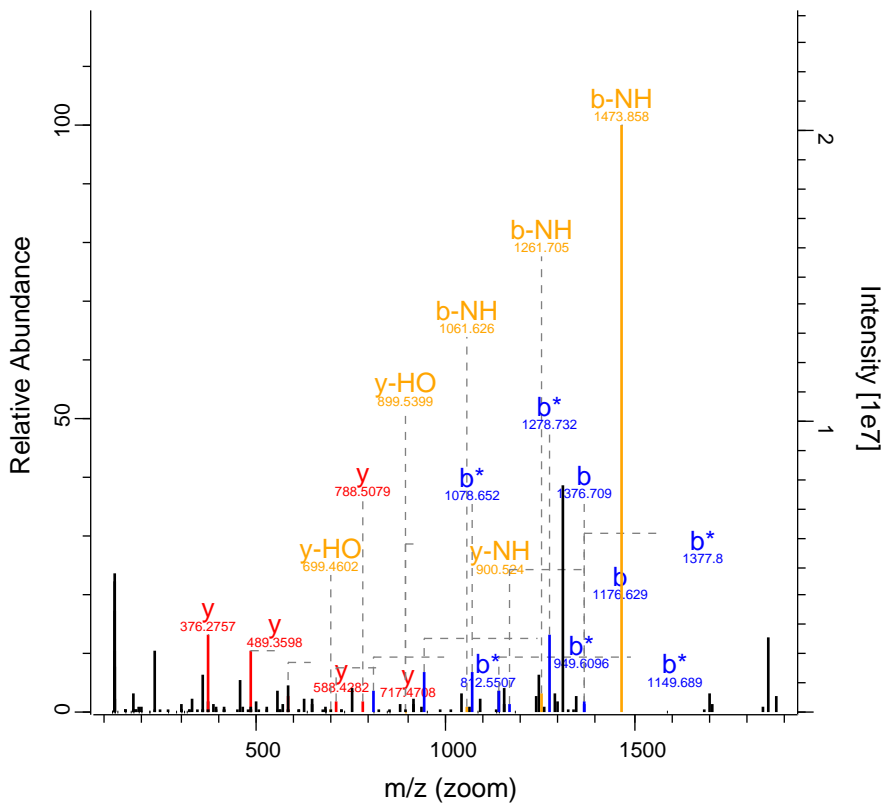

RO-QC-160121_ZackD_SS_Set_01_Fractio 10305 FTMS; HC 113.43 984.95 CD276

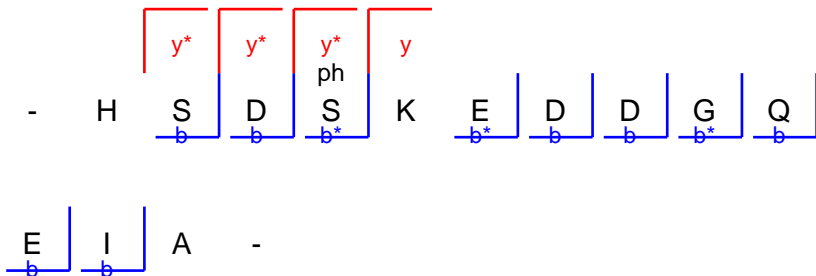
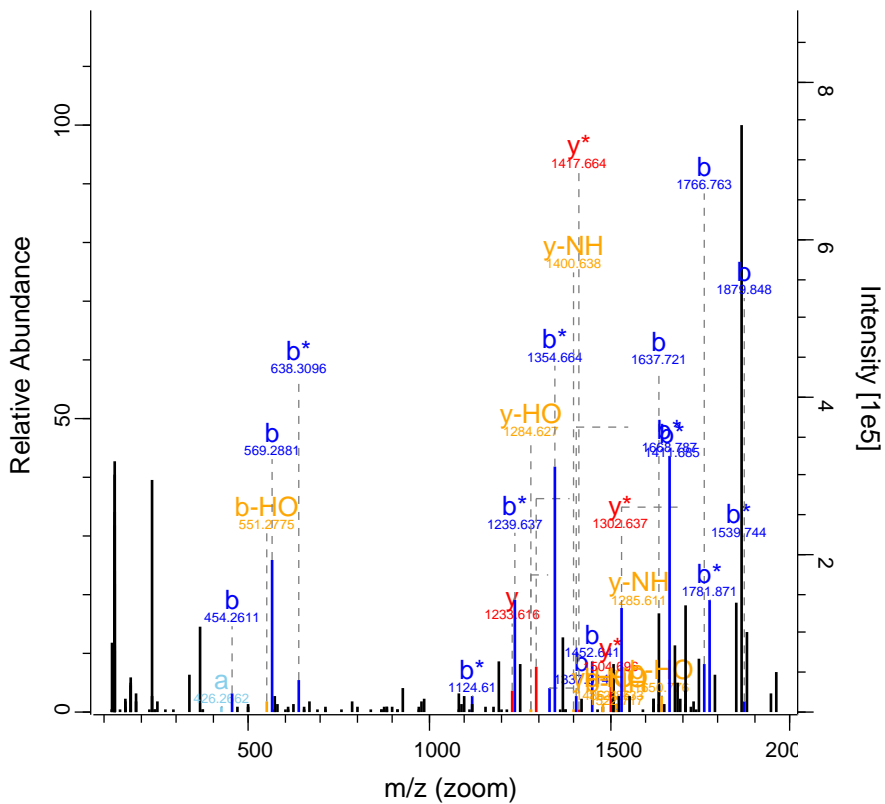

RO-QC-160121_ZackD_SS_Set_01_Fractio 11201 FTMS; HC 115.66 680.33 MARCKS

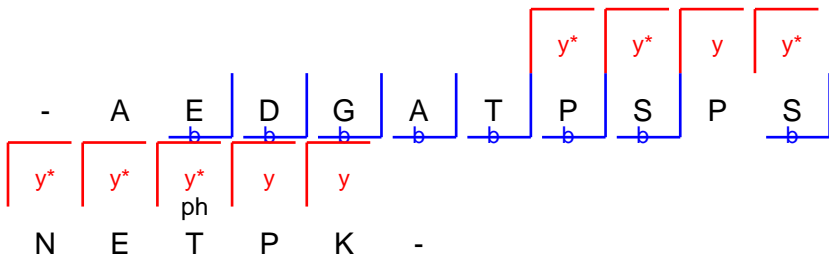
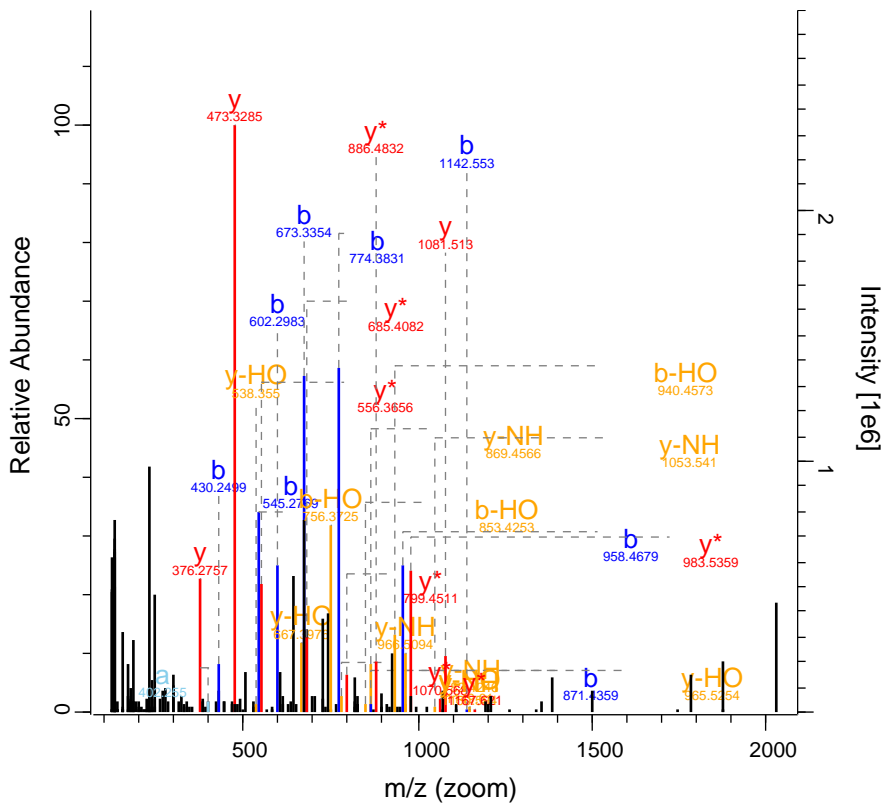

N E T P K -

RO-QC-160121_ZackD_SS_Set_01_Fractic 12017 FTMS; HC 75.51 1035.99 MRC1

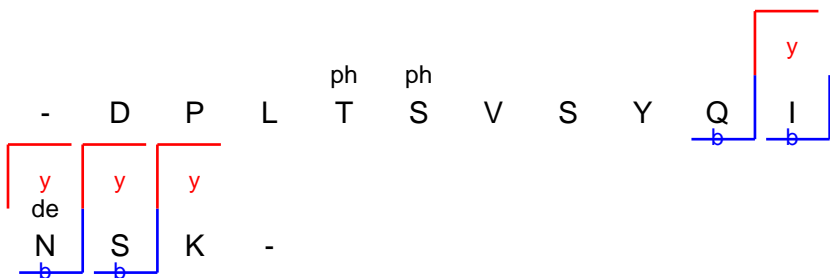
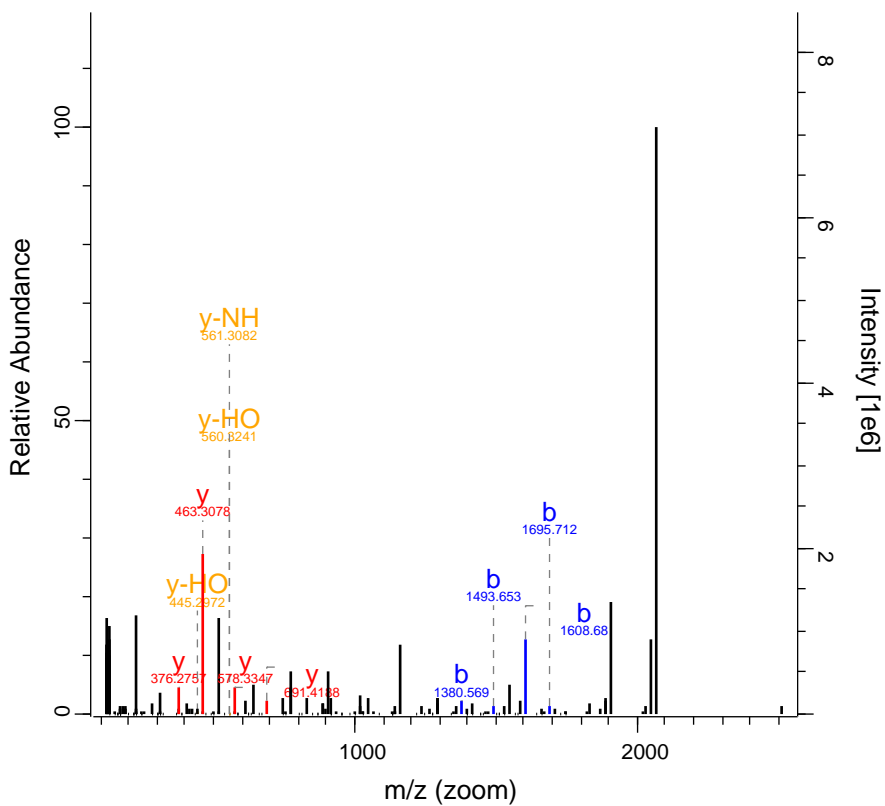

RO-QC-160121_ZackD_SS_Set_01_Fractic 12501 FTMS; HC 181.58 1019.99 MARCKS

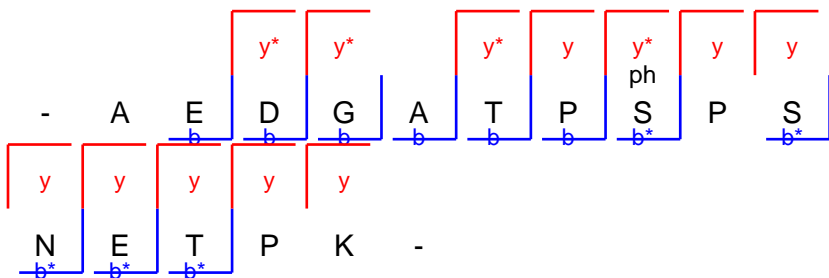
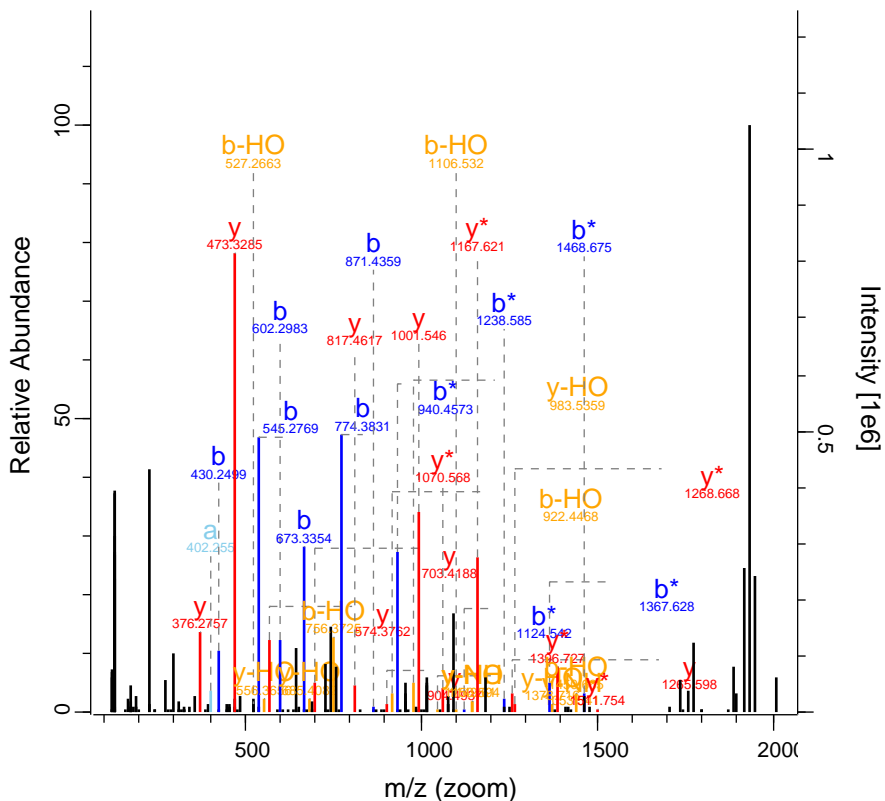

RO-QC-160121_ZackD_SS_Set_01_Fractio 12530 FTMS; HC 154.82 841.12 MATR3

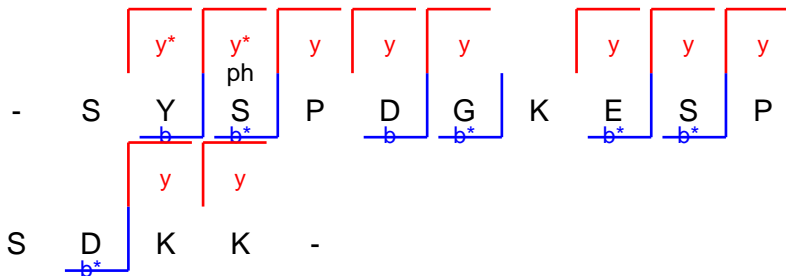
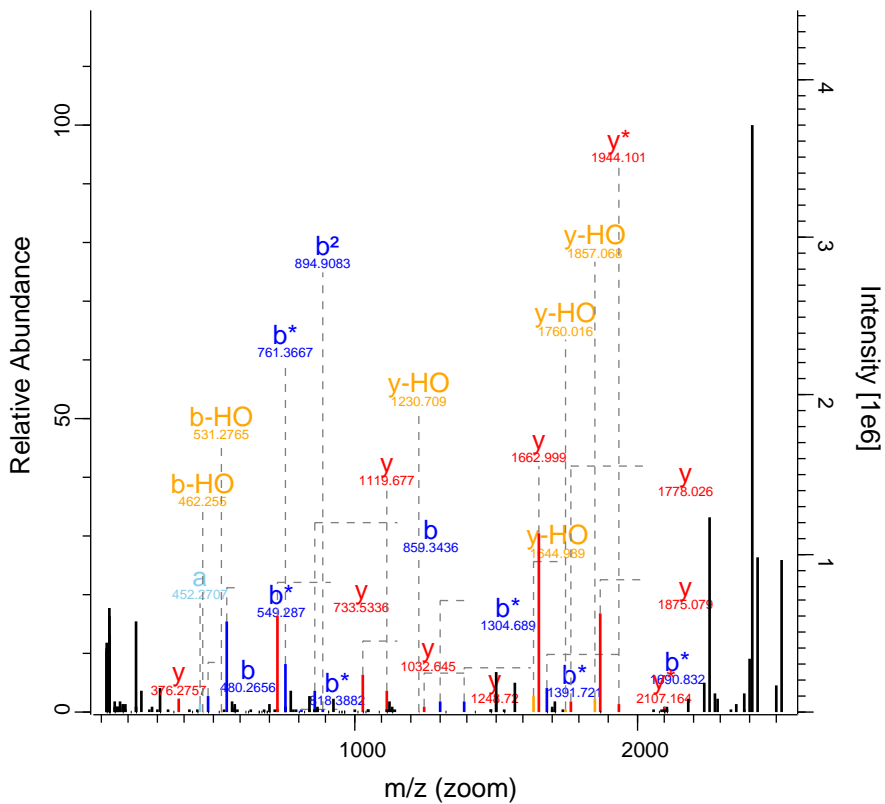

RO-QC-160121_ZackD_SS_Set_01_Fractio 12709 FTMS; HC 107.97 705.34 MCM2

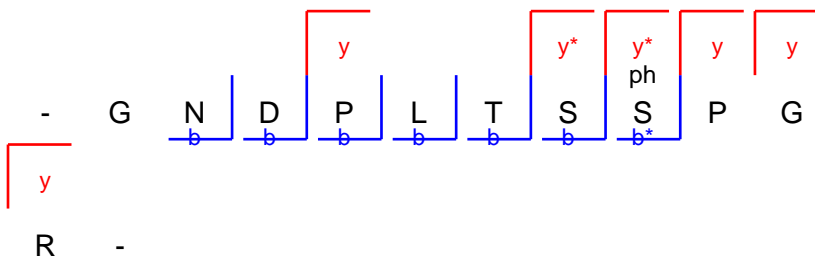
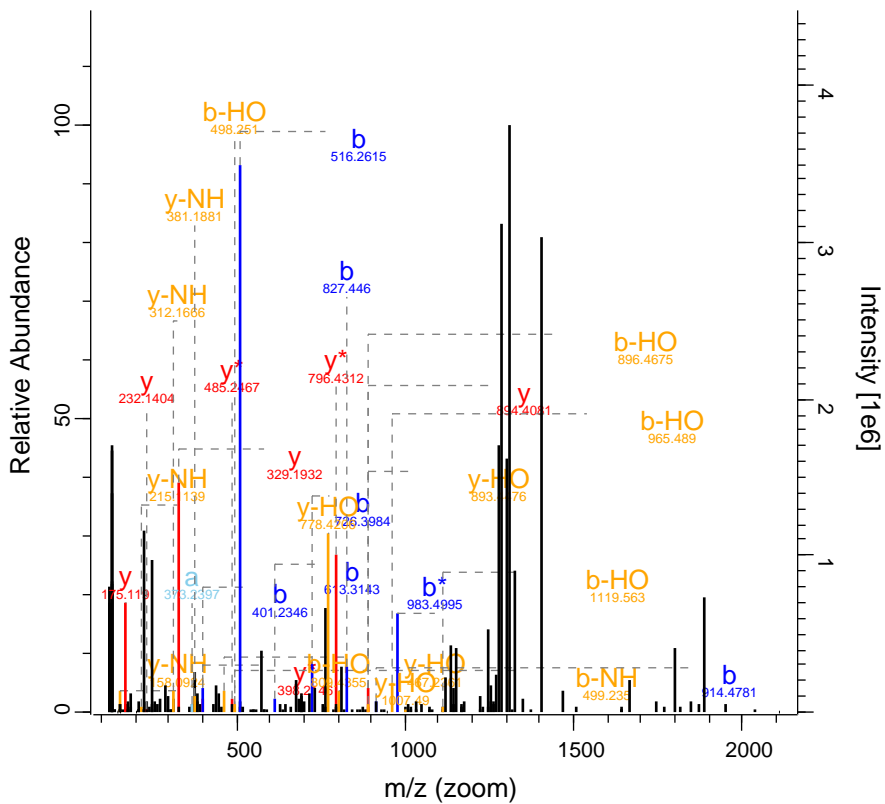

RO-QC-160121_ZackD_SS_Set_01_Fractic 13234 FTMS; HC 154.47 1022.06 PIKFYVE

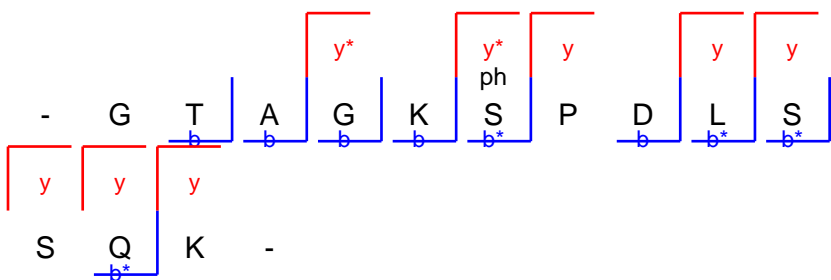
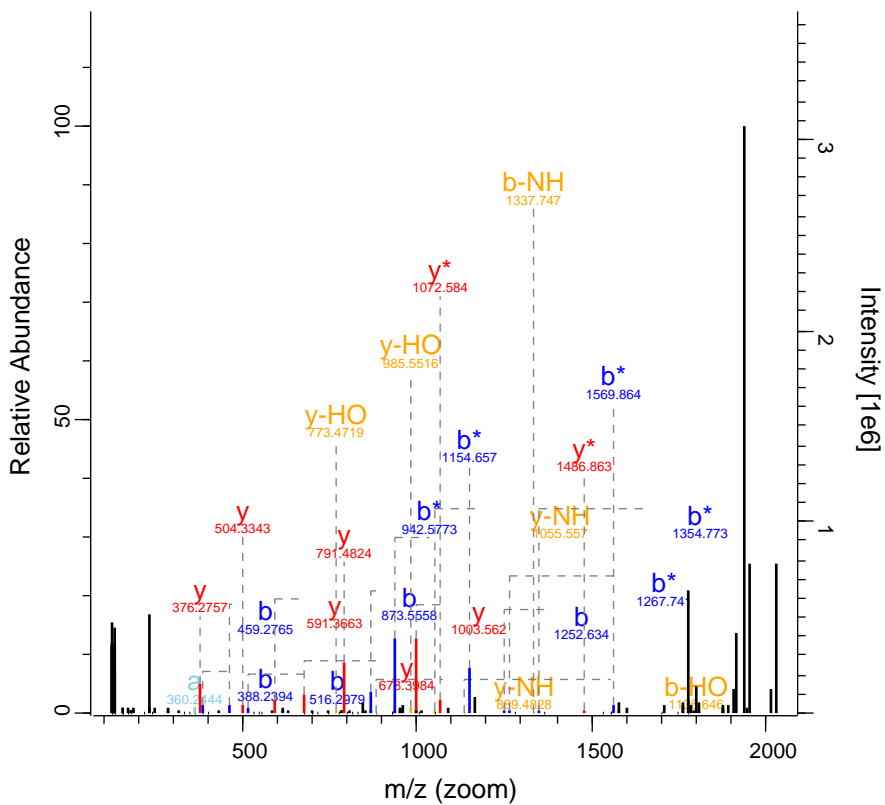

RO-QC-160121_ZackD_SS_Set_01_Fractio 13853 FTMS; HC 136.02 865.47 PSMD2

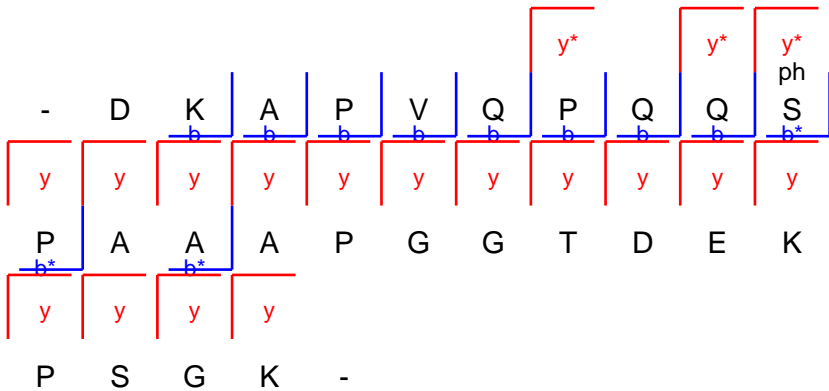
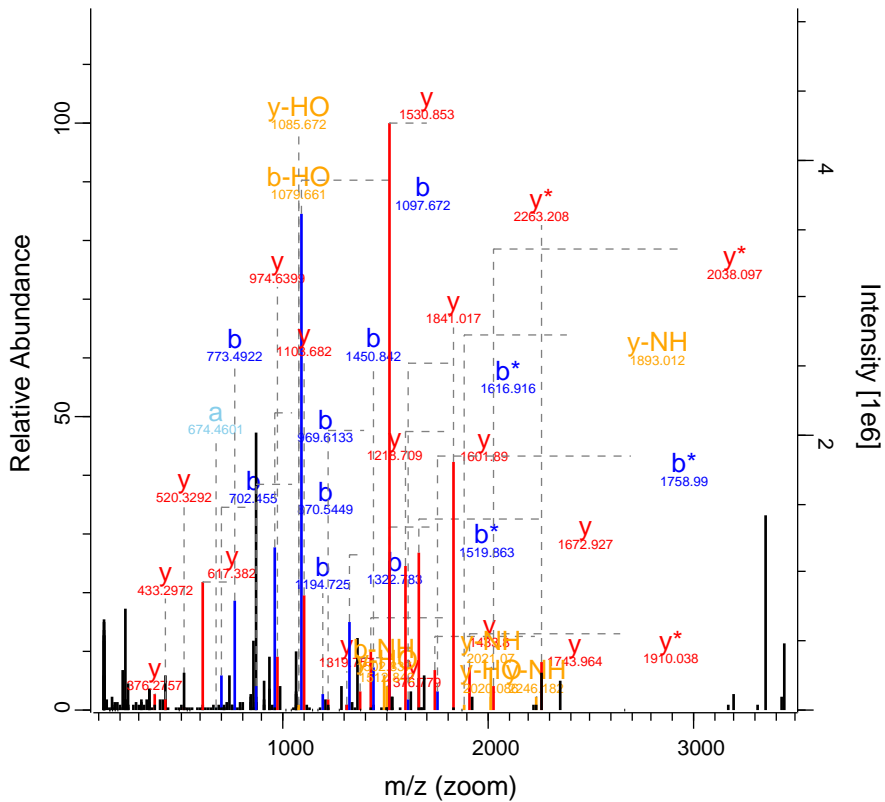

RO-QC-160121_ZackD_SS_Set_01_Fraction 14201 FTMS; HC 84.66 956.01 GPR110

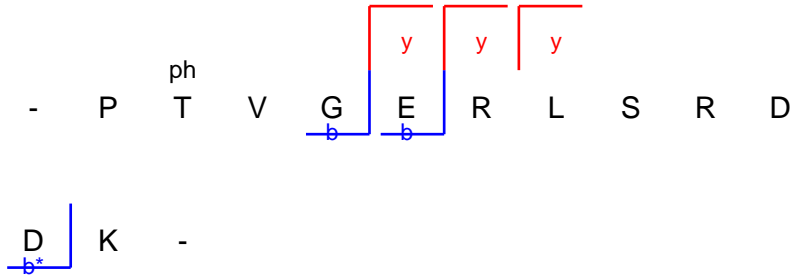
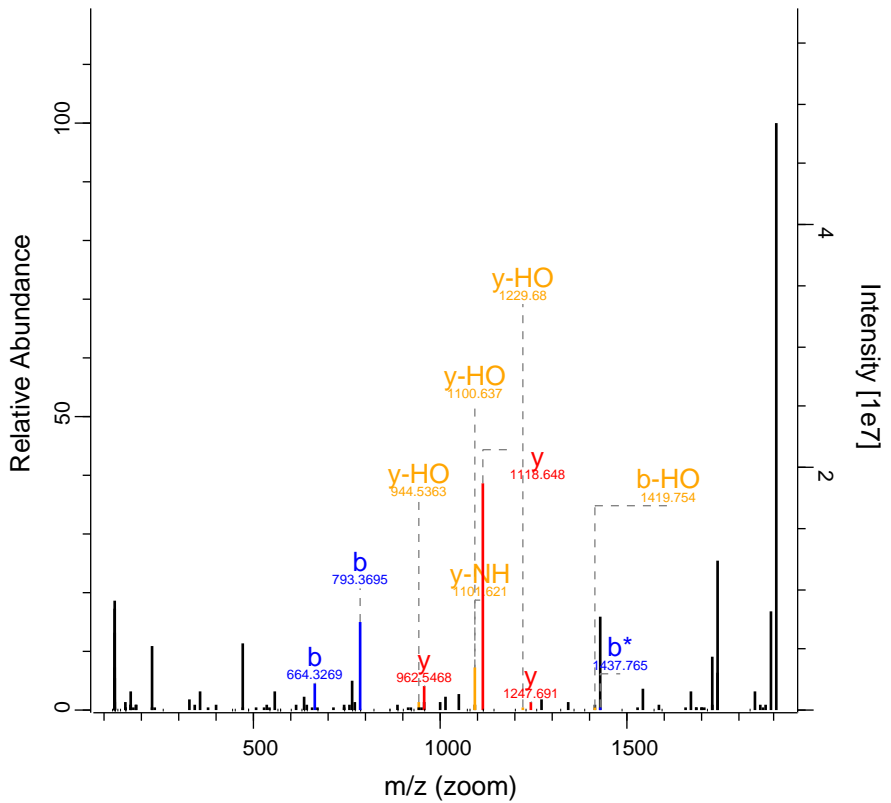

RO-QC-160121_ZackD_SS_Set_01_Fraction 14492 FTMS; HC 74.7 852.11 RPP30

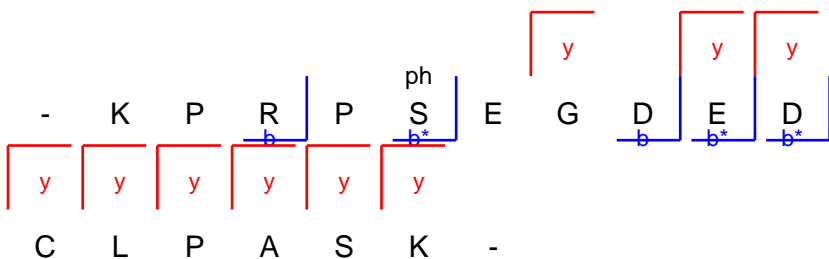
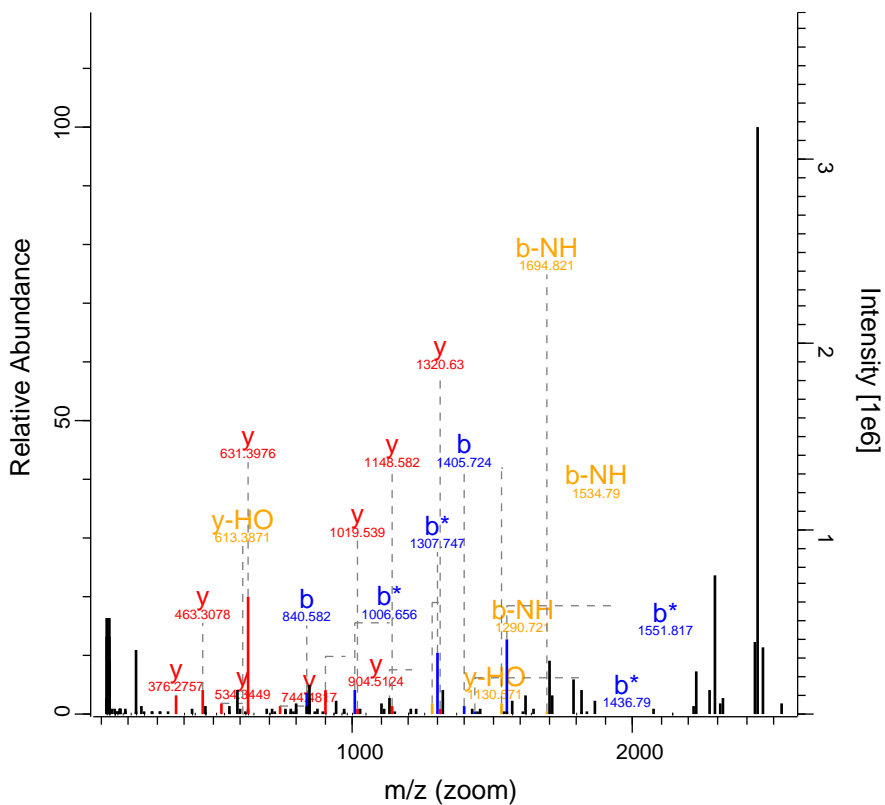

RO-QC-160121_ZackD_SS_Set_01_Fraction 15216 FTMS; HC 66.39 558.32 SORBS2

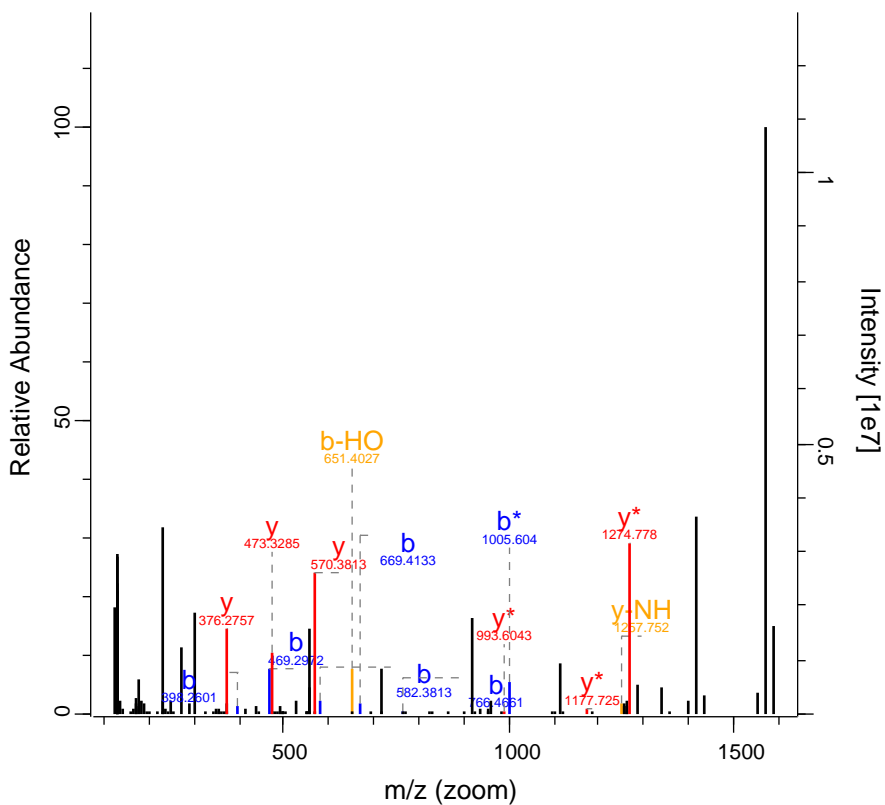

m/z (zoom)

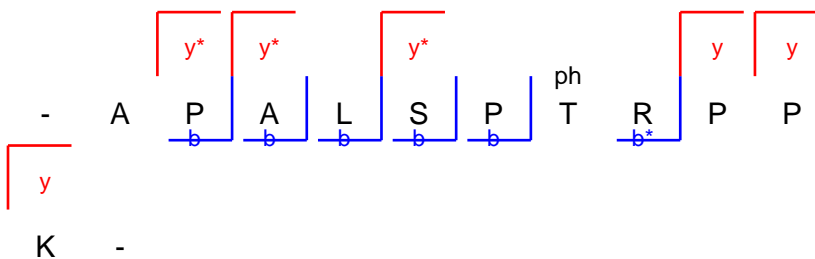

K -

RO-QC-160121_ZackD_SS_Set_01_Fractio 15238 FTMS; HC 134.13 836.98 SORBS2

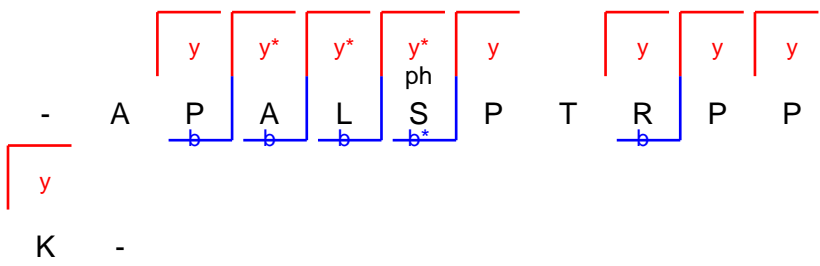
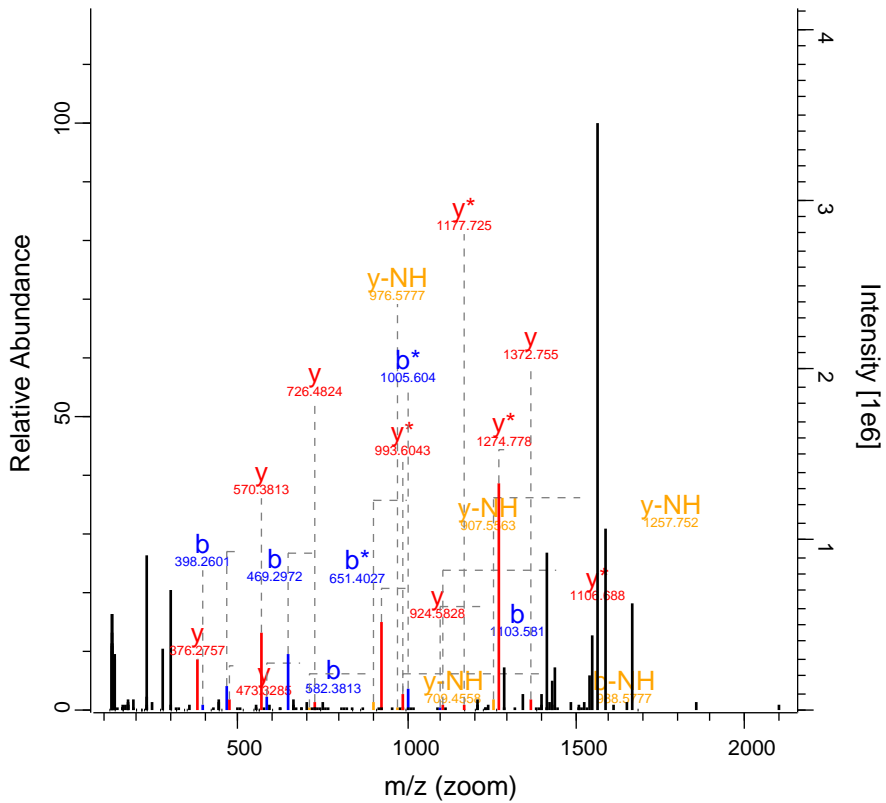

-
y
K -

RO-QC-160121_ZackD_SS_Set_01_Fraction 15448 FTMS; HC 73.17 825.76 UBR4

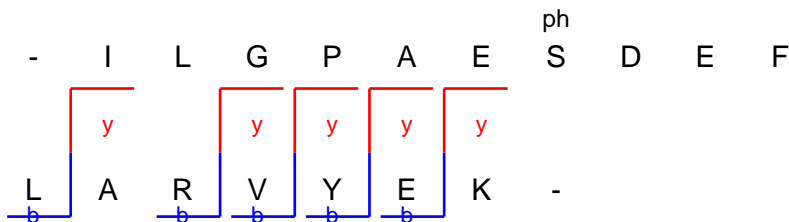
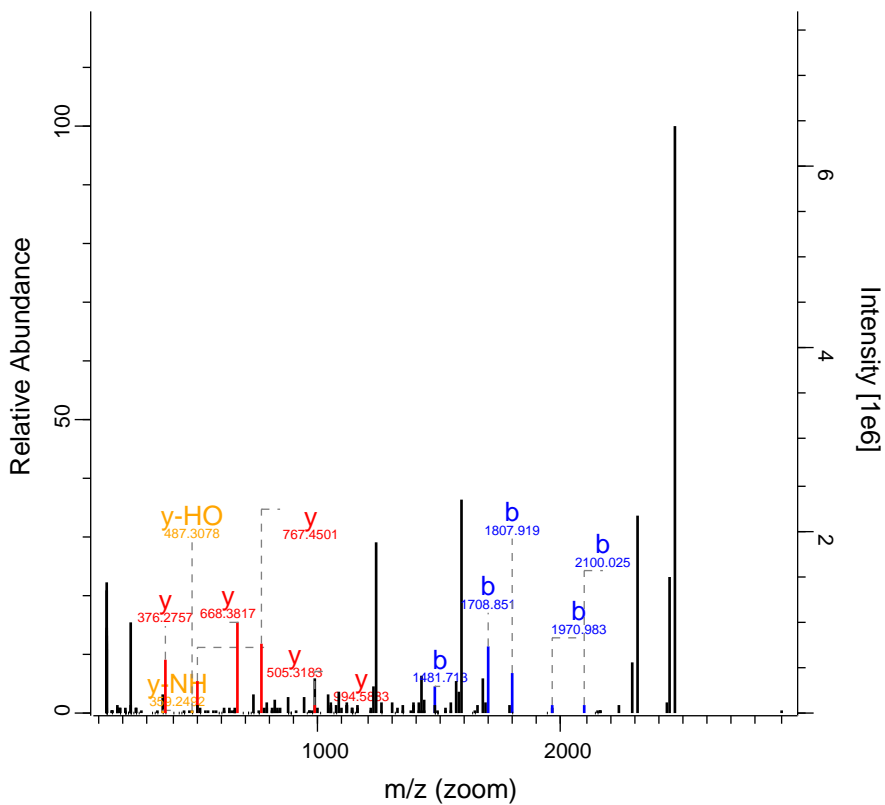

RO-QC-160121_ZackD_SS_Set_01_Fractio 15816 FTMS; HC 134.08 984.06 CCNK

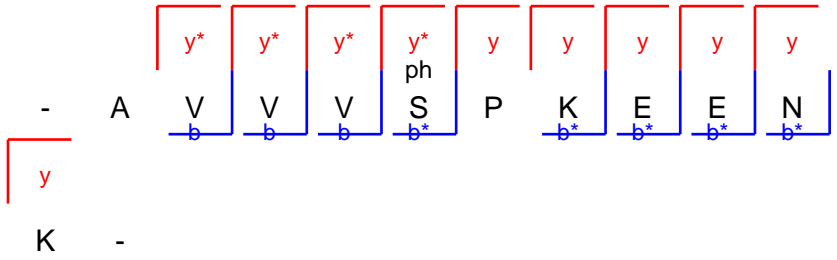
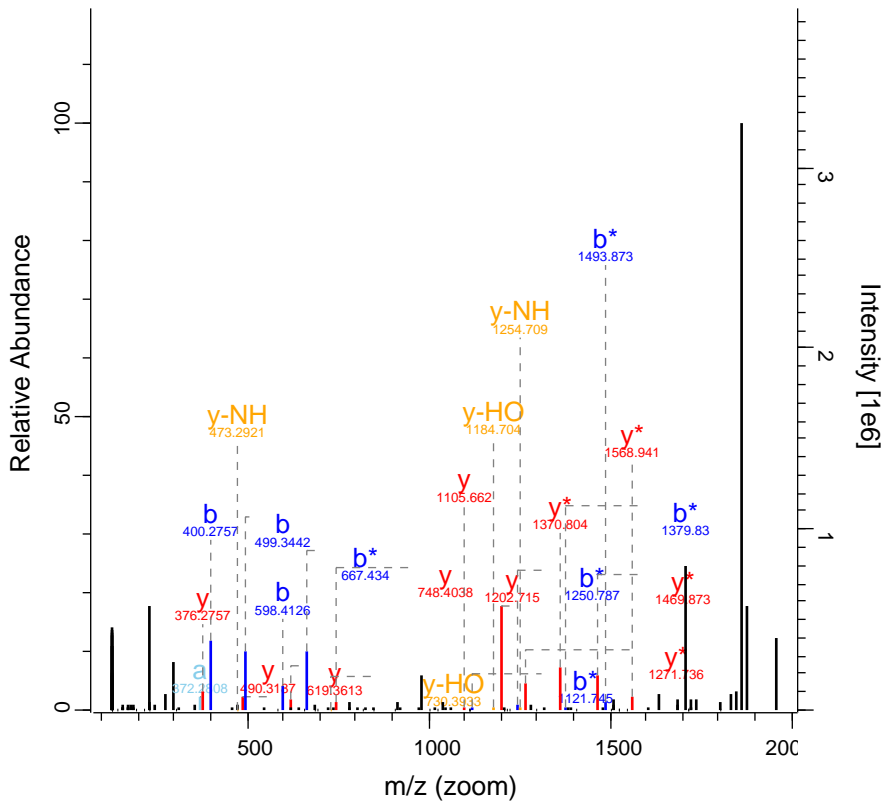

RO-QC-160121_ZackD_SS_Set_01_Fractic 15985 FTMS; HC 465.48 1209.06 SLC9A3R1

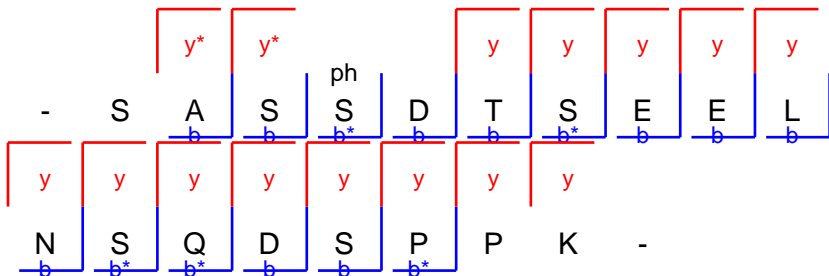
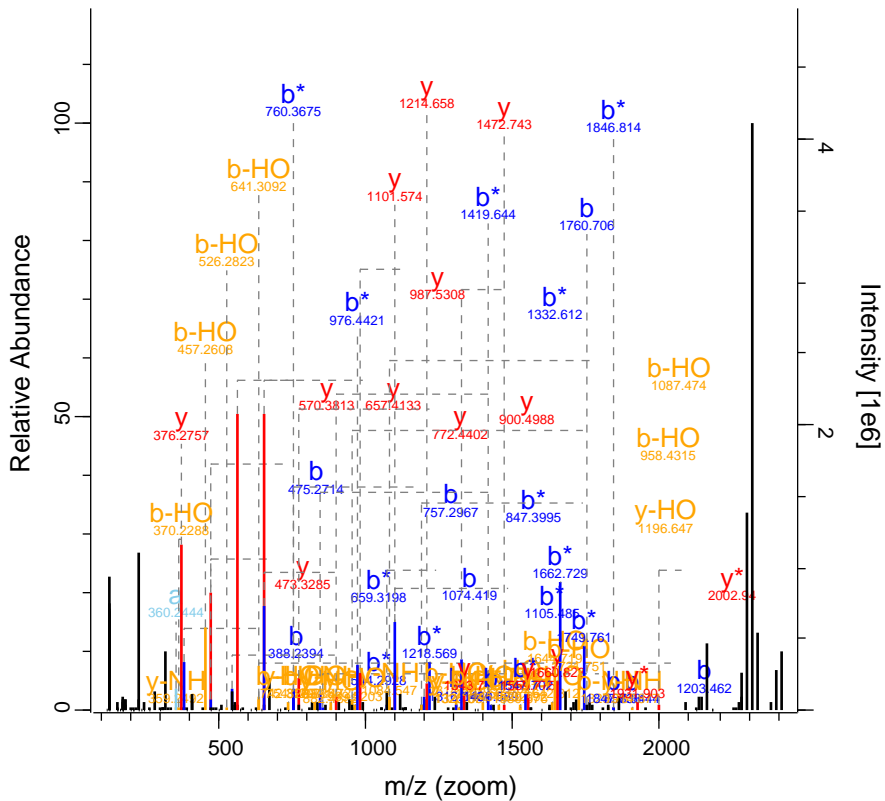

RO-QC-160121_ZackD_SS_Set_01_Fractio 16085 FTMS; HC 137.73 806.71 SLC9A3R1

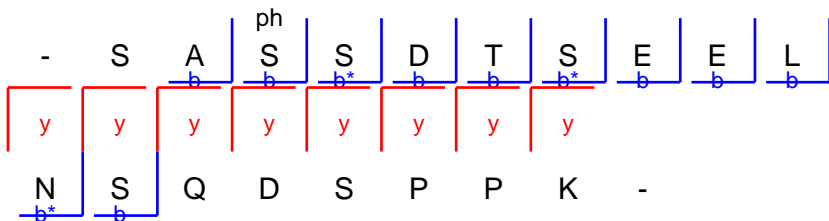
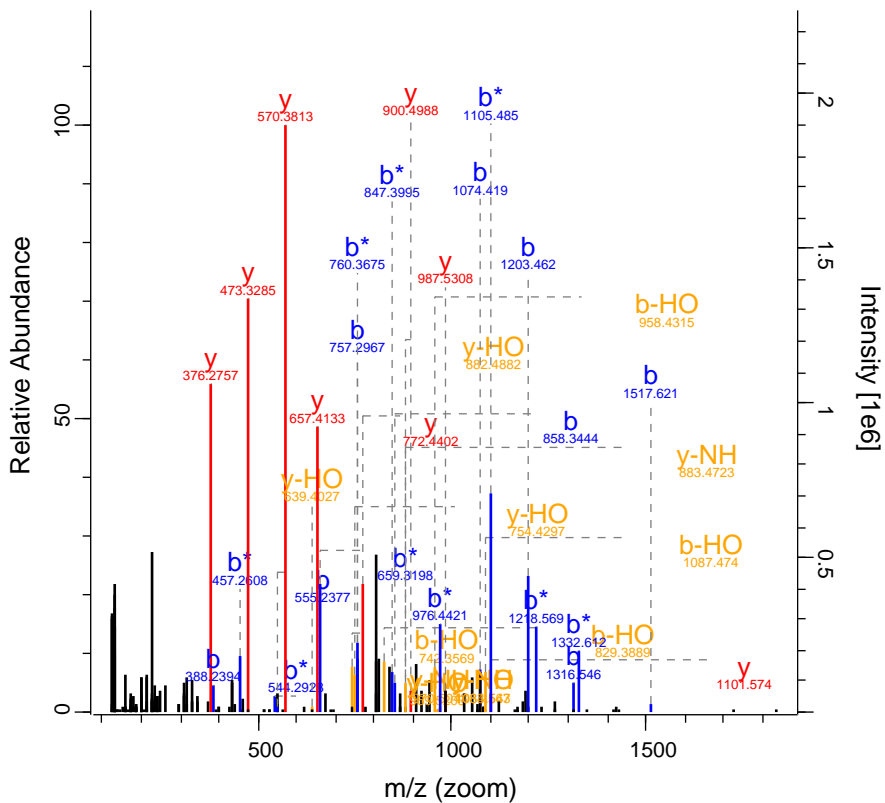

RO-QC-160121_ZackD_SS_Set_01_Fraction16105_FTMS; HCl 213.73 947.5 RBM25

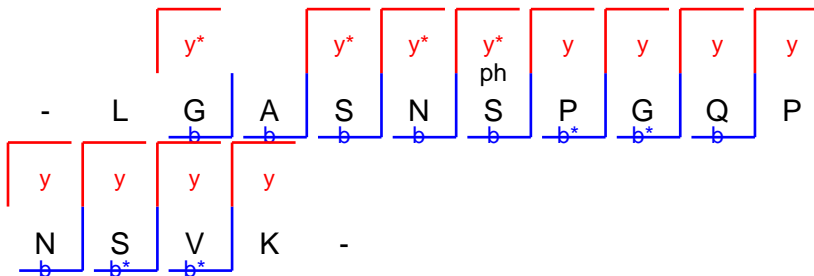
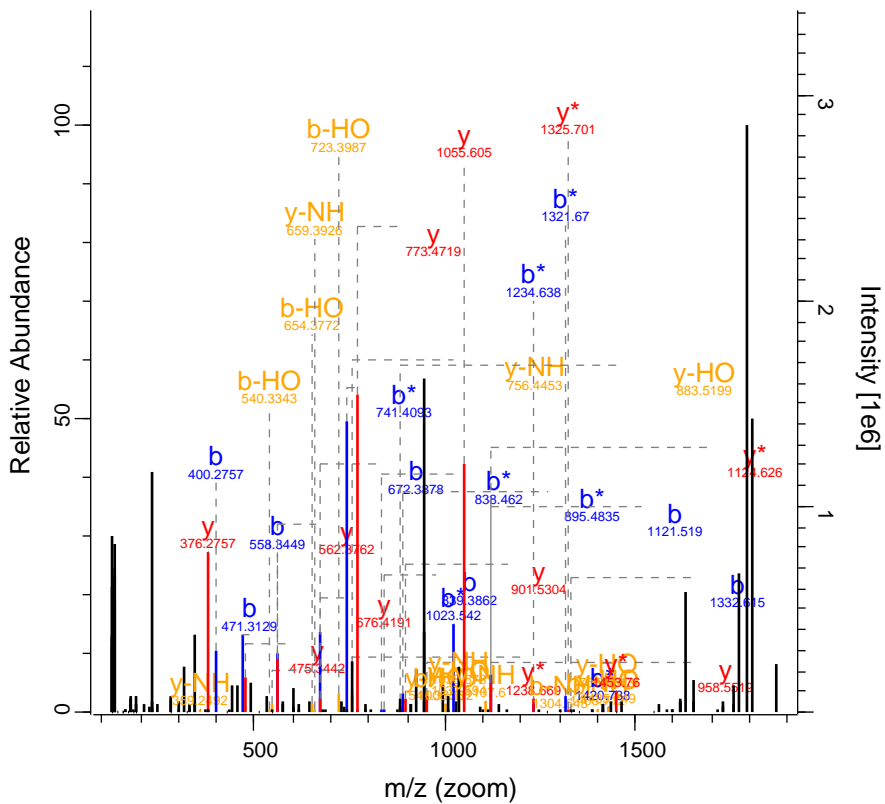

RO-QC-160121_ZackD_SS_Set_01_Fractic 16562 FTMS; HC 216.72 1141.98 CTNND1

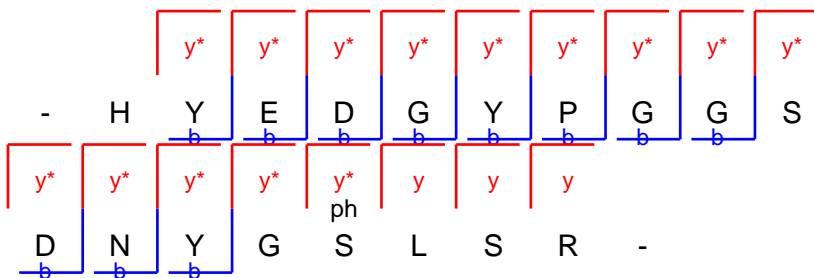
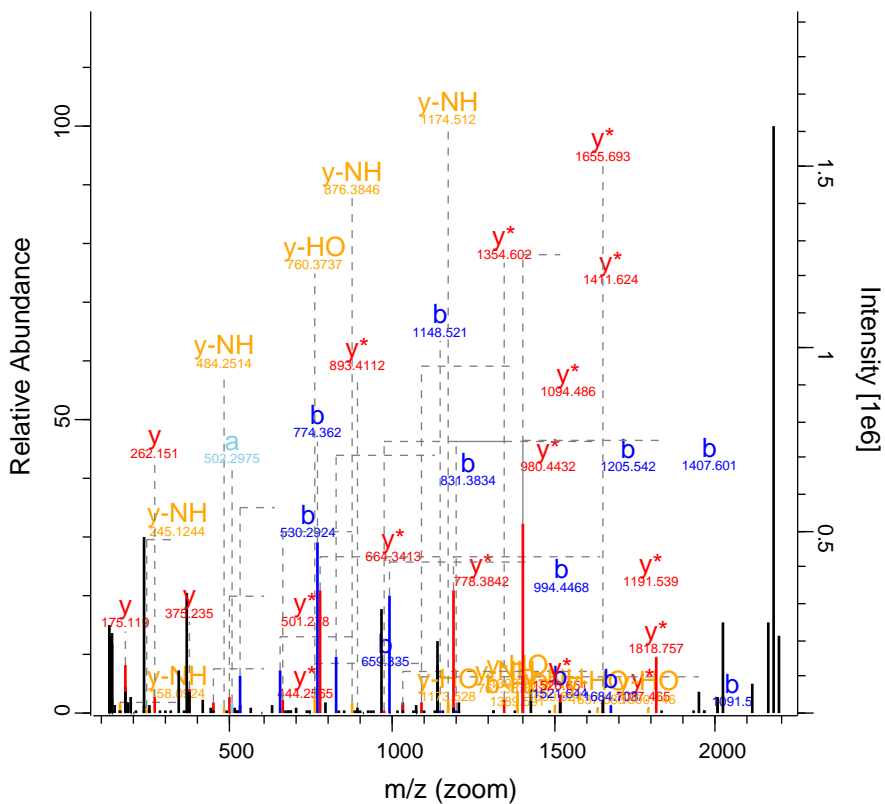

RO-QC-160121_ZackD_SS_Set_01_Fractic 16767 FTMS; HC 88.55 1029.09 CALD1

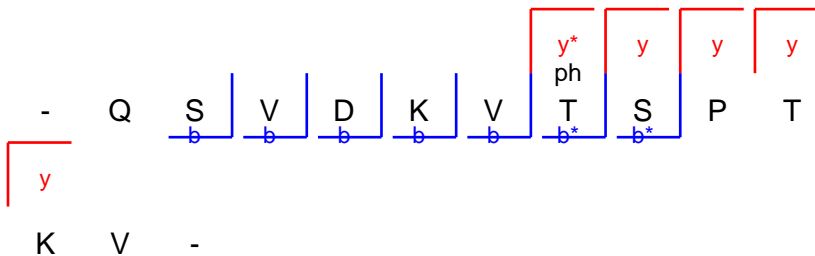
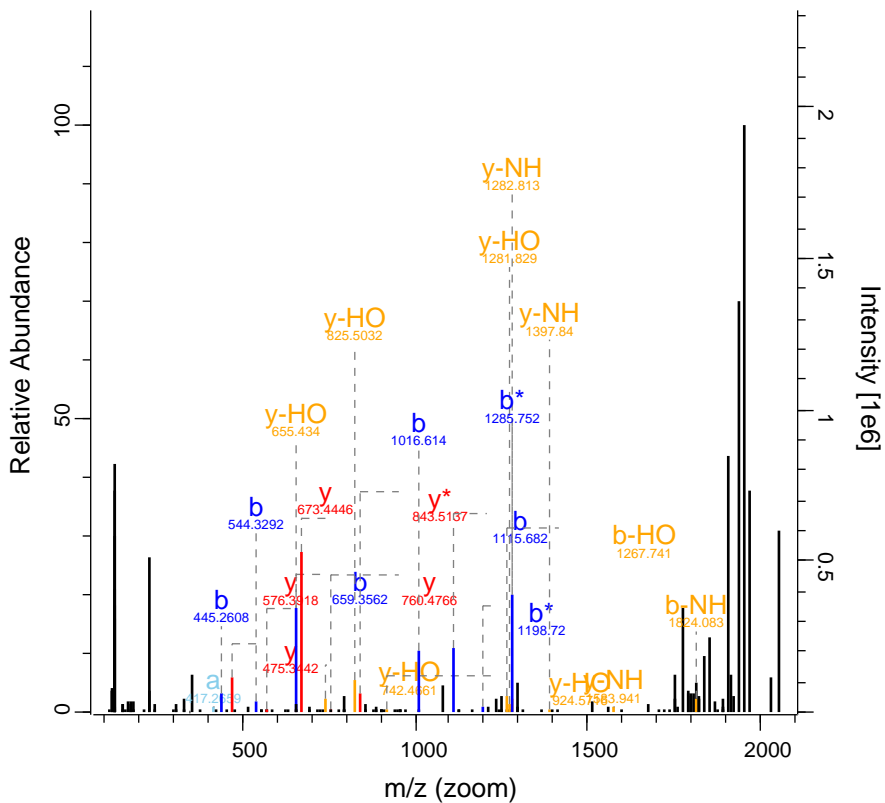

K V -

RO-QC-160121_ZackD_SS_Set_01_Fractic 17061 FTMS; HC 43.63 1007.49 KIF23

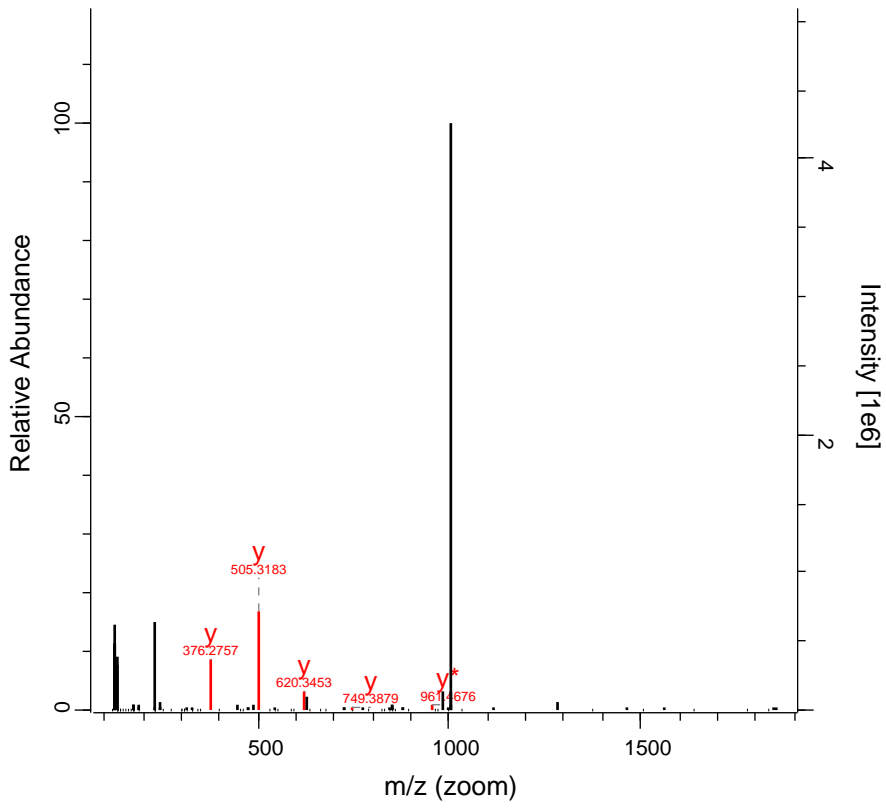

RO-QC-160121_ZackD_SS_Set_01_Fractio 18475 FTMS; HC 137.11 892.43 MYEF2

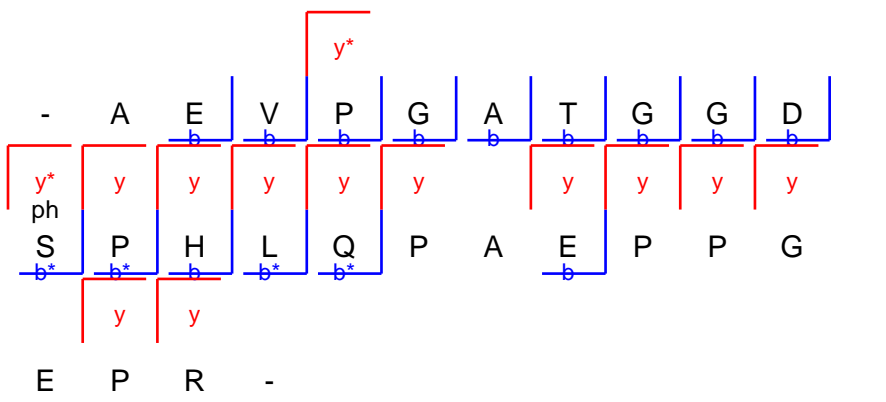
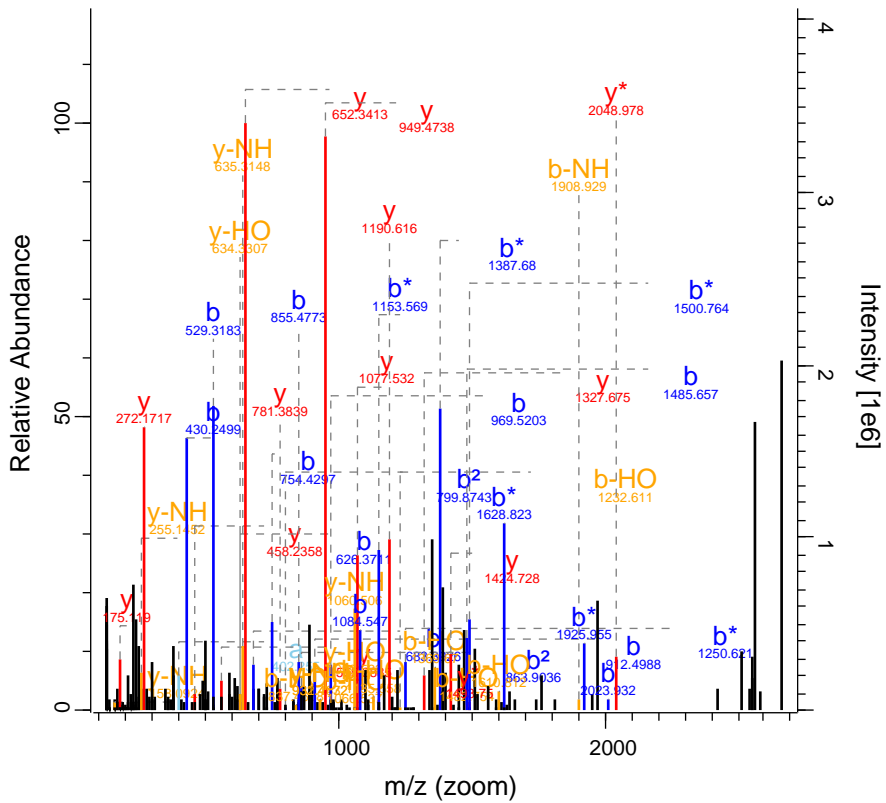

E P R -

RO-QC-160121_ZackD_SS_Set_01_Fraction 18818 FTMS; HC 60.4 929.98 MPP5

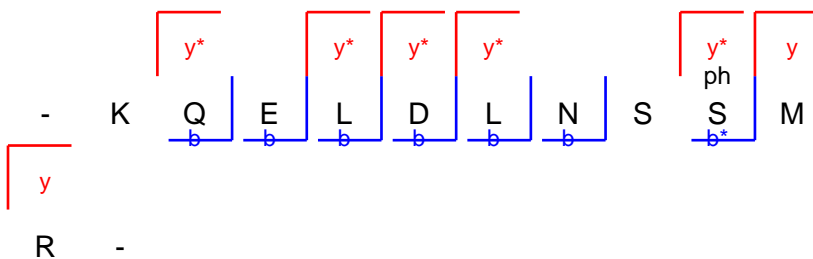
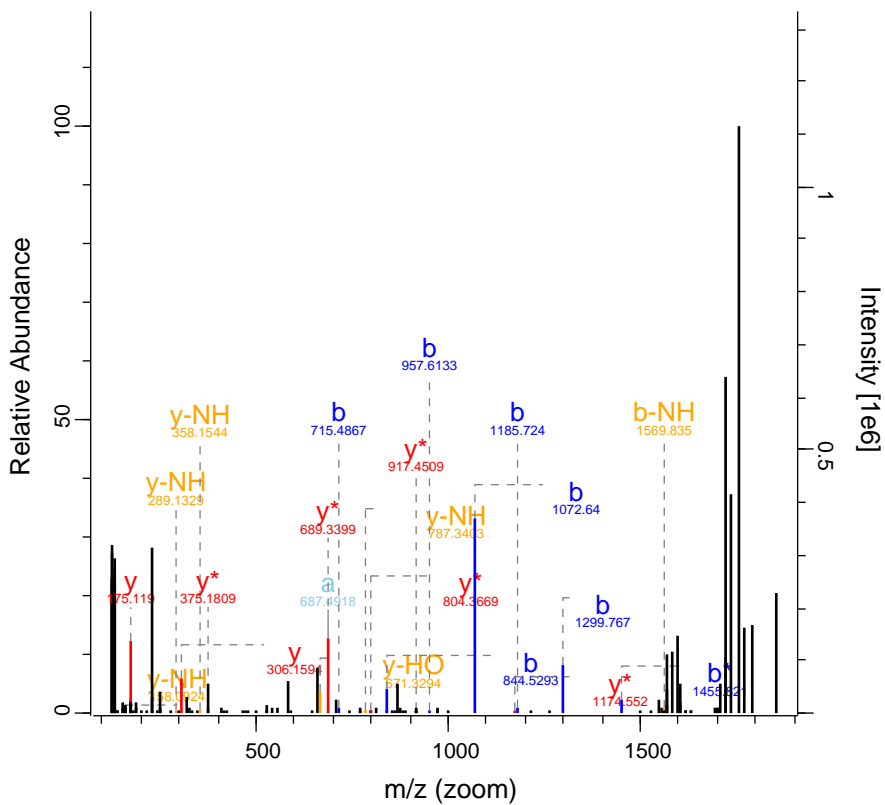

RO-QC-160121_ZackD_SS_Set_01_Fractio 19394 FTMS; HC 109.16 764.92 RAI14

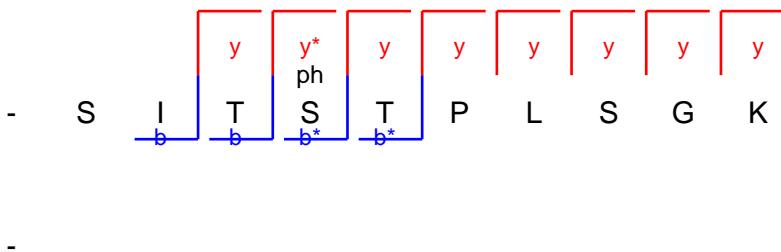
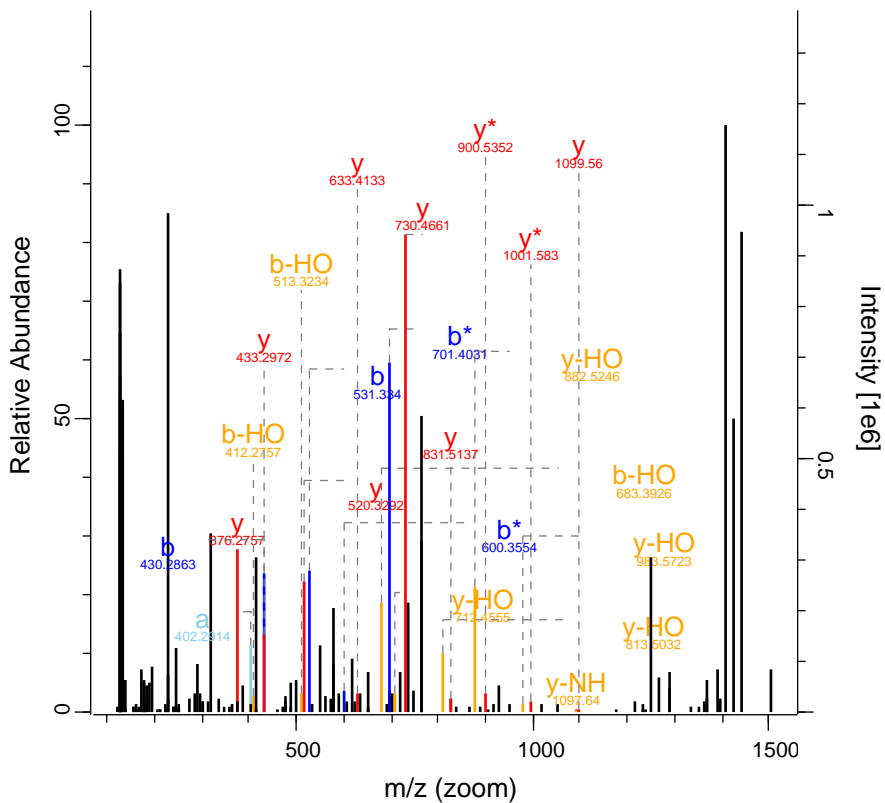

RO-QC-160121_ZackD_SS_Set_01_Fraction19580 FTMS; HC 63.28 742.59 NOP58

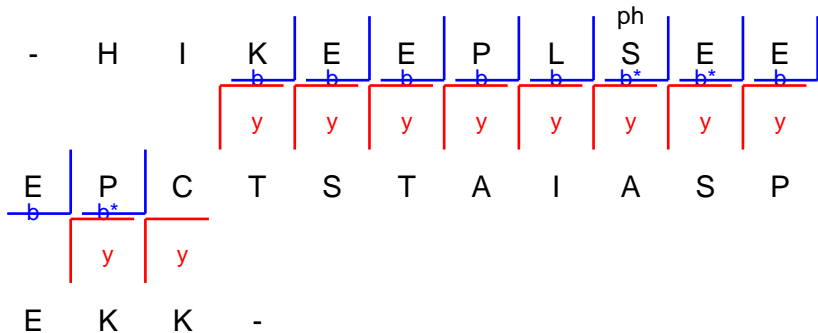
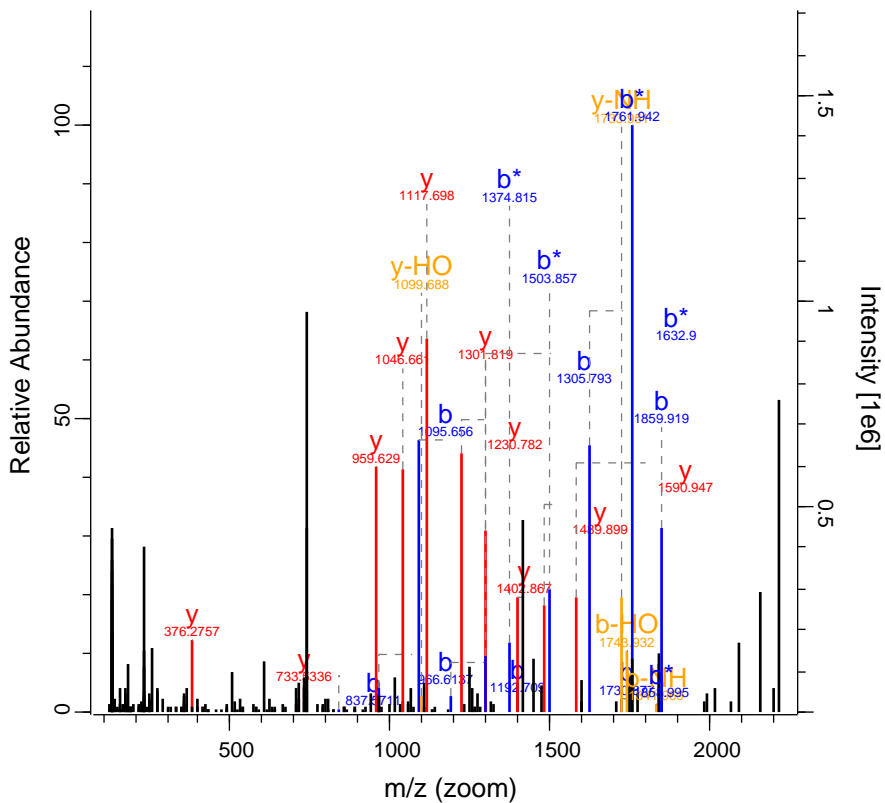

RO-QC-160121_ZackD_SS_Set_01_Fractic 19802 FTMS; HC 226.25 1240.67 STUB1

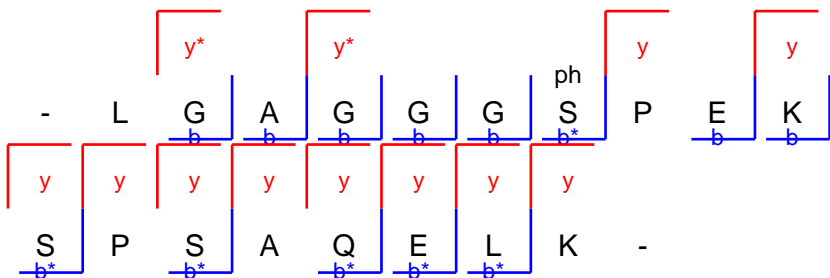
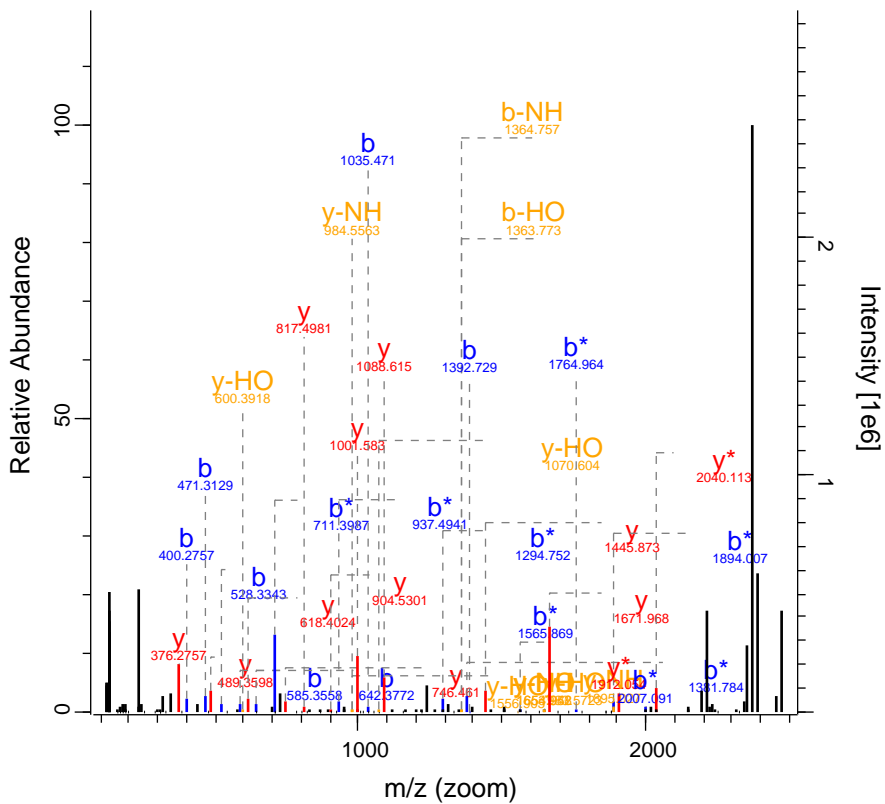

RO-QC-160121_ZackD_SS_Set_01_Fractic 20785 FTMS; HC 40.49 1015.84 DCST1

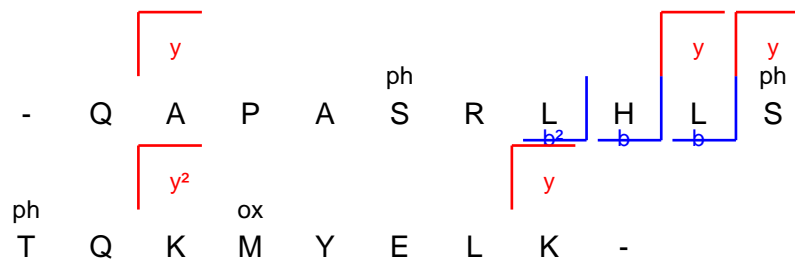
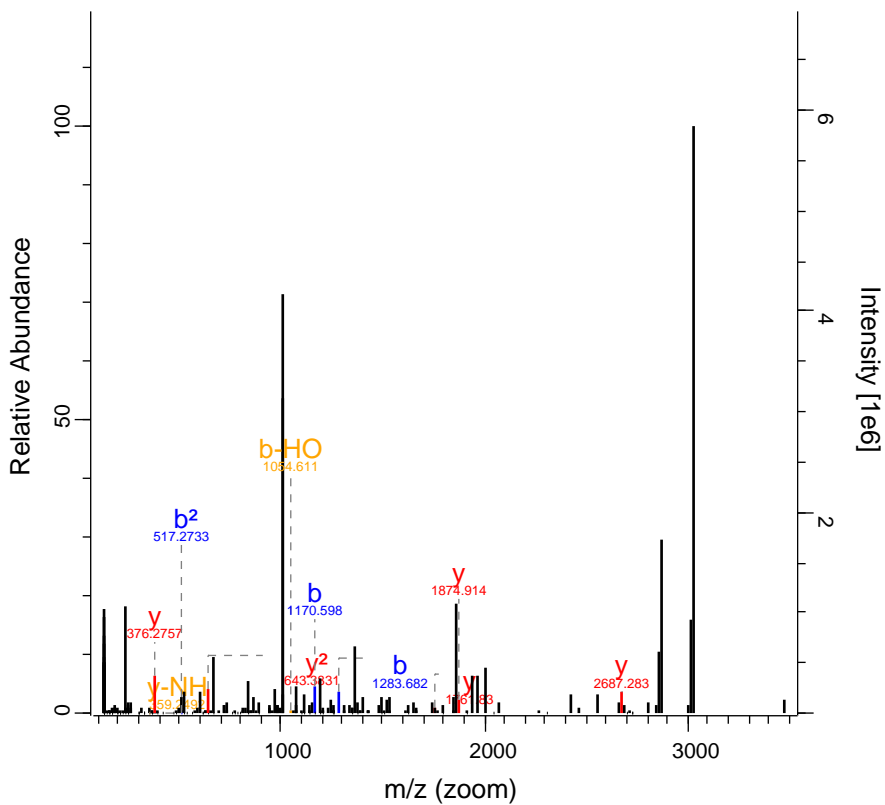

RO-QC-160121_ZackD_SS_Set_01_Fractic 21200 FTMS; HC 46.73 1108.05 EEF1G

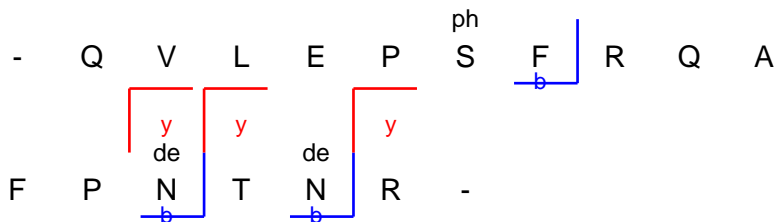
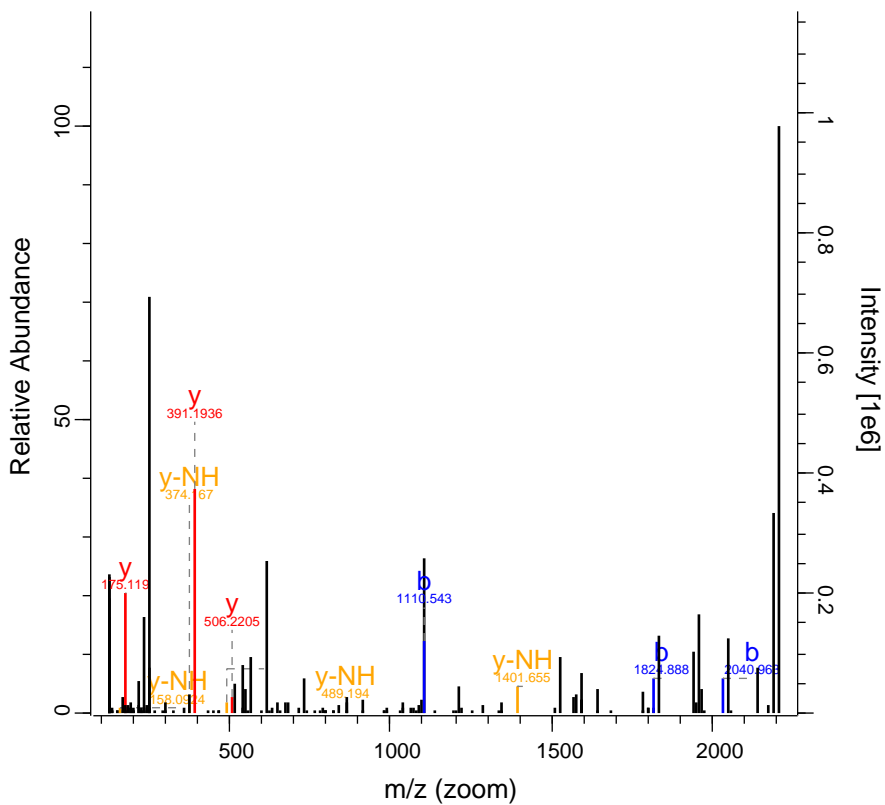

RO-QC-160121_ZackD_SS_Set_01_Fraction 21256 FTMS; HC 174.59 922.83 HABP4

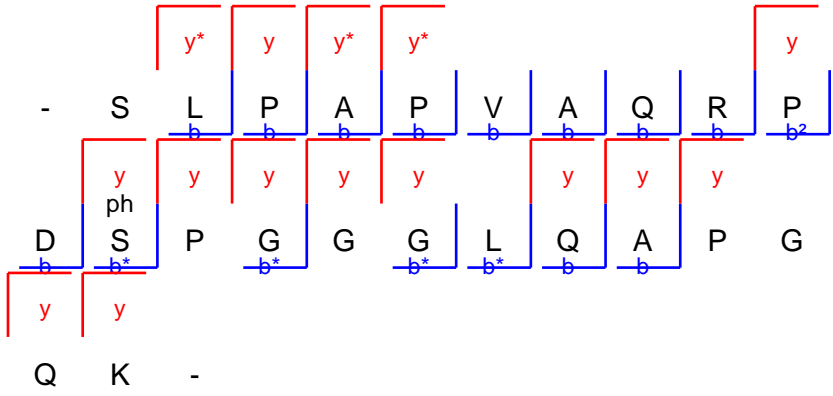
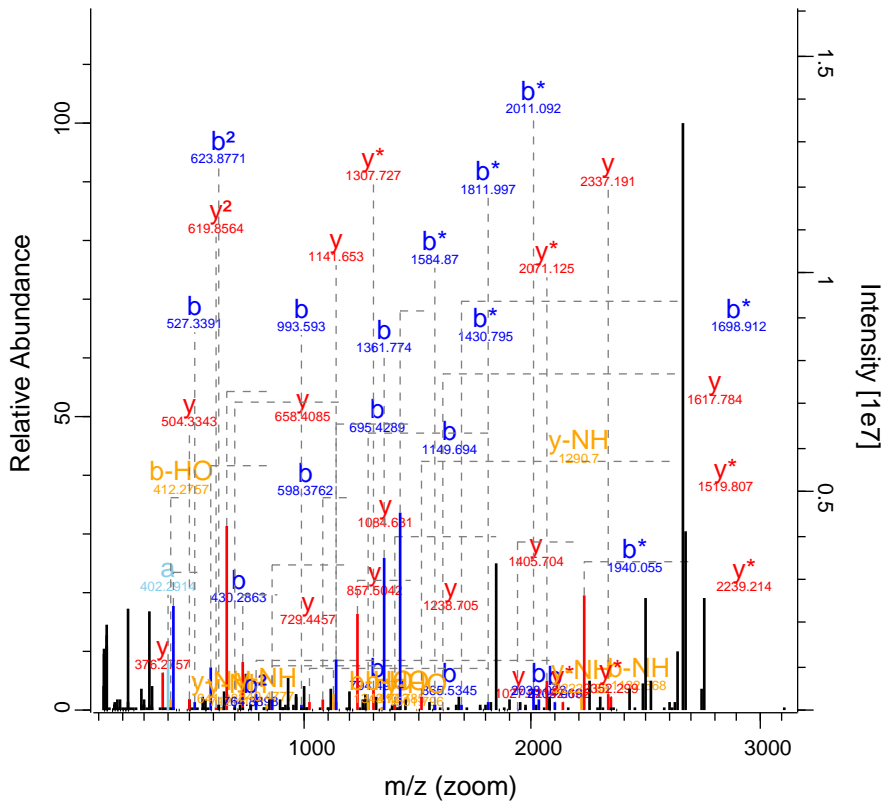

RO-QC-160121_ZackD_SS_Set_01_Fraction 22603 FTMS; HC 74.16 998.56 MTUS2

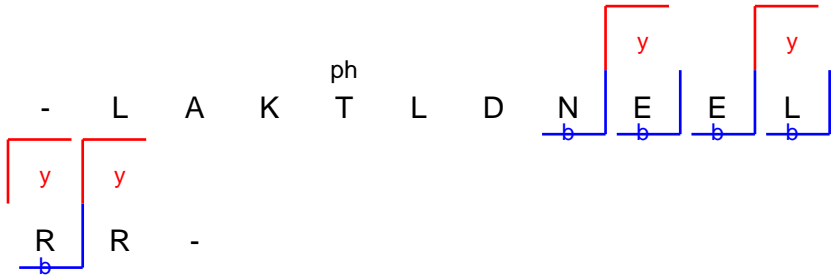
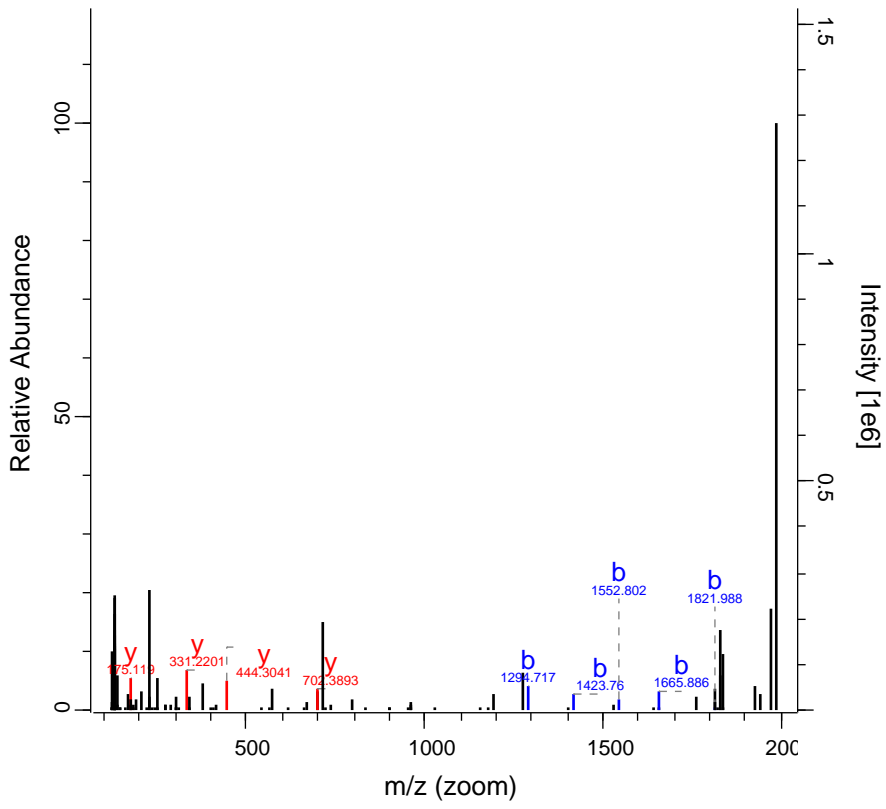

RO-QC-160121_ZackD_SS_Set_01_Fractic 23487 FTMS; HC 55.23 1086.19 SLX4

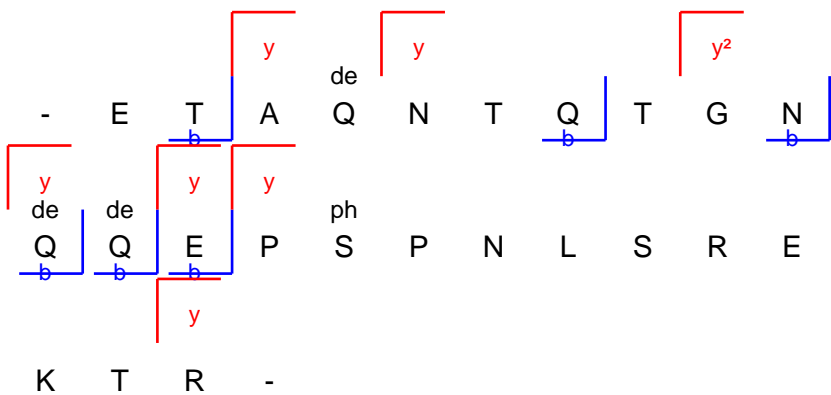
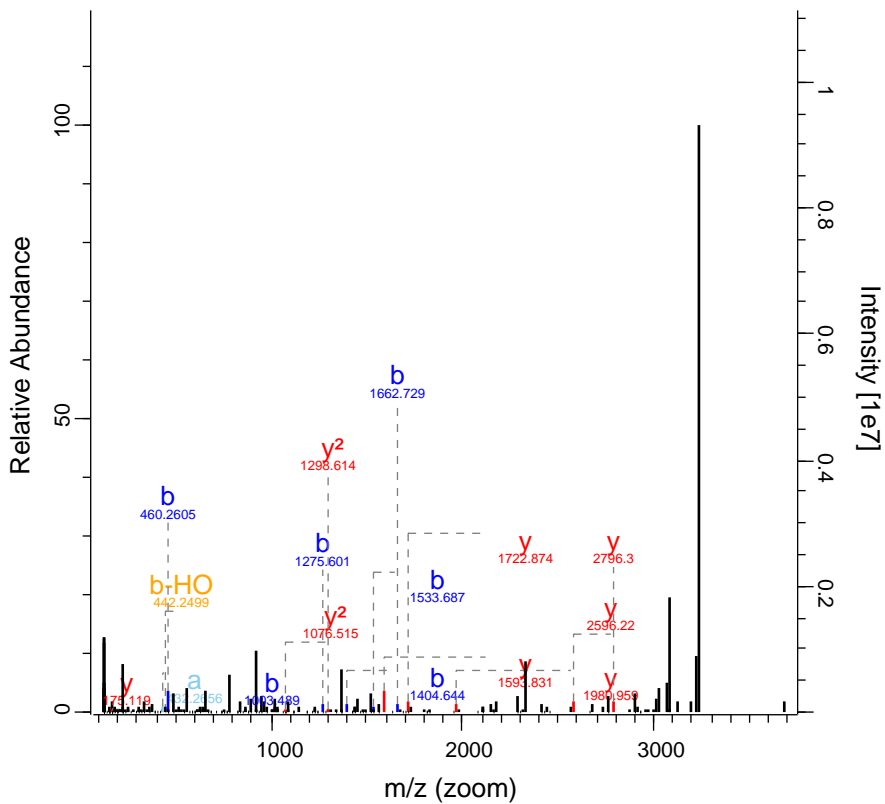

RO-QC-160121_ZackD_SS_Set_01_Fractic 24320 FTMS; HC 72.53 1220.25 THUMPD1

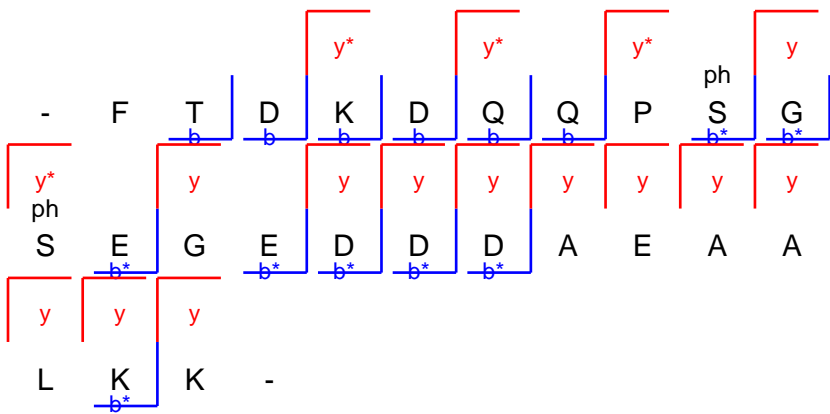
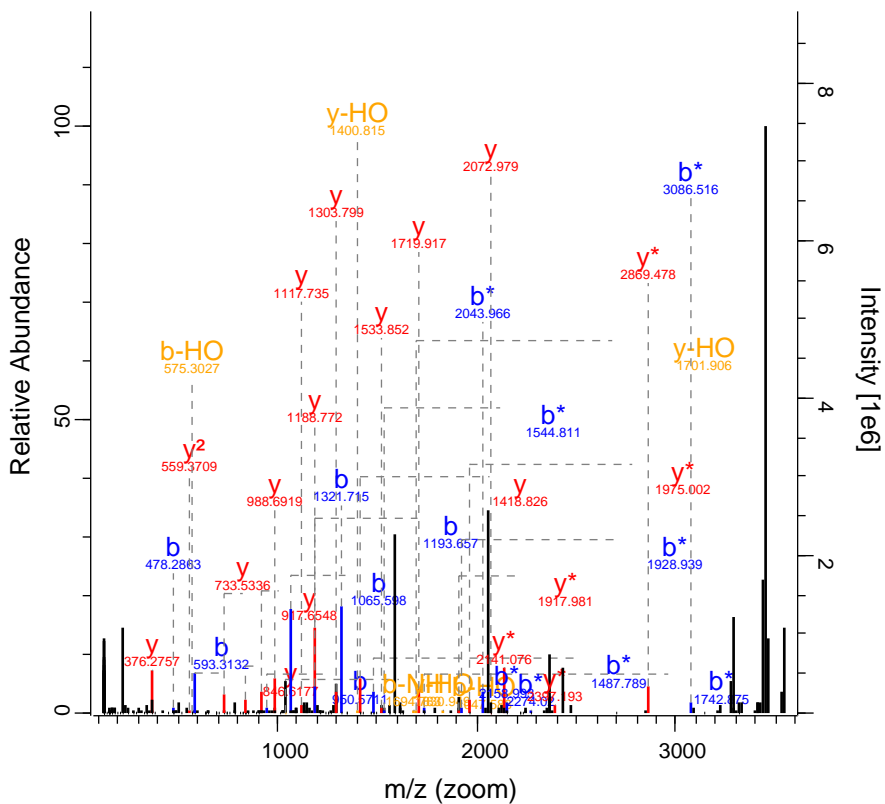

RO-QC-160121_ZackD_SS_Set_01_Fraction 24927 FTMS; HCl 224.05 936 ALDOA

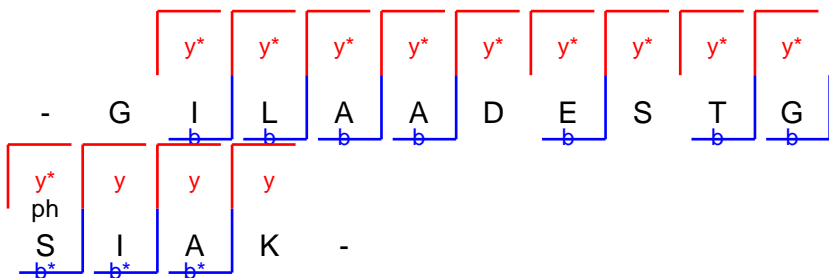
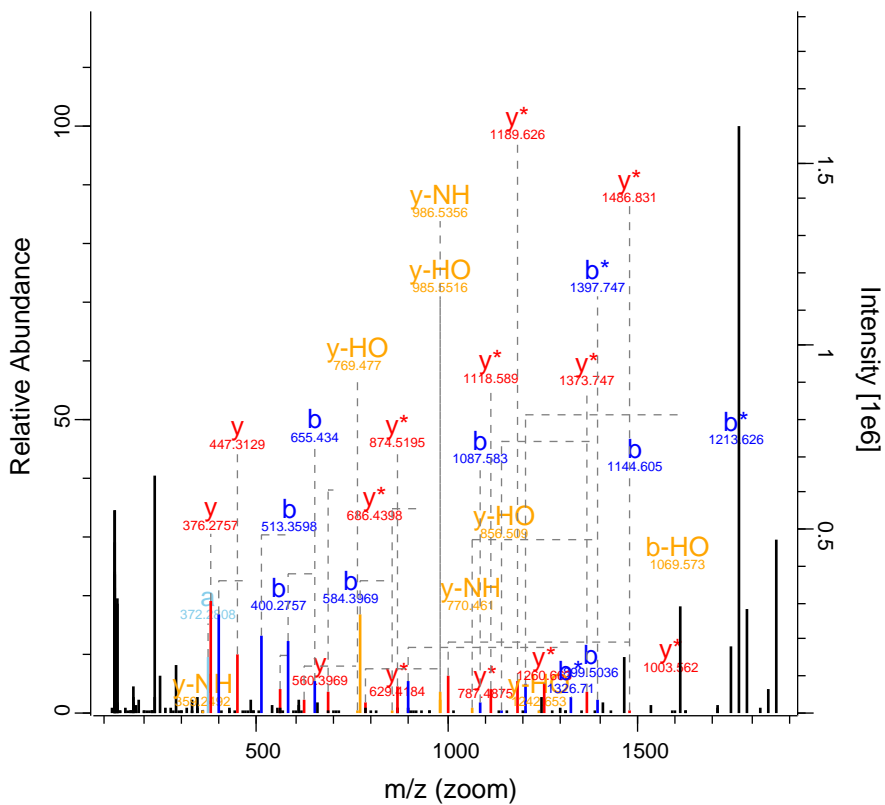

RO-QC-160121_ZackD_SS_Set_01_Fraction 25671 FTMS; HC 56.91 717.13 LARP1

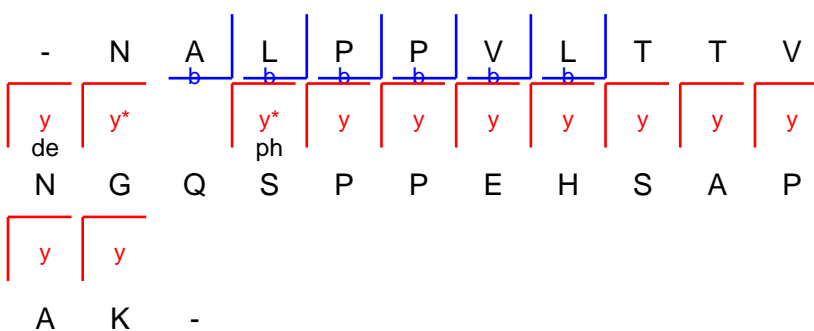
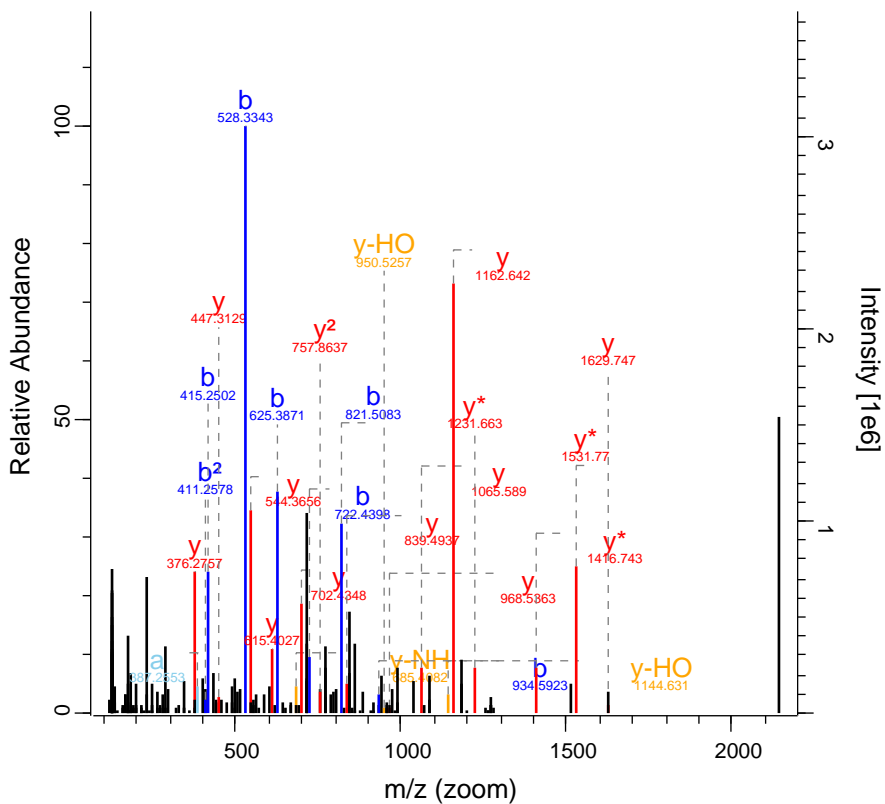

RO-QC-160121_ZackD_SS_Set_01_Fraction 27159 FTMS; HC 49.5 920.88 EIF2S2

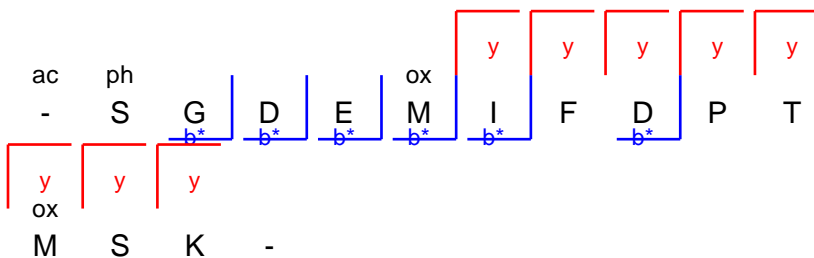
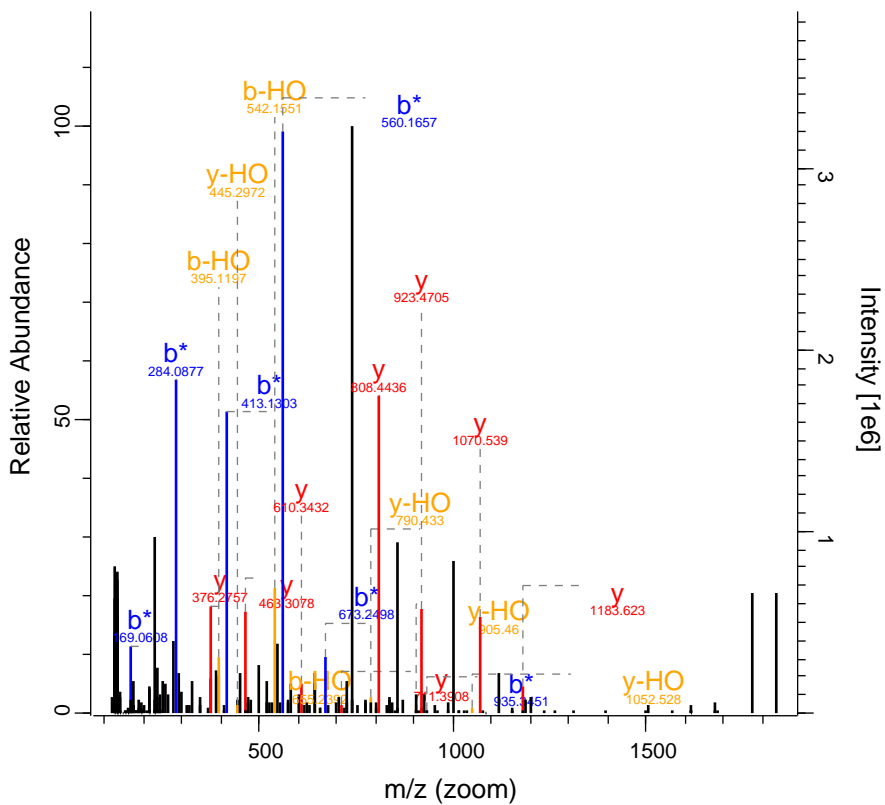

RO-QC-160121_ZackD_SS_Set_01_Fraction 27207 FTMS; HC 40.49 992.85 PLCH1

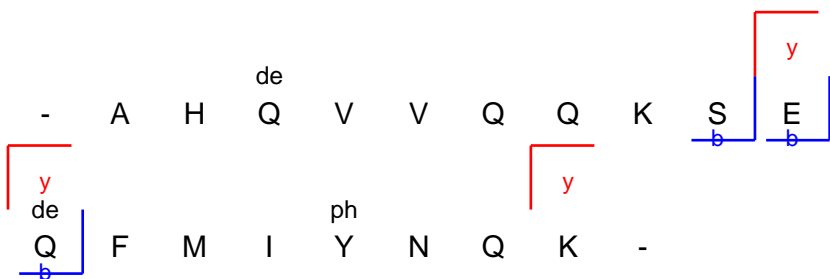
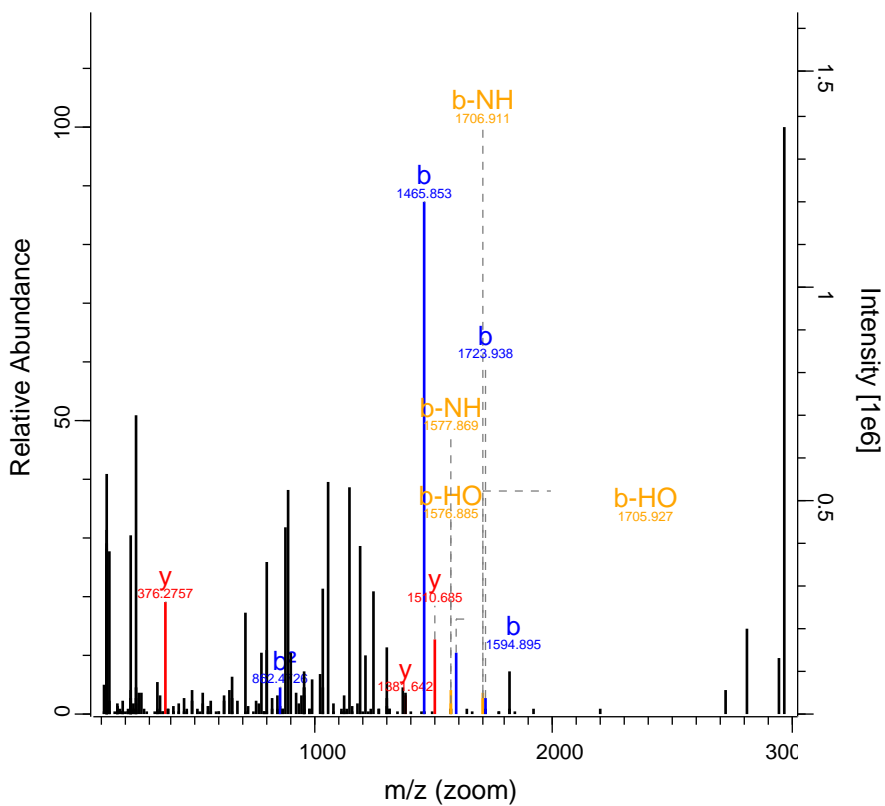

RO-QC-160121_ZackD_SS_Set_01_Fraction 27497 FTMS; HC 54.78 554.81 ADAMDEC1

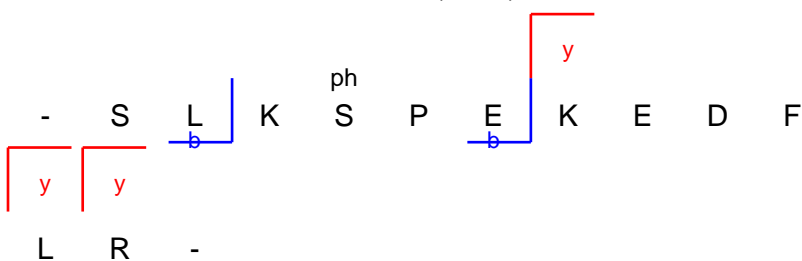
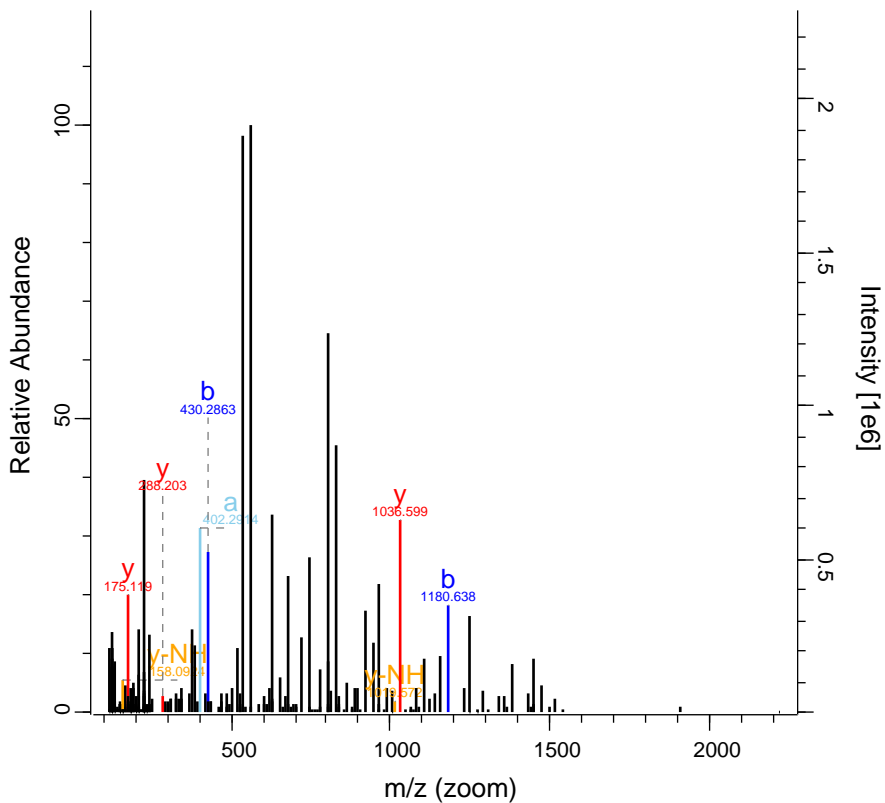

RO-QC-160121_ZackD_SS_Set_01_Fractic 27835 FTMS; HC 69.62 1060.86 MAP1B

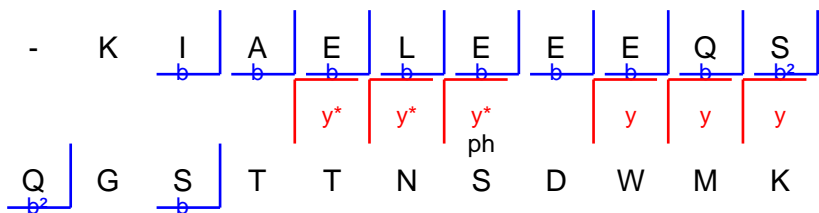
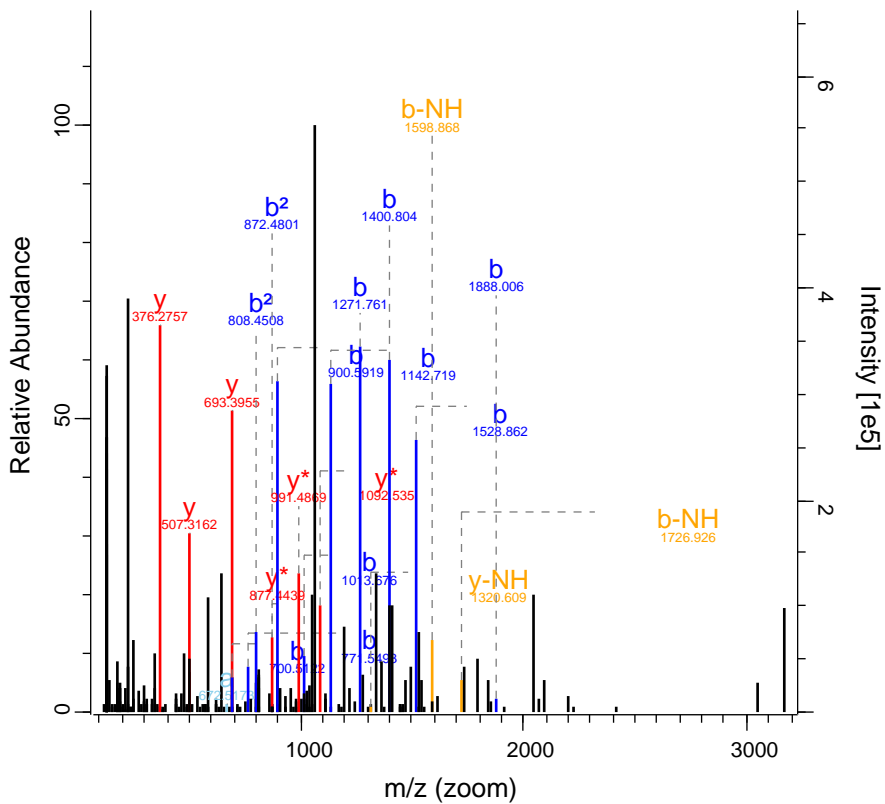

RO-QC-160121_ZackD_SS_Set_01_Fractic 27940 FTMS; HC 205.33 1158.13 MAP4

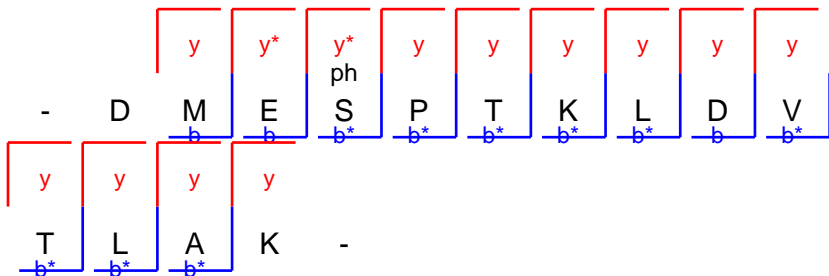
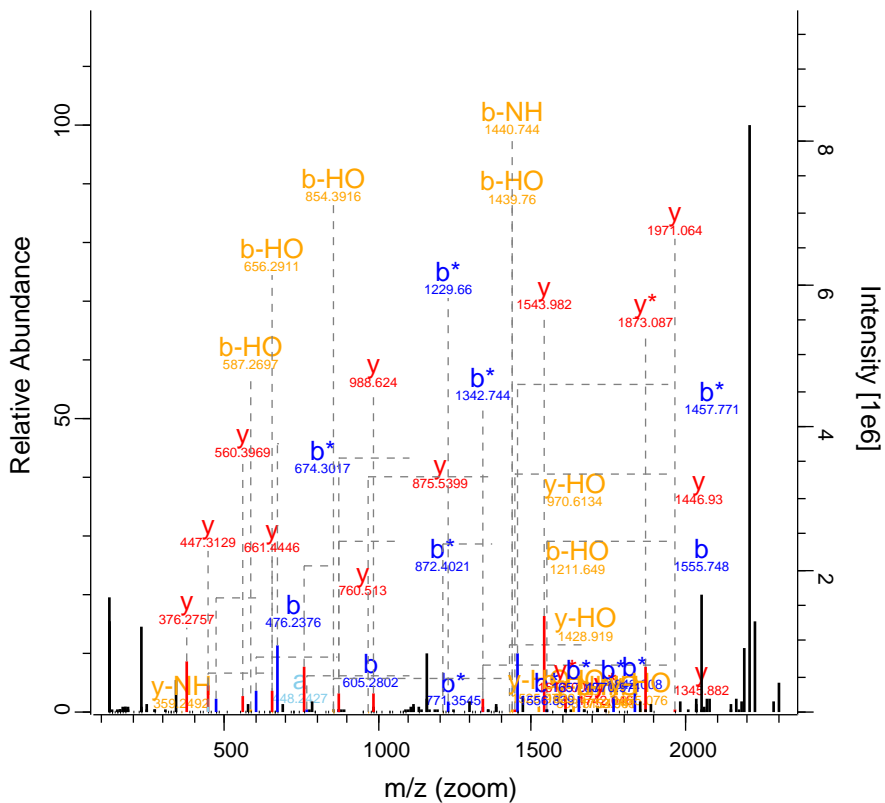

RO-QC-160121_ZackD_SS_Set_01_Fractic 28043 FTMS; HC 100.17 1216.63 TCOF1

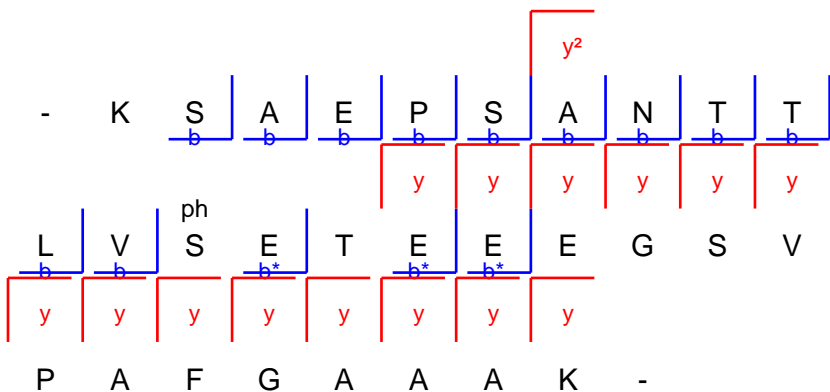
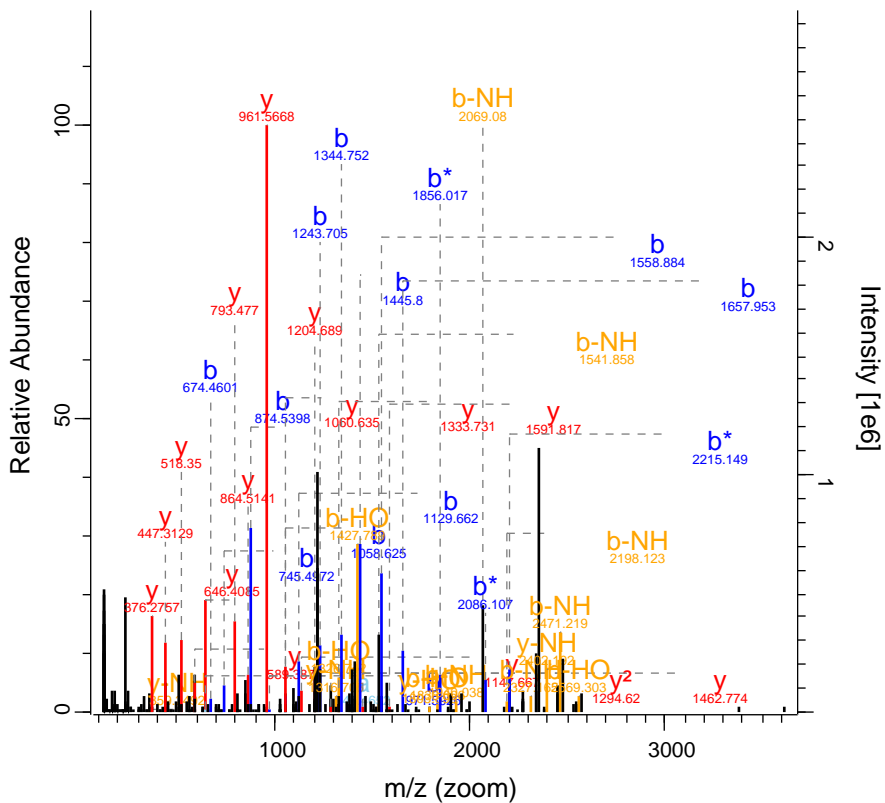

RO-QC-160121_ZackD_SS_Set_01_Fractio 28330 FTMS; HC 186.02 941.45 TOM1L1

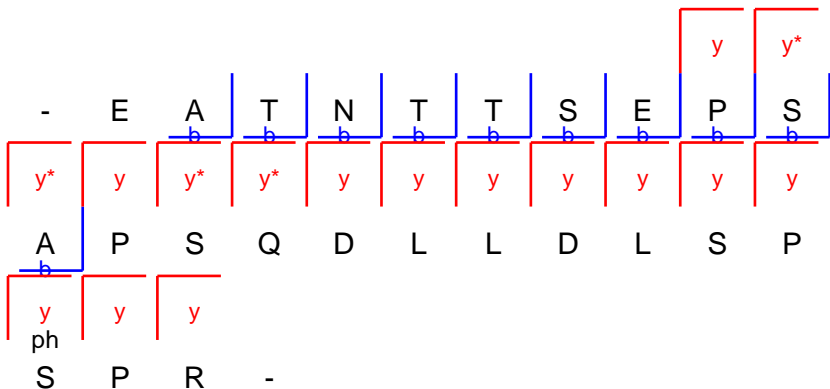
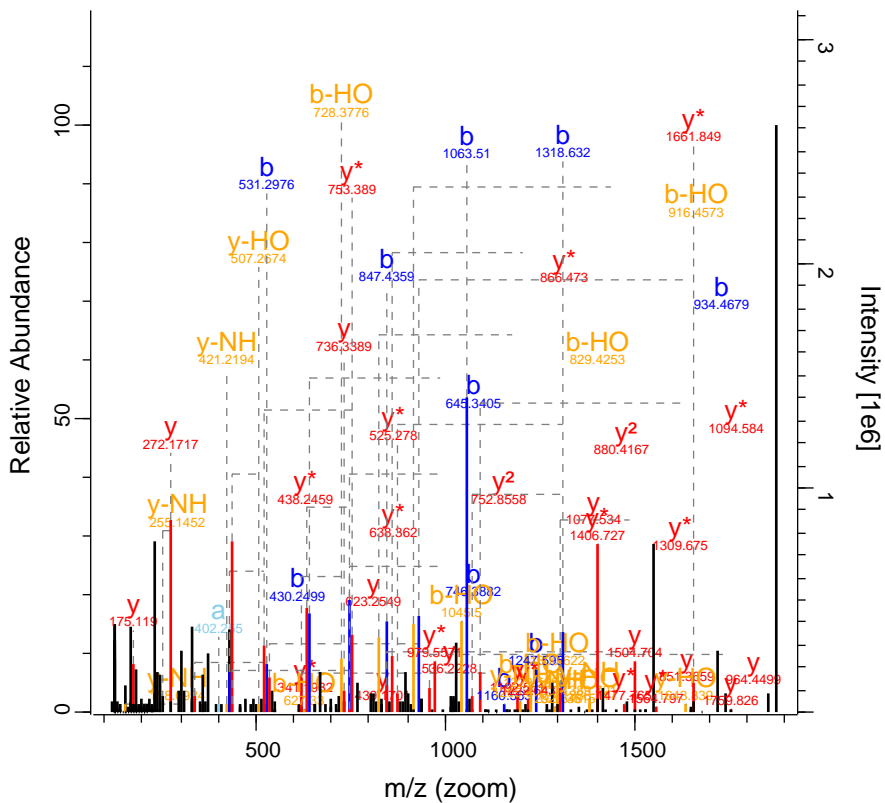

RO-QC-160121_ZackD_SS_Set_01_Fraccio 30061 FTMS; HC 222.45 942.23 FAM13A

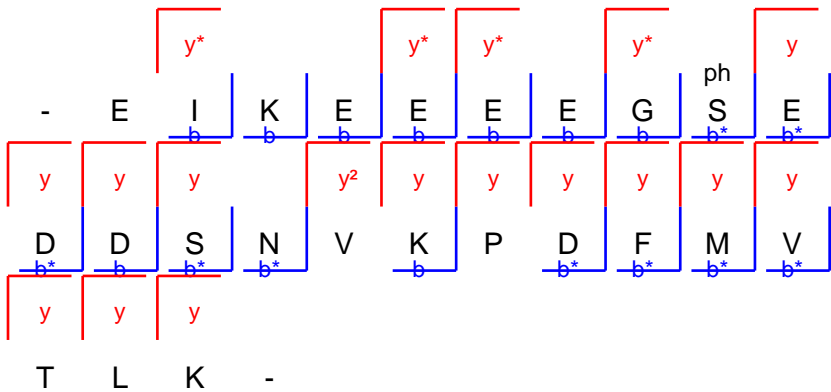
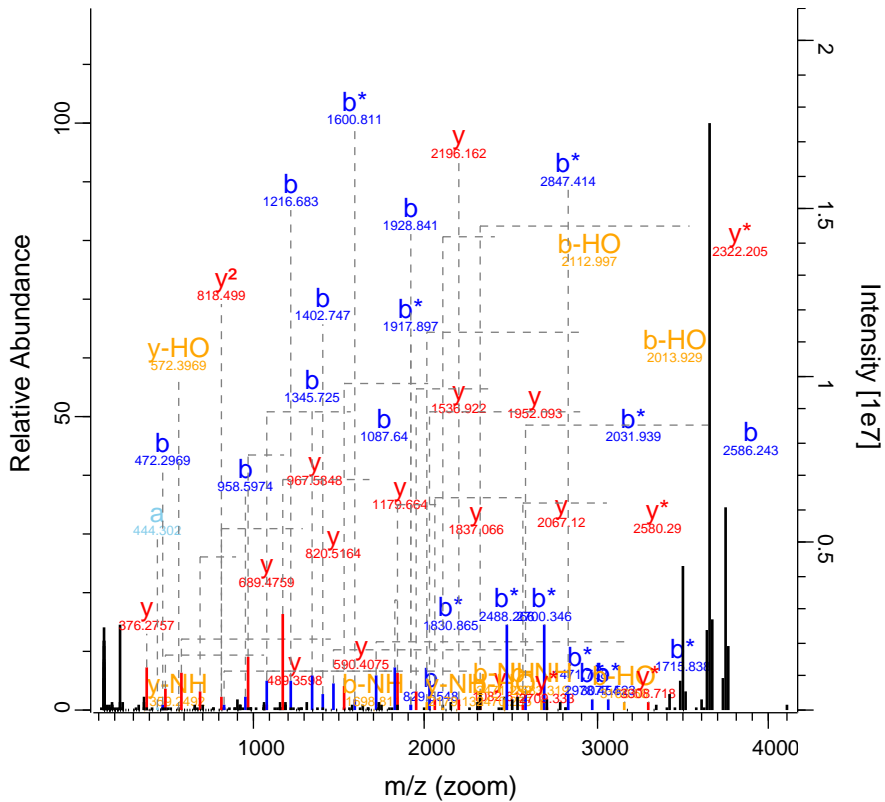

RO-QC-160121_ZackD_SS_Set_01_Fractic 30399 FTMS; HC 46.98 1090.05 TOP2B

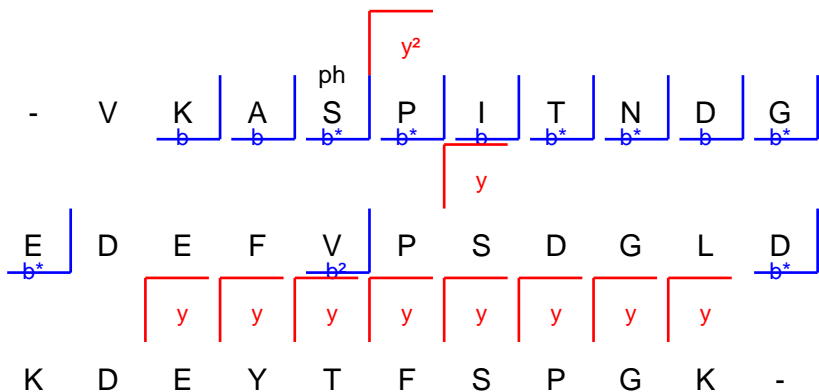
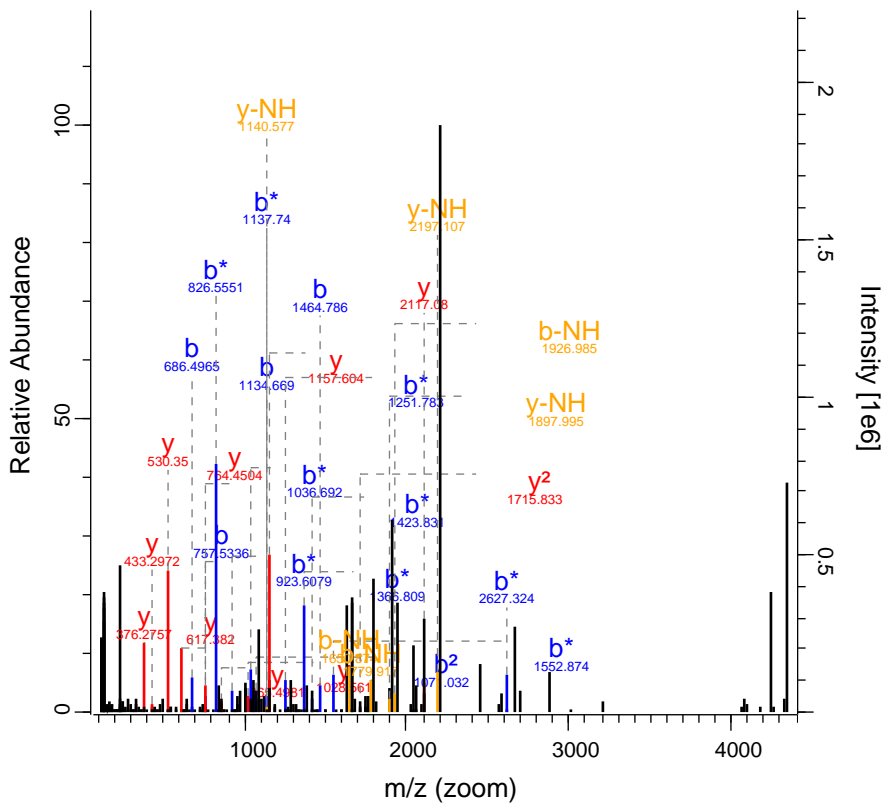

RO-QC-160121_ZackD_SS_Set_01_Fractio 30597 FTMS; HC 154.74 732.73 NEDD4L

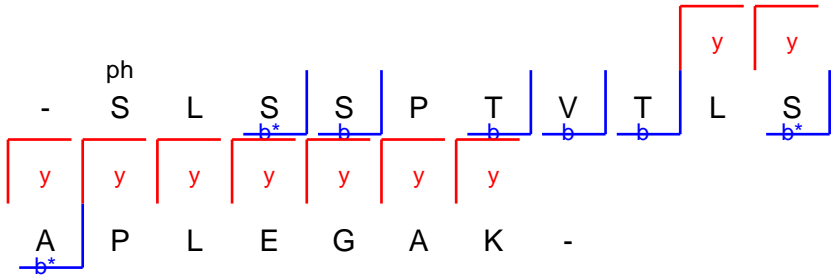
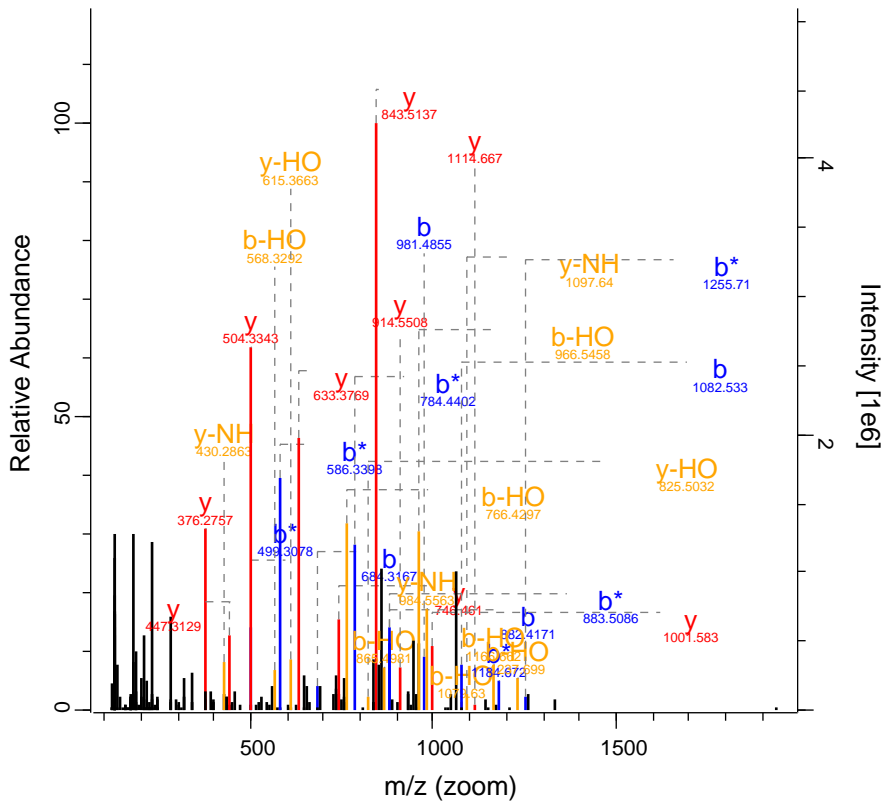

RO-QC-160121_ZackD_SS_Set_01_Fractio 30665 FTMS; HC 319.74 1098.6 NEDD4L

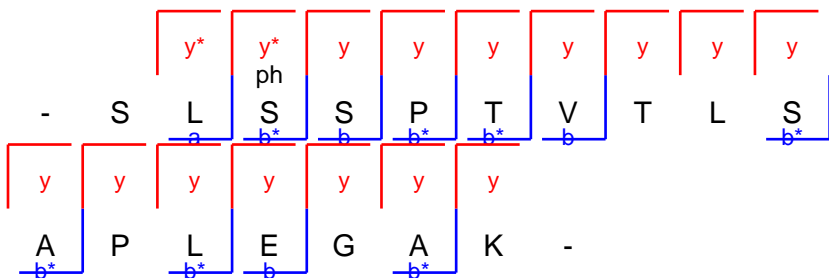
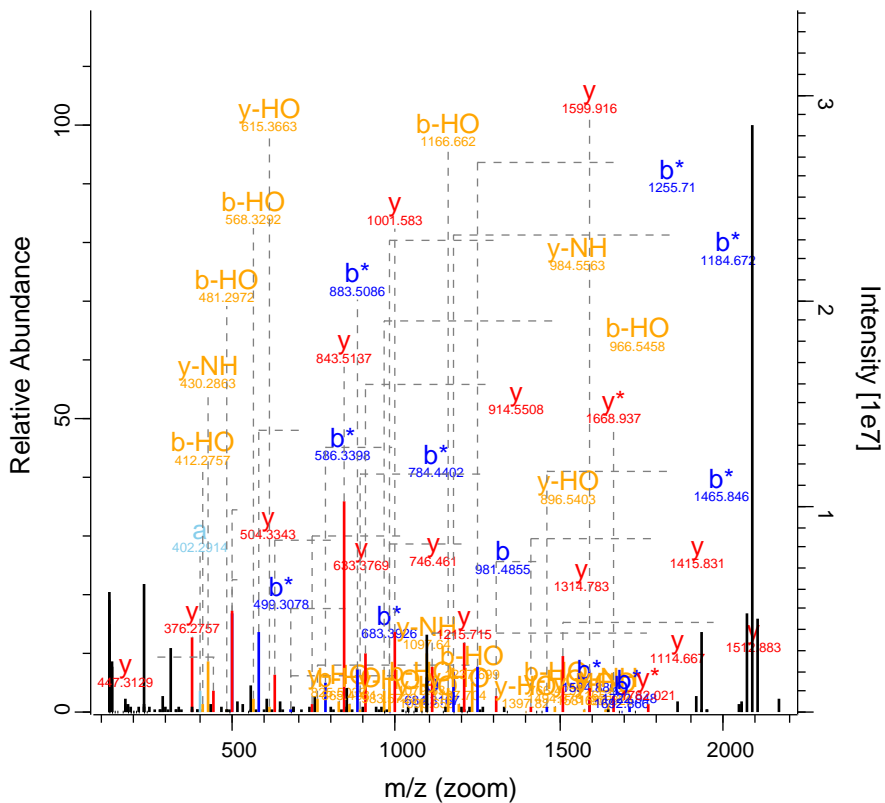

RO-QC-160121_ZackD_SS_Set_01_Fractic 31738 FTMS; HC 51.77 1465.21 RABAC1

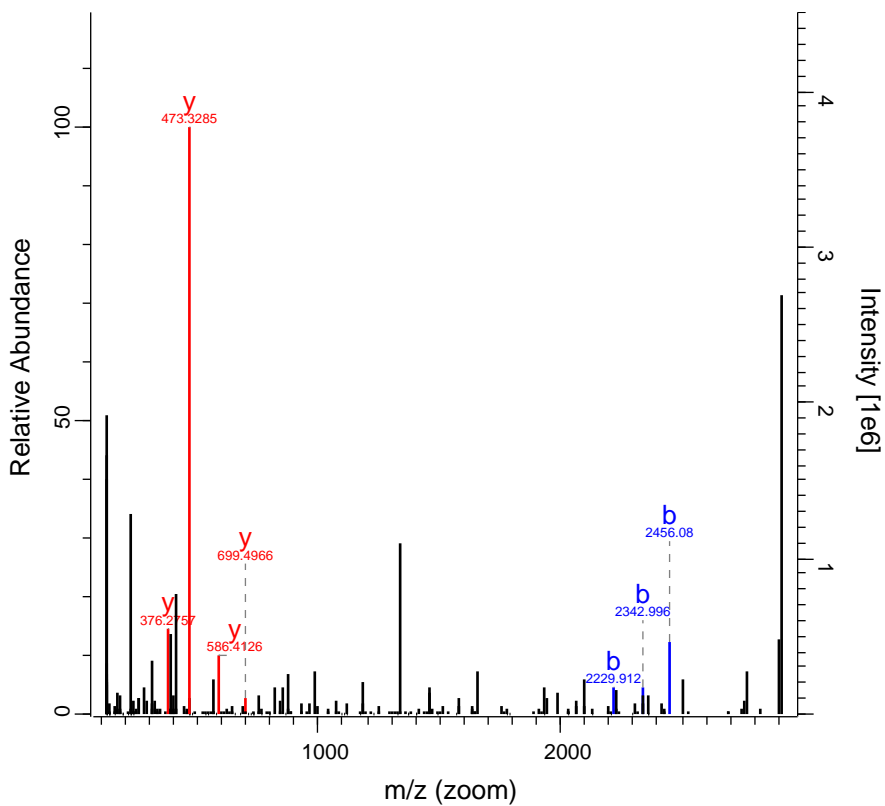

- D Q Q K D A E A E G

ph ph ph y y y y

L S G T T L L P K -

b b b

RO-QC-160121_ZackD_SS_Set_01_Fraction 32393 FTMS; HC 52.79 1307.7 EFCAB3

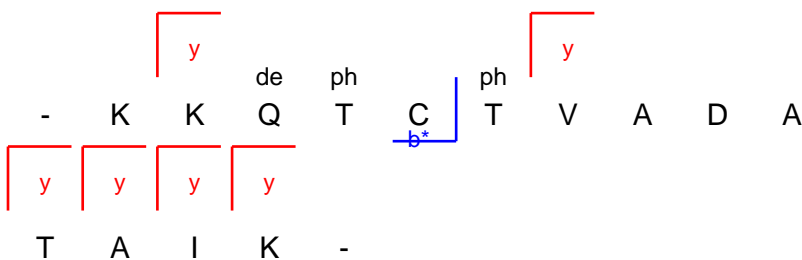
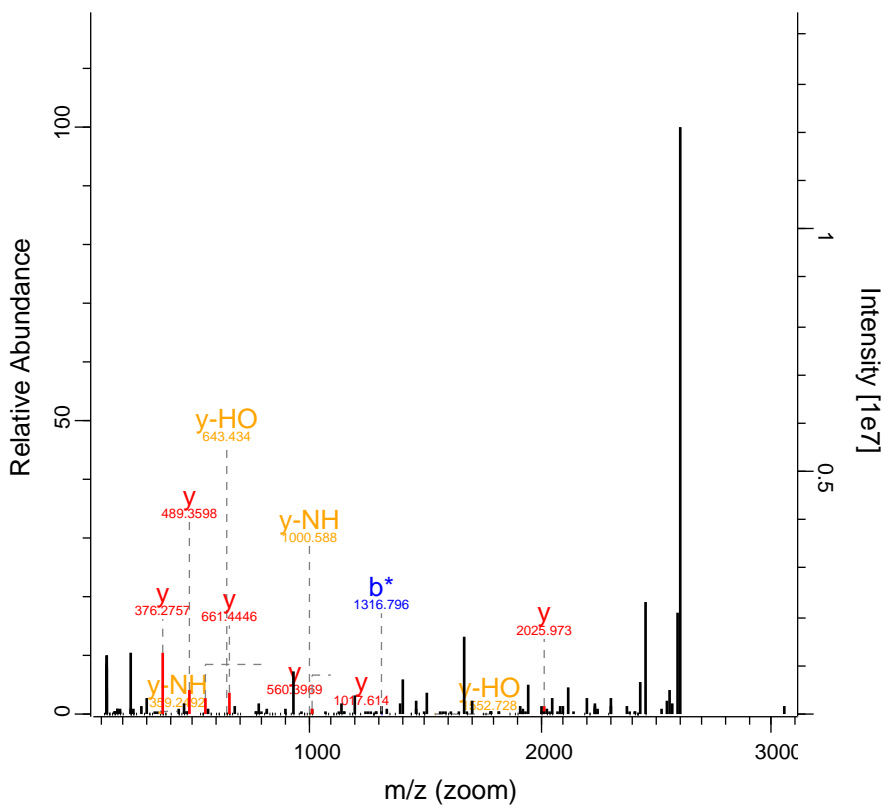

RO-QC-160121_ZackD_SS_Set_01_Fractio 33020 FTMS; HC 128.25 923.22 AKAP13

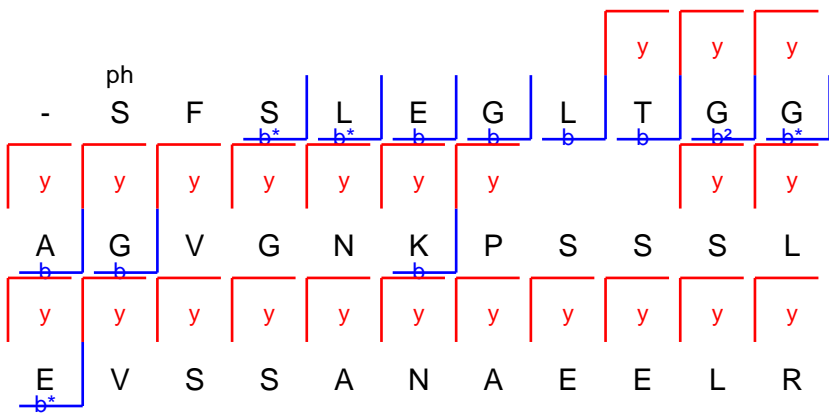
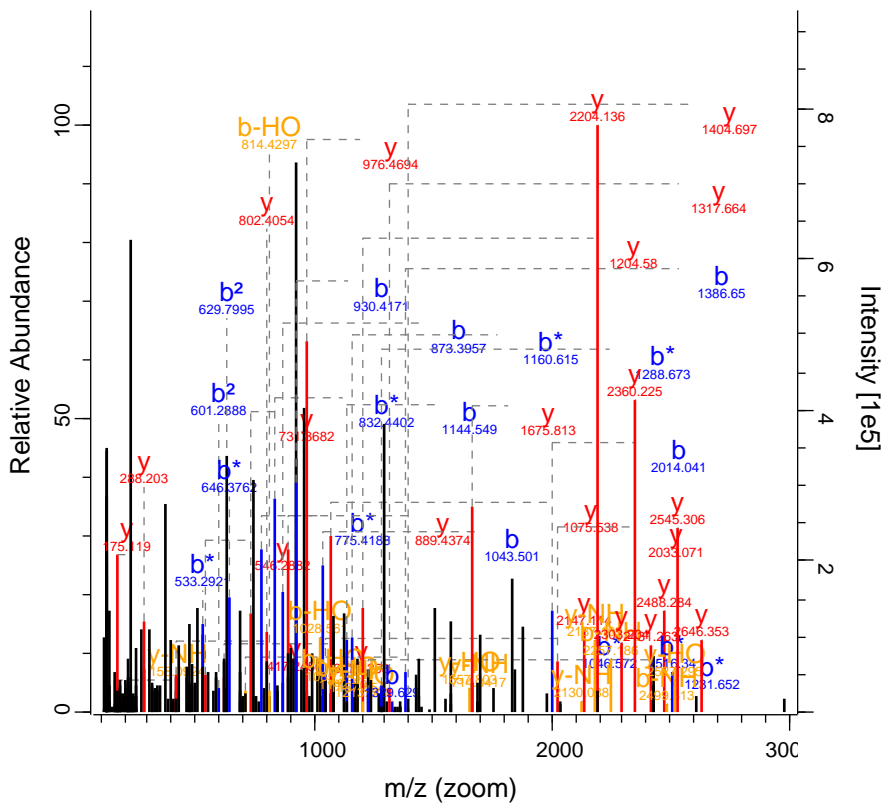

RO-QC-160121_ZackD_SS_Set_01_Fraction 34197 FTMS; HC 65.42 952.83 EHD1

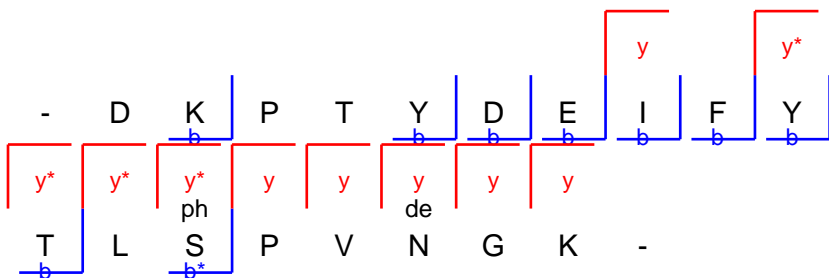
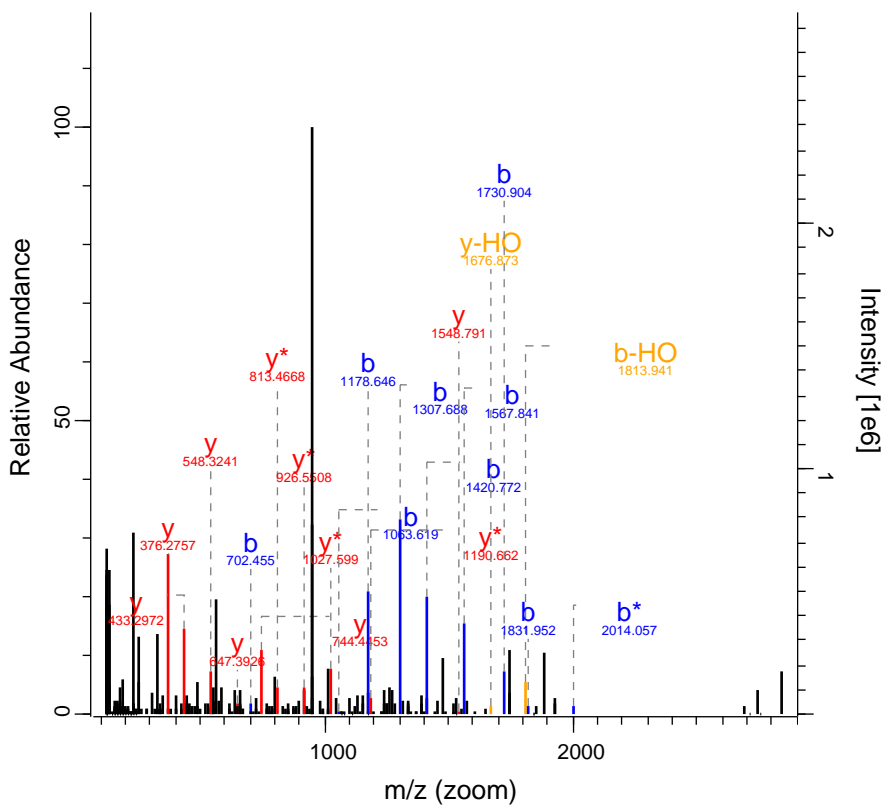

RO-QC-160121_ZackD_SS_Set_01_Fractic 34430 FTMS; HC 132.47 1236.08 PA2G4

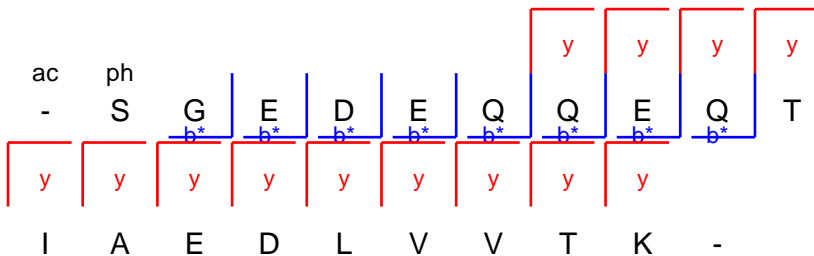
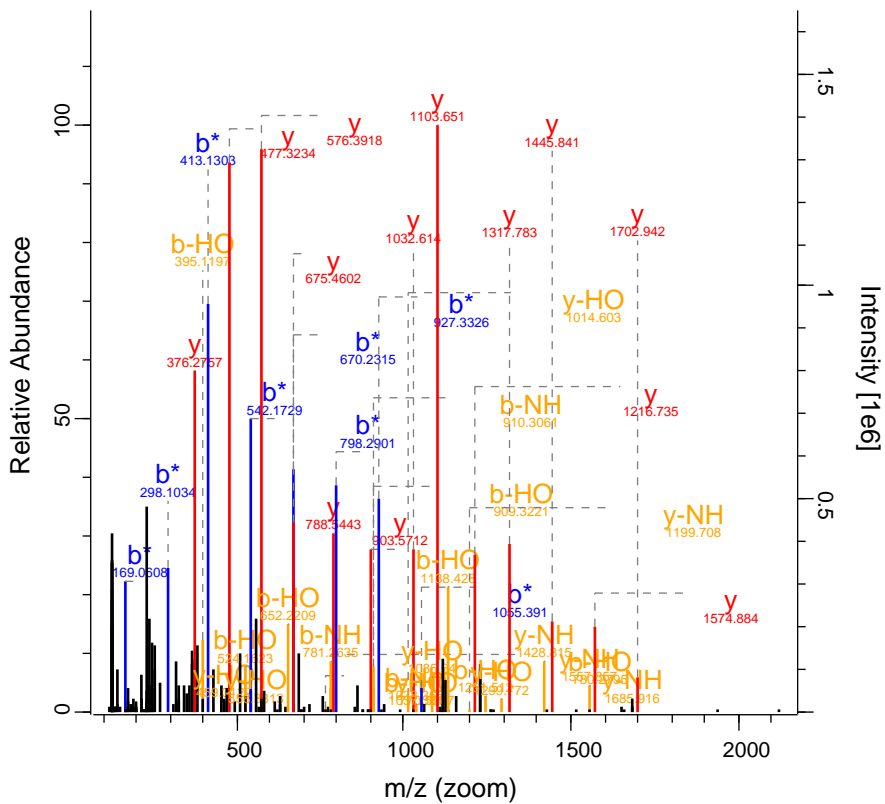

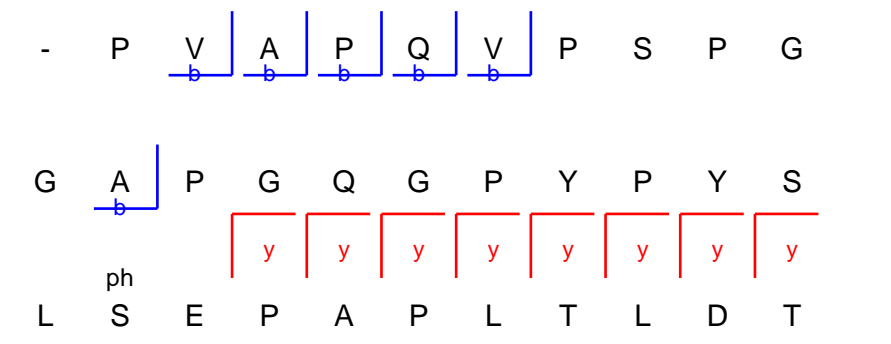
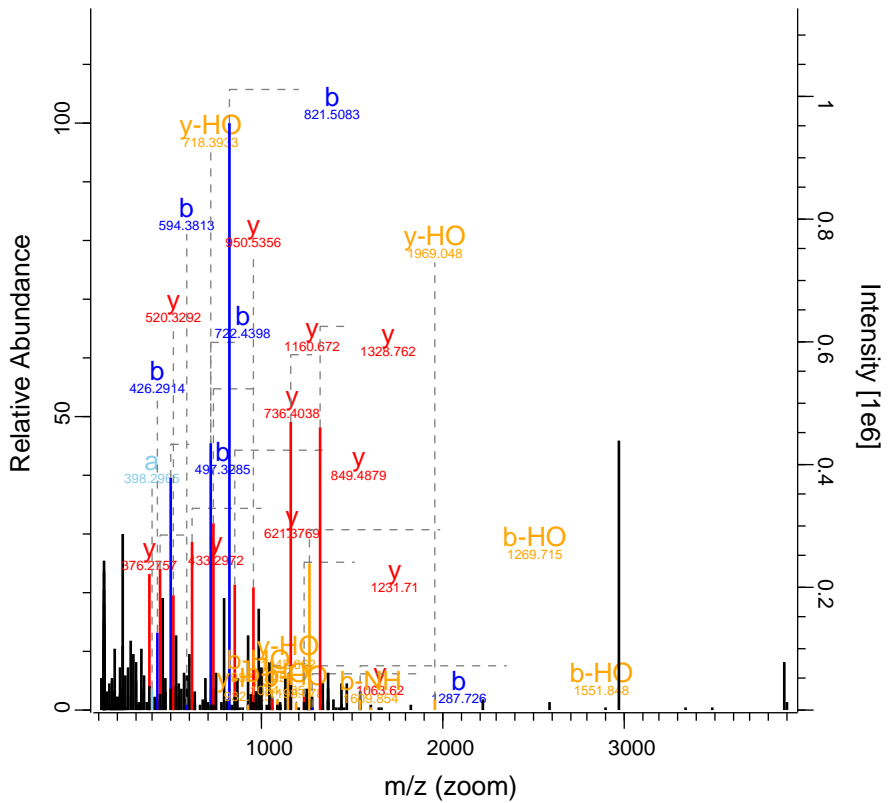

RO-QC-160121_ZackD_SS_Set_01_Fraction_35303 FTMS; HC 47.55 779.08 VAV1

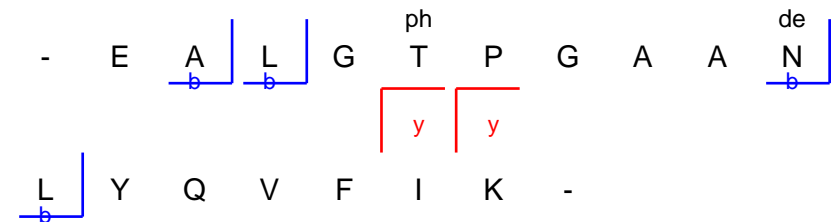
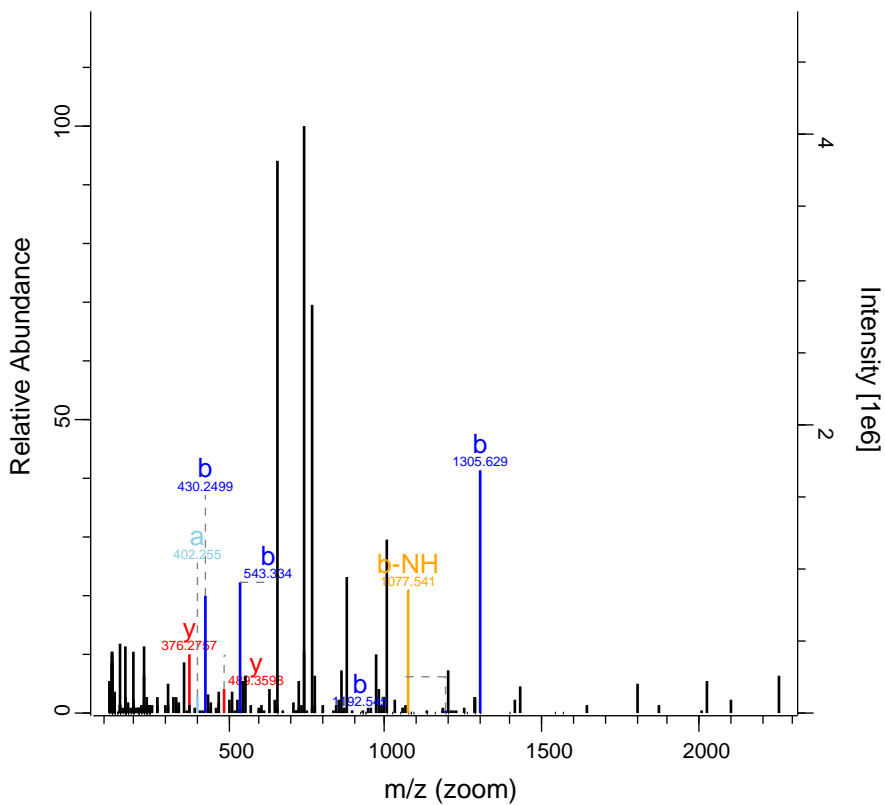

RO-QC-160121_ZackD_SS_Set_01_Fractic 36034 FTMS; HC 82.85 1001.88 EIF3G

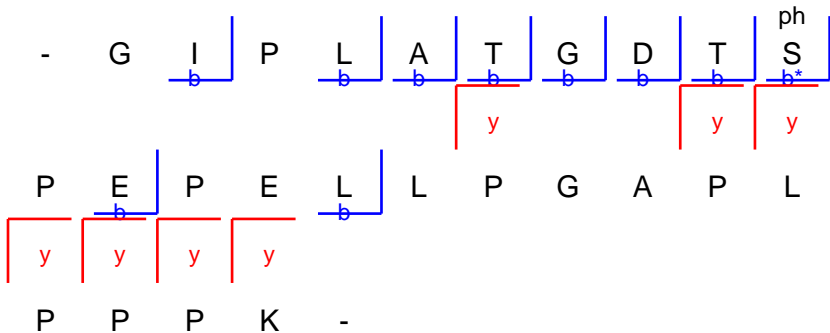
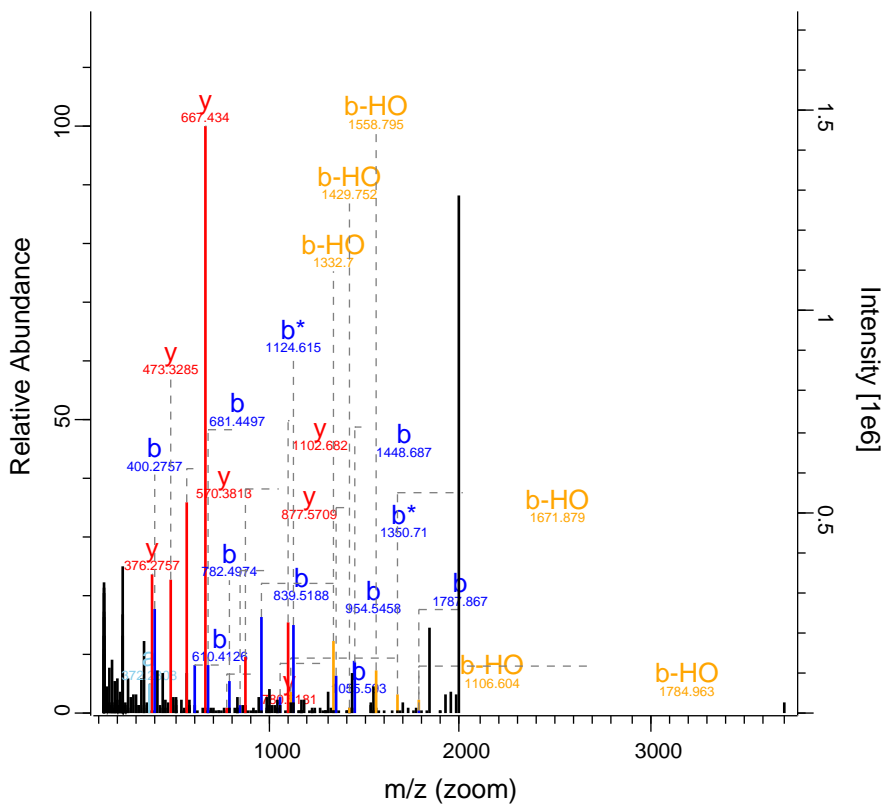

RO-QC-160121_ZackD_SS_Set_01_Fratio 36767 FTMS; HC 262.77 1048.5 SLK

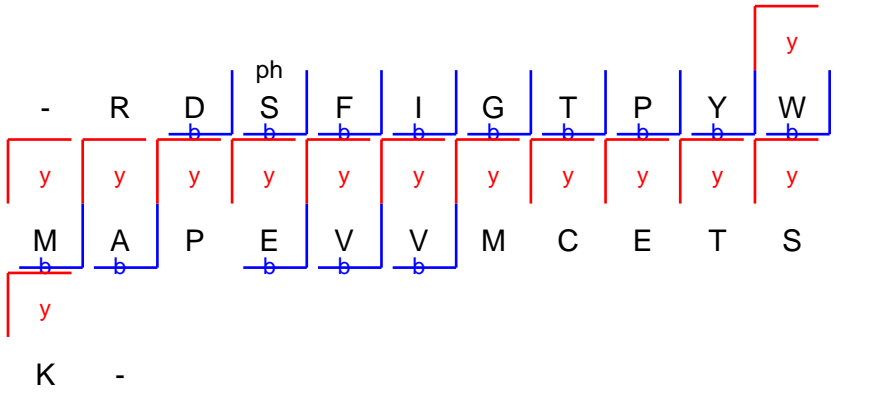
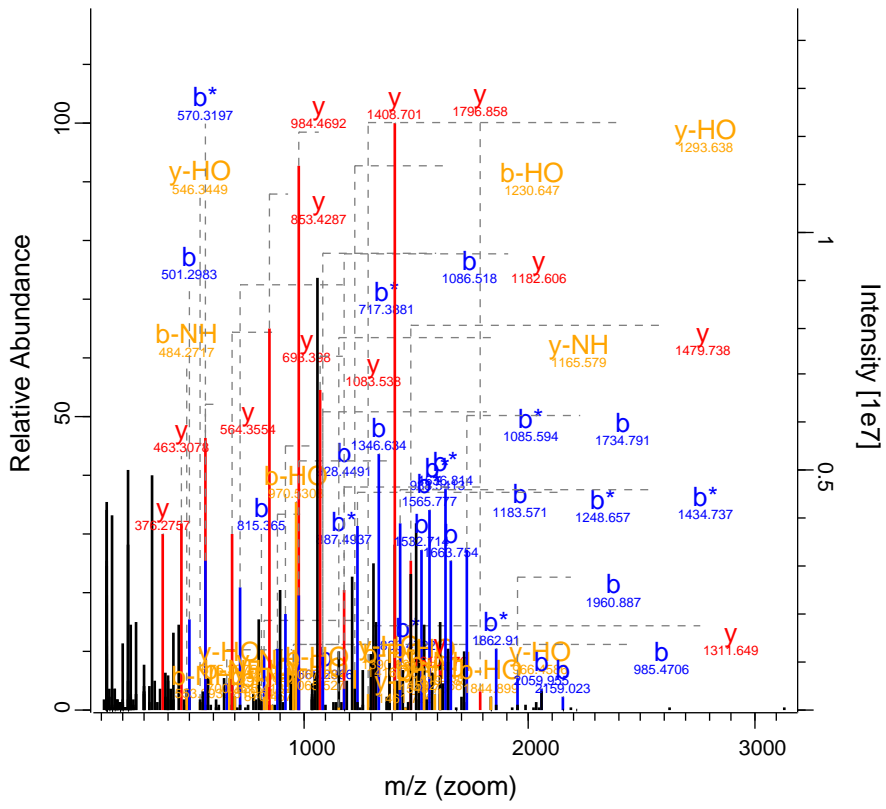

RO-QC-160121_ZackD_SS_Set_01_Fraction 36827 FTMS; HCl 148.04 865.7 PRKCB

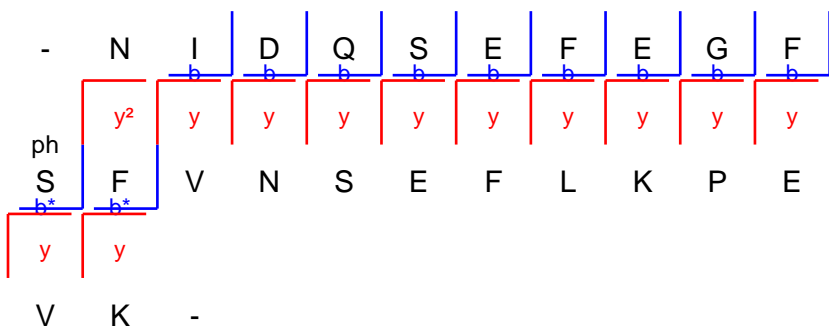
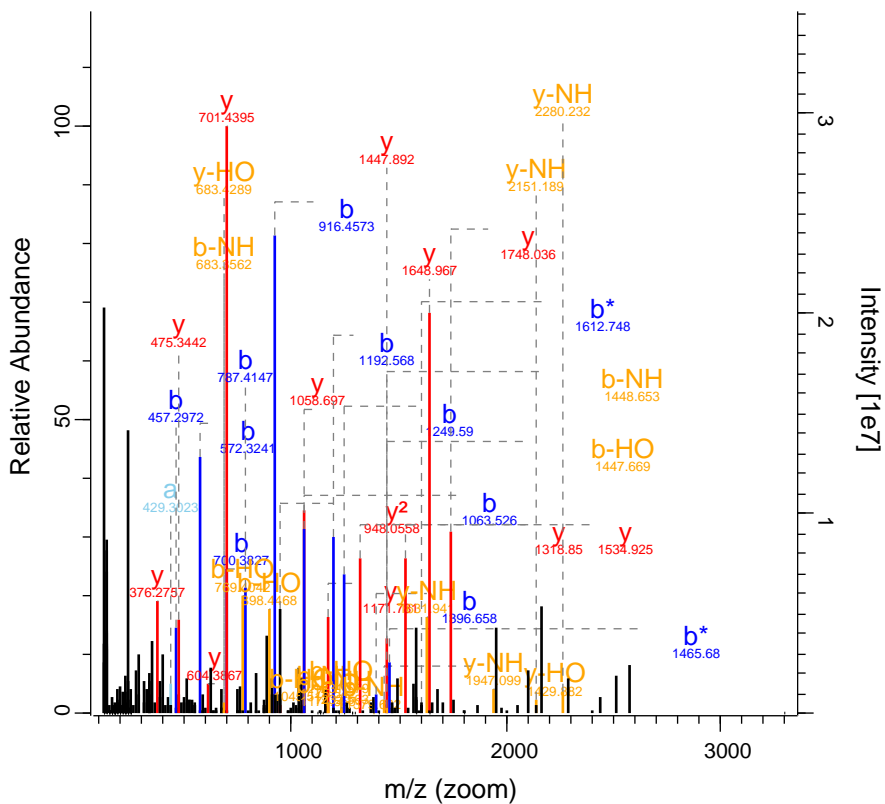

RO-QC-160121_ZackD_SS_Set_01_Fractic 36842 FTMS; HC 53.4 1323.69 SNCAIP

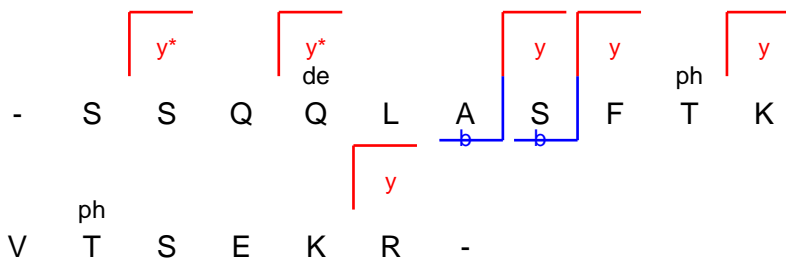
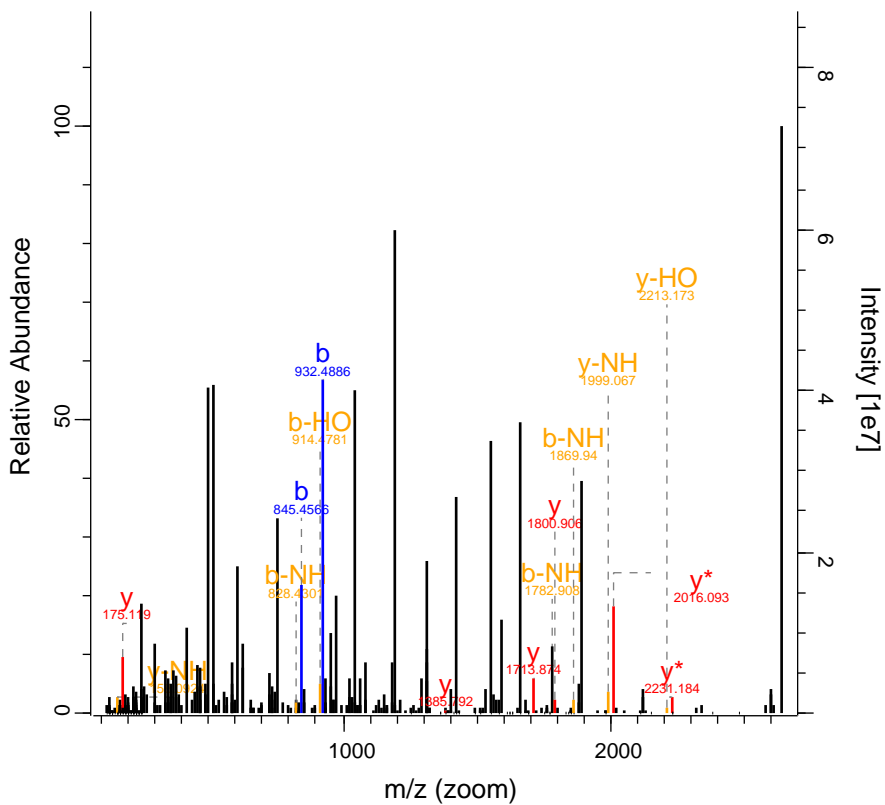

RO-QC-160121_ZackD_SS_Set_01_Fraccio 37034 FTMS; HC 220.28 907.47 PRKCD

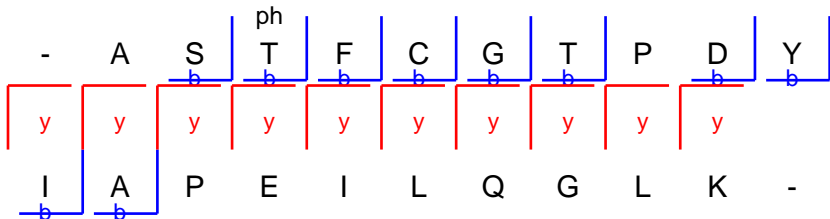
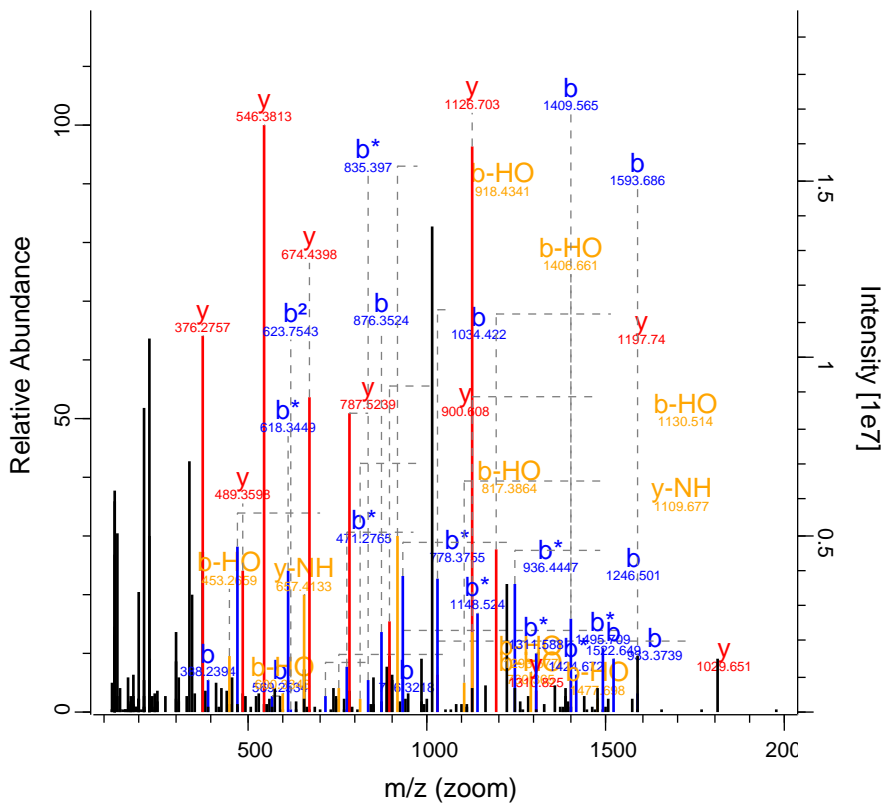

RO-QC-160121_ZackD_SS_Set_01_Fraction 37088 FTMS; HC 66.53 545.97 SMAD2

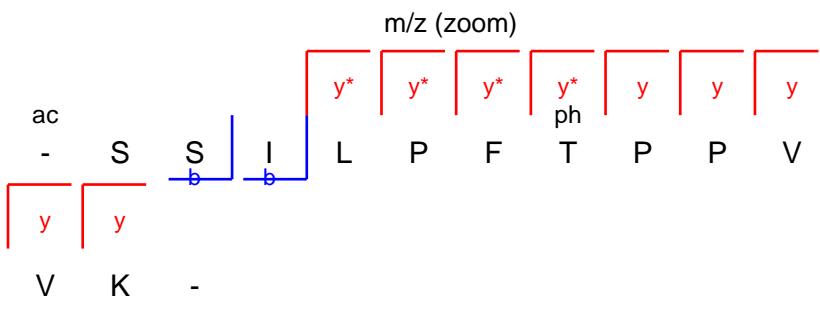
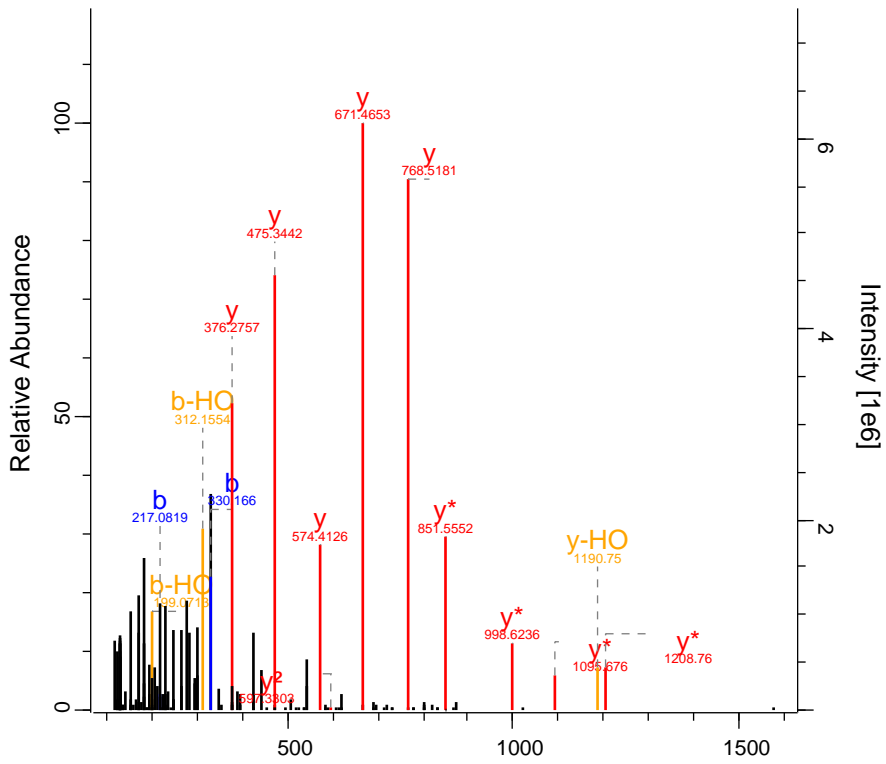

RO-QC-160121_ZackD_SS_Set_01_Fractic 37102 FTMS; HC 46.16 1097.57 HHIP

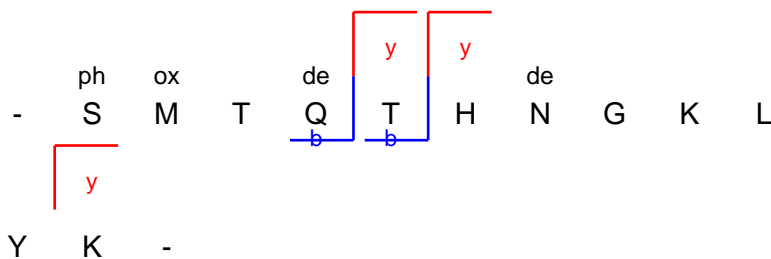
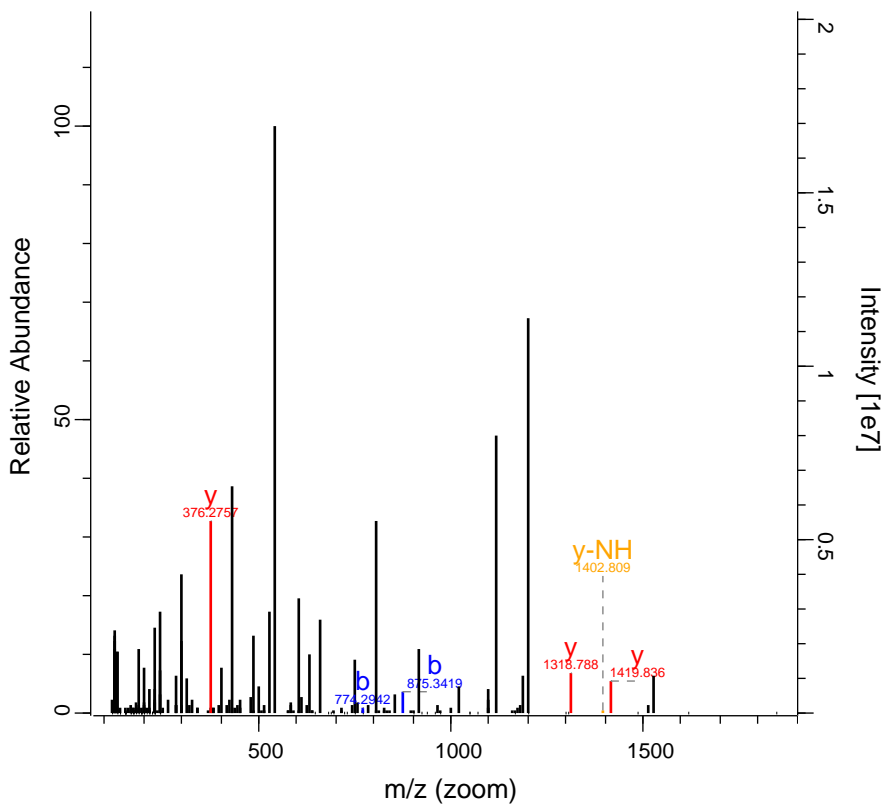

RO-QC-160121_ZackD_SS_Set_01_Fractic 37449 FTMS; HC 62.67 1140.86 PSMF1

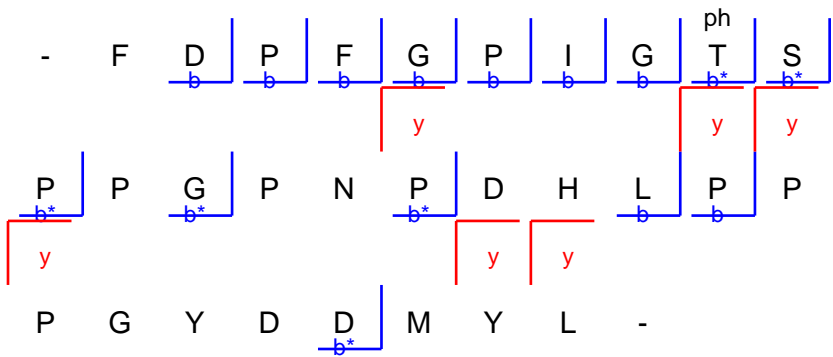
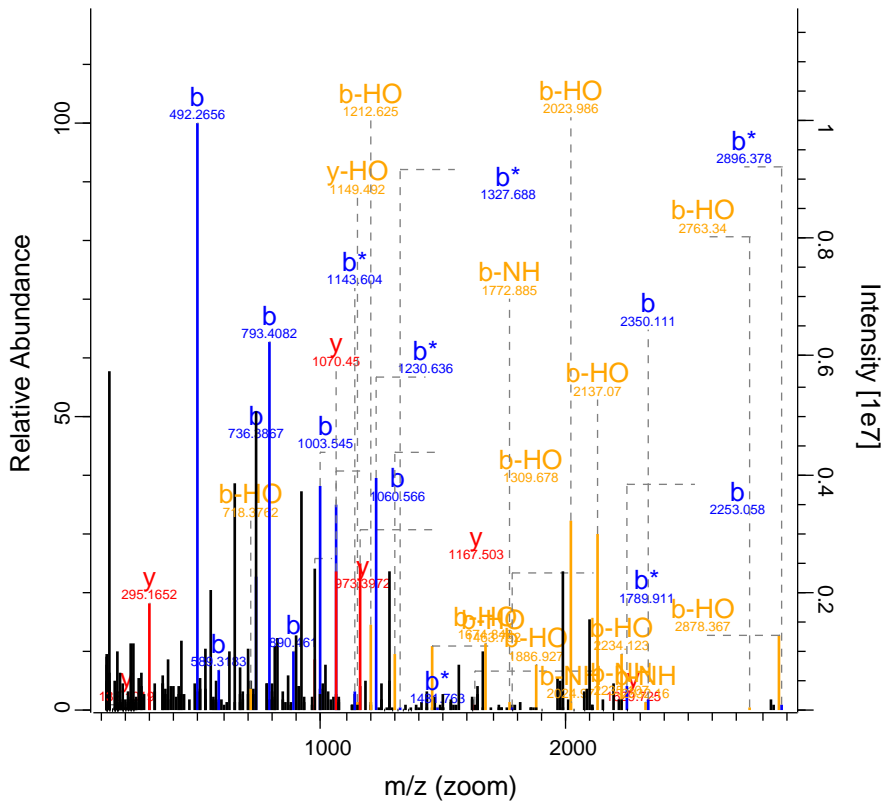

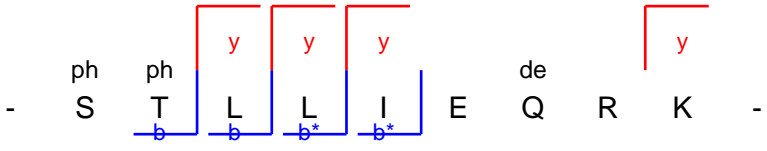
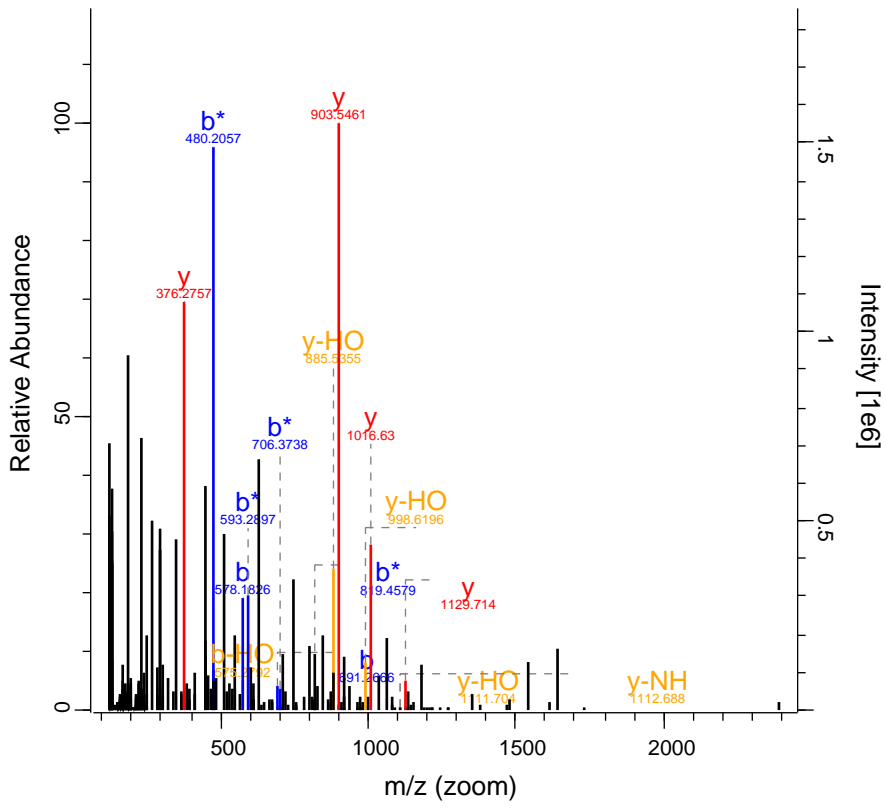

RO-QC-160121_ZackD_SS_Set_01_Fraction 38148 FTMS; HC 41.87 872.14 LRRK2

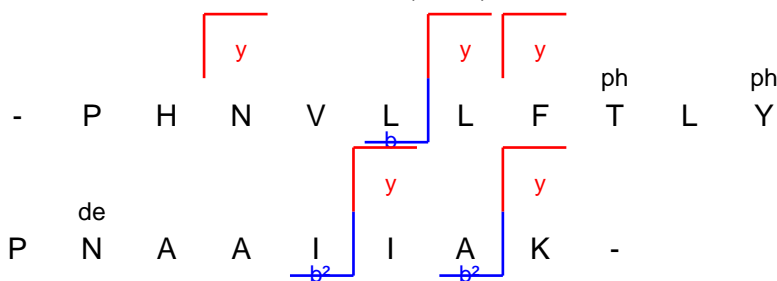
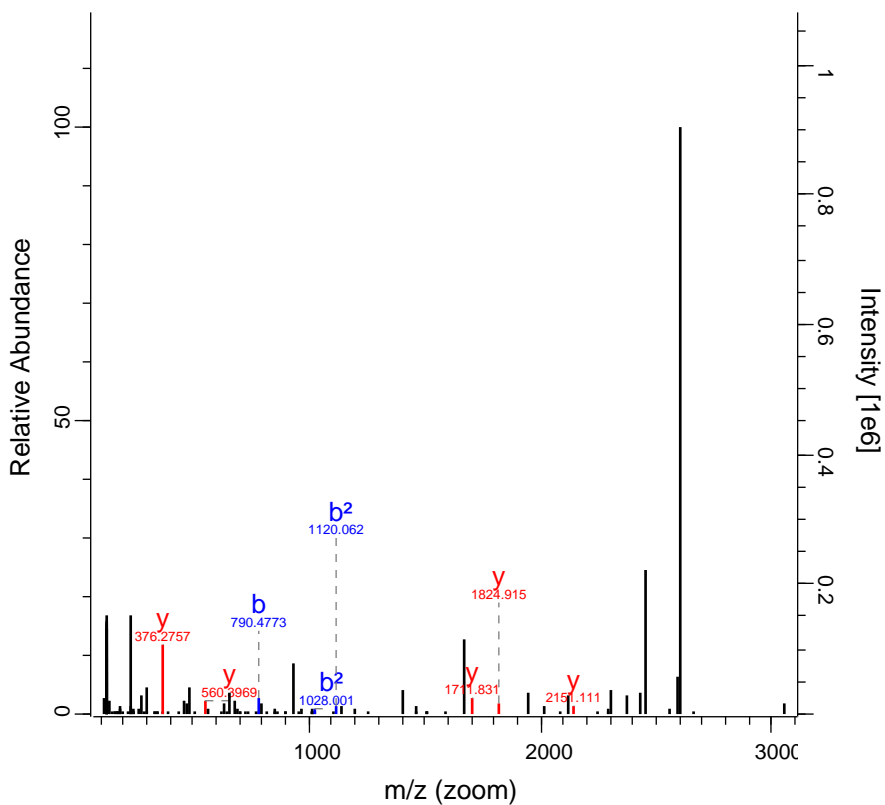

RO-QC-160121_ZackD_SS_Set_01_Fraction 4897 FTMS; HCl 74.77 428.24 SCLY

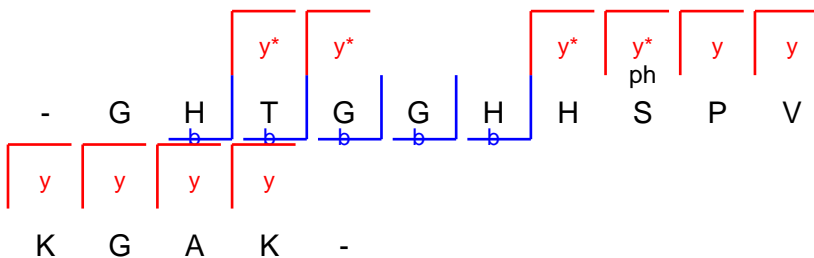
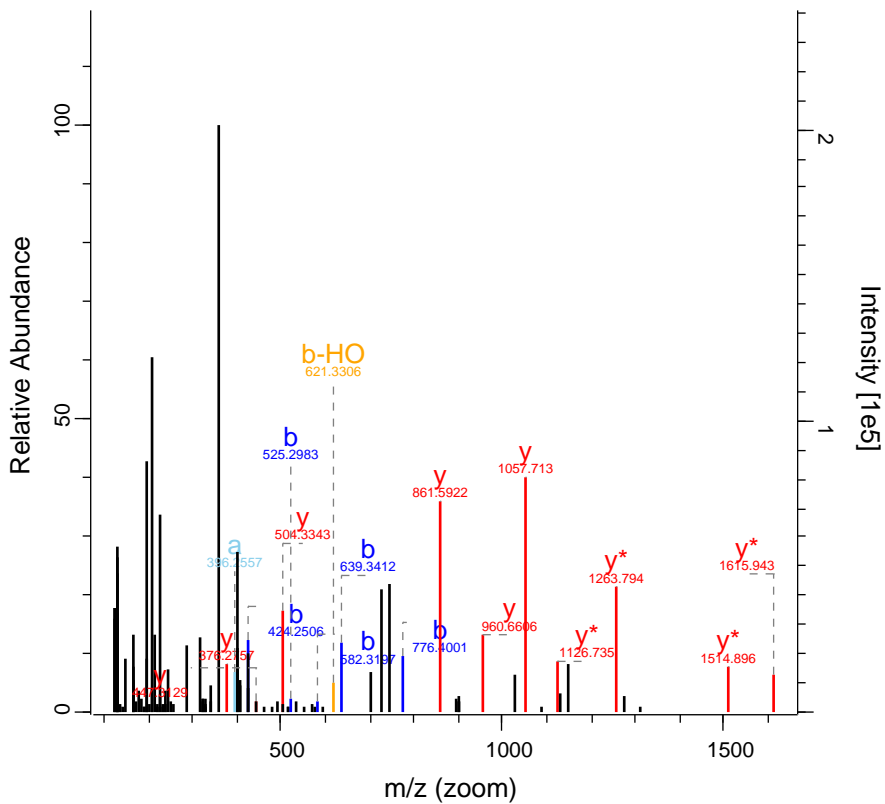

RO-QC-160121_ZackD_SS_Set_01_Fraction 7694 FTMS; HC 150.09 736.86 SORBS2

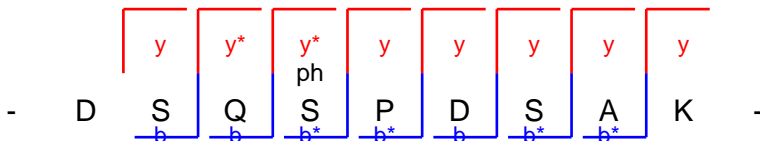
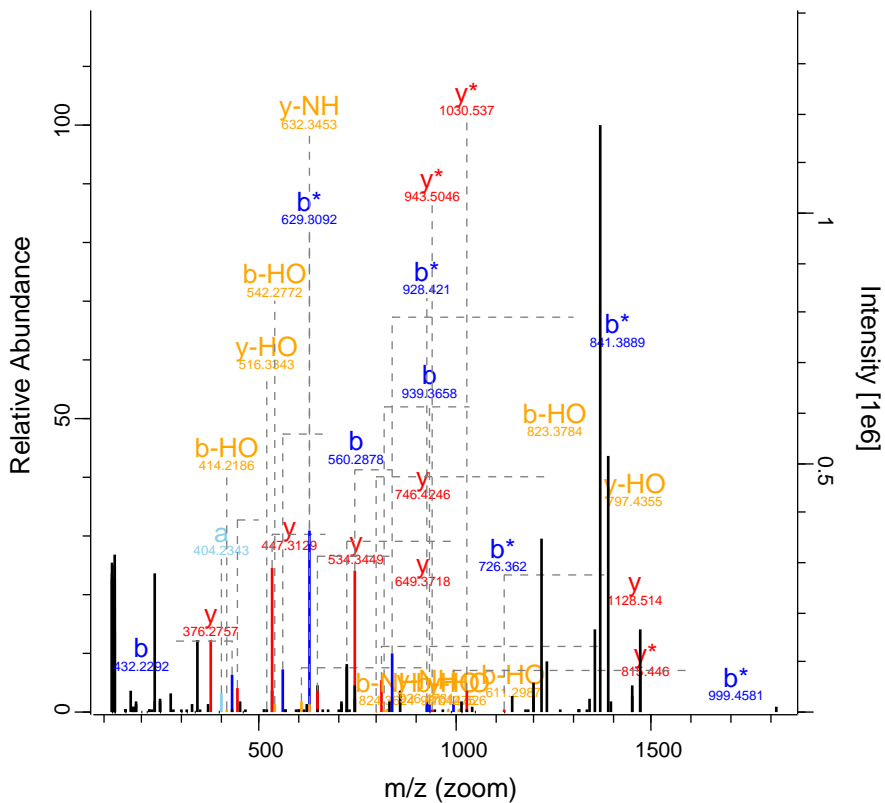

RO-QC-160121_ZackD_SS_Set_01_Fraction 8336 FTMS; HCl 86.62 910.97 KAT6A

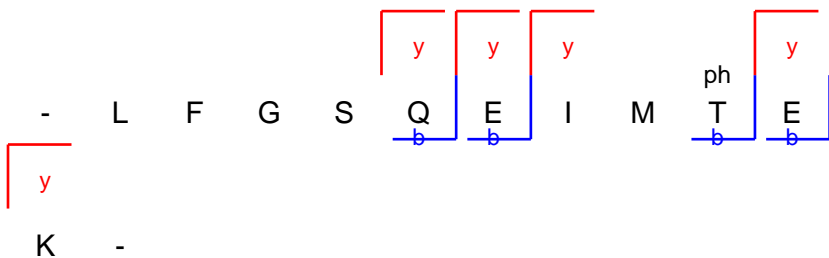
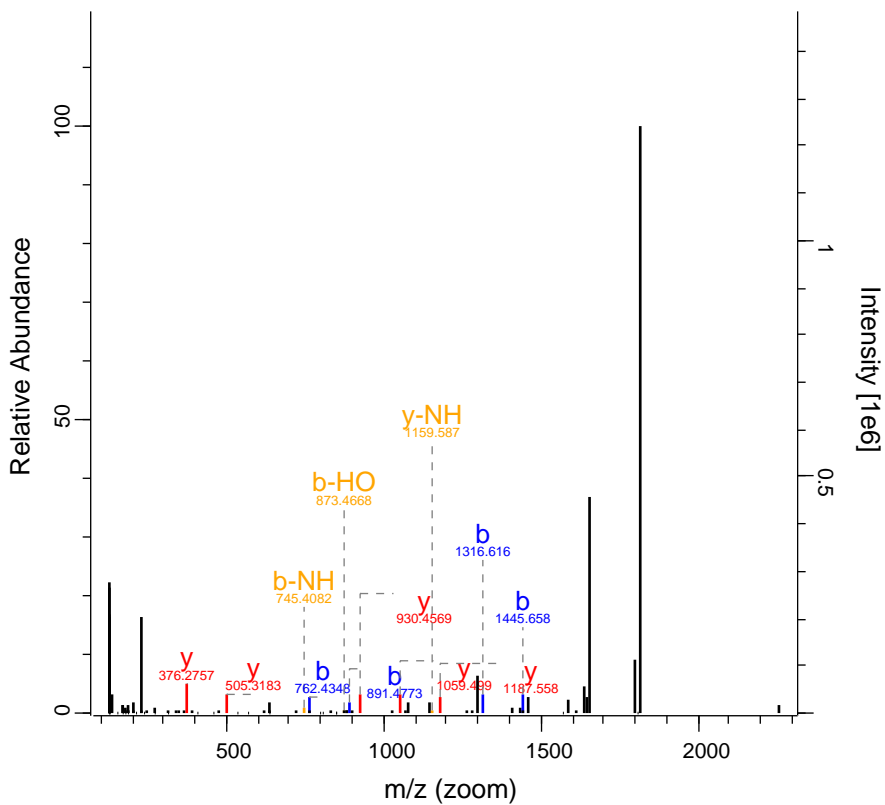

RO-QC-160121_ZackD_SS_Set_01_Fraction 8590 FTMS; HCl 80.16 929.44 LDB1

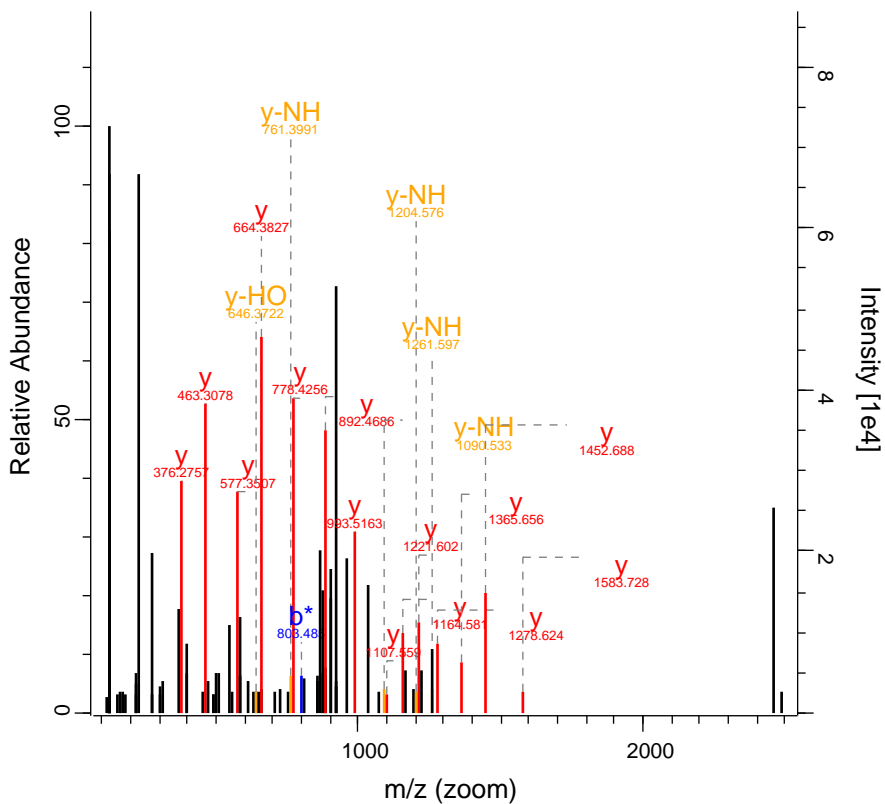

								y	y	y
		ox	ph							
-	K	M	S	G	G	S	T	M	S	S
			b*							
y	y	y	y	y	y	y	y	y	y	y
G	G	G	N	T	N	N	S	N	S	K

RO-QC-160121_ZackD_SS_Set_01_Fraction 10268 FTMS; HC 55.68 352.46 SDF2L1

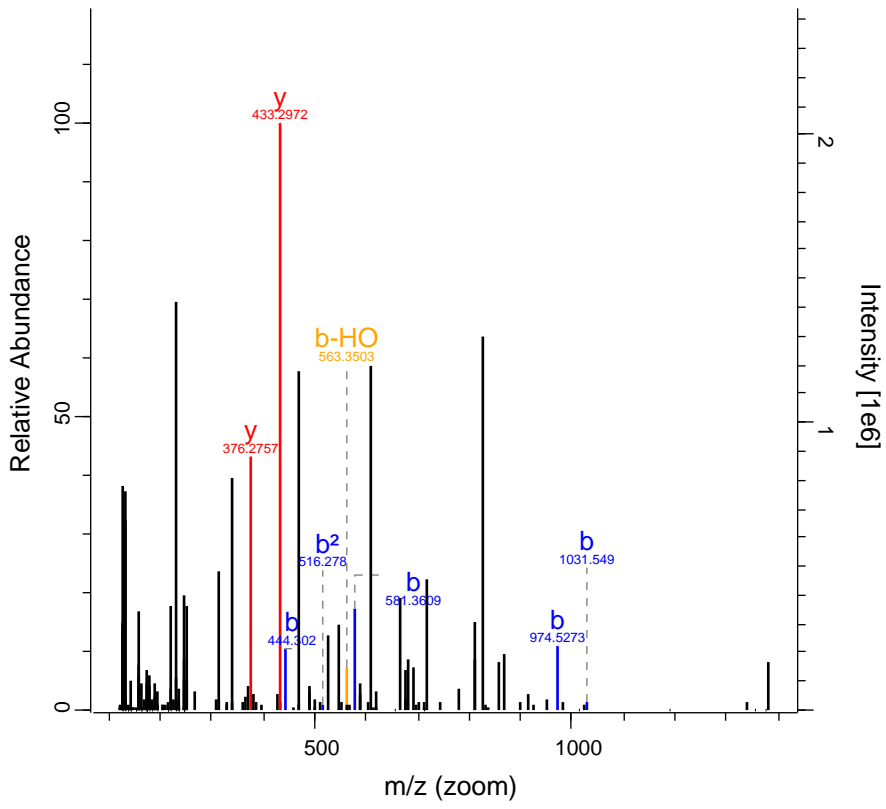

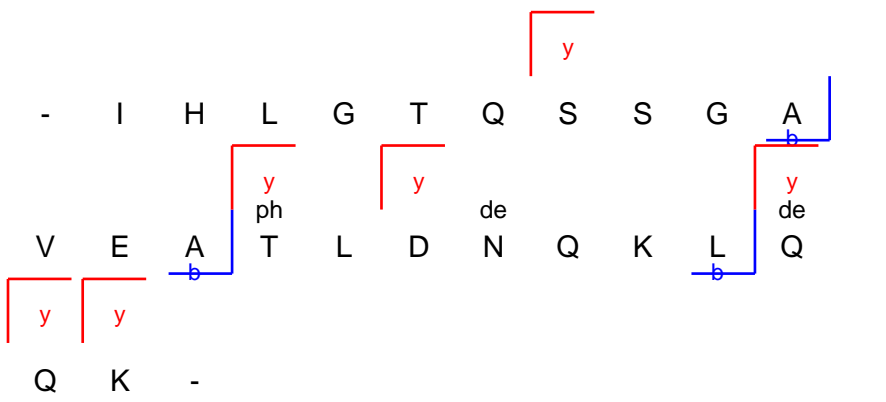
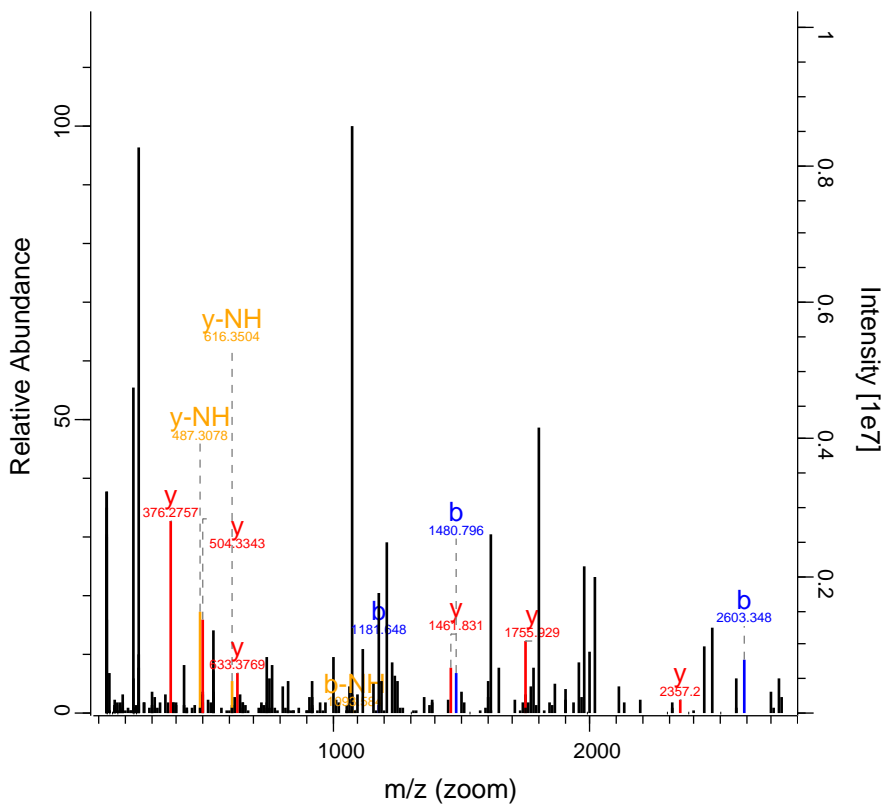

RO-QC-160121_ZackD_SS_Set_01_Fraction 10679 FTMS; HC 93.26 469.92 EFHC2

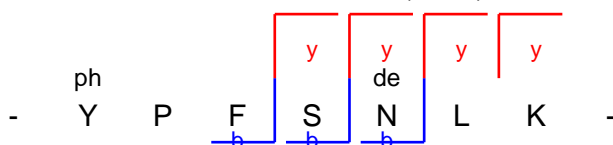
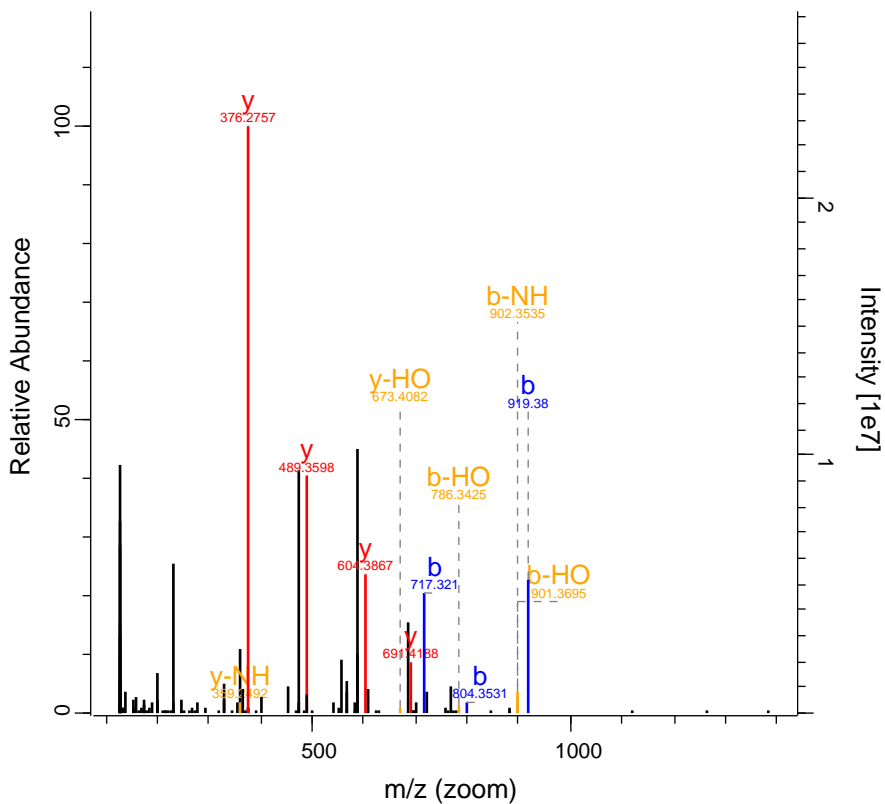

RO-QC-160121_ZackD_SS_Set_01_Fraction11022 FTMS; HC 188 701.99 DSG2

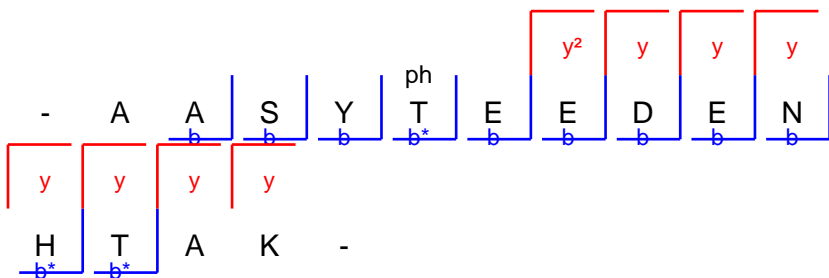
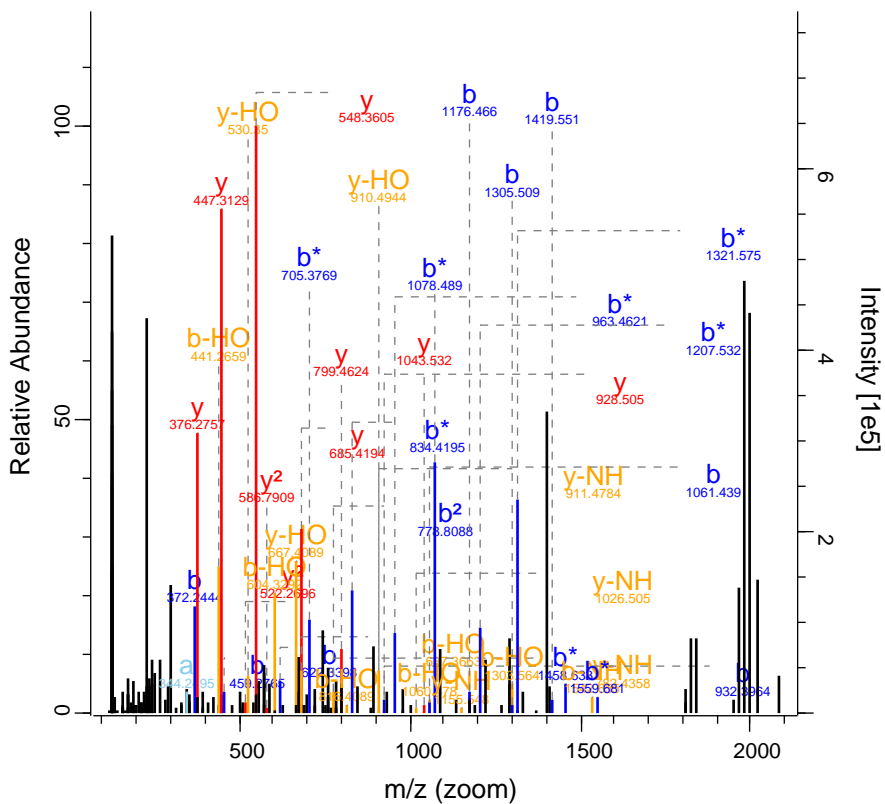

RO-QC-160121_ZackD_SS_Set_01_Fraction 11090 FTMS; HC 104.2 707.38 PRRC2A

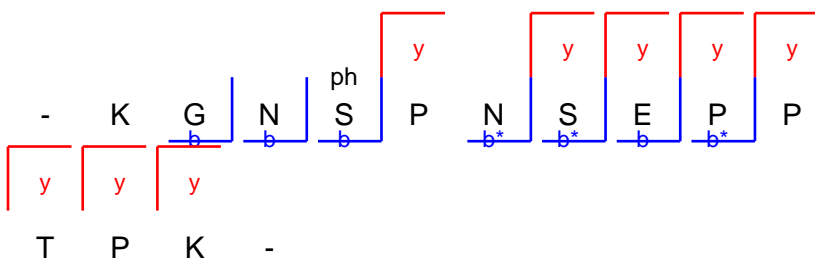
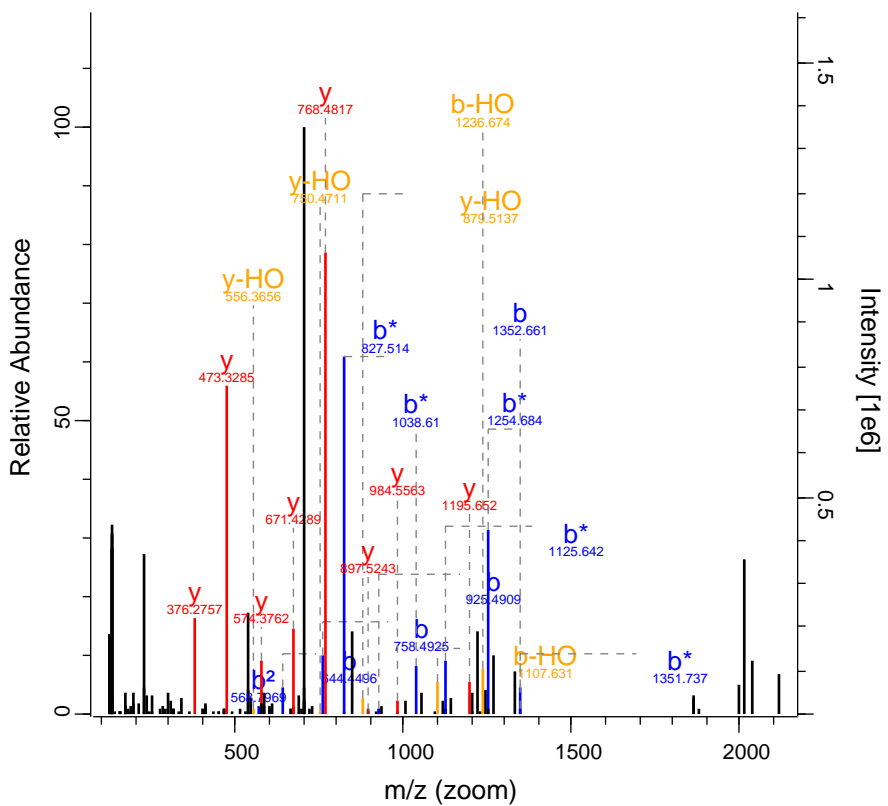

RO-QC-160121_ZackD_SS_Set_01_Fractio 12028 FTMS; HC 171.26 919.95 MAP7D1

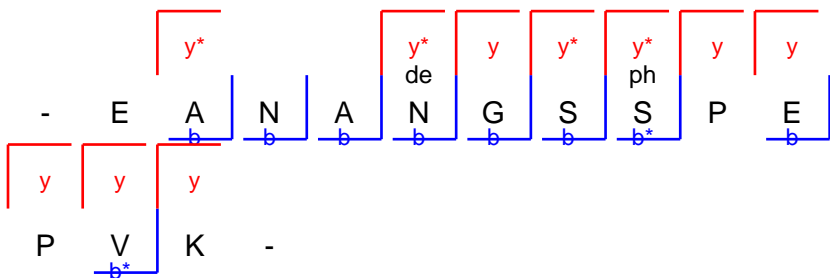
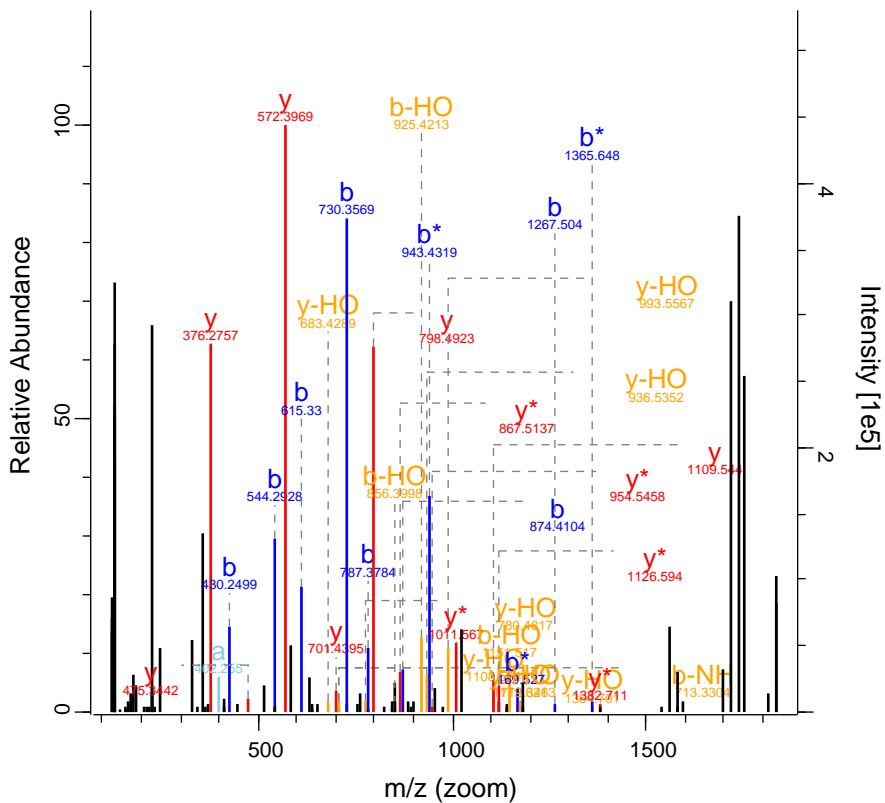

RO-QC-160121_ZackD_SS_Set_01_Fraction12178 FTMS; HC 95.95 749.09 APC

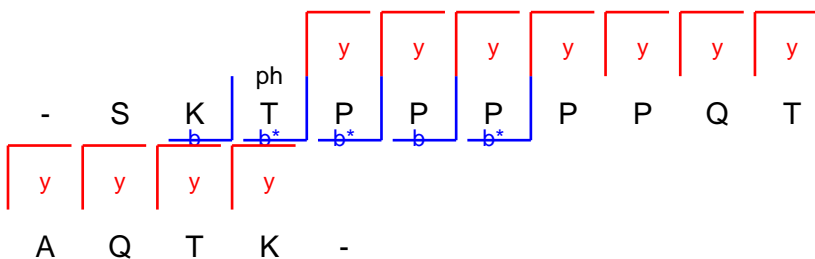
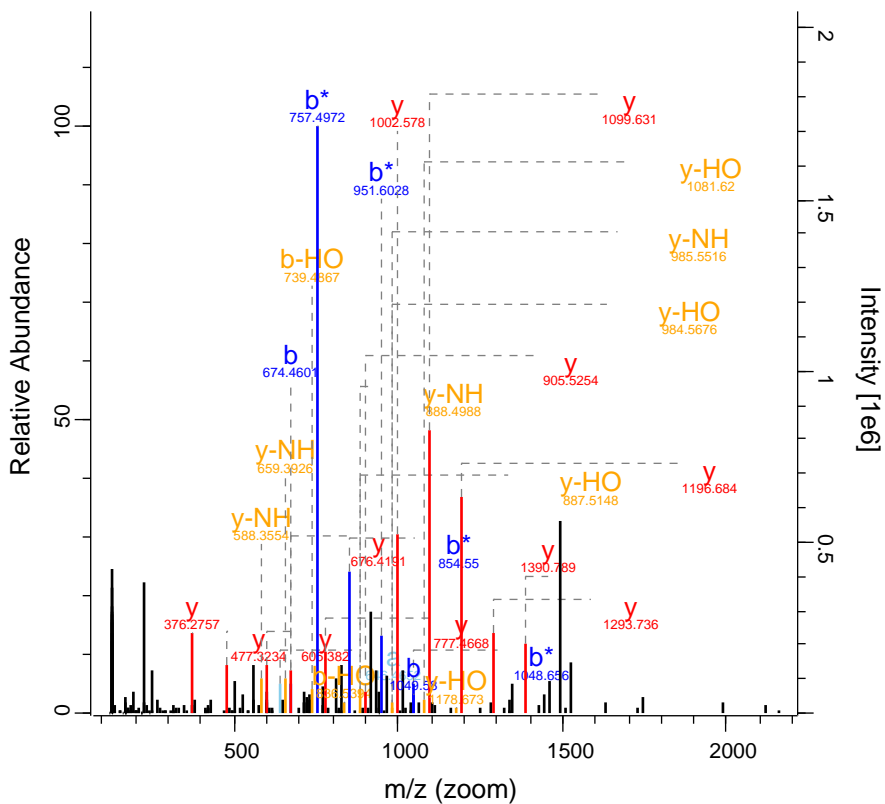

A Q T K -

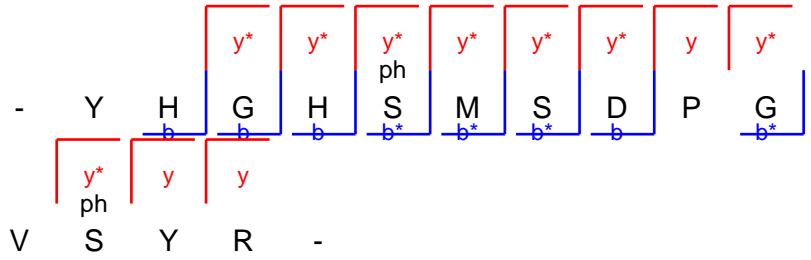
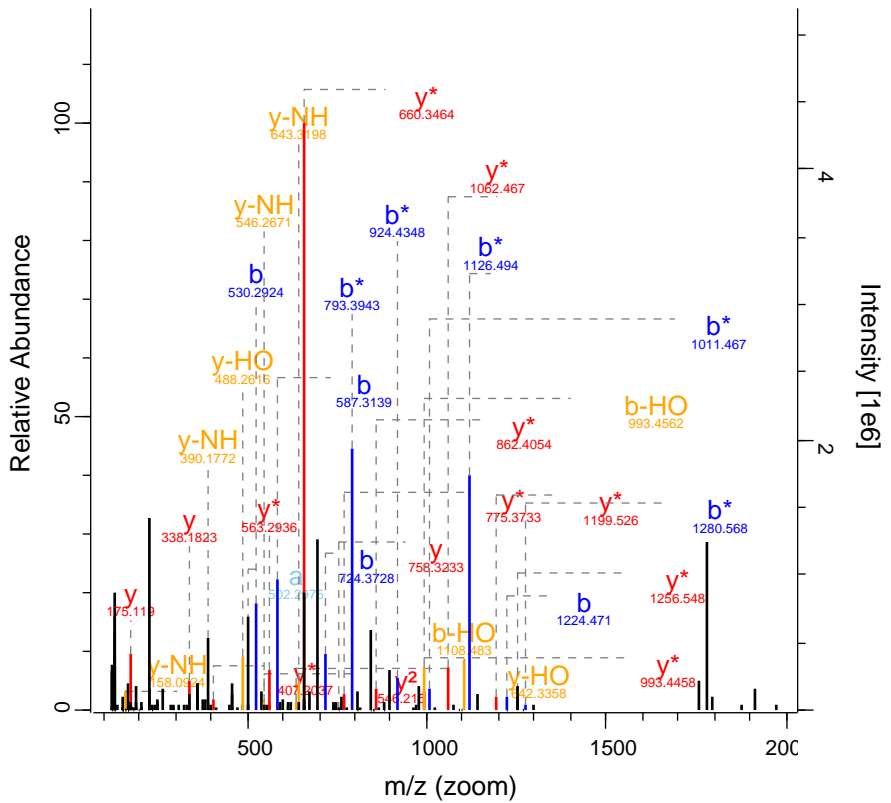

RO-QC-160121_ZackD_SS_Set_01_Fraction 13309 FTMS; HC 61.38 600.62 CCHCR1

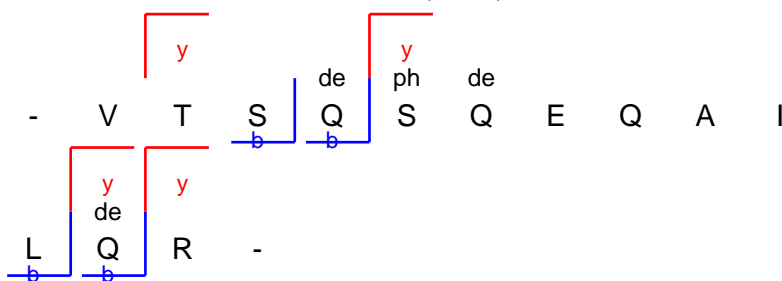
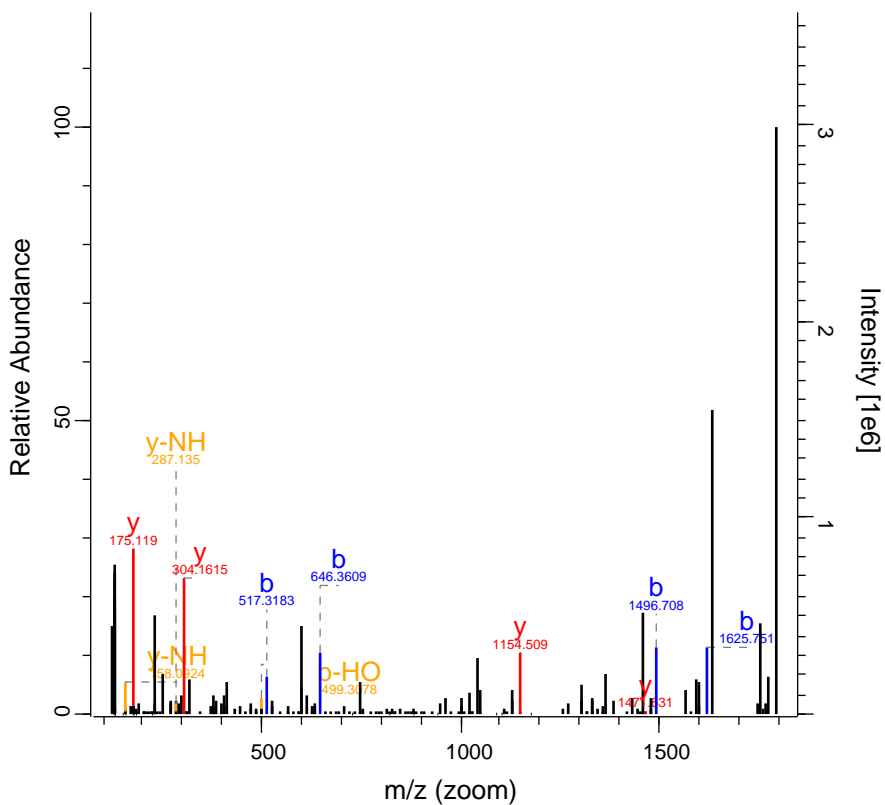

RO-QC-160121_ZackD_SS_Set_01_Fractio 13336 FTMS; HC 124.42 915.95 PRPF38B

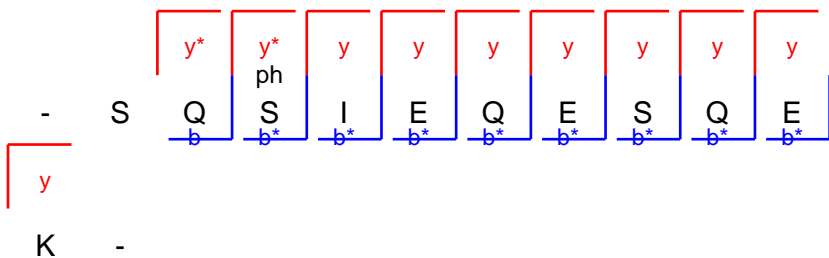
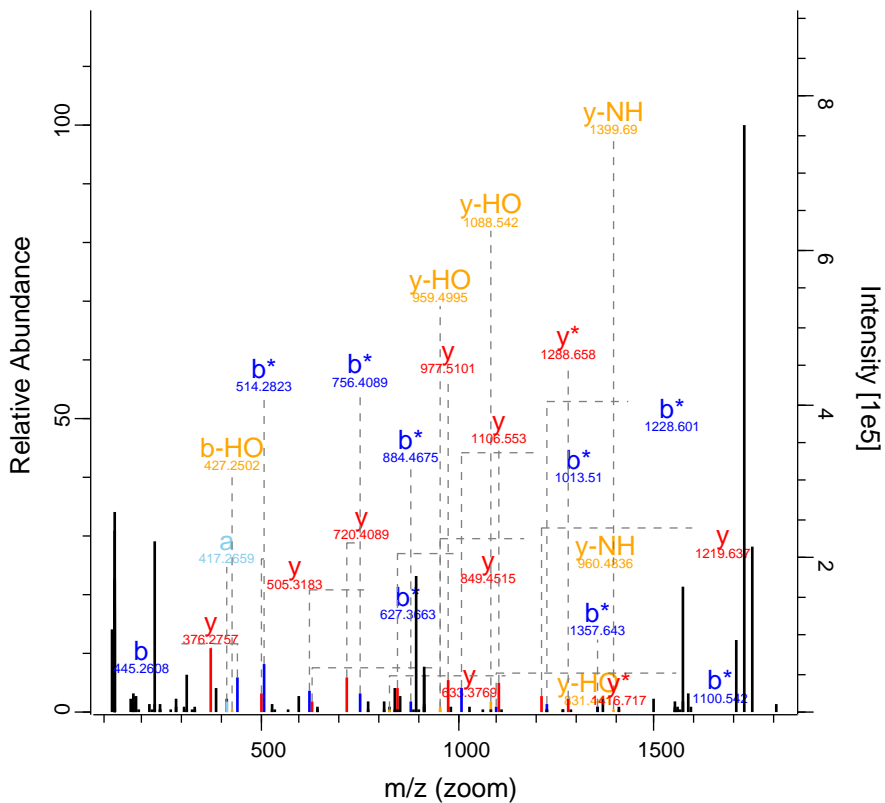

RO-QC-160121_ZackD_SS_Set_01_Fractio 13597 FTMS; HC 129.03 898.49 CDK12

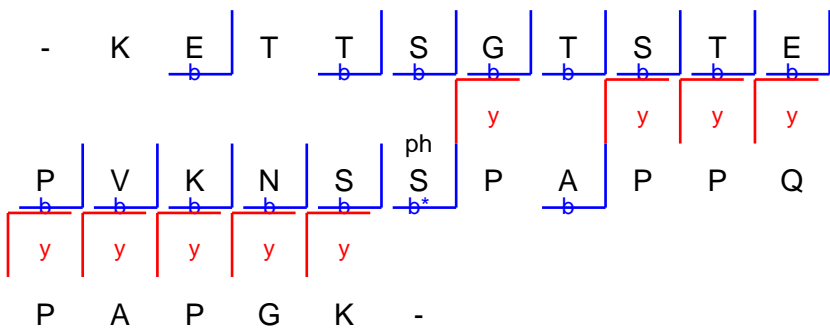
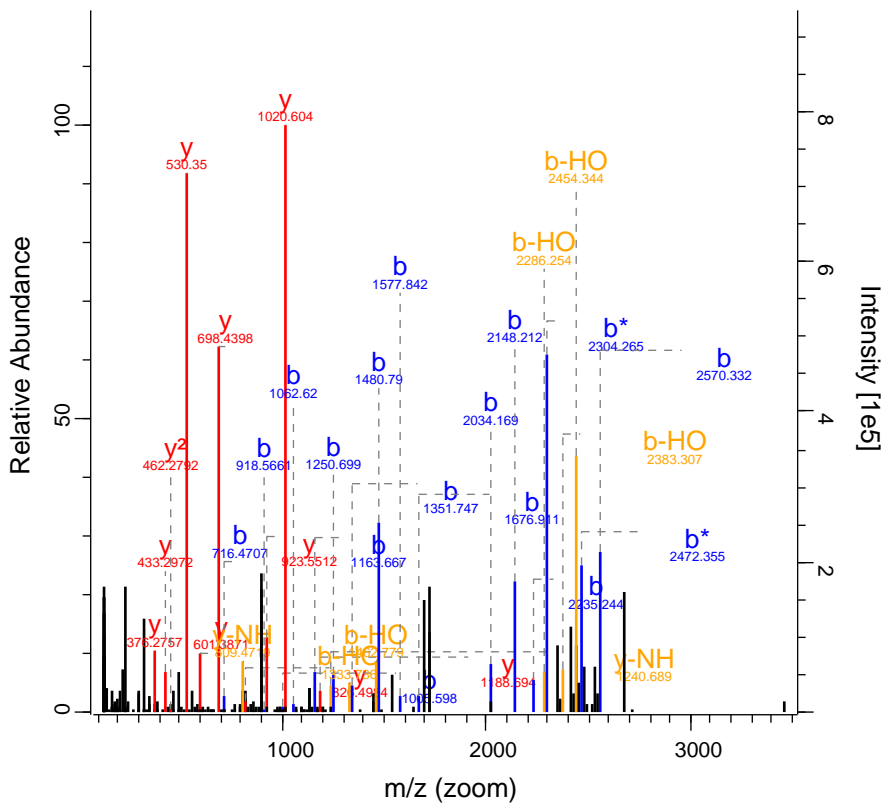

RO-QC-160121_ZackD_SS_Set_01_Fraction 13642 FTMS; HC 51.64 601.34 MAP1B

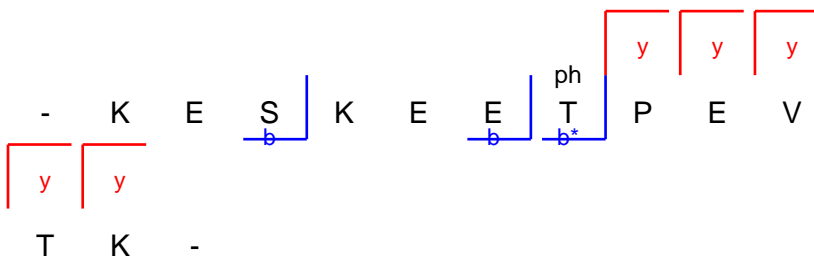
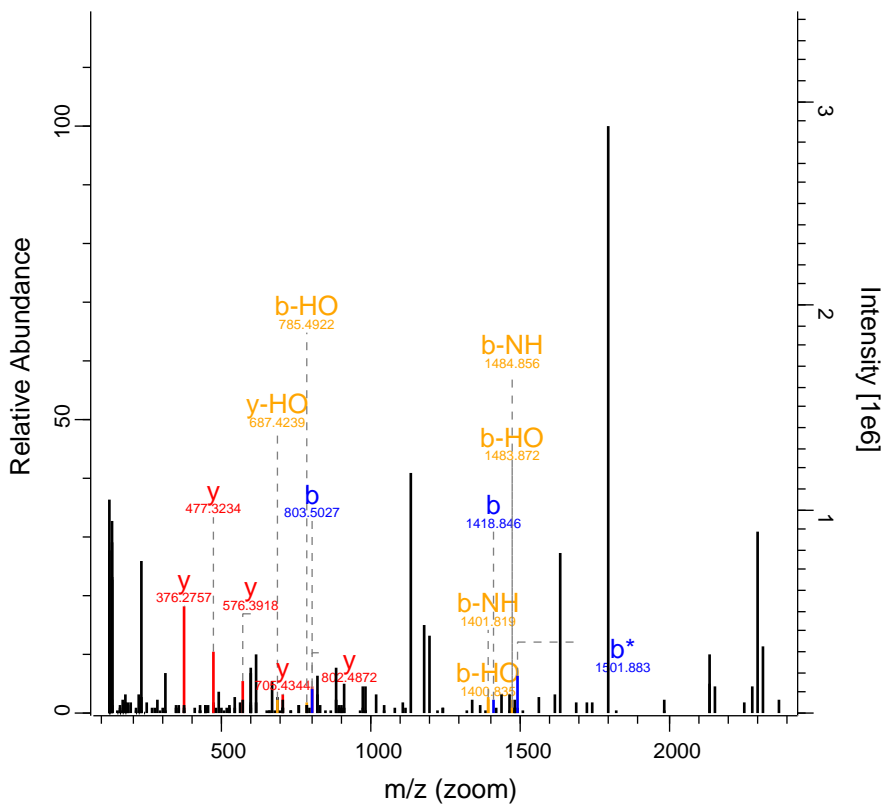

RO-QC-160121_ZackD_SS_Set_01_Fraction 13830 FTMS; HC 53.17 587.99 EPB41L1

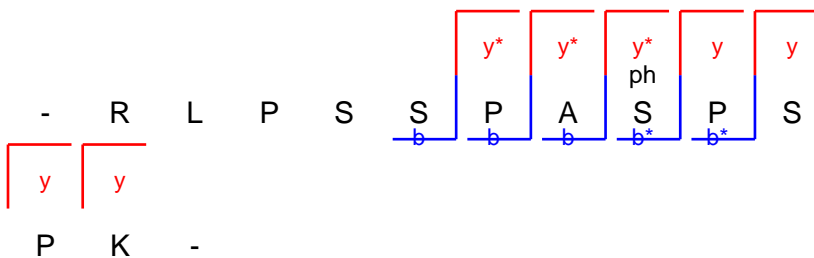
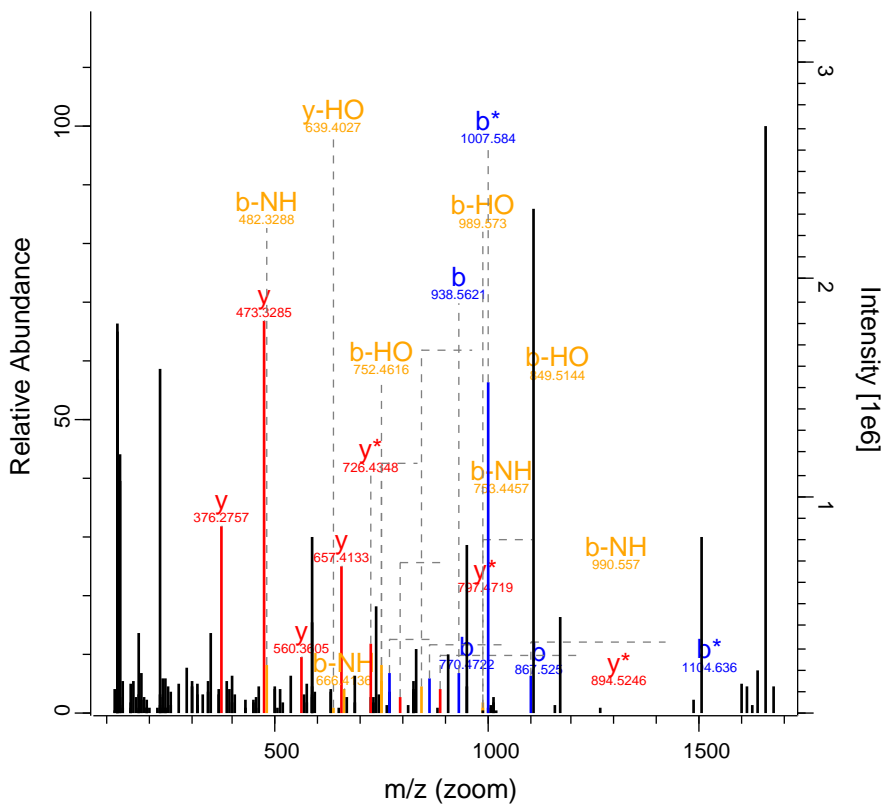

RO-QC-160121_ZackD_SS_Set_01_Fraction 15046 FTMS; HC 40.35 849.88 SLC4A7

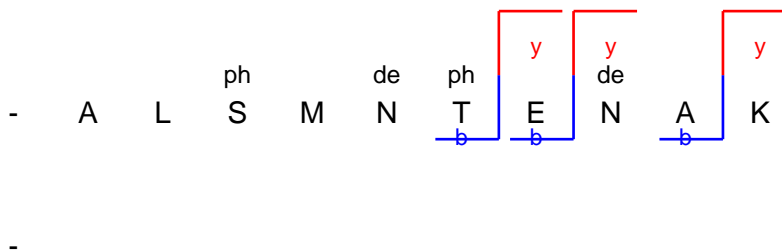
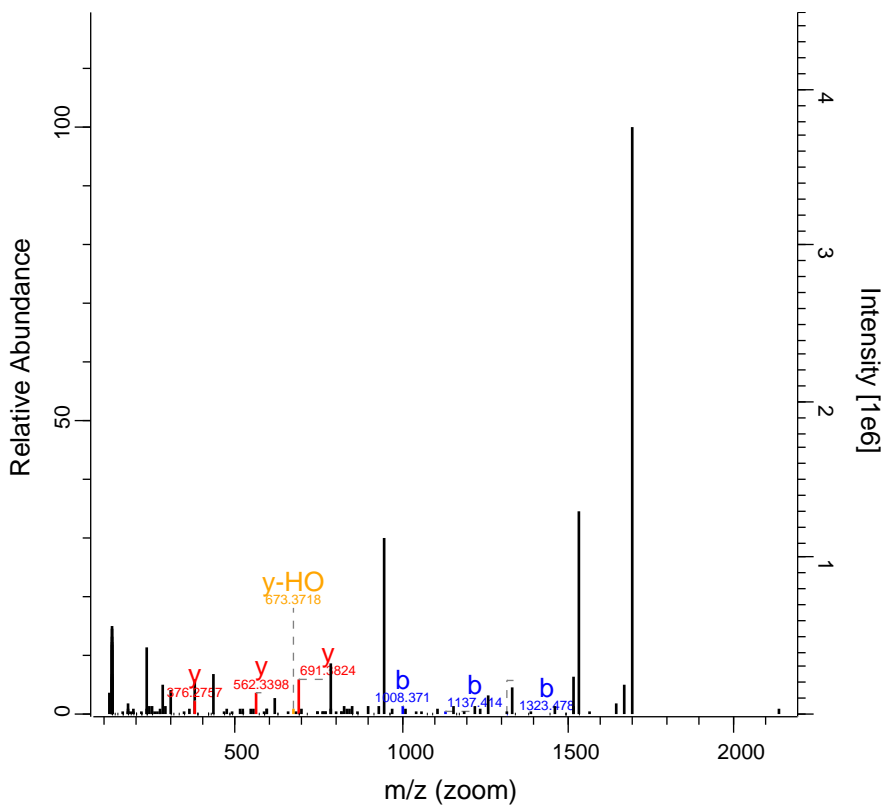

RO-QC-160121_ZackD_SS_Set_01_Fraction15912 FTMS; HCl 145.83 617.8 MECP2

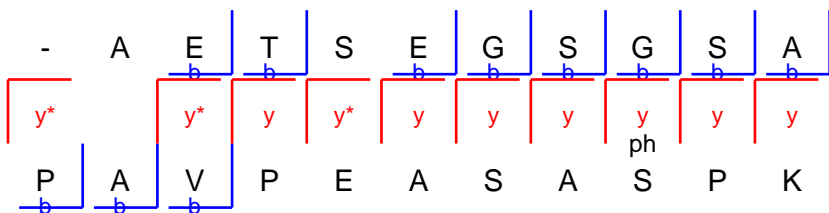
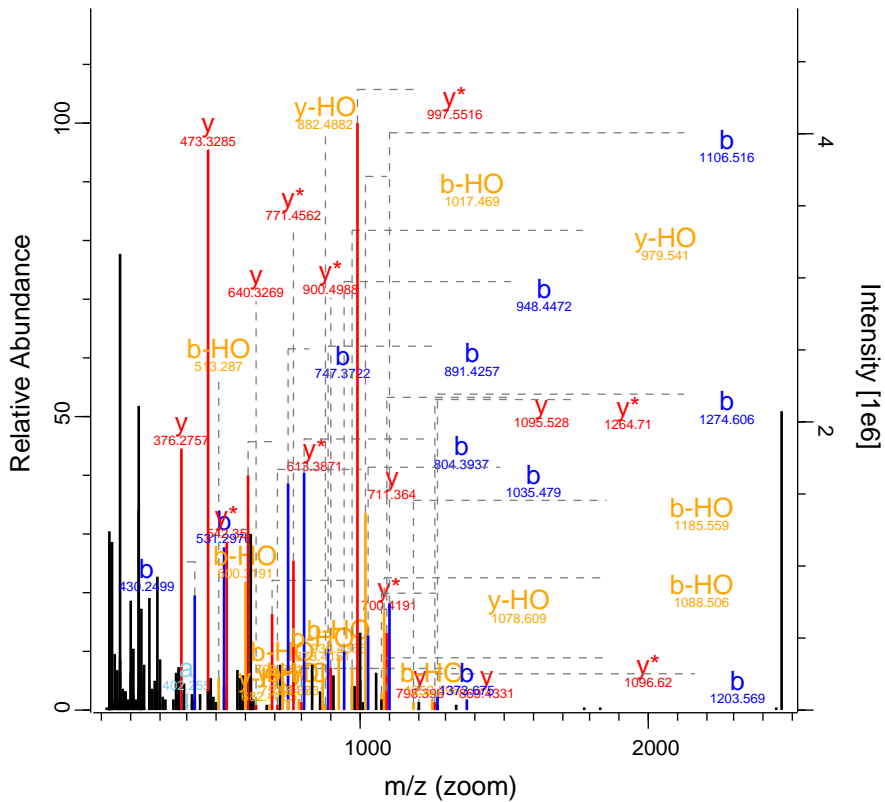

RO-QC-160121_ZackD_SS_Set_01_Fraction 16014 FTMS; HCl 100.97 799.7 PDS5B

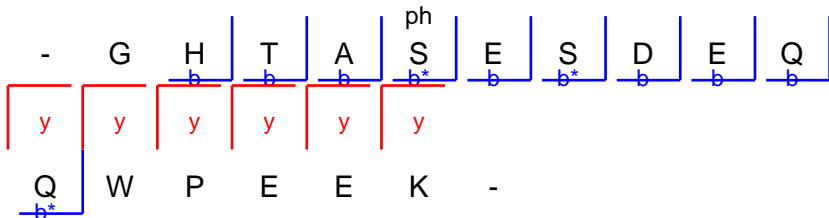
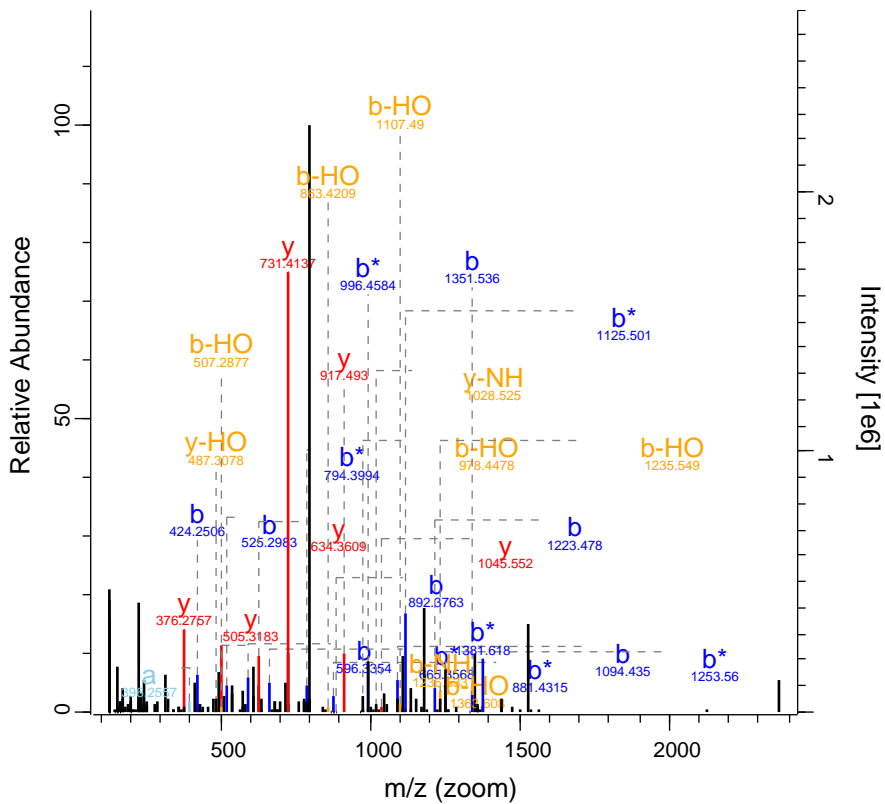

RO-QC-160121_ZackD_SS_Set_01_Fratio 16252 FTMS; HC 141.08 871.43 IRS2

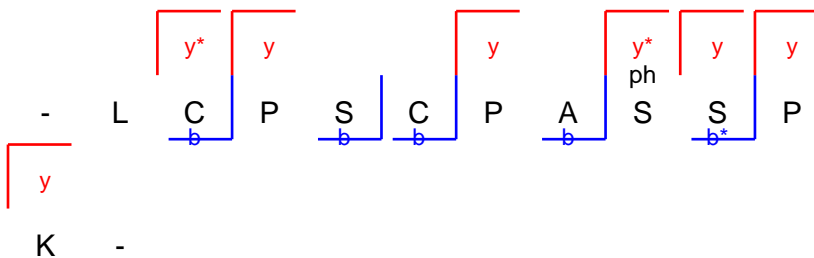
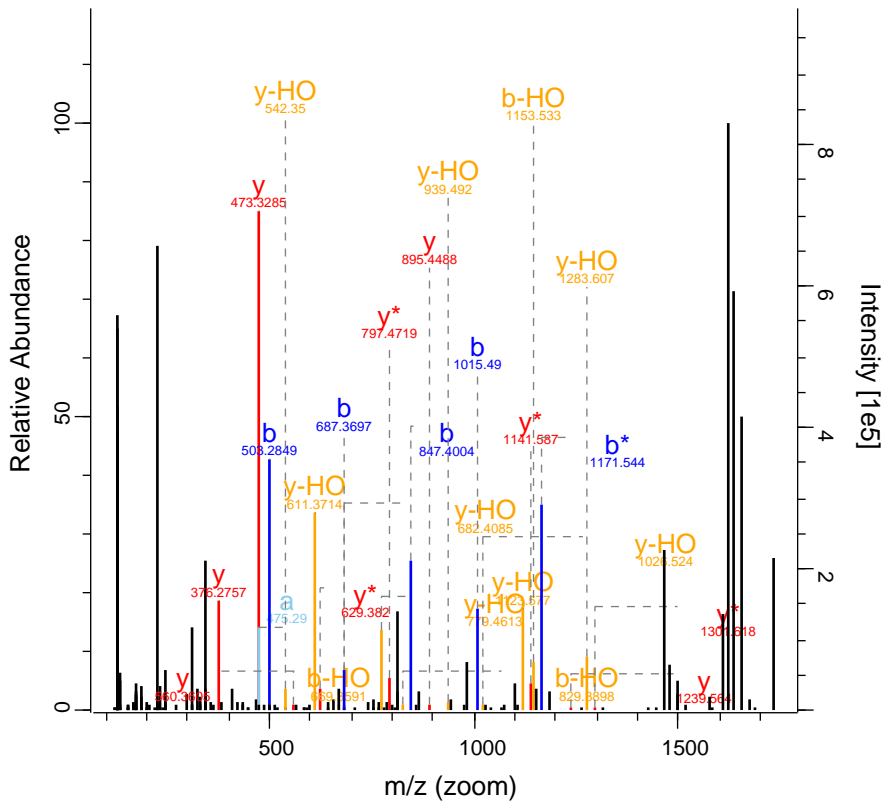

RO-QC-160121_ZackD_SS_Set_01_Fraction 16379 FTMS; HCl; 64.24 604 AKTIP

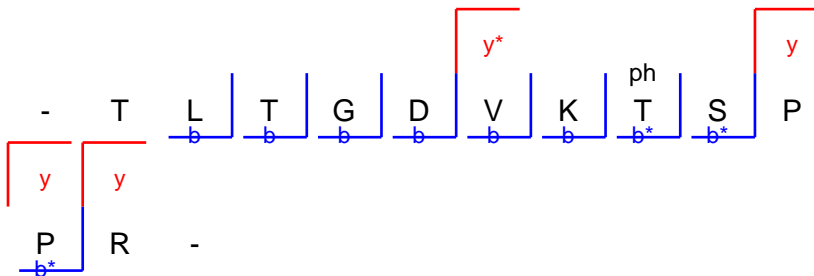
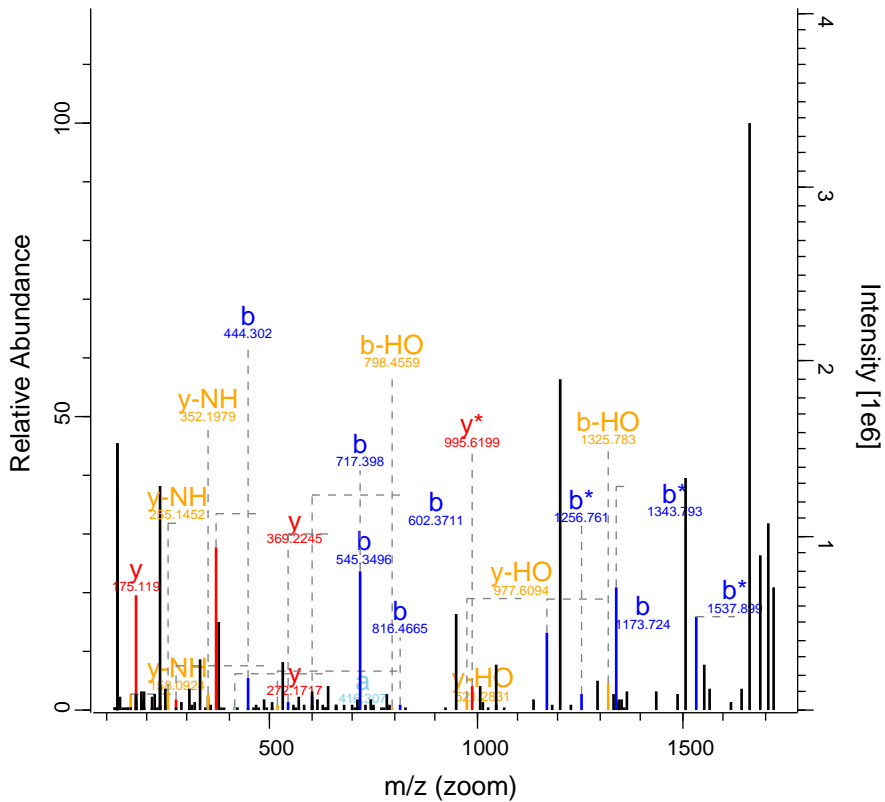

RO-QC-160121_ZackD_SS_Set_01_Fractic 17308 FTMS; HC 117.64 1002.15 HMGA1

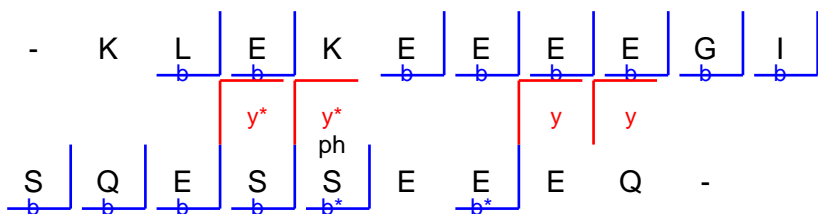
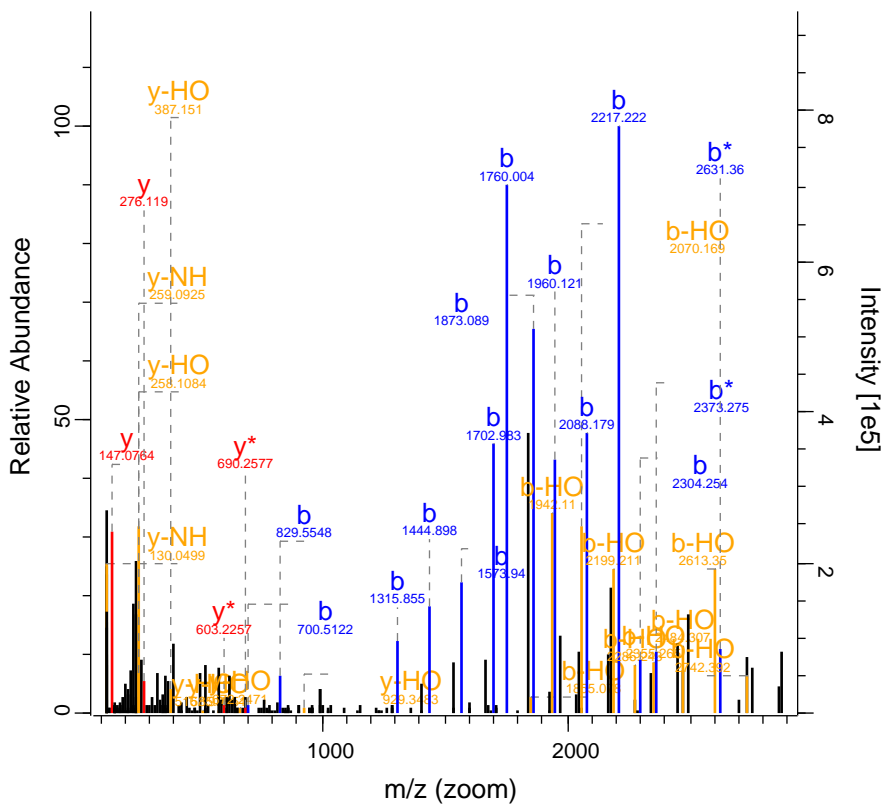

RO-QC-160121_ZackD_SS_Set_01_Fraction 17418 FTMS; HC 73.21 853.44 TERF1

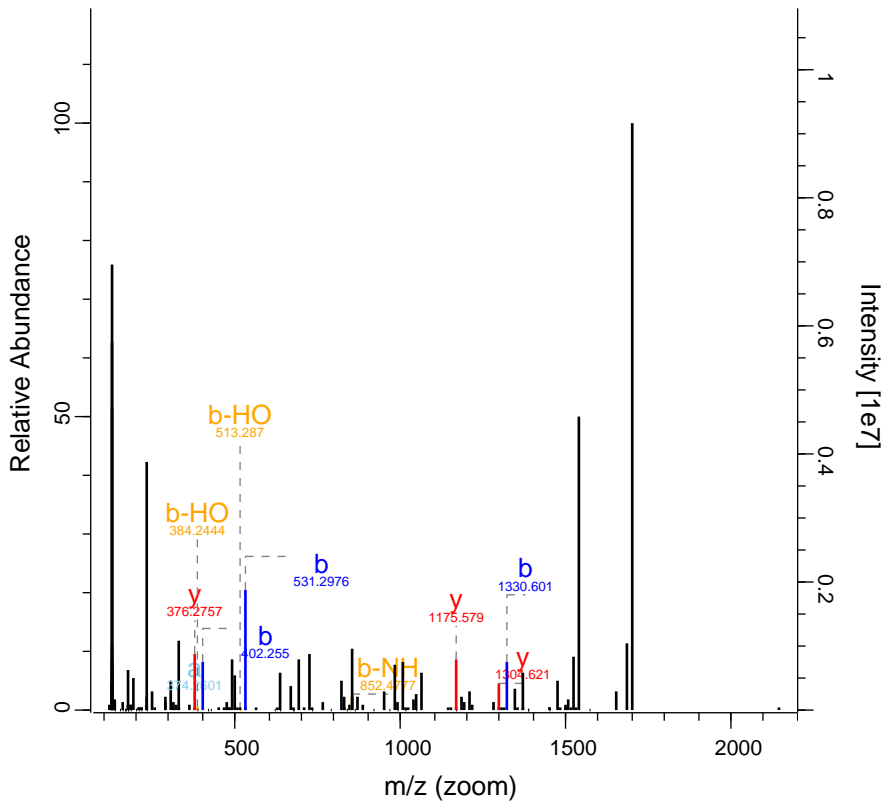

RO-QC-160121_ZackD_SS_Set_01_Fraction17793 FTMS; HC 209.7 1230.6 ATP8A1

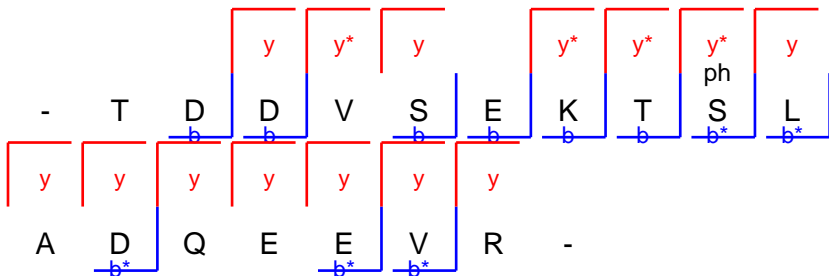
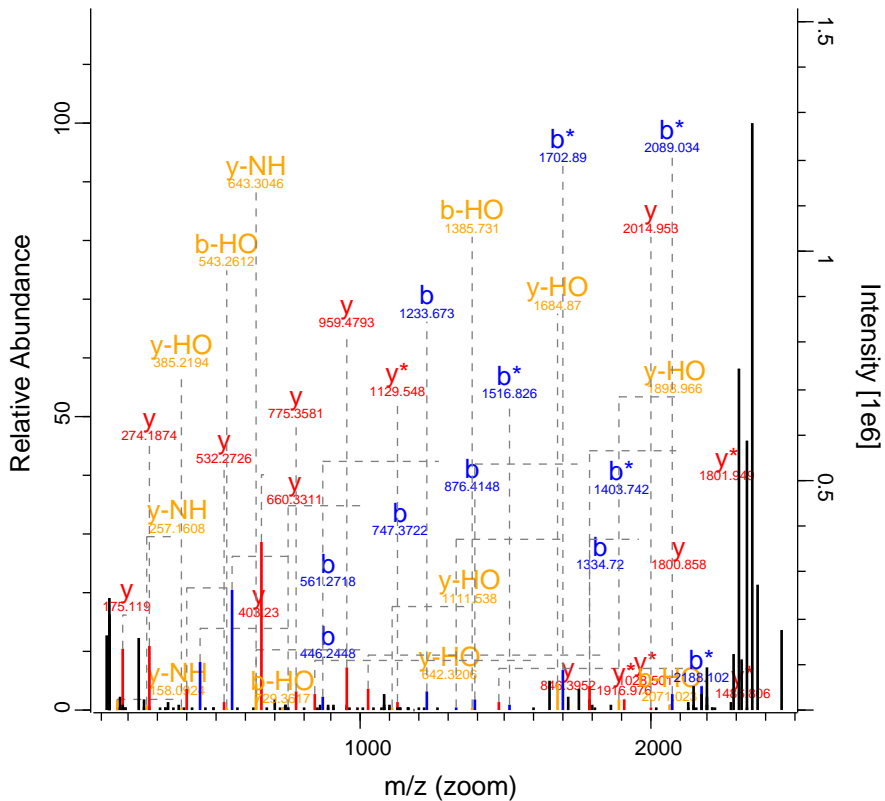

RO-QC-160121_ZackD_SS_Set_01_Fraction 18038 FTMS; HC 79.69 898.13 PALM

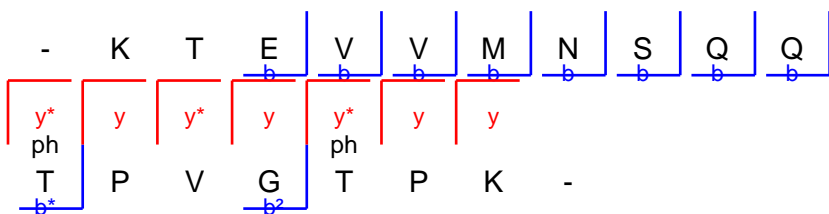
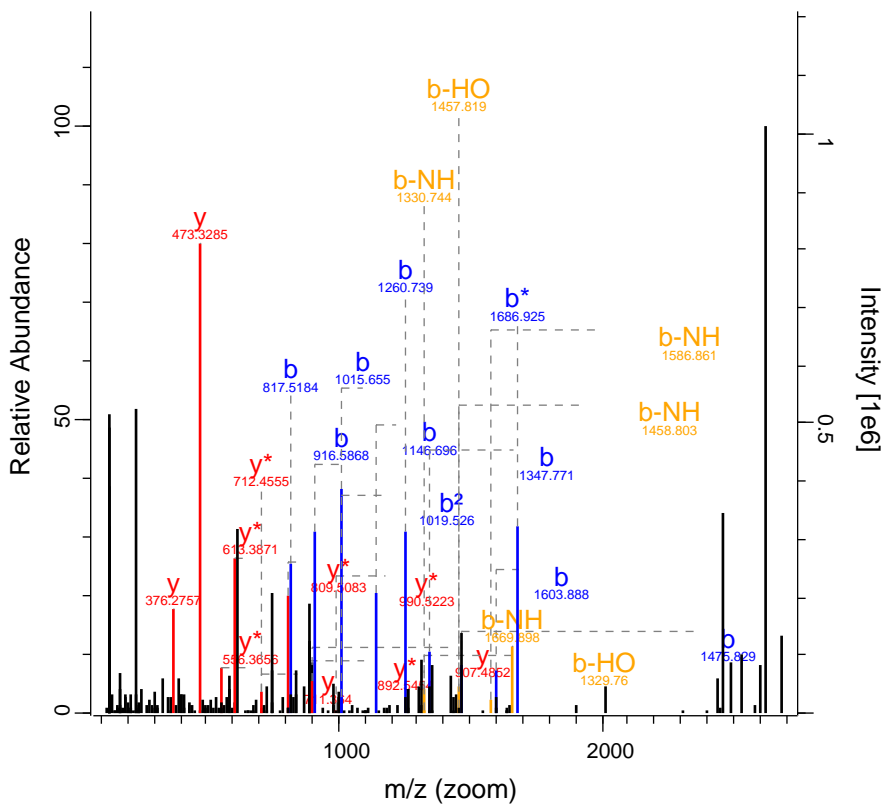

RO-QC-160121_ZackD_SS_Set_01_Fractic 18977 FTMS; HC 311.97 1249.57 DOCK7

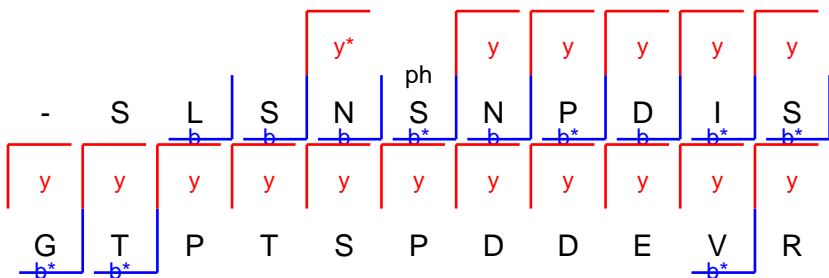
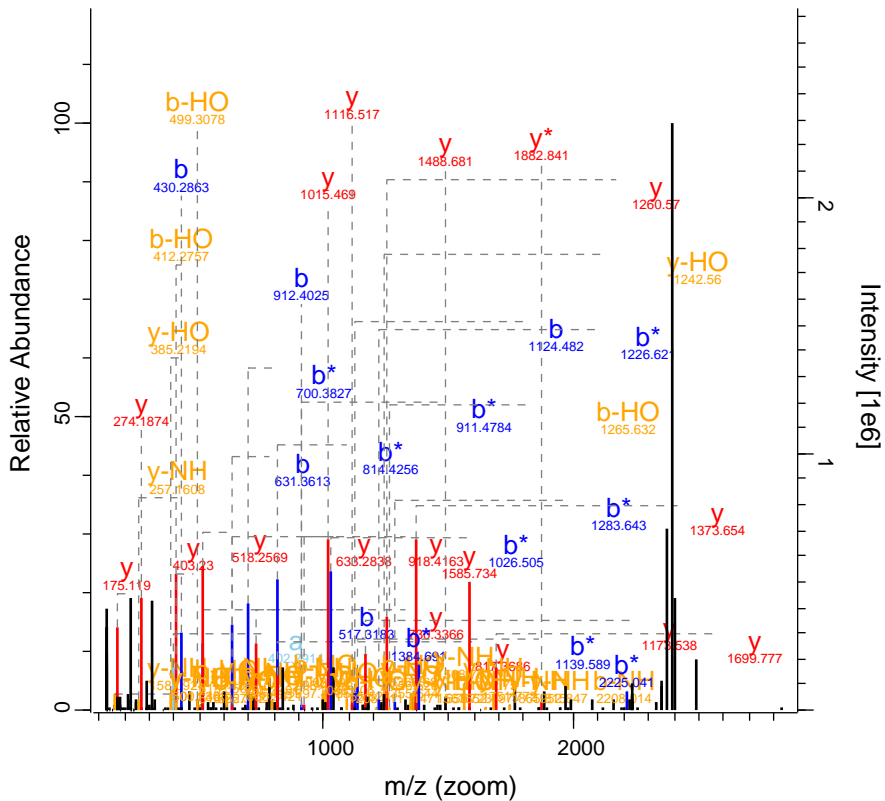

RO-QC-160121_ZackD_SS_Set_01_Fractio 19475 FTMS; HC 118.91 802.03 TBC1D2B

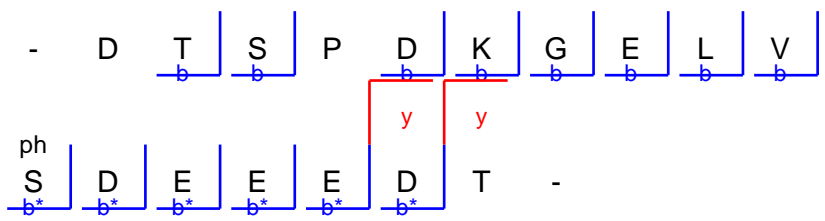
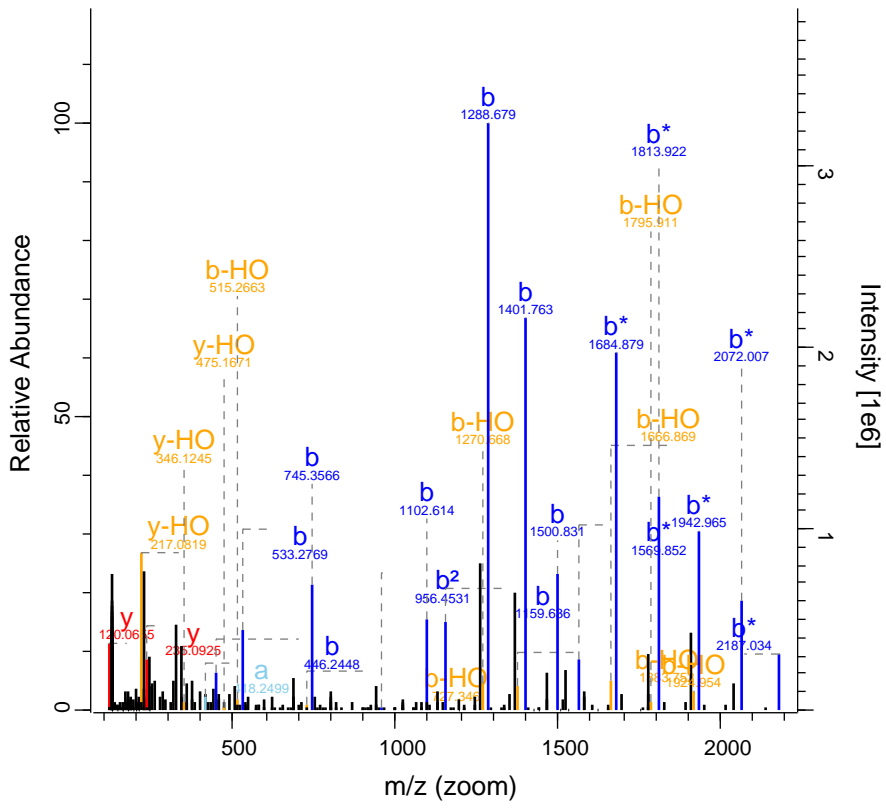

ph
S
b*

RO-QC-160121_ZackD_SS_Set_01_Fraction19965 FTMS; HC 96.17 762.93 PDCD4

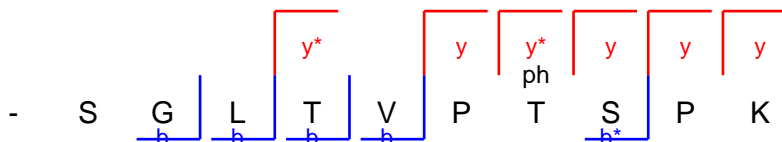
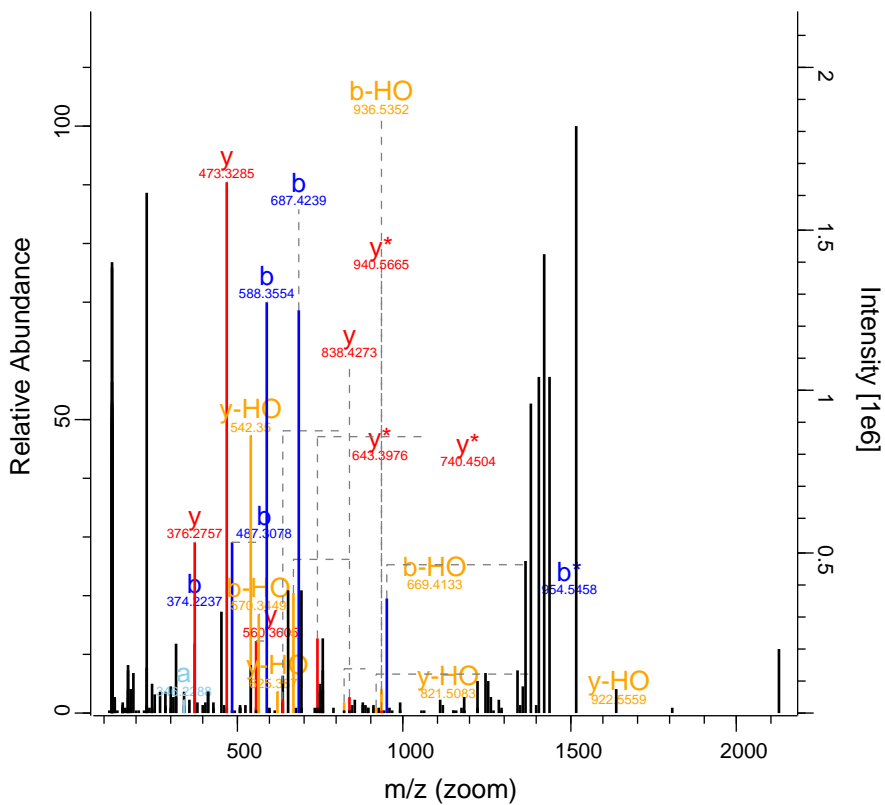

RO-QC-160121_ZackD_SS_Set_01_Fraction 20399 FTMS; HC 67.25 863.78 MAP1B

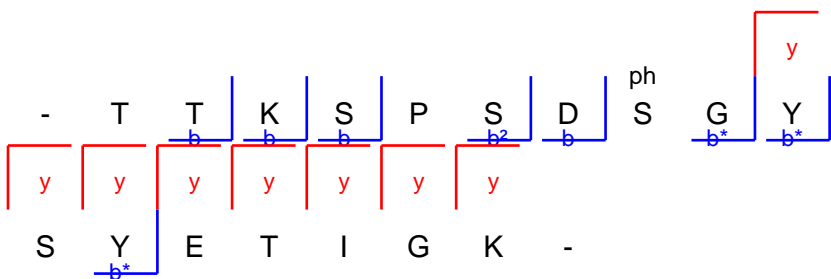
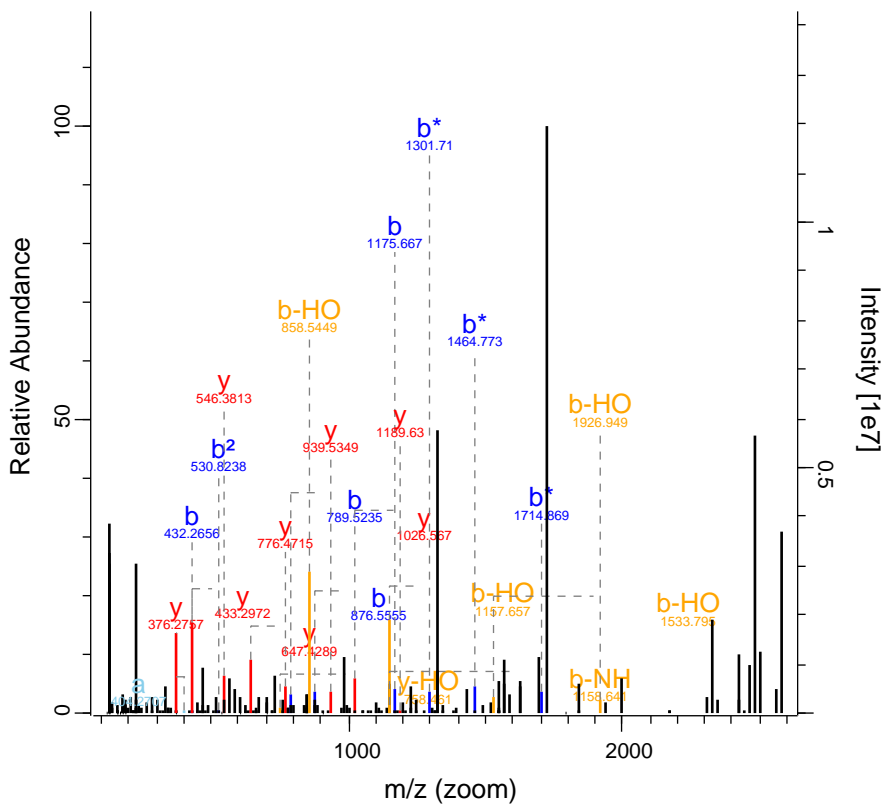

RO-QC-160121_ZackD_SS_Set_01_Fractic 21597 FTMS; HC 81.62 1260.64 KCNH5

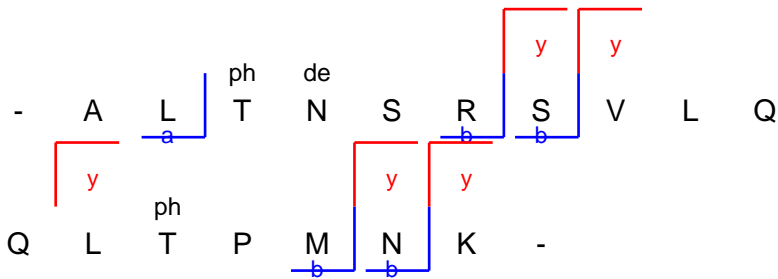
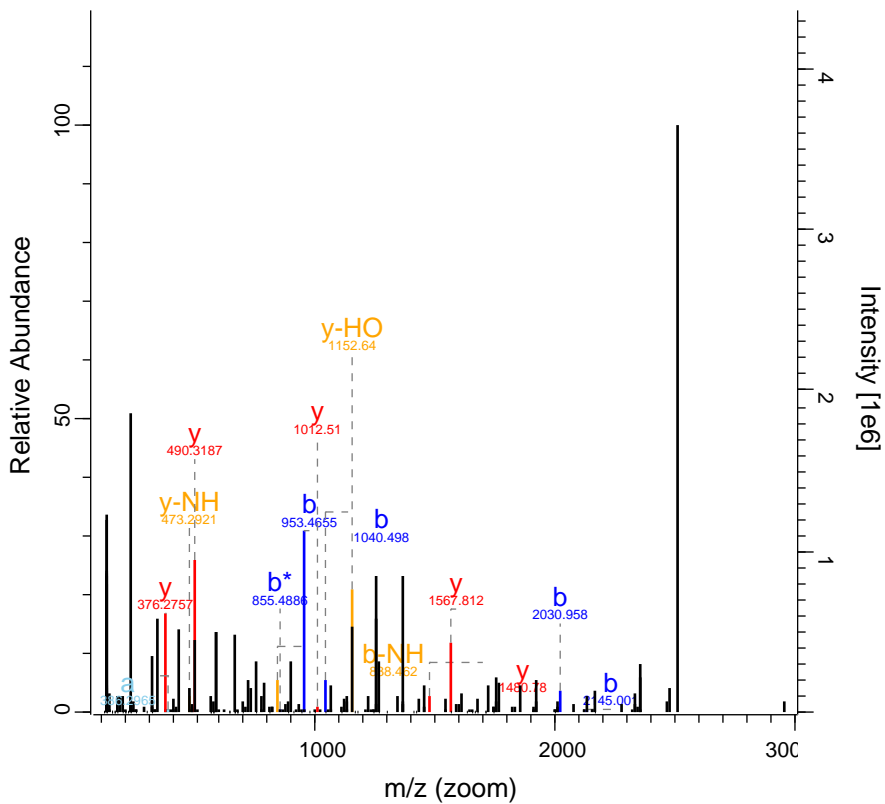

RO-QC-160121_ZackD_SS_Set_01_Fractic 21877 FTMS; HC 241.46 1140.24 PGRMC1

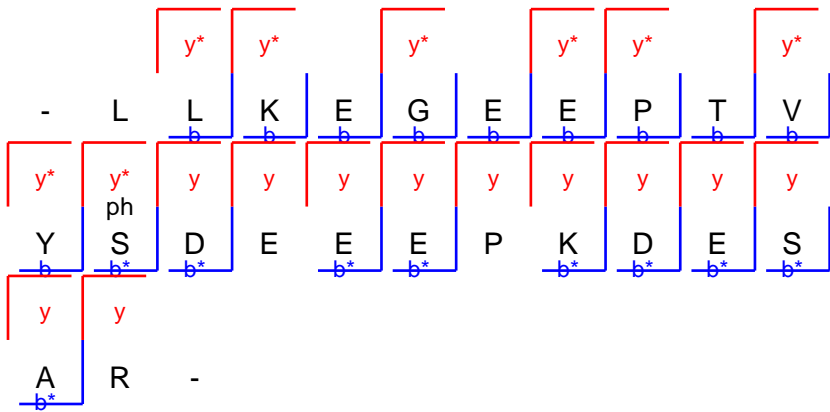
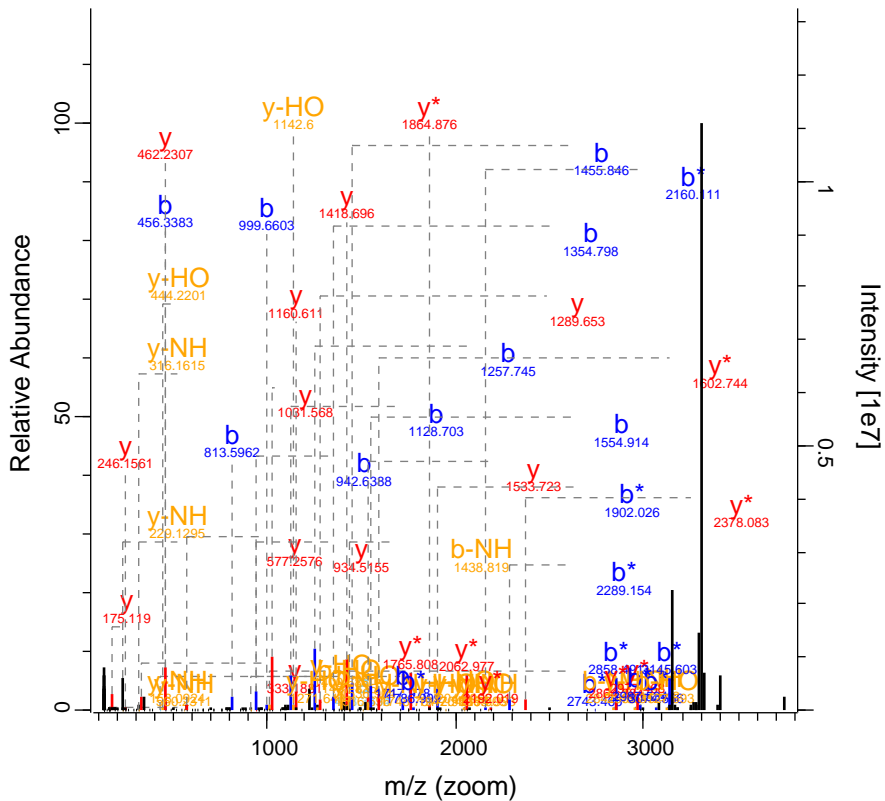

RO-QC-160121_ZackD_SS_Set_01_Fracti 22348 FTMS; HC 149.33 1112.81 FBN1

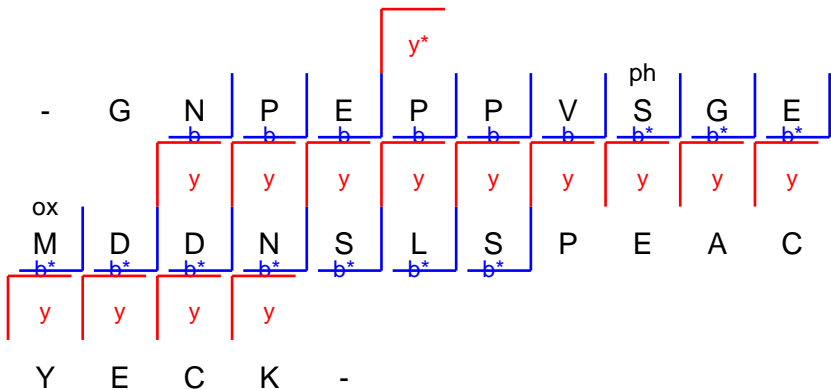
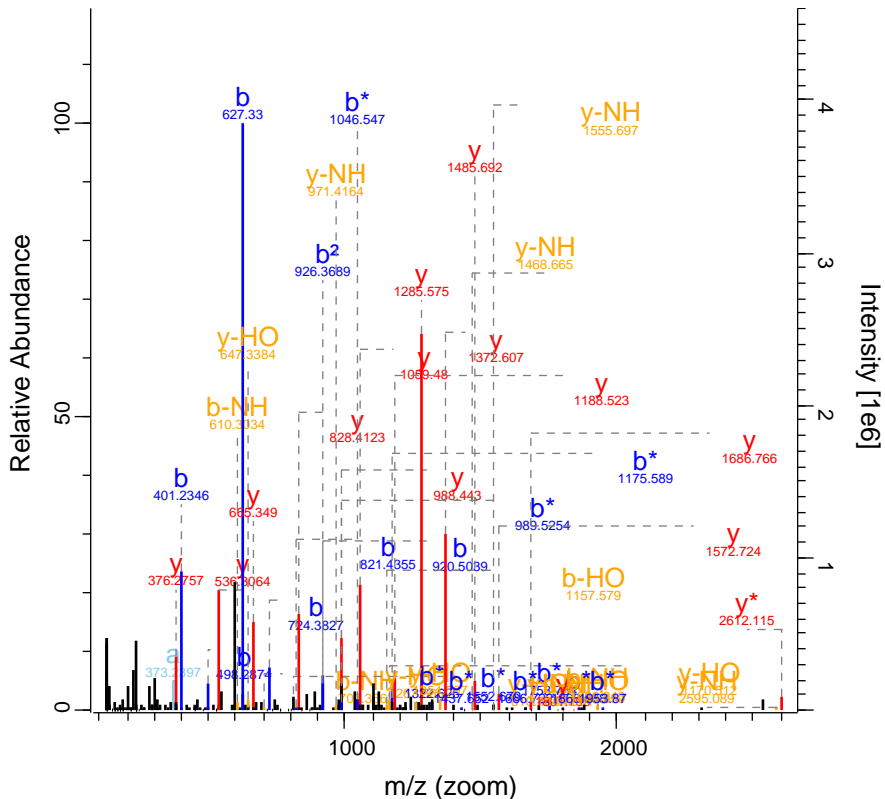

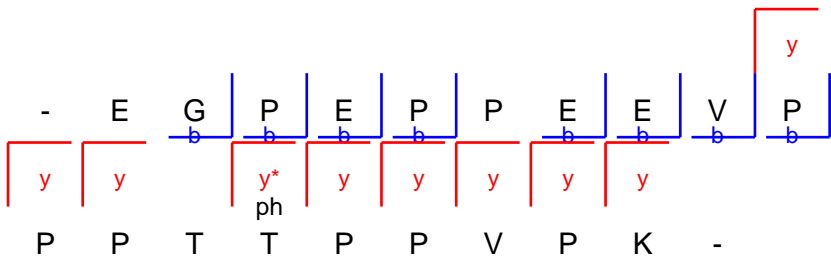
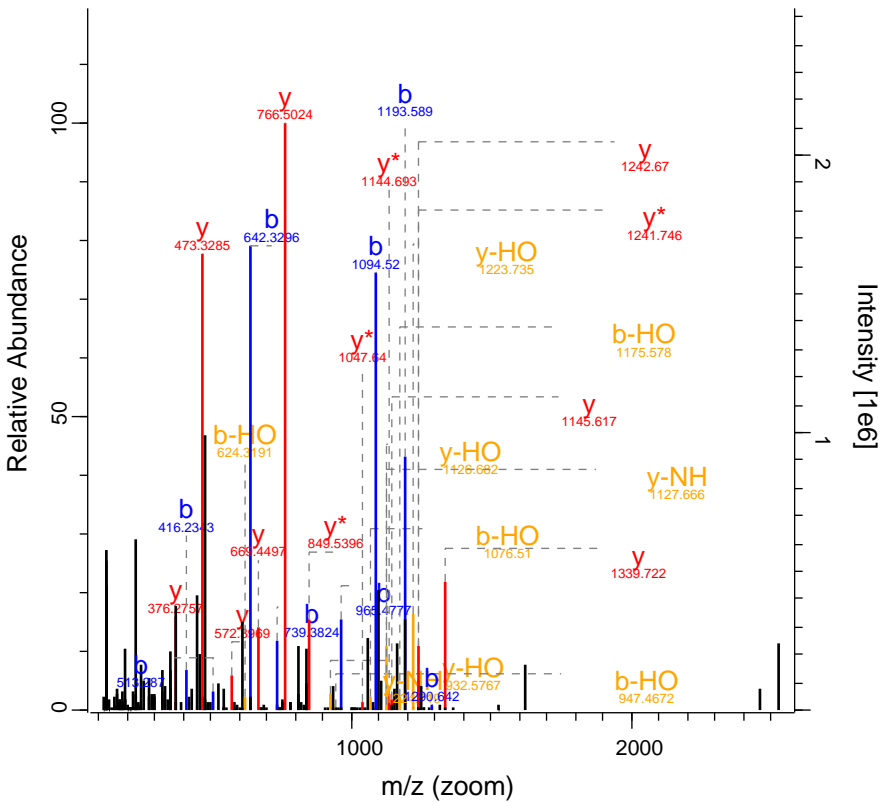

RO-QC-160121_ZackD_SS_Set_01_Fraction 22870 FTMS; HC 70.09 906.76 ANTXR1

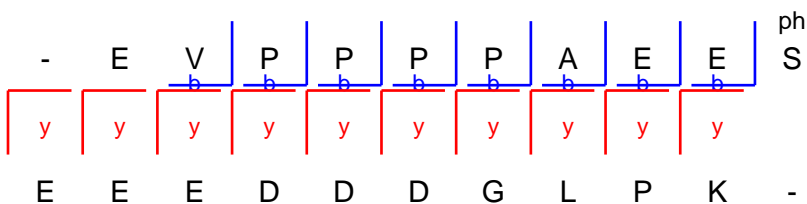
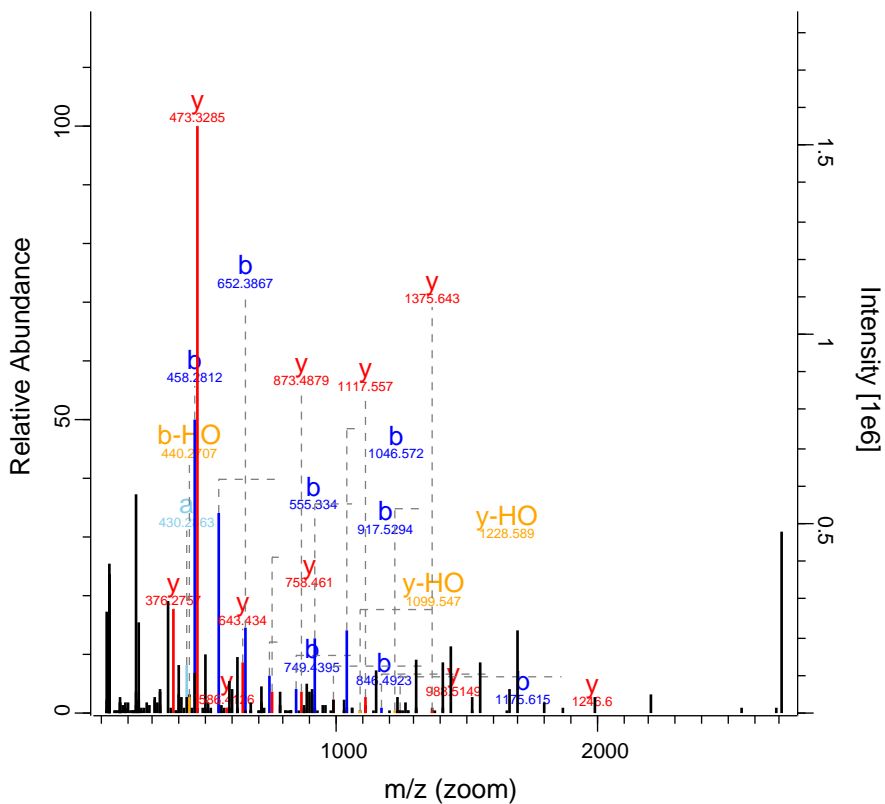

RO-QC-160121_ZackD_SS_Set_01_Fractic 23320 FTMS; HC 74.4 1022.03 CLIP1

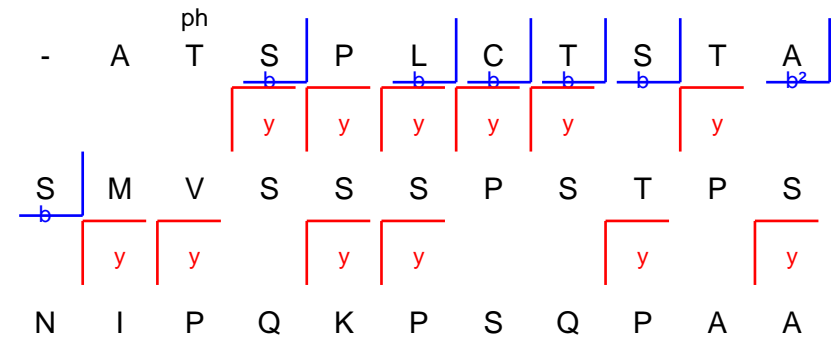
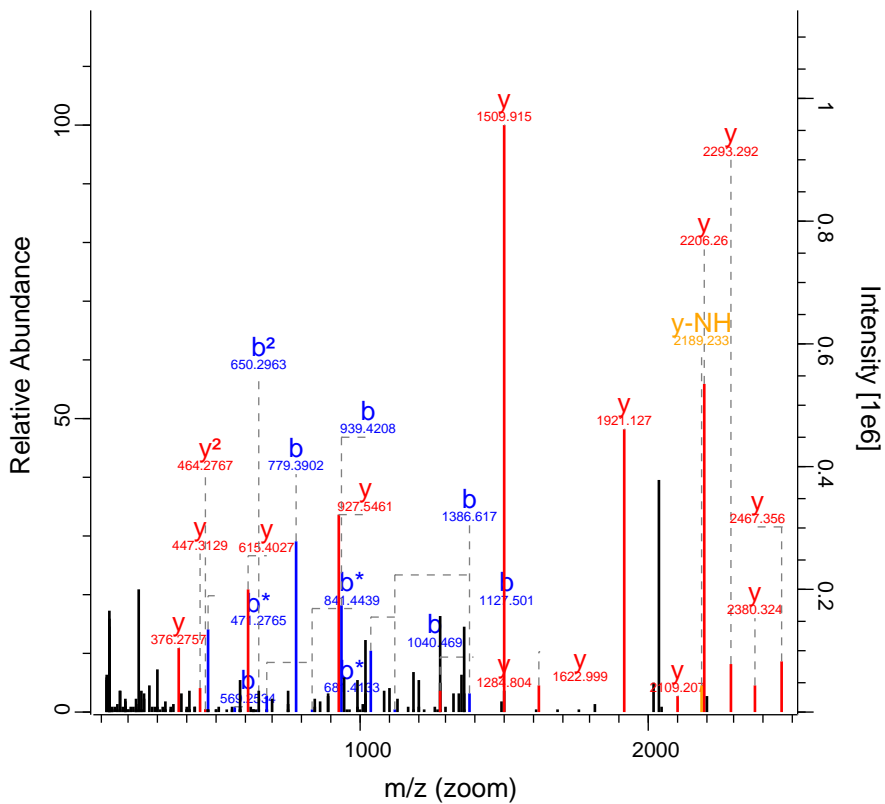

RO-QC-160121_ZackD_SS_Set_01_Fraction 25658 FTMS; HC 69.6 713.34 CNTRL

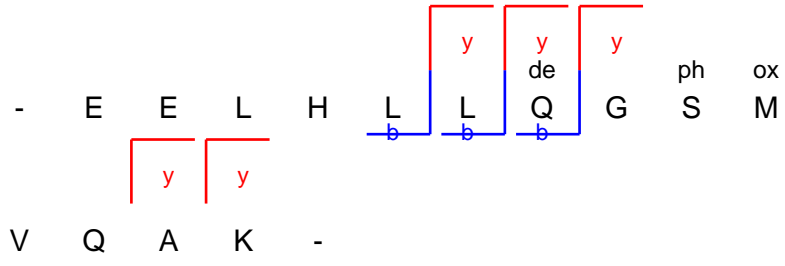
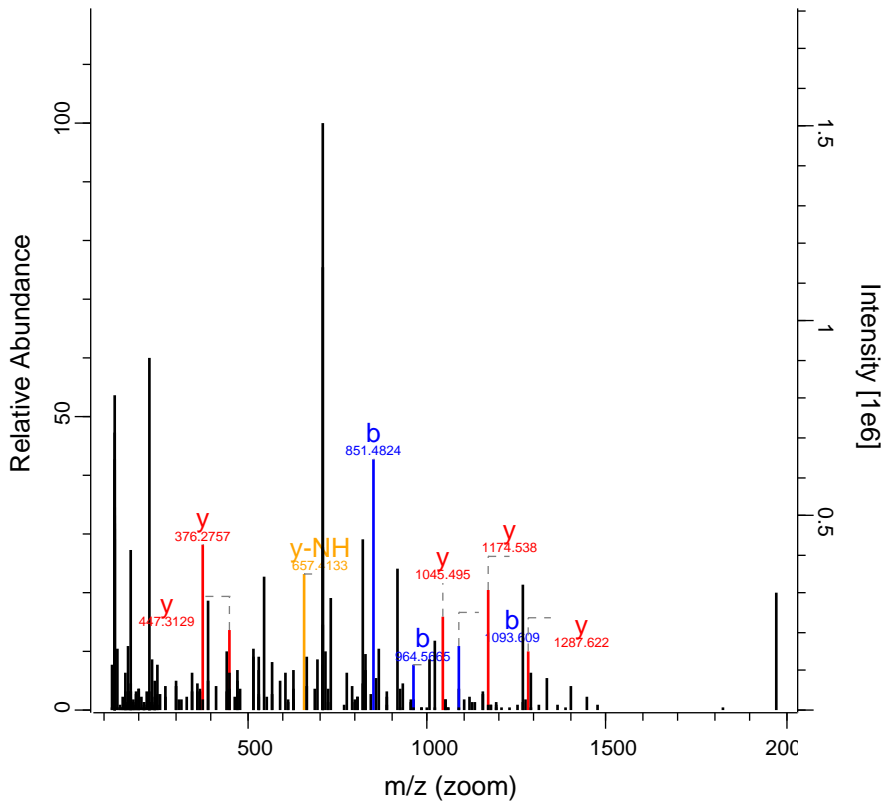

RO-QC-160121_ZackD_SS_Set_01_Fraction 27476 FTMS; HC 125.52 815.16 NOP56

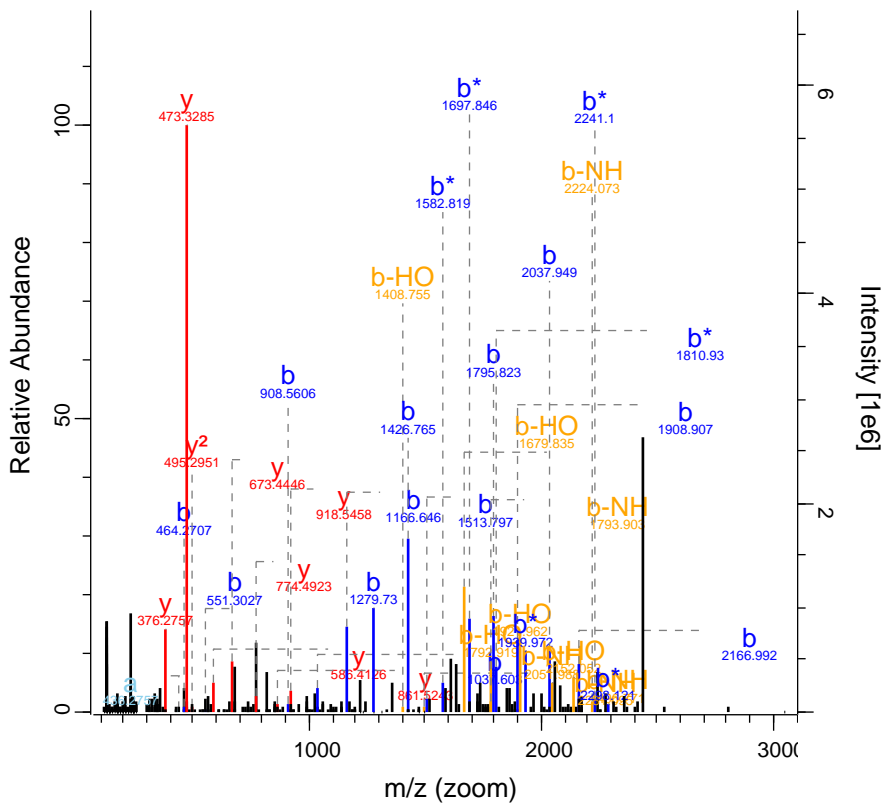

RO-QC-160121_ZackD_SS_Set_01_Fraction 27800 FTMS; HC 96.02 986.49 CCNYL1

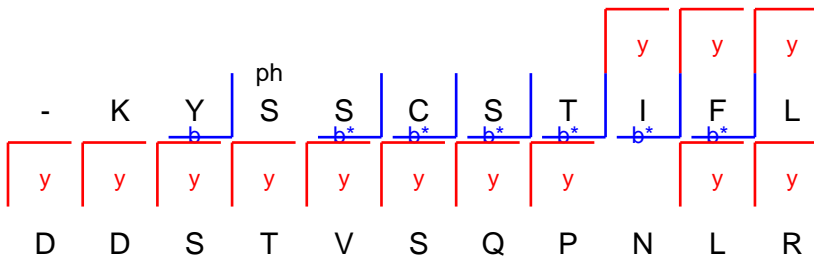
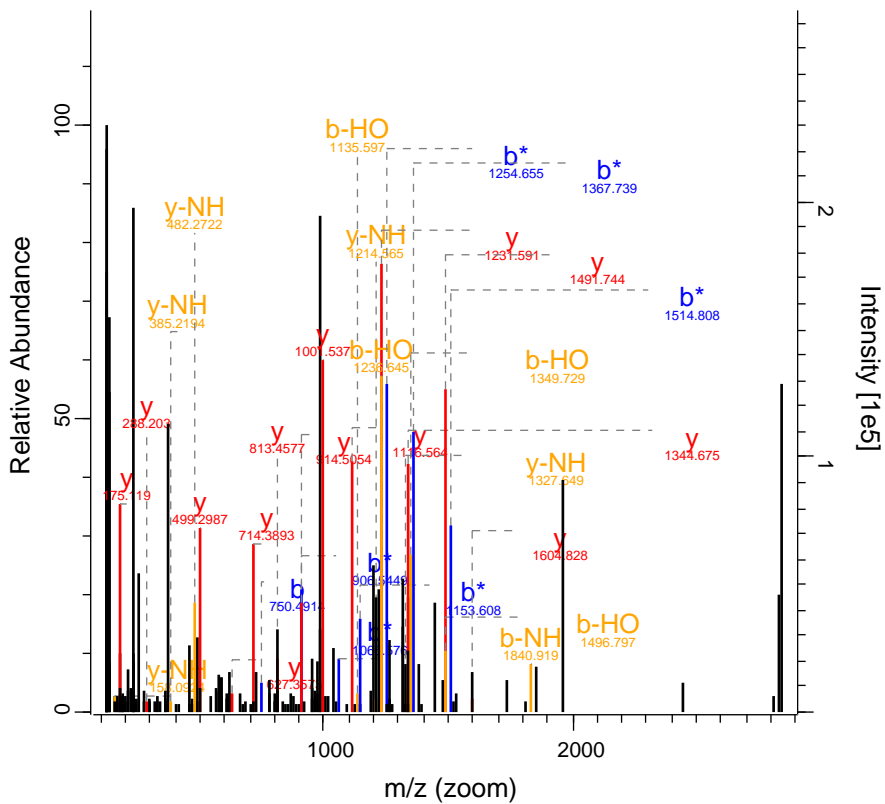

RO-QC-160121_ZackD_SS_Set_01_Fraction 28159 FTMS; HC 93.16 882.41 SRSF9

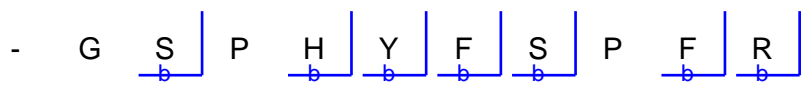
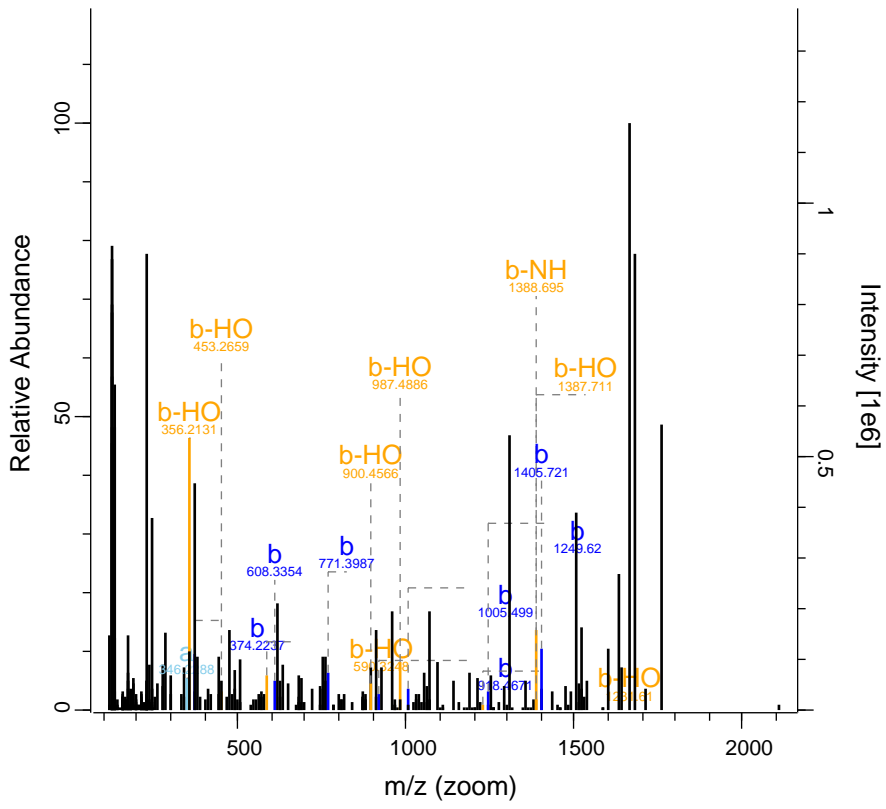

ph
 P Y -

RO-QC-160121_ZackD_SS_Set_01_Fraction 28375 FTMS; HC 90.32 836.41 RAB11FIP1

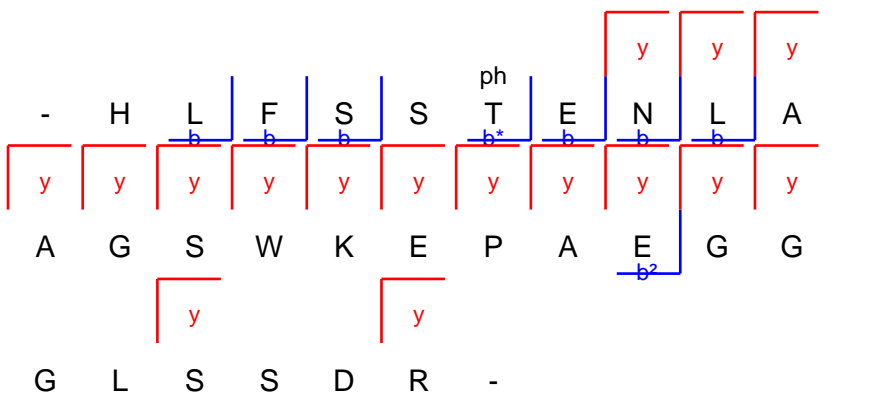
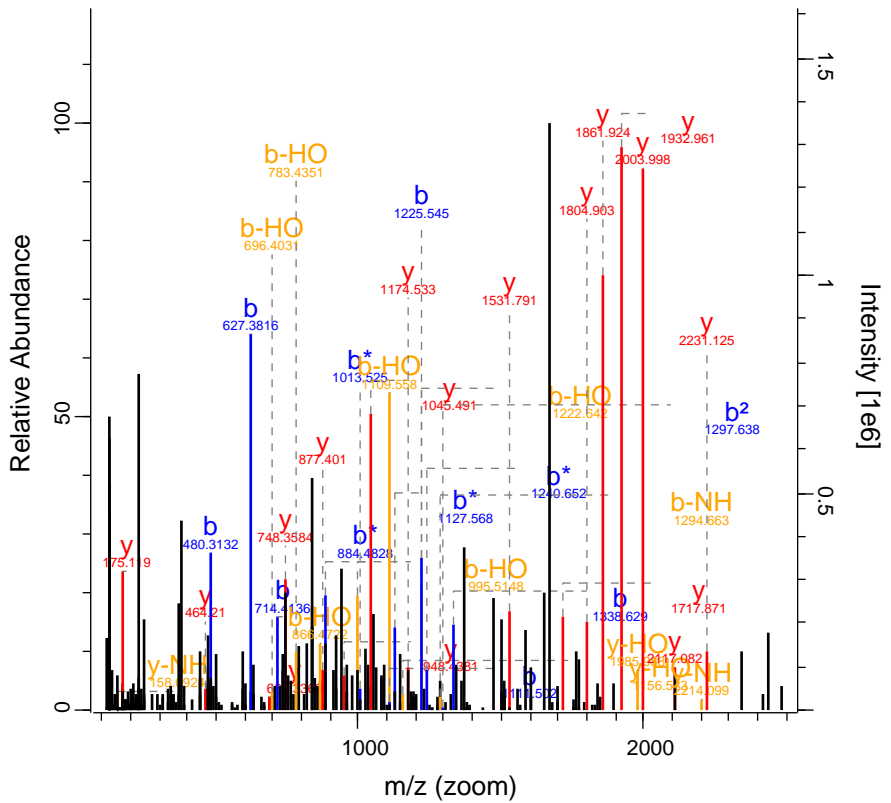

RO-QC-160121_ZackD_SS_Set_01_Fraction 29143 FTMS; HCl 61.96 907 GOLGA4

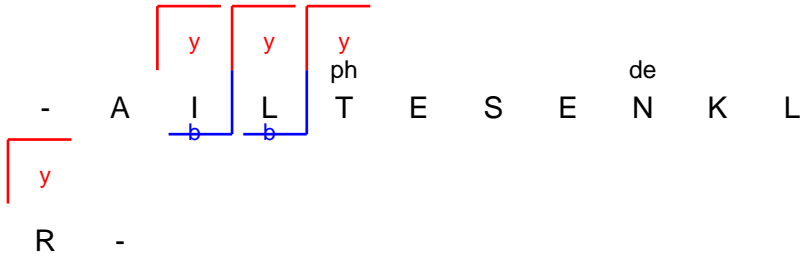
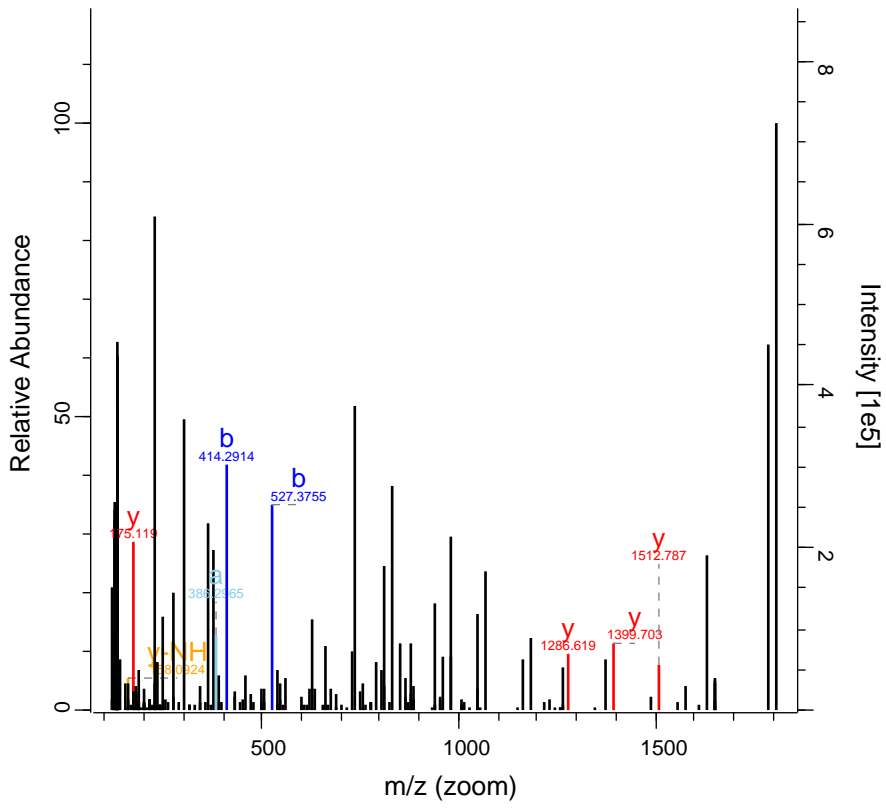

RO-QC-160121_ZackD_SS_Set_01_Fractio 29747 FTMS; HC 350.23 948.98 AQP1

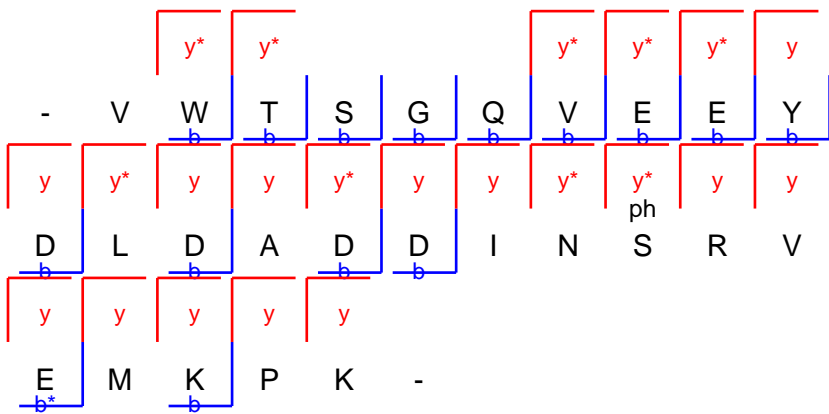
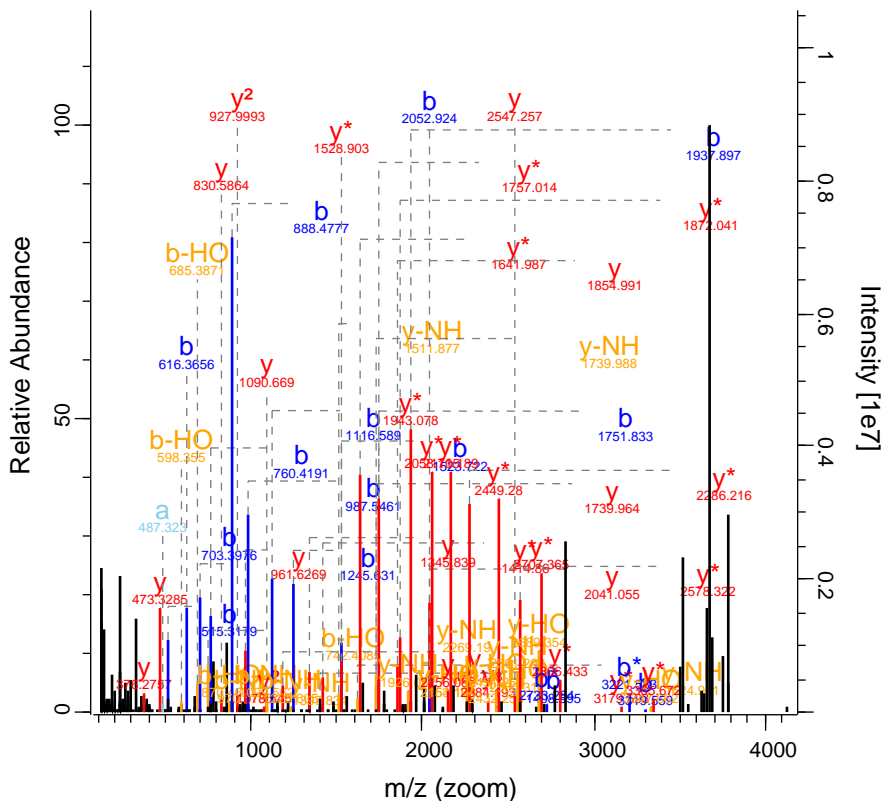

RO-QC-160121_ZackD_SS_Set_01_Fractic 29958 FTMS; HC 71.68 1017.14 GJA1

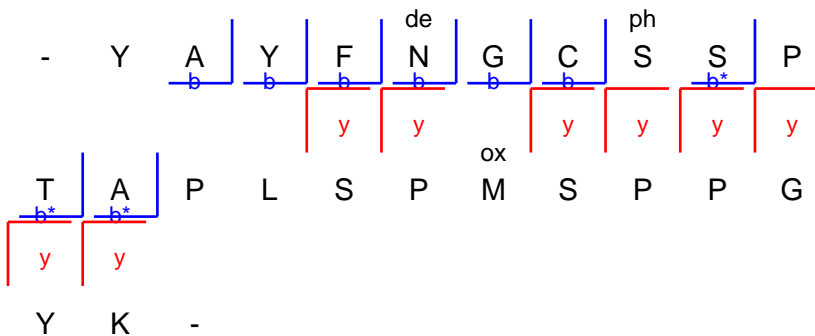
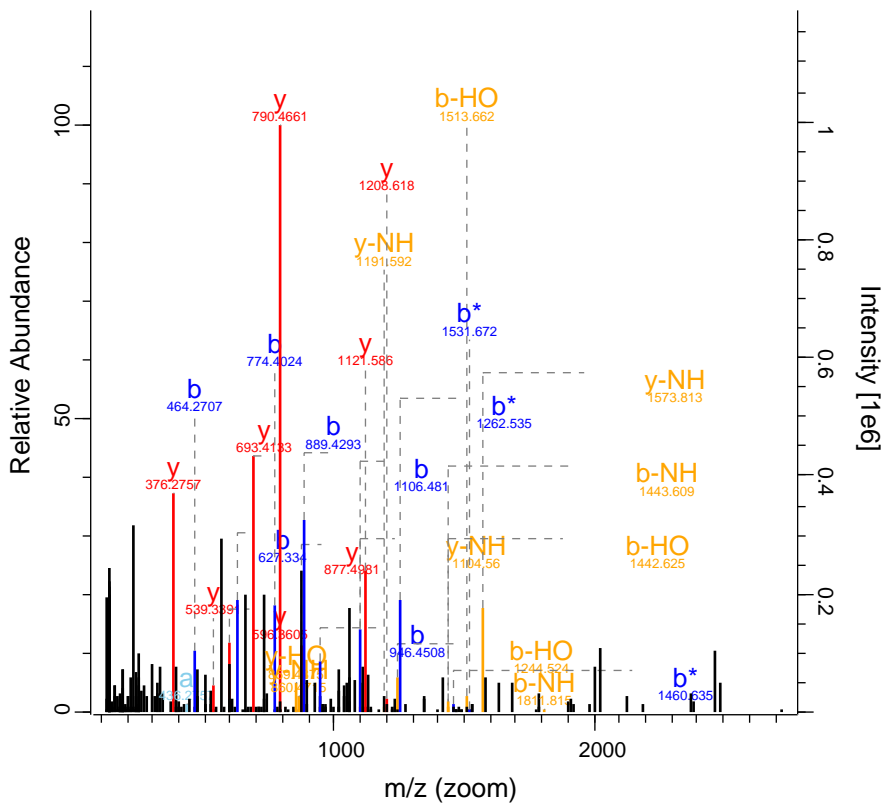

RO-QC-160121_ZackD_SS_Set_01_Fraccio 30836 FTMS; HC 140.89 1349.6 MPHOSPH8

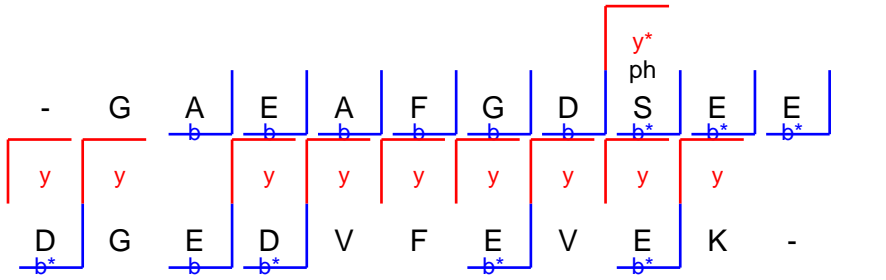
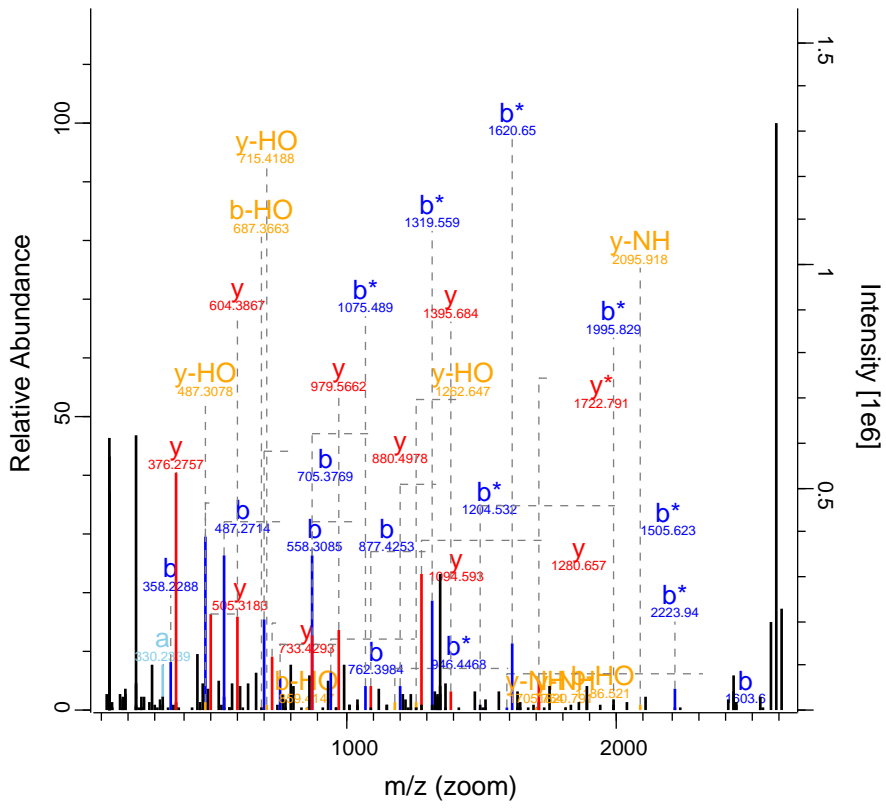

RO-QC-160121_ZackD_SS_Set_01_Fractic 31848 FTMS; HC 40.35 1196.56 SPNS1

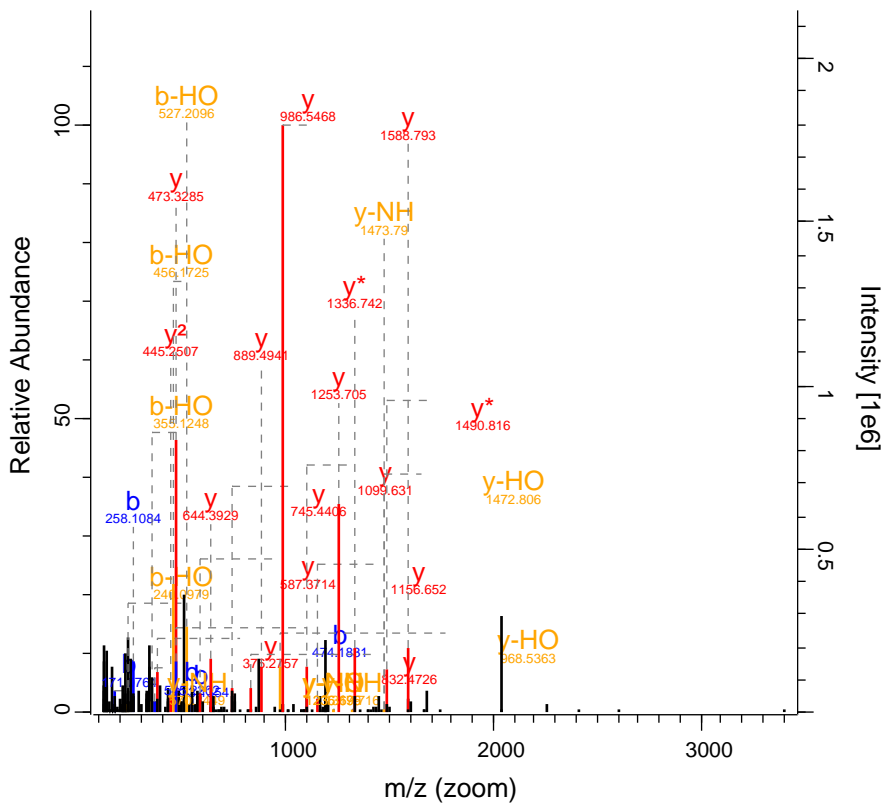

ac

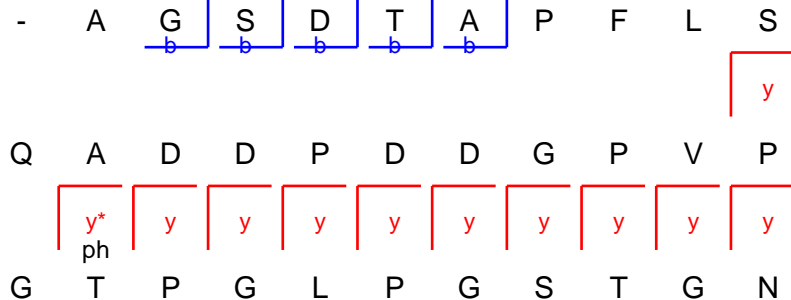

RO-QC-160121_ZackD_SS_Set_01_Fraction 31877 FTMS; HC 42.45 772.39 TOMM22

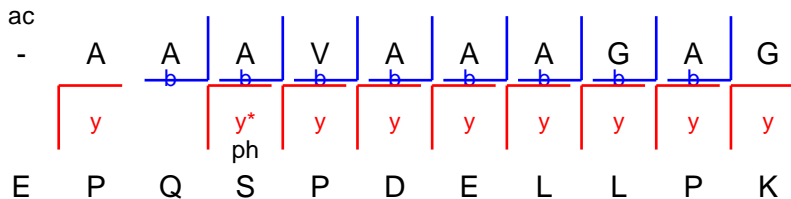
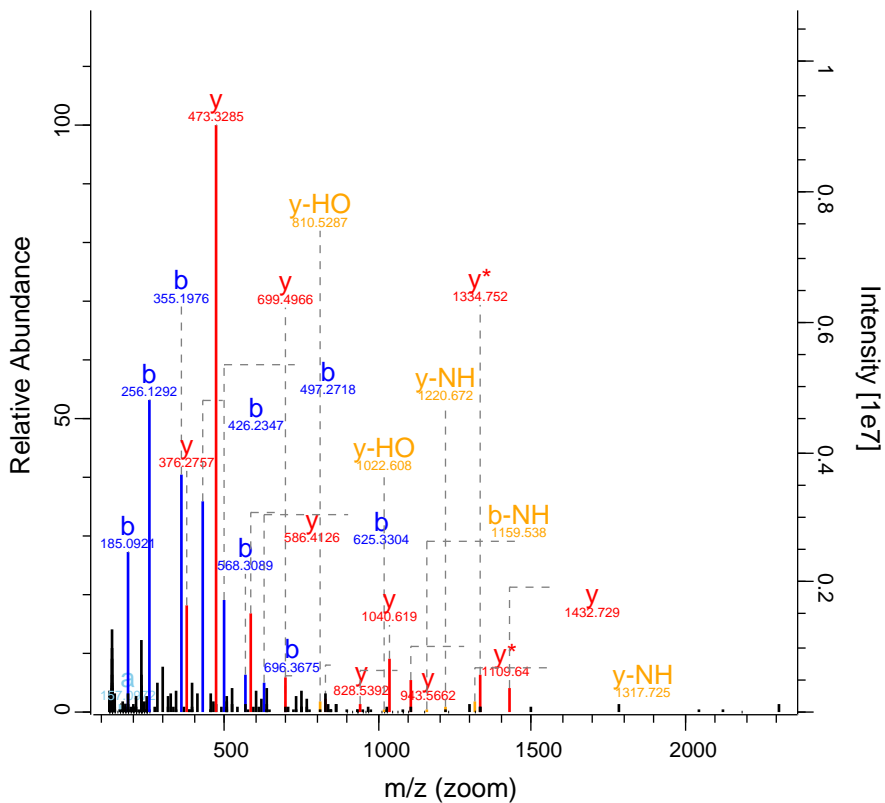

RO-QC-160121_ZackD_SS_Set_01_Fraction 32904 FTMS; HC 54.05 946.73 LIMD1

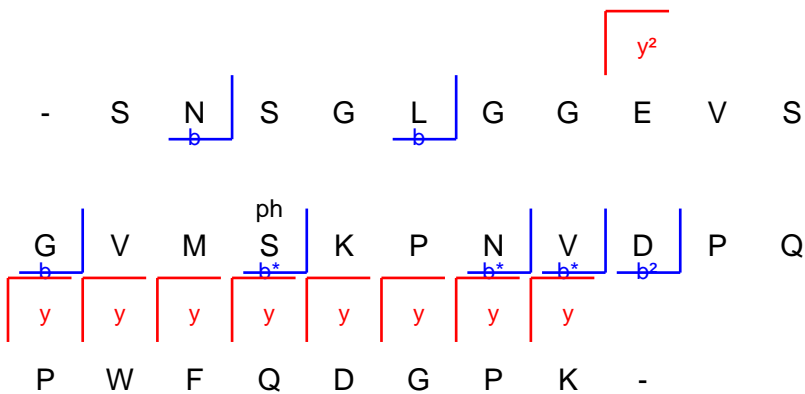
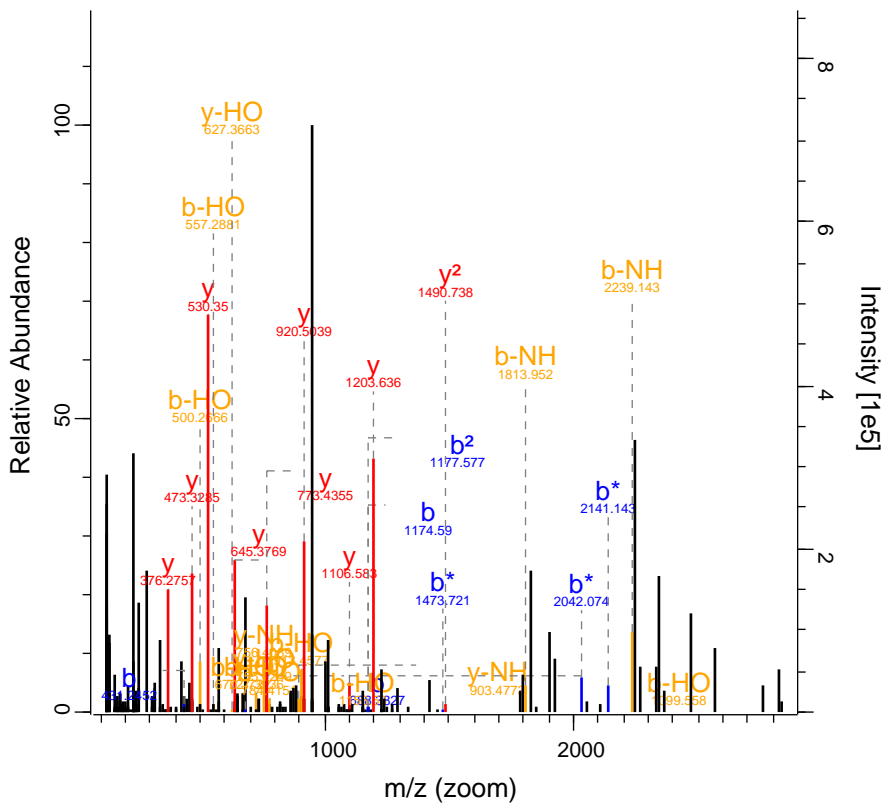

RO-QC-160121_ZackD_SS_Set_01_Fractic 34307 FTMS; HC 66.43 1016.59 RPSA

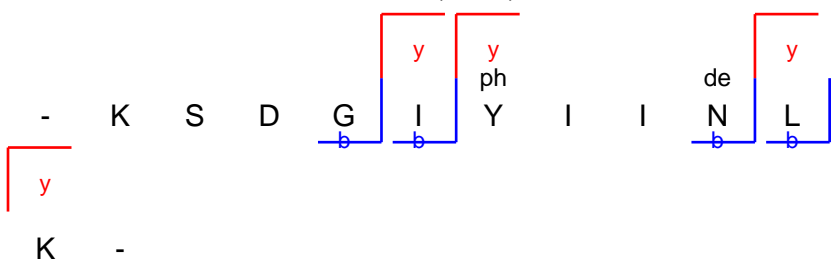
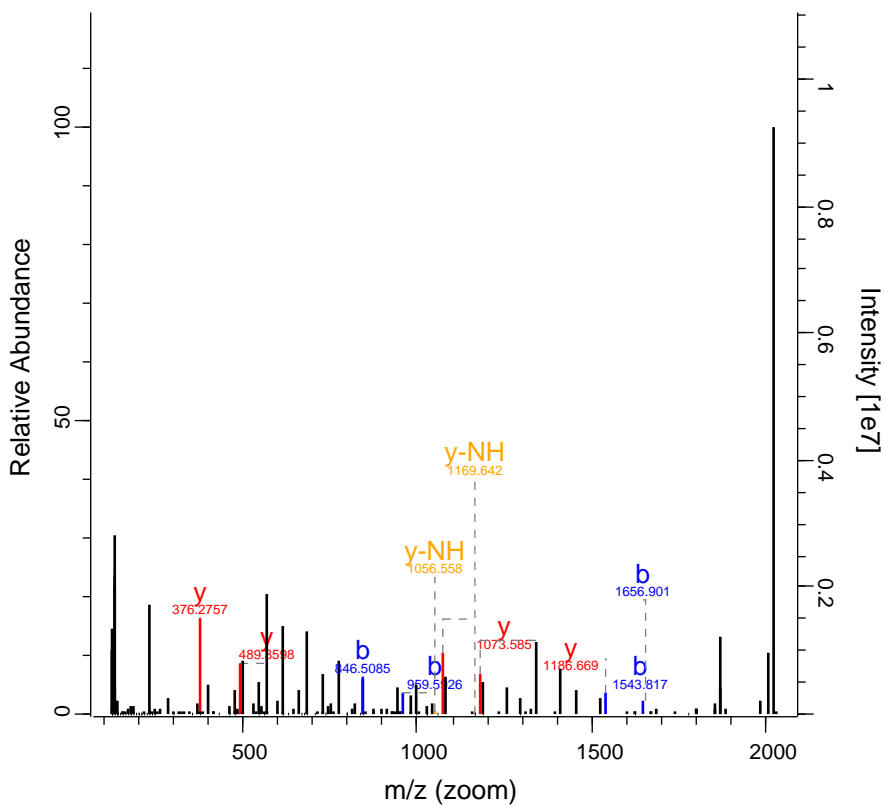

RO-QC-160121_ZackD_SS_Set_01_Fractic 34374 FTMS; HC 57.84 1290.13 ZZEF1

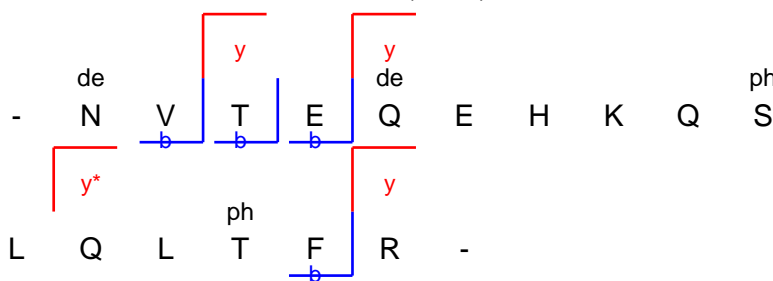
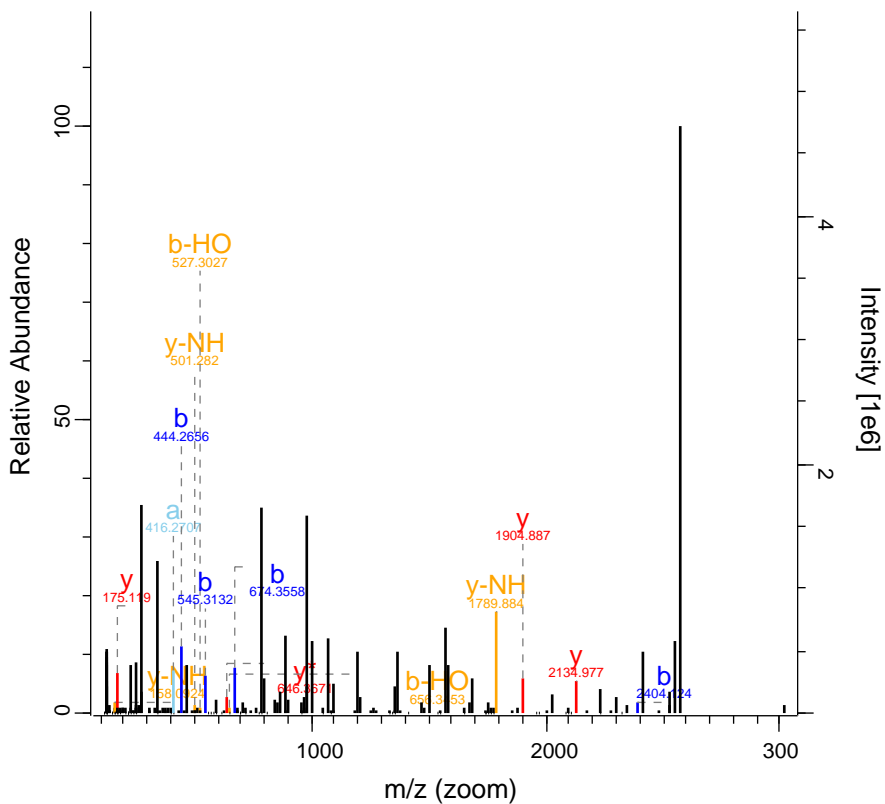

RO-QC-160121_ZackD_SS_Set_01_Fractic 34467 FTMS; HC 75.23 1002.22 EIF3G

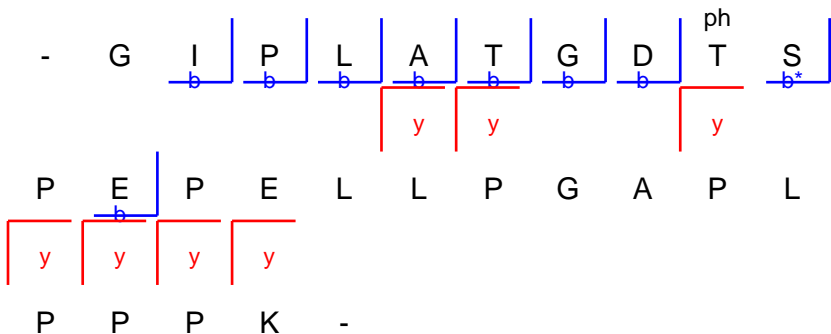
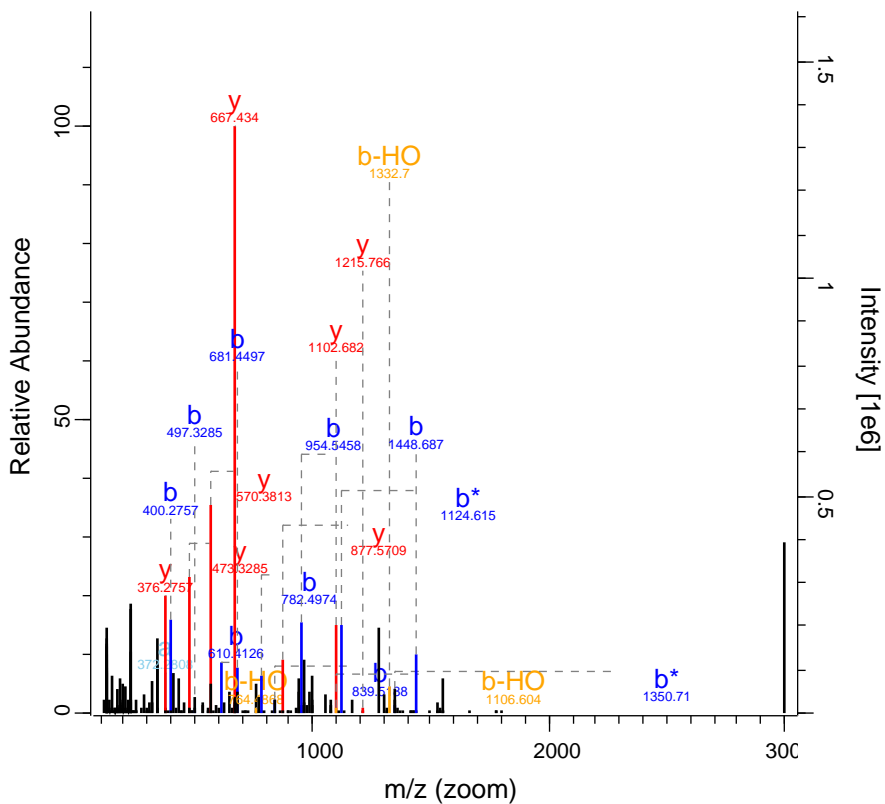

RO-QC-160121_ZackD_SS_Set_01_Fractic 35559 FTMS; HC 104.44 1126.91 NOTCH2

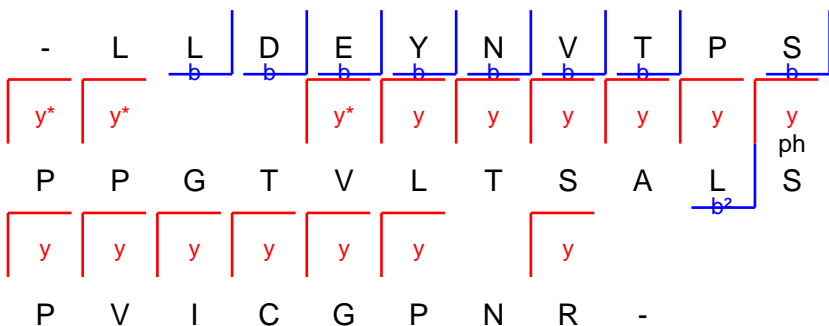
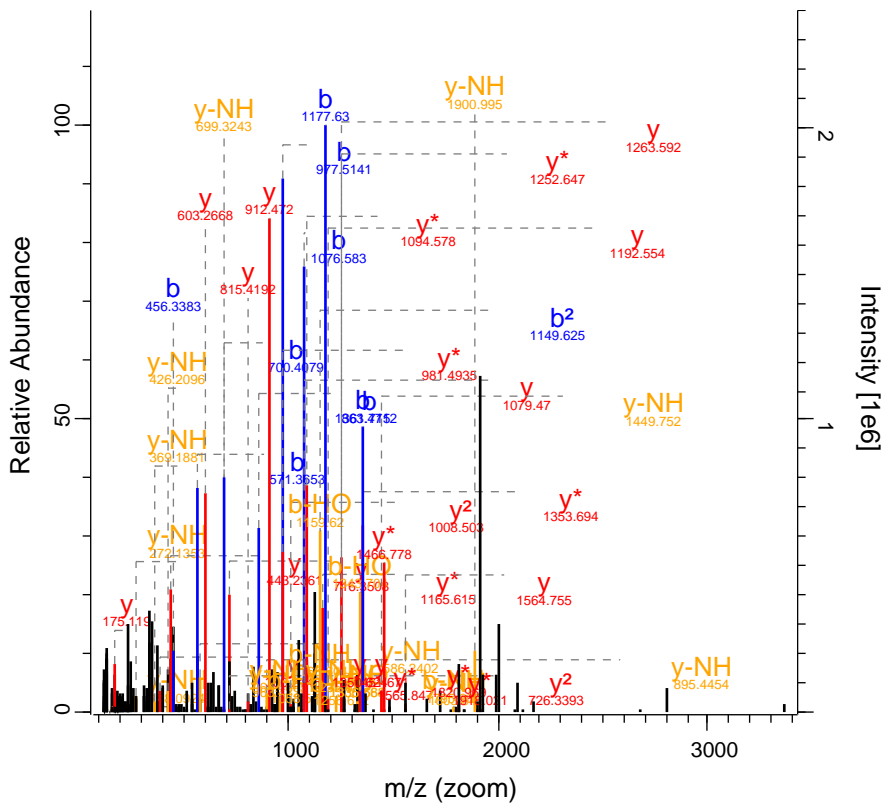

RO-QC-160121_ZackD_SS_Set_01_Fr 35783 FTMS; H1 256.79 1315.34 MYL12B;MYL12A;M

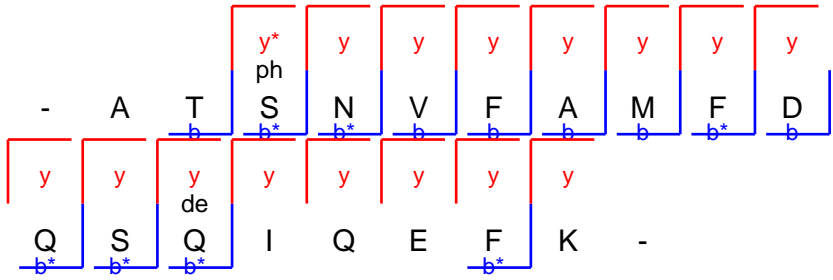
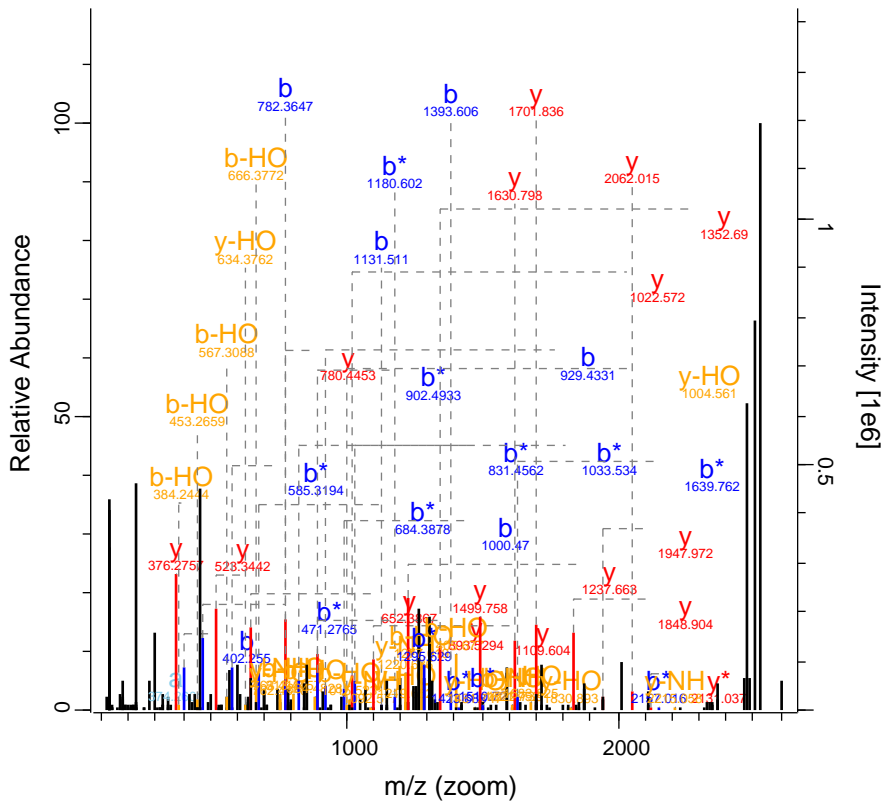

RO-QC-160121_ZackD_SS_Set_01_Fraction 4858 FTMS; HCl 42.56 444.06 RBM17

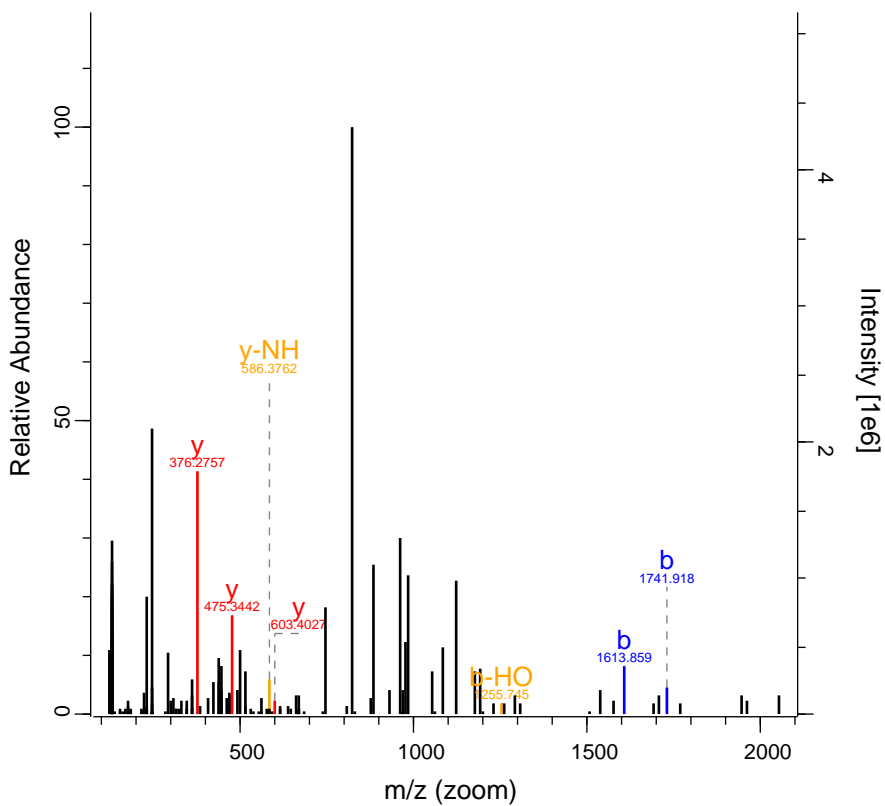

V K -

RO-QC-160121_ZackD_SS_Set_01_Fraction_6347 FTMS; HCl 108.96 668 SHROOM2

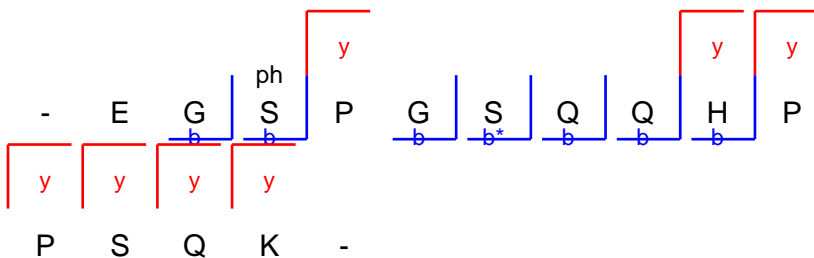
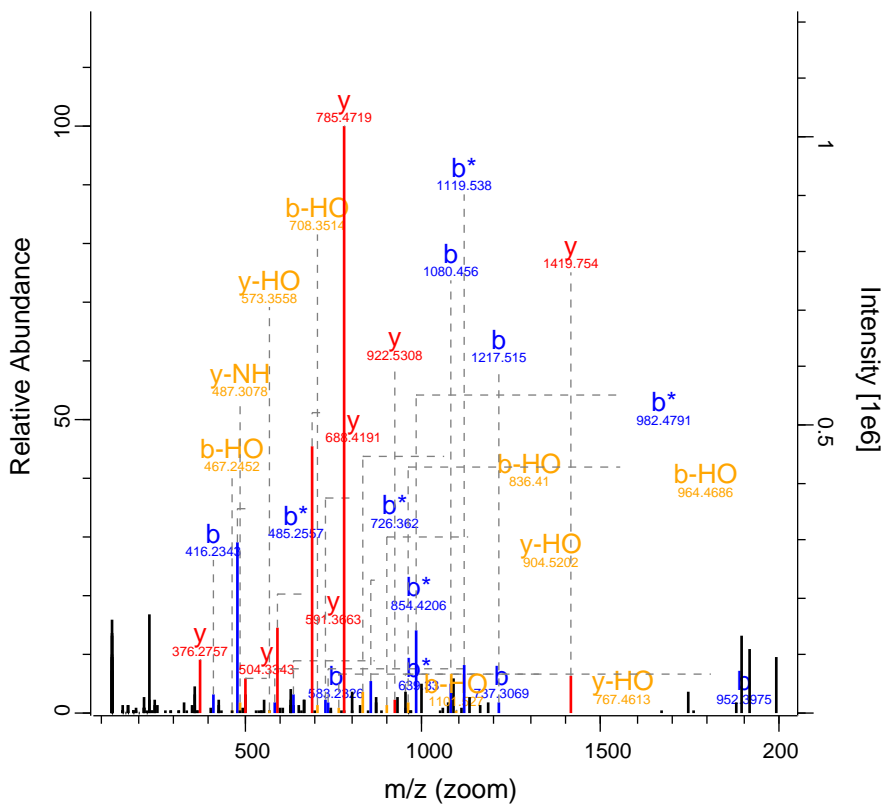

RO-QC-160121_ZackD_SS_Set_01_Fractio 7560 FTMS; HC 159.81 1110.02 EIF4B

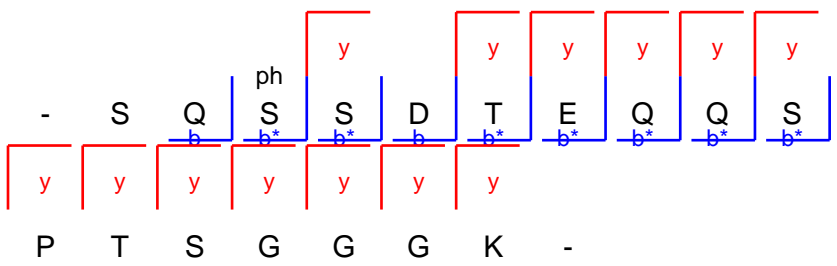
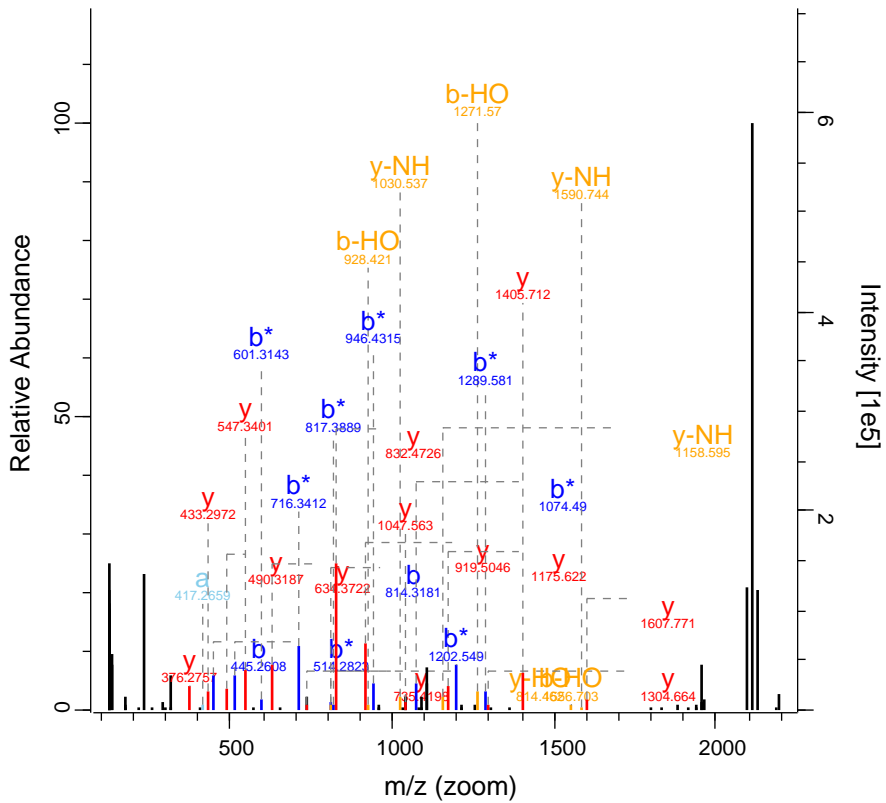

P T S G G G K -

RO-QC-160121_ZackD_SS_Set_01_Fraction 8215 FTMS; HC 160.38 942.03 ARHGAP1

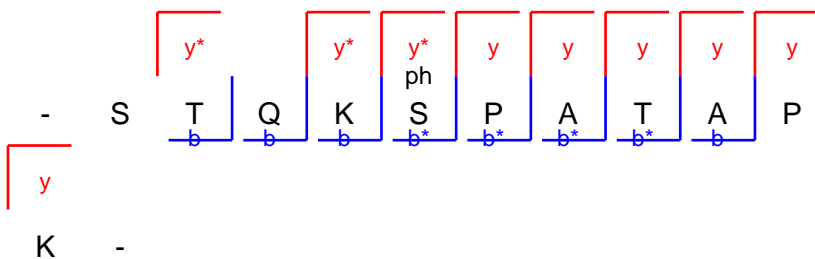
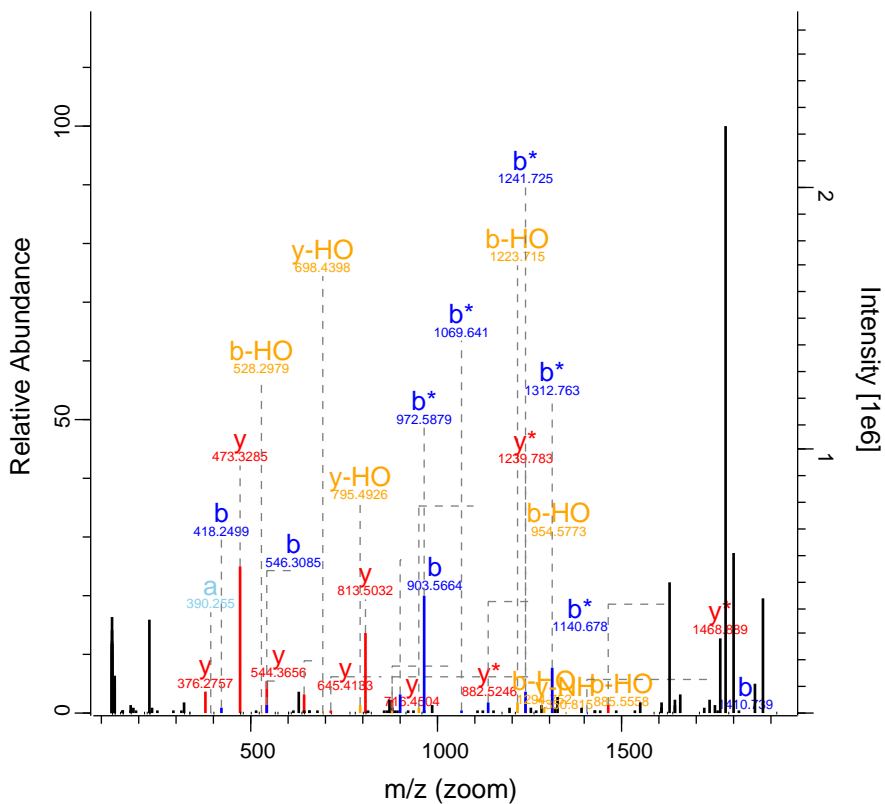

RO-QC-160121_ZackD_SS_Set_01_Fraction 8801 FTMS; HC 122.46 735.35 PLEC

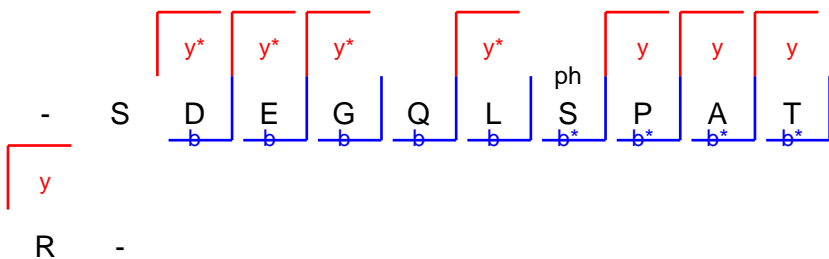
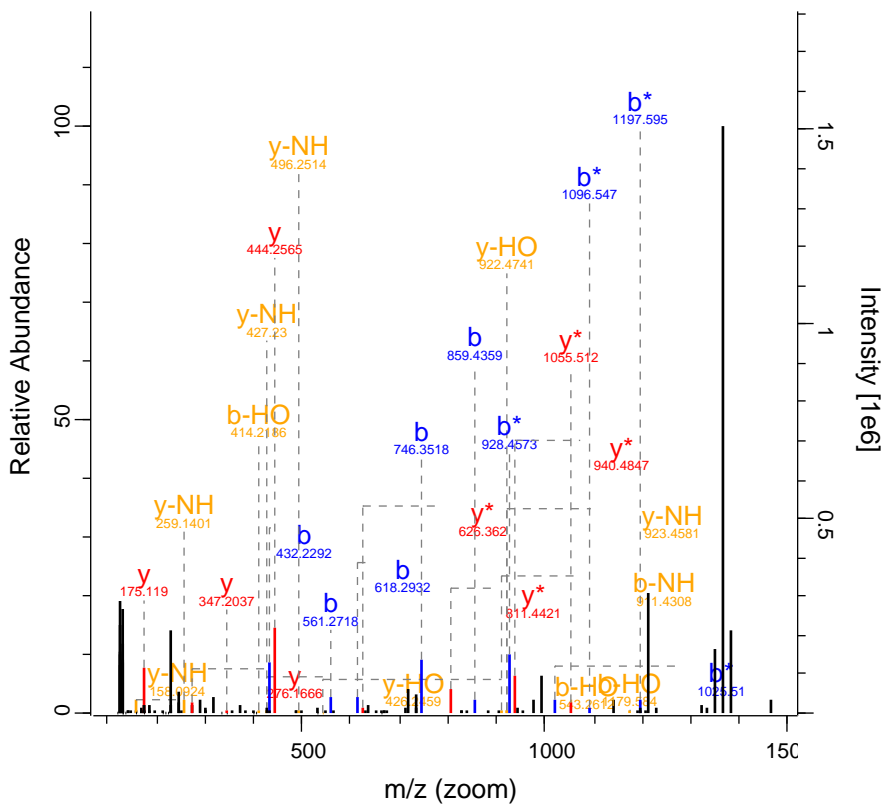

RO-QC-160121_ZackD_SS_Set_01_Fraction 9140 FTMS; HCl 98.3 720.08 VPS4A

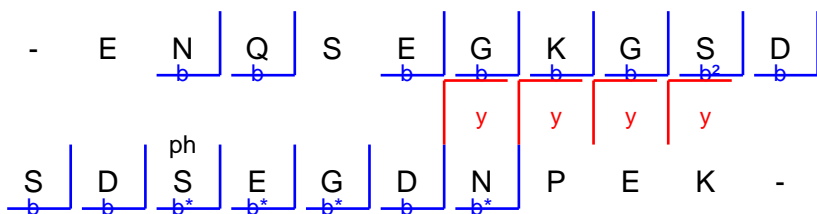
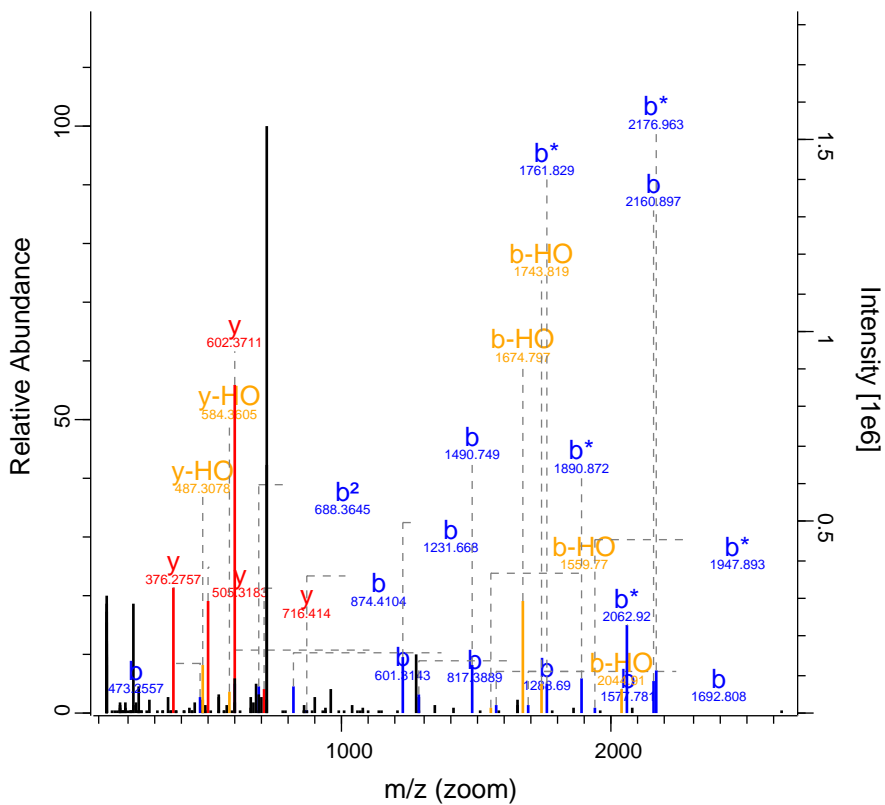

RO-QC-160121_ZackD_SS_Set_01_Fractio 10514 FTMS; HC 184.44 792.41 BCLAF1

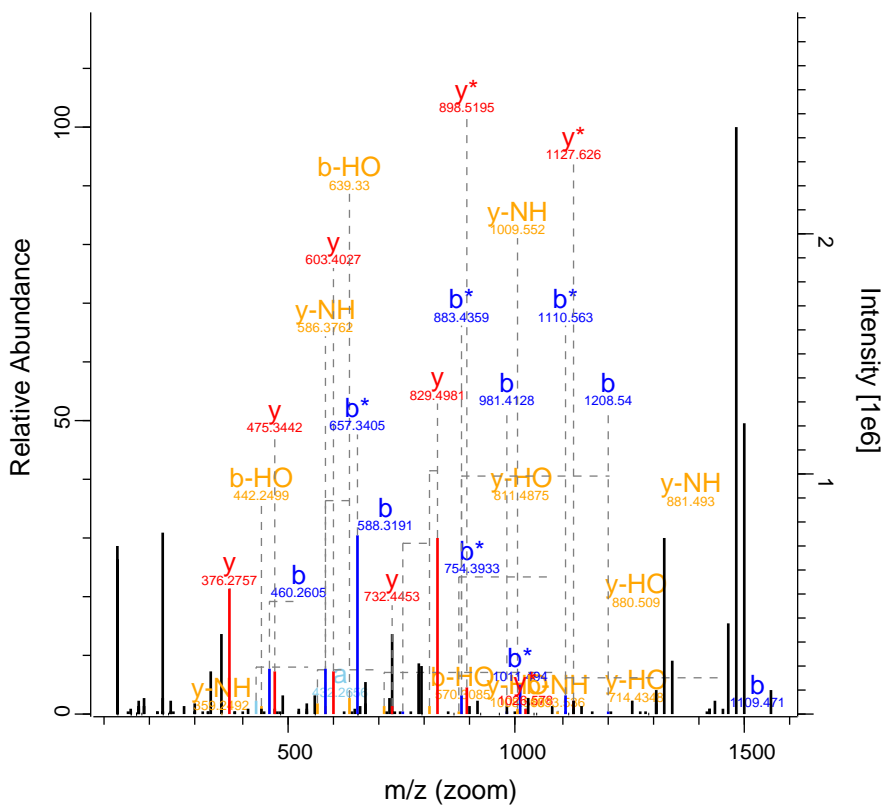

m/z (zoom)

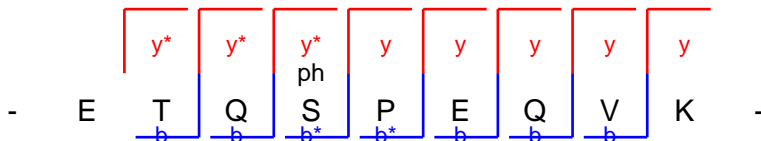

RO-QC-160121_ZackD_SS_Set_01_Fraction 11456 FTMS; HC 52.55 460.02 PFKFB3

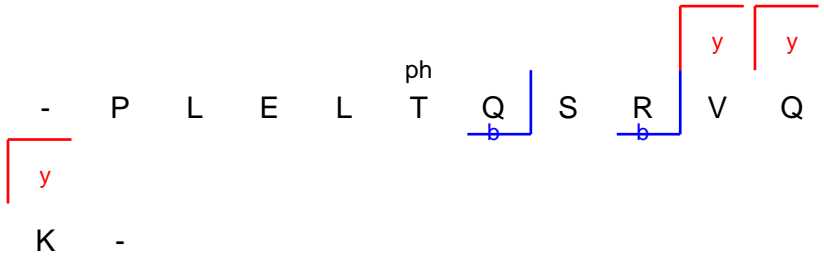
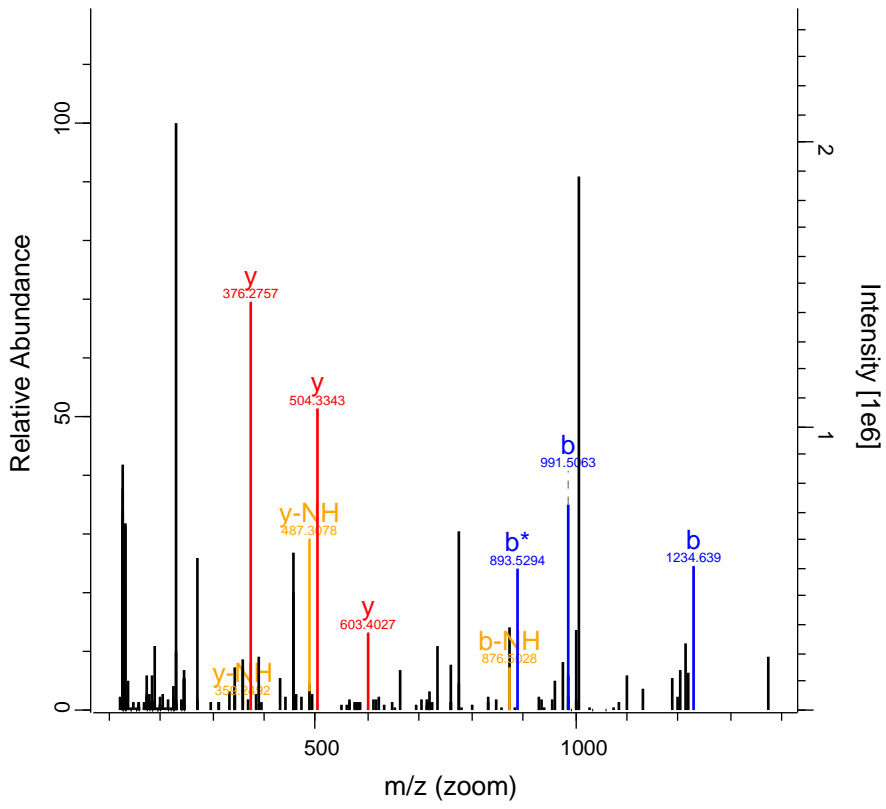

K -

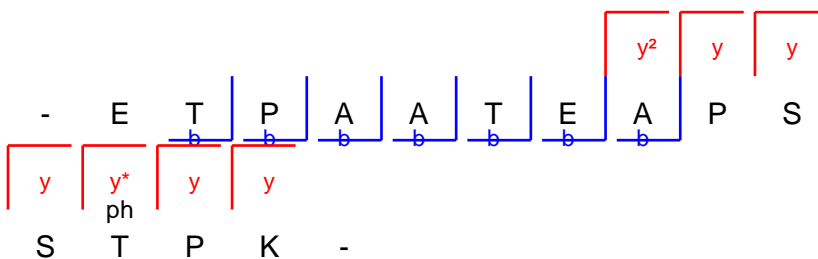
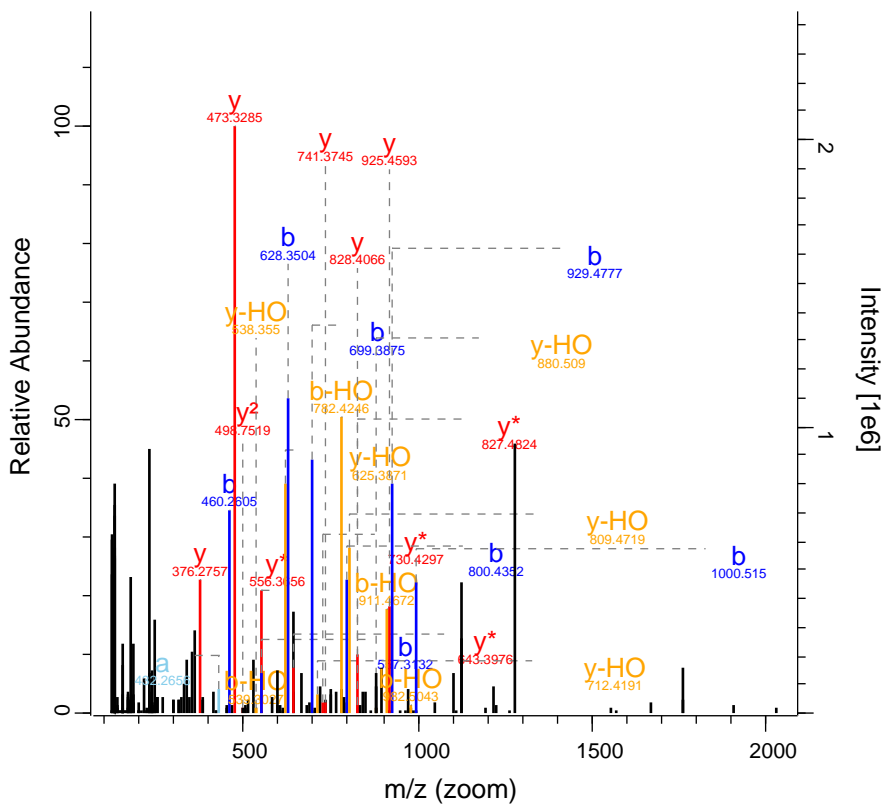

RO-QC-160121_ZackD_SS_Set_01_Fraction 12071 FTMS; HC 47.08 943.51 CDCA3

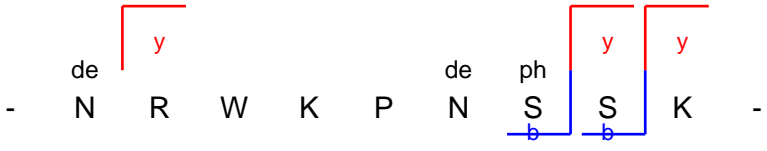
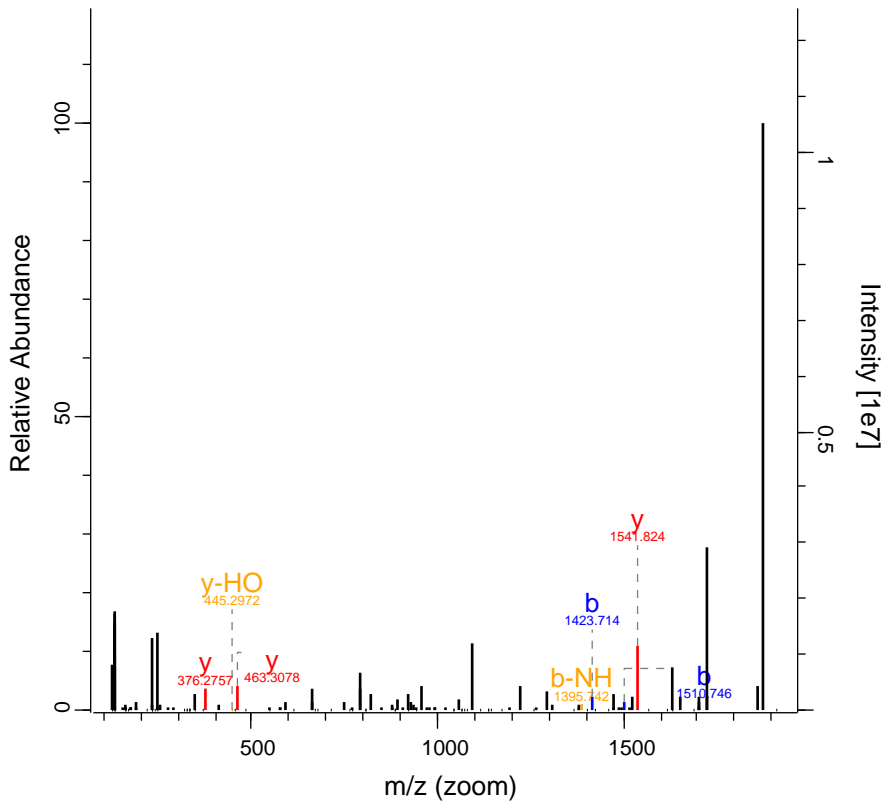

RO-QC-160121_ZackD_SS_Set_01_Fractio 13018 FTMS; HC 217.22 854.39 CBX3

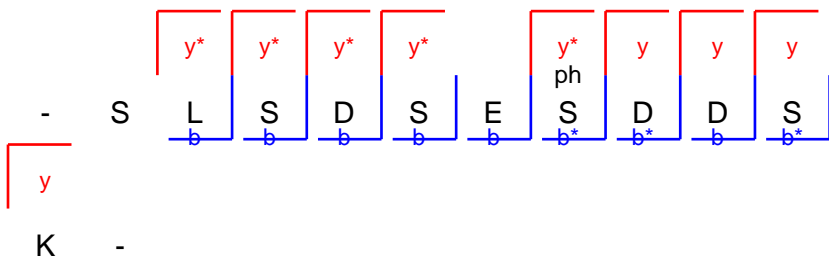
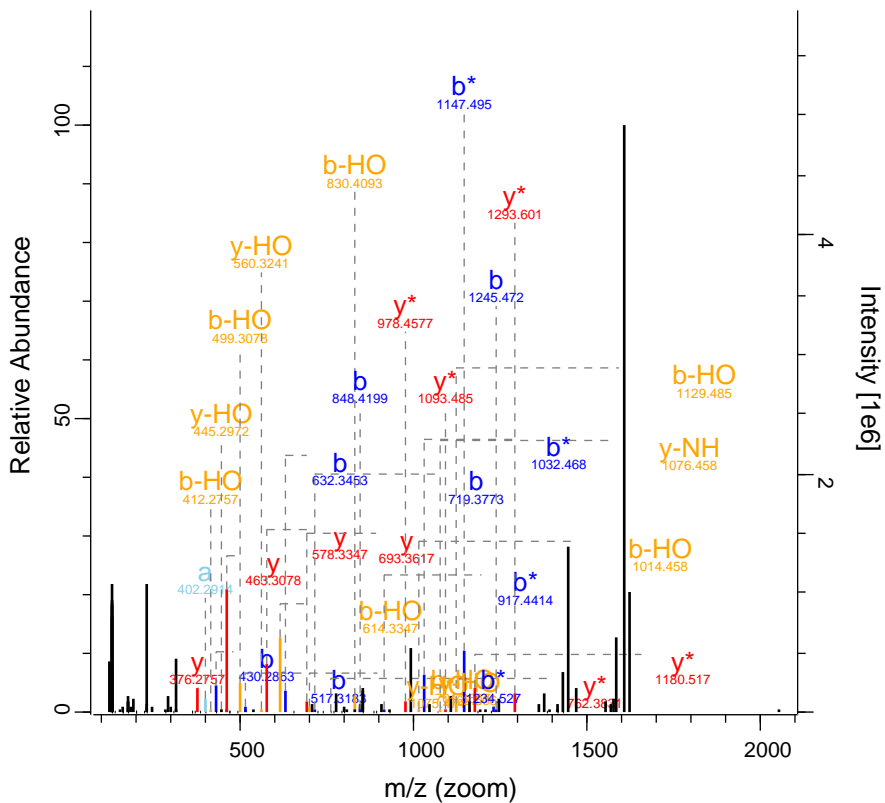

RO-QC-160121_ZackD_SS_Set_01_Fraction1 13177 FTMS; HCl 122.3 882.1 HMGN3

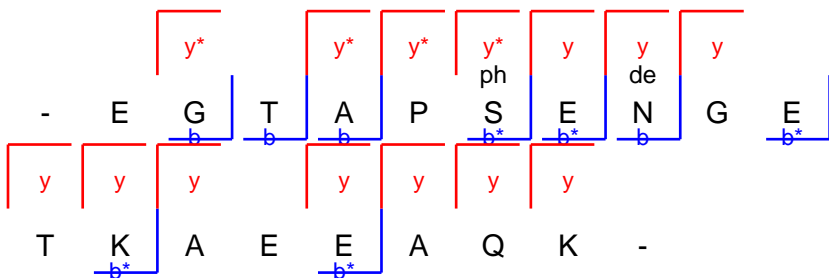
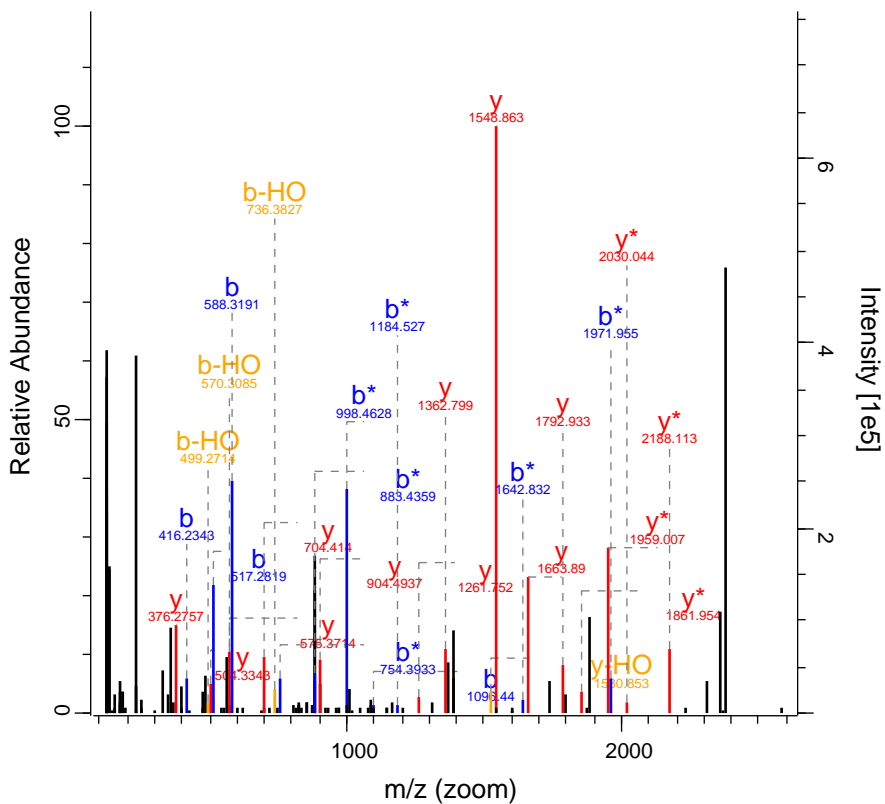

RO-QC-160121_ZackD_SS_Set_01_Fraction 14341 FTMS; HC 96.1 964.05 GAS2

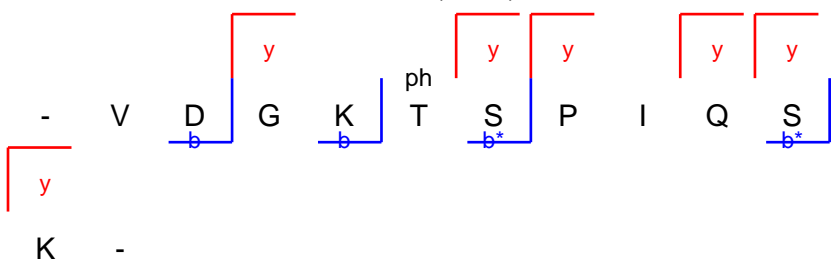
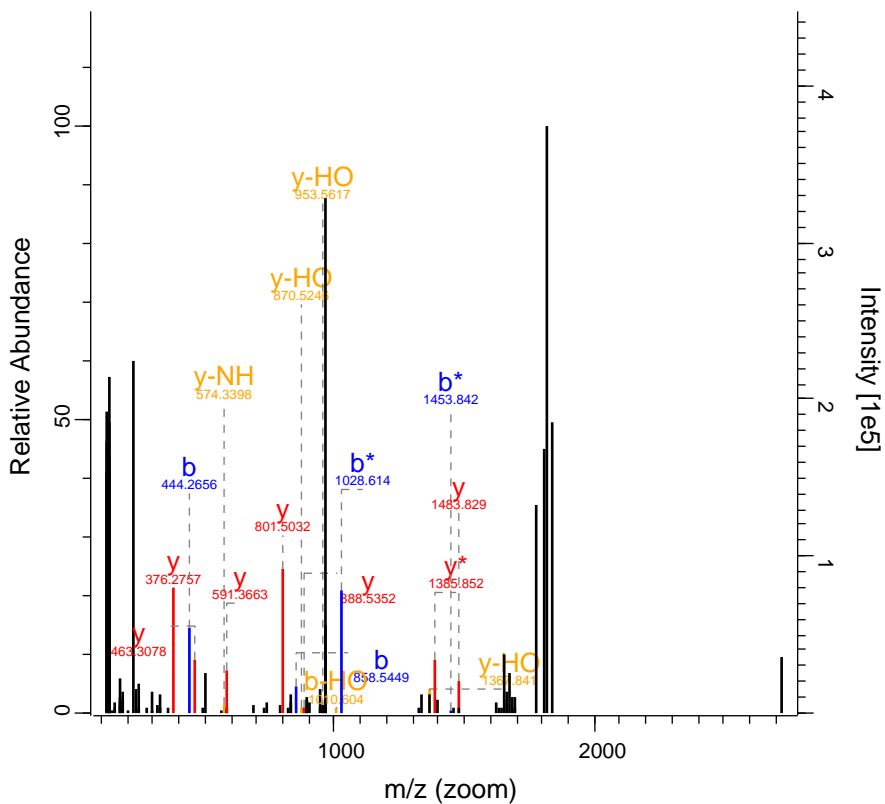

RO-QC-160121_ZackD_SS_Set_01_Fractio 14583 FTMS; HC 210.79 905.43 HTATSF1

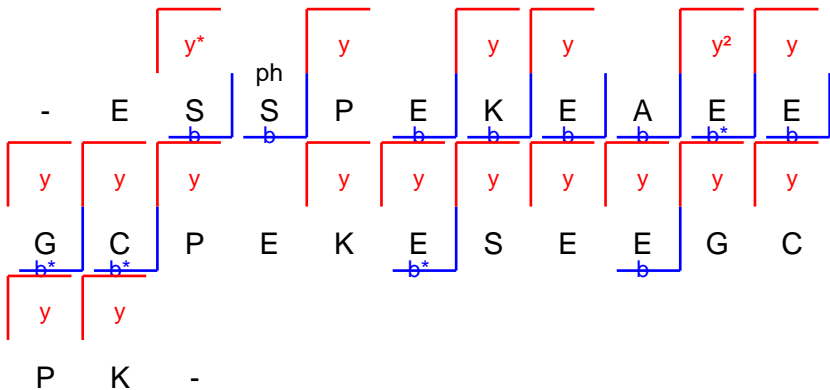
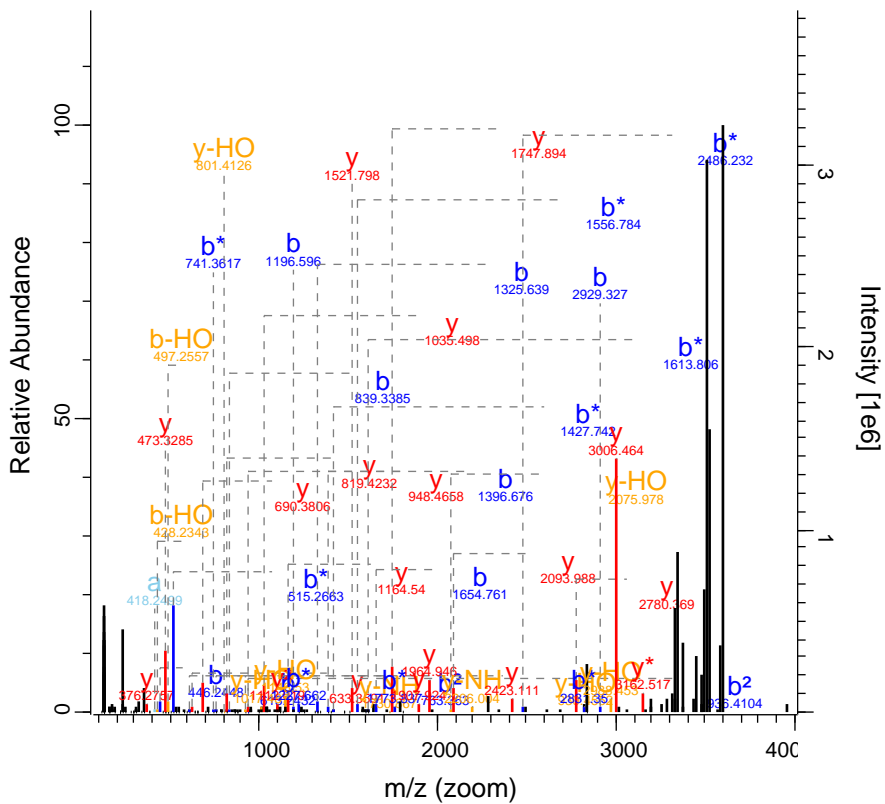

RO-QC-160121_ZackD_SS_Set_01_Fractio 14952 FTMS; HC 138.76 663.34 THRAP3

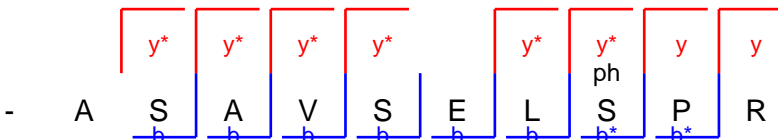
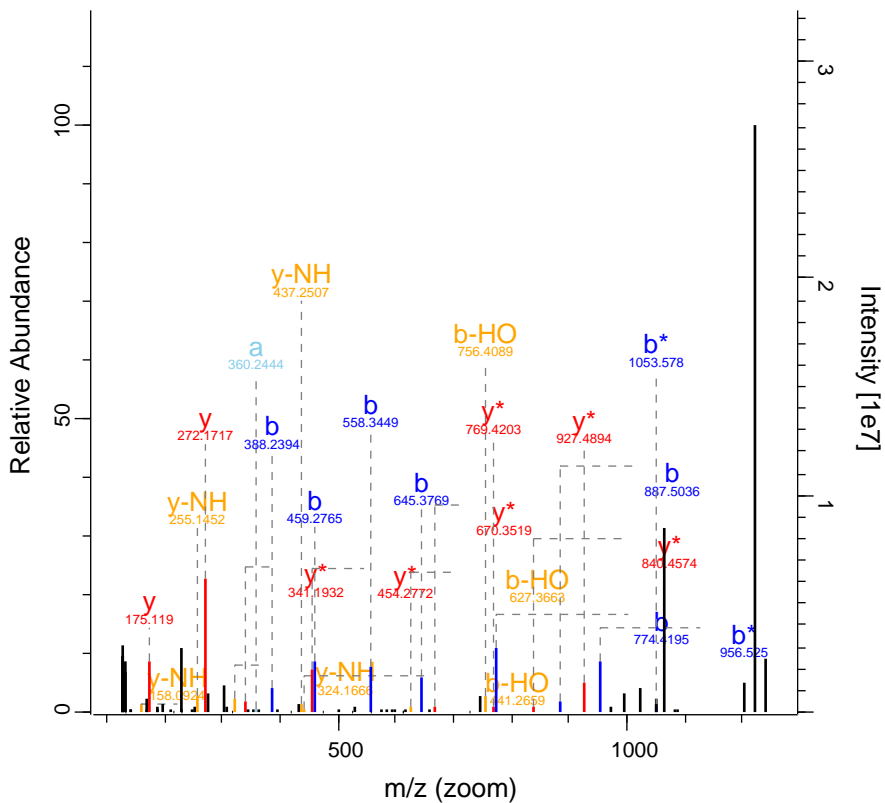

RO-QC-160121_ZackD_SS_Set_01_Fraction 15476 FTMS; HC 62.92 831.47 KIF21A

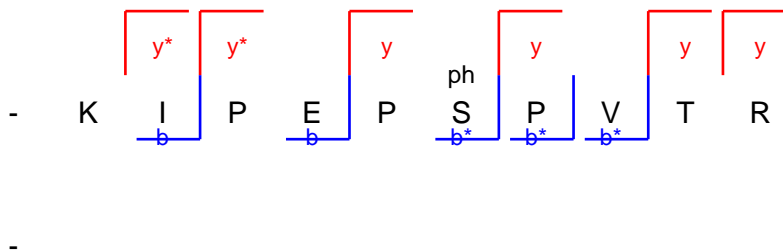
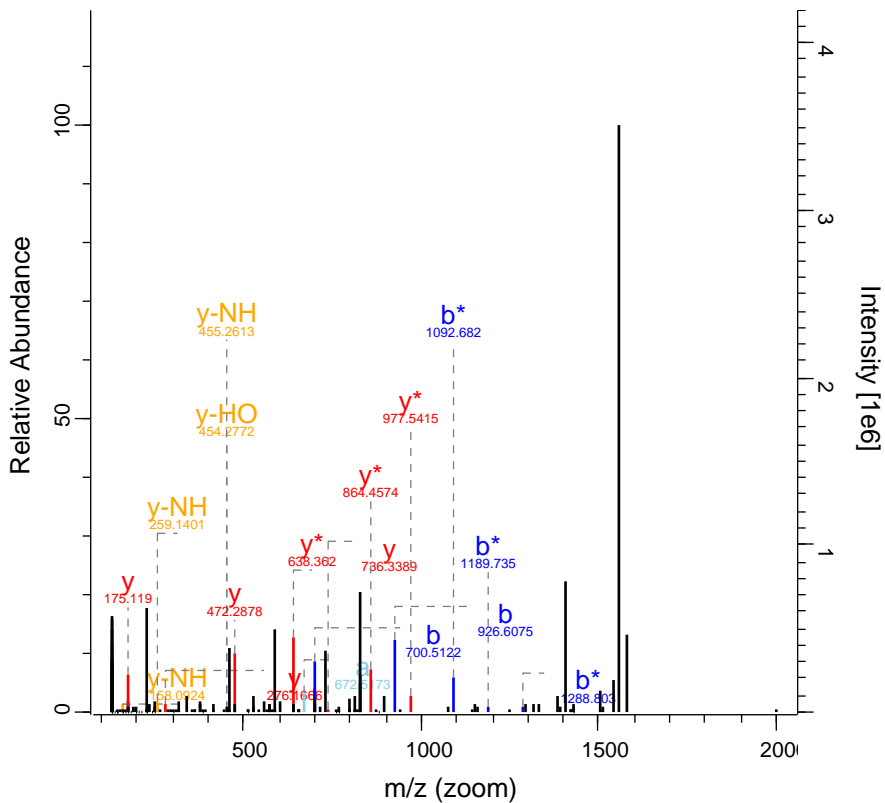

RO-QC-160121_ZackD_SS_Set_01_Fraction 15773 FTMS; HC 48.14 677.36 ANKRD26

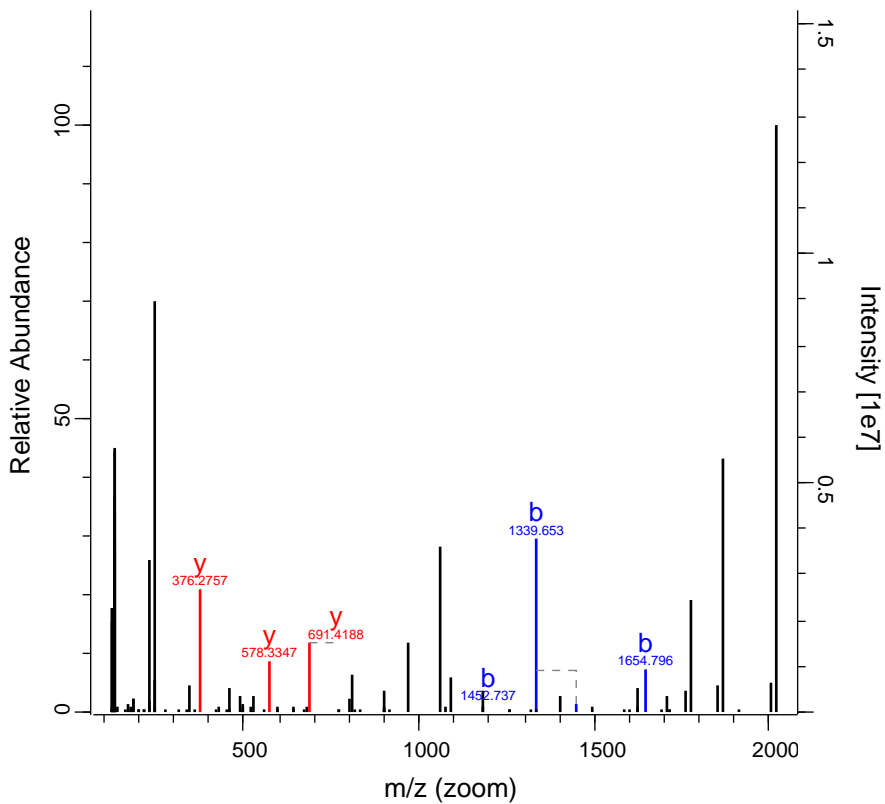

RO-QC-160121_ZackD_SS_Set_01_Fractic 15799 FTMS; HC 46.78 1118.19 LUC7L3

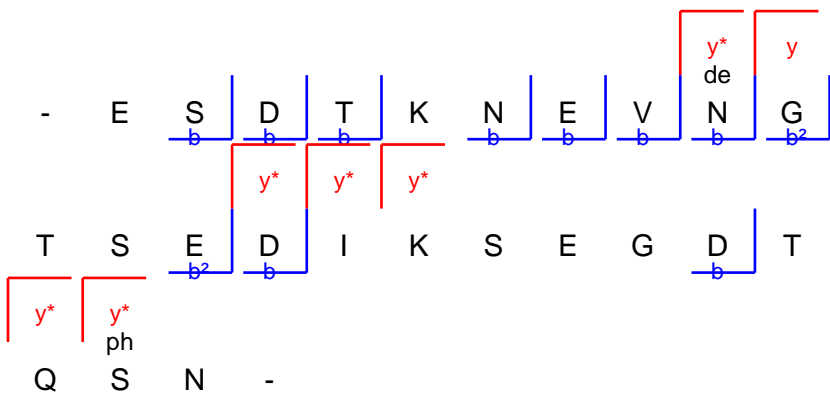
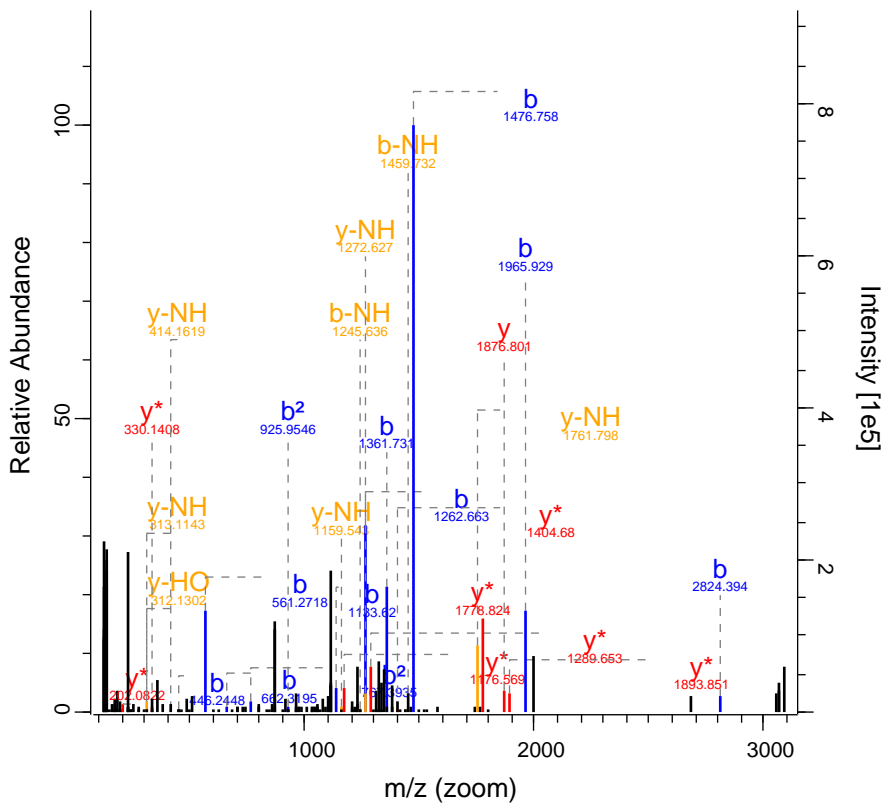

RO-QC-160121_ZackD_SS_Set_01_Fraction 15847 FTMS; HC 78.2 739.36 SLC16A1

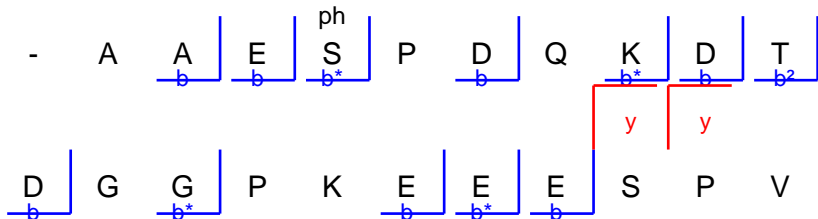
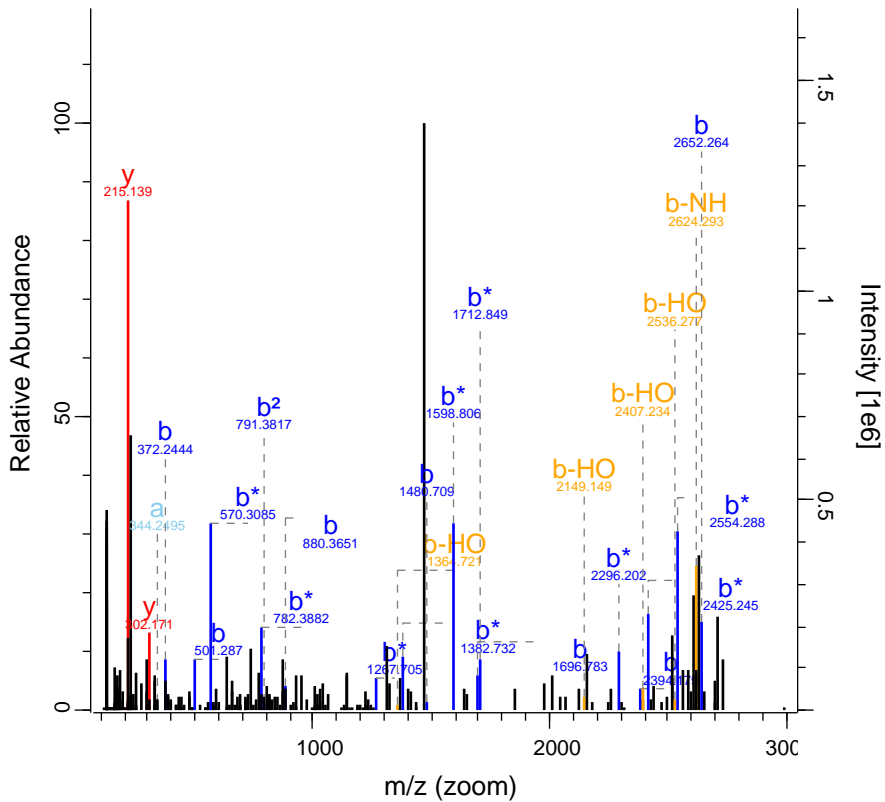

RO-QC-160121_ZackD_SS_Set_01_Fractio 15924 FTMS; HC 113.65 796.04 TOE1

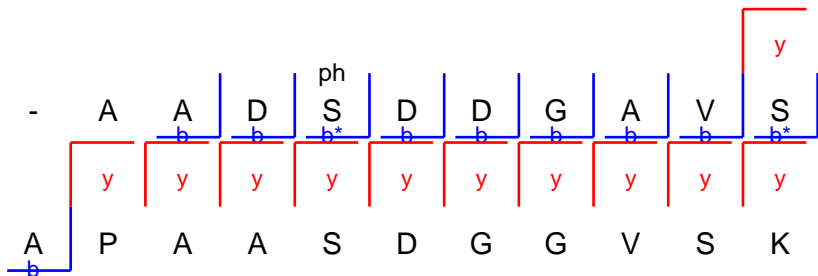
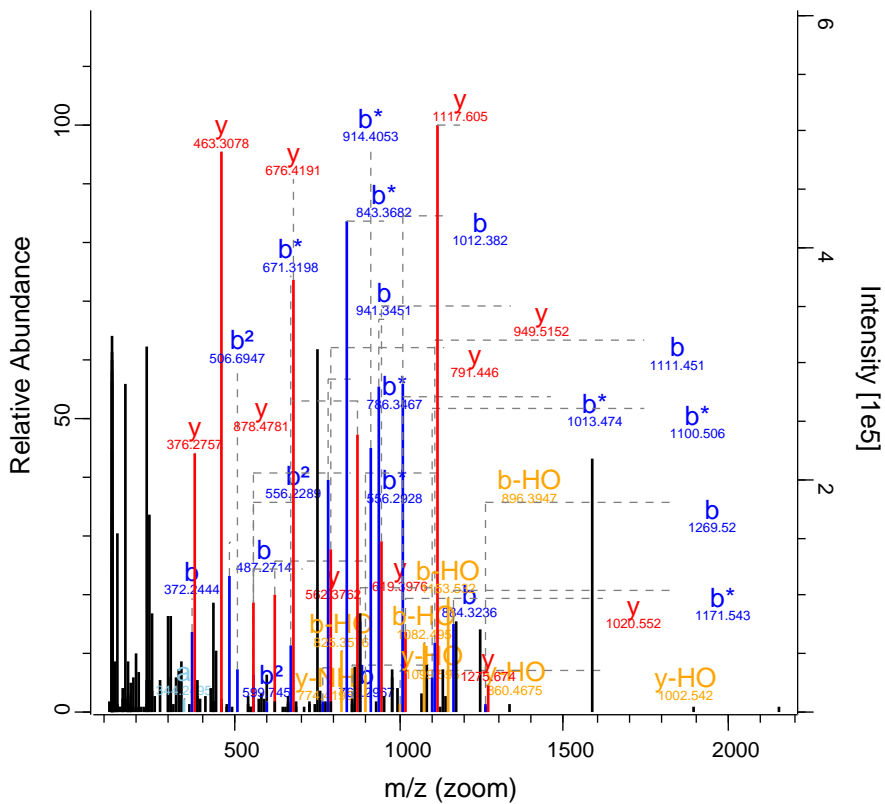

RO-QC-160121_ZackD_SS_Set_01_Fractio 16636 FTMS; HC 187.16 990.49 TNS3

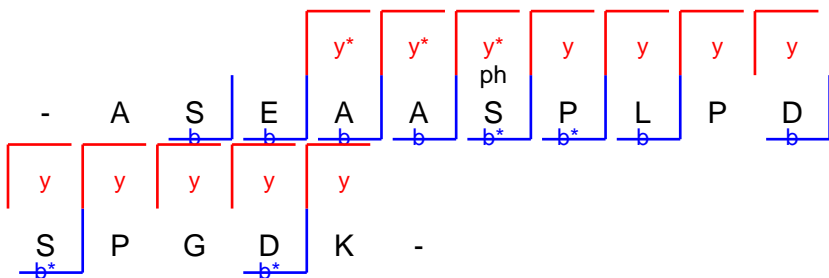
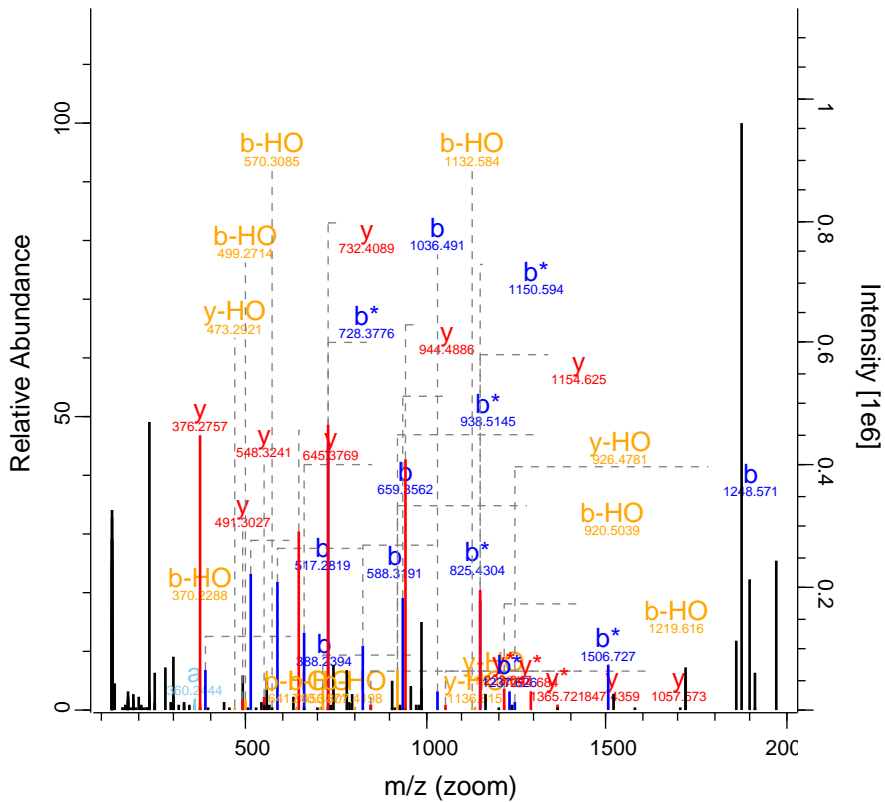

RO-QC-160121_ZackD_SS_Set_01_Fraction 16984 FTMS; HC 75.36 788.06 SLC16A3

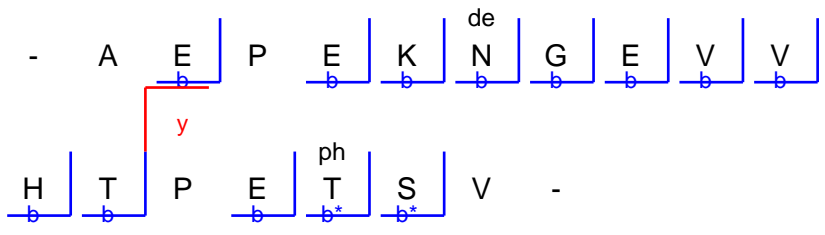
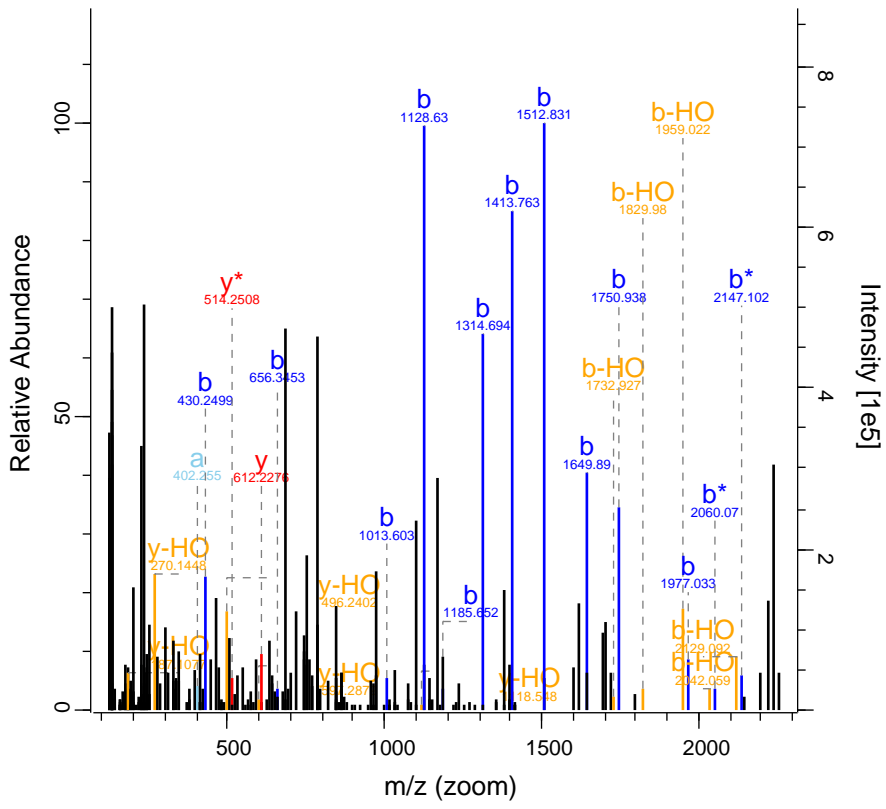

RO-QC-160121_ZackD_SS_Set_01_Fraction 17301 FTMS; HC 96.06 811.37 PGAM1

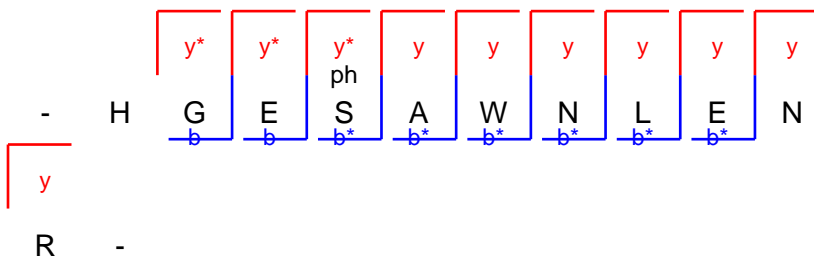
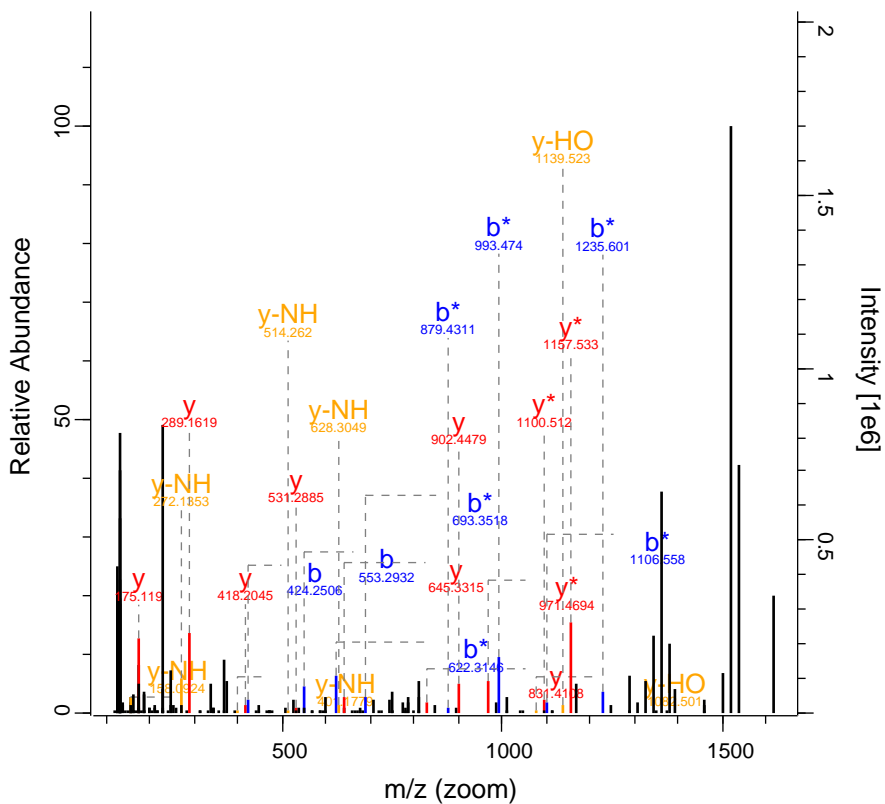

RO-QC-160121_ZackD_SS_Set_01_Fractic 17390 FTMS; HC 109.02 1017.06 PLEKHA7

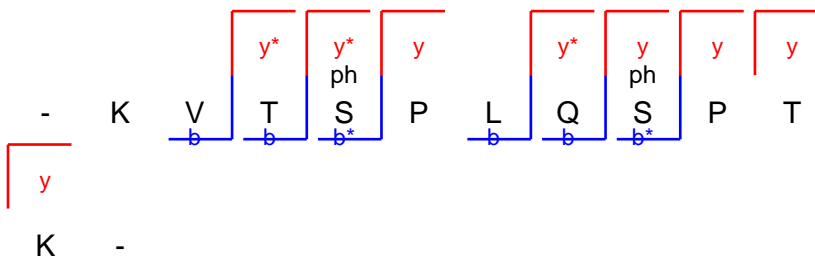
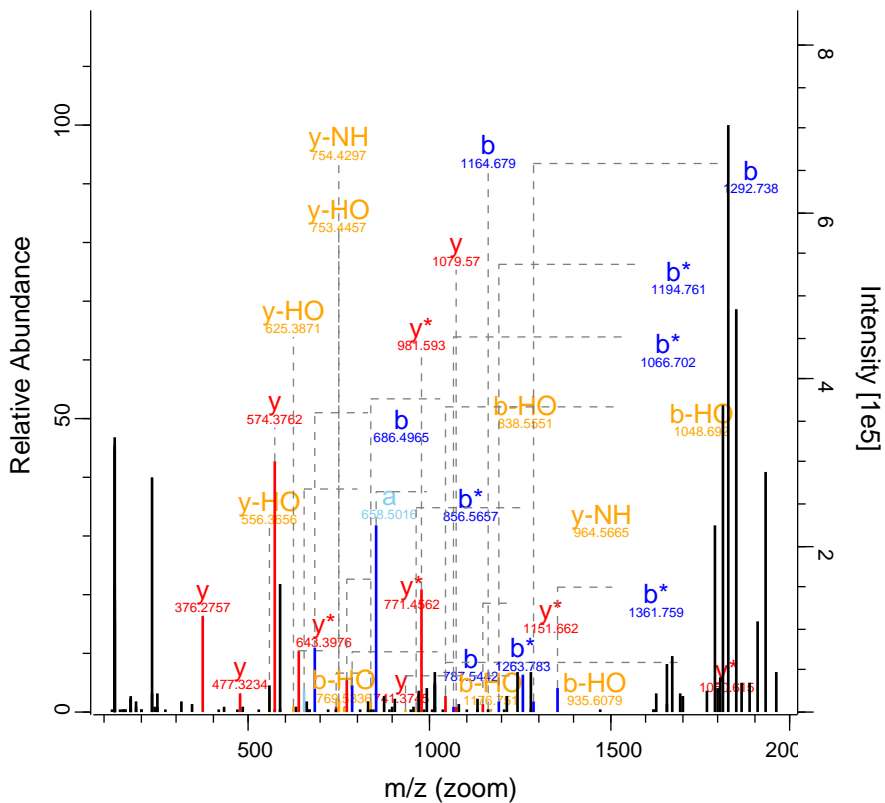

RO-QC-160121_ZackD_SS_Set_01_Fraction 17469 FTMS; HC 73.8 852.72 AKT2

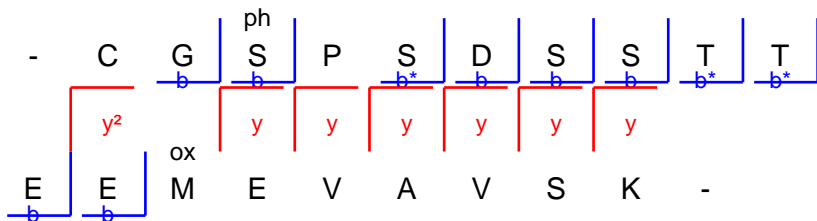
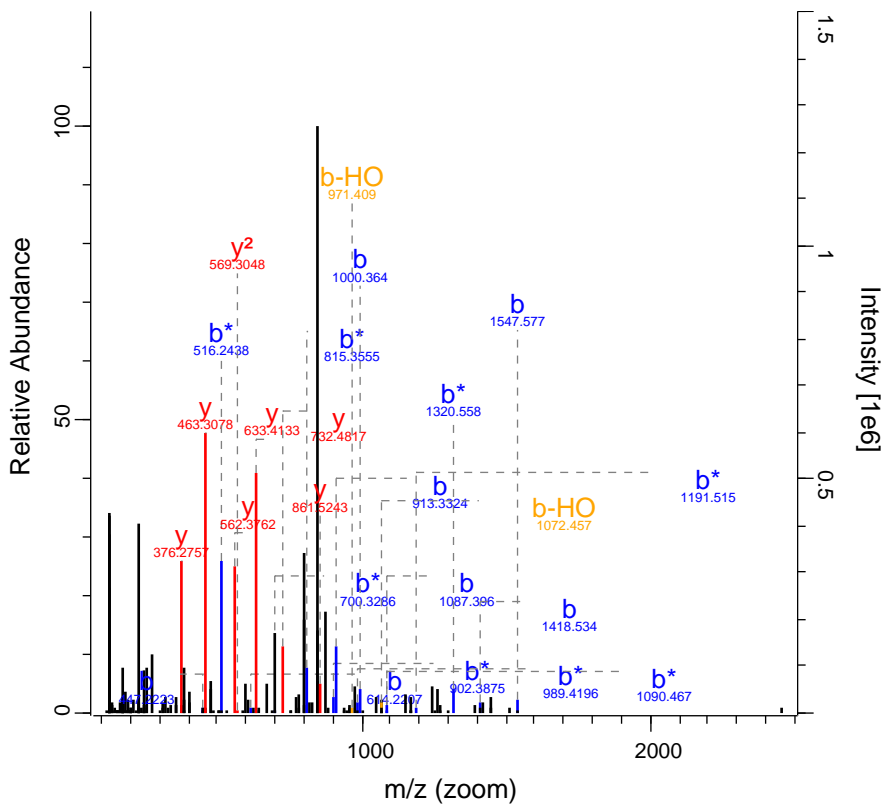

RO-QC-160121_ZackD_SS_Set_01_Fractio 18149 FTMS; HC 107.83 766.38 MAP1B

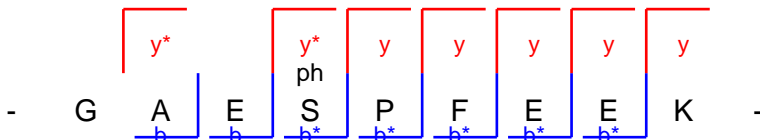
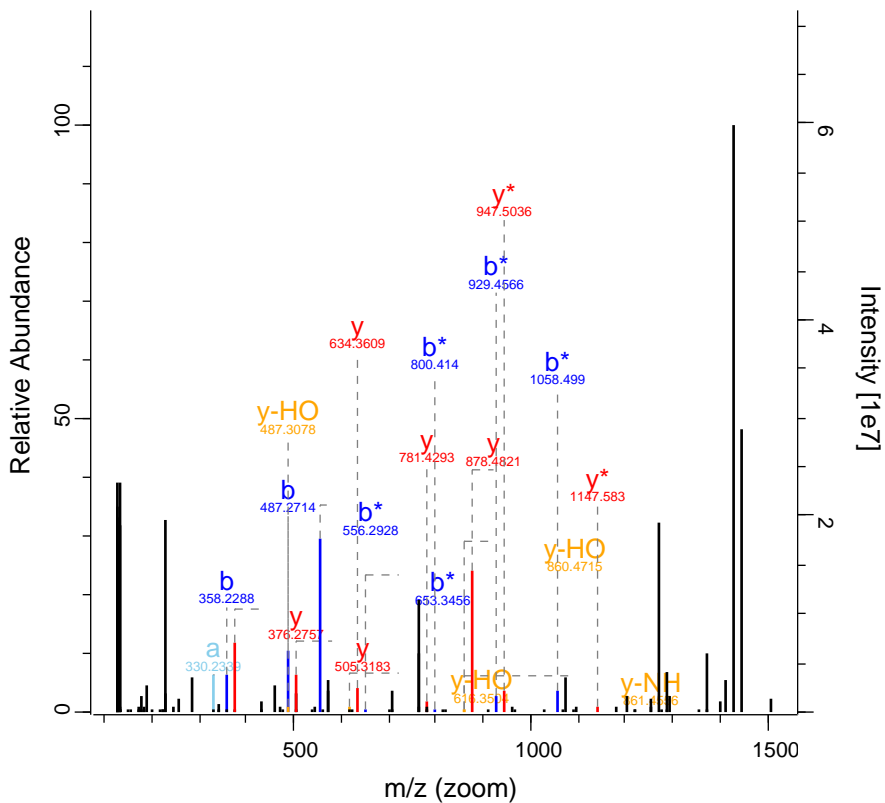

RO-QC-160121_ZackD_SS_Set_01_Fraction 18408 FTMS; HC 79.15 643.82 TSPYL4

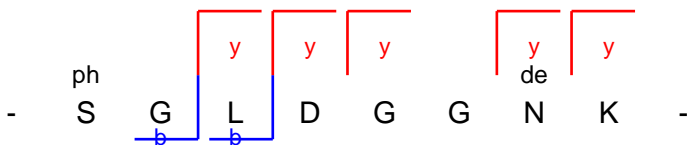
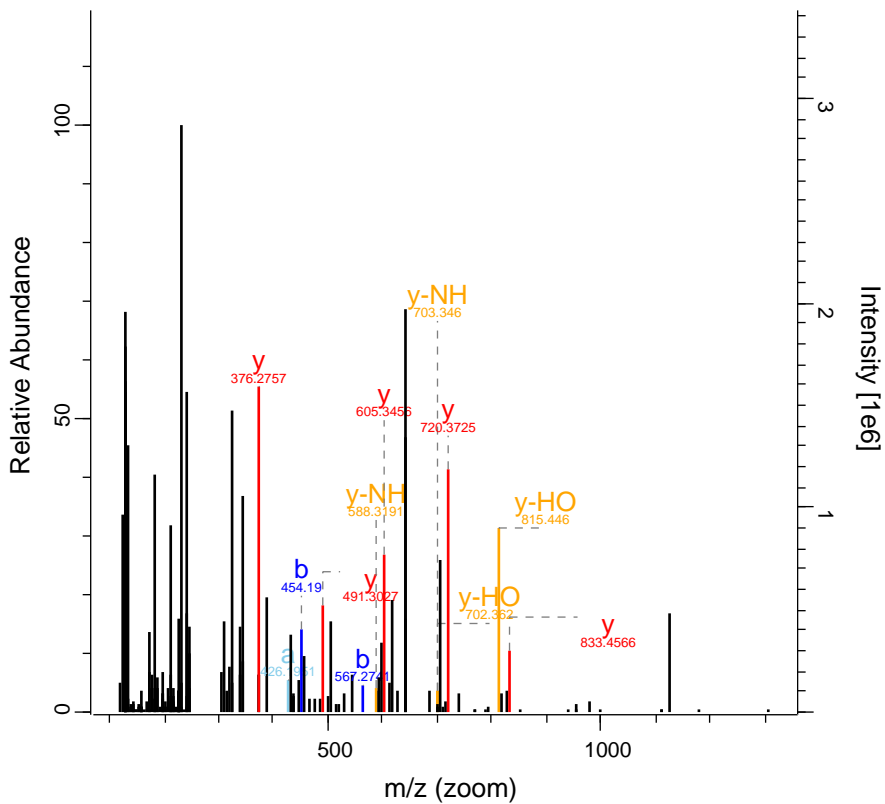

RO-QC-160121_ZackD_SS_Set_01_Fraction 18628 FTMS; HCl 51.61 638.6 MCTP2

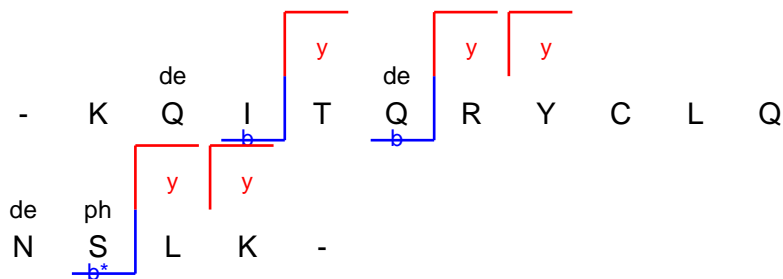
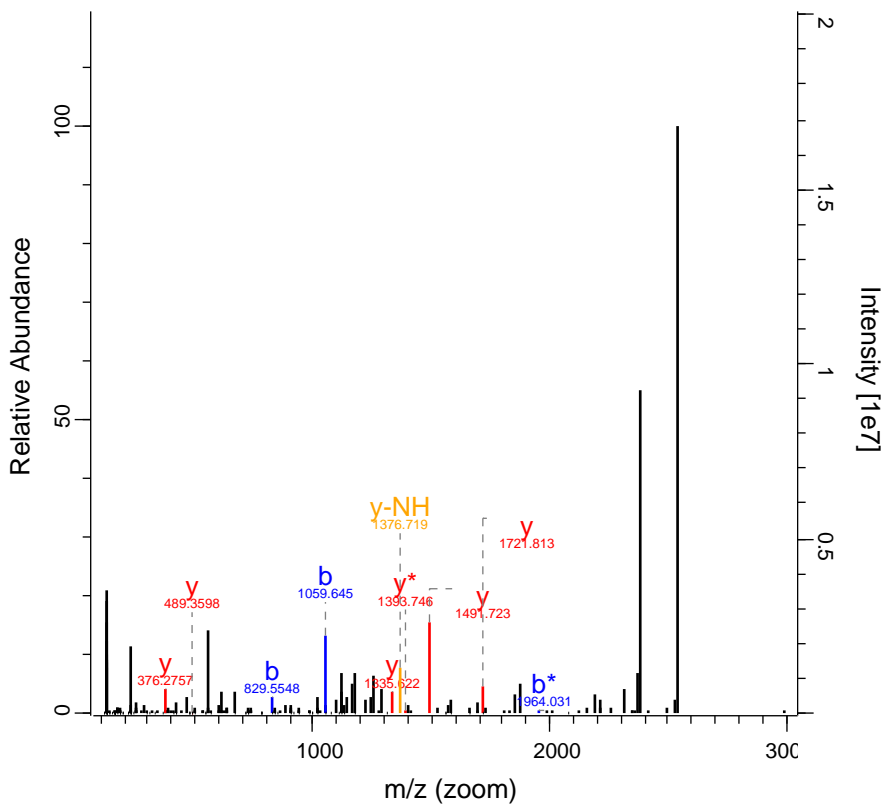

RO-QC-160121_ZackD_SS_Set_01_Fraction 19182 FTMS; HCl; 58.98 891 ELP4

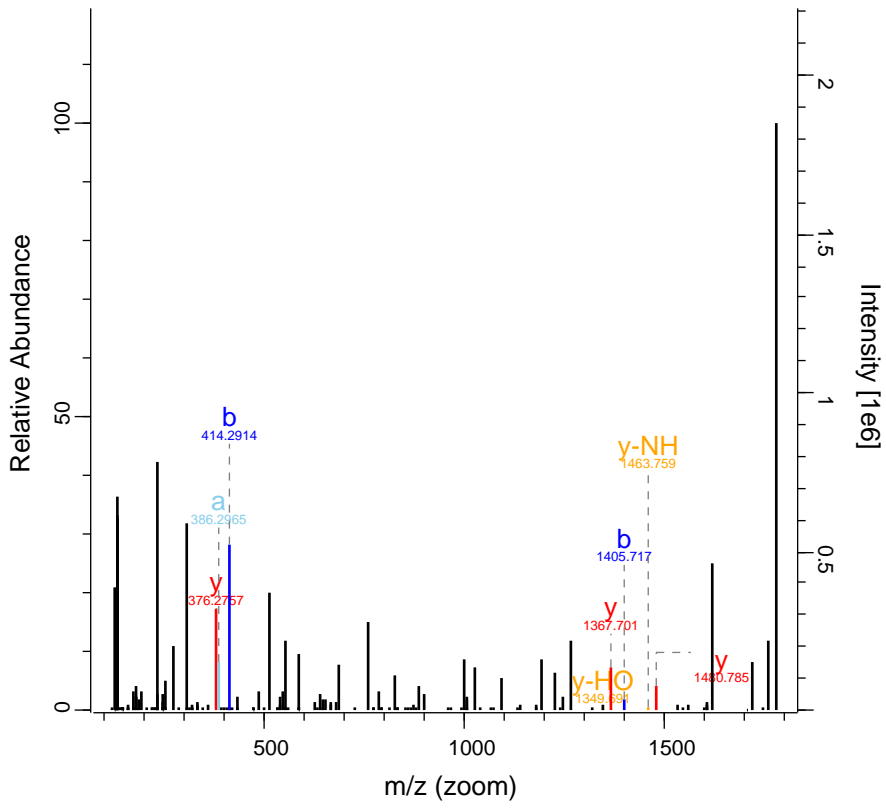

RO-QC-160121_ZackD_SS_Set_01_Fraction 20445 FTMS; HC 73.98 622.66 PFKP

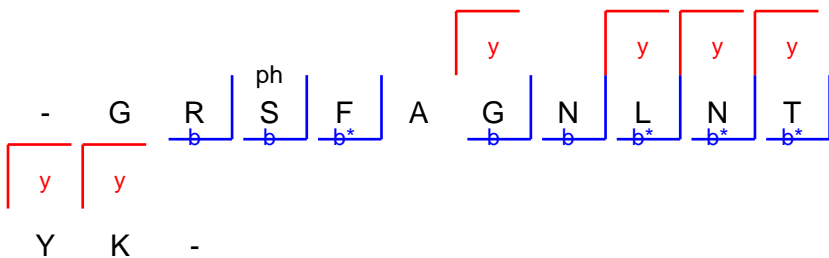
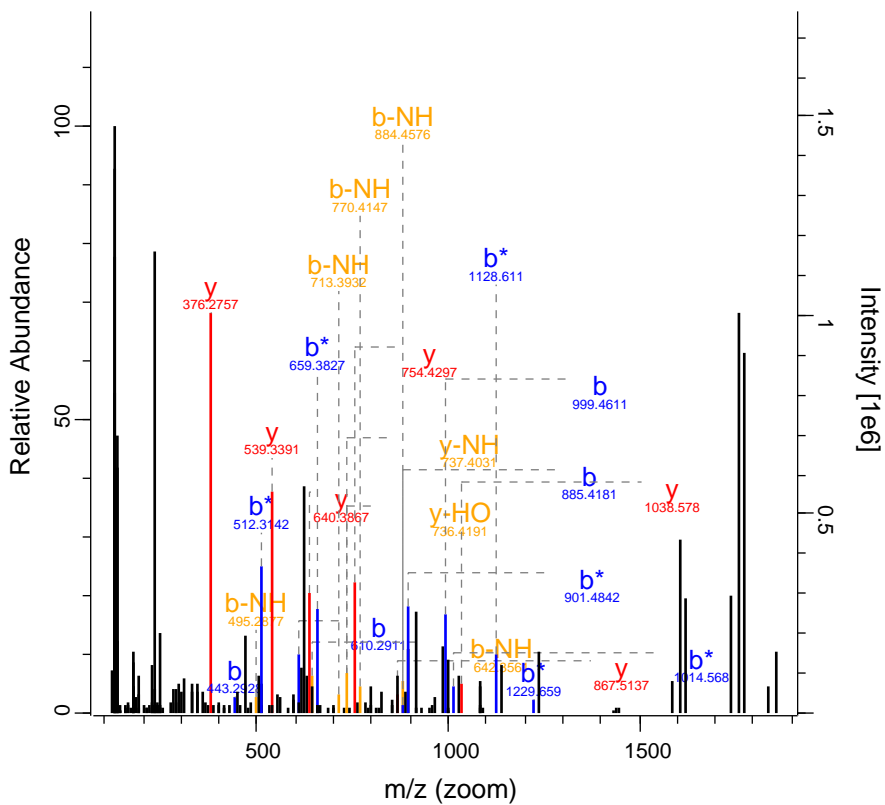

RO-QC-160121_ZackD_SS_Set_01_Fractio 20651 FTMS; HC 142.89 735.38 PRPH

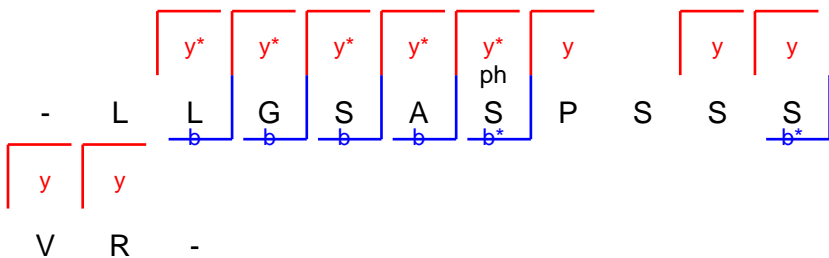
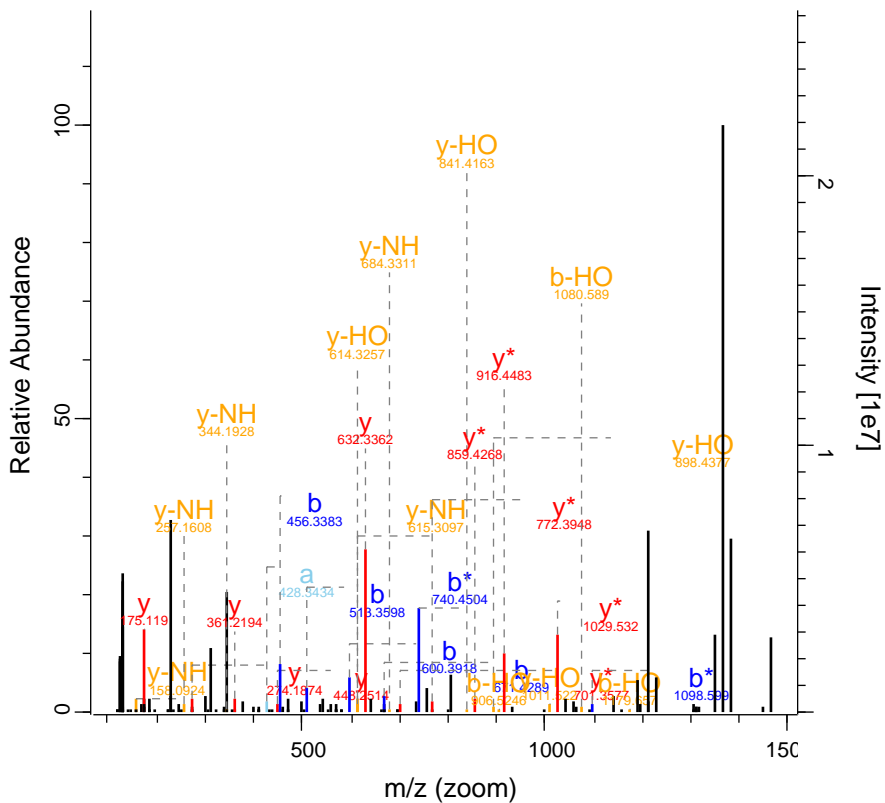

RO-QC-160121_ZackD_SS_Set_01_Fraction 21245 FTMS; HC 45.83 623.68 SOWAHC

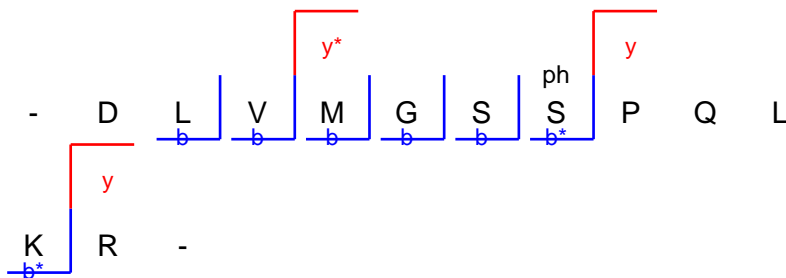
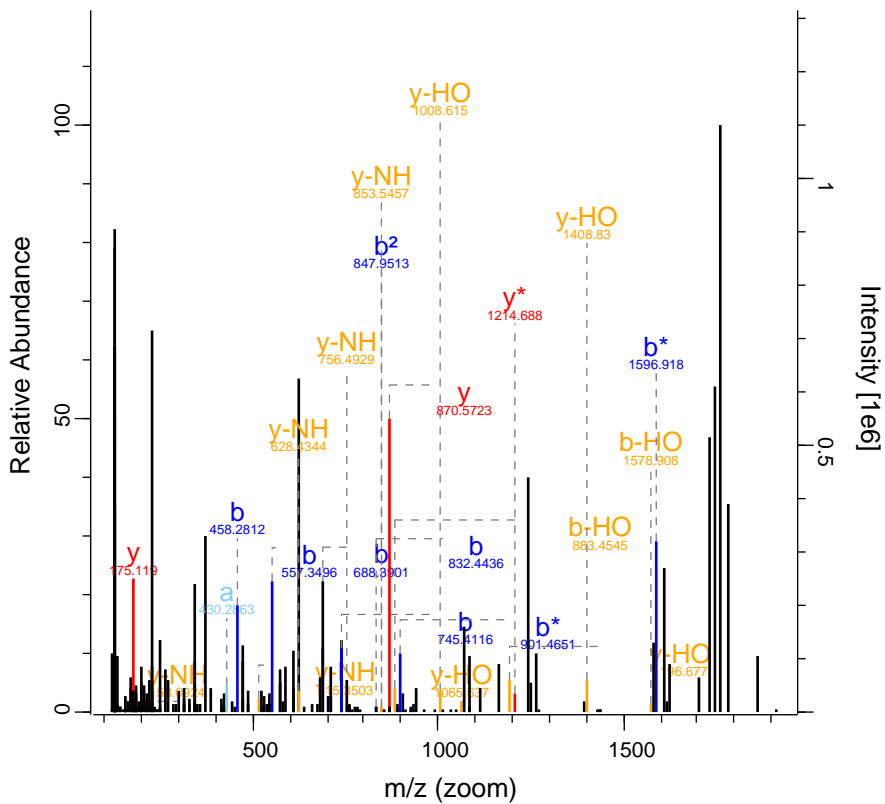

RO-QC-160121_ZackD_SS_Set_01_Fractic 21387 FTMS; HC 108.49 1138.53 RMDN3

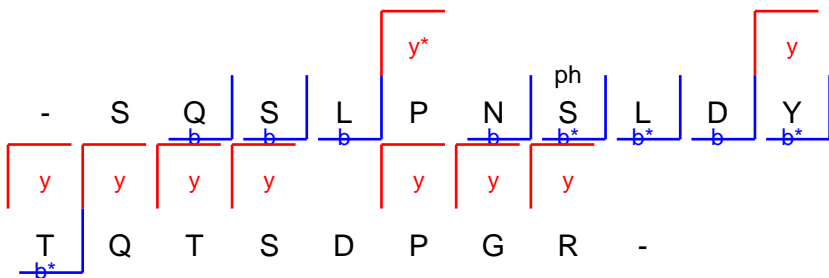
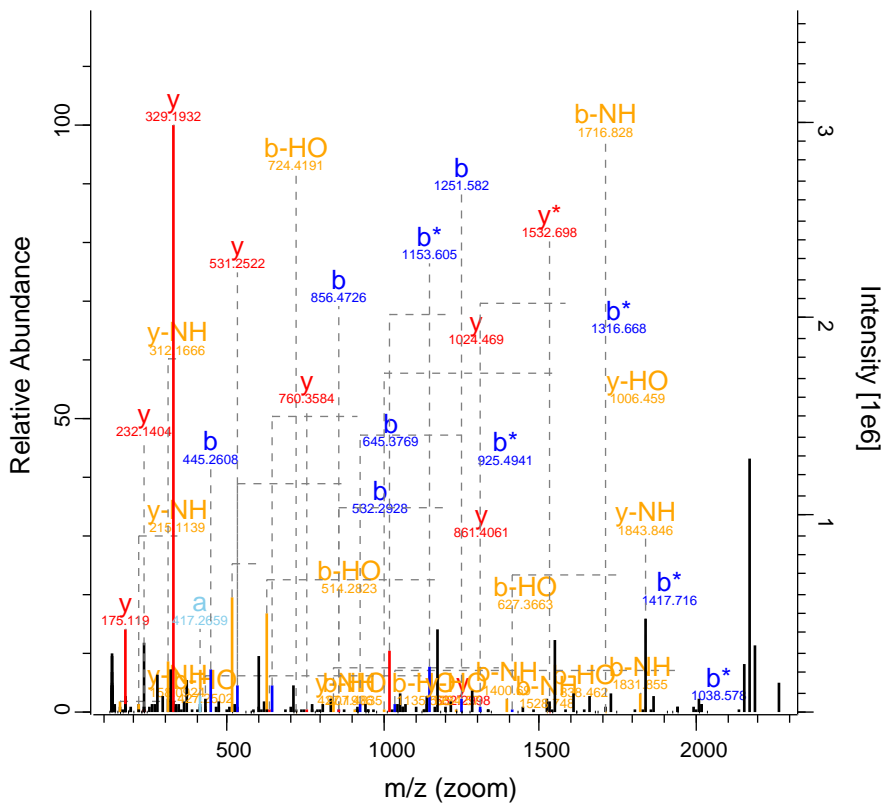

RO-QC-160121_ZackD_SS_Set_01_Fraction 21609 FTMS; HC 78.49 927.47 MIOS

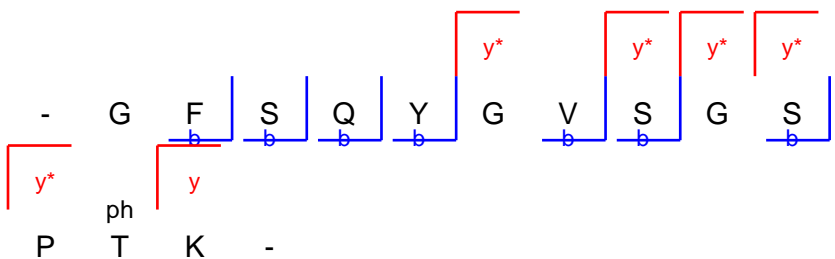
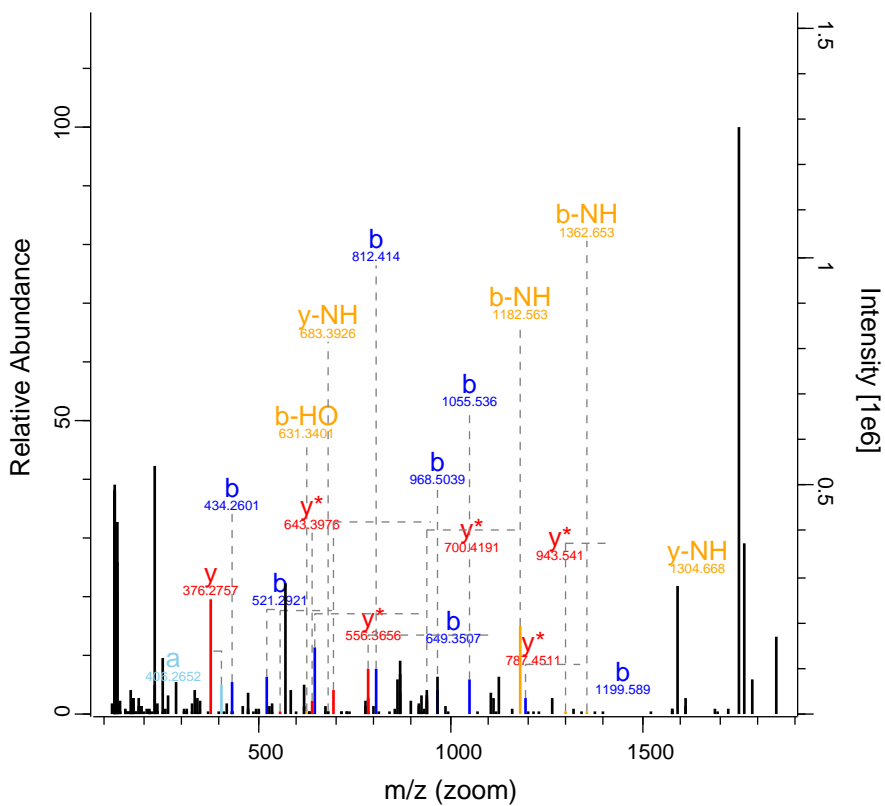

RO-QC-160121_ZackD_SS_Set_01_Fraction 21705 FTMS; HC 40.5 521.53 PRSS55

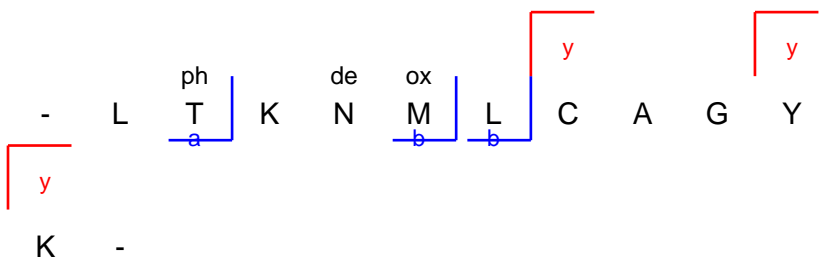
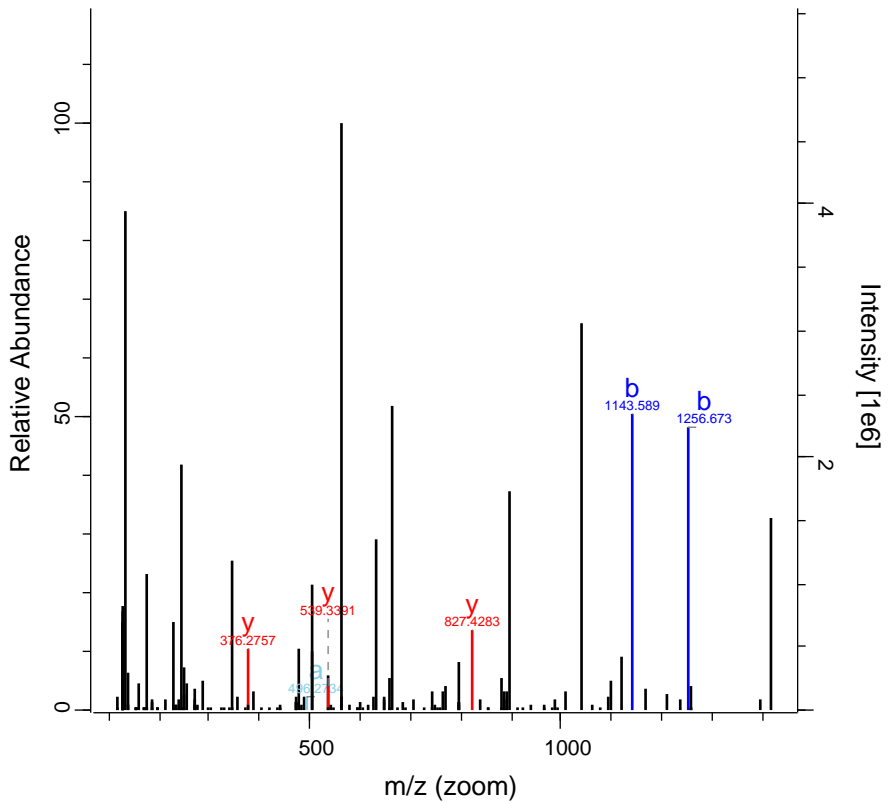

RO-QC-160121_ZackD_SS_Set_01_Fractic 22170 FTMS; HC 171.26 1285.11 MAP1B

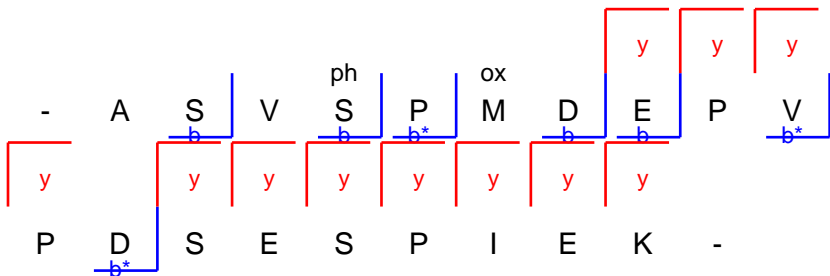
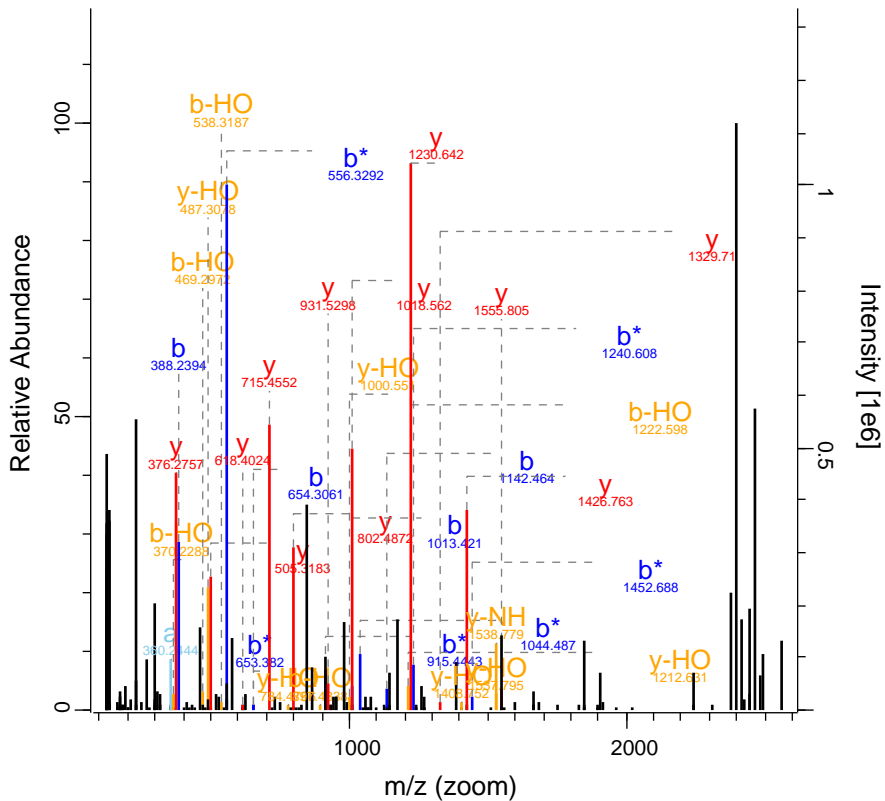

RO-QC-160121_ZackD_SS_Set_01_Fractic 22833 FTMS; HC 61.65 1016.51 CASC4

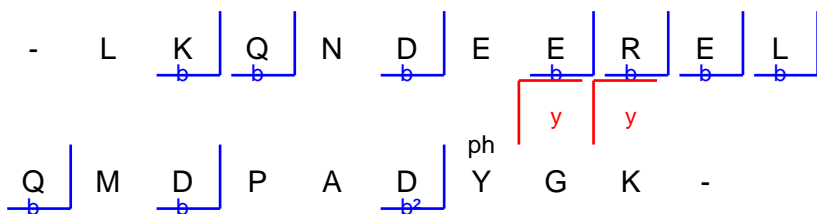
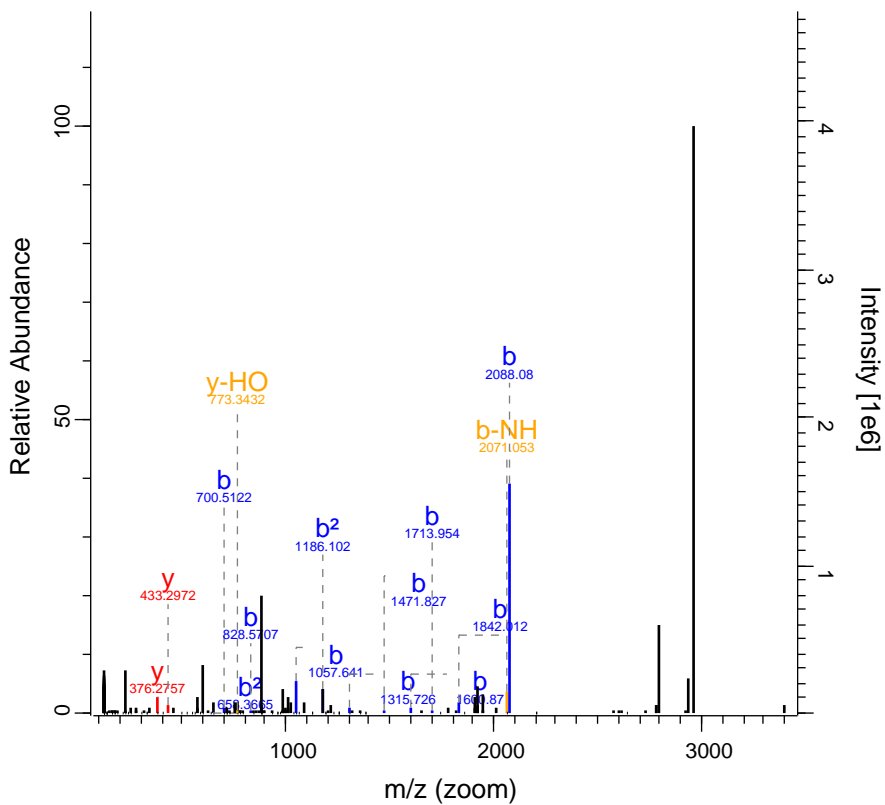

RO-QC-160121_ZackD_SS_Set_01_Fraction 22988 FTMS; HC 42.56 568.56 LSM7

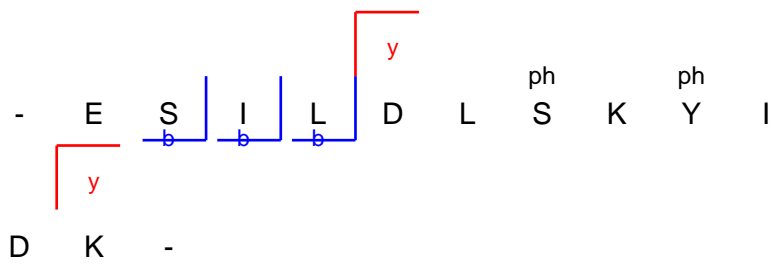
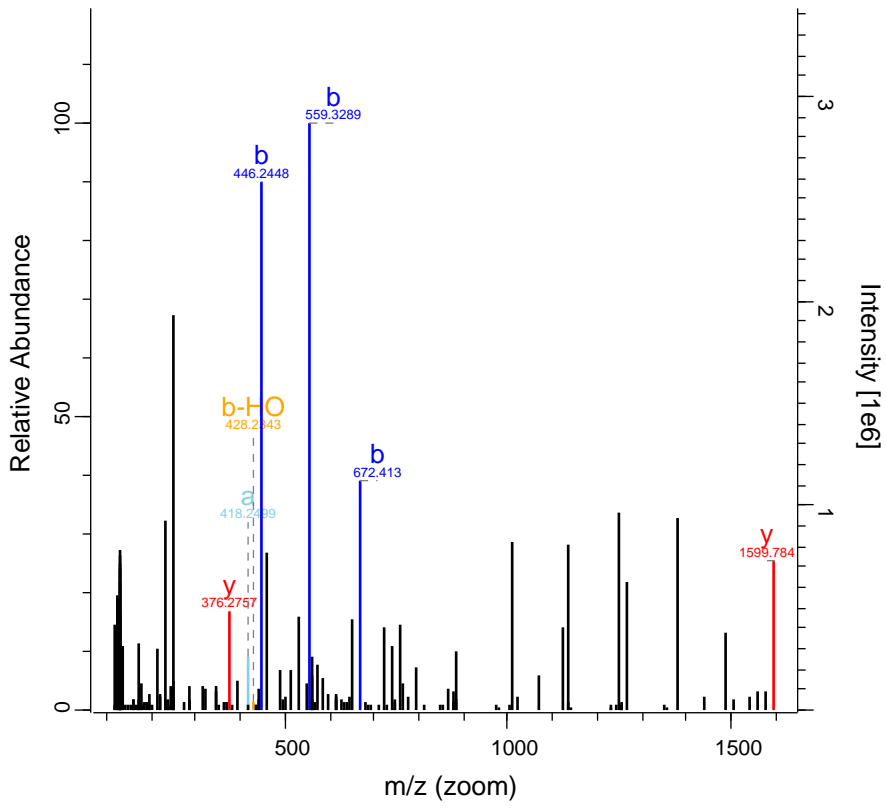

RO-QC-160121_ZackD_SS_Set_01_Fraction23377 FTMS; HC 78.76 615.33 GPRC5A

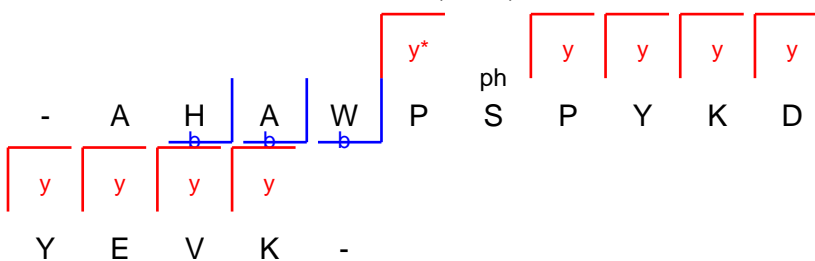
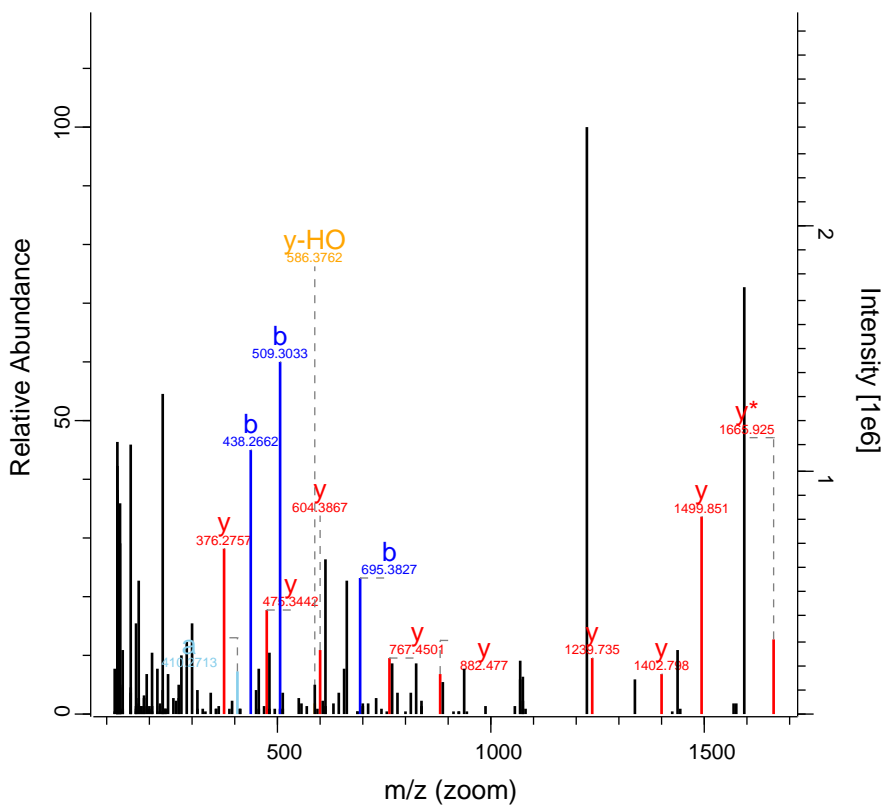

RO-QC-160121_ZackD_SS_Set_01_Fraction 23456 FTMS; HC 83.76 777.42 TBC1D15

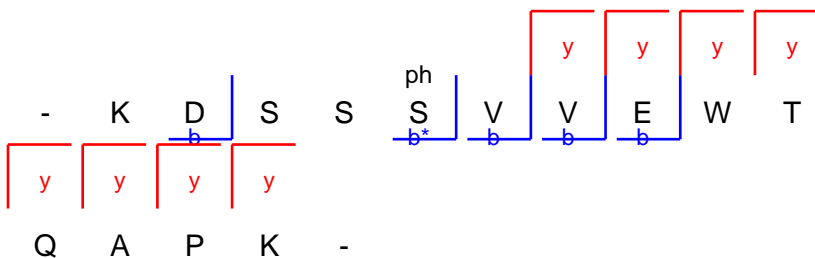
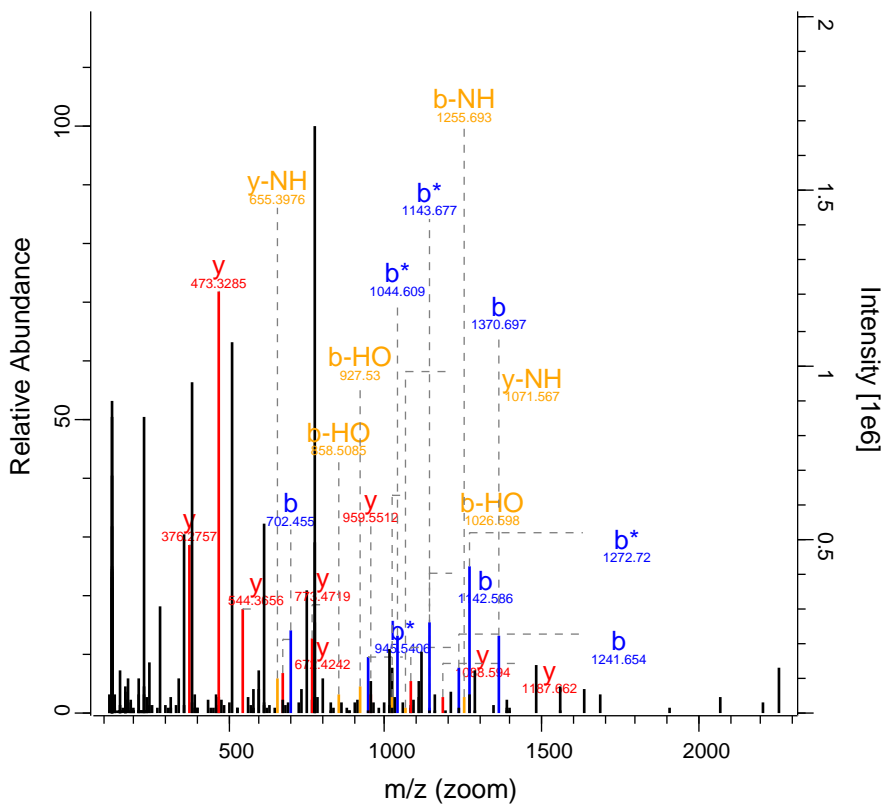

Q A P K -

RO-QC-160121_ZackD_SS_Set_01_Fraction 23814 FTMS; HC 83.36 562.32 CTNND1

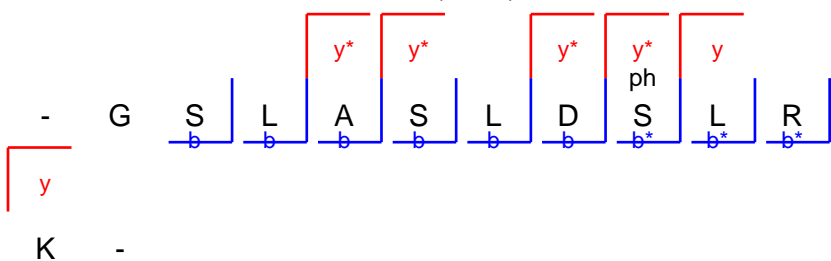
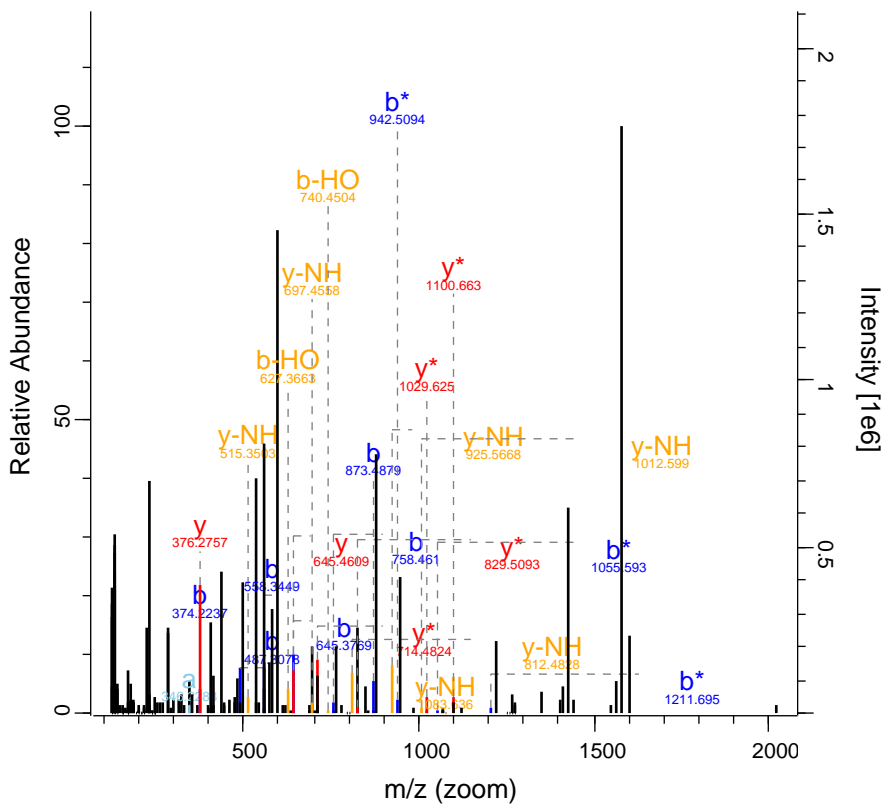

RO-QC-160121_ZackD_SS_Set_01_Fractio 25779 FTMS; HC 111.79 803.19 ADD3

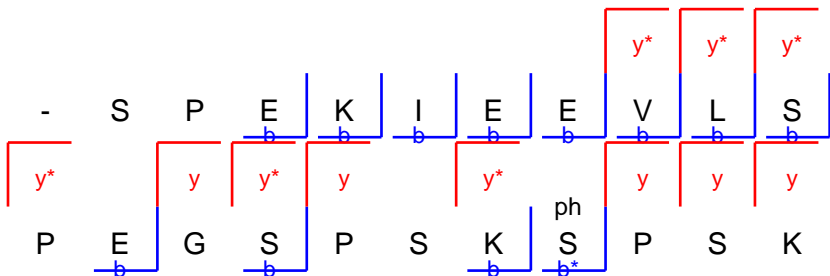
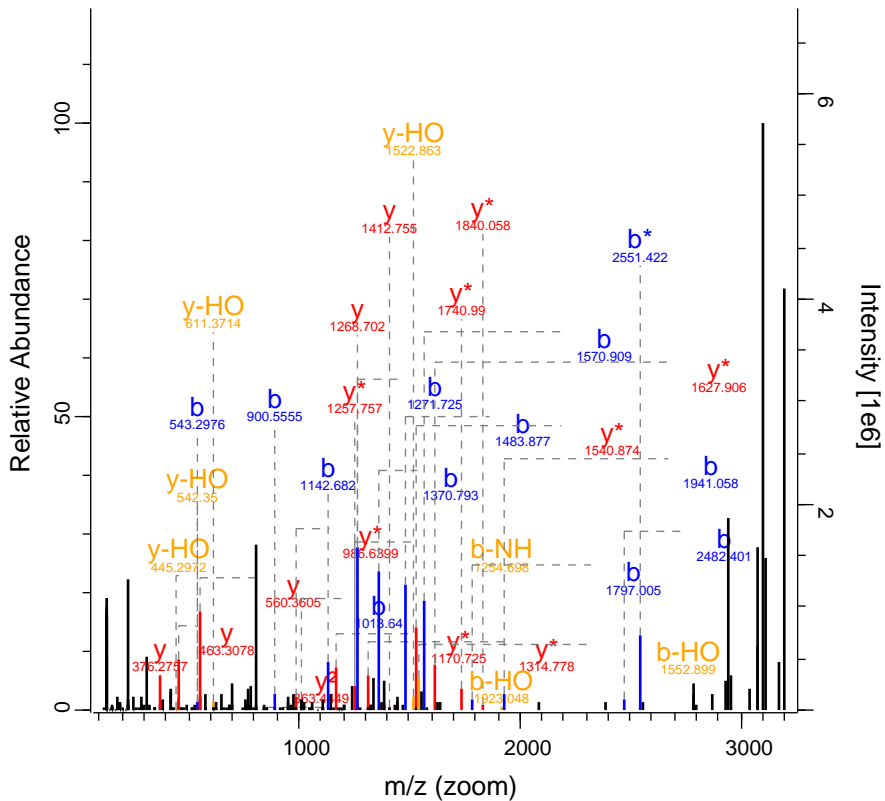

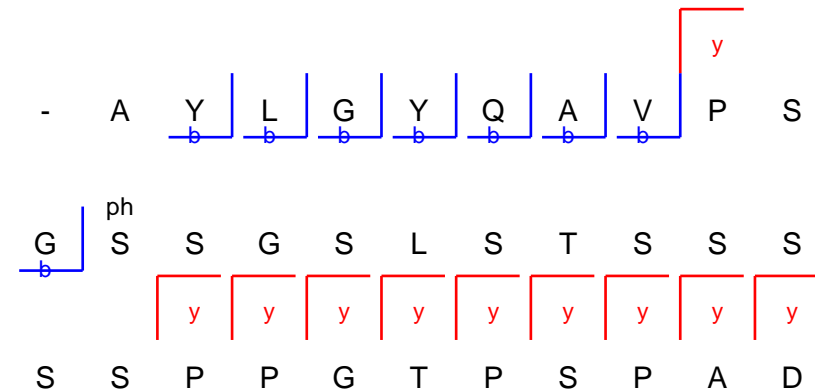
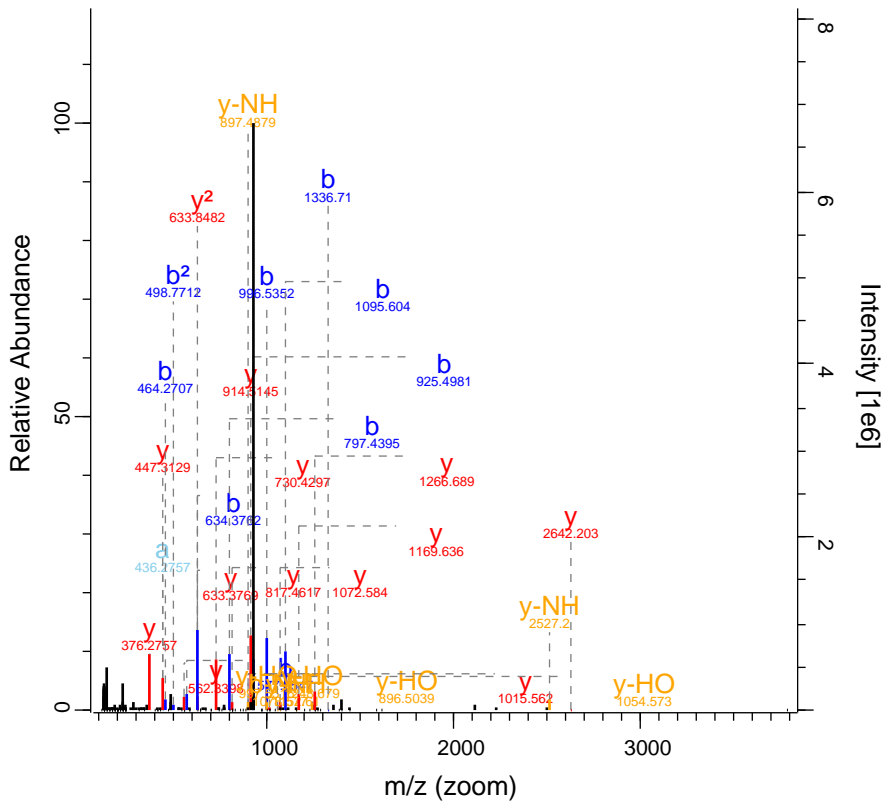

RO-QC-160121_ZackD_SS_Set_01_Fractio 26883 FTMS; HC 156.87 859.07 KPNA3

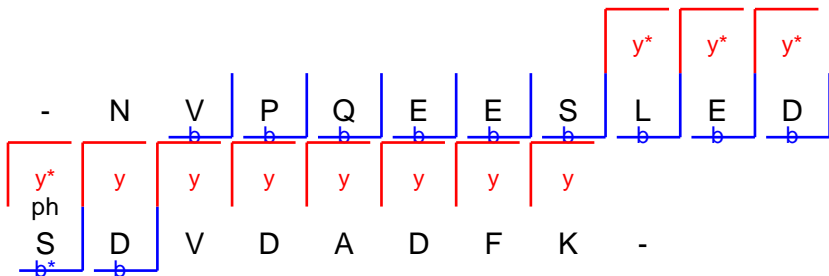
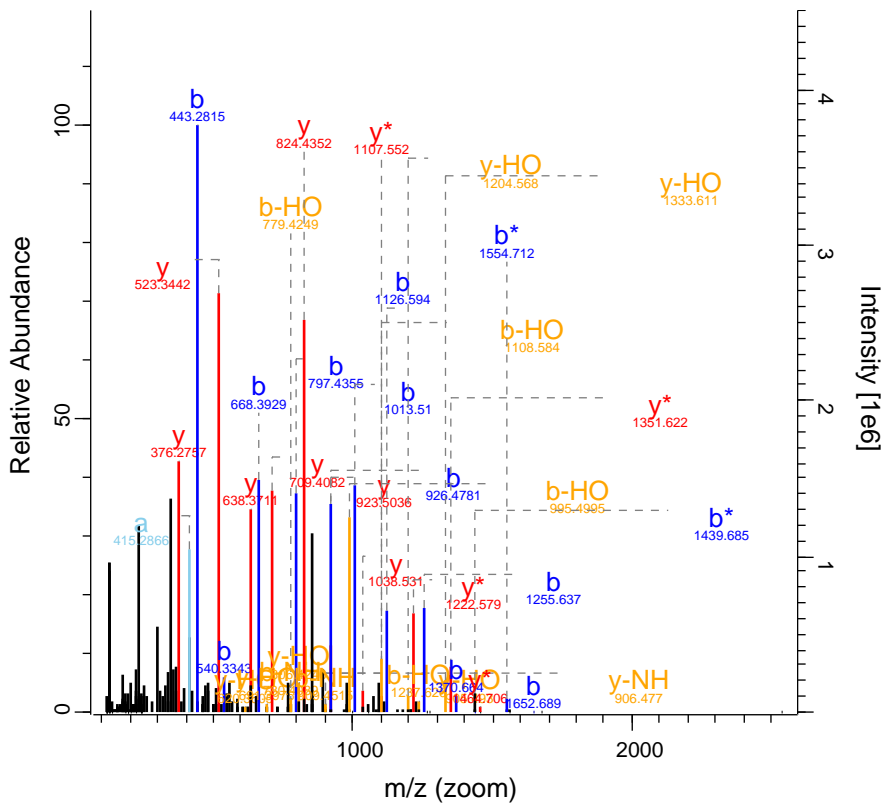

RO-QC-160121_ZackD_SS_Set_01_Fractic 27118 FTMS; HC 146.5 1095.81 STK39

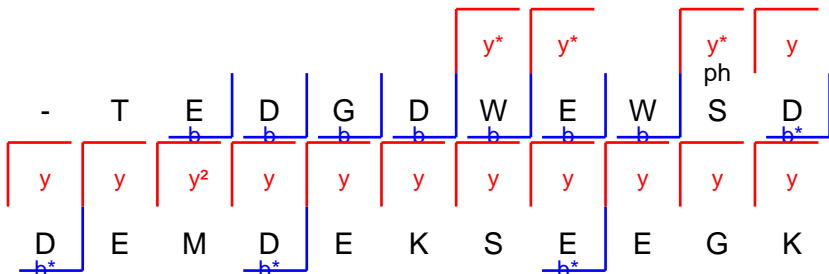
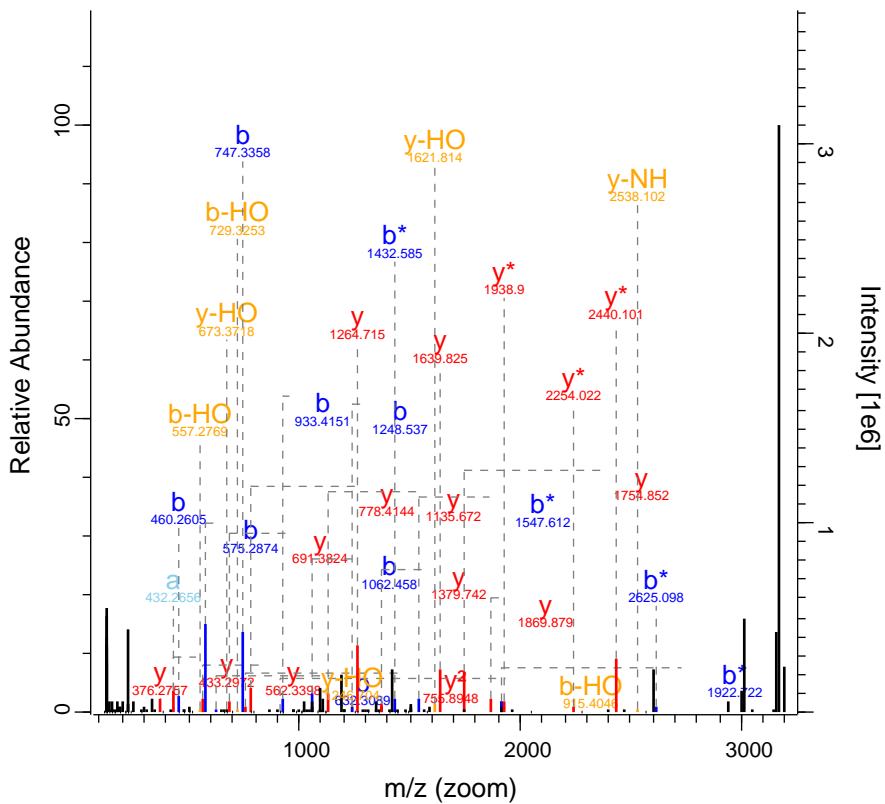

RO-QC-160121_ZackD_SS_Set_01_Fraction 27121 FTMS; HC 41.64 644.59 EDF1

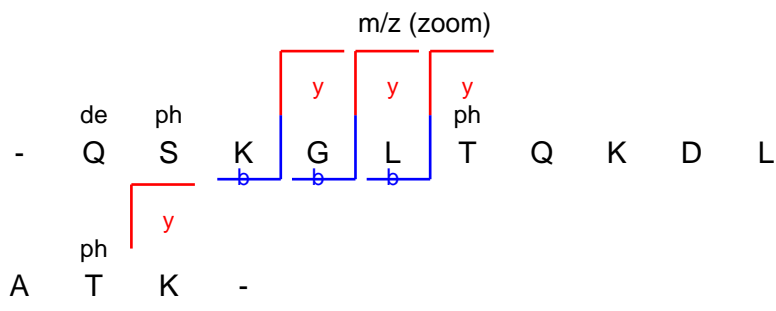
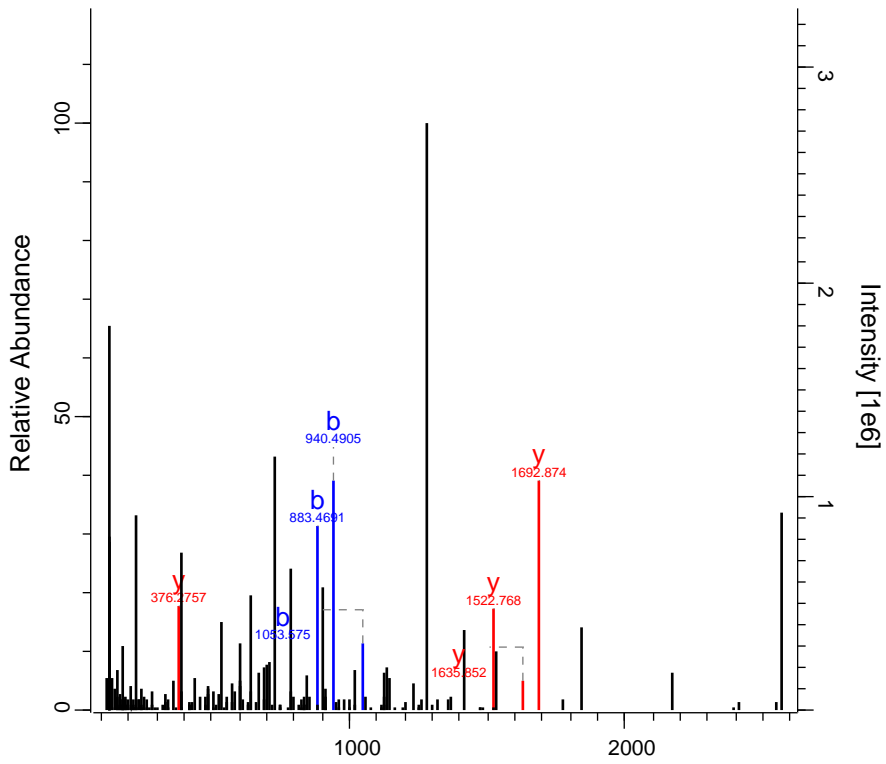

RO-QC-160121_ZackD_SS_Set_01_Fractic 28122 FTMS; HC 154.77 1034.49 TP53BP1

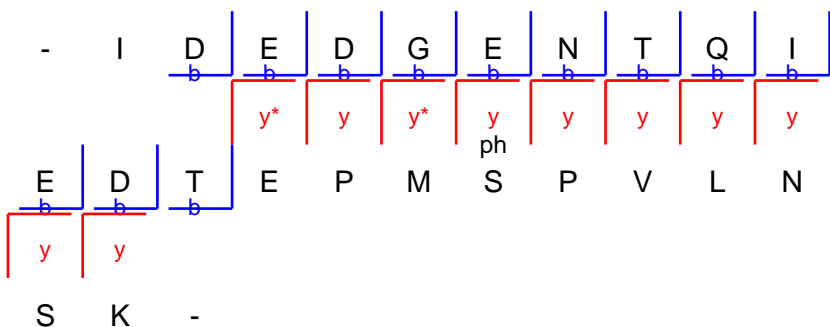
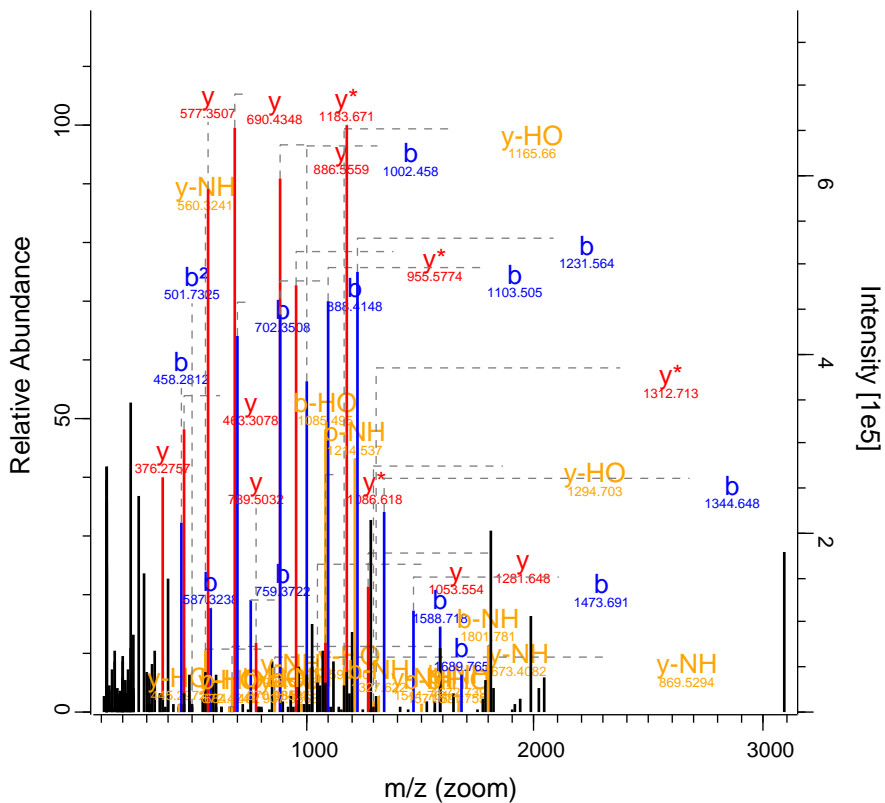

RO-QC-160121_ZackD_SS_Set_01_Fractic 28717 FTMS; HC 56.01 1026.49 SIRPB2

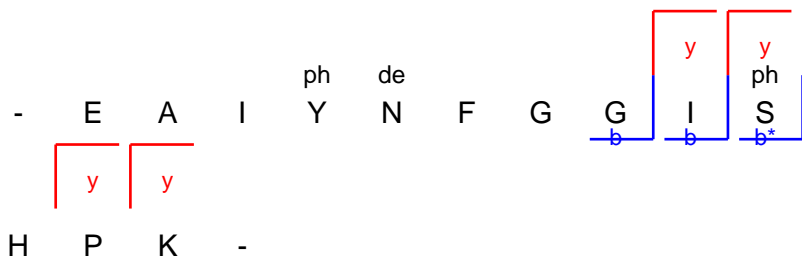
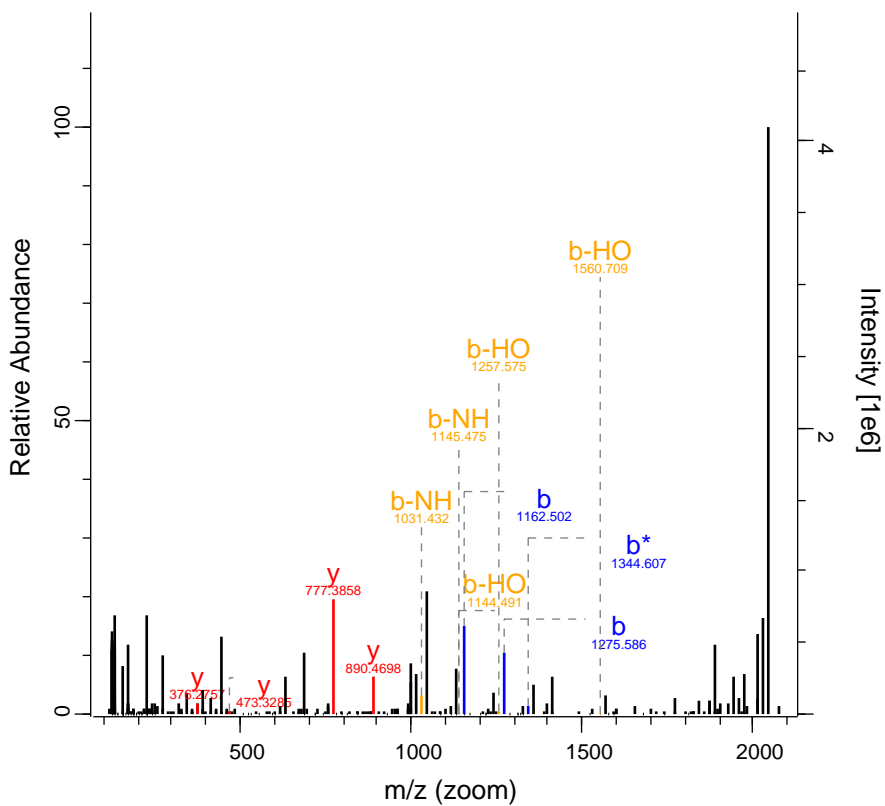

RO-QC-160121_ZackD_SS_Set_01_Fractic 29675 FTMS; HC 120.85 1012.11 EHD2

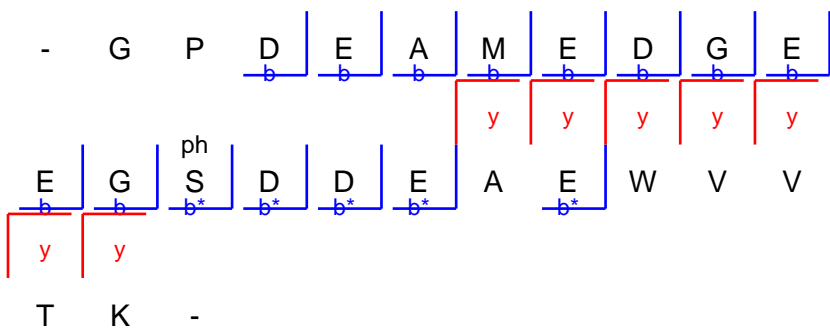
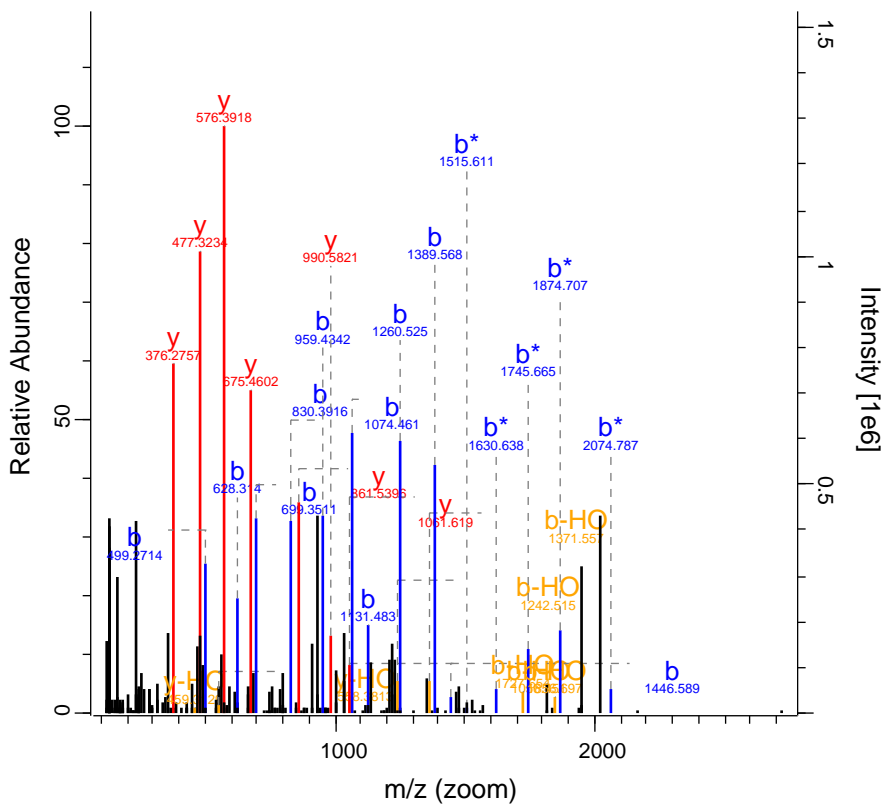

RO-QC-160121_ZackD_SS_Set_01_F 31114 FTMS; H⁺ 159.7(920.4) RPS6KA3;RPS6KA6;RPS

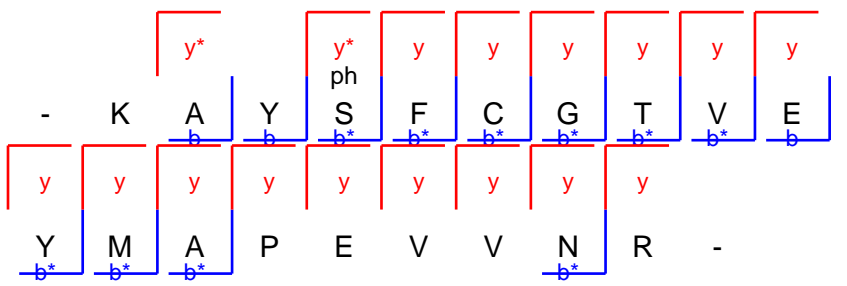
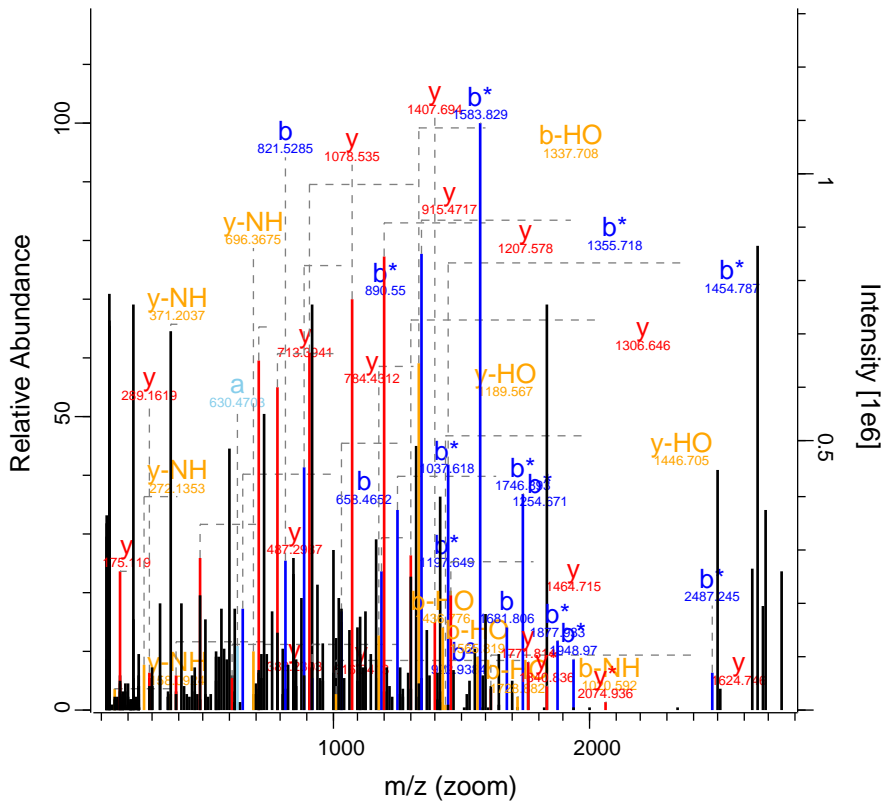

RO-QC-160121_ZackD_SS_Set_01_Fractic 31827 FTMS; HC 100.19 1104.32 TPD52

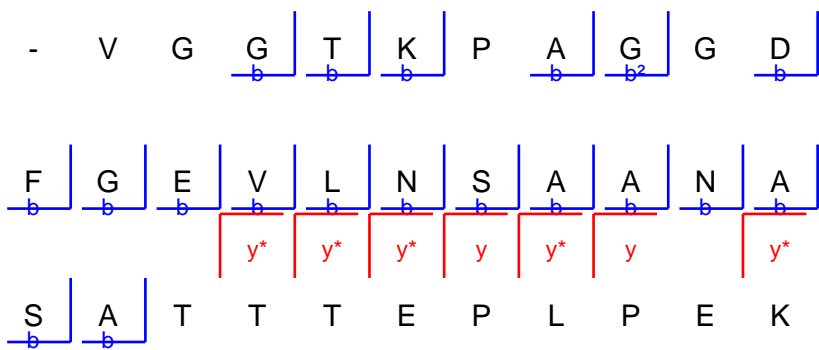
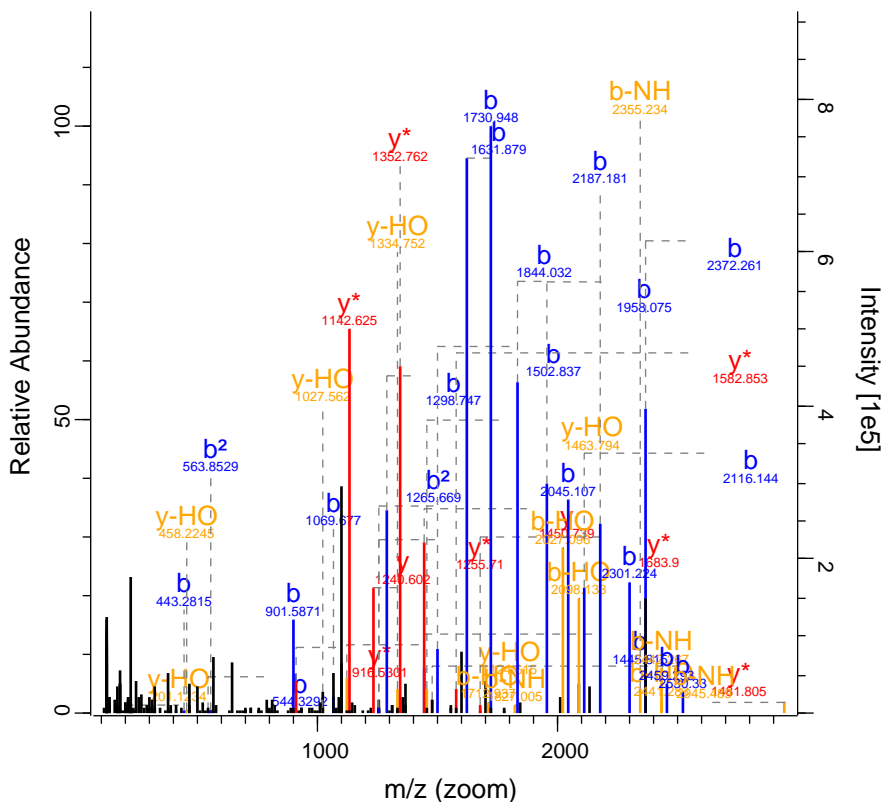

RO-QC-160121_ZackD_SS_Set_01_Fraction 33488 FTMS; HC 40.15 581.92 NLRC5

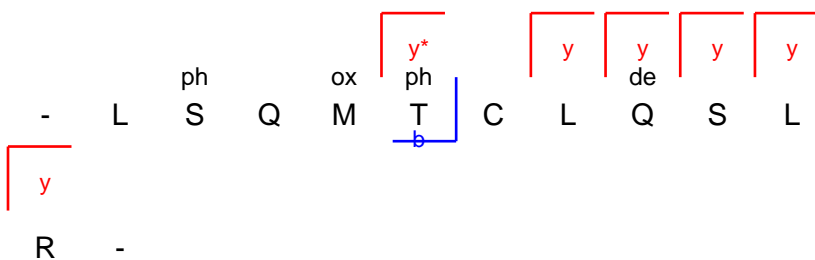
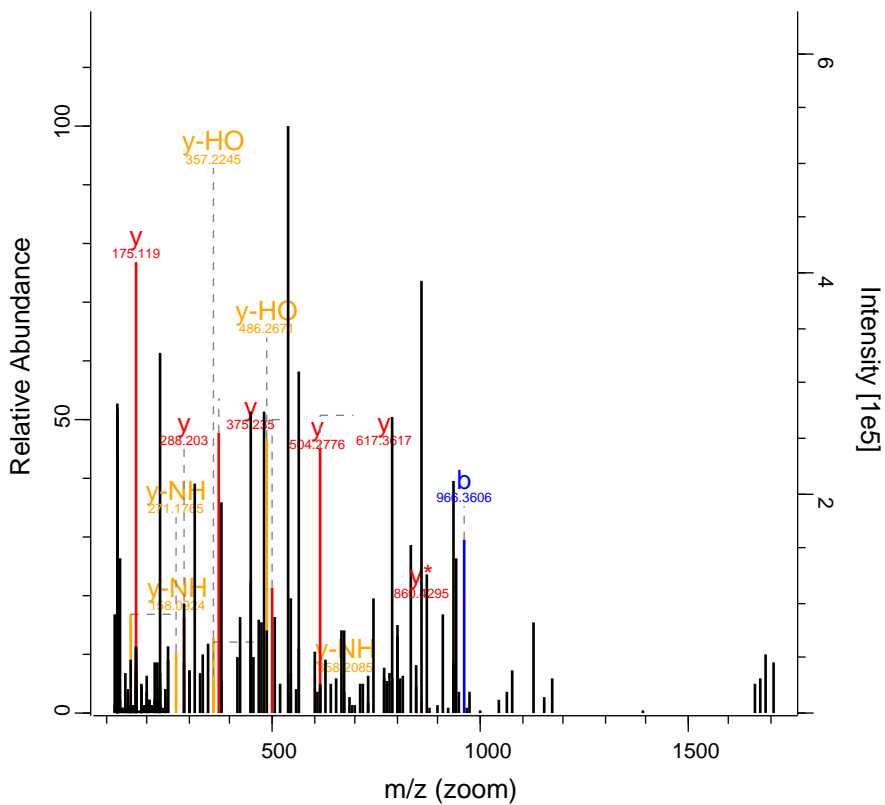

R -

RO-QC-160121_ZackD_SS_Set_01_Fraccio 35822 FTMS; HC 107.75 929.72 PPA2

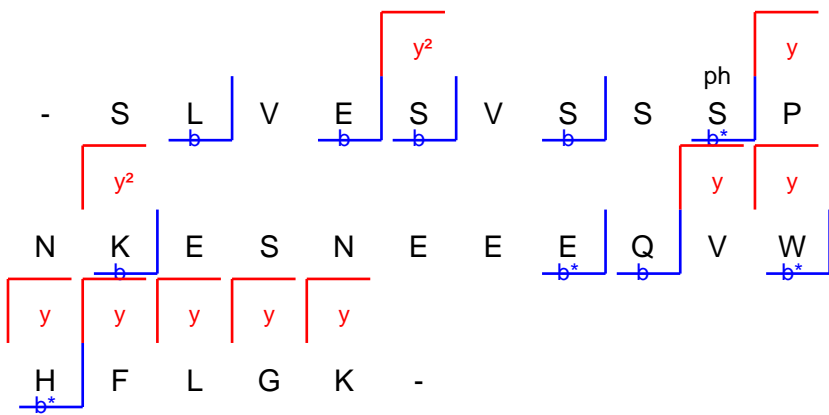
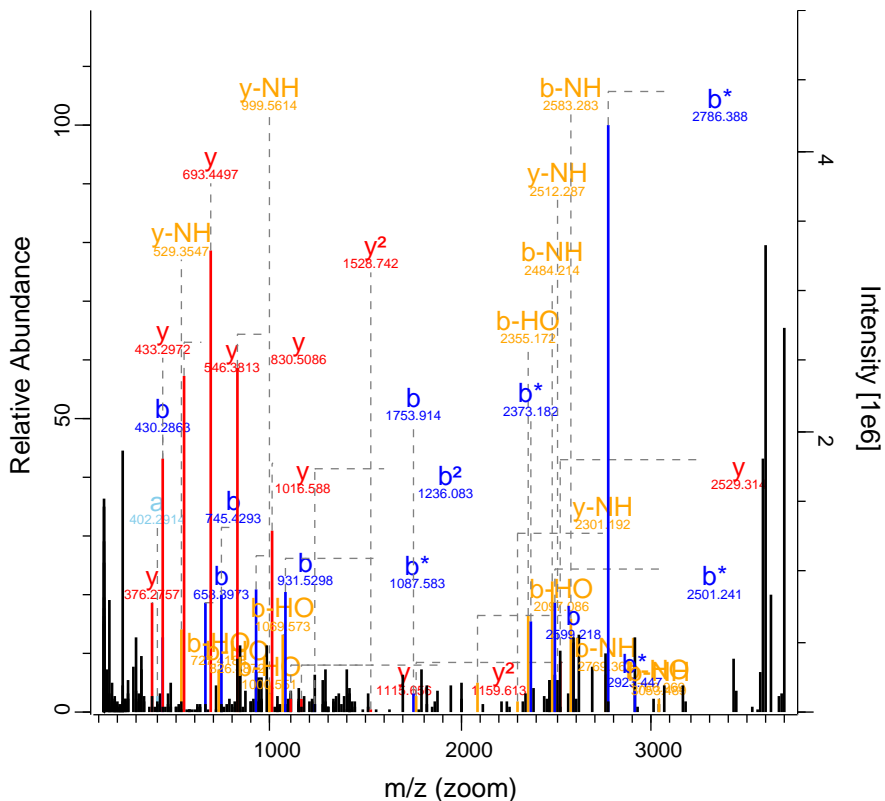

RO-QC-160121_ZackD_SS_Set_01_Fractic 36357 FTMS; HC 89.55 1230.64 NEK10

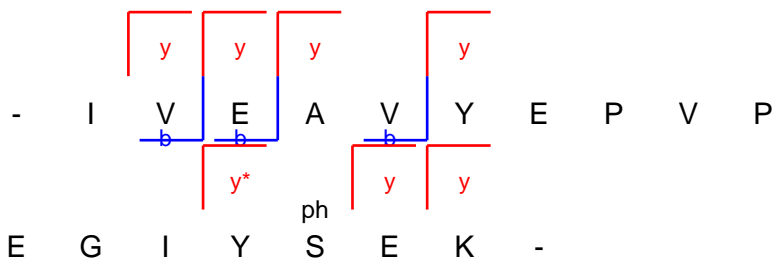
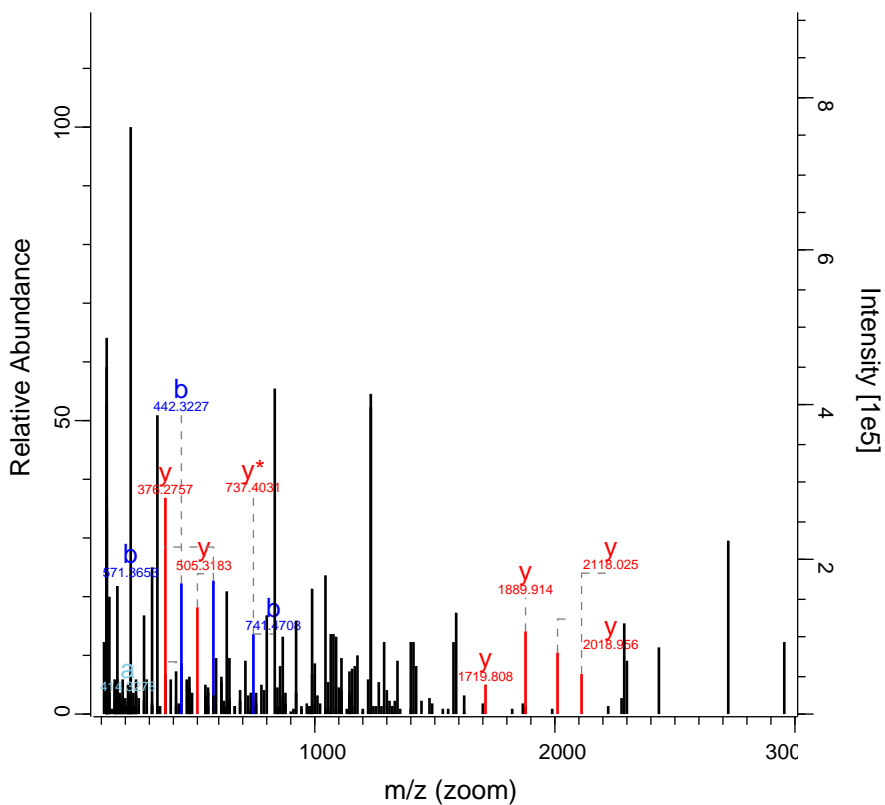

RO-QC-160121_ZackD_SS_Set_01_Fractic 36527 FTMS; HC 134.14 1065.54 PAK4

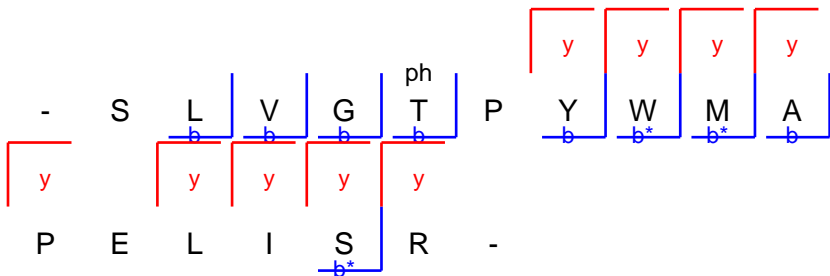
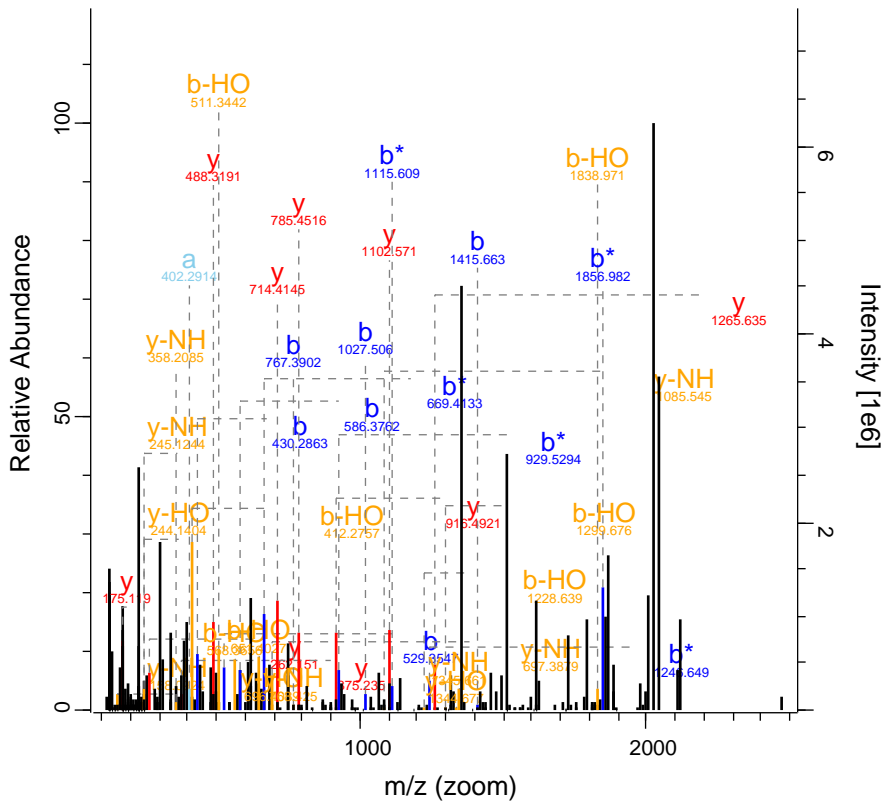

RO-QC-160121_ZackD_SS_Set_01_Fraction36550 FTMS; HC 65.28 837.93 DYNC112

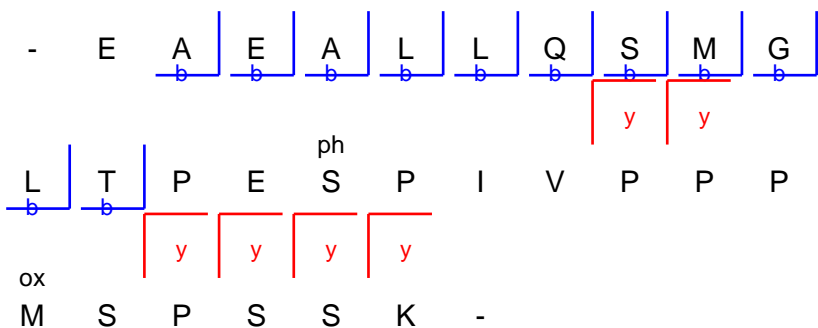
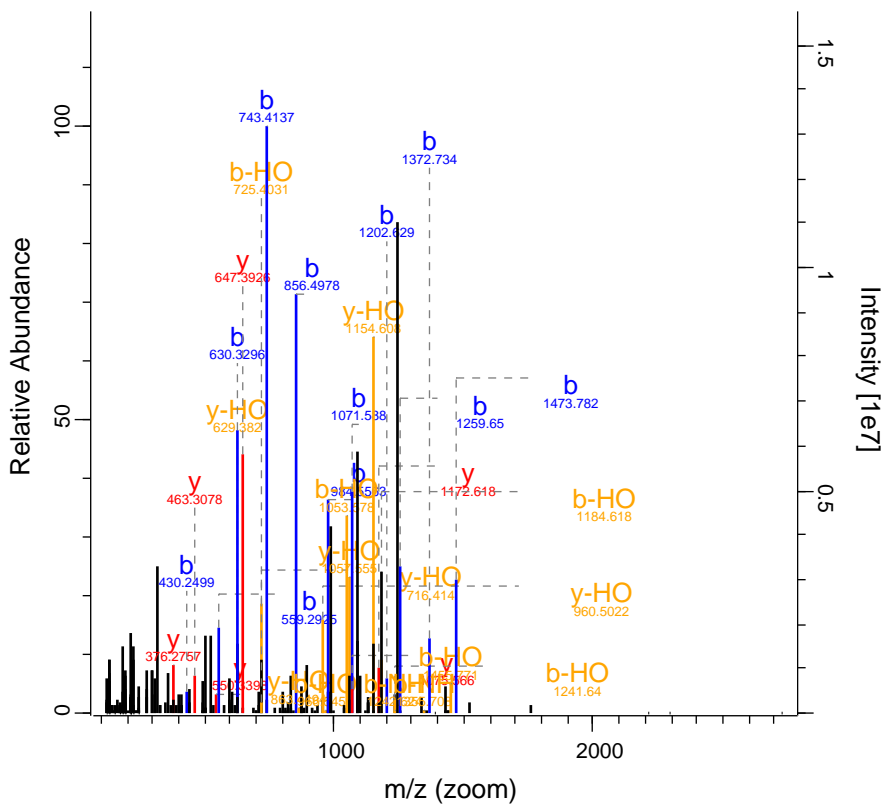

RO-QC-160121_ZackD_SS_Set_01_Fraction 3665 FTMS; HCl; 51.21 479.73 SLC8A3

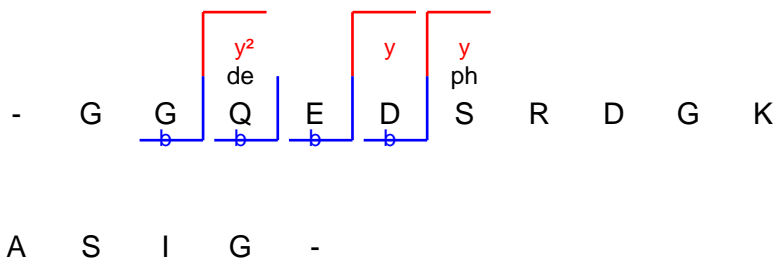
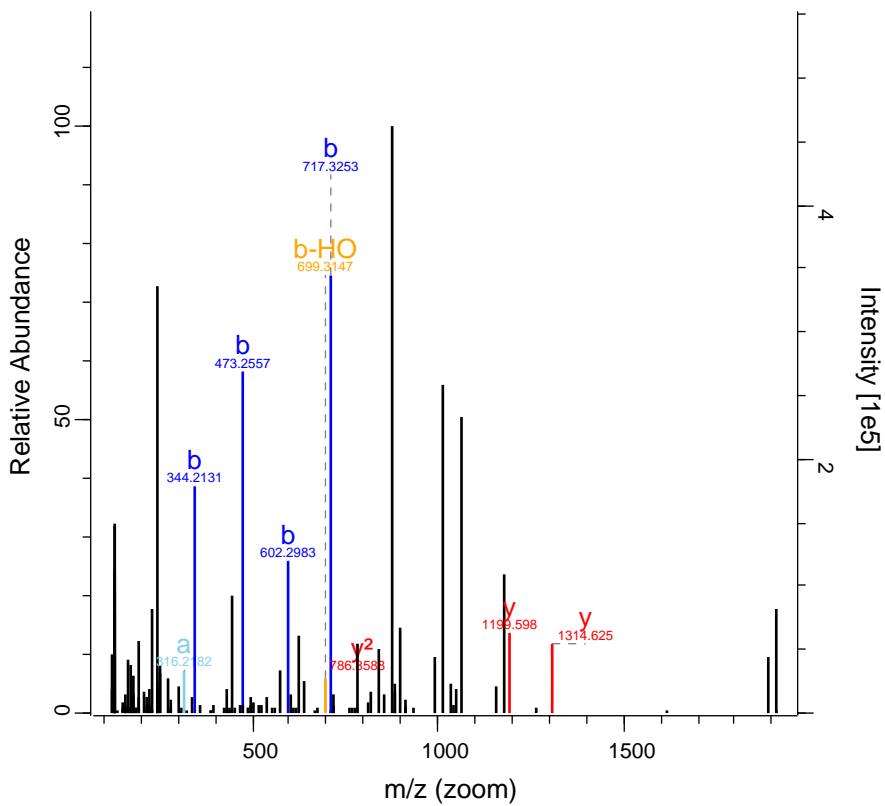

RO-QC-160121_ZackD_SS_Set_01_Fraction 4761 FTMS; HCl 45.08 811.13 MYCBP2

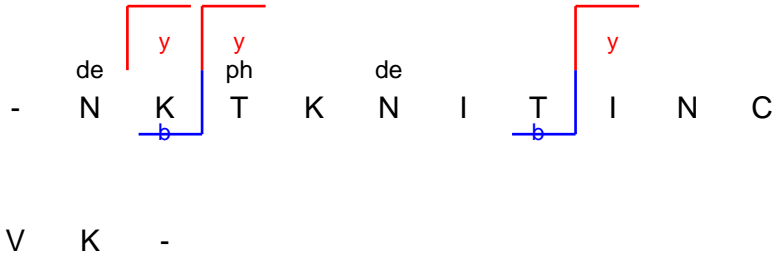
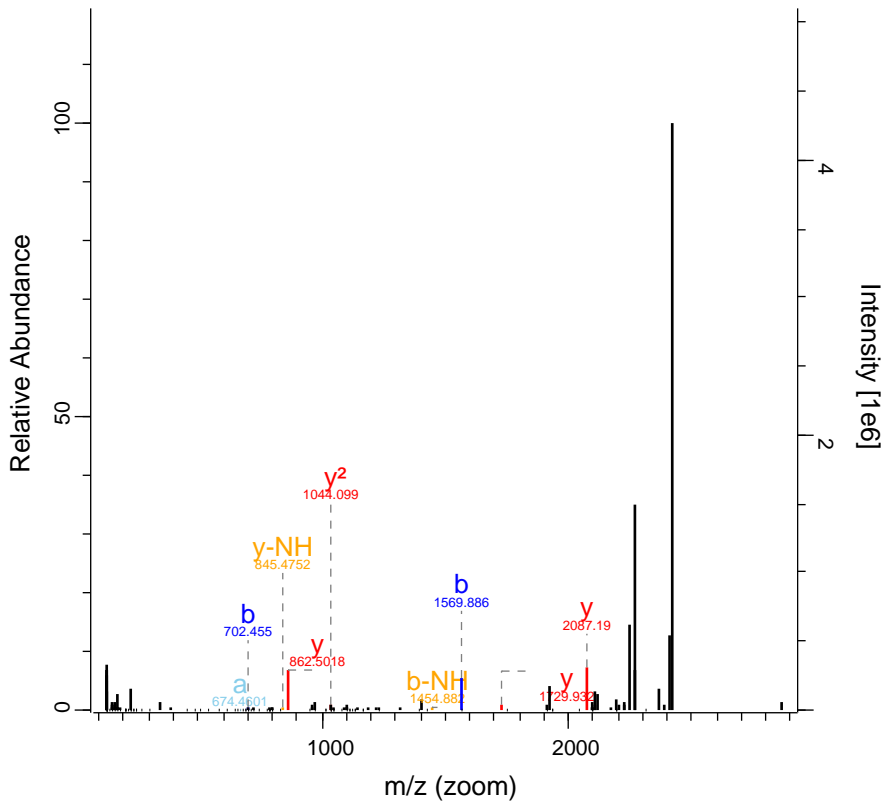

RO-QC-160121_ZackD_SS_Set_01_Fraction 5422 FTMS; HCl 41.98 786.39 HAS1

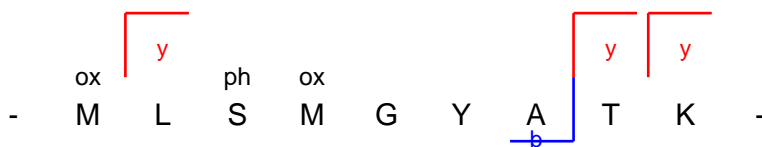
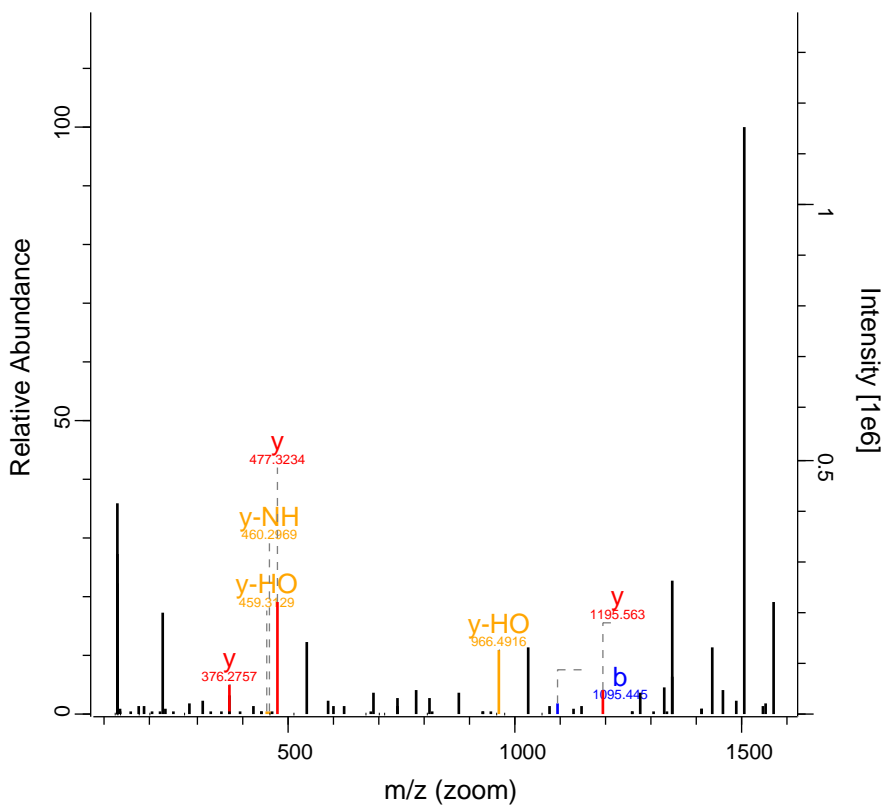

RO-QC-160121_ZackD_SS_Set_01_Fraction 5831 FTMS; HCl 78.24 646.98 C18orf25

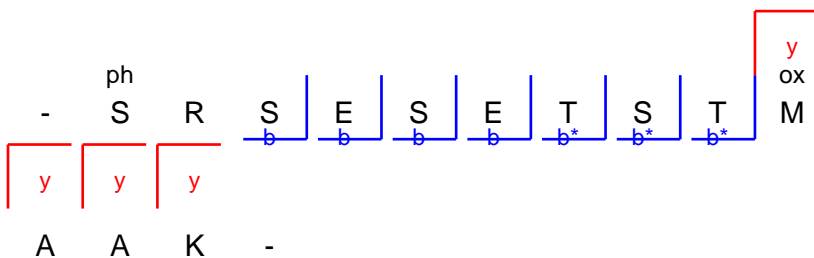
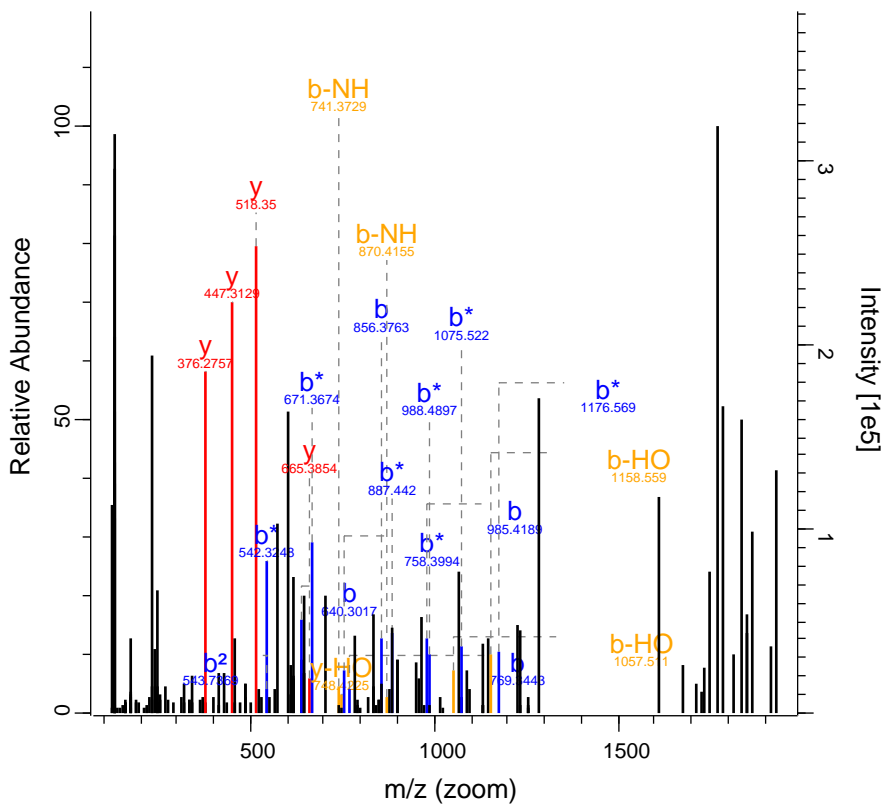

RO-QC-160121_ZackD_SS_Set_01_Fraction7000 FTMS; HC 128.81 782.87 SRRM2

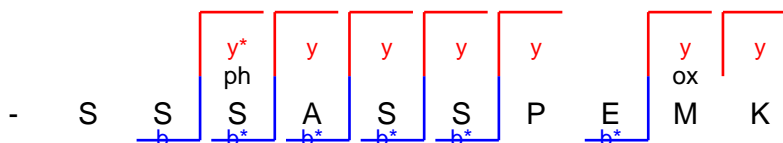
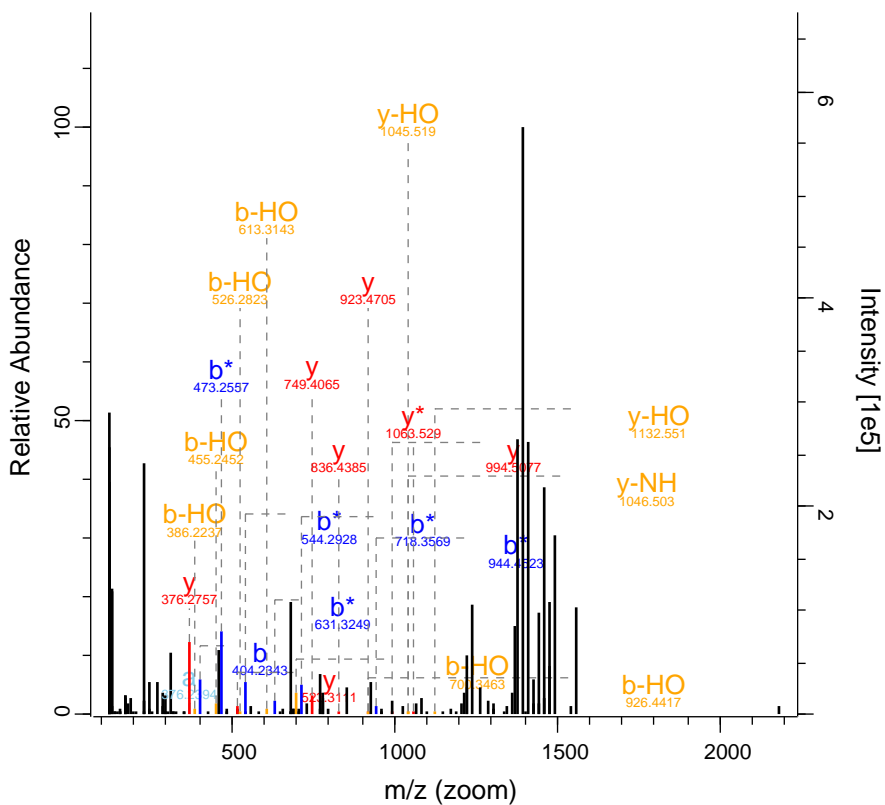

RO-QC-160121_ZackD_SS_Set_01_Fraction 7384 FTMS; HCl 81.45 605.67 CCDC86

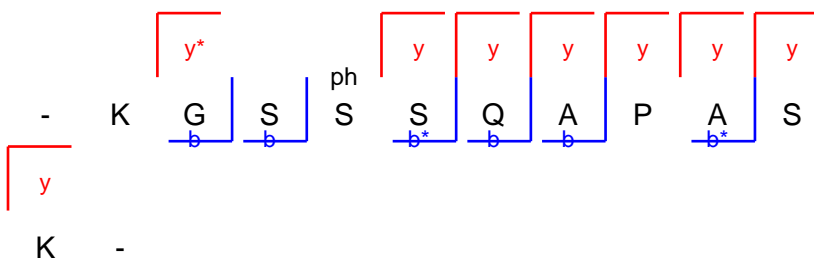
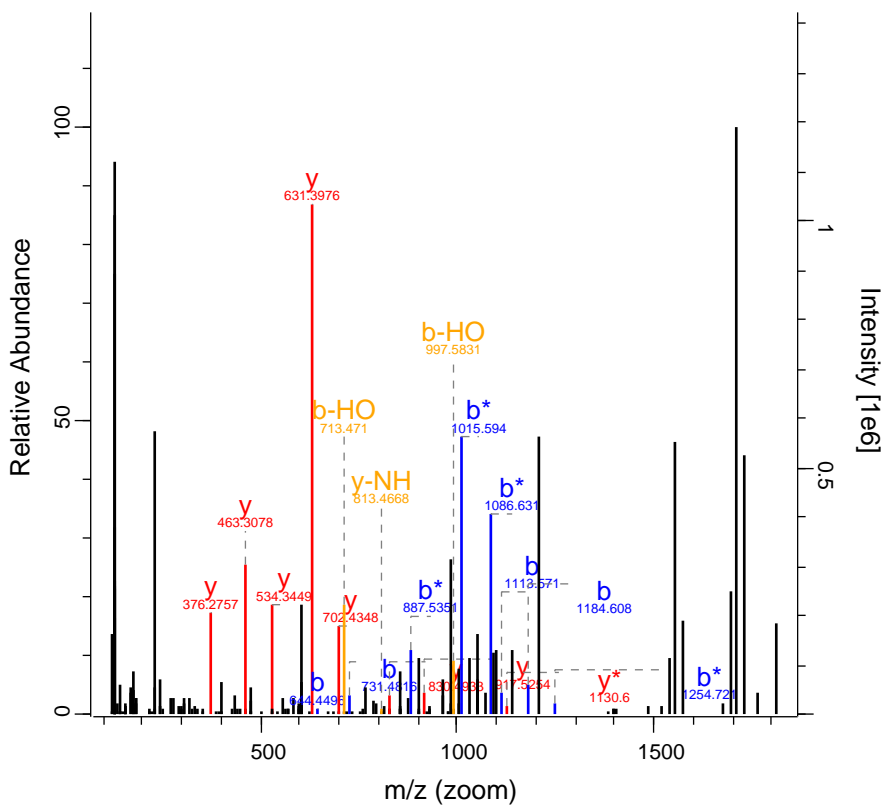

RO-QC-160121_ZackD_SS_Set_01_Fractio 7387 FTMS; HC 124.43 1110.52 EIF4B

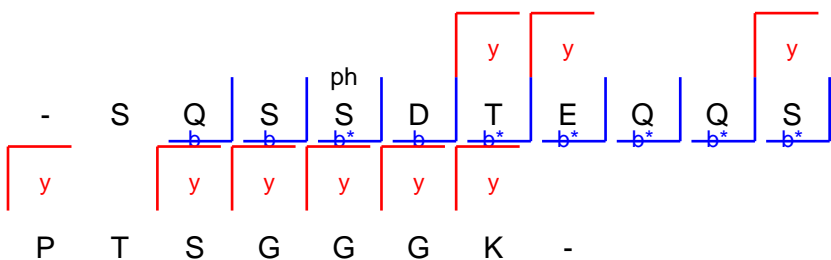
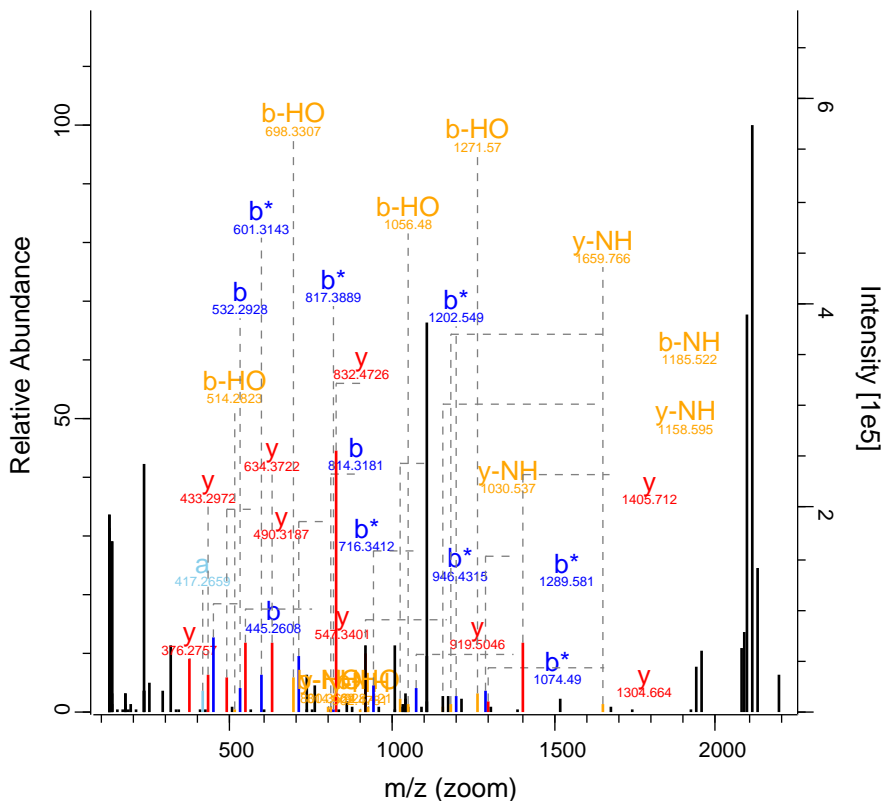

RO-QC-160121_ZackD_SS_Set_01_Fraction 7713 FTMS; HCl 65.11 648.36 SLTM

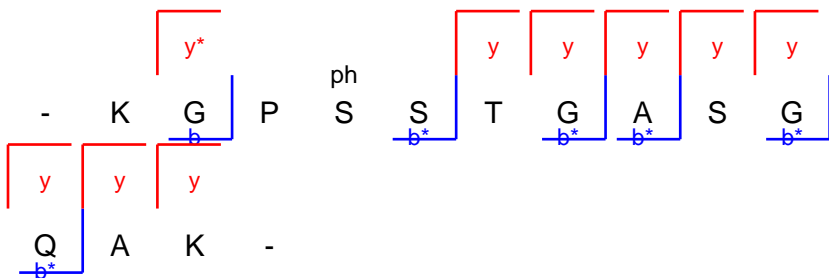
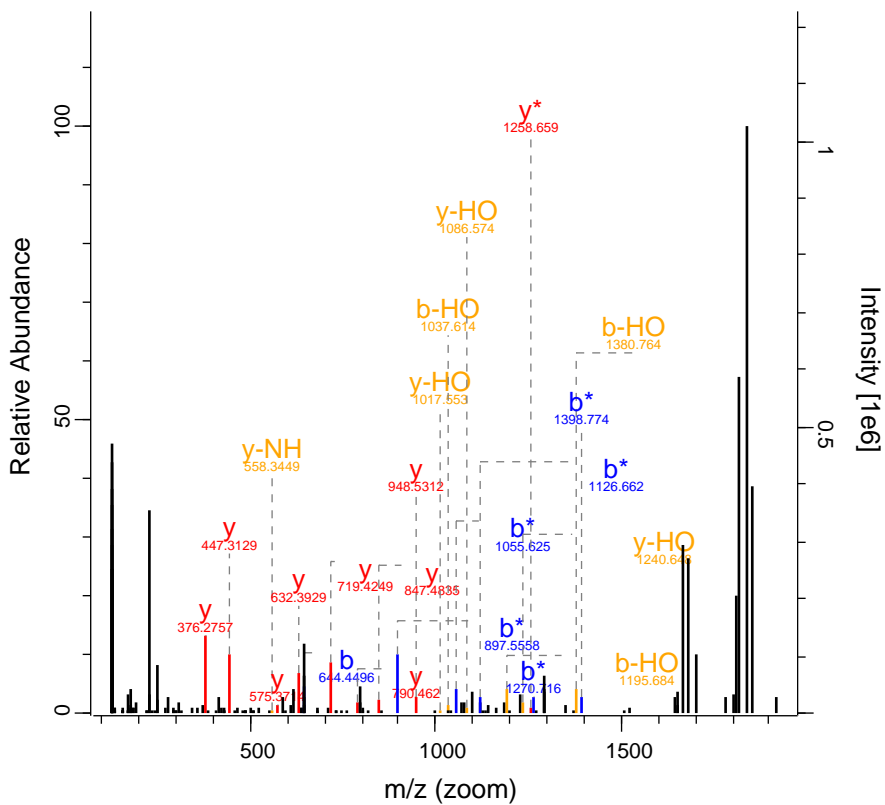

RO-QC-160121_ZackD_SS_Set_01_Fraction 10414 FTMS; HC 71.56 817.44 PRRC2A

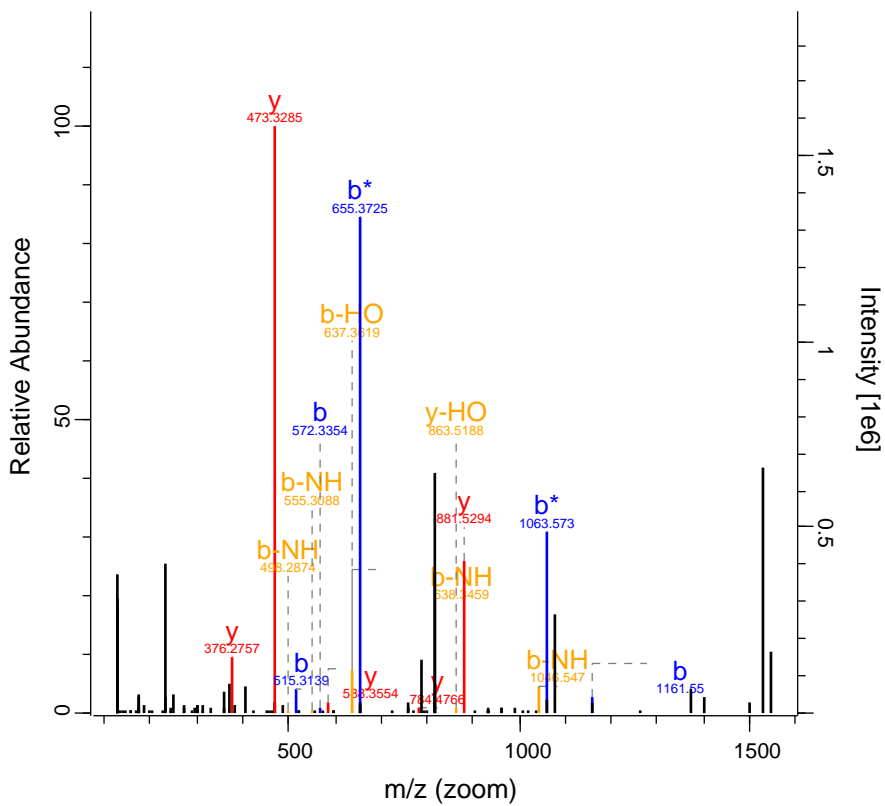

m/z (zoom)

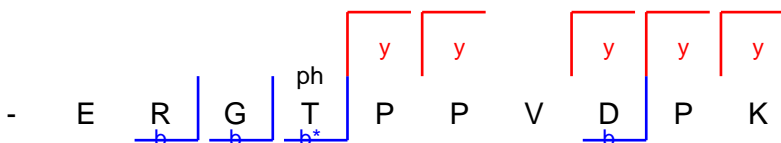

RO-QC-160121_ZackD_SS_Set_01_Fractio 10501 FTMS; HC 104.44 711.74 CC2D1A

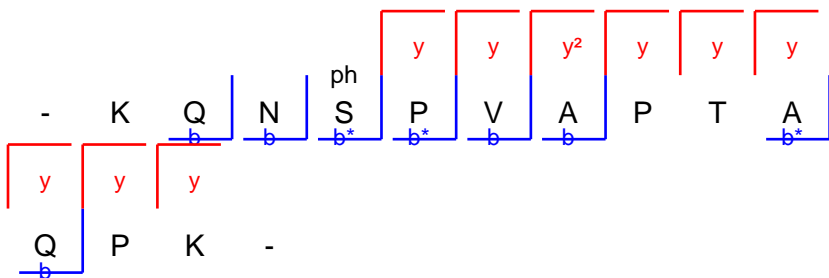
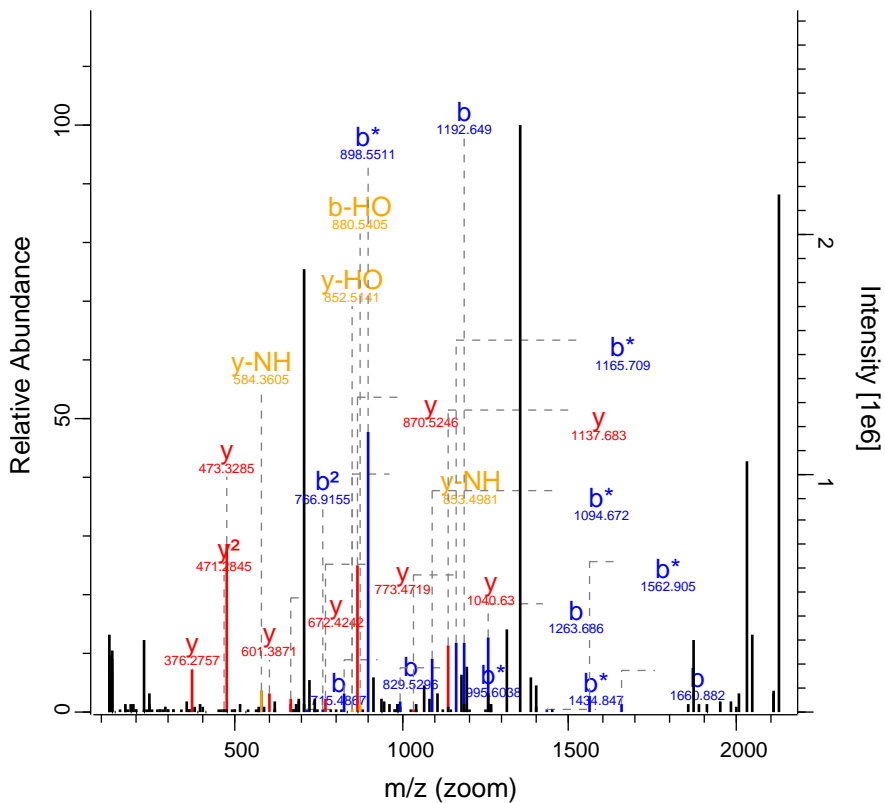

RO-QC-160121_ZackD_SS_Set_01_Fraction 11460 FTMS; HCl44.45 761.4 ZNF490

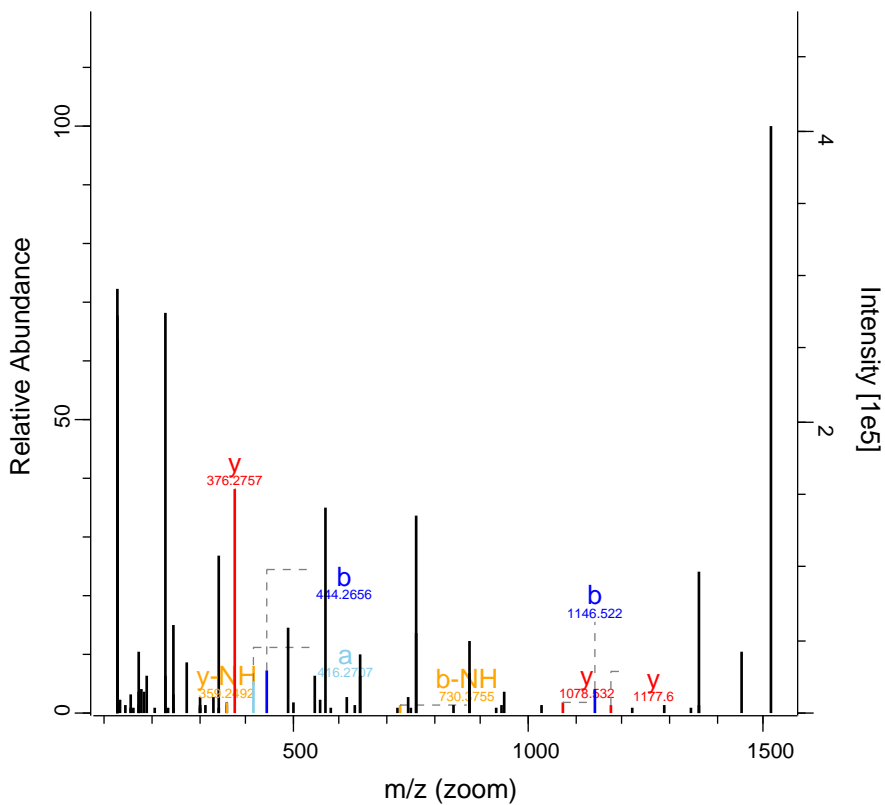

RO-QC-160121_ZackD_SS_Set_01_Fraction11663 FTMS; HC 98.82 741.71 PI4KB

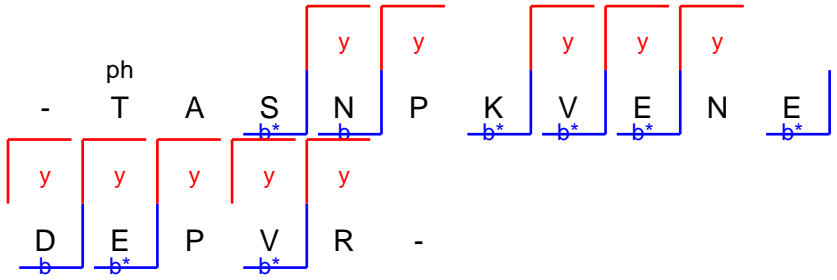
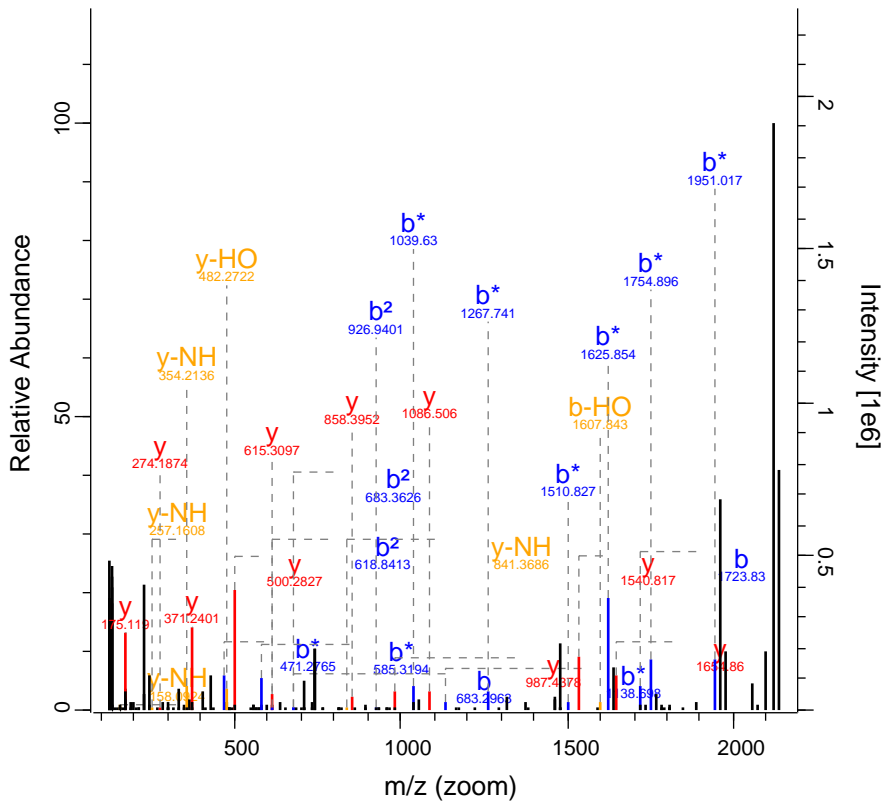

RO-QC-160121_ZackD_SS_Set_01_Fraction 11792 FTMS; HC 135.13 919.48 HNRNPA1

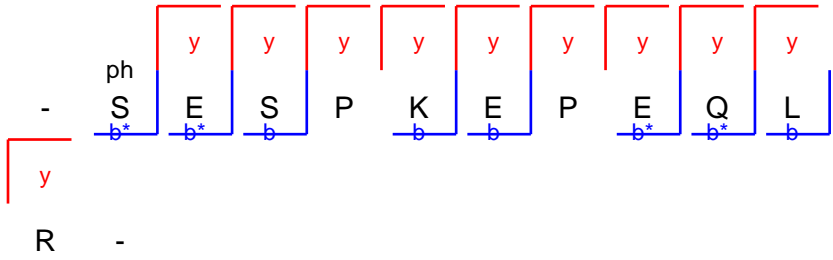
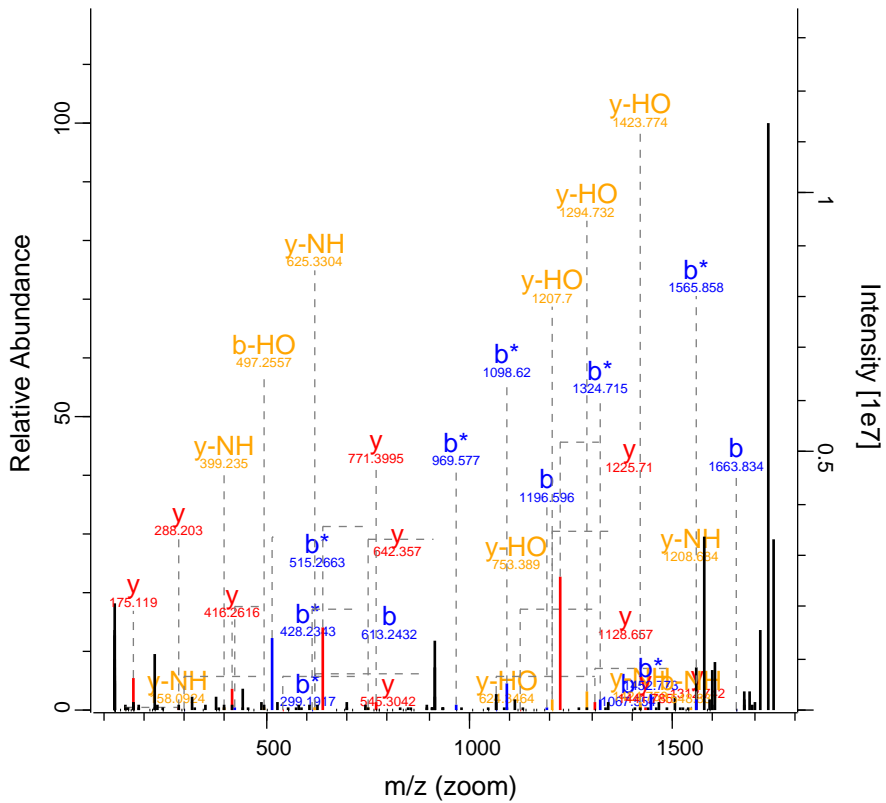

RO-QC-160121_ZackD_SS_Set_01_Fraction 15026 FTMS; HC 58.68 744.04 CNTLN

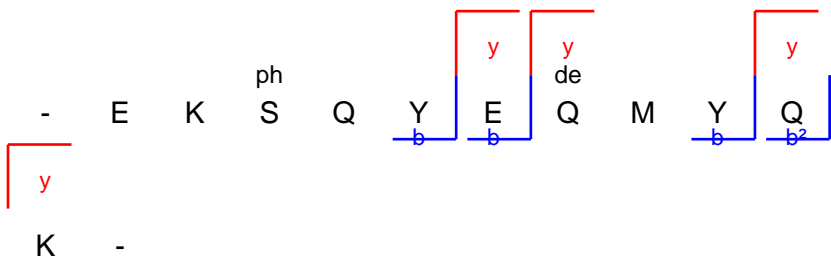
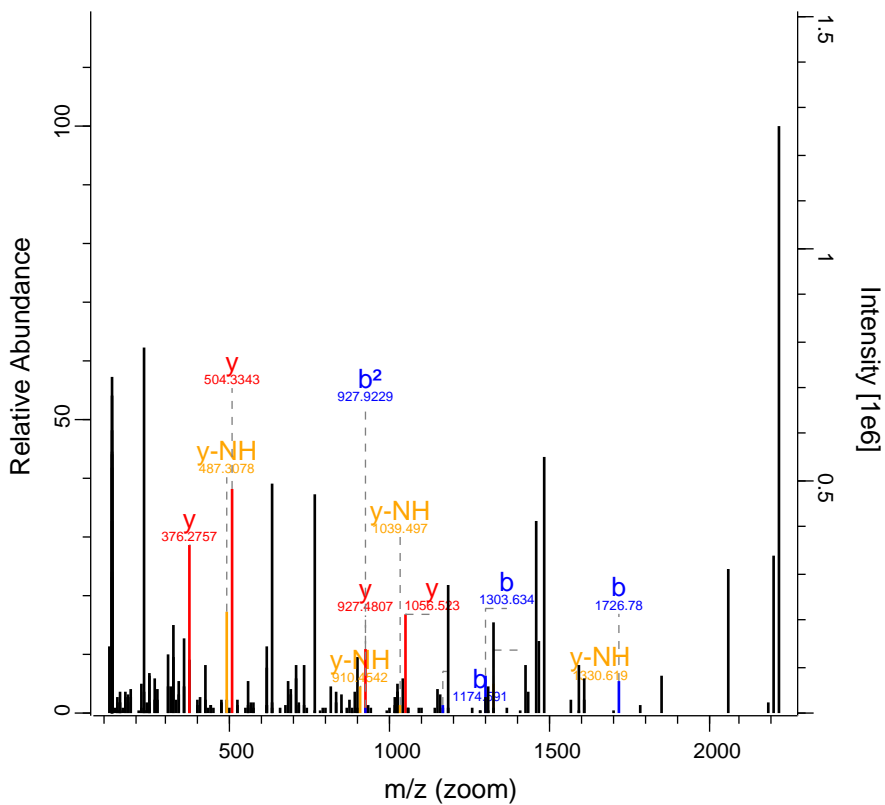

K -

RO-QC-160121_ZackD_SS_Set_01_Fraction 15436 FTMS; HC 124.3 956.48 PCIF1

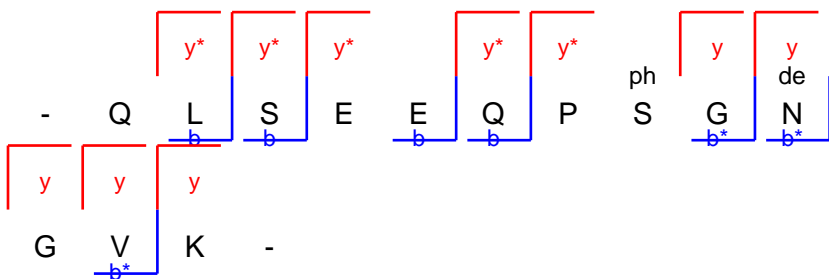
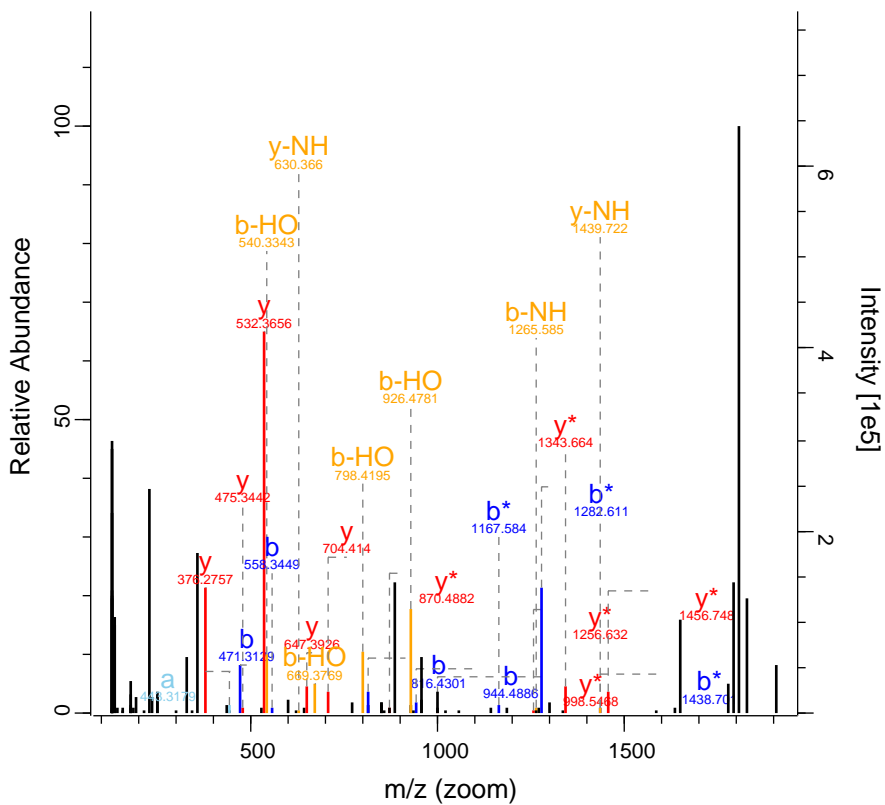

RO-QC-160121_ZackD_SS_Set_01_Fractic 16678 FTMS; HC 141.6 1281.66 HIST1H1B

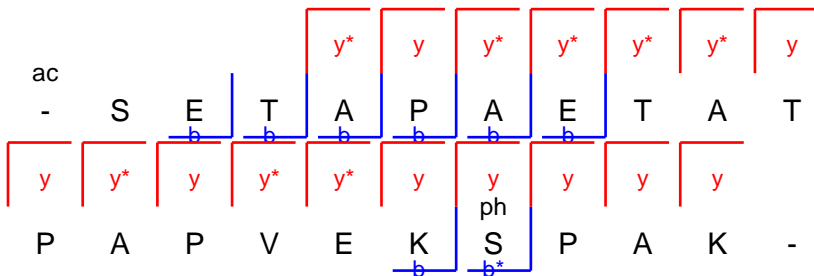
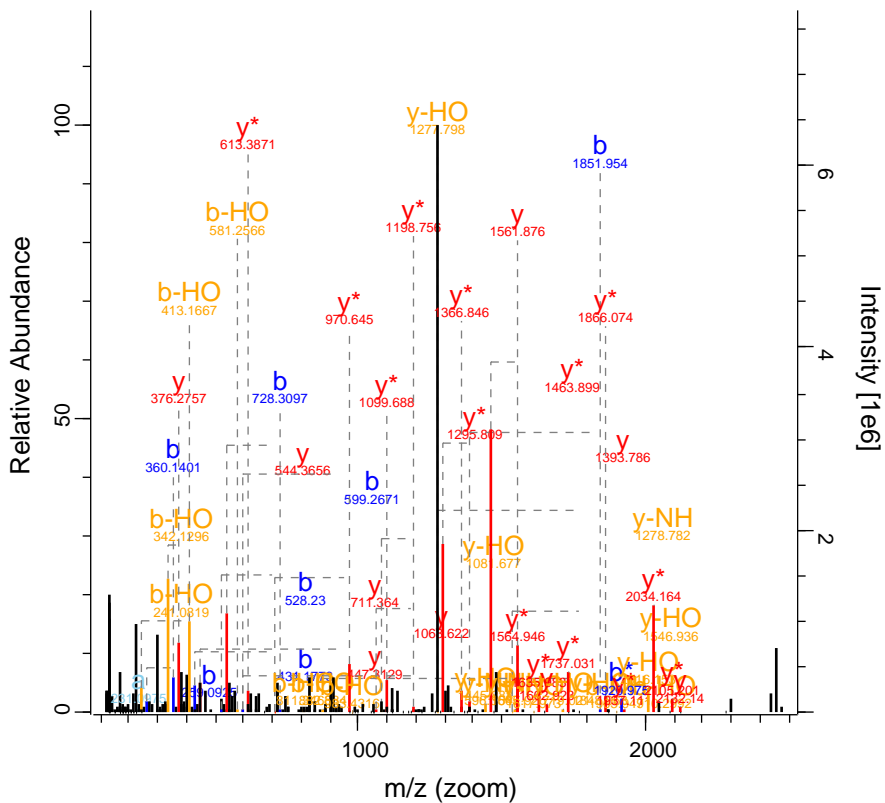

RO-QC-160121_ZackD_SS_Set_01_Fractio 17314 FTMS; HC 117.09 846.44 BRD3

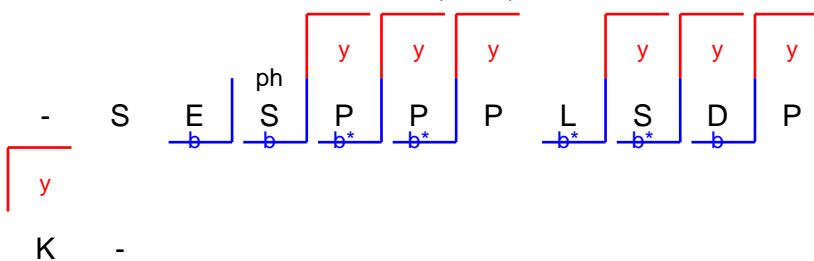
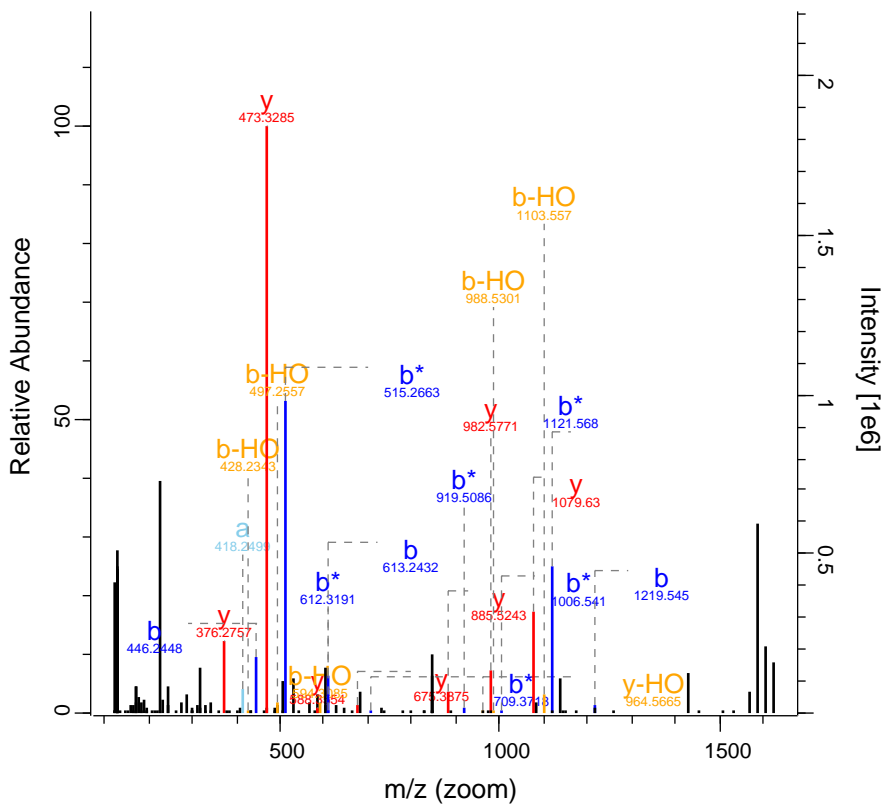

RO-QC-160121_ZackD_SS_Set_01_Fractio 17980 FTMS; HC 132.79 975.42 EIF5B

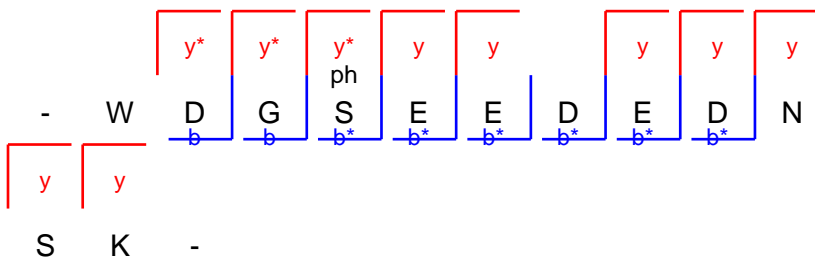
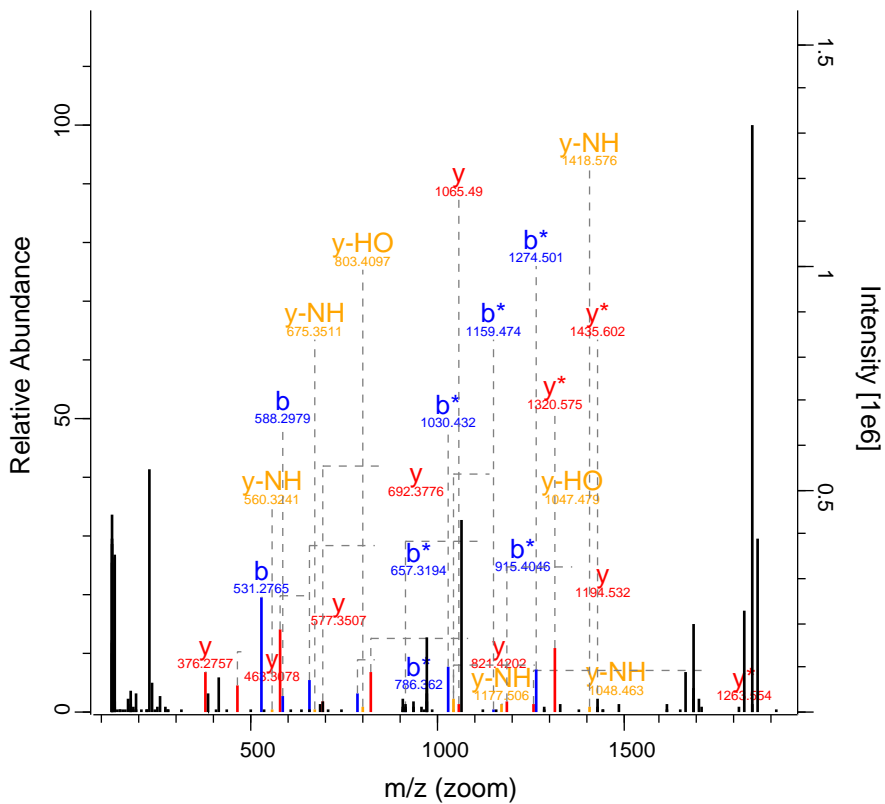

RO-QC-160121_ZackD_SS_Set_01_Fractio 18580 FTMS; HC 134.49 692.86 HSPB1

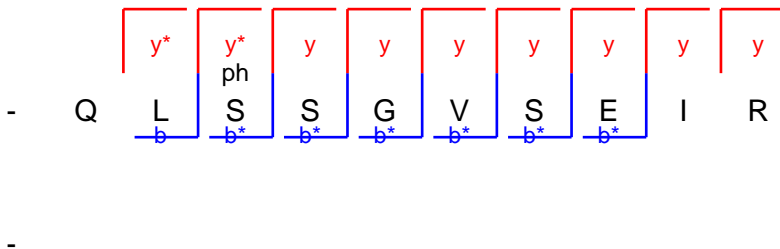
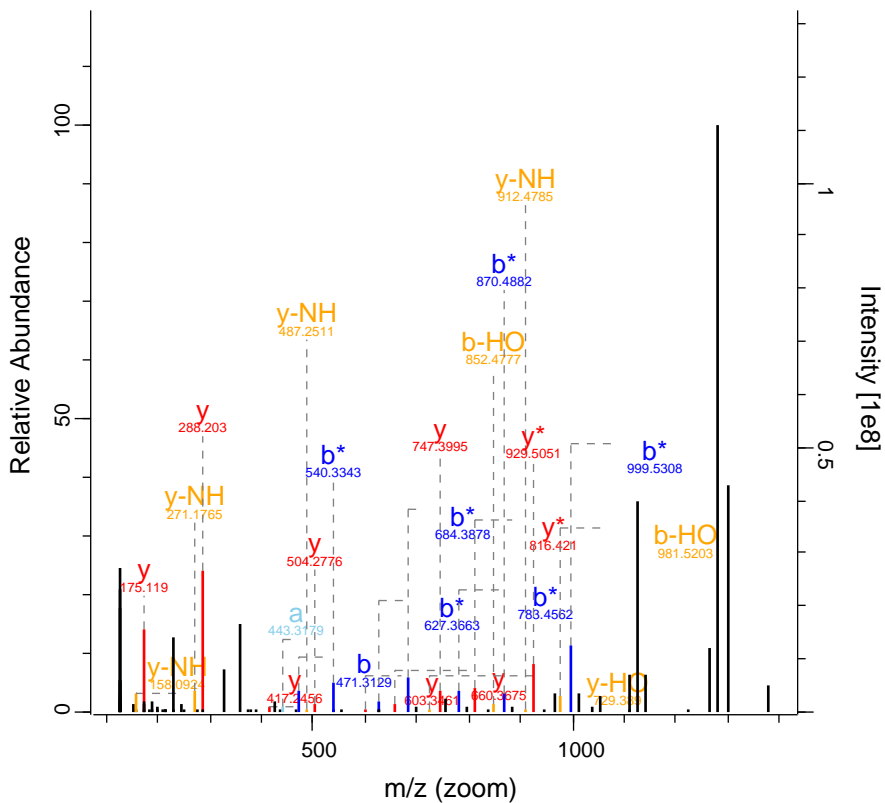

RO-QC-160121_ZackD_SS_Set_01_Fractic 19103 FTMS; HC 45.66 1173.57 LRRC28

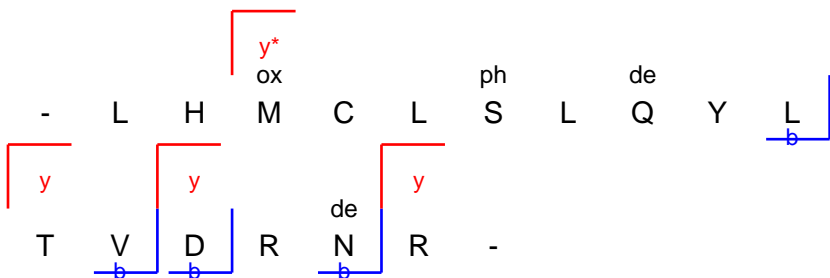
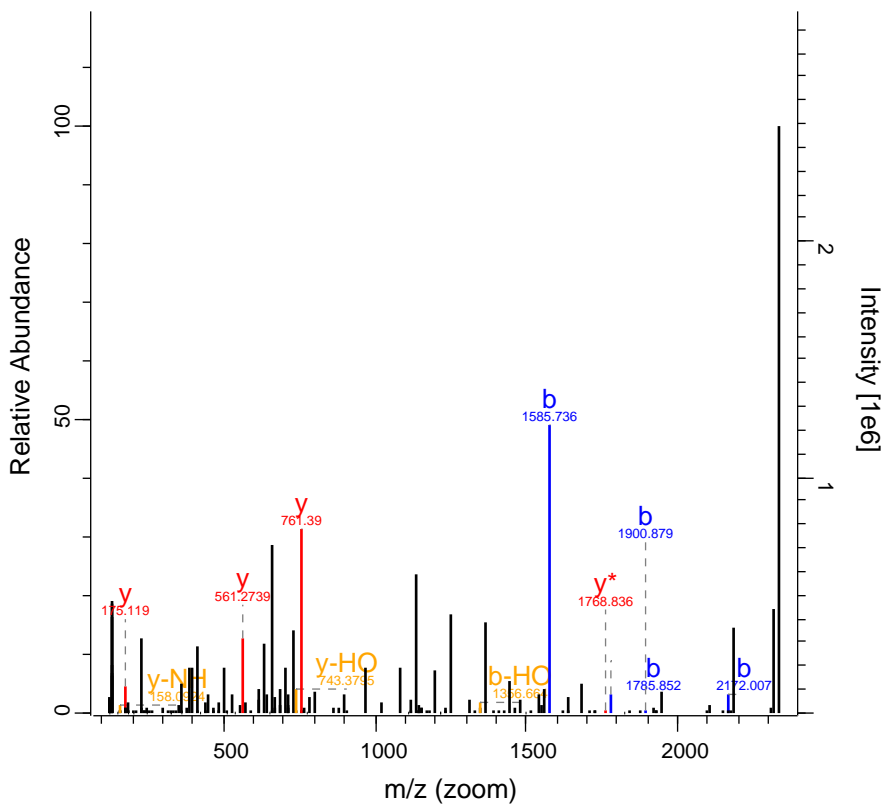

RO-QC-160121_ZackD_SS_Set_01_Fraction 20831 FTMS; HC 66.06 1235.1 HELT

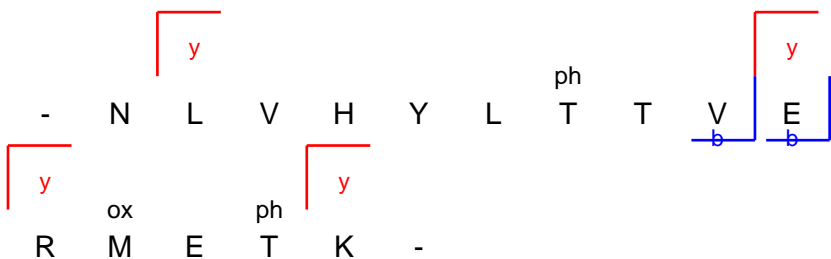
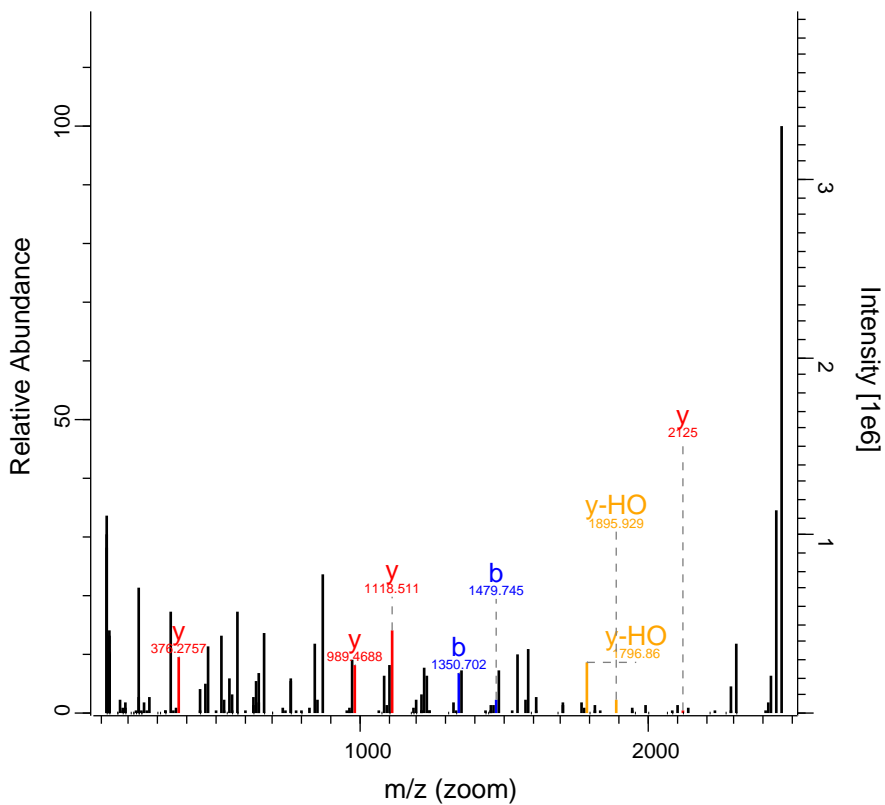

RO-QC-160121_ZackD_SS_Set_01_Fraction 20872 FTMS; HC 47.07 689.86 CNKSR1

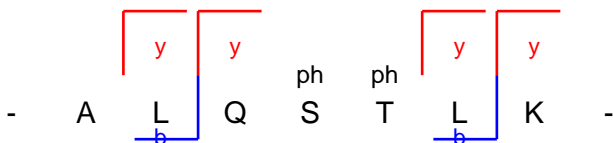
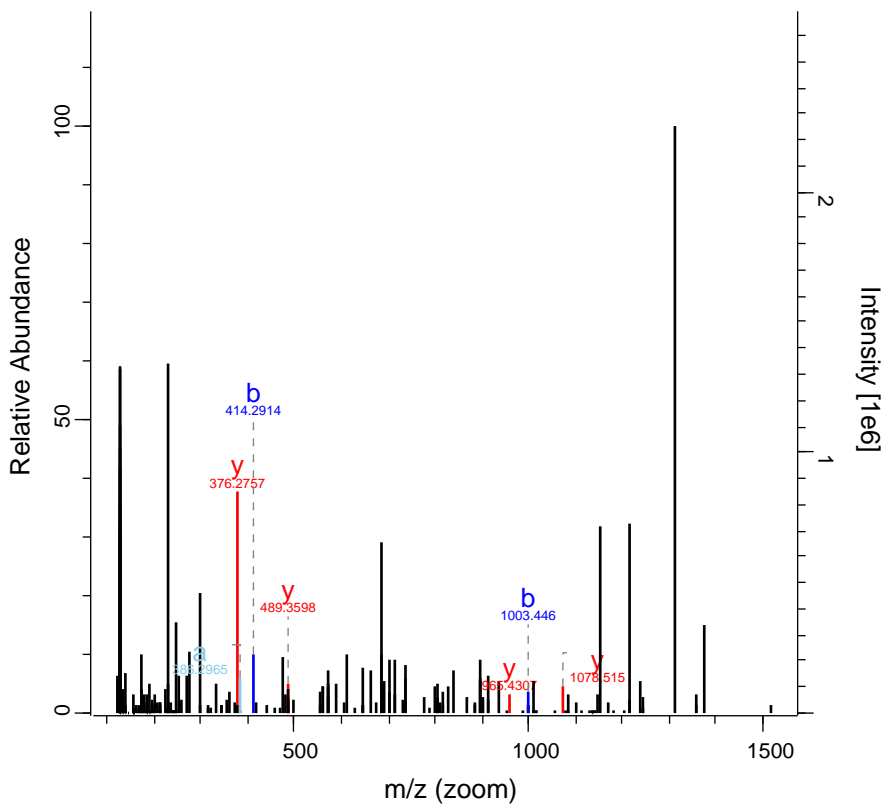

RO-QC-160121_ZackD_SS_Set_01_Fraction 21184 FTMS; HC 43 471.91 NKPD1

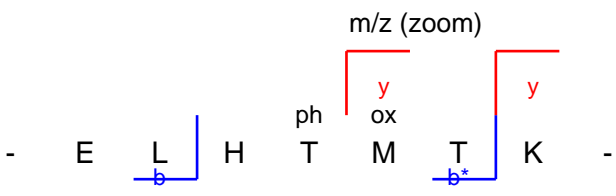
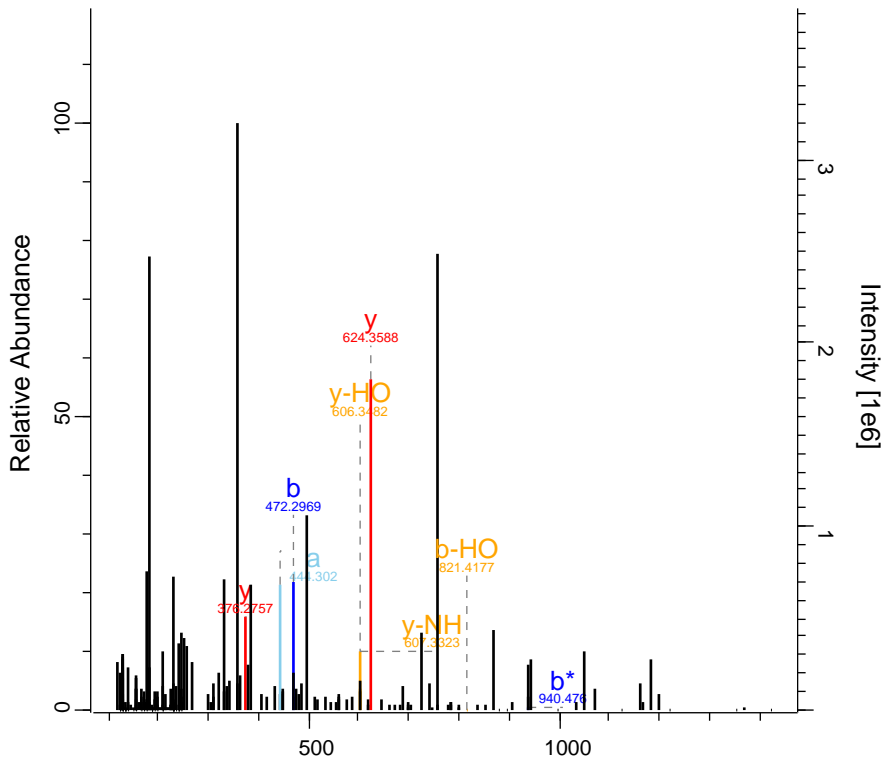

RO-QC-160121_ZackD_SS_Set_01_Fratio 21416 FTMS; HC 178.43 887.72 FBXW9

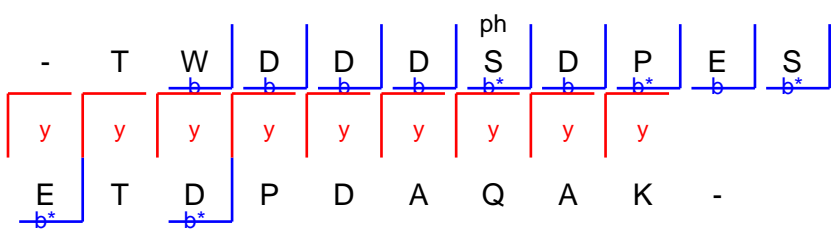
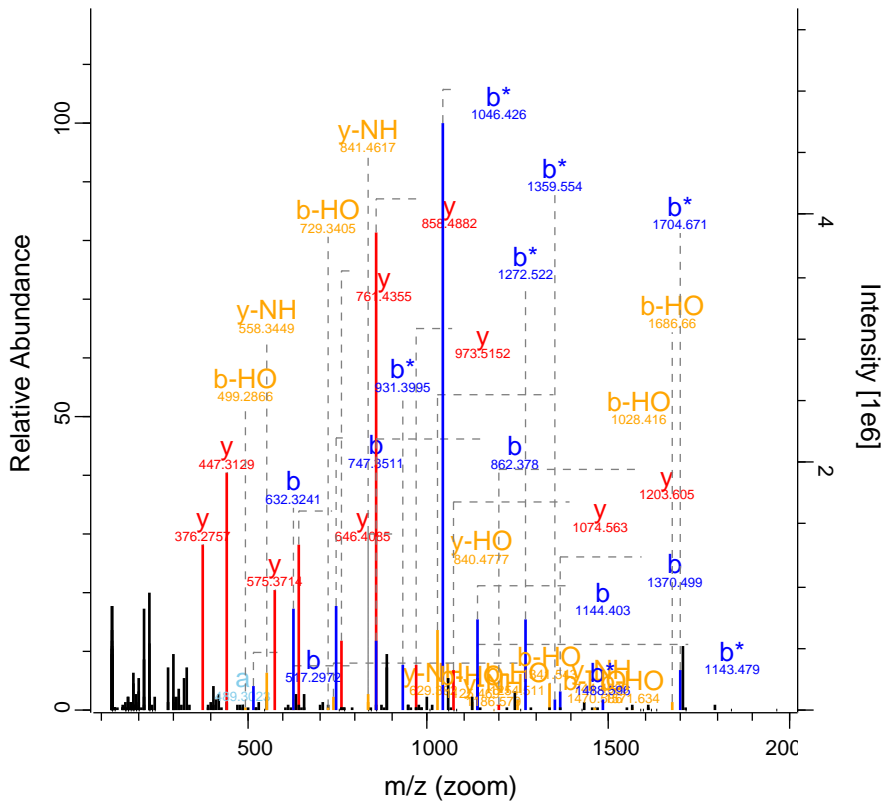

RO-QC-160121_ZackD_SS_Set_01_Fractio 21560 FTMS; HC 107.08 867.49 ZYX

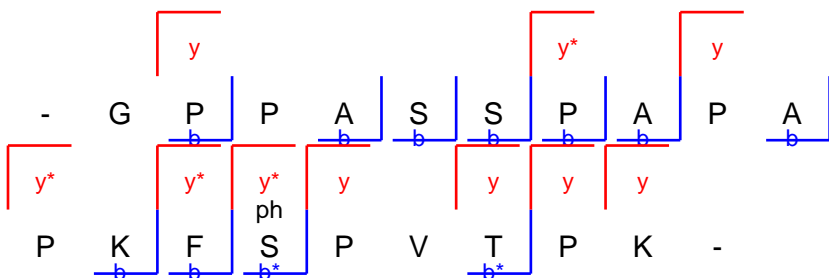
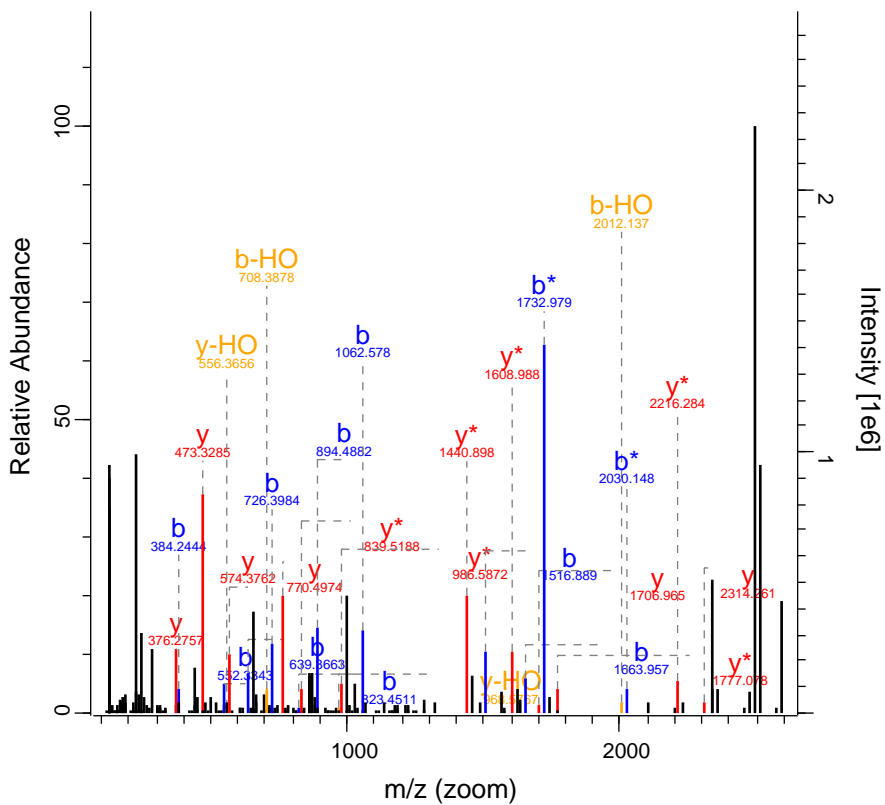

RO-QC-160121_ZackD_SS_Set_01_Fraction22835 FTMS; HC 60.81 890.42 CCDC132

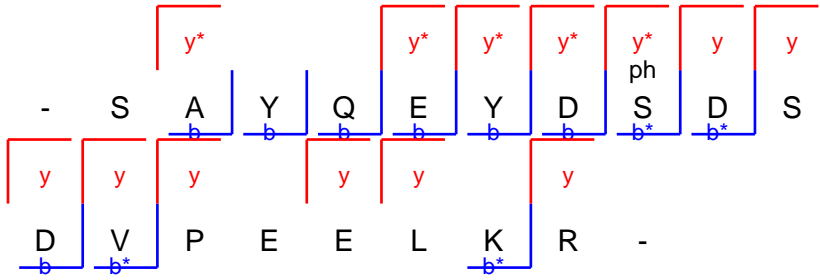
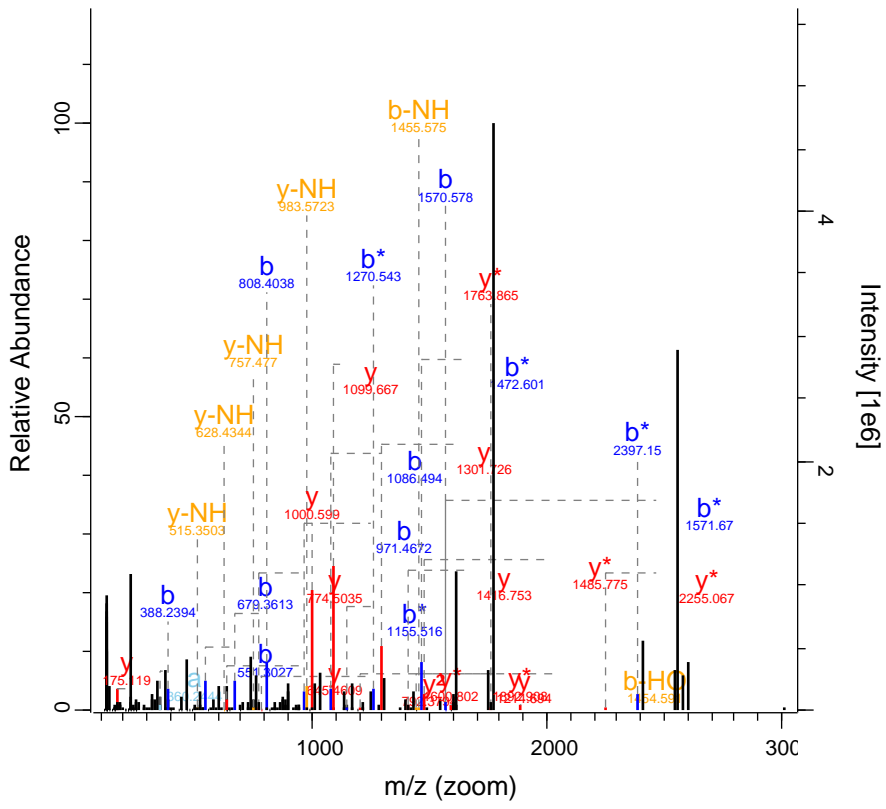

RO-QC-160121_ZackD_SS_Set_01_Fraction 24846 FTMS; HC 99.83 563.64 CDK18

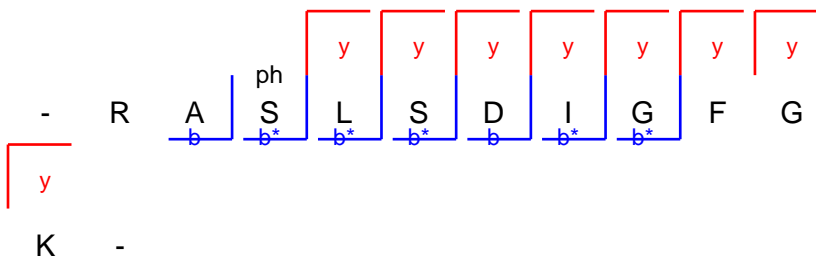
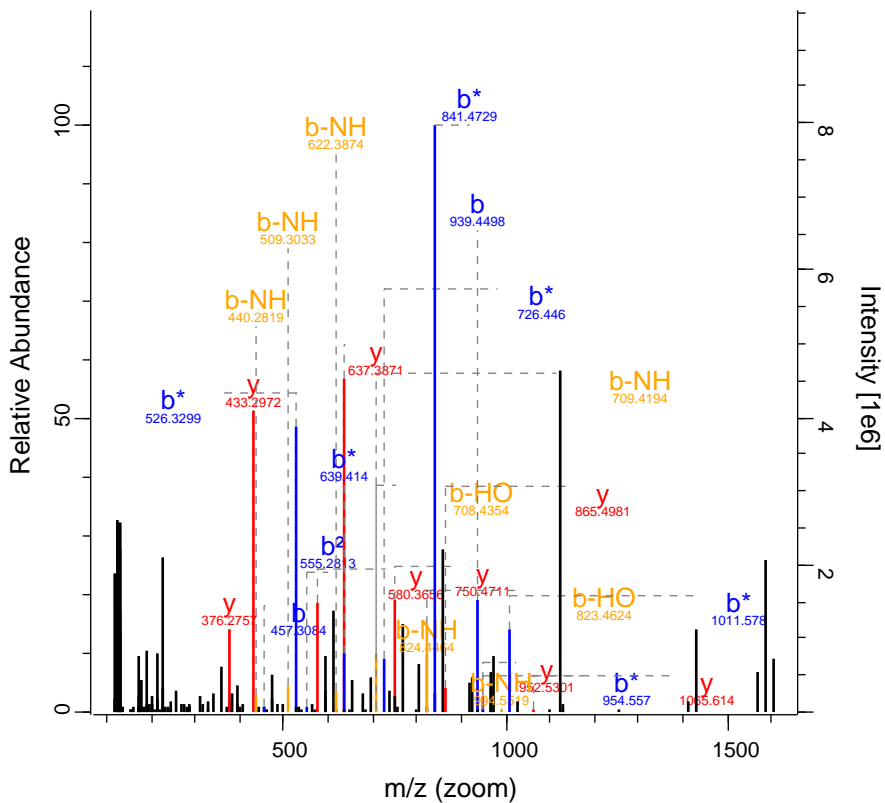

RO-QC-160121_ZackD_SS_Set_01_Fraction 26651 FTMS; HC 100 967.44 MAP1A

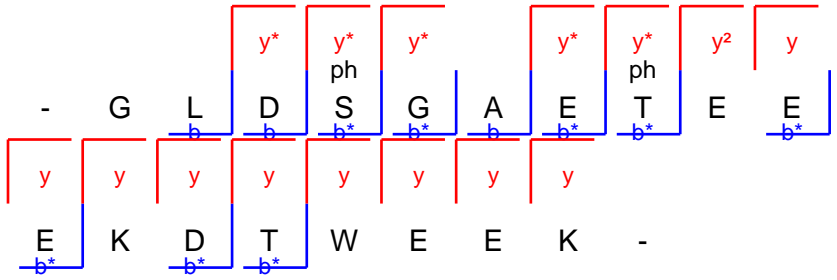
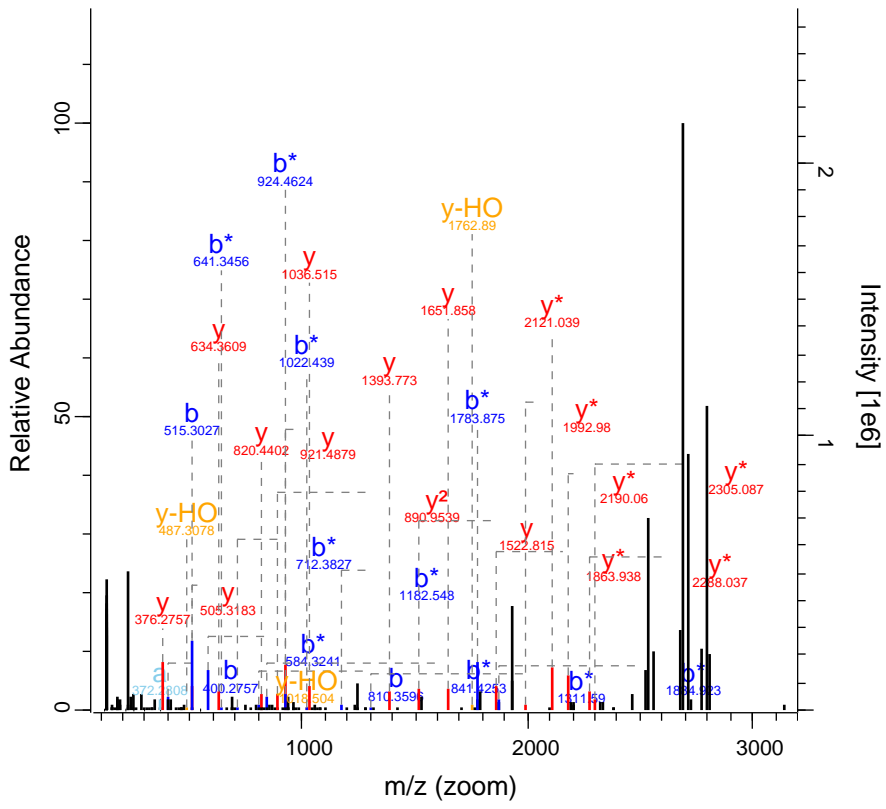

- G L D S G A E T E E
 y y y y y y y y
 E K D T W E E K -
 b* b* b* b* b* b* b* b*

RO-QC-160121_ZackD_SS_Set_01_Fraction 26674 FTMS; HC 49.5 1164.1 KCNQ1

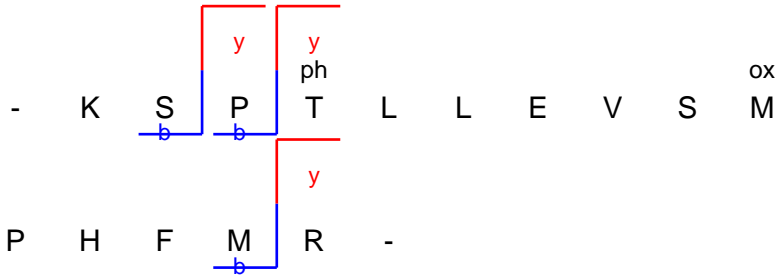
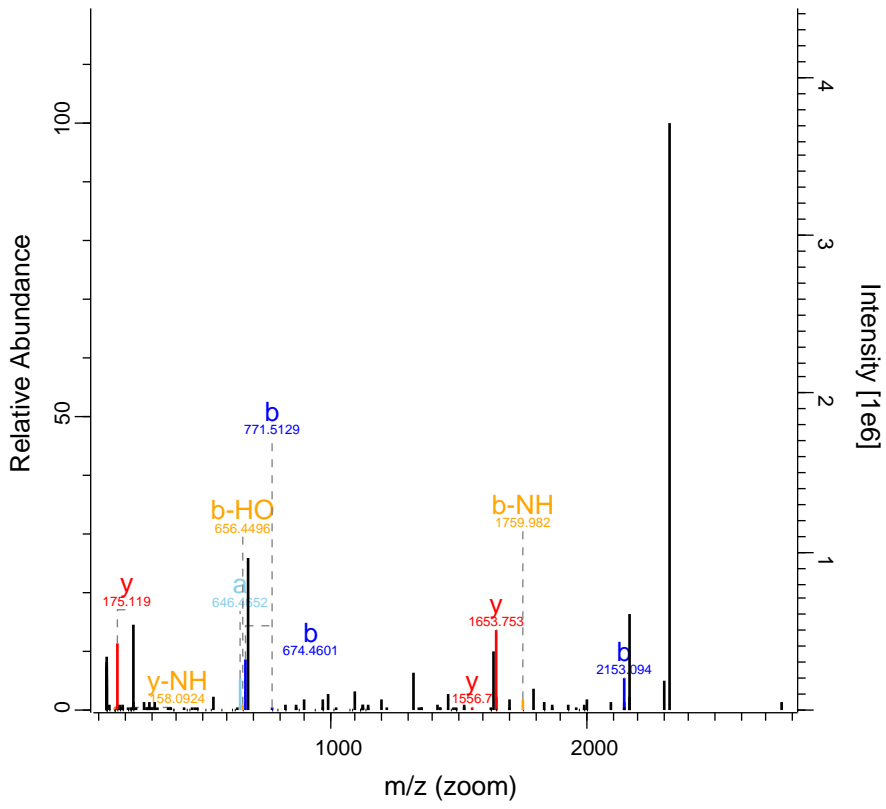

RO-QC-160121_ZackD_SS_Set_01_Fraction 27451 FTMS; HC 45.86 694.63 PCNT

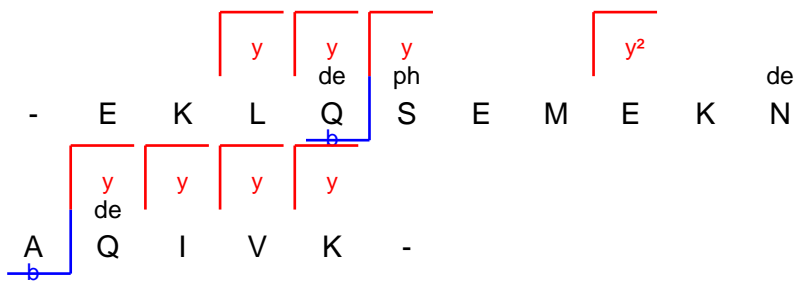
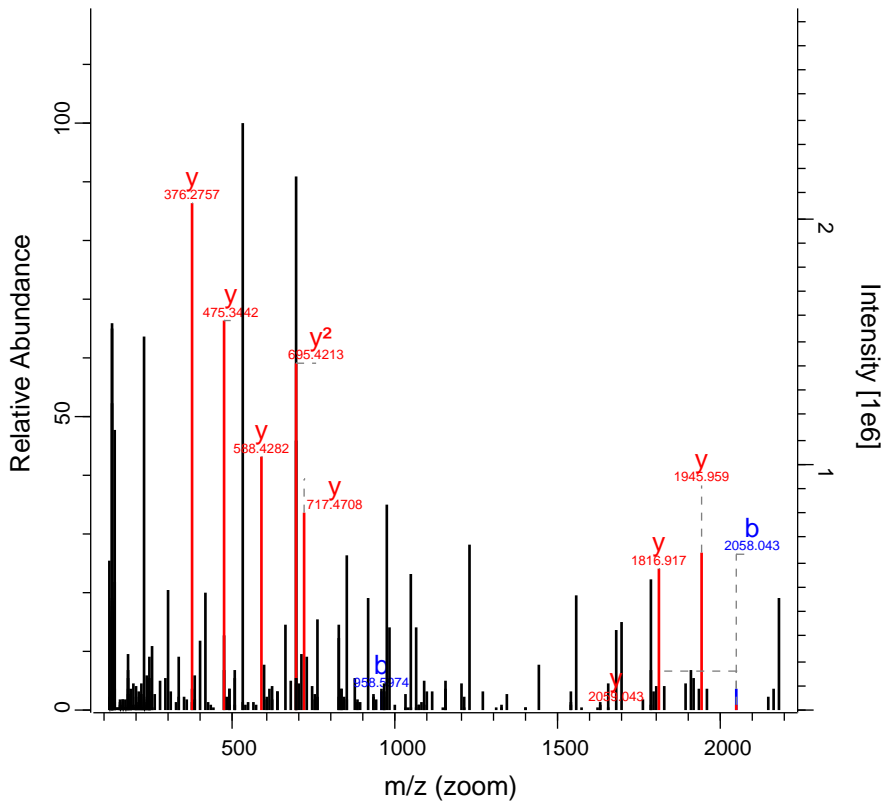

RO-QC-160121_ZackD_SS_Set_01_Fractic 27781 FTMS; HC 68.17 1001.02 TERF2IP

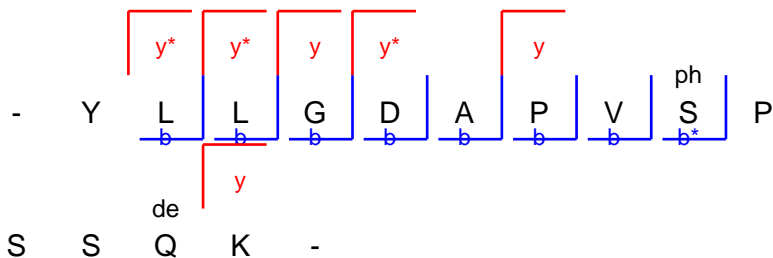
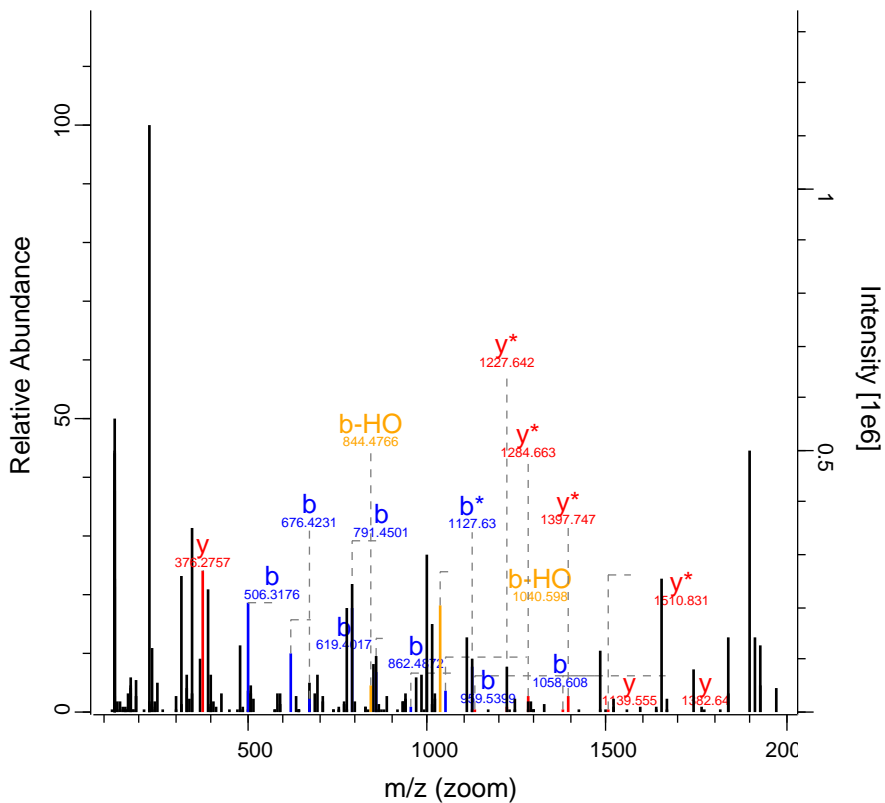

RO-QC-160121_ZackD_SS_Set_01_Fractic 27915 FTMS; HC 188.44 1261.08 MAP1B

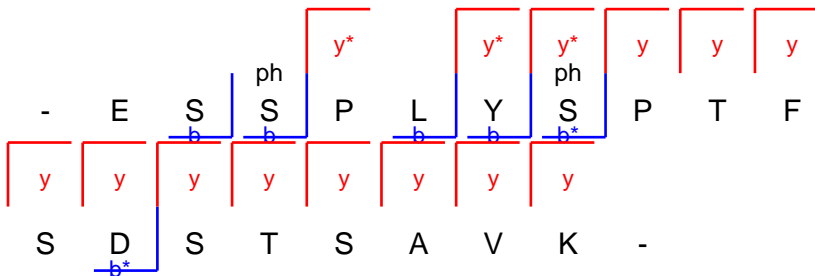
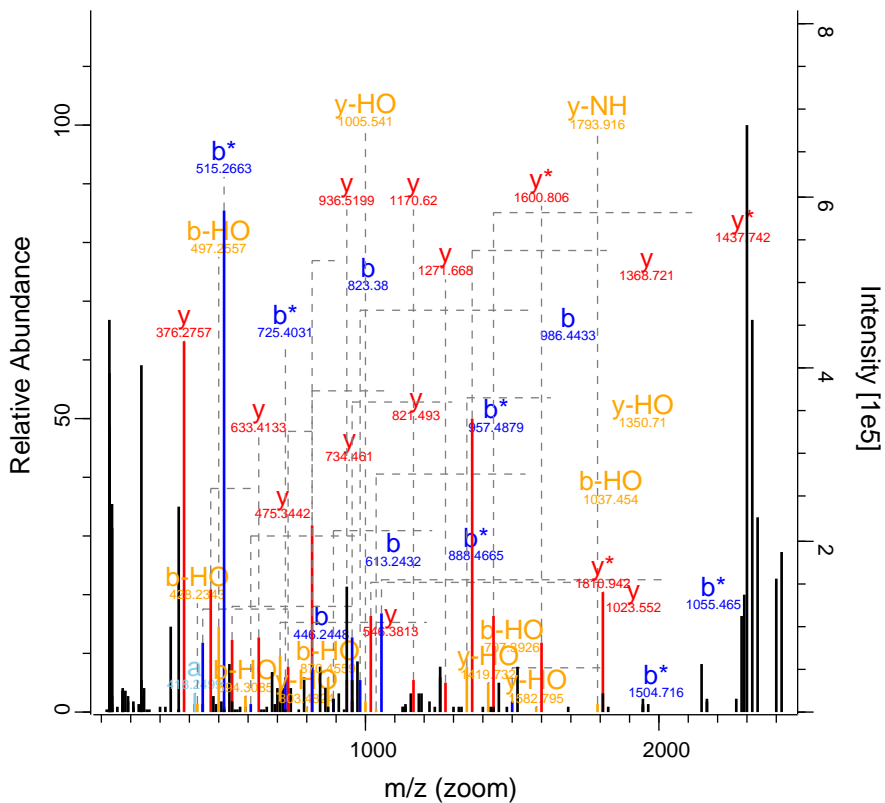

RO-QC-160121_ZackD_SS_Set_01_Fraccio 28372 FTMS; HC 170.79 848.97 KLC1

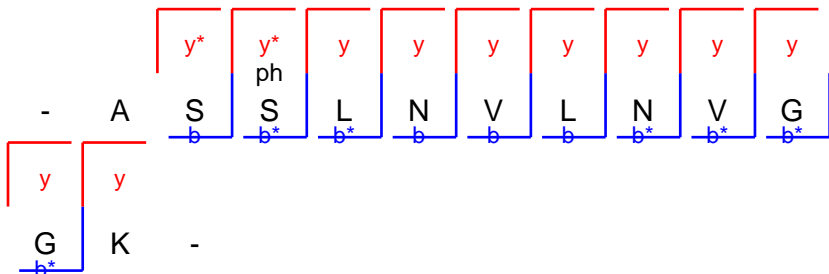
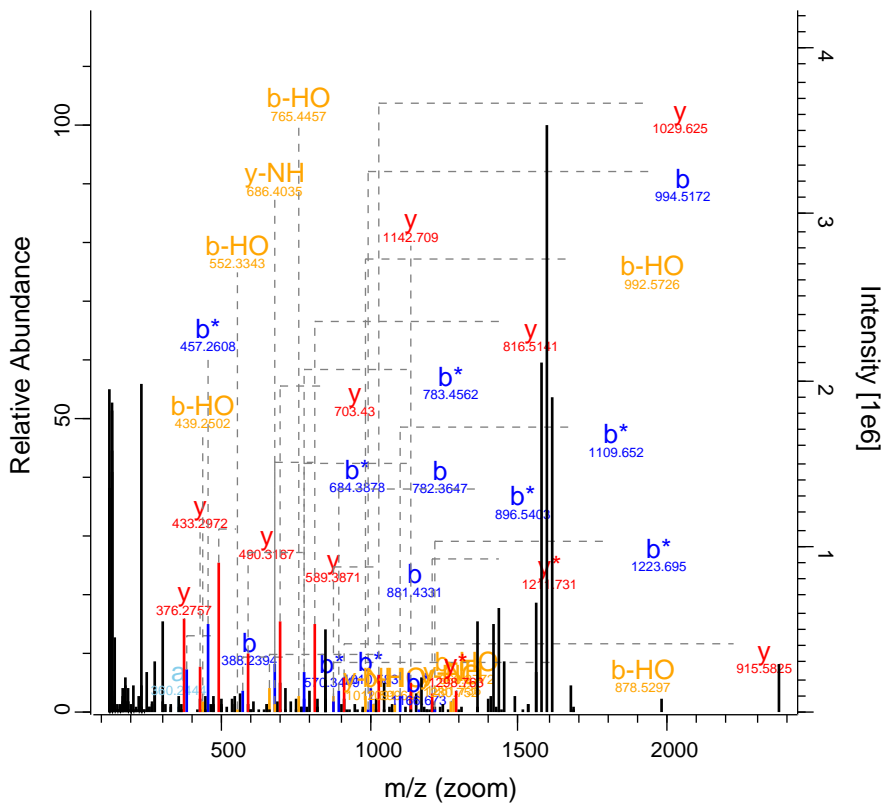

RO-QC-160121_ZackD_SS_Set_01_Fractio 28880 FTMS; HC 105.92 1100.5 MAP1B

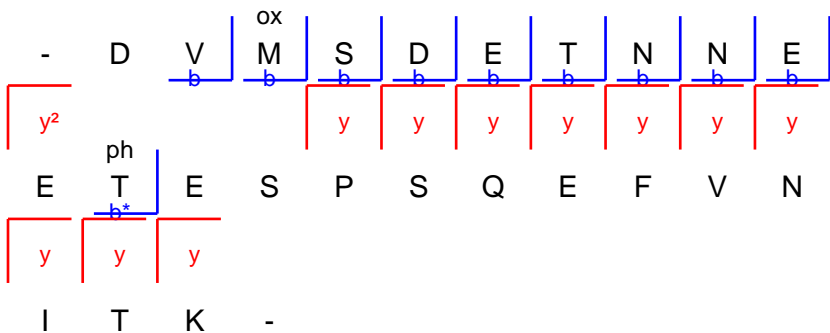
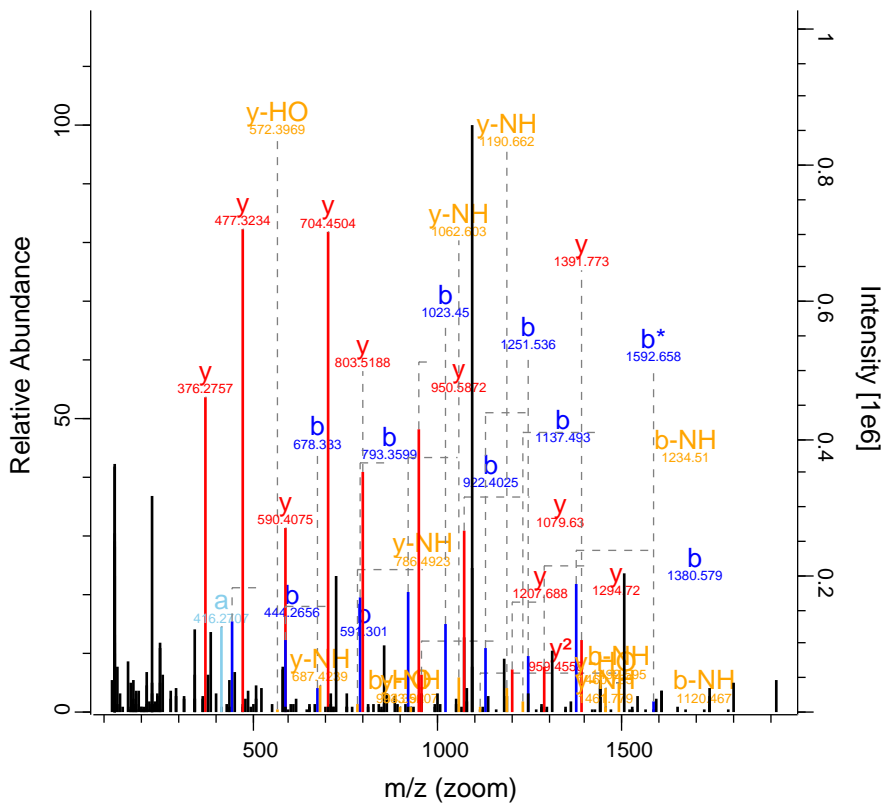

RO-QC-160121_ZackD_SS_Set_01_Fraction 29869 FTMS; HC 43.2 912.72 DNTTIP2

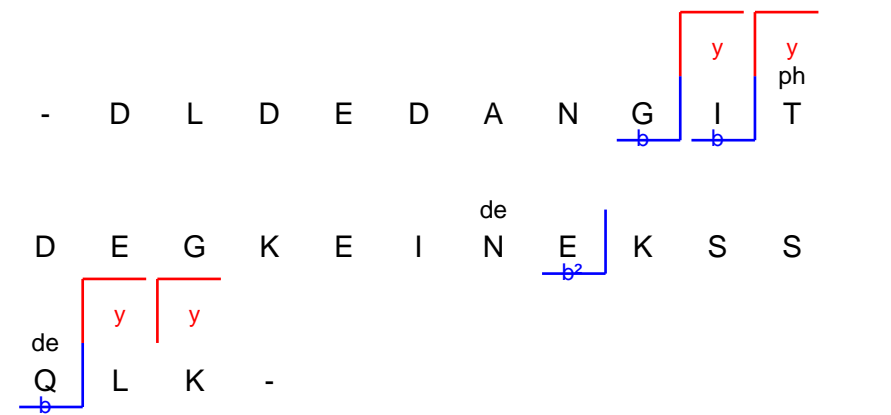
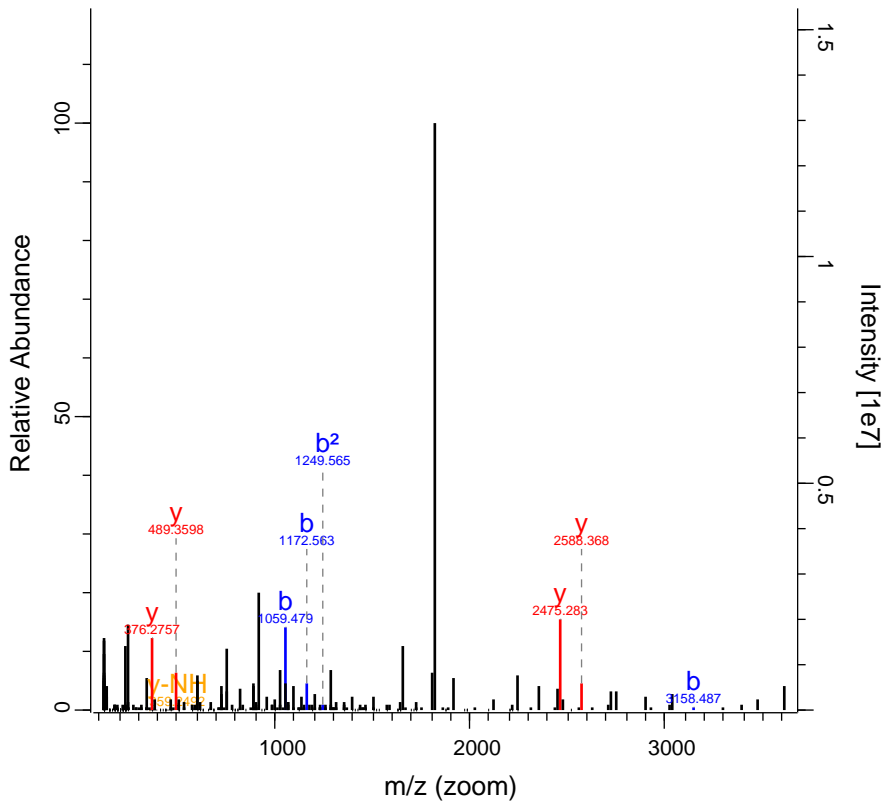

RO-QC-160121_ZackD_SS_Set_01_Fraction 31594 FTMS; HC 61.37 784.37 AHNAK

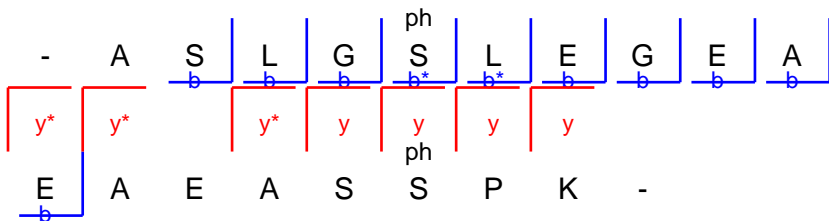
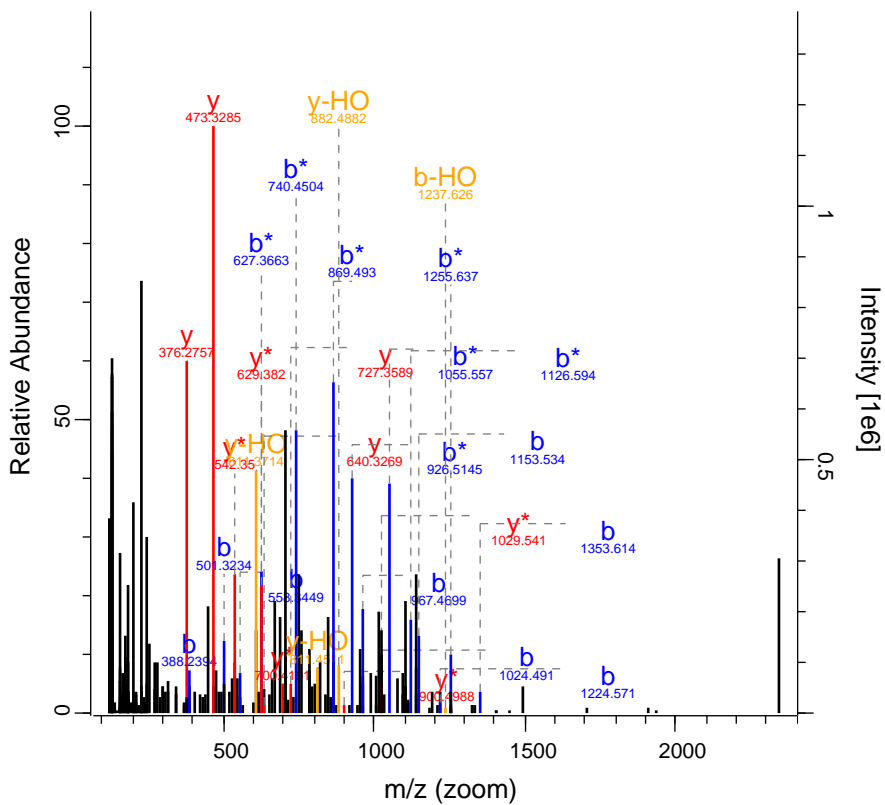

RO-QC-160121_ZackD_SS_Set_01_Fractic 32023 FTMS; HC 41.73 1303.26 DMKN

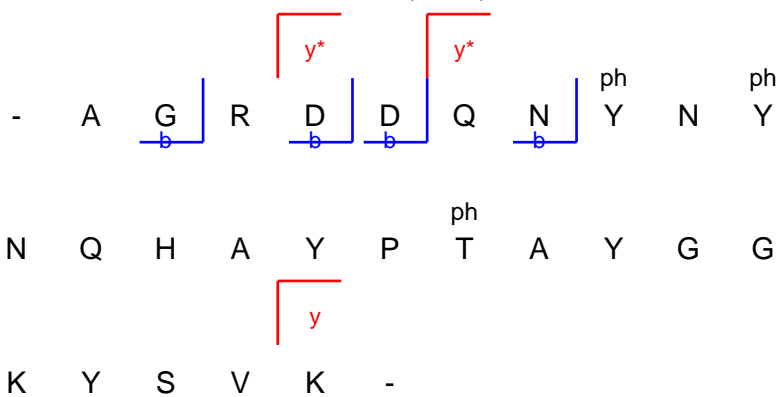
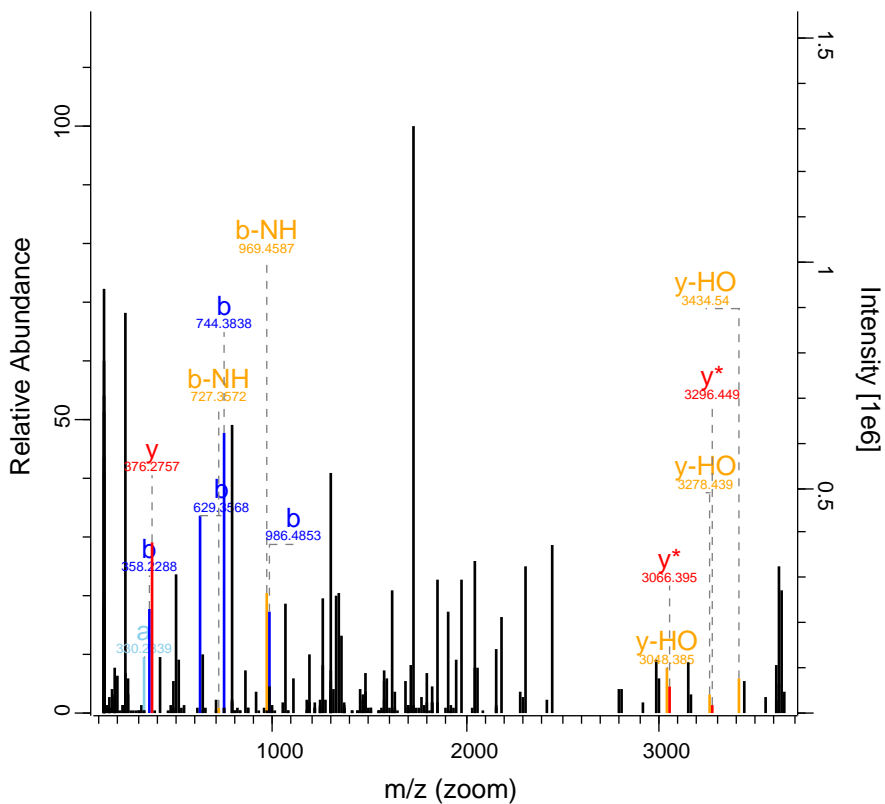

RO-QC-160121_ZackD_SS_Set_01_Fractic 32440 FTMS; HC 82.71 1325.62 AHNAK

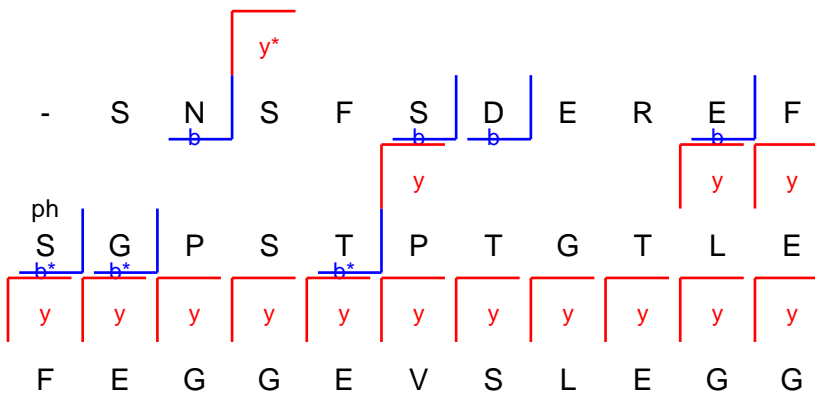
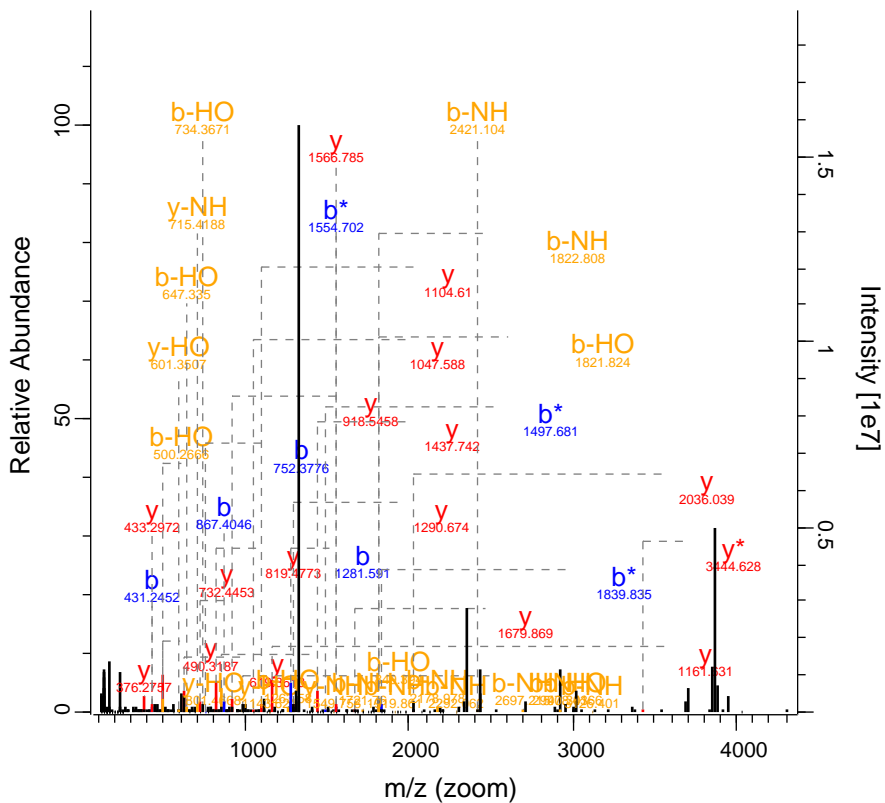

RO-QC-160121_ZackD_SS_Set_01_Fraction 33890 FTMS; HC 47.4 1069.9 C2CD4C

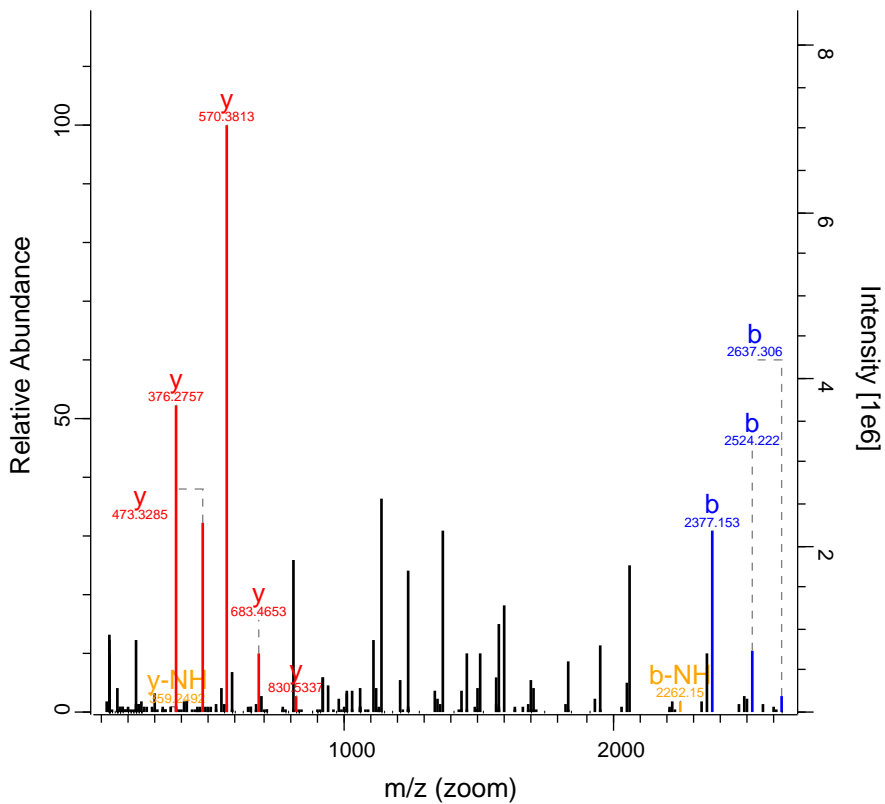

					ph	de			ph	
-	G	P	L	Y	S	N	V	L	T	P
						y	y	y	y	y
D	K	I	P	D	F	F	I	P	P	K
					b	b	b			

RO-QC-160121_ZackD_SS_Set_01_Fractic 34389 FTMS; HC 49.25 1007.18 ATP6V0D1

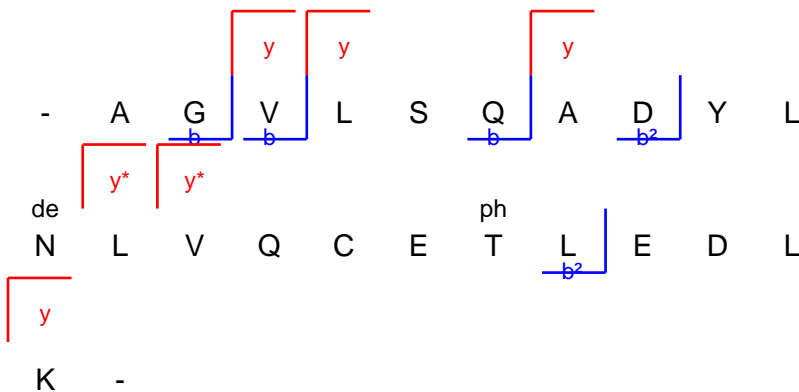
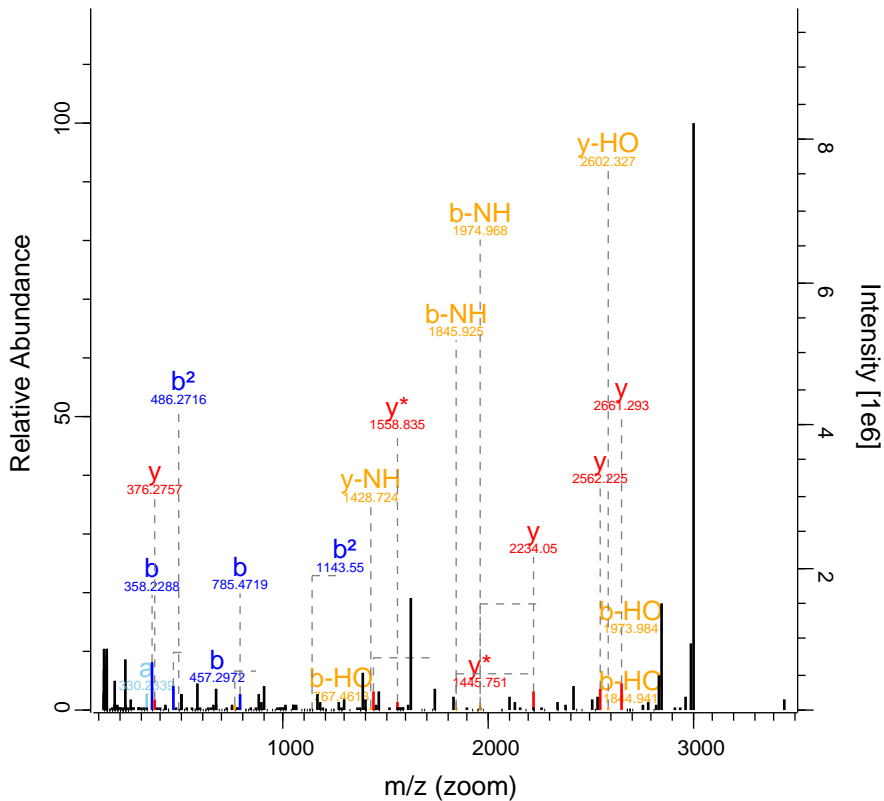

RO-QC-160121_ZackD_SS_Set_01_Fractic 34408 FTMS; HC 105.03 1011.14 GJA1

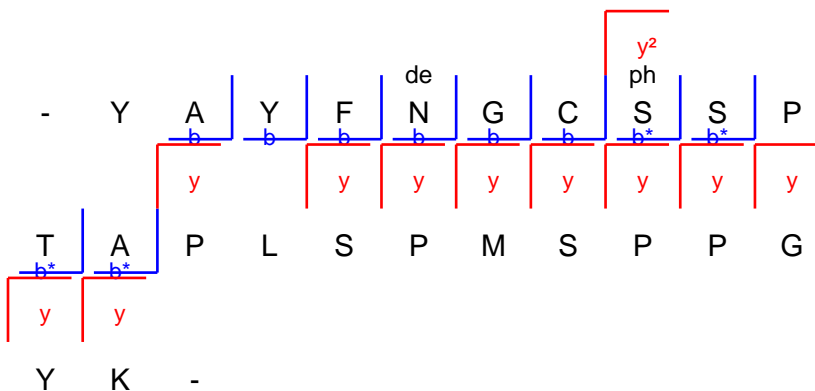
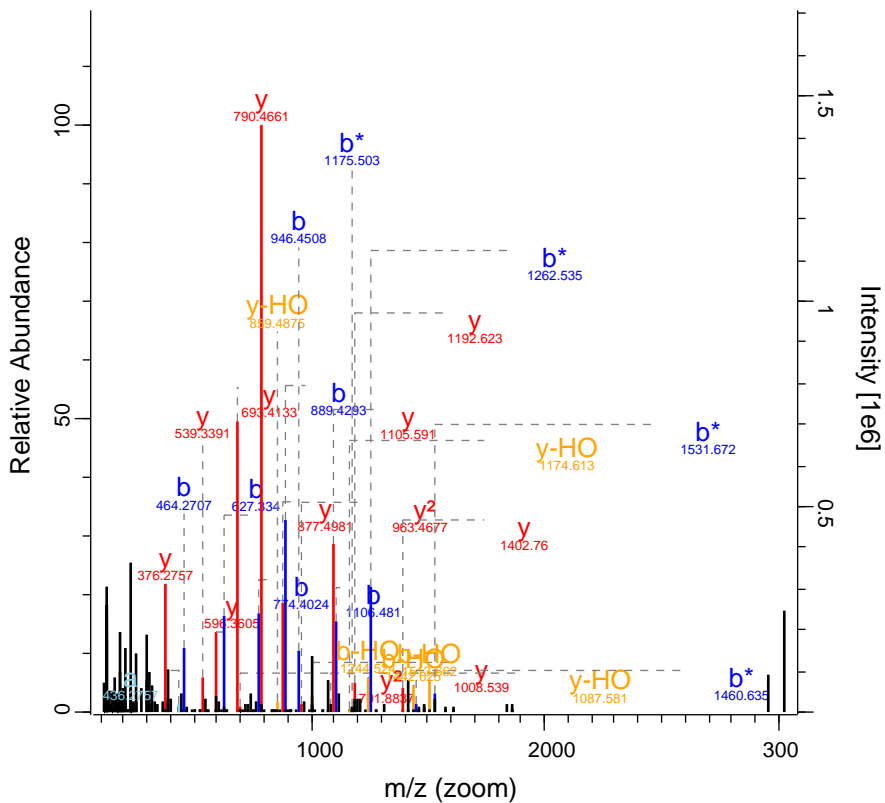

RO-QC-160121_ZackD_SS_Set_01_Fractio 36756 FTMS; HC 131.62 671.85 GOLGA4

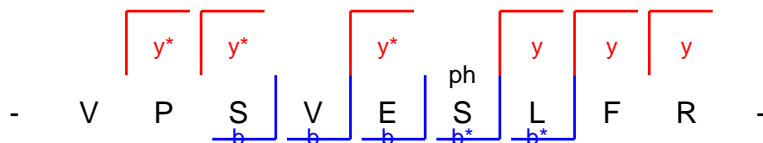
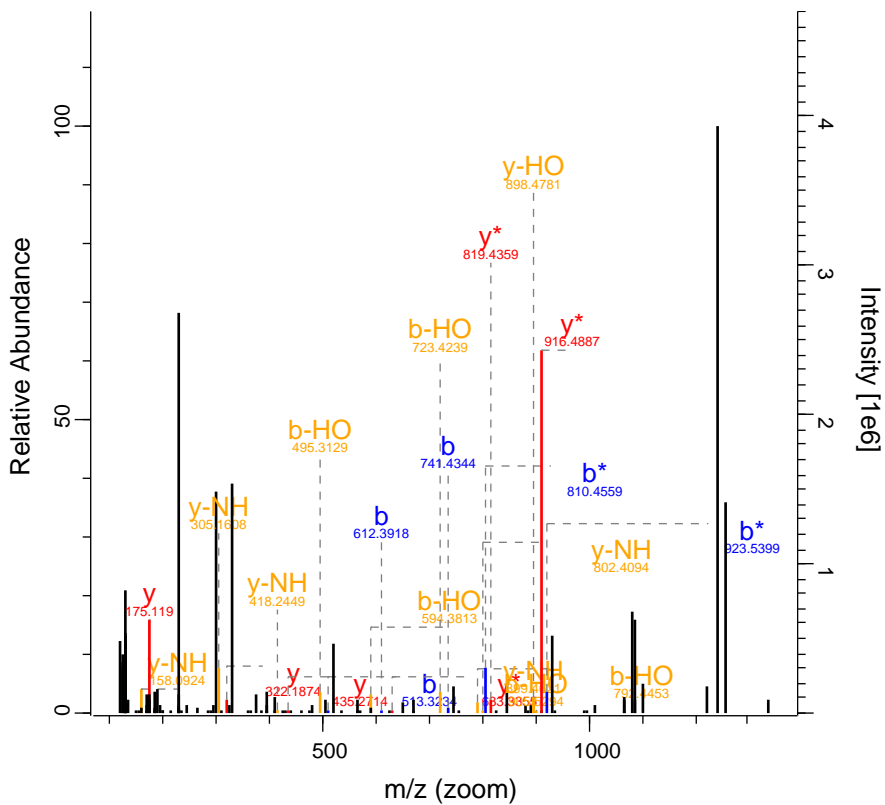

RO-QC-160121_ZackD_SS_Set_01_Fractic 37820 FTMS; HC 103.71 1106.91 MAP1B

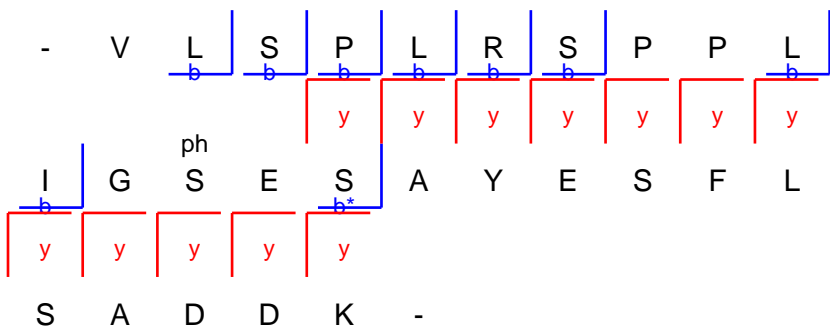
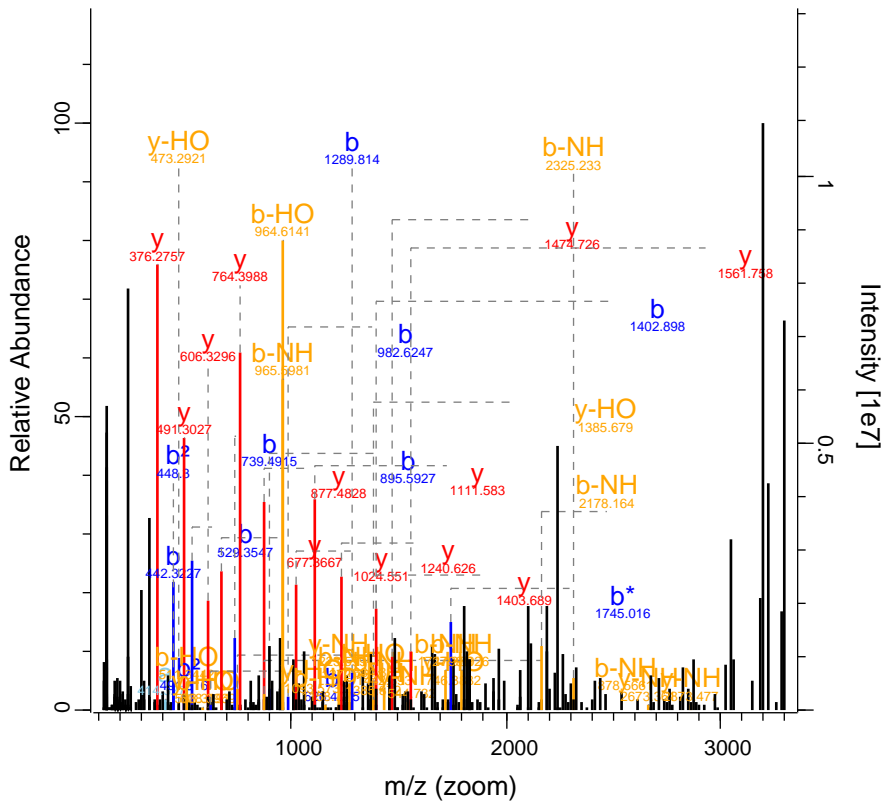

RO-QC-160121_ZackD_SS_Set_01_Fractic 38199 FTMS; HC 61.35 1146.57 CHD8

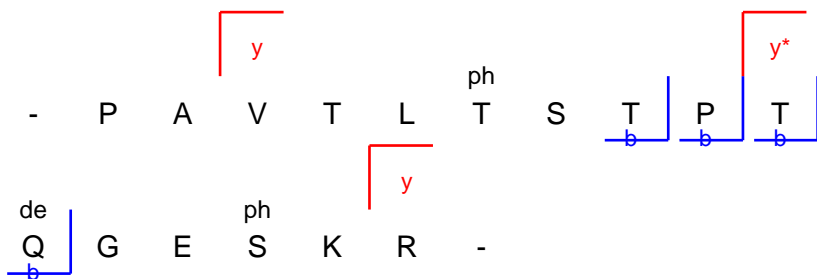
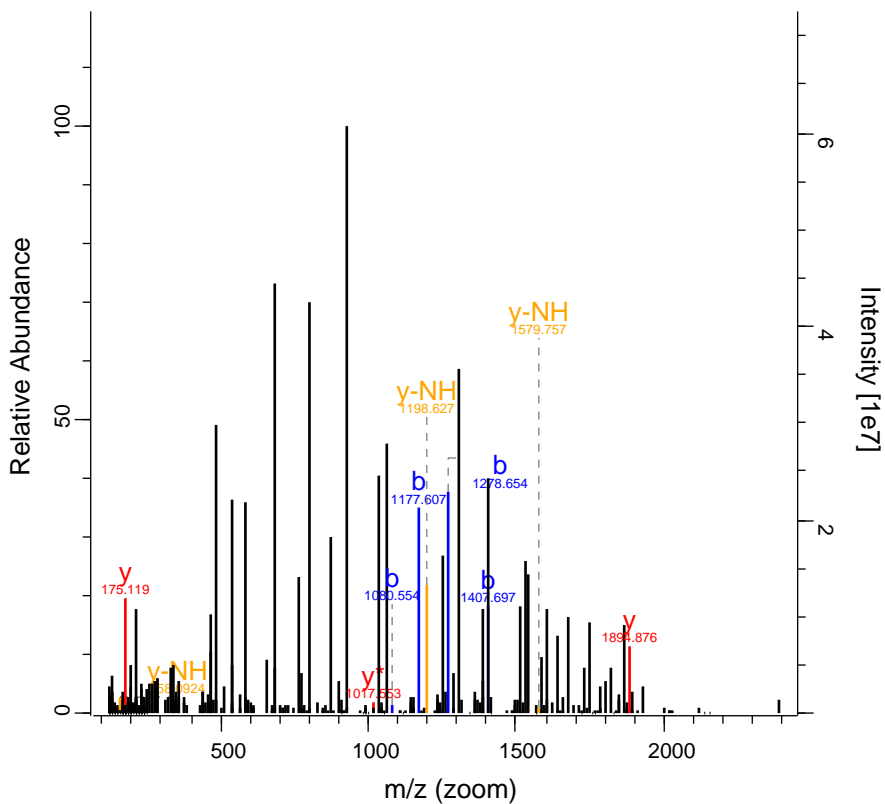

RO-QC-160121_ZackD_SS_Set_01_Fractio 38318 FTMS; HC 166.49 821.44 USP24

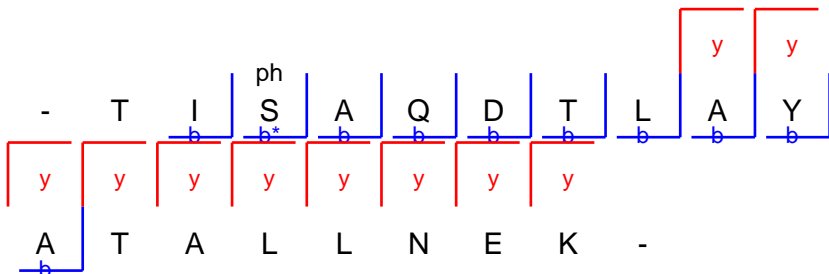
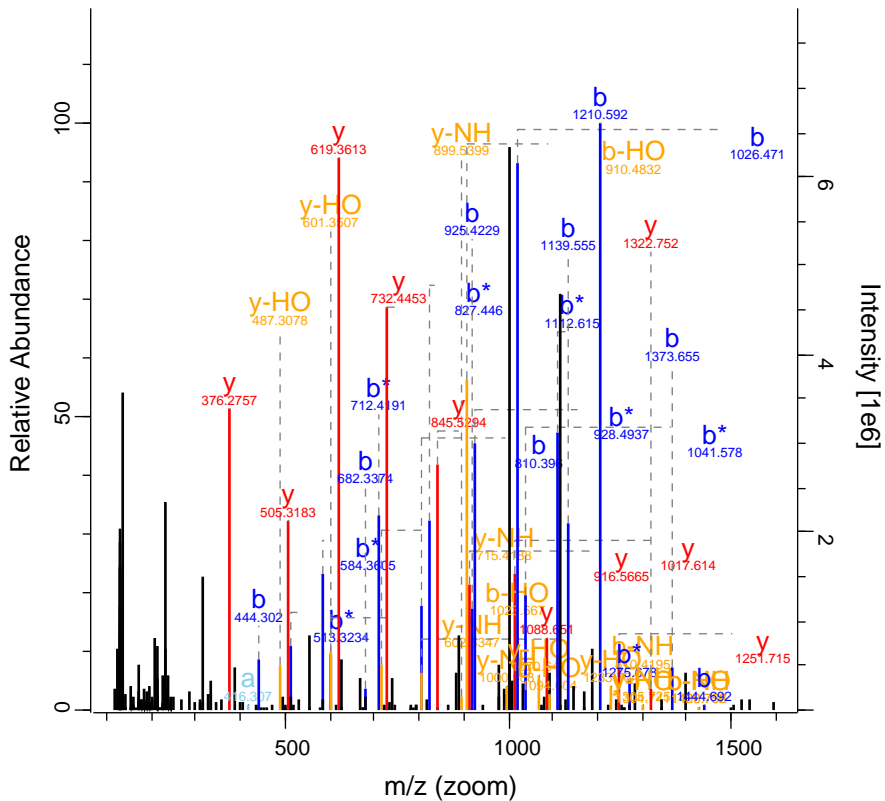

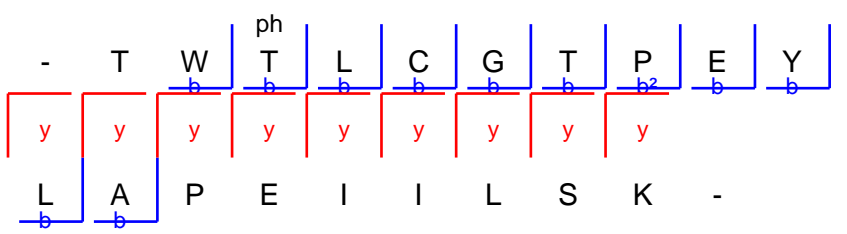
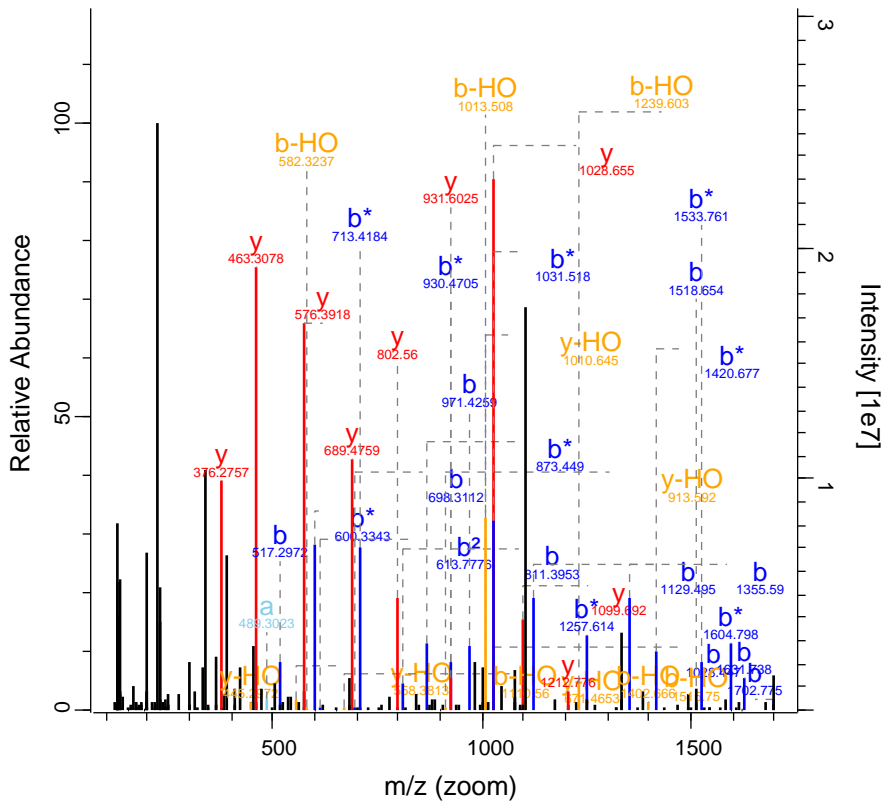

RO-QC-160121_ZackD_SS_Set_01_Fraction 38492 FTMS; HC 57.35 1284.7 BBS7

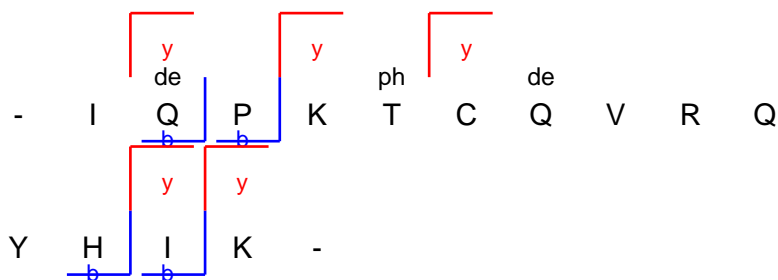
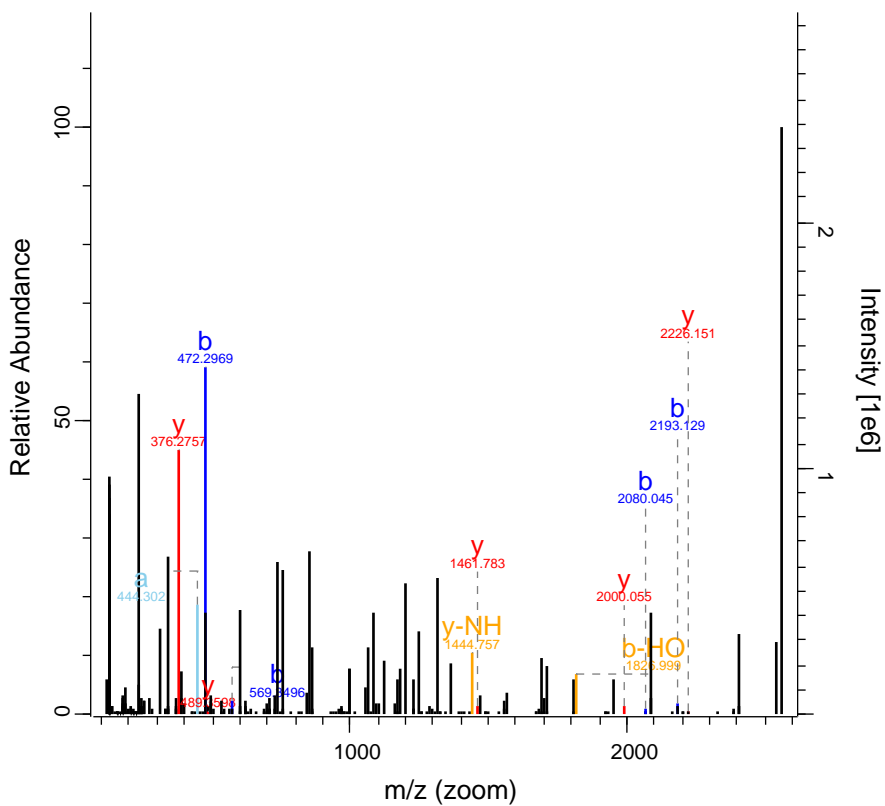

RO-QC-160121_ZackD_SS_Set_01_Fraction 38938 FTMS; HC 52.68 733.38 SCN10A

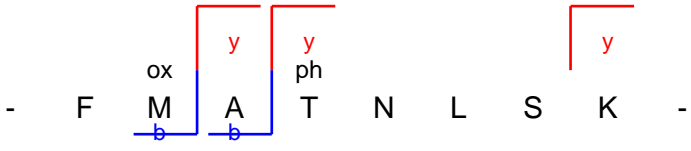
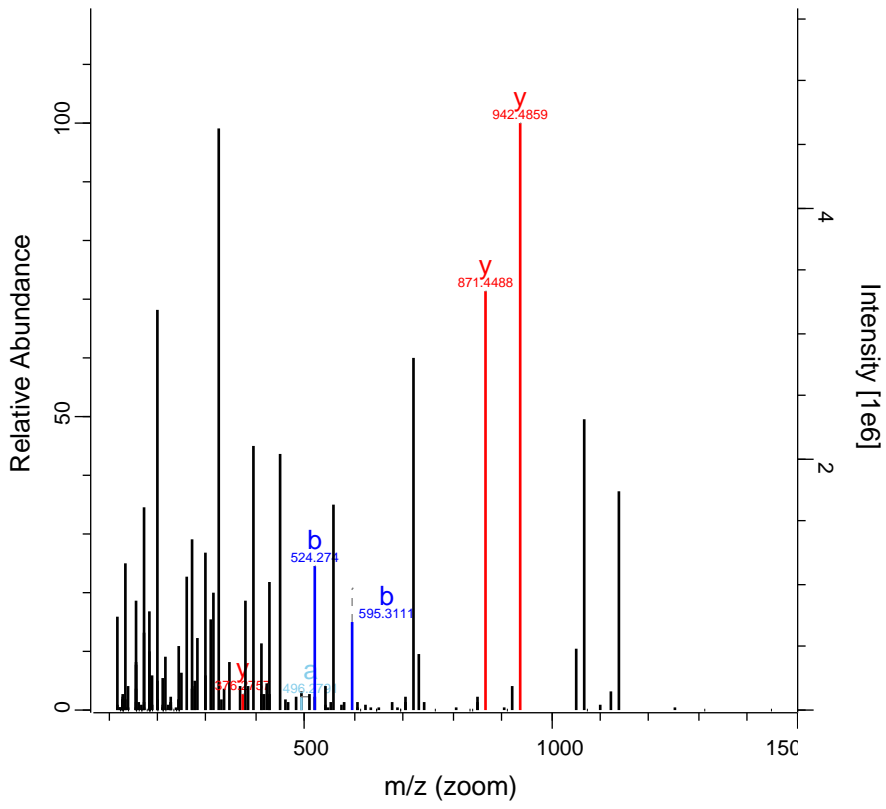

RO-QC-160121_ZackD_SS_Set_01_Fraction 4594 FTMS; HCl 60.03 587.04 PRRC2C

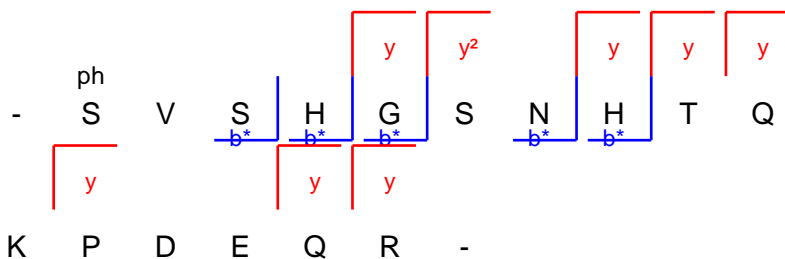
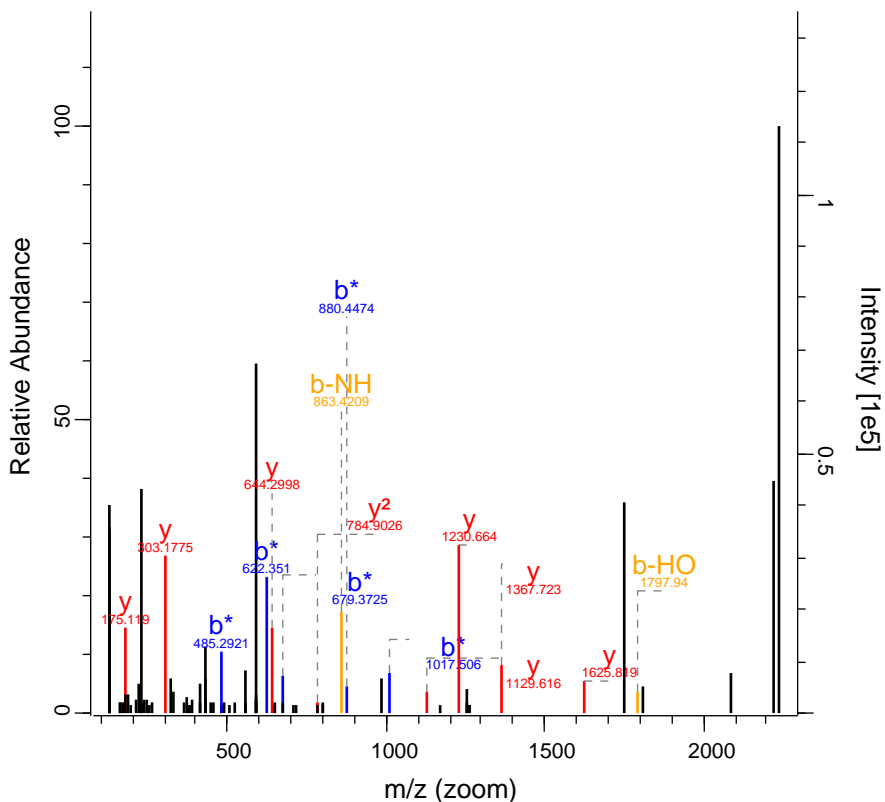

RO-QC-160121_ZackD_SS_Set_01_Fraction 5311 FTMS; HCl; 51.01 351.19 PRC1

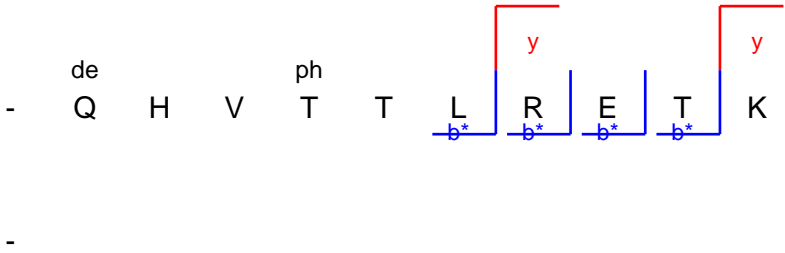
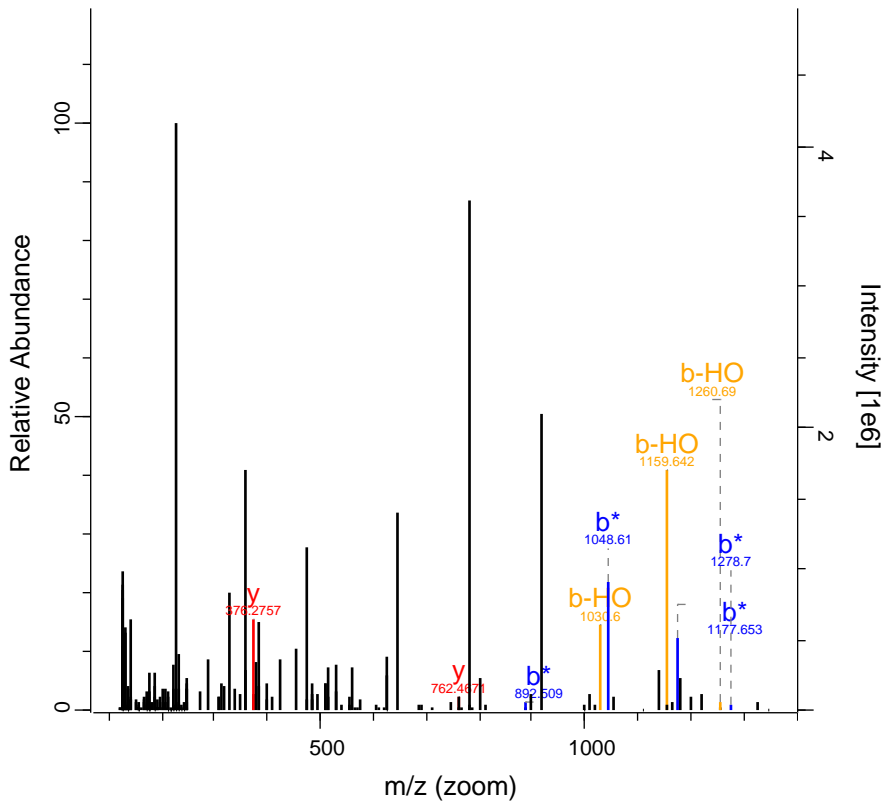

RO-QC-160121_ZackD_SS_Set_01_Fraction 6494 FTMS; HC 135.56 729.87 SRRM2

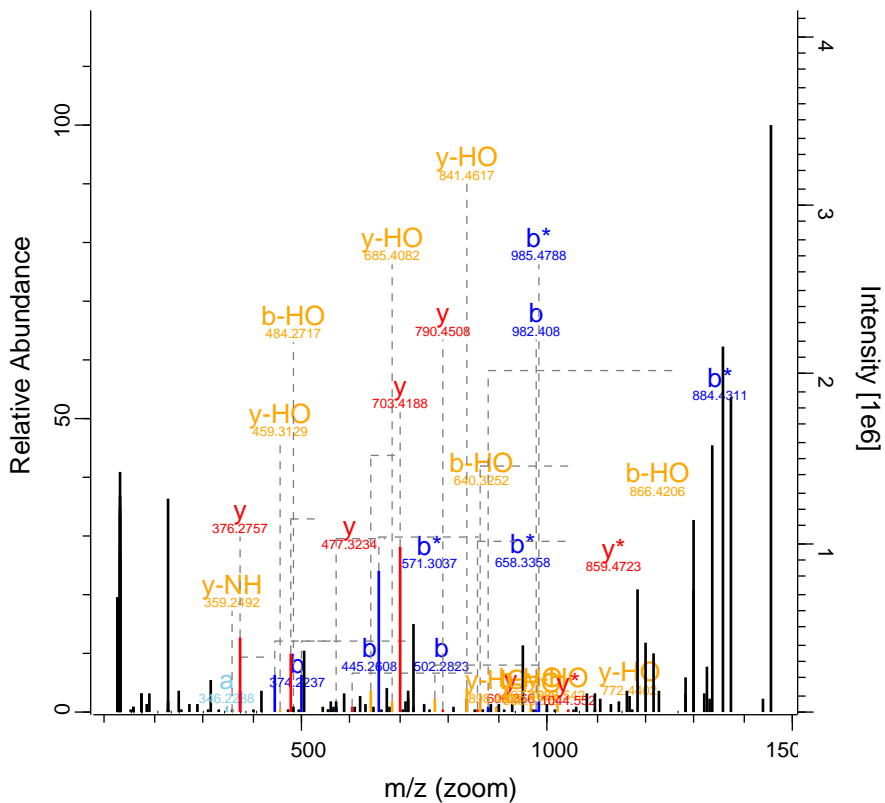

m/z (zoom)

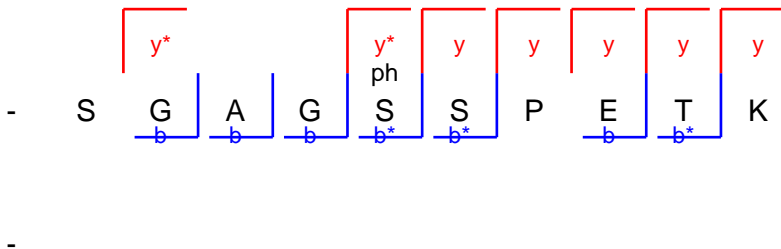

RO-QC-160121_ZackD_SS_Set_01_Fraction 6509 FTMS; HCl 83.05 544.26 GTF2F2

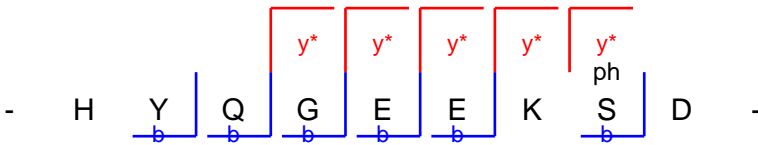
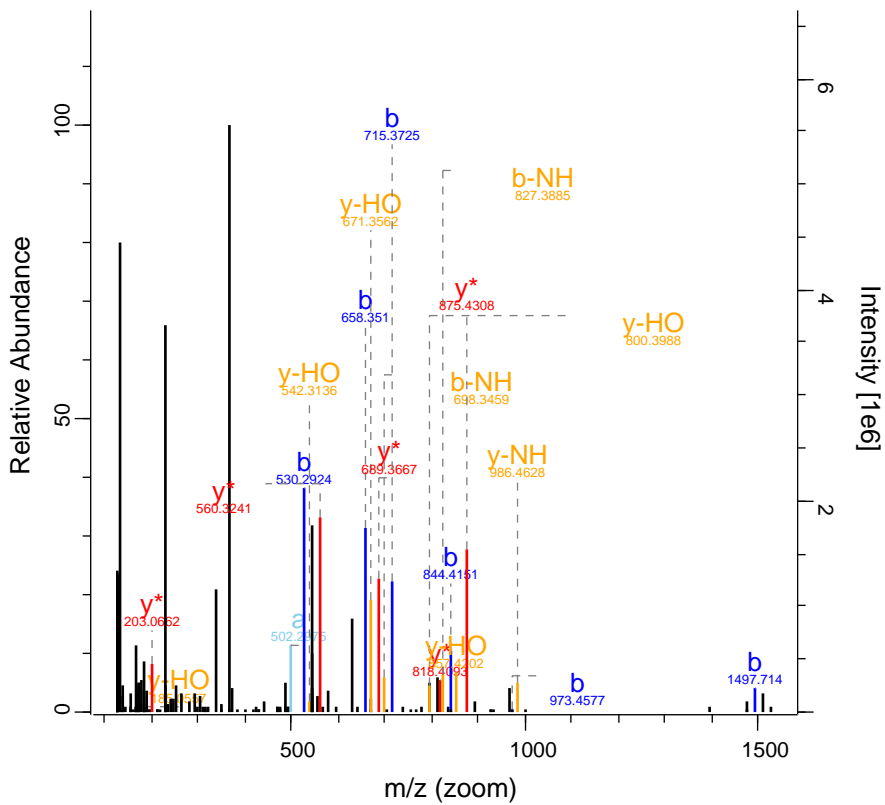

RO-QC-160121_ZackD_SS_Set_01_Fraction 6924 FTMS; HC 131.46 740.38 LIMA1

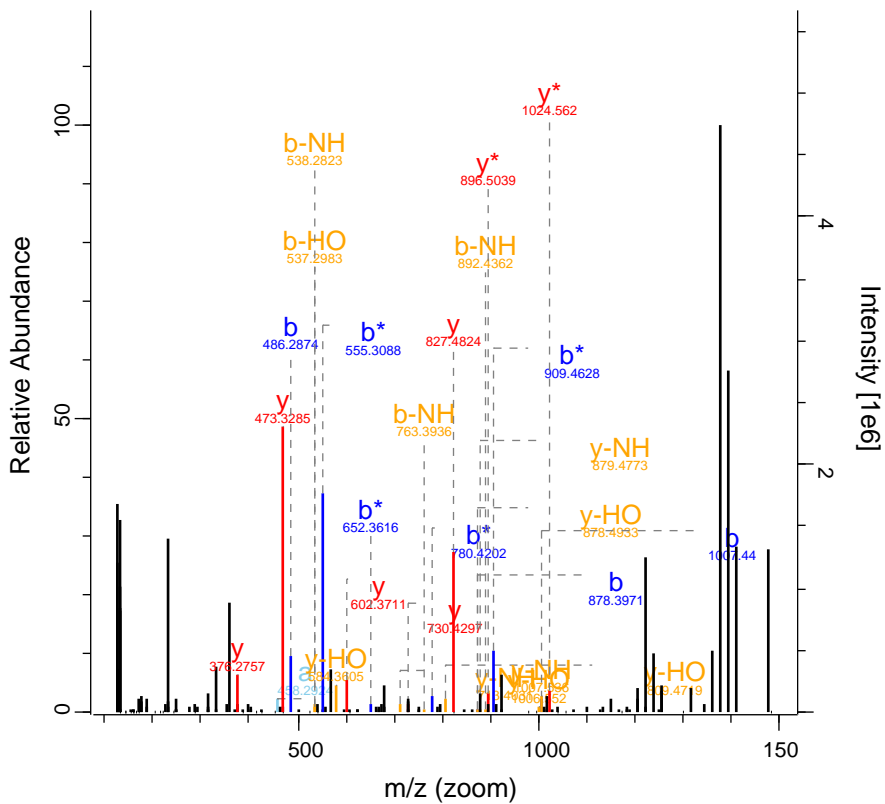

m/z (zoom)

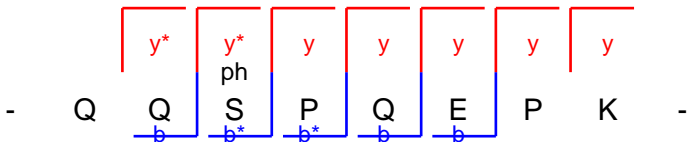

RO-QC-160121_ZackD_SS_Set_01_Fraction 7163 FTMS; HC 113.77 886.45 ZC3H13

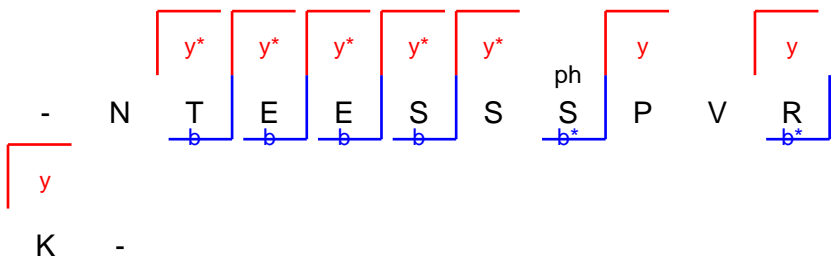
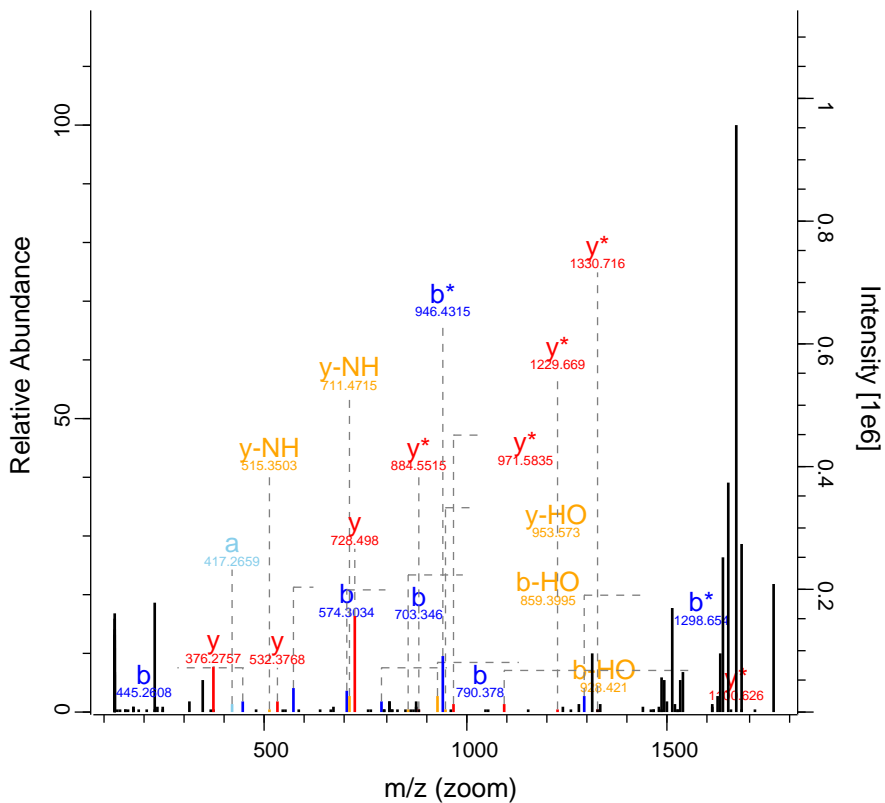

K

RO-QC-160121_ZackD_SS_Set_01_Fraction18758 FTMS; HC 147.26 813.91 SF3B1

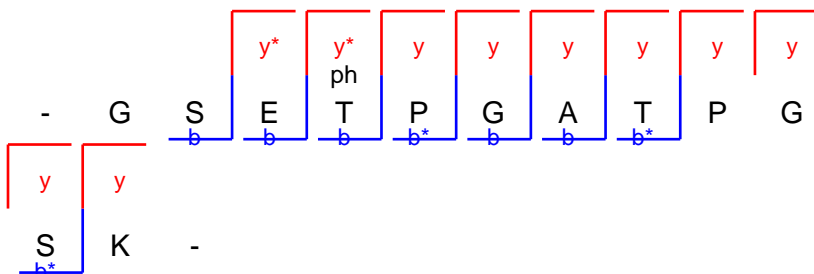
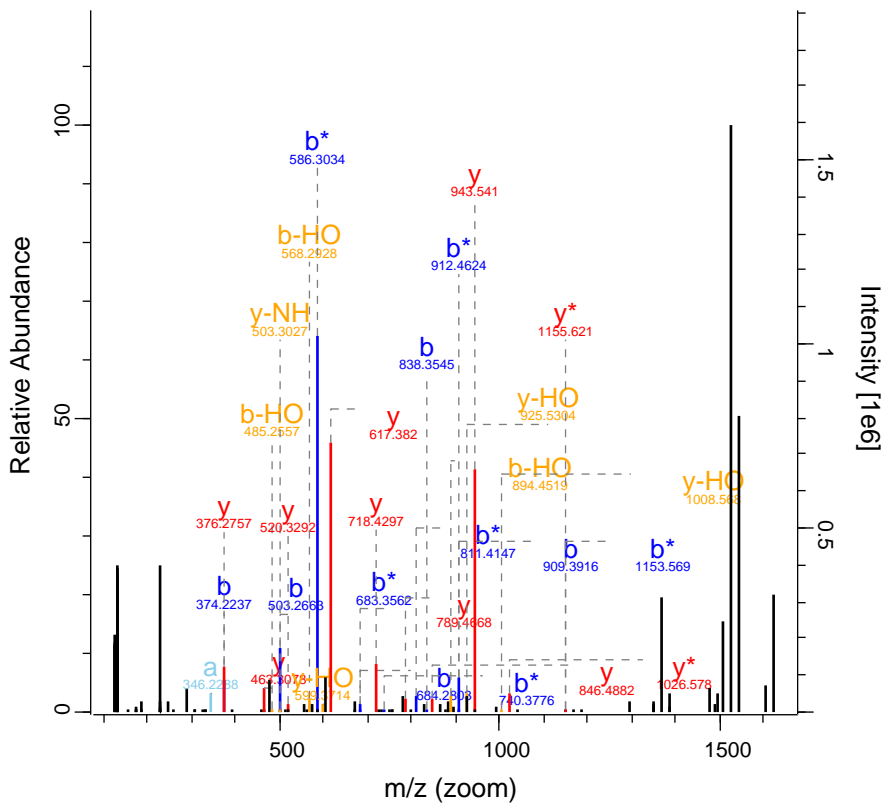

RO-QC-160121_ZackD_SS_Set_01_Fraction 8836 FTMS; HCl 50.87 772.61 UBAP2L

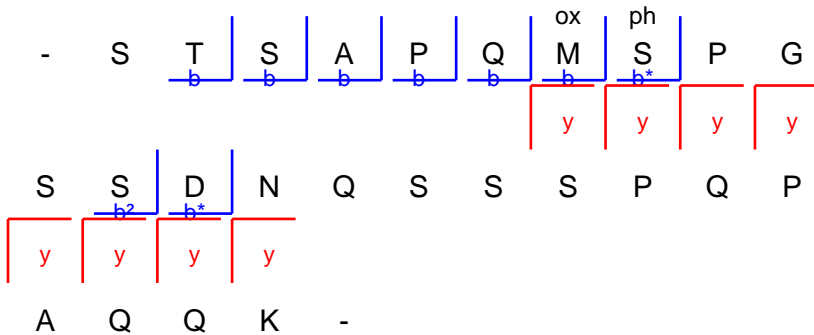
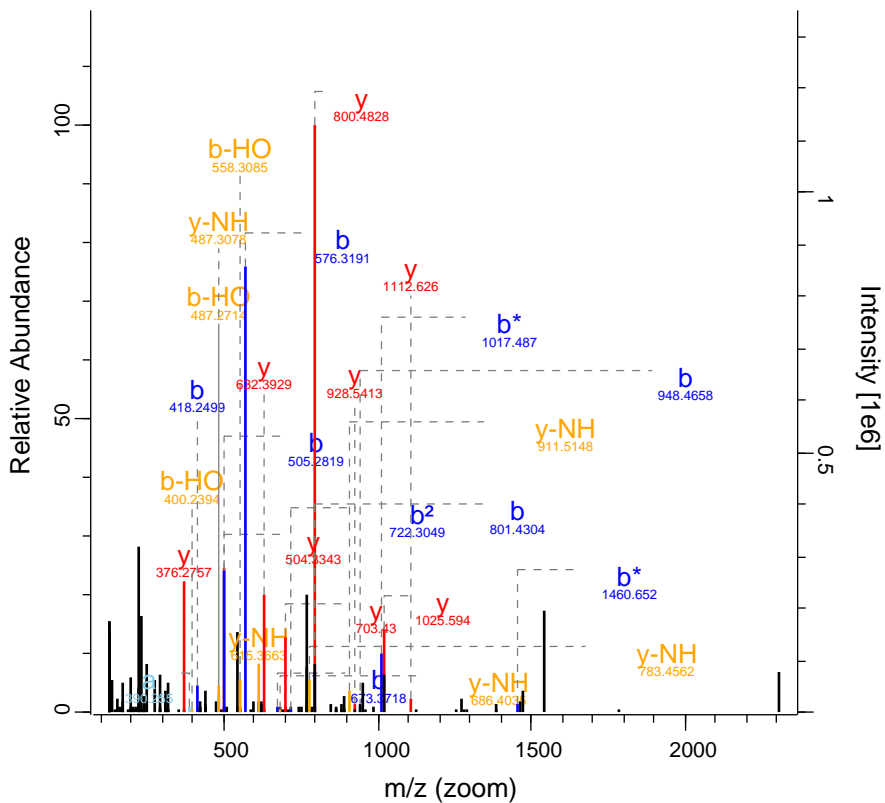

RO-QC-160121_ZackD_SS_Set_01_Fractic 10452 FTMS; HC 90.63 1128.65 ZNF559

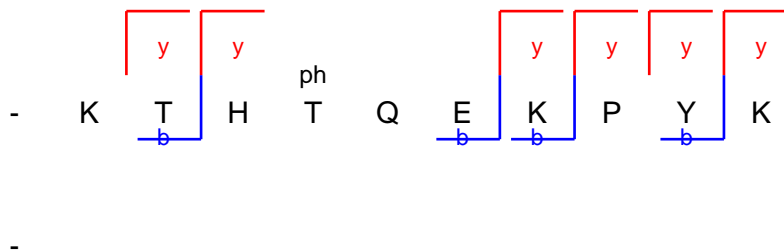
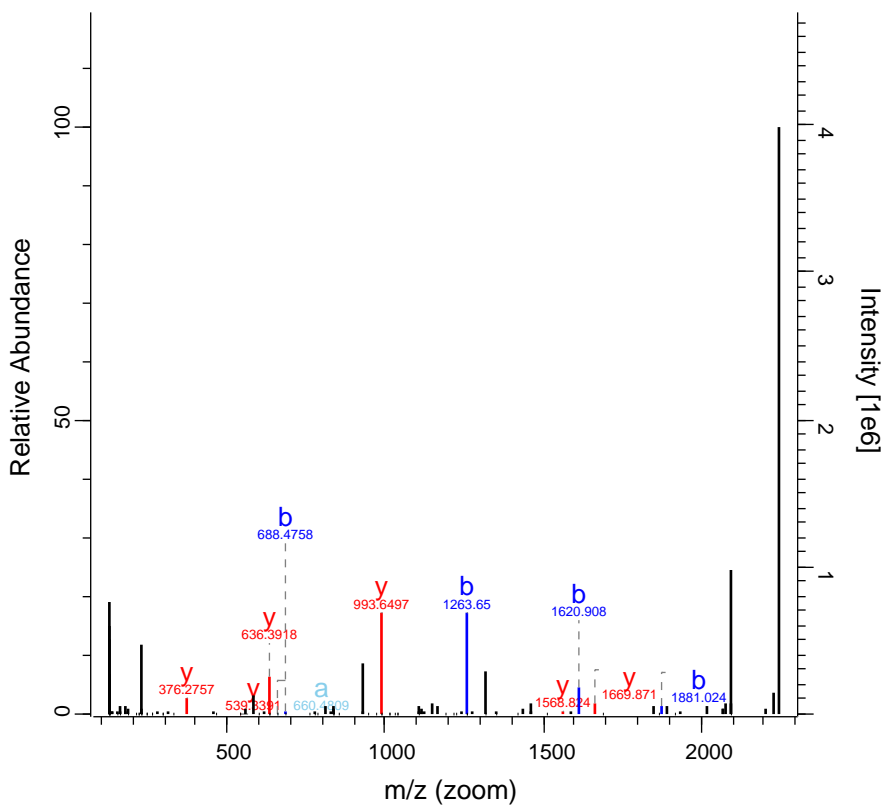

RO-QC-160121_ZackD_SS_Set_01_Fraction10551 FTMS; HC 59.76 564.83 ZNF559

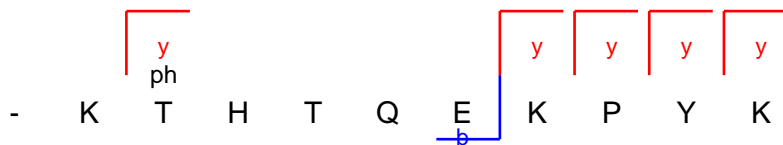
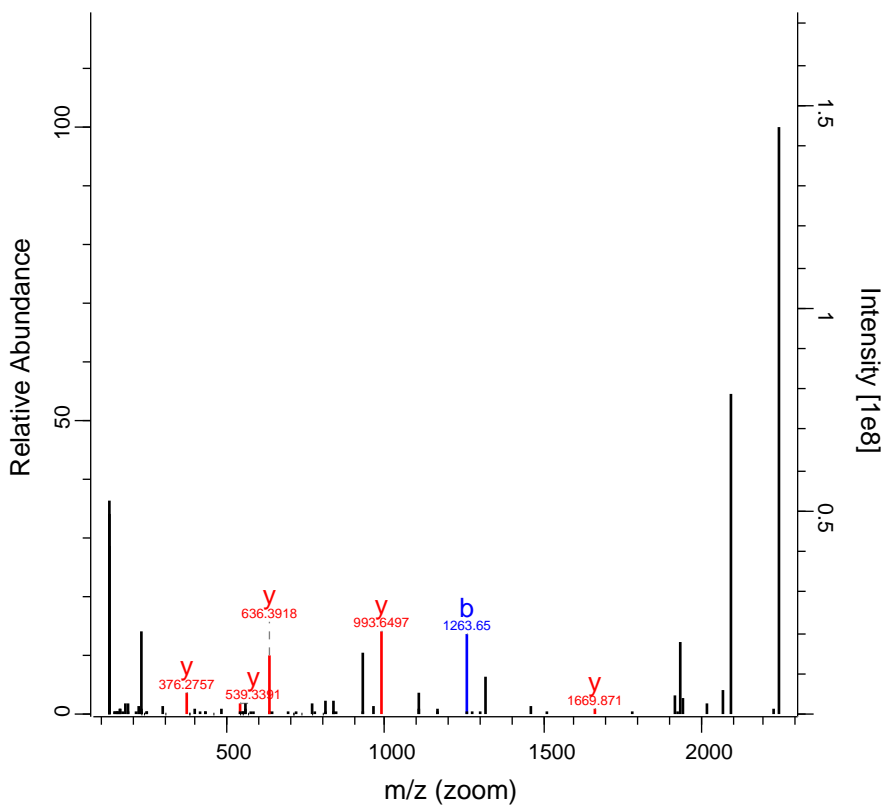

RO-QC-160121_ZackD_SS_Set_01_Fraction 10603 FTMS; HC 91.09 805.98 GTF3C2

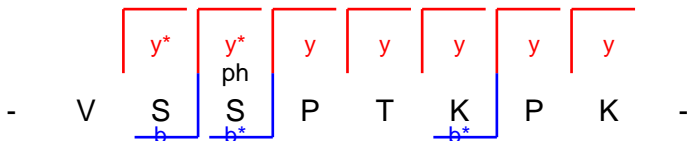
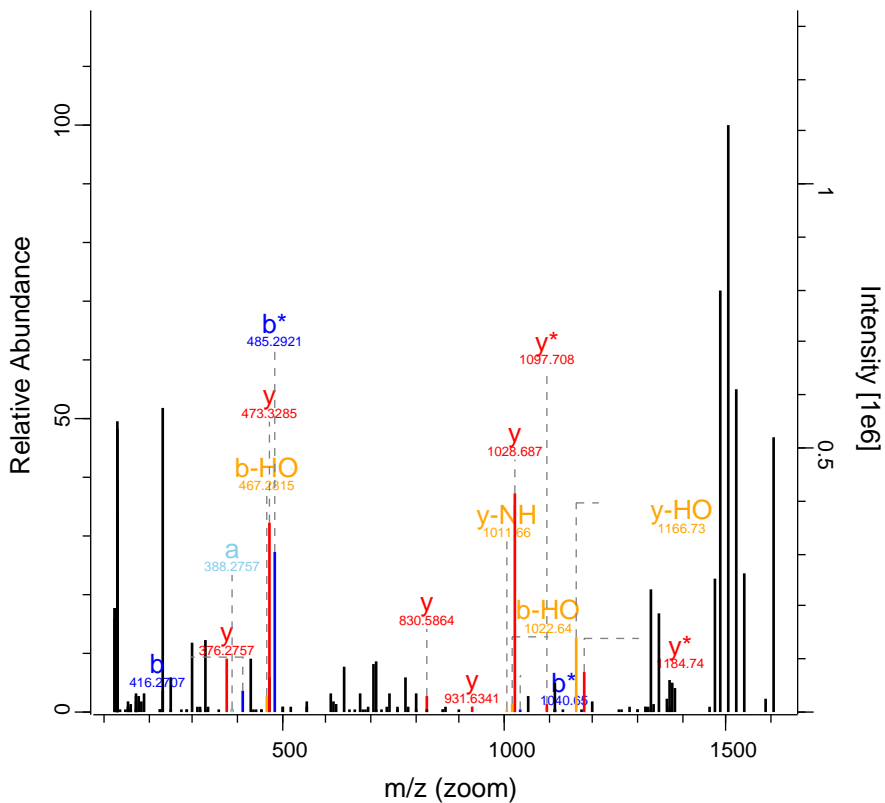

RO-QC-160121_ZackD_SS_Set_01_Fraction 11114 FTMS; HC 143 843.42 SON

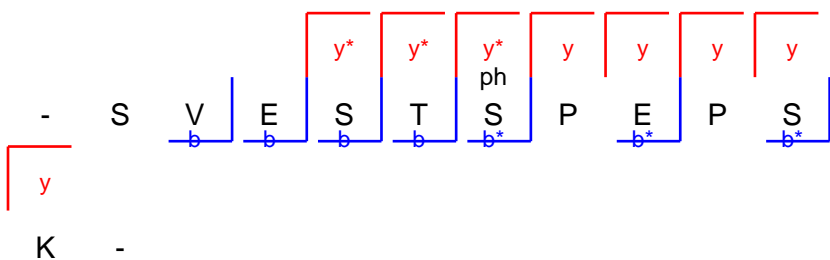
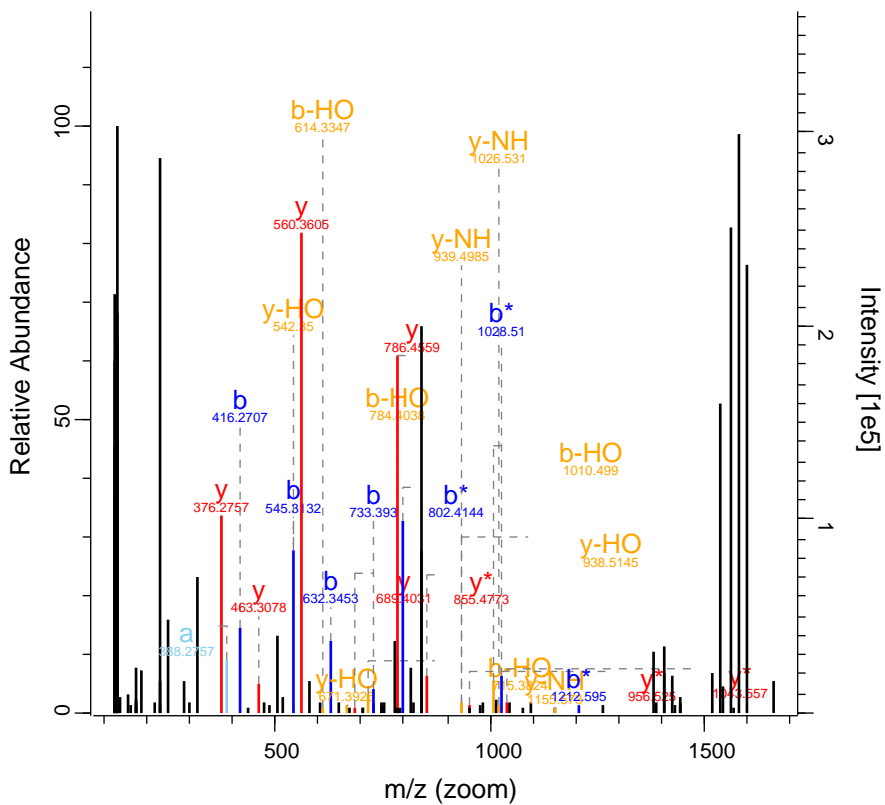

RO-QC-160121_ZackD_SS_Set_01_Fractio 11612 FTMS; HC 249.32 744.11 CANX

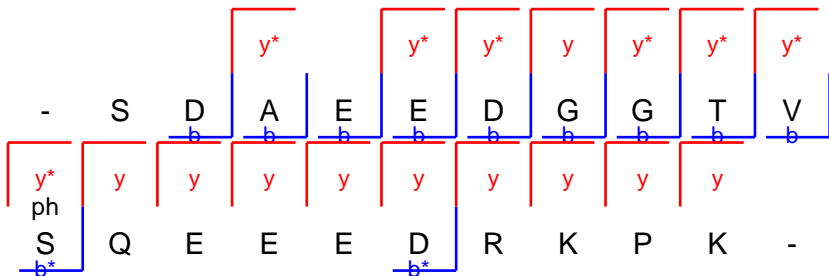
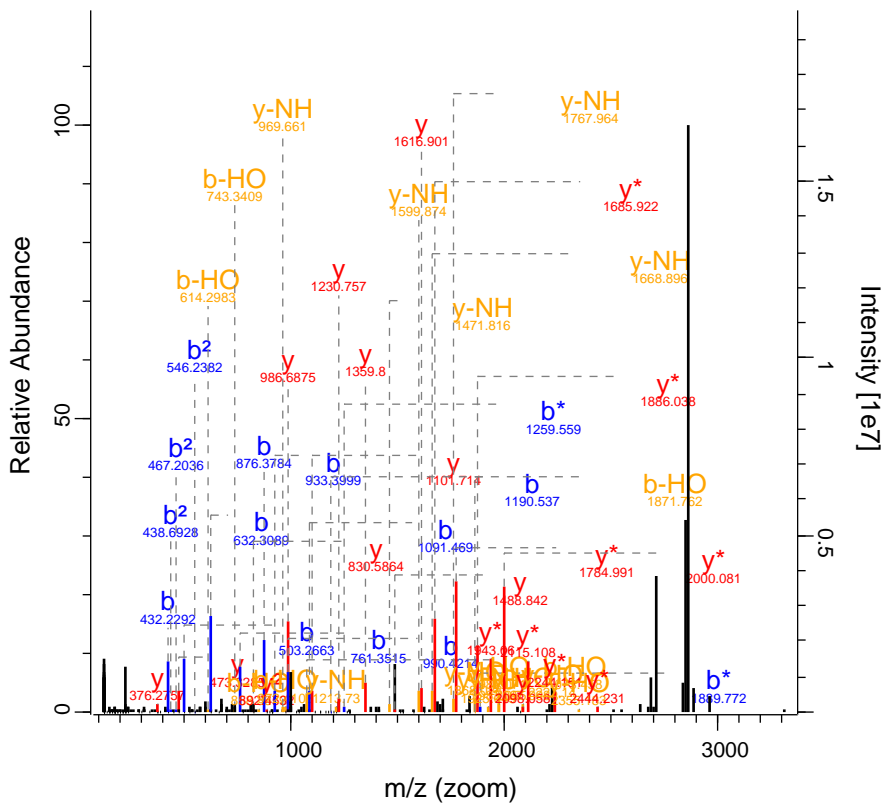

RO-QC-160121_ZackD_SS_Set_01_Fractio 11803 FTMS; HC 120.96 782.88 WWC1

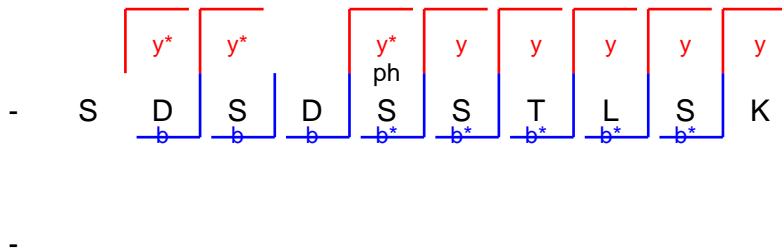
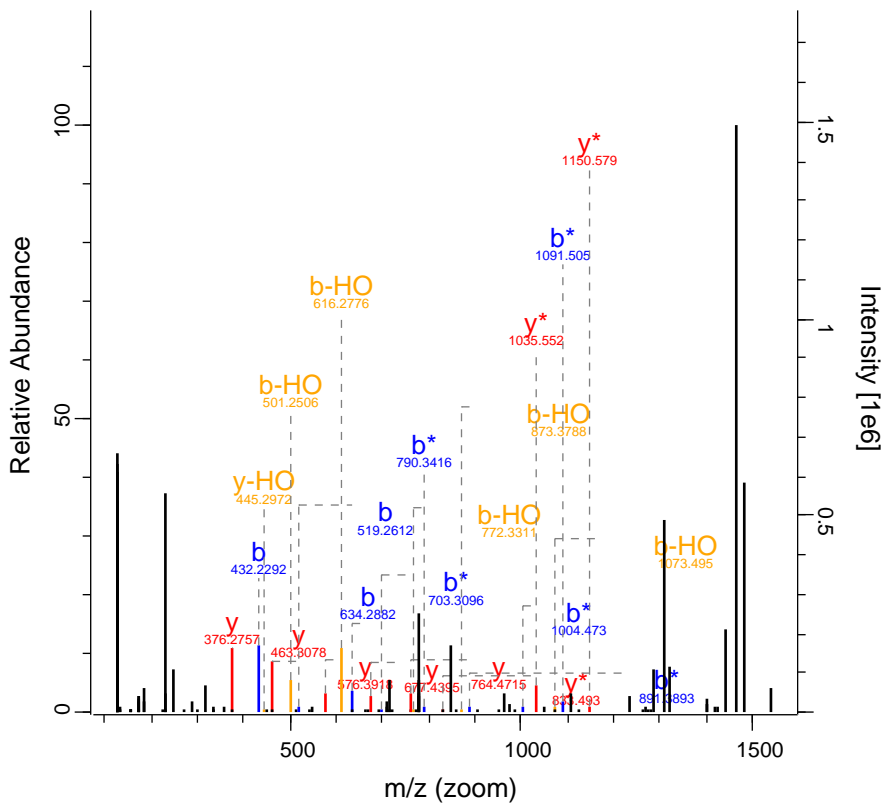

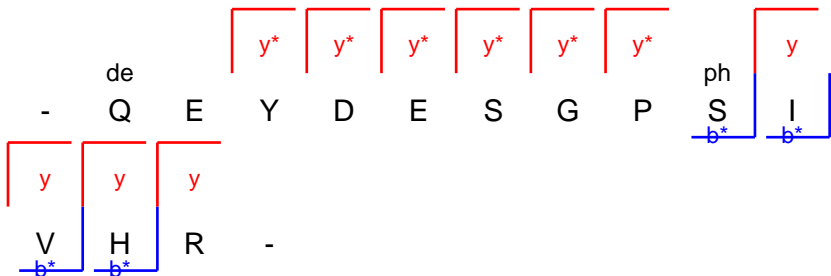
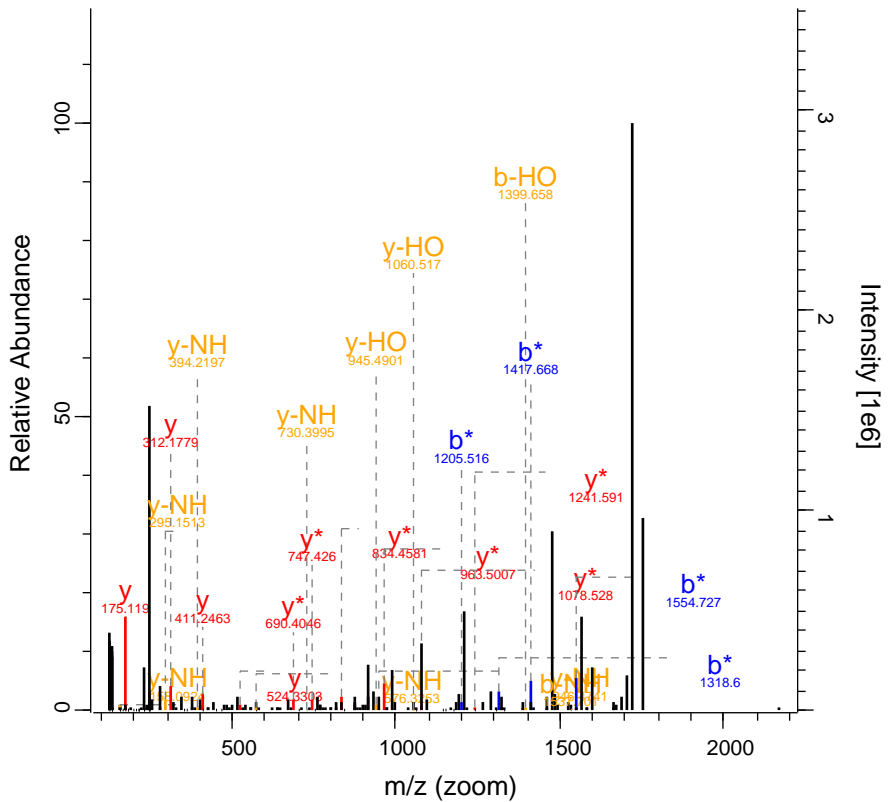

RO-QC-160121_ZackD_SS_Set_01_Fraction 12569 FTMS; HC 51.77 575.34 SRSF11

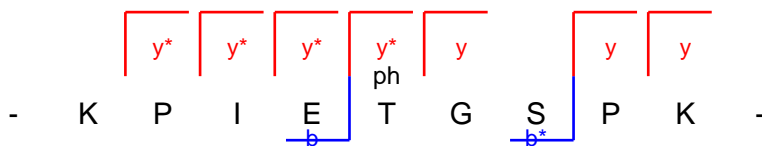
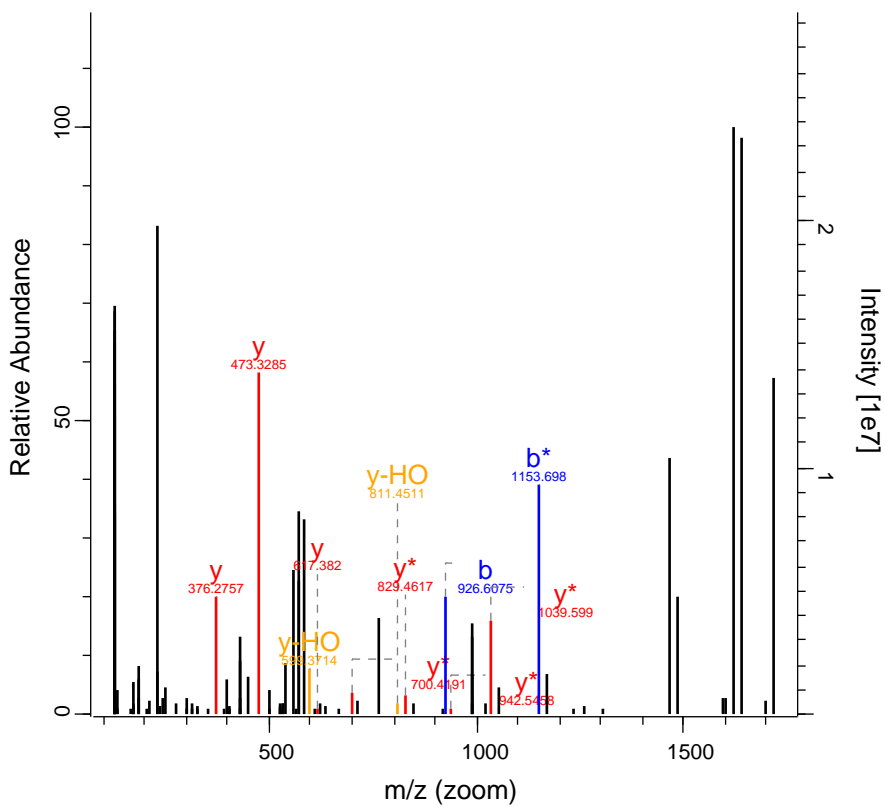

RO-QC-160121_ZackD_SS_Set_01_Fraction 13633 FTMS; HC 74.96 556.33 SCAMP3

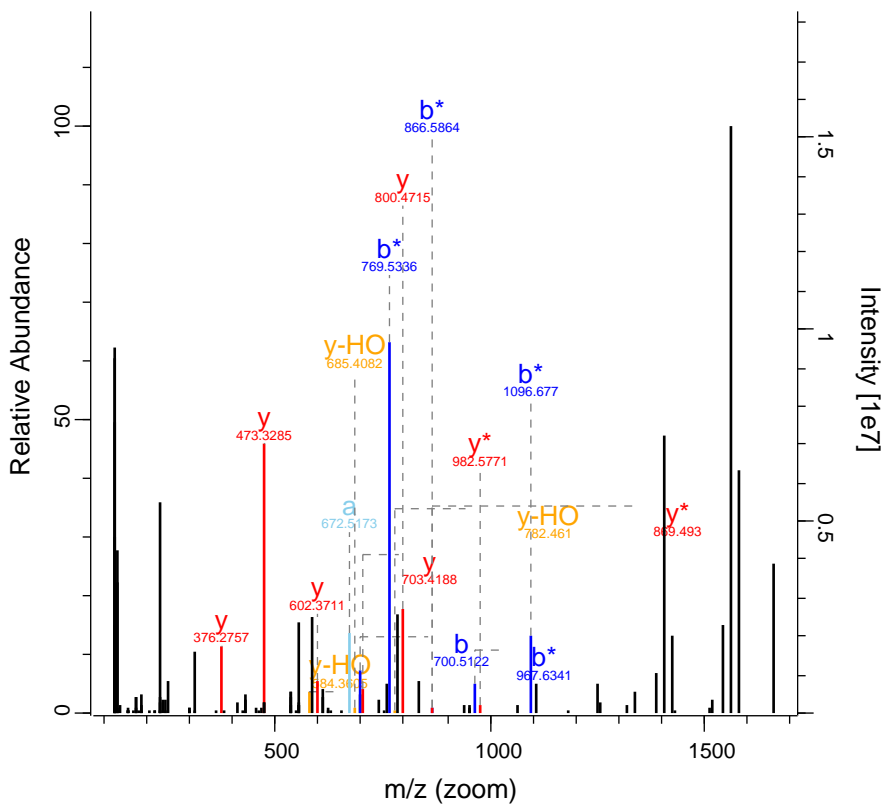

m/z (zoom)

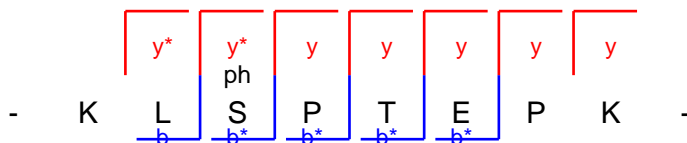

RO-QC-160121_ZackD_SS_Set_01_Fraction 14261 FTMS; HC 51.85 880.48 CEP350

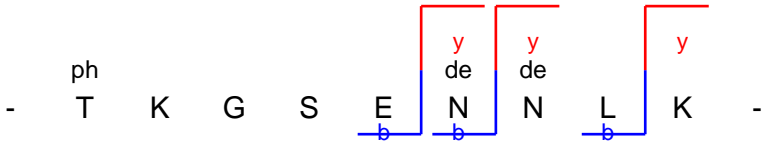
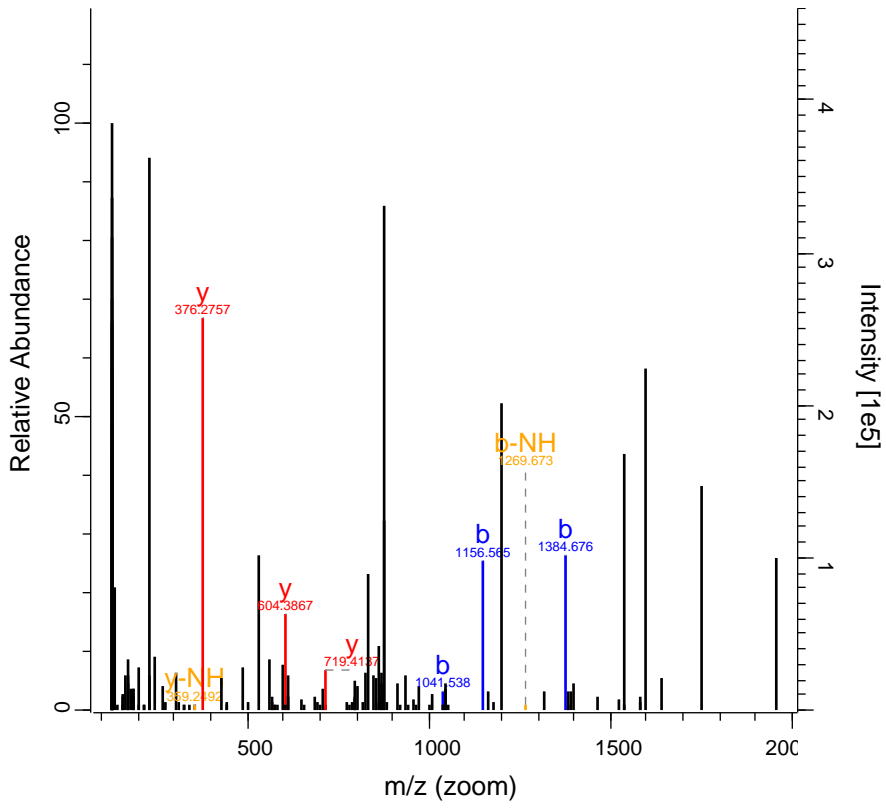

RO-QC-160121_ZackD_SS_Set_01_Fraction 14927 FTMS; HC 90.32 769.03 CASK

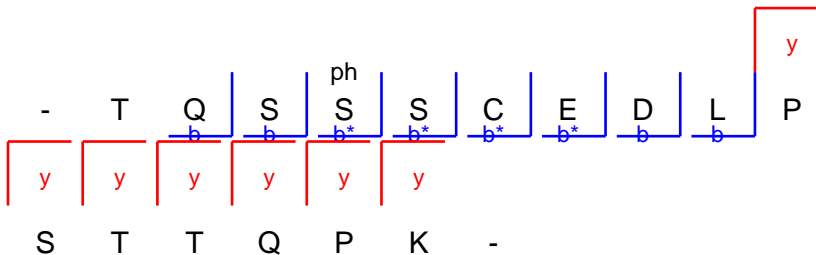
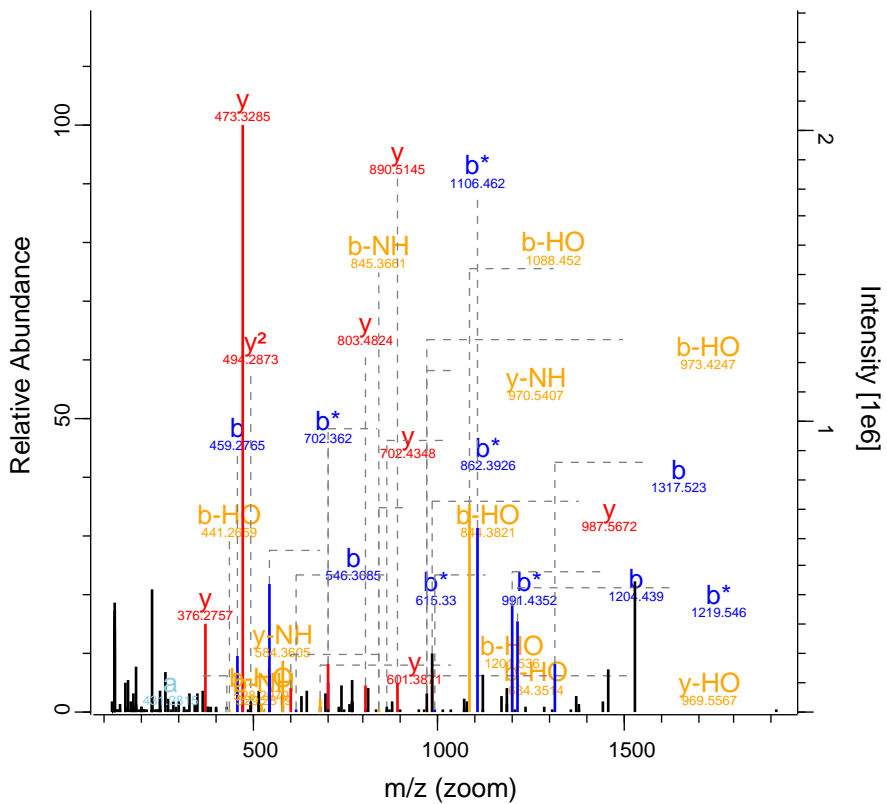

RO-QC-160121_ZackD_SS_Set_01_Fractic 16632 FTMS; HC 89.63 1242.66 HIST1H1E

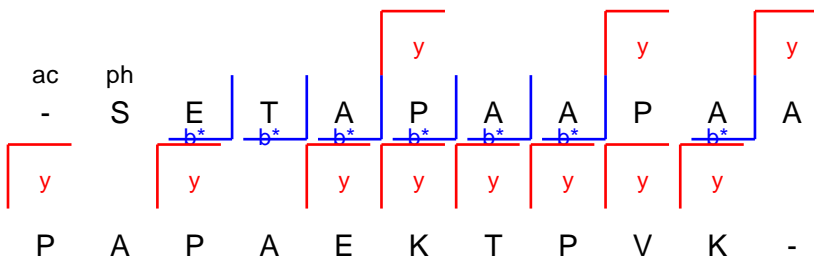
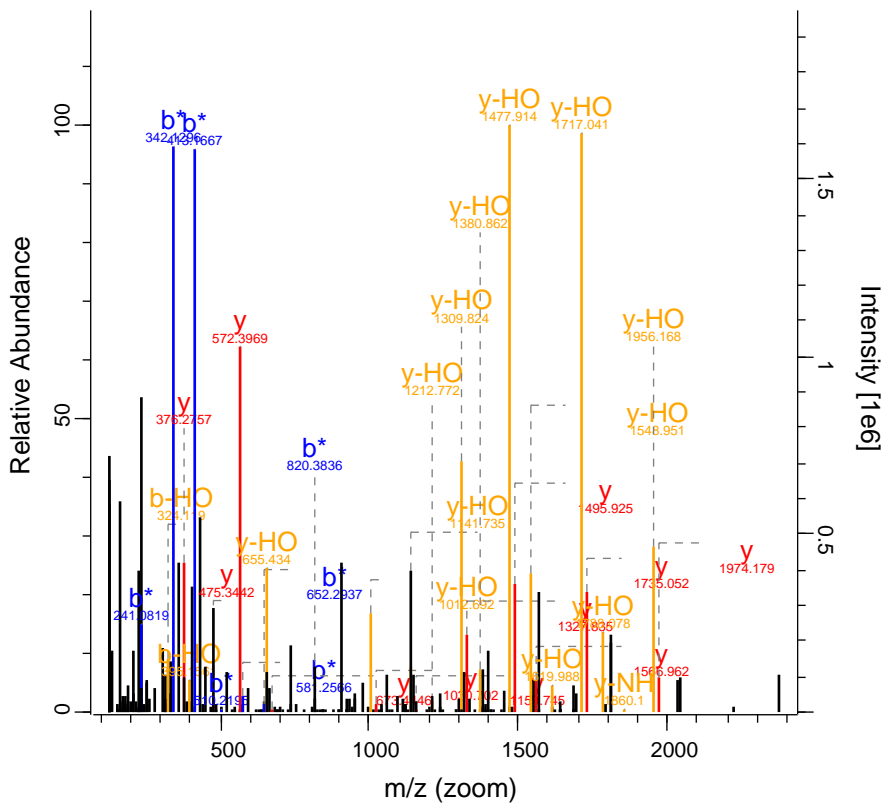

RO-QC-160121_ZackD_SS_Set_01_Fraction16781 FTMS; HC 43.79 991.19 RBL1

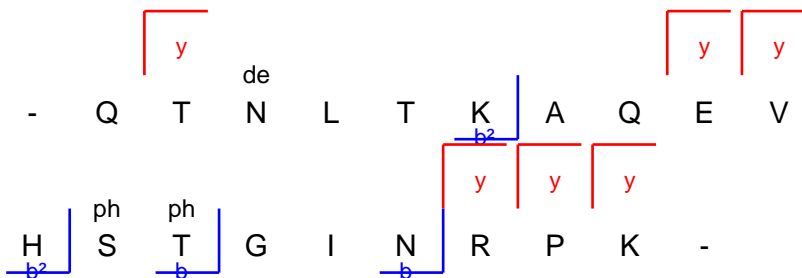
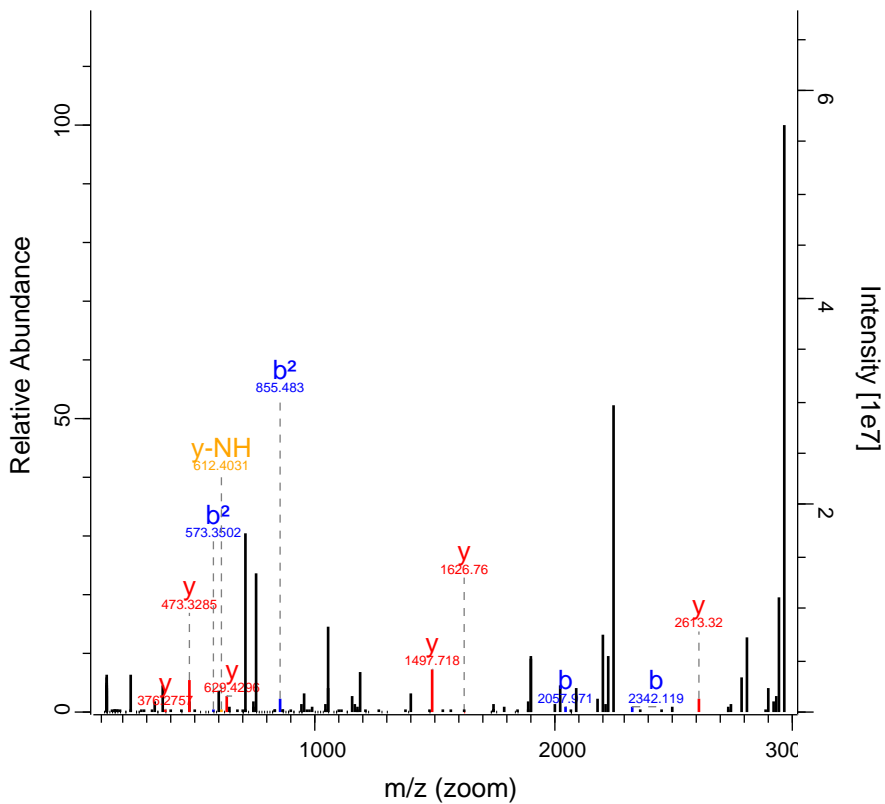

RO-QC-160121_ZackD_SS_Set_01_Fraction17621 FTMS; HC 43.96 796.11 TP53BP1

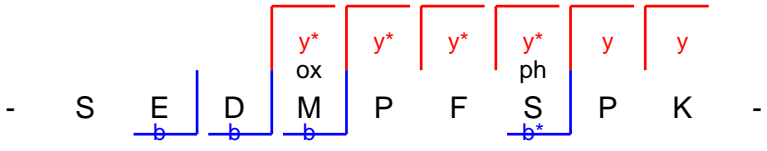
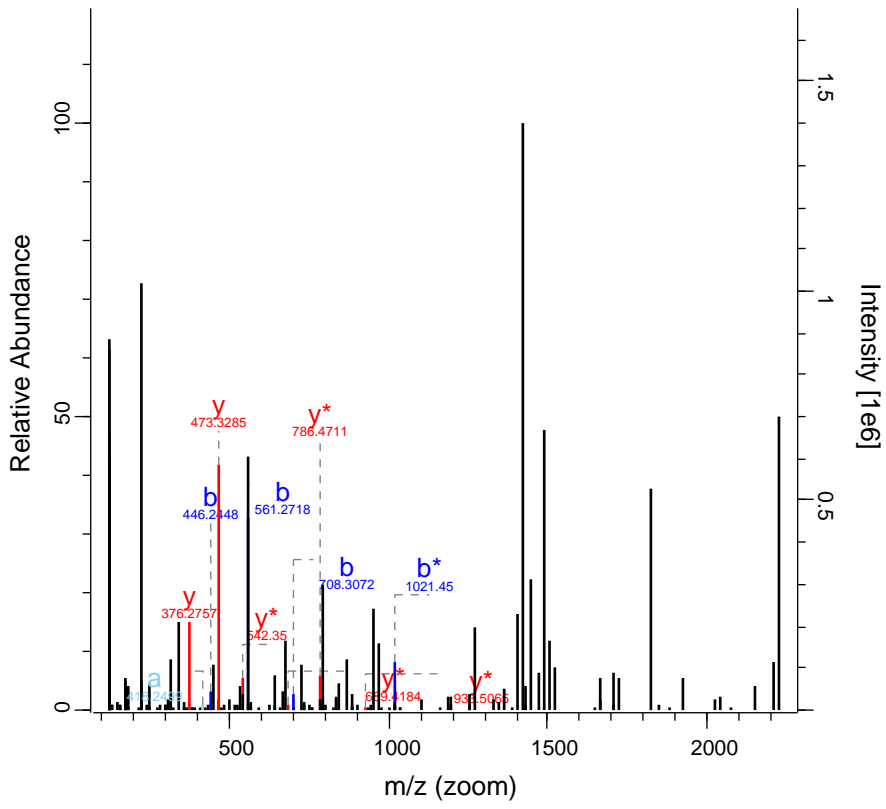

RO-QC-160121_ZackD_SS_Set_01_Fractic 18809 FTMS; HC 89.31 1236.59 MAP1B

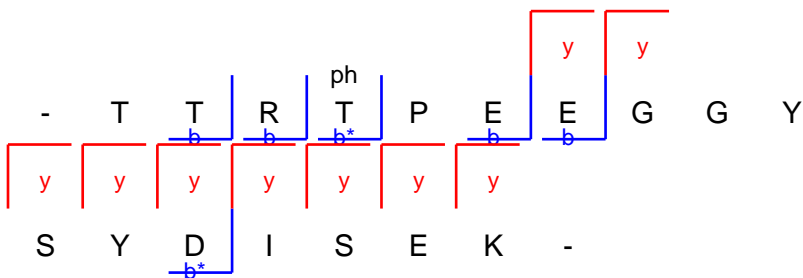
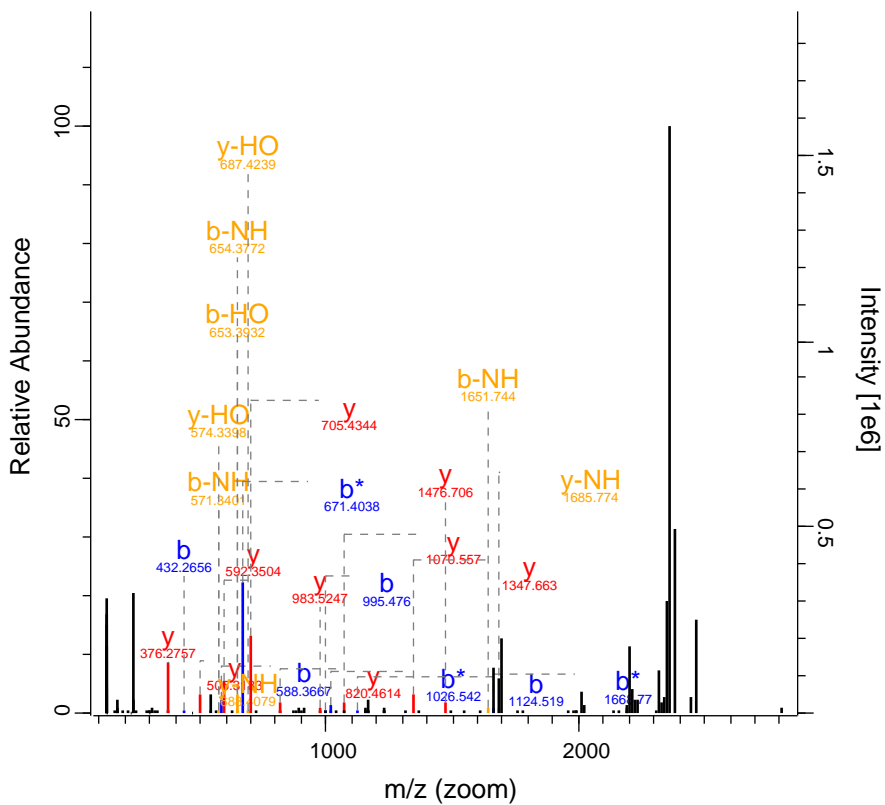

RO-QC-160121_ZackD_SS_Set_01_Fractio 18896 FTMS; HC 126.99 715.17 PGRMC2

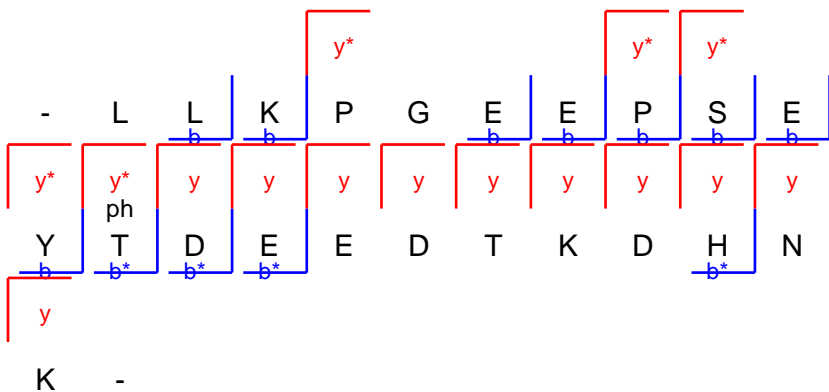
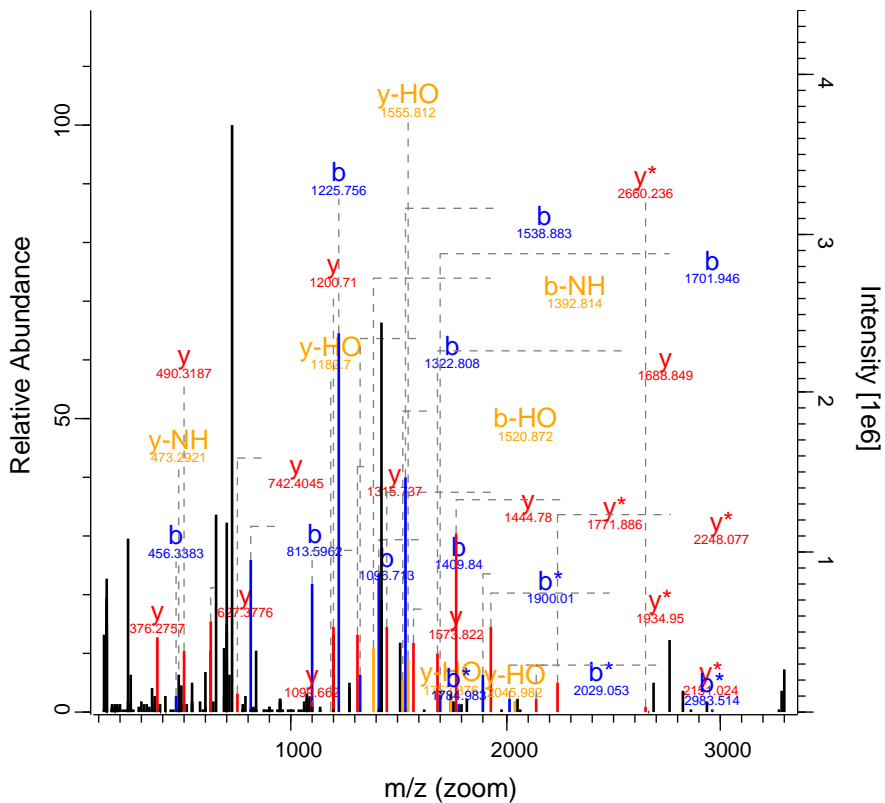

RO-QC-160121_ZackD_SS_Set_01_Fraction 20034 FTMS; HCl 79.24 943.2 PCDH7

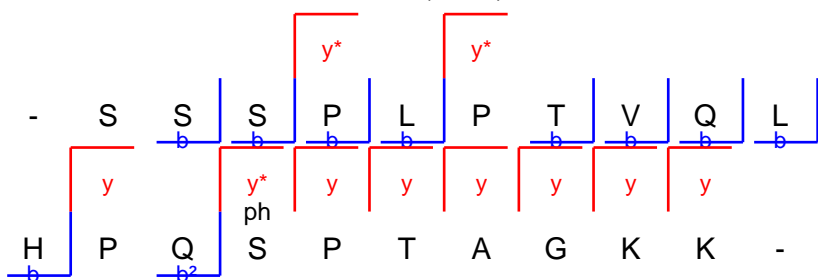
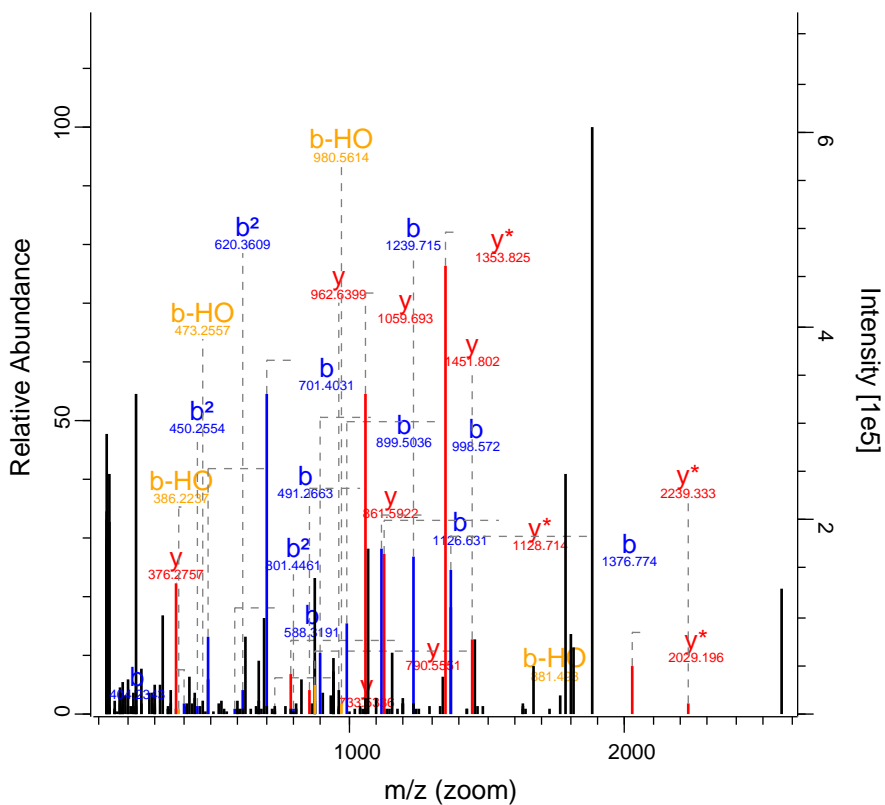

RO-QC-160121_ZackD_SS_Set_01_Fractio 20506 FTMS; HC 206.17 900.93 AP3B1

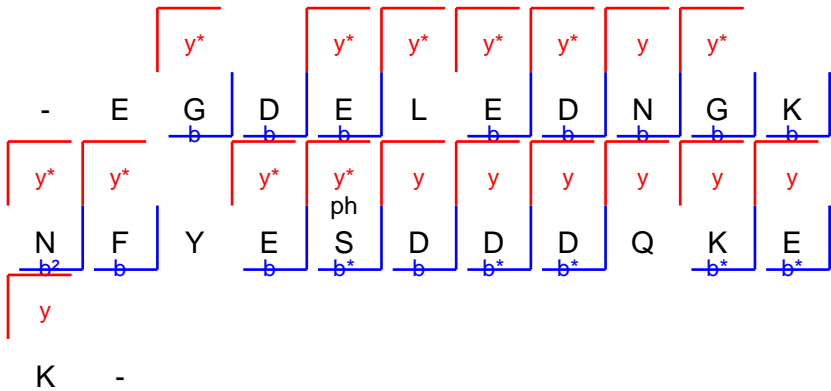
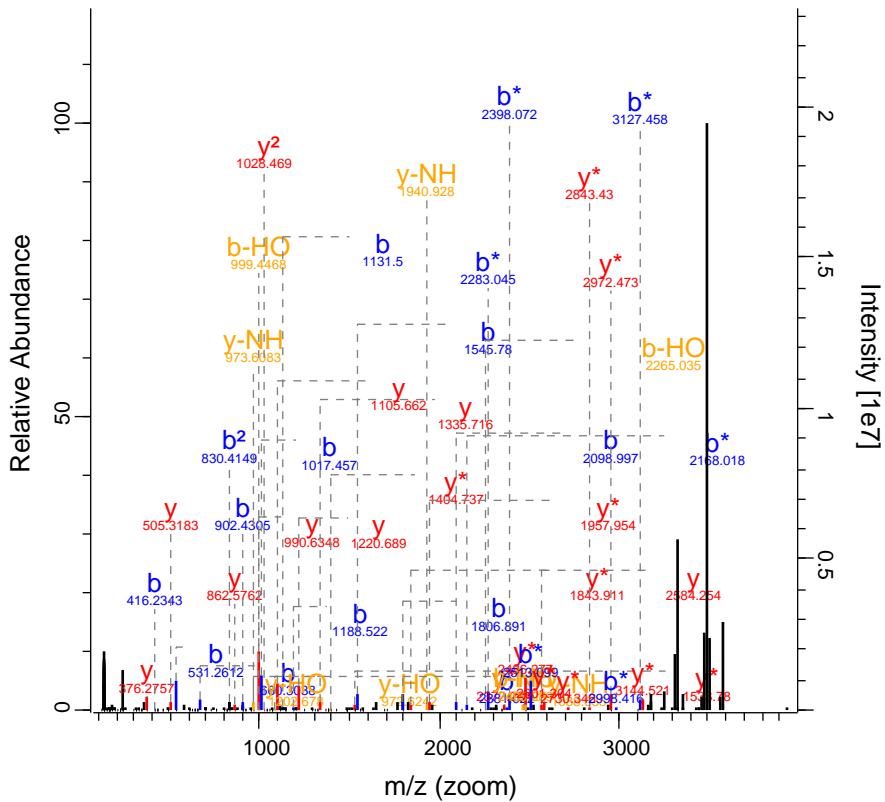

RO-QC-160121_ZackD_SS_Set_01_Fraction 21111 FTMS; HC 43.7 555.32 ABCD2

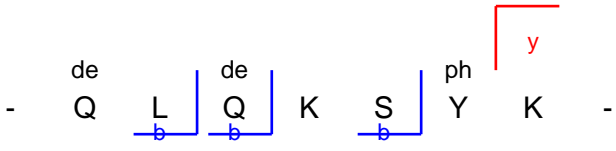
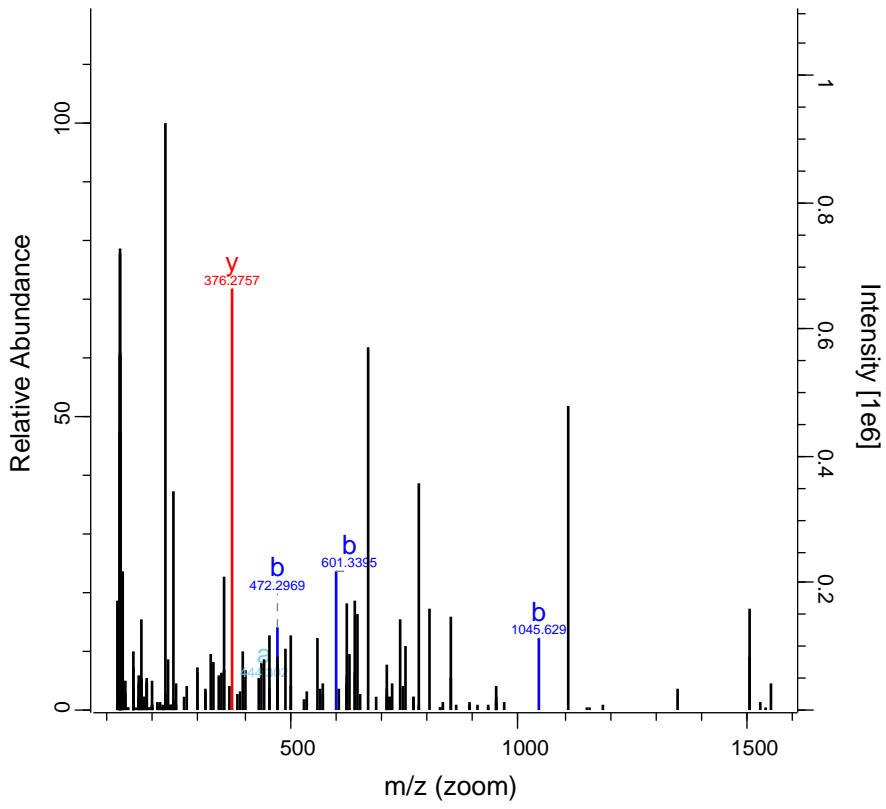

RO-QC-160121_ZackD_SS_Set_01_Fraction 21218 FTMS; HC 64.52 636.34 PRKCB

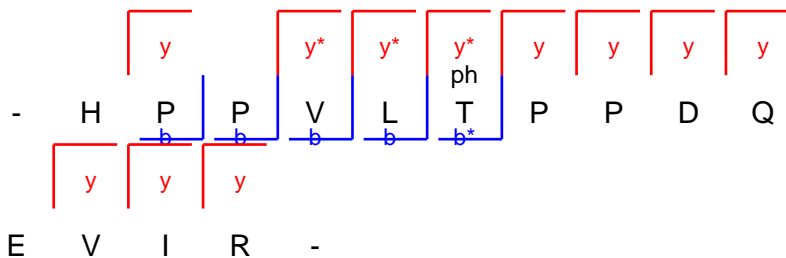
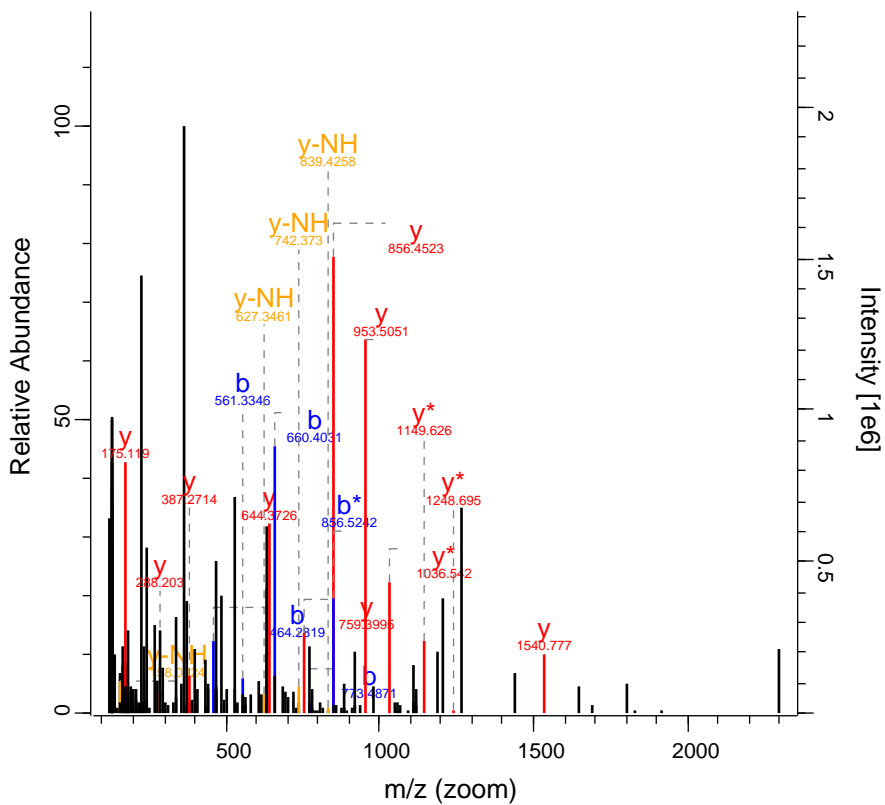

RO-QC-160121_ZackD_SS_Set_01_Fraction22746 FTMS; HC 105 980.47 CEP170

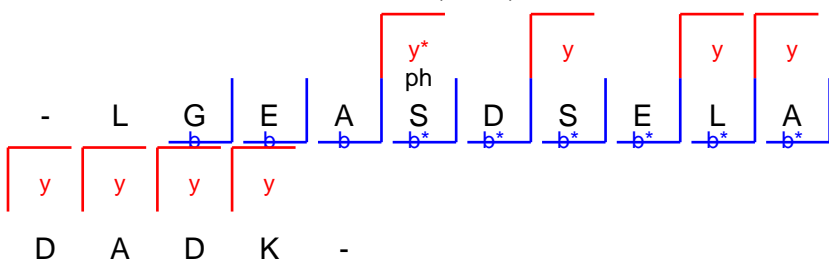
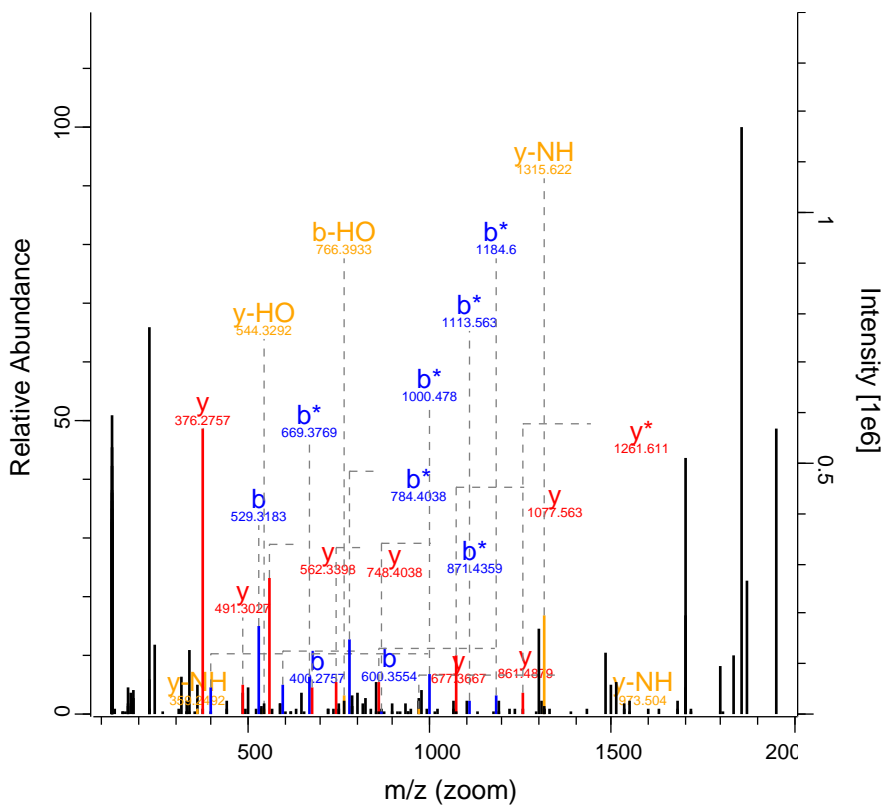

RO-QC-160121_ZackD_SS_Set_01_Fraction 24292 FTMS; HC 58.63 916.99 TSHZ2

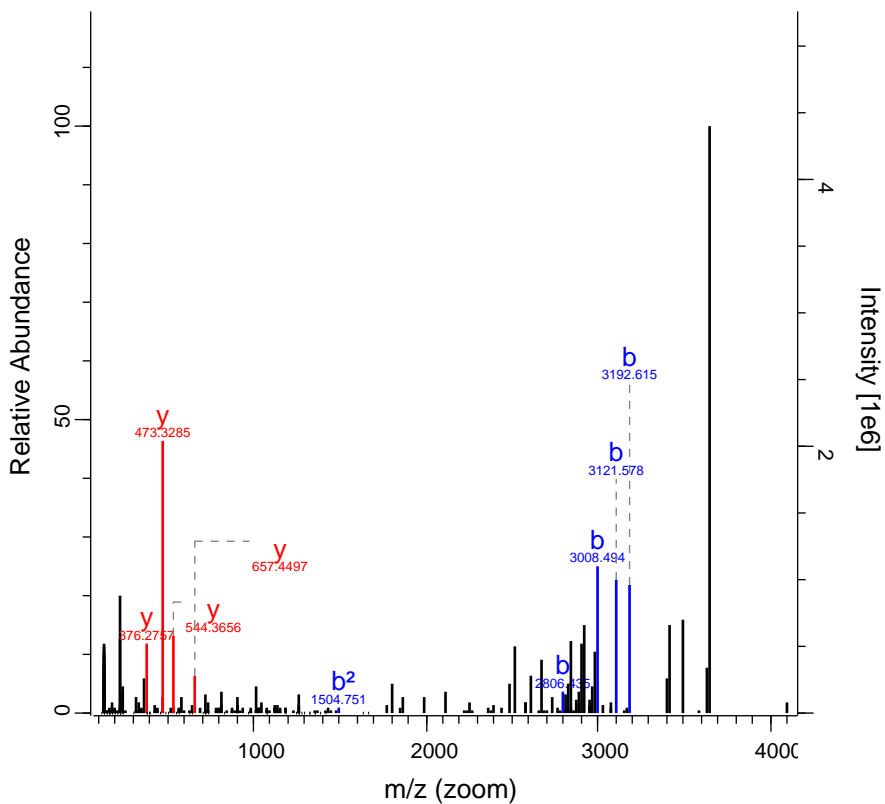

- Q L V L D P L A V E

K ox de ph
M Q S L S E A P N S

D S L A P K -

Red brackets connect the following amino acids: S-L, L-A, A-P, P-K. Blue brackets connect the following amino acids: S-L, L-A, A-P, P-K, and N-S.

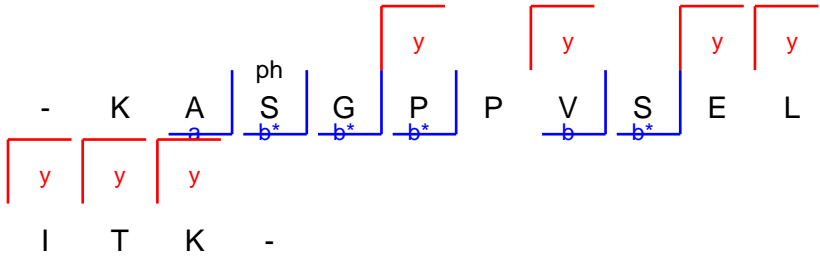
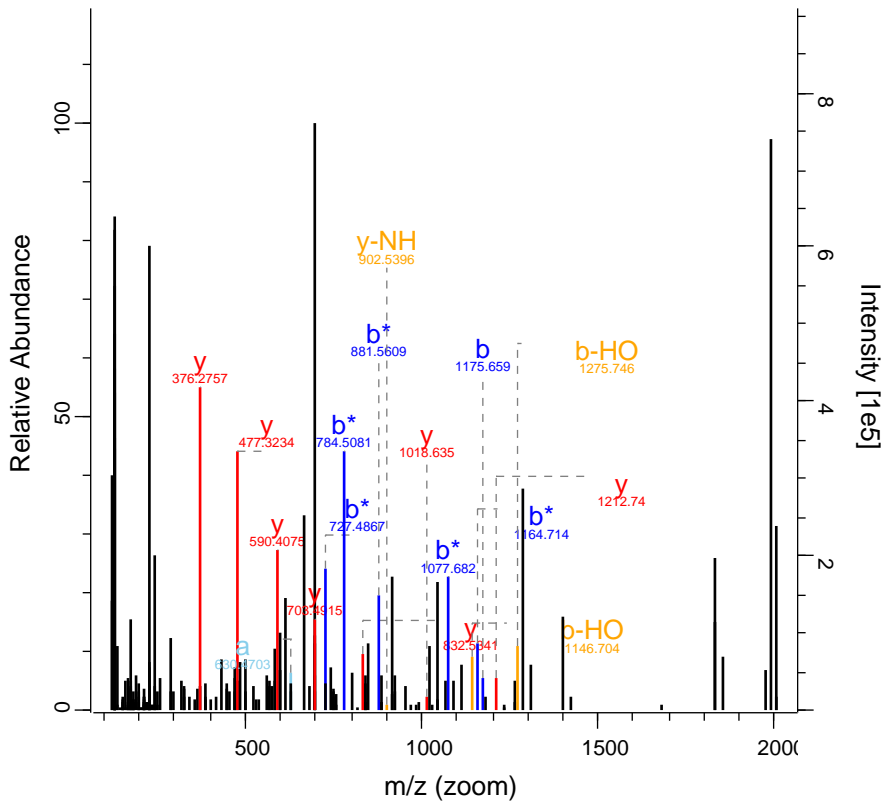

RO-QC-160121_ZackD_SS_Set_01_Fractic 26209 FTMS; HC 138.42 1005.54 RPS3

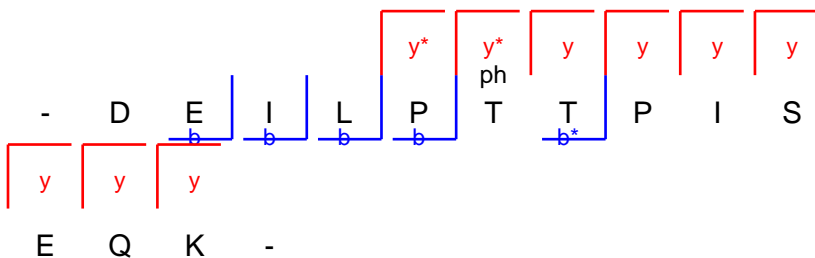
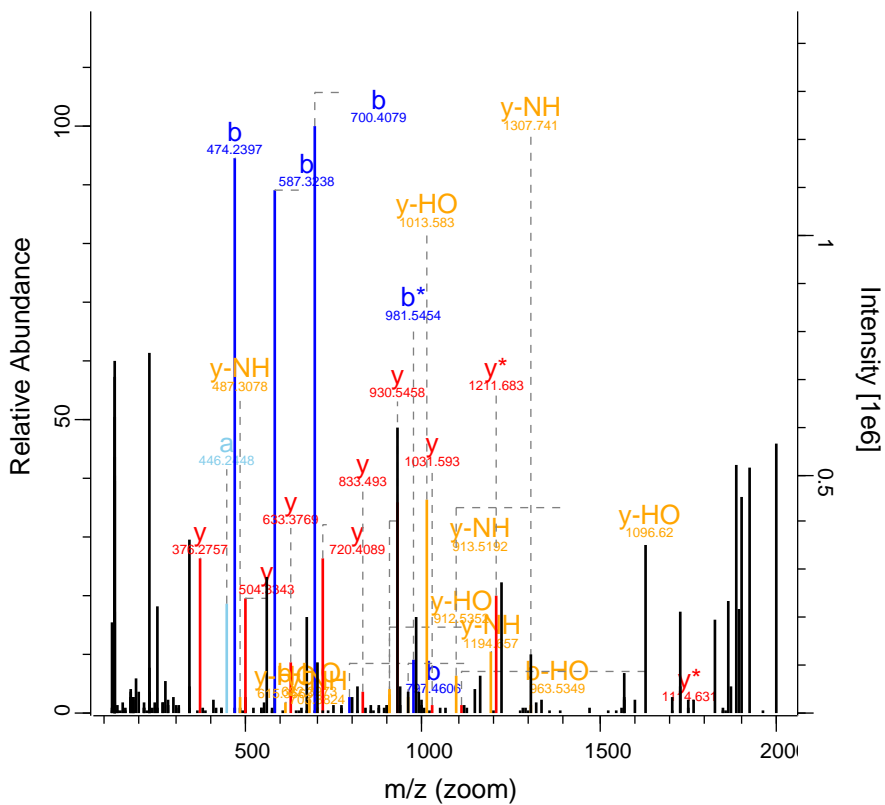

RO-QC-160121_ZackD_SS_Set_01_Fraction 26227 FTMS; HC 89.25 898.48 ABL2

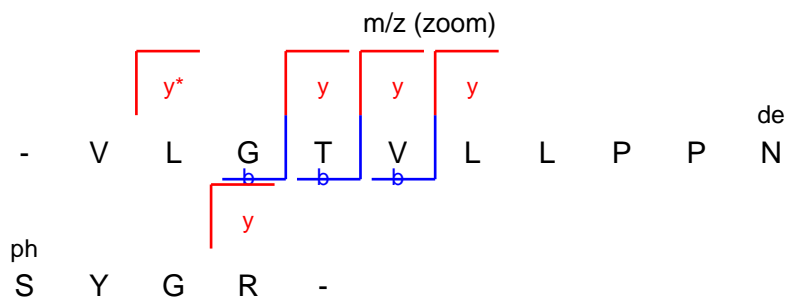
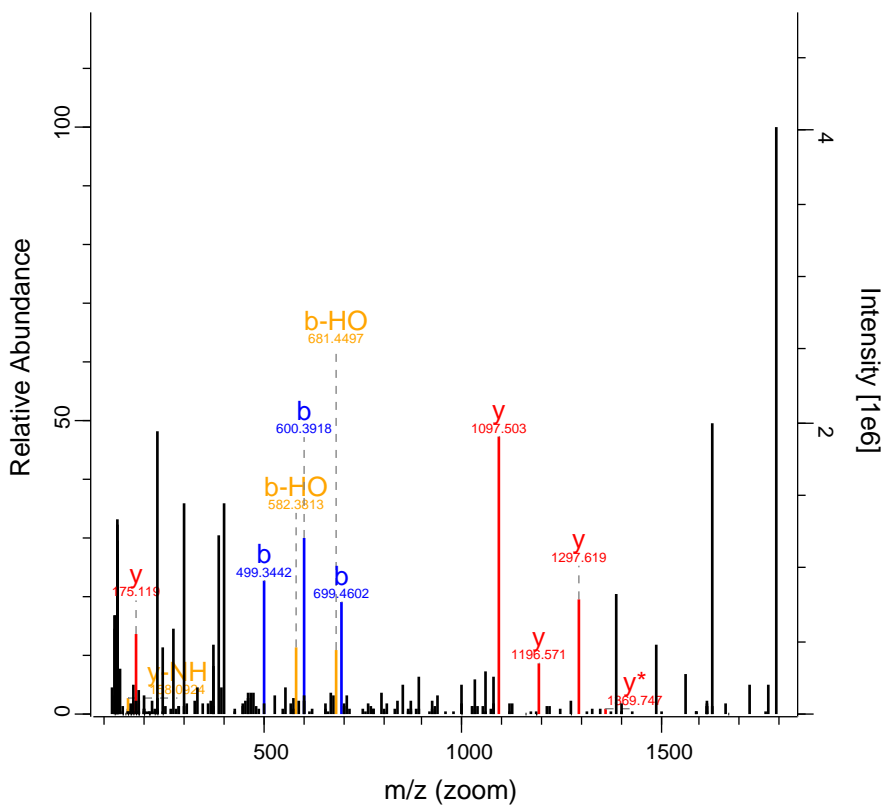

RO-QC-160121_ZackD_SS_Set_01_Fractic 26283 FTMS; HC 104.52 1141.51 EDC4

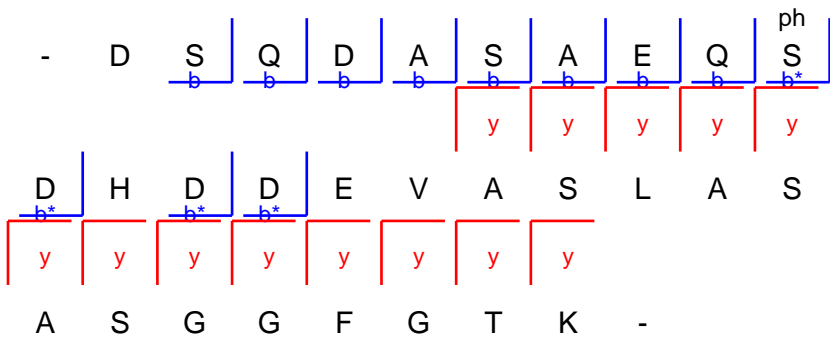
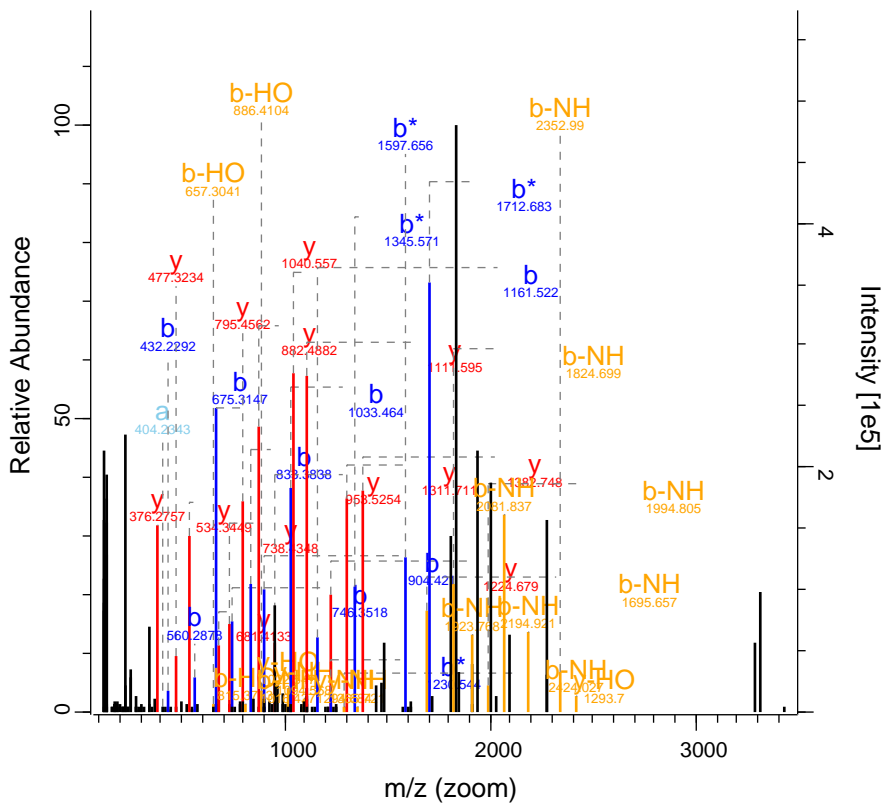

RO-QC-160121_ZackD_SS_Set_01_Fraction 26552 FTMS; HC 84.14 613.03 NUFIP2

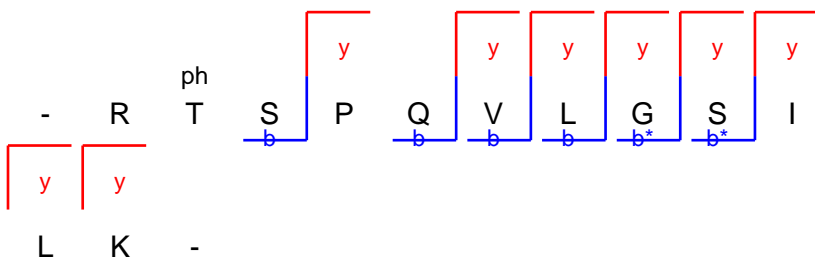
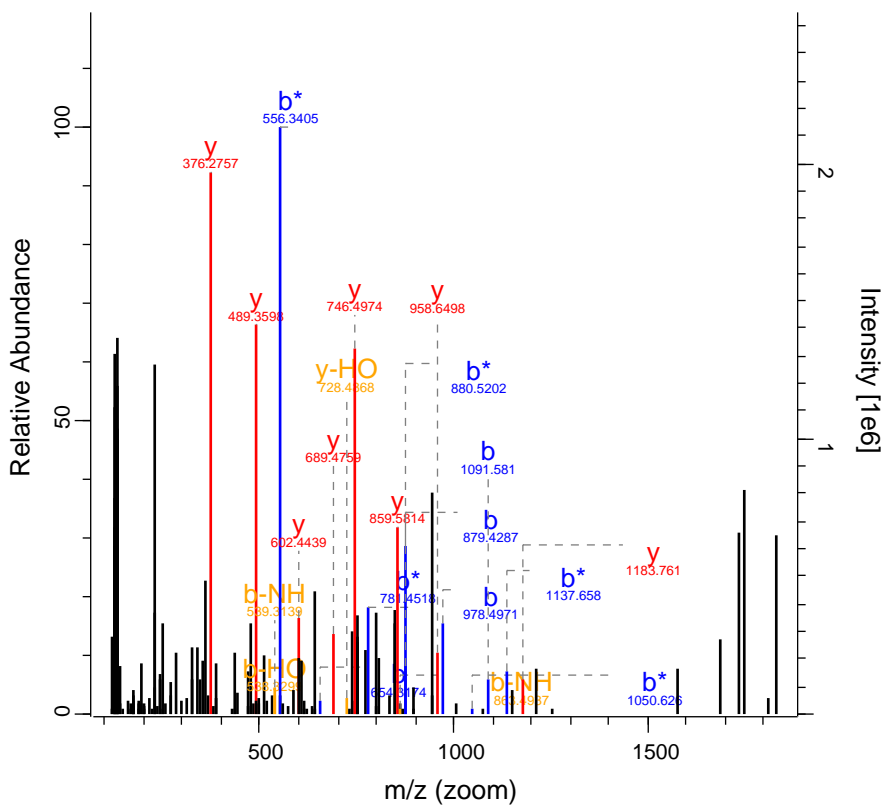

RO-QC-160121_ZackD_SS_Set_01_Fractic 26993 FTMS; HC 70.53 1388.22 COL4A1

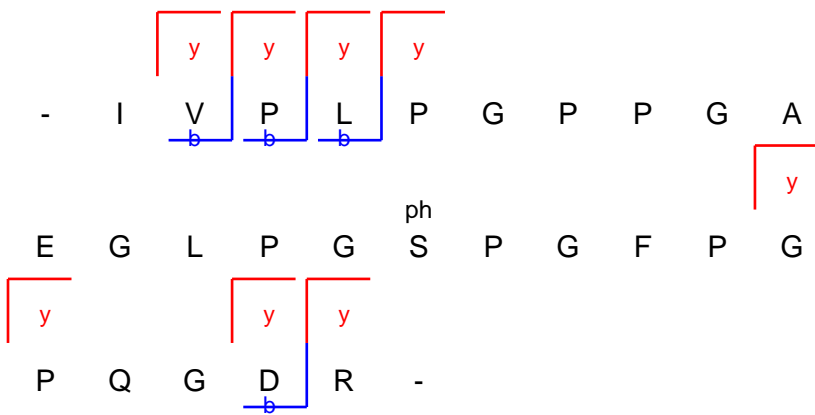
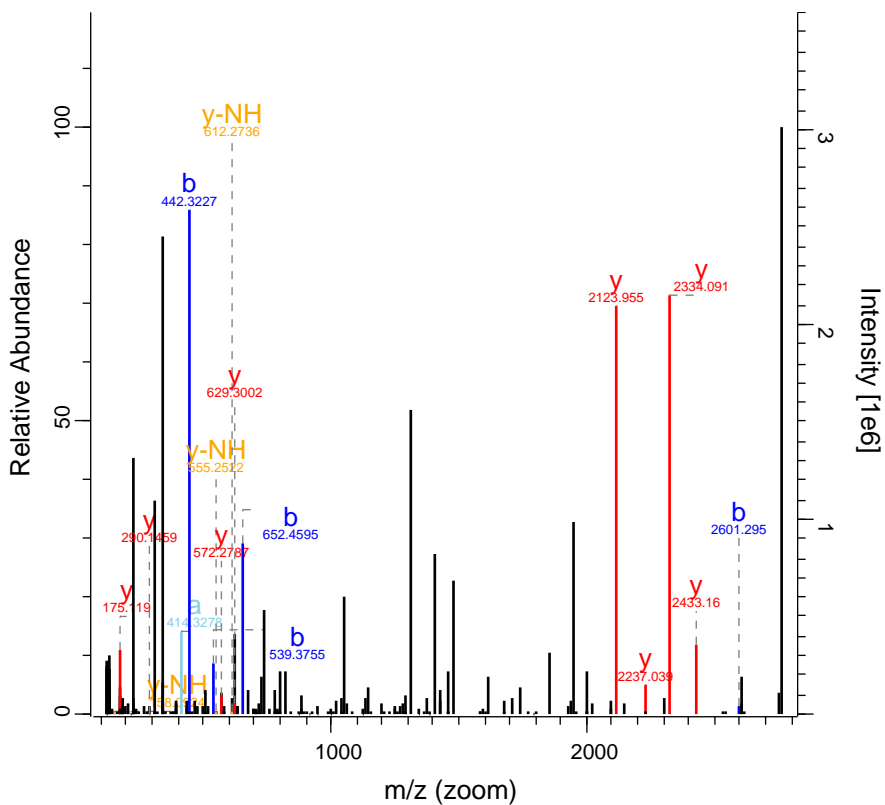

RO-QC-160121_ZackD_SS_Set_01_Fraction 27133 FTMS; HC 86.09 405.21 SCTR

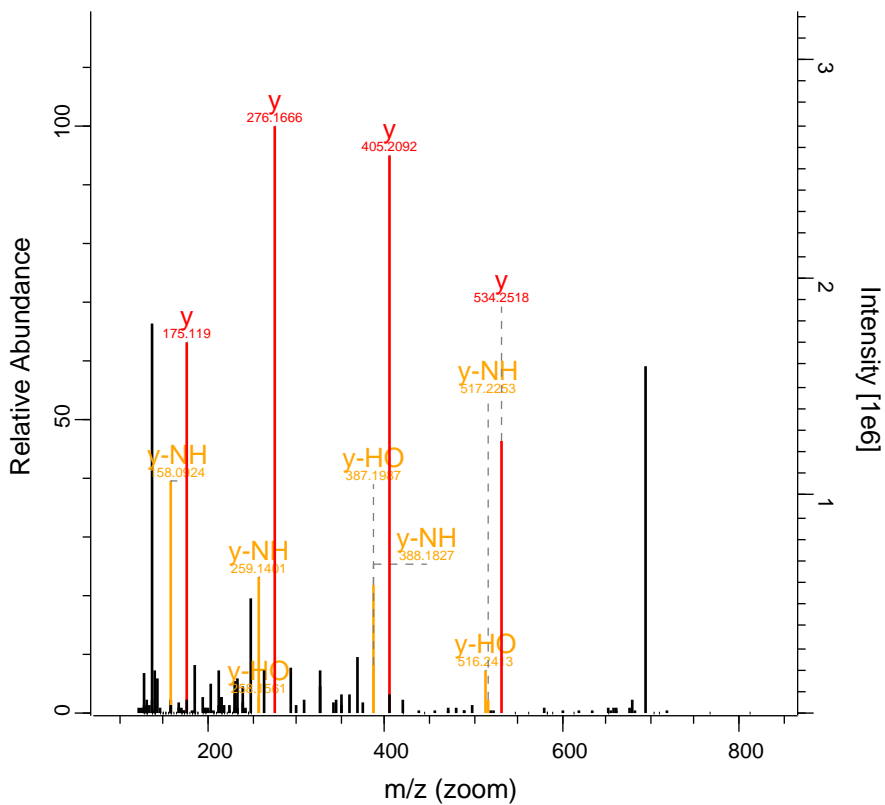

ph y de y y y
 - L R T Q E T R -

RO-QC-160121_ZackD_SS_Set_01_Fractic 28092 FTMS; HC 66.53 1499.21 RTN4

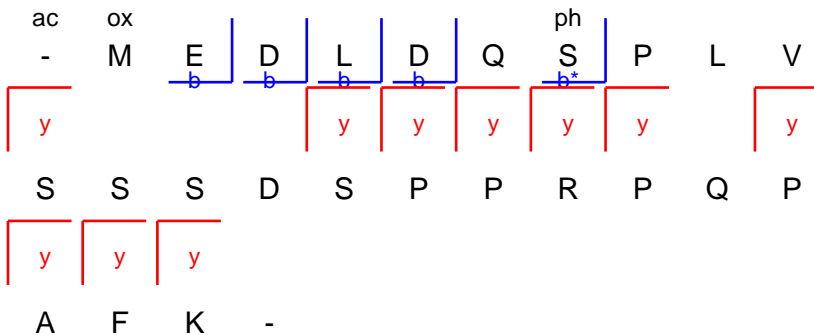
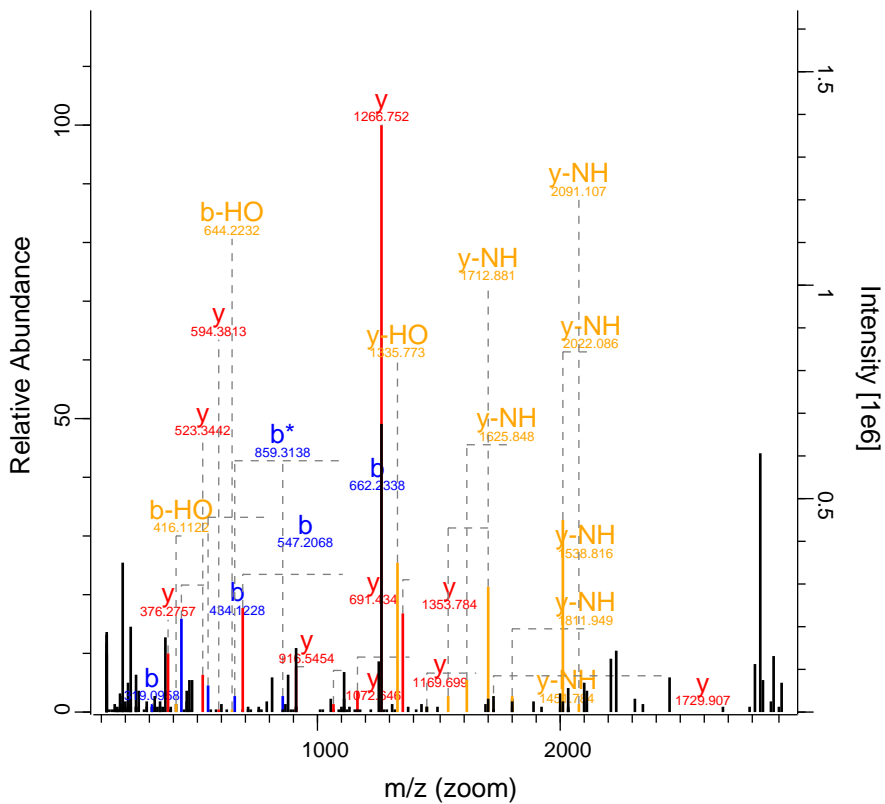

RO-QC-160121_ZackD_SS_Set_01_Fractio 28561 FTMS; HC 41.91 873.76 N4BP2

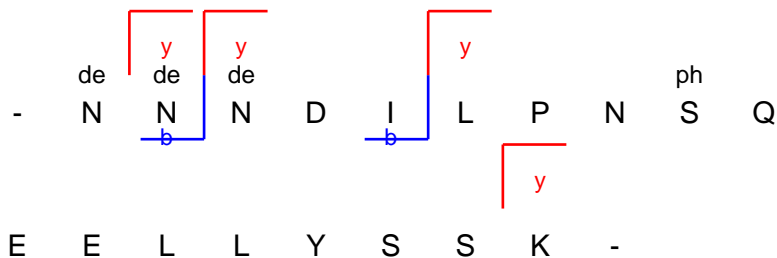
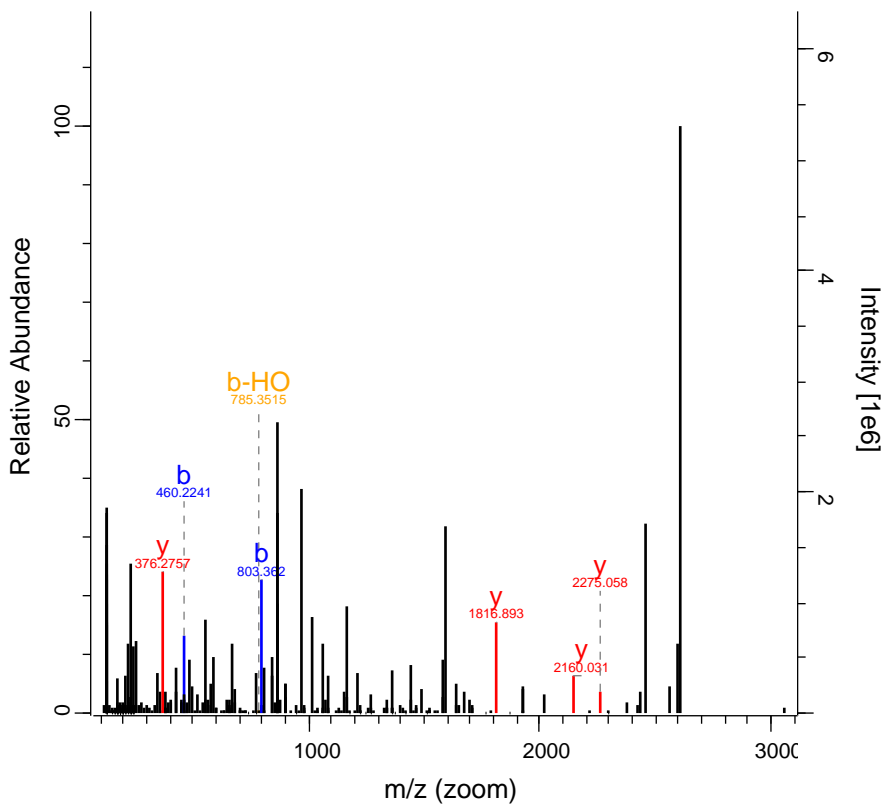

RO-QC-160121_ZackD_SS_Set_01_Fractic 29216 FTMS; HC 150.45 1013.17 SLC2A1

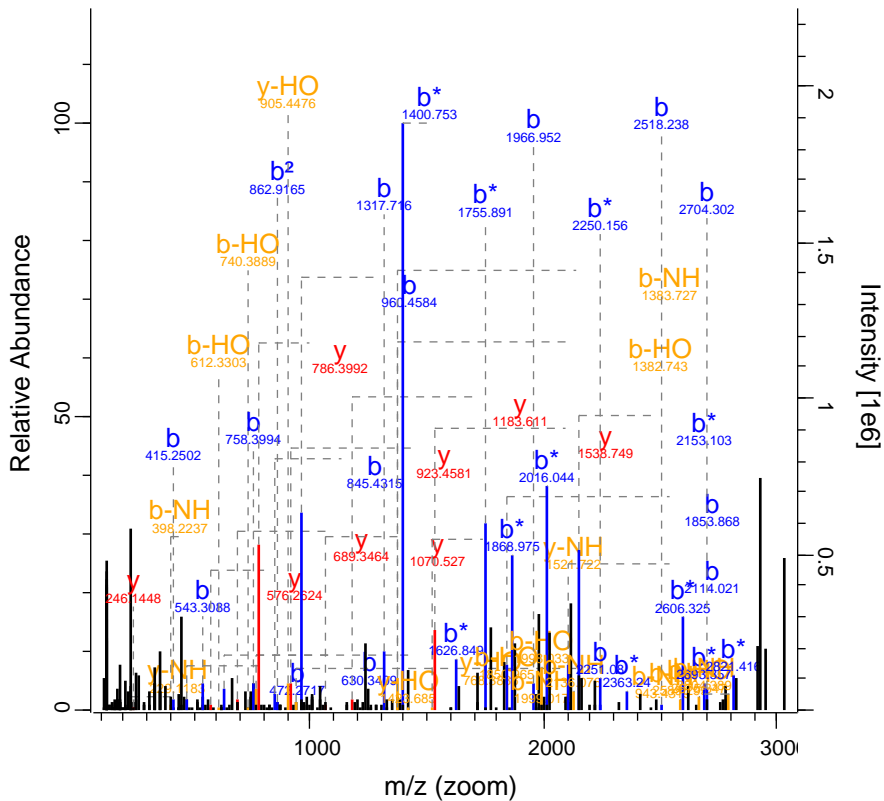

RO-QC-160121_ZackD_SS_Set_01_Fraction 29436 FTMS; HC 41.64 732.38 SLC22A7

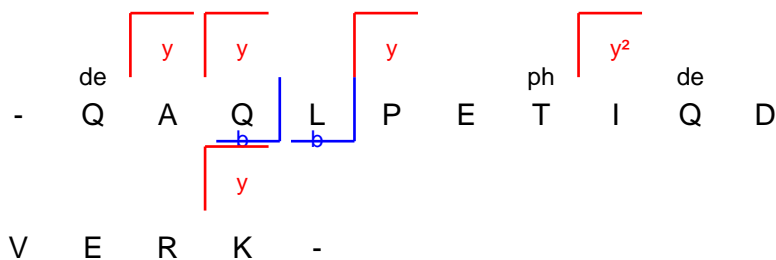
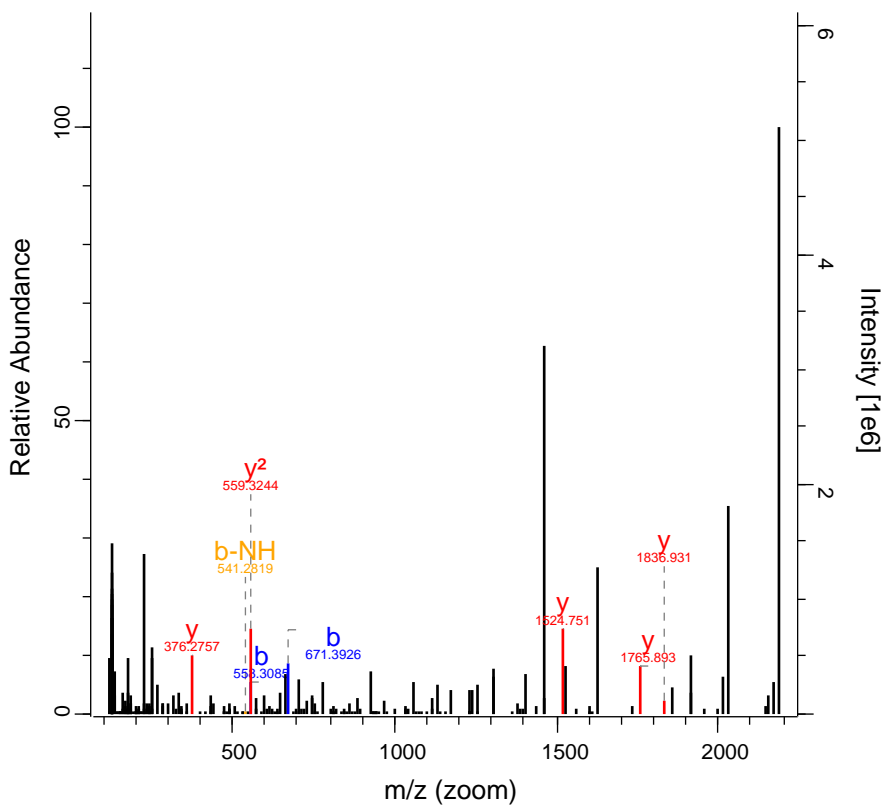

RO-QC-160121_ZackD_SS_Set_01_Fractic 29440 FTMS; HC 216.48 1053.21 CCNY

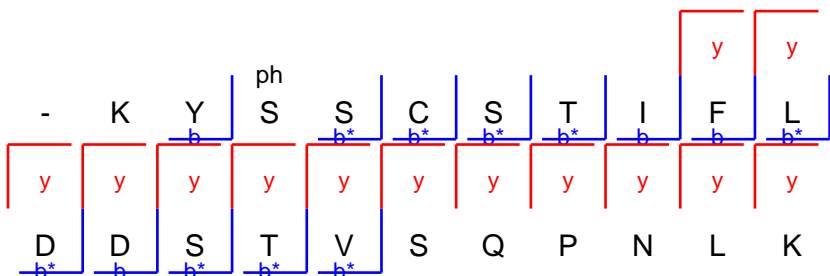
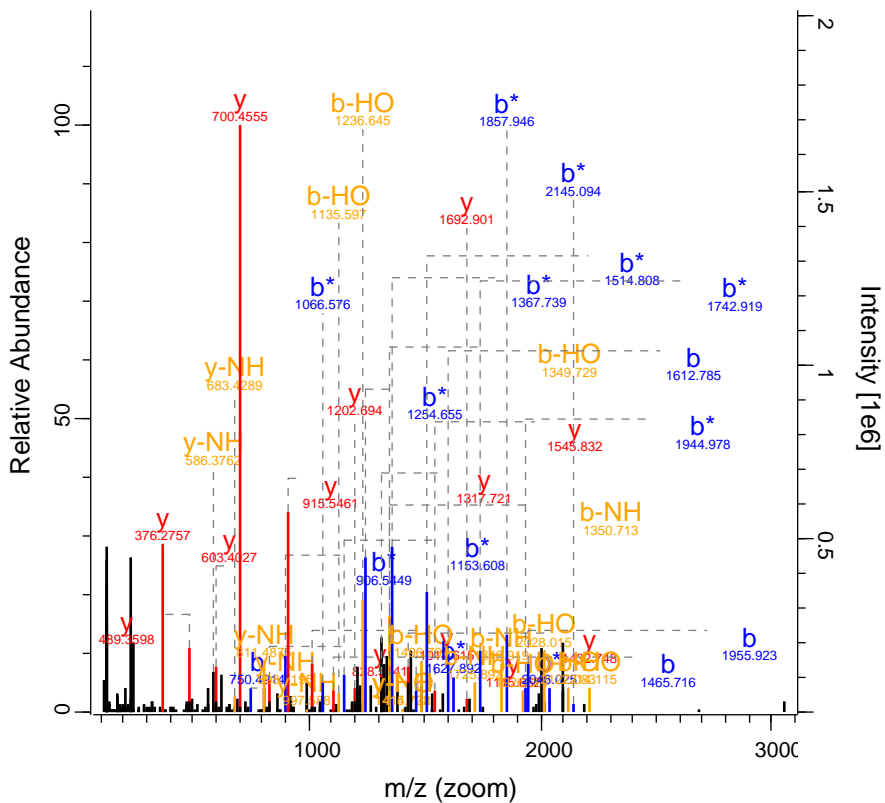

RO-QC-160121_ZackD_SS_Set_01_Fraction 30470 FTMS; HC 73.29 643.87 SYNPO

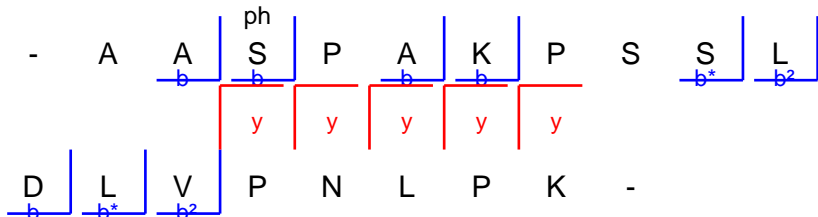
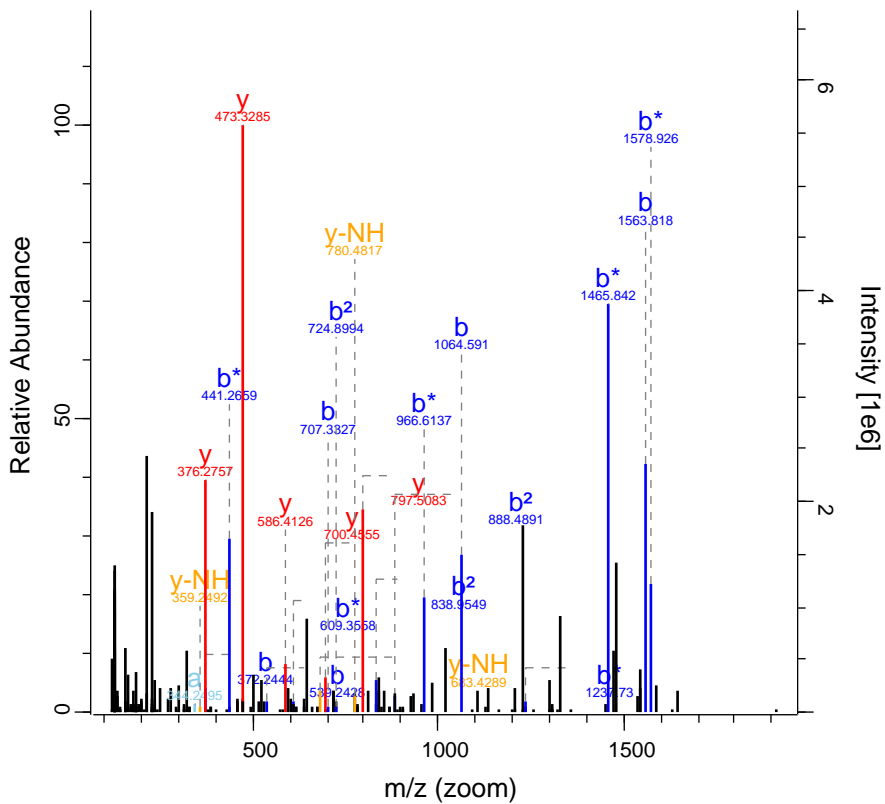

RO-QC-160121_ZackD_SS_Set_01_Fractic 30886 FTMS; HC 159.56 1094.83 MAP1B

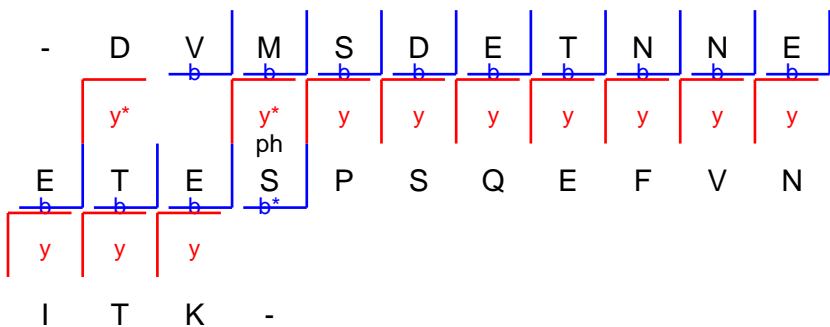
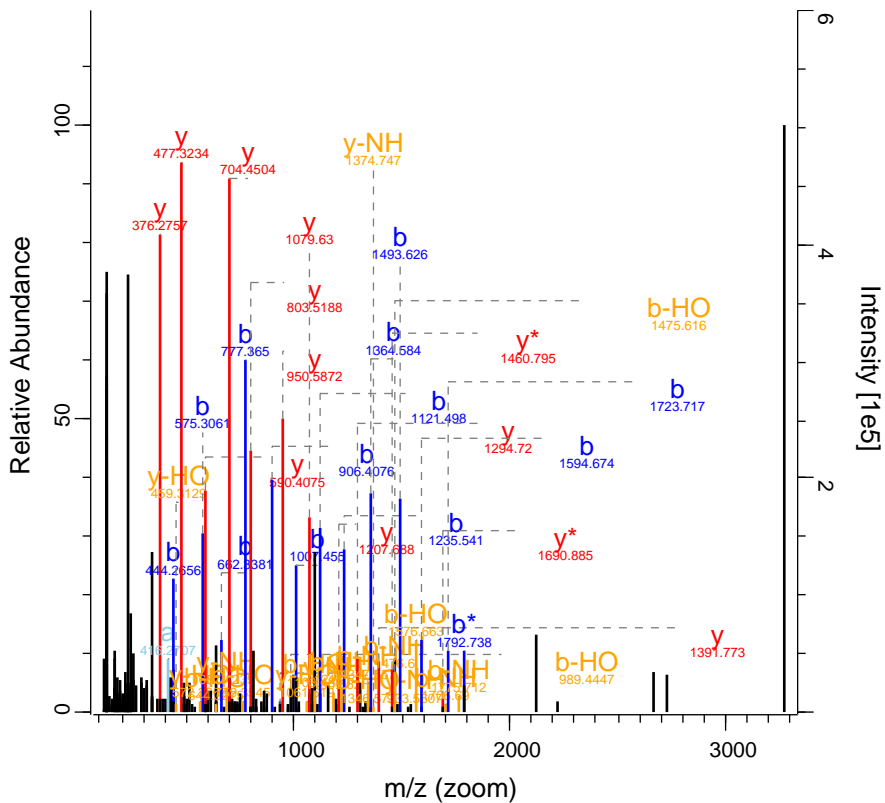

RO-QC-160121_ZackD_SS_Set_01_Fractic 32008 FTMS; HC 211.77 1325.29 AHNAK

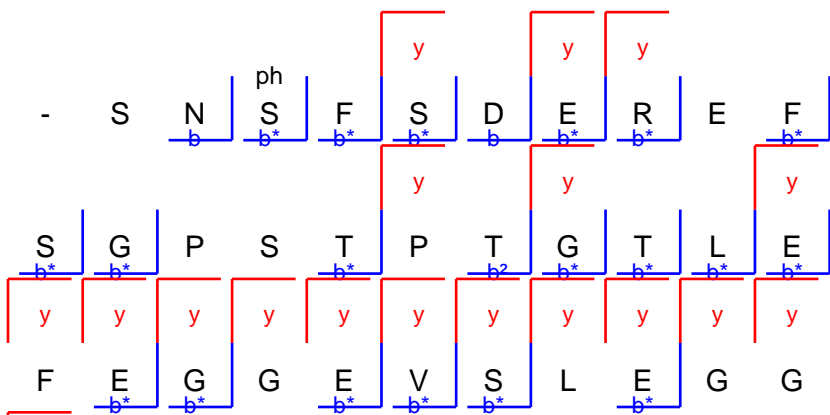
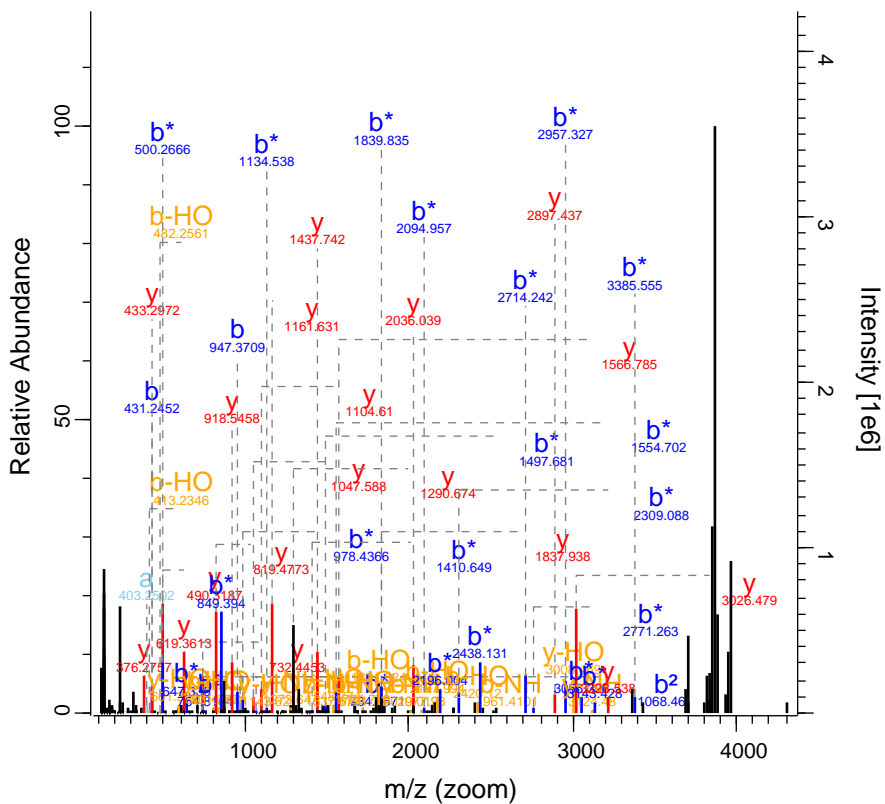

RO-QC-160121_ZackD_SS_Set_01_Fractic 32049 FTMS; HC 122.06 1017.49 SQSTM1

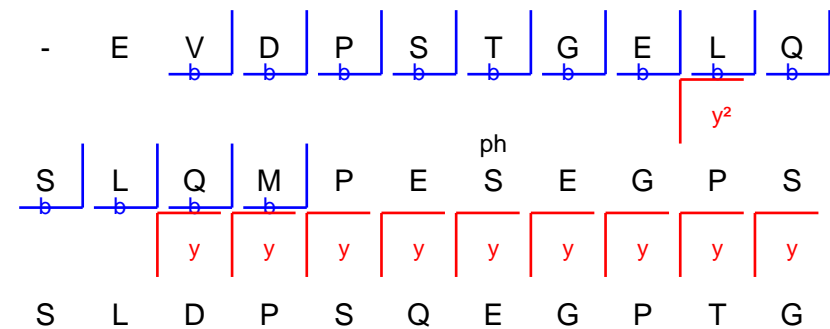
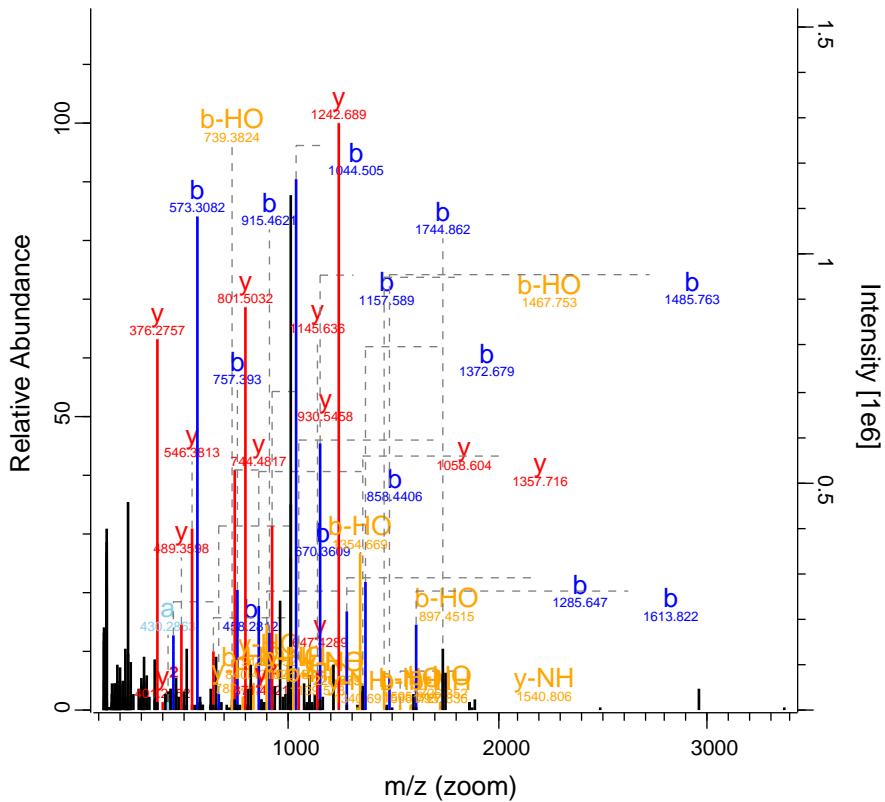

RO-QC-160121_ZackD_SS_Set_01_Fraction 32295 FTMS; HC 43.73 847.24 SYNE1

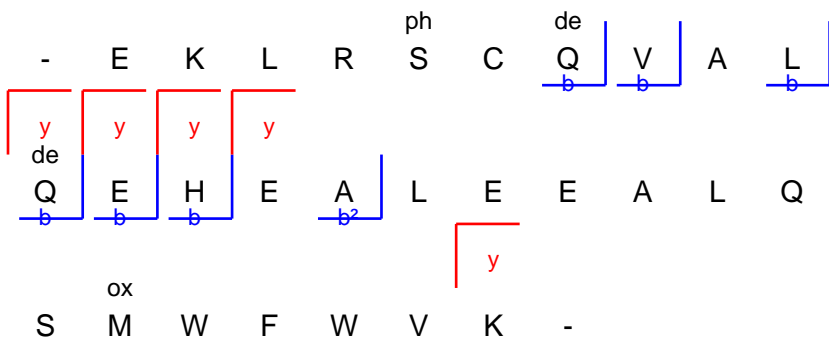
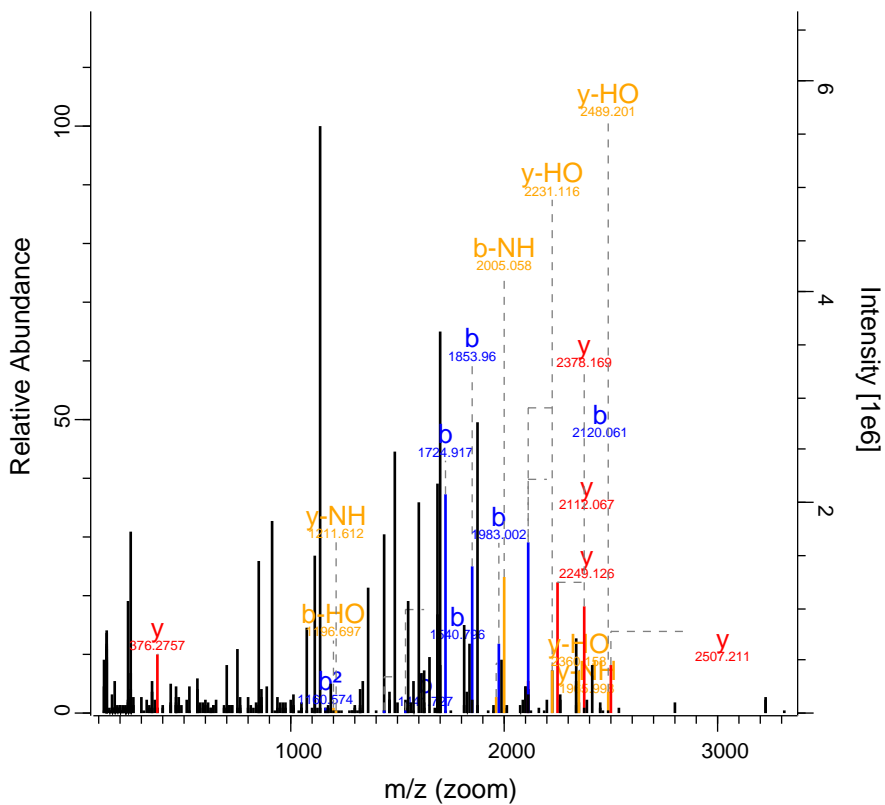

RO-QC-160121_ZackD_SS_Set_01_Fractio 32810 FTMS; HC 141.78 994.14 RTN4

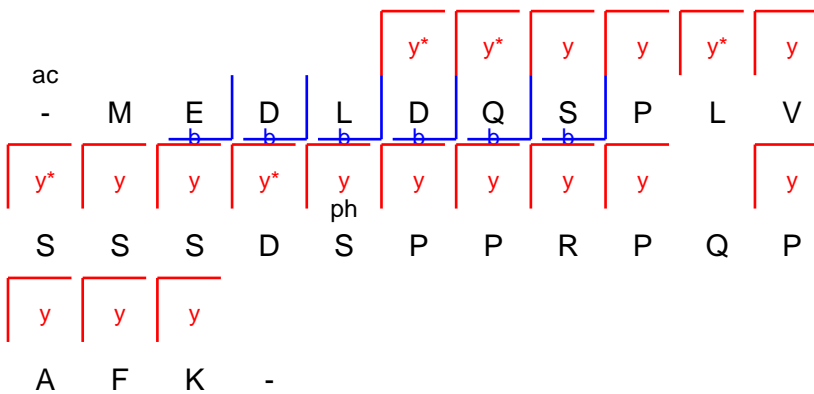
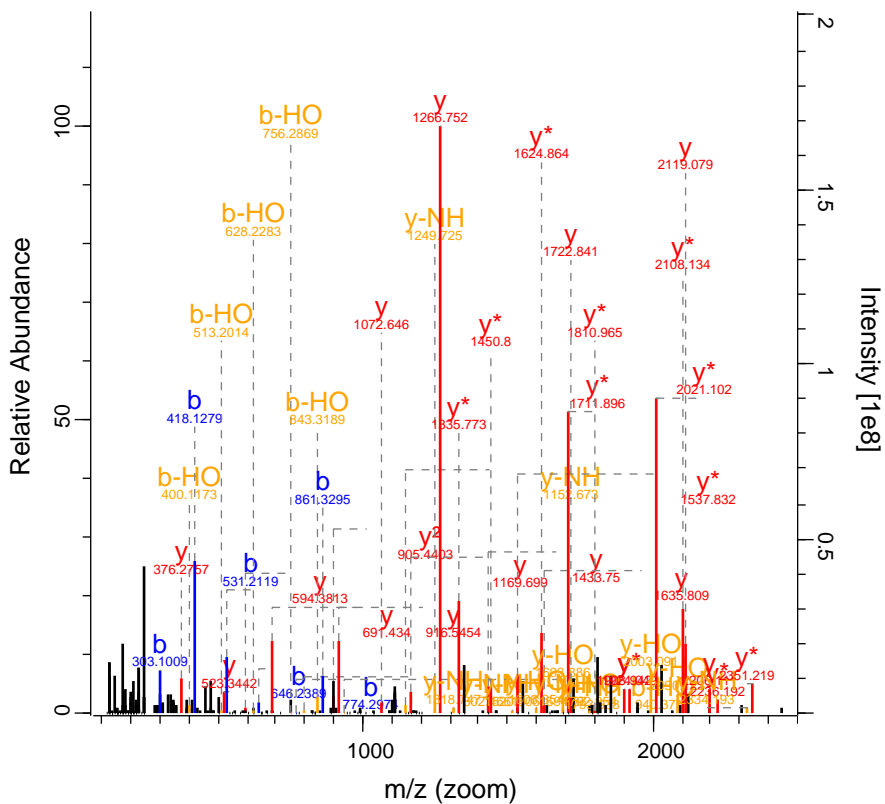

RO-QC-160121_ZackD_SS_Set_01_Fractic 32899 FTMS; HC 216.04 1490.71 RTN4

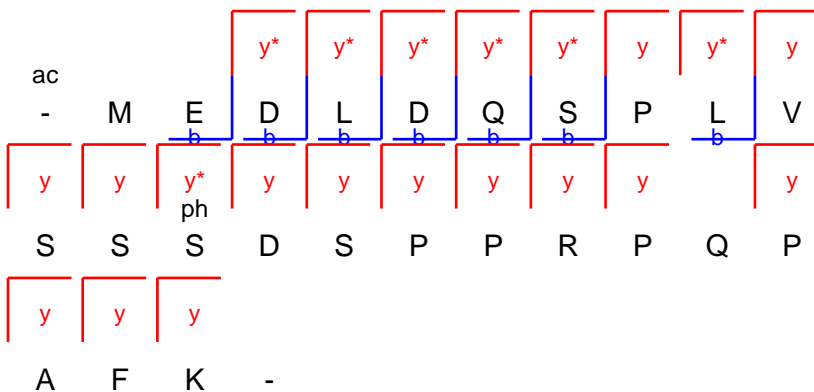
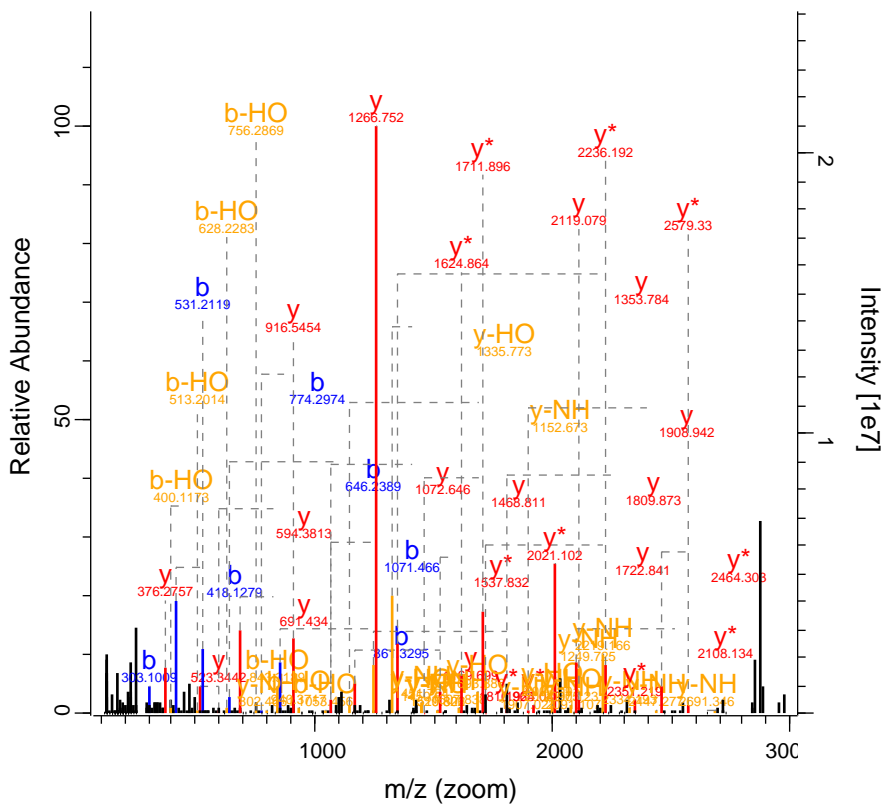

RO-QC-160121_ZackD_SS_Set_01_Fraction 35159 FTMS; HCl 40.5 1086 SMC3

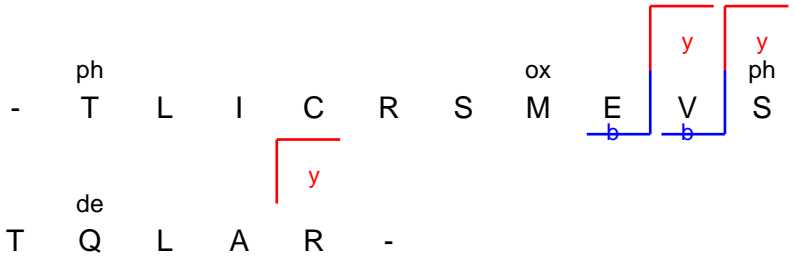
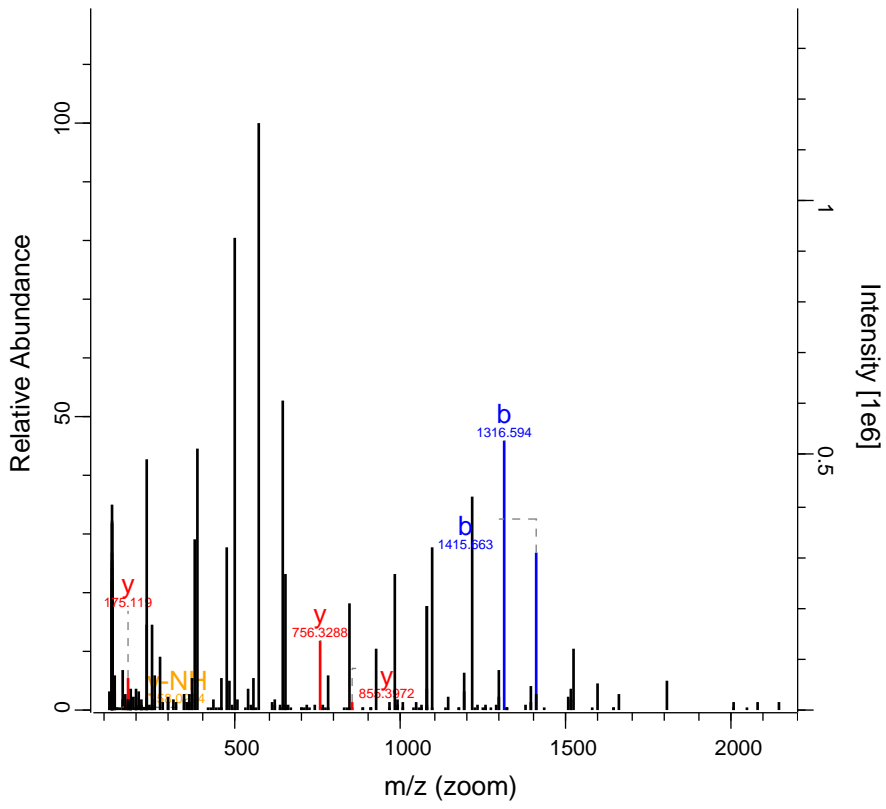

de
T Q L A R -

RO-QC-160121_ZackD_SS_Set_01_Fraction 36083 FTMS; HC 96.1 765.38 AKAP2

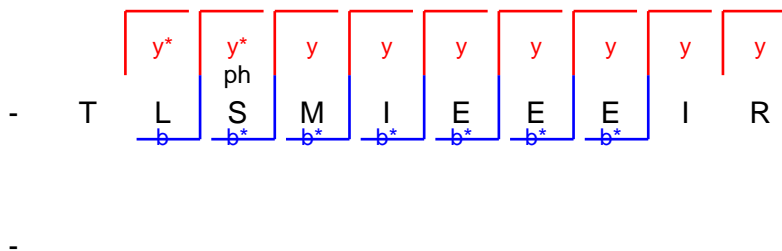
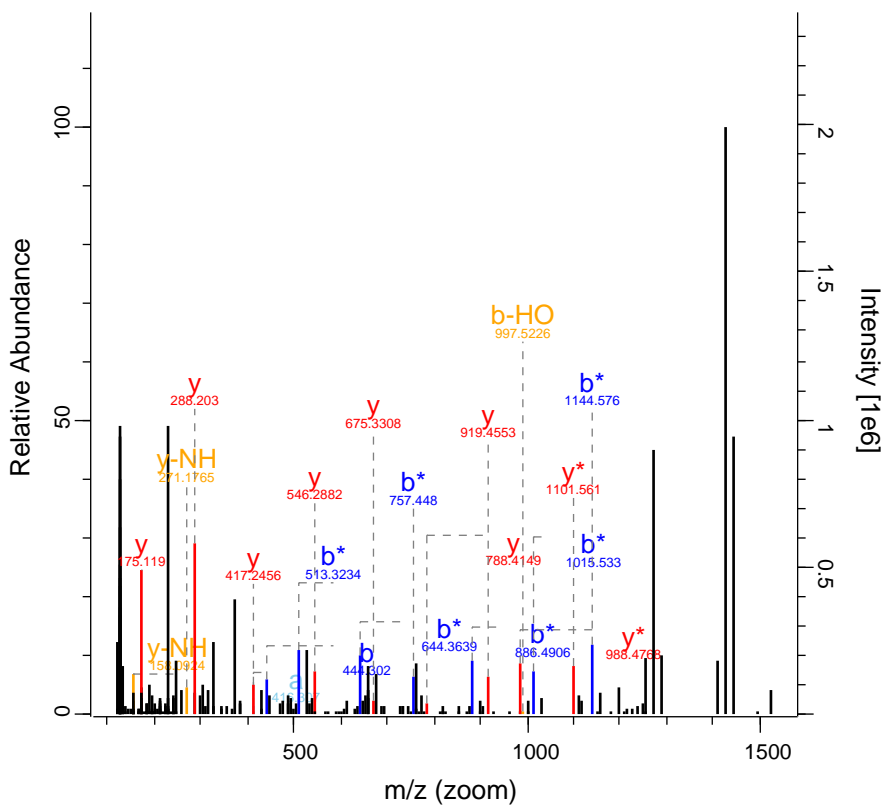

RO-QC-160121_ZackD_SS_Set_01_Fractic 36146 FTMS; HC 43.29 1023.04 SMG1

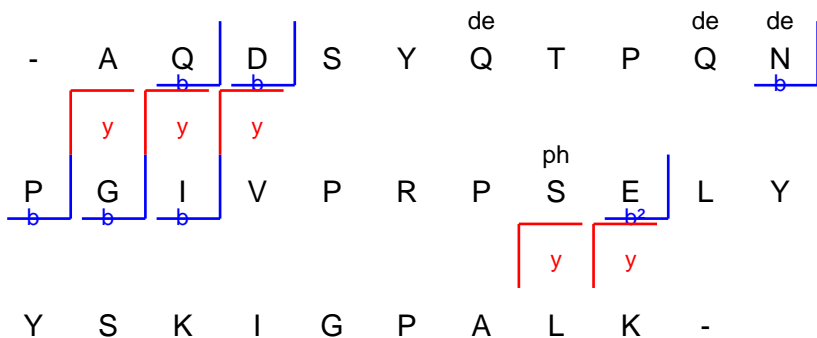
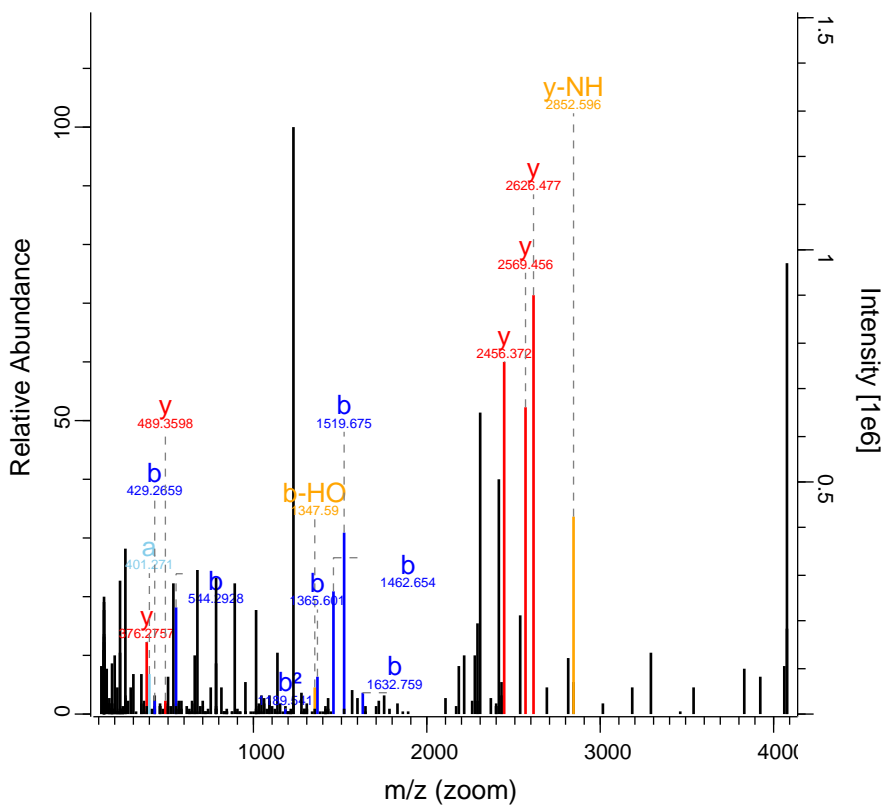

RO-QC-160121_ZackD_SS_Set_01_Fraction 36729 FTMS; HC 40.02 860.81 GNP NAT1

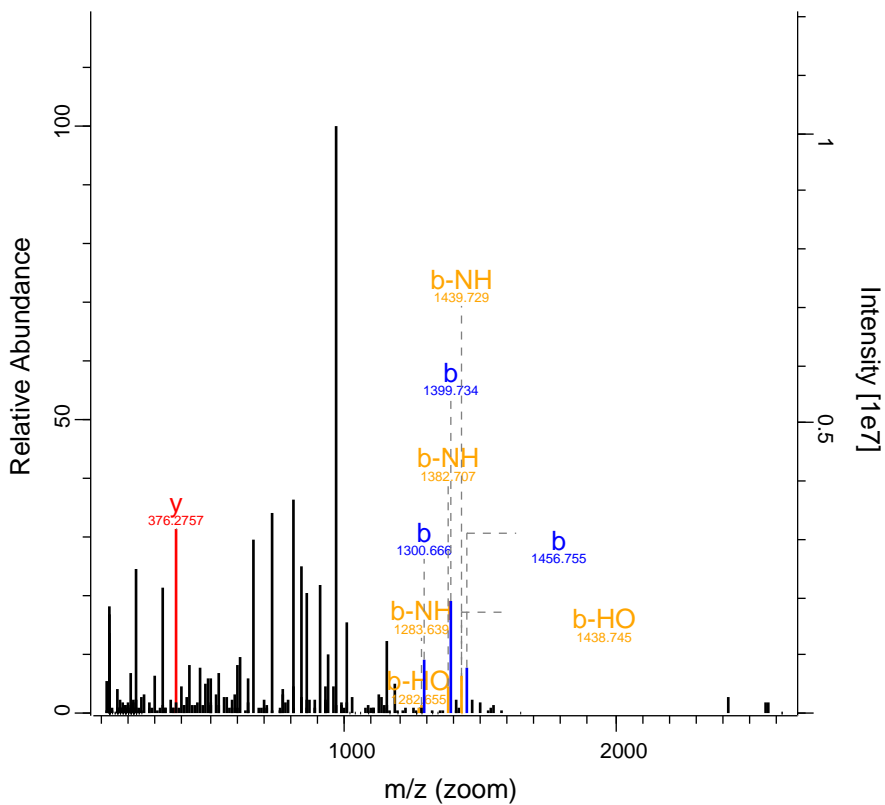

- I T L E C L P Q de de
 G F Y K K - N V

Fragmentation diagram showing peptide sequence: - I T L E C L P Q de de. Fragmentation sites are indicated by blue lines with 'b' labels. A red line with 'y' label indicates a specific fragmentation site between L and E.

RO-QC-160121_ZackD_SS_Set_01_Fractic 38250 FTMS; HC 161.55 1381.12 TNKS1BP1

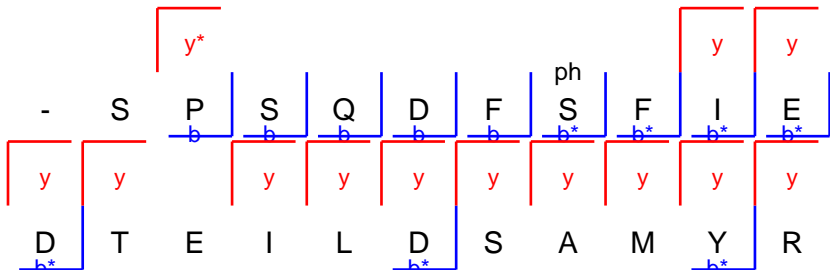
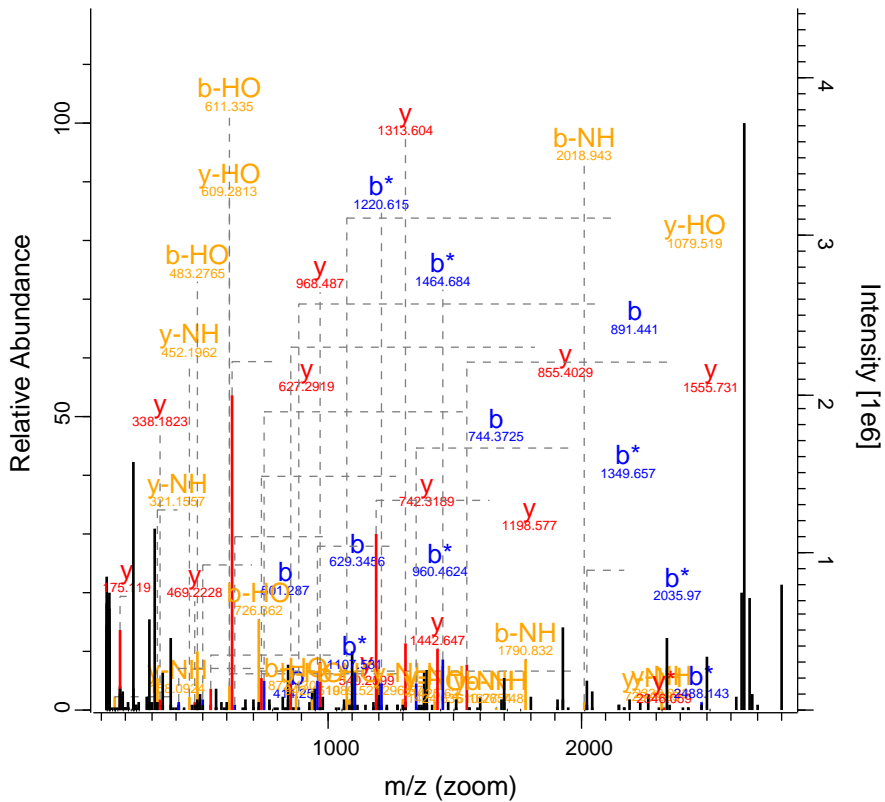

RO-QC-160121_ZackD_SS_Set_01_Fraction 38507 FTMS; HCl 40.96 998.5 ITGB6

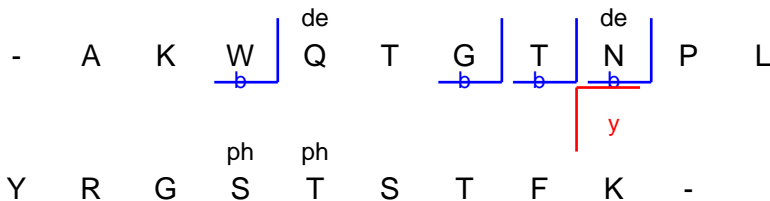
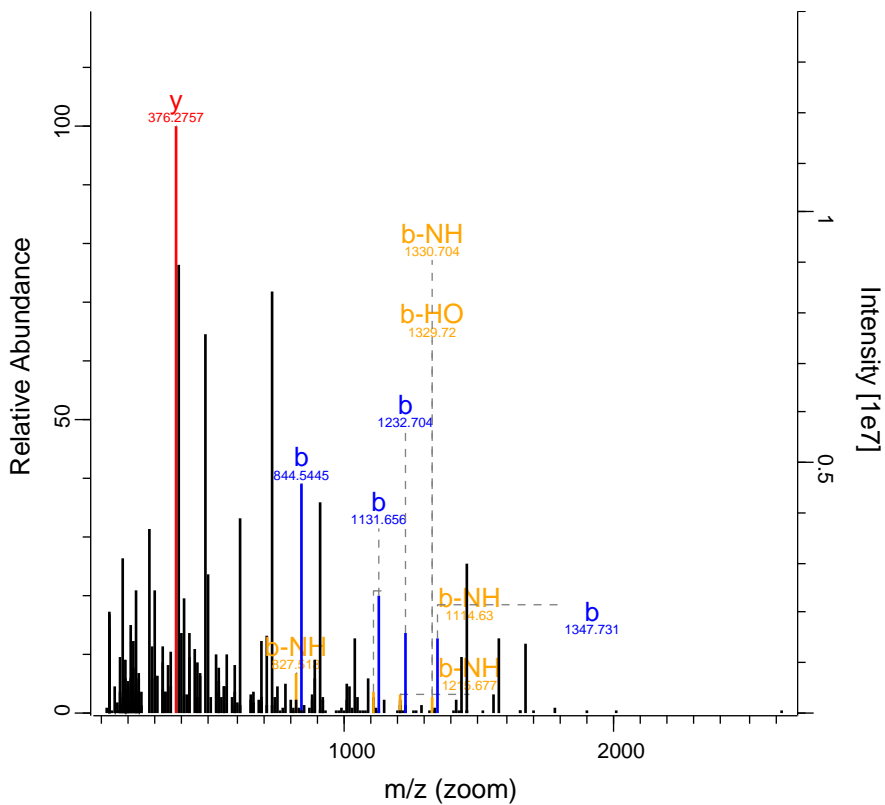

RO-QC-160121_ZackD_SS_Set_01_Fractio 38677 FTMS; HC 153.72 740.39 PSME3

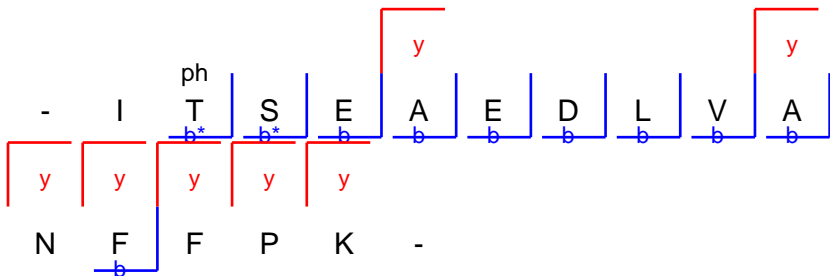
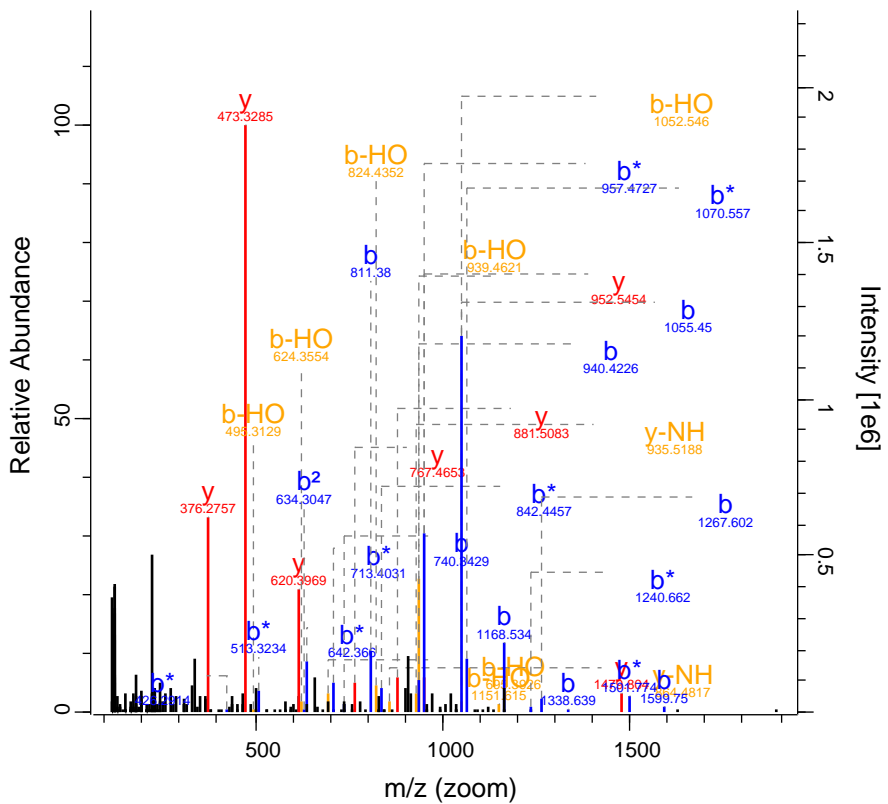

RO-QC-160121_ZackD_SS_Set_01_Fractic 38915 FTMS; HC 53.38 1476.74 DIP2C

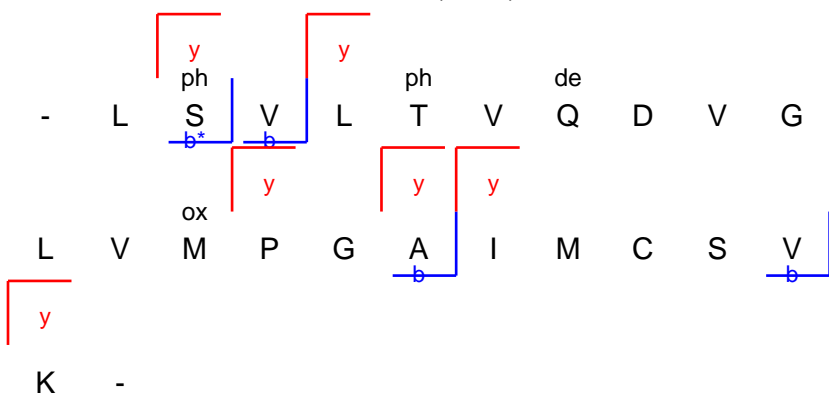
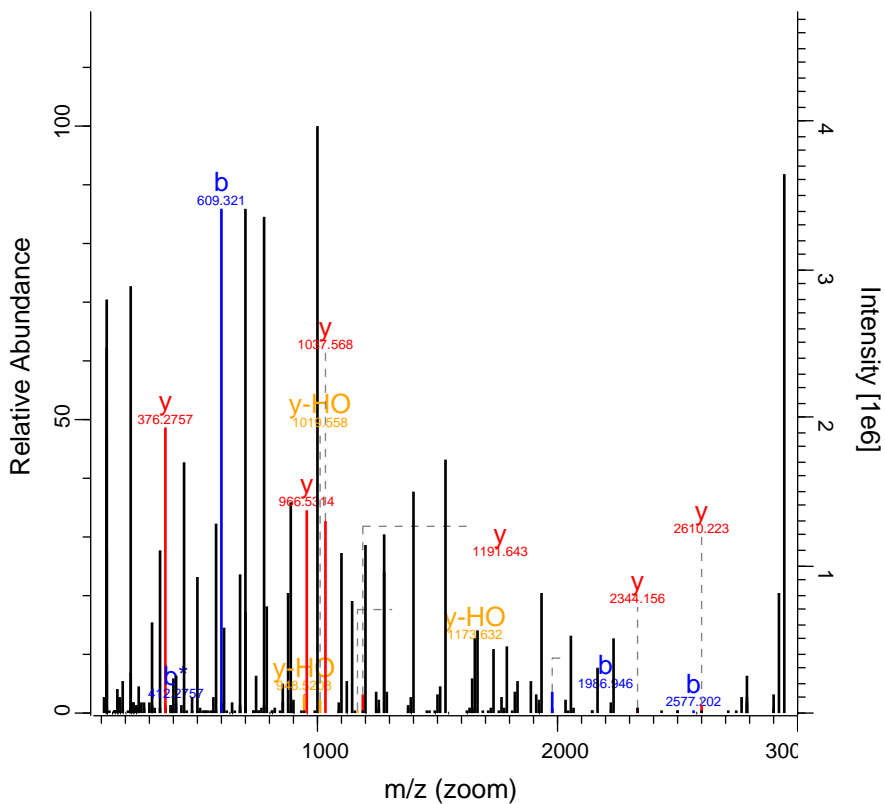

RO-QC-160121_ZackD_SS_Set_01_Fraction 5604 FTMS; HCl 45.7 791.08 NPM1

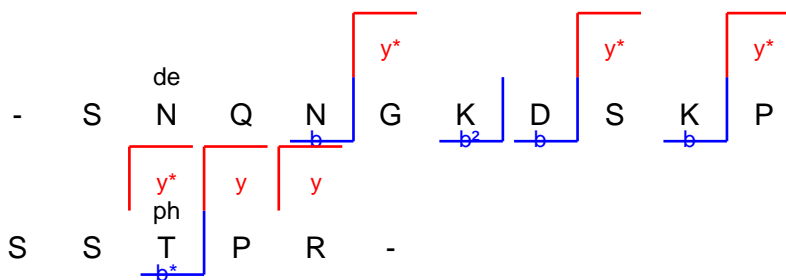
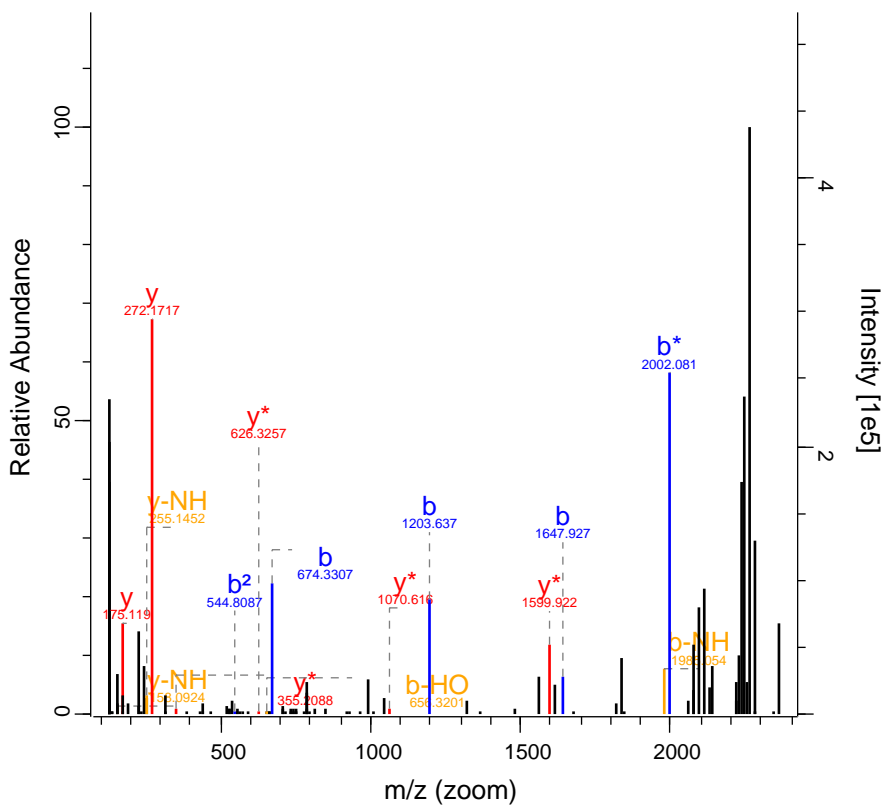

RO-QC-160121_ZackD_SS_Set_01_Fraction 6235 FTMS; HC 113.35 474.77 INTS1

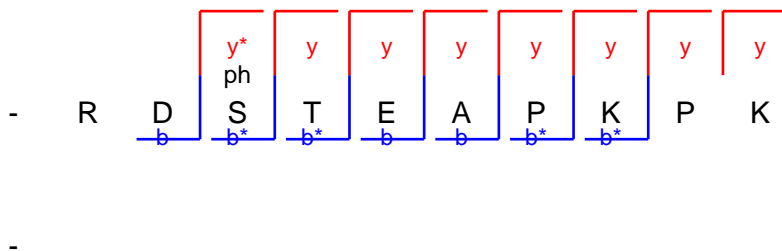
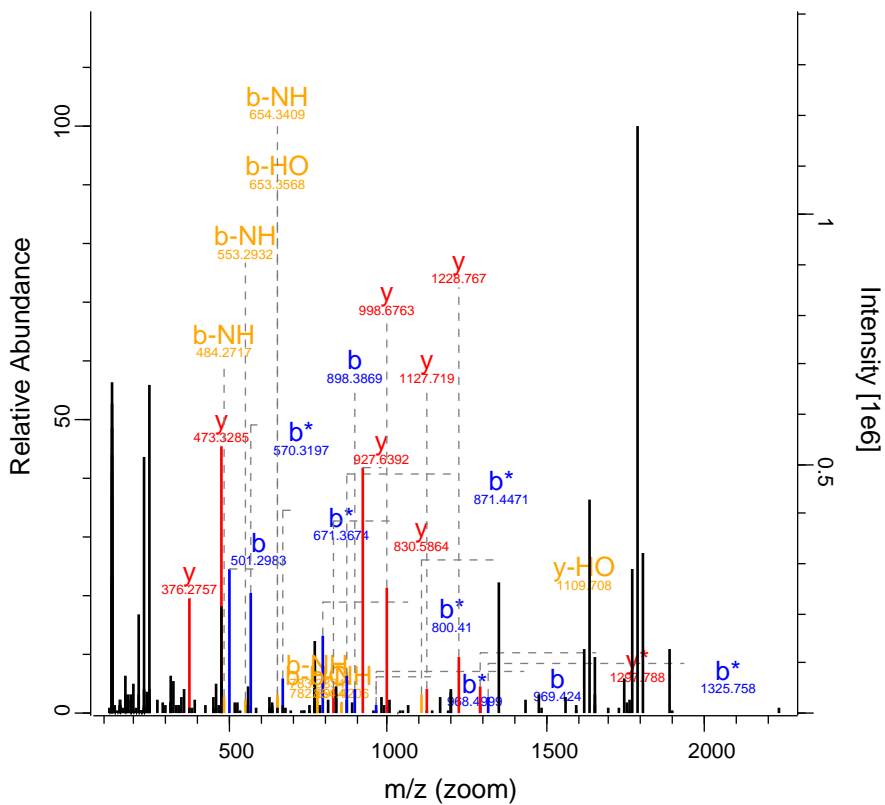

RO-QC-160121_ZackD_SS_Set_01_Fraction 6611 FTMS; HC 103.39 773.09 HTATSF1

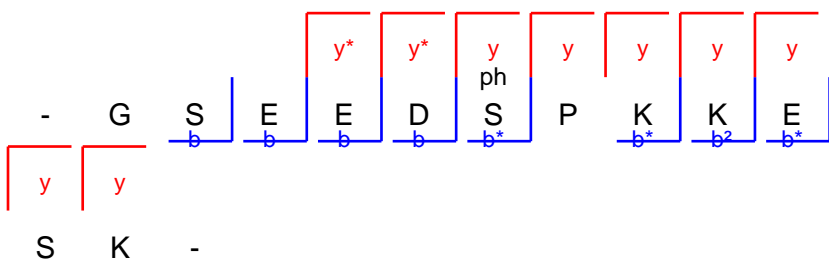
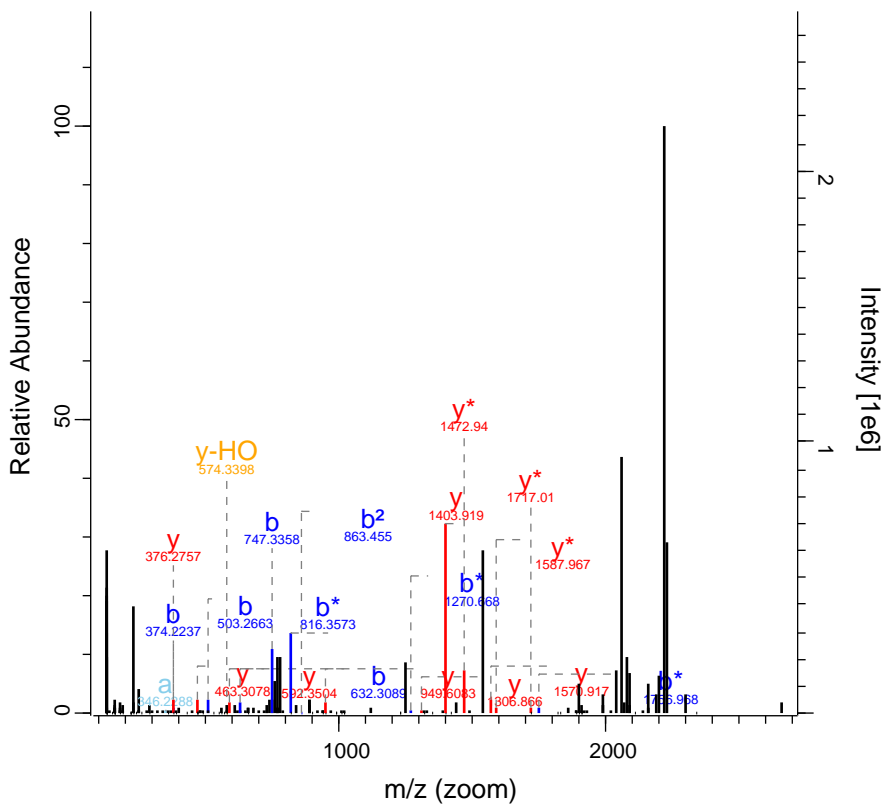

S K -

RO-QC-160121_ZackD_SS_Set_01_Fraction 7305 FTMS; HC 108.75 741.05 CBX3

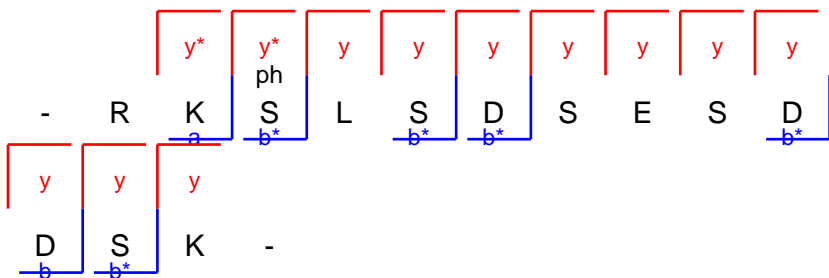
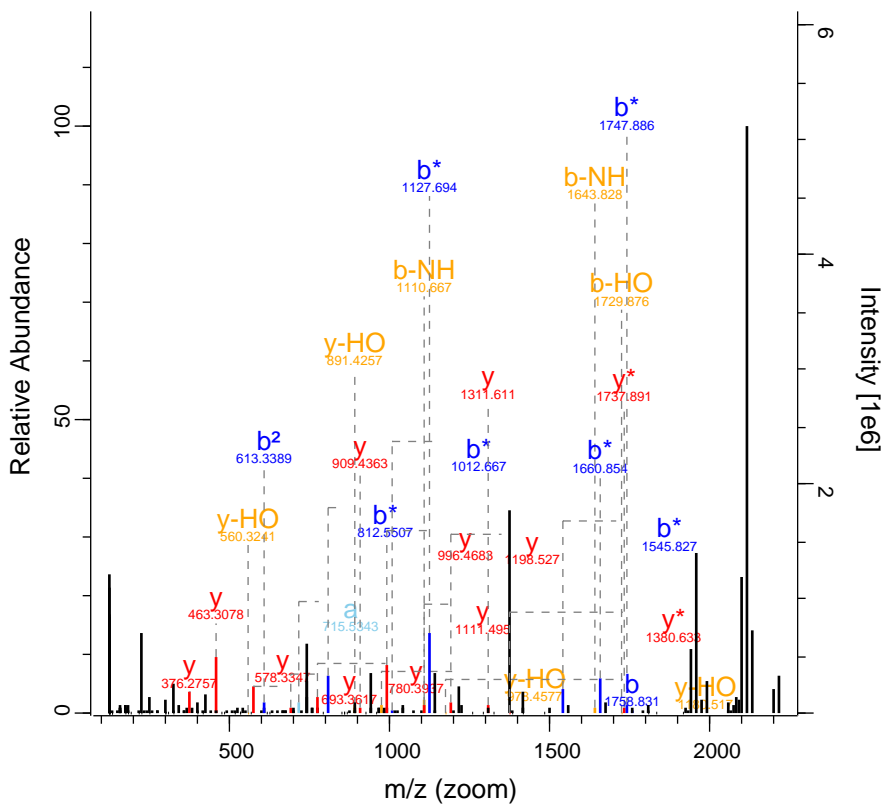

RO-QC-160121_ZackD_SS_Set_01_Fraction 7328 FTMS; HC 122.33 877.49 SEC62

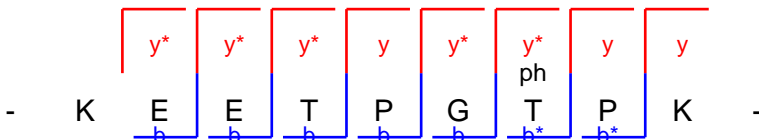
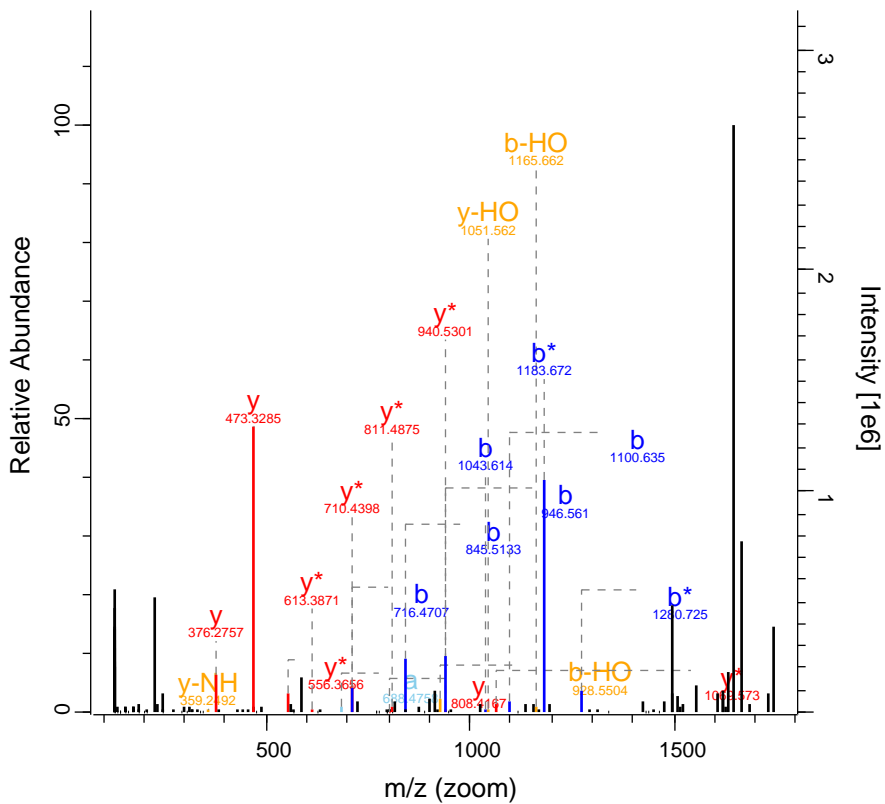

RO-QC-160121_ZackD_SS_Set_01_Fraction 7330 FTMS; HCl 50.68 714.07 SRRM1

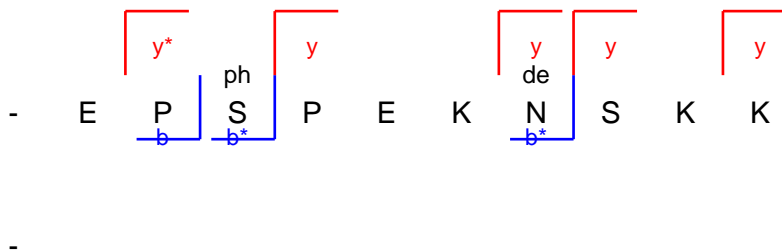
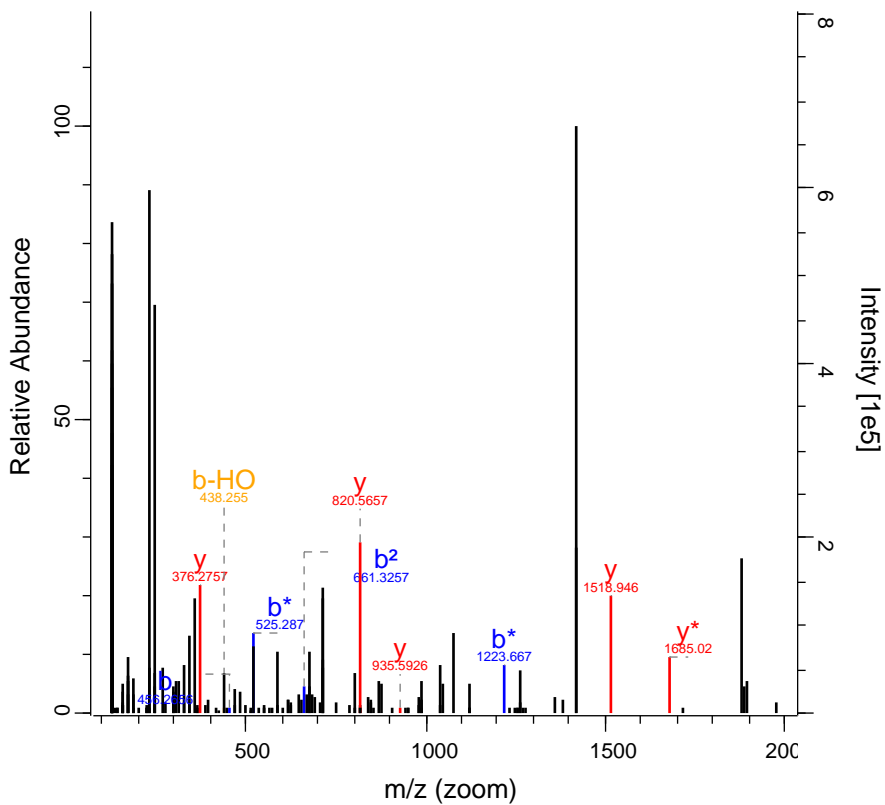

RO-QC-160121_ZackD_SS_Set_01_Fraction11233 FTMS; HC 58.37 661.36 CAD

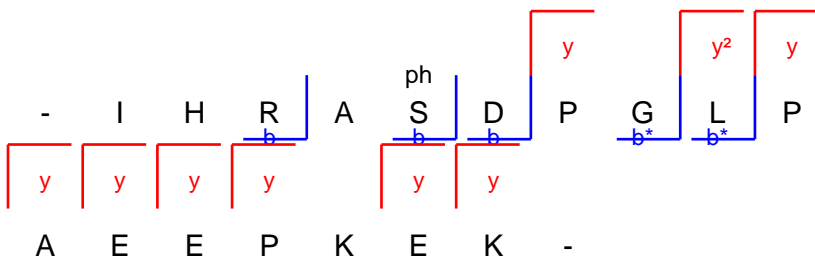
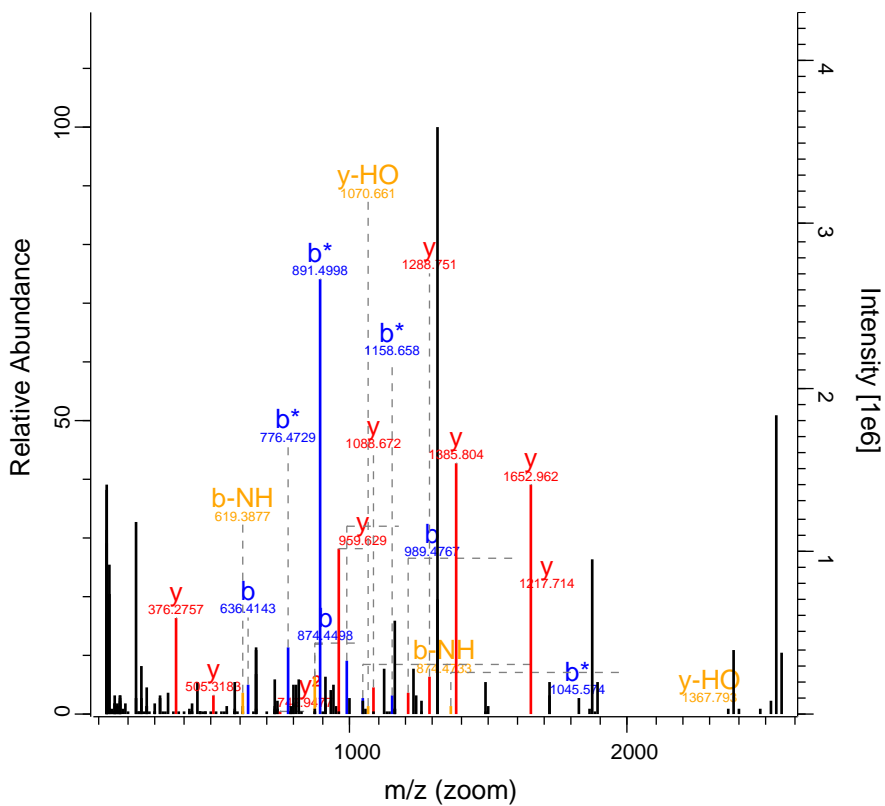

RO-QC-160121_ZackD_SS_Set_01_Fractio 11630 FTMS; HC 102.48 610.72 NUCKS1

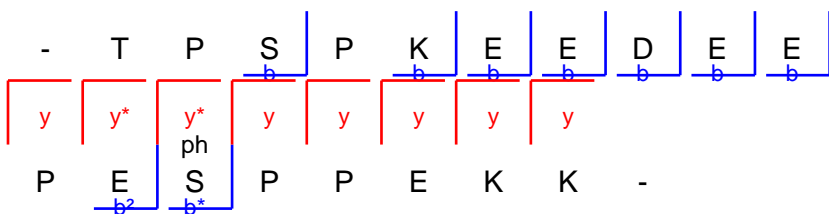
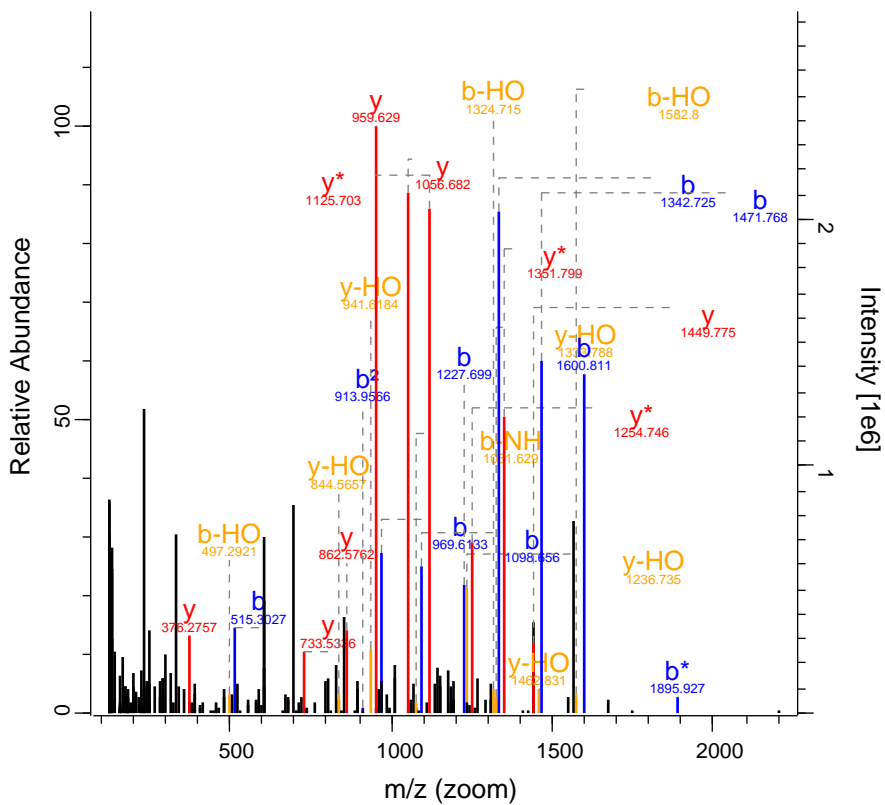

RO-QC-160121_ZackD_SS_Set_01_Fraction_7

12214 FTMS; HCD 53.47 755.37

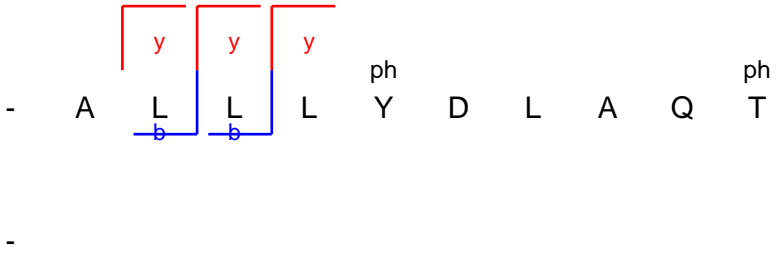
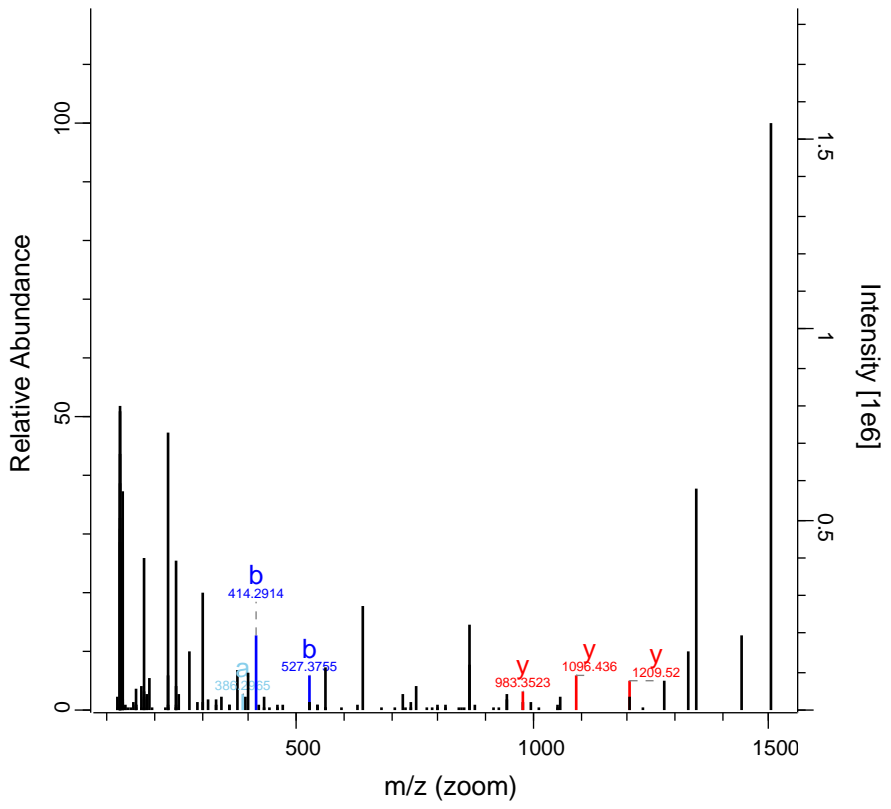

RO-QC-160121_ZackD_SS_Set_01_Fractio 12508 FTMS; HC 105.39 671.37 ADD1

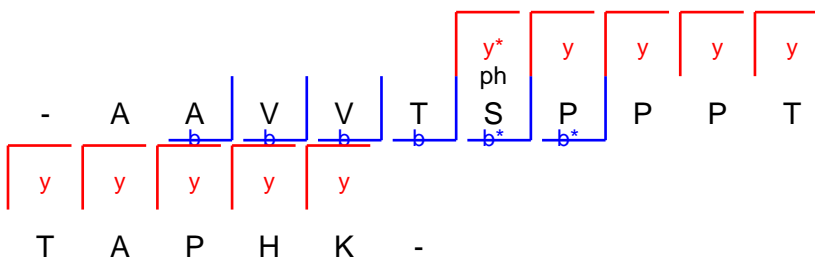
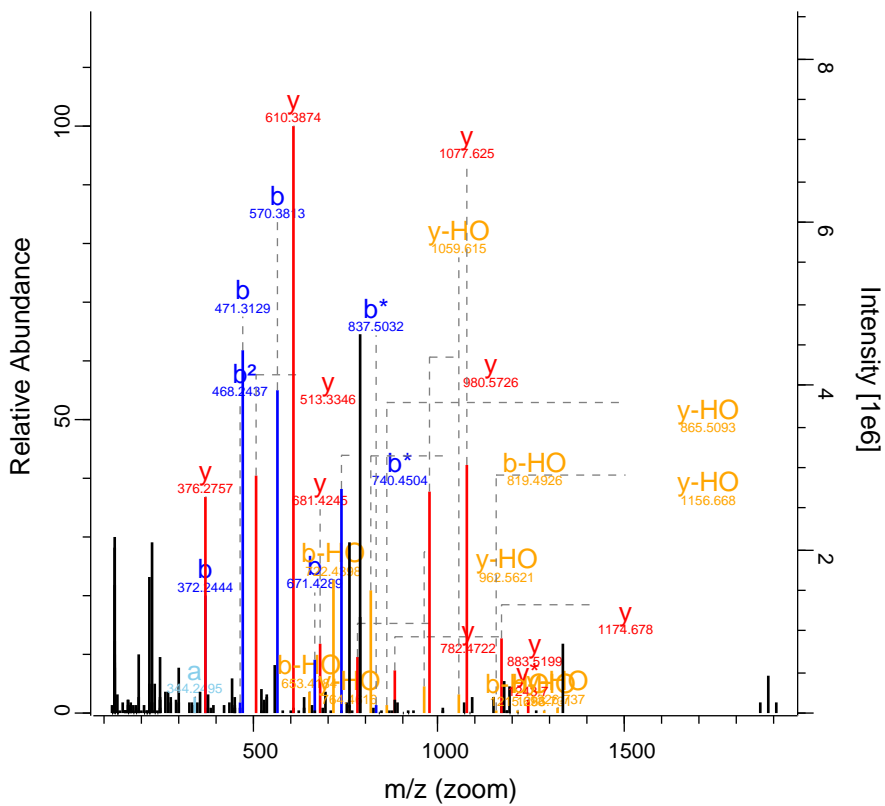

RO-QC-160121_ZackD_SS_Set_01_Fraction 13594 FTMS; HC 61.96 377.21 ZNF224

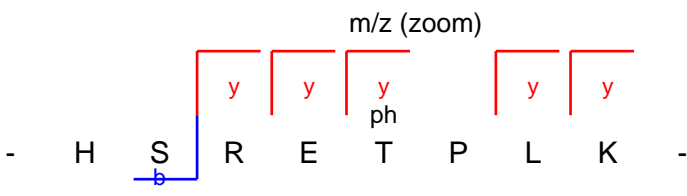
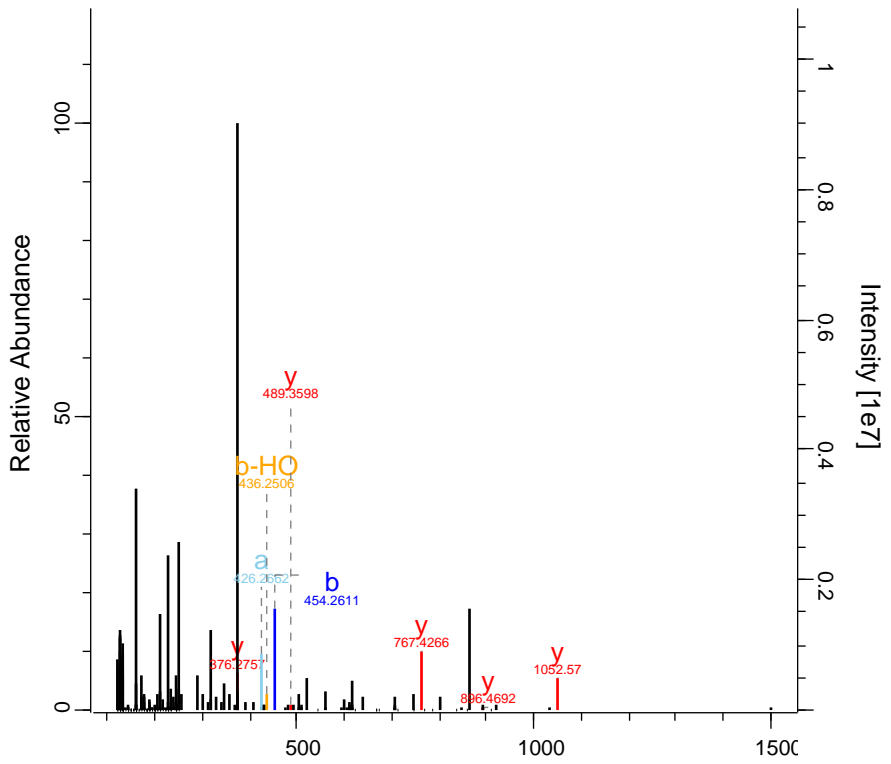

RO-QC-160121_ZackD_SS_Set_01_Fraction 15956 FTMS; HC 69.12 823.45 LAYN

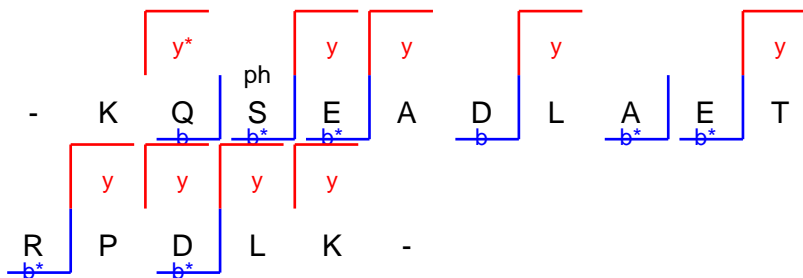
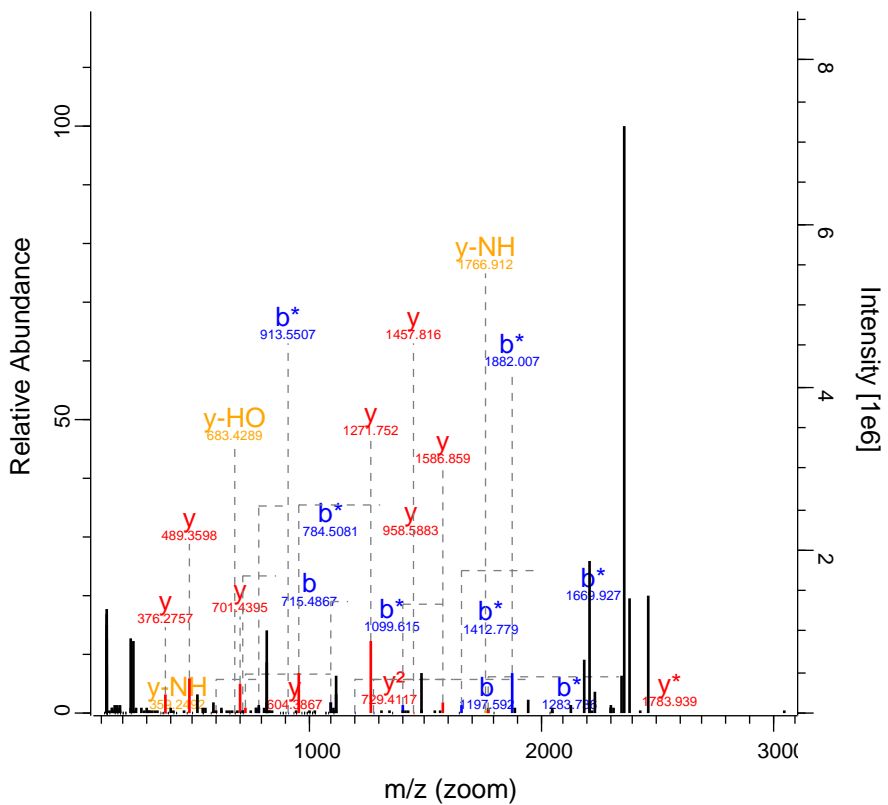

RO-QC-160121_ZackD_SS_Set_01_Fraction 18208 FTMS; HC 68.66 971.02 KSR2

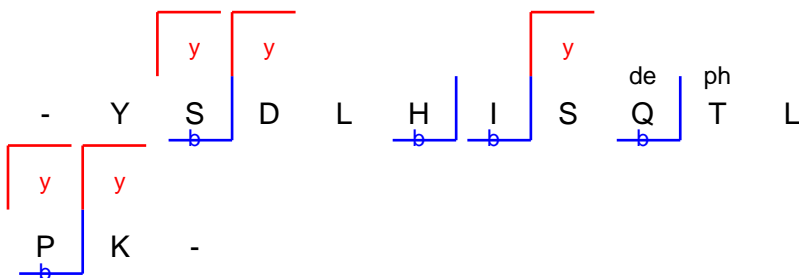
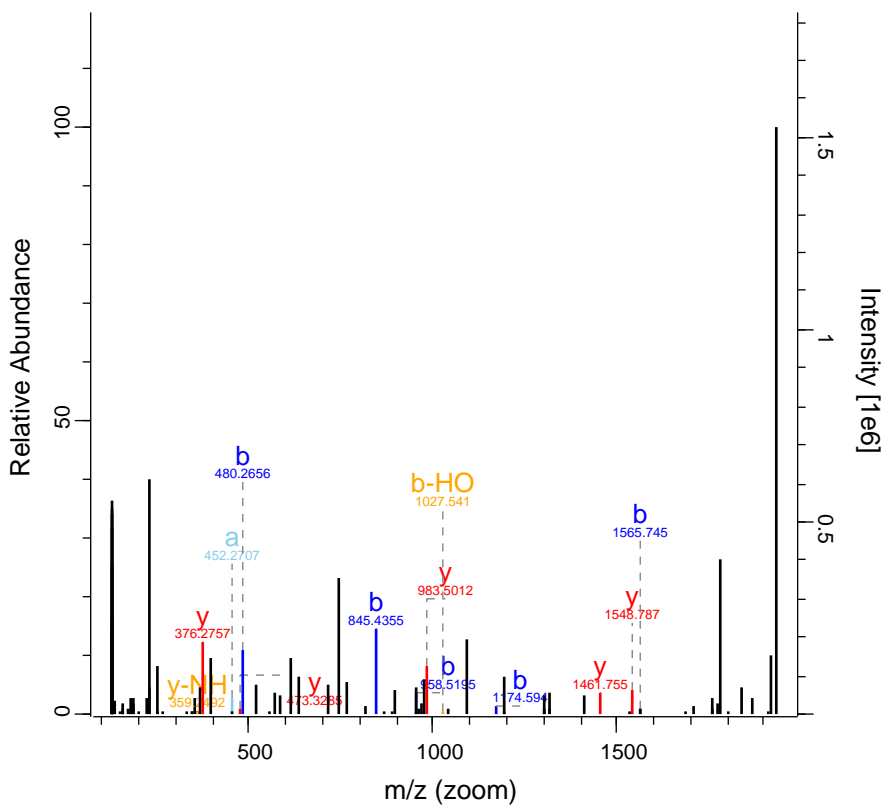

RO-QC-160121_ZackD_SS_Set_01_Fraction 18472 FTMS; HC 76.82 635.85 MAP4

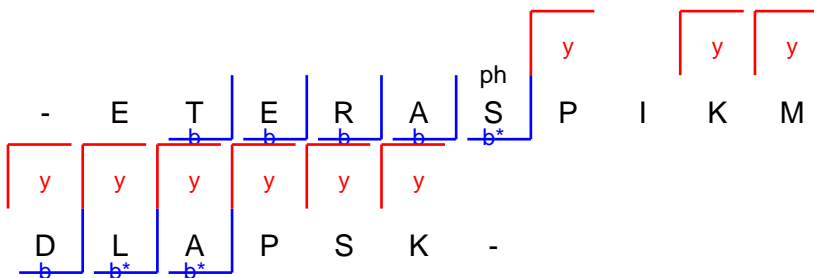
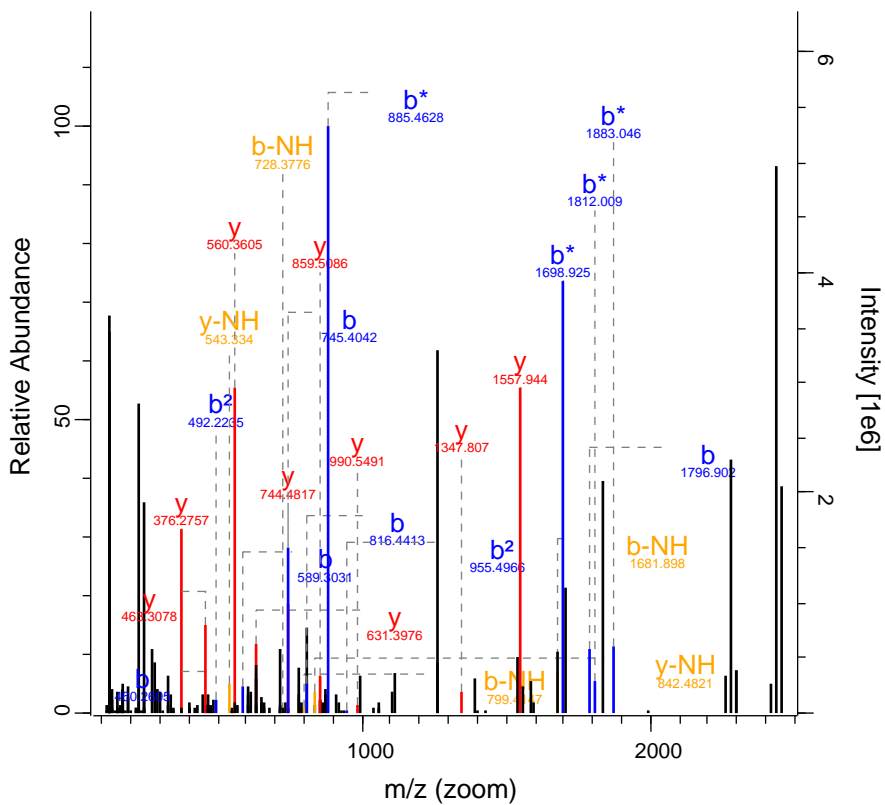

RO-QC-160121_ZackD_SS_Set_01_Fraction 18551 FTMS; HC 84.93 833.78 UBAP2L

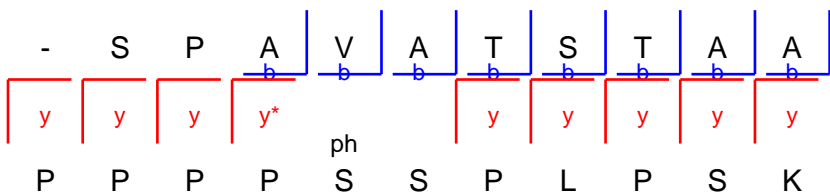
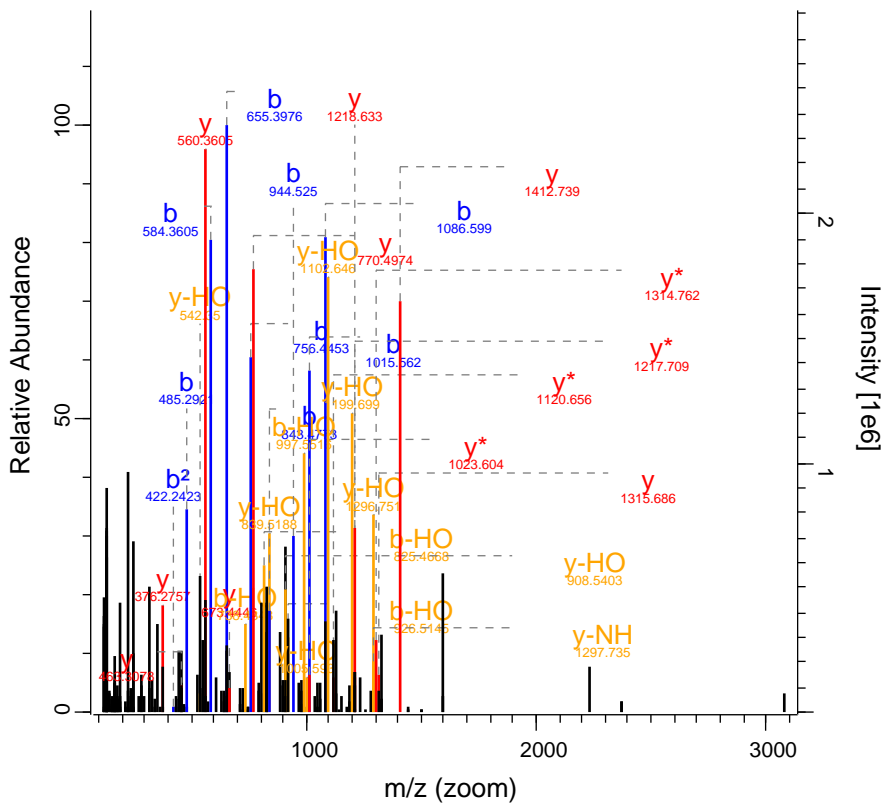

RO-QC-160121_ZackD_SS_Set_01_Fraction 20310 FTMS; HC 88.94 752.74 SORBS2

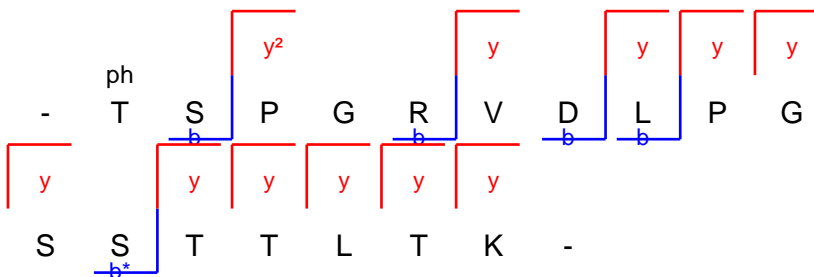
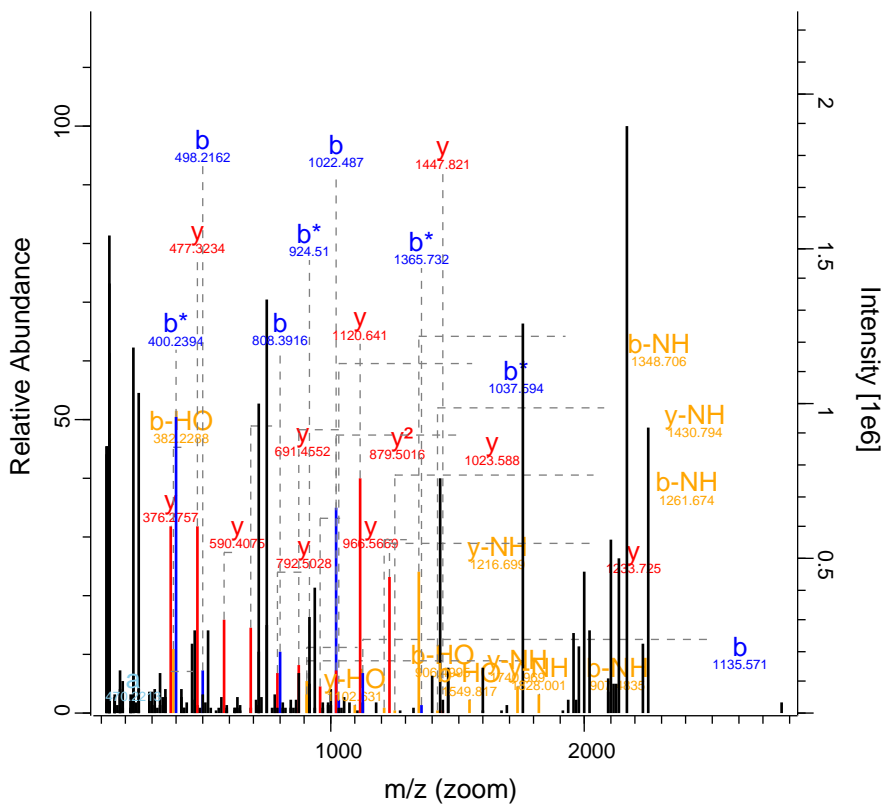

RO-QC-160121_ZackD_SS_Set_01_Fractio 20350 FTMS; HC 206.46 869.43 VIM

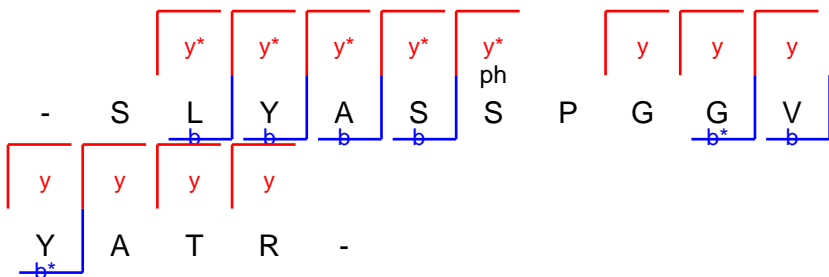
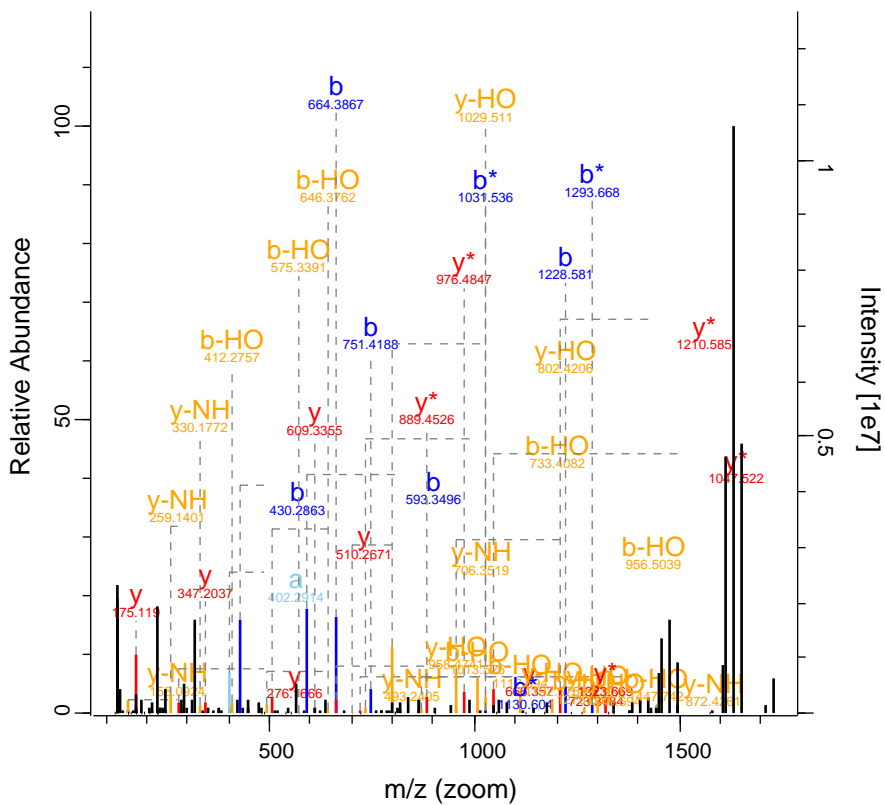

RO-QC-160121_ZackD_SS_Set_01_Fractic 20382 FTMS; HC 76.14 1134.08 SPTLC3

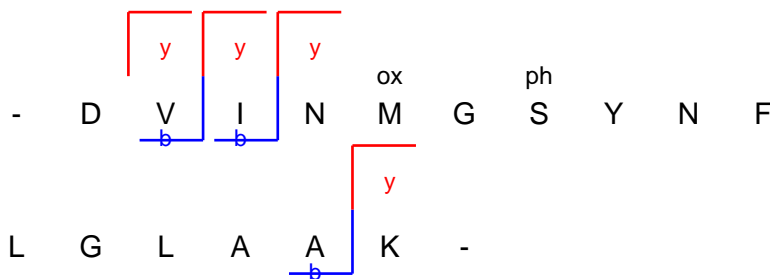
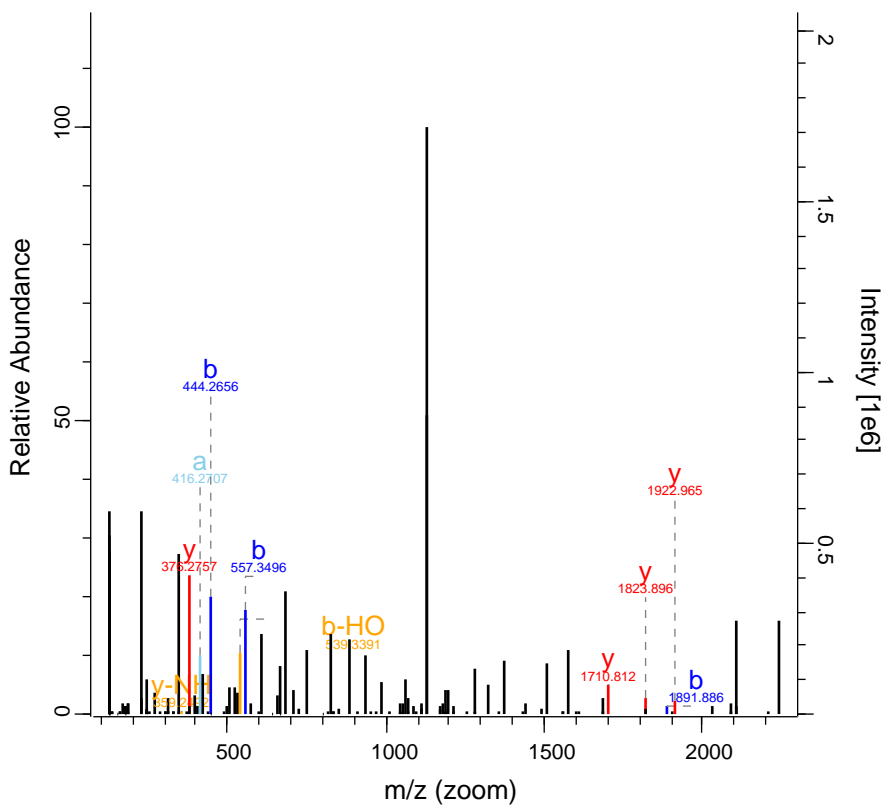

RO-QC-160121_ZackD_SS_Set_01_Fraction 20383 FTMS; HC 41.19 829.56 RECQL5

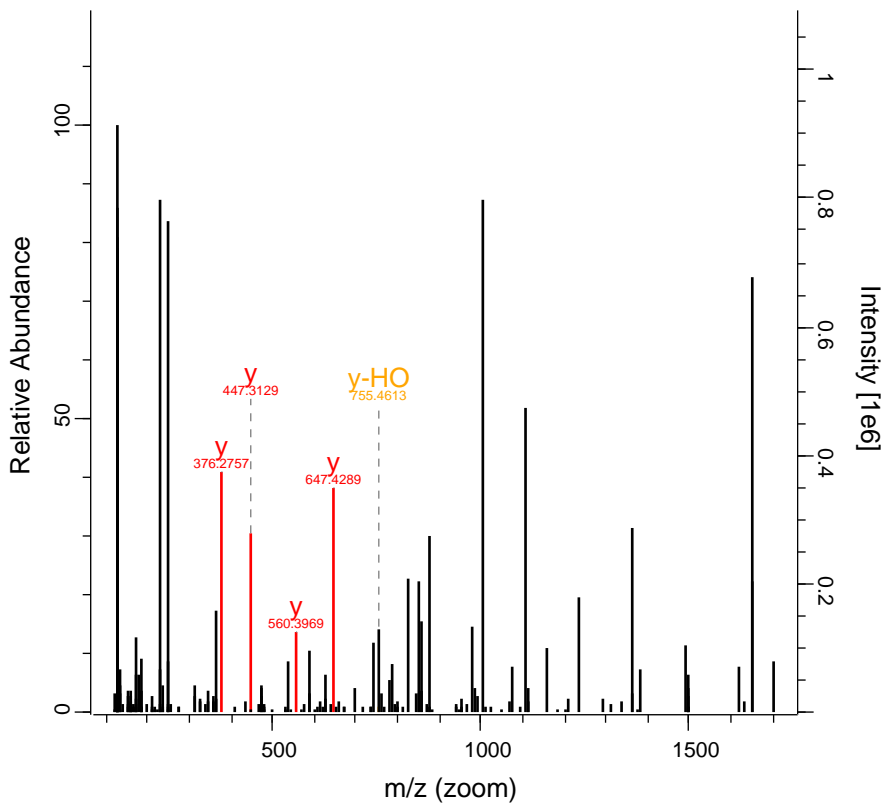

							y	y	y	y
-	ph	ph	ph	G	G	ph	S	L	A	K
-	S	S	S			S				

RO-QC-160121_ZackD_SS_Set_01_Fractic 21866 FTMS; HC 64.65 1154.63 PRC1

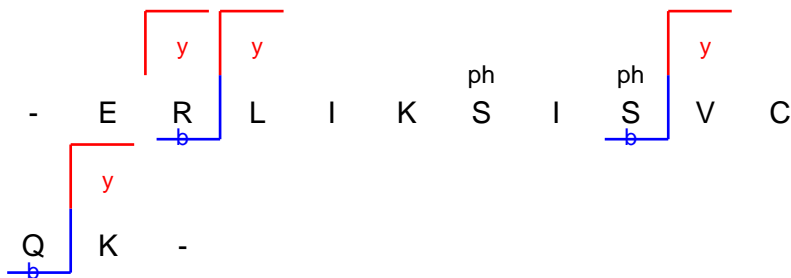
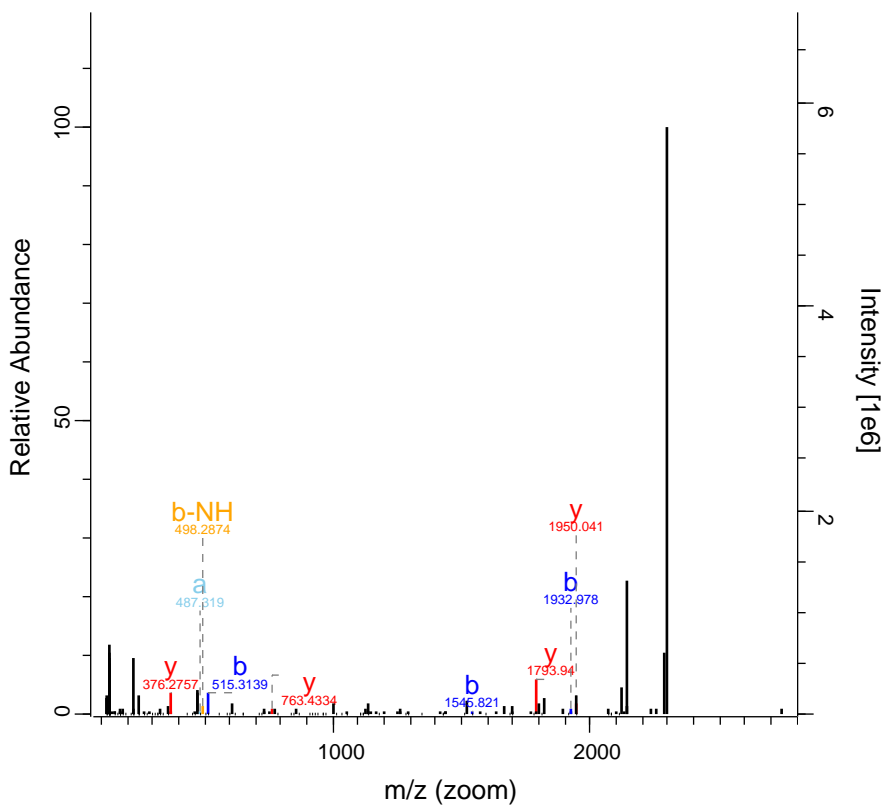

RO-QC-160121_ZackD_SS_Set_01_Fractio 22651 FTMS; HC 191.01 981.03 MAP1B

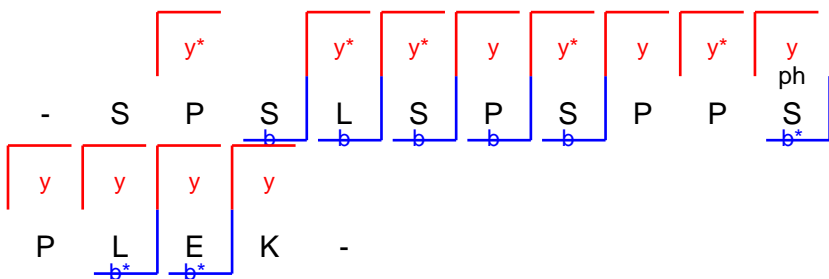
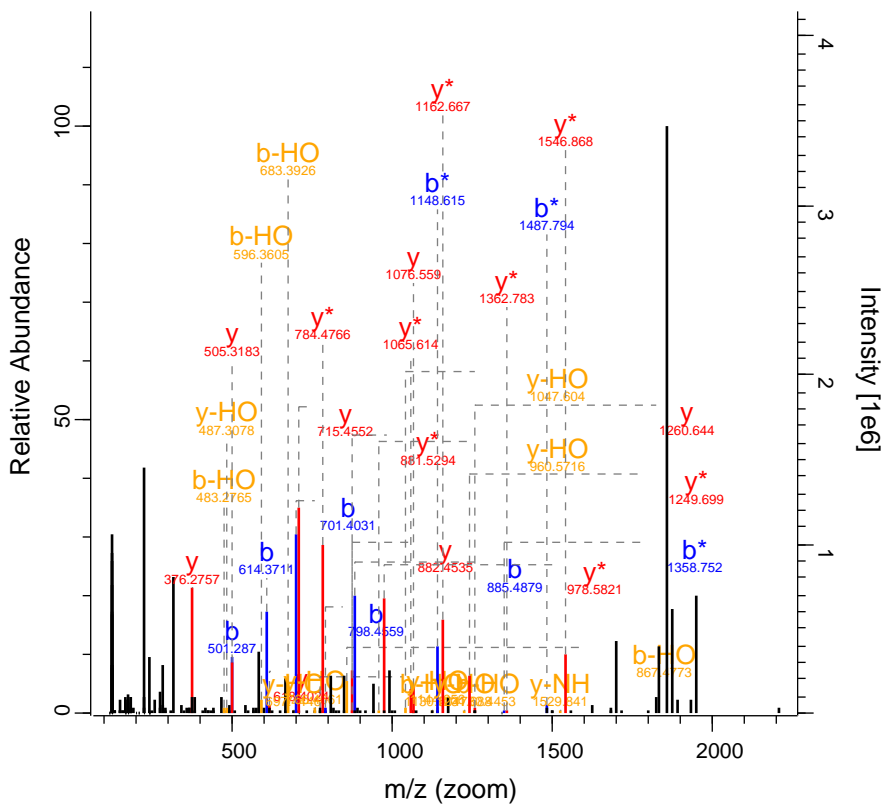

RO-QC-160121_ZackD_SS_Set_01_Fractic 24456 FTMS; HC 50.56 1198.58 CCDC110

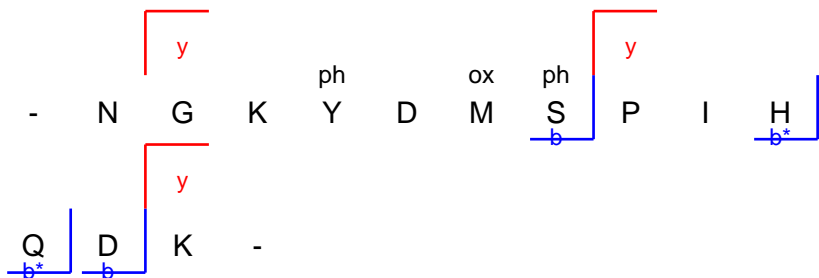
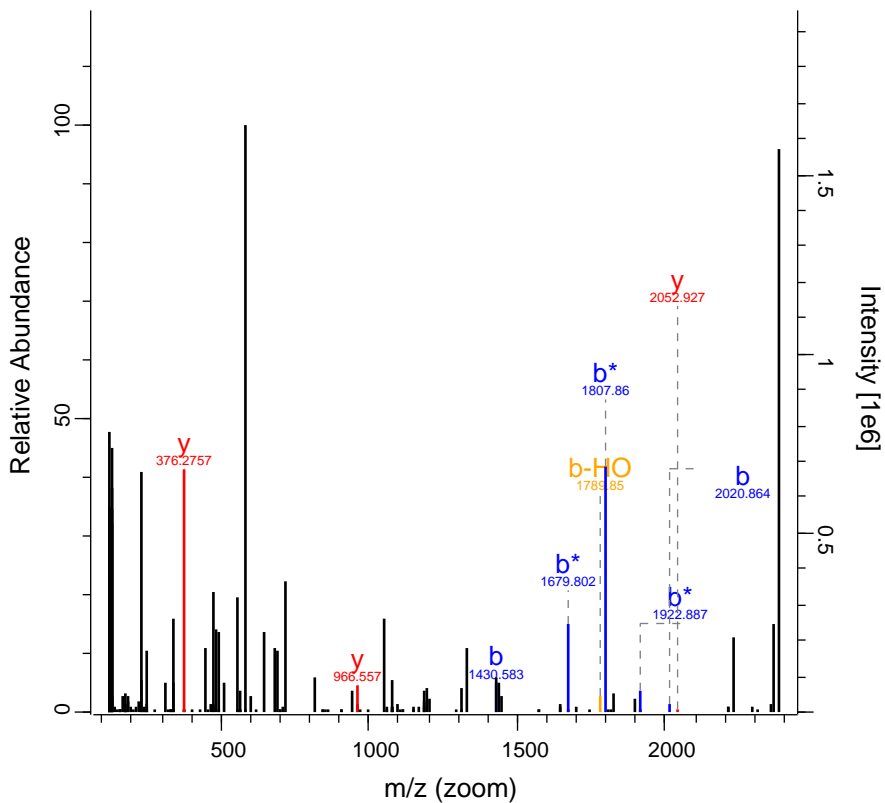

RO-QC-160121_ZackD_SS_Set_01_Fraction 27271 FTMS; HC 40.43 873.69 TTN

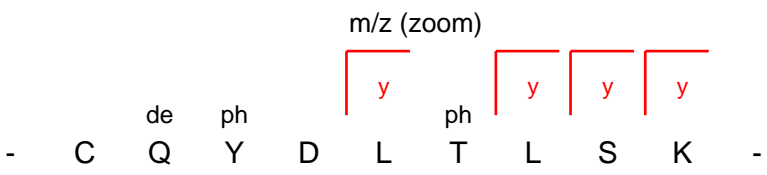
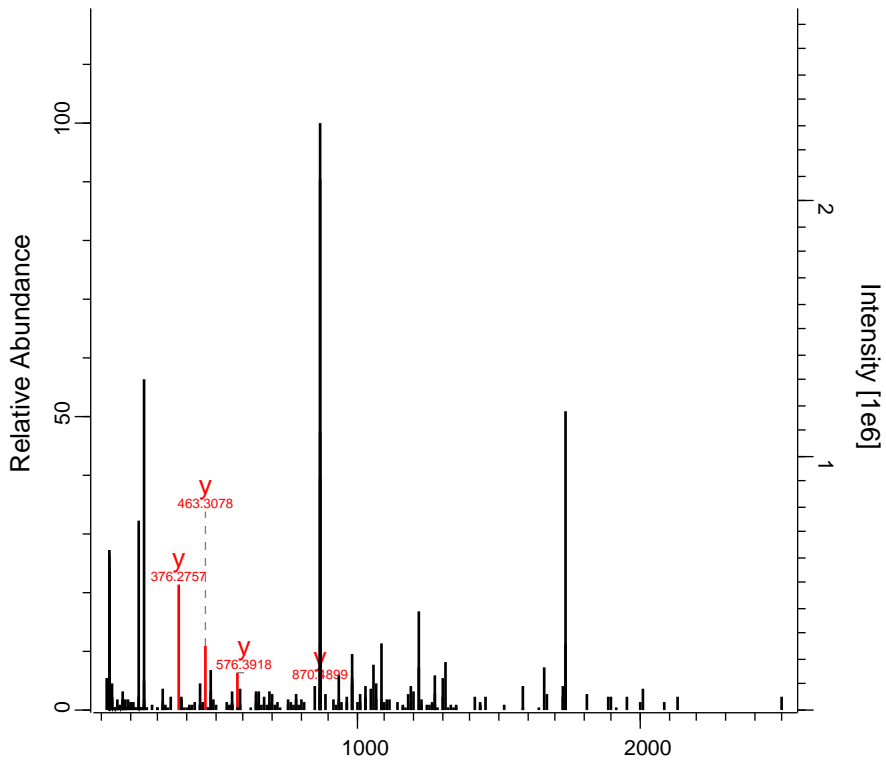

RO-QC-160121_ZackD_SS_Set_01_Fractic 27986 FTMS; HC 54.61 1075.59 DRAXIN

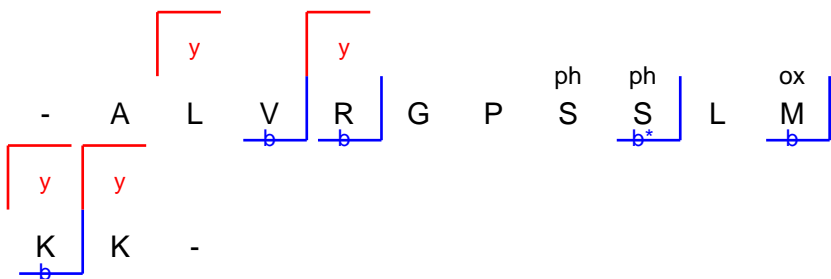
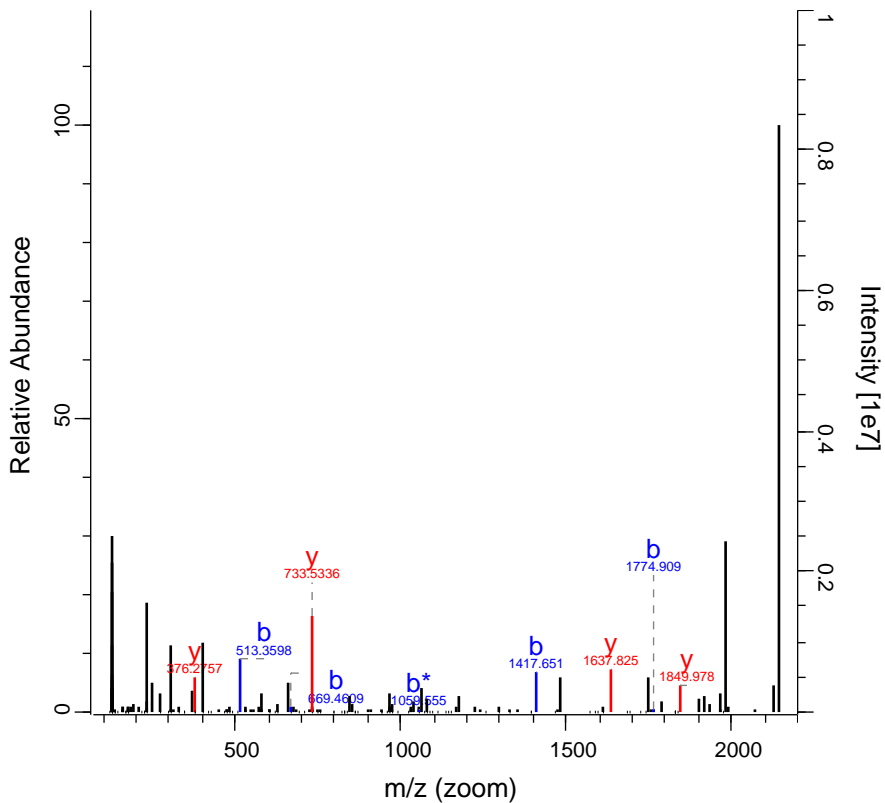

RO-QC-160121_ZackD_SS_Set_01_Fraction 28567 FTMS; HC 64.44 1253.7 KIF15

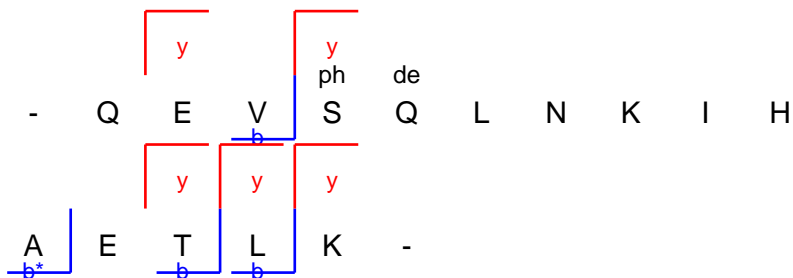
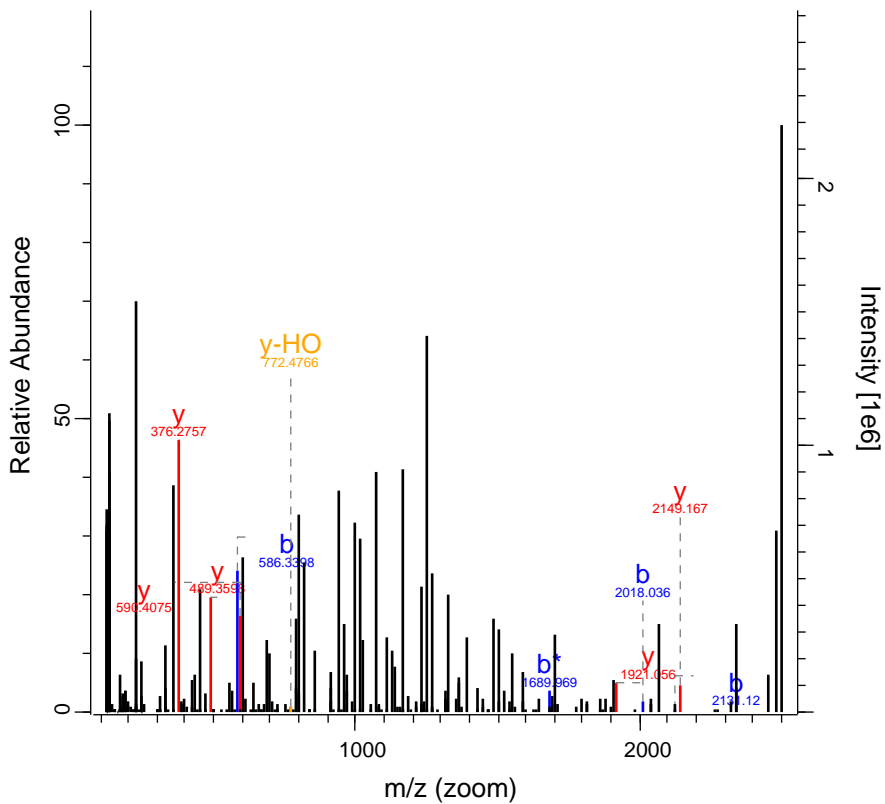

RO-QC-160121_ZackD_SS_Set_01_Fractic 28874 FTMS; HC 50.3 1740.91 POU6F2

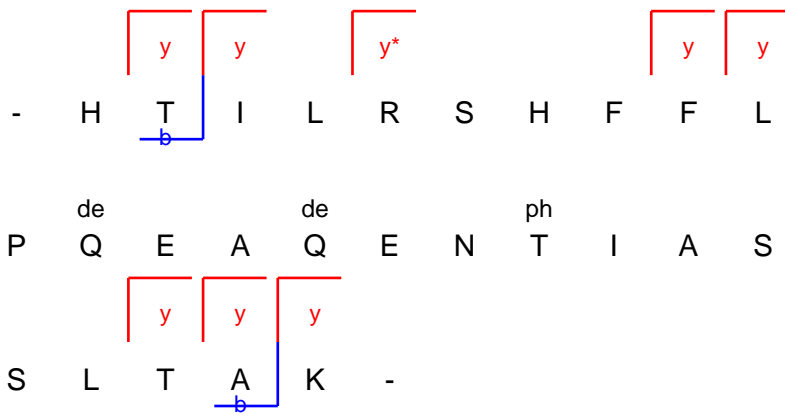
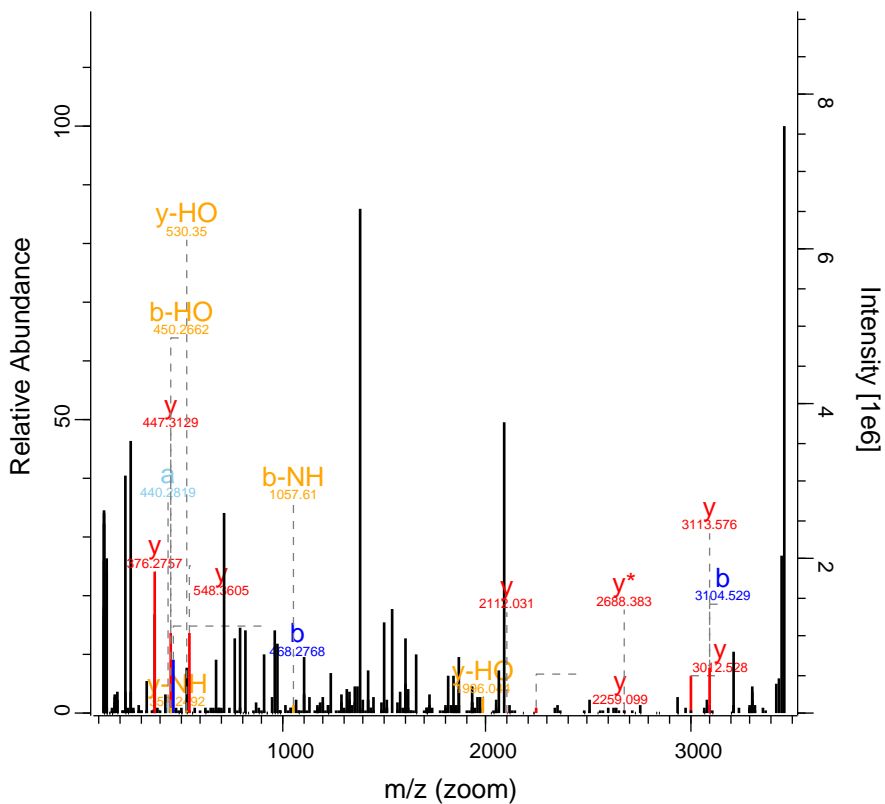

RO-QC-160121_ZackD_SS_Set_01_Fractic 29871 FTMS; HC 55.45 1136.05 LGI4

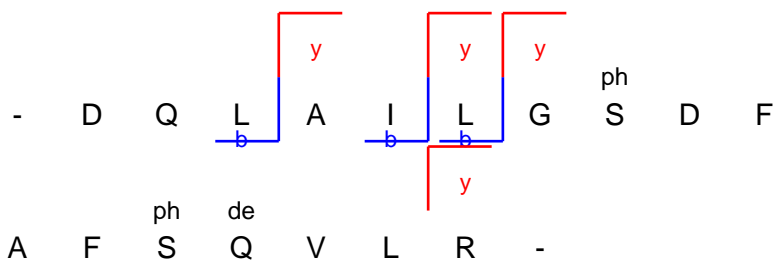
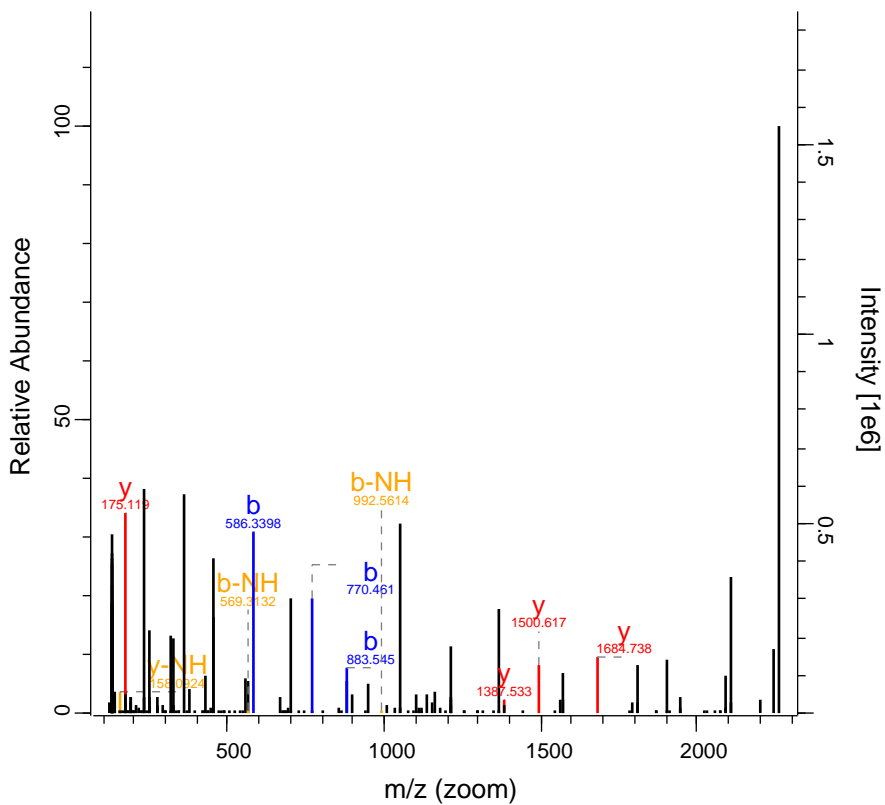

RO-QC-160121_ZackD_SS_Set_01_Fractic 30503 FTMS; HC 115.33 1104.57 VIM

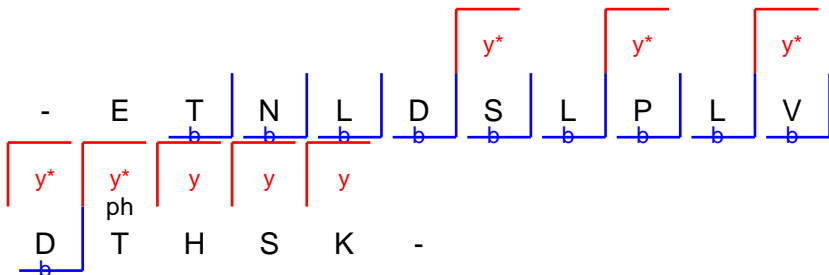
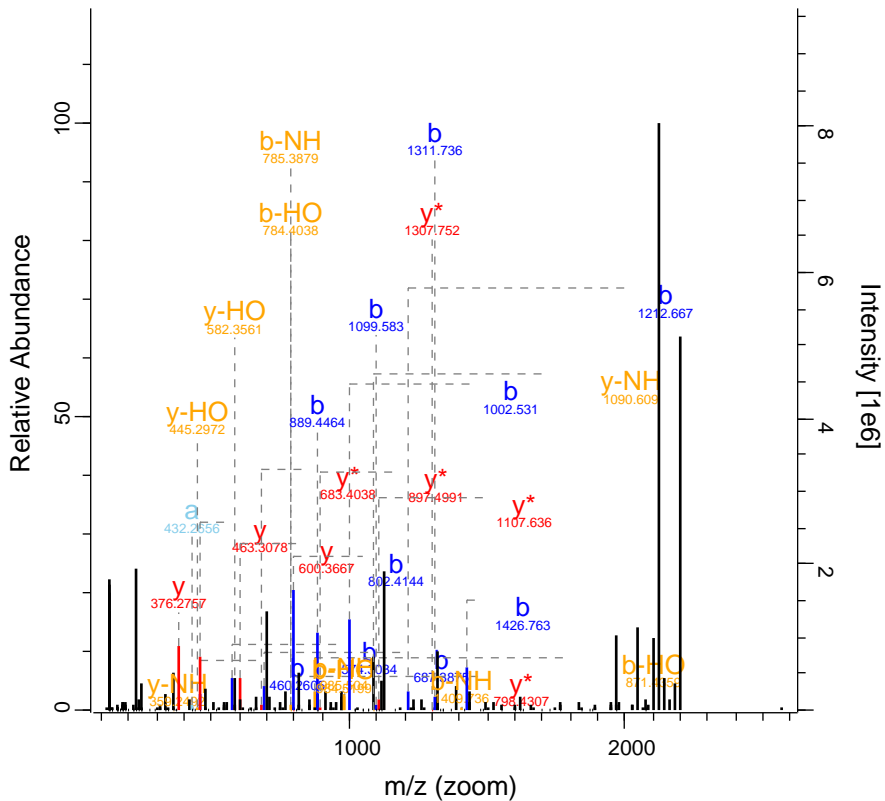

RO-QC-160121_ZackD_SS_Set_01_Fractic 32362 FTMS; HC 70.94 1318.66 NEUROD4

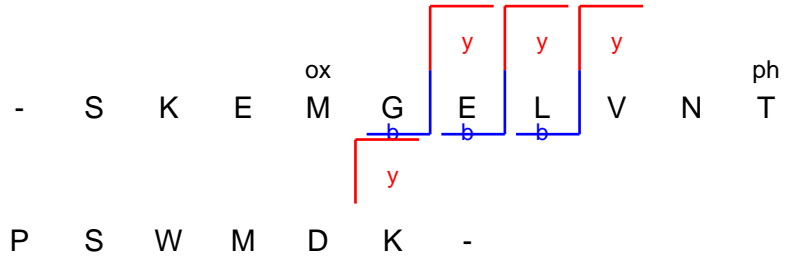
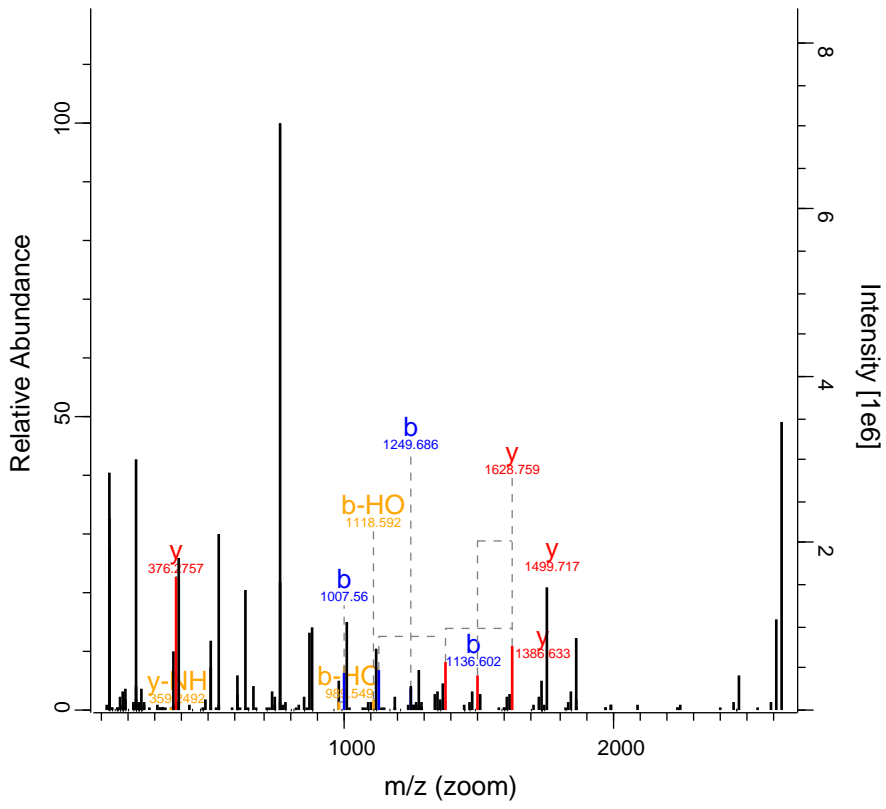

RO-QC-160121_ZackD_SS_Set_01_Fraction 32422 FTMS; HC 41.53 872.71 DDX50

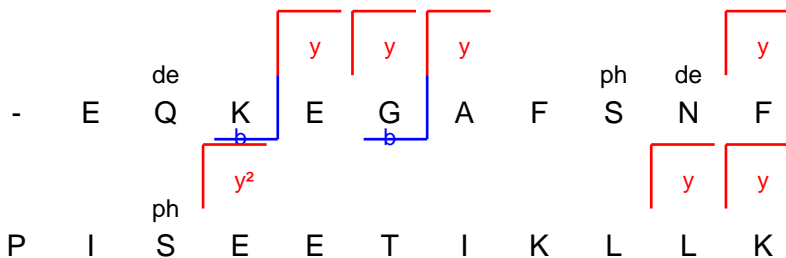
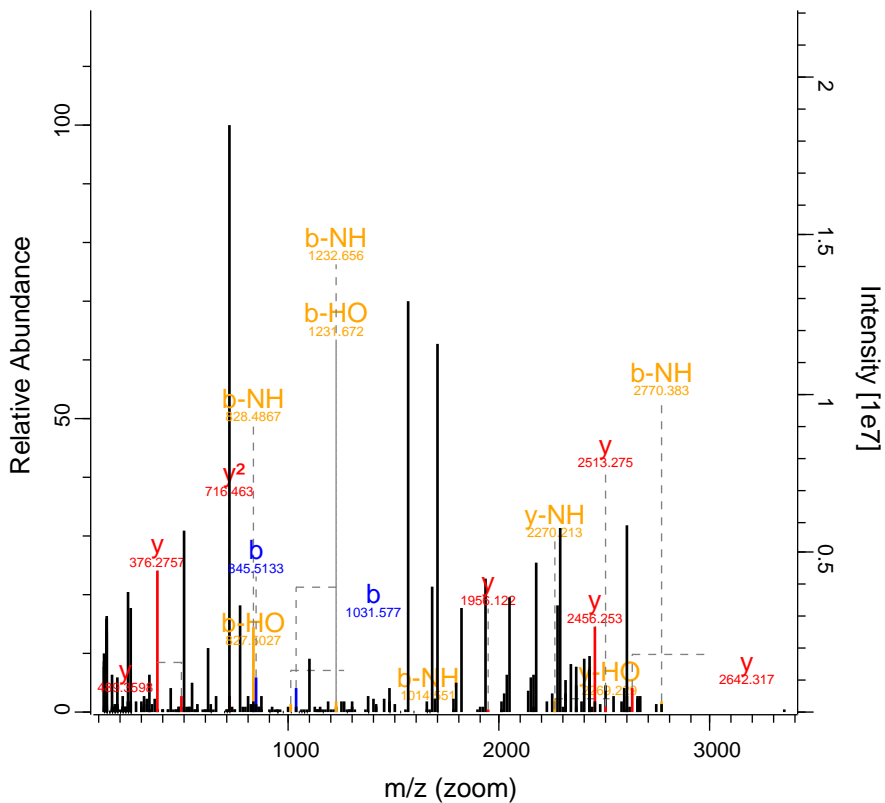

RO-QC-160121_ZackD_SS_Set_01_Fractic 34832 FTMS; HC 50.03 1155.63 EBF2

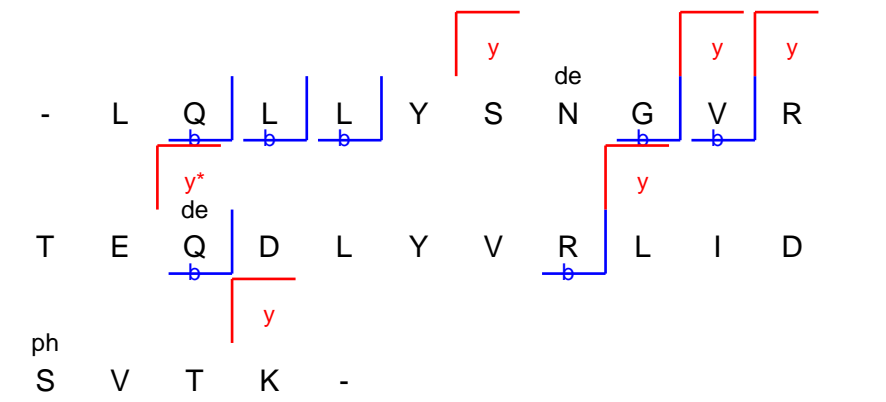
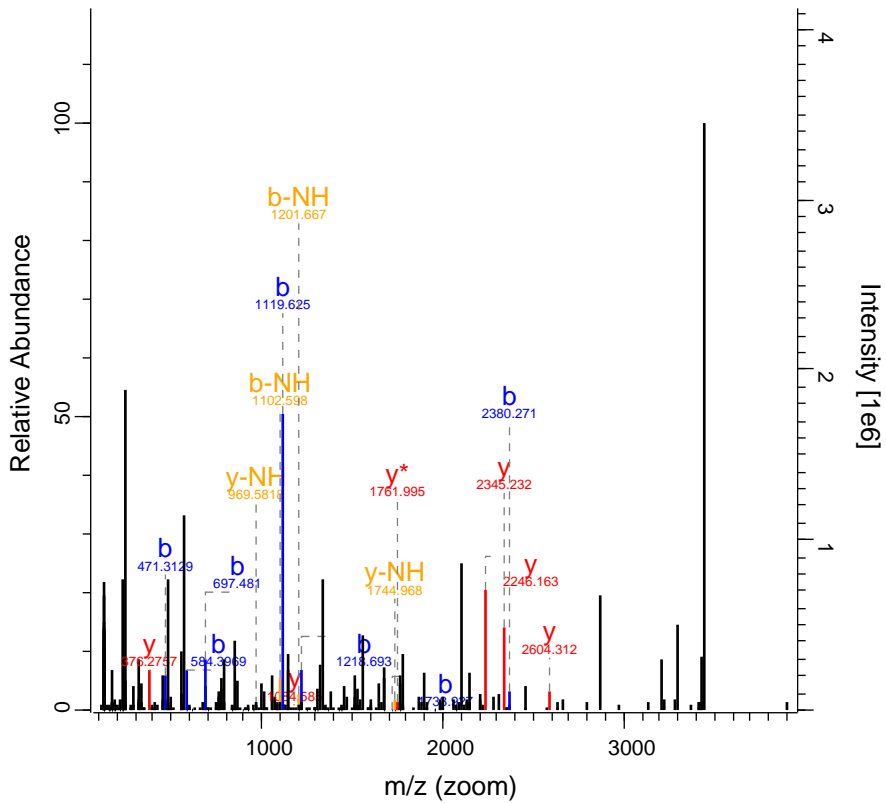

RO-QC-160121_ZackD_SS_Set_01_Fractic 35736 FTMS; HC 65.5 1045.09 EED

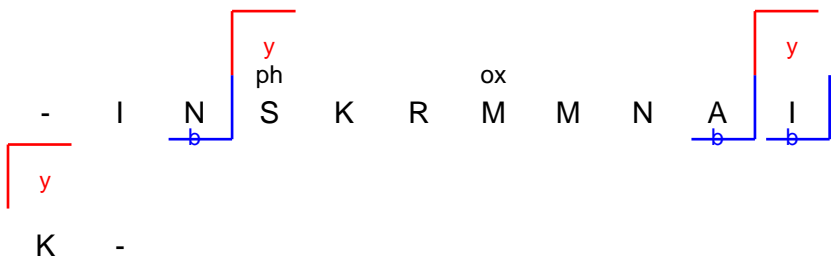
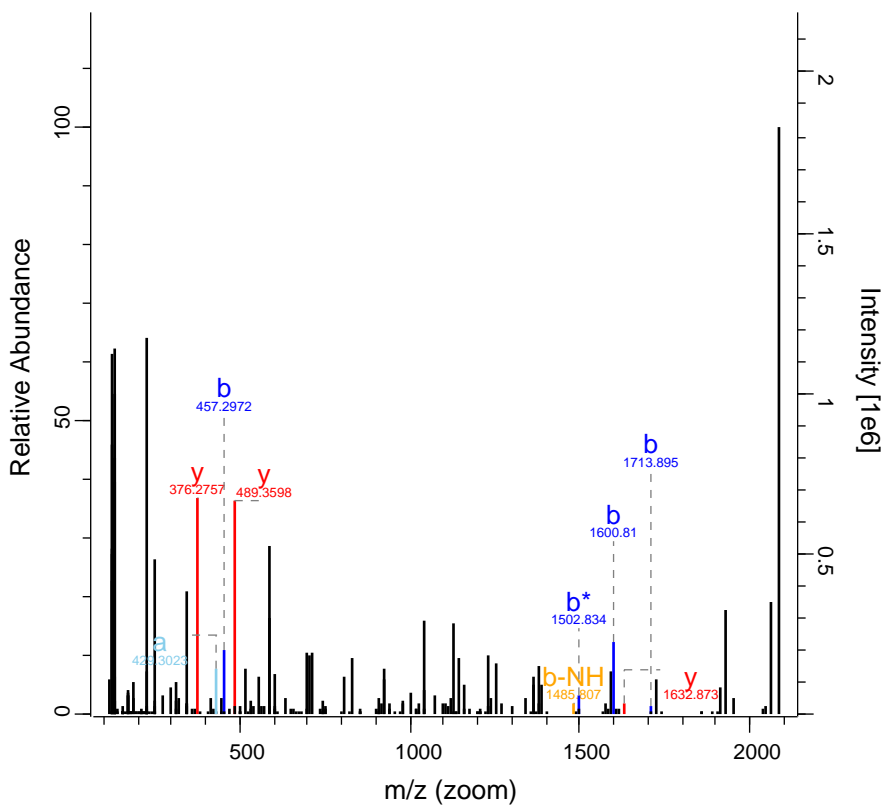

RO-QC-160121_ZackD_SS_Set_01_Fractic 36809 FTMS; HC 76.14 1193.18 MGEA5

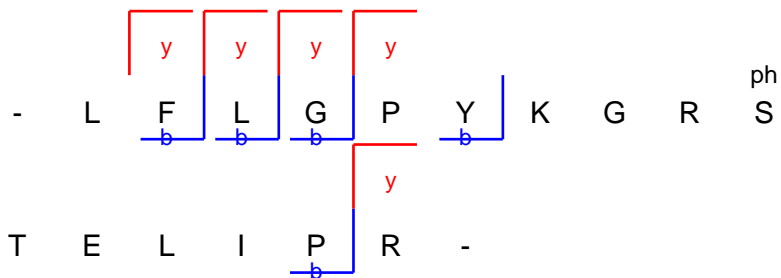
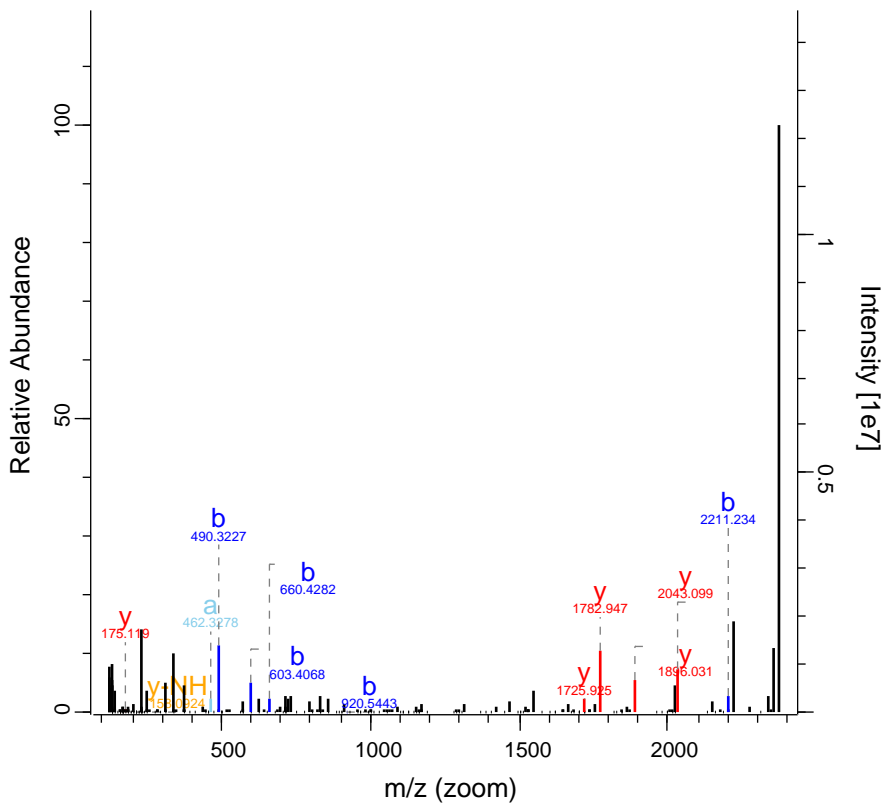

RO-QC-160121_ZackD_SS_Set_01_Fractic 37315 FTMS; HC 84 1305.63 SSR1

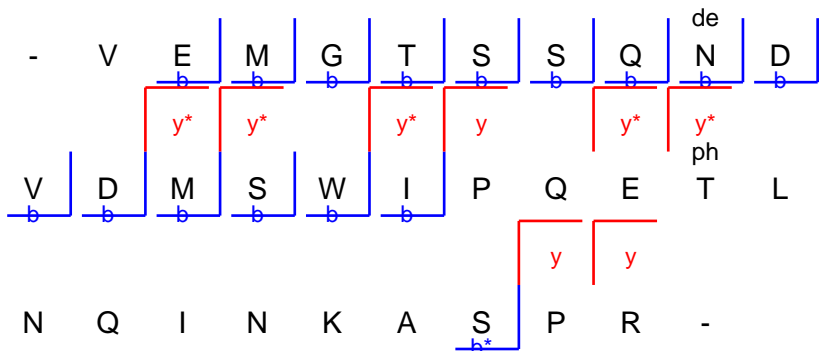
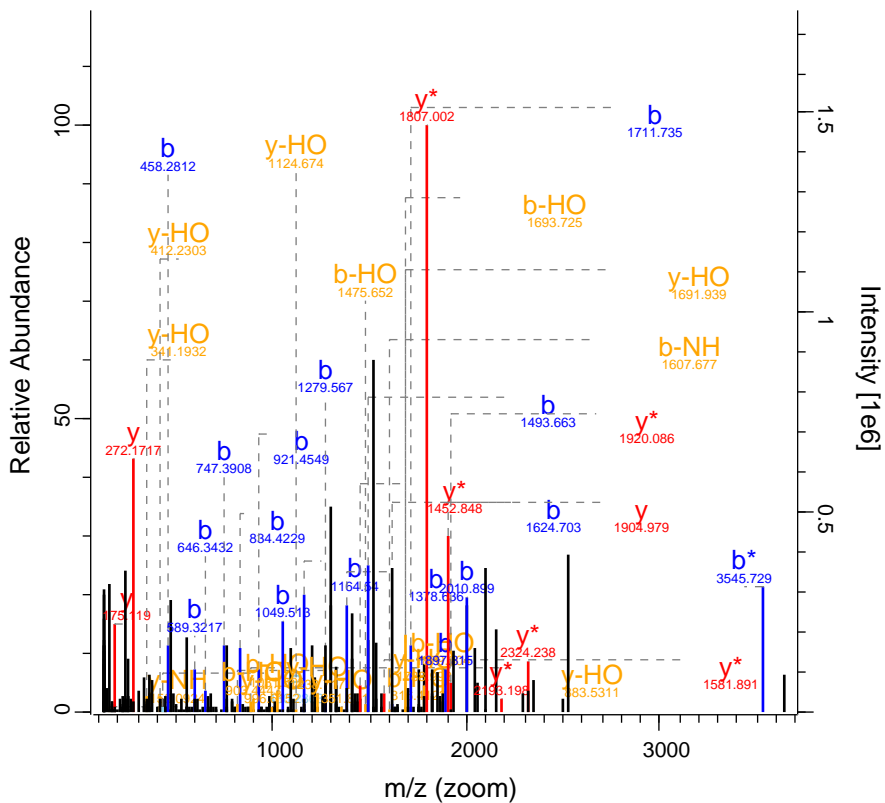

RO-QC-160121_ZackD_SS_Set_01_Fraction 39255 FTMS; HC 50.94 995.54 ANXA1

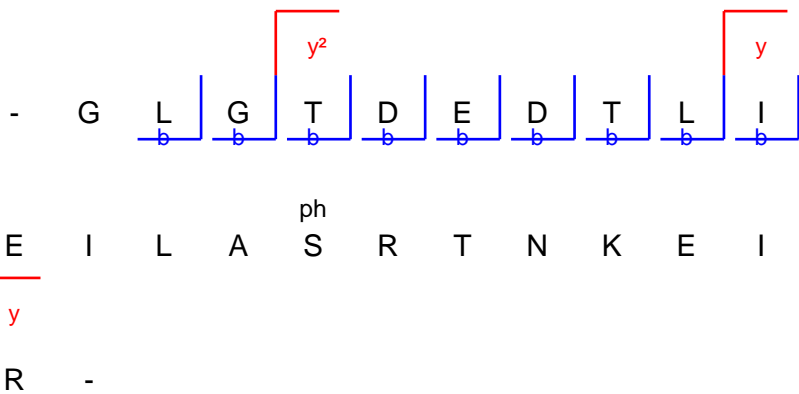
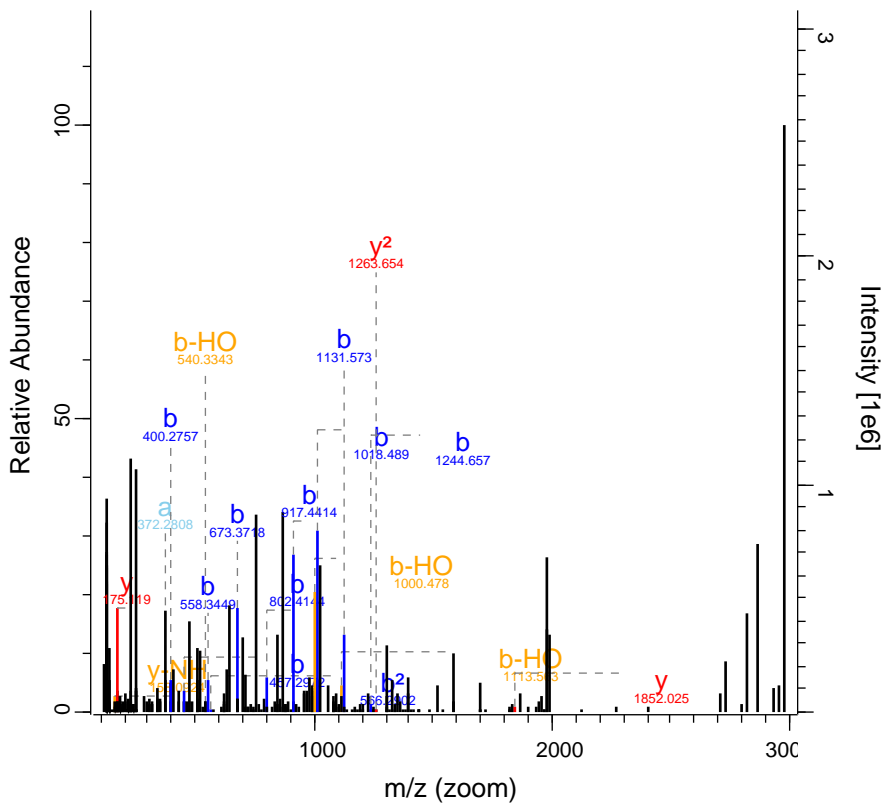

RO-QC-160121_ZackD_SS_Set_01_Fractic 39269 FTMS; HC 53.95 1570.28 POFUT2

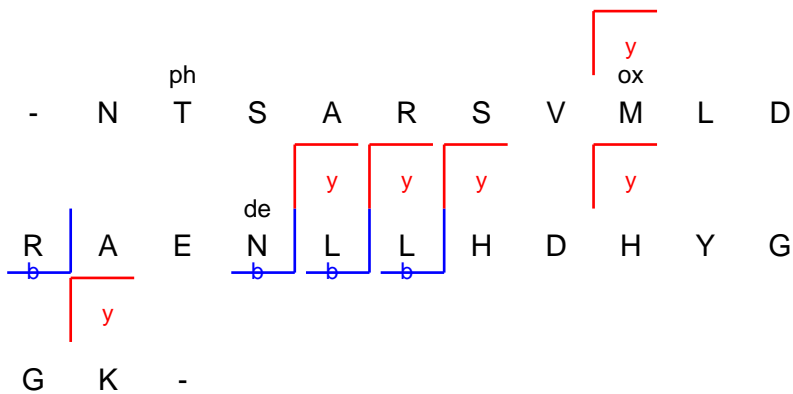
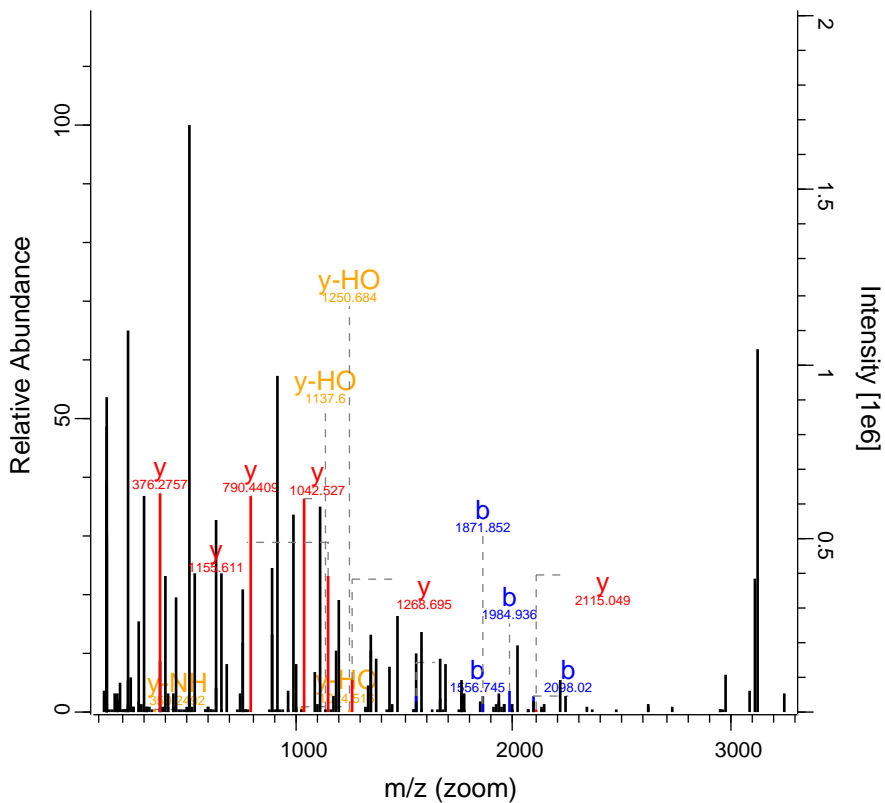

RO-QC-160121_ZackD_SS_Set_01_Fraction 41442 FTMS; HC 75.31 893.96 TINAG

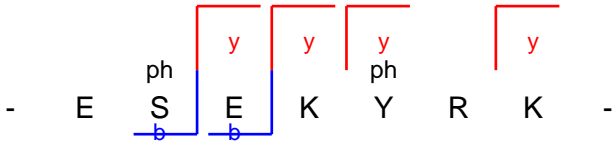
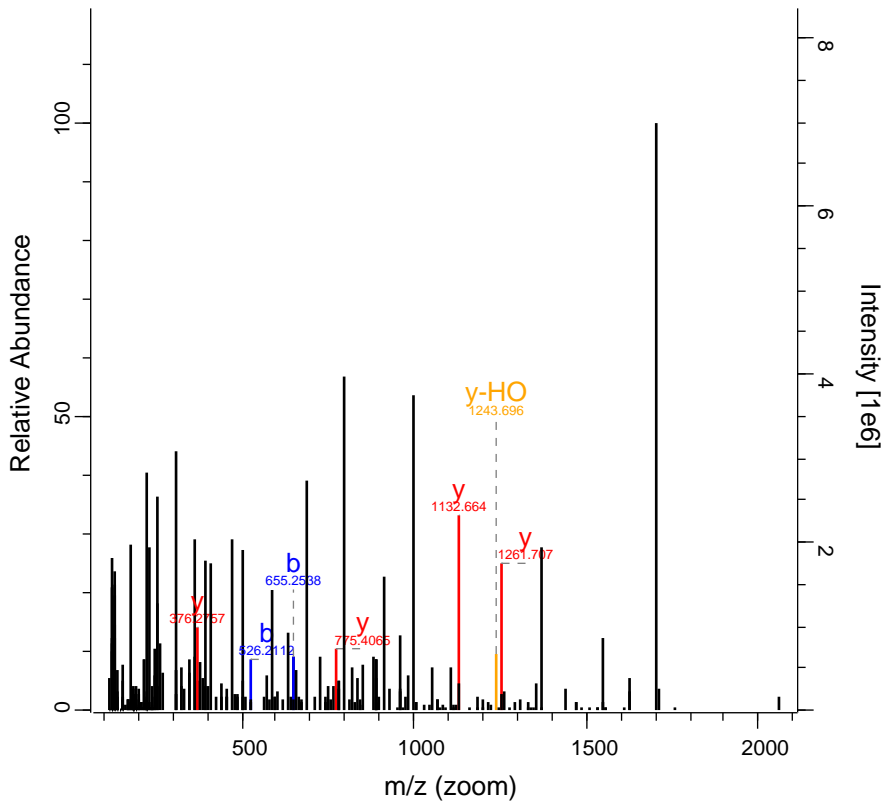

RO-QC-160121_ZackD_SS_Set_01_Fraction 5868 FTMS; HCl 59.9 506.78 NIPBL

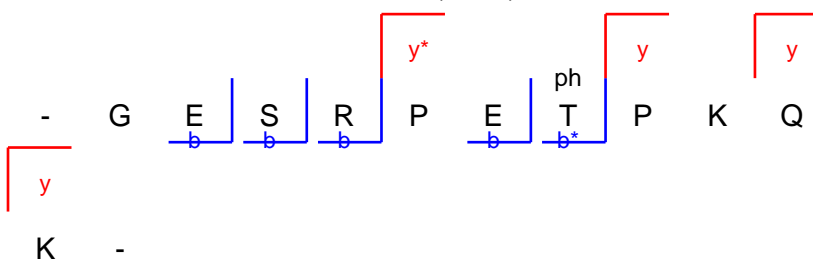
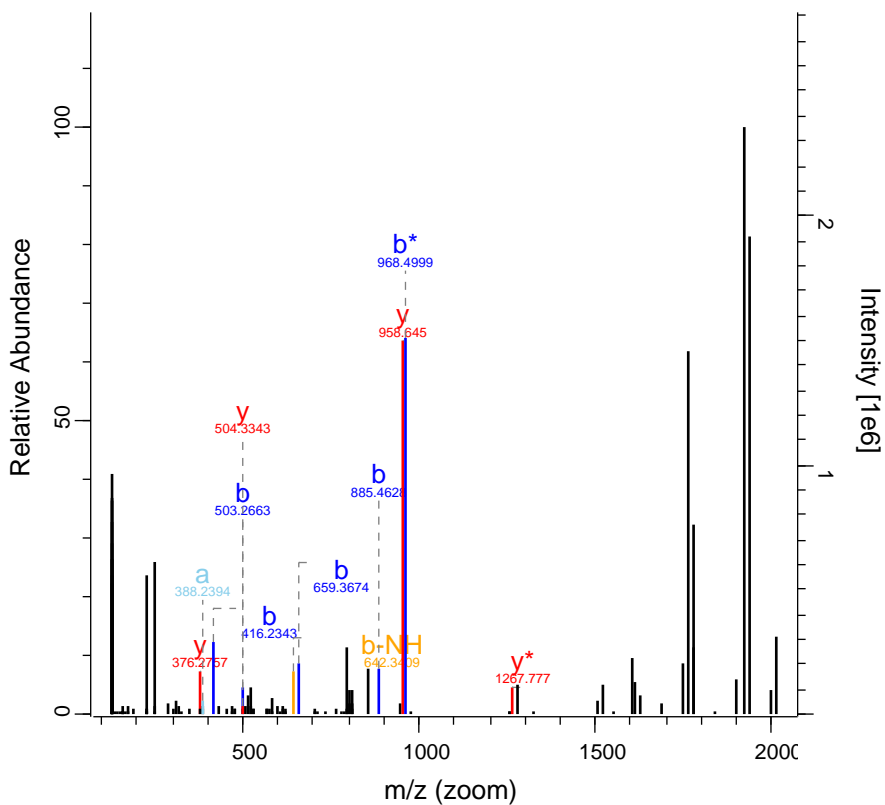

RO-QC-160121_ZackD_SS_Set_01_Fraction 6082 FTMS; HCl 71.69 594.3 NOC2L

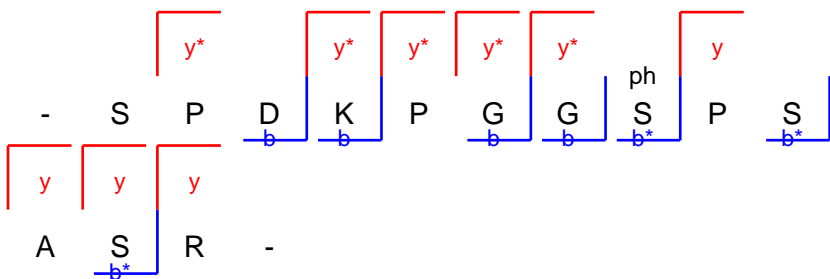
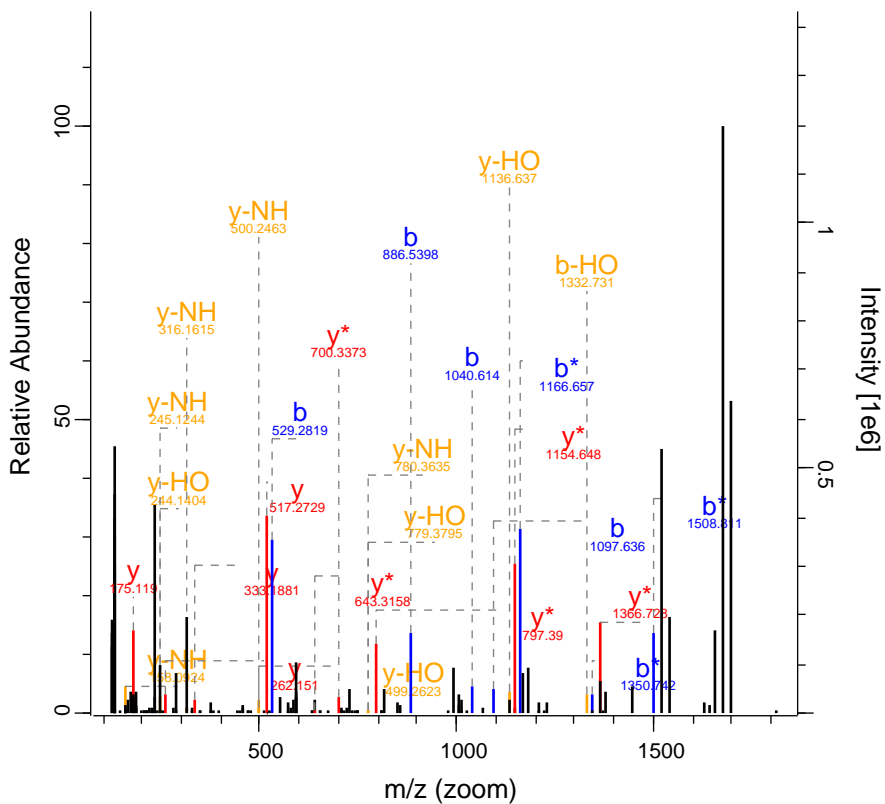

RO-QC-160121_ZackD_SS_Set_01_Fraction 6241 FTMS; HCl 50.35 622.32 PECAM1

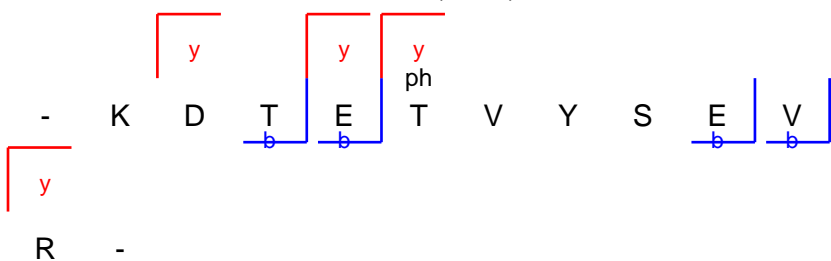
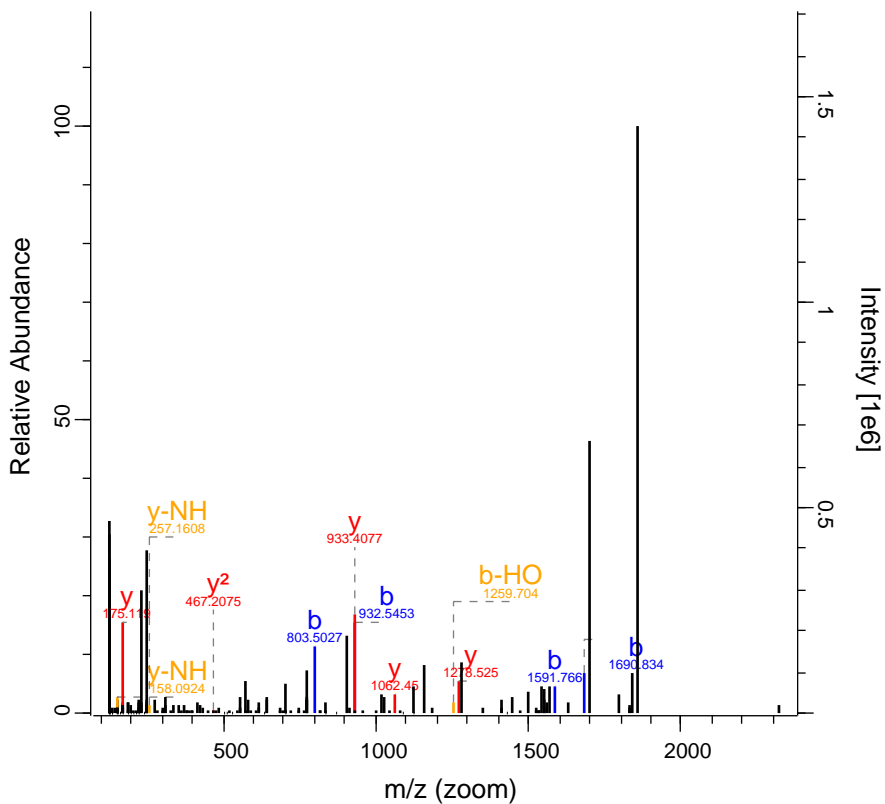

RO-QC-160121_ZackD_SS_Set_01_Fraction 6289 FTMS; HC 102.87 854.41 BMI1

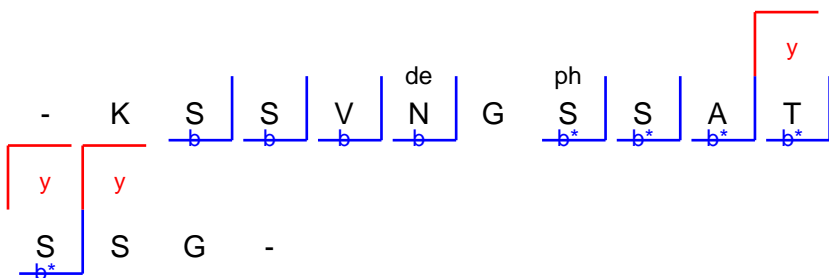
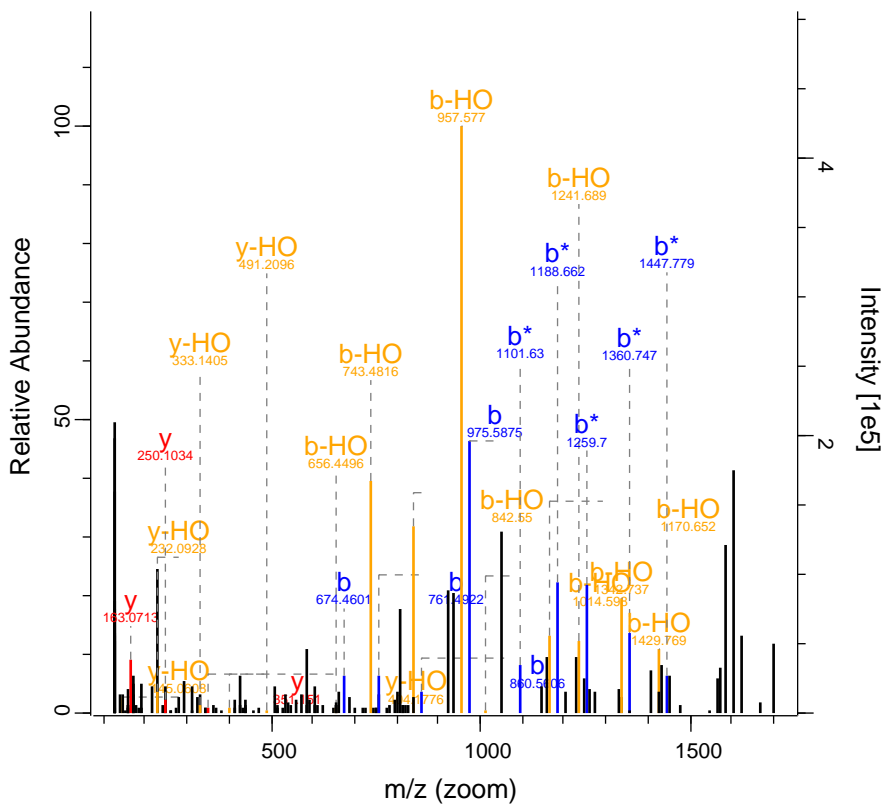

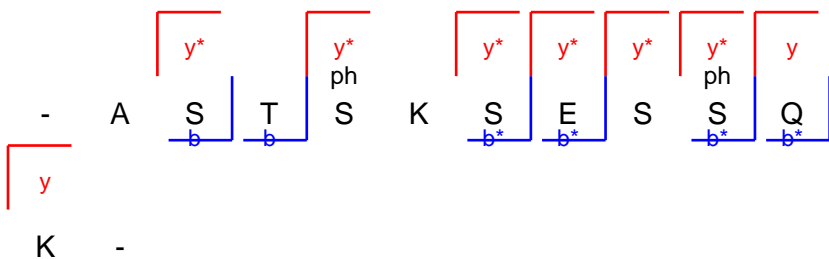
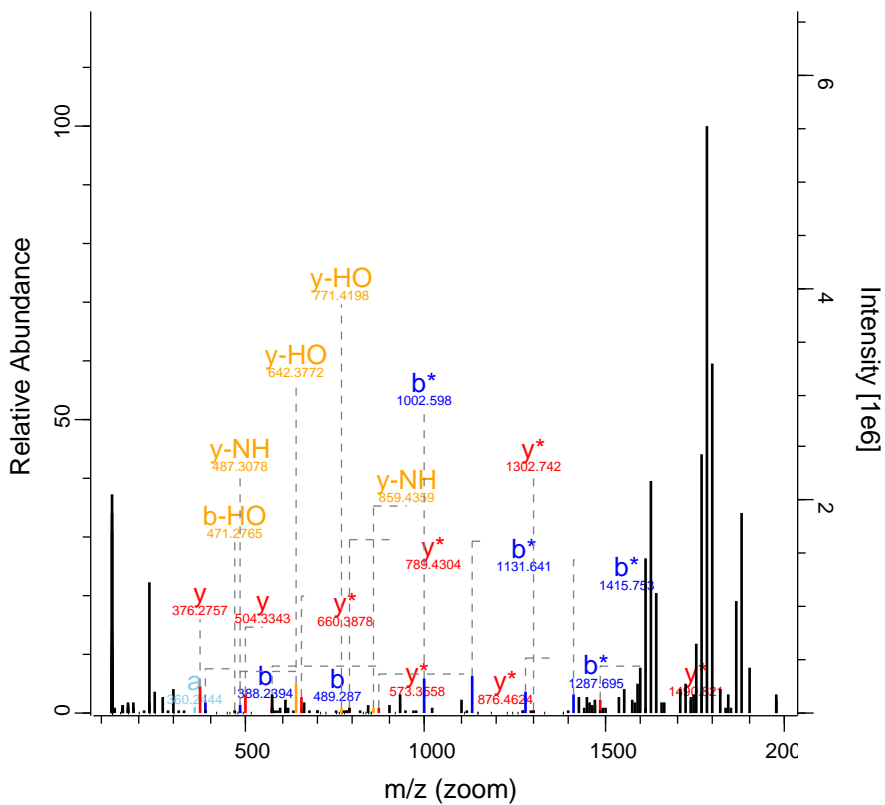

RO-QC-160121_ZackD_SS_Set_01_Fraction 6651 FTMS; HCl 65.4 993.99 RPS6

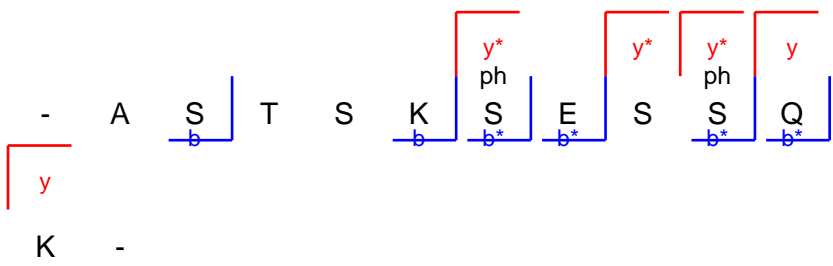
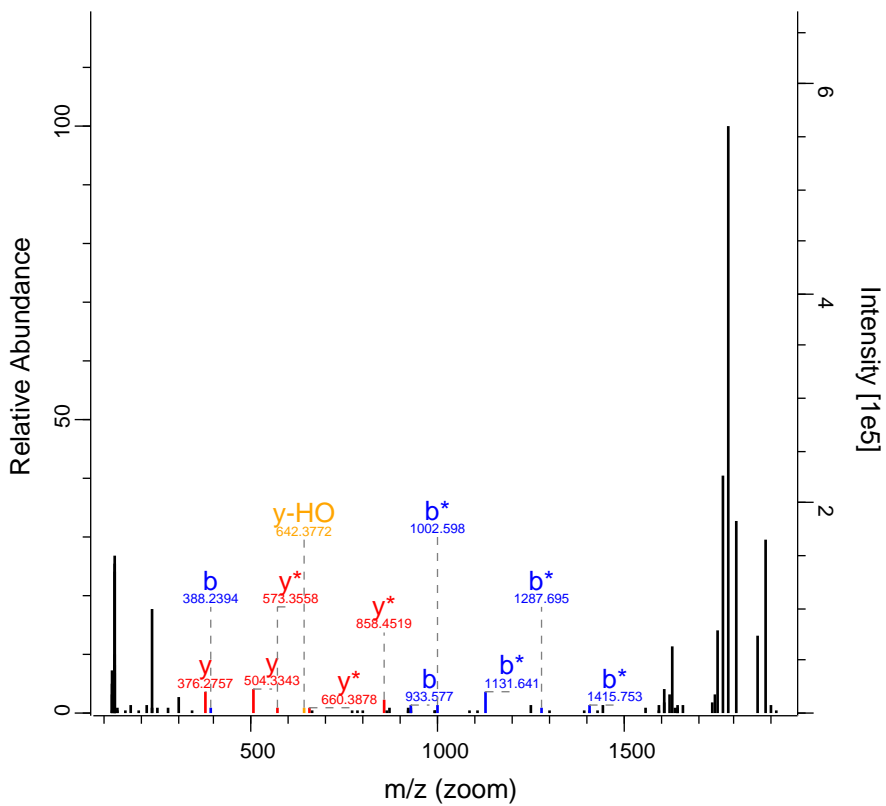

RO-QC-160121_ZackD_SS_Set_01_Fraction 6841 FTMS; HCl 89.46 597.99 SEPT9

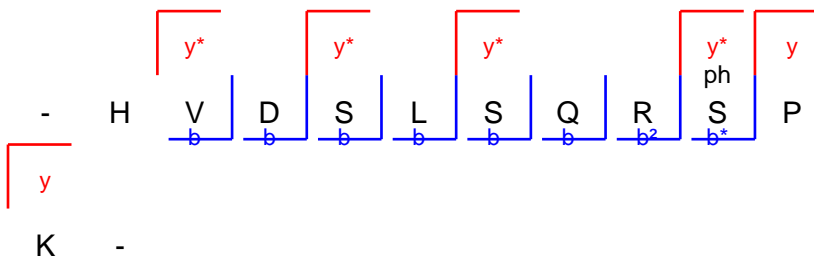
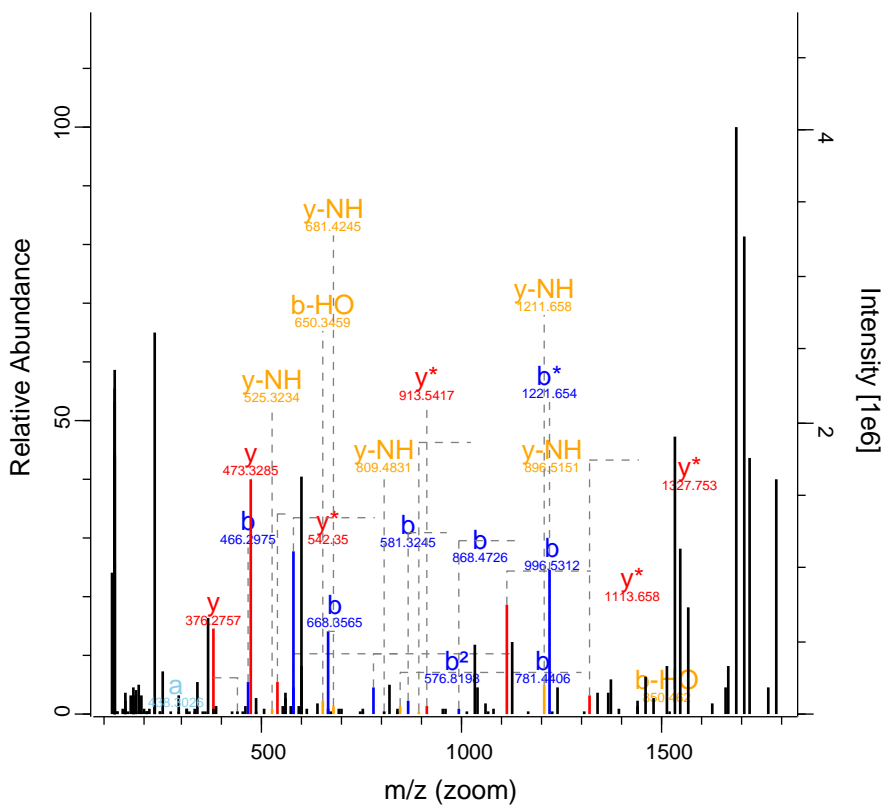

RO-QC-160121_ZackD_SS_Set_01_Fraction 7499 FTMS; HCl 66.26 394.98 MYBPC3

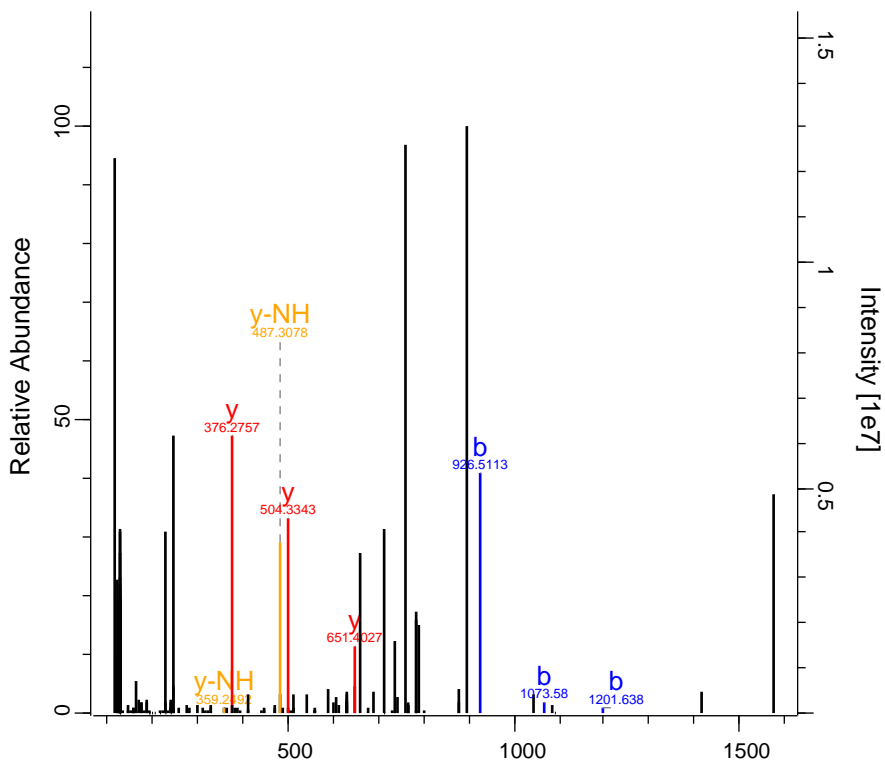

m/z (zoom)

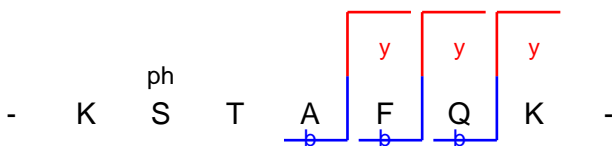

RO-QC-160121_ZackD_SS_Set_01_Fraction12482 FTMS; HC 42.74 1195.6 SPATA31D1

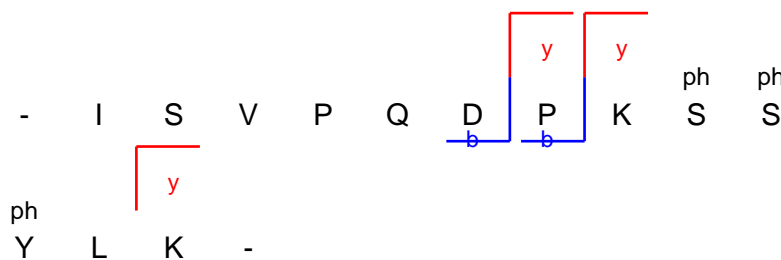
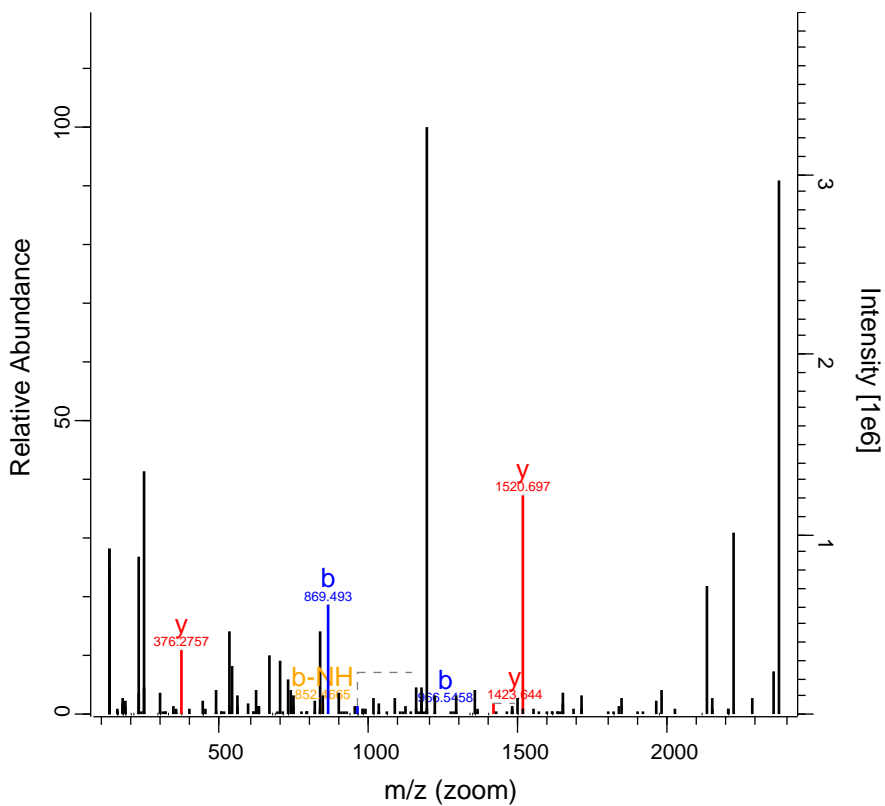

RO-QC-160121_ZackD_SS_Set_01_Fraction 13418 FTMS; HC 123.2 729.32 SORBS2

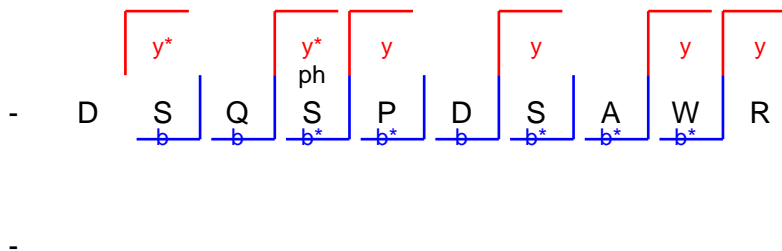
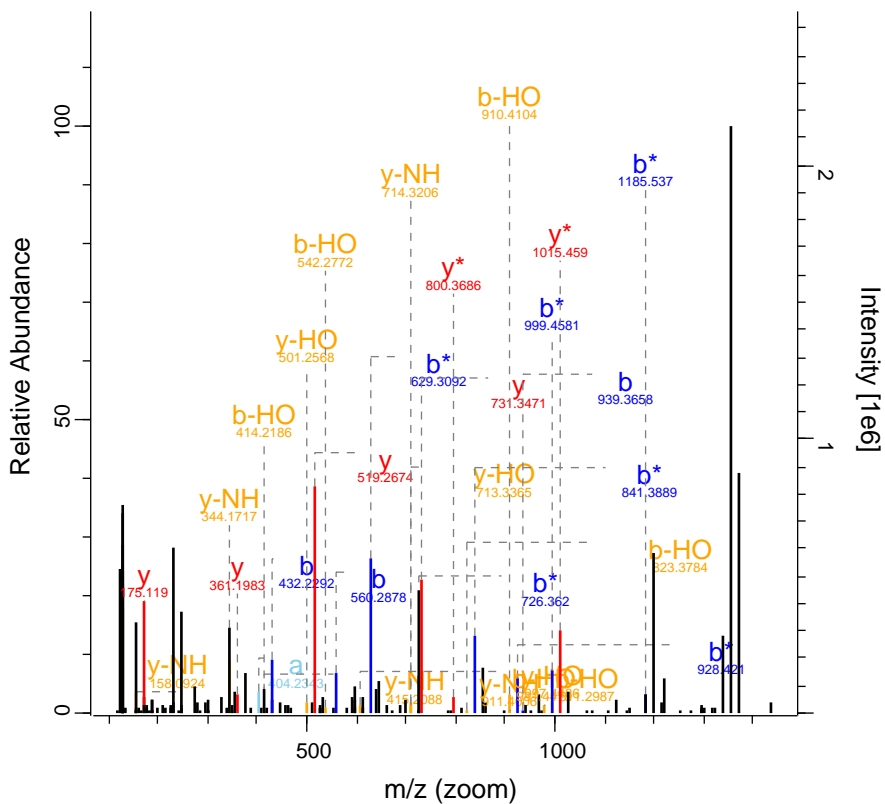

RO-QC-160121_ZackD_SS_Set_01_Fraction 13919 FTMS; HC 70.92 854.46 CARD14

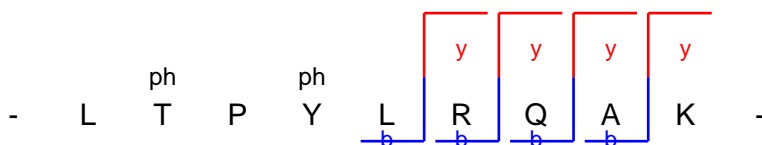
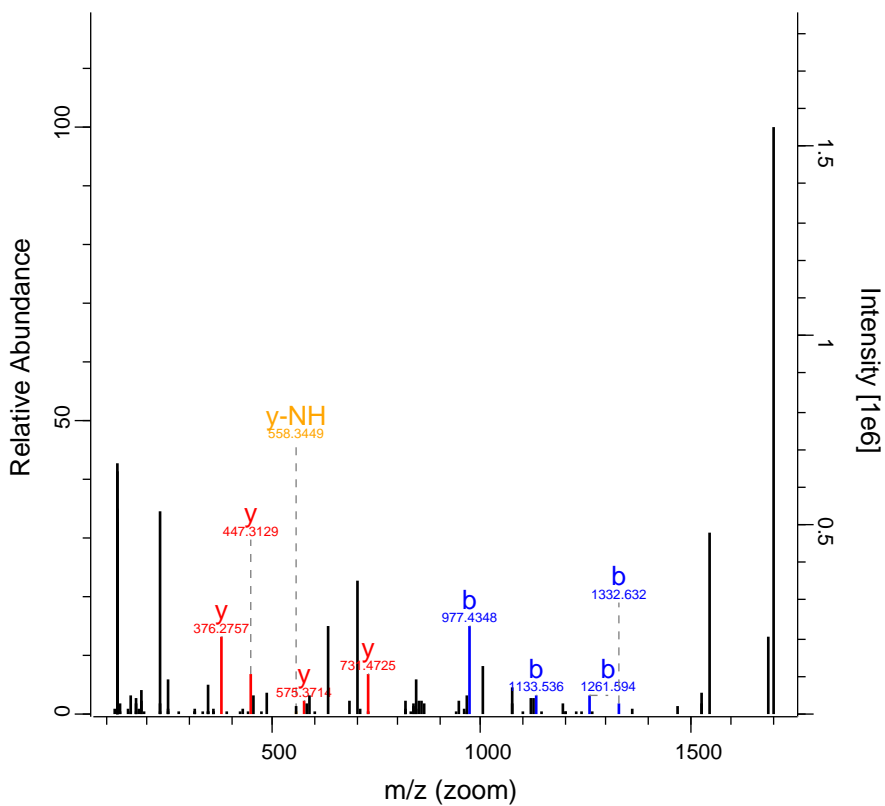

RO-QC-160121_ZackD_SS_Set_01_Fractic 14102 FTMS; HC 45.88 1211.59 LARP4

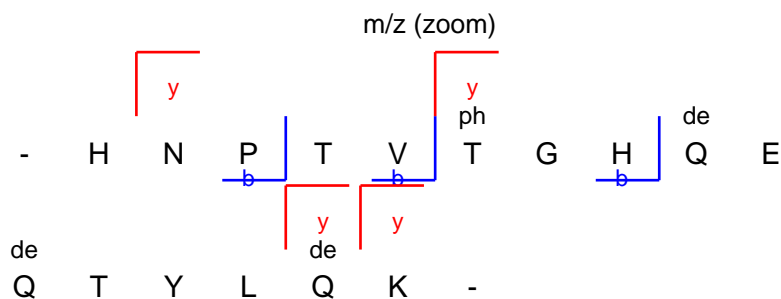
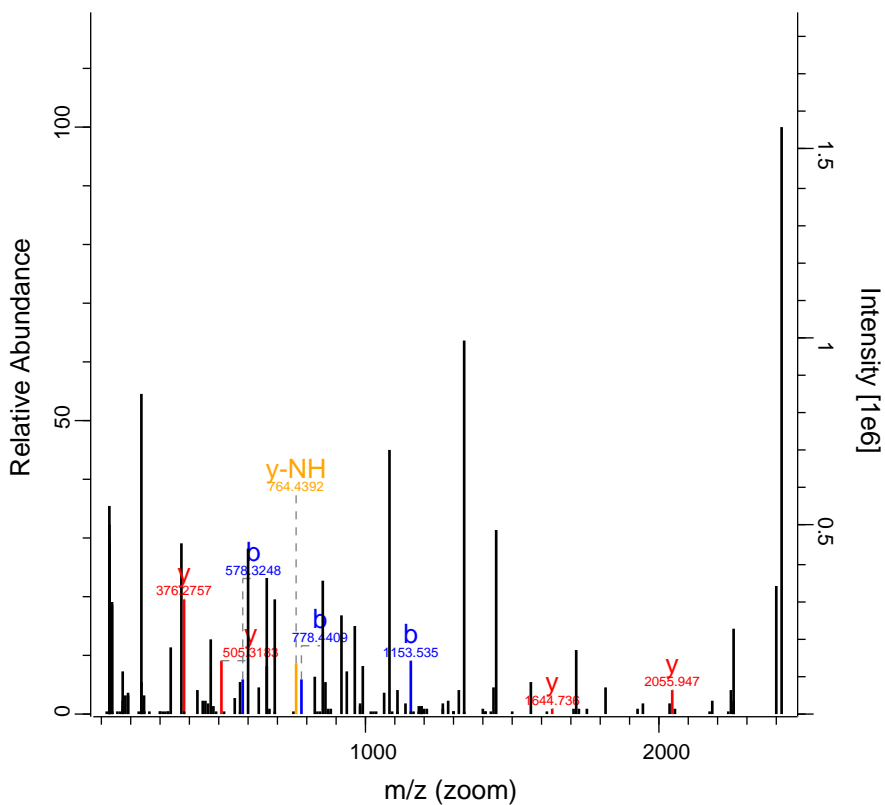

RO-QC-160121_ZackD_SS_Set_01_Fraction 14674 FTMS; HC 59.9 470.07 WDR31

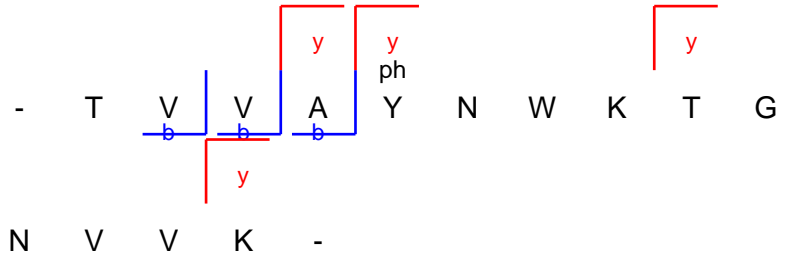
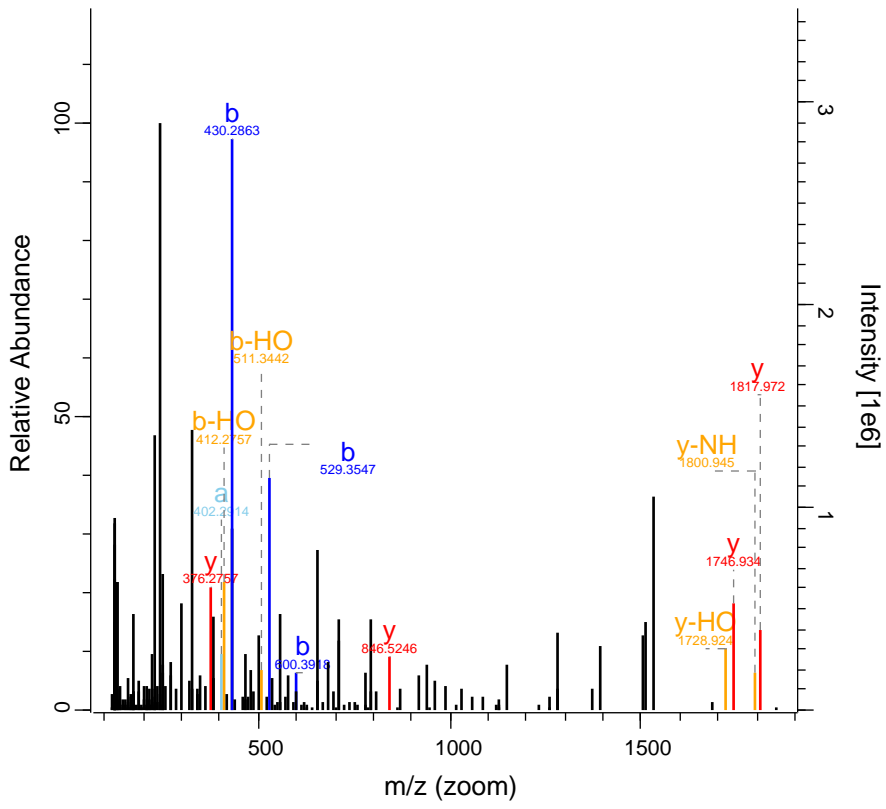

N V V K -

RO-QC-160121_ZackD_SS_Set_01_Fraction 14993 FTMS; HC 136.1 853.09 TRAM1

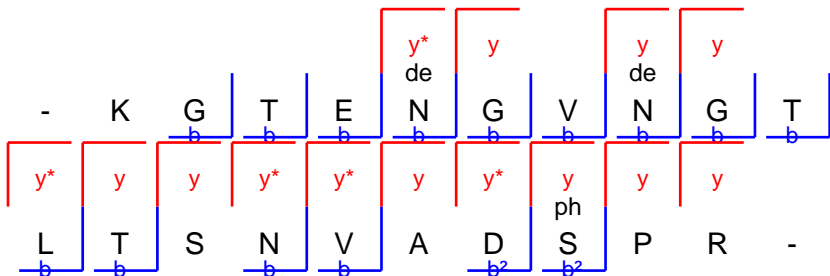
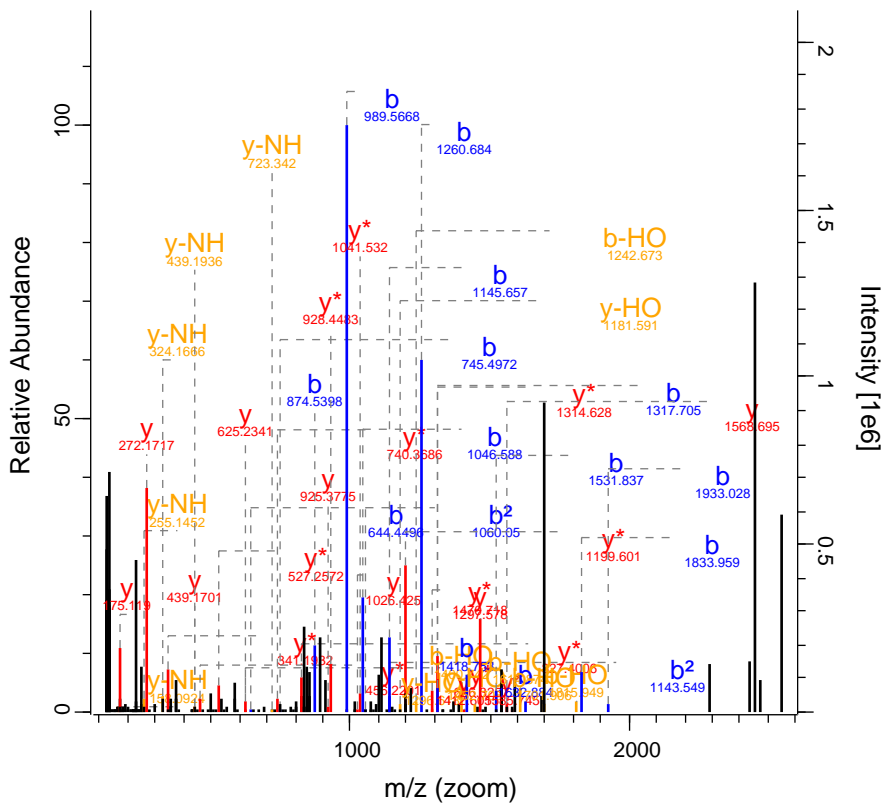

RO-QC-160121_ZackD_SS_Set_01_Fraction 15049 FTMS; HC 70.33 787.82 MAP1B

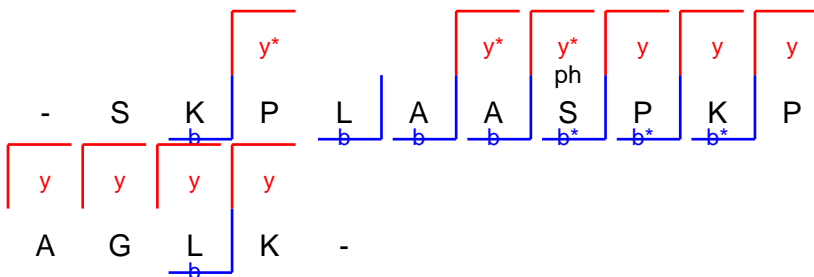
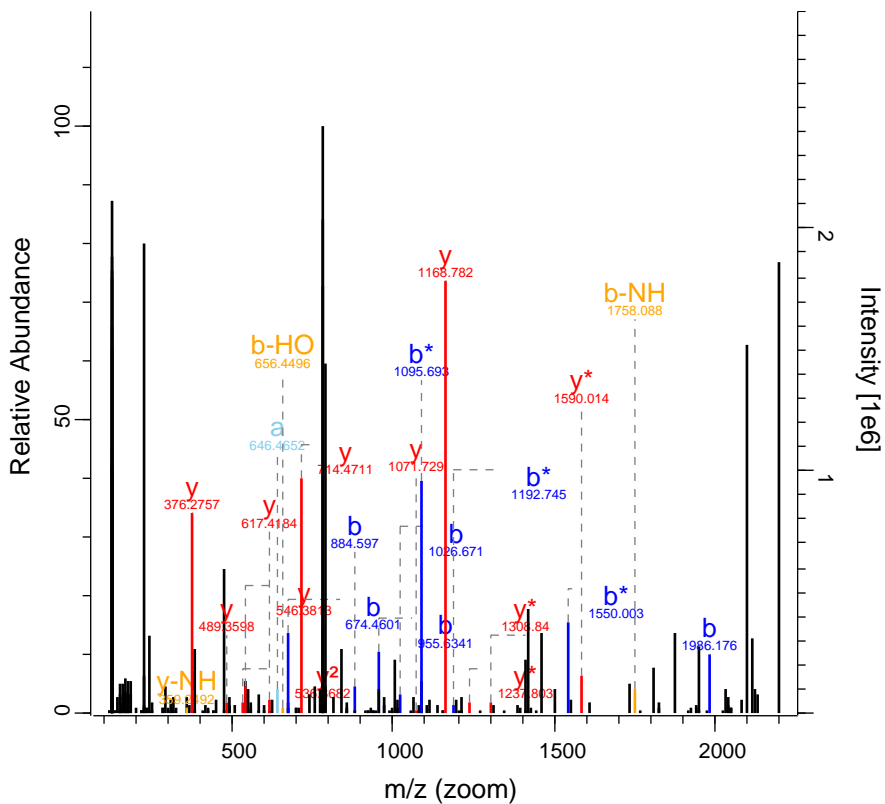

RO-QC-160121_ZackD_SS_Set_01_Fraction 15876 FTMS; HC 95.04 988.15 KIF21A

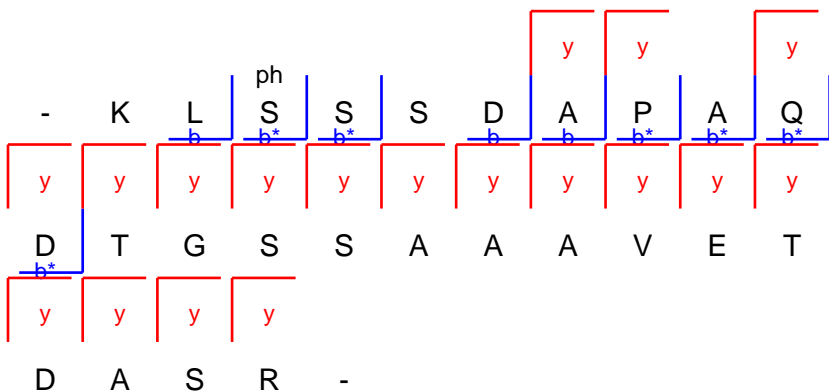
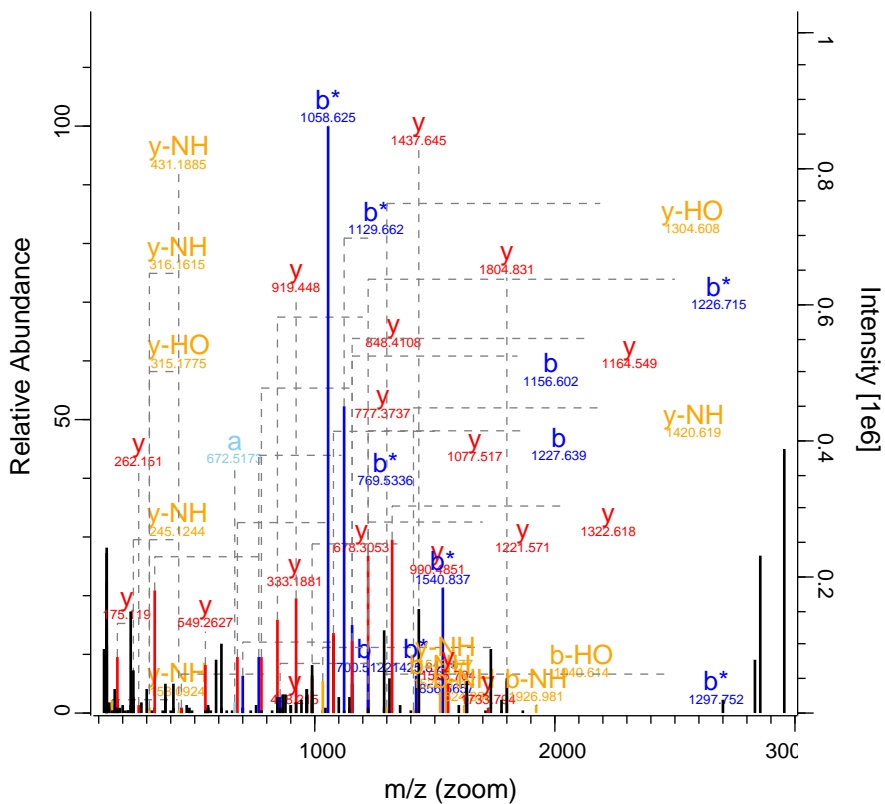

RO-QC-160121_ZackD_SS_Set_01_Fraction 16909 FTMS; HC 62.82 965.03 C2CD5

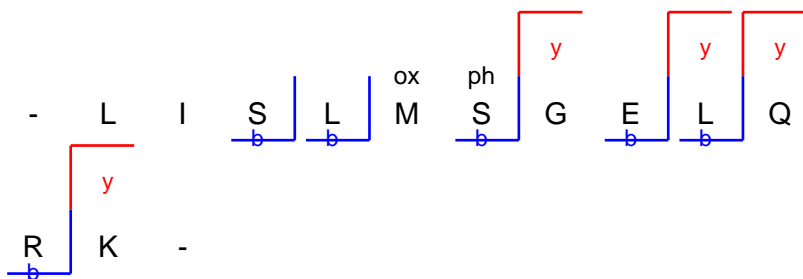
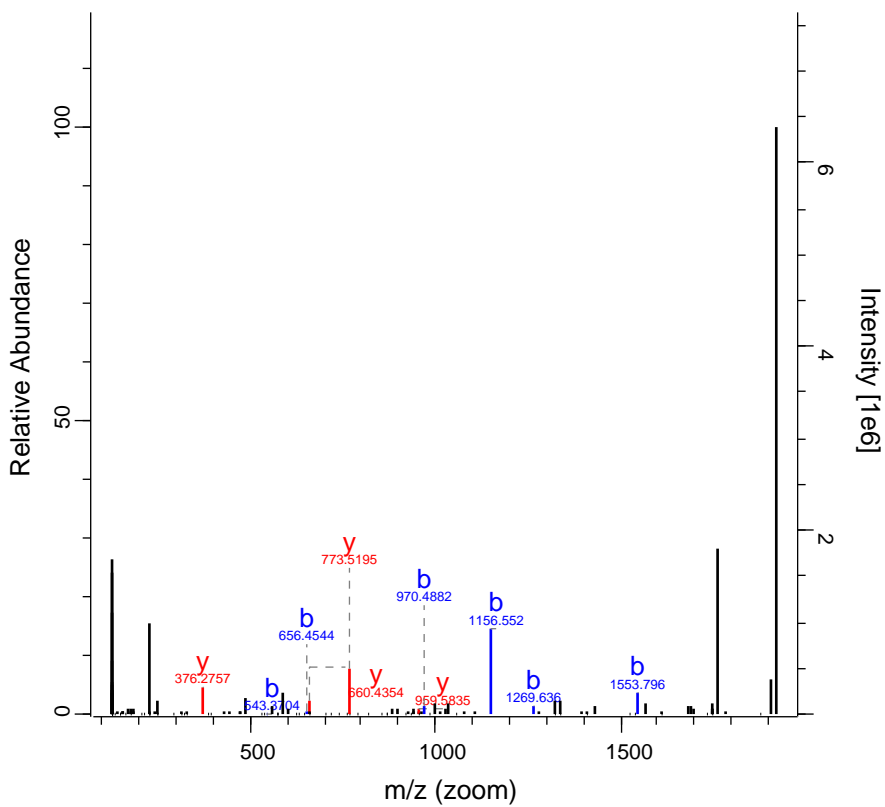

RO-QC-160121_ZackD_SS_Set_01_Fractic 18118 FTMS; HC 58.98 1116.62 NUP107

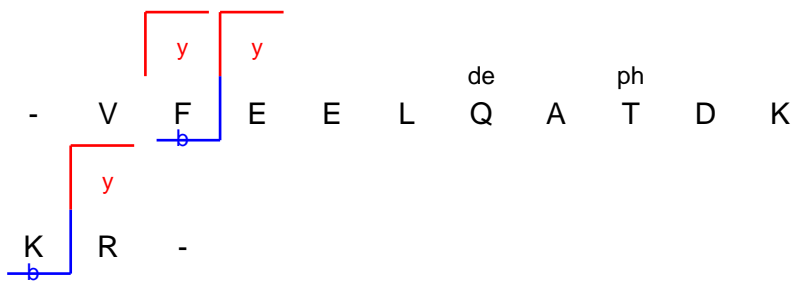
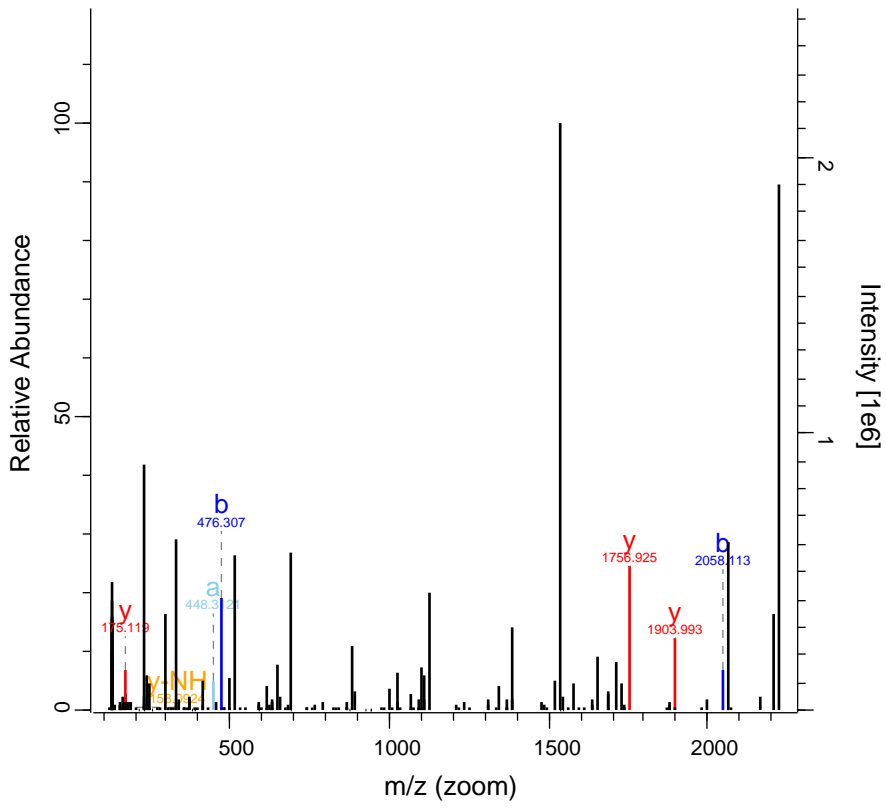

RO-QC-160121_ZackD_SS_Set_01_Fraction 18199 FTMS; HC 54.28 574.65 USP24

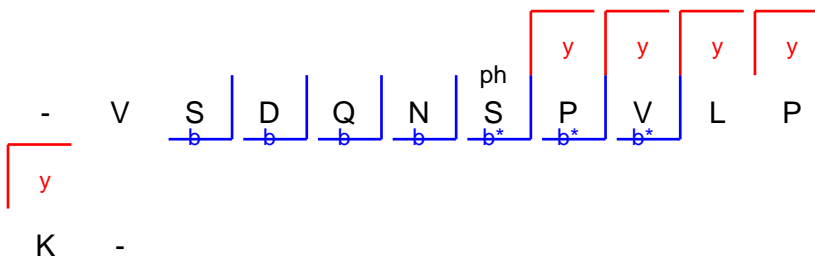
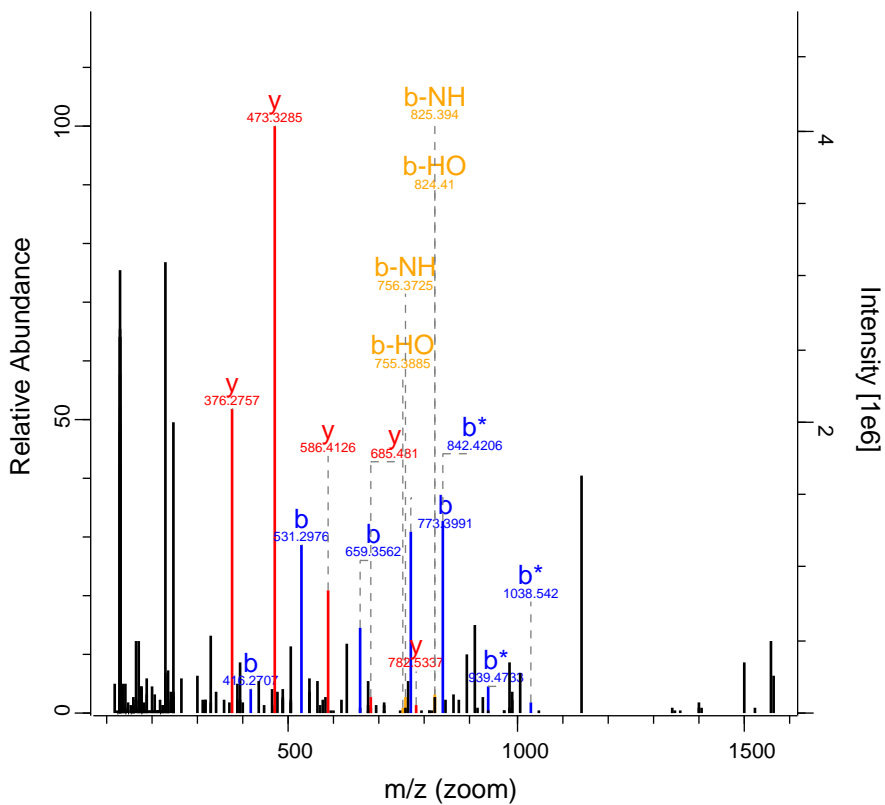

RO-QC-160121_ZackD_SS_Set_01_Fractic 18906 FTMS; HC 48.4 1155.12 DHX8

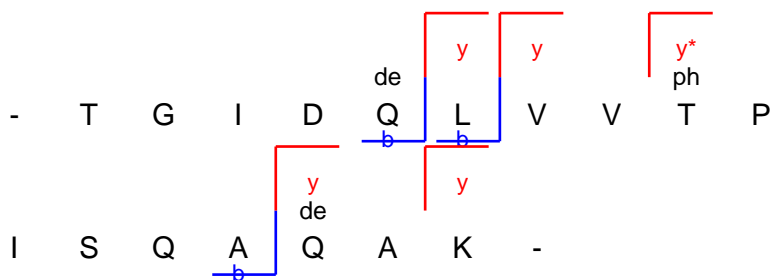
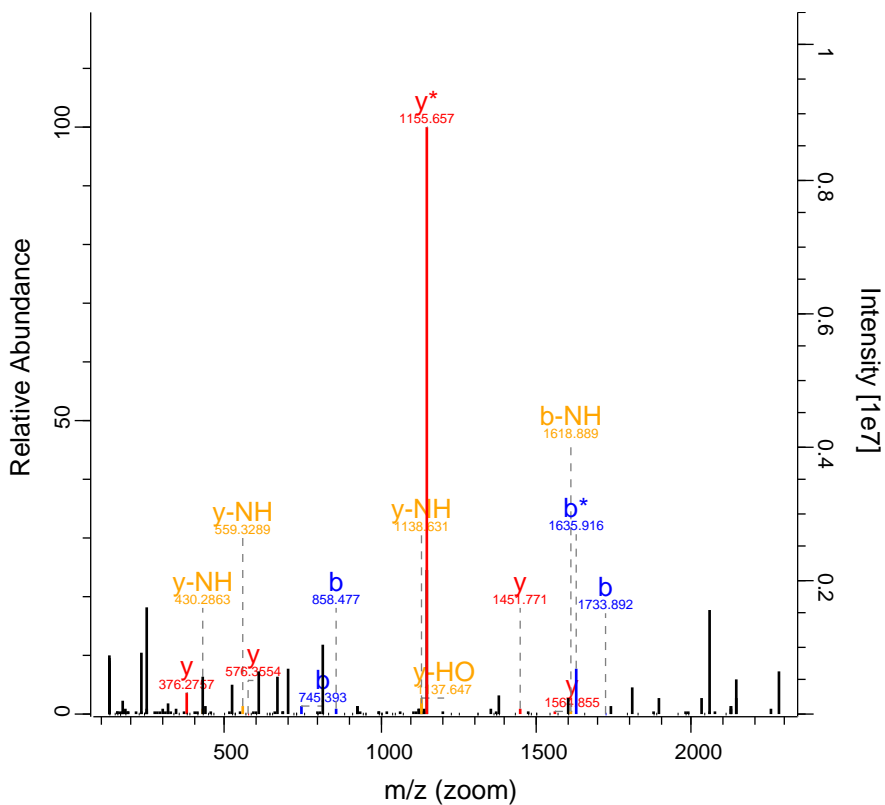

RO-QC-160121_ZackD_SS_Set_01_Fraction 19265 FTMS; HC 40.08 869.18 VLDLR

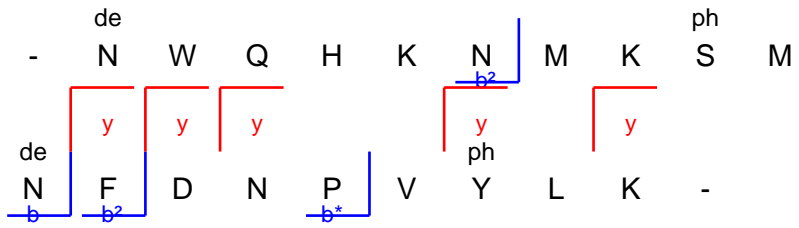
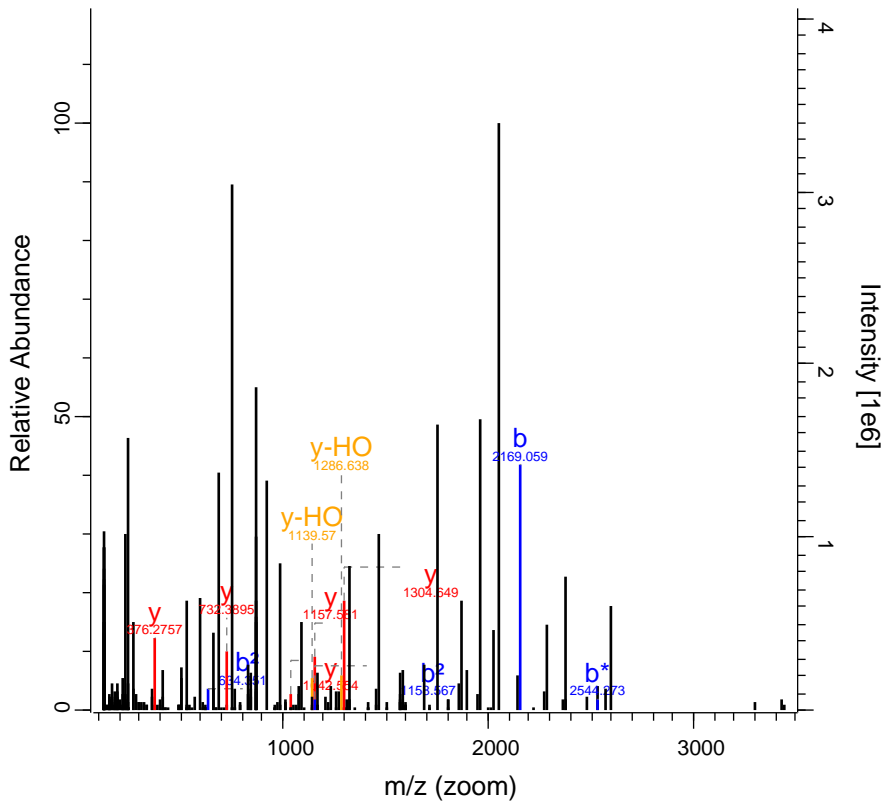

RO-QC-160121_ZackD_SS_Set_01_Fractic 19338 FTMS; HC 48.74 1082.04 ELAVL1

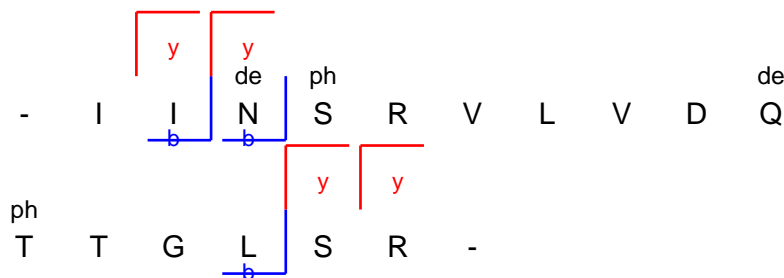
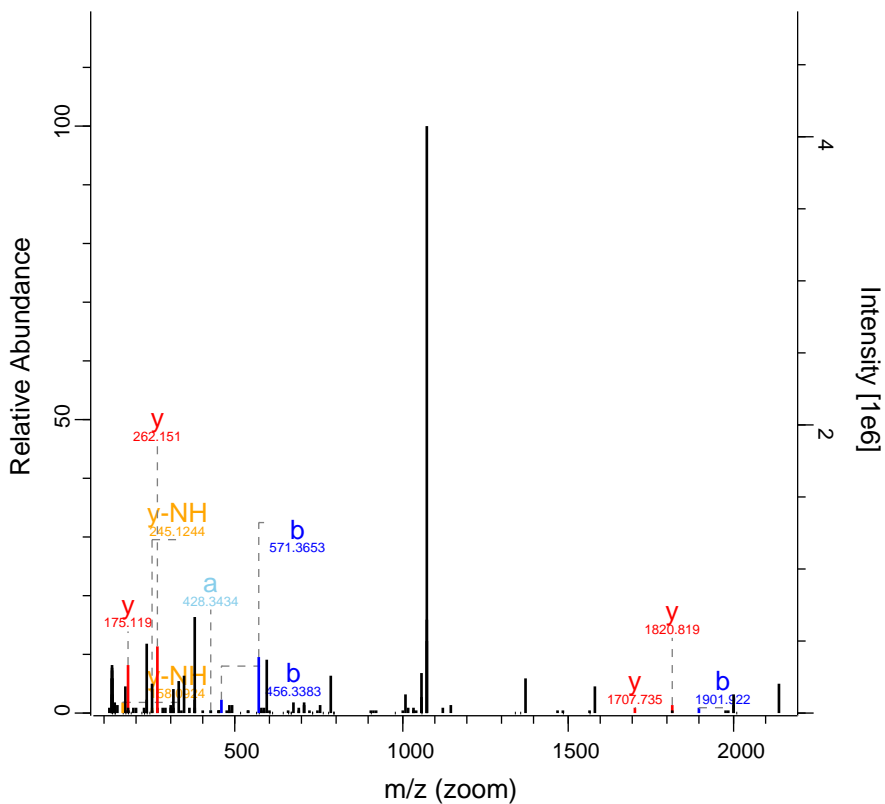

RO-QC-160121_ZackD_SS_Set_01_Fraction 20152 FTMS; HC 55.53 825.42 CELSR3

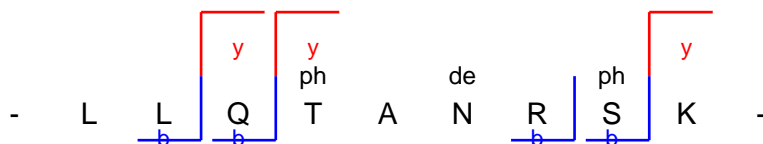
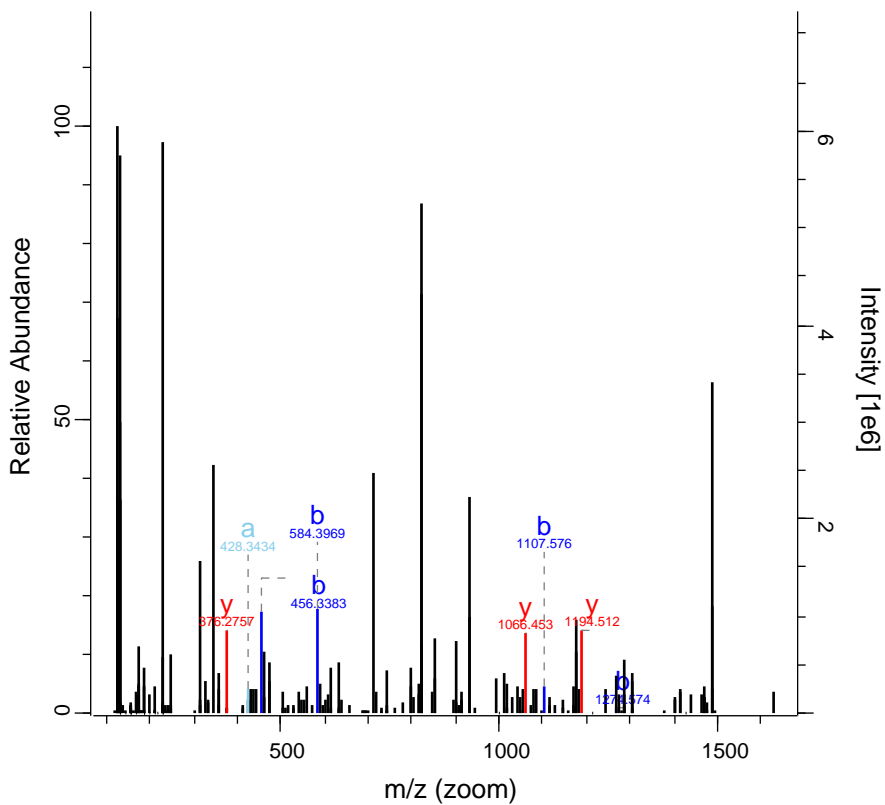

RO-QC-160121_ZackD_SS_Set_01_Fraccio 20579 FTMS; HC 214.34 976.49 AHNAK

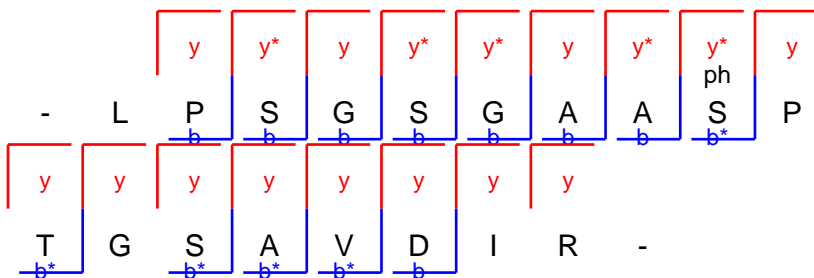
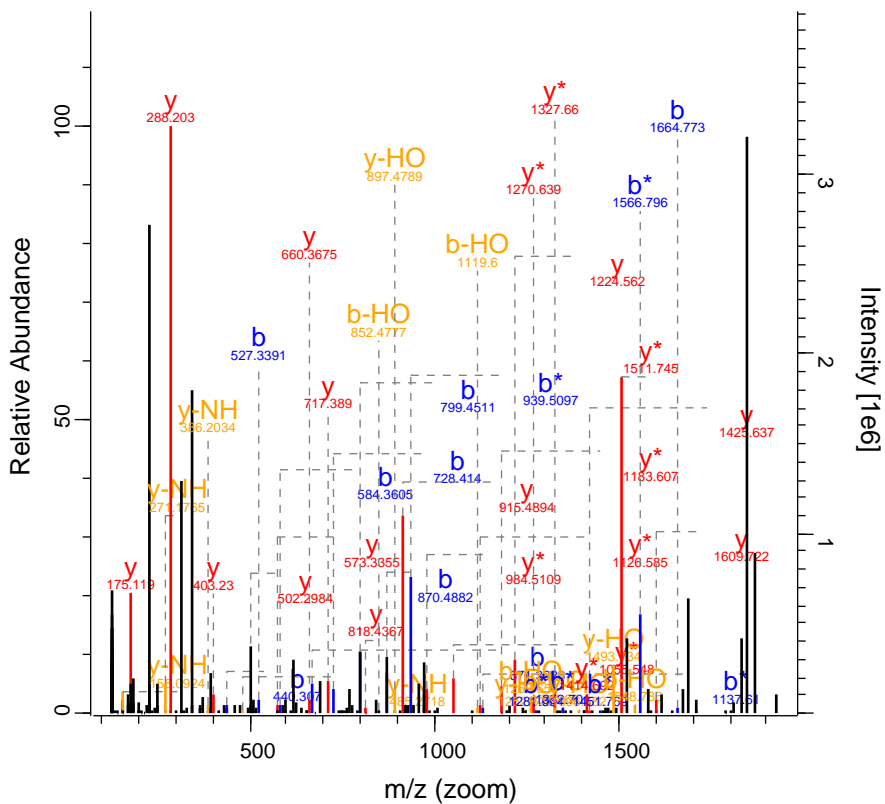

RO-QC-160121_ZackD_SS_Set_01_Fraction 20909 FTMS; HC 65.25 810.91 SRRM2

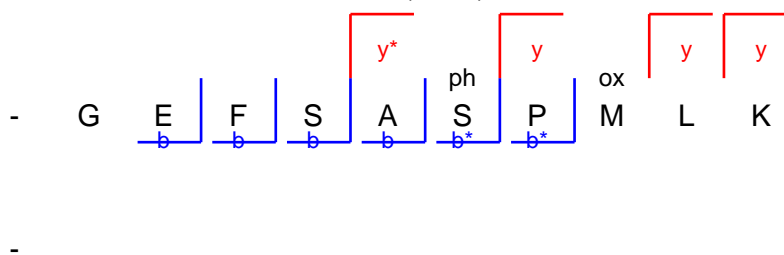
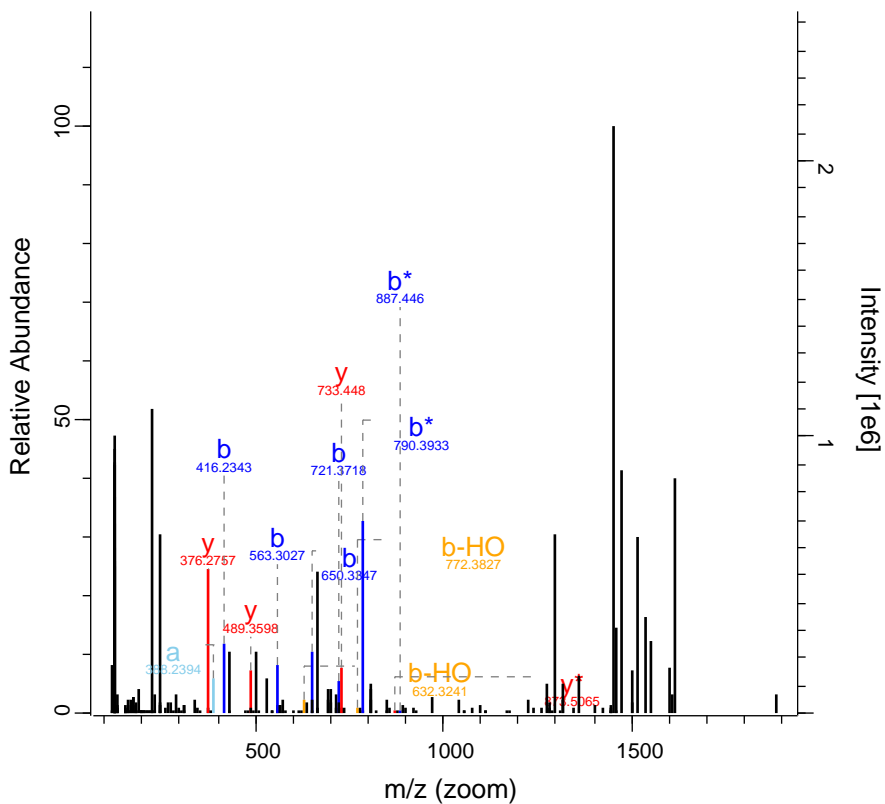

RO-QC-160121_ZackD_SS_Set_01_Fraction 21855 FTMS; HC 71.55 702.73 CHM

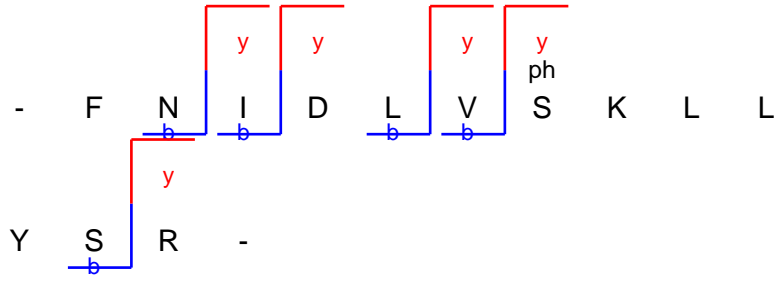
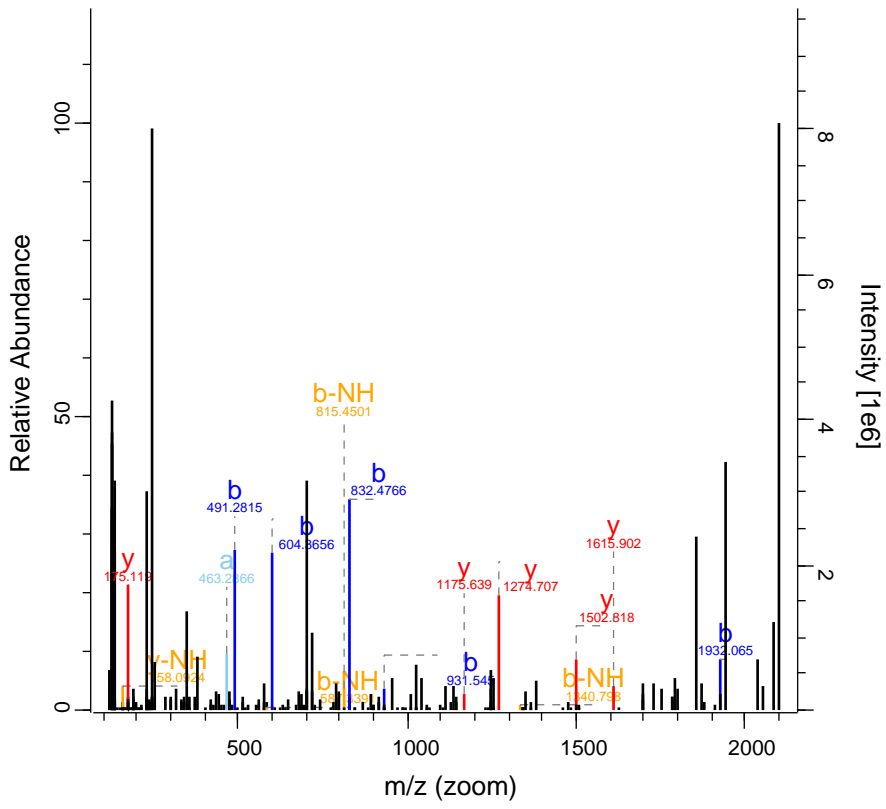

RO-QC-160121_ZackD_SS_Set_01_Fraction 22840 FTMS; HC 78.1 1080.6 CHM

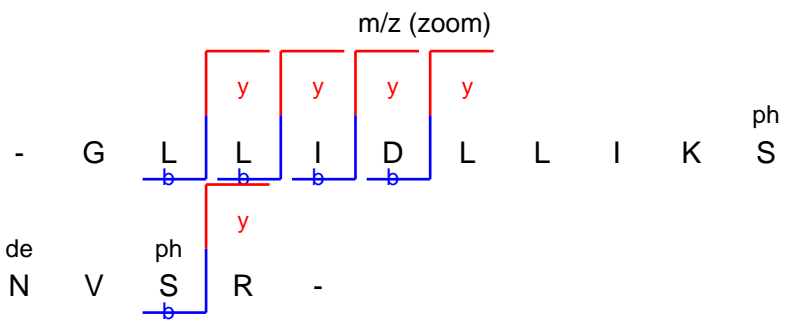
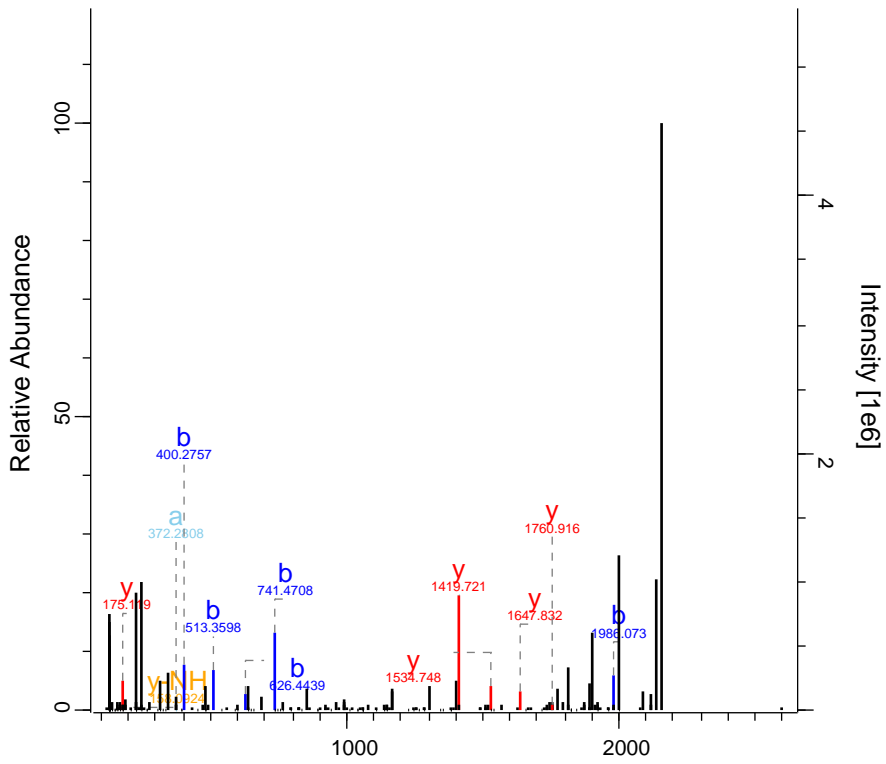

RO-QC-160121_ZackD_SS_Set_01_Fractic 22971 FTMS; HC 47.56 1016.01 INPP5D

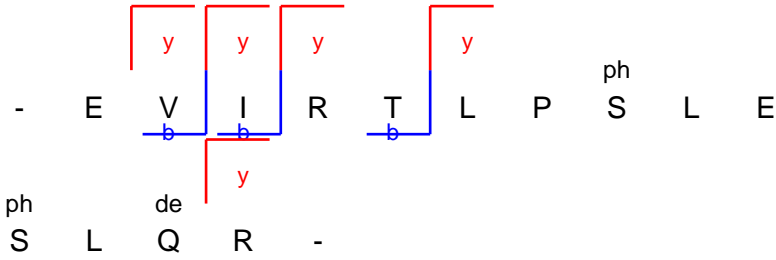
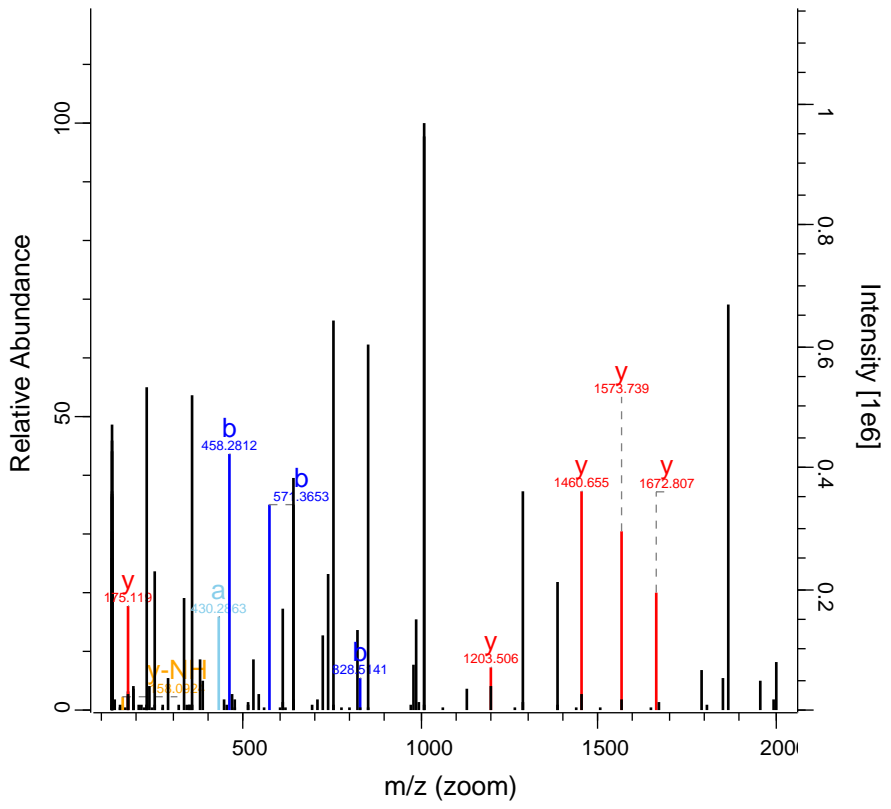

RO-QC-160121_ZackD_SS_Set_01_Fraction 26029 FTMS; HC 41.98 809.41 ZDBF2

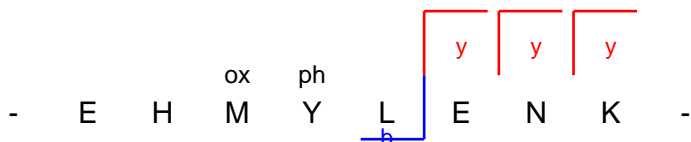
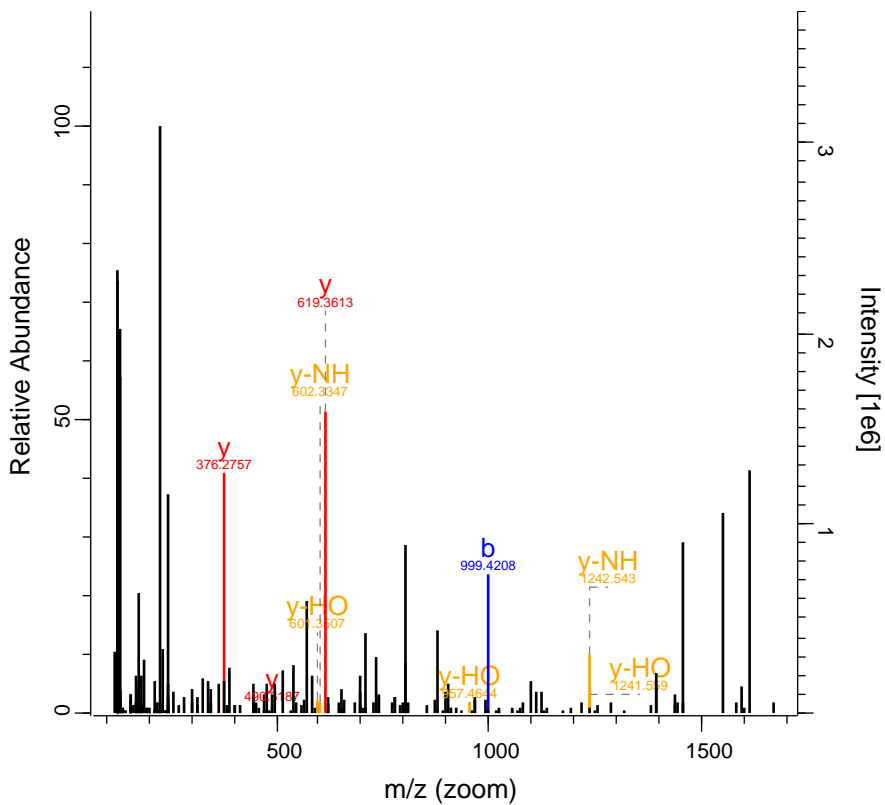

RO-QC-160121_ZackD_SS_Set_01_Fraction 26230 FTMS; HCl 54.6 948.2 PIBF1

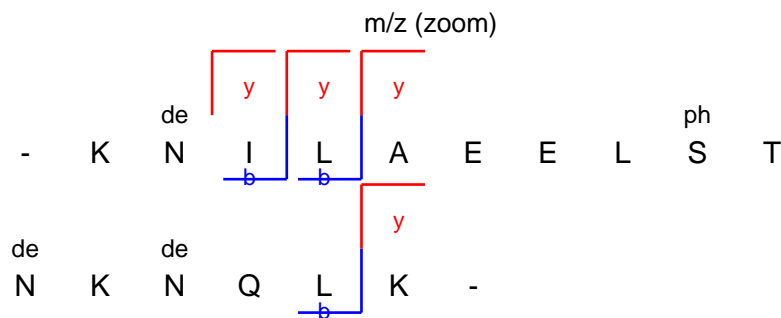
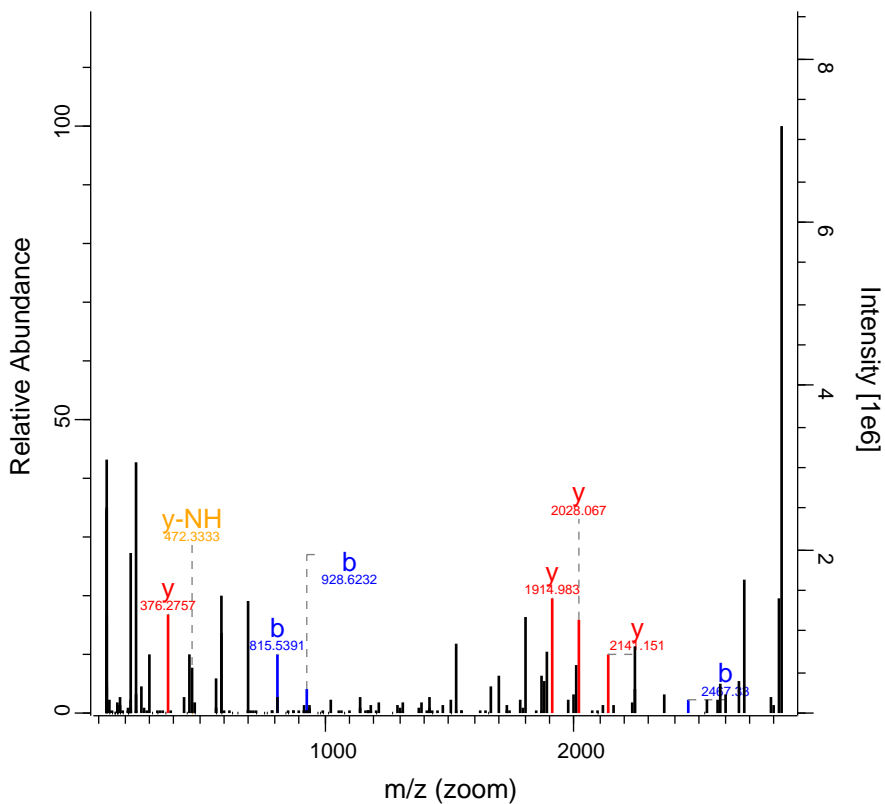

RO-QC-160121_ZackD_SS_Set_01_Fractic 26990 FTMS; HC 56.2 1116.63 CNGA2

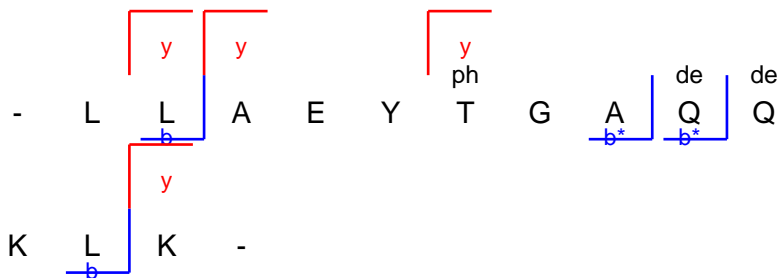
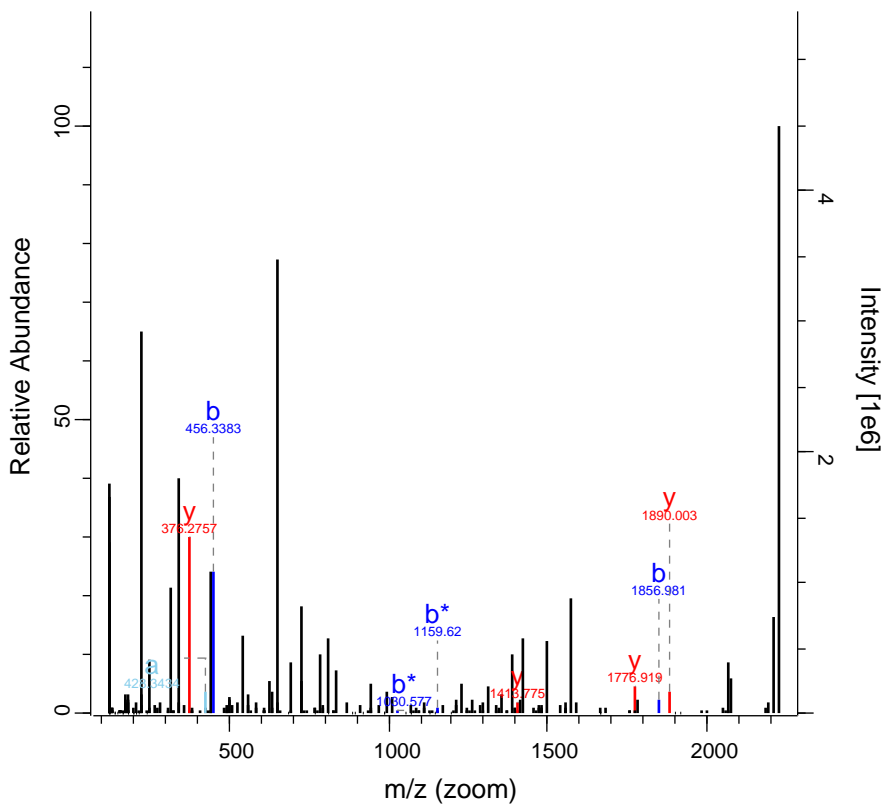

RO-QC-160121_ZackD_SS_Set_01_Fractic 27525 FTMS; HC 64.22 1283.22 CYB561D2

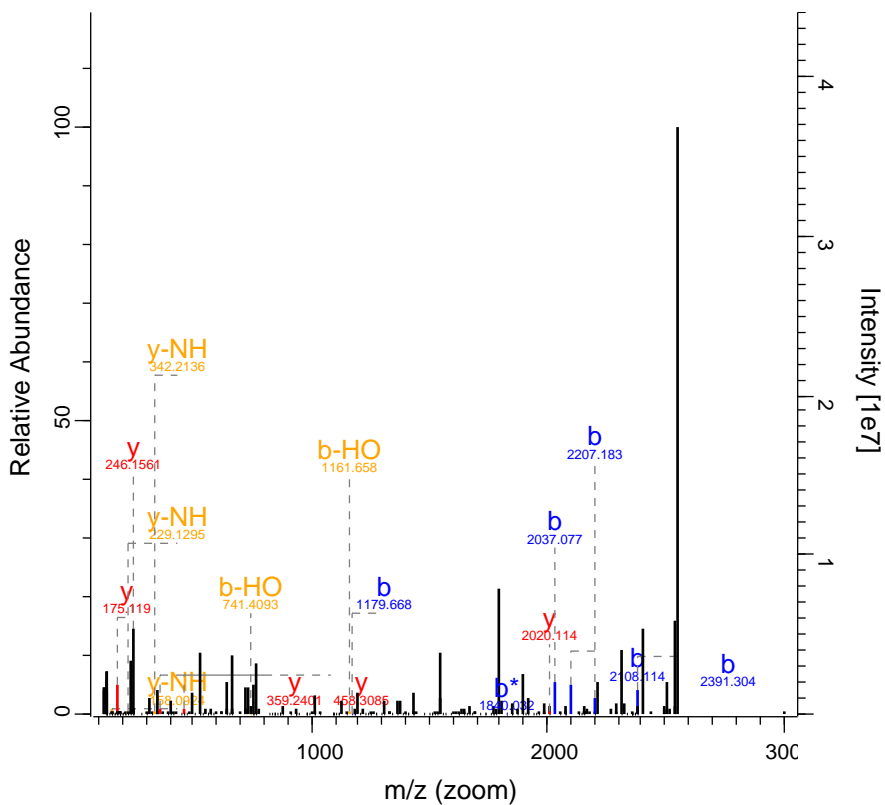

RO-QC-160121_ZackD_SS_Set_01_Fractic 29594 FTMS; HC 66.6 1210.63 ANK1

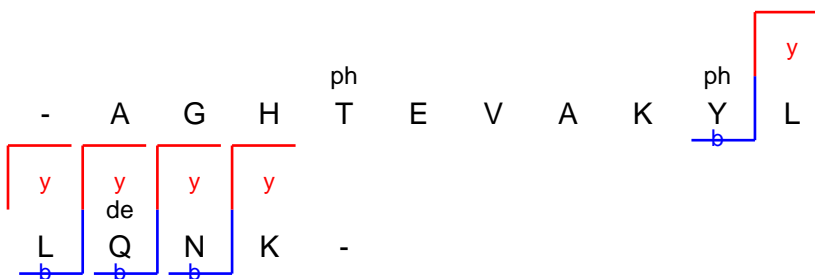
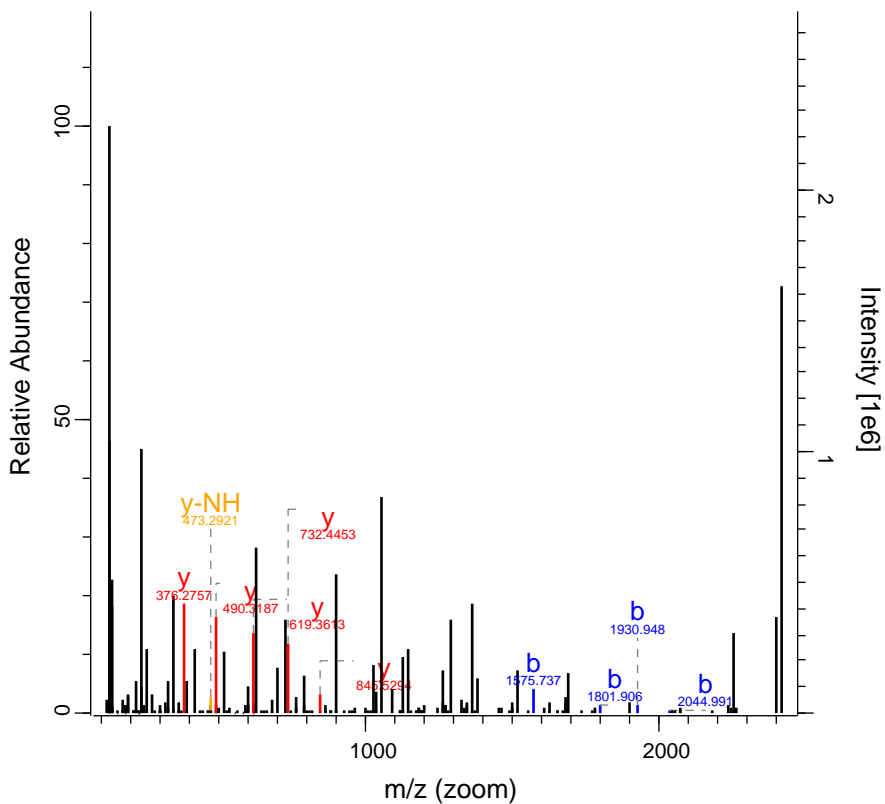

RO-QC-160121_ZackD_SS_Set_01_Fractic 29933 FTMS; HC 55.55 1048.47 C5orf42

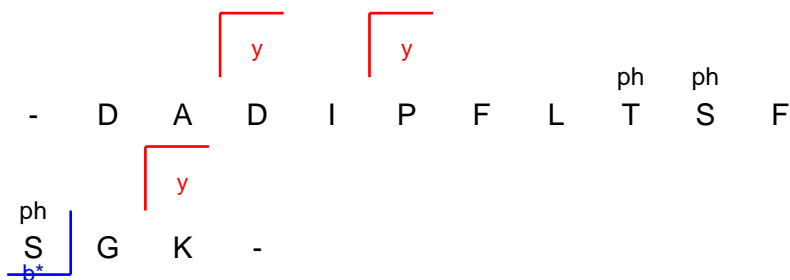
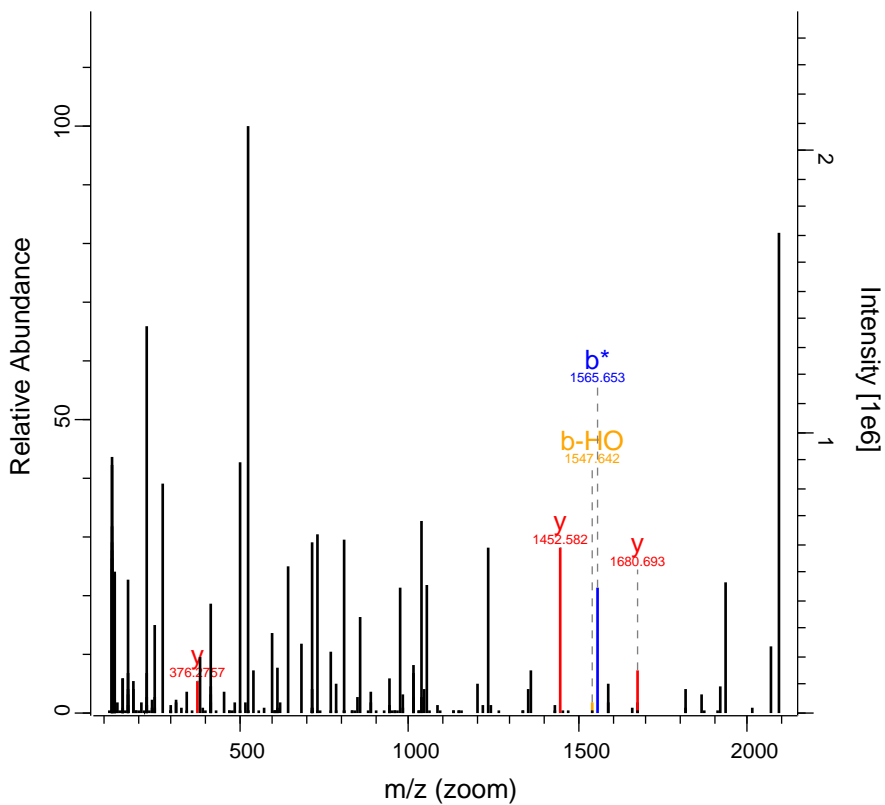

RO-QC-160121_ZackD_SS_Set_01_Fraction 30406 FTMS; HC 61.45 828.71 EIF4G1

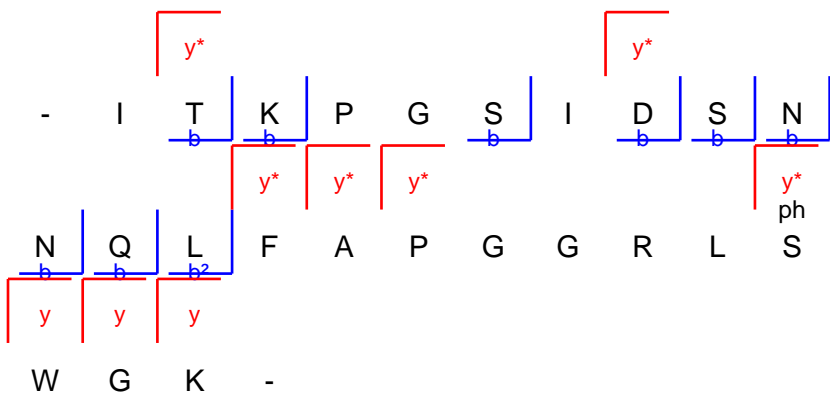
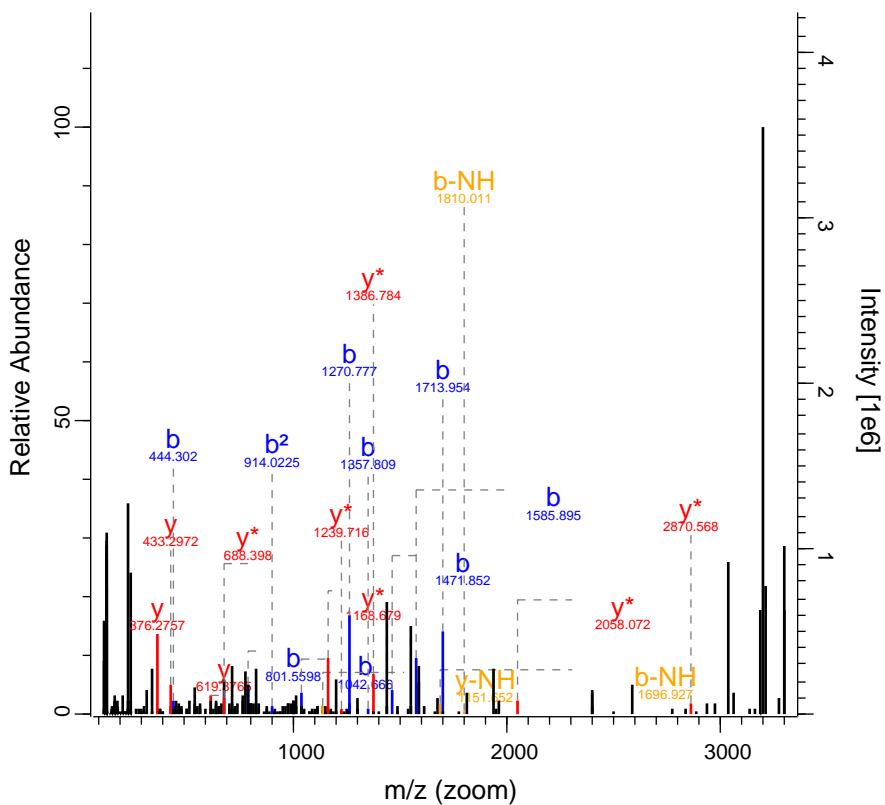

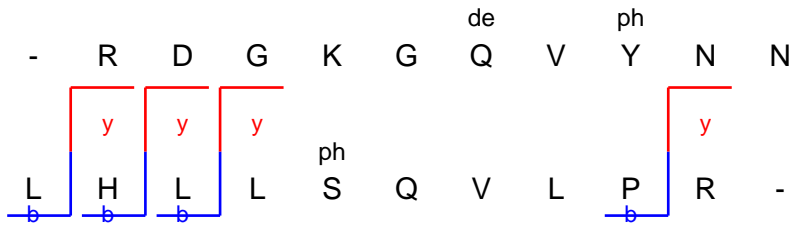
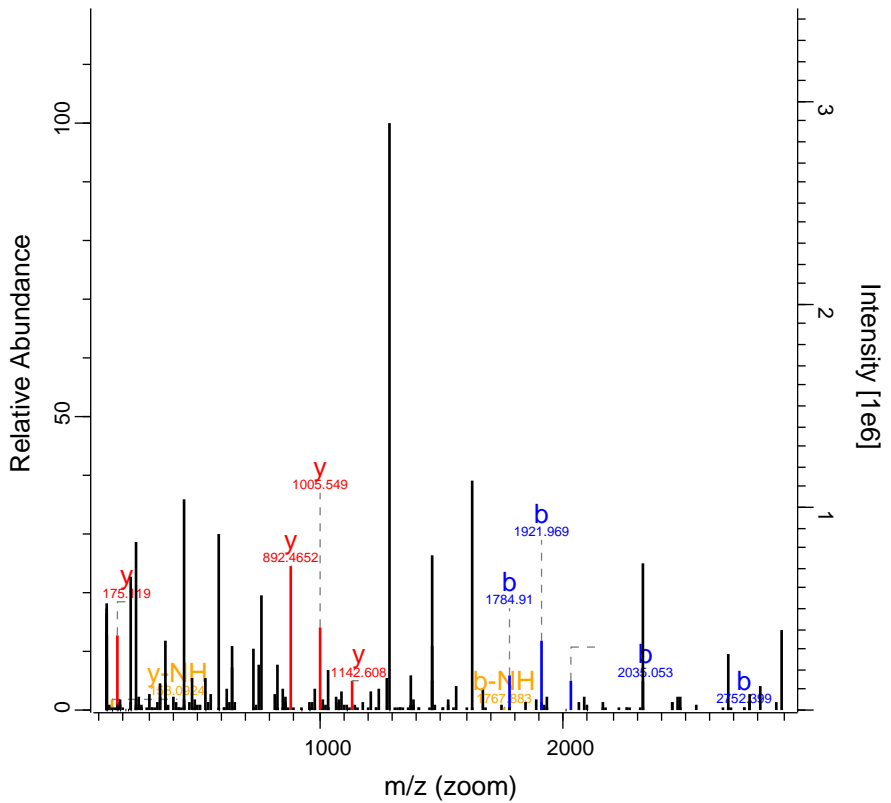

RO-QC-160121_ZackD_SS_Set_01_Fractic 33217 FTMS; HC 91.94 1315.12 ZNF540

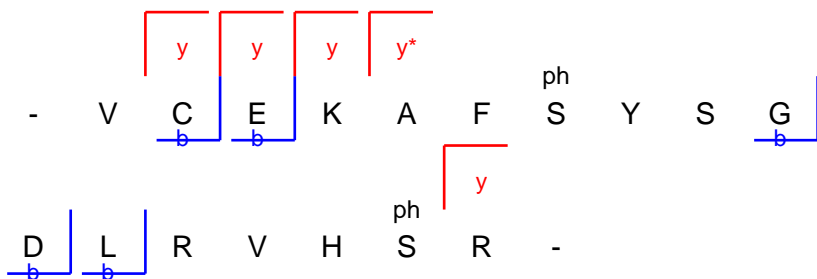
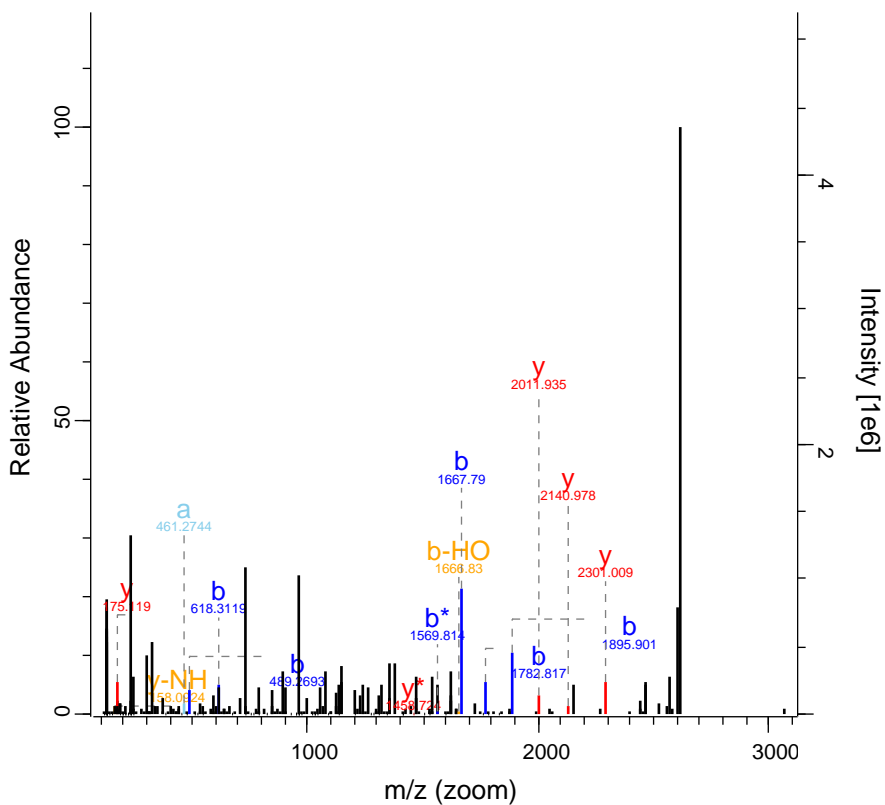

RO-QC-160121_ZackD_SS_Set_01_Fractic 33469 FTMS; HC 57.35 1225.08 ULK3

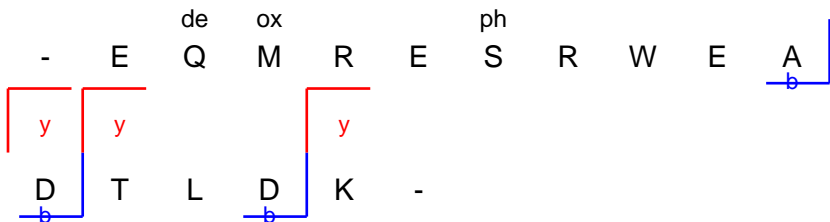
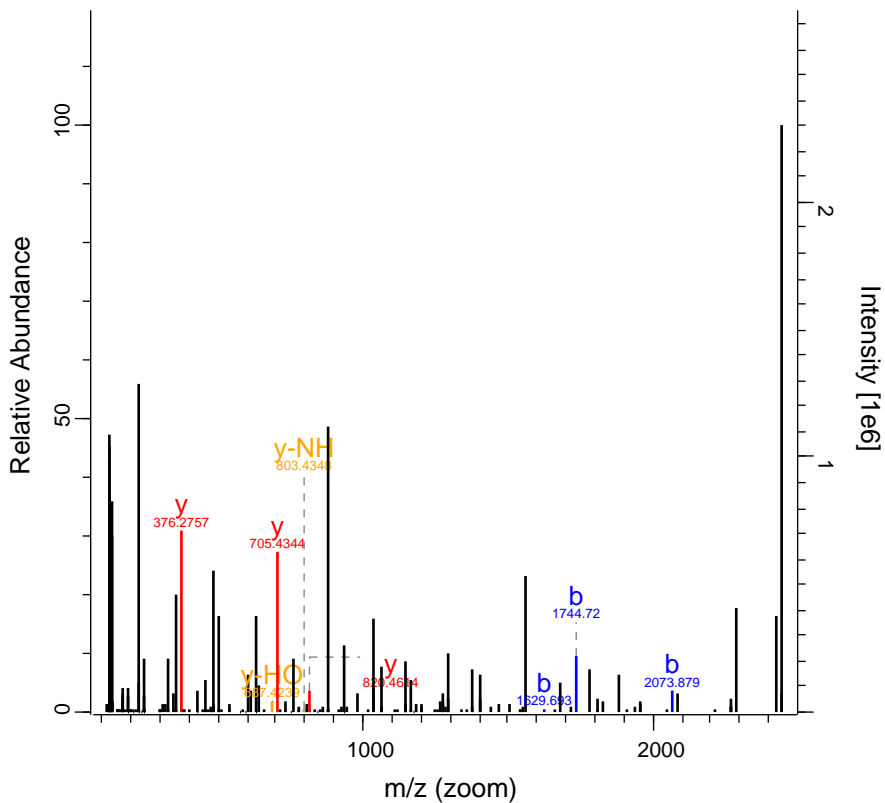

RO-QC-160121_ZackD_SS_Set_01_Fraction 33632 FTMS; HC 61.38 586.08 BCLAF1

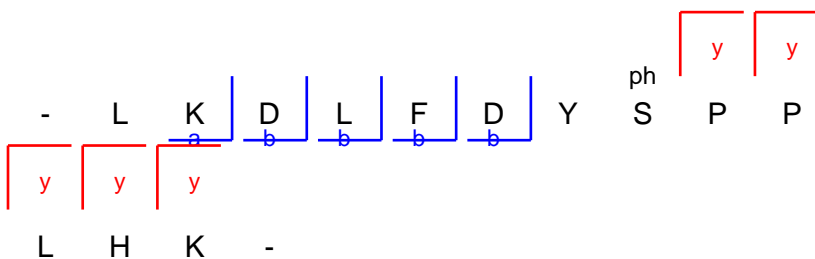
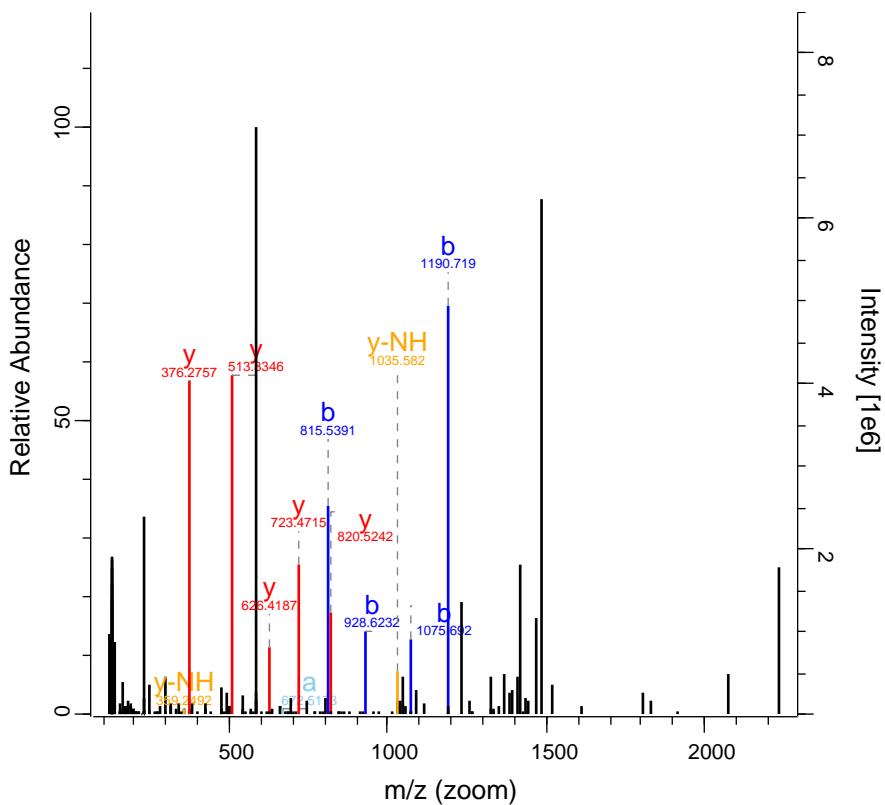

RO-QC-160121_ZackD_SS_Set_01_Fraction 35300 FTMS; HCl 123.67 538.3 SKIV2L

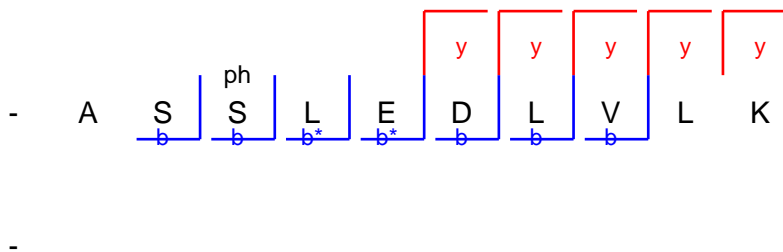
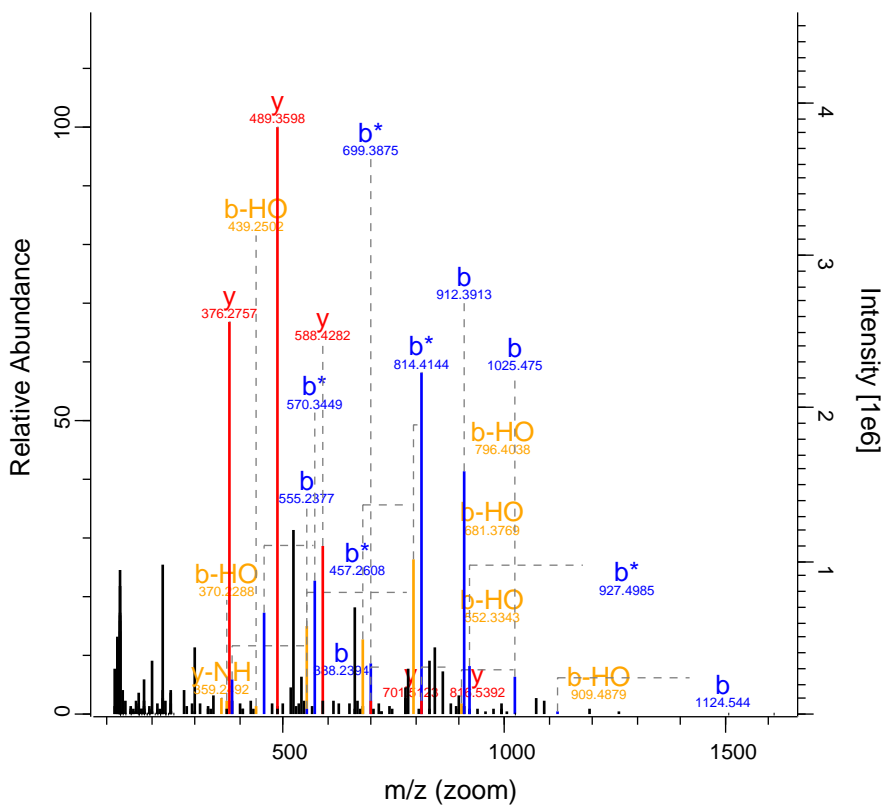

RO-QC-160121_ZackD_SS_Set_01_Fraction 37051 FTMS; HC 52.25 808.15 AKT3

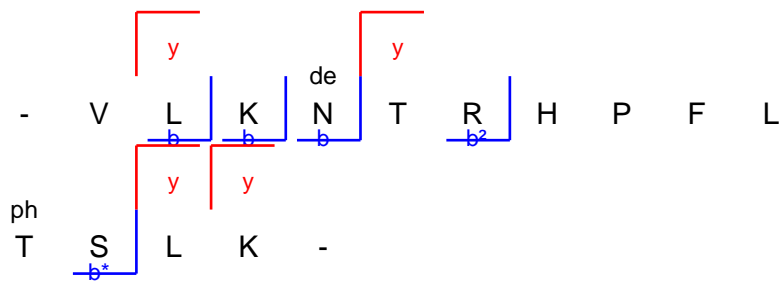
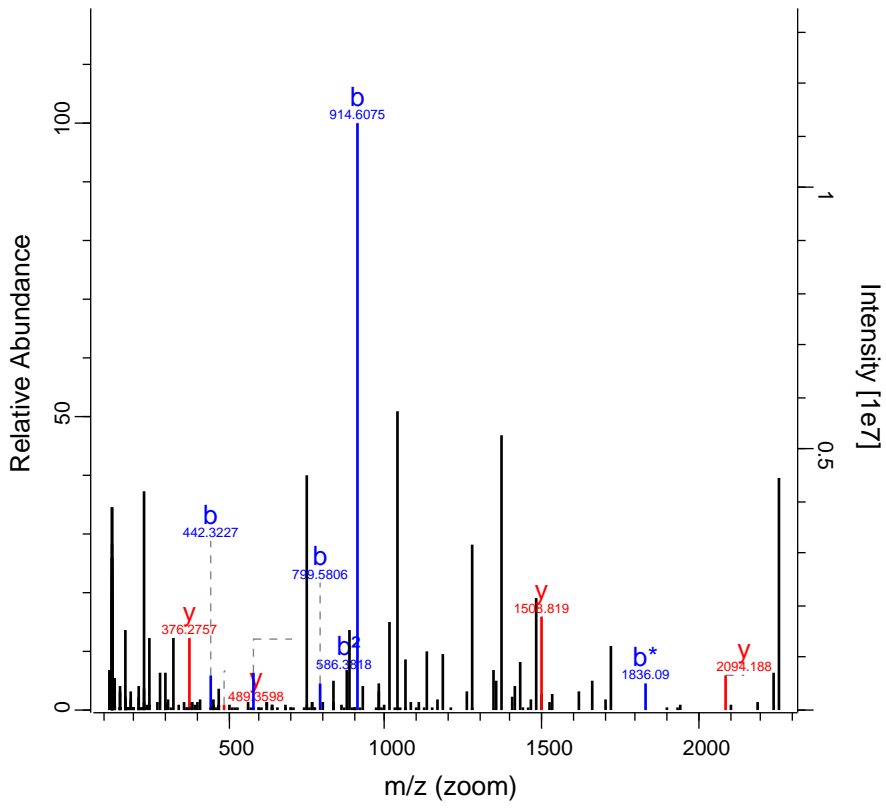

RO-QC-160121_ZackD_SS_Set_01_Fractic 37661 FTMS; HC 50.8 1070.04 REPIN1

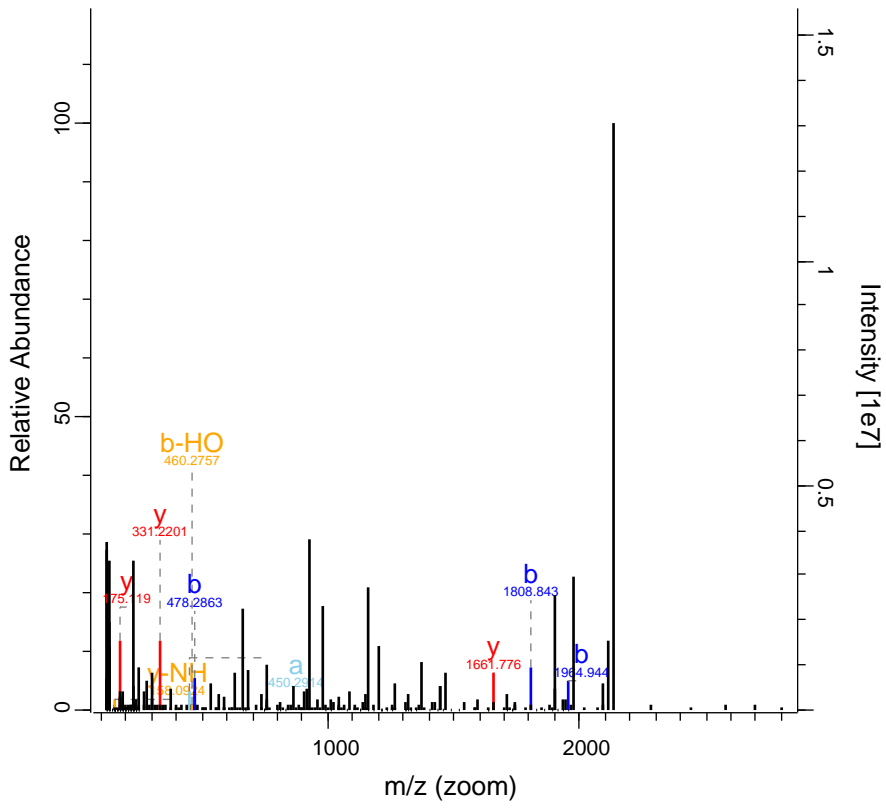

RO-QC-160121_ZackD_SS_Set_01_Fractic 39487 FTMS; HC 44.82 1107.23 FANCI

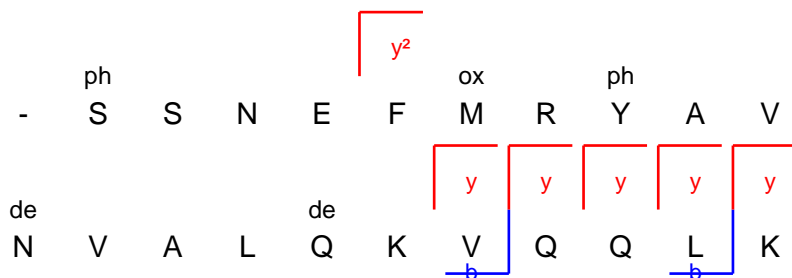
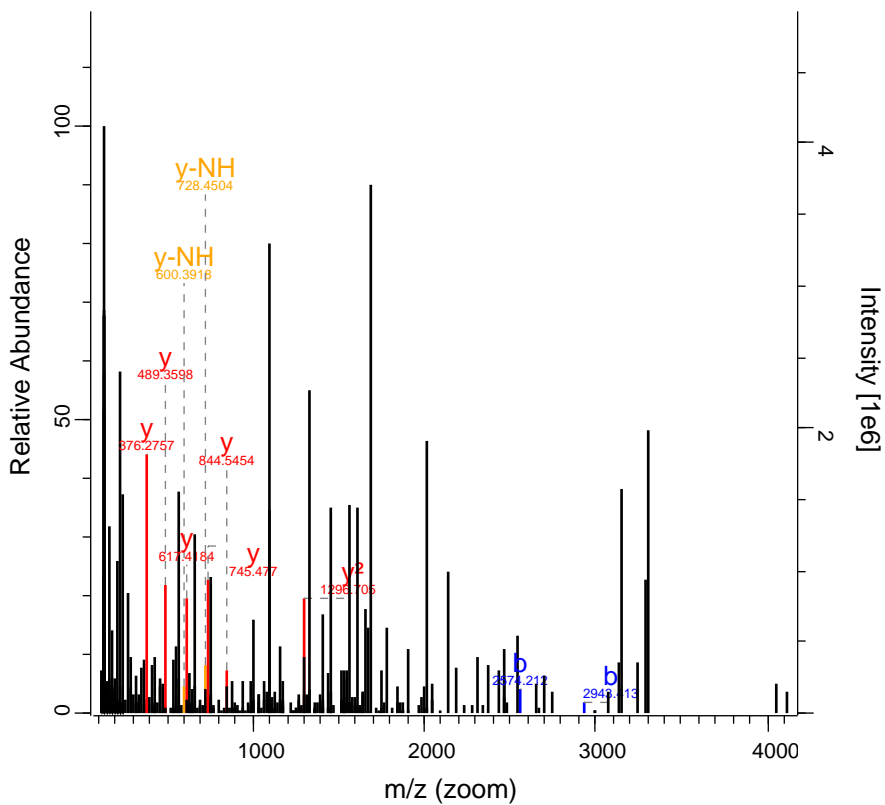

RO-QC-160121_ZackD_SS_Set_01_Fraction 40420 FTMS; HCl 70.92 917 ITGA9

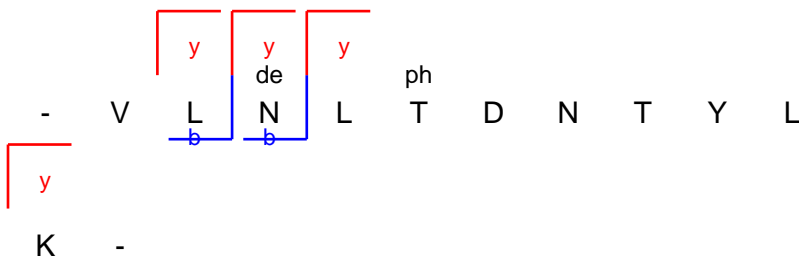
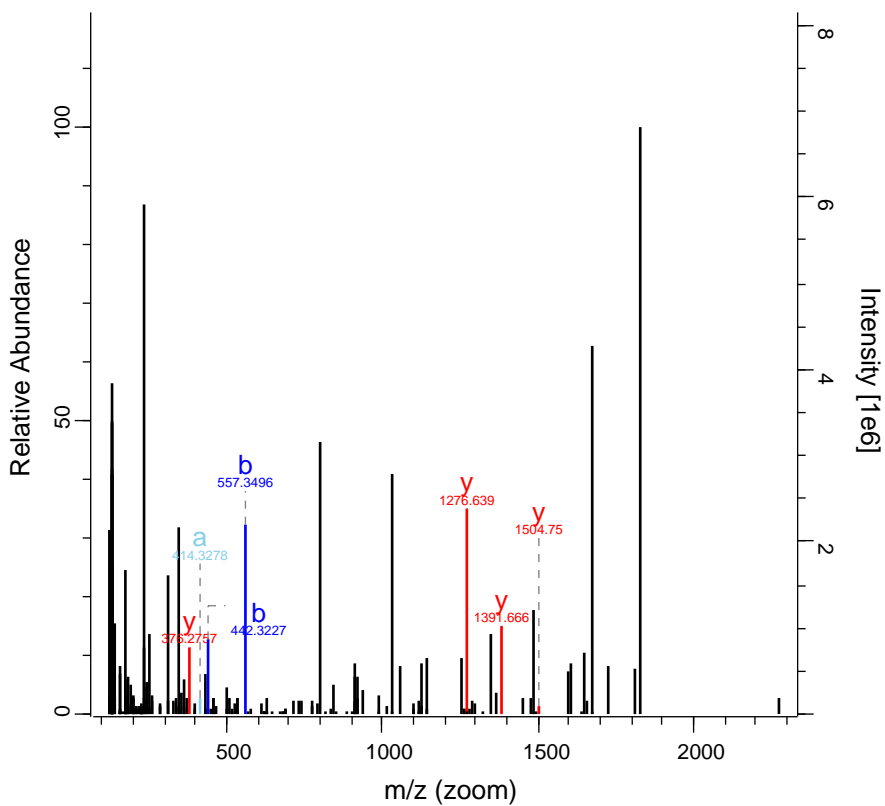

RO-QC-160121_ZackD_SS_Set_01_Fraction 5192 FTMS; HCl 98.94 427.99 PRPF38B

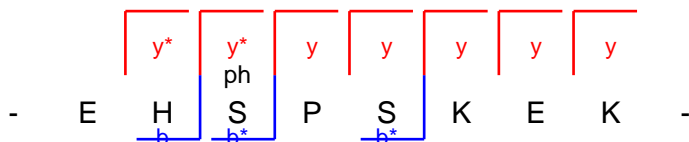
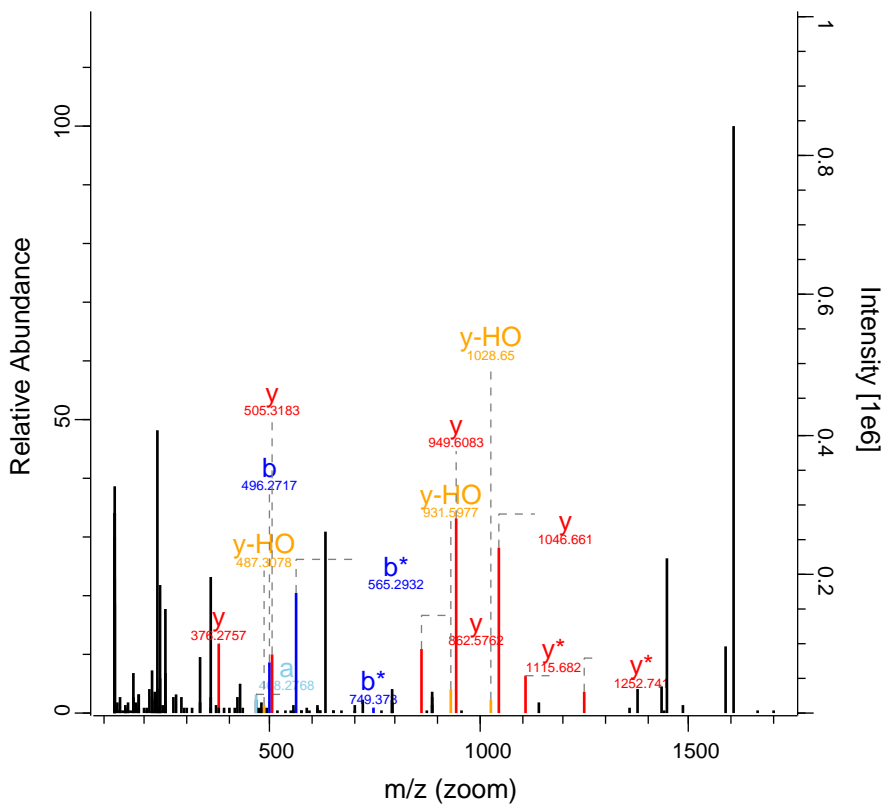

RO-QC-160121_ZackD_SS_Set_01_Fraction 6439 FTMS; HCl 43.54 585.81 ASCC1

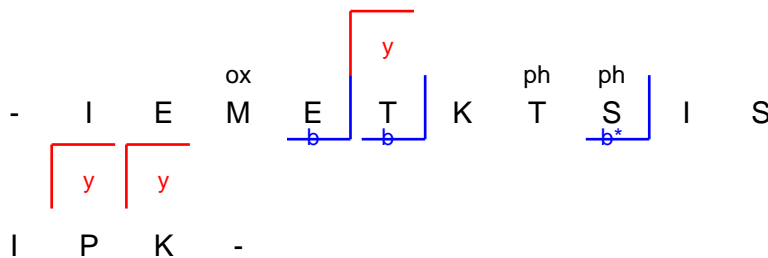
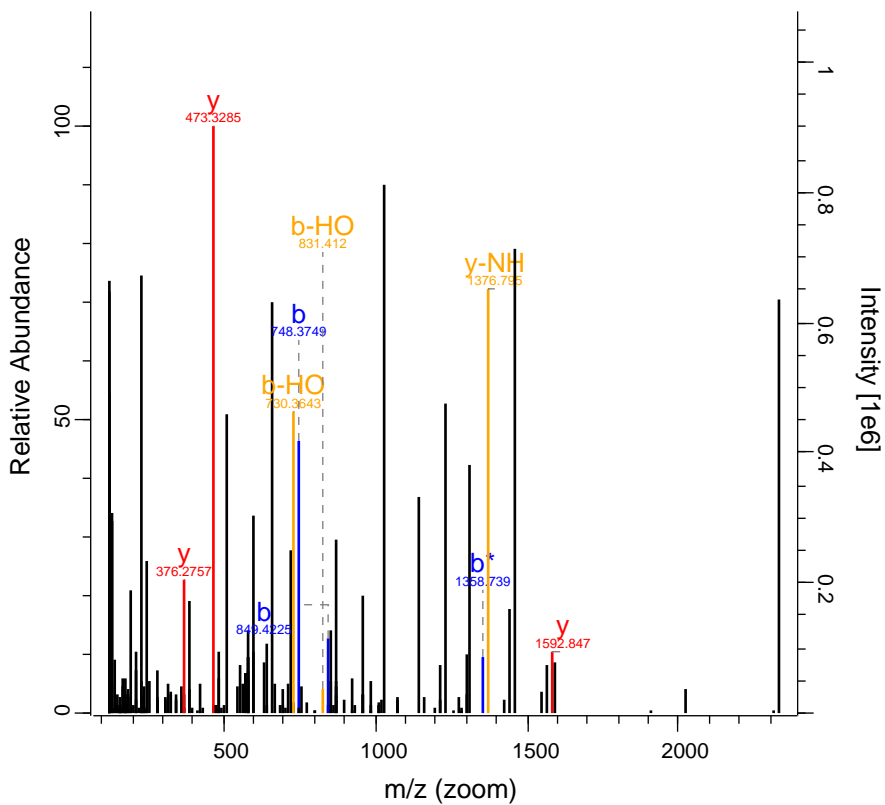

RO-QC-160121_ZackD_SS_Set_01_Fraction 8210 FTMS; HCl 56.26 920.99 FES

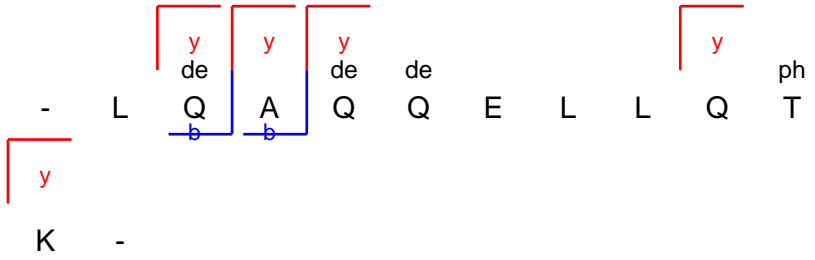
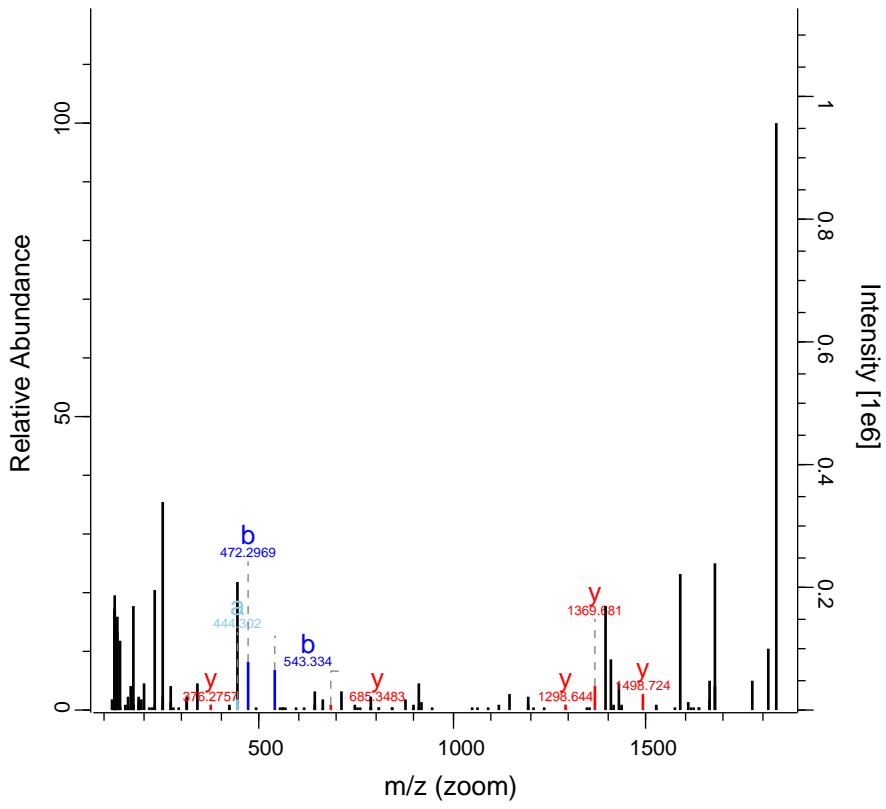

RO-QC-160121_ZackD_SS_Set_01_Fraction 9356 FTMS; HC 162.38 807.94 ZYX

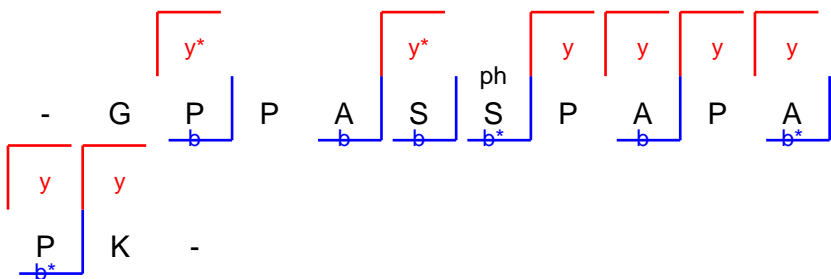
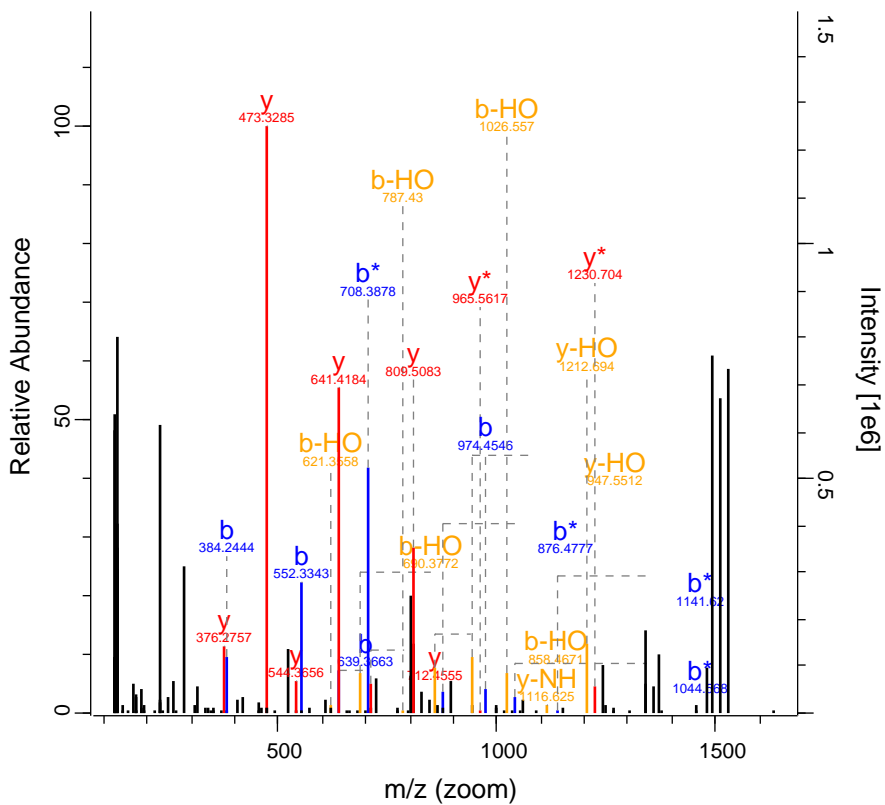

RO-QC-160121_ZackD_SS_Set_01_Fraction 10624 FTMS; HC 66.87 755.73 MYO9B

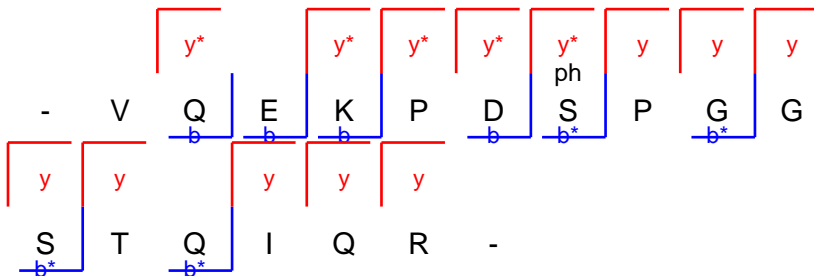
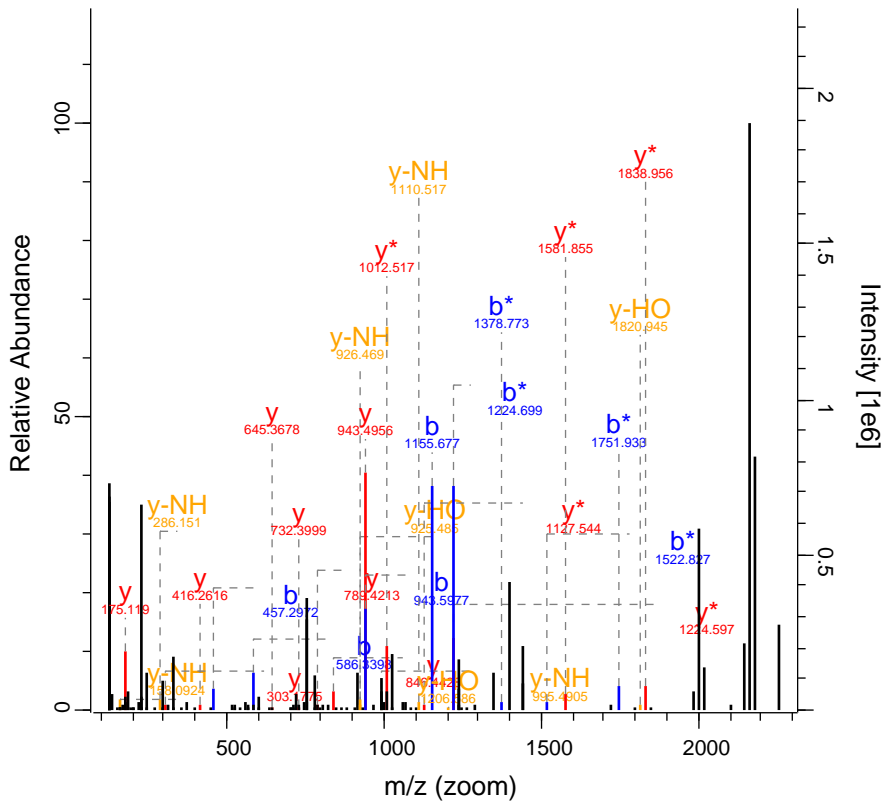

RO-QC-160121_ZackD_SS_Set_01_Fractio 10654 FTMS; HC 115.57 739.38 AFAP1

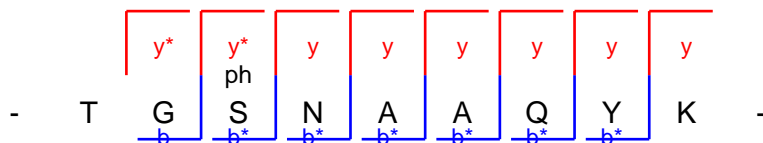
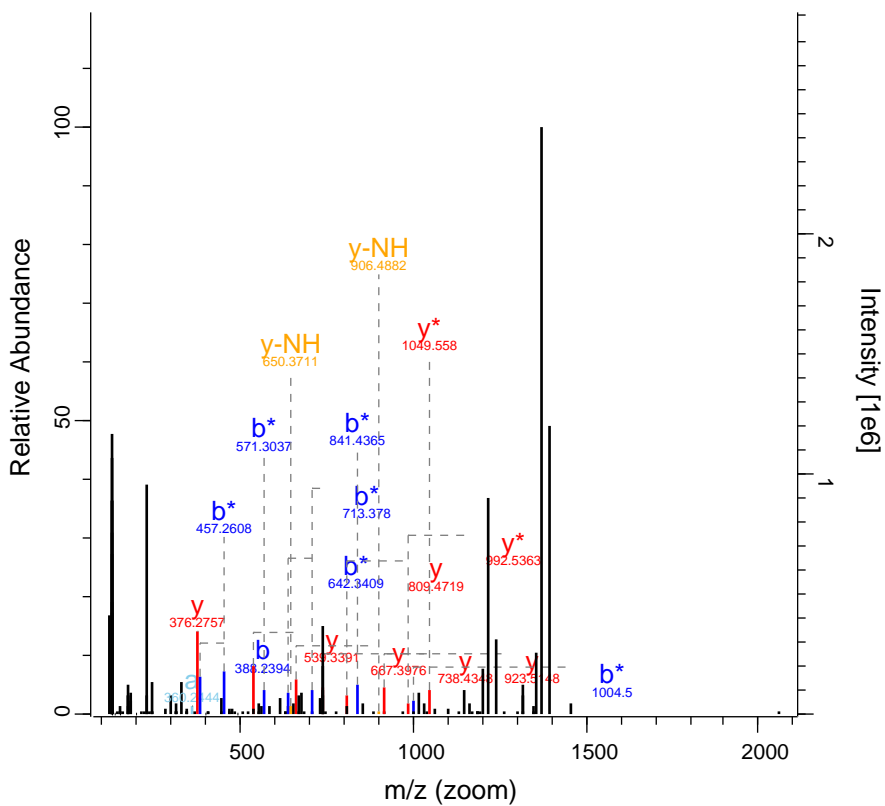

RO-QC-160121_ZackD_SS_Set_01_Fractio 11140 FTMS; HC 109.84 732.41 HNRNPA1

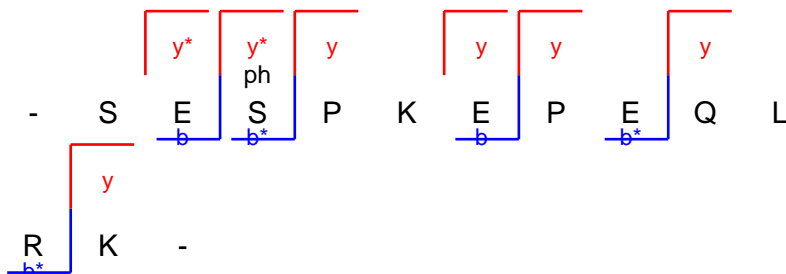
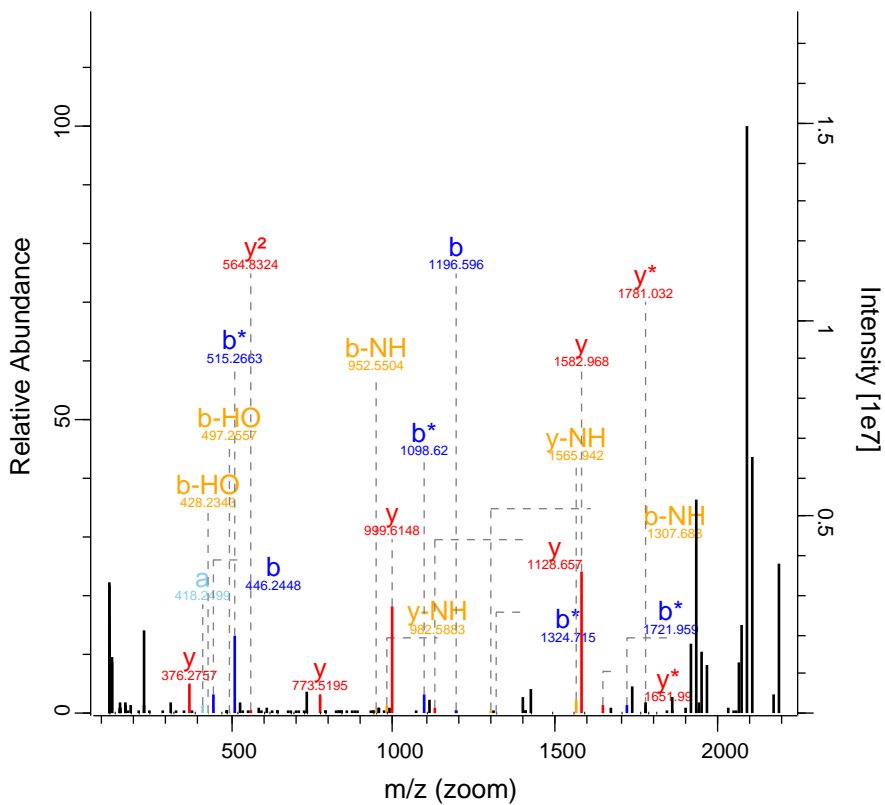

RO-QC-160121_ZackD_SS_Set_01_Fractio 13132 FTMS; HC 103.34 814.42 LIMA1

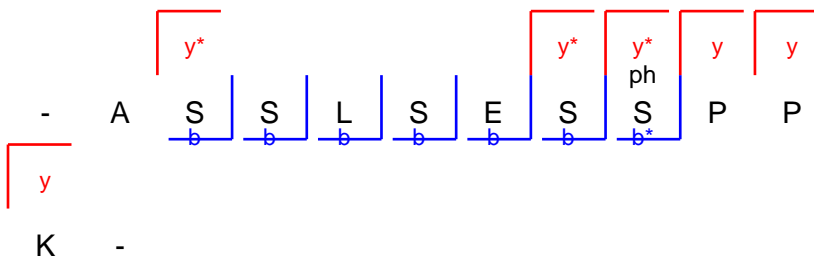
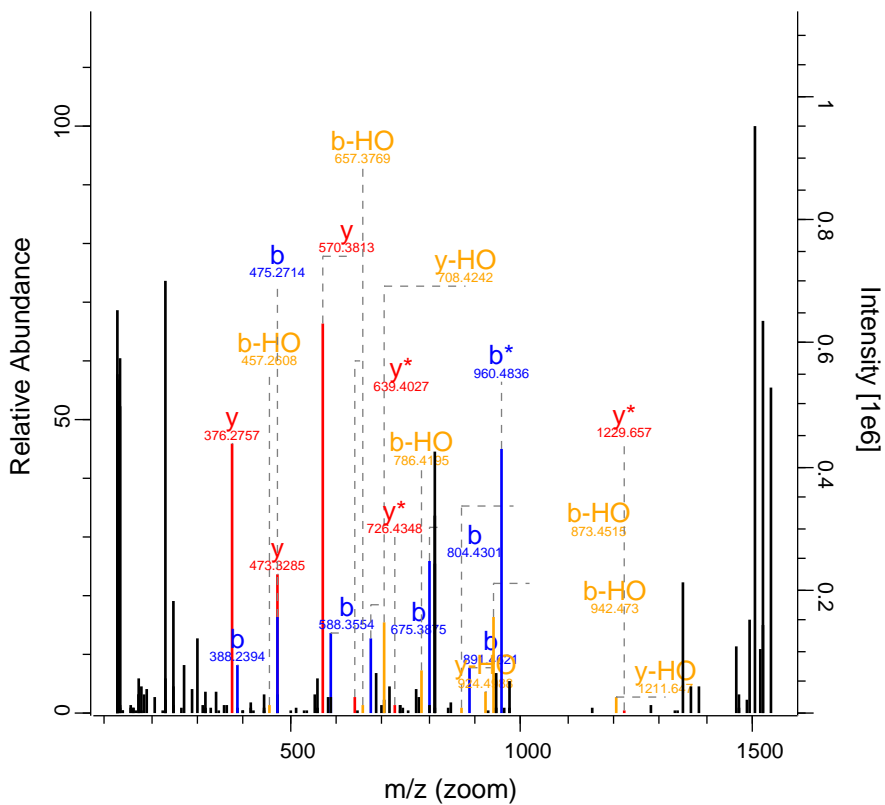

RO-QC-160121_ZackD_SS_Set_01_Fraction 13915 FTMS; HCl; 51.01 943.4 PDCD5

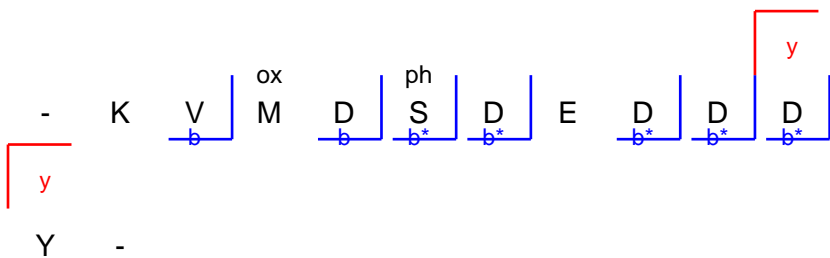
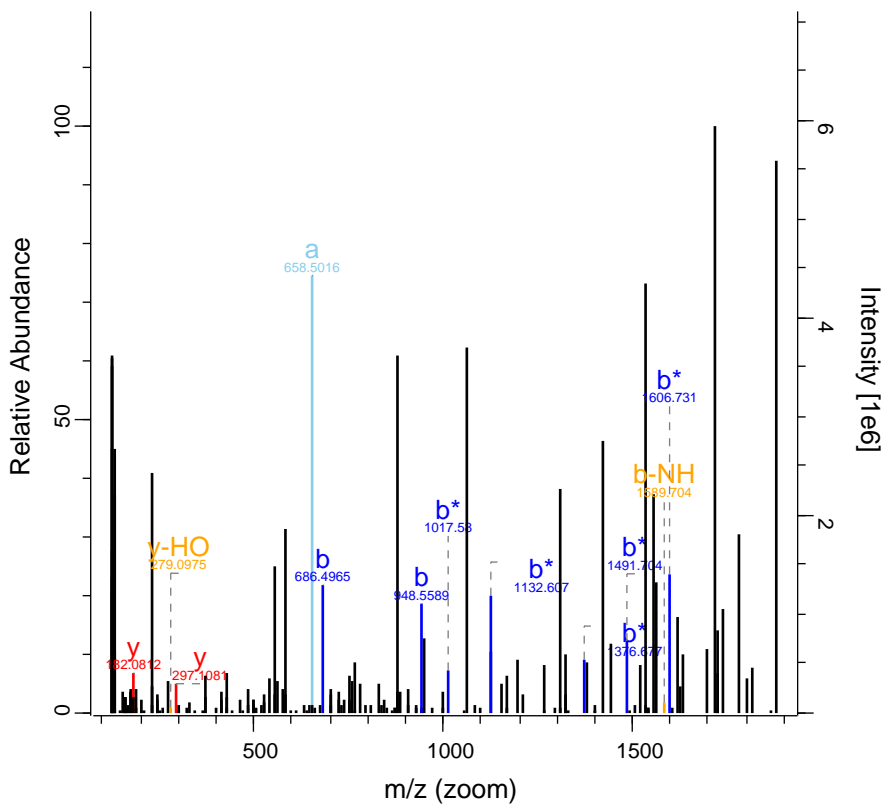

RO-QC-160121_ZackD_SS_Set_01_Fraction 14339 FTMS; HC 74.65 484.04 RASSF8

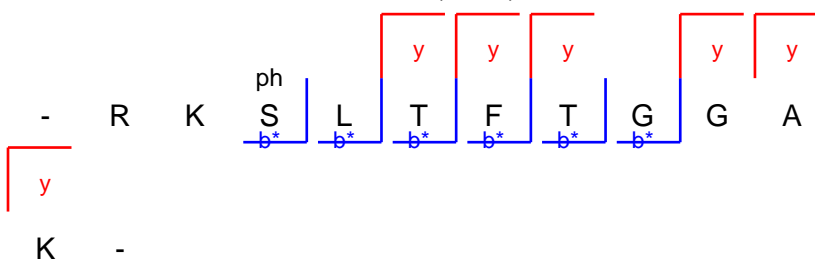
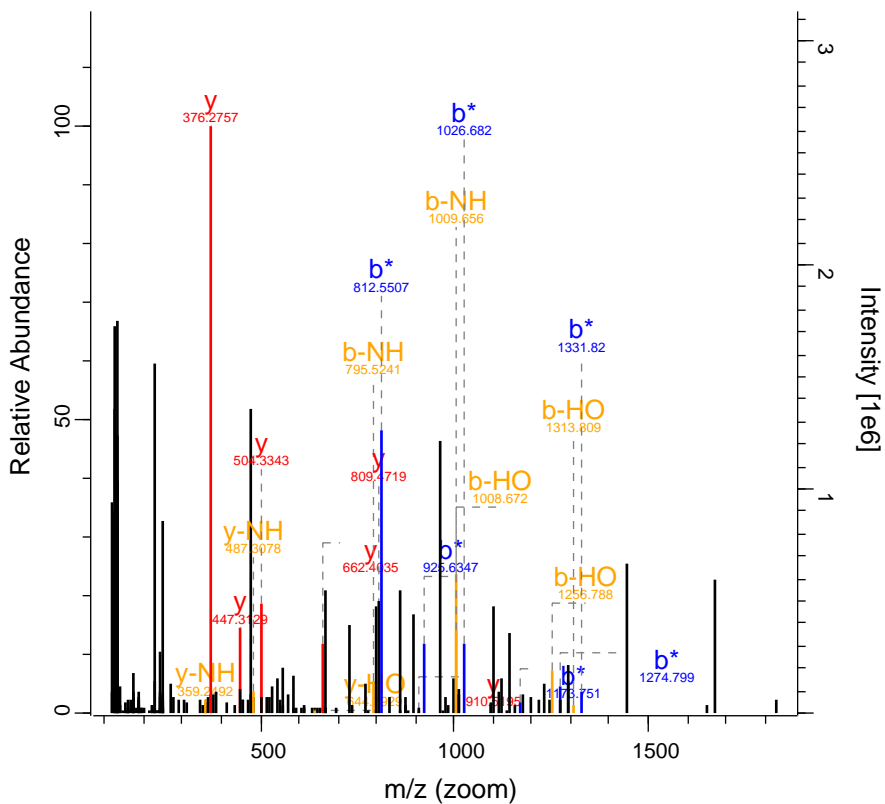

RO-QC-160121_ZackD_SS_Set_01_Fraction16392 FTMS; HC 61.22 813.08 MYRIP

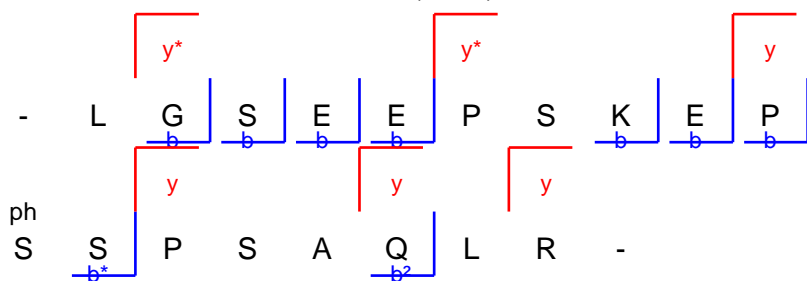
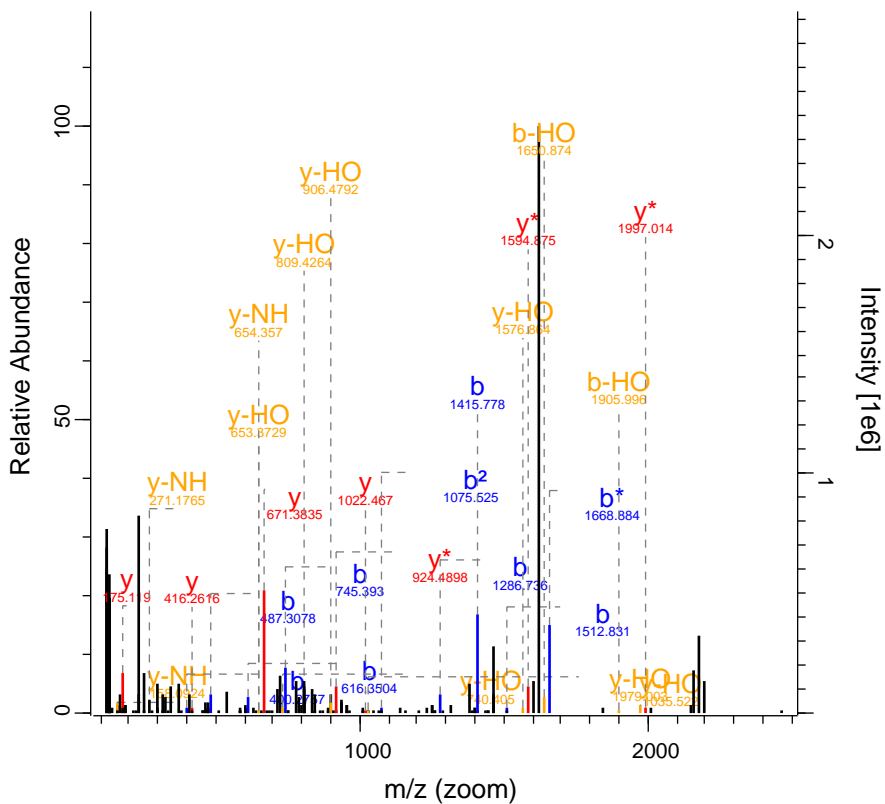

RO-QC-160121_ZackD_SS_Set_01_Fraction 17179 FTMS; HC 44.09 670.74 HNRNPF

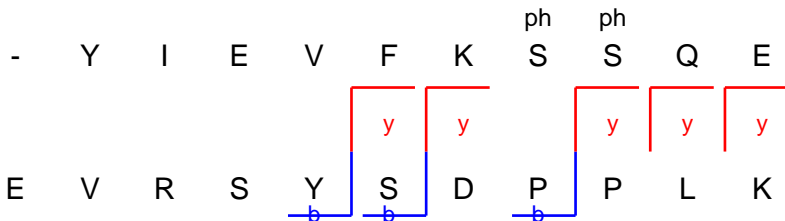
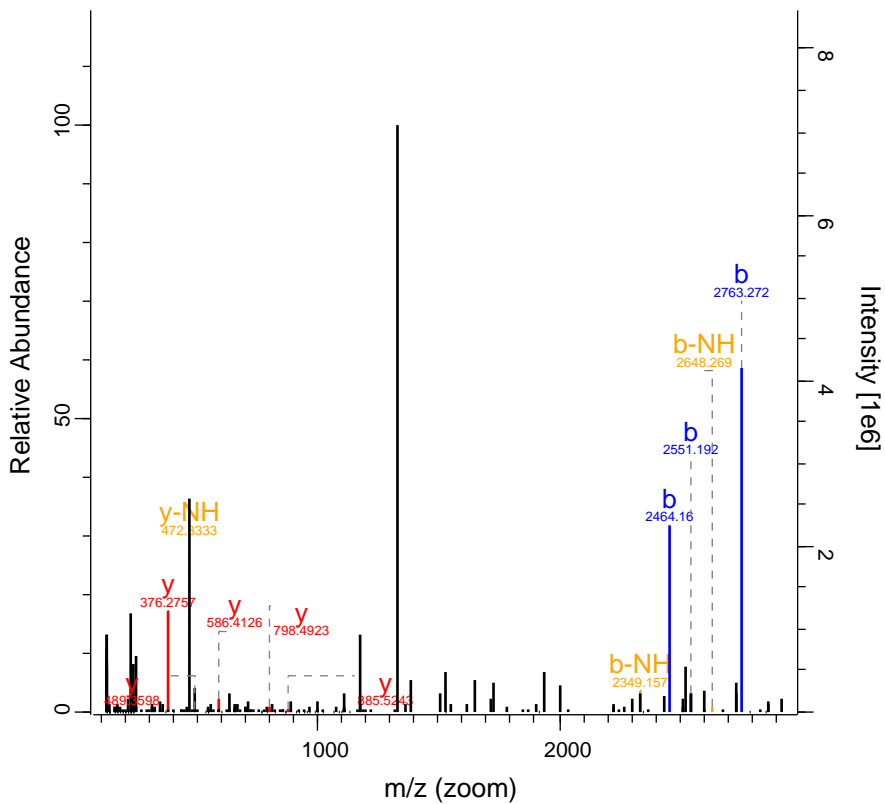

RO-QC-160121_ZackD_SS_Set_01_Fraccio 17270 FTMS; HC 120.14 824.96 PLEC

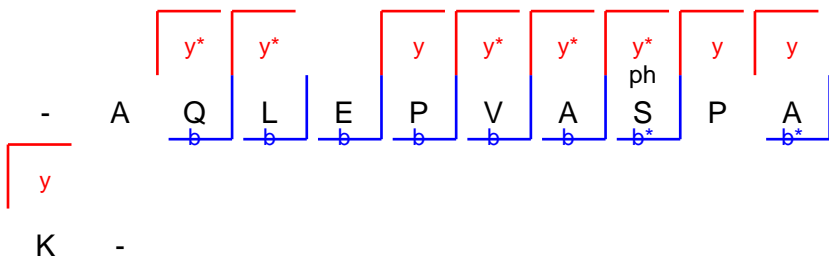
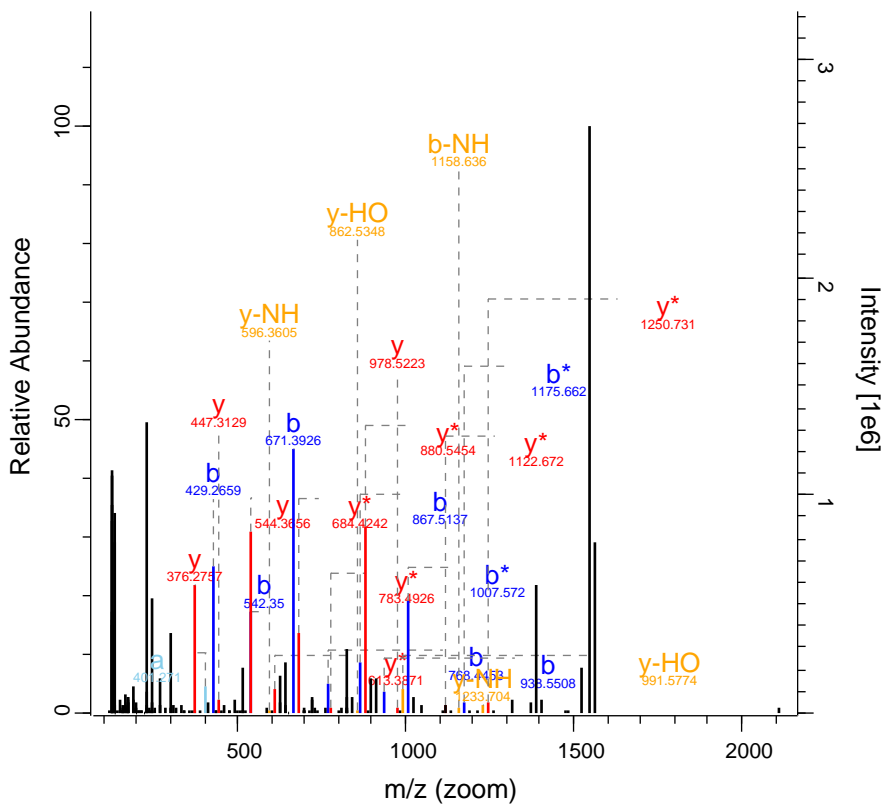

RO-QC-160121_ZackD_SS_Set_01_Fraction 18714 FTMS; HC 40.28 783.42 CTNND2

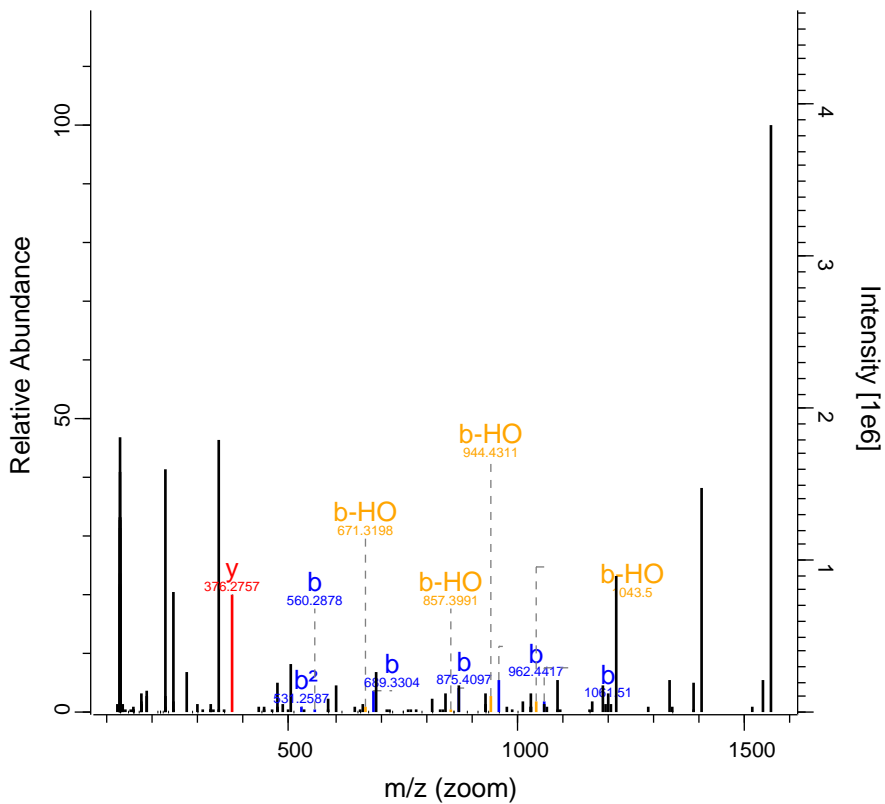

- S Q D Q W S V Y I R

de

ph

- A A V R K -

Fragmentation diagram showing peptide sequence: - S Q D Q W S V Y I R. The diagram illustrates the formation of b and y ions from the sequence. Blue lines indicate b-ion formation (D, Q, W, S, V) and red lines indicate y-ion formation (D, Q). The y-ion is labeled 'y' in red. The de and ph modifications are indicated above the Q and Y residues, respectively.

RO-QC-160121_ZackD_SS_Set_01_Fraction 19153 FTMS; HC 40

890.94 EIF4G2

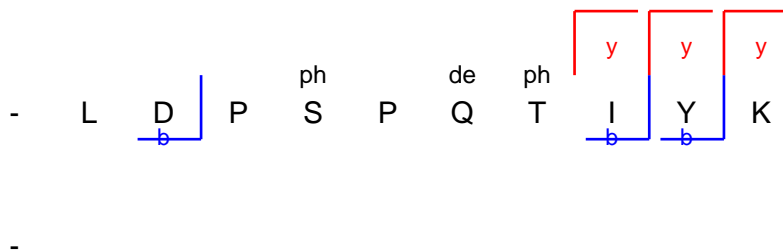
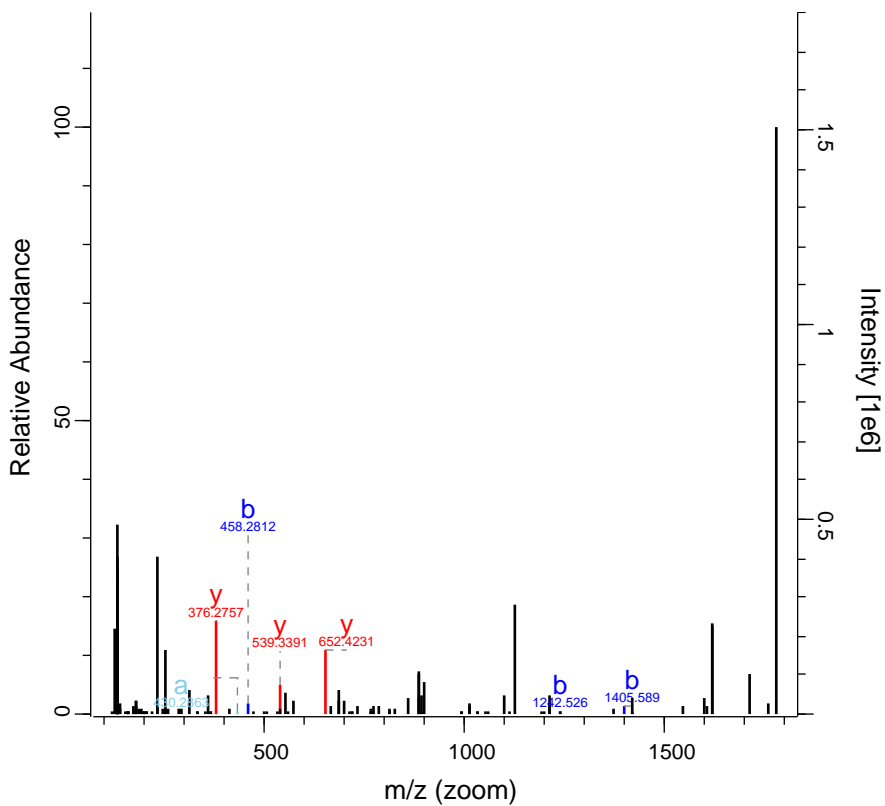

RO-QC-160121_ZackD_SS_Set_01_Fractio 19563 FTMS; HC 148.85 1061.1 SRRM1

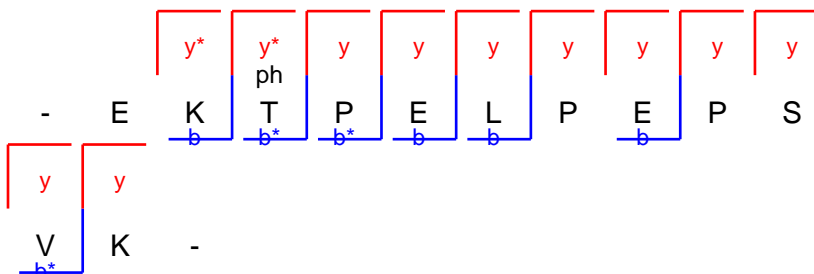
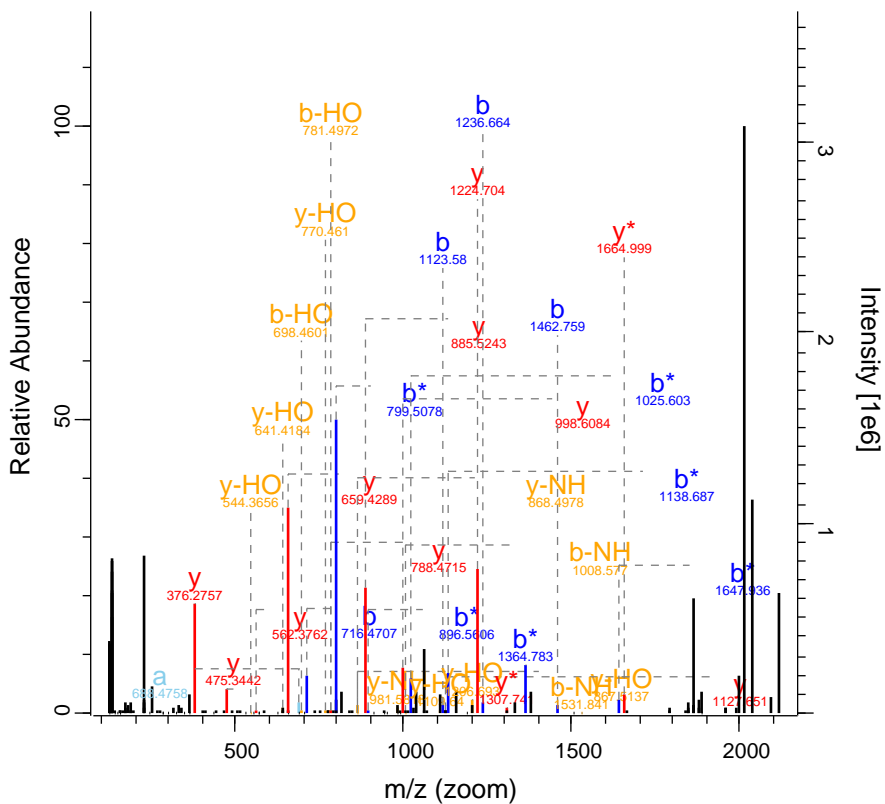

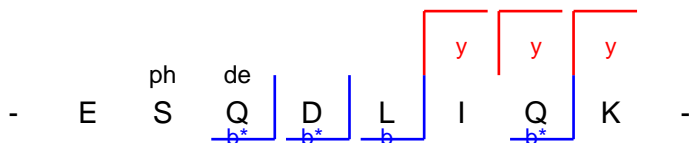
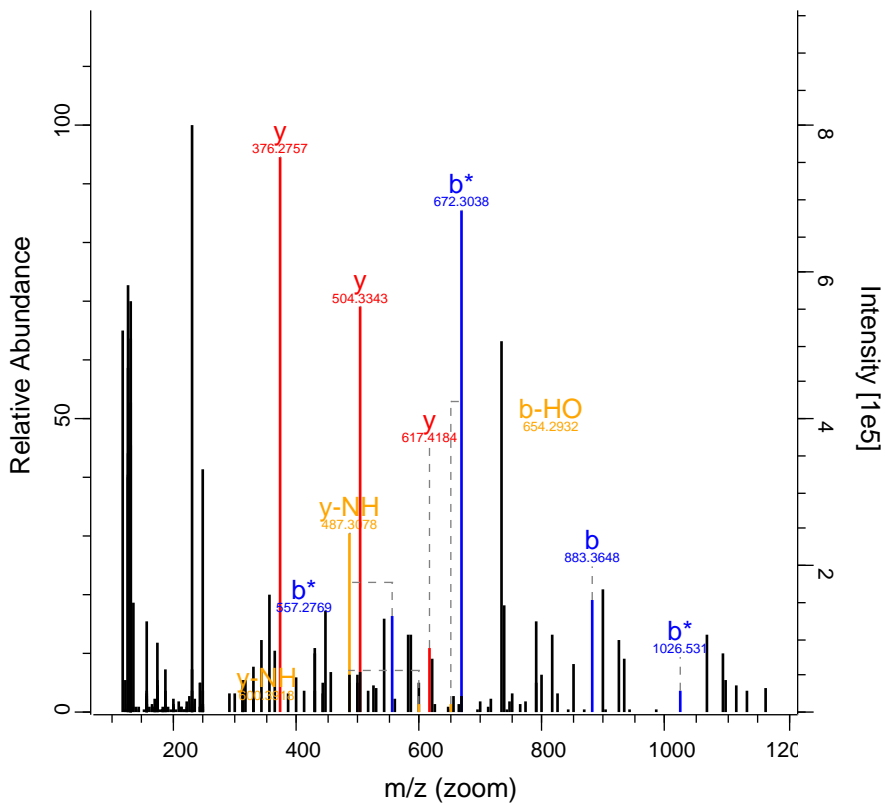

RO-QC-160121_ZackD_SS_Set_01_Fraction 20466 FTMS; HC 42.81 717.36 VPS13B

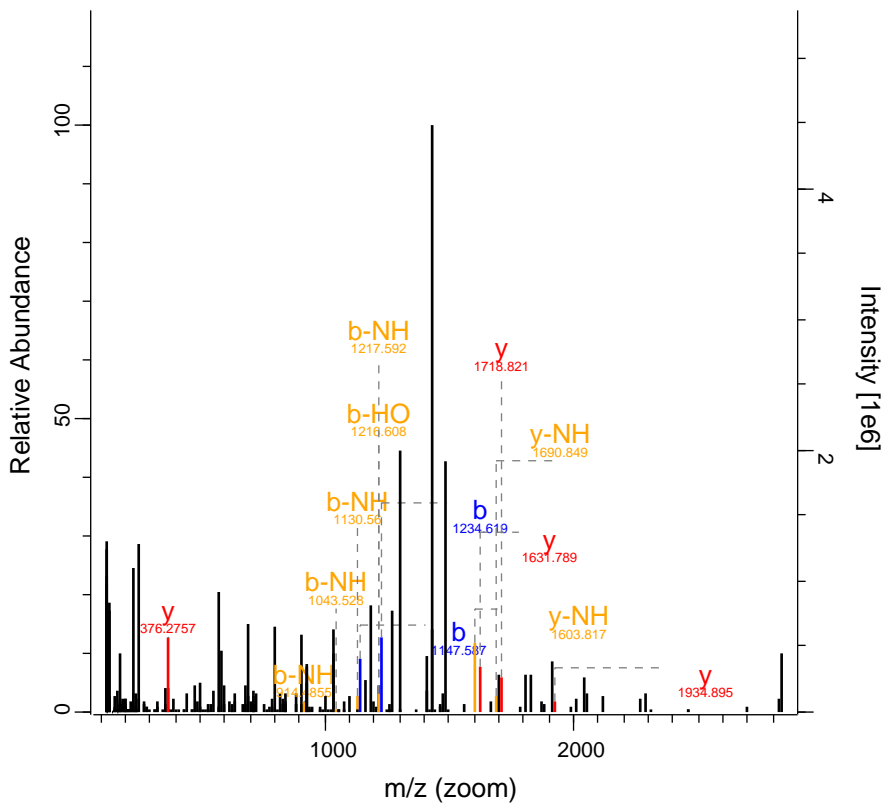

-	L	T	E	M	Q	V	E	S	S	ph	Y
	ph		de			y		b	b		
Y	S	P	Q	K	V	K	-				

RO-QC-160121_ZackD_SS_Set_01_Fractic 22804 FTMS; HC 52.93 1046.56 ZFH33

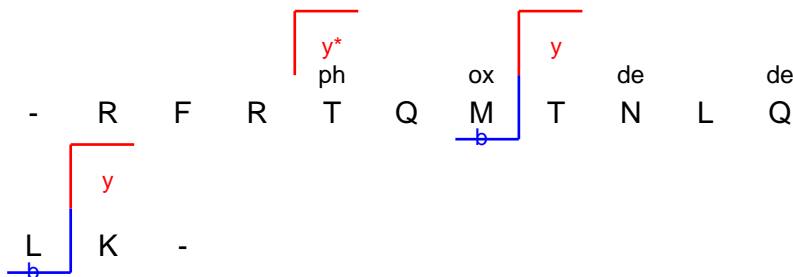
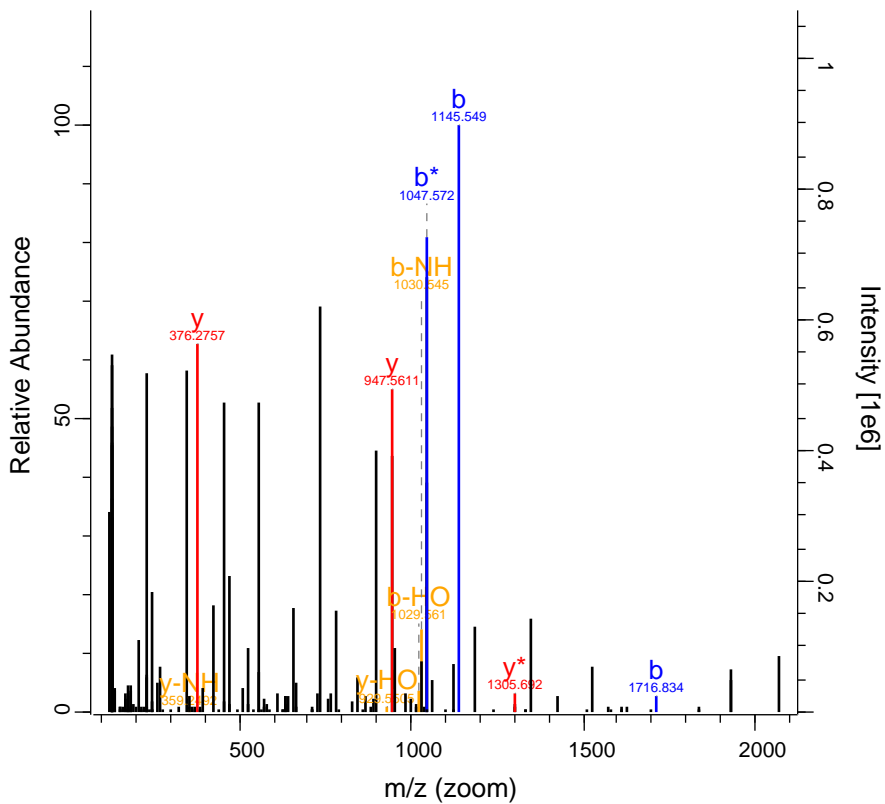

RO-QC-160121_ZackD_SS_Set_01_Fractic 23306 FTMS; HC 54.78 1219.65 CELA2A

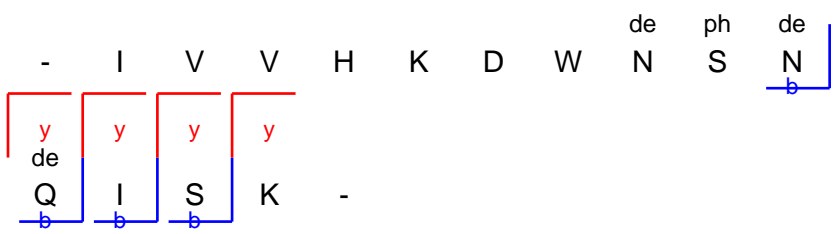
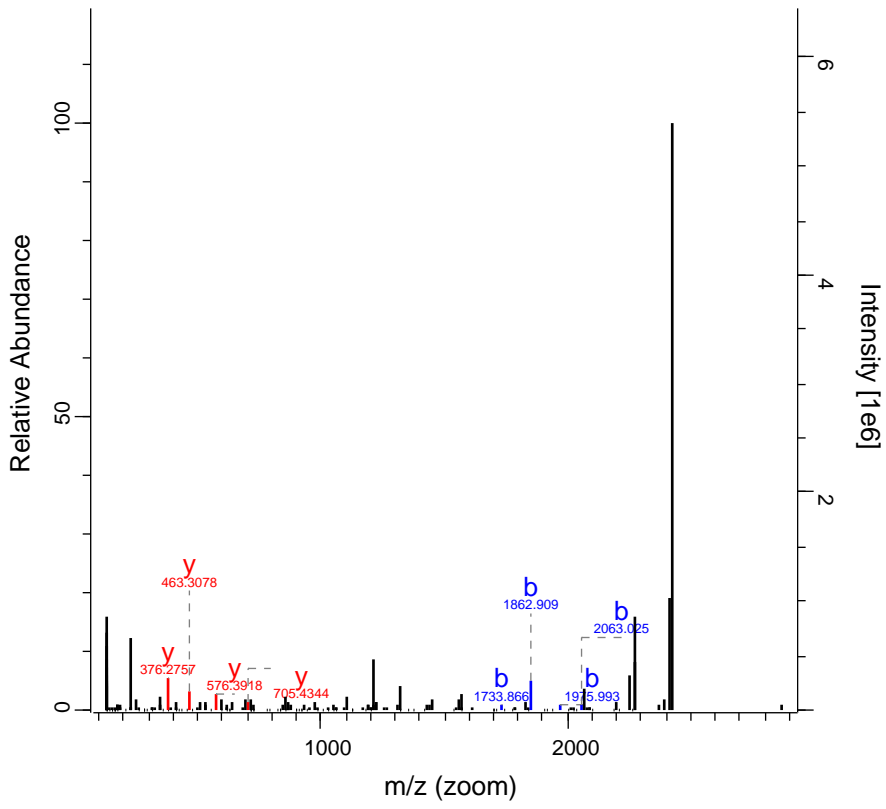

RO-QC-160121_ZackD_SS_Set_01_Fraction 24120 FTMS; HCl40.8 528.9 MYH15

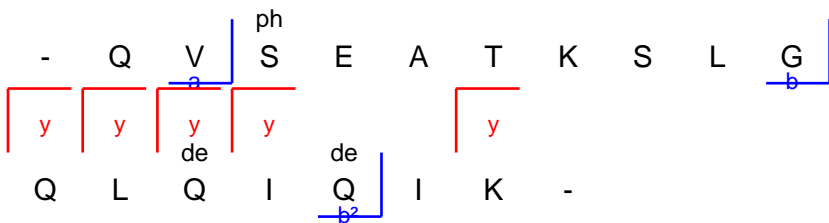
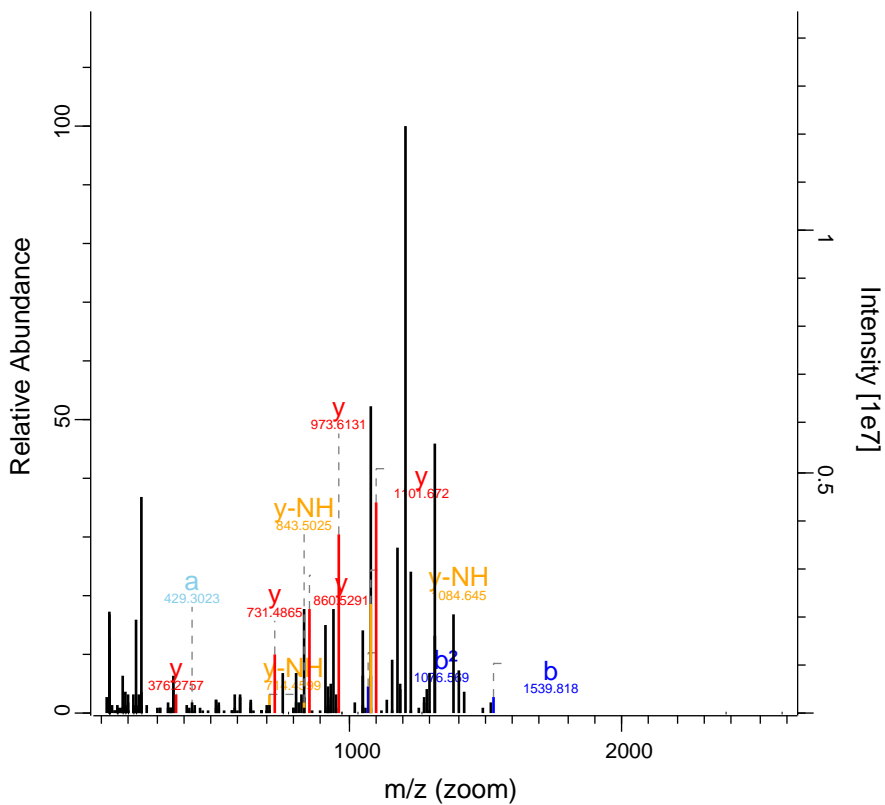

RO-QC-160121_ZackD_SS_Set_01_Fractic 27234 FTMS; HC 46.61 1237.69 LRRC66

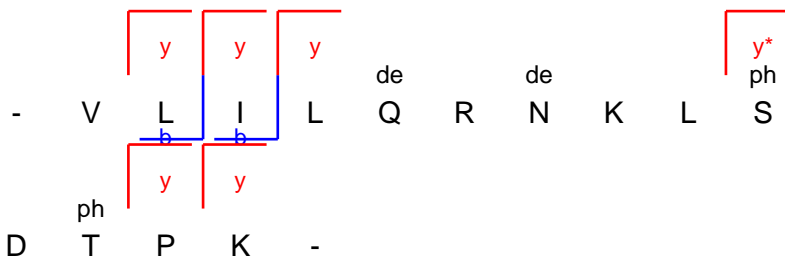
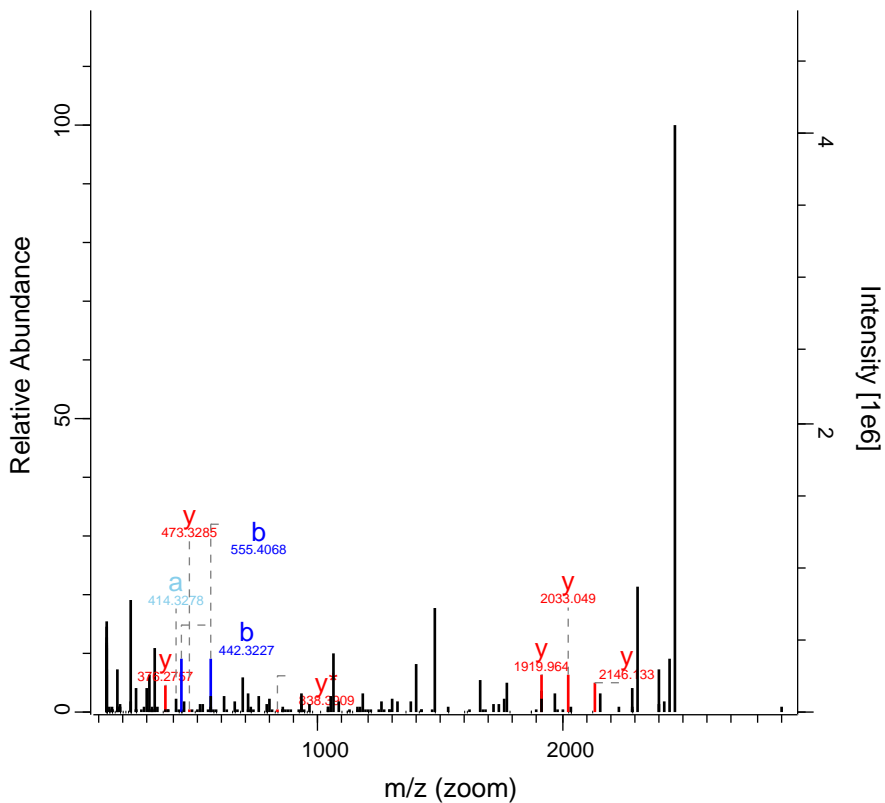

RO-QC-160121_ZackD_SS_Set_01_Fractic 27377 FTMS; HC 60.16 1221.17 CYP4F12

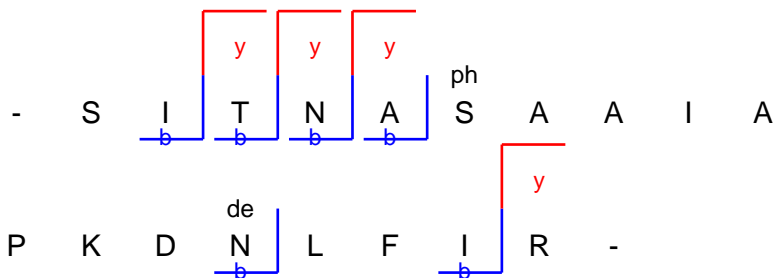
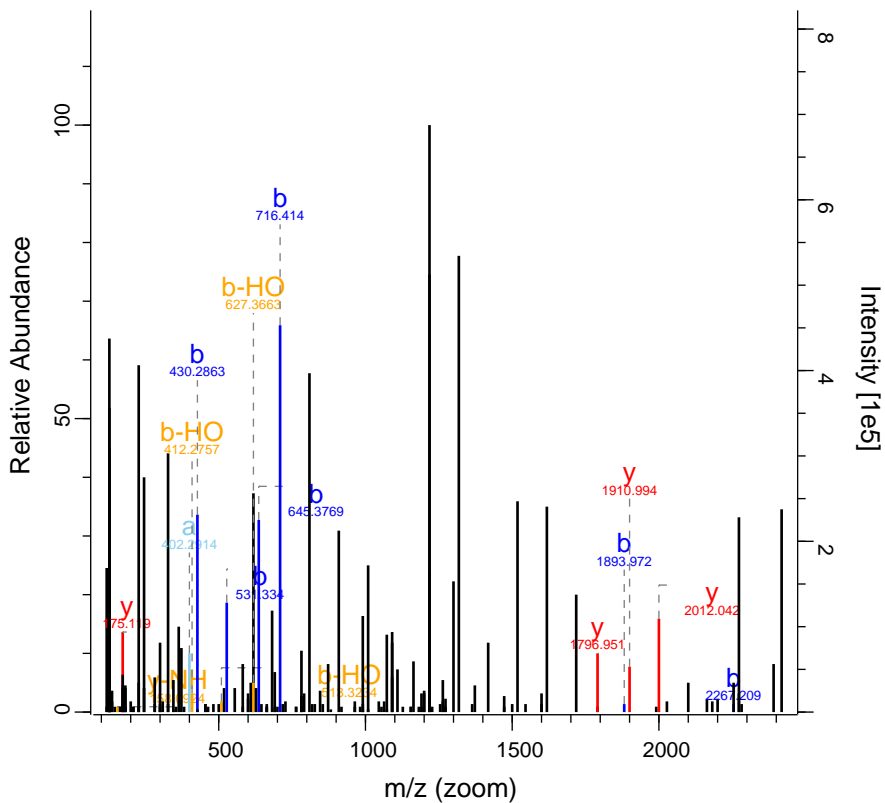

RO-QC-160121_ZackD_SS_Set_01_Fractic 28306 FTMS; HC 50.29 1194.13 TCERG1L

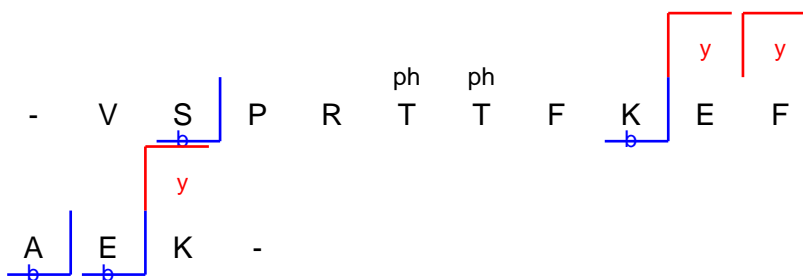
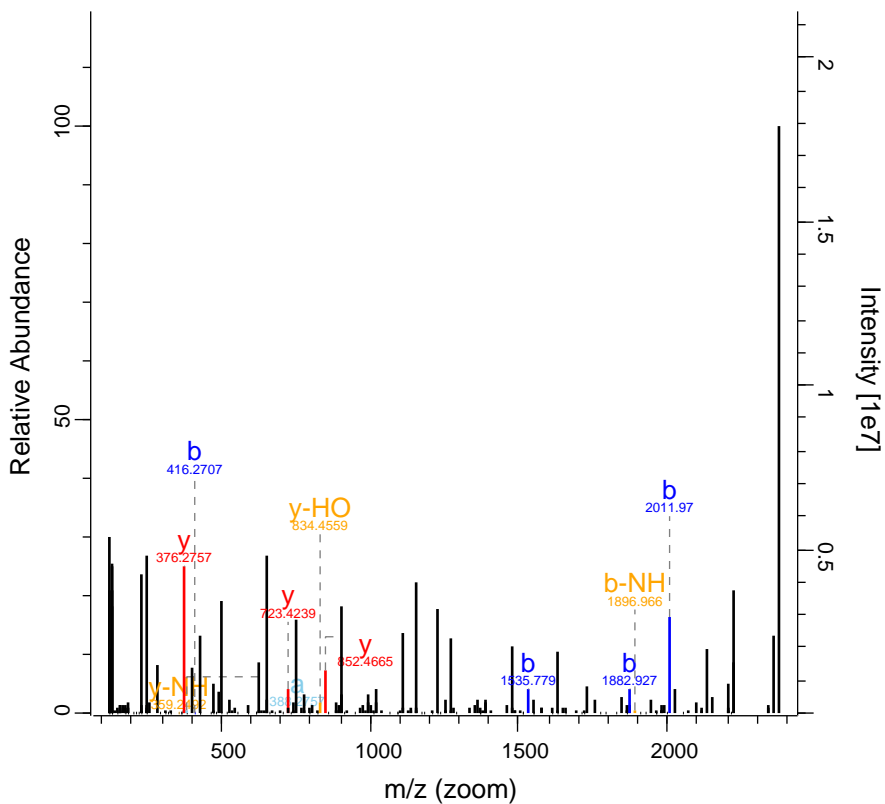

RO-QC-160121_ZackD_SS_Set_01_Fractic 29683 FTMS; HC 243.06 1254.16 LIPE

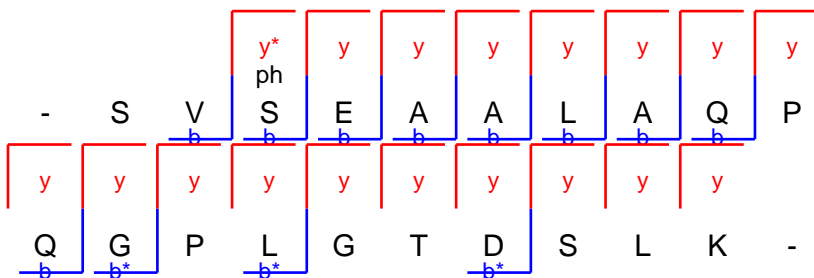
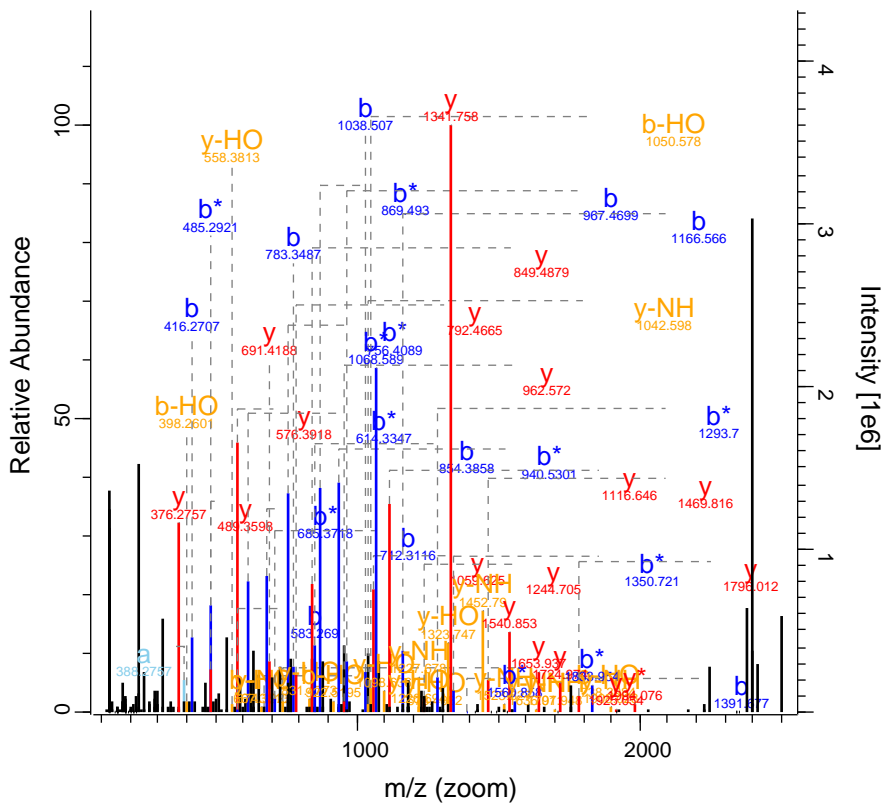

RO-QC-160121_ZackD_SS_Set_01_Fractic 29863 FTMS; HC 56.09 1041.06 TICRR

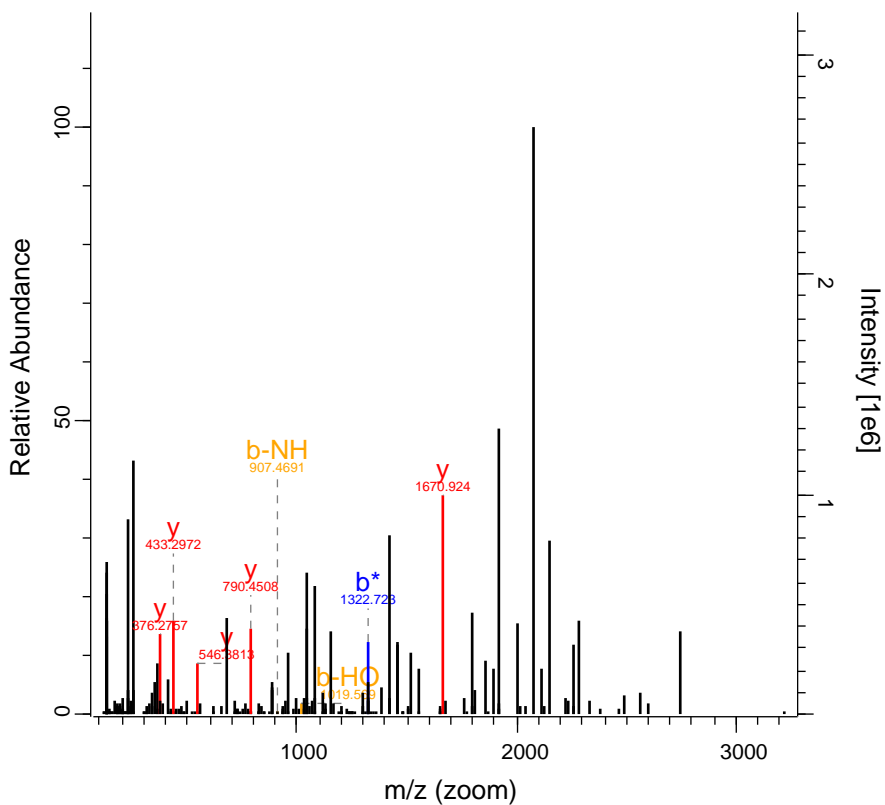

RO-QC-160121_ZackD_SS_Set_01_Fraction 30567 FTMS; HC 52.61 899.13 CEMIP

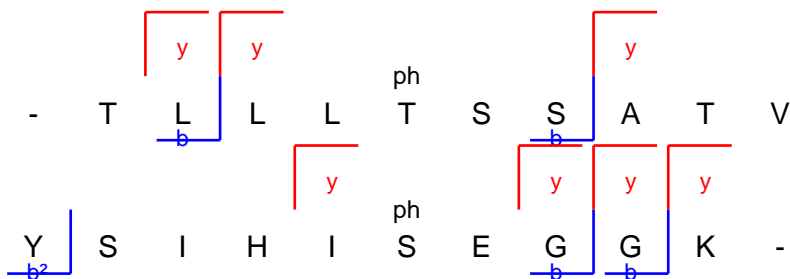
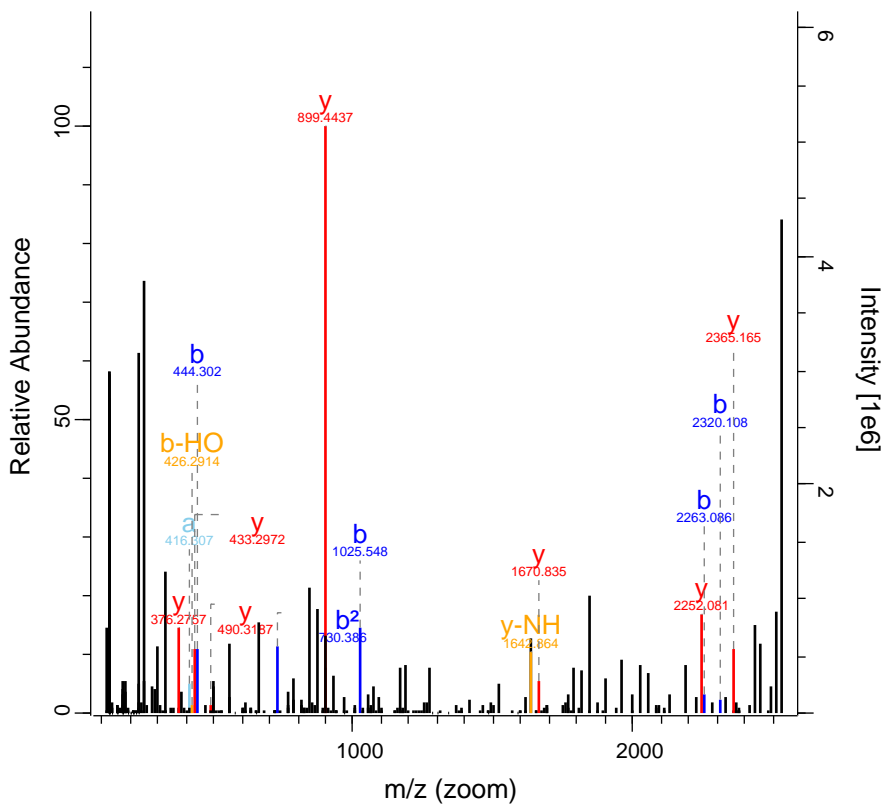

RO-QC-160121_ZackD_SS_Set_01_Fraction 35601 FTMS; HCl 40.18 976.5 ENAM

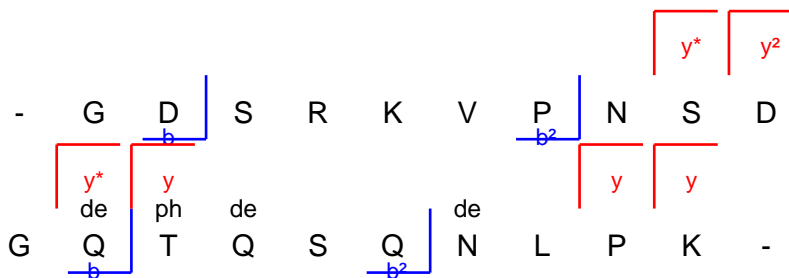
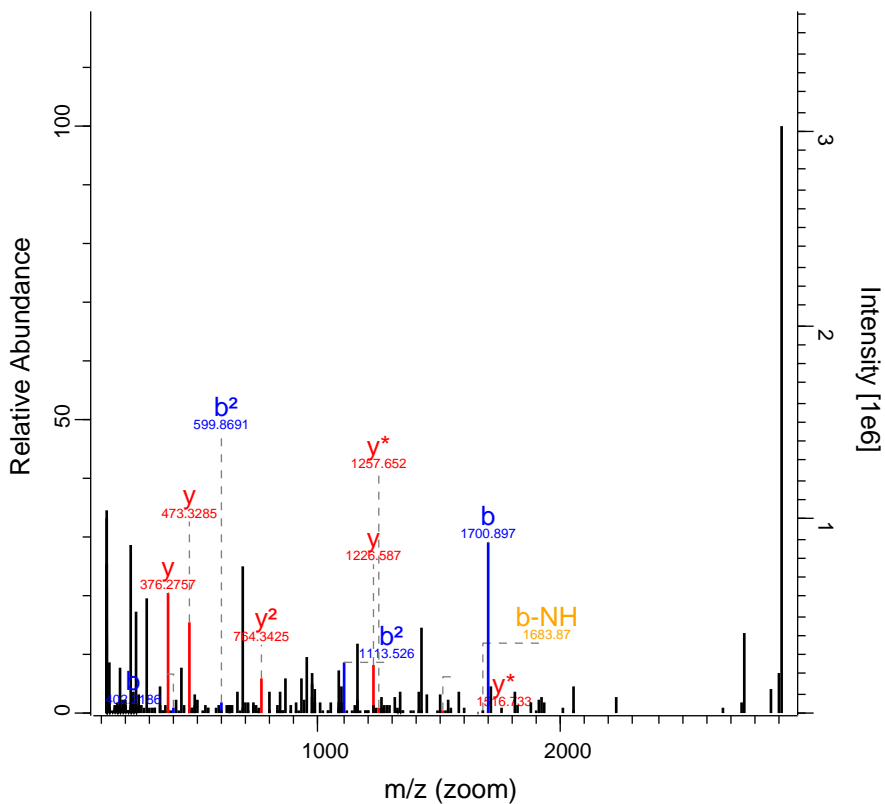

RO-QC-160121_ZackD_SS_Set_01_Fractic 37749 FTMS; HC 48.66 1243.32 ZNF300

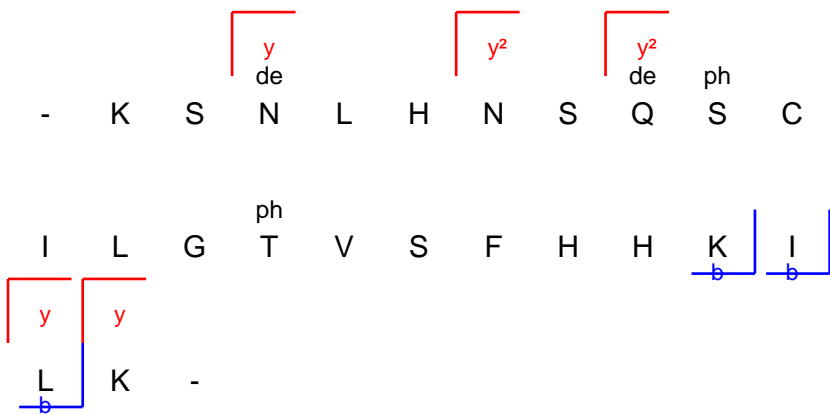
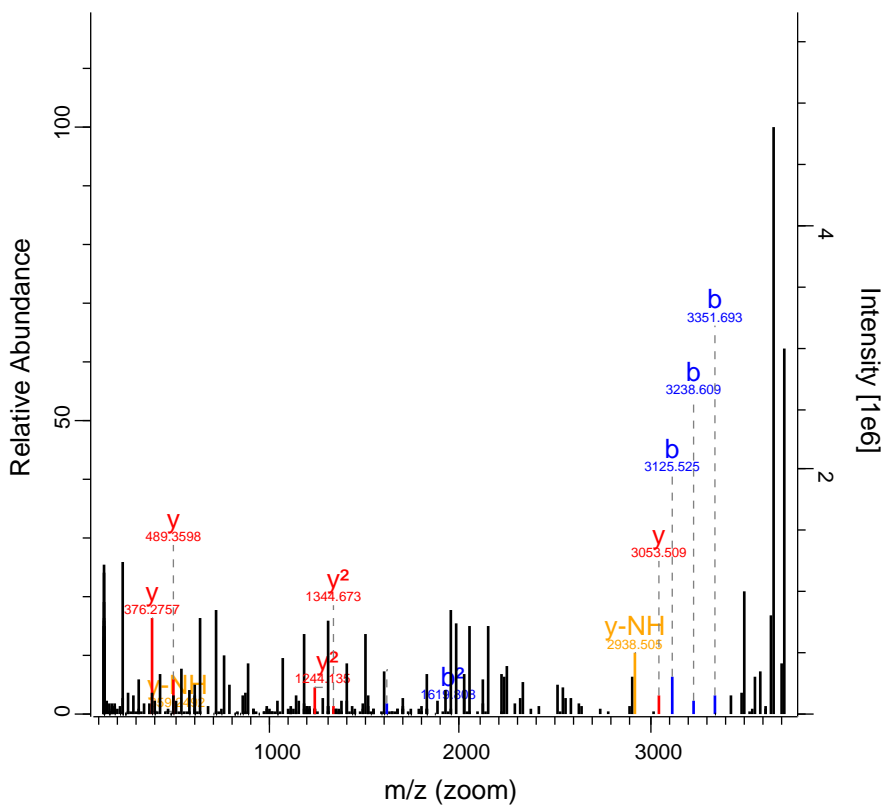

RO-QC-160121_ZackD_SS_Set_01_Fractic 40211 FTMS; HC 51.73 1233.16 RASA1

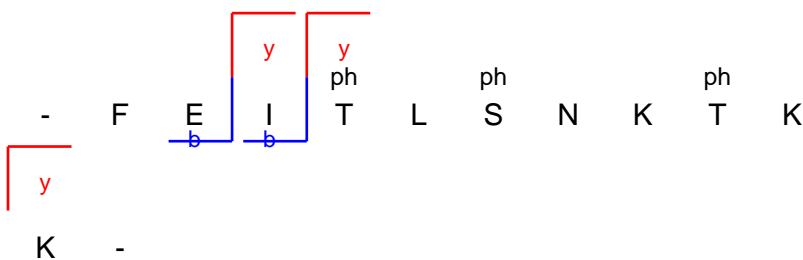
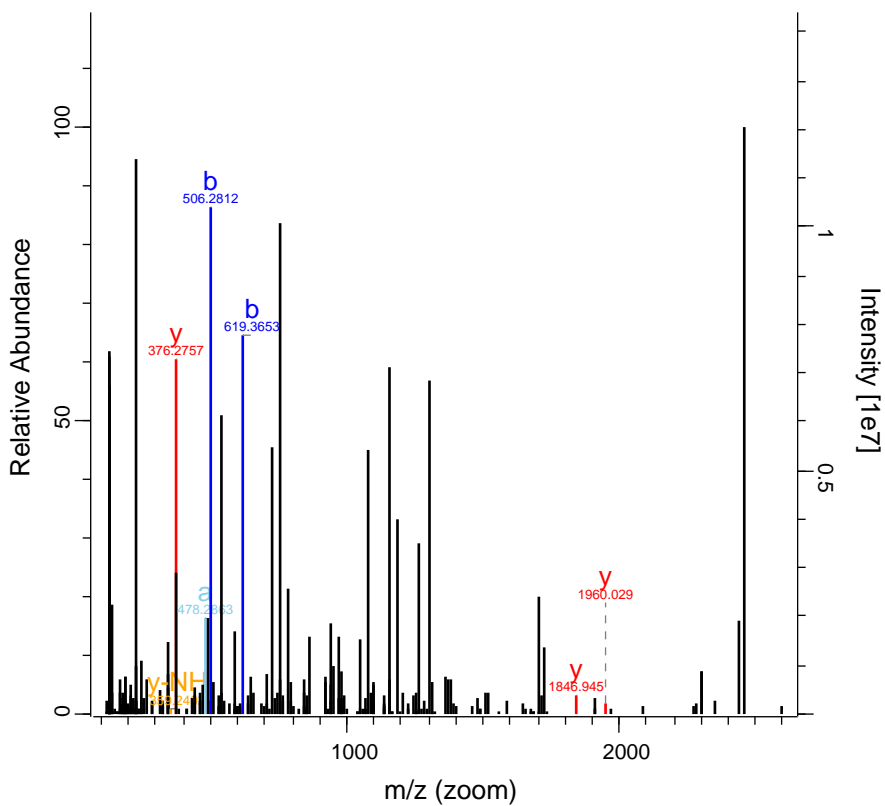

K -

RO-QC-160121_ZackD_SS_Set_01_Fraction 41715 FTMS; HC 47.99 640.03 PIGR

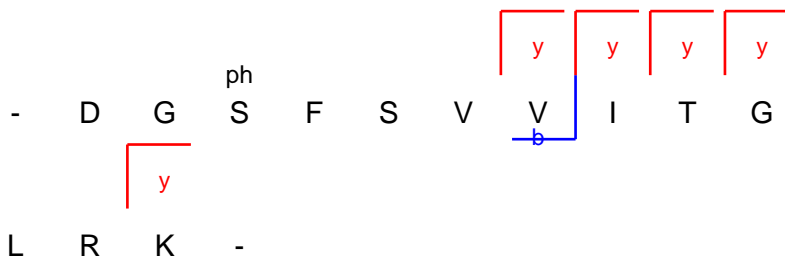
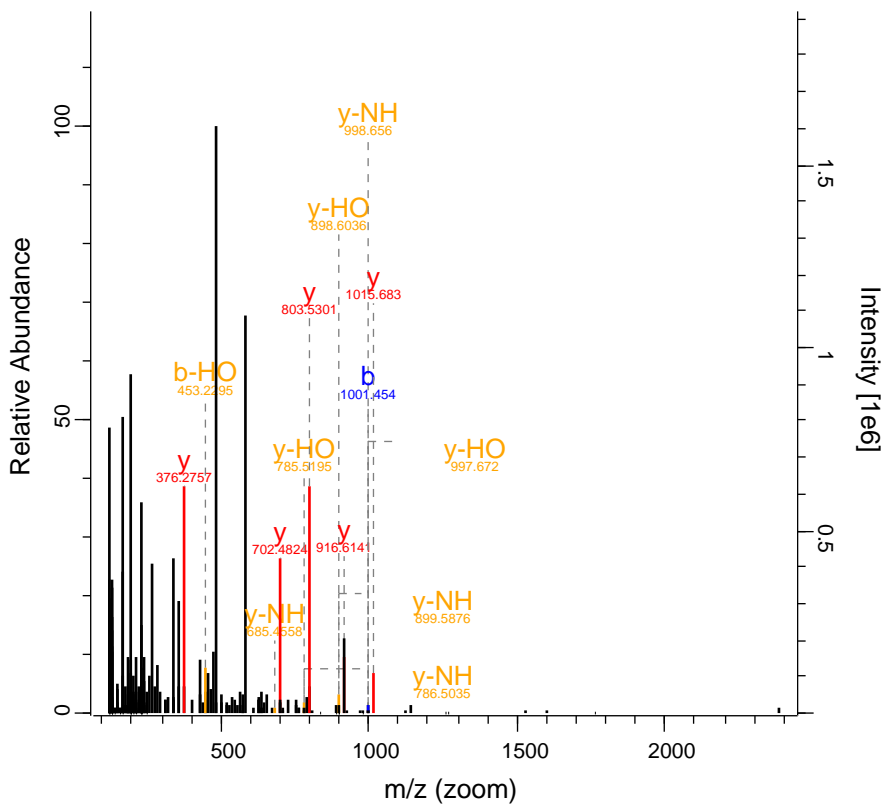

RO-QC-160121_ZackD_SS_Set_01_Fraction 4511 FTMS; HC 107.45 721.84 ENAH

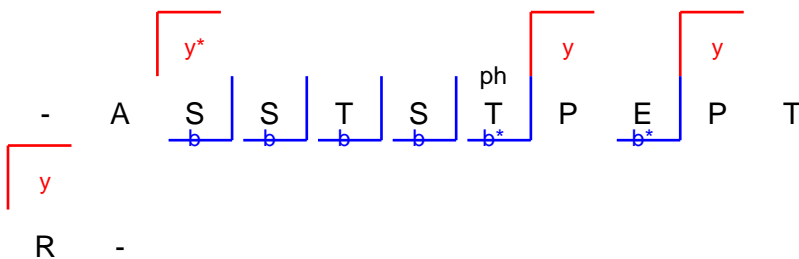
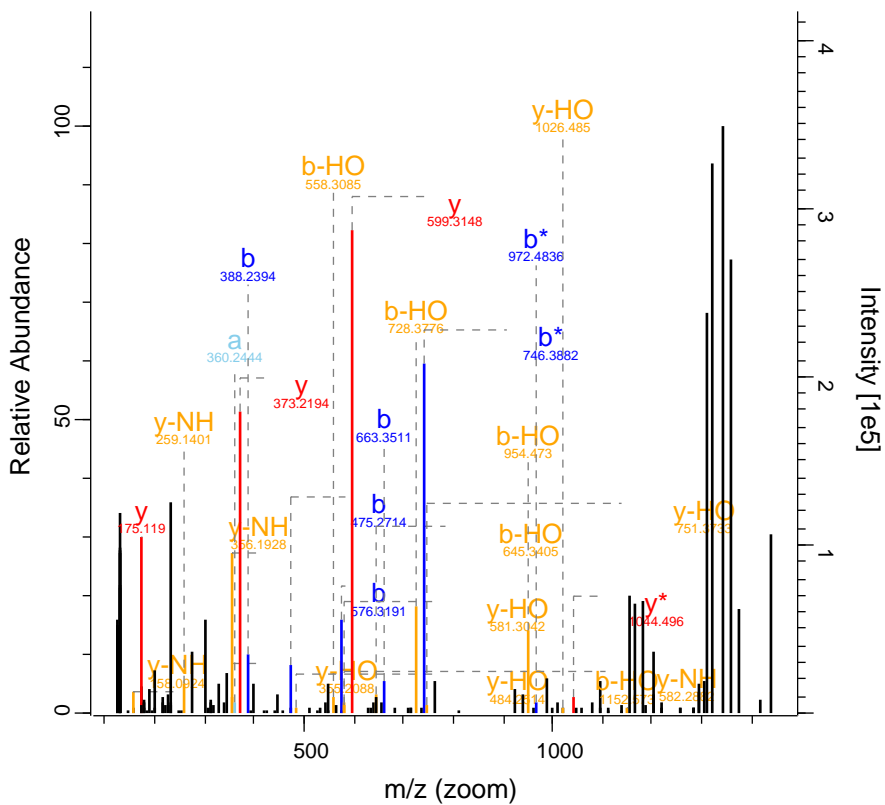

RO-QC-160121_ZackD_SS_Set_01_Fraction 5508 FTMS; HC 44.39 834.41 B3GALT2

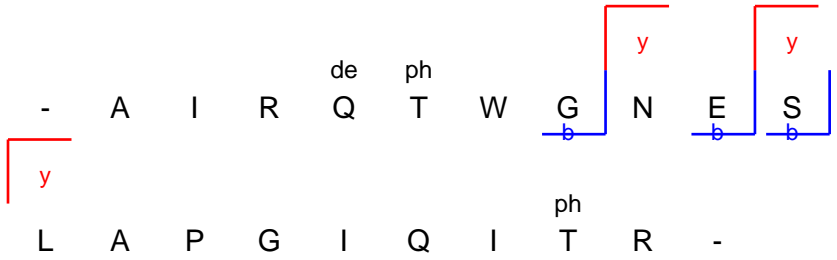
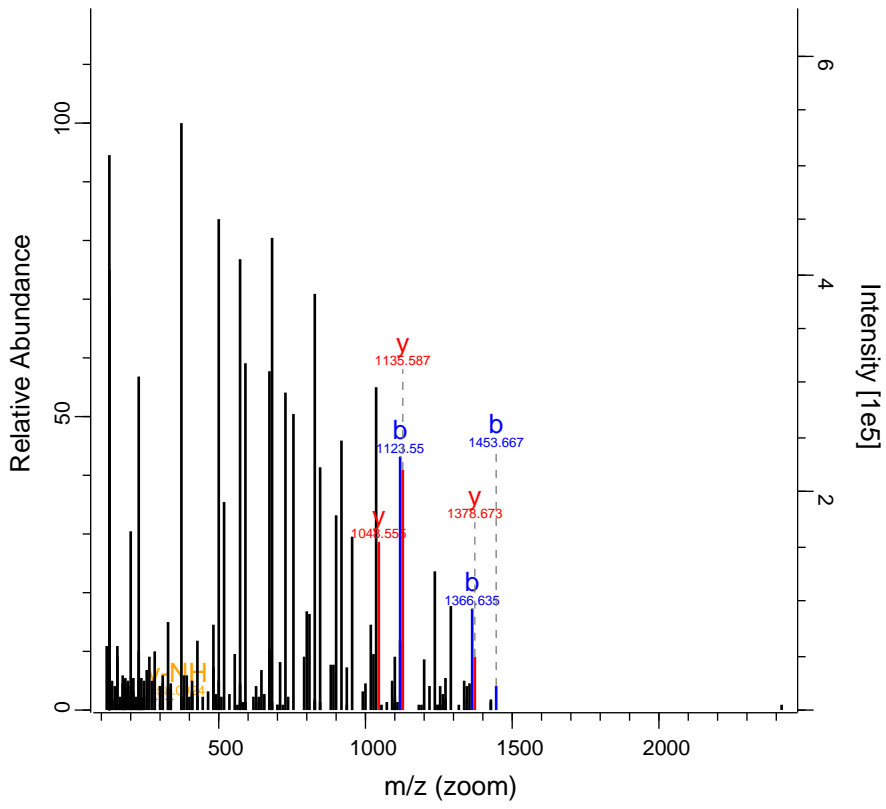

L A P G I Q I T R -

ph

RO-QC-160121_ZackD_SS_Set_01_Fraction 5865 FTMS; HC 54.55 440.52 C15orf41

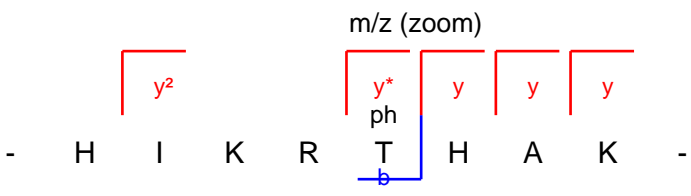
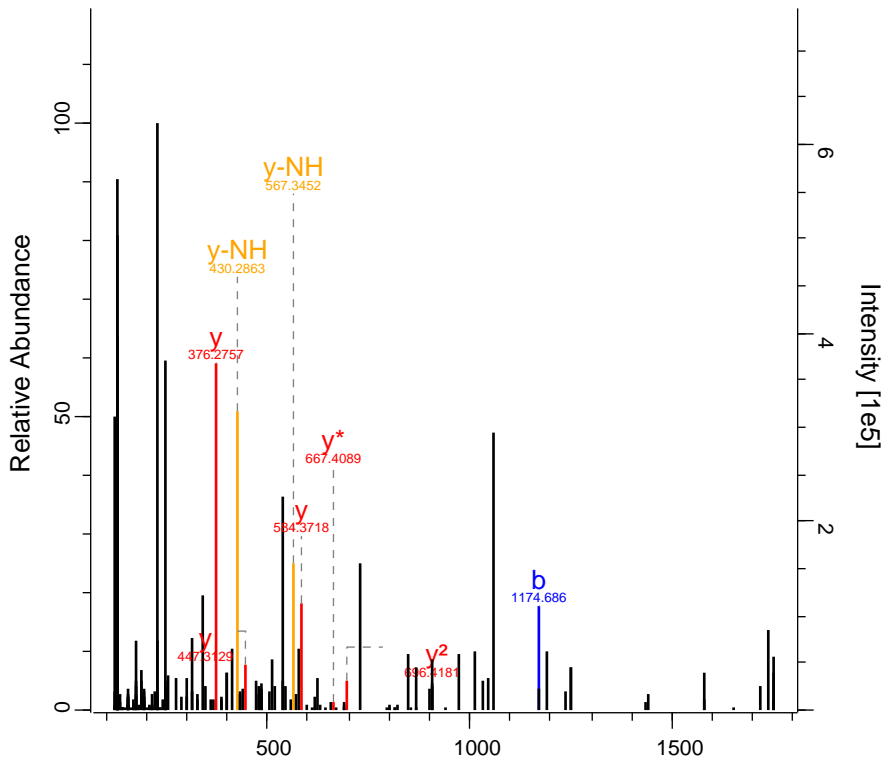

RO-QC-160121_ZackD_SS_Set_01_Fraction 7241 FTMS; HC 101.67 677.64 ADD1

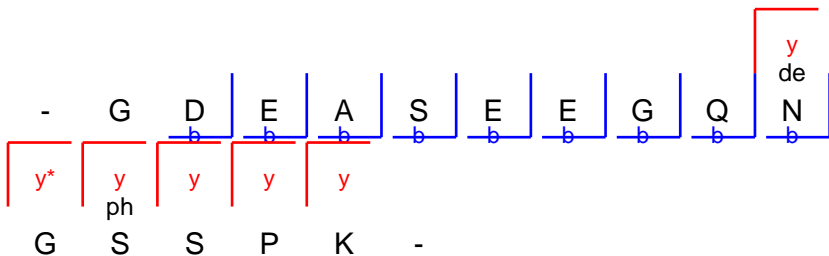
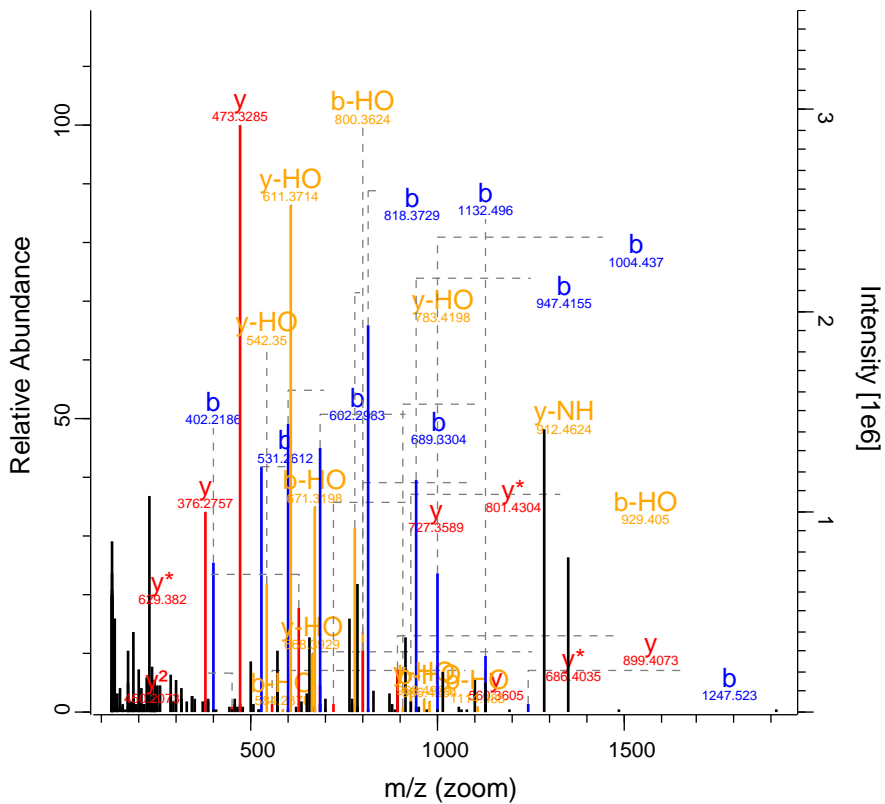

RO-QC-160121_ZackD_SS_Set_01_Fraction 7650 FTMS; HC 113.61 817.44 SPTBN1

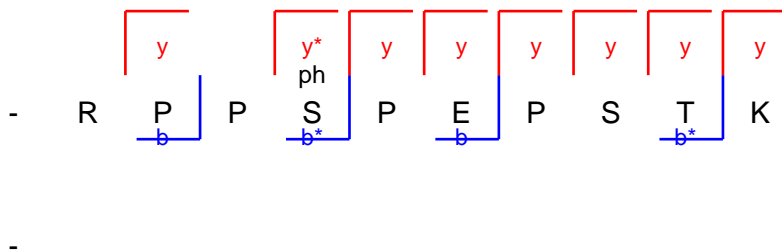
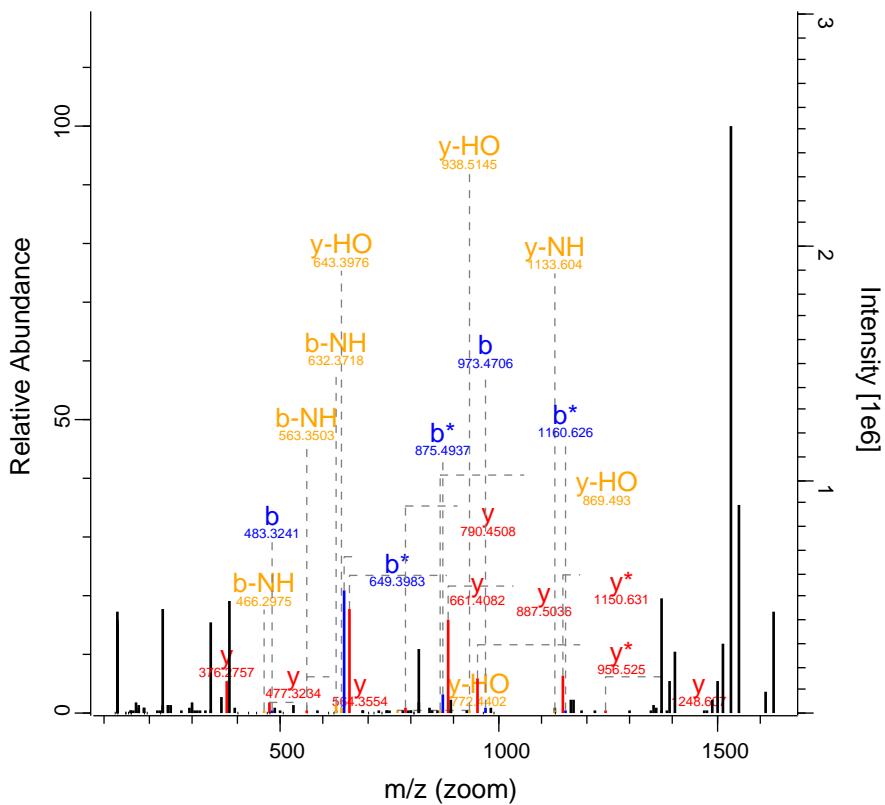

RO-QC-160121_ZackD_SS_Set_01_Fraction 8132 FTMS; HC 49.93 679.82 KPNA5

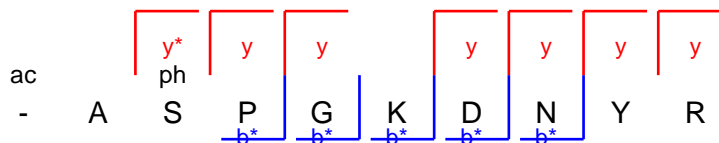
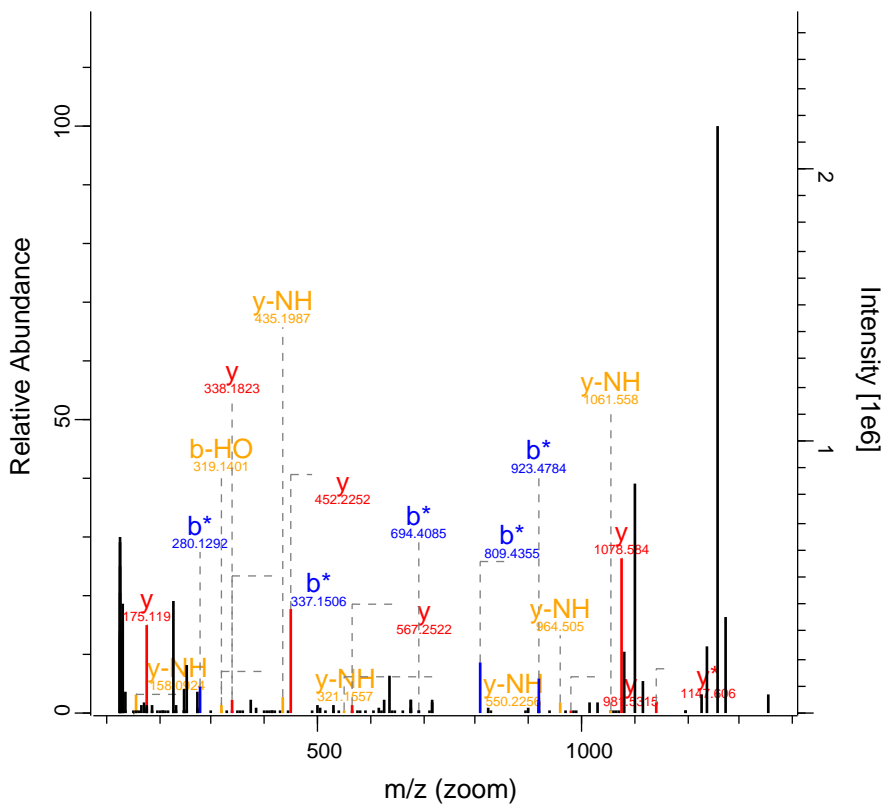

RO-QC-160121_ZackD_SS_Set_01_Fraction 9843 FTMS; HC 58.58 873.79 CBX1

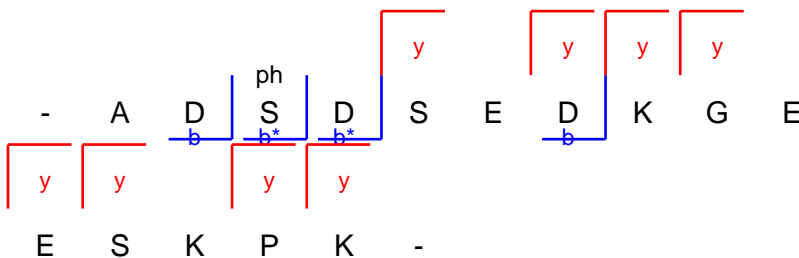
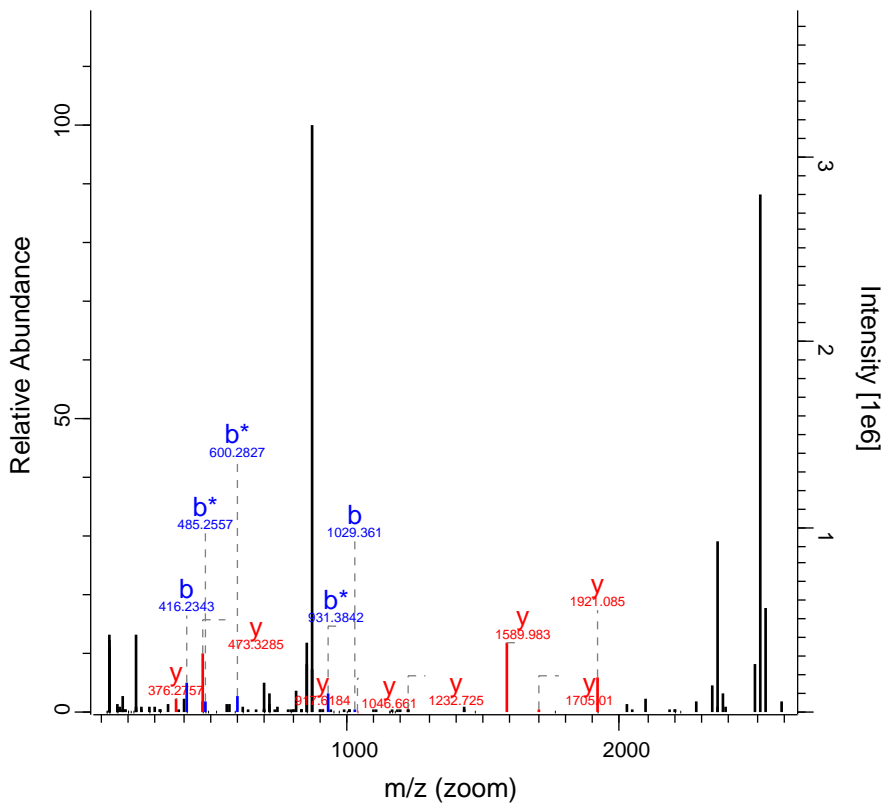

RO-QC-160121_ZackD_SS_Set_01_Fraction_11987 FTMS; HC 105.46 936 TSPAN10

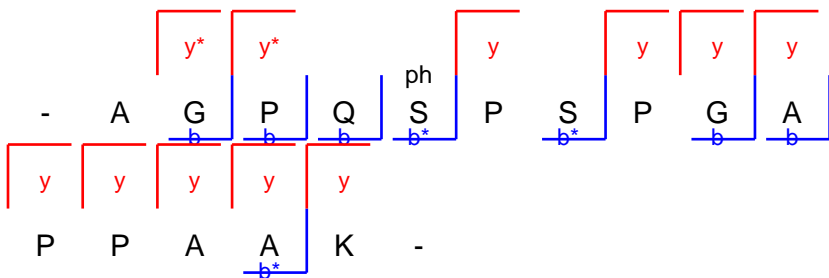
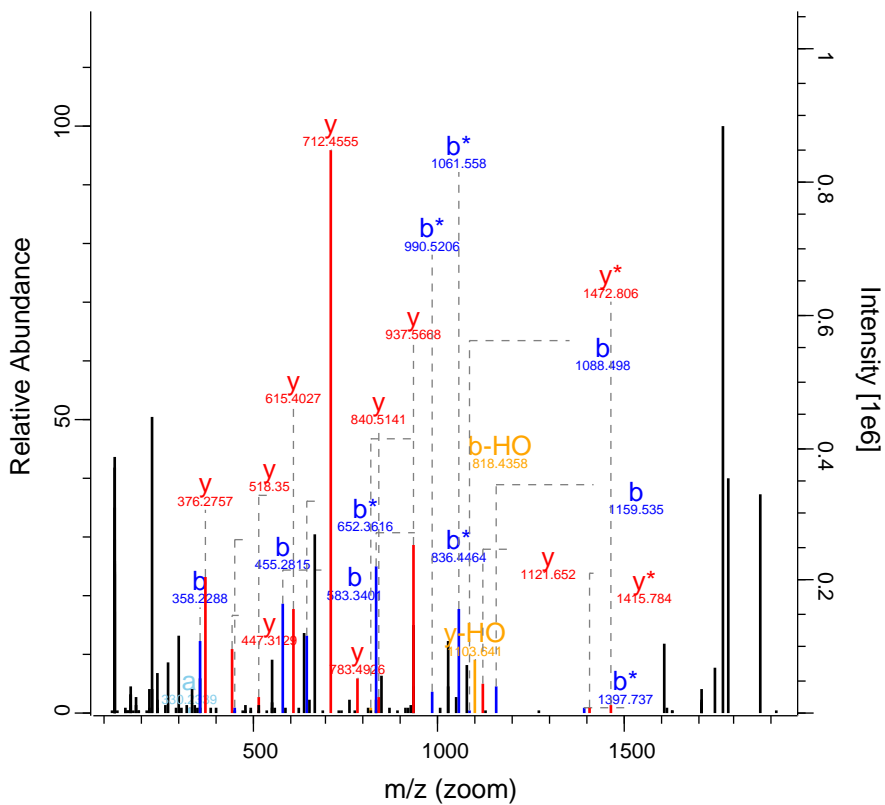

RO-QC-160121_ZackD_SS_Set_01_Fraction 13612 FTMS; HC 65.25 715.38 TMIGD3

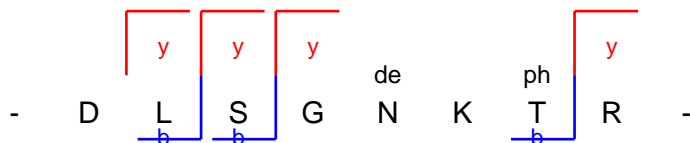
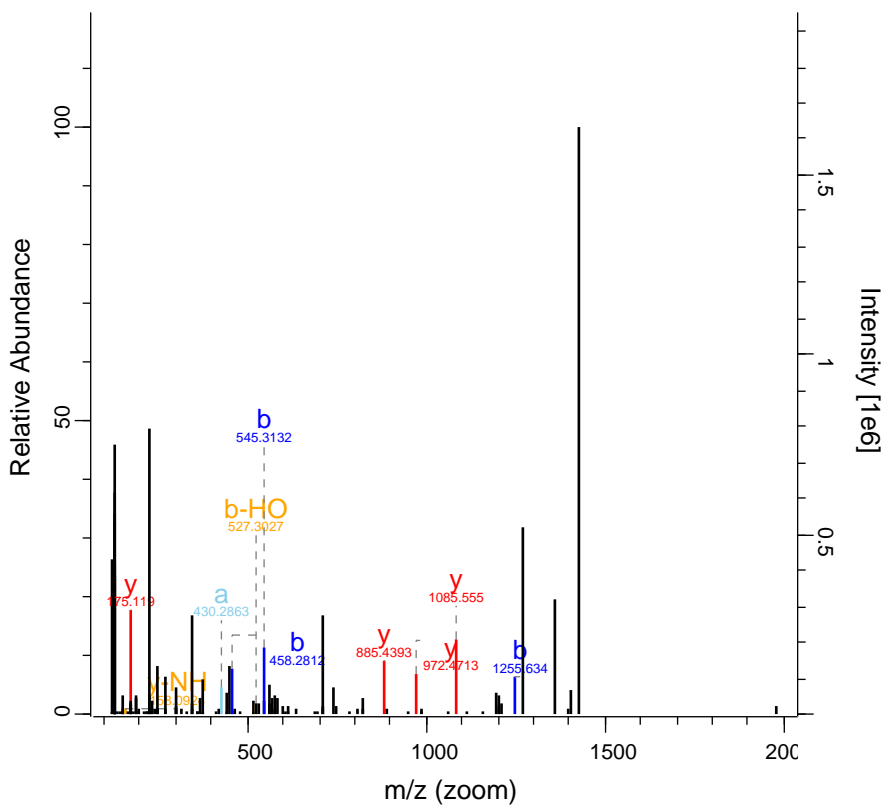

RO-QC-160121_ZackD_SS_Set_01_Fraction14134 FTMS; HC 131.32 813.42 NMT1

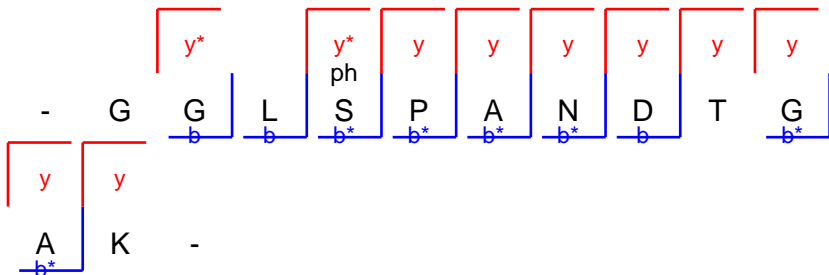
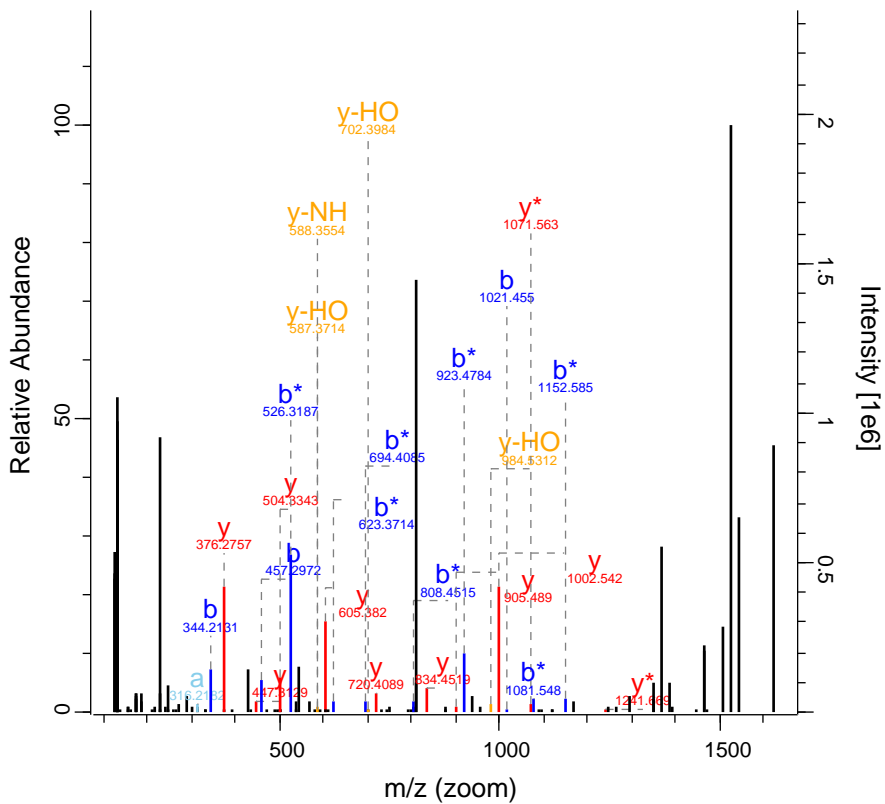

RO-QC-160121_ZackD_SS_Set_01_Fraction 16750 FTMS; HC 78.23 1120.58 PLEKHA6

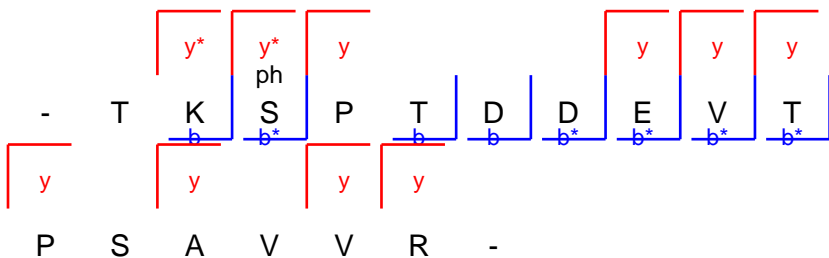
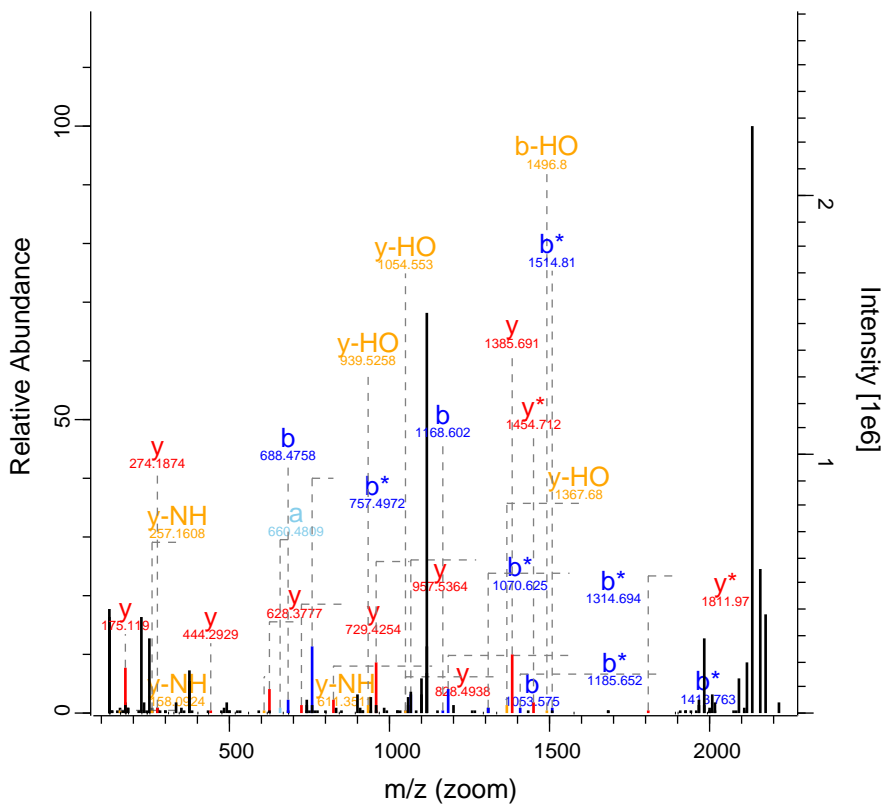

RO-QC-160121_ZackD_SS_Set_01_Fraction17086 FTMS; HC 44.19 711.05 KIAA2018

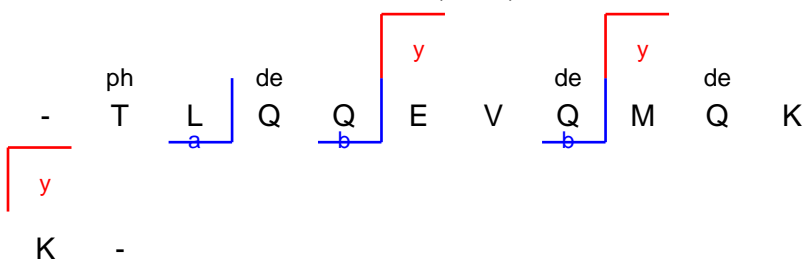
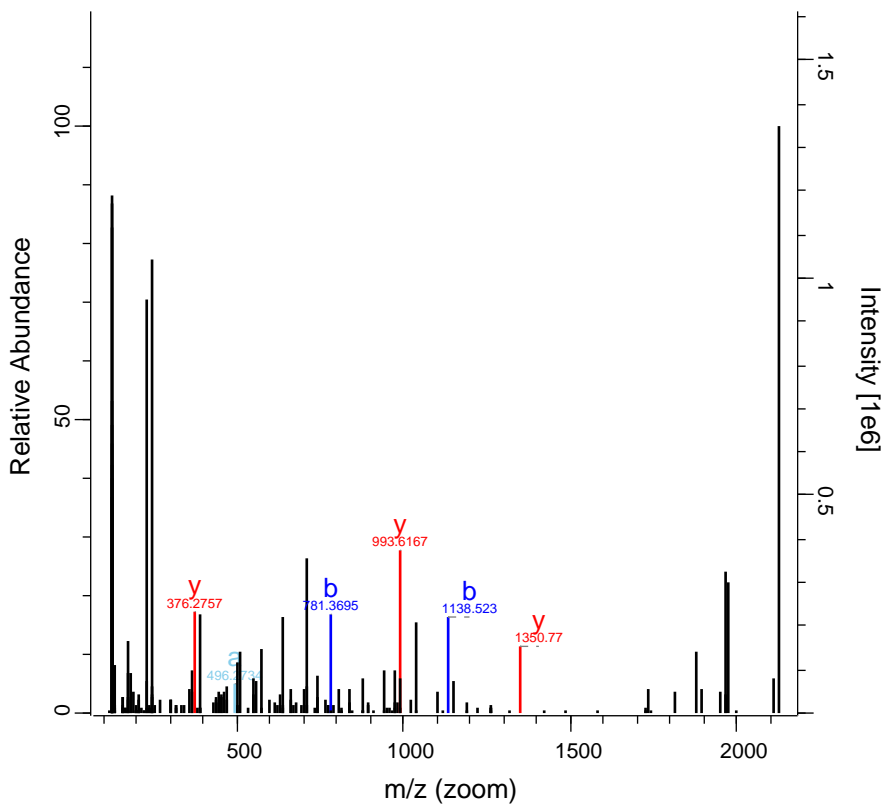

RO-QC-160121_ZackD_SS_Set_01_Fraction17871 FTMS; HC 105.17 726.11 SRRM2

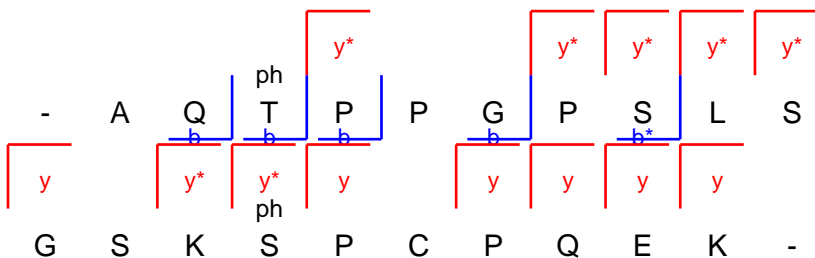
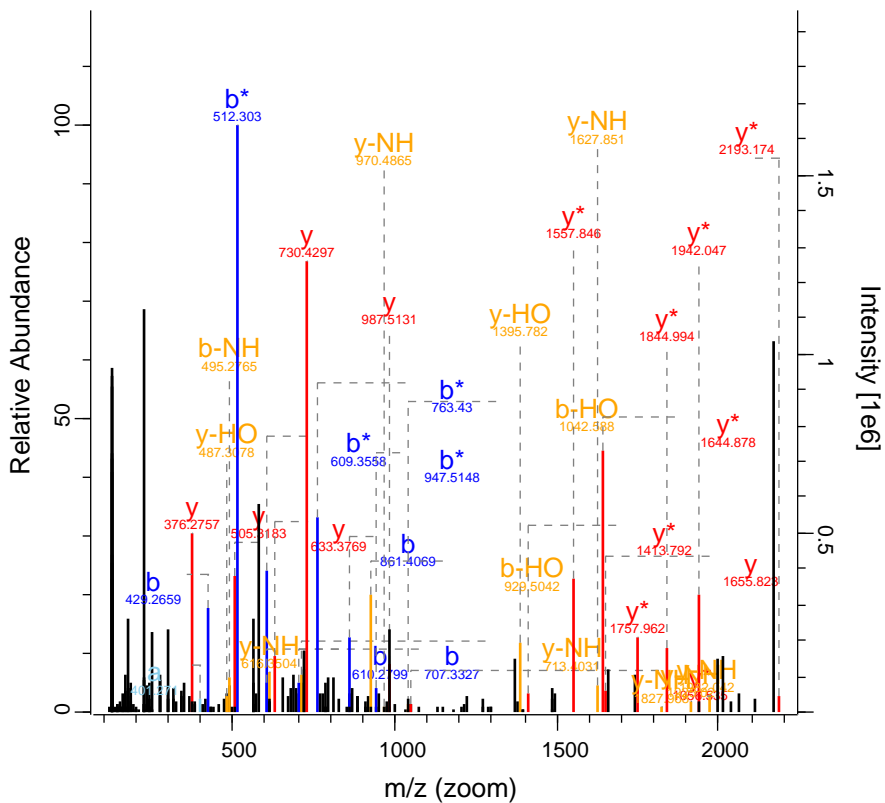

RO-QC-160121_ZackD_SS_Set_01_Fraction 22519 FTMS; HC 96.72 671.85 ARHGAP5

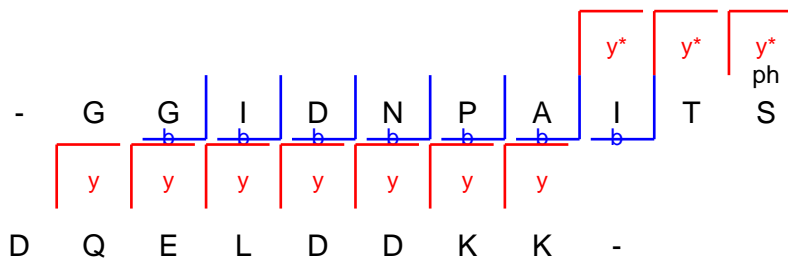
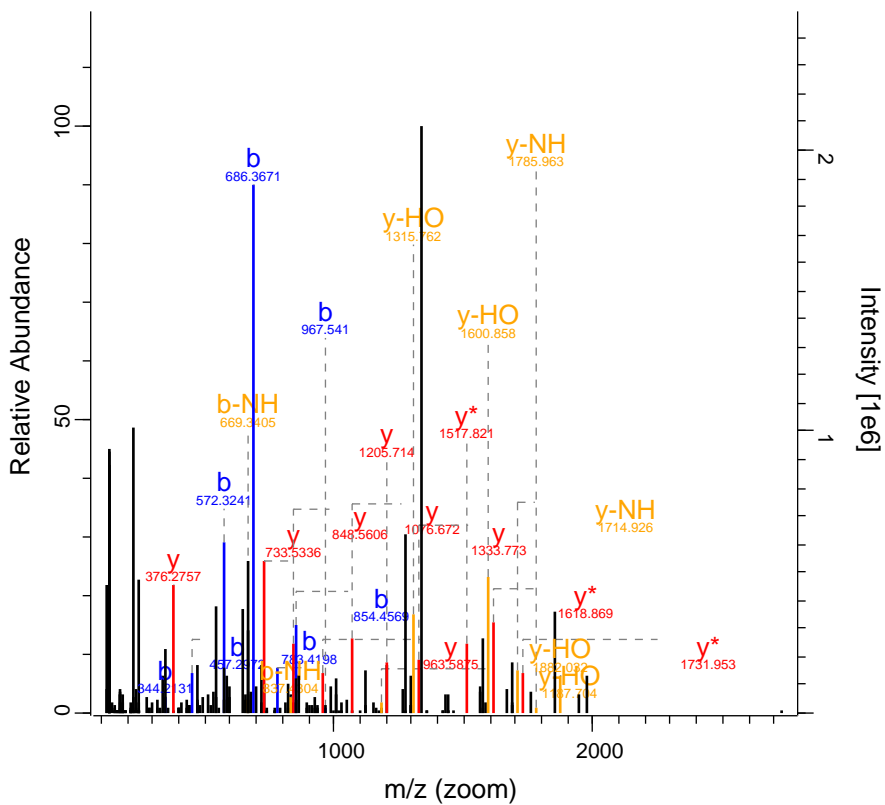

RO-QC-160121_ZackD_SS_Set_01_Fraction 23829 FTMS; HC 94.2 1127.24 HDGF

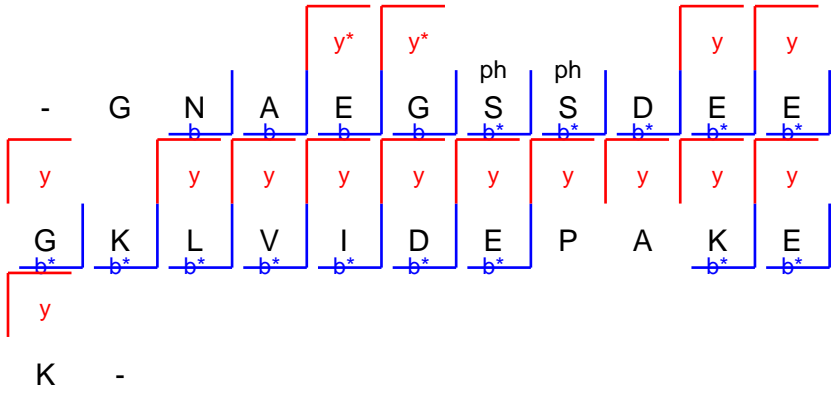
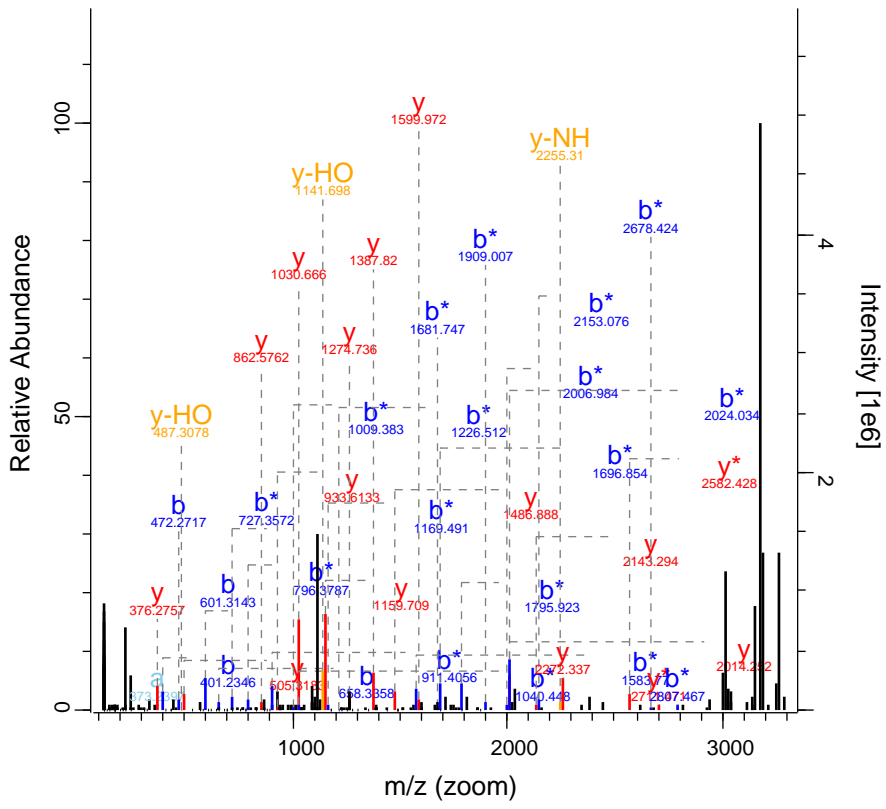

RO-QC-160121_ZackD_SS_Set_01_Fraction 25288 FTMS; HC 45.86 611.56 HOXD8

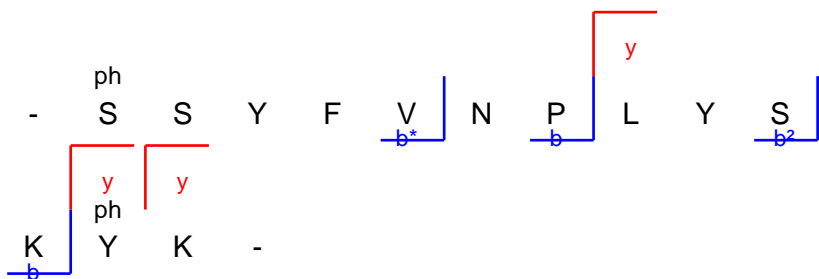
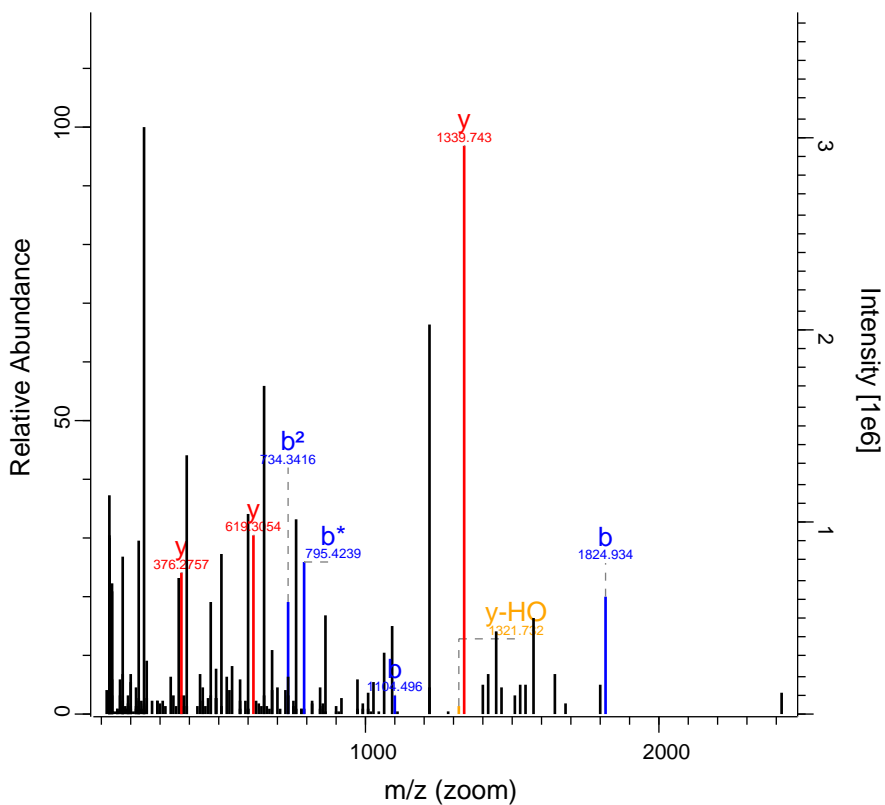

RO-QC-160121_ZackD_SS_Set_01_Fraction 27539 FTMS; HC 77.51 776.62 G3BP2

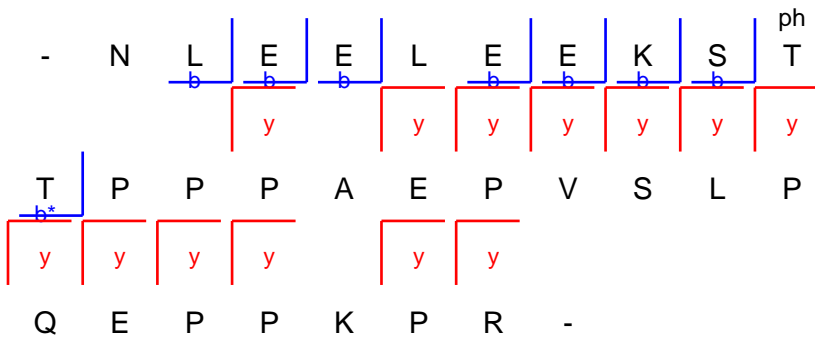
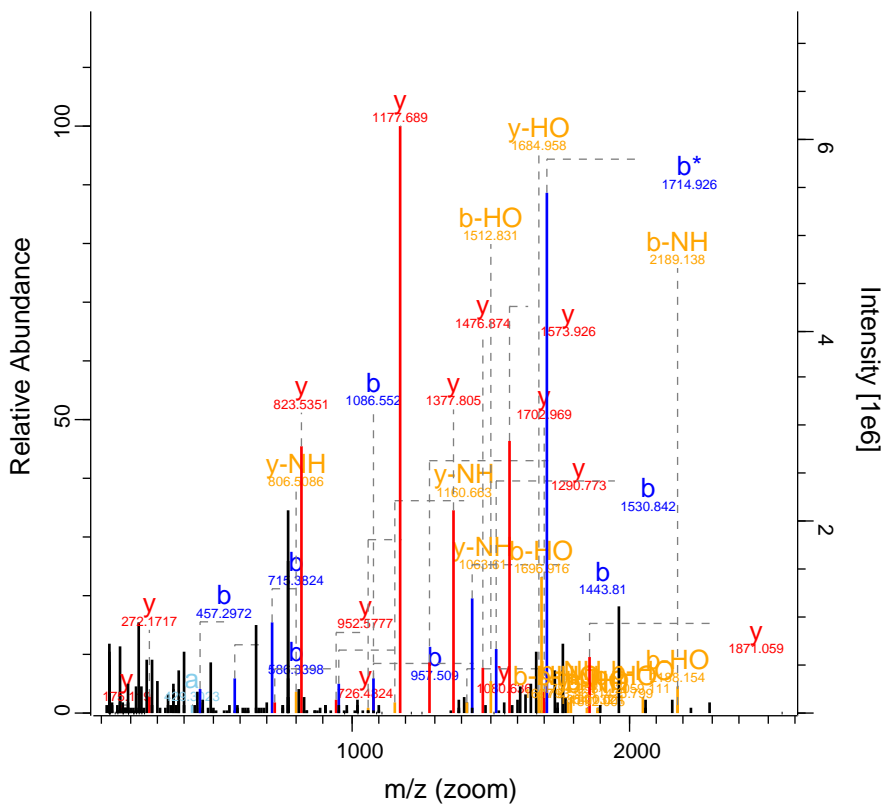

RO-QC-160121_ZackD_SS_Set_01_Fraccio 27545 FTMS; HC 107.74 1080.23 SPAG9

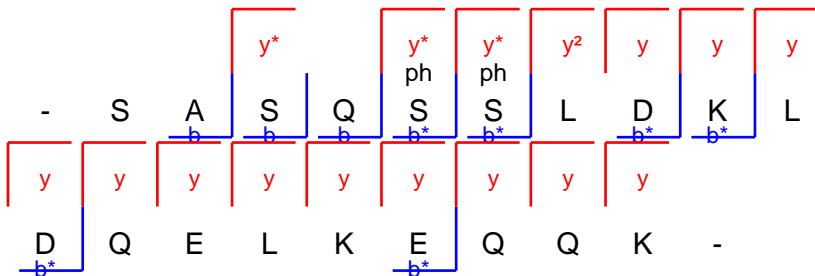
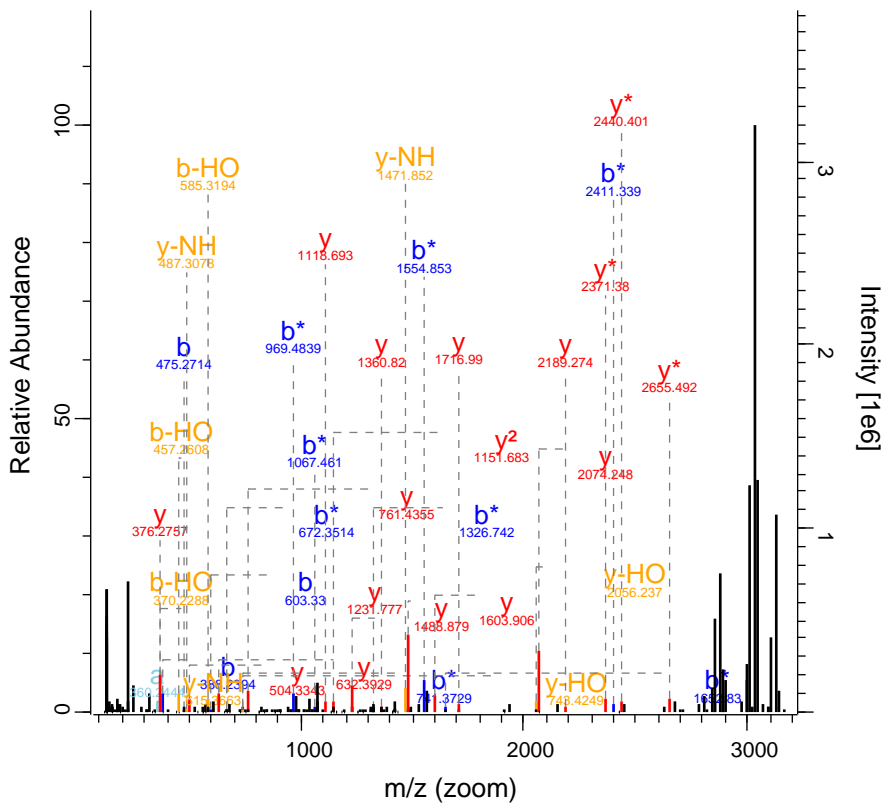

RO-QC-160121_ZackD_SS_Set_01_Fraction 29831 FTMS; HC 52.03 752.91 PSAP

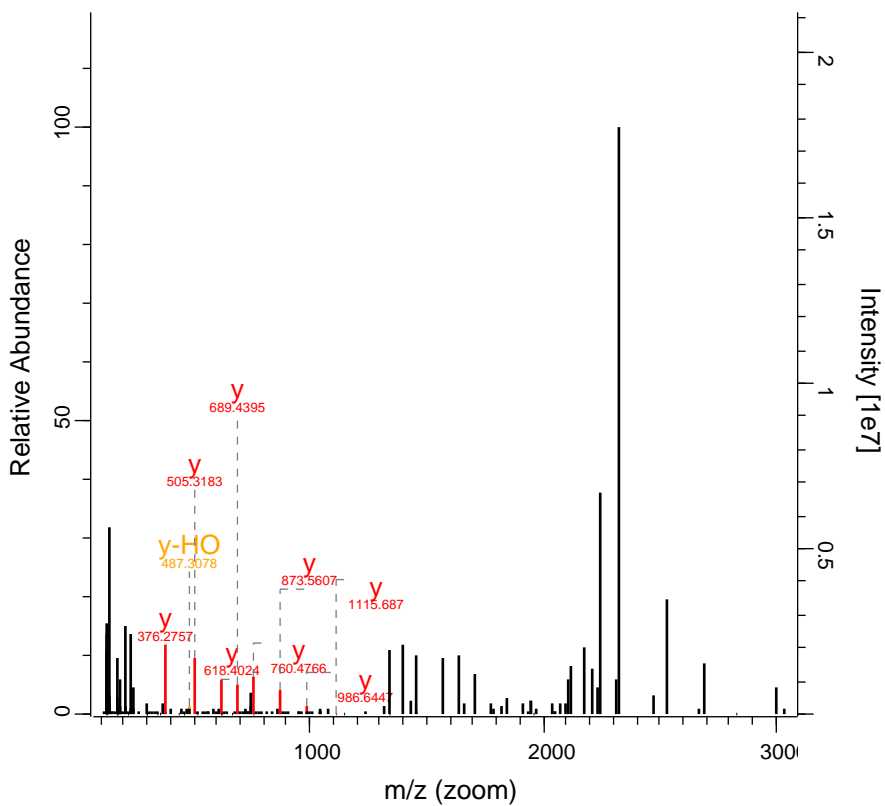

	de				de	ph	ph		de	y
-	N	L	E	K	N	S	T	K	Q	E
y	y	y	y	y	y	y				
I	L	A	A	L	E	K	-			

RO-QC-160121_ZackD_SS_Set_01_Fraction 30657 FTMS; HC 40.58 571.09 VPS13D

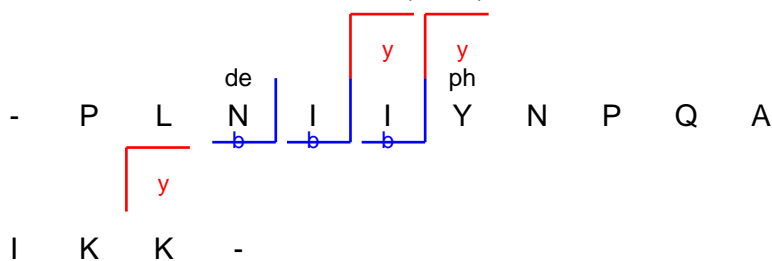
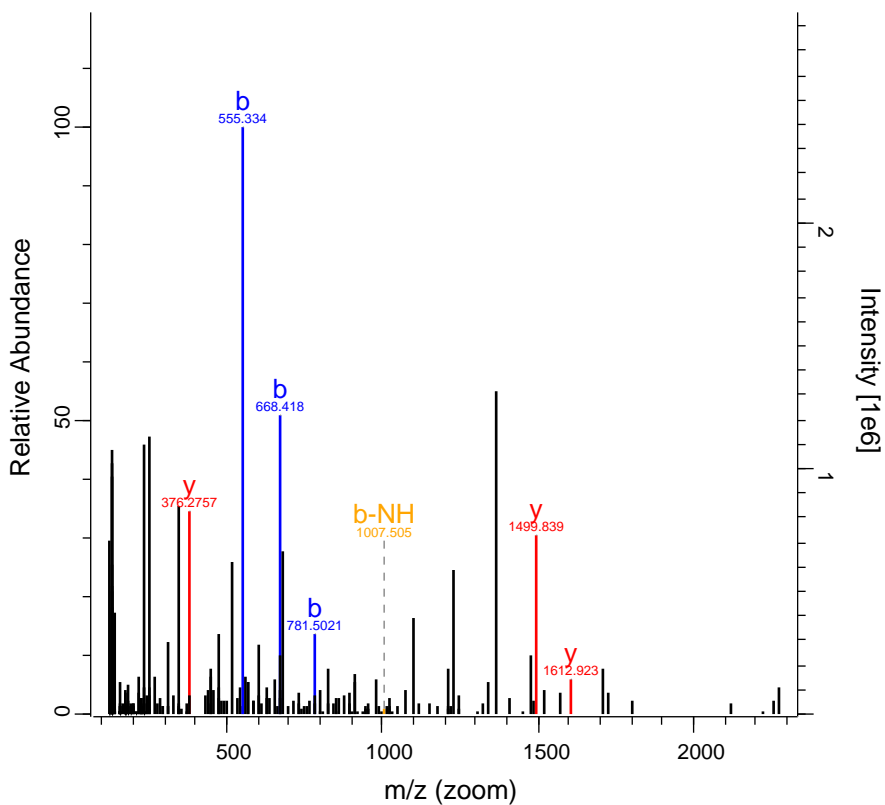

RO-QC-160121_ZackD_SS_Set_01_Fractio 33394 FTMS; HC 128.68 1015.53 VIM

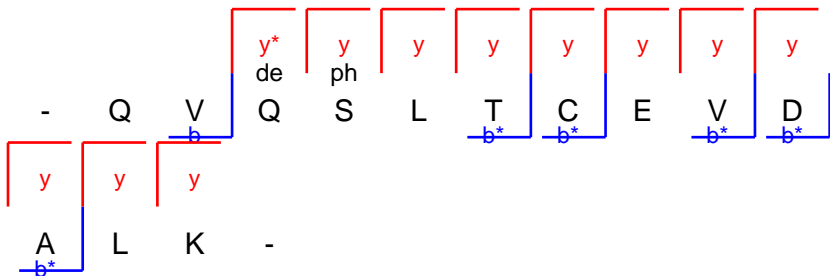
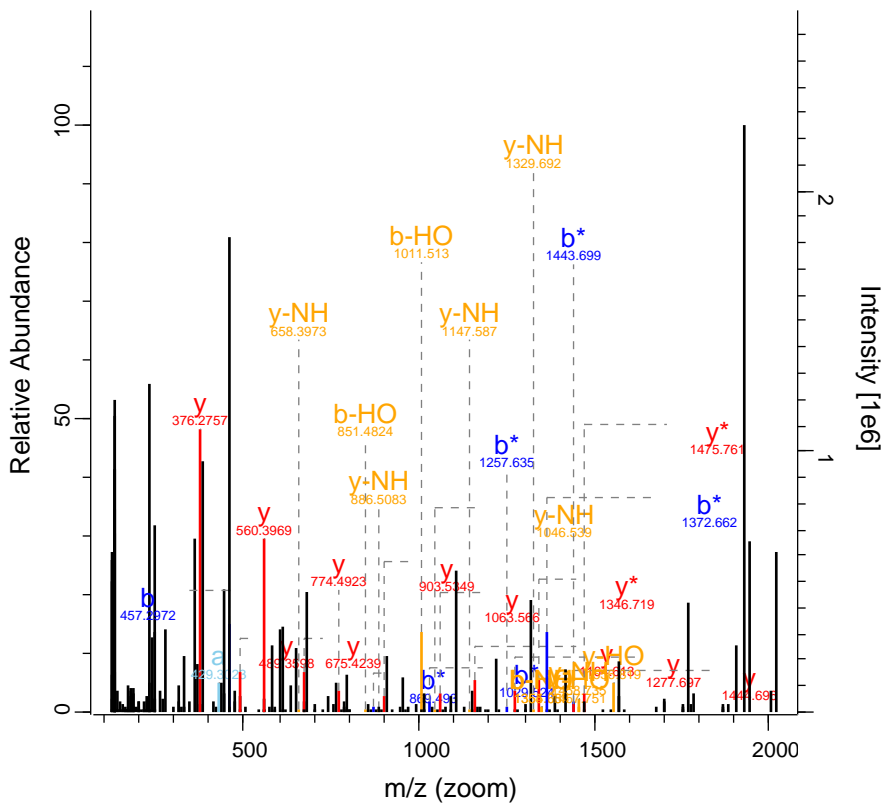

RO-QC-160121_ZackD_SS_Set_01_Fractio 34539 FTMS; HC 205.62 1411.26 MAP1B

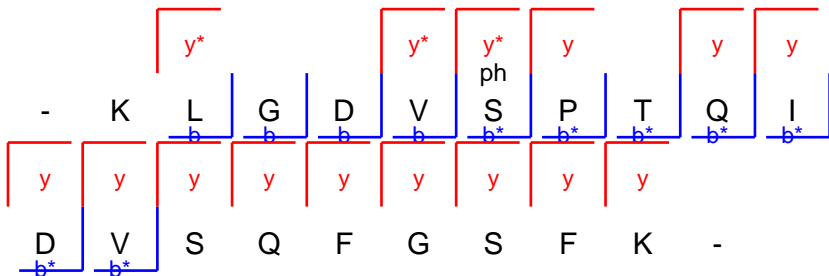
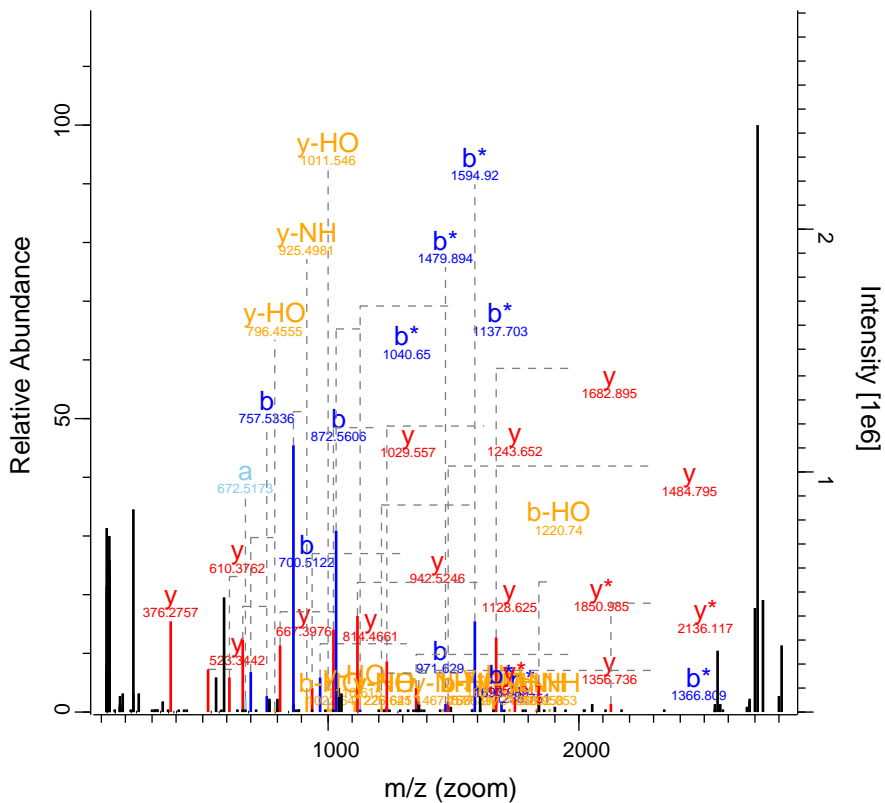

RO-QC-160121_ZackD_SS_Set_01_Fraction 35548 FTMS; HC 47.82 976.99 ENC1

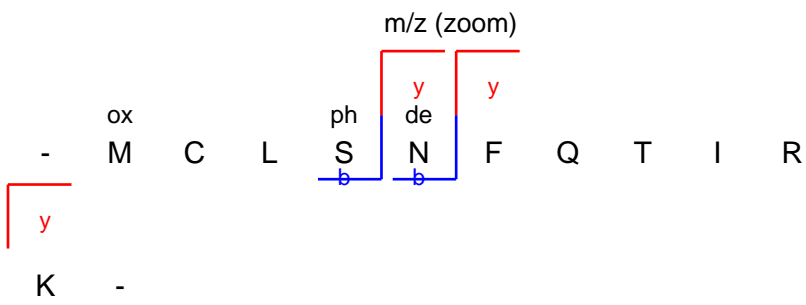
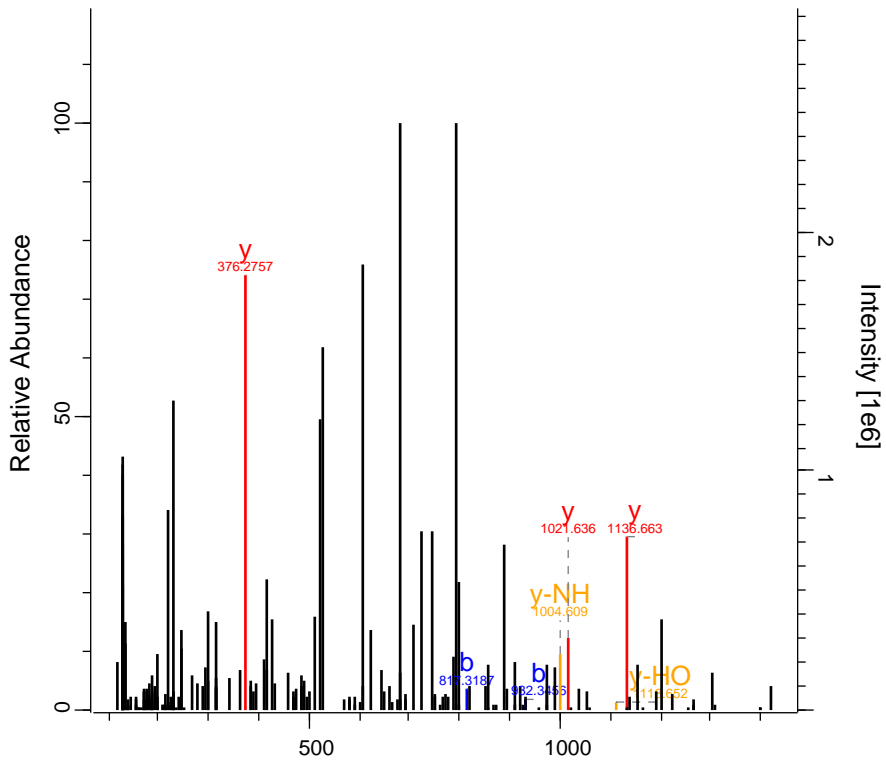

RO-QC-160121_ZackD_SS_Set_01_Fractic 36186 FTMS; HC 199.29 906.42 FAM21A; FAM21

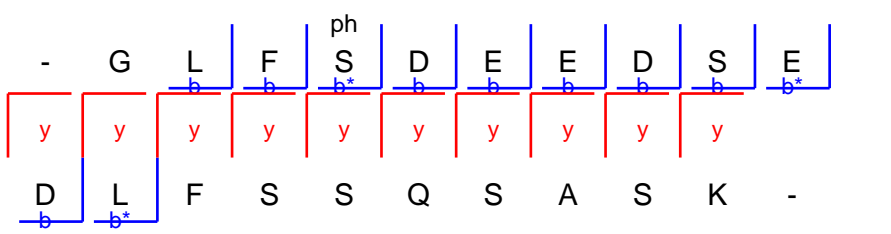
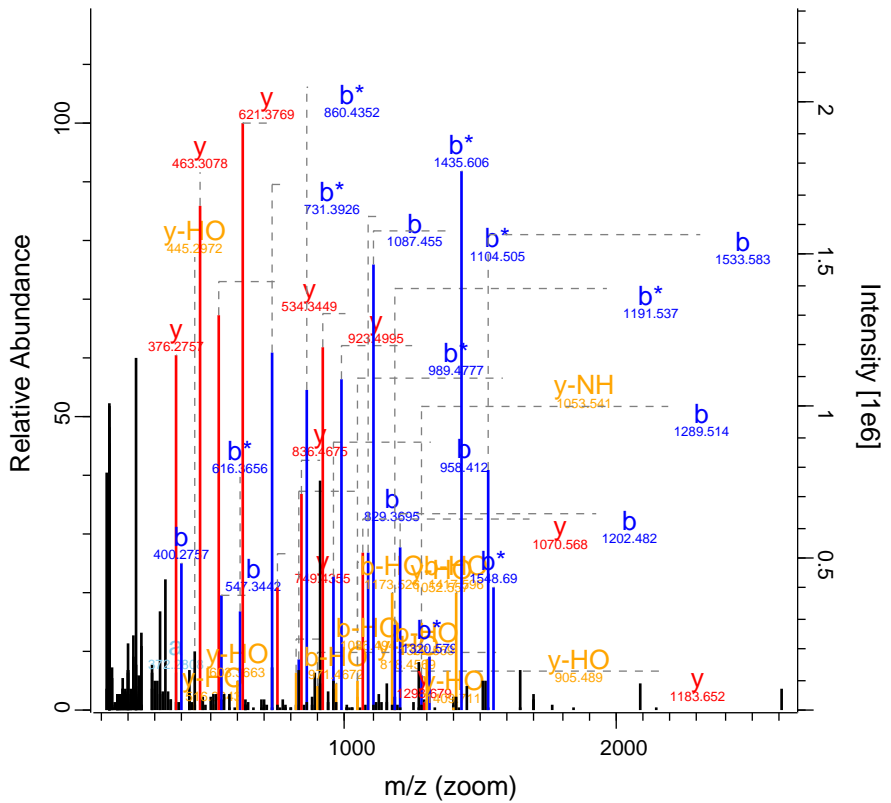

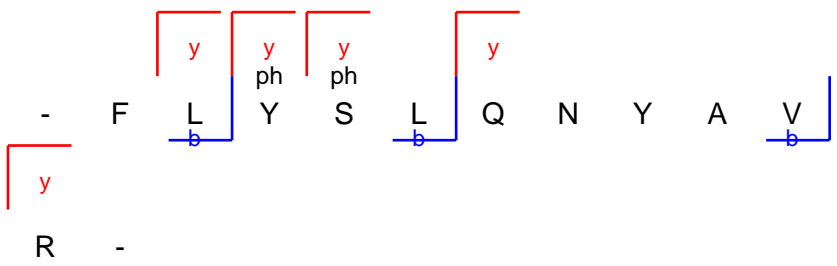
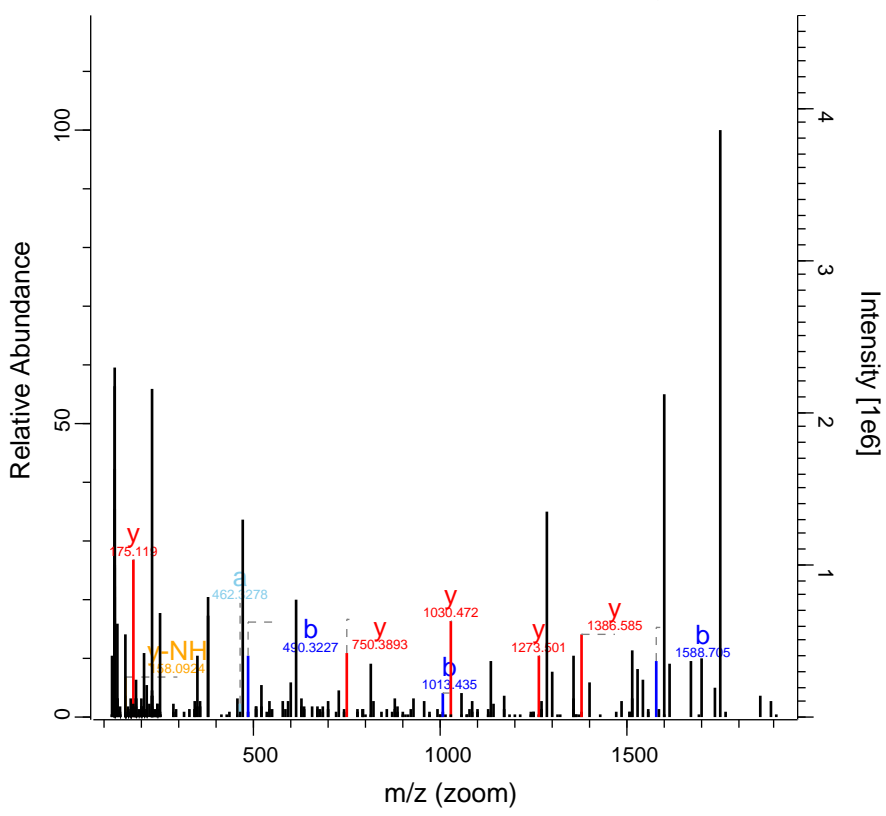

RO-QC-160121_ZackD_SS_Set_01_Fraction 37434 FTMS; HC 41.73 864.84 SCAPER

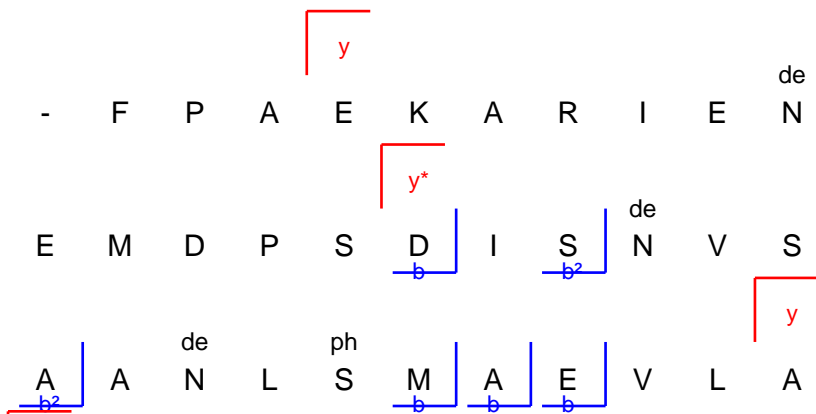
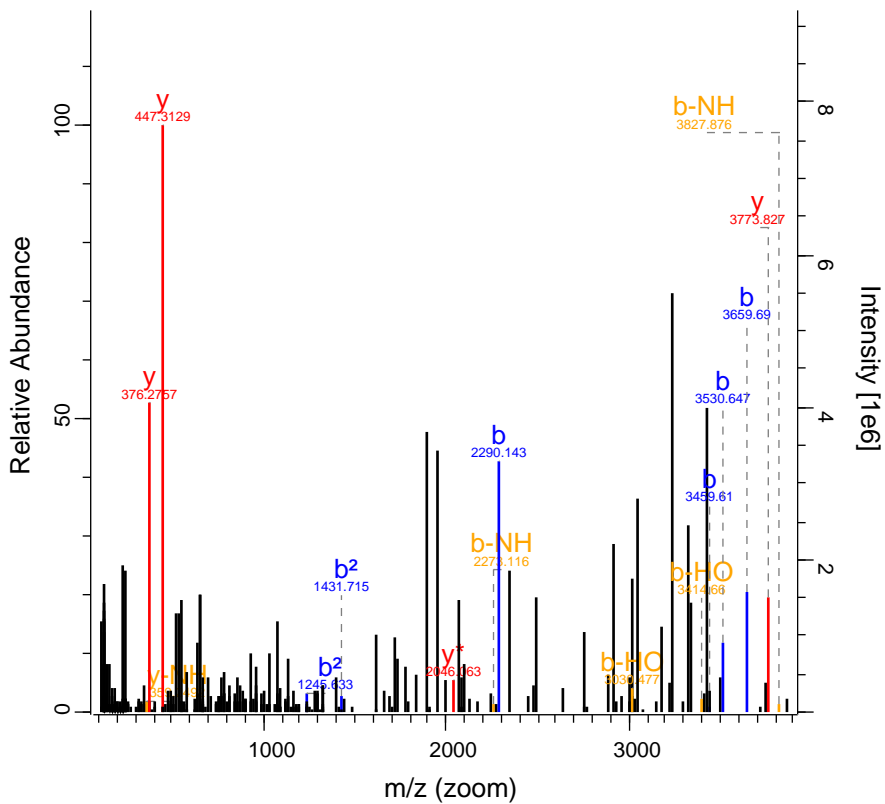

RO-QC-160121_ZackD_SS_Set_01_Fraction 38518 FTMS; HC 58.92 924.79 YAP1

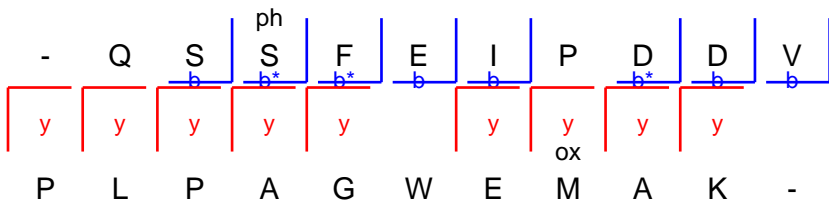
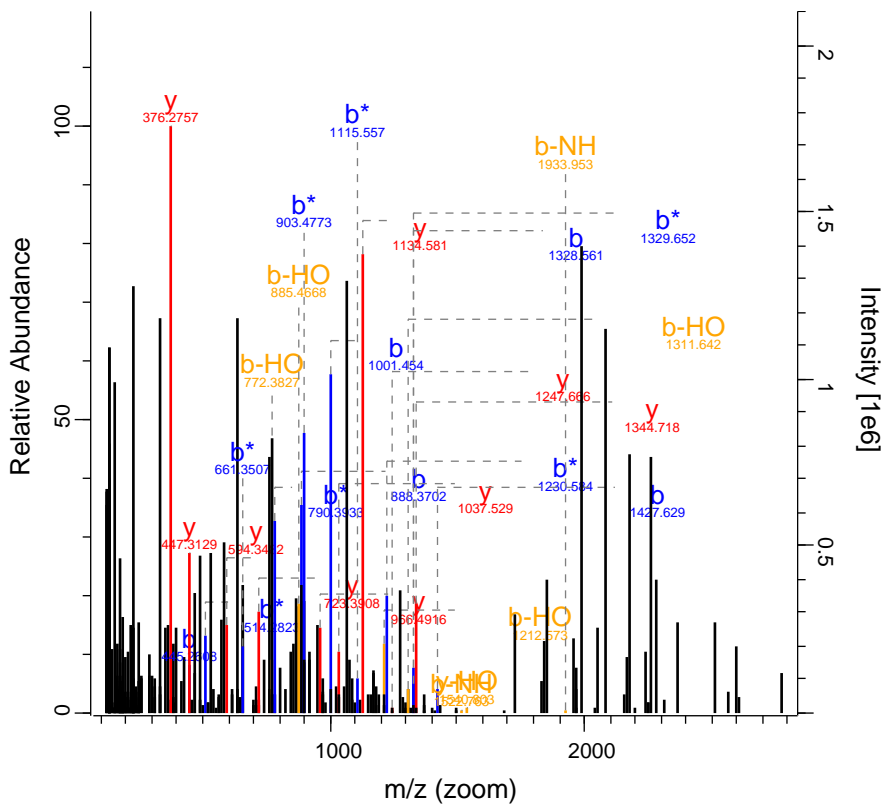

RO-QC-160121_ZackD_SS_Set_01_Fraction 38903 FTMS; HC 50.23 1076.26 CCNL1

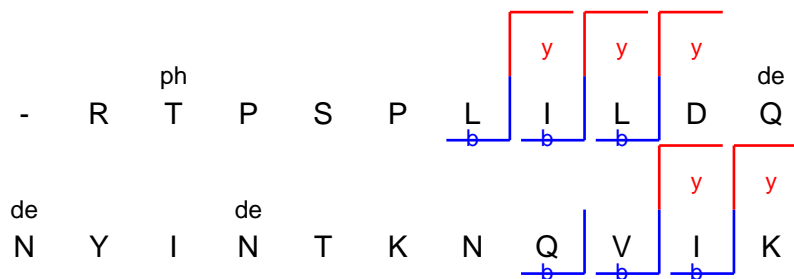
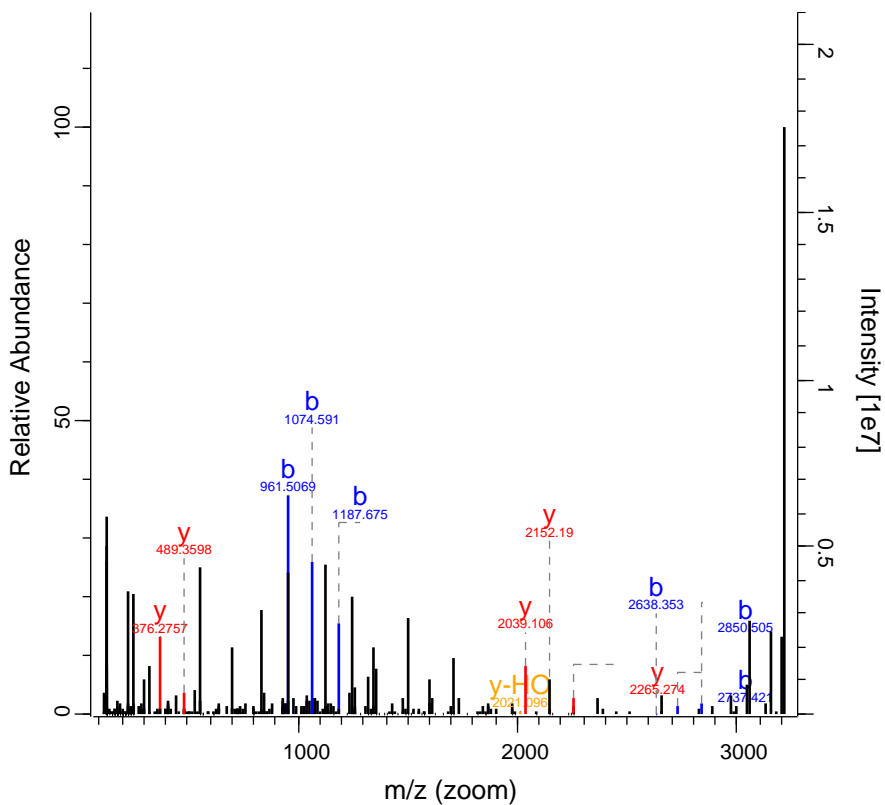

RO-QC-160121_ZackD_SS_Set_01_Fraction 40182 FTMS; HC 94.69 1017.52 FLEM1

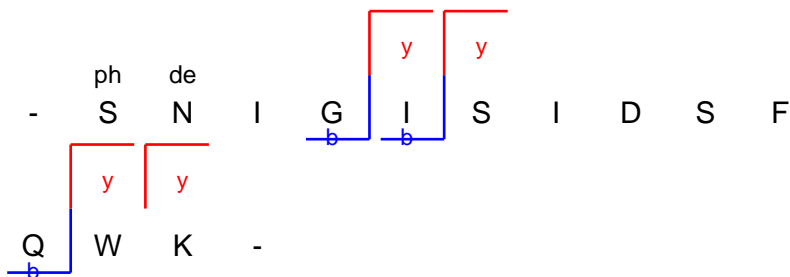
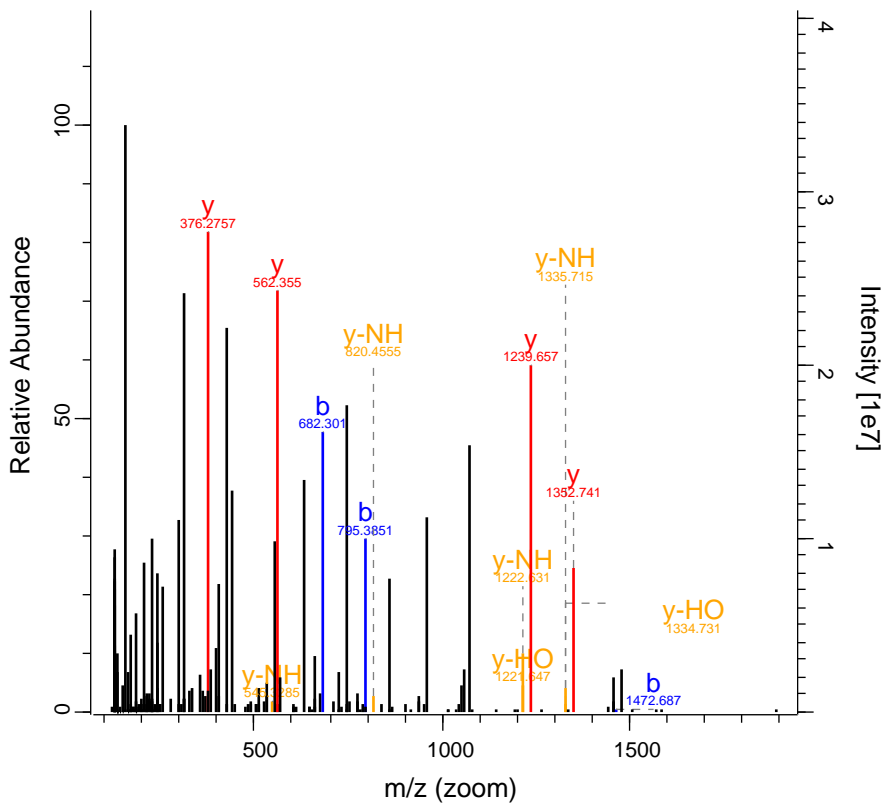

RO-QC-160121_ZackD_SS_Set_01_Fraction 40908 FTMS; HC 61.38 1440.68 TCF7L1

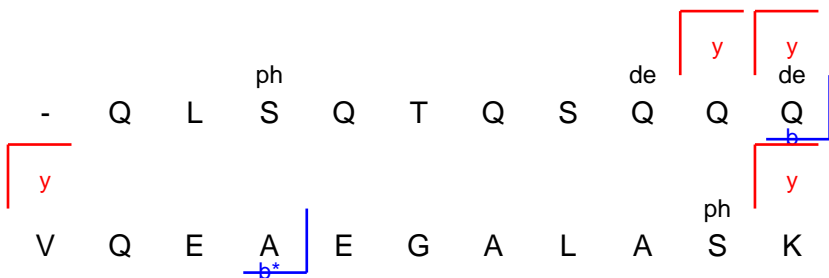
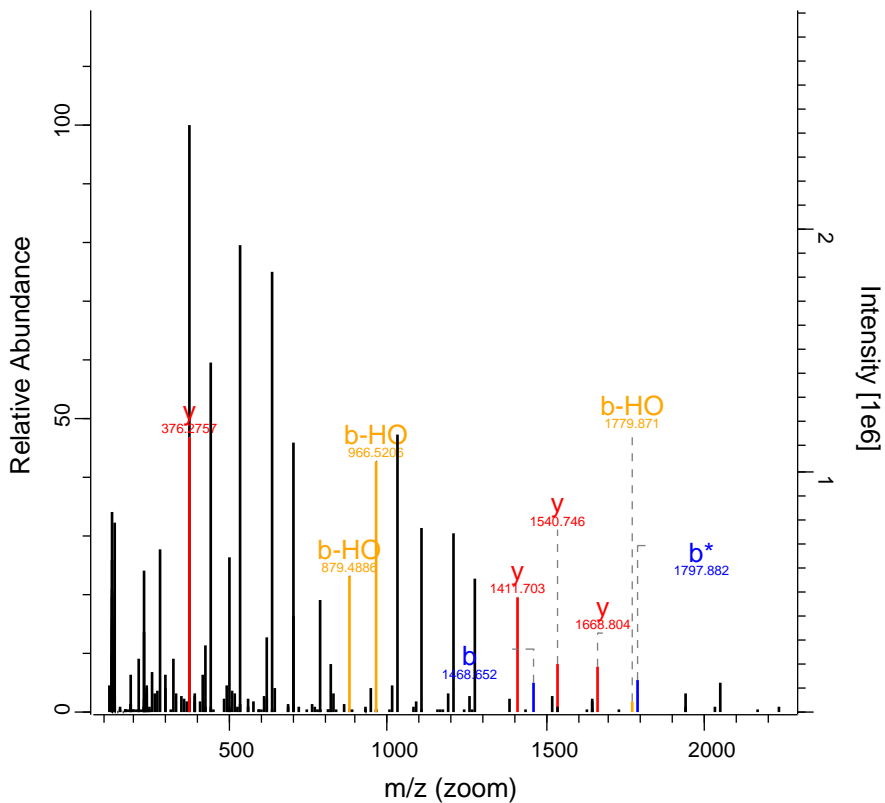

RO-QC-160121_ZackD_SS_Set_01_Fraction 4891 FTMS; HC 43.38 552.31 PADI4

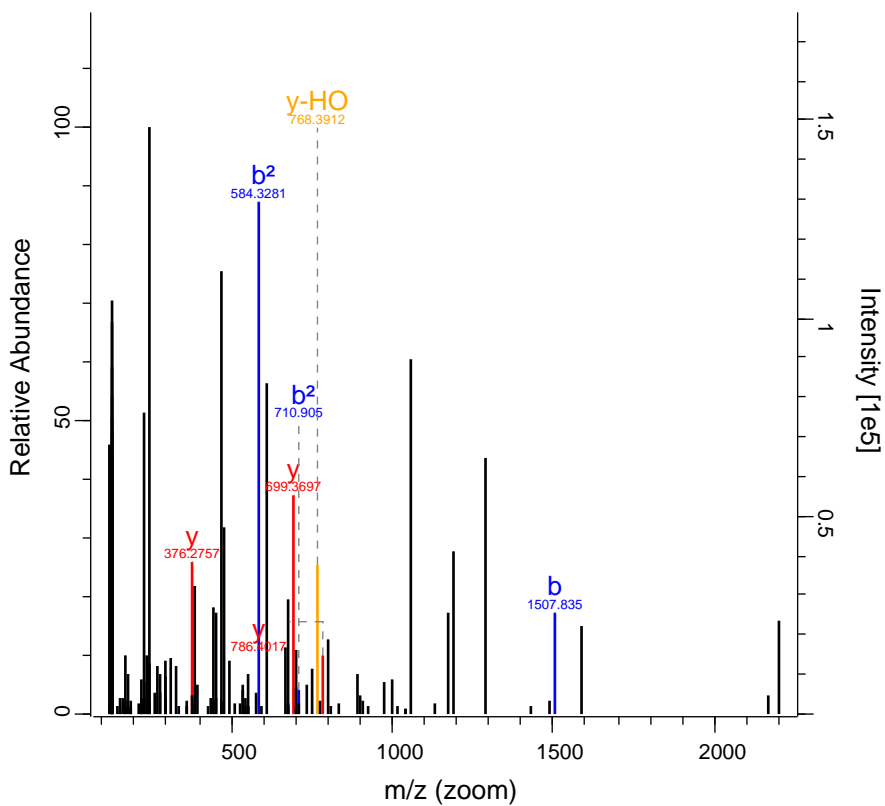

RO-QC-160121_ZackD_SS_Set_01_Fraction 4940 FTMS; HC 92.26 686.34 LMNA

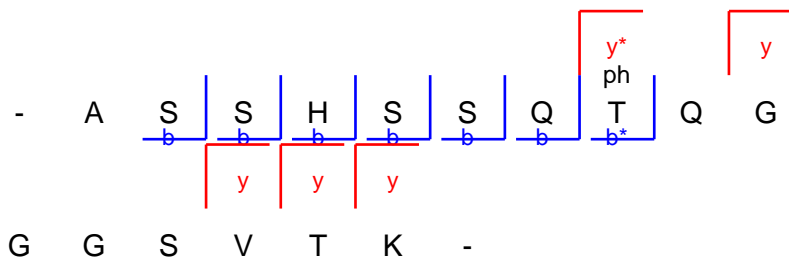
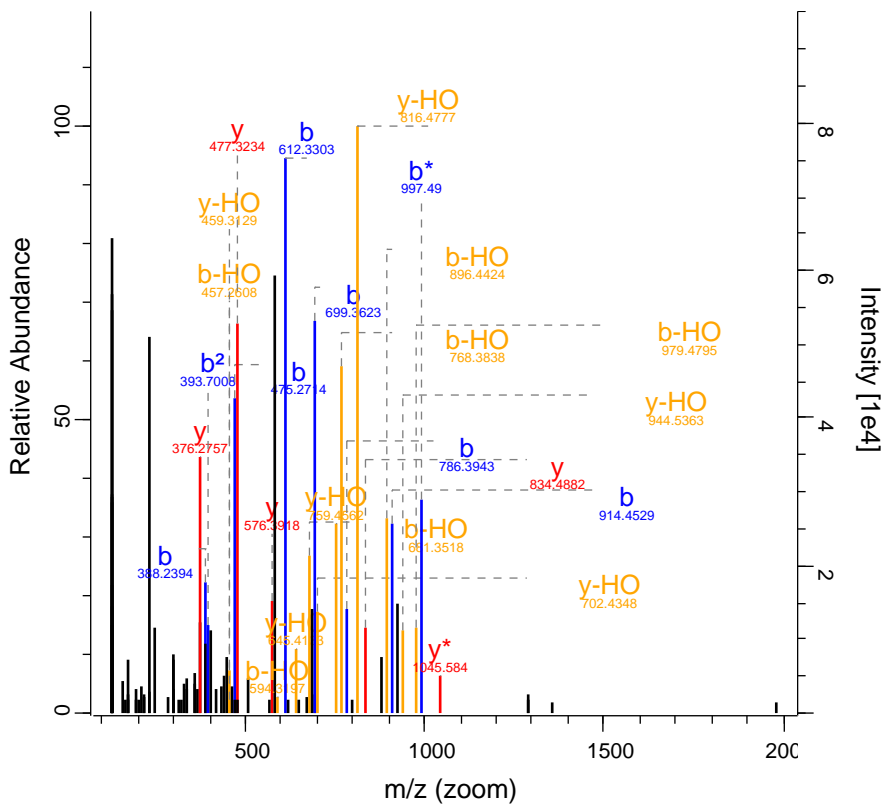

RO-QC-160121_ZackD_SS_Set_01_Fraction 5131 FTMS; HC 58.51 512.93 TNIK

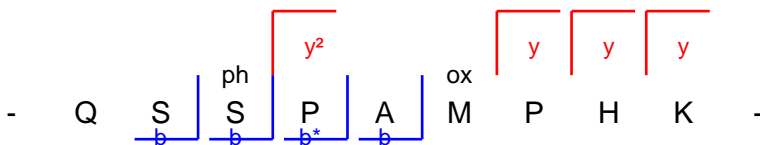
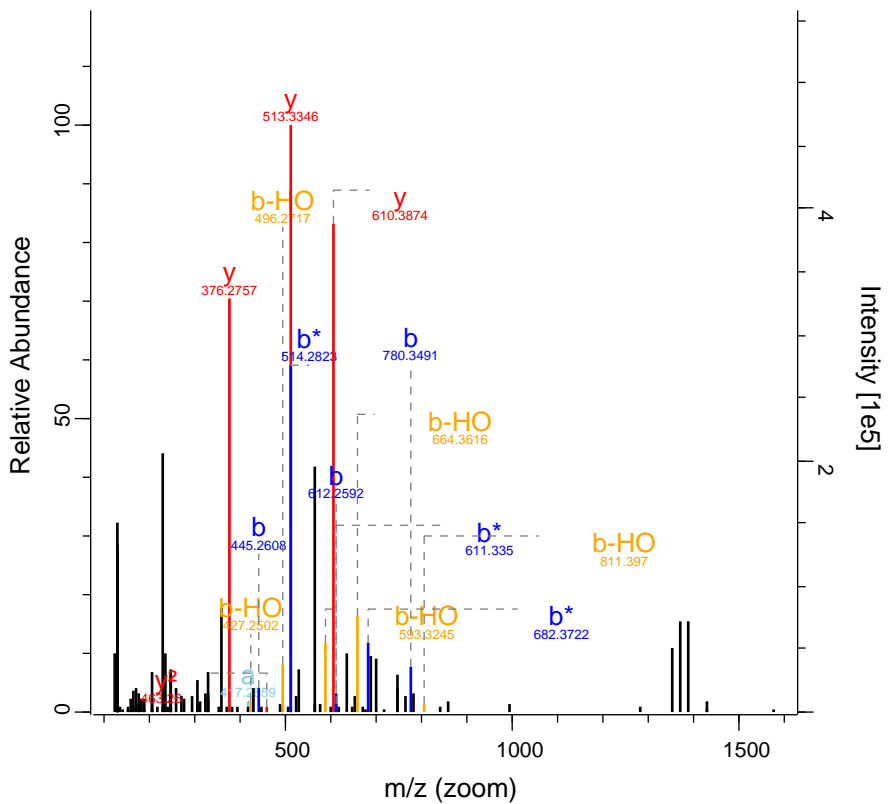

RO-QC-160121_ZackD_SS_Set_01_Fraction 5606 FTMS; HC 121.68 807.42 GTF2I

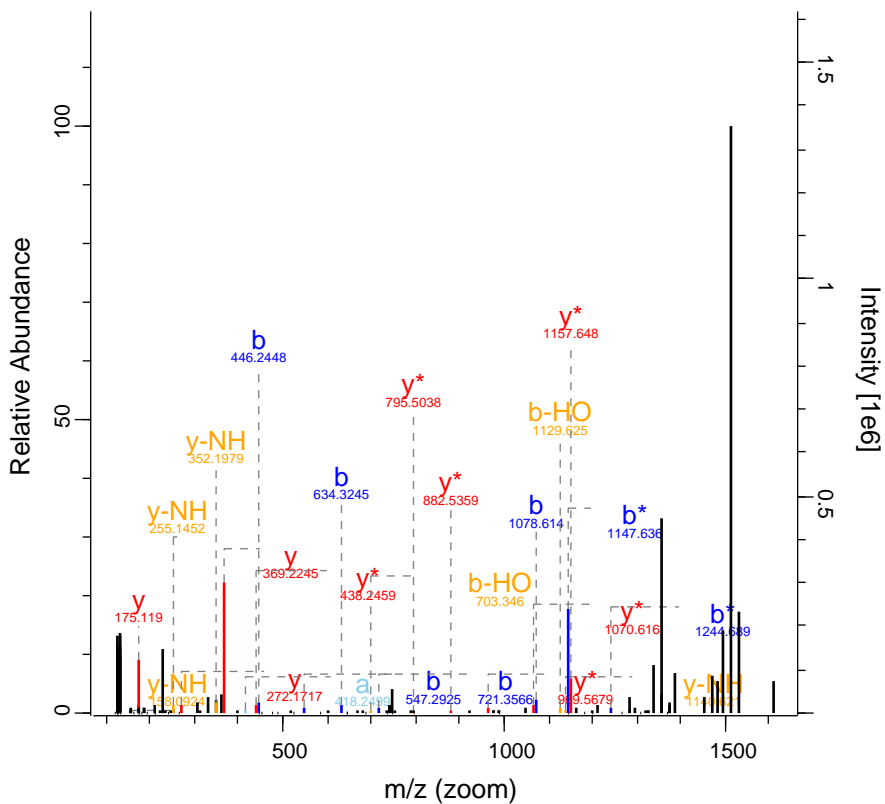

RO-QC-160121_ZackD_SS_Set_01_Fraction 5777 FTMS; HC 138.45 568.29 ABCC1

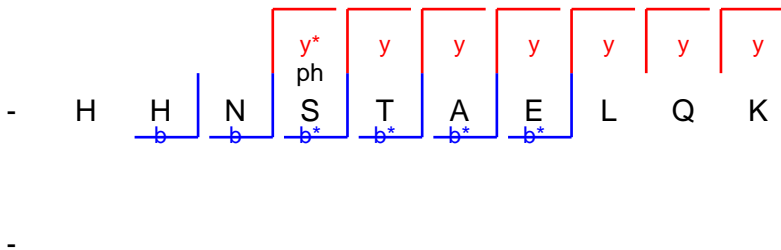
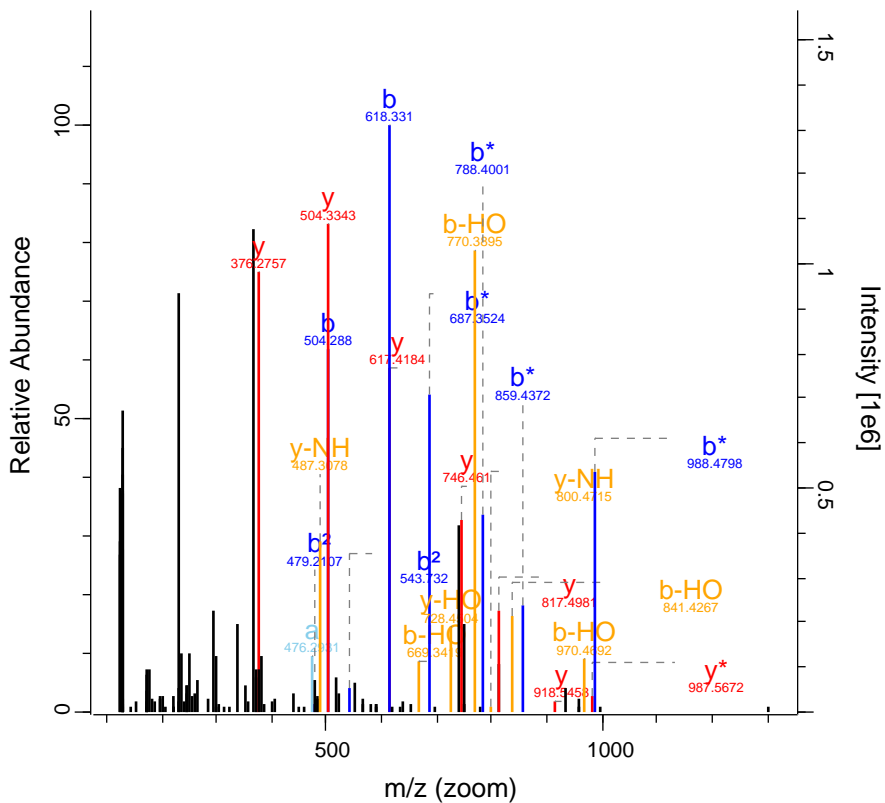

RO-QC-160121_ZackD_SS_Set_01_Fraction 5861 FTMS; HC 46.43 540.93 FAM65A

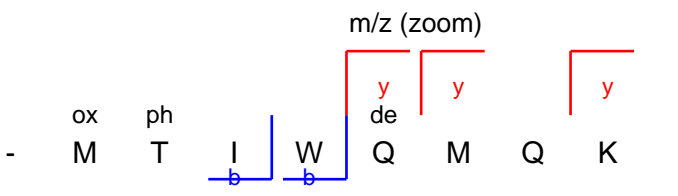
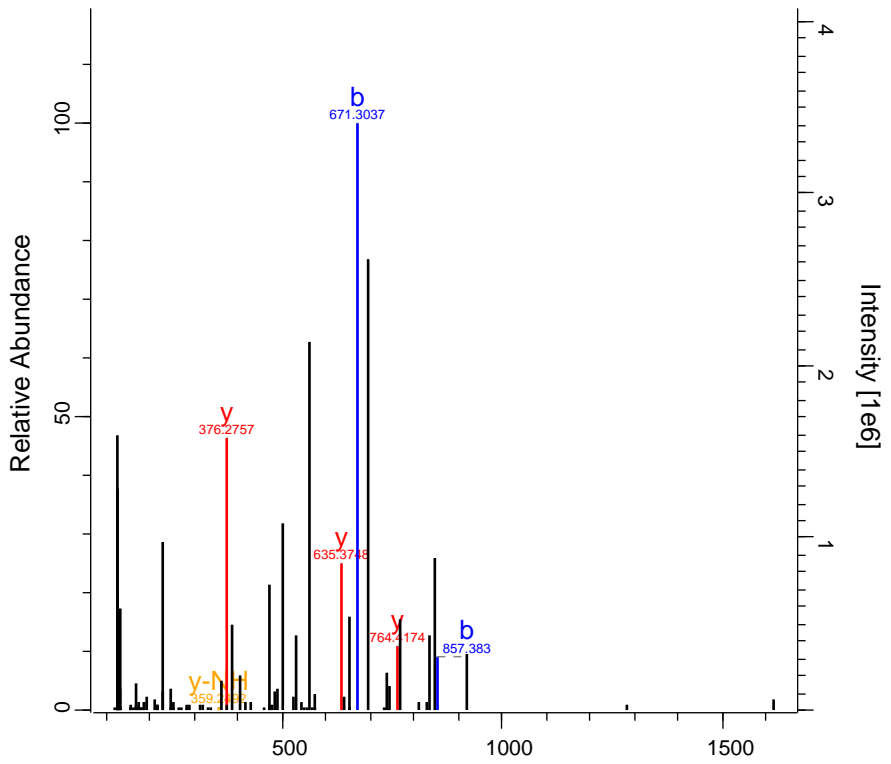

RO-QC-160121_ZackD_SS_Set_01_Fraction_6346 FTMS; HC 106.58 629.8 RABGEF1

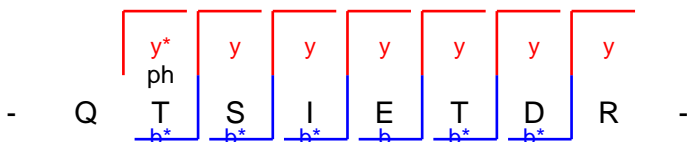
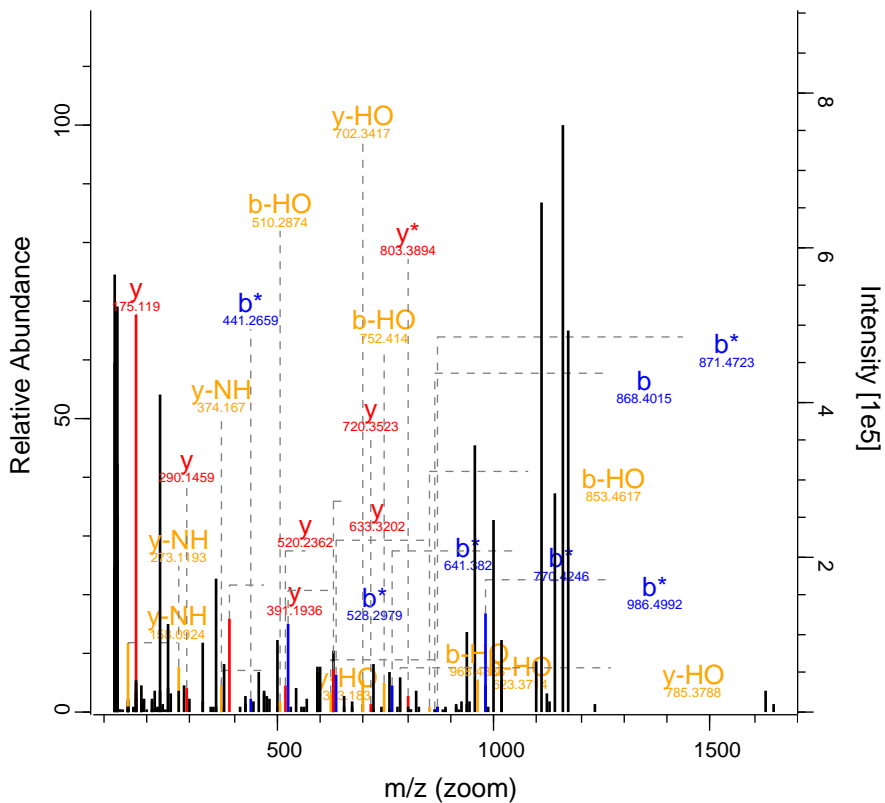

Raw File	Scan	Method	Score	m/z
RO-QC-160121_ZackD_SS_Set_01_Fraction_11	8021	FTMS; HCD	52.4	795.4

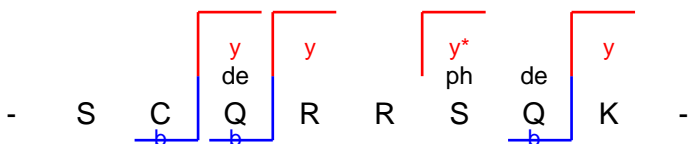
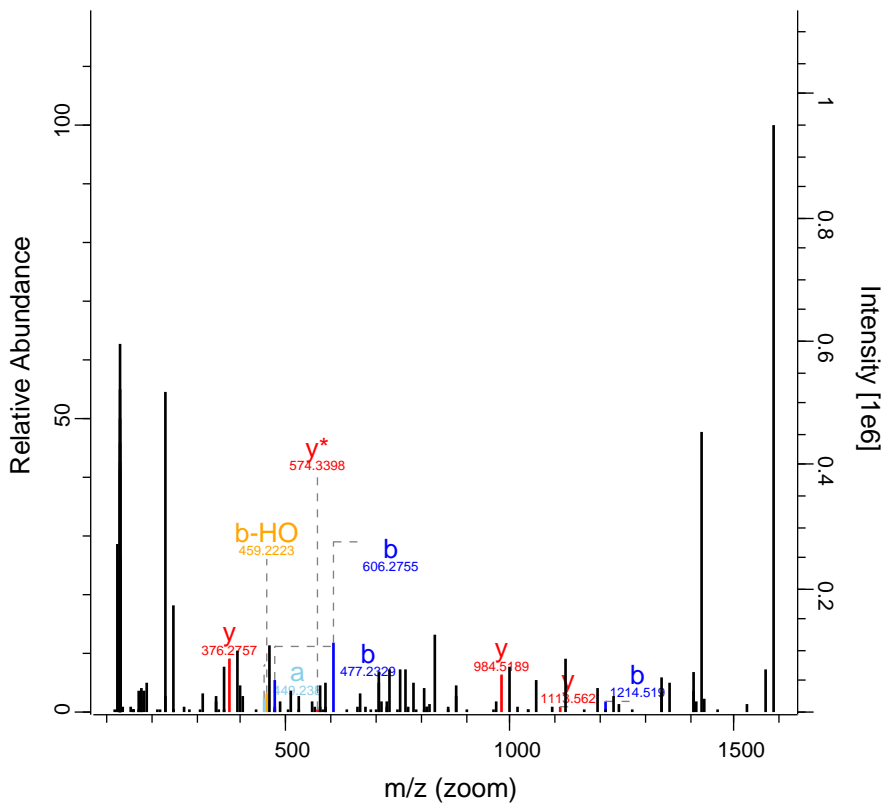

RO-QC-160121_ZackD_SS_Set_01_Fraction 8386 FTMS; HC 45.14 751.89 LRRRC74A

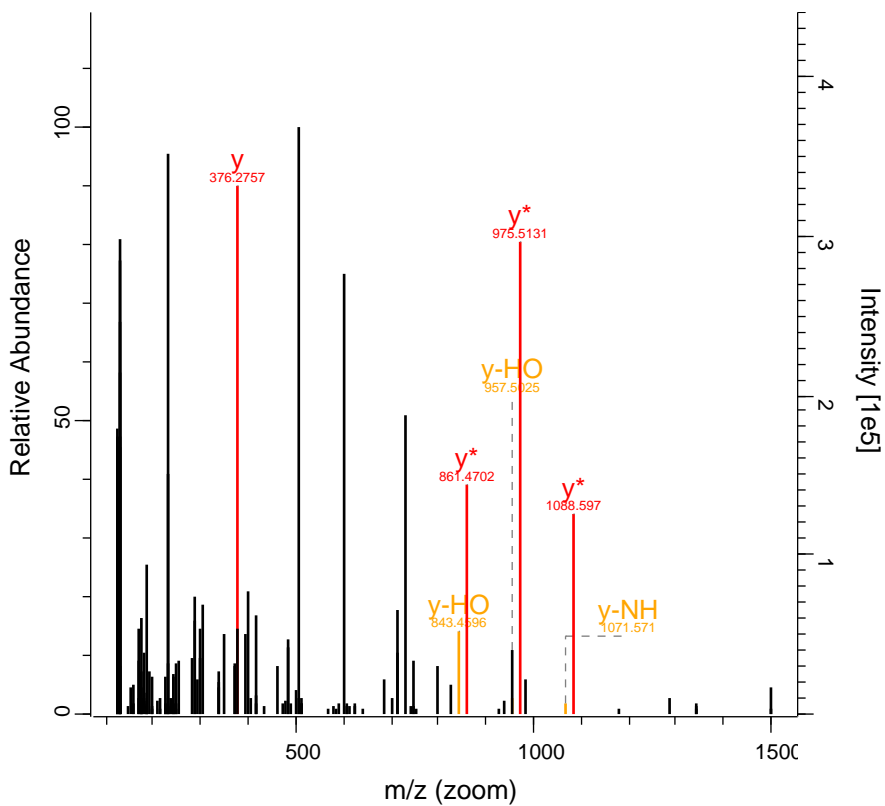

m/z (zoom)

y* y* y*

ph

ox

y

- S L N P T G T M K -

RO-QC-160121_ZackD_SS_Set_01_Fraction 9084 FTMS; HC 139.32 641.32 LMNA

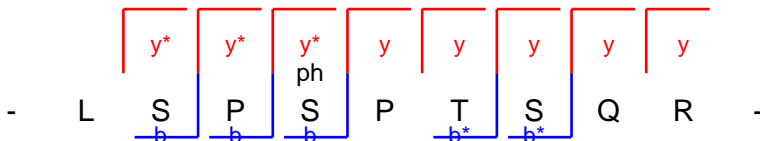
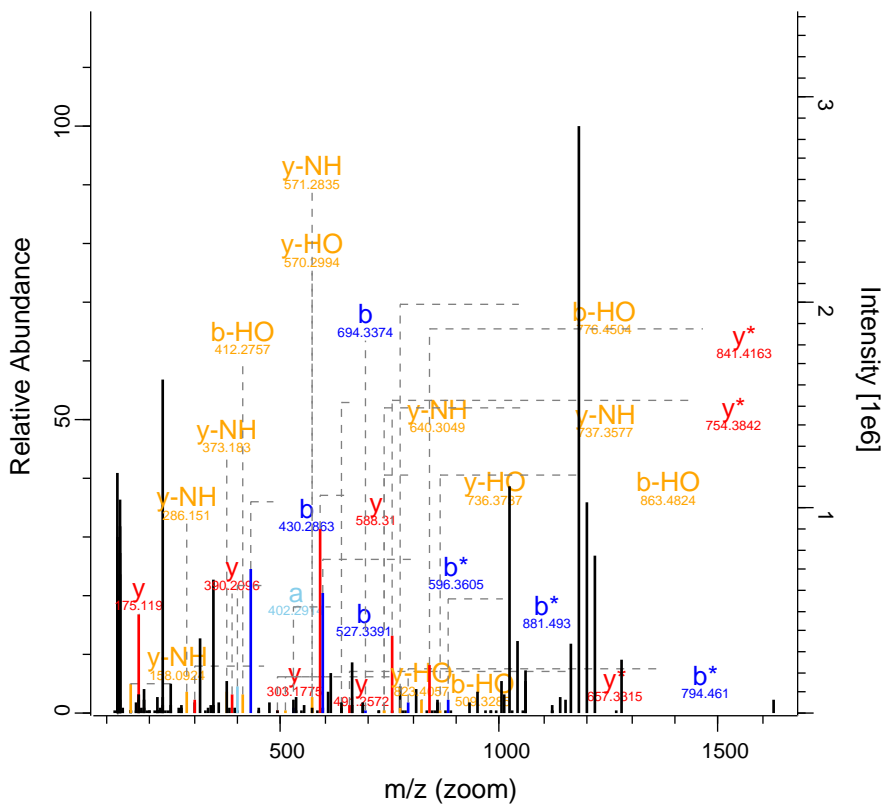

RO-QC-160121_ZackD_SS_Set_01_Fraction10283 FTMS; HC 106.67 841.95 ACIN1

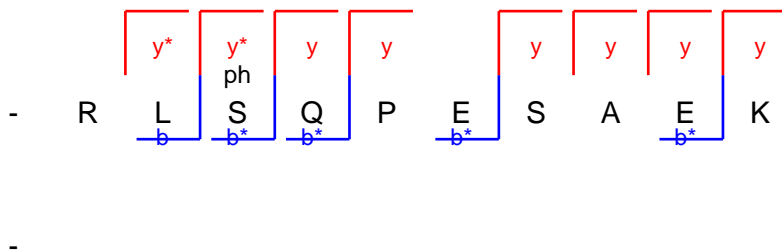
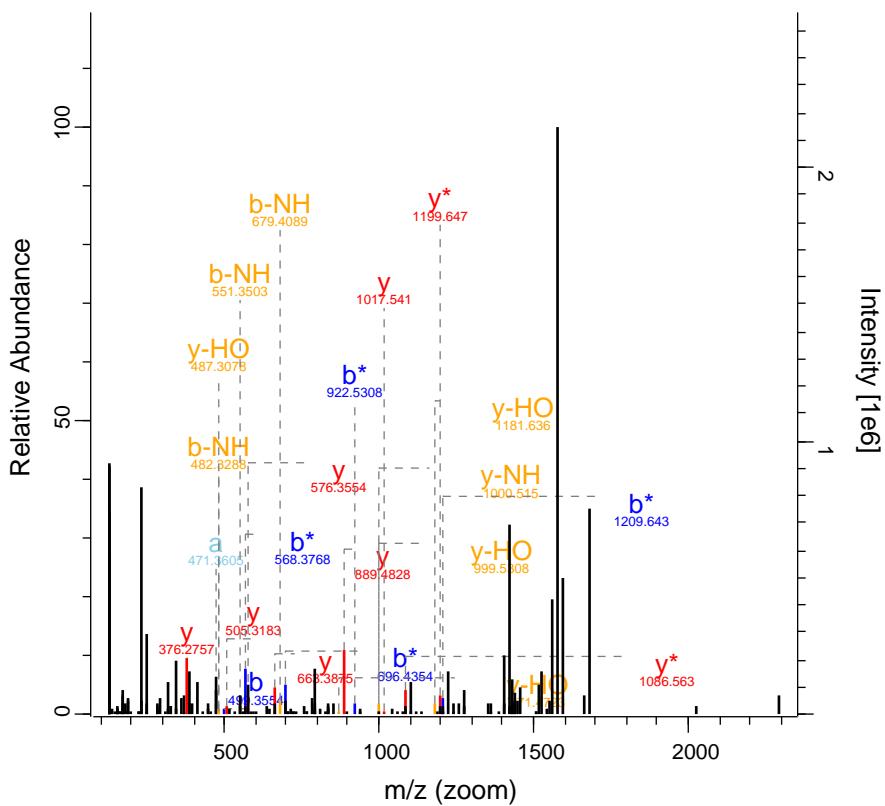

RO-QC-160121_ZackD_SS_Set_01_Fraction1 11015 FTMS; HC 42.21 476.47 C6orf165

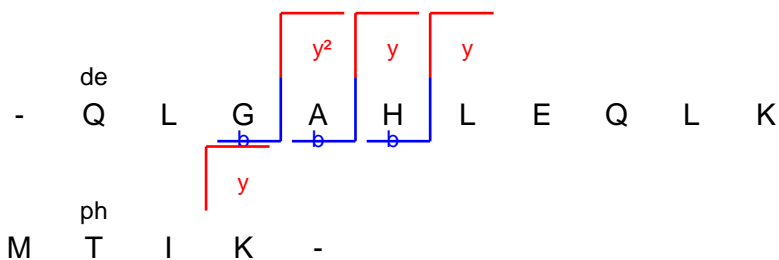
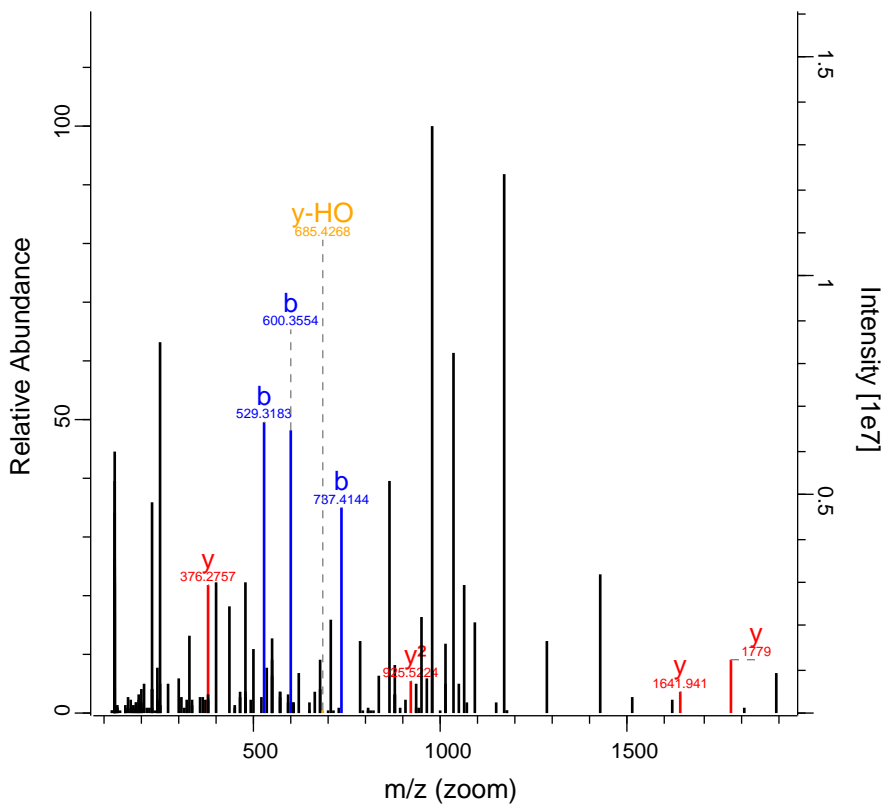

RO-QC-160121_ZackD_SS_Set_01_Fraction1 13952 FTMS; HC 77.22 638.67 CLASP2

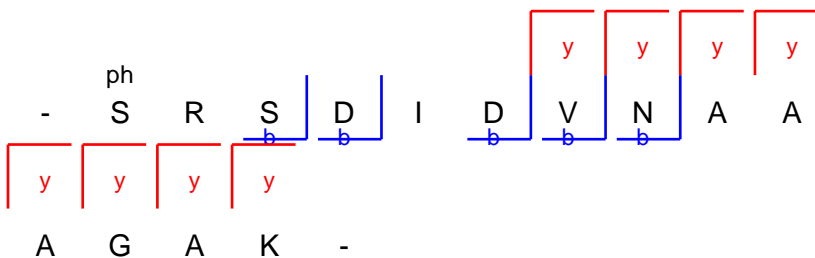
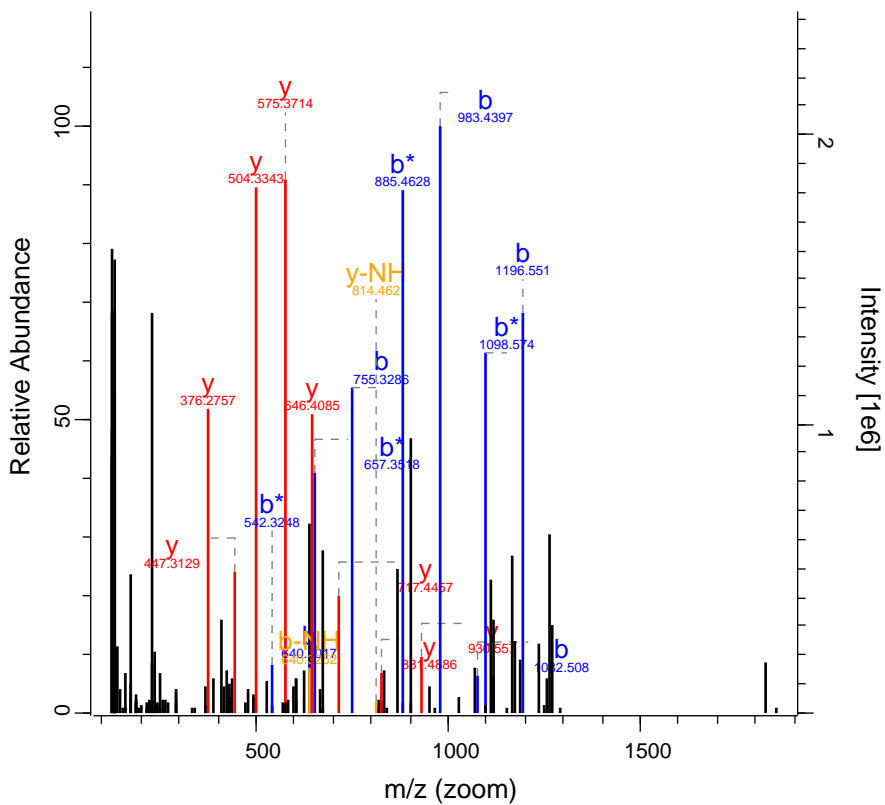

RO-QC-160121_ZackD_SS_Set_01_Fraction 14213 FTMS; HC 77.15 788.47 NOP2

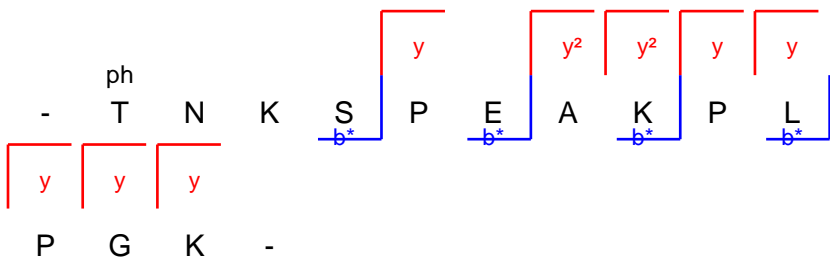
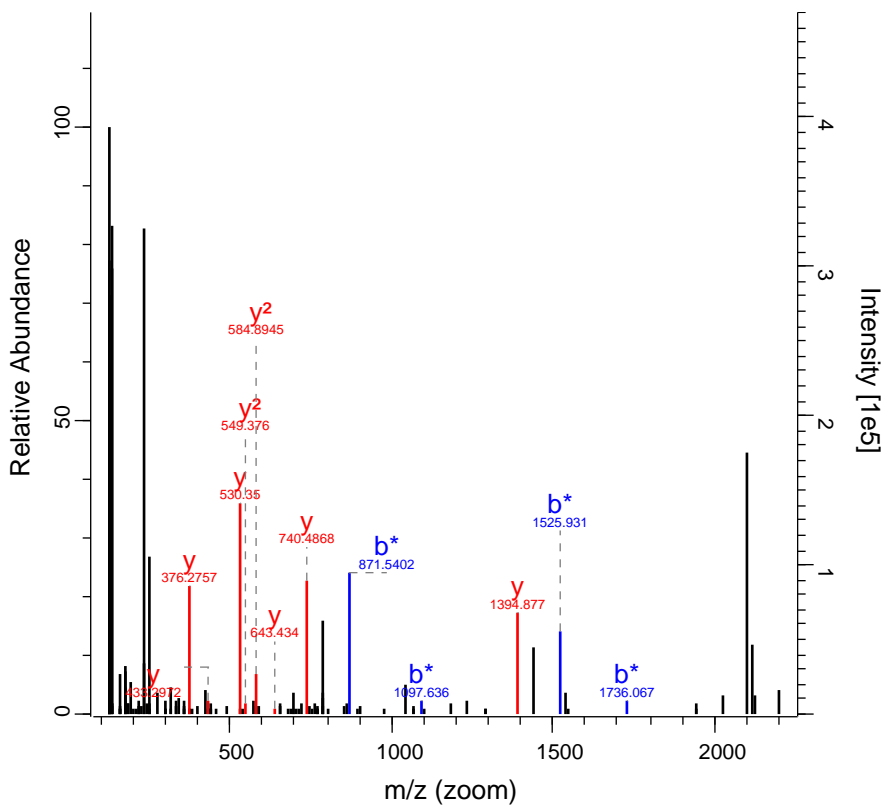

RO-QC-160121_ZackD_SS_Set_01_Fraction1 16560 FTMS; HC 85.76 659.84 IRS2

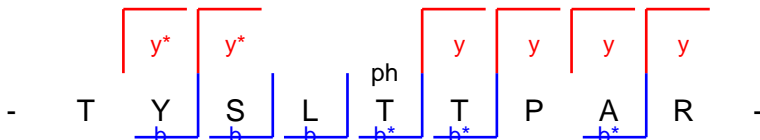
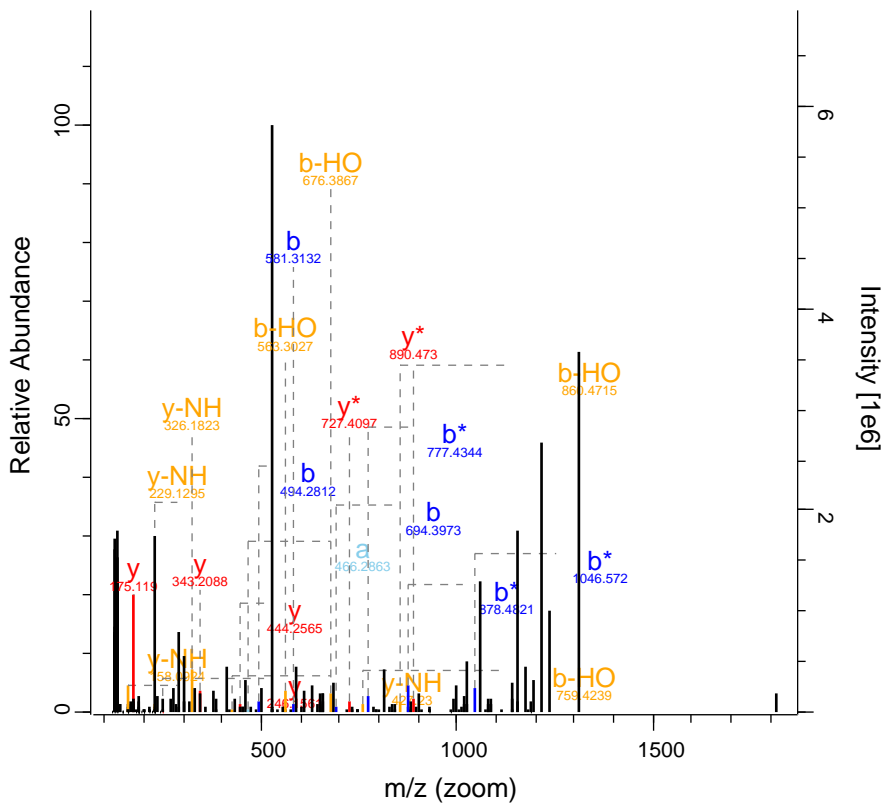

RO-QC-160121_ZackD_SS_Set_01_Fraction1 16693 FTMS; HC 69.52 661.36 NRD1

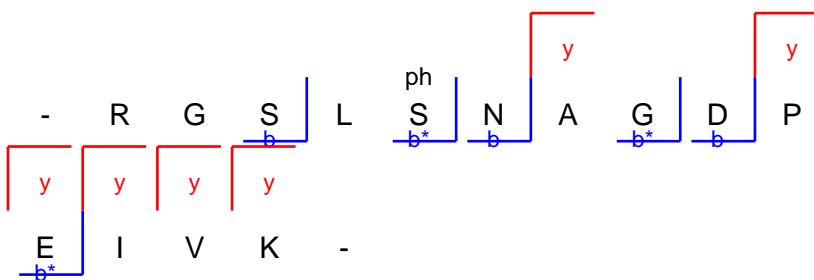
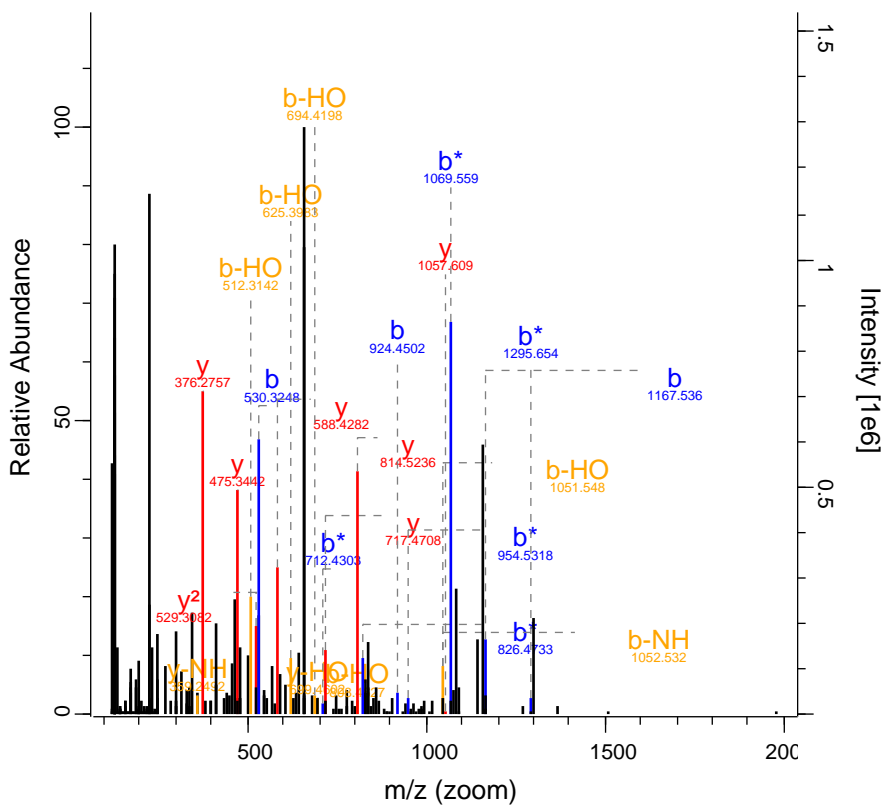

RO-QC-160121_ZackD_SS_Set_01_Fraction 17232 FTMS; HC 71.02 876.96 DAP

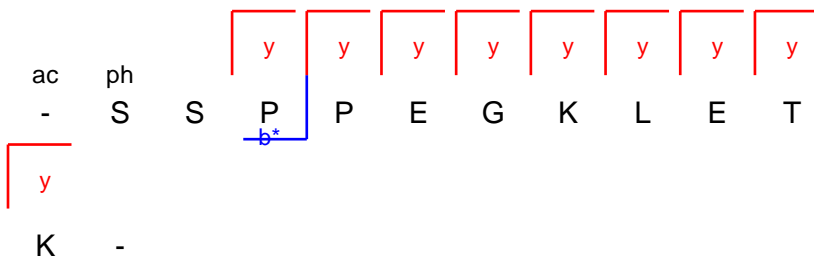
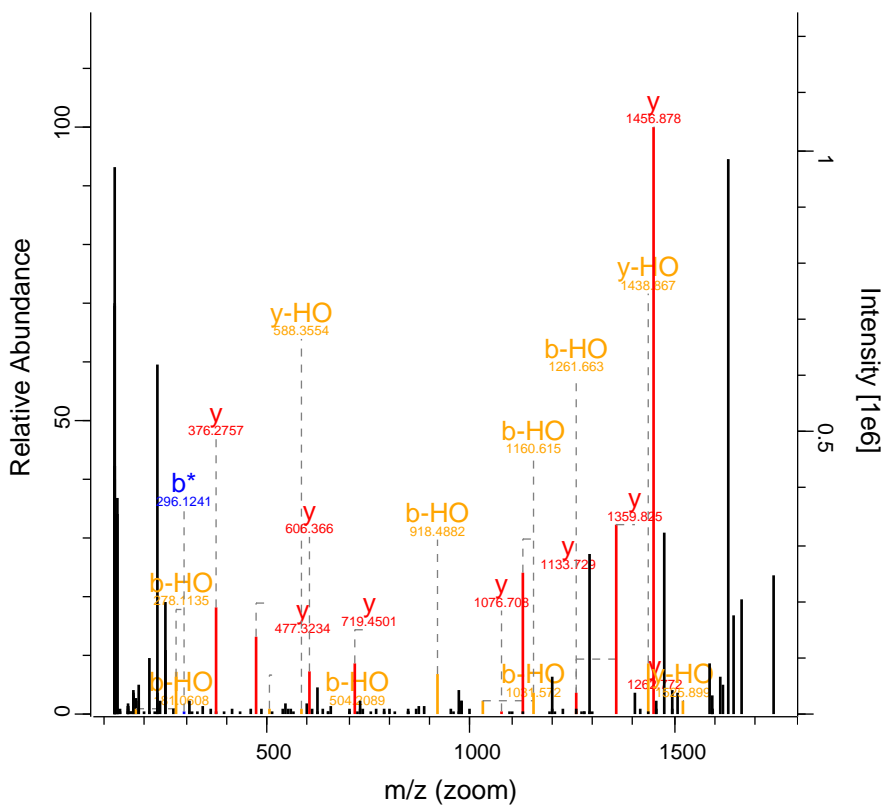

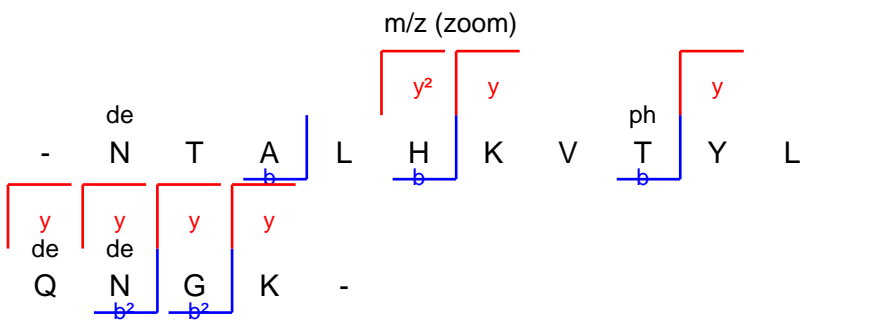
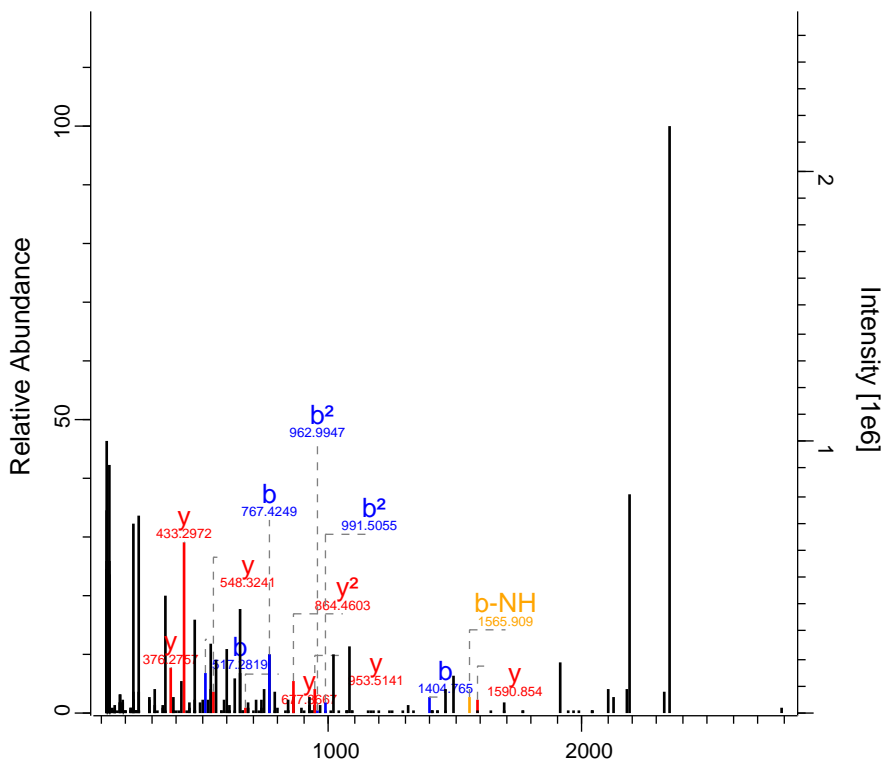

RO-QC-160121_ZackD_SS_Set_01_Fraction19103 FTMS; HC 136.81 793.42 FCHO2

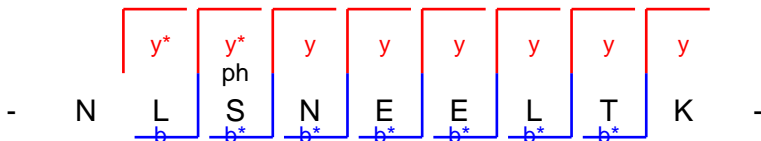
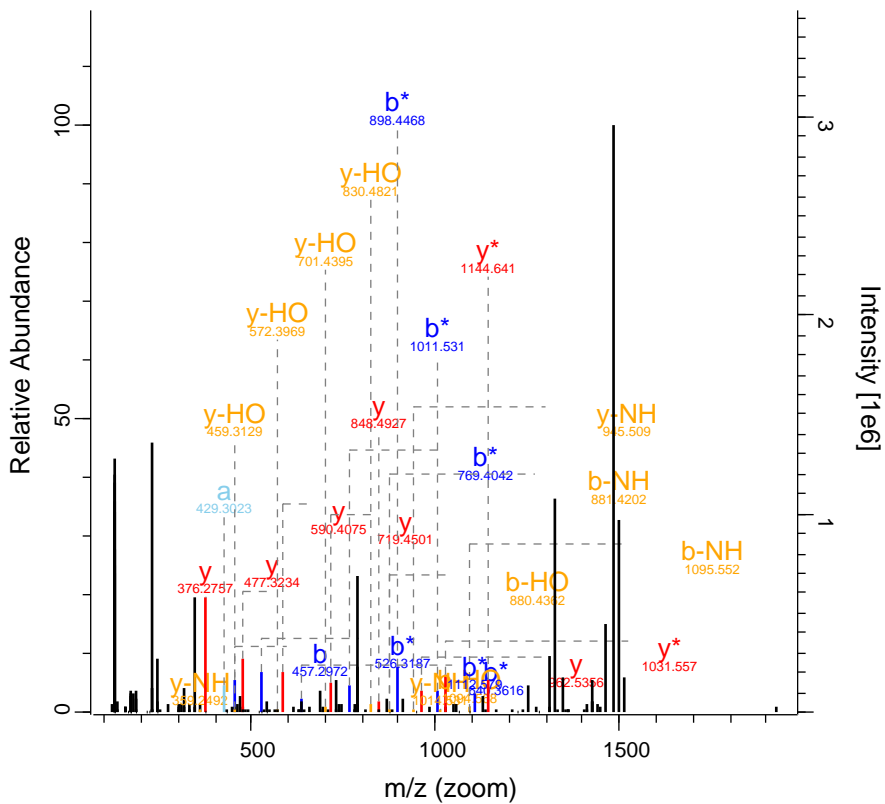

RO-QC-160121_ZackD_SS_Set_01_Fraction19377 FTMS; HC 141.88 764.41 TEX2

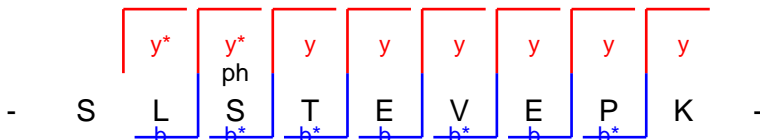
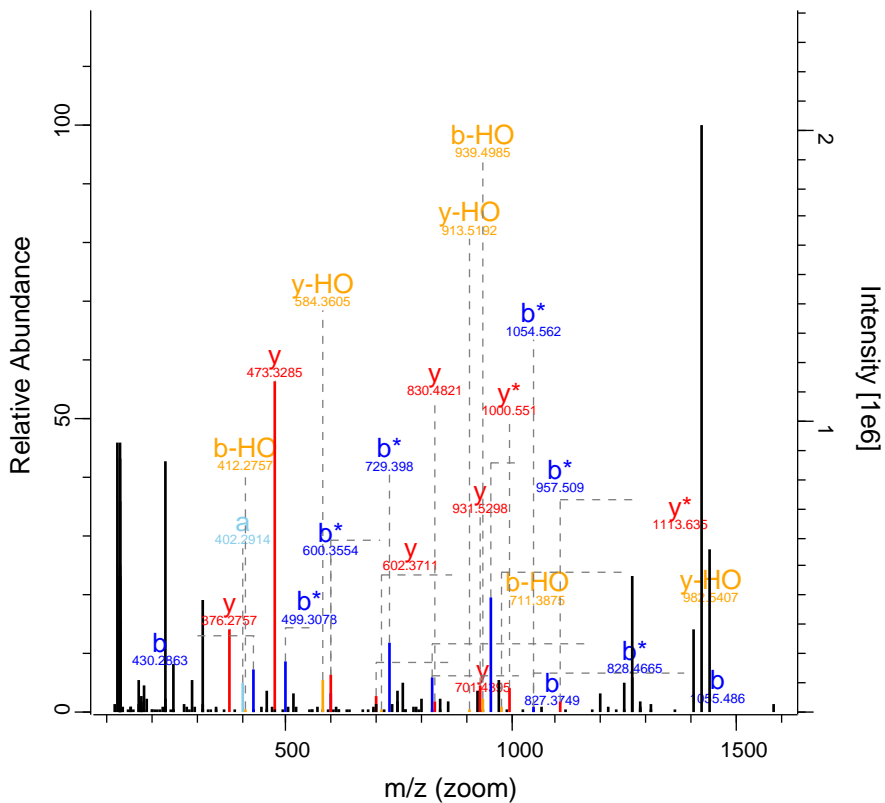

RO-QC-160121_ZackD_SS_Set_01_Fraction19602 FTMS; HC 89.8 839.41 STX7

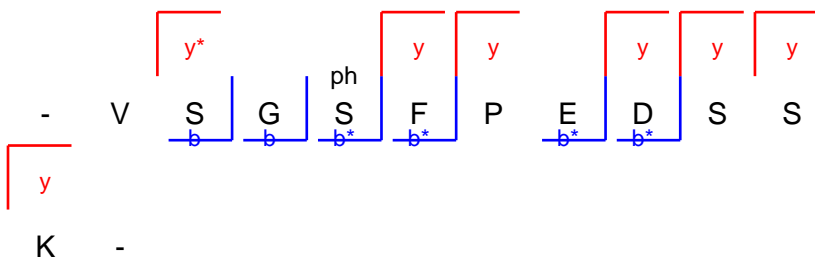
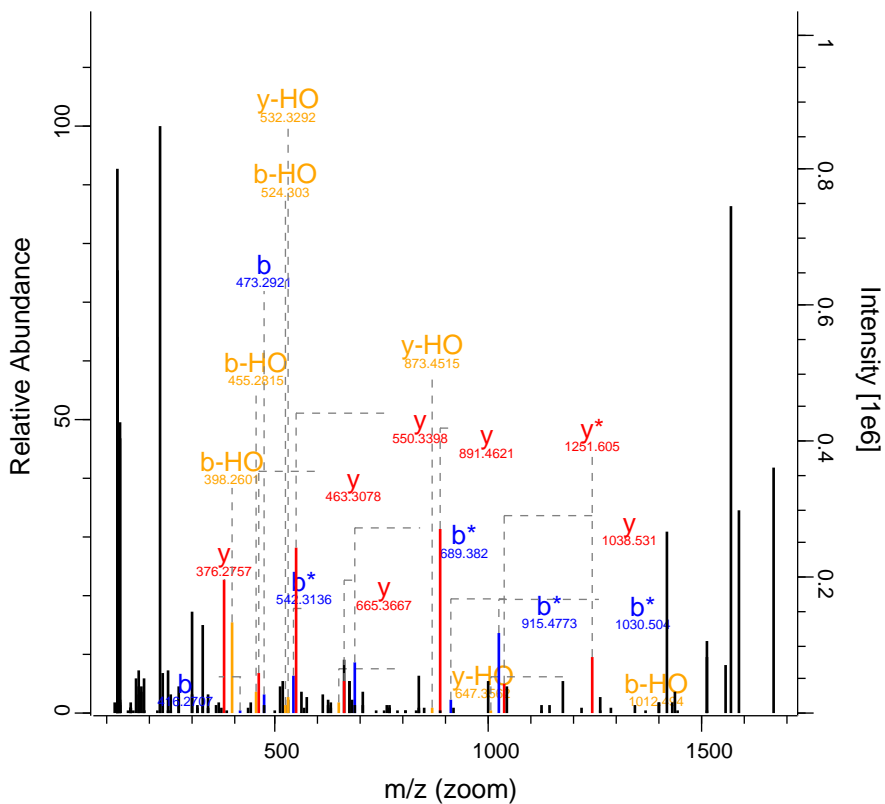

K

RO-QC-160121_ZackD_SS_Set_01_Fraction 21005 FTMS; HC 58.72 749.92 STX12

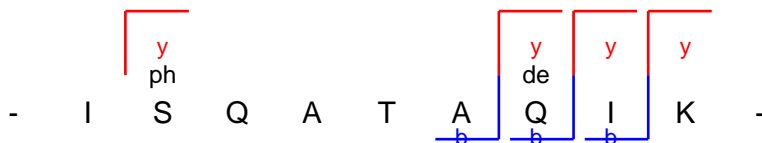
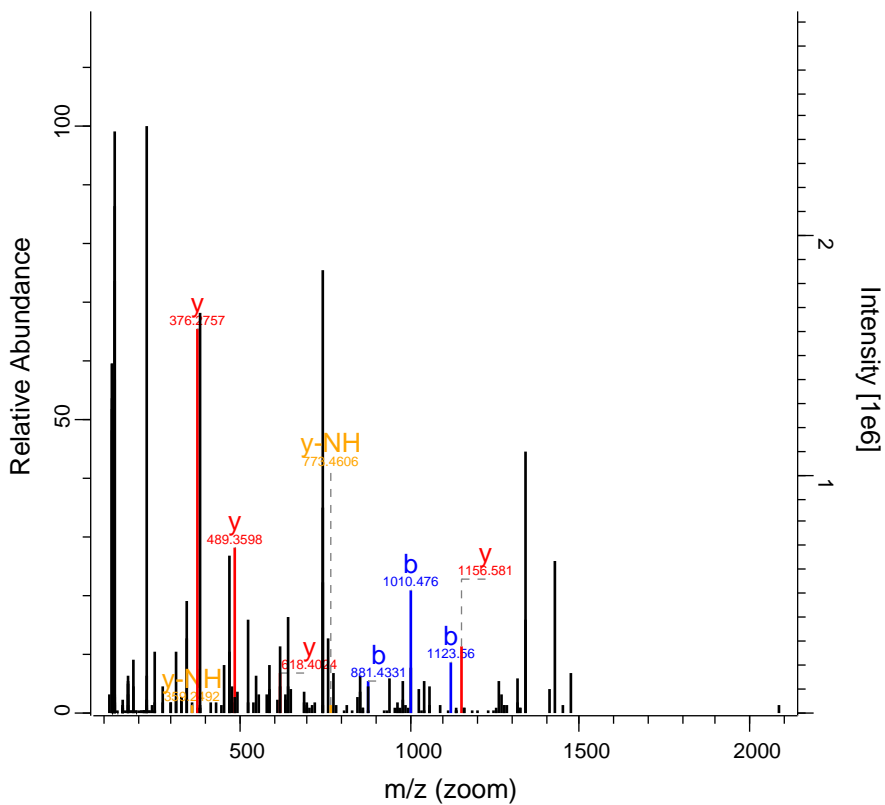

RO-QC-160121_ZackD_SS_Set_01_Fraction 22783 FTMS; HC 77.67 806.45 GSDMA

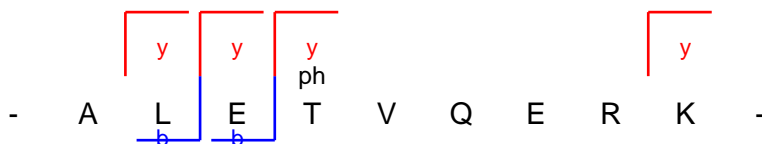
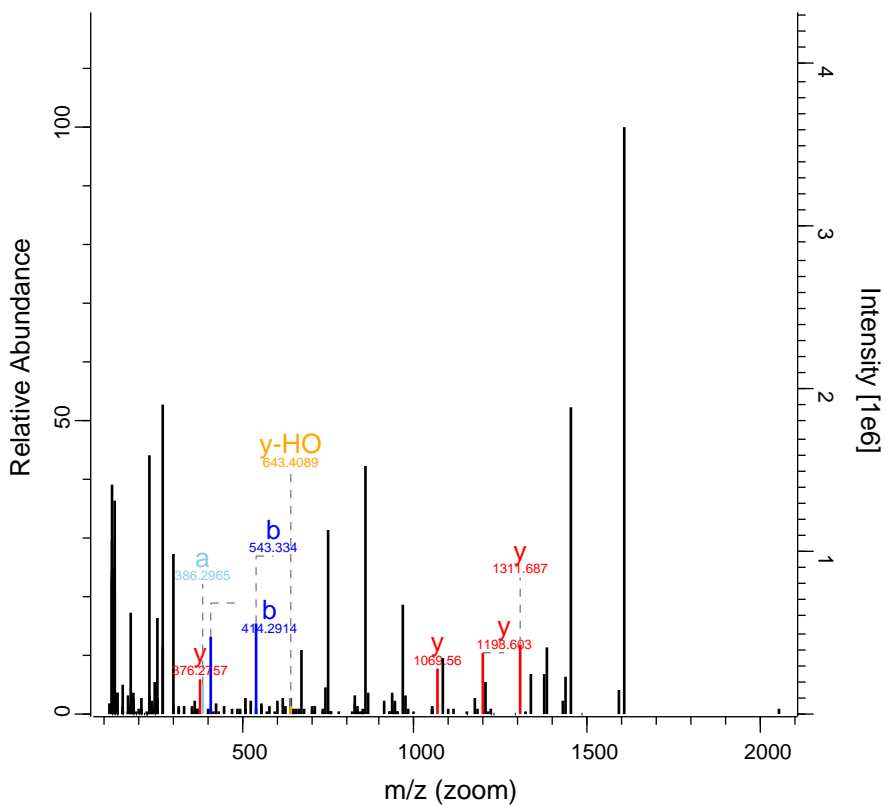

RO-QC-160121_ZackD_SS_Set_01_Fraction 25637 FTMS; HC 174.71 747.38 PGM2

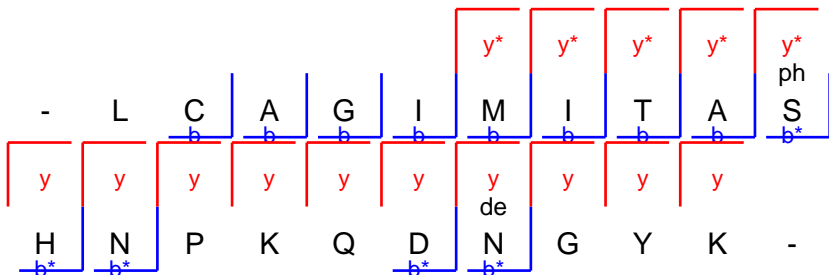
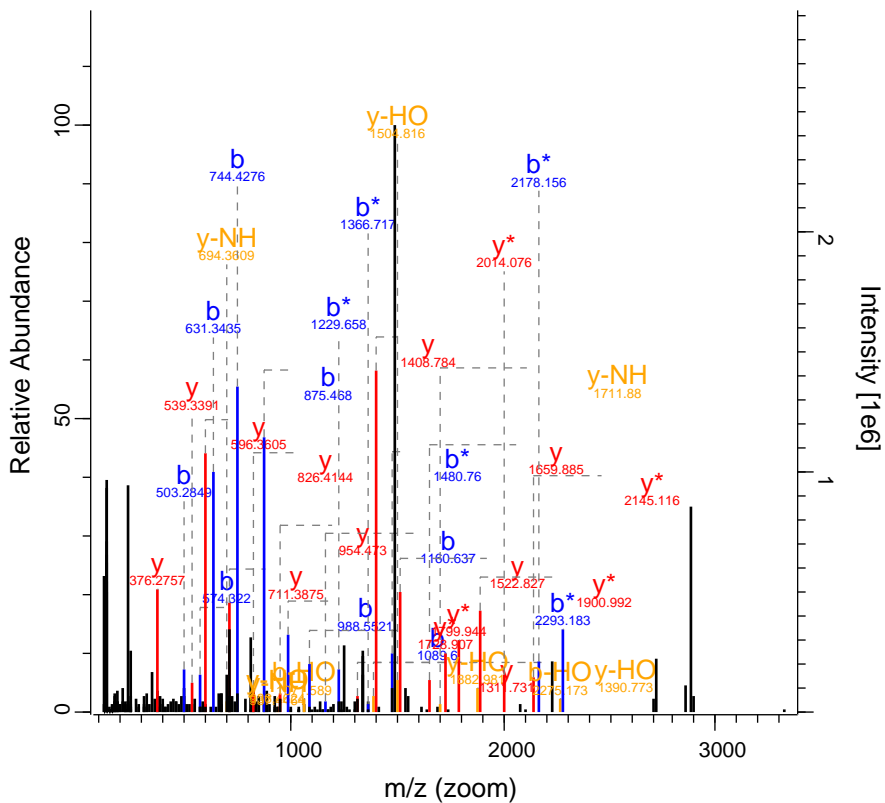

RO-QC-160121_ZackD_SS_Set_01_Fraction 25863 FTMS; HC 100.45 642.37 RASSF8

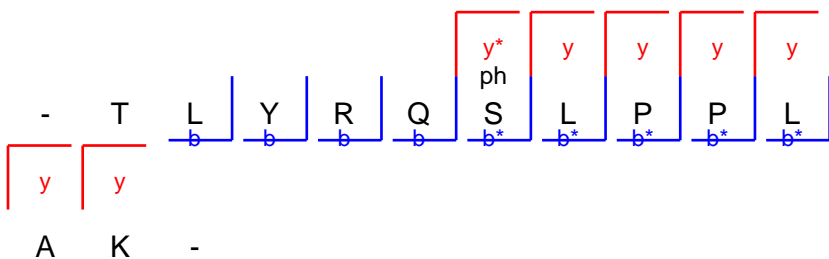
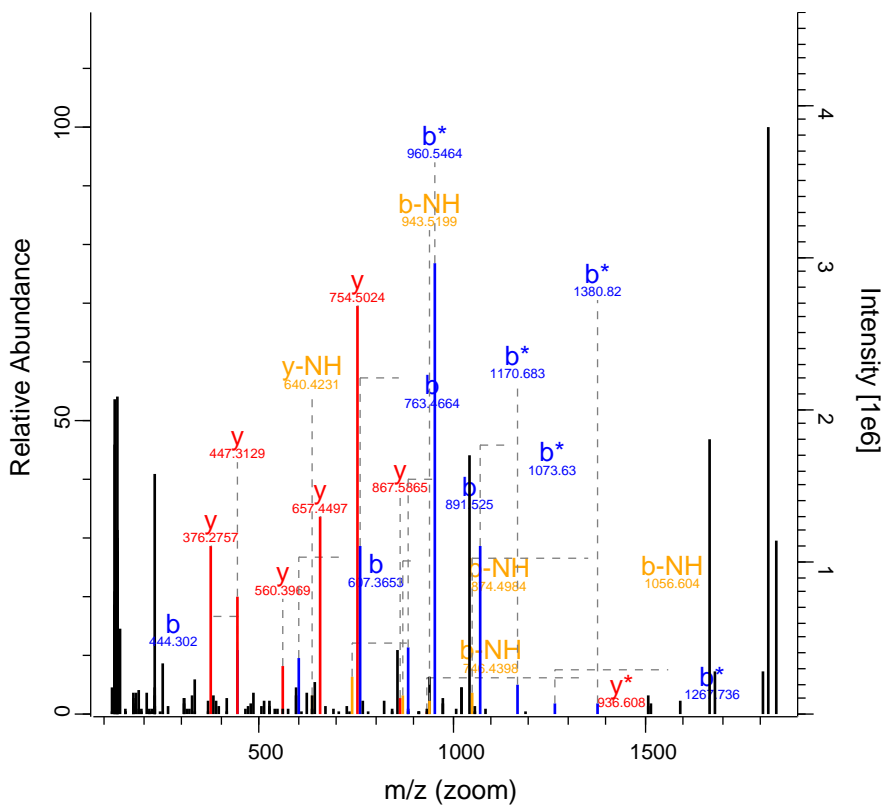

RO-QC-160121_ZackD_SS_Set_01_Fraction_11

26500 FTMS; HCD 44.3 533.54

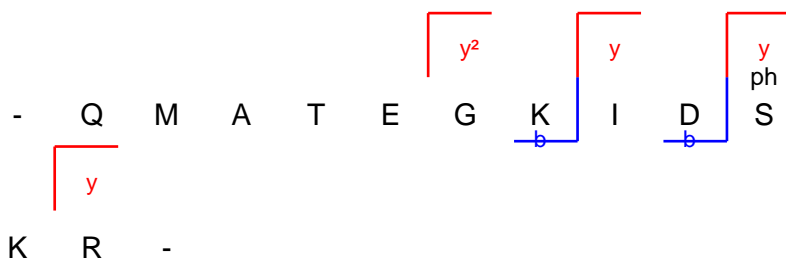
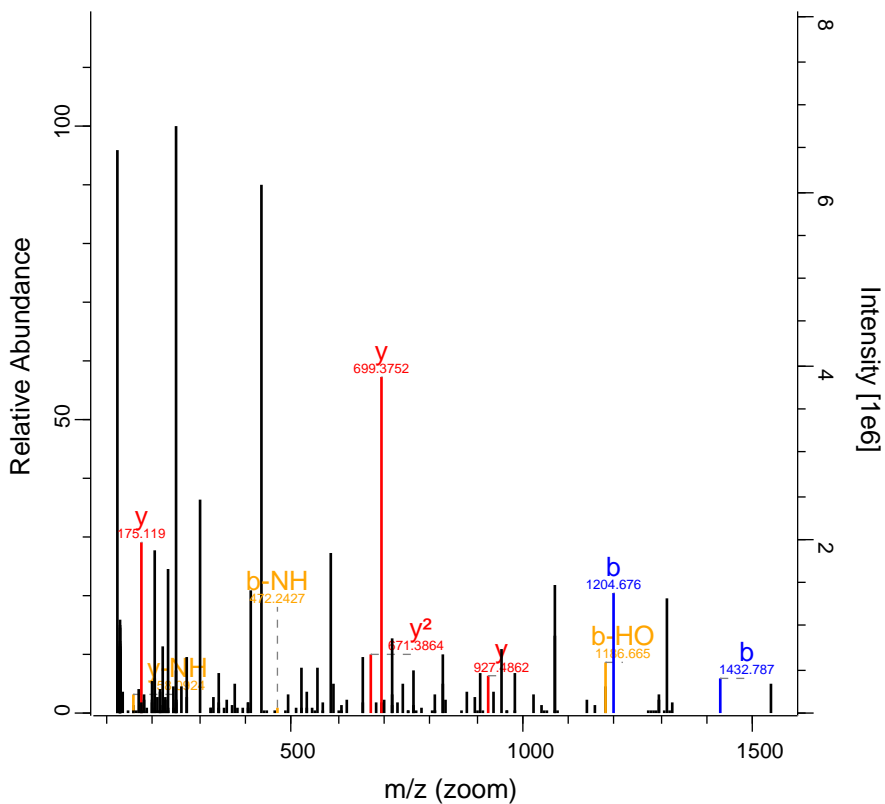

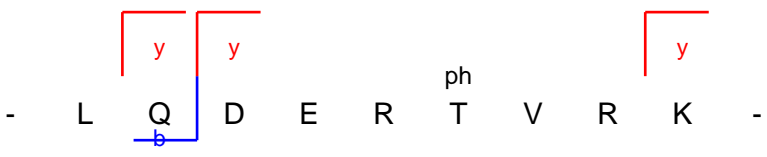
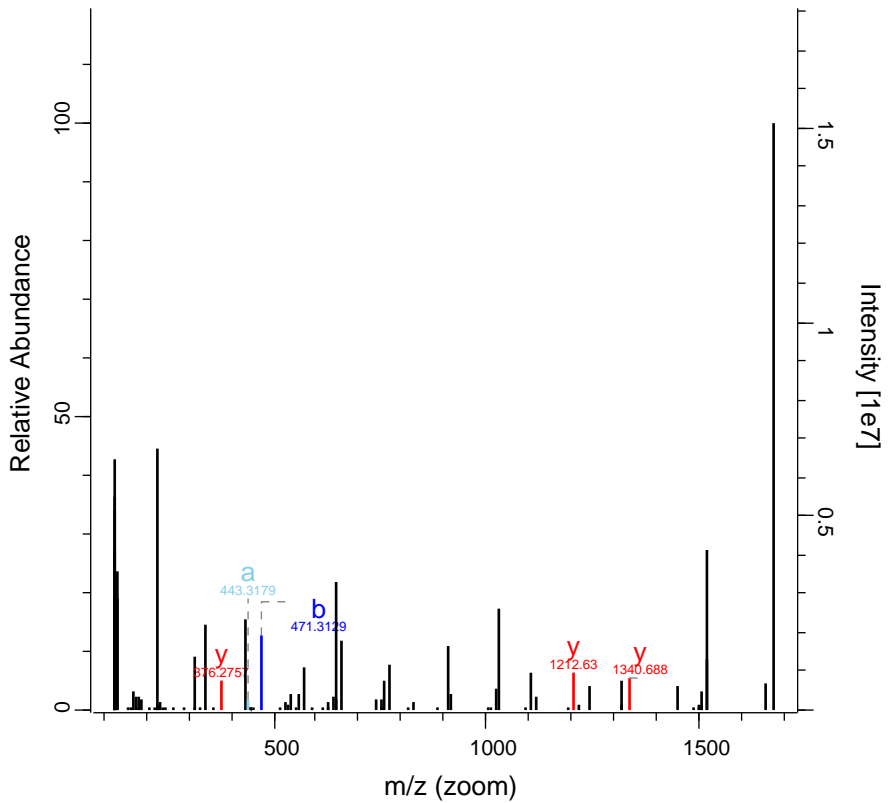

RO-QC-160121_ZackD_SS_Set_01_Fraction 27592 FTMS; HC 180.48 923.71 RAB11FIP1

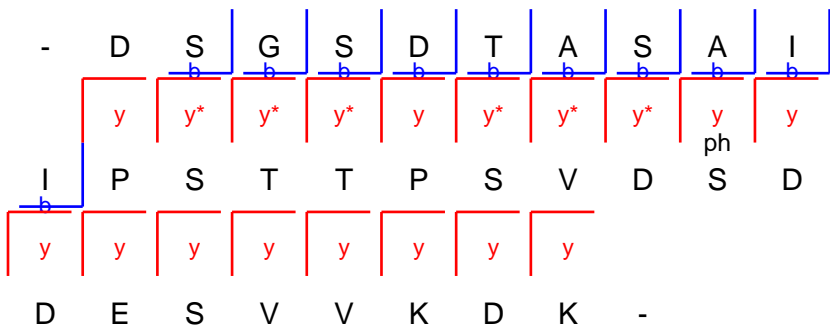
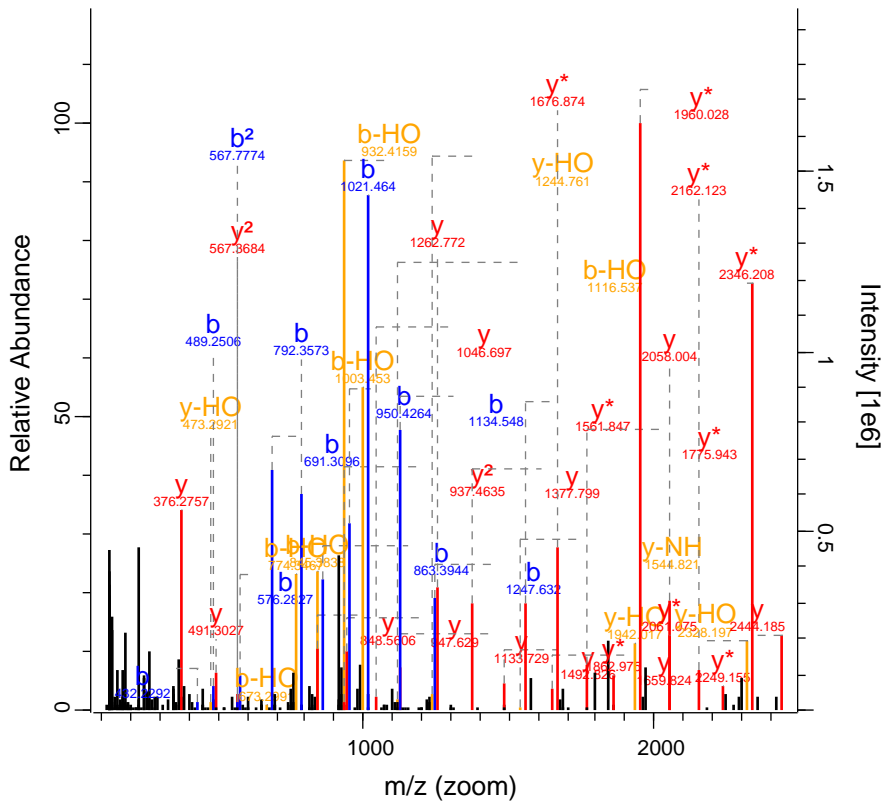

RO-QC-160121_ZackD_SS_Set_01_Fraction 28583 FTMS; HC 75.77 758.04 AHNAK

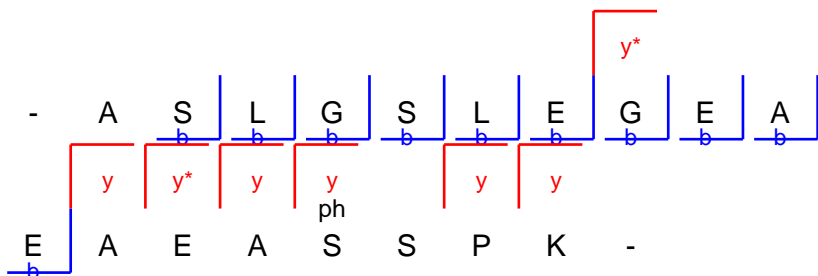
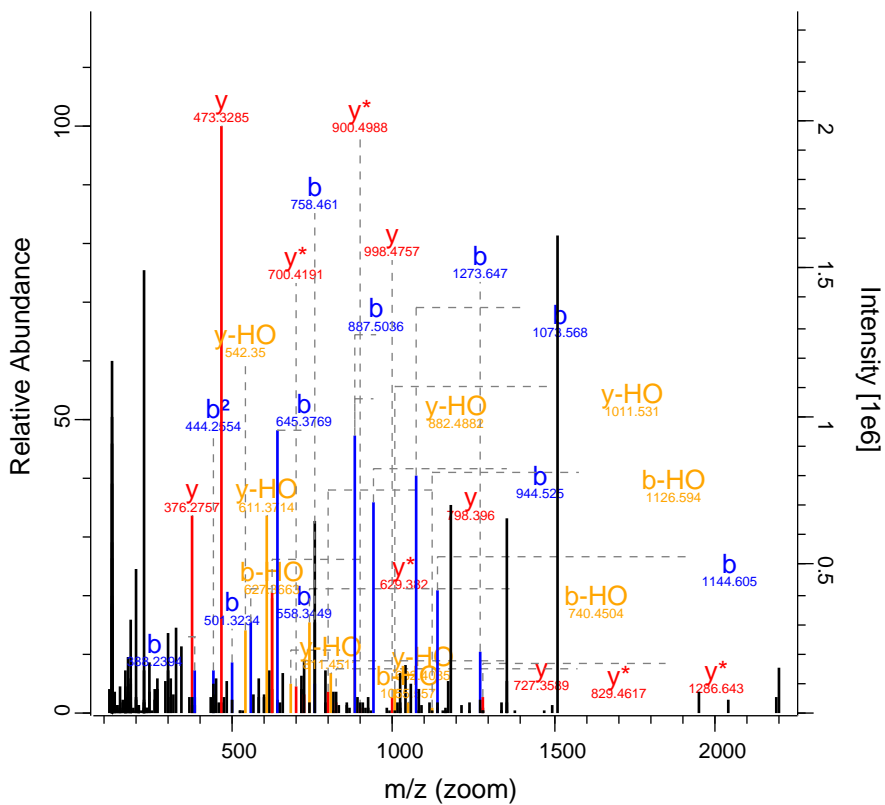

RO-QC-160121_ZackD_SS_Set_01_Fraction 29381 FTMS; HC 148.24 736.38 VIM

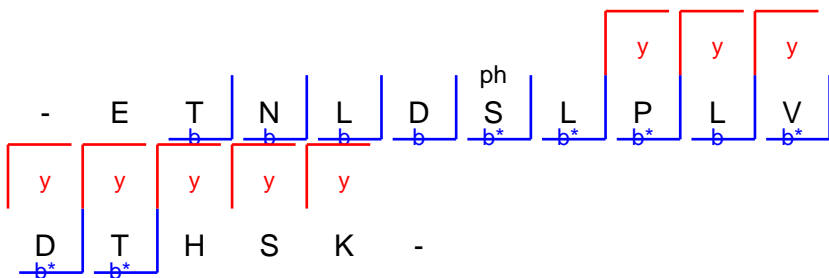
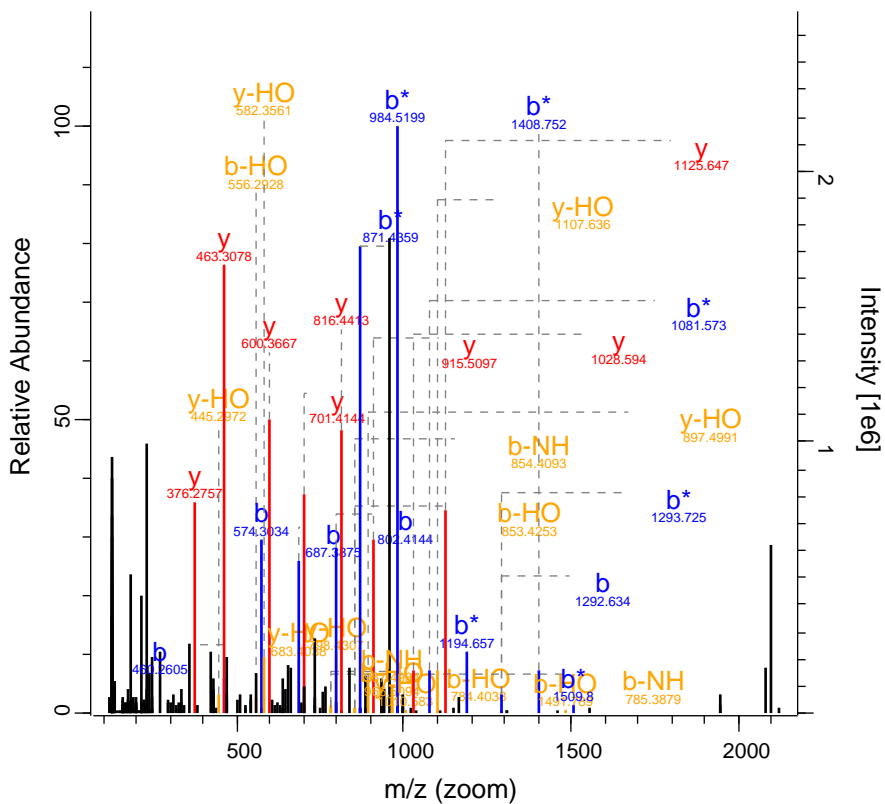

RO-QC-160121_ZackD_SS_Set_01_Fraction 29438 FTMS; HC 73.34 1001.52 METTL3

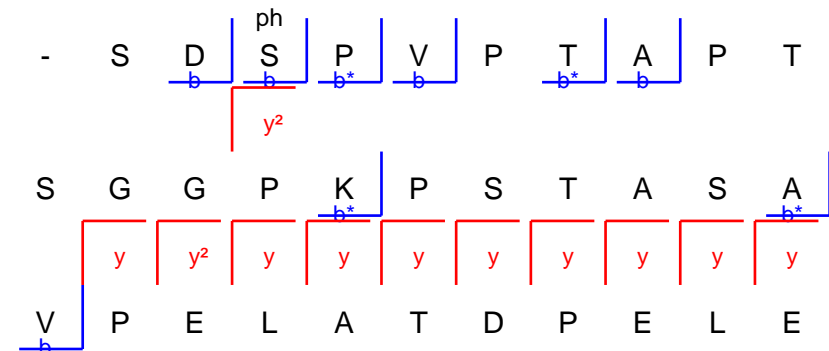
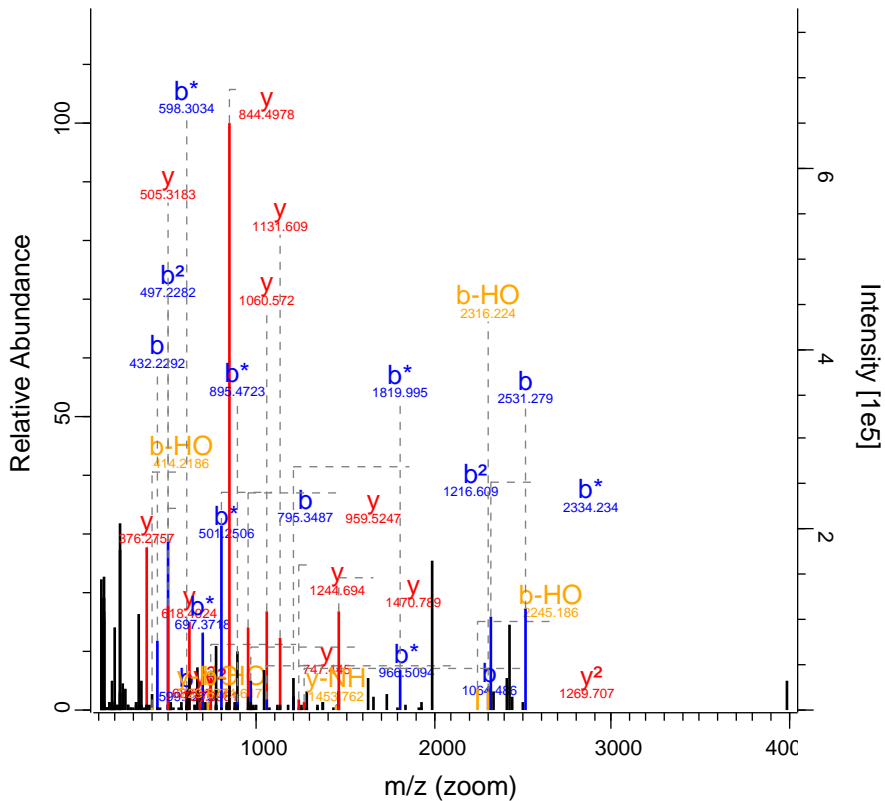

RO-QC-160121_ZackD_SS_Set_01_Fraction 30760 FTMS; HC 78.33 991.06 OGN

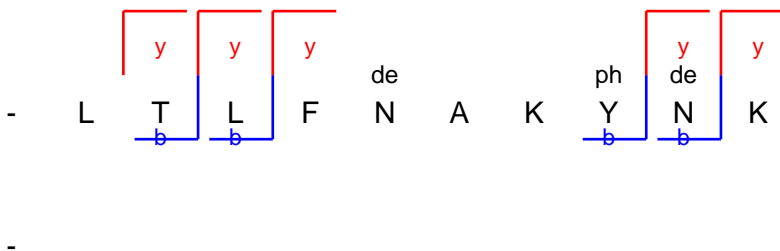
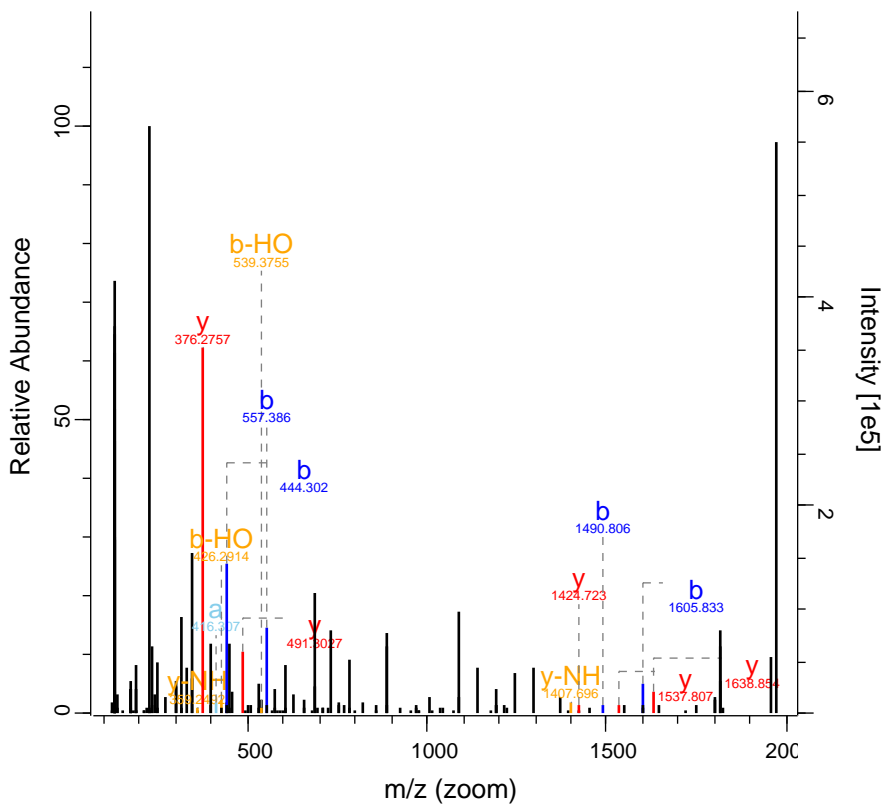

RO-QC-160121_ZackD_SS_Set_01_Fraccio 31655 FTMS; HC 103.07 1013.17 SLC2A1

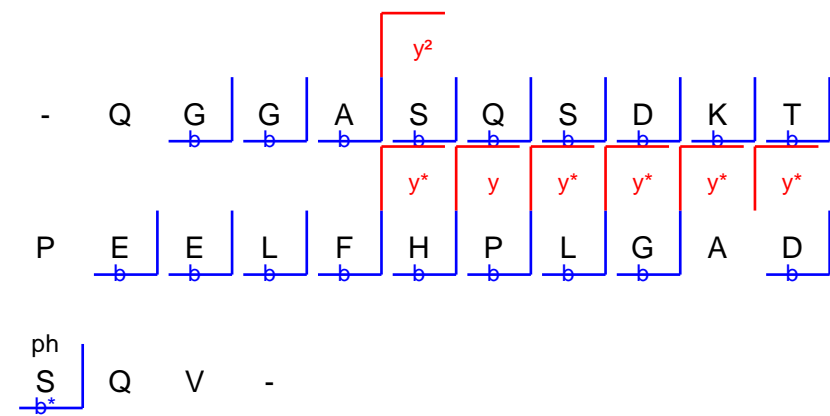
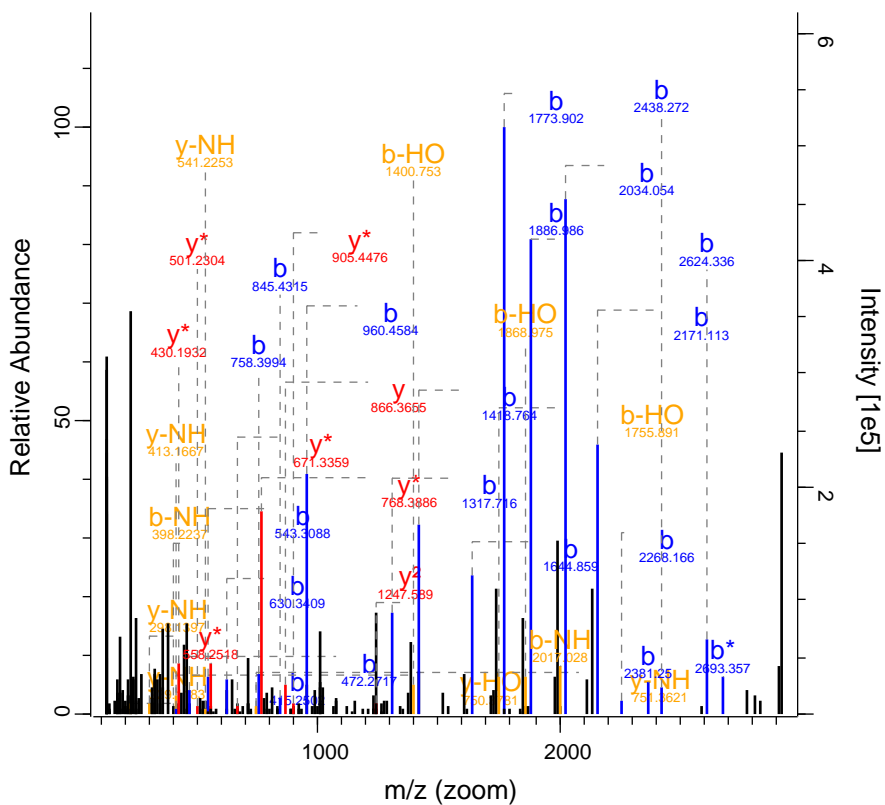

RO-QC-160121_ZackD_SS_Set_01_Fraction 31751 FTMS; HC 65.05 1015.42 CTNND1

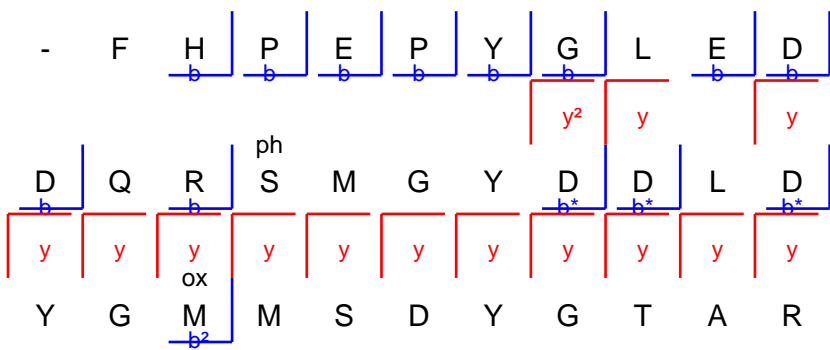
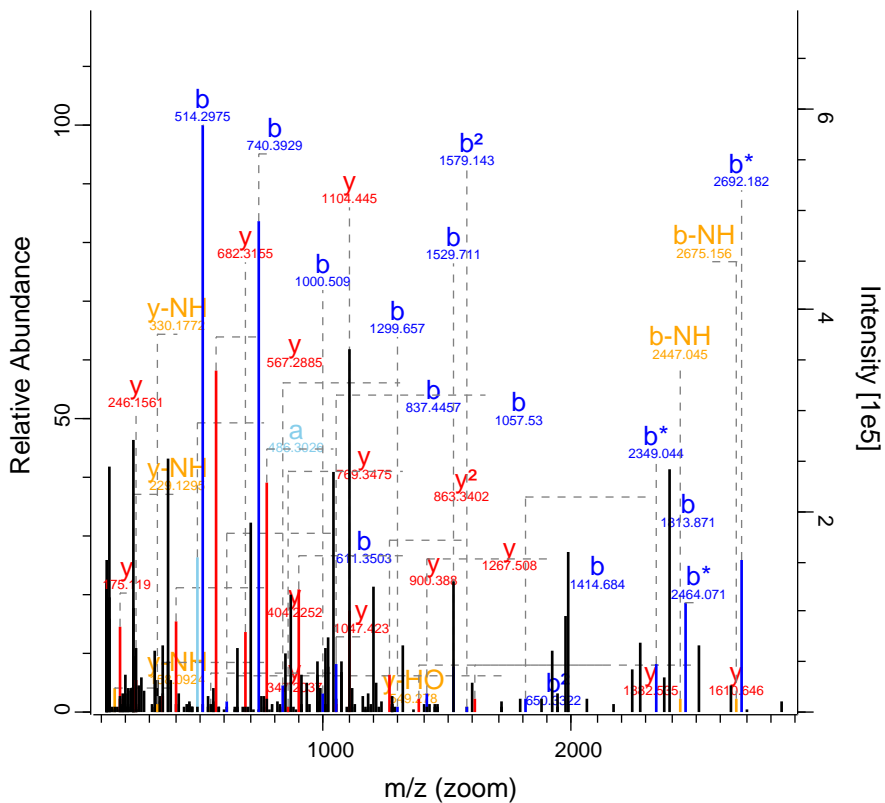

RO-QC-160121_ZackD_SS_Set_01_Fraction1 32105 FTMS; HC 141.99 920.97 GIT1

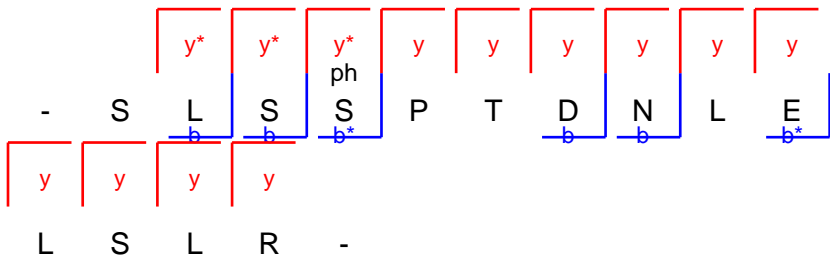
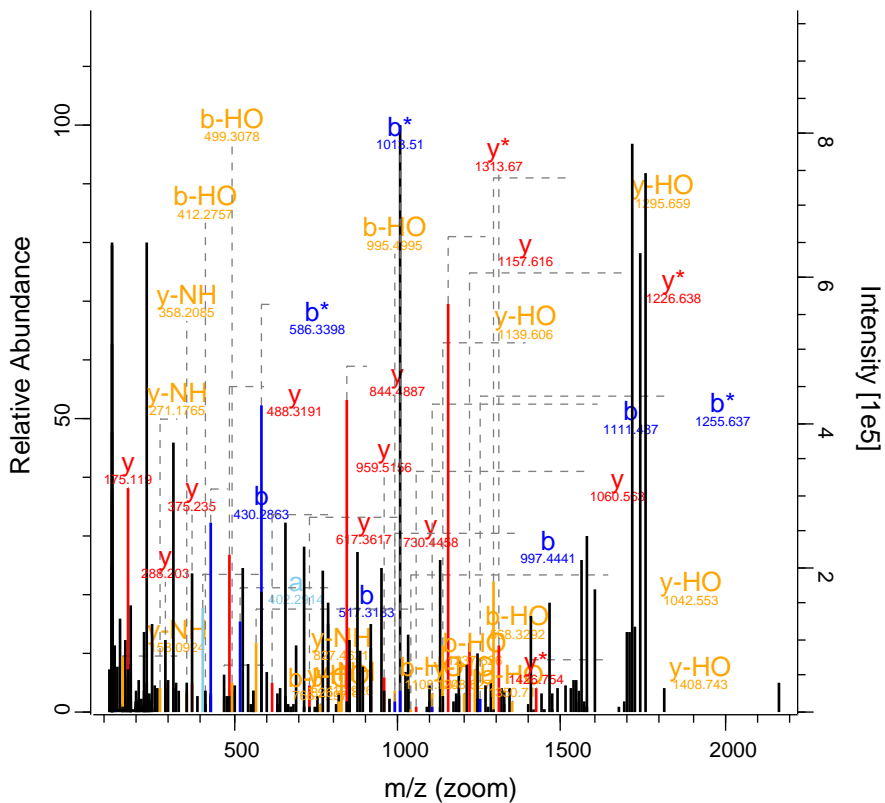

RO-QC-160121_ZackD_SS_Set_01_Fraction 33050 FTMS; HC 46

1016.55 TMTc3

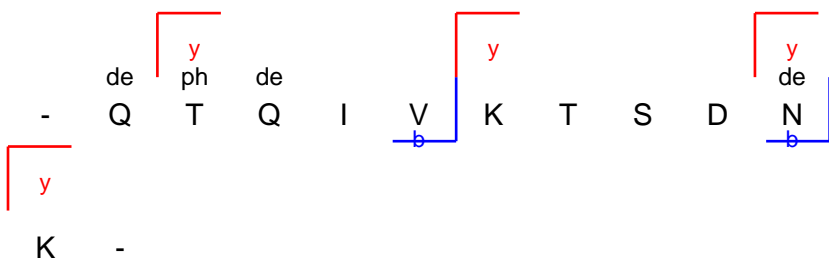
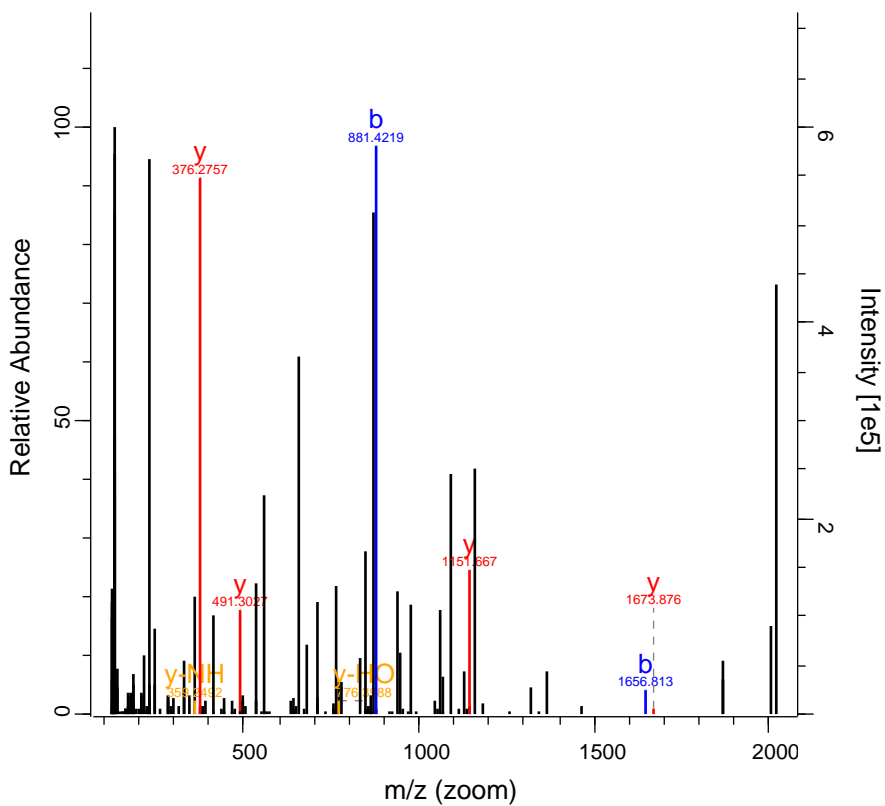

K -

RO-QC-160121_ZackD_SS_Set_01_Fraction 33931 FTMS; HC 64.88 720.09 OFD1

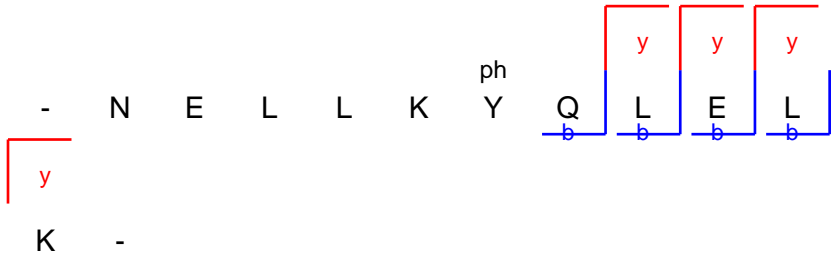
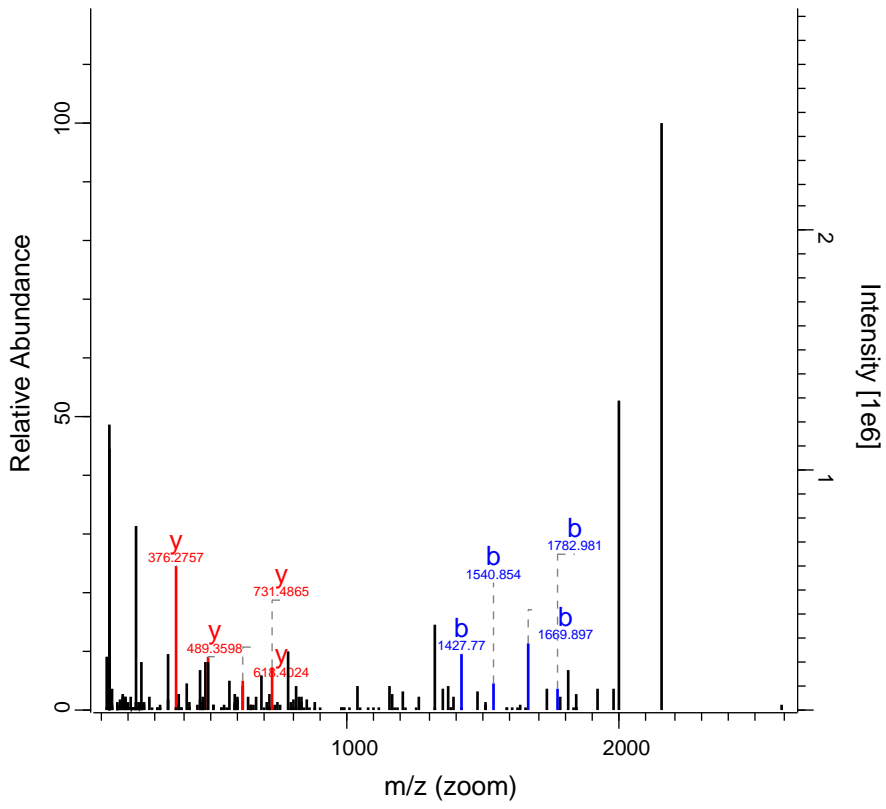

RO-QC-160121_ZackD_SS_Set_01_Fractio 34404 FTMS; HC 108.09 1078.81 ADD1

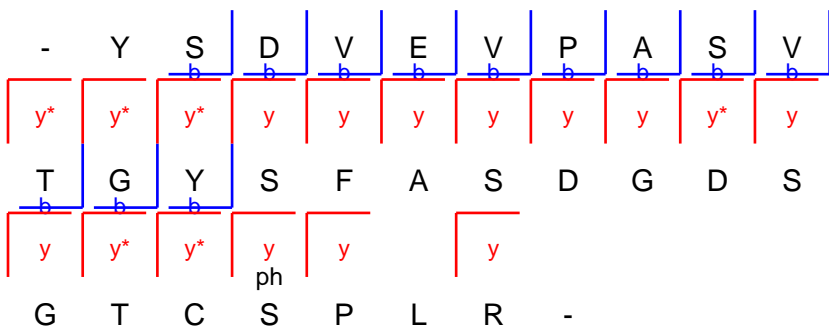
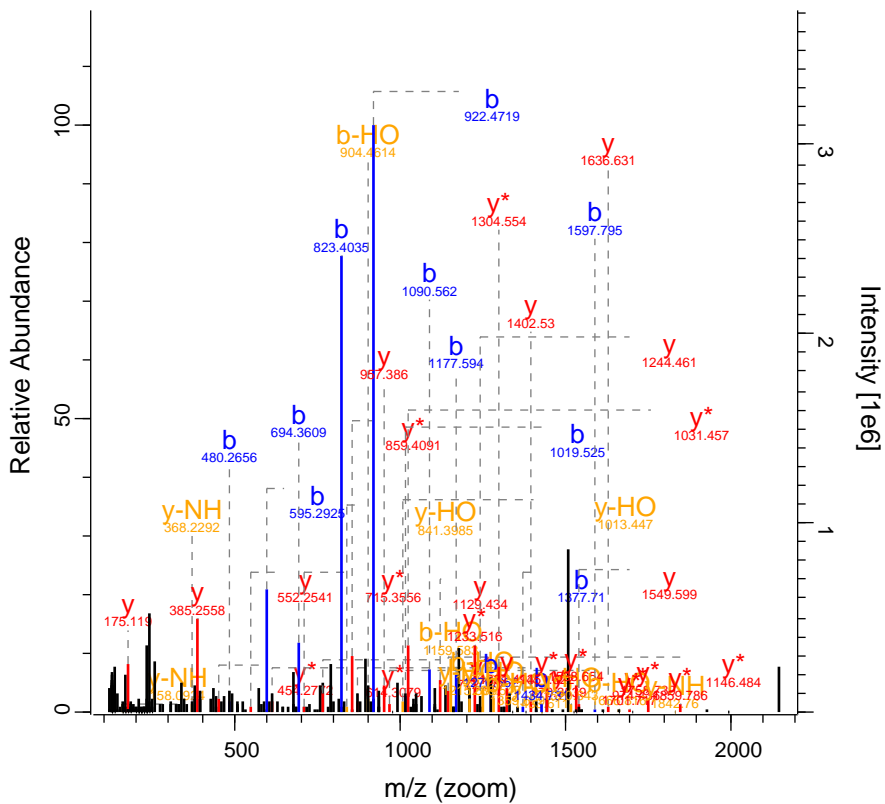

RO-QC-160121_ZackD_SS_Set_01_Fraction 34511 FTMS; HC 69.38 829.96 PLEC

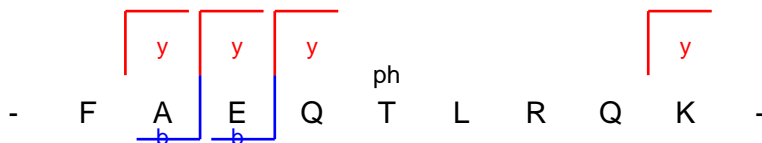
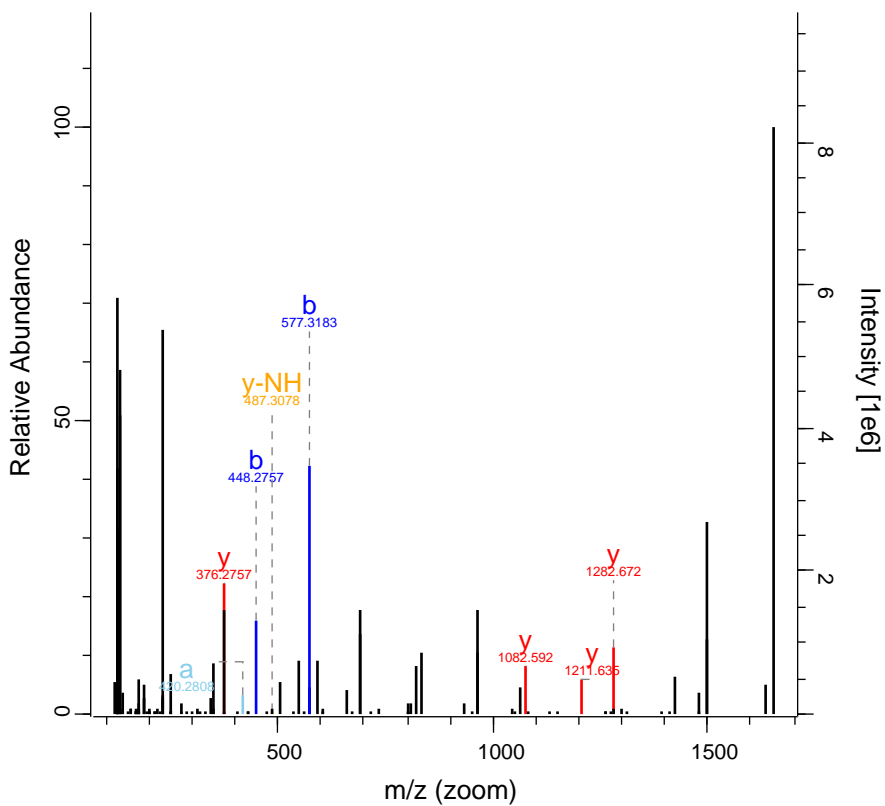

RO-QC-160121_ZackD_SS_Set_01_Fraction 35307 FTMS; HC 51.73 950.93 RTF1

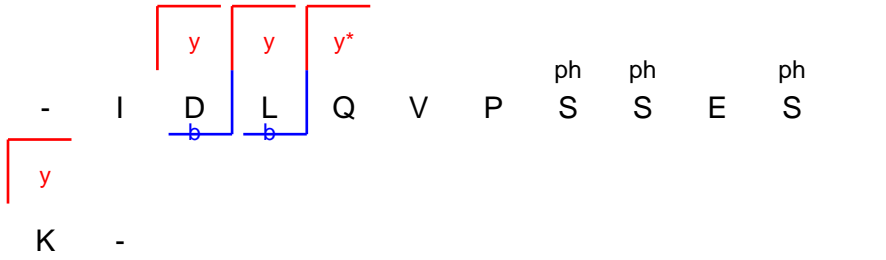
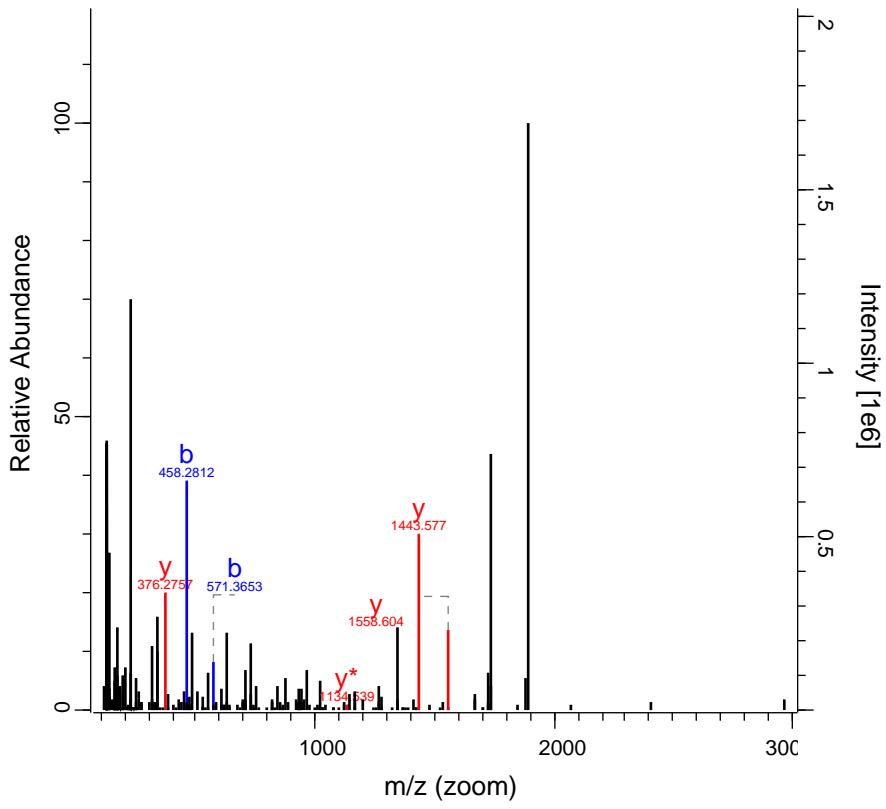

K -

RO-QC-160121_ZackD_SS_Set_01_Fraction 36023 FTMS; HC 43.16 837.23 TDRD10

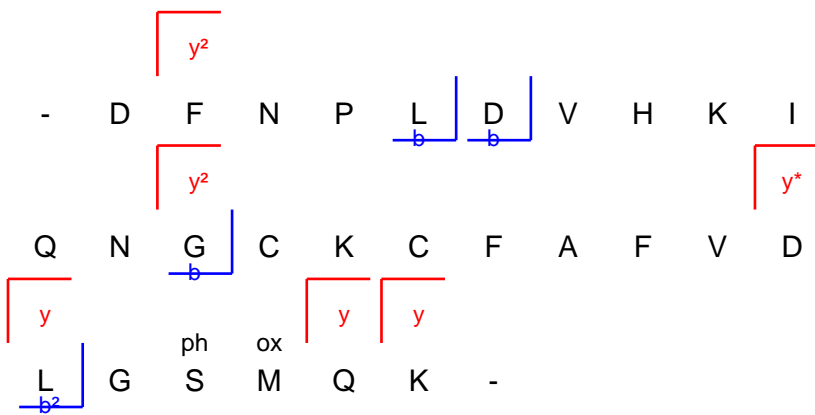
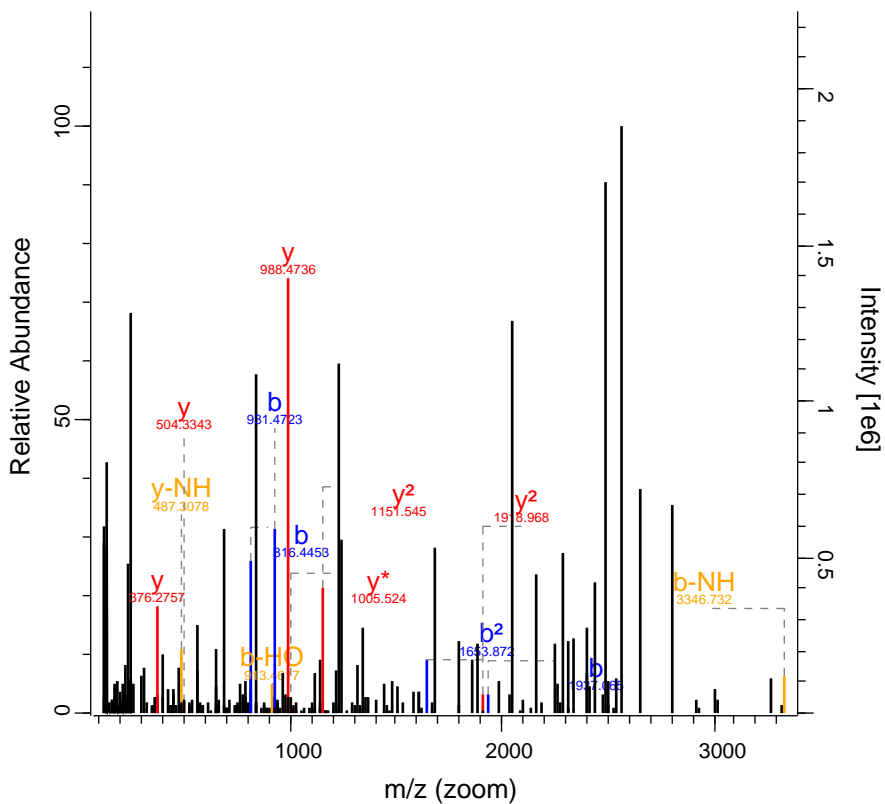

RO-QC-160121_ZackD_SS_Set_01_Fraction 37682 FTMS; HC 40.75 793.07 CEP295

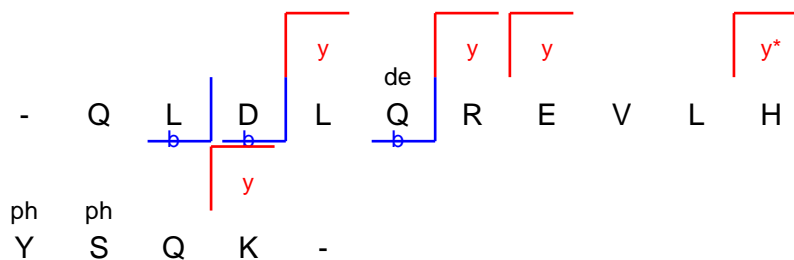
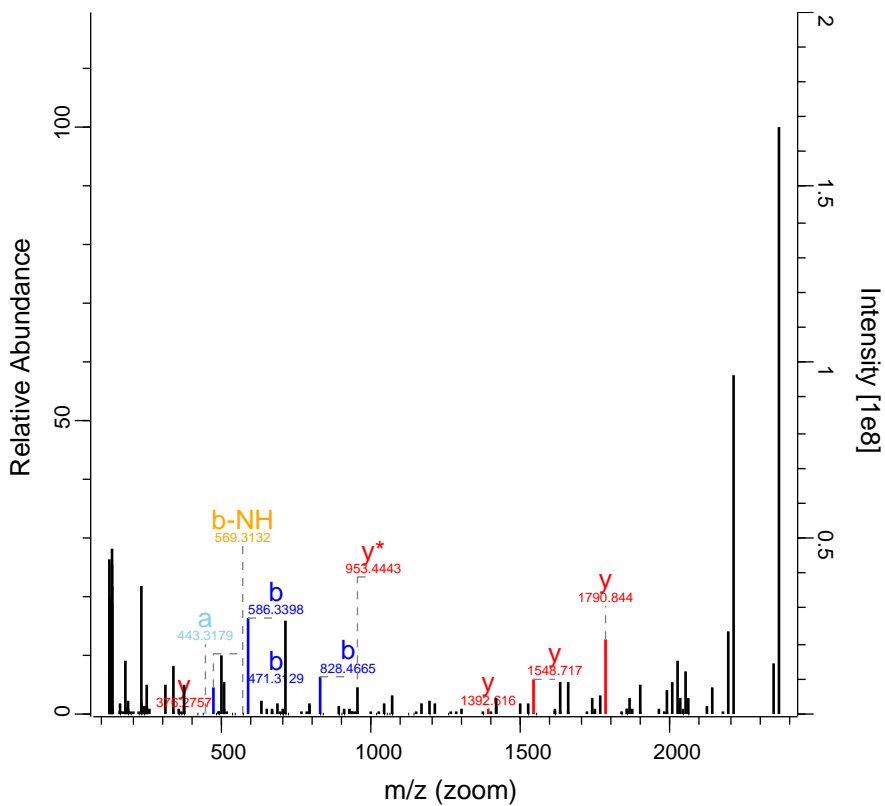

RO-QC-160121_ZackD_SS_Set_01_Fraction 37879 FTMS; HC 70.94 1313.69 HELZ2

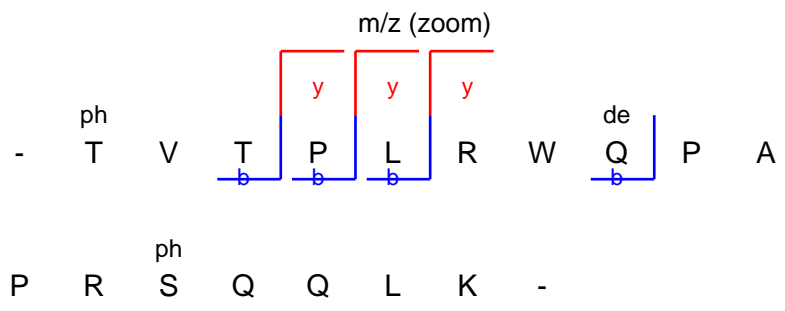
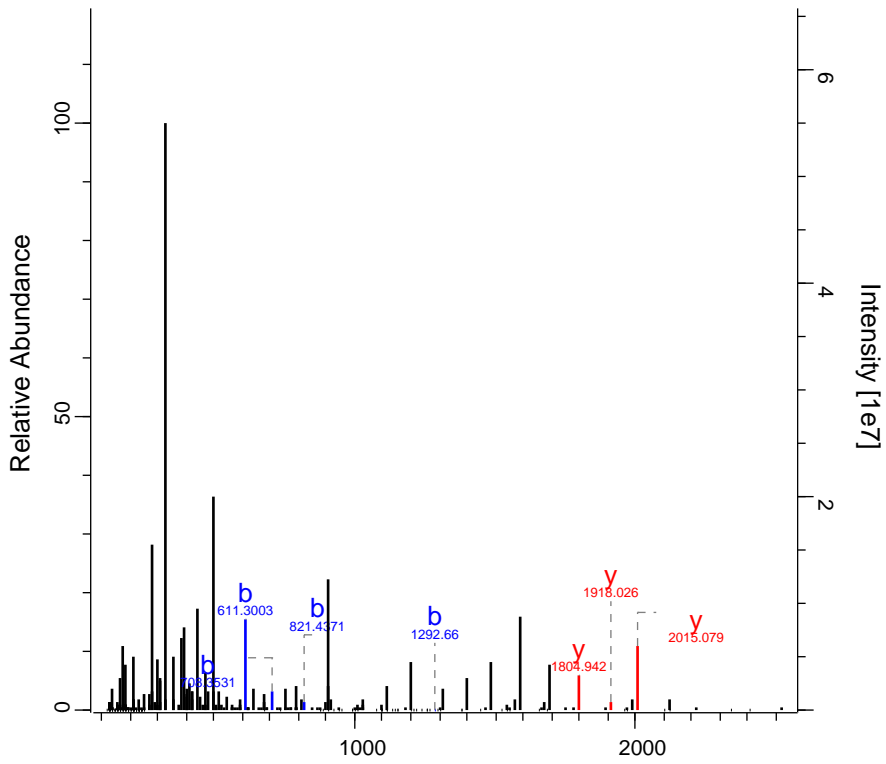

RO-QC-160121_ZackD_SS_Set_01_Fraction 4711 FTMS; HC 151.26 732.84 RFTN1

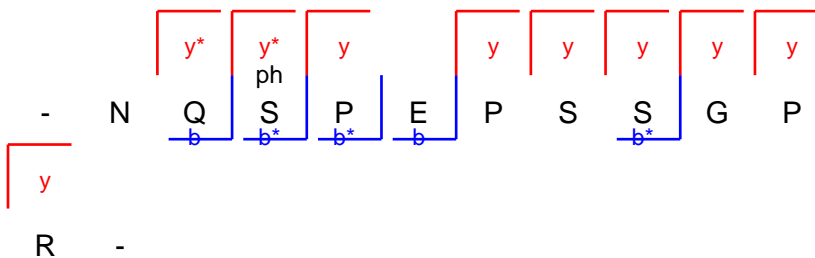
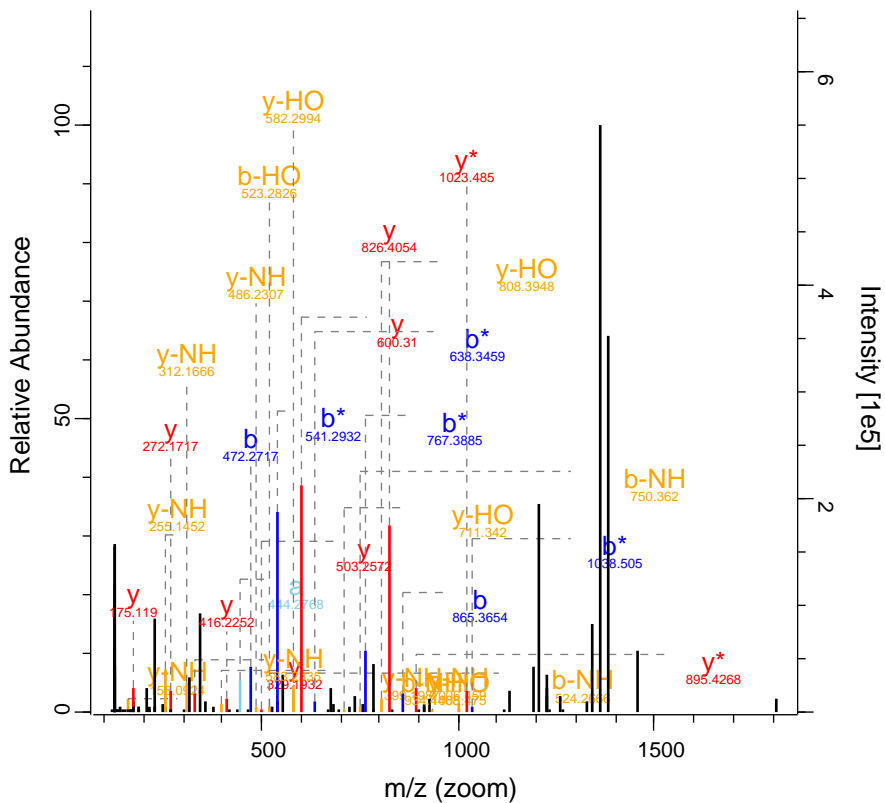

RO-QC-160121_ZackD_SS_Set_01_Fraction 6195 FTMS; HC 60.91 972.99 CDCA7

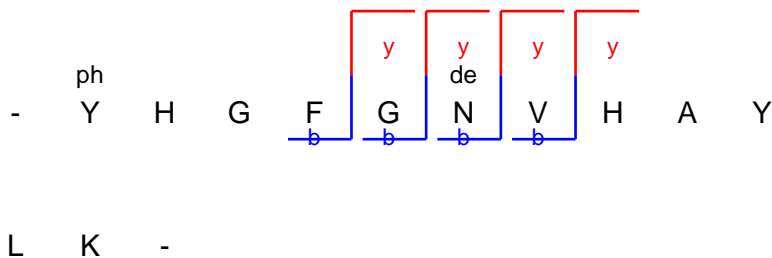
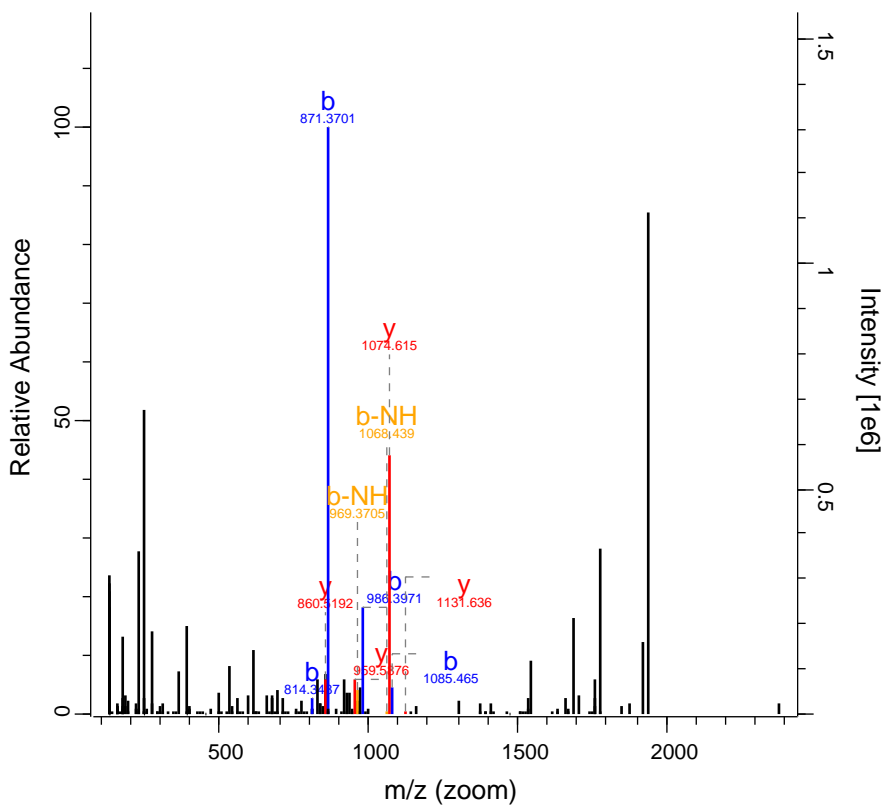

RO-QC-160121_ZackD_SS_Set_01_Fraction 6541 FTMS; HC 67.08 469.78 THRAP3

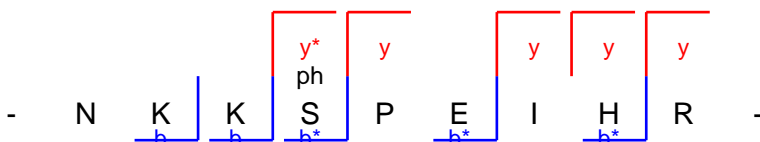
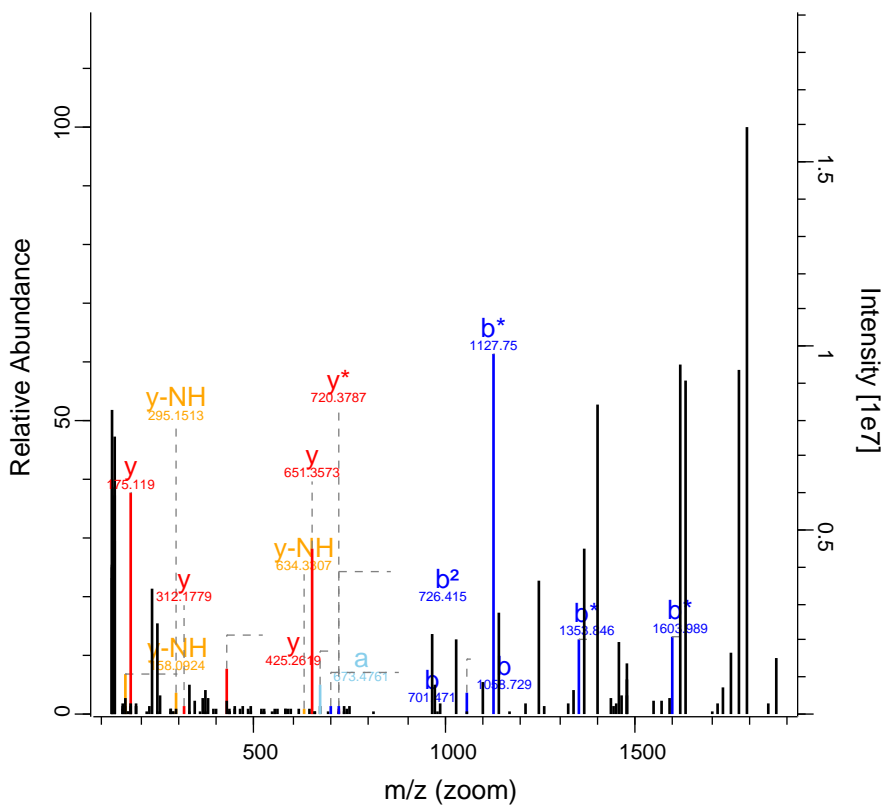

RO-QC-160121_ZackD_SS_Set_01_Fraction 8440 FTMS; HC 112.63 618.31 SRRM2

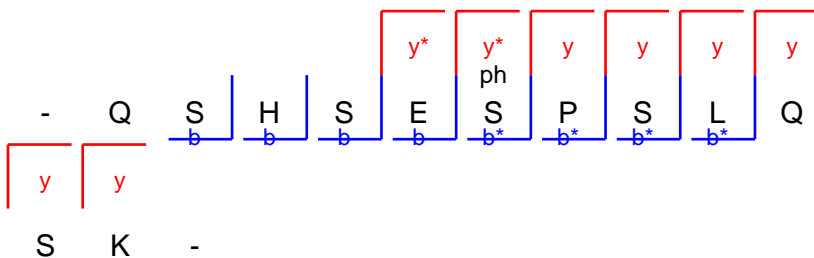
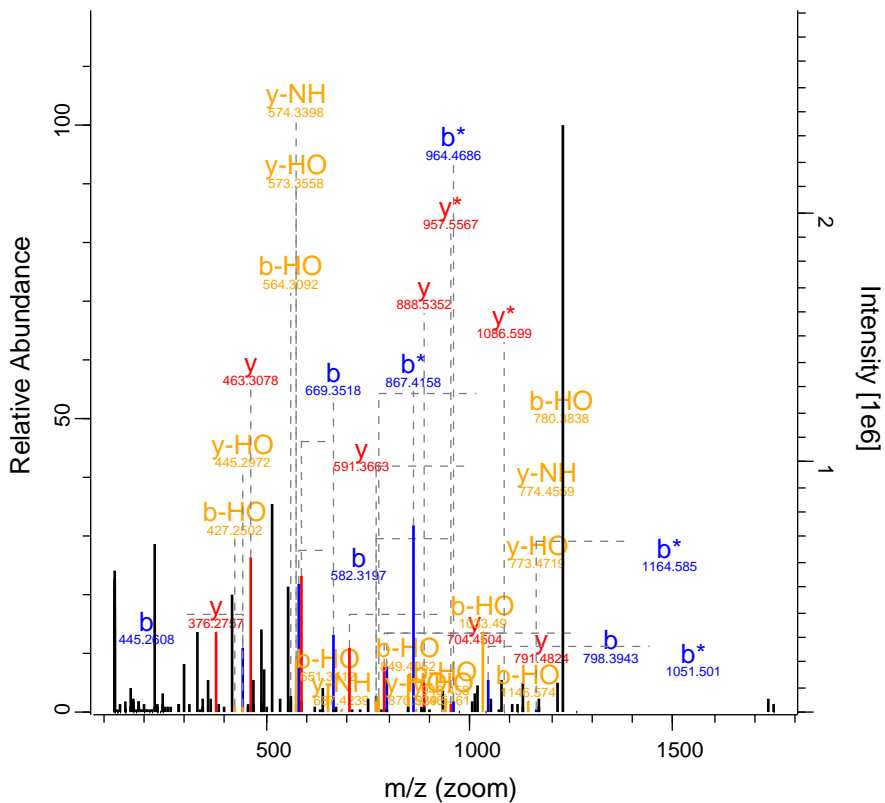

RO-QC-160121_ZackD_SS_Set_01_Fraction 11976 FTMS; HC 56.56 915.99 TRIM36

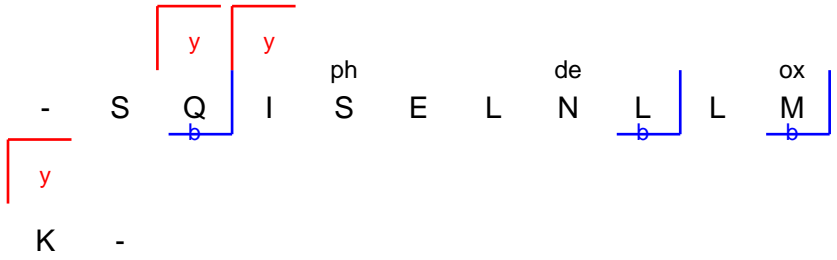
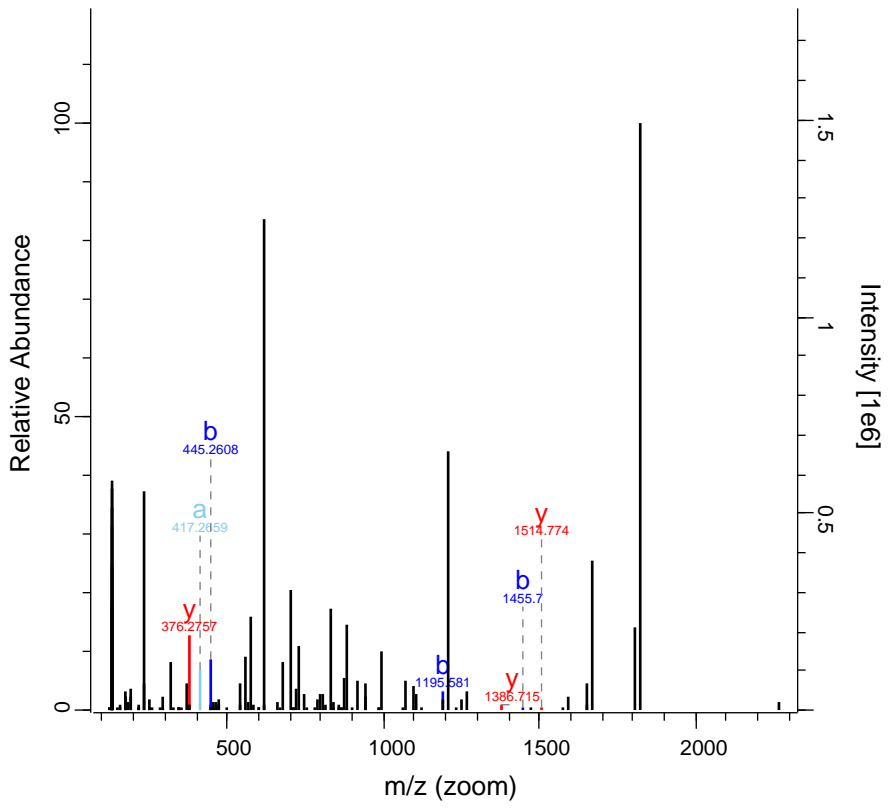

RO-QC-160121_ZackD_SS_Set_01_Fraction1 12833 FTMS; HC 141 946.48 ADD1

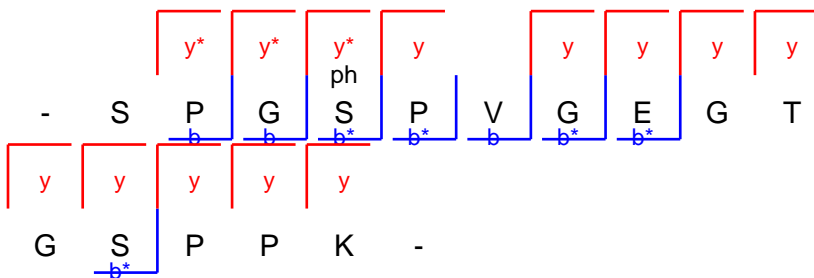
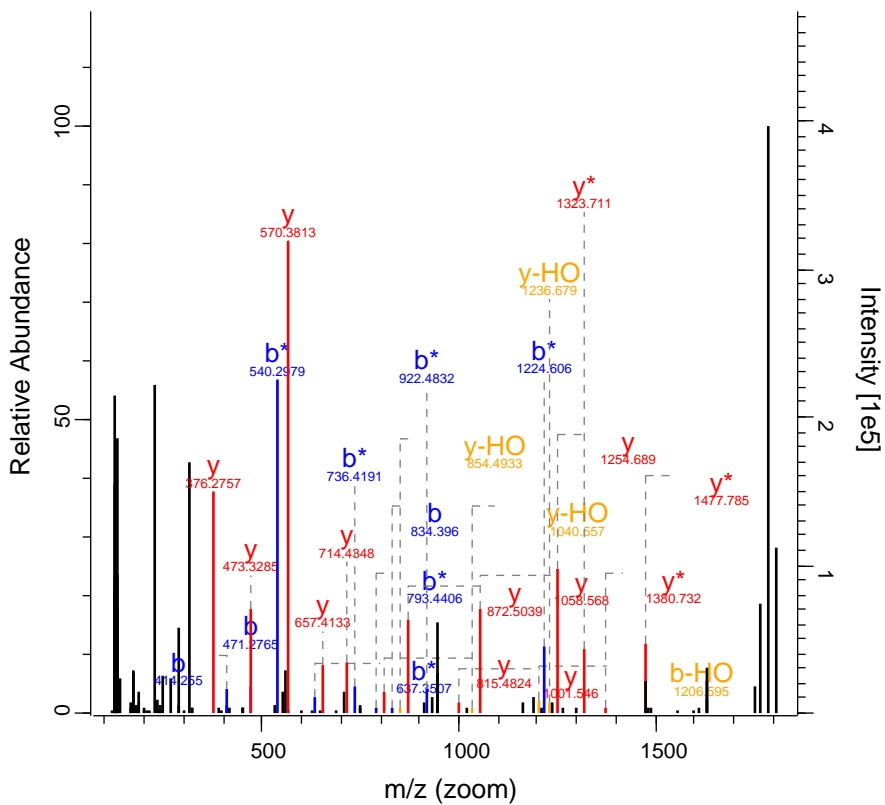

RO-QC-160121_ZackD_SS_Set_01_Fraction14004 FTMS; HC 108.59 927.49 SPECC1

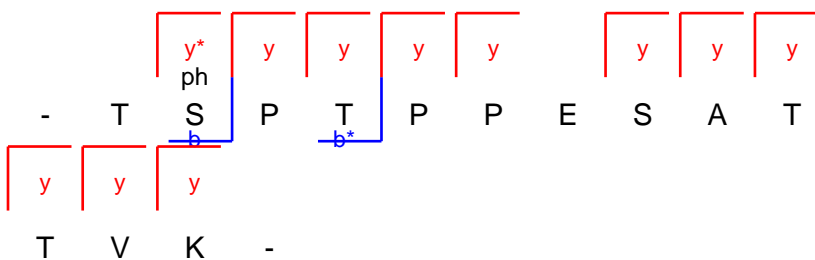
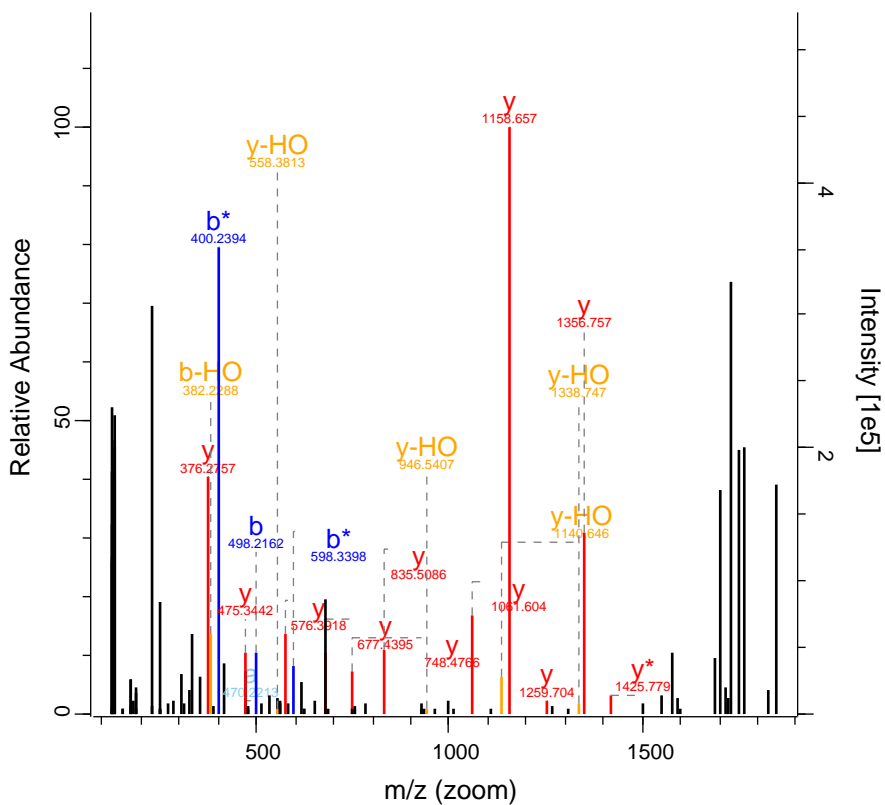

RO-QC-160121_ZackD_SS_Set_01_Fraction 15373 FTMS; HC 98.51 1119.53 SLC4A7

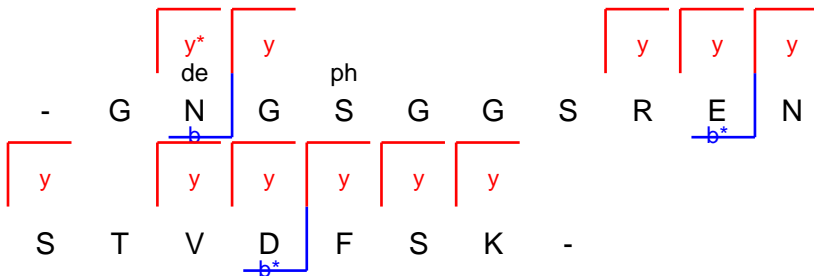
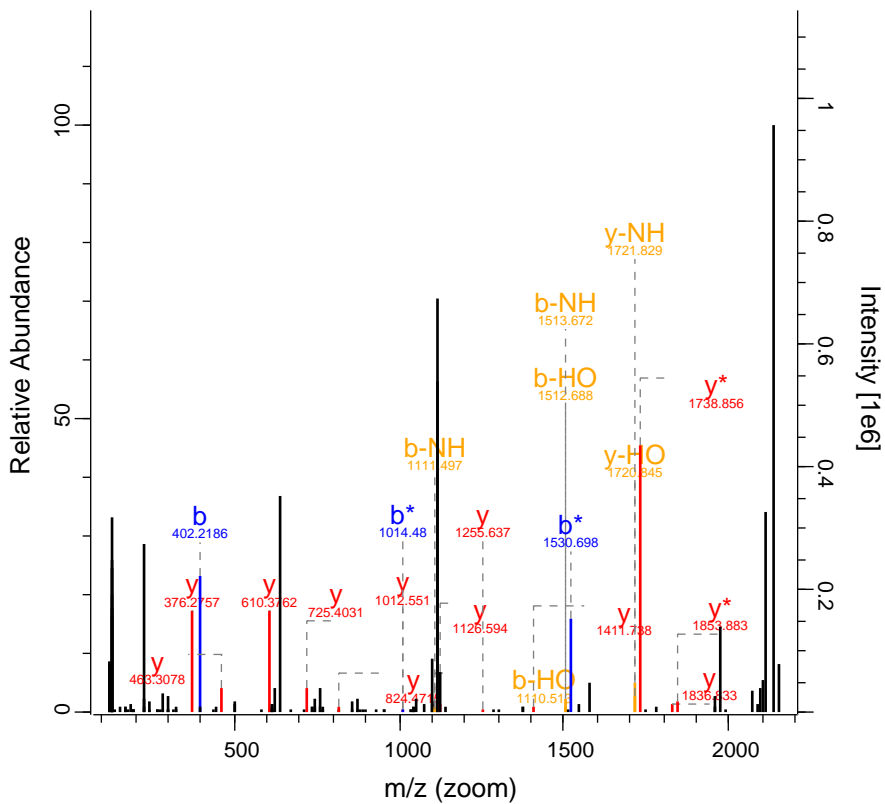

RO-QC-160121_ZackD_SS_Set_01_Fraction16302 FTMS; HC 146.89 855.76 ZMYM4

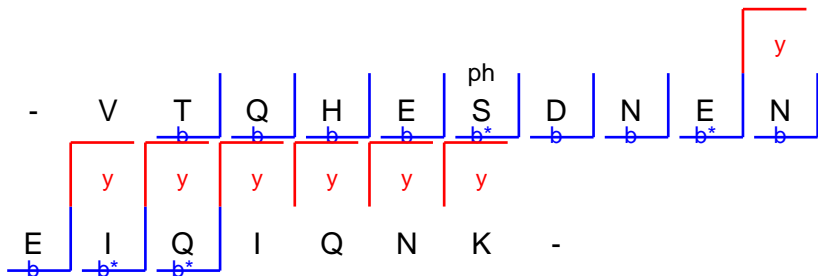
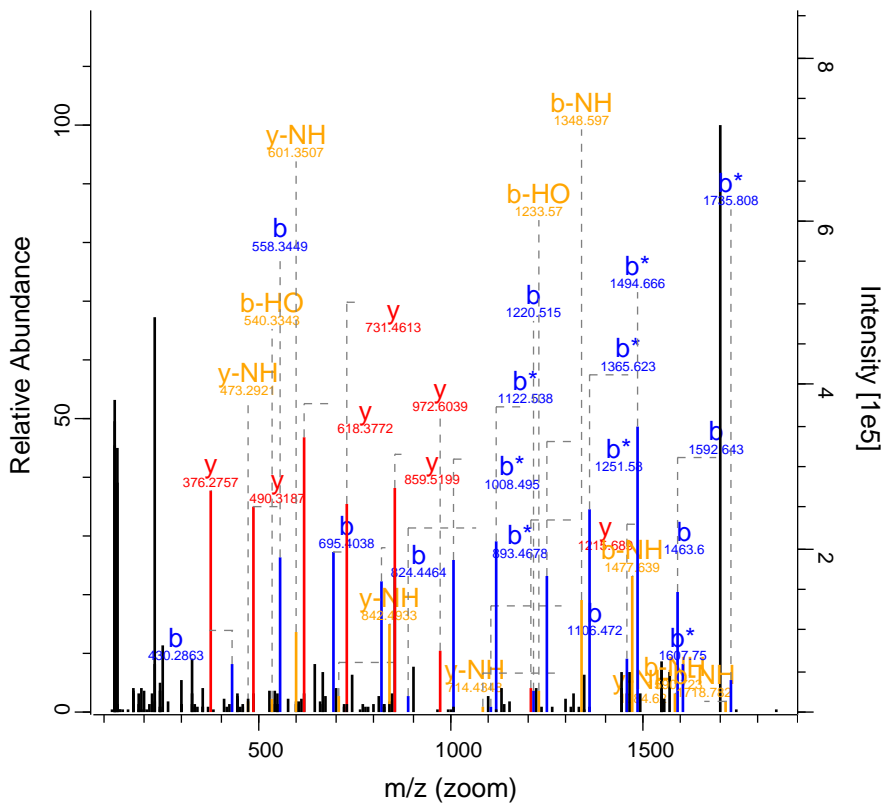

RO-QC-160121_ZackD_SS_Set_01_Fraction17059 FTMS; HC 164.97 794.89 MTDH

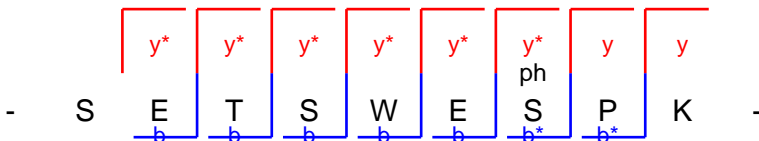
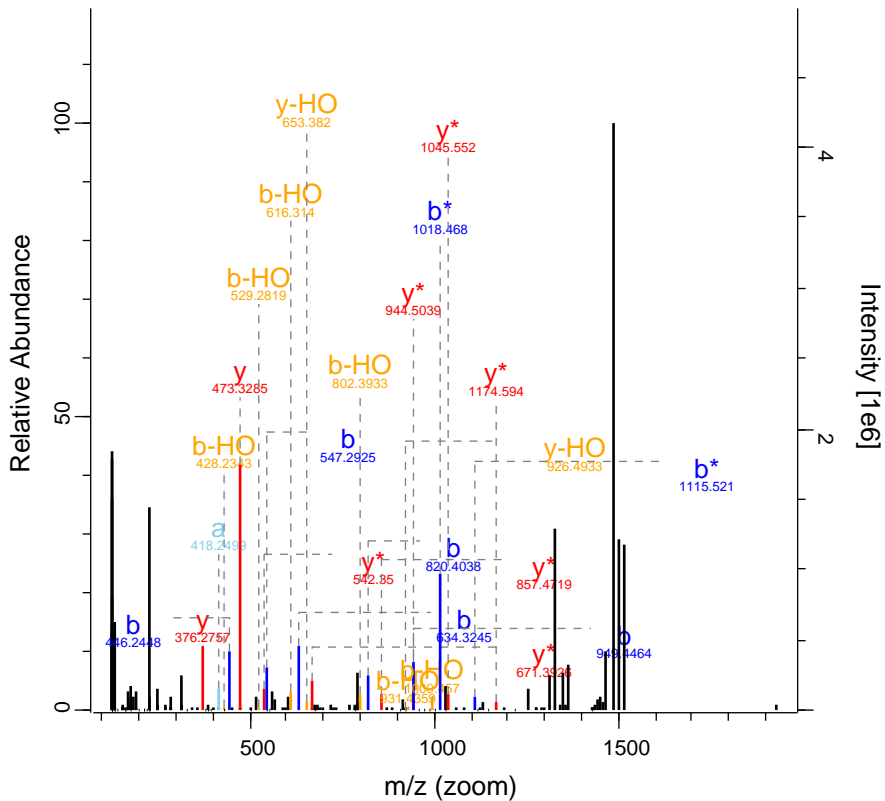

RO-QC-160121_ZackD_SS_Set_01_Fraction1 17212 FTMS; HC 96.14 876.96 DAP

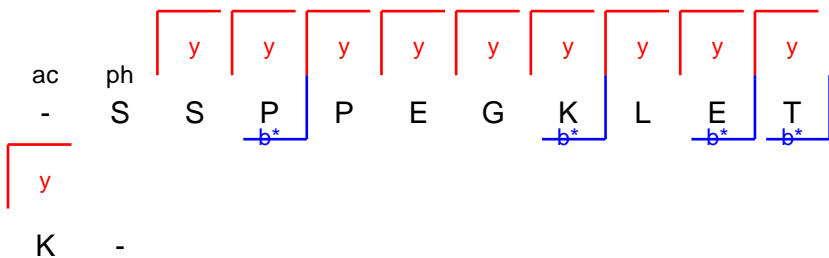
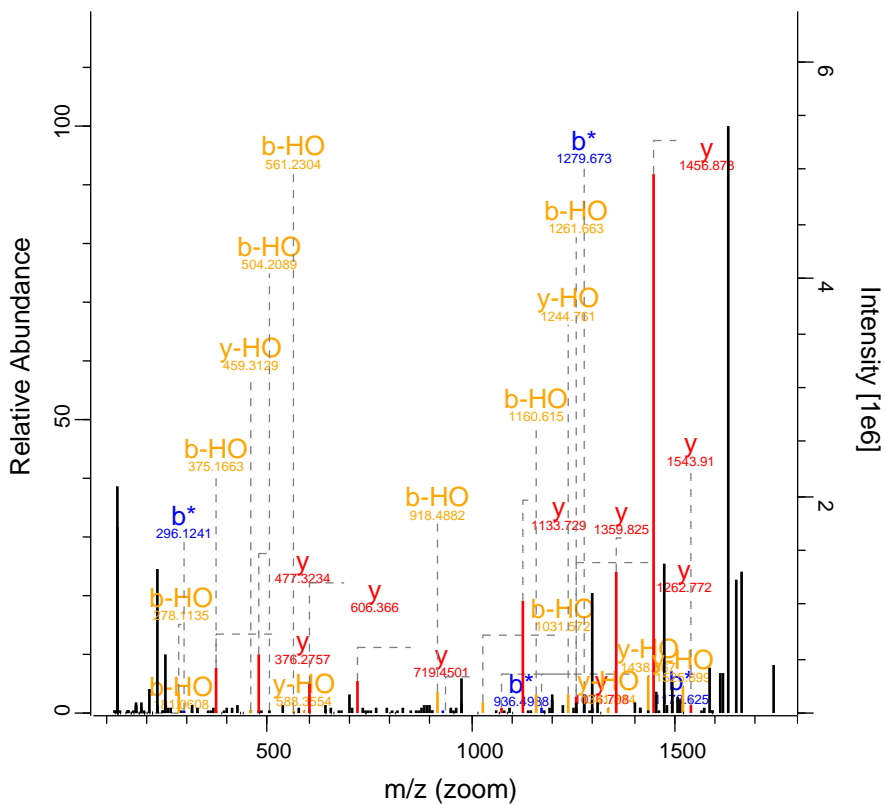

RO-QC-160121_ZackD_SS_Set_01_Fraction 18509 FTMS; HC 132.69 828.9 TMPO

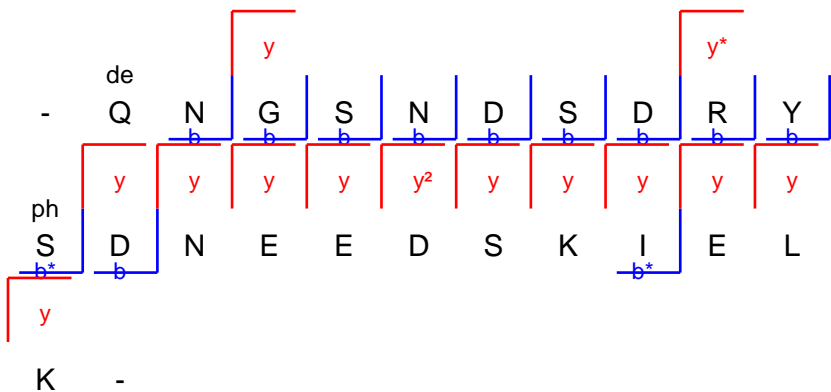
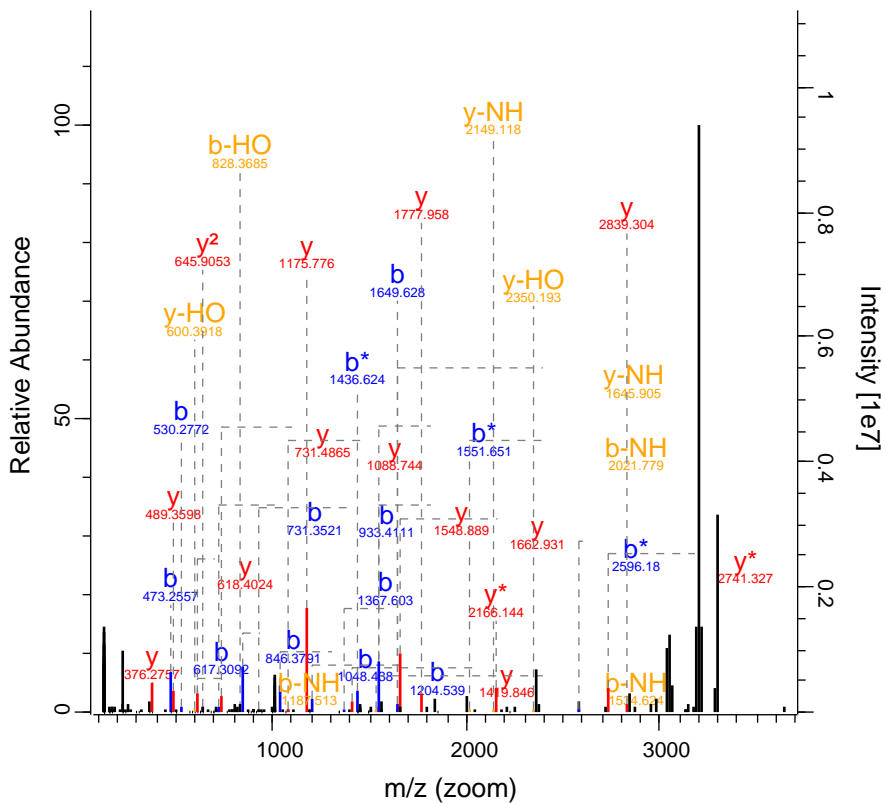

K -

RO-QC-160121_ZackD_SS_Set_01_Fraction18990 FTMS; HC 107.39 763.86 FLNA

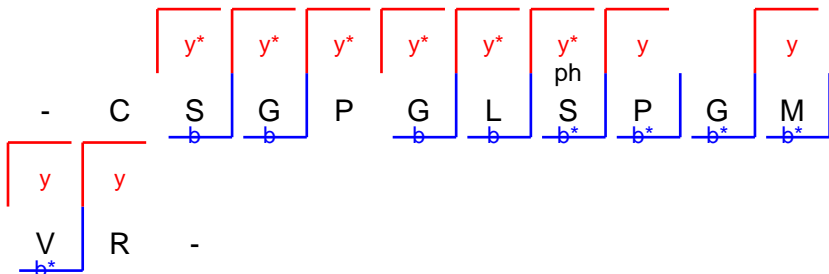
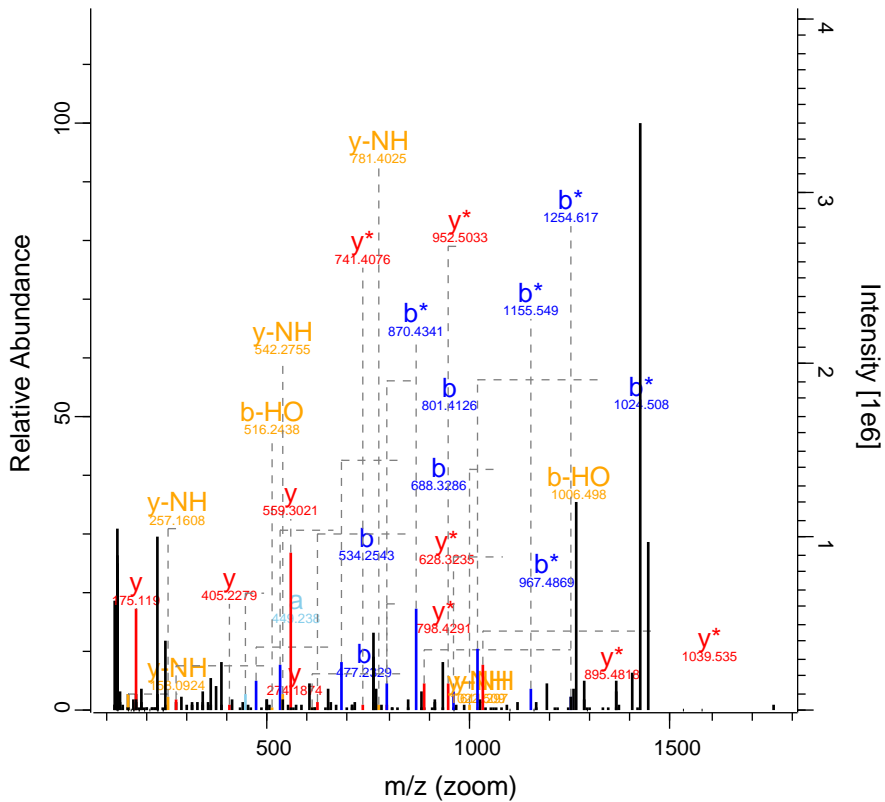

RO-QC-160121_ZackD_SS_Set_01_Fraction 26216 FTMS; HC 48.09 1049.52 ZNF107

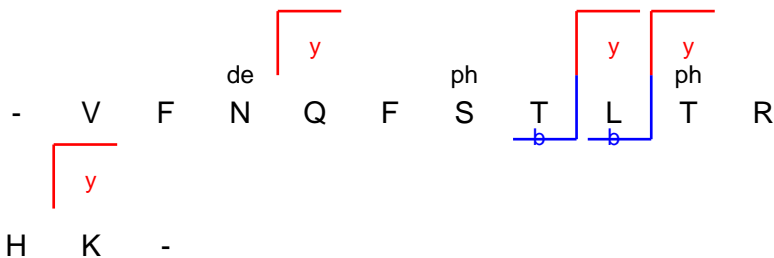
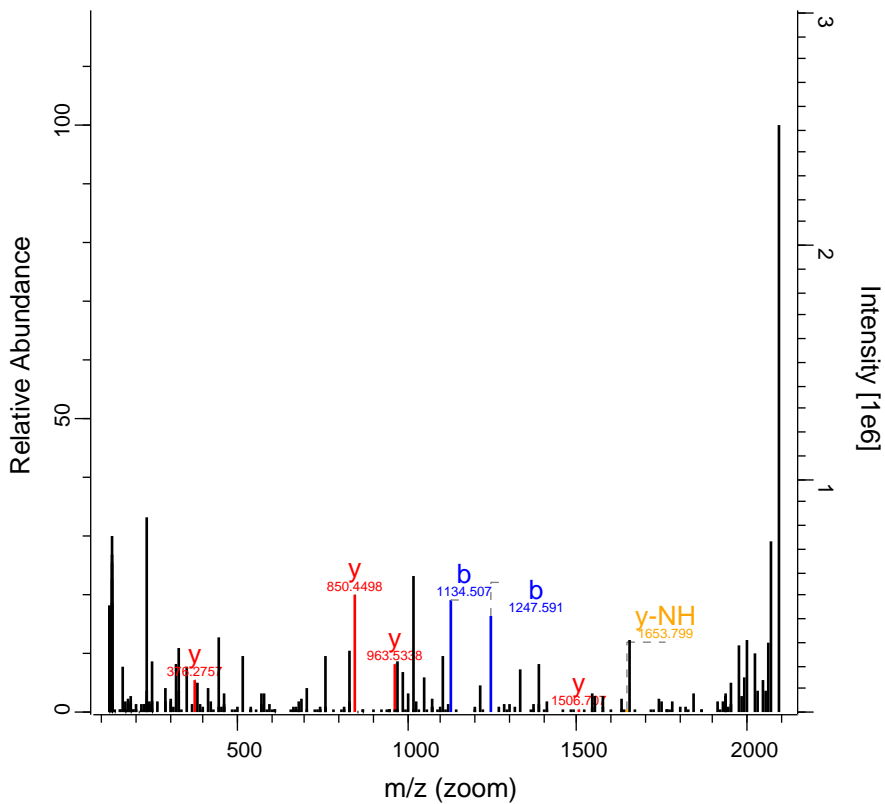

RO-QC-160121_ZackD_SS_Set_01_Fraction 26304 FTMS; HC 69.34 483.93 ZNF770

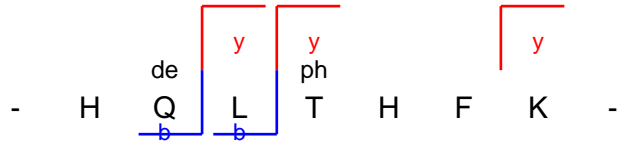
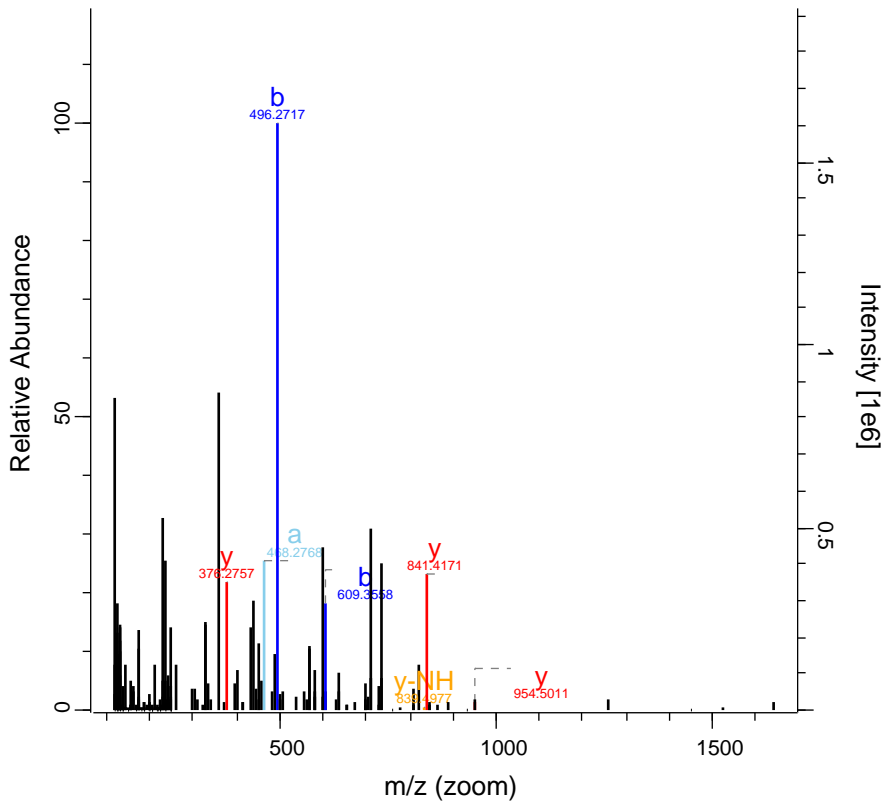

RO-QC-160121_ZackD_SS_Set_01_Fractio 26729 FTMS; HC 141.97 1133.13 PPP1R12A

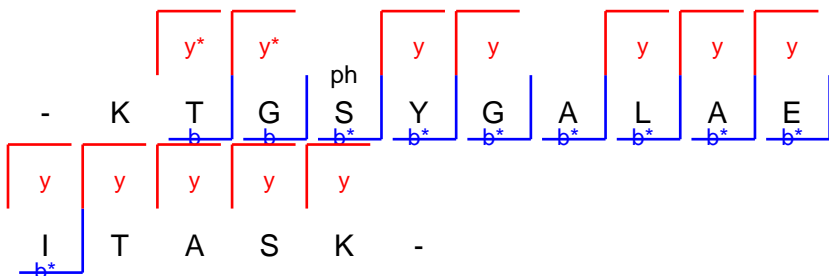
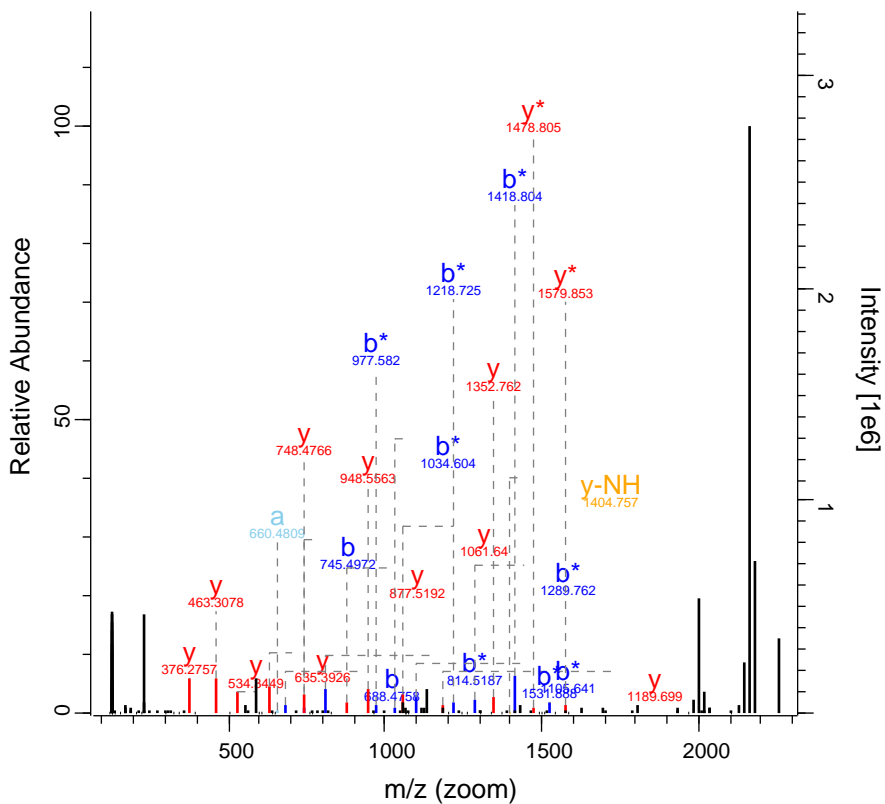

RO-QC-160121_ZackD_SS_Set_01_Fraction 26969 FTMS; HC 53.68 1165.14 FHOD3

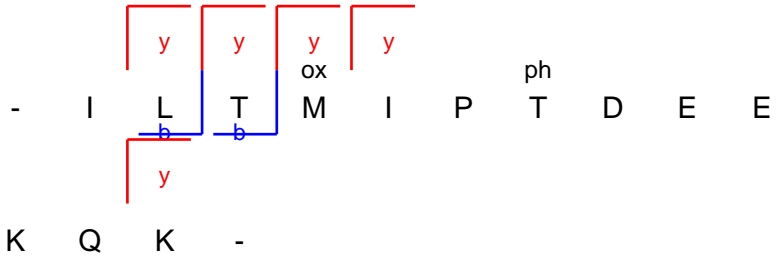
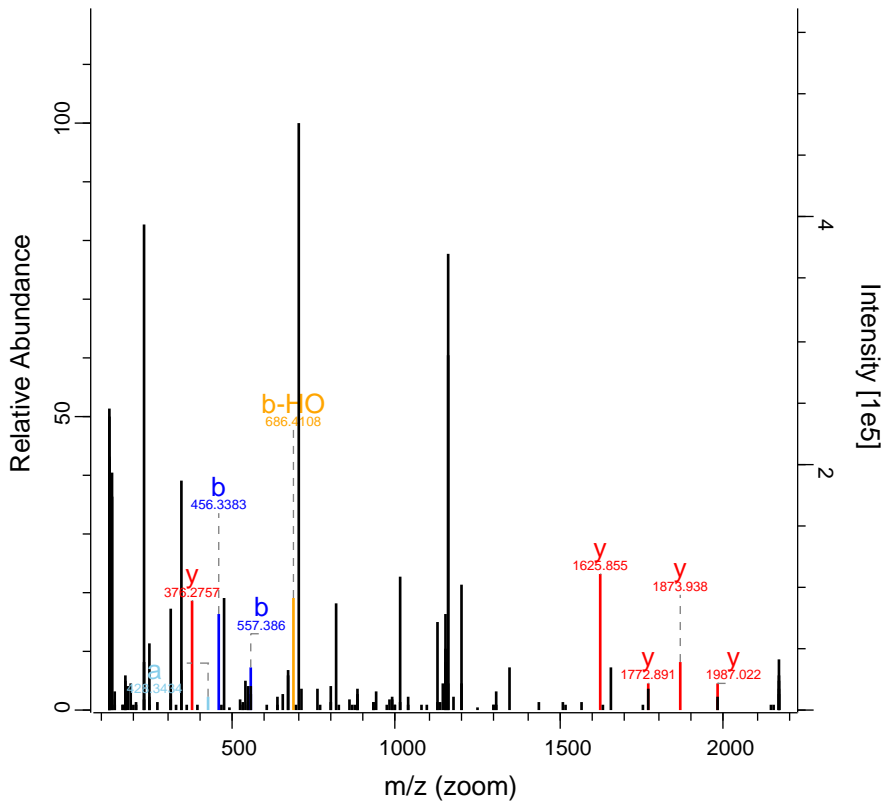

RO-QC-160121_ZackD_SS_Set_01_Fraction 27045 FTMS; HC 67.43 708.9 SLC6A15

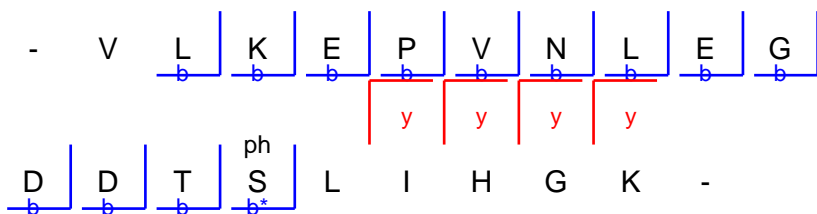
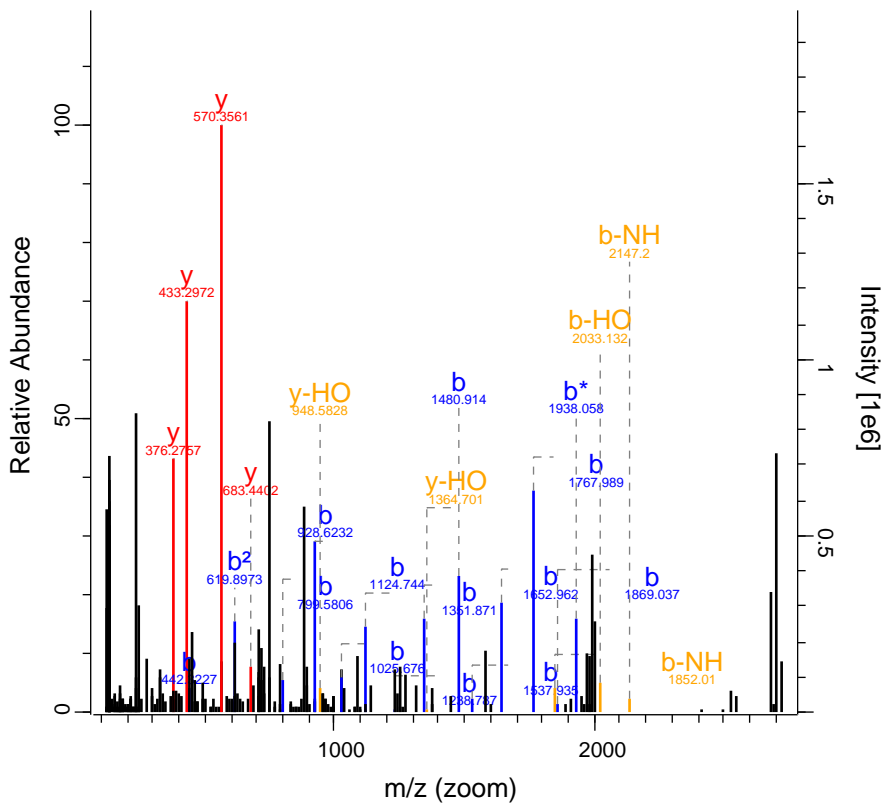

RO-QC-160121_ZackD_SS_Set_01_Fraction

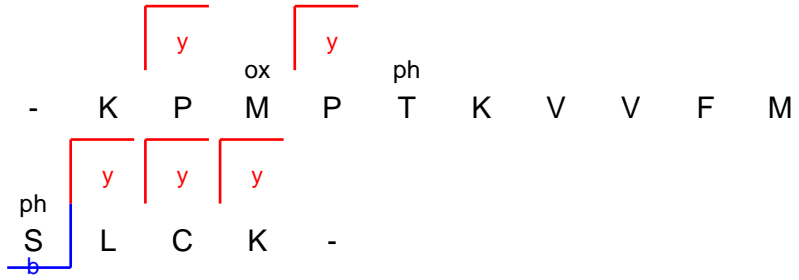
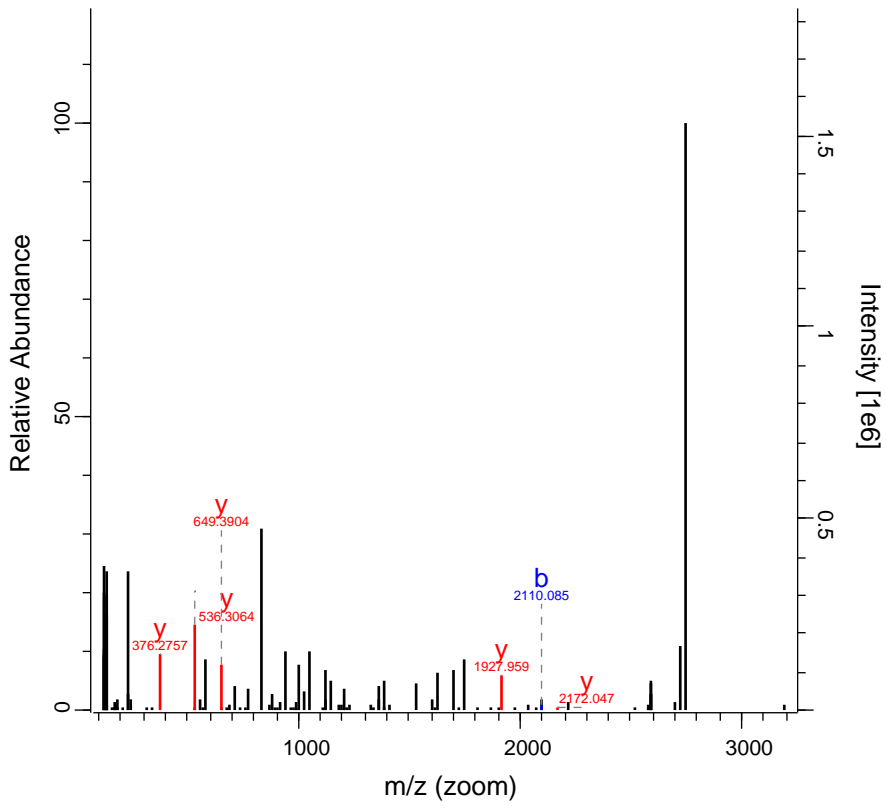

RO-QC-160121_ZackD_SS_Set_01_Fraction 28789 FTMS; HC 85.08 577.66 CDK16

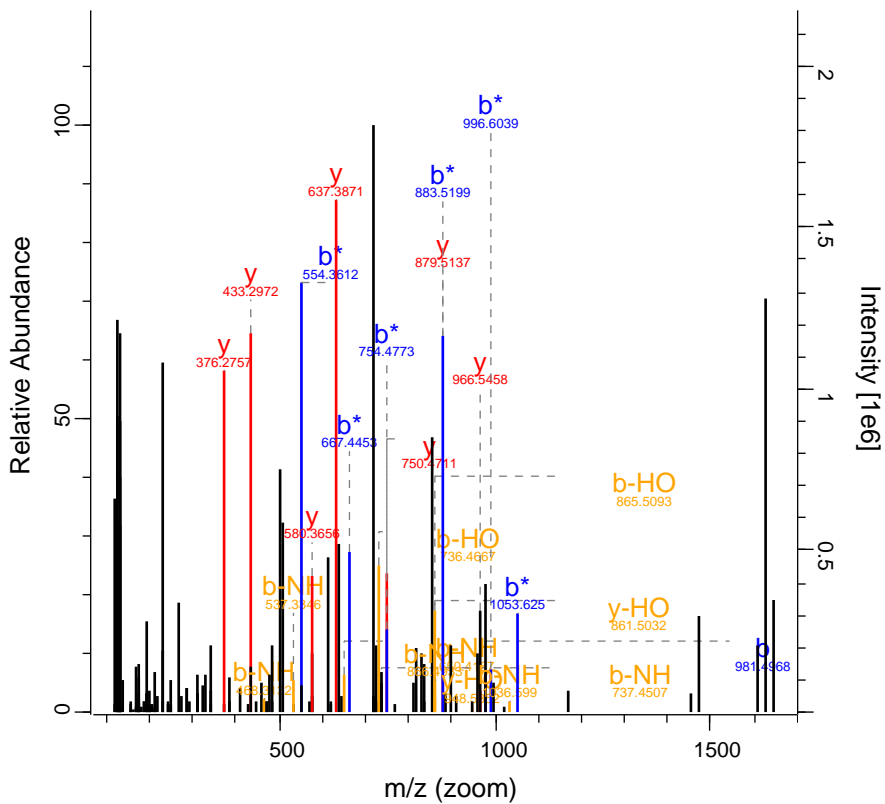

RO-QC-160121_ZackD_SS_Set_01_Fratio 30103 FTMS; HC 263.45 1248.58 SLC12A4

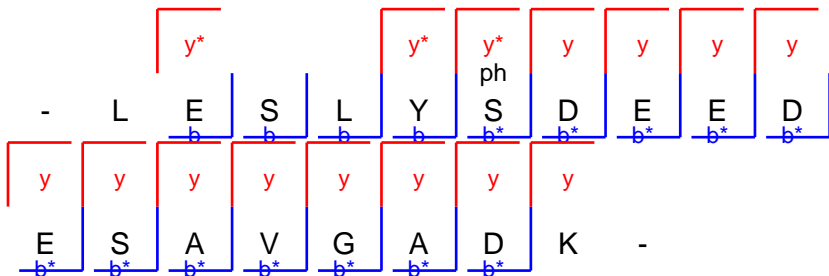
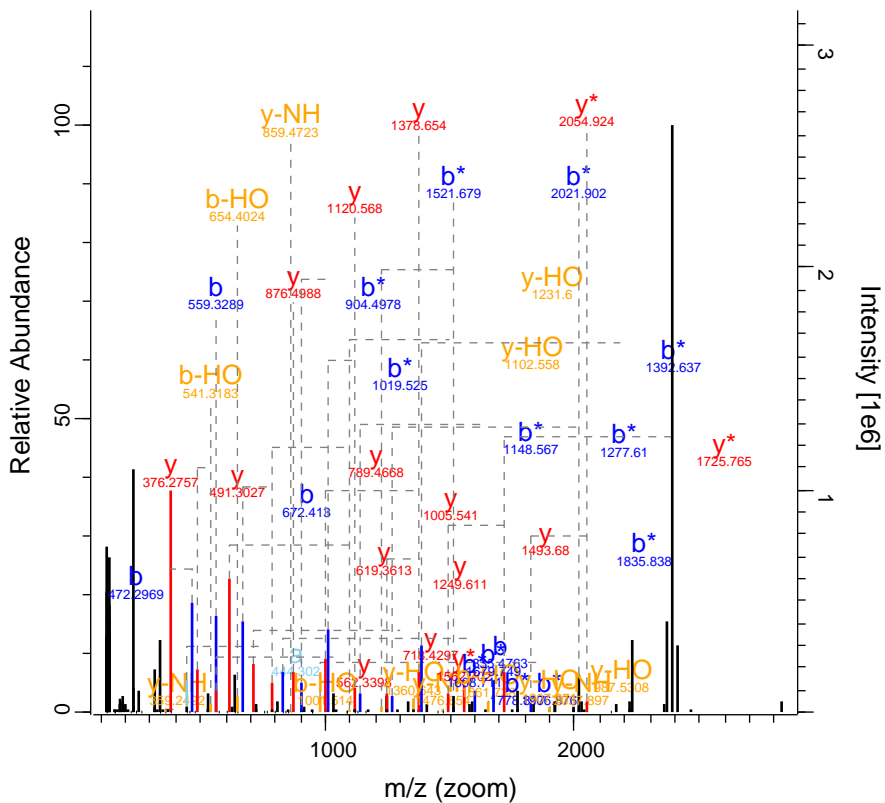

RO-QC-160121_ZackD_SS_Set_01_Fraction 30116 FTMS; HC 90.39 775.44 AHNAK

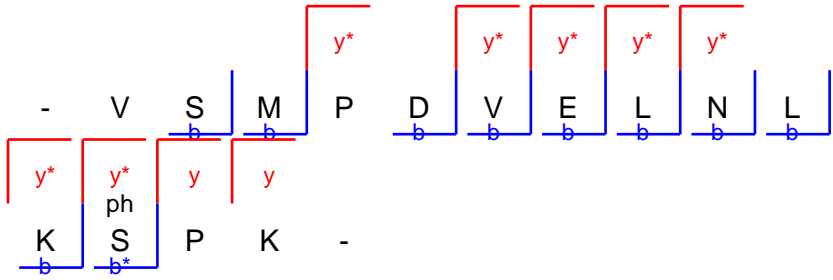
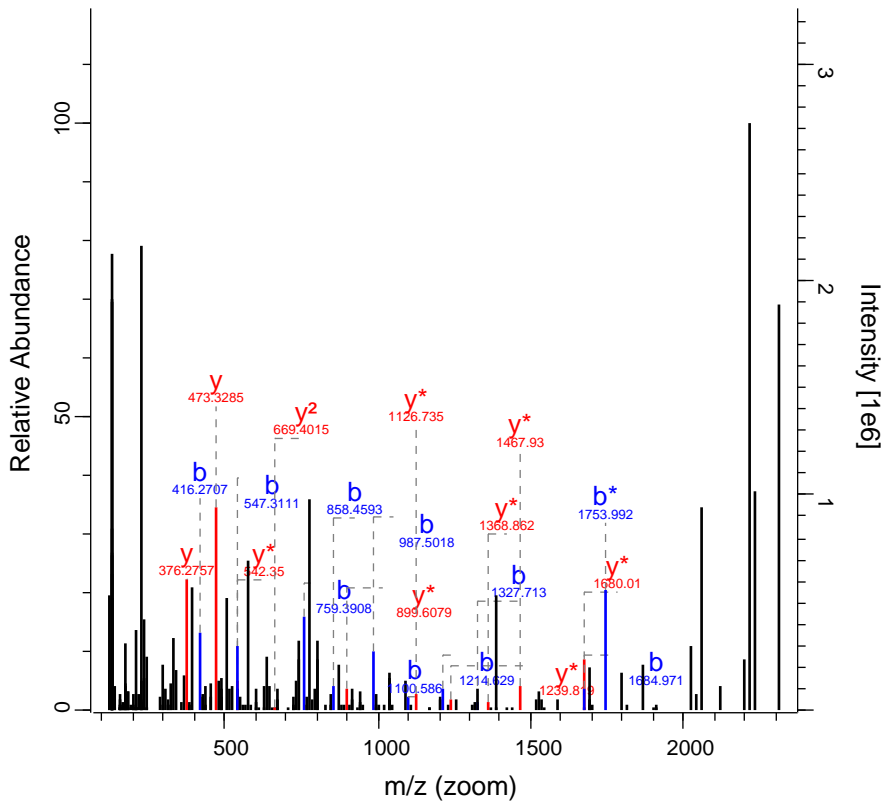

RO-QC-160121_ZackD_SS_Set_01_Fraction 30314 FTMS; HC 49.12 842.16 SIRT7

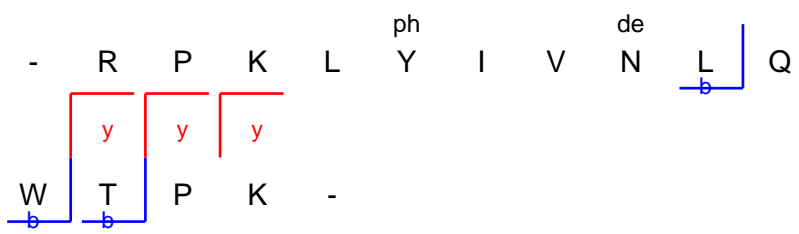
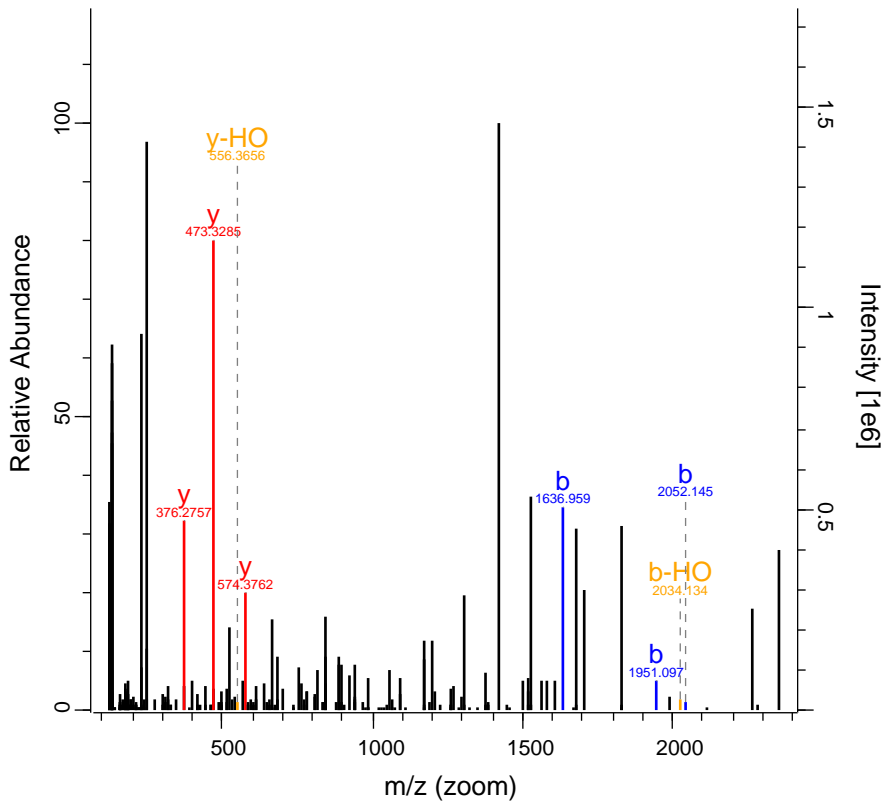

RO-QC-160121_ZackD_SS_Set_01_Fraction 31820 FTMS; HC 73.11 941.17 RUFY1

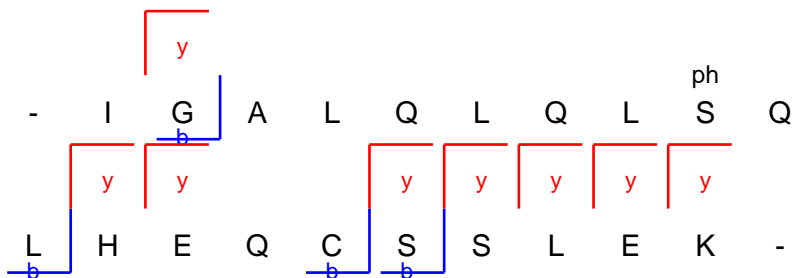
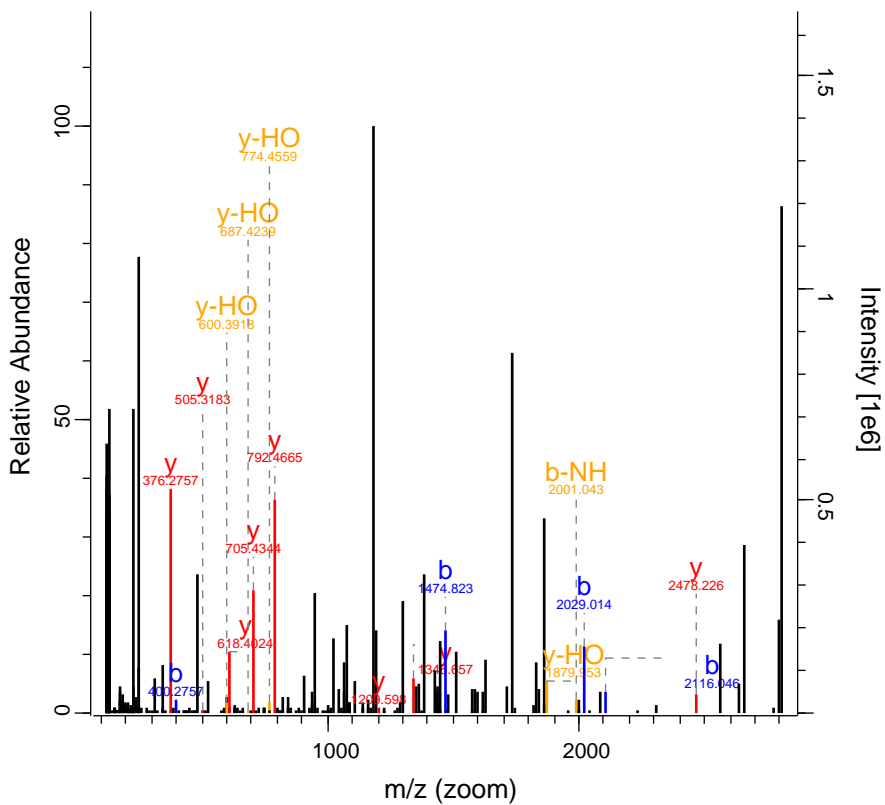

RO-QC-160121_ZackD_SS_Set_01_Fractio 33592 FTMS; HC 132.35 1004.15 MTSS1L

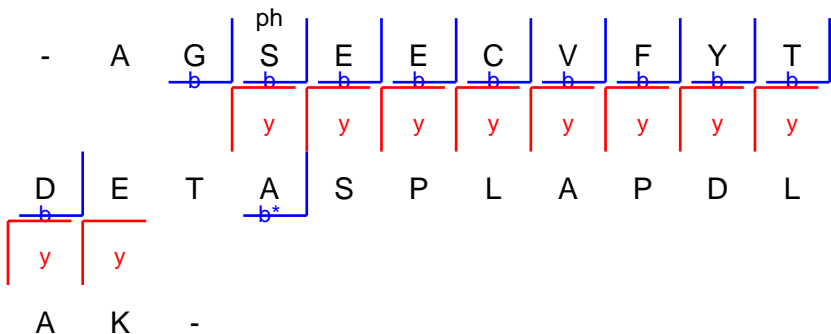
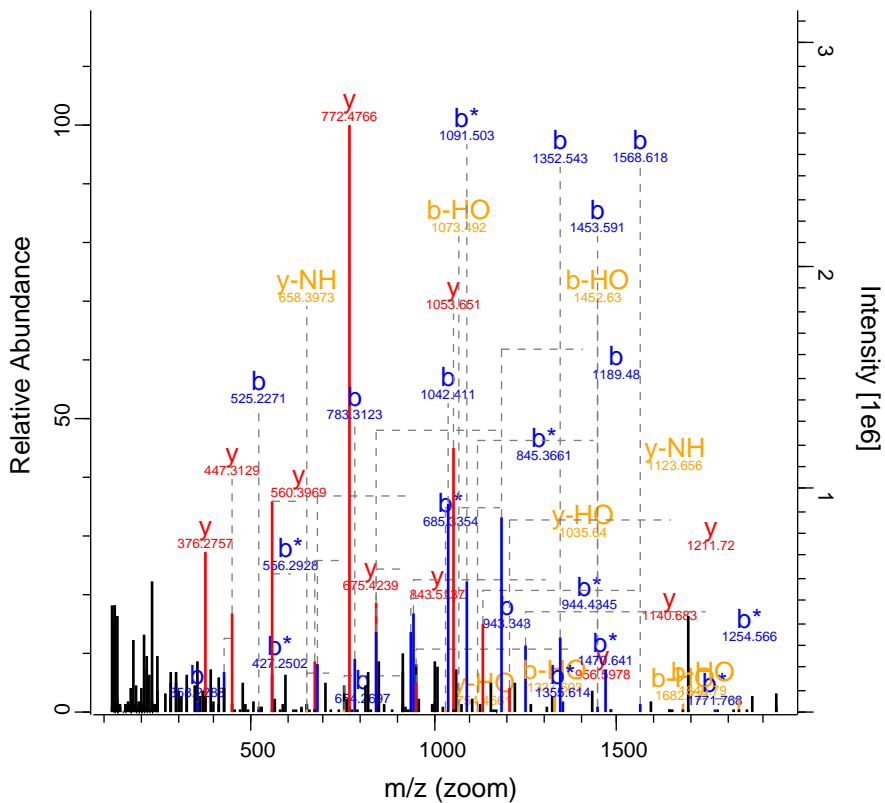

RO-QC-160121_ZackD_SS_Set_01_Fraction 34378 FTMS; HC 41.89 1041.25 MOCS1

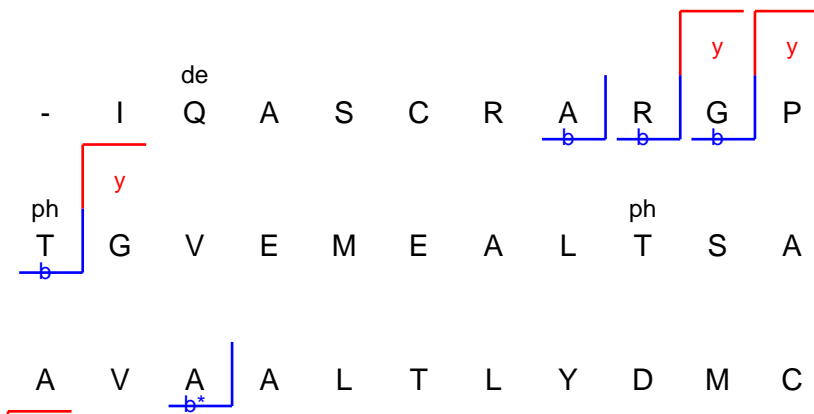
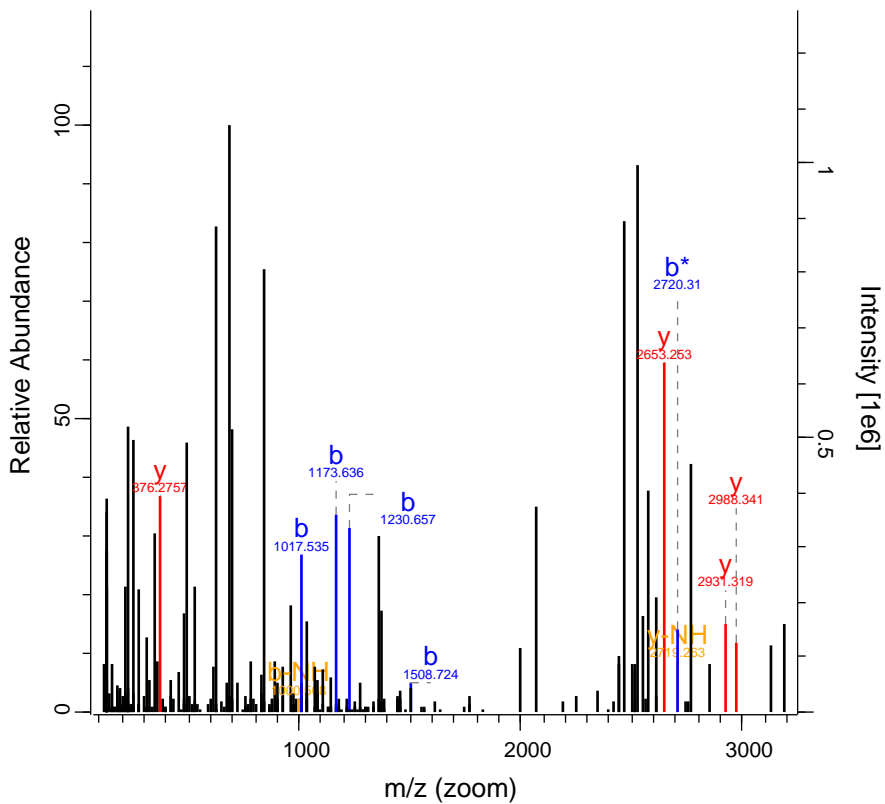

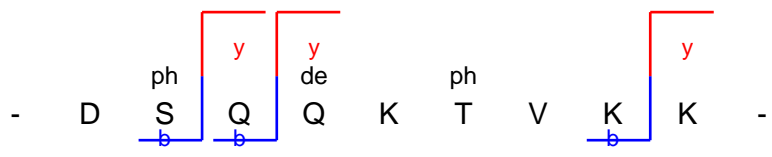
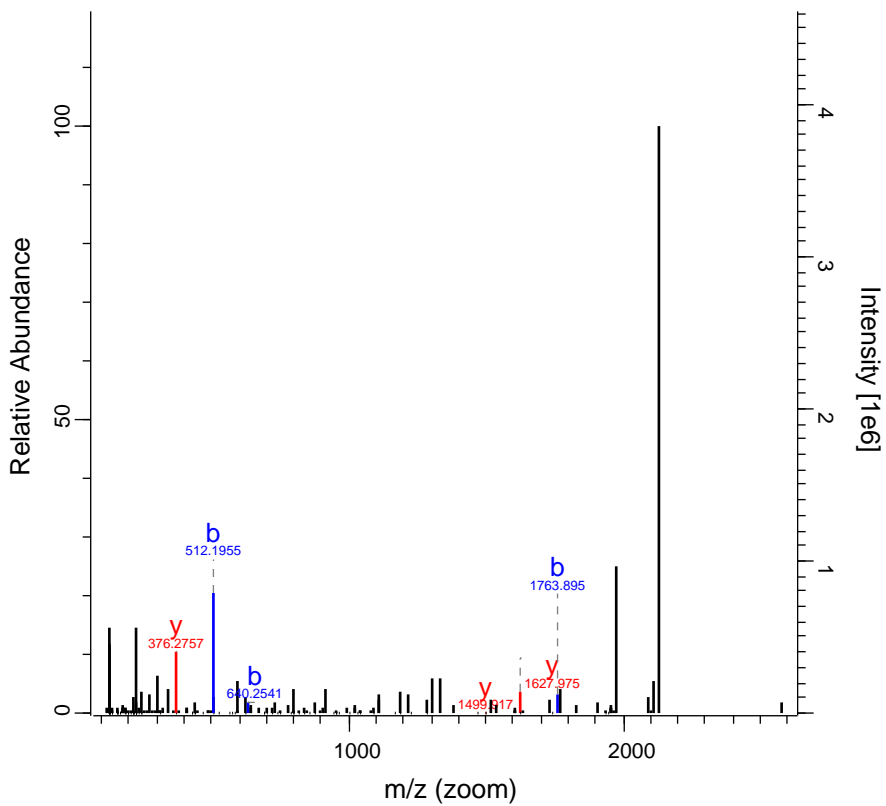

RO-QC-160121_ZackD_SS_Set_01_Fraction 37707 FTMS; HC 91.58 1117.1 RPS13

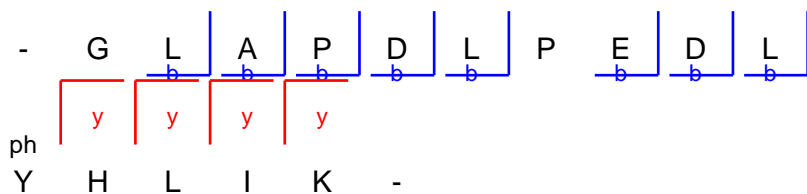
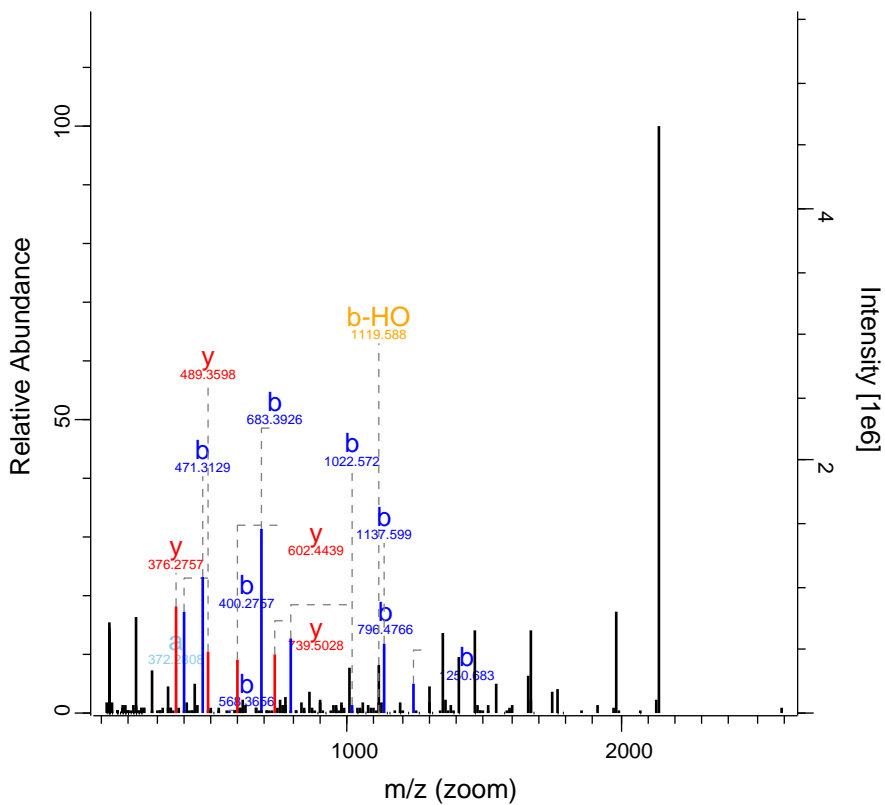

RO-QC-160121_ZackD_SS_Set_01_Fraction 37851 FTMS; HC 62.84 723.39 WWC2

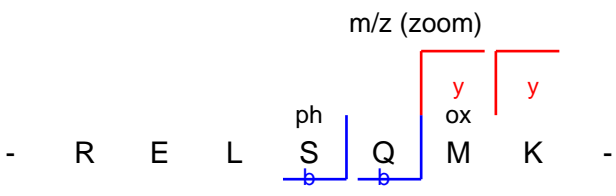
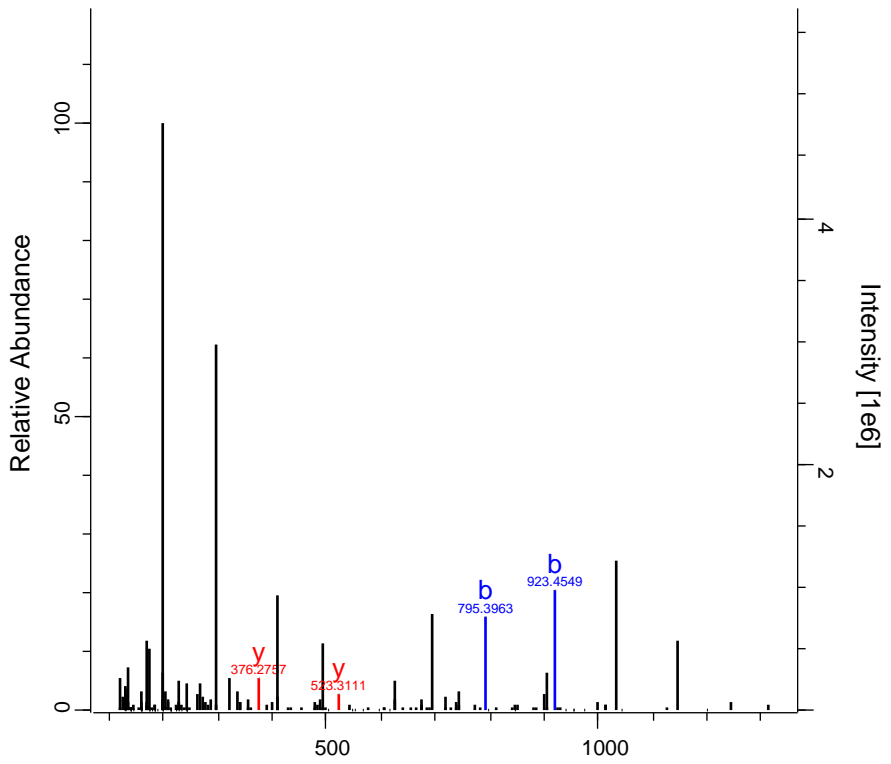

RO-QC-160121_ZackD_SS_Set_02_Fraction4706 FTMS; HCl 132.25 637.3 TANC2

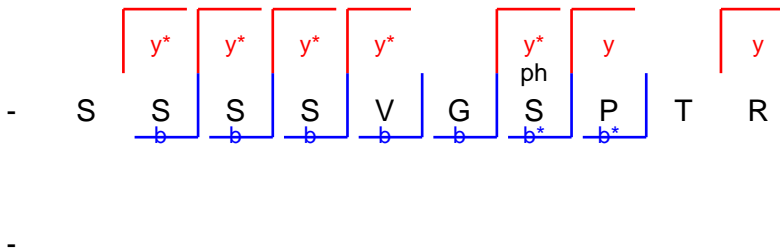
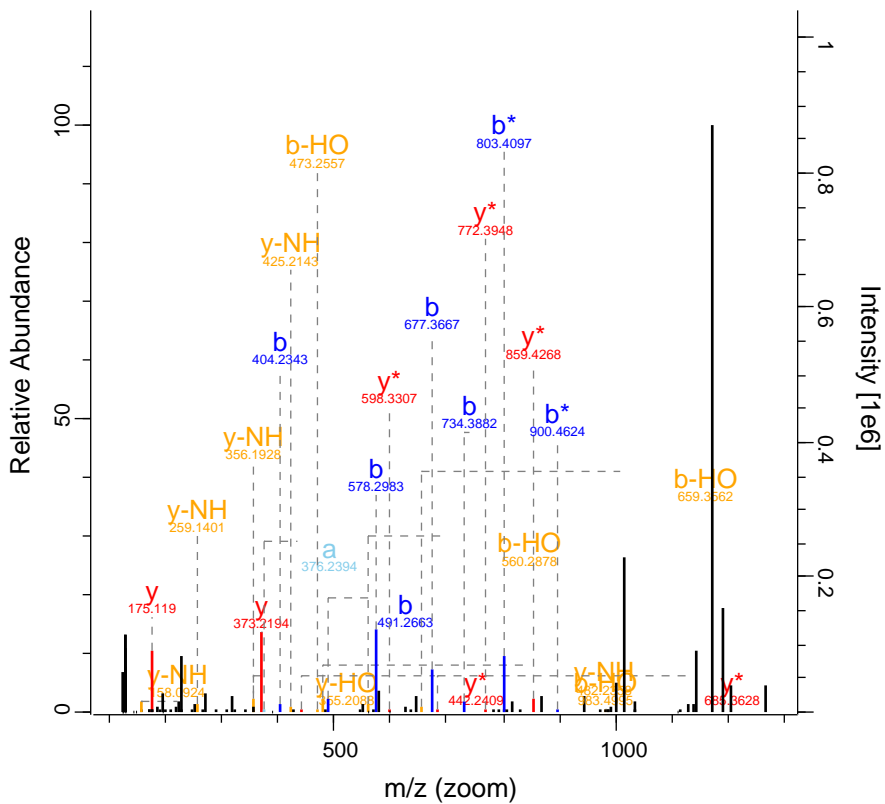

RO-QC-160121_ZackD_SS_Set_02_Fraction 5464 FTMS; HC 132.44 697.64 CEP350

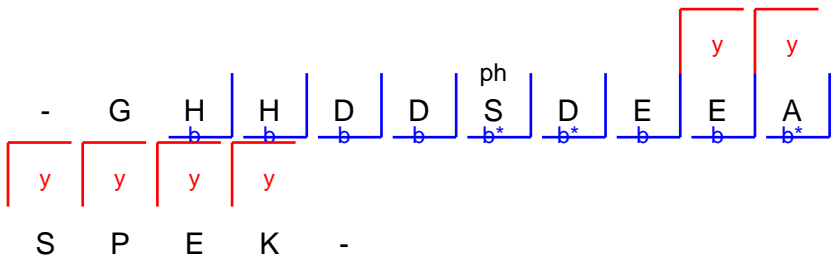
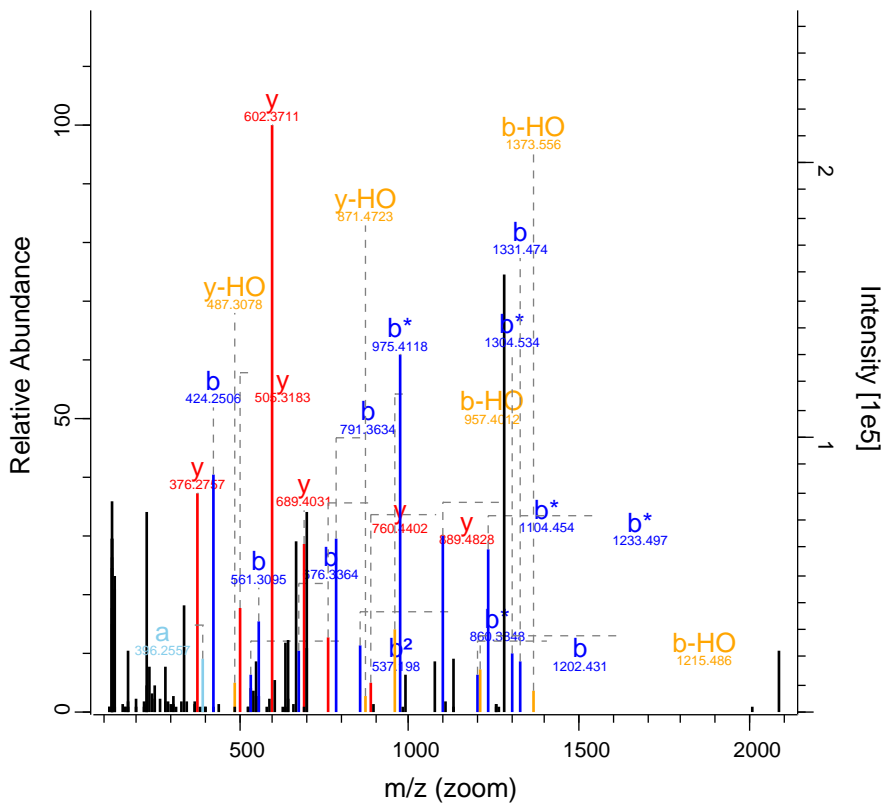

RO-QC-160121_ZackD_SS_Set_02_Fraction 5777 FTMS; HCl 67.23 659.02 RNPS1

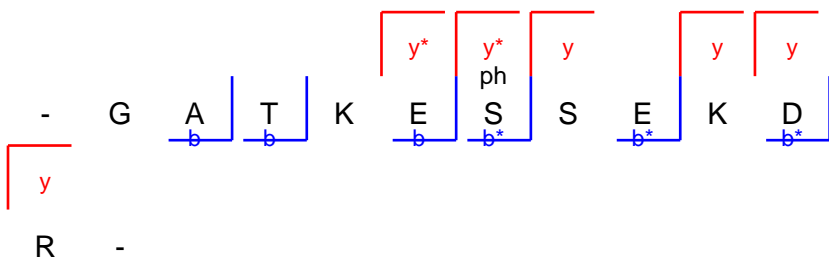
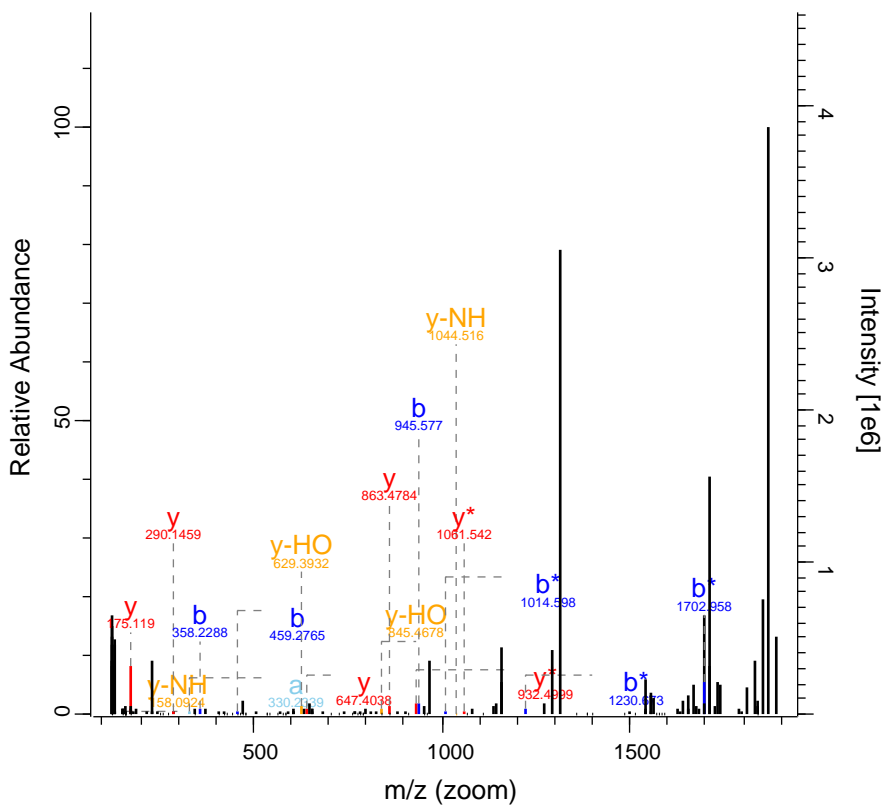

RO-QC-160121_ZackD_SS_Set_02_Fraction 6201 FTMS; HCl 47.26 485.53 SRSF4

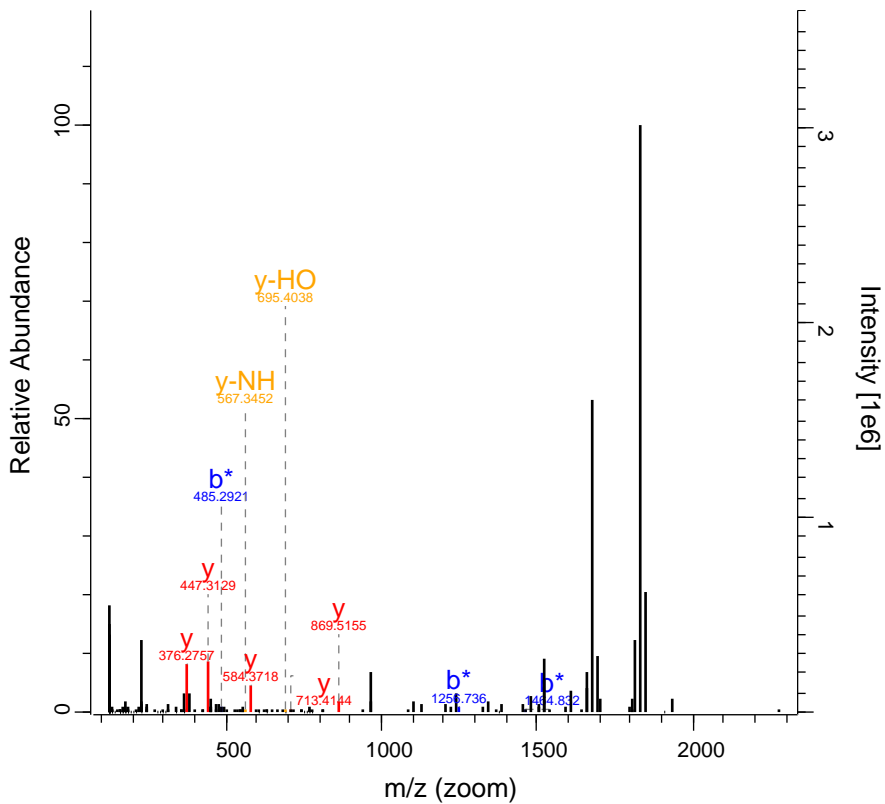

ph

- S V S K E R E H A K

-

RO-QC-160121_ZackD_SS_Set_02_Fraction 6281 FTMS; HCl 60.6 613.36 NIPBL

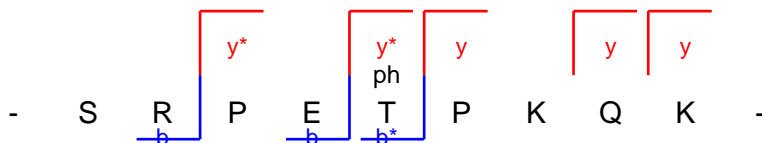
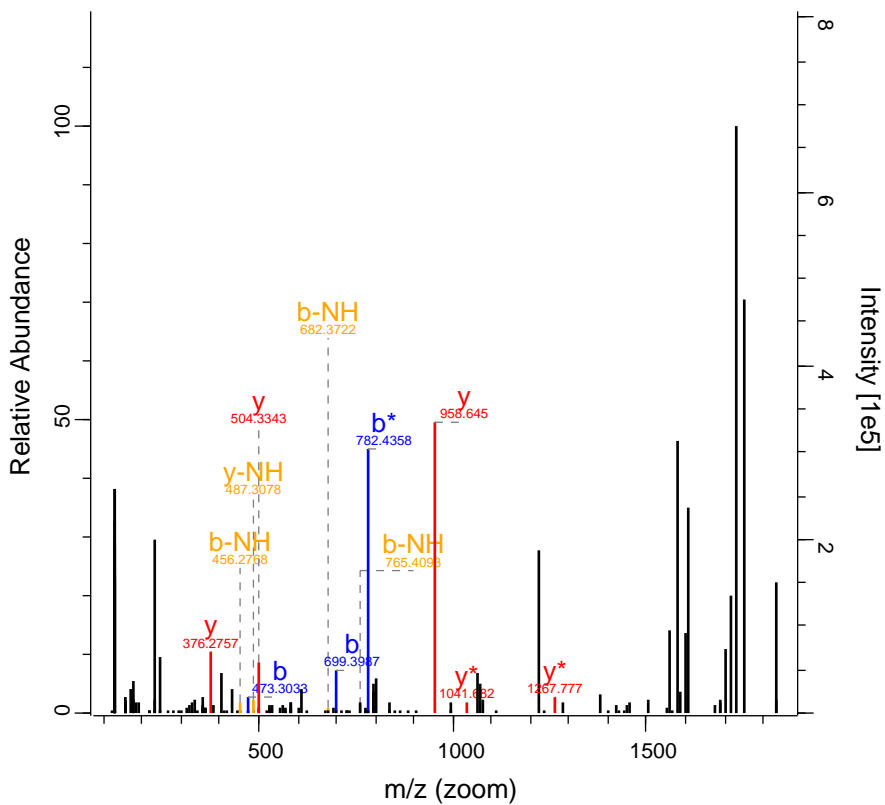

RO-QC-160121_ZackD_SS_Set_02_Fraction 6298 FTMS; HC 116.24 772.34 ZMYM4

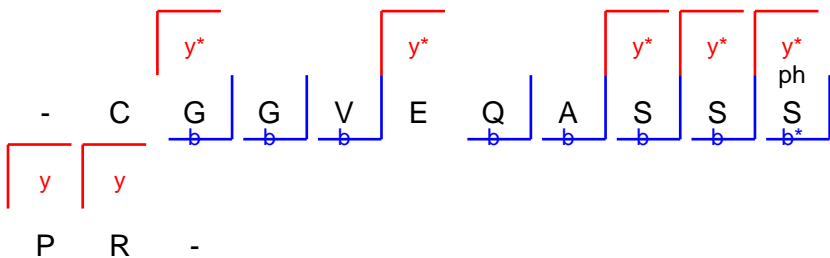
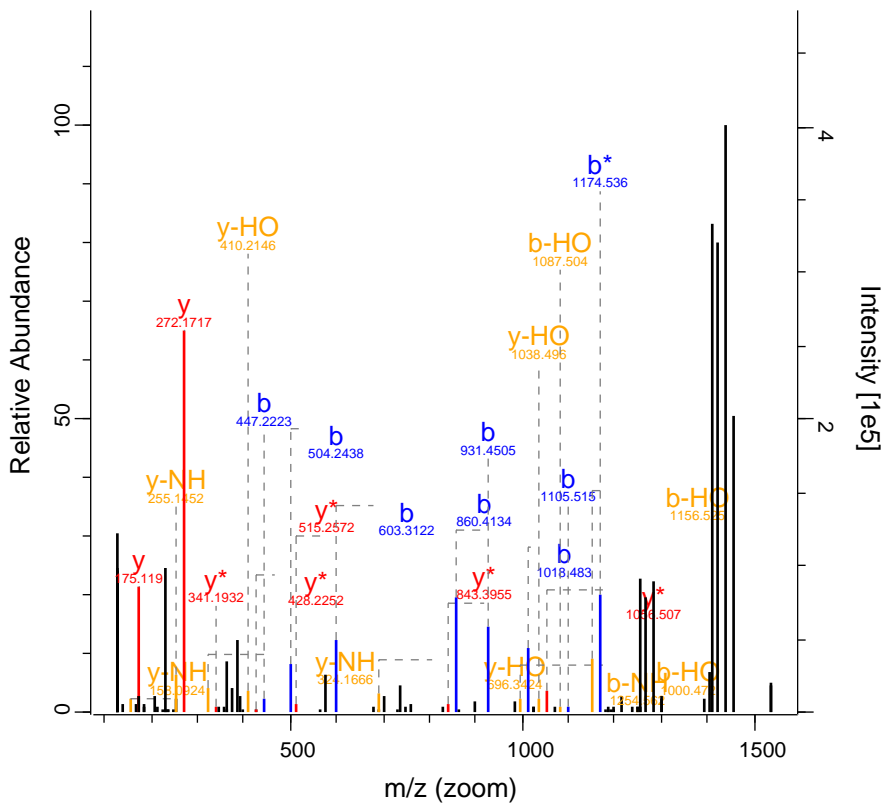

RO-QC-160121_ZackD_SS_Set_02_Fraction 6855 FTMS; HC 131.44 692.29 FTH1

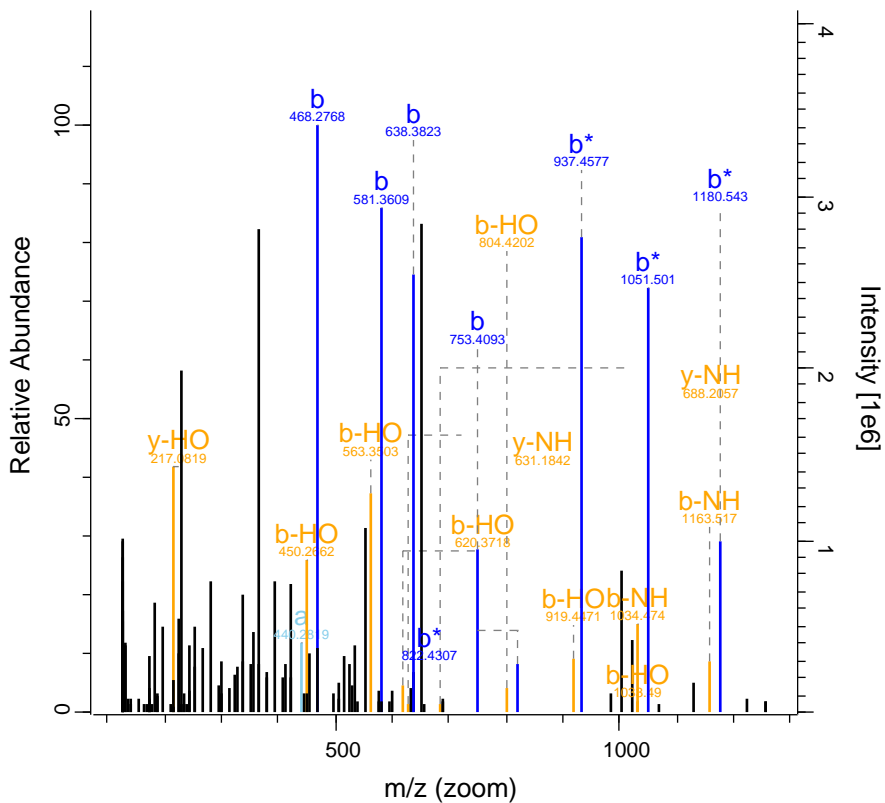

- H T L G D S D N E S

-

-

Fragmentation diagram showing the sequence H T L G D S D N E S. The sequence is broken into fragments: H, T, L, G, D, S, D, N, E, S. The fragments T, L, G, D, S, D, N, E are connected by blue lines, indicating fragmentation sites. The fragment S is shown as a separate peak. The label 'ph' is positioned above the S fragment. The label 'b' is positioned below the T, L, G, D, S, D, N, E fragments. The label 'b*' is positioned below the S, D, N, E fragments.

RO-QC-160121_ZackD_SS_Set_02_Fraction 7021 FTMS; HCl 87.9 610.78 KRT8

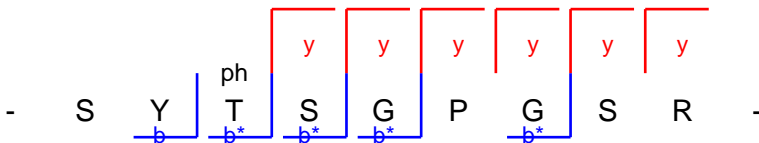
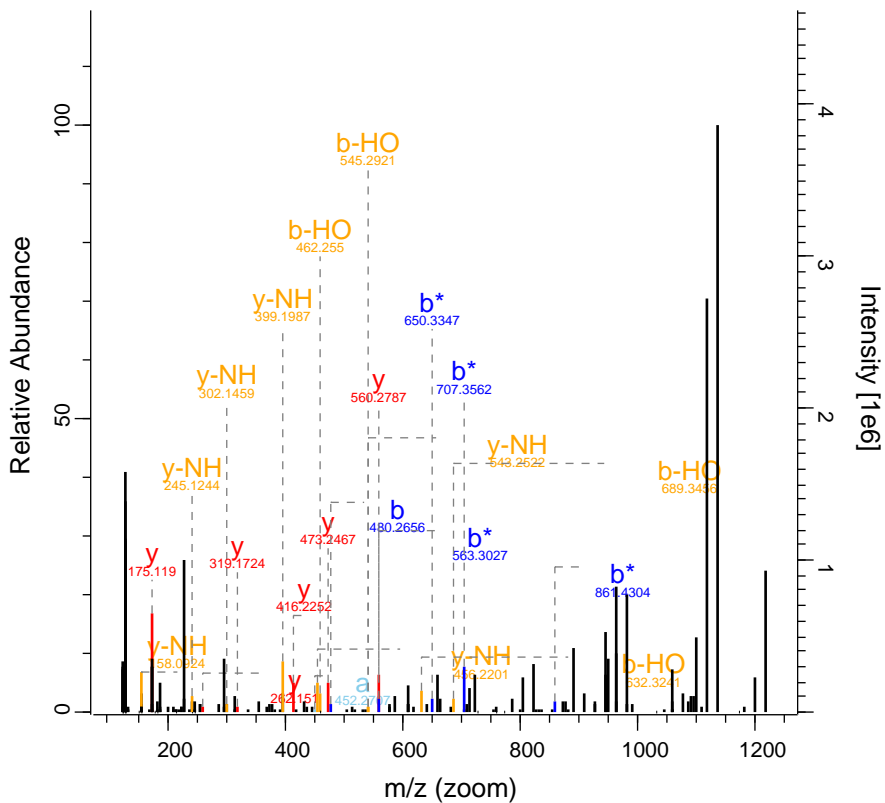

RO-QC-160121_ZackD_SS_Set_02_Fraction 8527 FTMS; HCl 63.6 595.67 CEND1

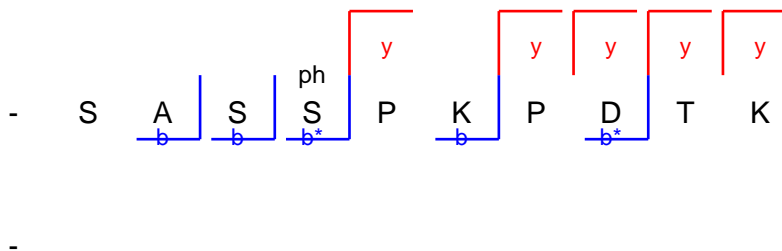
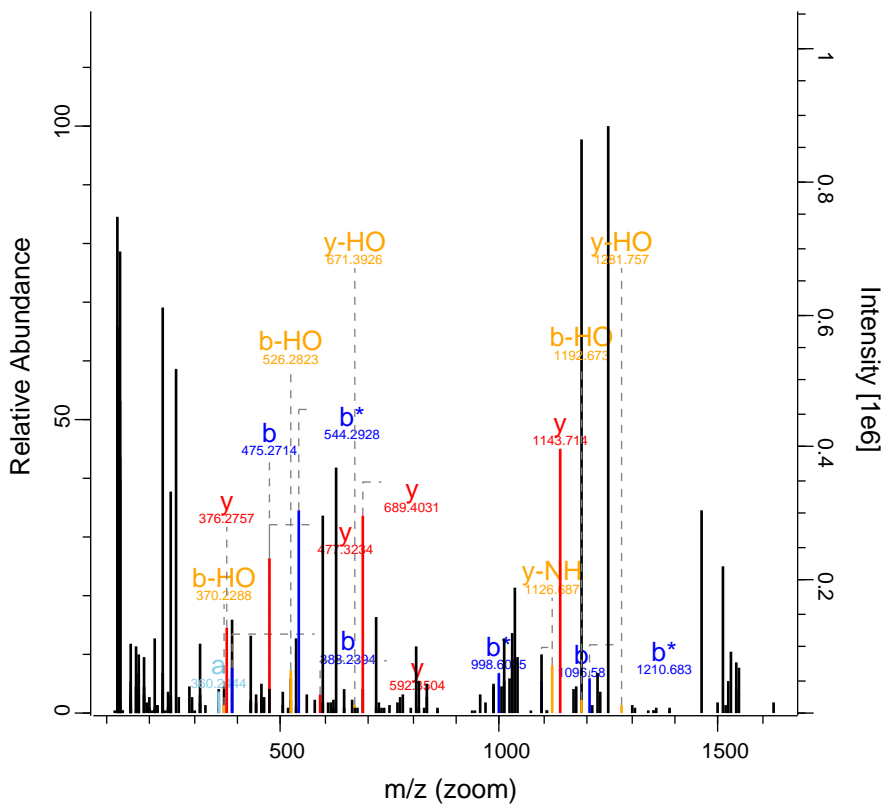

RO-QC-160121_ZackD_SS_Set_02_Fraction 10894 FTMS; HC 47.26 996.96 ANO3

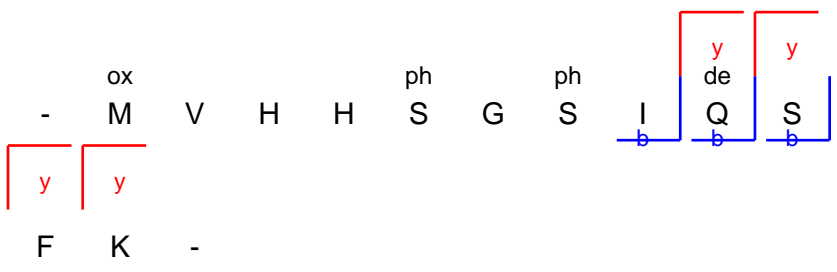
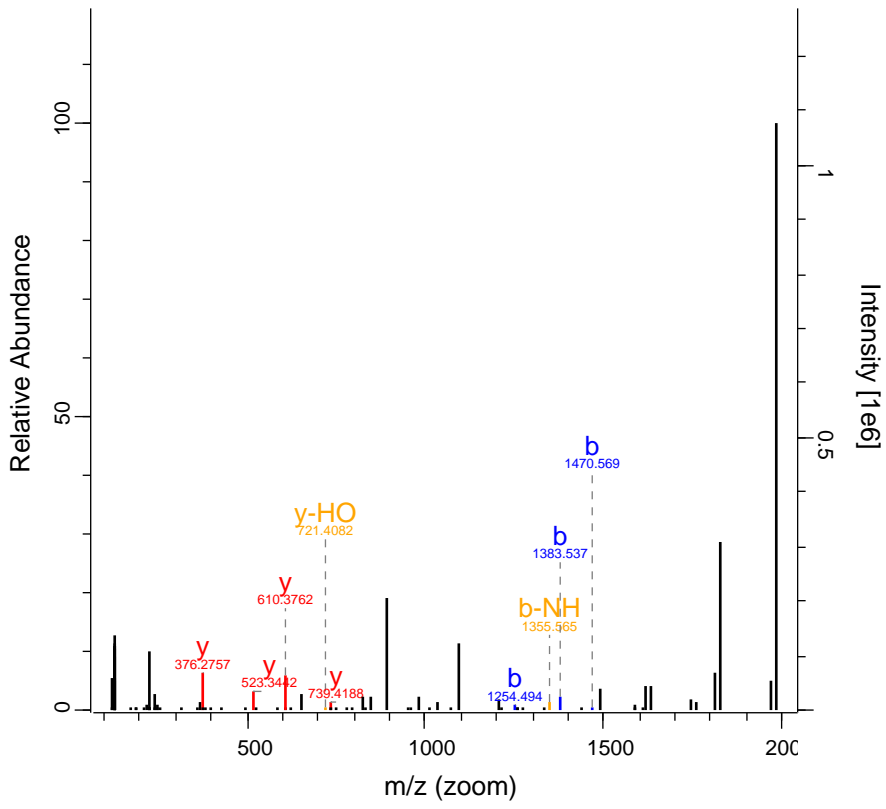

RO-QC-160121_ZackD_SS_Set_02_Fraction 11403 FTMS; HCl 167.99 782.4 H2AFX

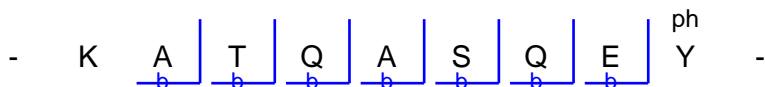
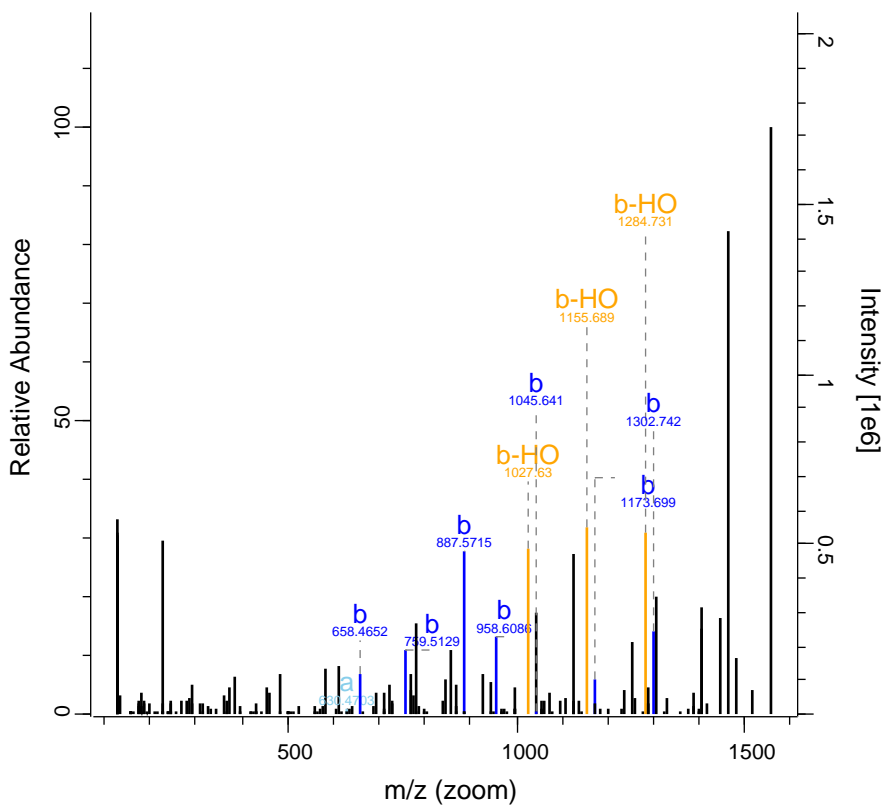

RO-QC-160121_ZackD_SS_Set_02_Fractio 11944 FTMS; HC 120.55 777.39 CHD4

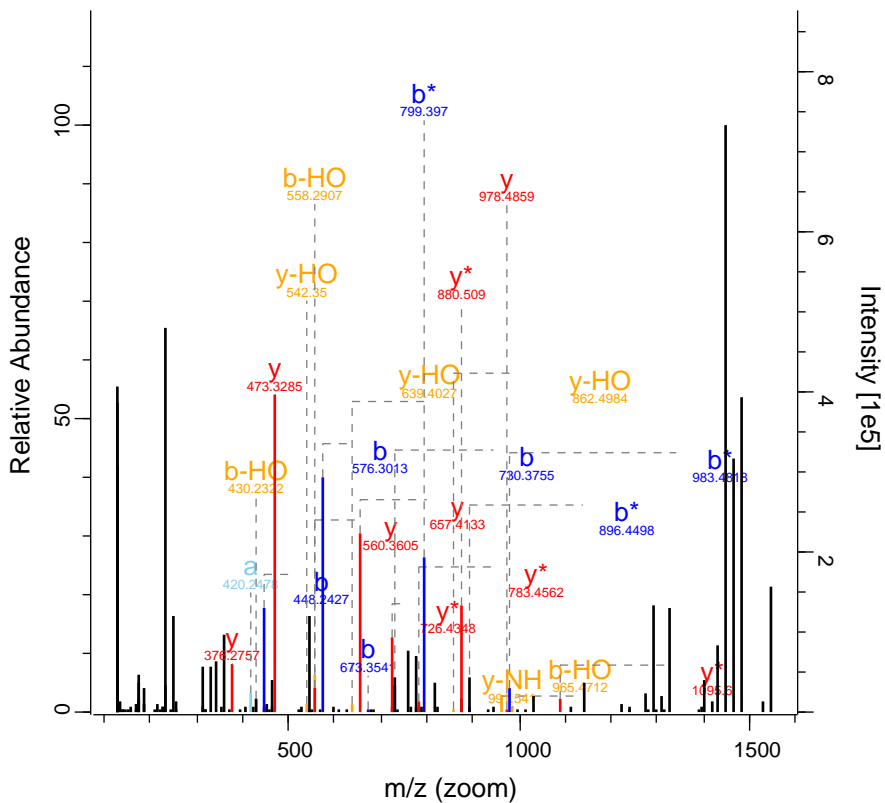

m/z (zoom)

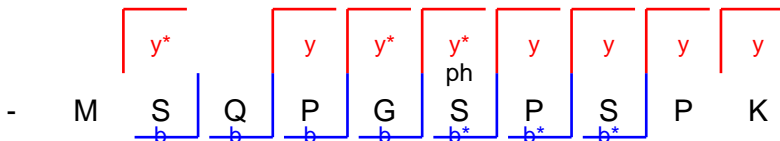

RO-QC-160121_ZackD_SS_Set_02_Fraction 12024 FTMS; HC 52.79 639.37 CCP110

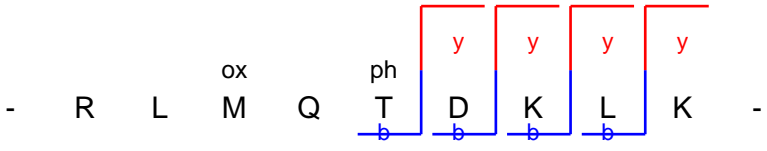
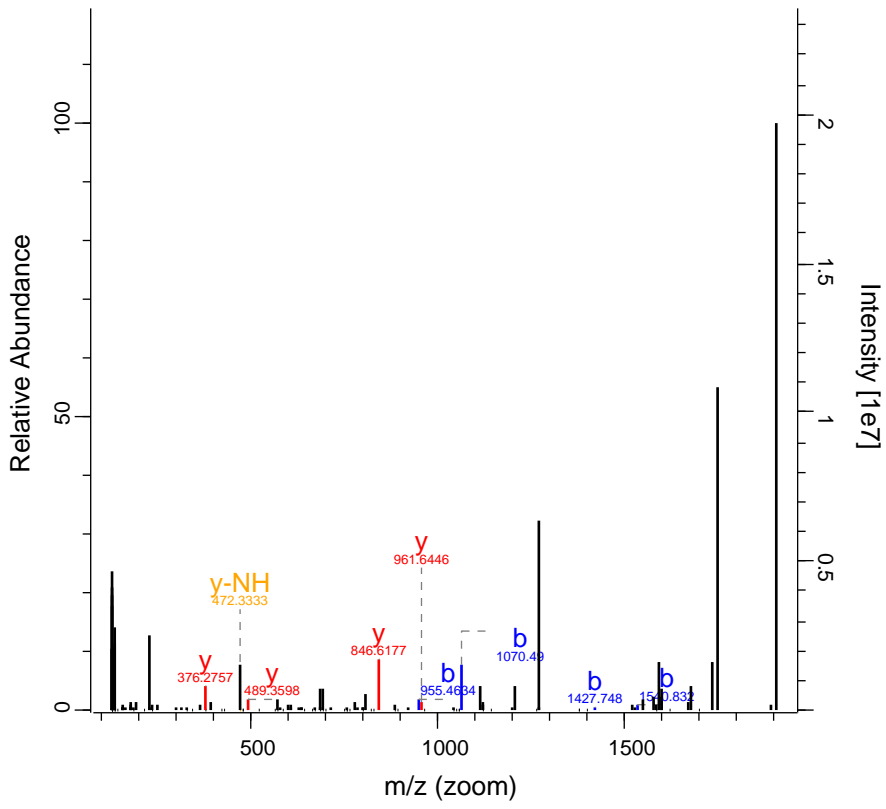

RO-QC-160121_ZackD_SS_Set_02_Fraction 12047 FTMS; HC 80.28 812.09 SRSF11

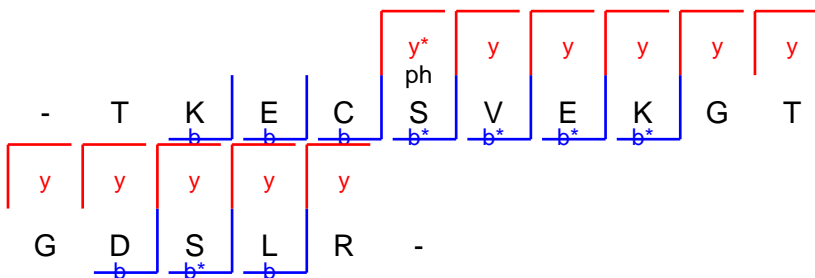
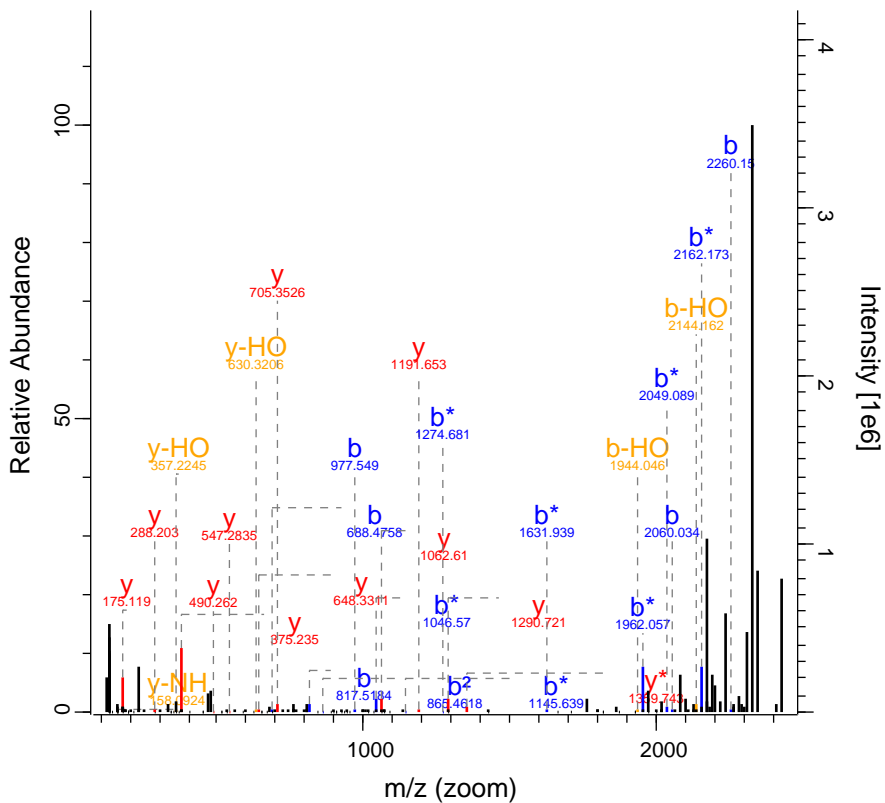

RO-QC-160121_ZackD_SS_Set_02_Fraction 12346 FTMS; HC 86.55 860.09 GTF3C1

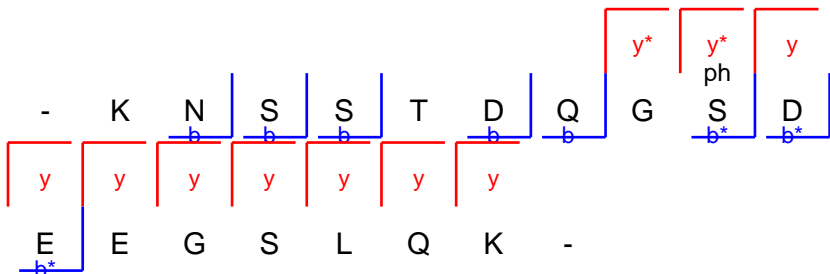
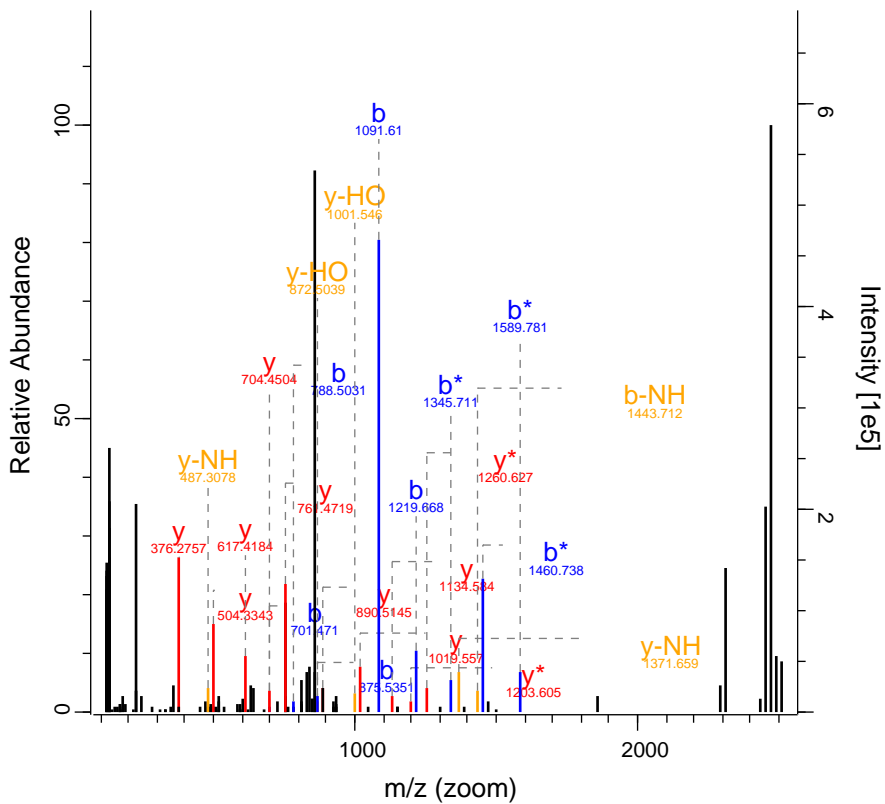

RO-QC-160121_ZackD_SS_Set_02_Fractio 12414 FTMS; HC 221.66 838.38 MYRIP

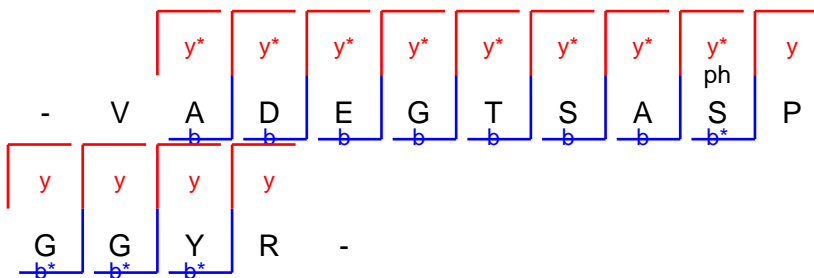
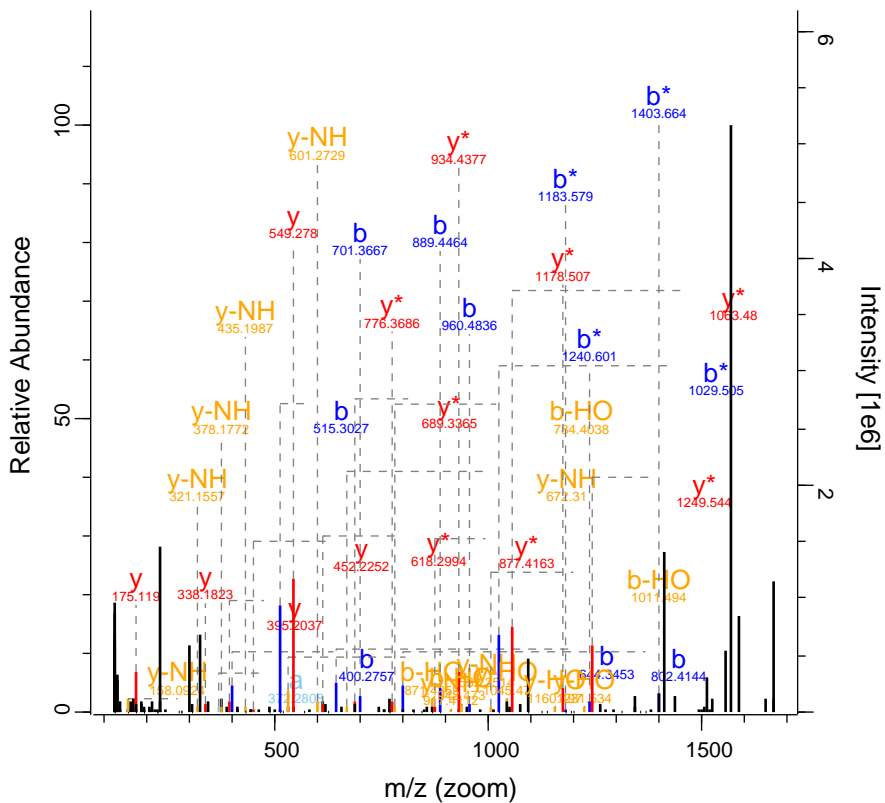

RO-QC-160121_ZackD_SS_Set_02_Fraction12517 FTMS; HCl 231.74 878.9 FNBP4

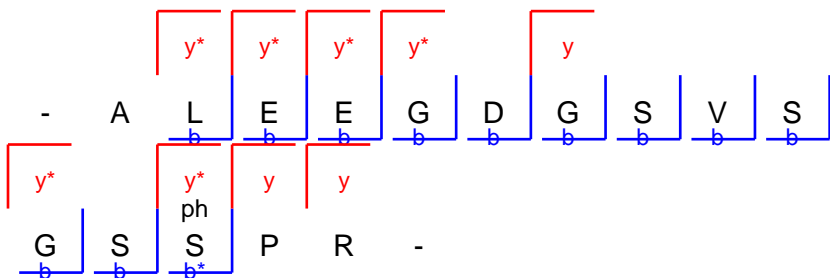
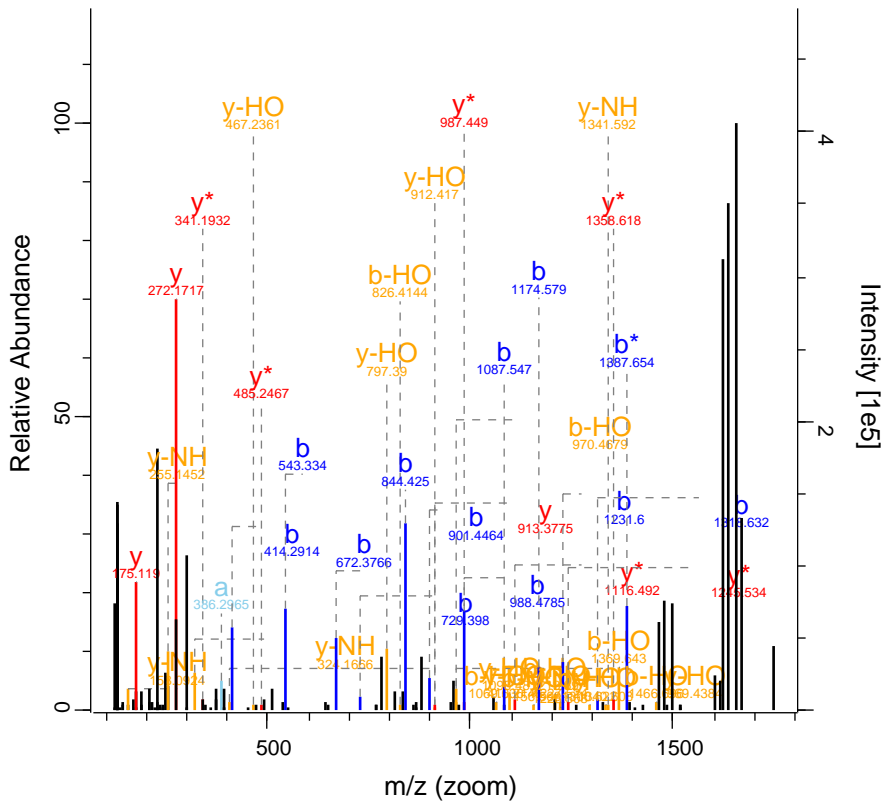

RO-QC-160121_ZackD_SS_Set_02_Fraction 12981 FTMS; HC 90.05 835.97 ARHGEF7

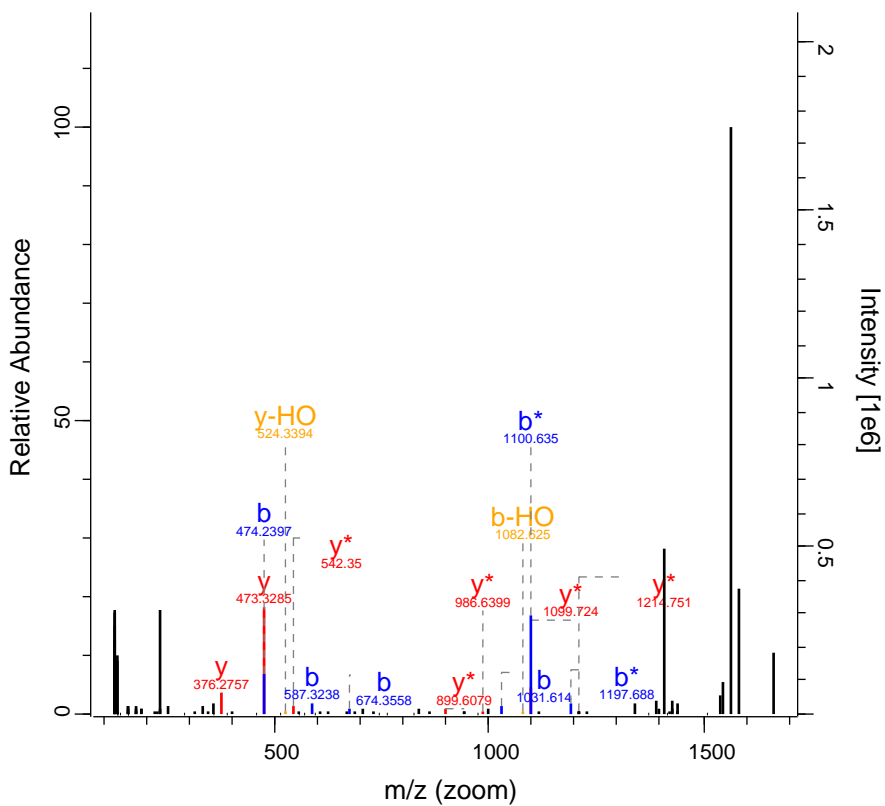

m/z (zoom)

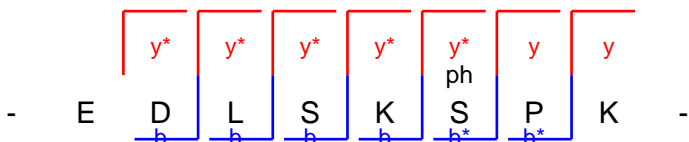

RO-QC-160121_ZackD_SS_Set_02_Fractio 14177 FTMS; HC 139.64 835.39 PPAN

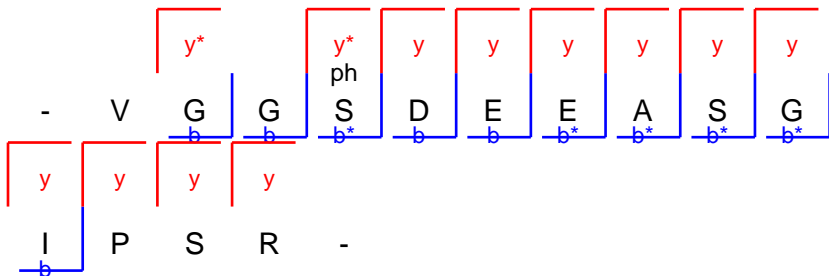
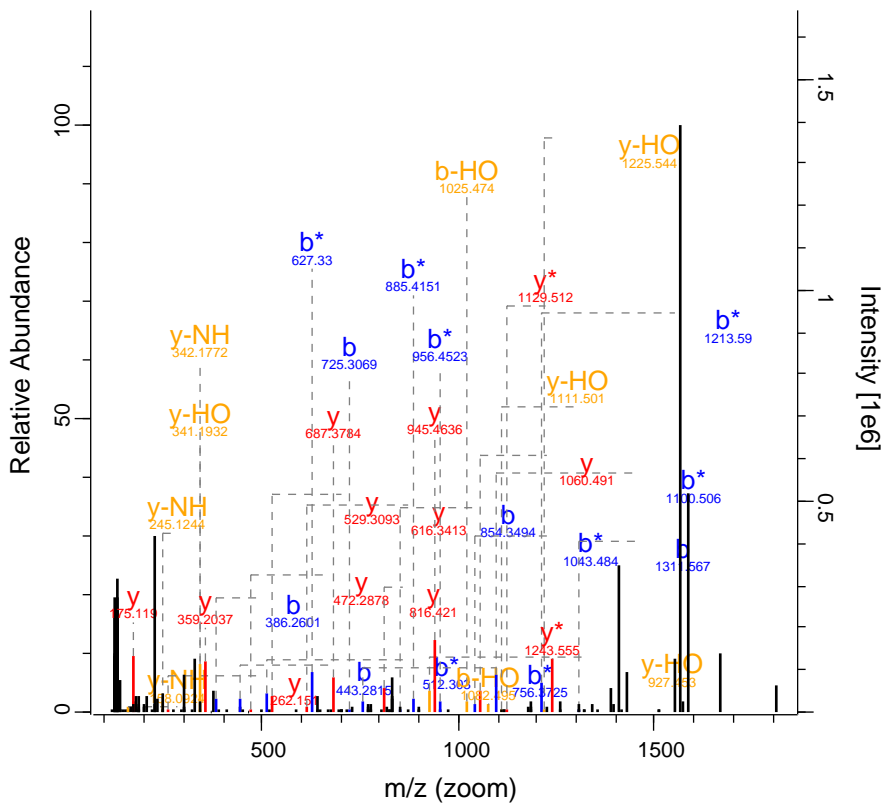

RO-QC-160121_ZackD_SS_Set_02_Fraction 15403 FTMS; HC 97.73 764.93 WRNIP1

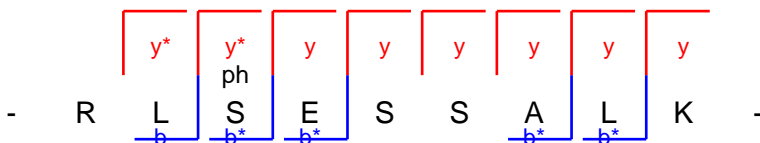
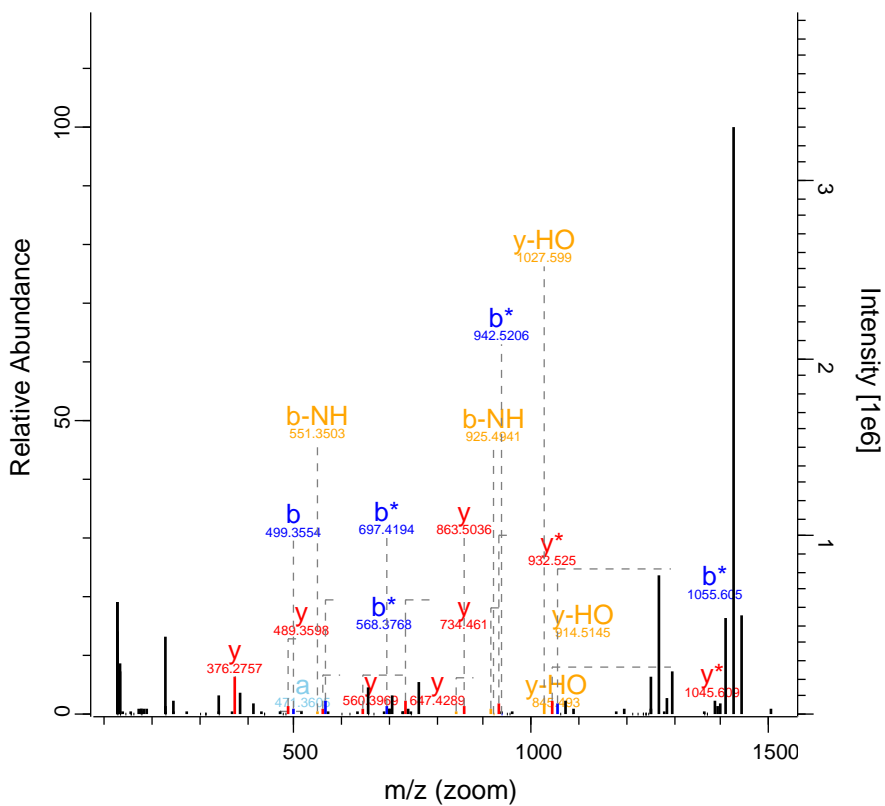

RO-QC-160121_ZackD_SS_Set_02_Fraction 15732 FTMS; HC 59.21 462.26 RPL4

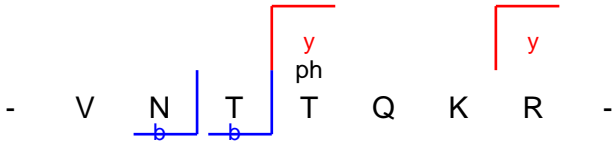
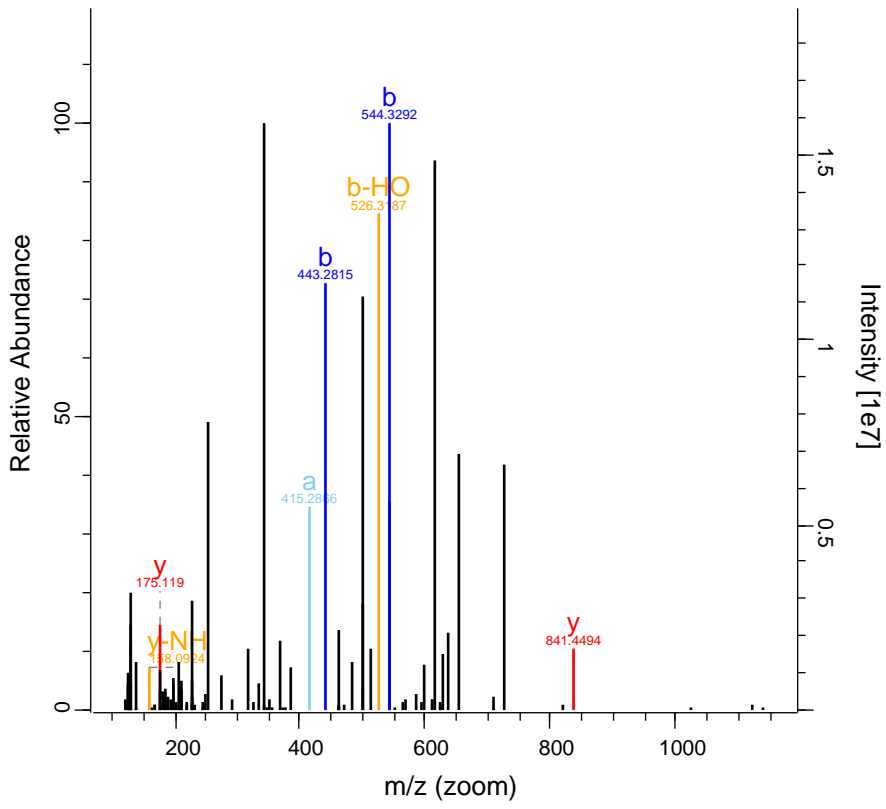

RO-QC-160121_ZackD_SS_Set_02_Fraction 16407 FTMS; HCl 69.4 641.1 ACLY

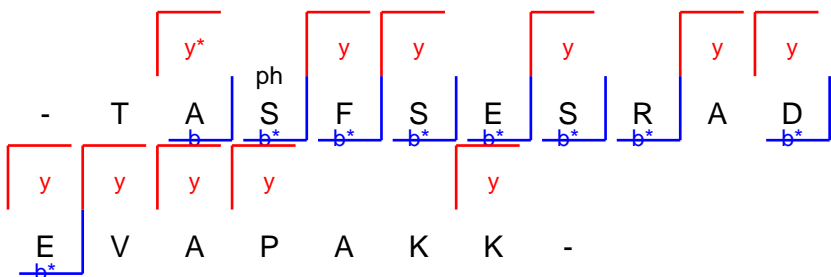
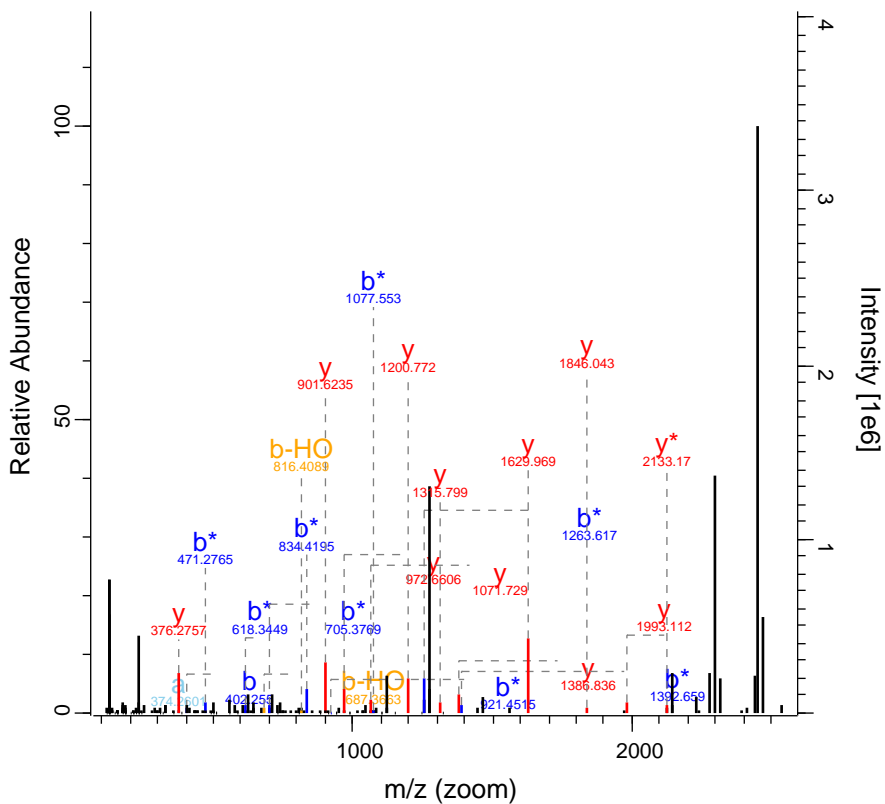

RO-QC-160121_ZackD_SS_Set_02_Fraction 16843 FTMS; HC 53.28 772.06 PCNP

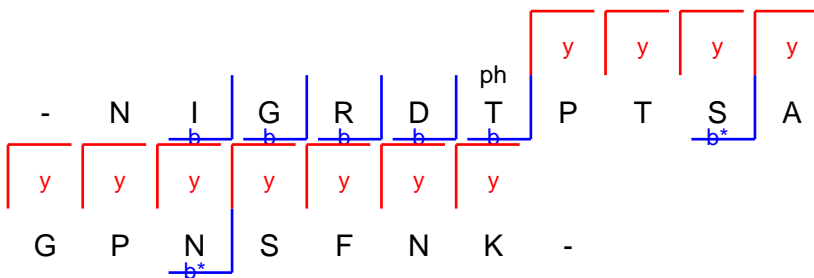
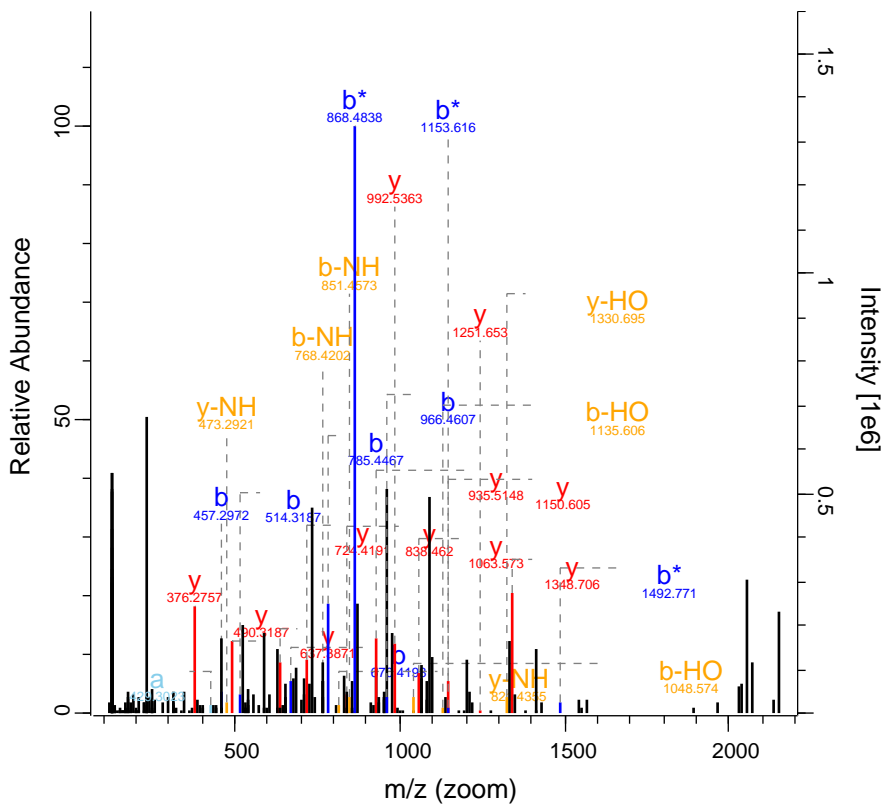

RO-QC-160121_ZackD_SS_Set_02_Fractic 18586 FTMS; HC 46.35 1164.61 PATL2

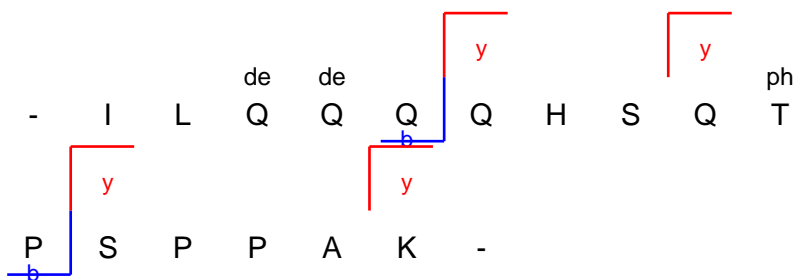
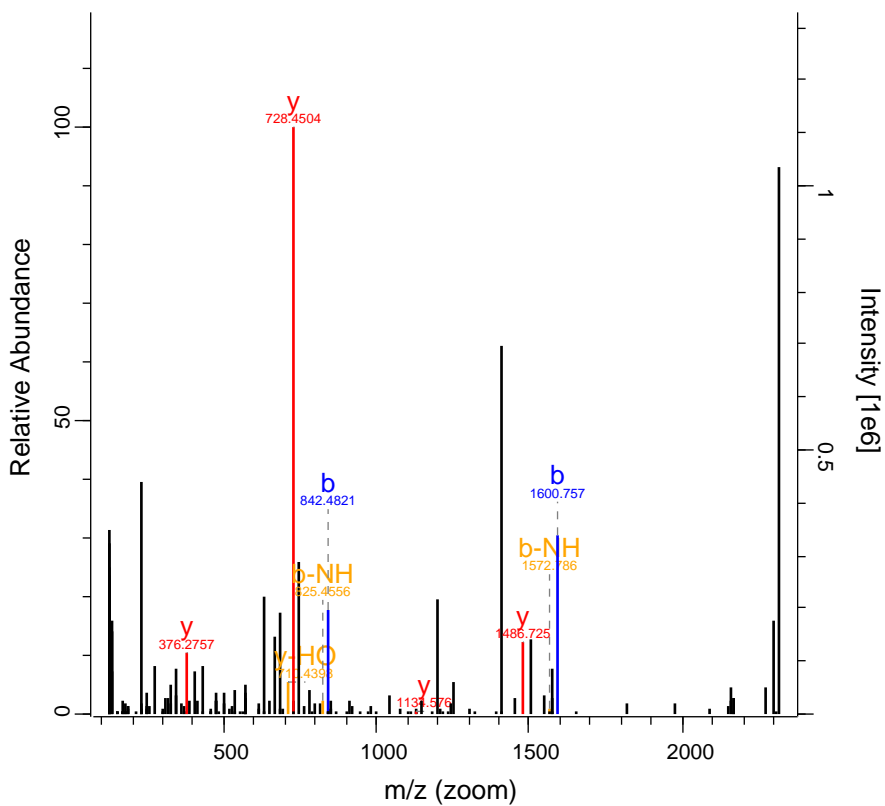

RO-QC-160121_ZackD_SS_Set_02_Fractio 19007 FTMS; HC 106.32 842.93 DOCK7

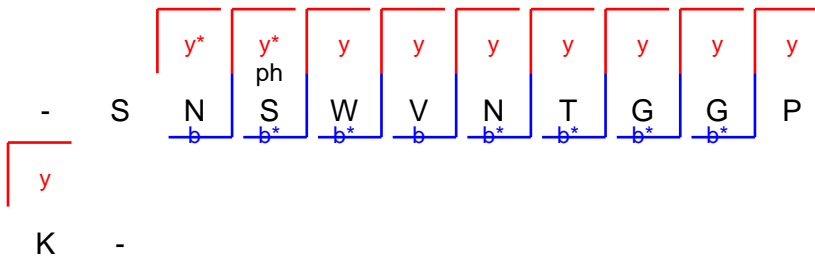
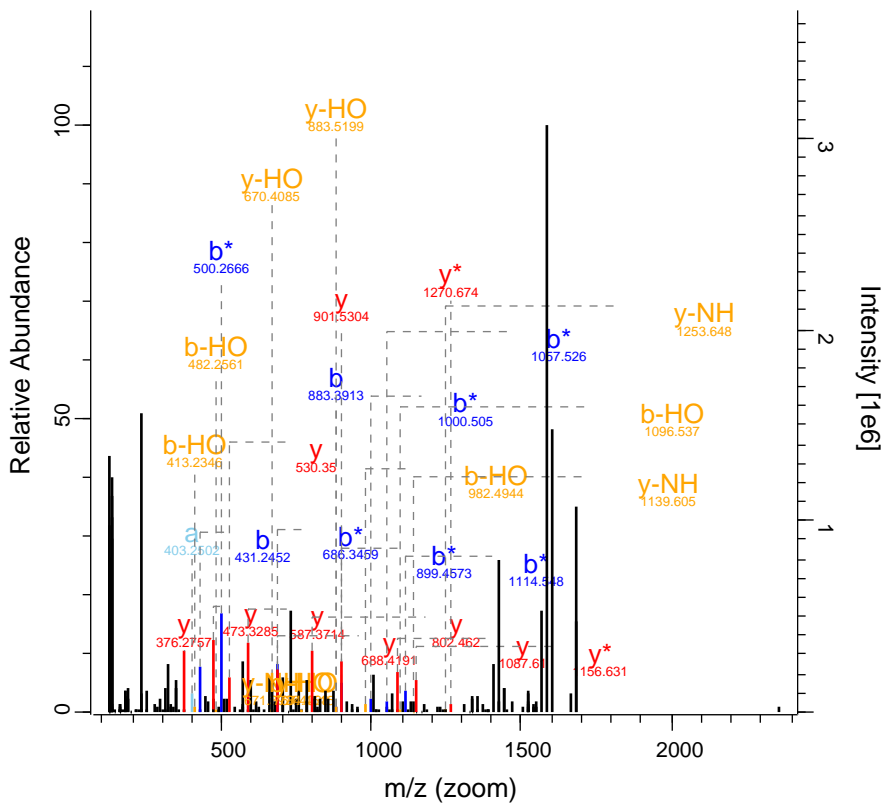

RO-QC-160121_ZackD_SS_Set_02_Fratio 19103 FTMS; HC 104.44 732.06 BNIP2

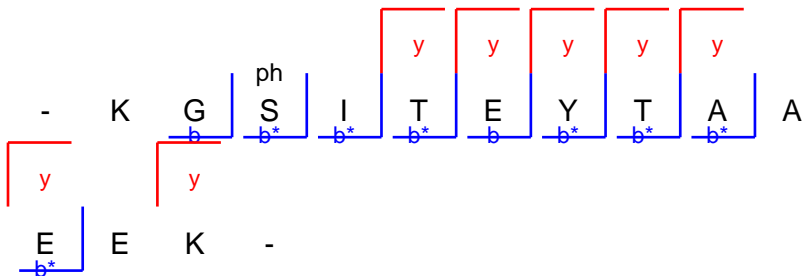
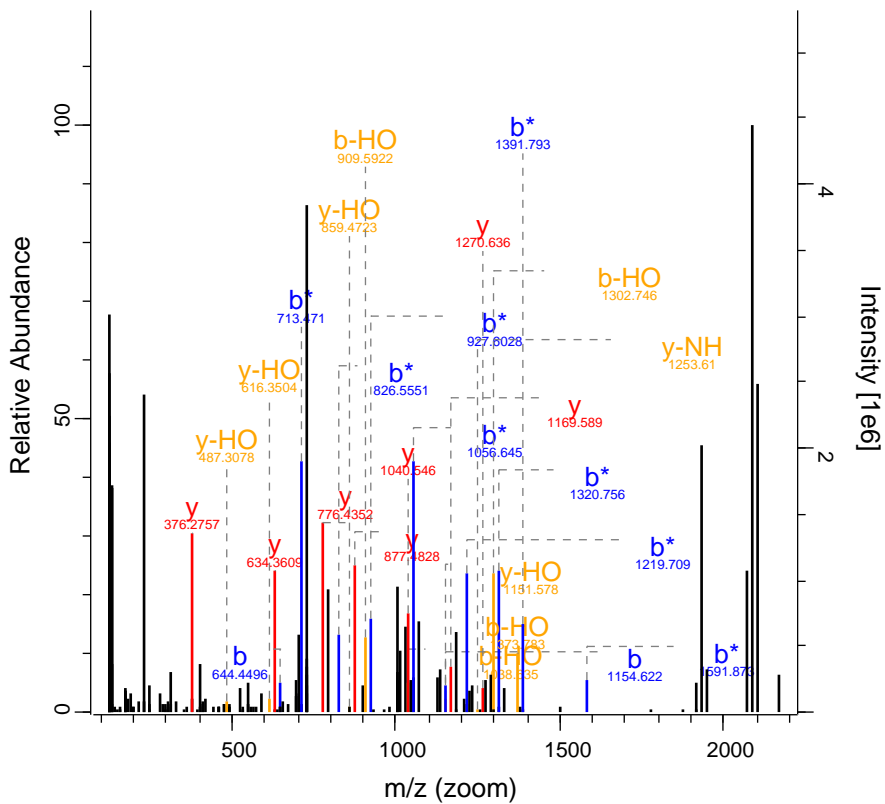

RO-QC-160121_ZackD_SS_Set_02_Fraction 19206 FTMS; HC 66.61 903.81 AKAP12

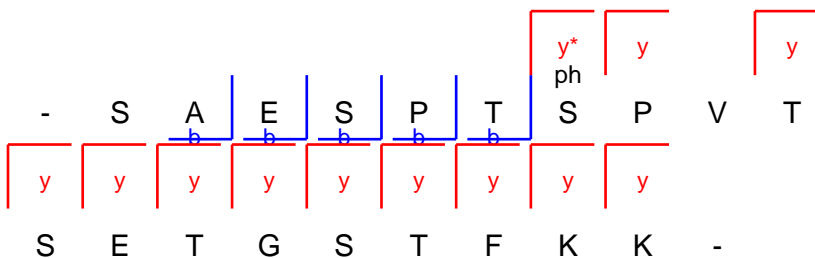
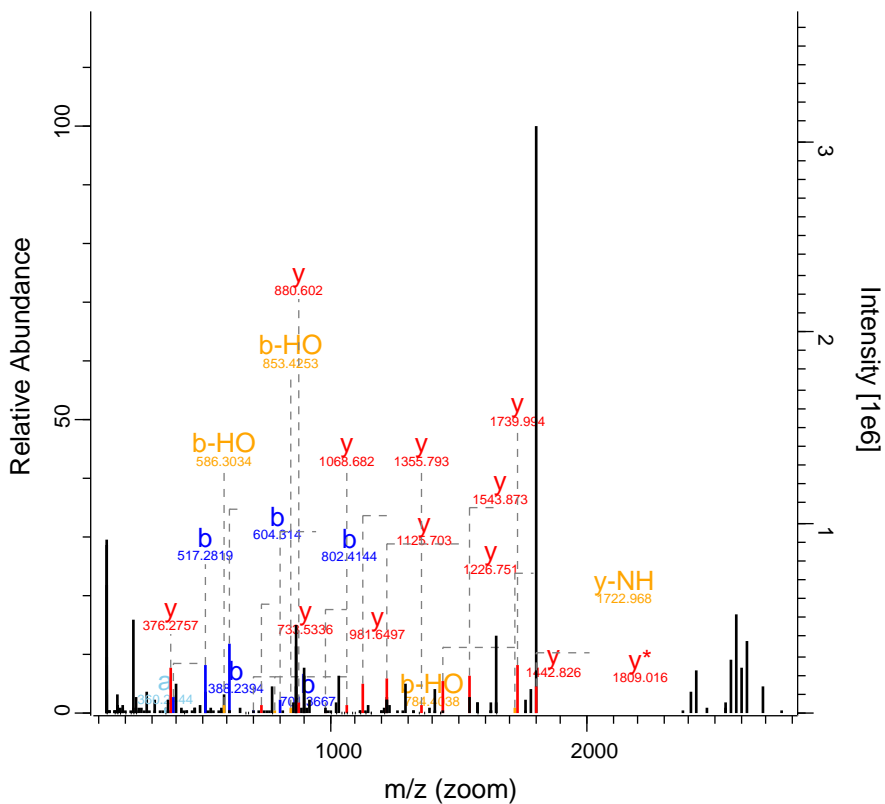

RO-QC-160121_ZackD_SS_Set_02_Fractio 19387 FTMS; HC 137.72 701.35 EIF5B

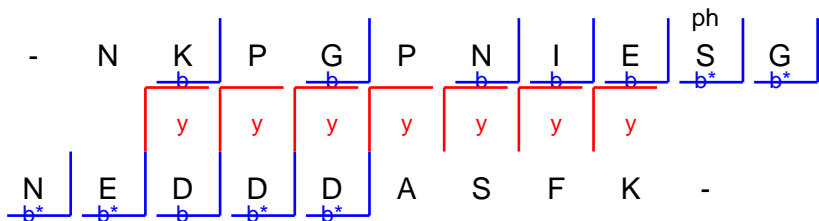
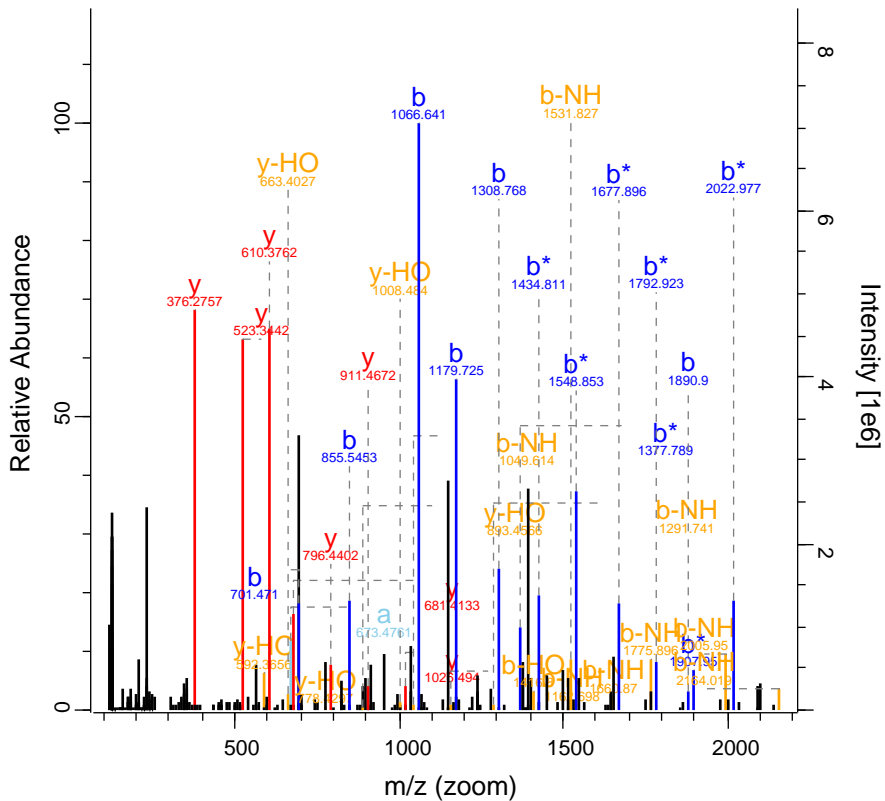

RO-QC-160121_ZackD_SS_Set_02_Fraction 20141 FTMS; HC 72.03 810.09 MAF1

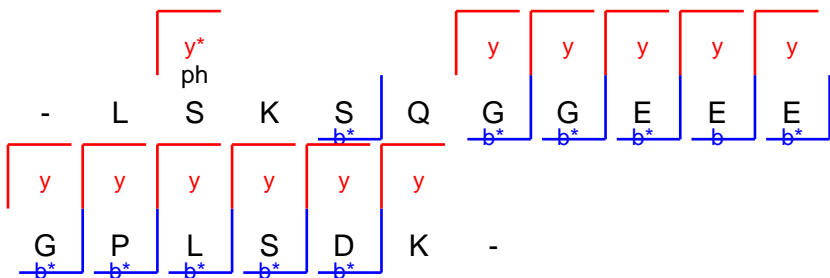
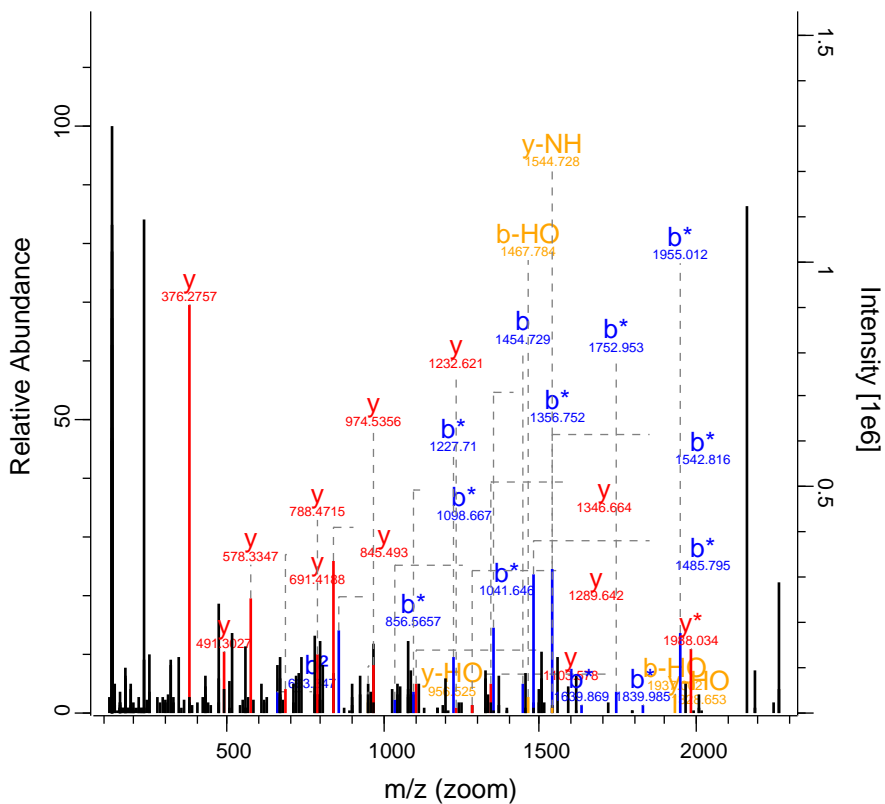

RO-QC-160121_ZackD_SS_Set_02_Fraction 21140 FTMS; HC 79.01 711.72 MICALL1

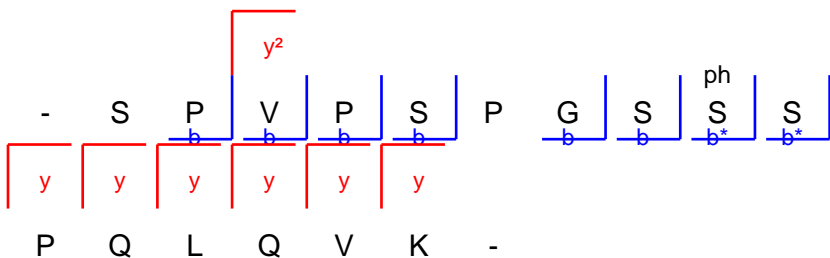
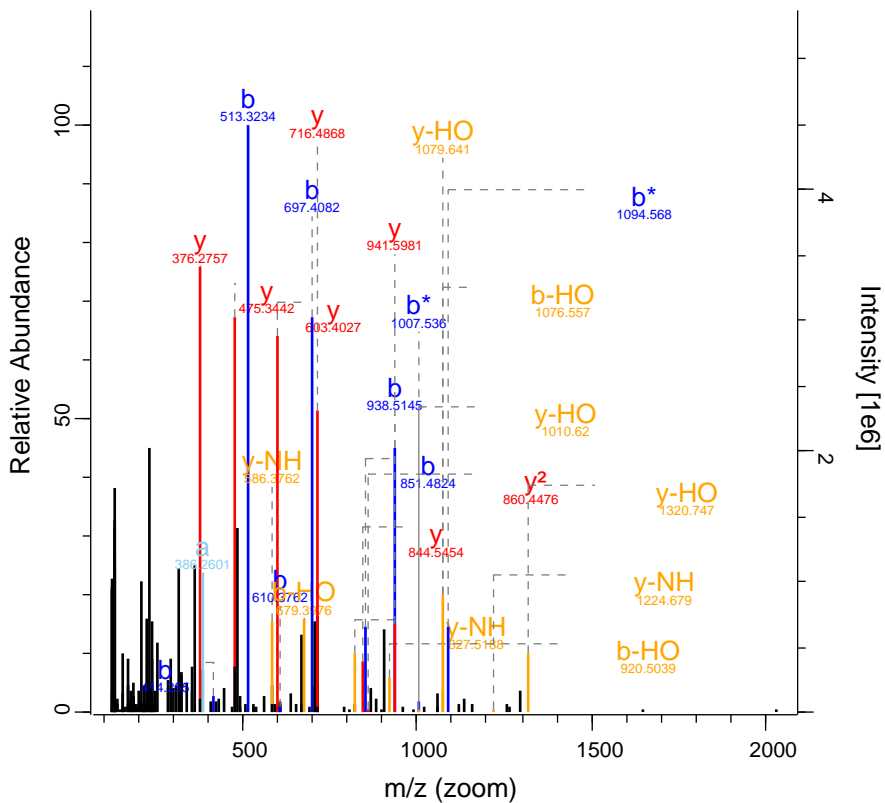

RO-QC-160121_ZackD_SS_Set_02_Fraction 21831 FTMS; HC 81.62 827.81 LARP1

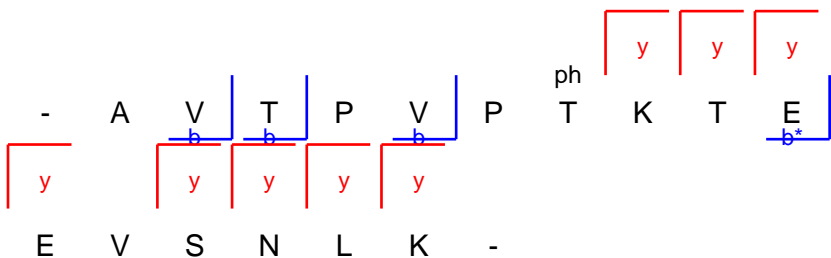
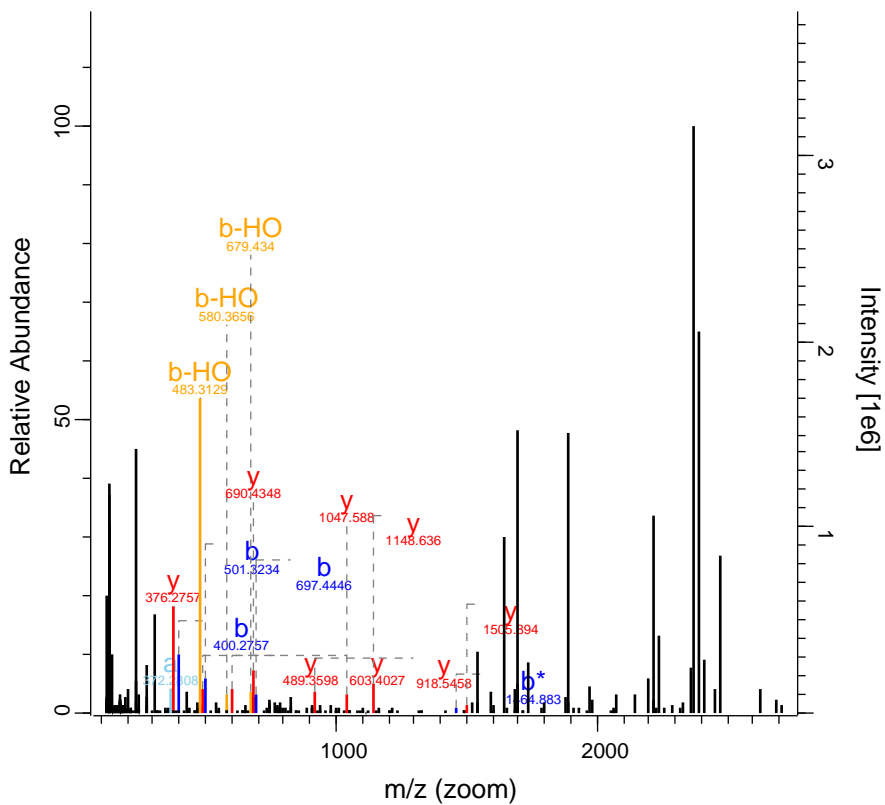

Raw File	Scan	Method	Score	m/z
RO-QC-160121_ZackD_SS_Set_02_Fraction_1	21849	FTMS; HCD	95.1	892.47

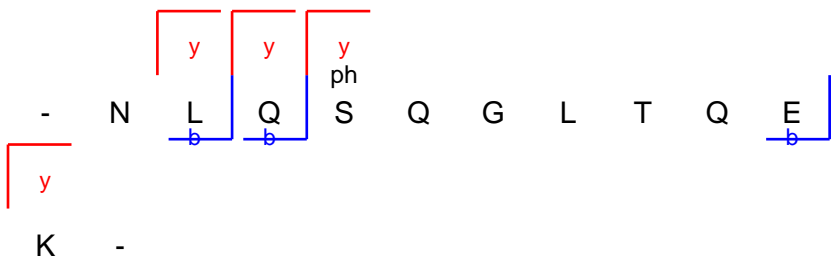
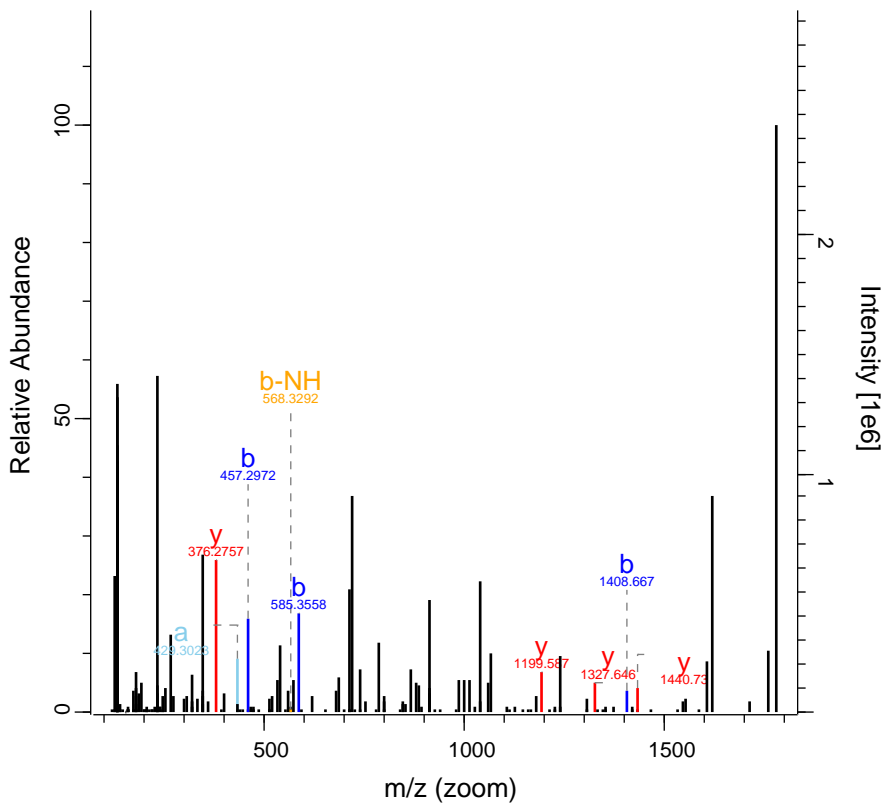

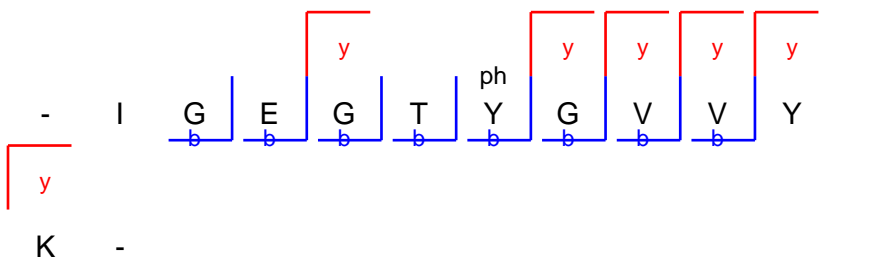
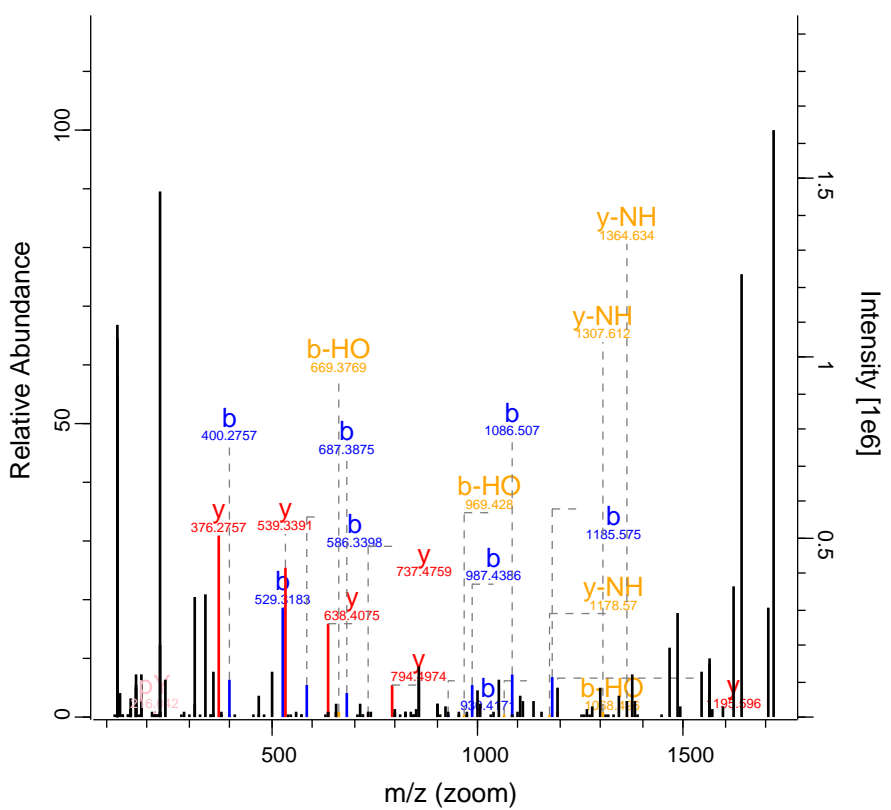

K -

RO-QC-160121_ZackD_SS_Set_02_Fractic 23816 FTMS; HC 132.51 1065.58 MAP4

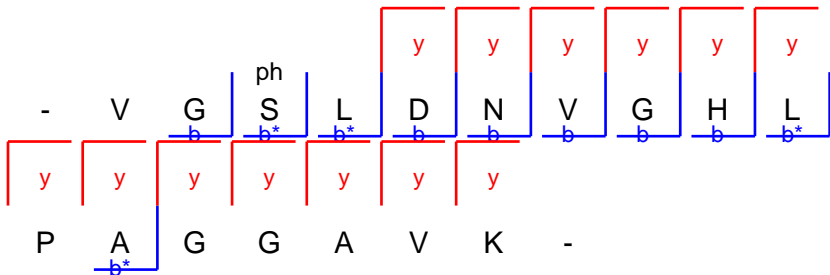
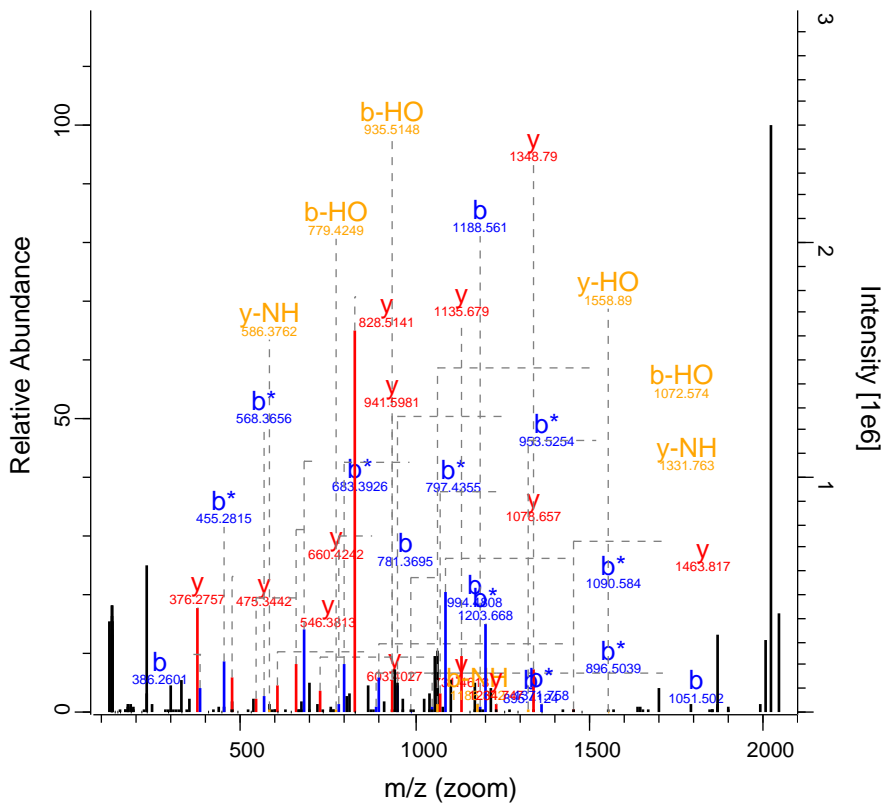

RO-QC-160121_ZackD_SS_Set_02_Fraction 24572 FTMS; HC 84.17 824.77 PNN

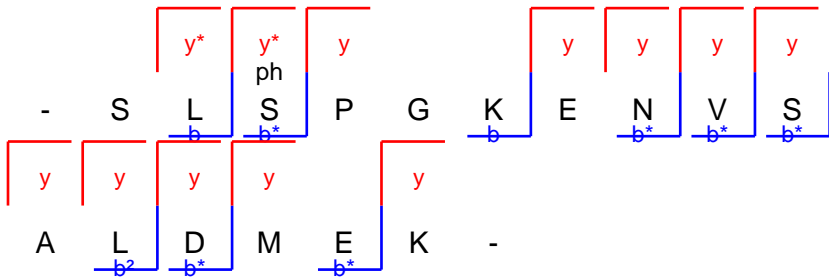
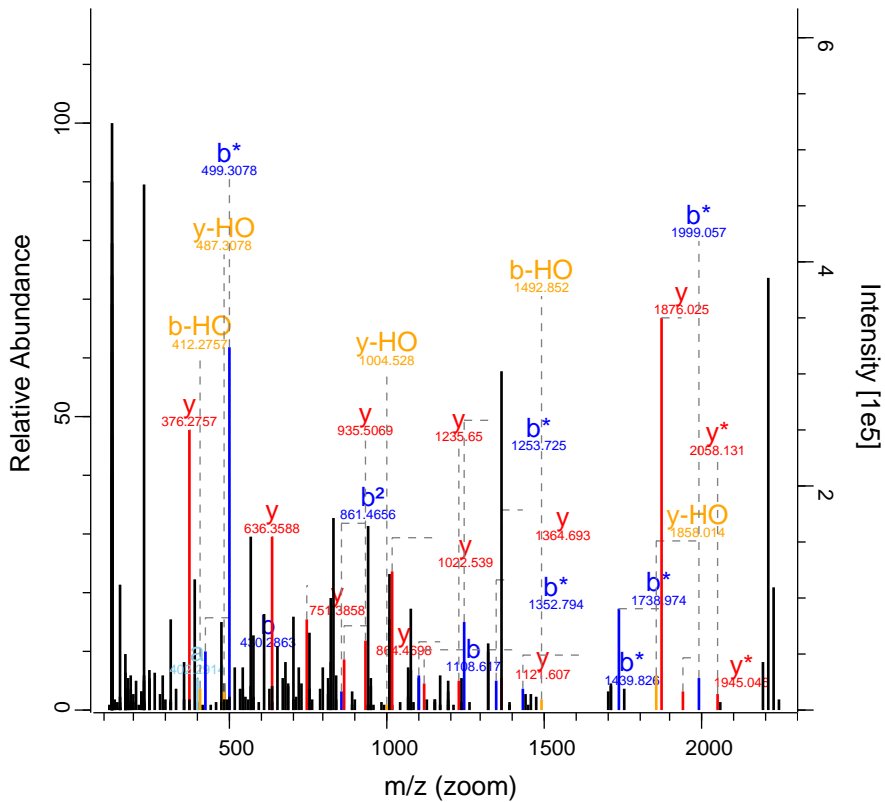

RO-QC-160121_ZackD_SS_Set_02_Fractio 25477 FTMS; HC 125.39 896.78 NOB1

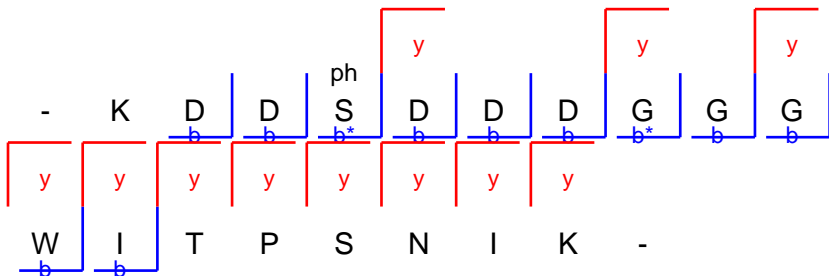
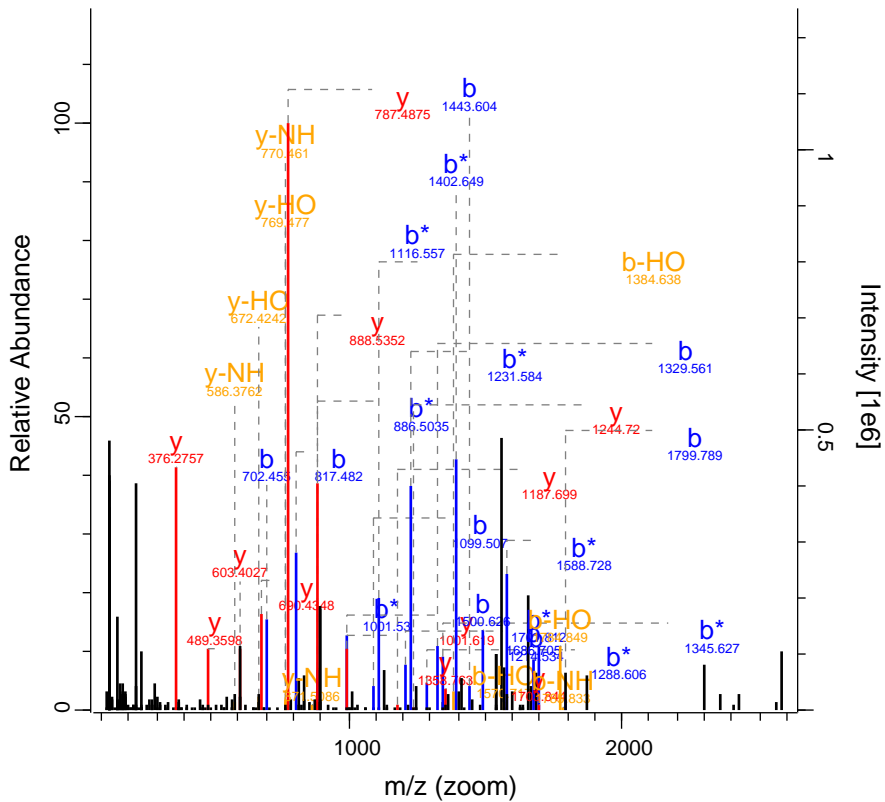

RO-QC-160121_ZackD_SS_Set_02_Fraction 25973 FTMS; HC 41.54 414.22 MACF1

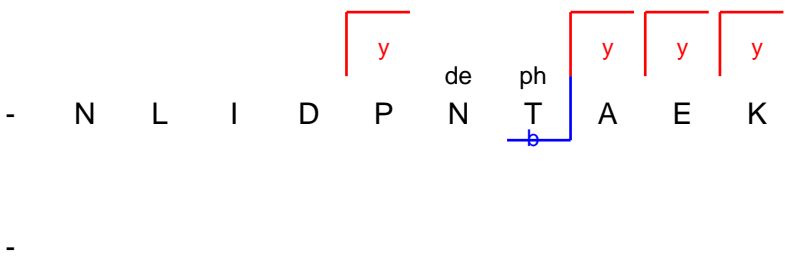
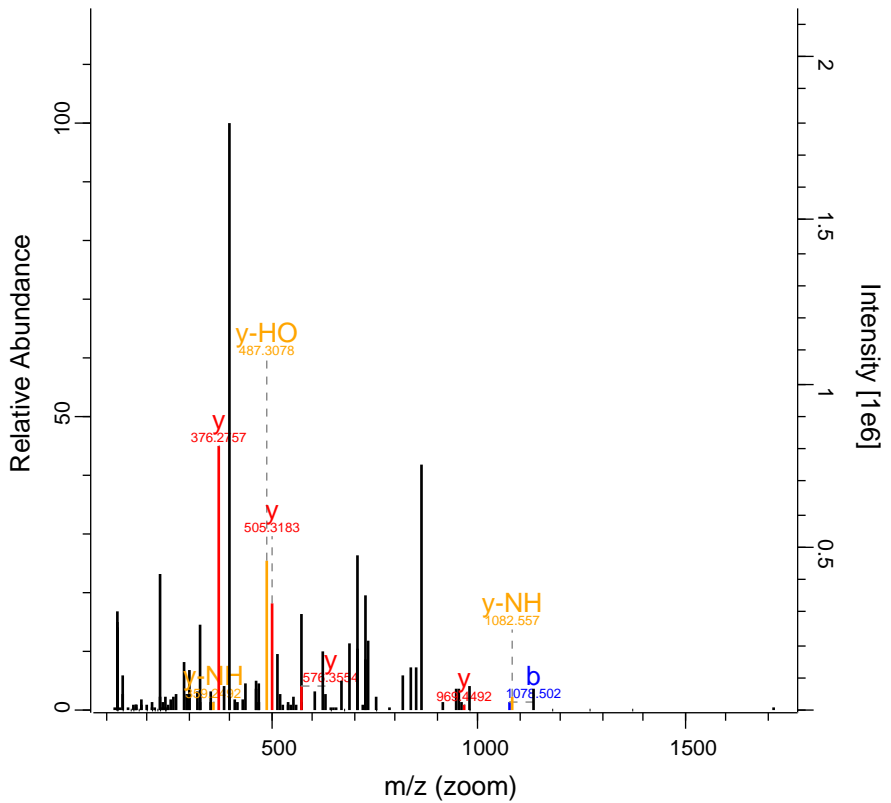

RO-QC-160121_ZackD_SS_Set_02_Fraction 26534 FTMS; HC 83.05 602.63 INA

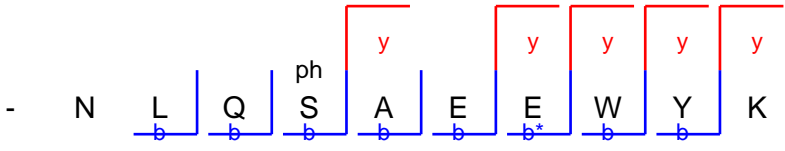
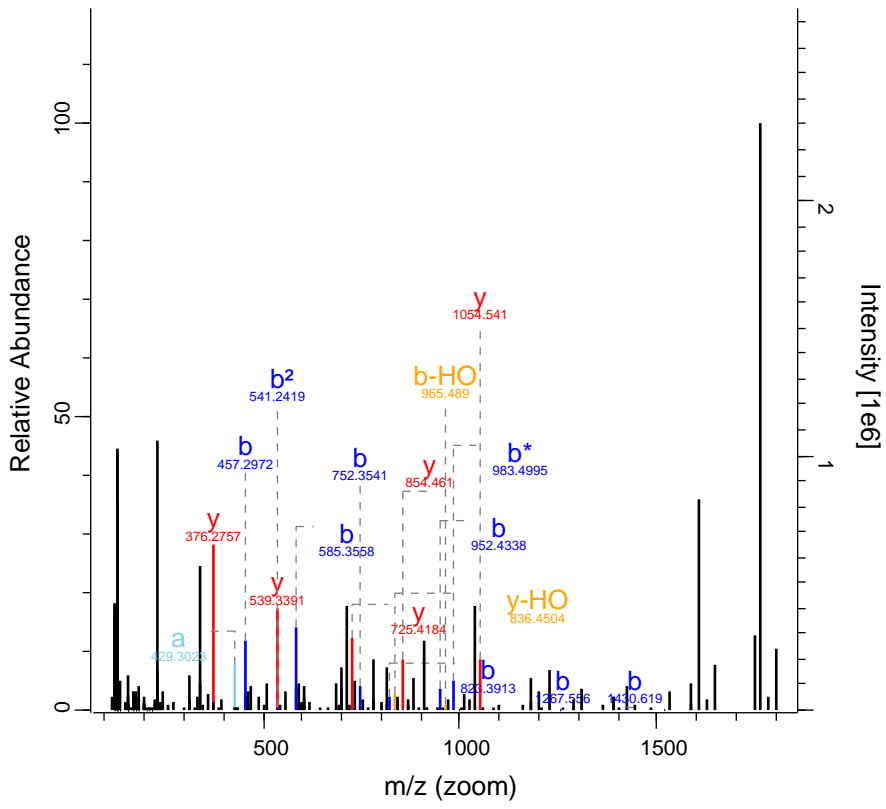

RO-QC-160121_ZackD_SS_Set_02_Fraction 27531 FTMS; HCl 106.13 583.3 PHIP

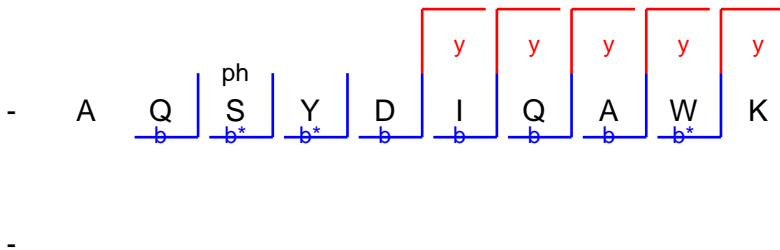
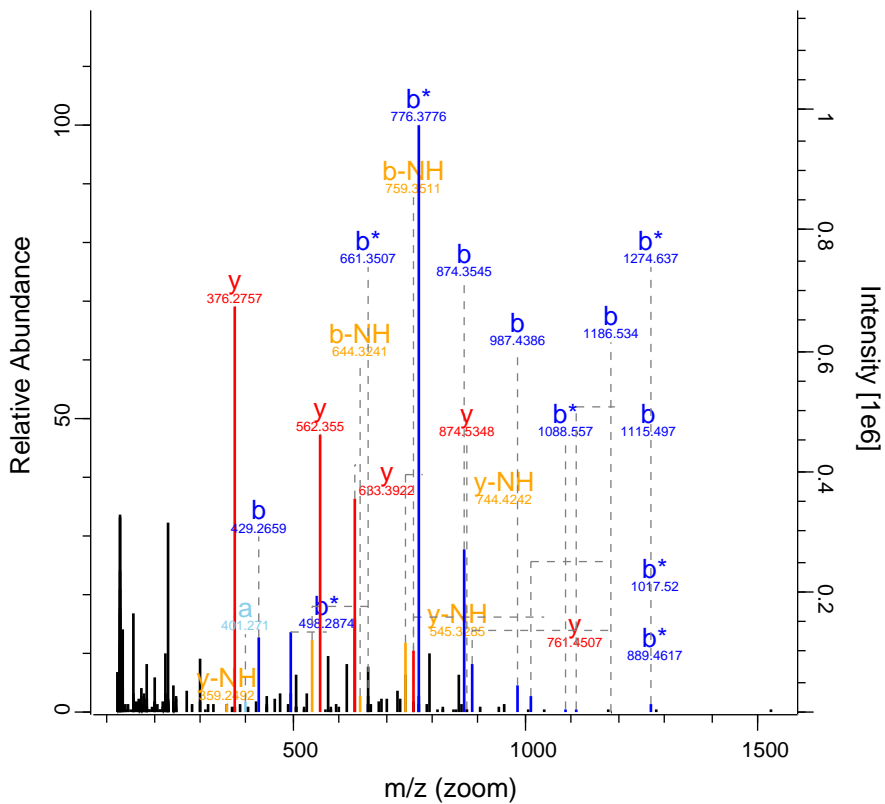

RO-QC-160121_ZackD_SS_Set_02_Fractic 28126 FTMS; HC 93.36 1031.03 UBA1

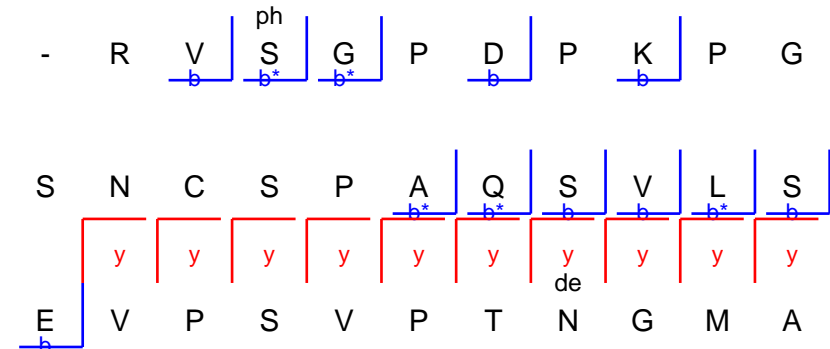
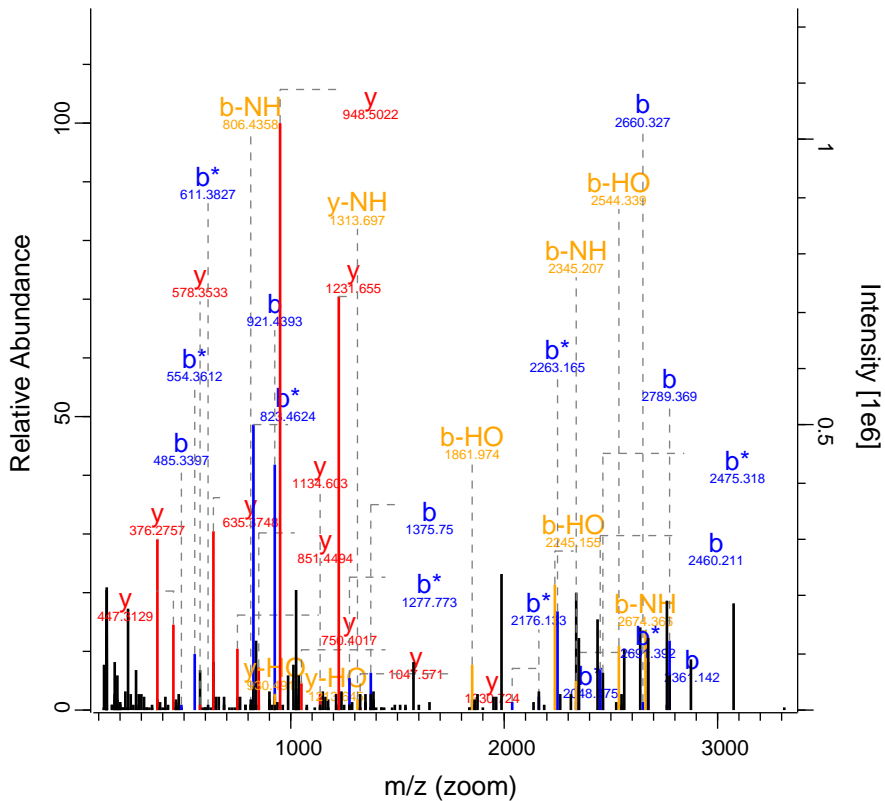

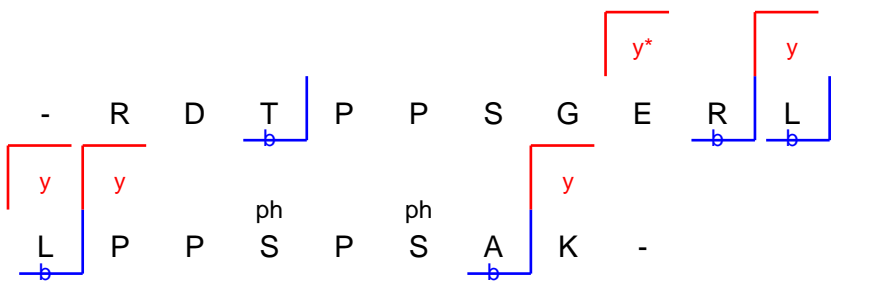
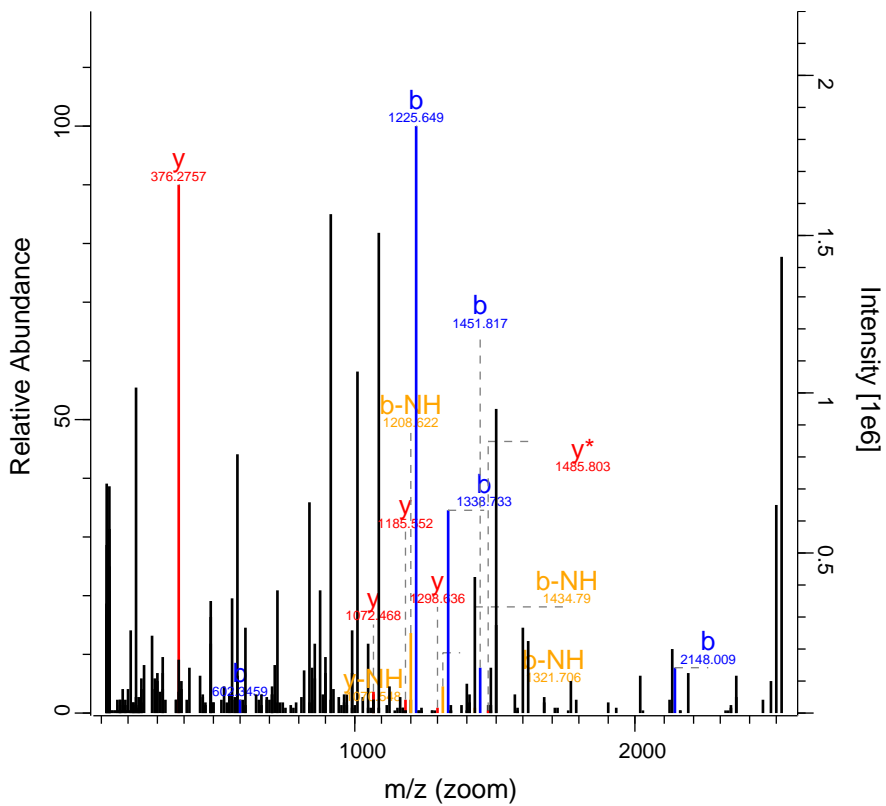

RO-QC-160121_ZackD_SS_Set_02_Fraction 28479 FTMS; HC 51.21 843.44 AKAP9

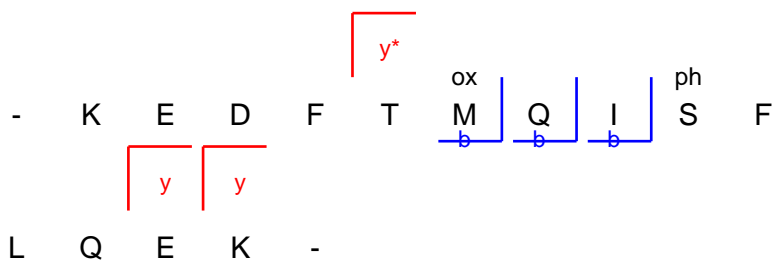
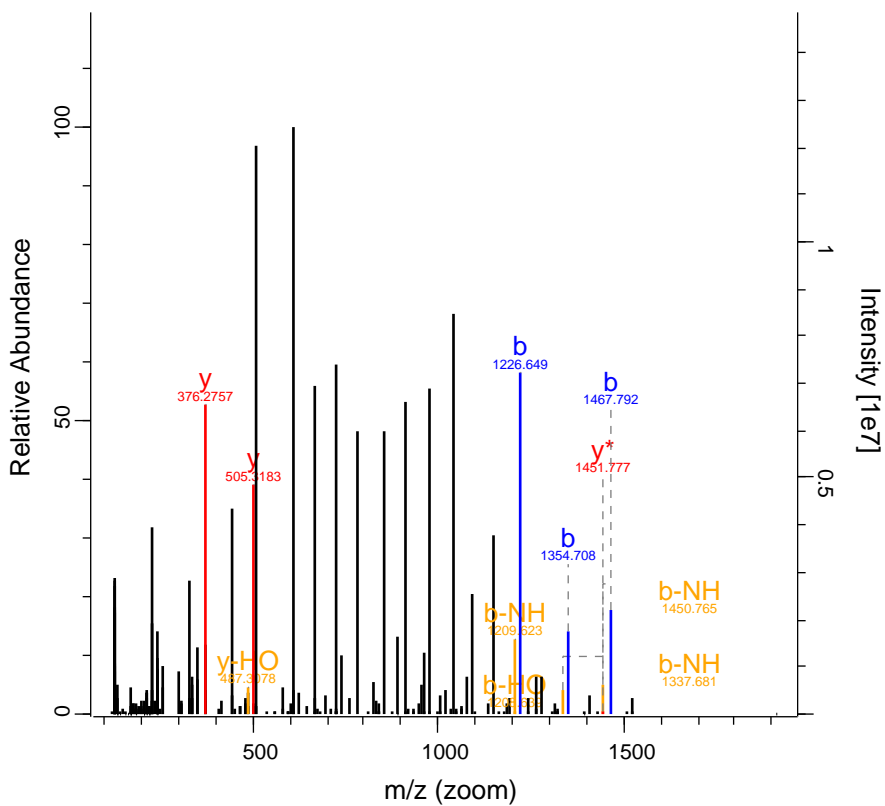

RO-QC-160121_ZackD_SS_Set_02_Fratio 28708 FTMS; HC 140.35 807.45 PSIP1

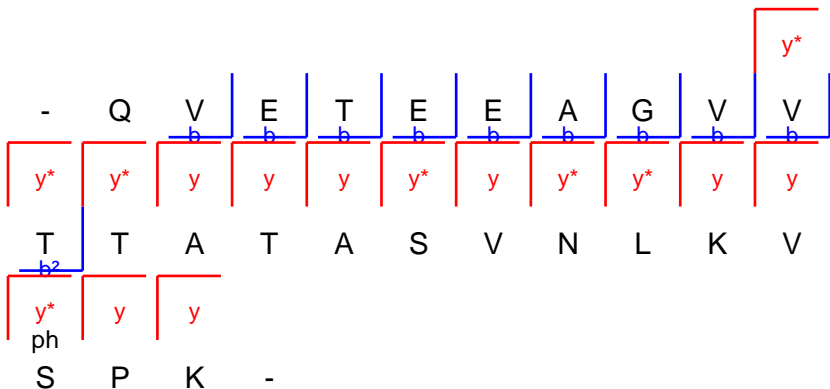
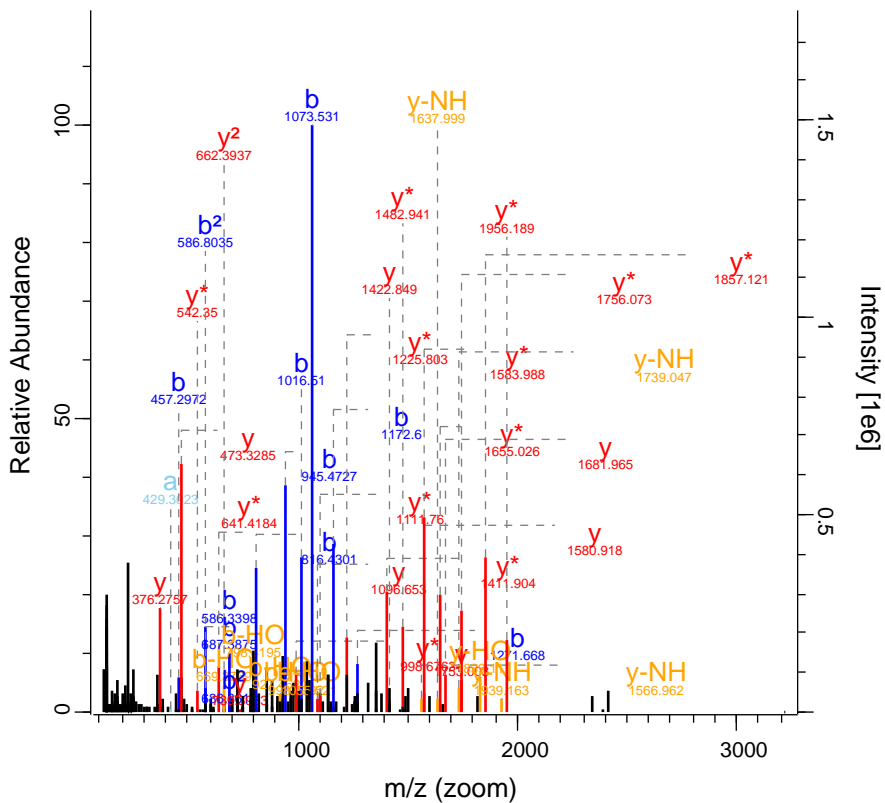

RO-QC-160121_ZackD_SS_Set_02_Fractio 28898 FTMS; HC 105.39 636.34 PPP1R12A

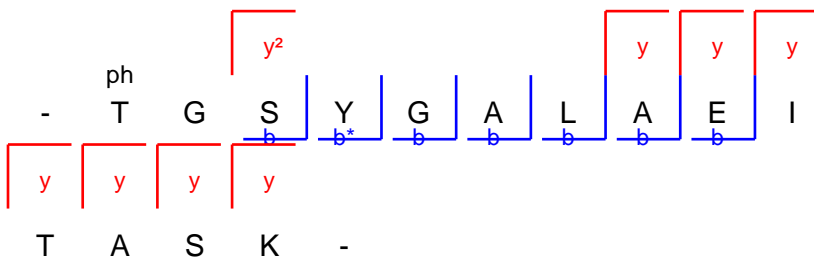
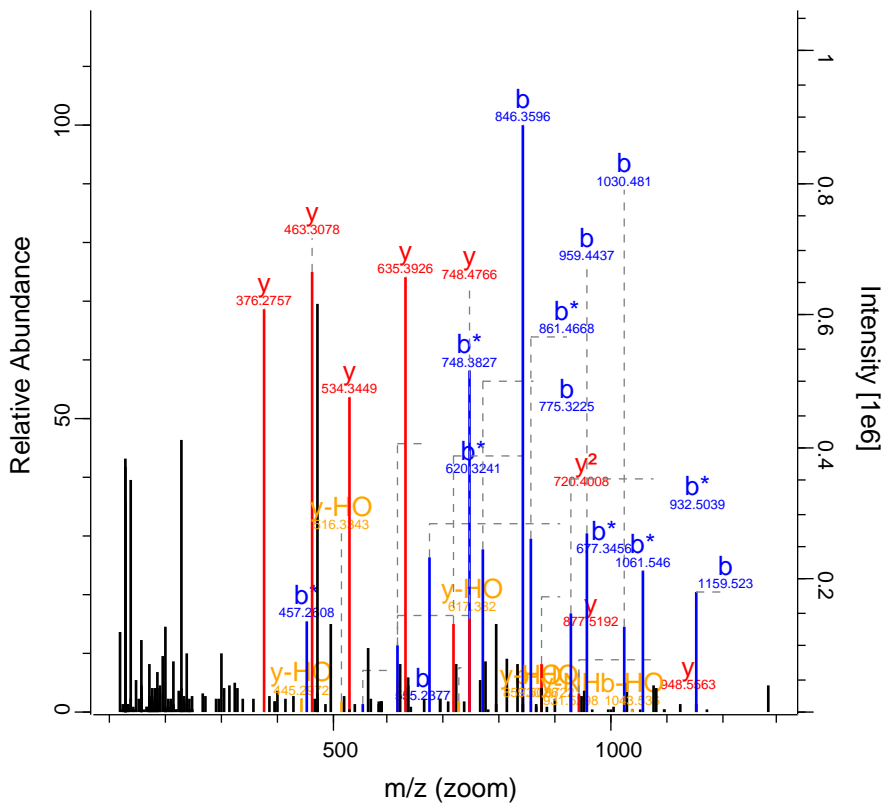

RO-QC-160121_ZackD_SS_Set_02_Fraction 29975 FTMS; HC 46.31 876.94 TUBA8

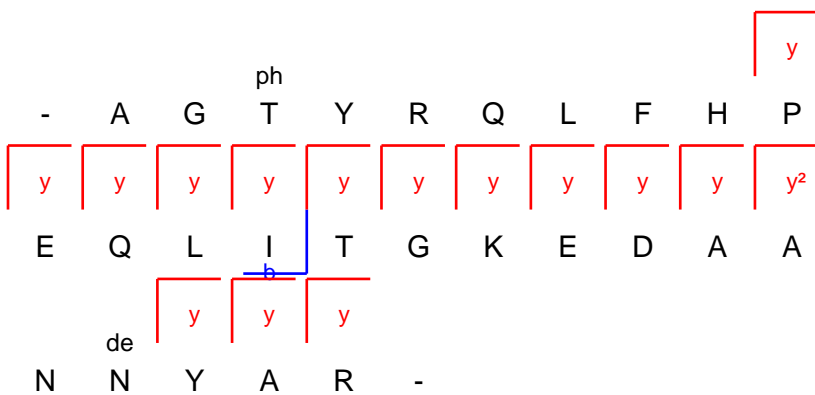
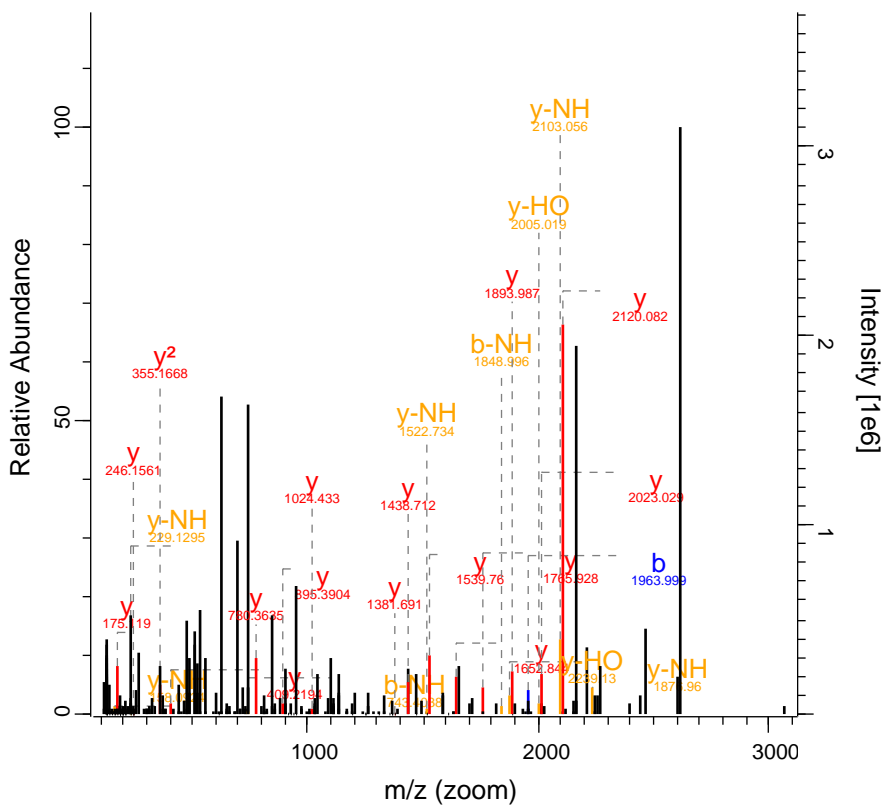

RO-QC-160121_ZackD_SS_Set_02_Fractic 30957 FTMS; HC 93.97 1005.74 OXSR1

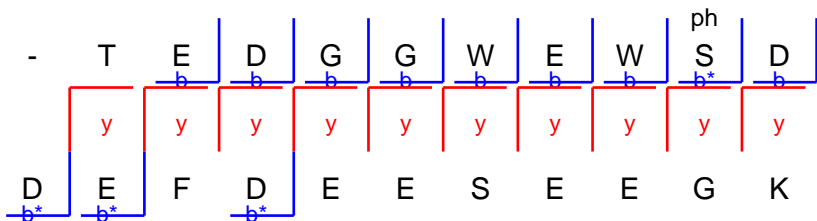
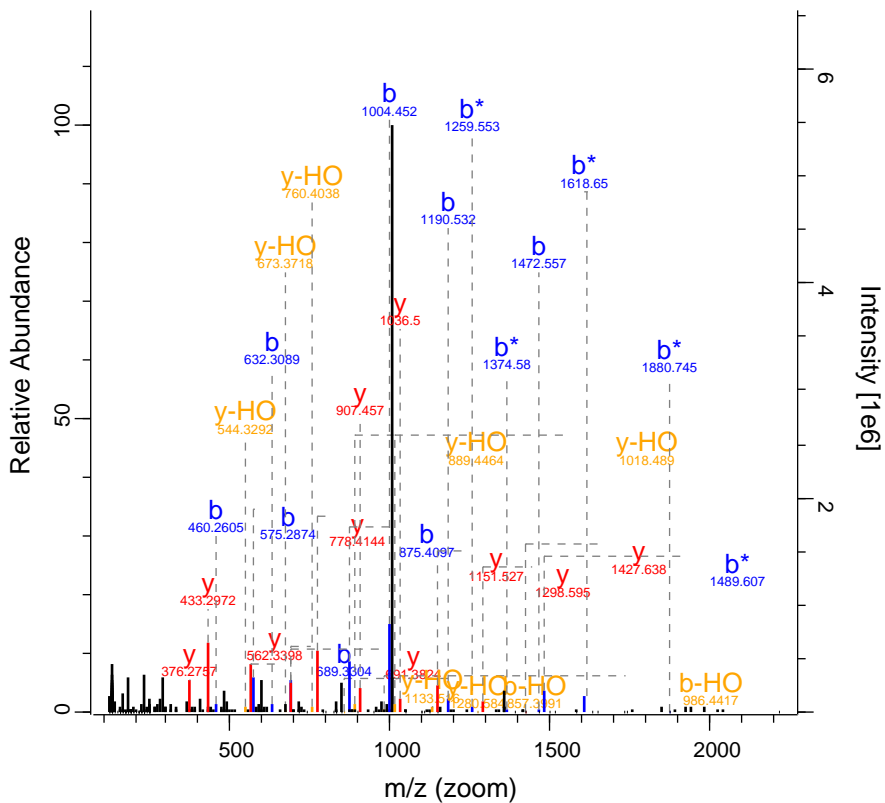

RO-QC-160121_ZackD_SS_Set_02_Fraction 32025 FTMS; HC 108.1 1033.5 PLEC

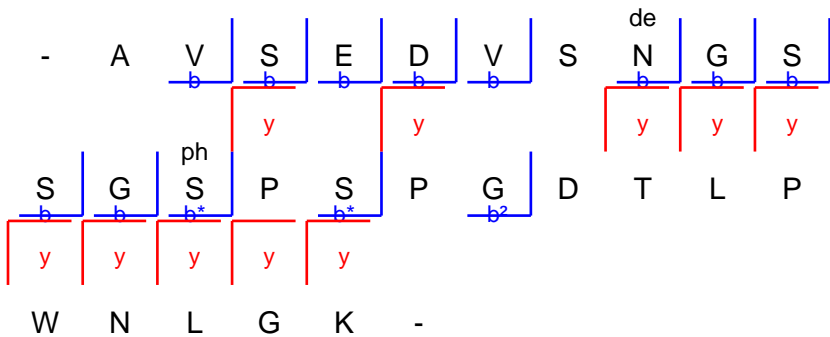
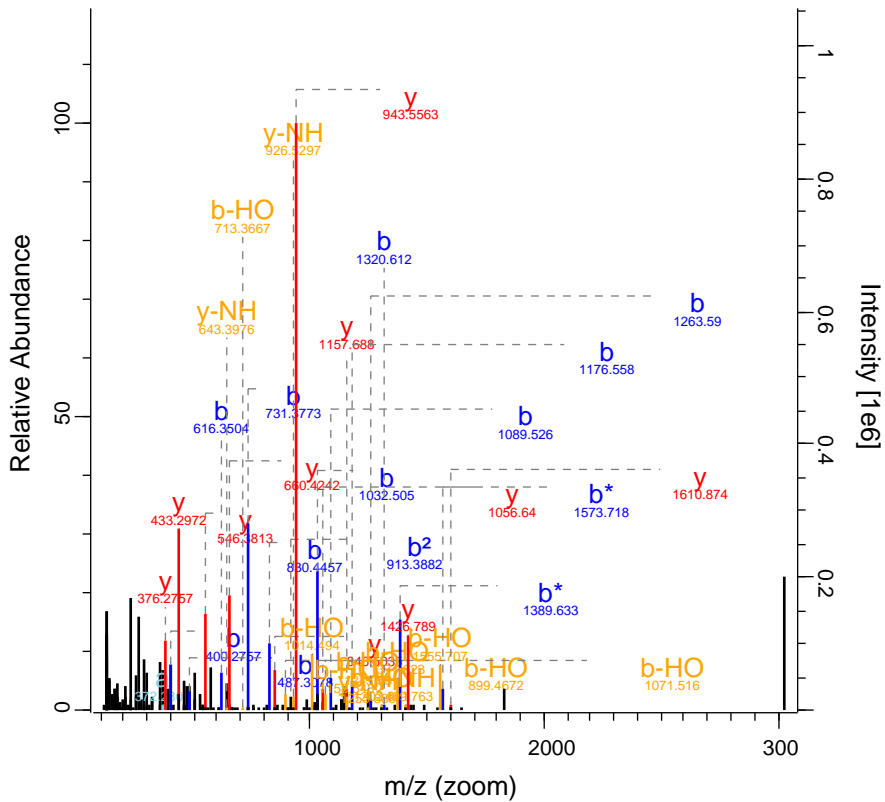

RO-QC-160121_ZackD_SS_Set_02_Fractic 33115 FTMS; HC 139.75 1305.97 SSR1

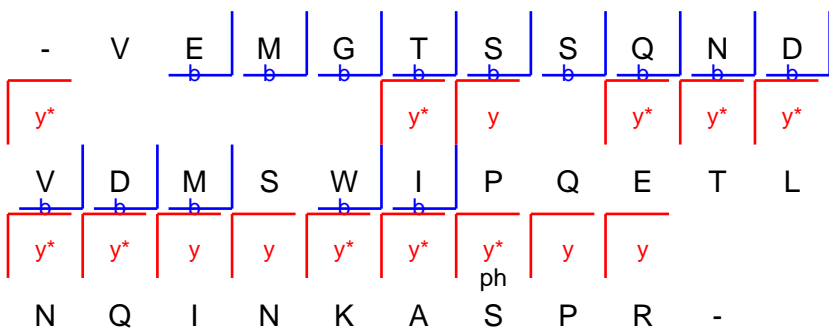
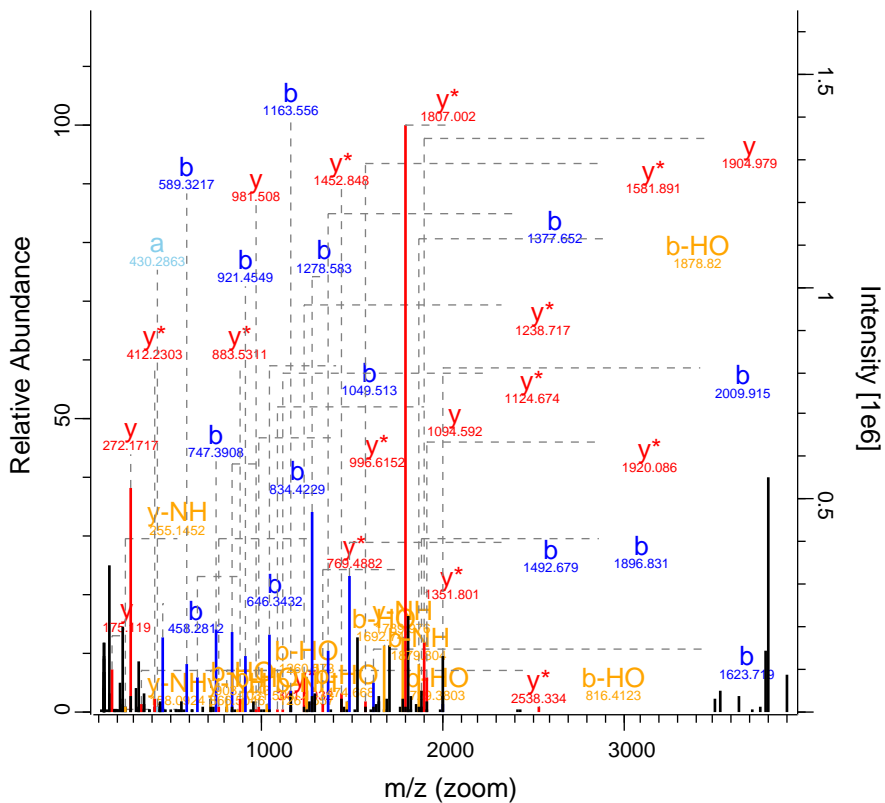

RO-QC-160121_ZackD_SS_Set_02_Fraction 33165 FTMS; HC 91.11 819.93 MYRIP

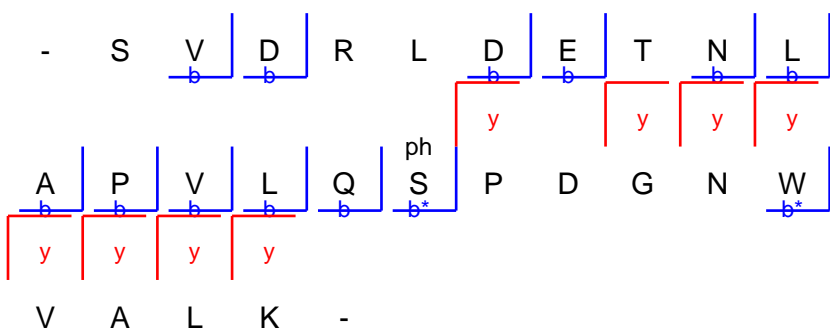
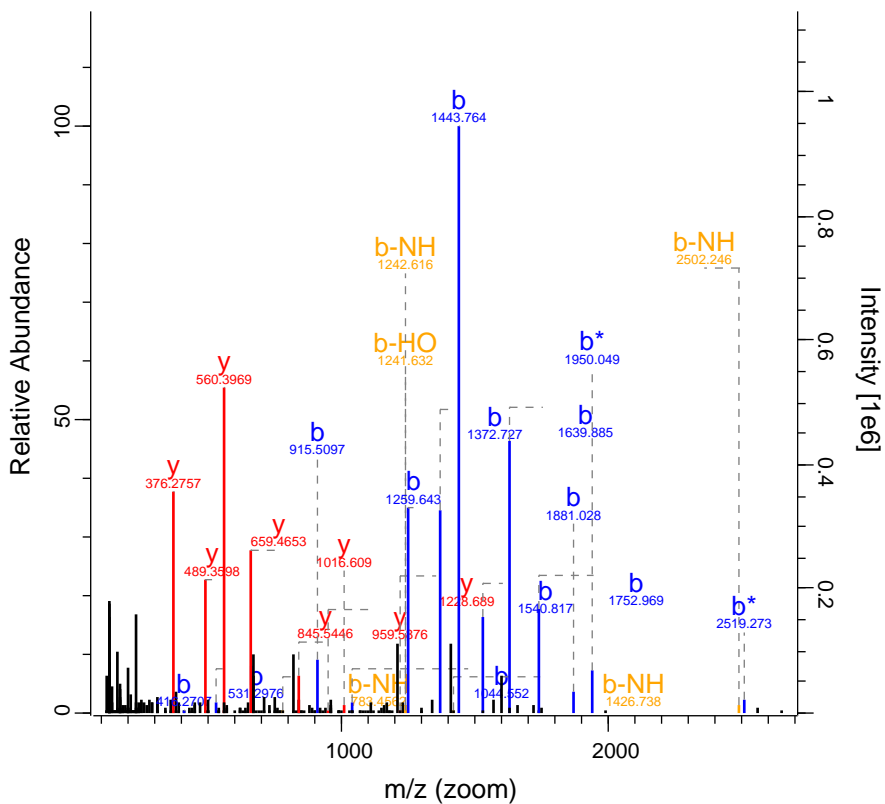

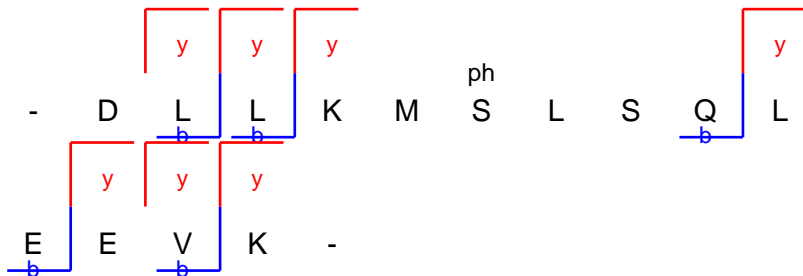
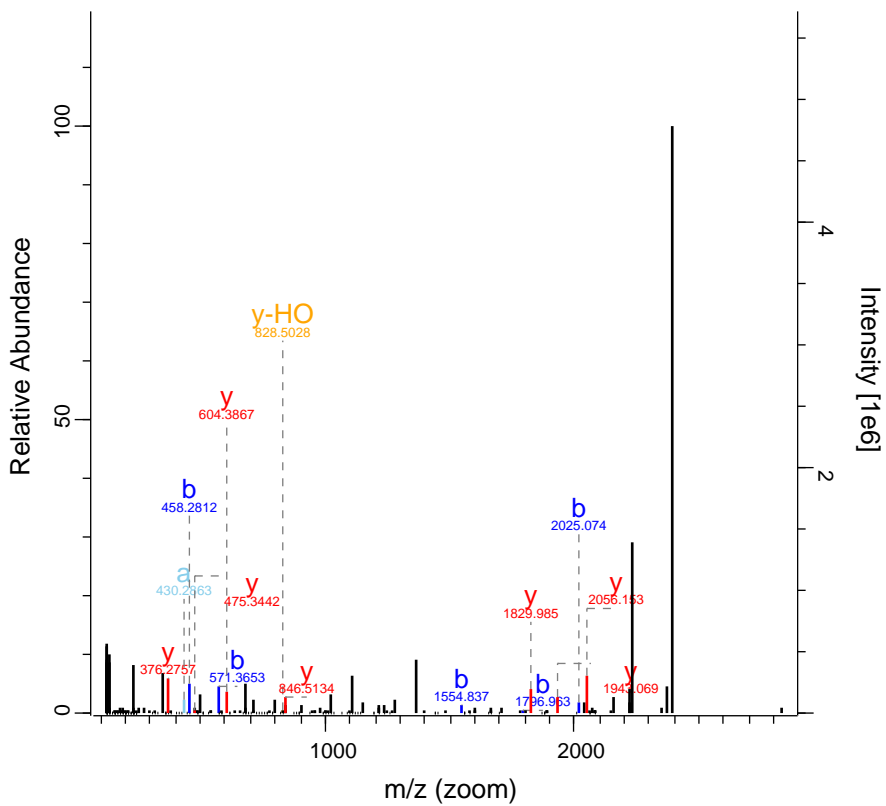

RO-QC-160121_ZackD_SS_Set_02_Fractic 33562 FTMS; HC 133.62 1067.51 SCAF1

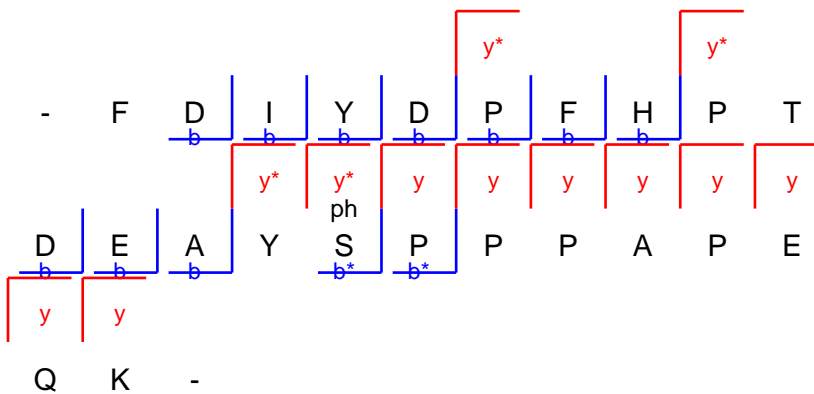
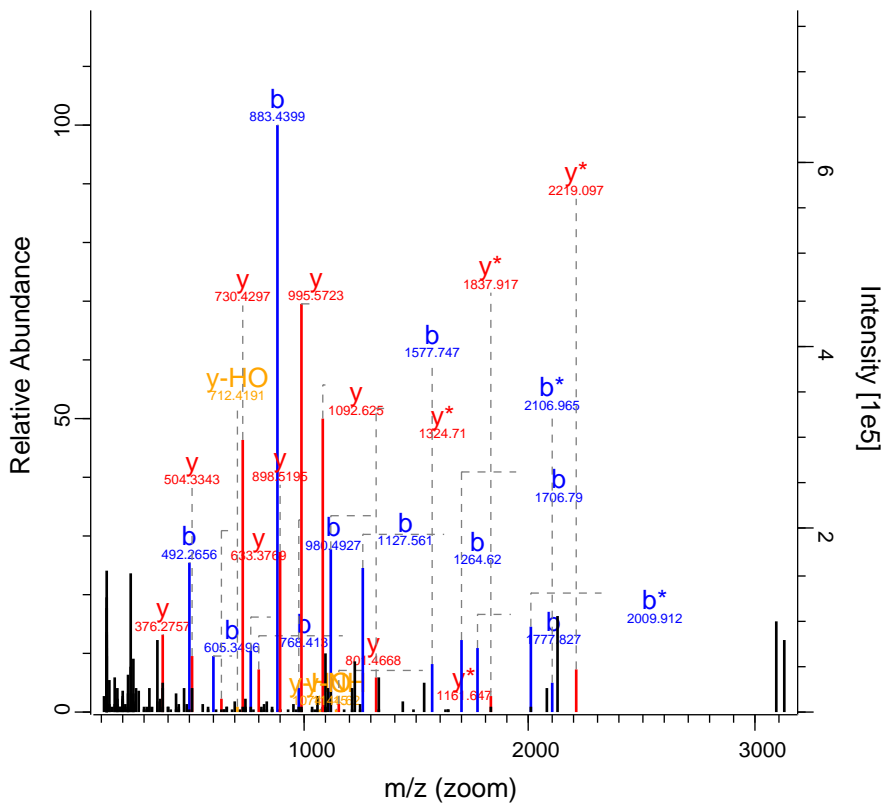

RO-QC-160121_ZackD_SS_Set_02_Fractio 33621 FTMS; HC 132.84 921.49 DMXL1

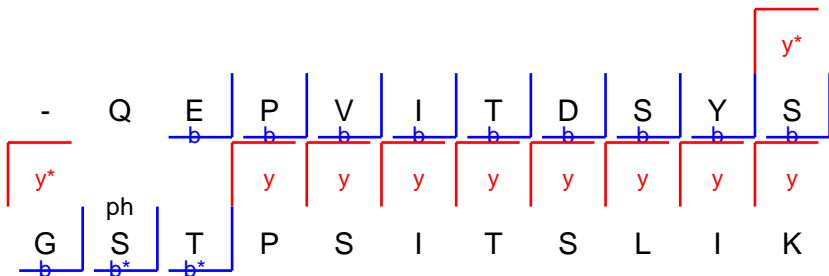
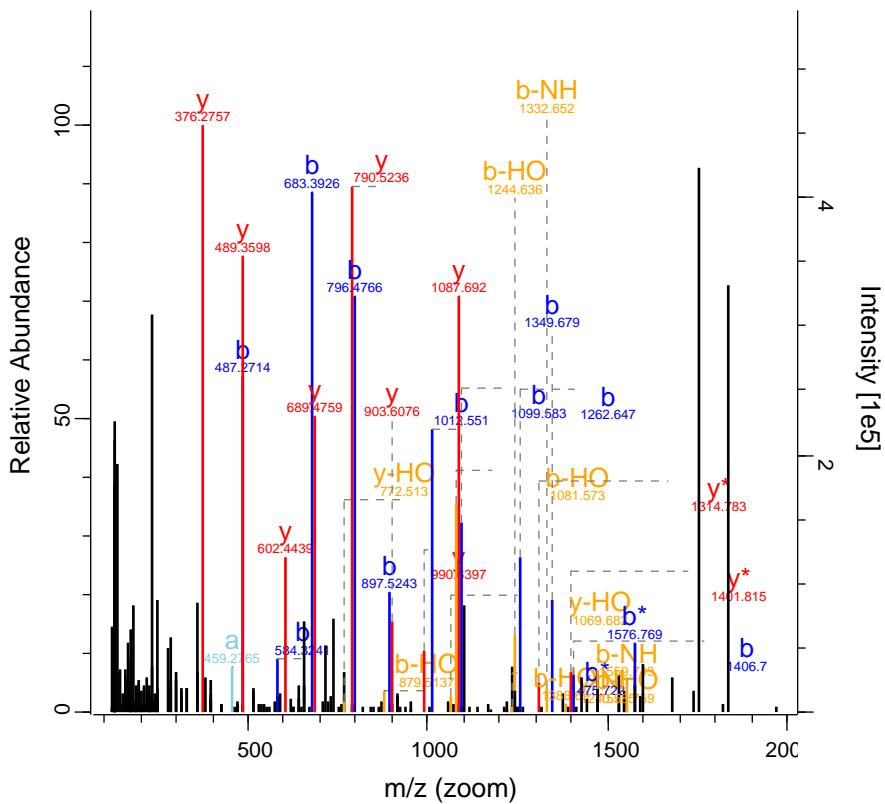

RO-QC-160121_ZackD_SS_Set_02_Fraction 33827 FTMS; HC 75.38 522.29 WASL

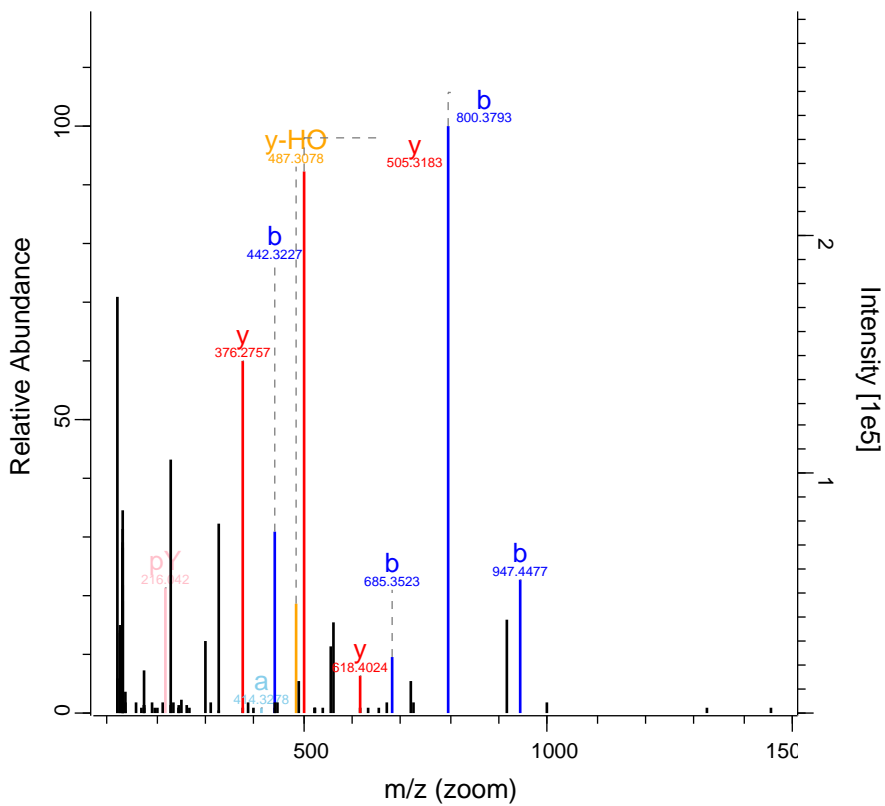

m/z (zoom)



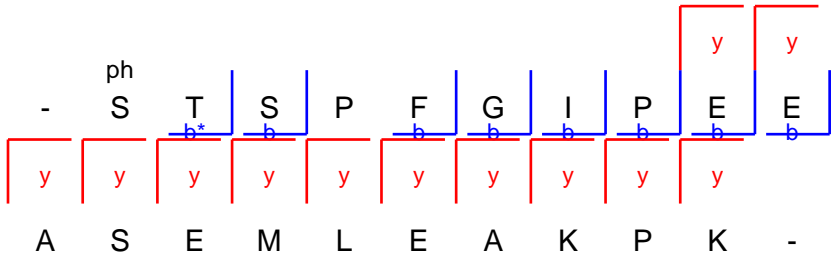
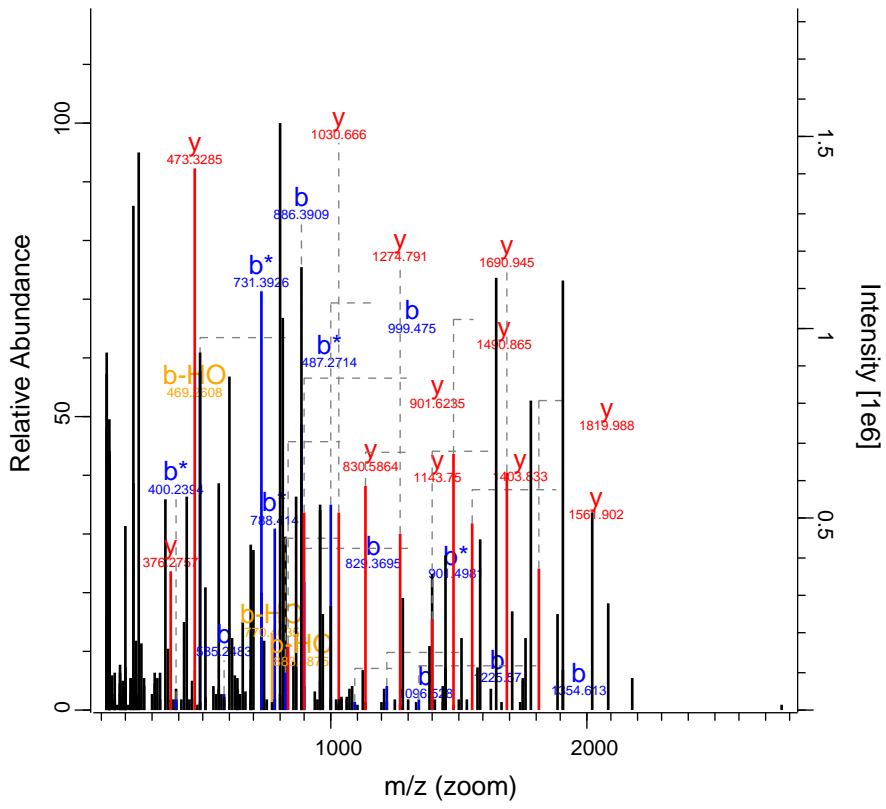

RO-QC-160121_ZackD_SS_Set_02_Fraction 35403 FTMS; HC 55.72 836.96 GLS2

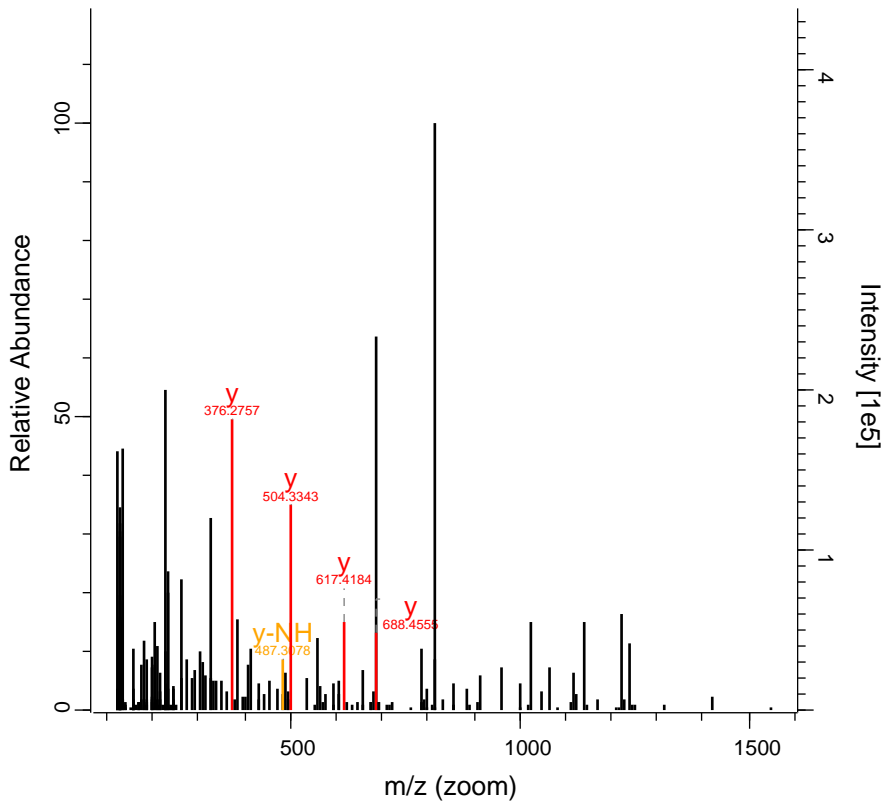

ac
- M R S M K A L Q K -



RO-QC-160121_ZackD_SS_Set_02_Fraction 5929 FTMS; HCl 94.69 698.84 ATXN2L

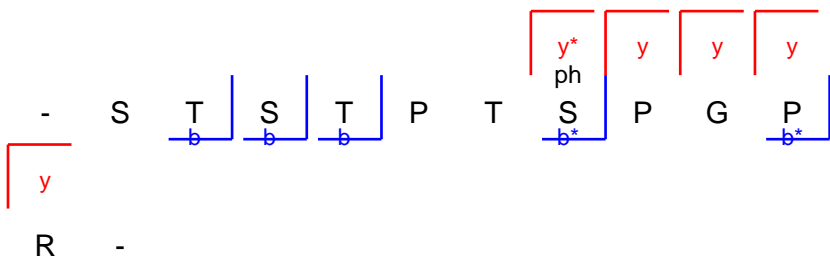
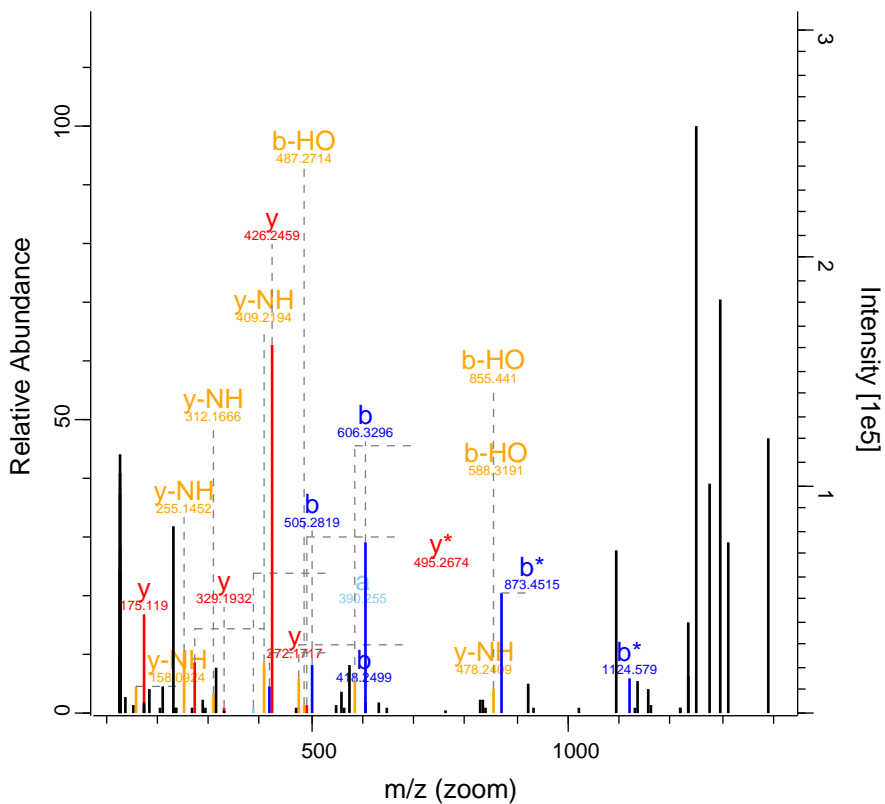

RO-QC-160121_ZackD_SS_Set_02_Fraction 6092 FTMS; HCl 78.53 638.35 HMGN3

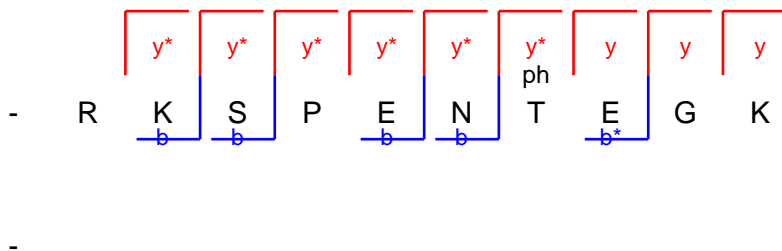
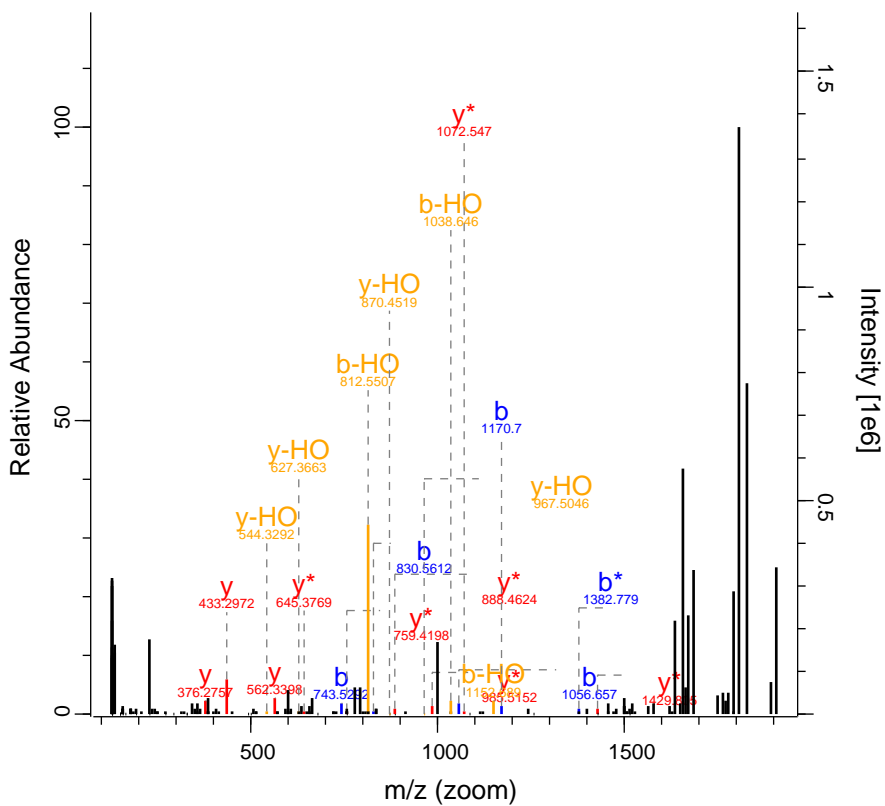

RO-QC-160121_ZackD_SS_Set_02_Fraction 6286 FTMS; HCl 97.63 653.32 CHAMP1

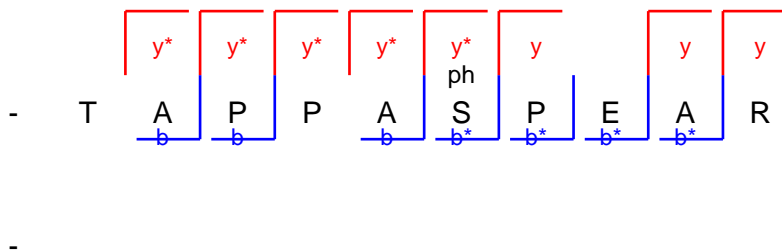
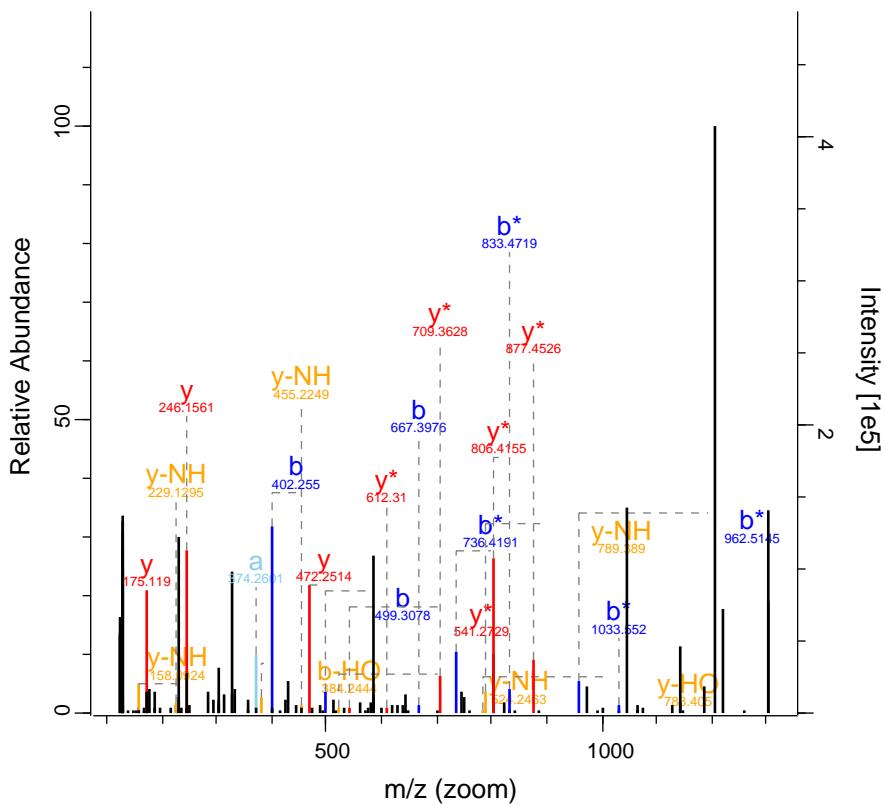

RO-QC-160121_ZackD_SS_Set_02_Fraction 6554 FTMS; HCl 83.25 713.67 SIPA1L3

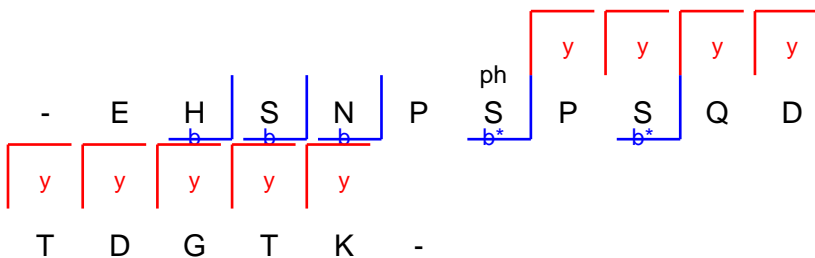
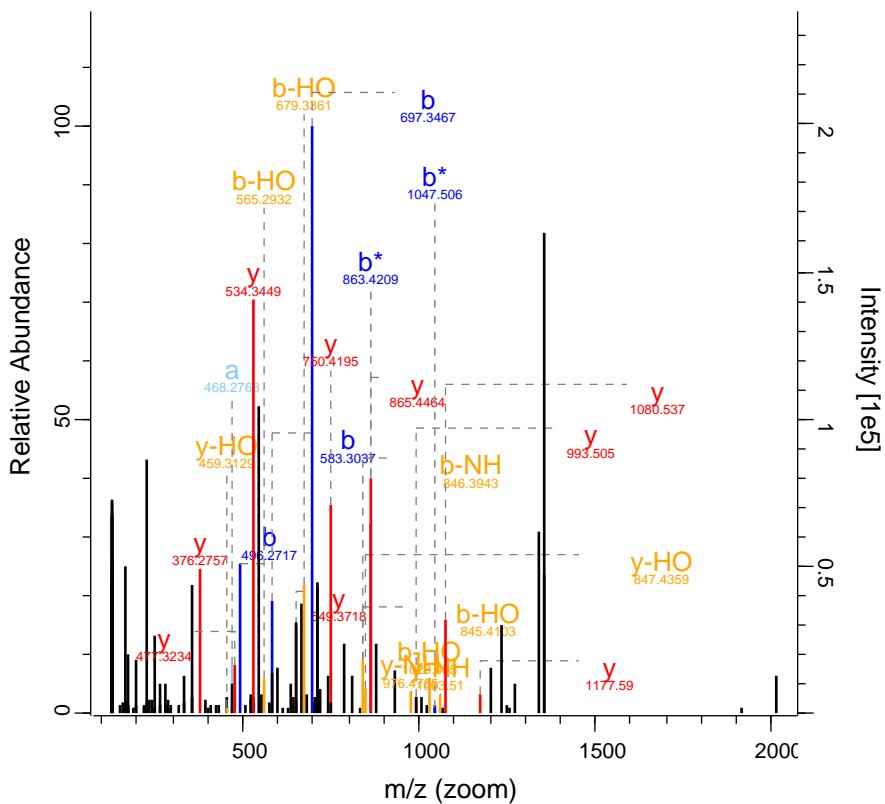

RO-QC-160121_ZackD_SS_Set_02_Fractio 6983 FTMS; HC 239.87 1041.96 SH3KBP1

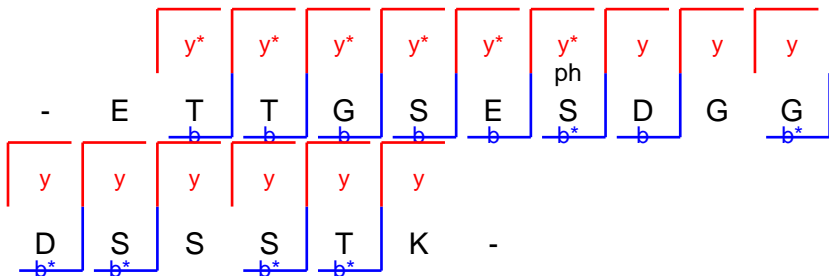
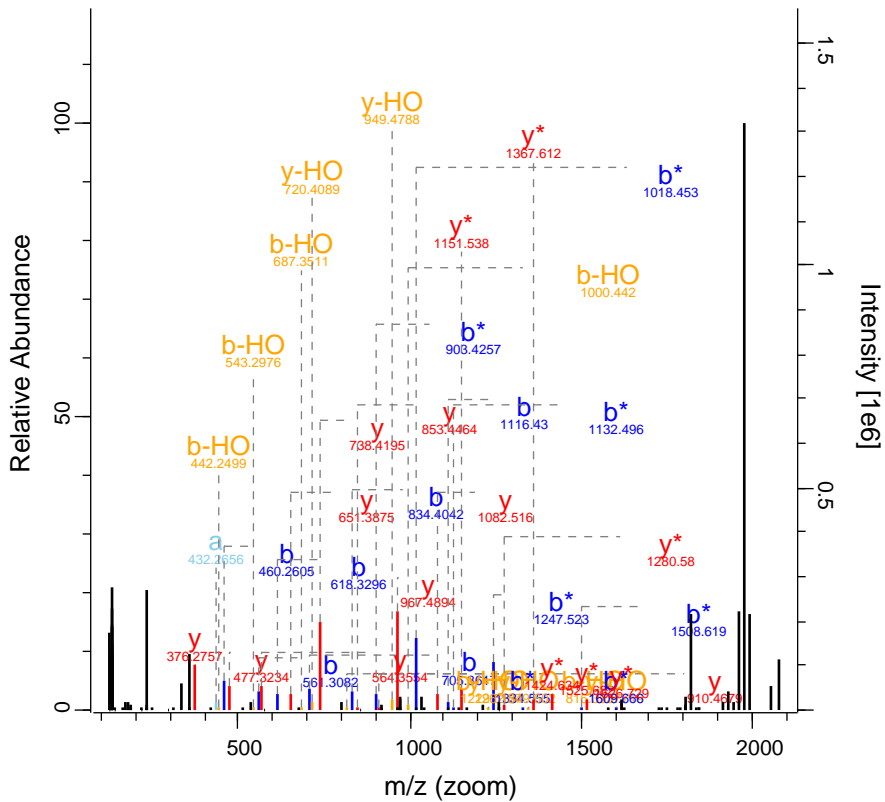

RO-QC-160121_ZackD_SS_Set_02_Fraction 7459 FTMS; HC 119.39 773.37 PRKAA1

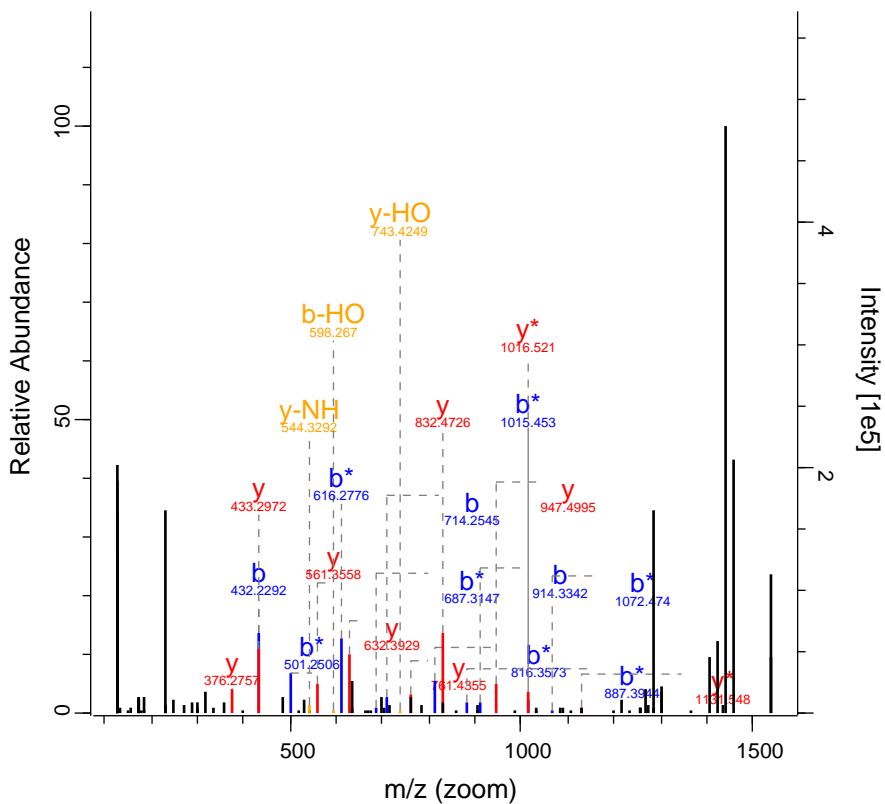

m/z (zoom)

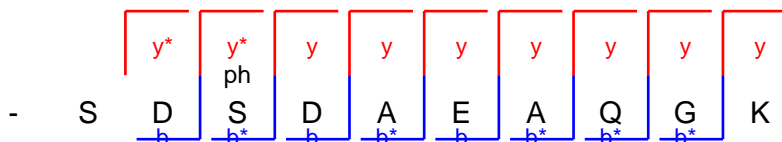

RO-QC-160121_ZackD_SS_Set_02_Fraction 7825 FTMS; HCl 57.41 586.32 RRBP1

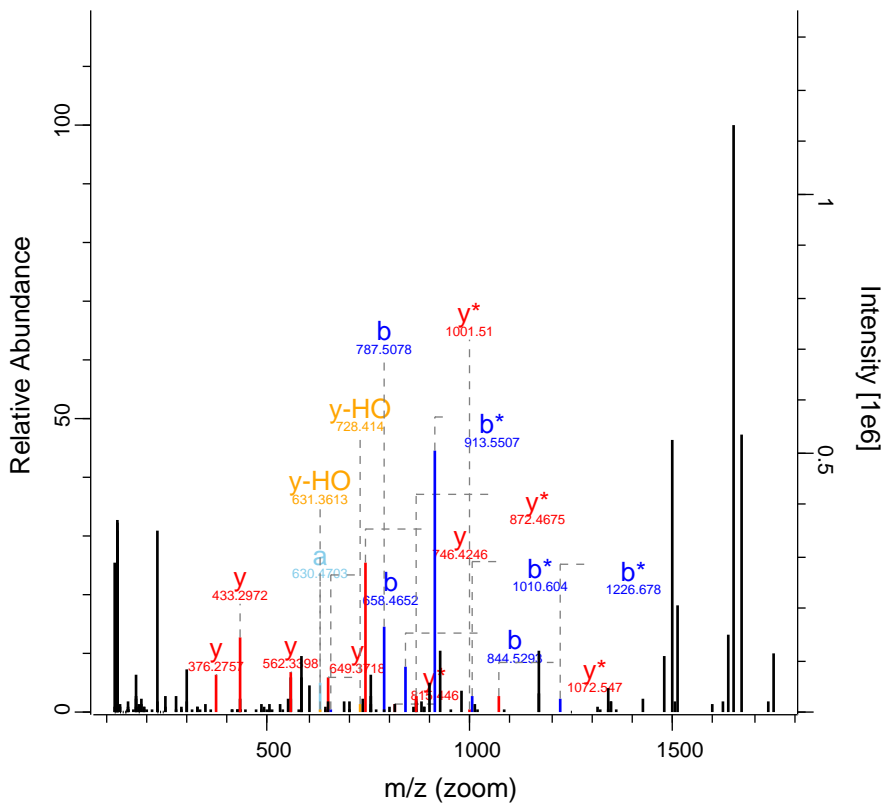

m/z (zoom)

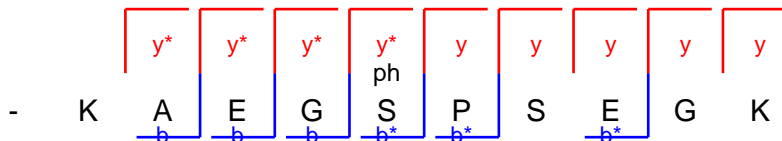

-

RO-QC-160121_ZackD_SS_Set_02_Fraction 8578 FTMS; HCl 58.83 717.06 TPPP

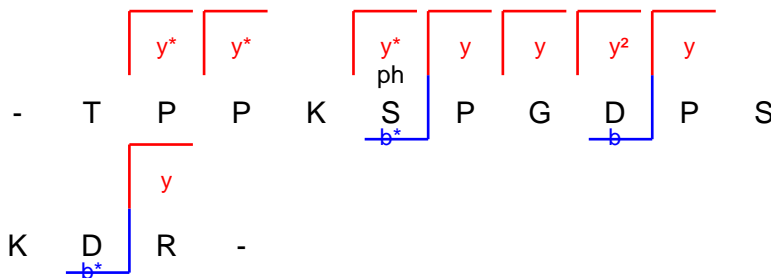
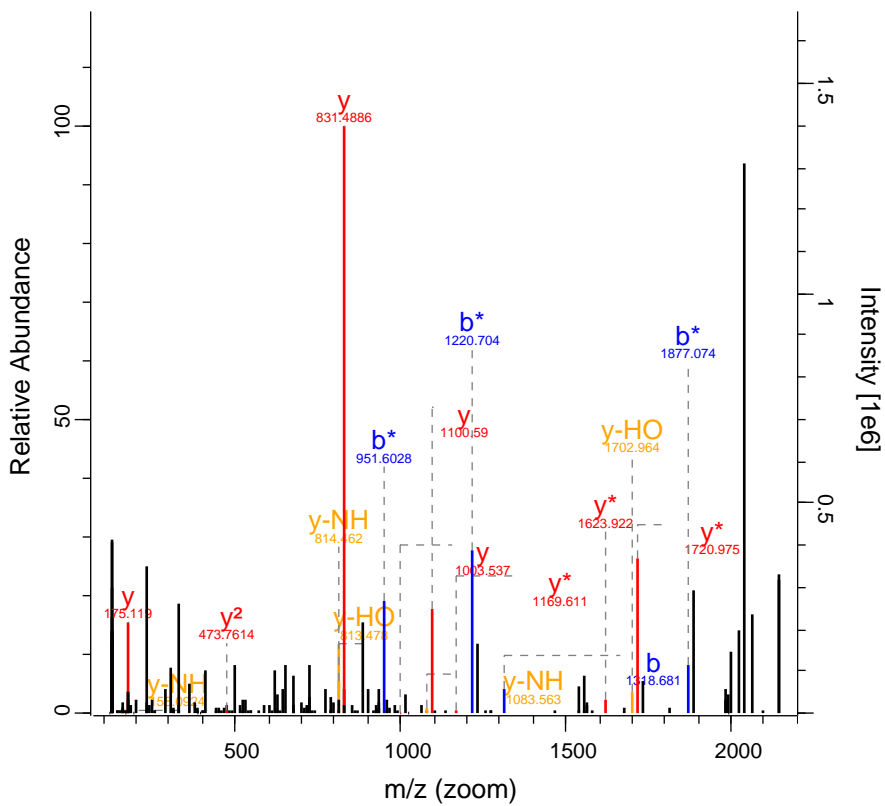

RO-QC-160121_ZackD_SS_Set_02_Fraction 9132 FTMS; HCl 73.46 741.07 HMG A2

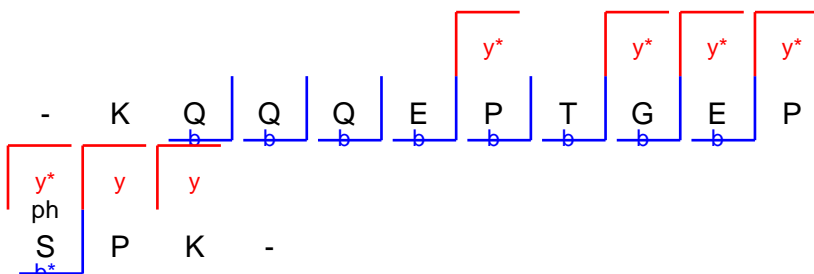
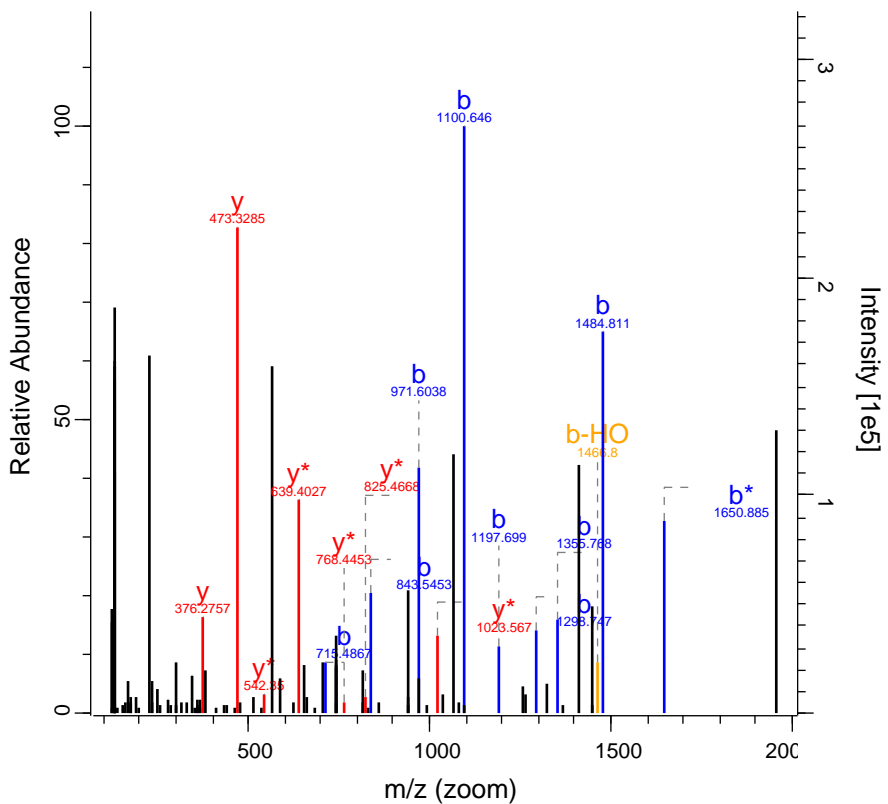

RO-QC-160121_ZackD_SS_Set_02_Fraction 9457 FTMS; HCl 50.08 554.31 HP1BP3

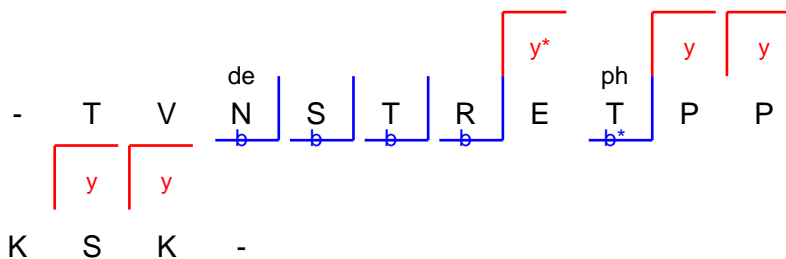
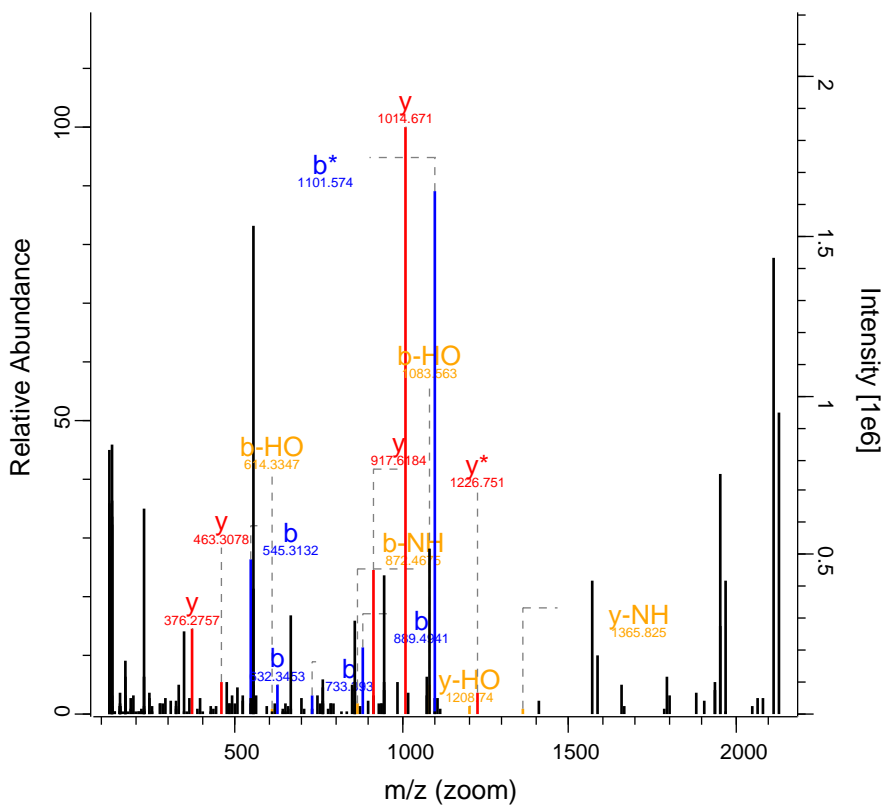

RO-QC-160121_ZackD_SS_Set_02_Fraction 10440 FTMS; HC 50.28 906.92 CC2D2B

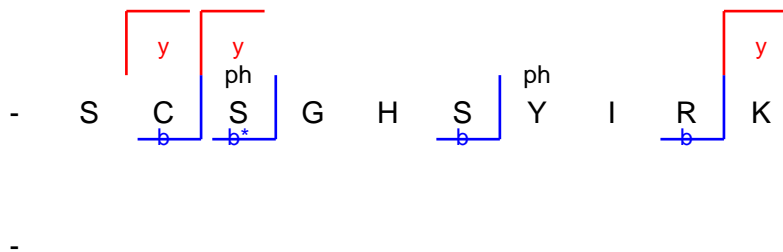
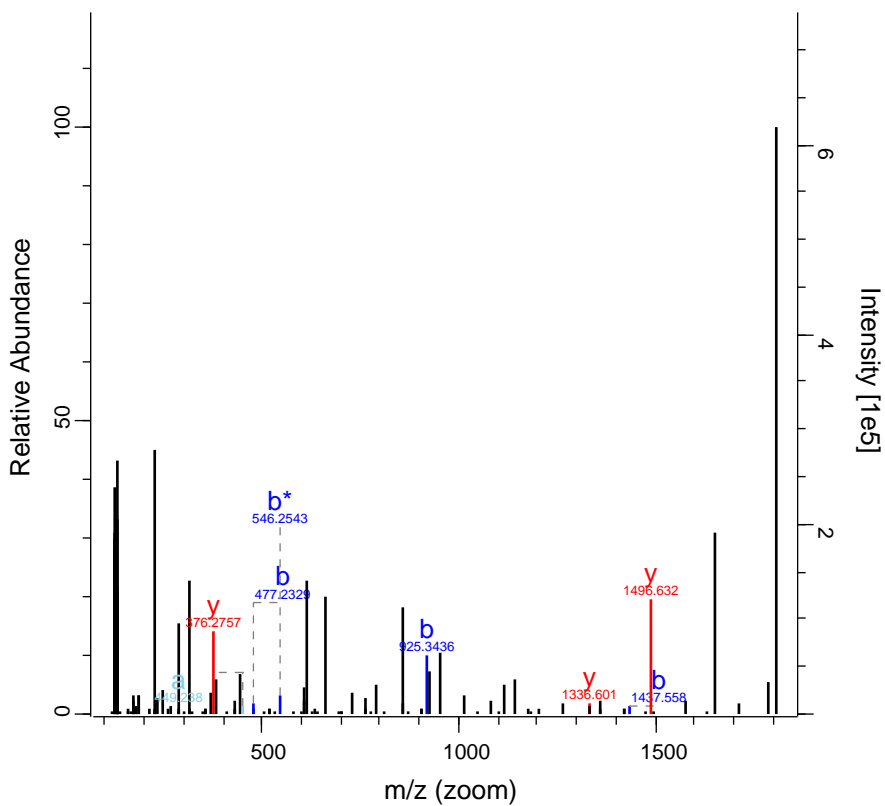

RO-QC-160121_ZackD_SS_Set_02_Fraction 10627 FTMS; HC 40.59 646.31 ATF7IP2

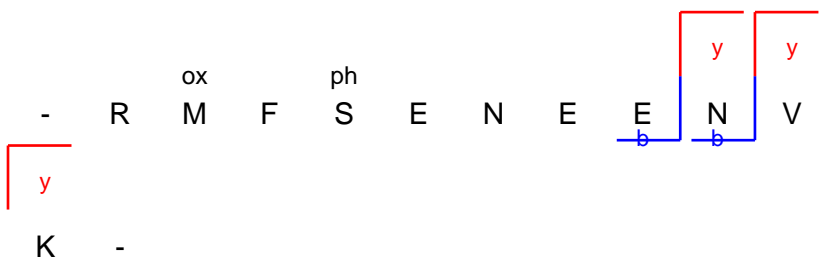
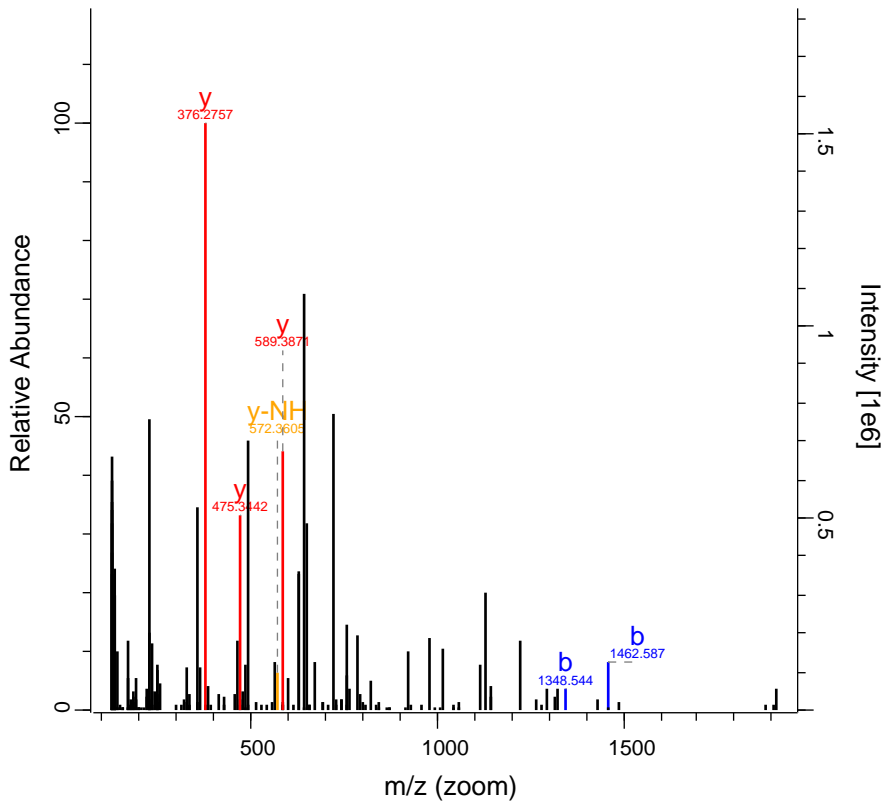

K -

RO-QC-160121_ZackD_SS_Set_02_Fraction 11197 FTMS; HC 55.75 680.72 MAP1B

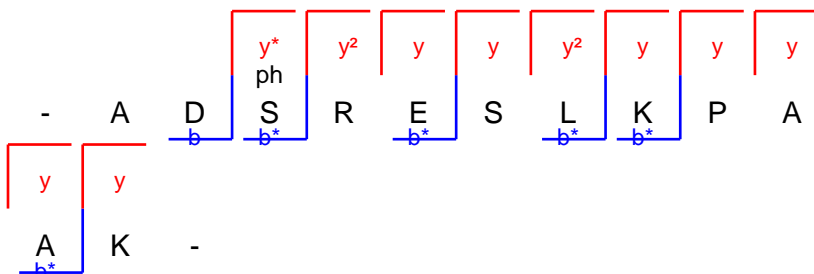
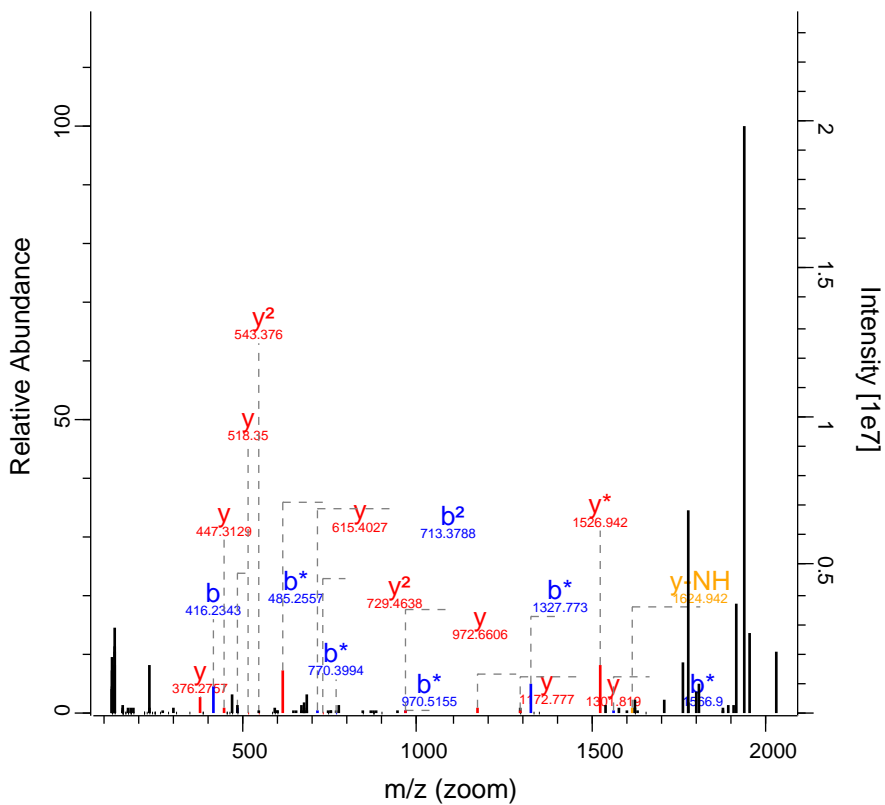

RO-QC-160121_ZackD_SS_Set_02_Fraction 11961 FTMS; HC 139 814.04 UTP18

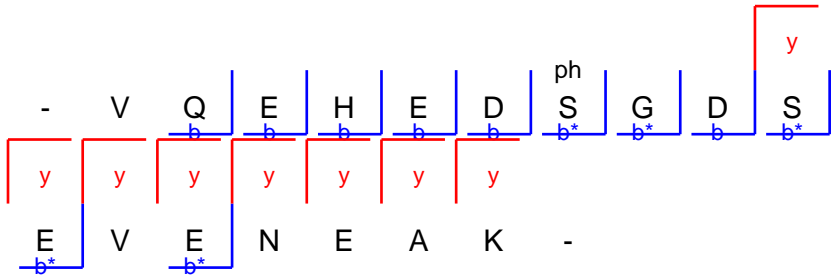
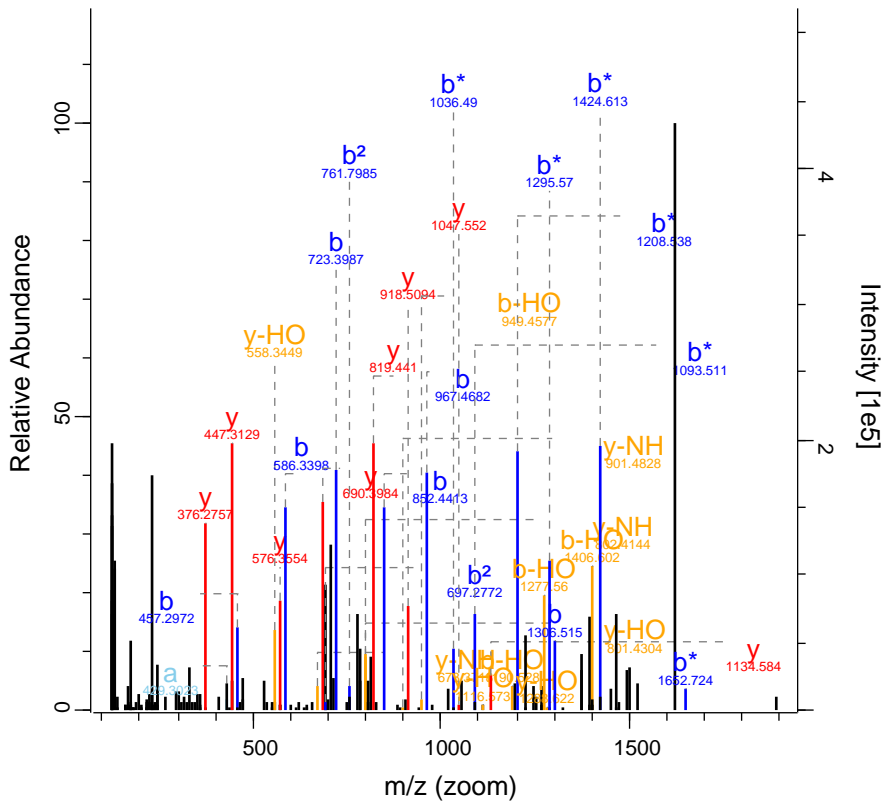

RO-QC-160121_ZackD_SS_Set_02_Fraction 12082 FTMS; HC 60.96 584.79 HNRNPU

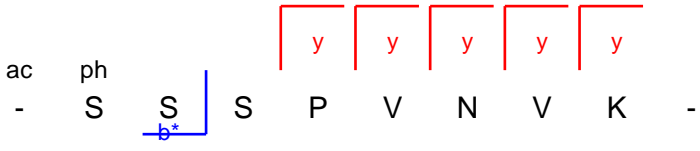
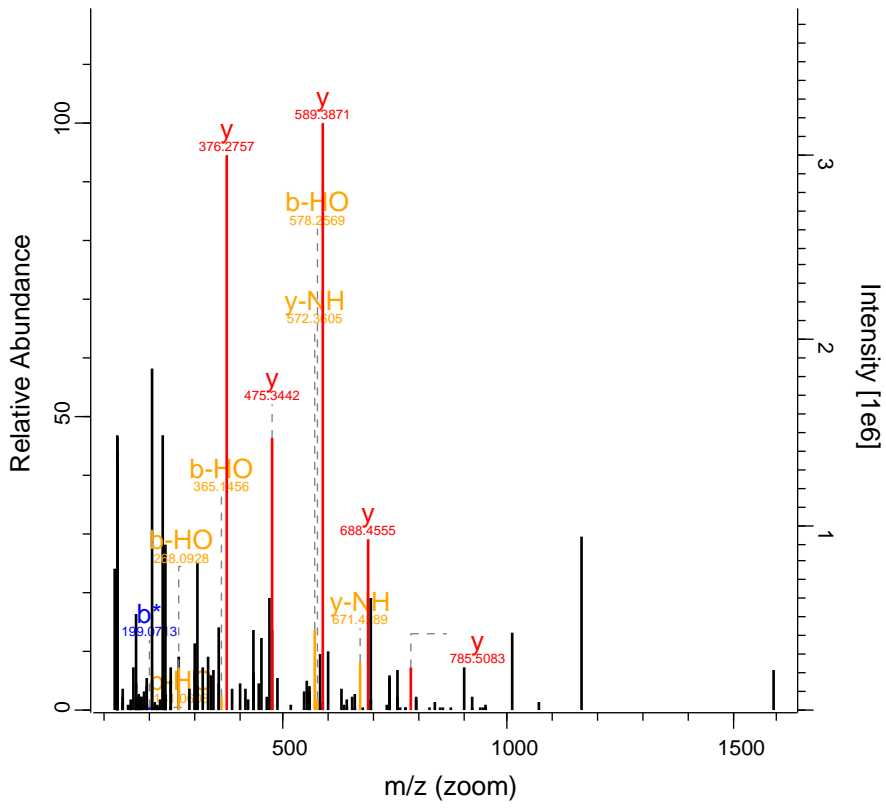

RO-QC-160121_ZackD_SS_Set_02_Fraction1 12285 FTMS; HCl 83.24 452.5 ARHGEF12

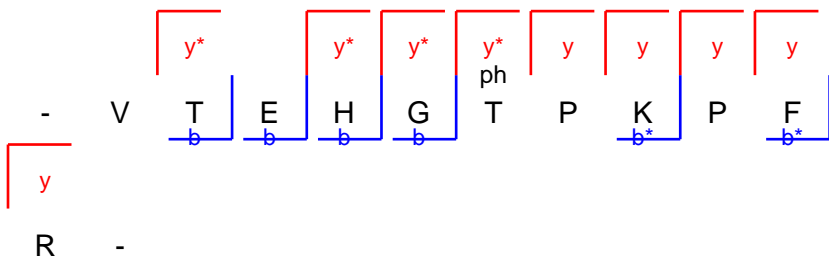
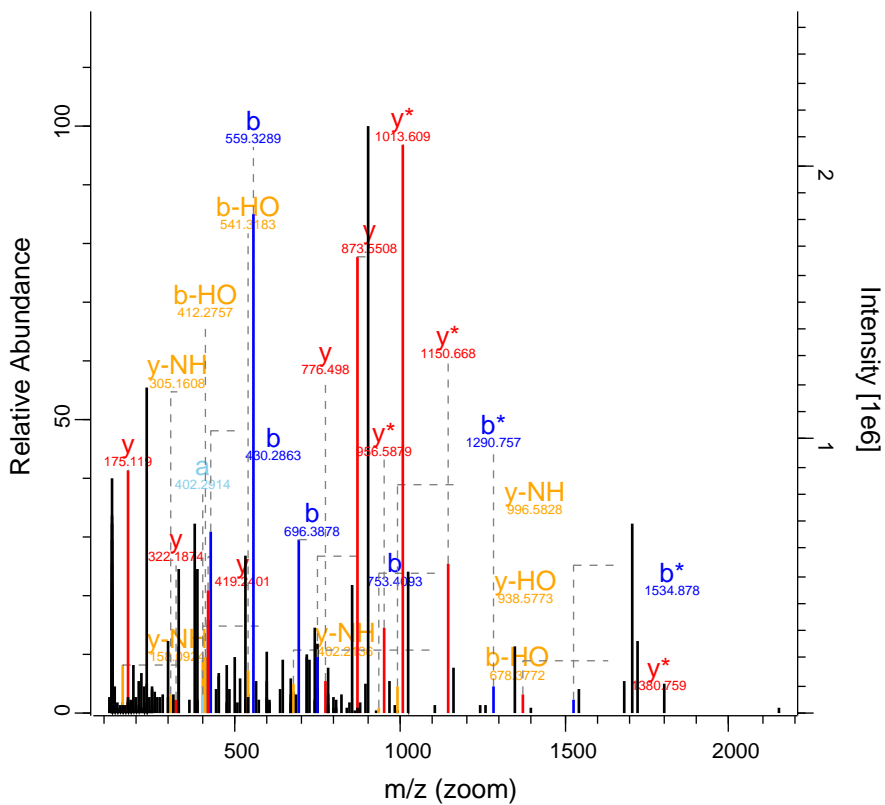

RO-QC-160121_ZackD_SS_Set_02_Fraction12794 FTMS; HCl 108.15 647.8 TNKS1BP1

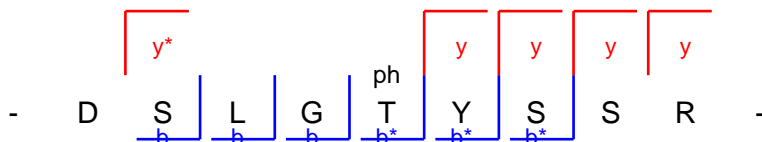
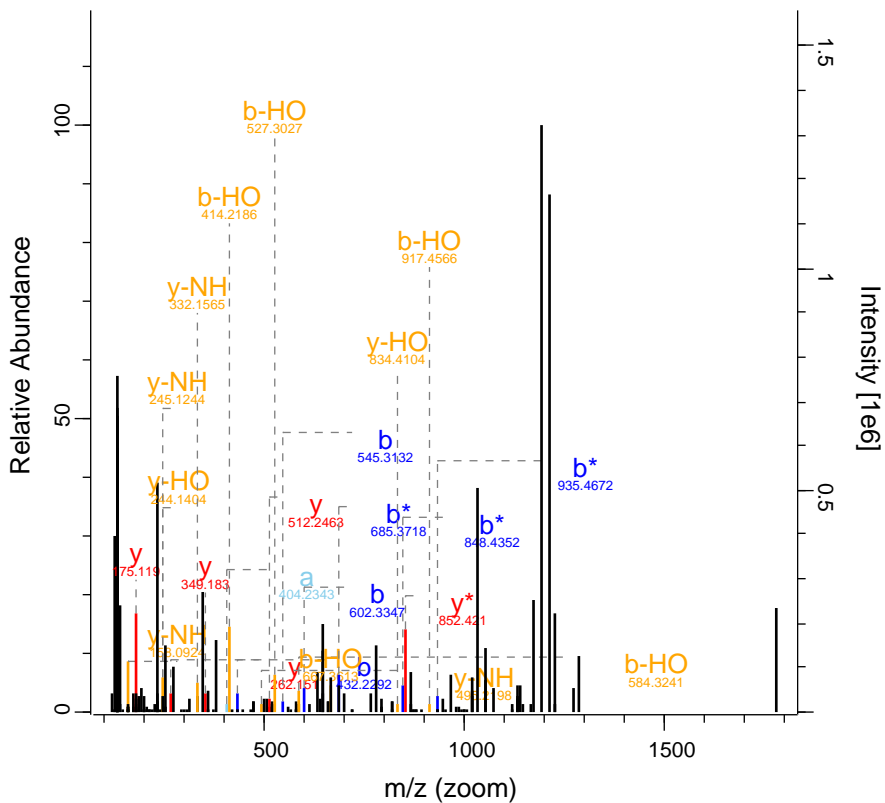

RO-QC-160121_ZackD_SS_Set_02_Fratio 12975 FTMS; HC 151.07 768.87 PCDH7

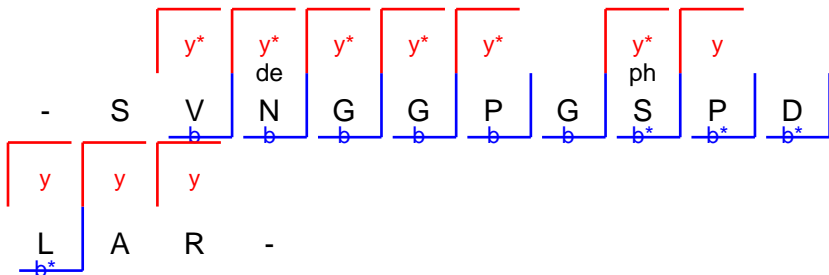
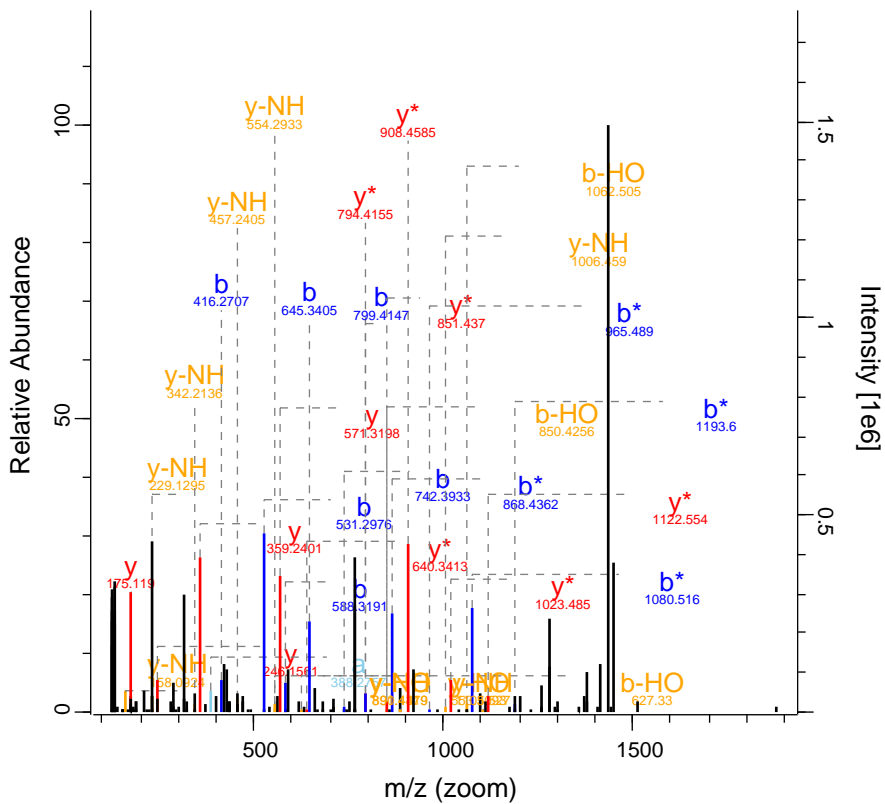

RO-QC-160121_ZackD_SS_Set_02_Fraction 14061 FTMS; HC 45.72 411.99 RBM39

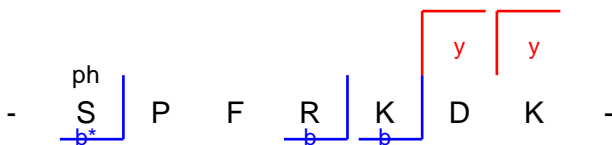
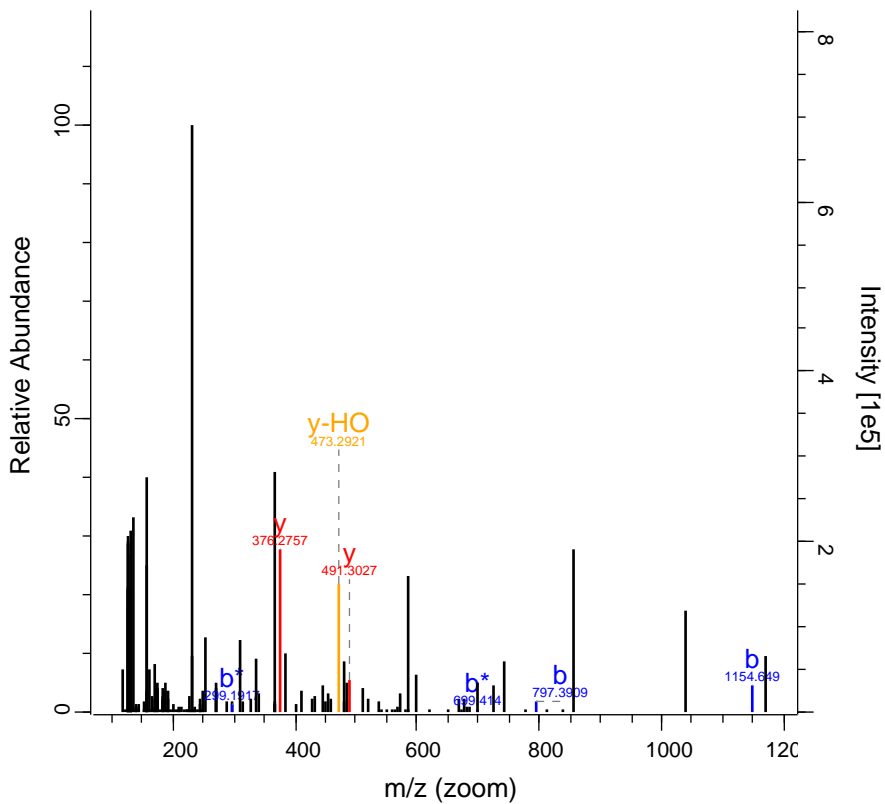

RO-QC-160121_ZackD_SS_Set_02_Fractio 14162 FTMS; HC 121.63 781.42 TP53BP1

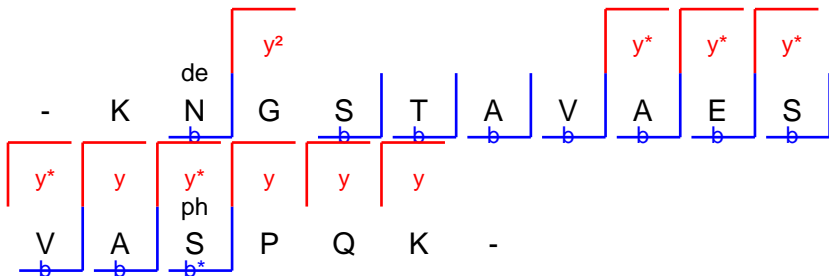
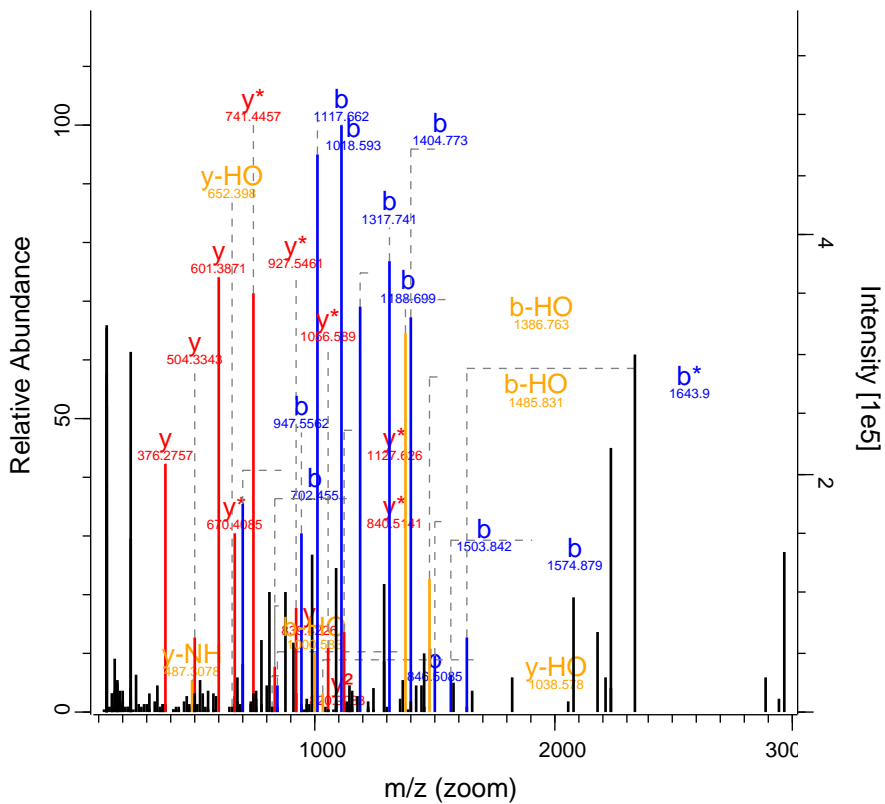

RO-QC-160121_ZackD_SS_Set_02_Fractio 14178 FTMS; HC 140.35 867.43 BASP1

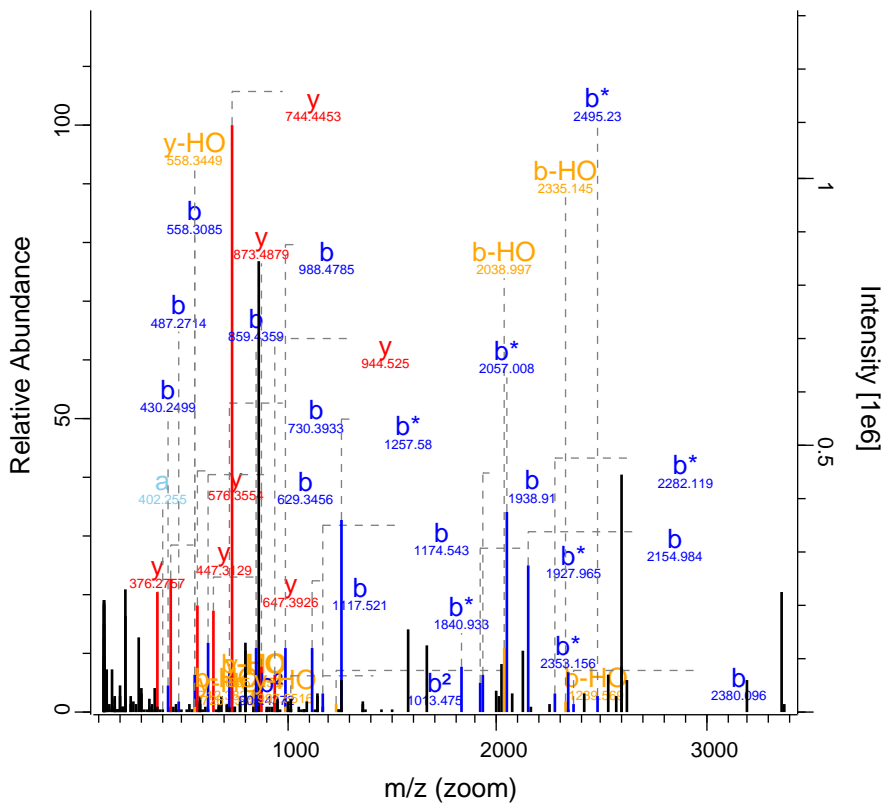

RO-QC-160121_ZackD_SS_Set_02_Fraction14666 FTMS; HC 45.43 576.52 TUFT1

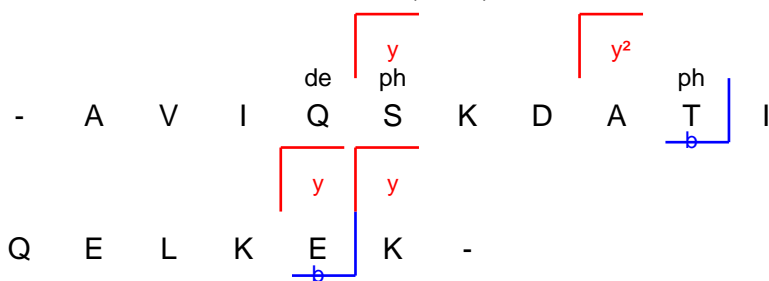
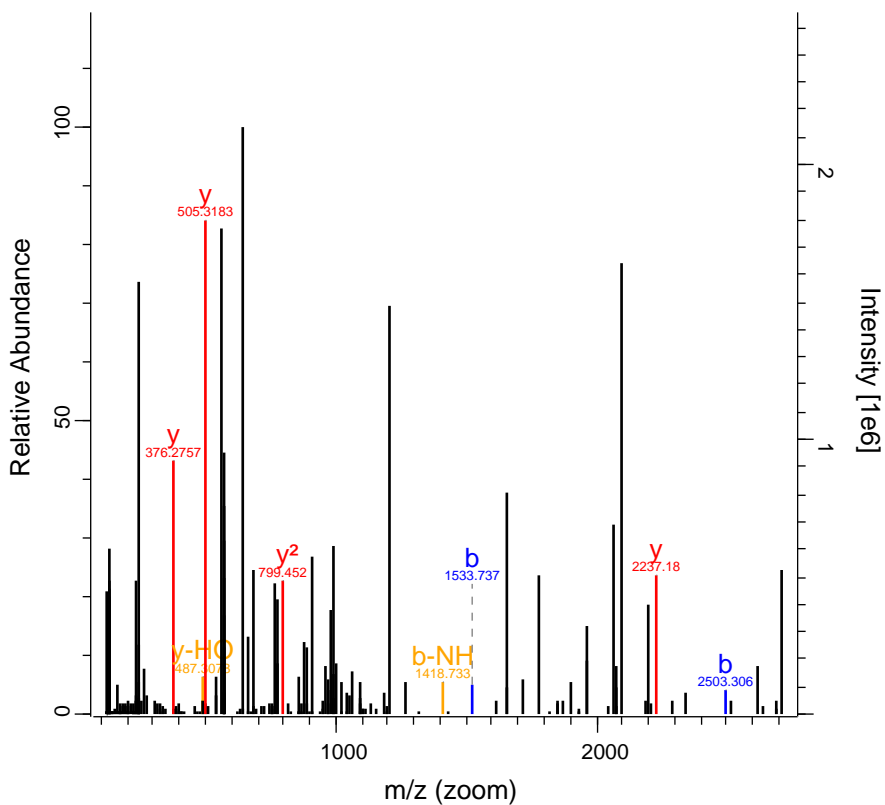

RO-QC-160121_ZackD_SS_Set_02_Fraction1 15355 FTMS; HCl 67.14 514.8 CALD1

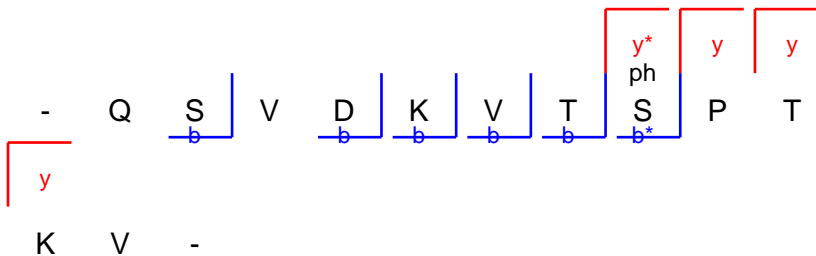
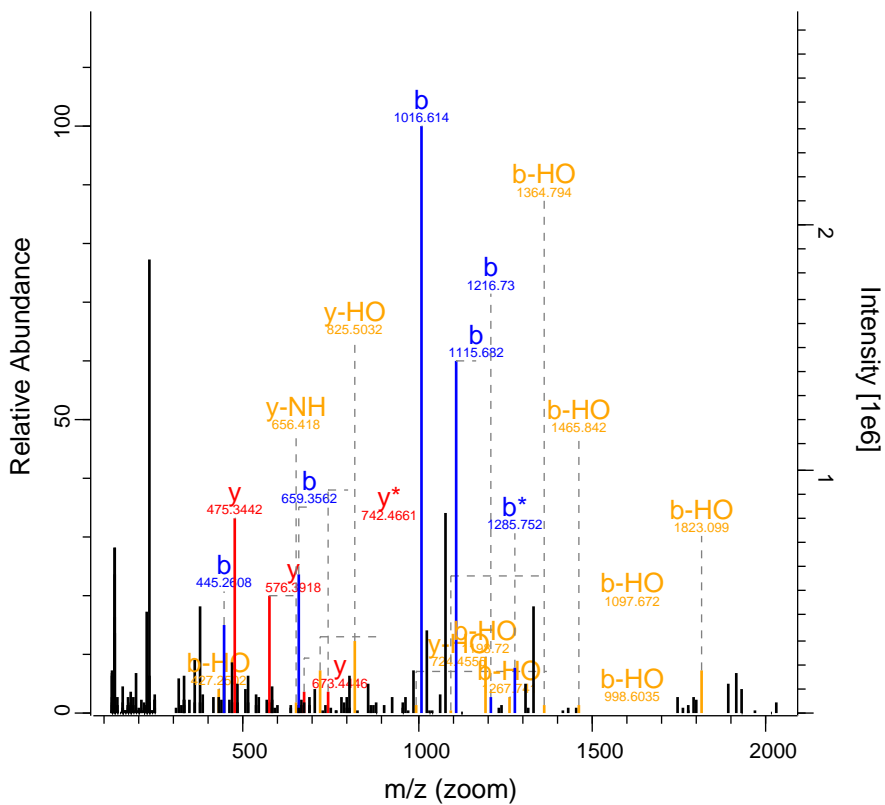

K V -

RO-QC-160121_ZackD_SS_Set_02_Fraction 15841 FTMS; HC 84.52 852.45 CAMK2D

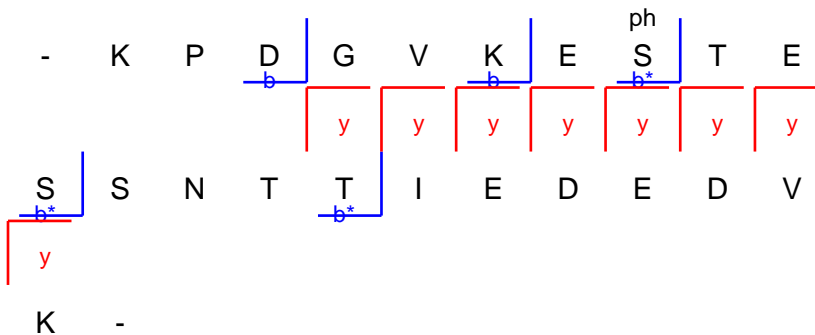
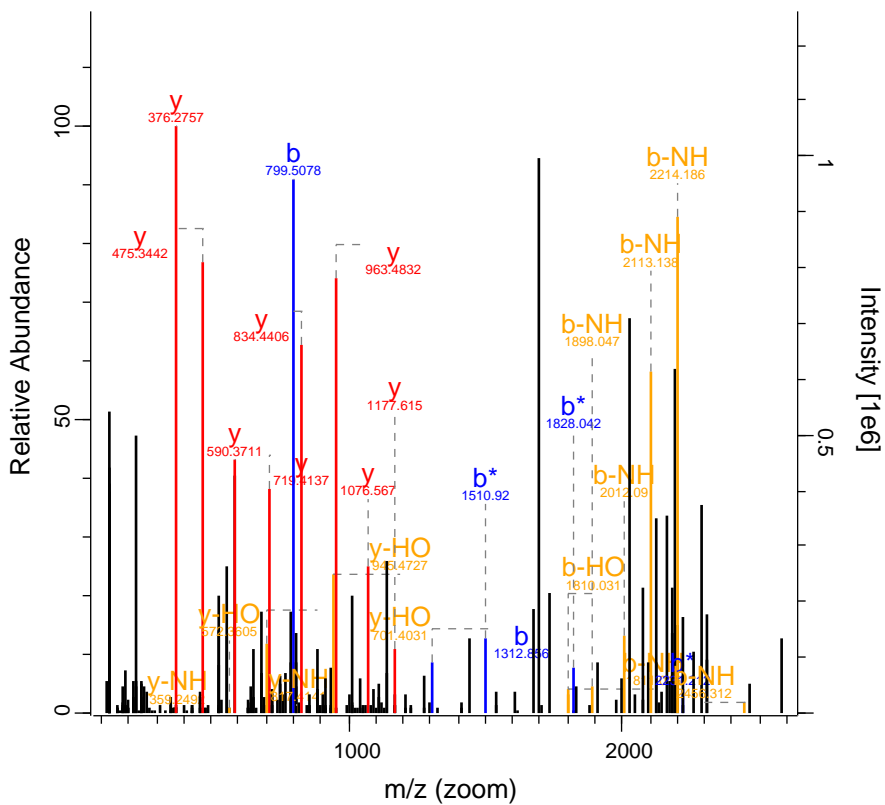

RO-QC-160121_ZackD_SS_Set_02_Fractio 16148 FTMS; HC 139.39 605.82 ZC3H18

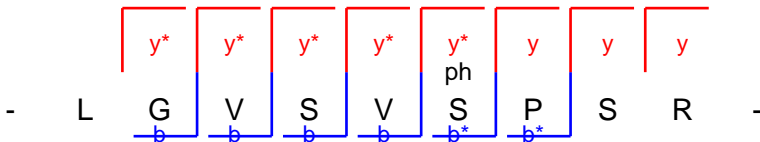
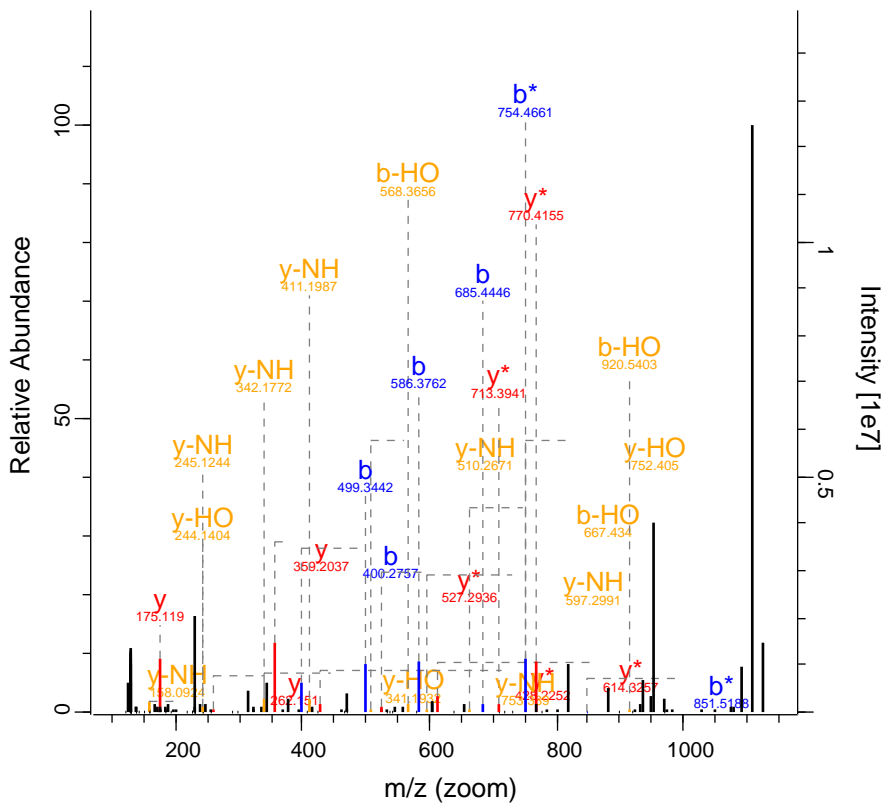

RO-QC-160121_ZackD_SS_Set_02_Fraction 16228 FTMS; HC 88.73 549.06 HDGF

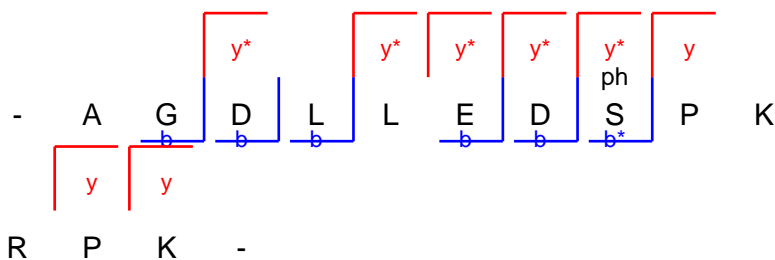
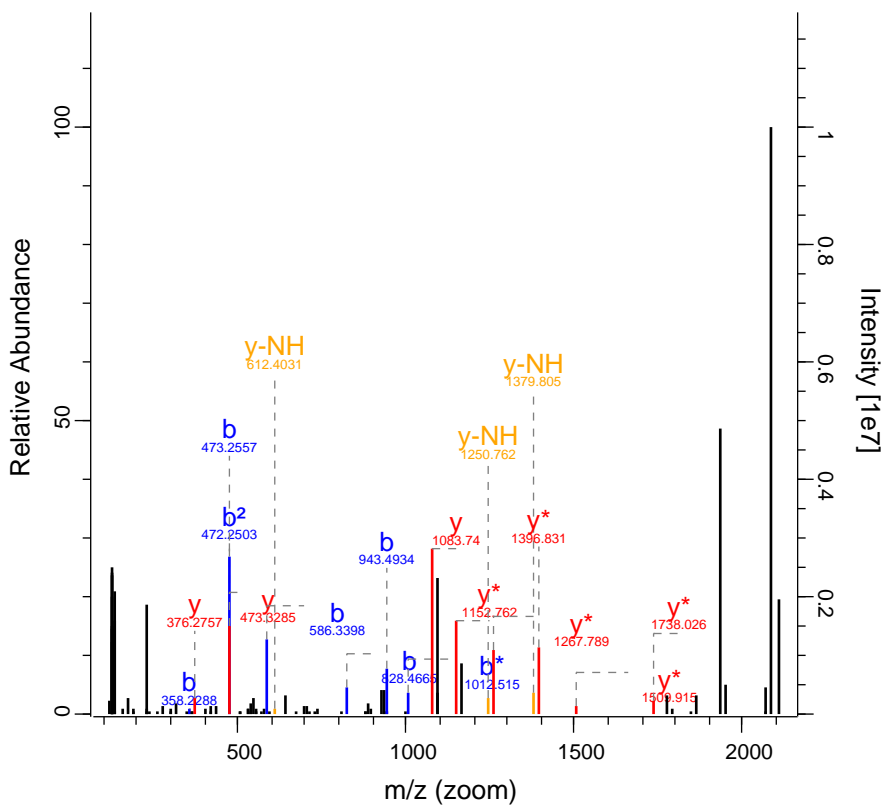

RO-QC-160121_ZackD_SS_Set_02_Fraction 16252 FTMS; HC 52.4 670.81 TOMM70A

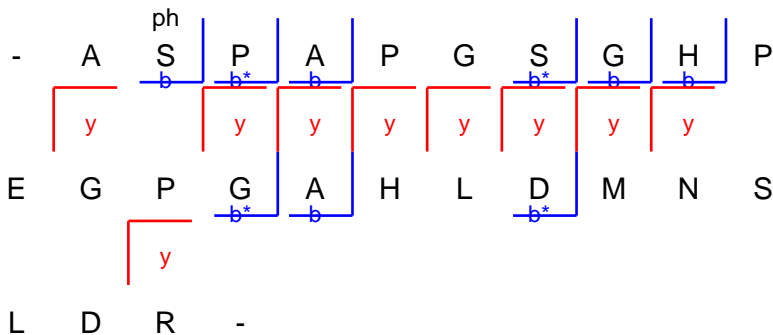
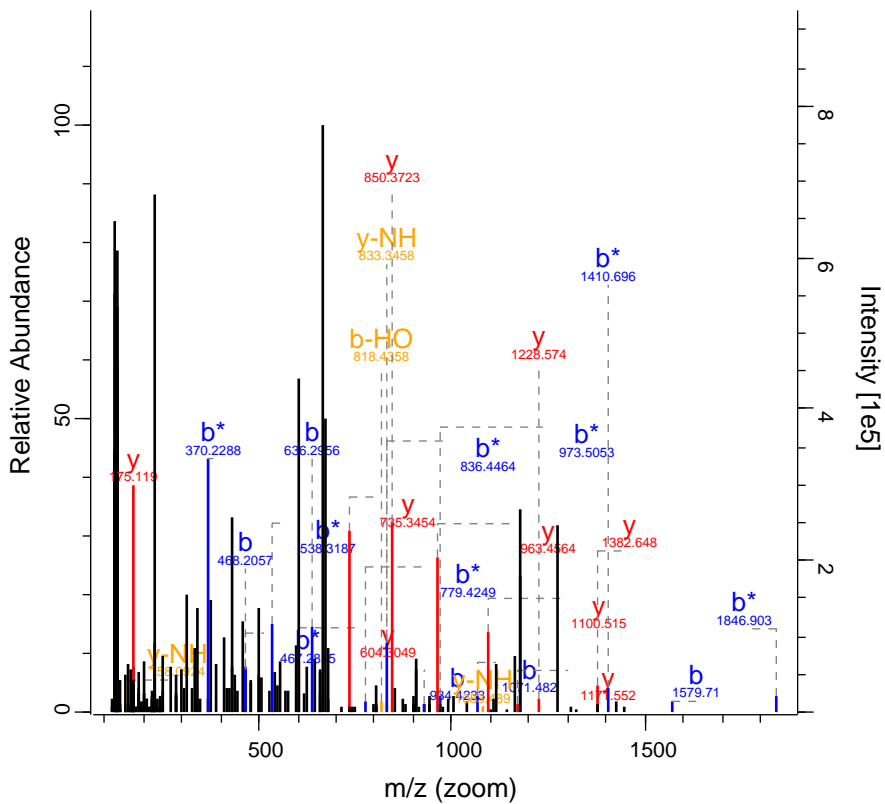

RO-QC-160121_ZackD_SS_Set_02_Fraction 16552 FTMS; HC 95.81 594.56 SRRM2

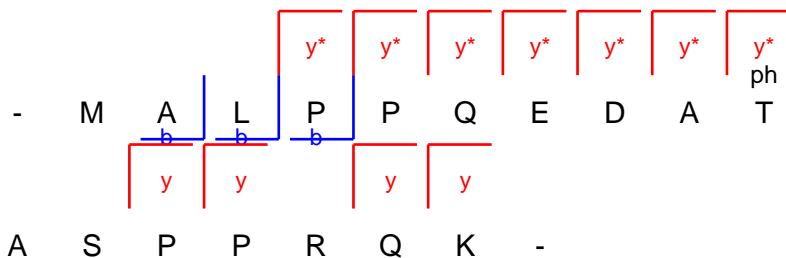
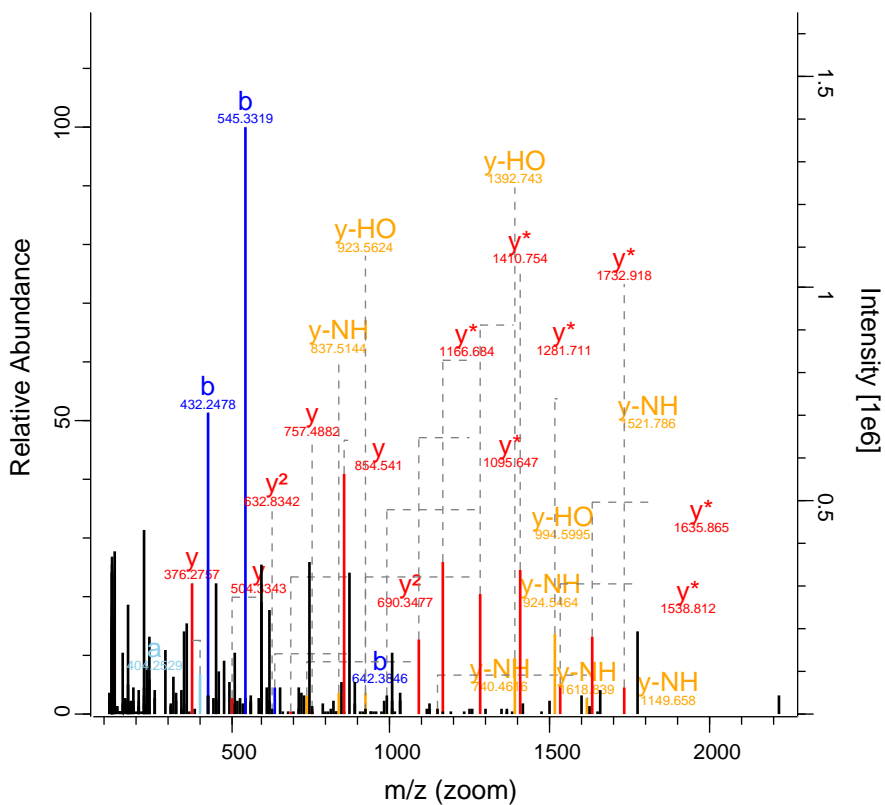

RO-QC-160121_ZackD_SS_Set_02_Fraction 16739 FTMS; HC 51.27 923.01 CEP350

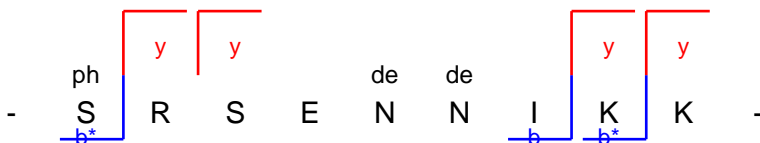
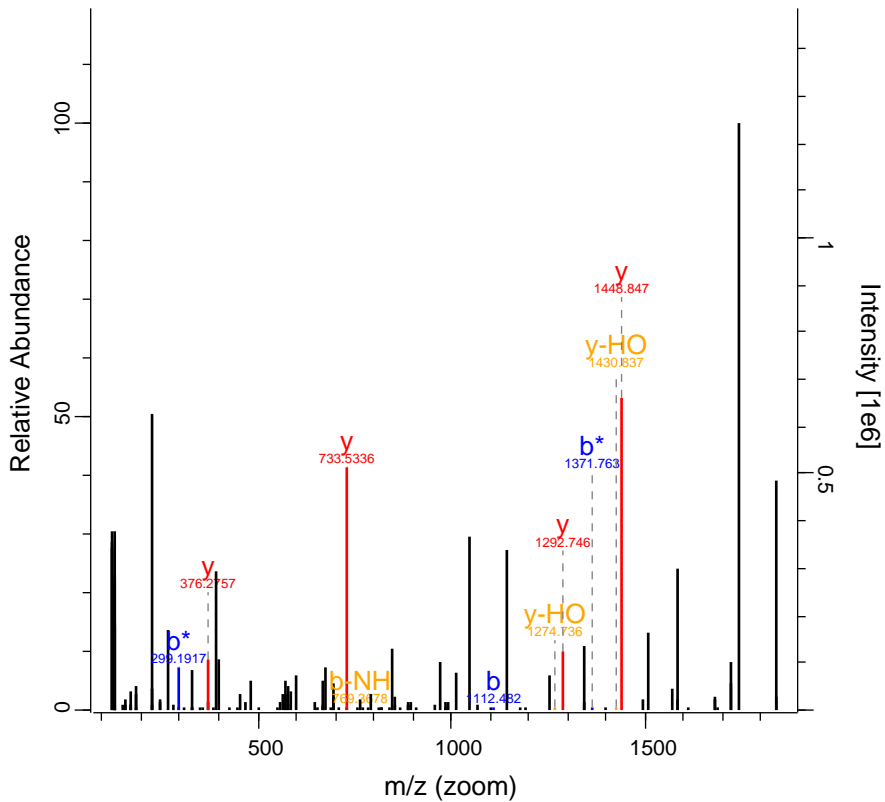

RO-QC-160121_ZackD_SS_Set_02_Fraction1 17568 FTMS; HCl 79.01 637.7 WDR77

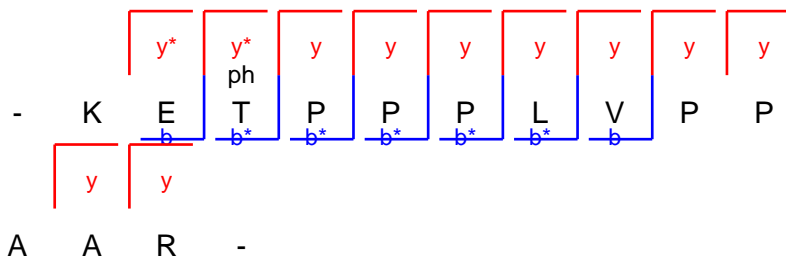
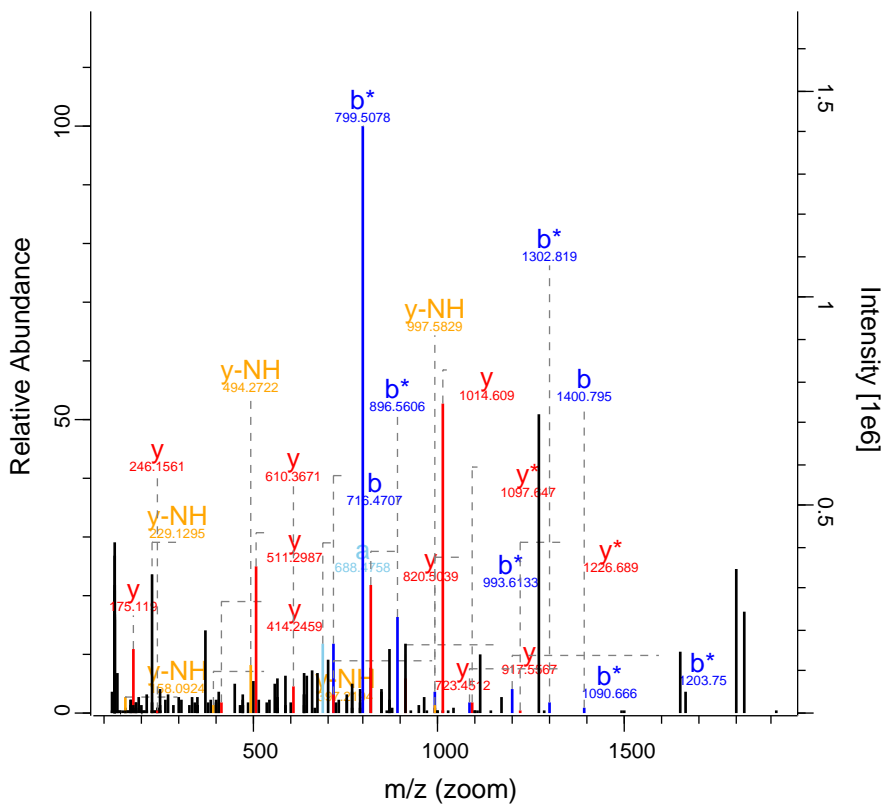

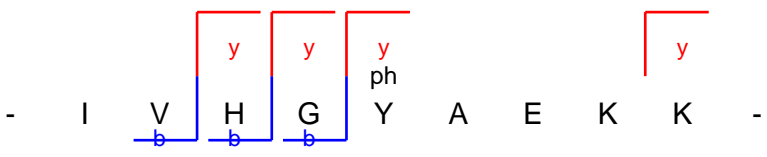
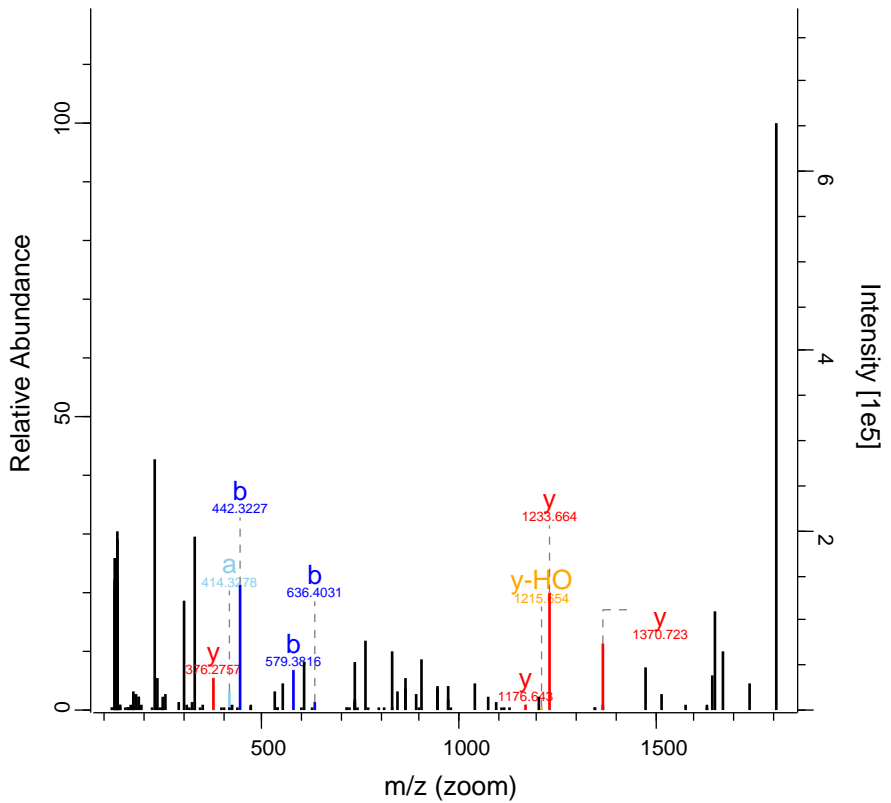

RO-QC-160121_ZackD_SS_Set_02_Fractio 17948 FTMS; HC 123.55 734.35 FAM134A

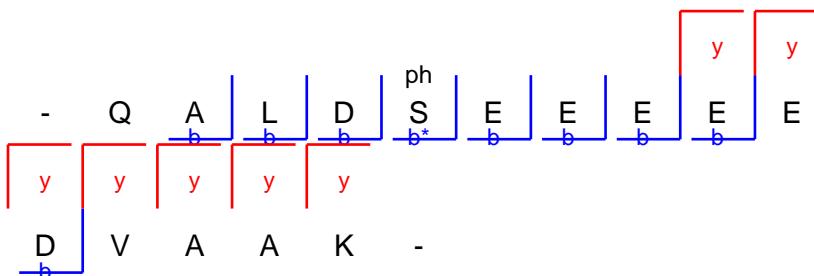
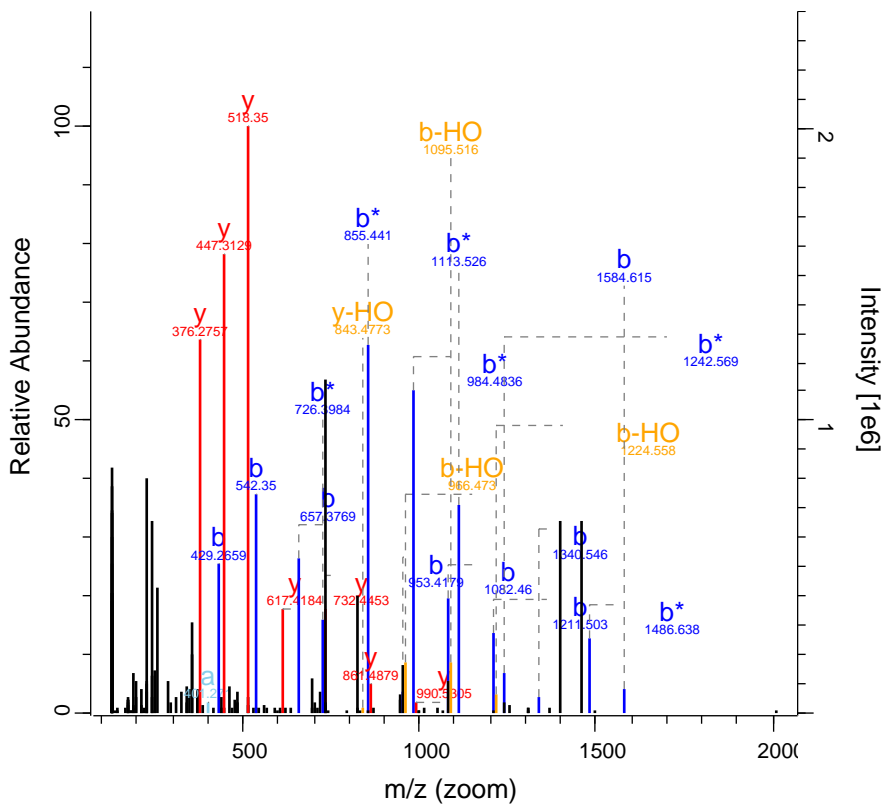

RO-QC-160121_ZackD_SS_Set_02_Fraction 17955 FTMS; HC 49.22 903.81 AKAP12

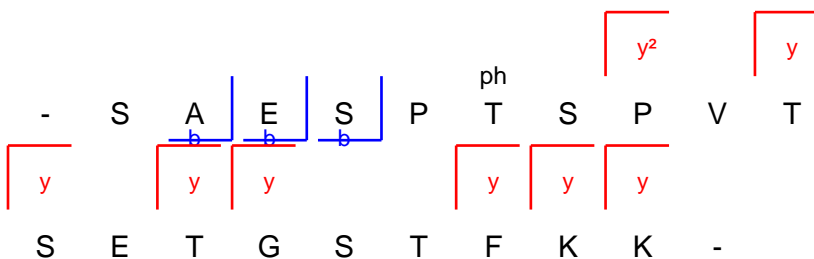
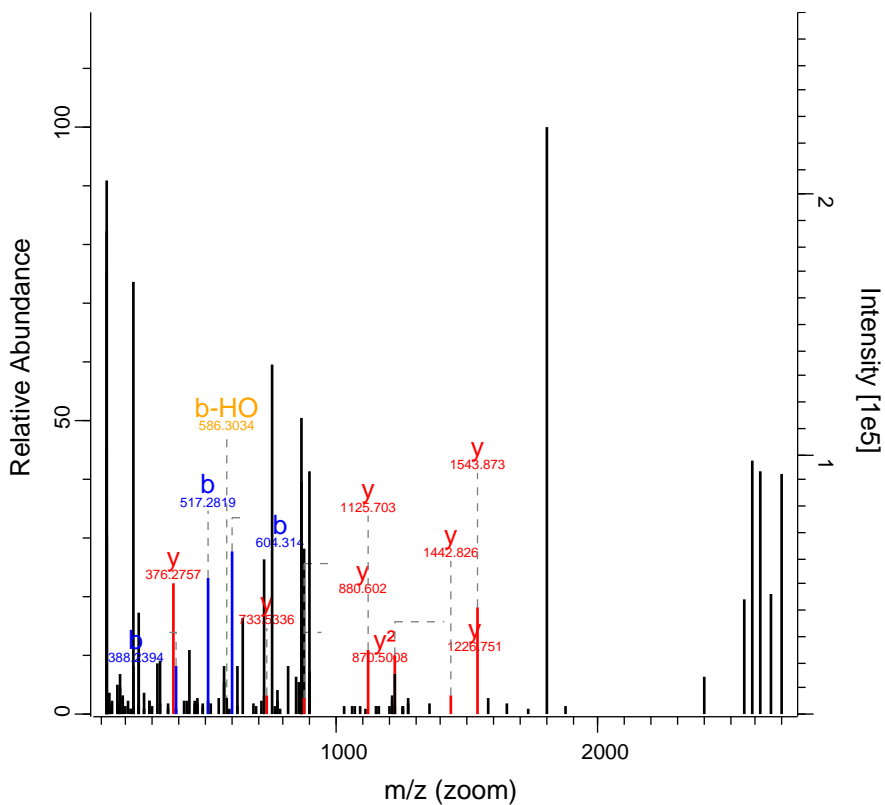

RO-QC-160121_ZackD_SS_Set_02_Fractic 18689 FTMS; HC 70.15 1152.54 MARCKS

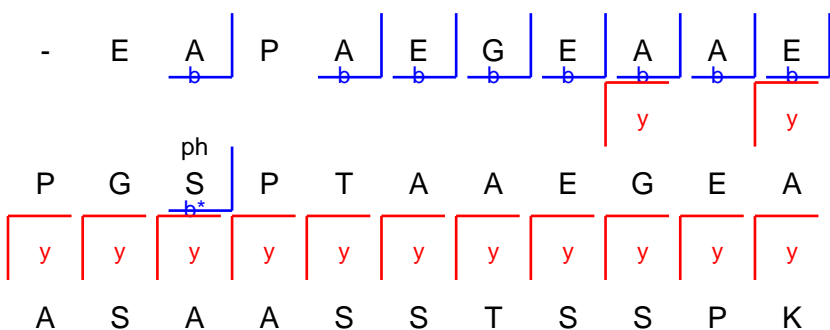
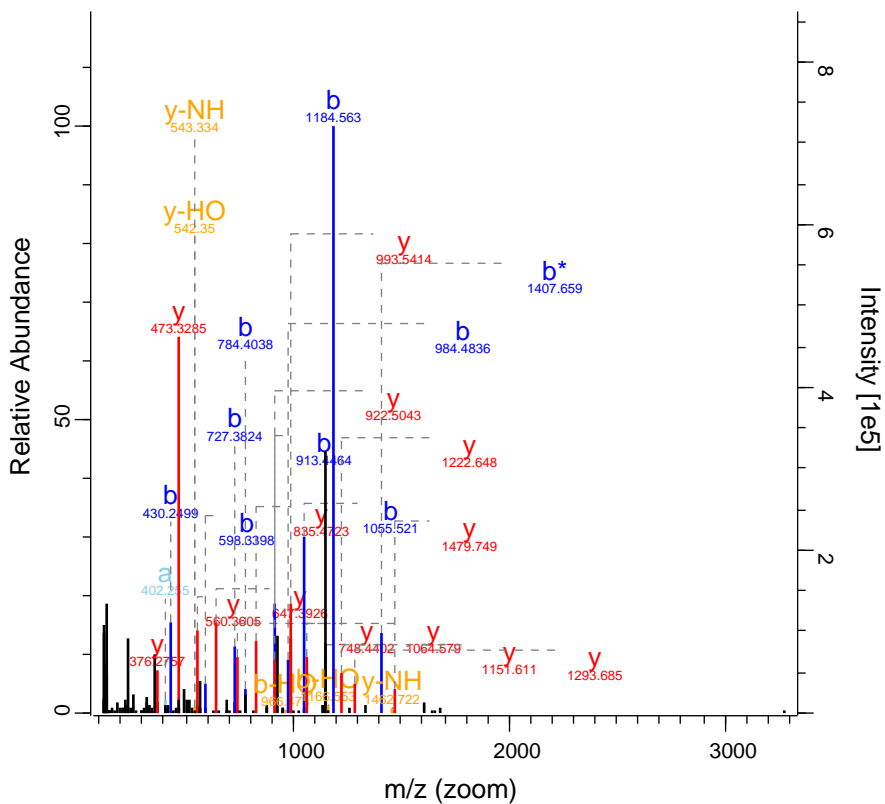

RO-QC-160121_ZackD_SS_Set_02_Fraction 18785 FTMS; HC 53.07 691.73 MARCKS

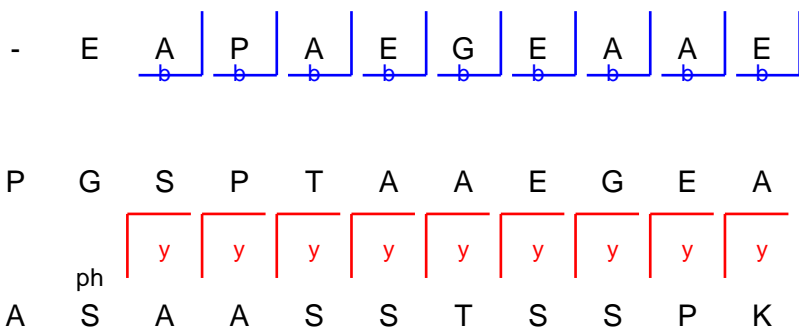
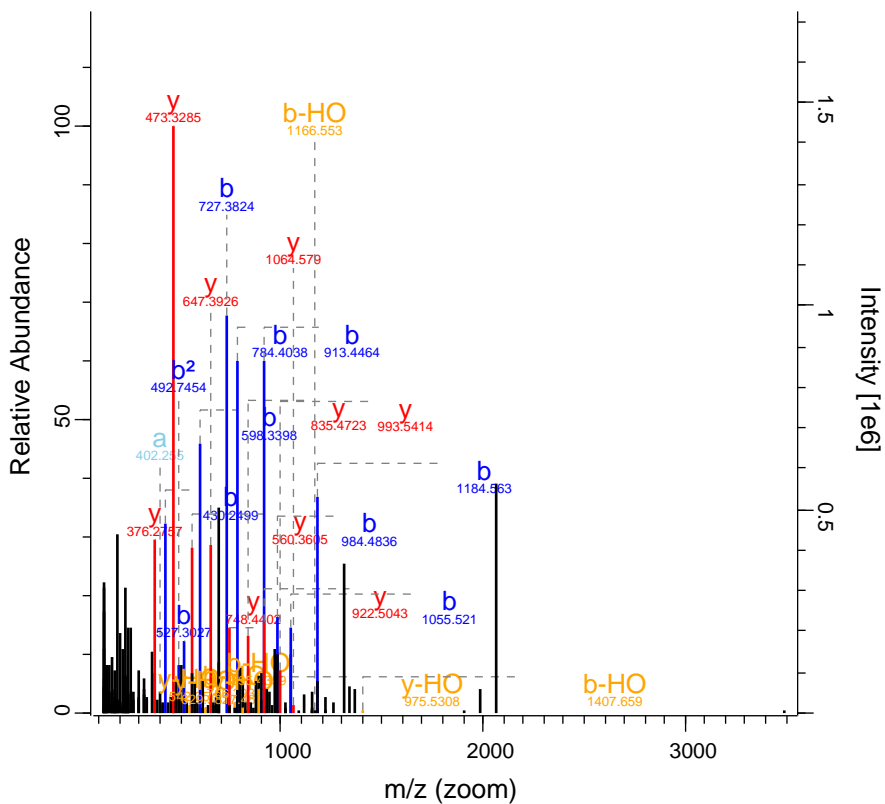

RO-QC-160121_ZackD_SS_Set_02_Fraction 19215 FTMS; HC 40.55 616.07 GRM4

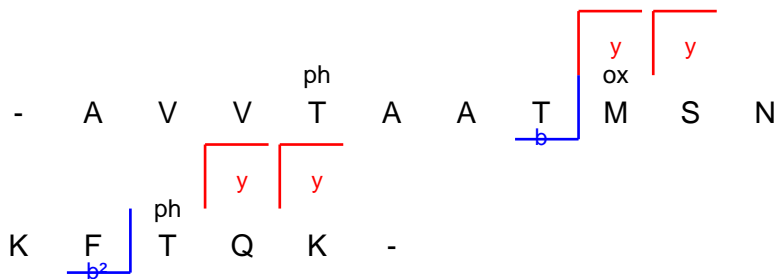
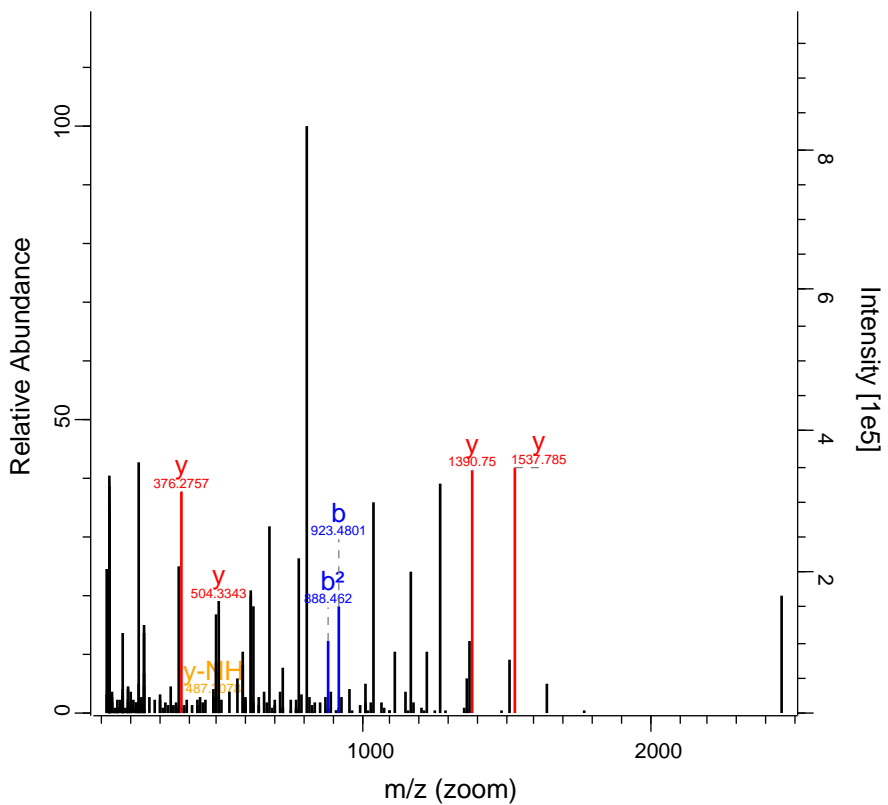

RO-QC-160121_ZackD_SS_Set_02_Fractic 20365 FTMS; HC 114.91 1052.53 RASAL2

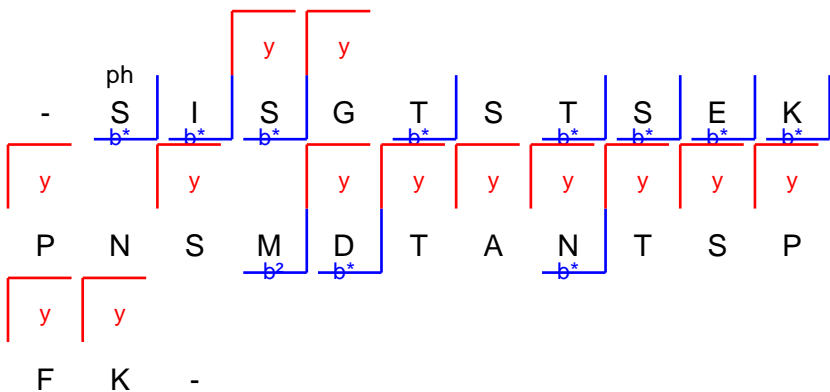
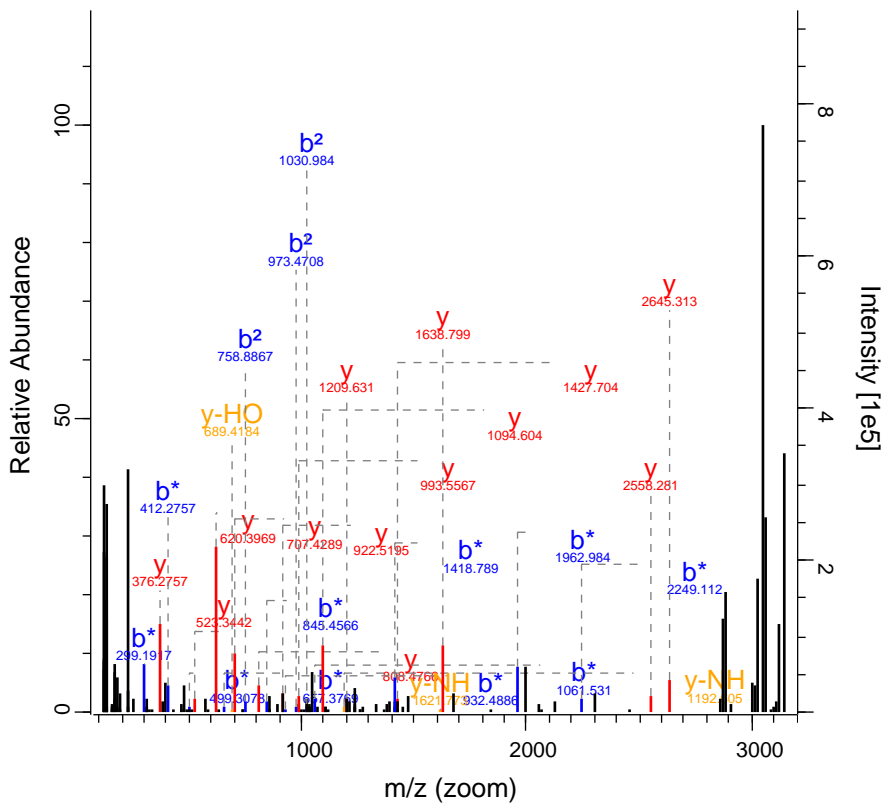

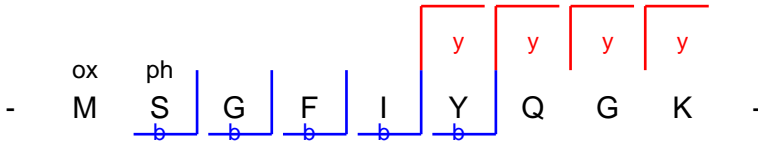
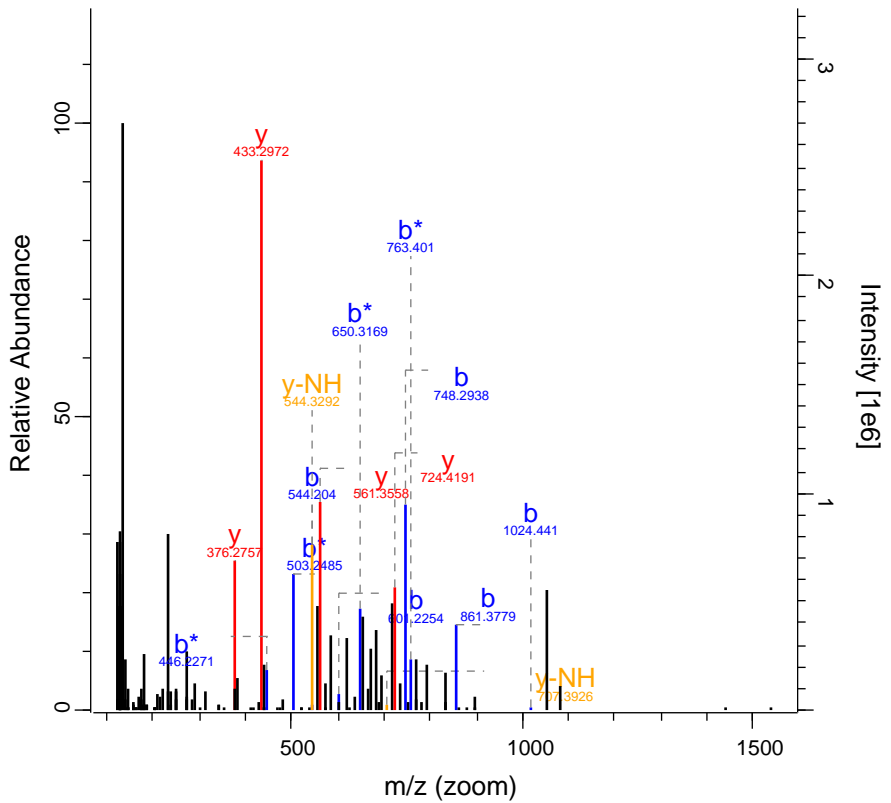

RO-QC-160121_ZackD_SS_Set_02_Fraction 21117 FTMS; HC 96.92 591.06 TEX2

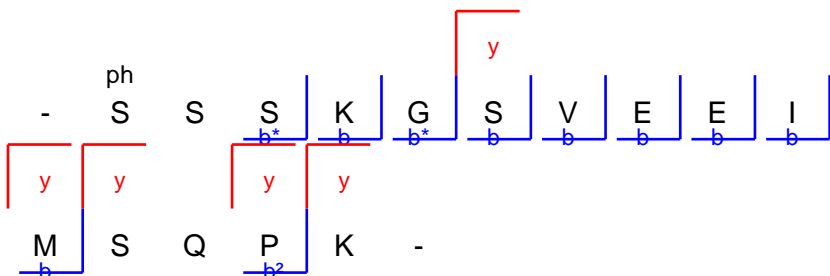
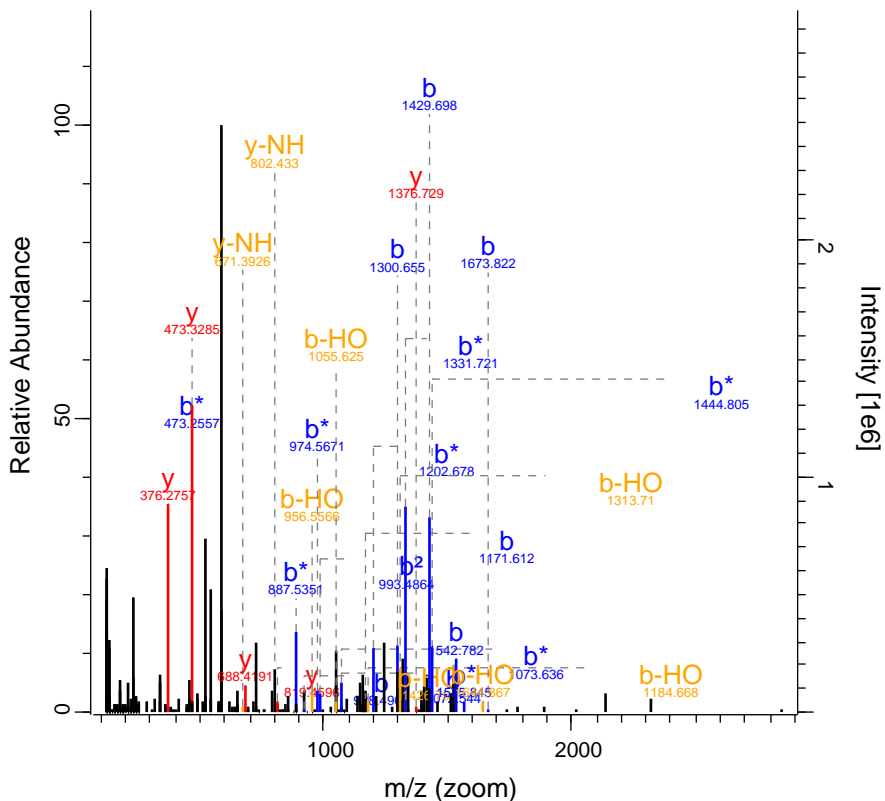

RO-QC-160121_ZackD_SS_Set_02_Fraction 21167 FTMS; HC 40.38 814.65 AZI2

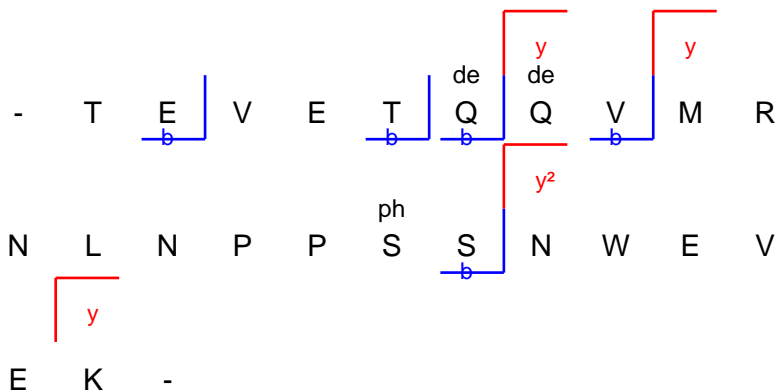
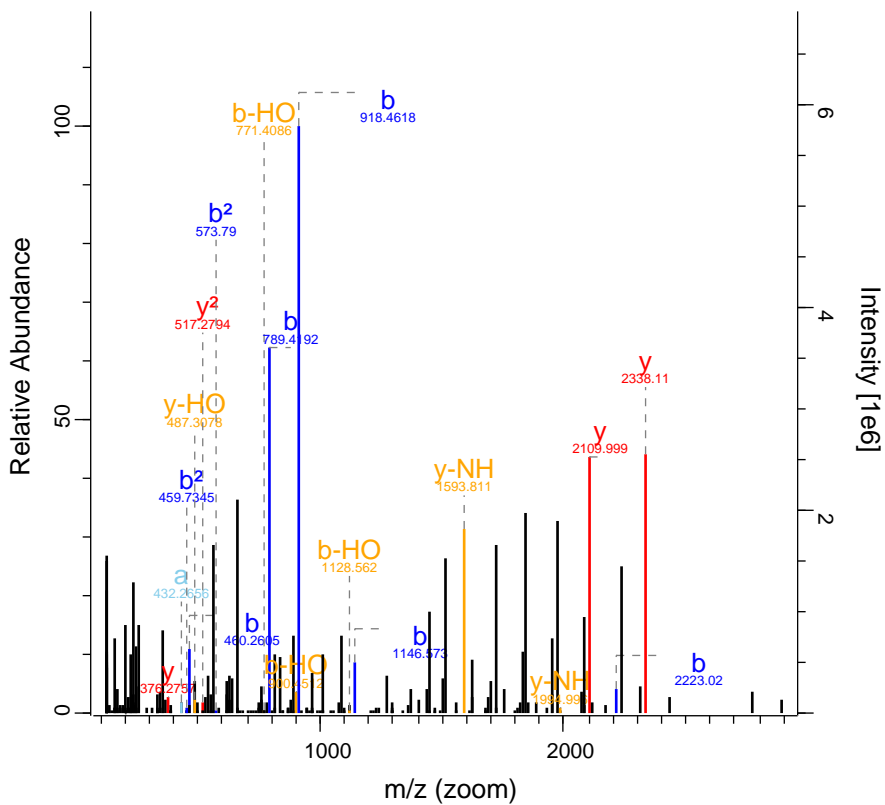

RO-QC-160121_ZackD_SS_Set_02_Fraction 21199 FTMS; HC 58.32 820.45 SIK3

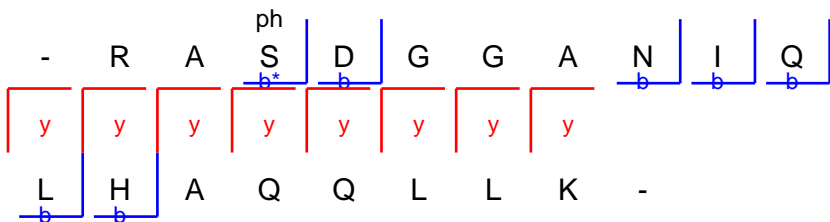
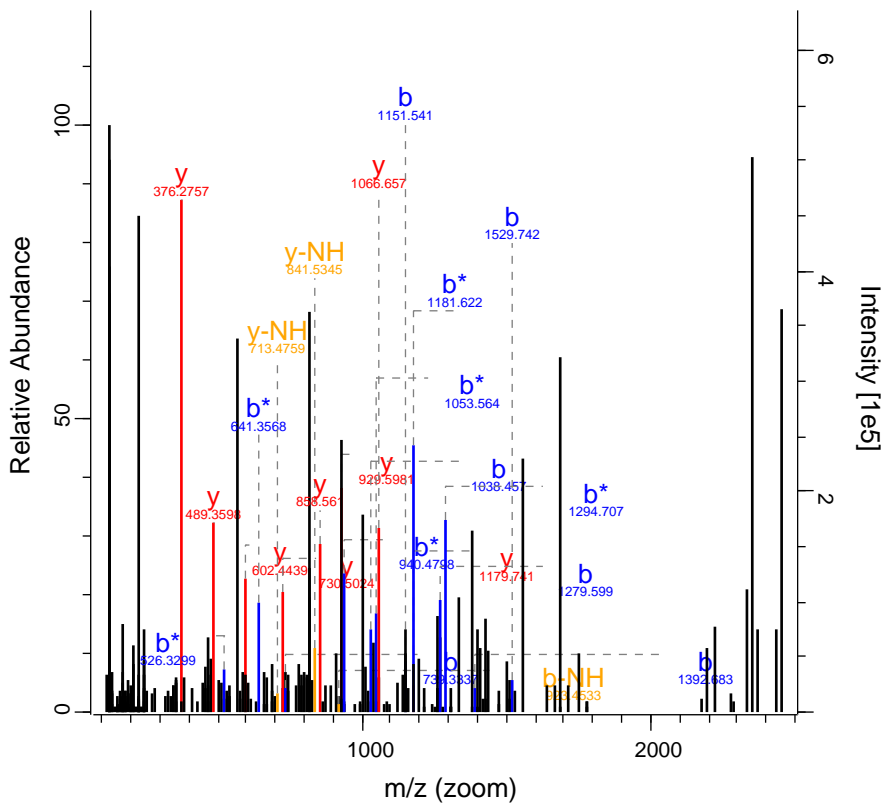

RO-QC-160121_ZackD_SS_Set_02_Fraction 21200 FTMS; HC 40.04 857.87 ERVK-16

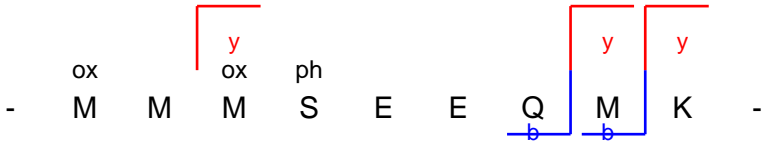
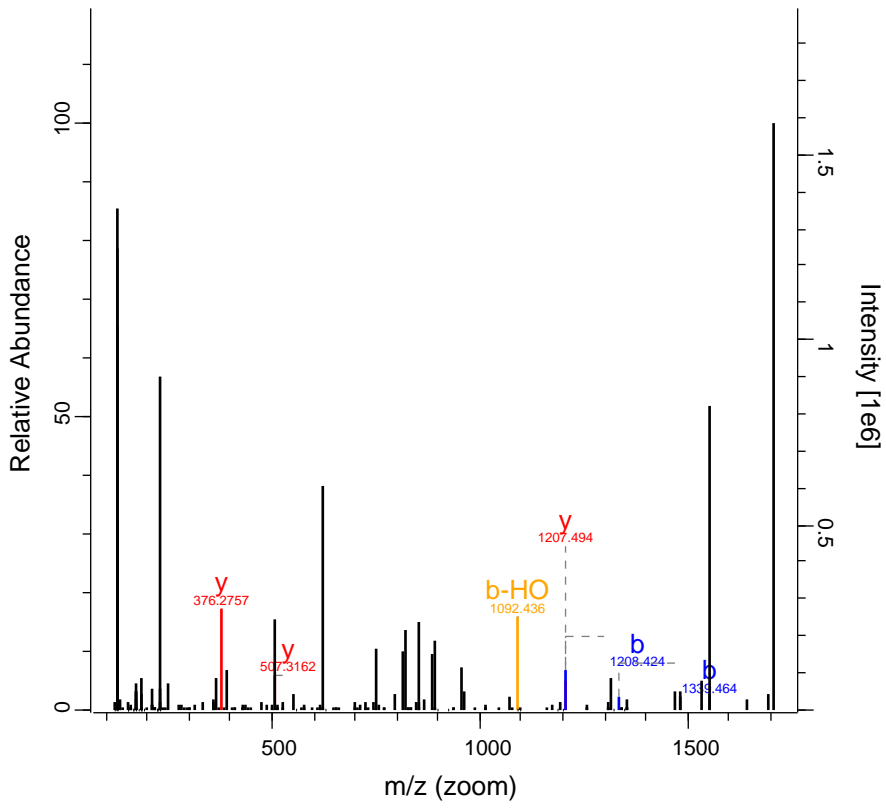

RO-QC-160121_ZackD_SS_Set_02_Fratio 21507 FTMS; HC 100.28 877.12 ITSN1

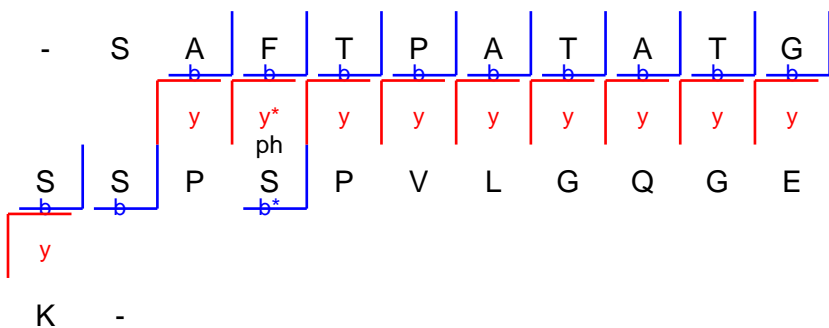
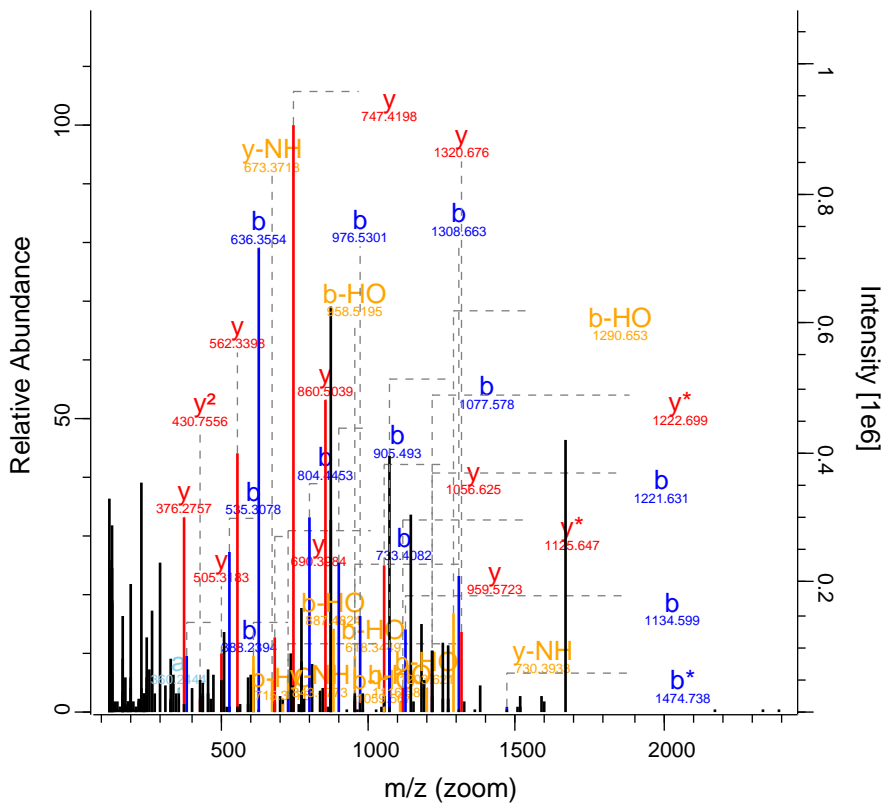

RO-QC-160121_ZackD_SS_Set_02_Fraction 21878 FTMS; HC 86.5 624.34 ALDOA

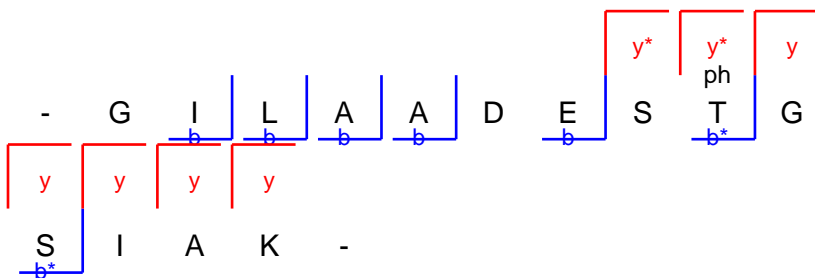
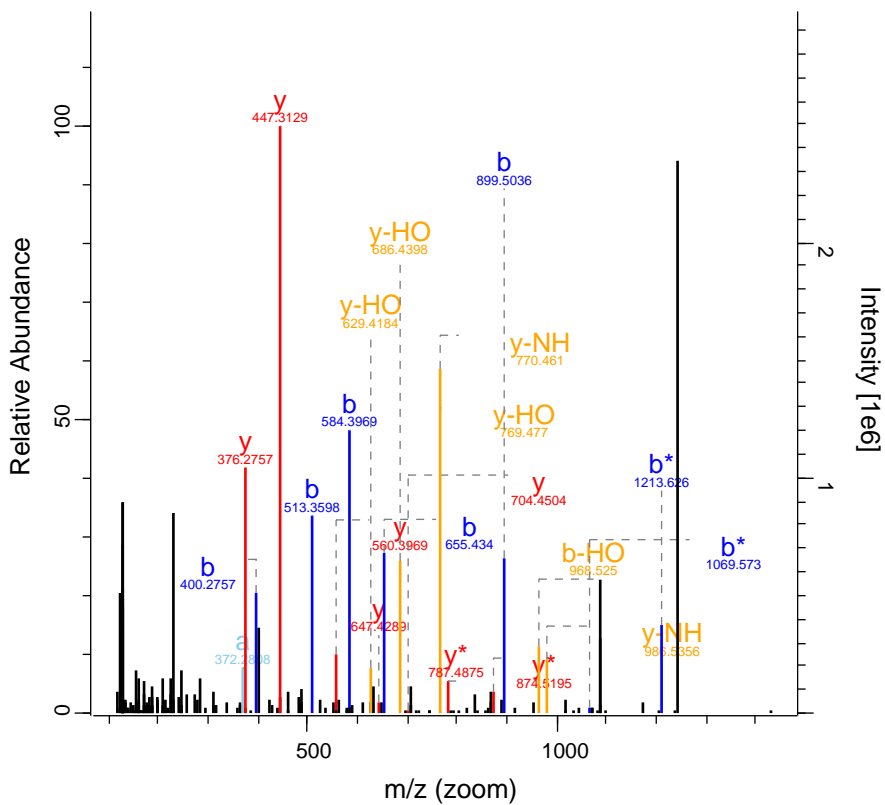

RO-QC-160121_ZackD_SS_Set_02_Fraction 22046 FTMS; HC 50.3 652.36 KIF5C

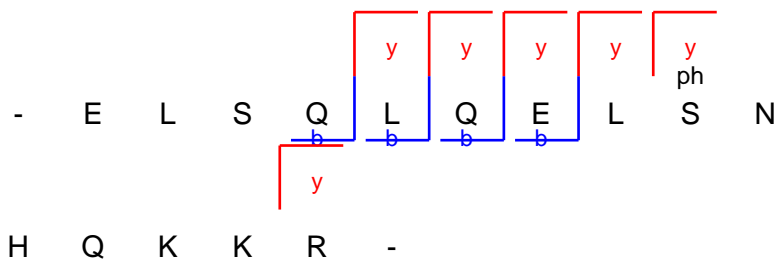
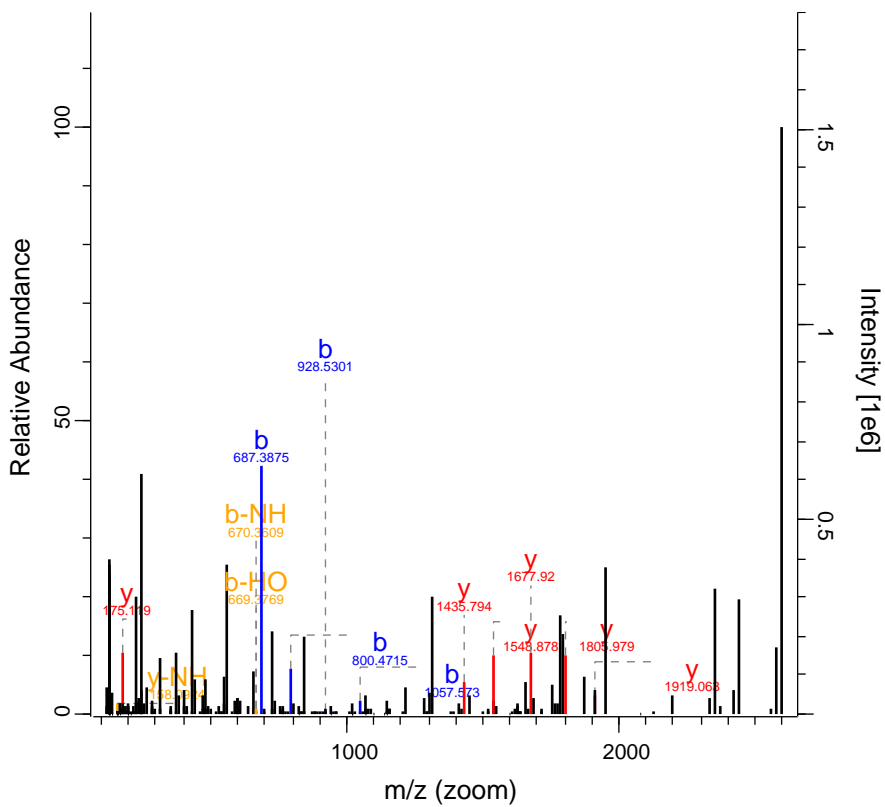

RO-QC-160121_ZackD_SS_Set_02_Fraction 22210 FTMS; HC 96.34 840.36 MCM3

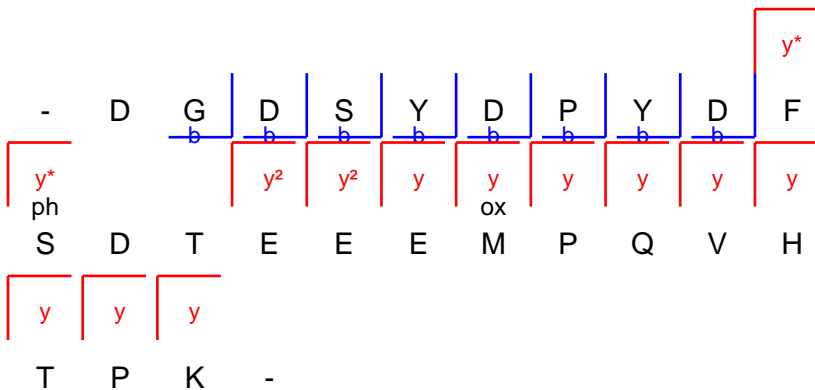
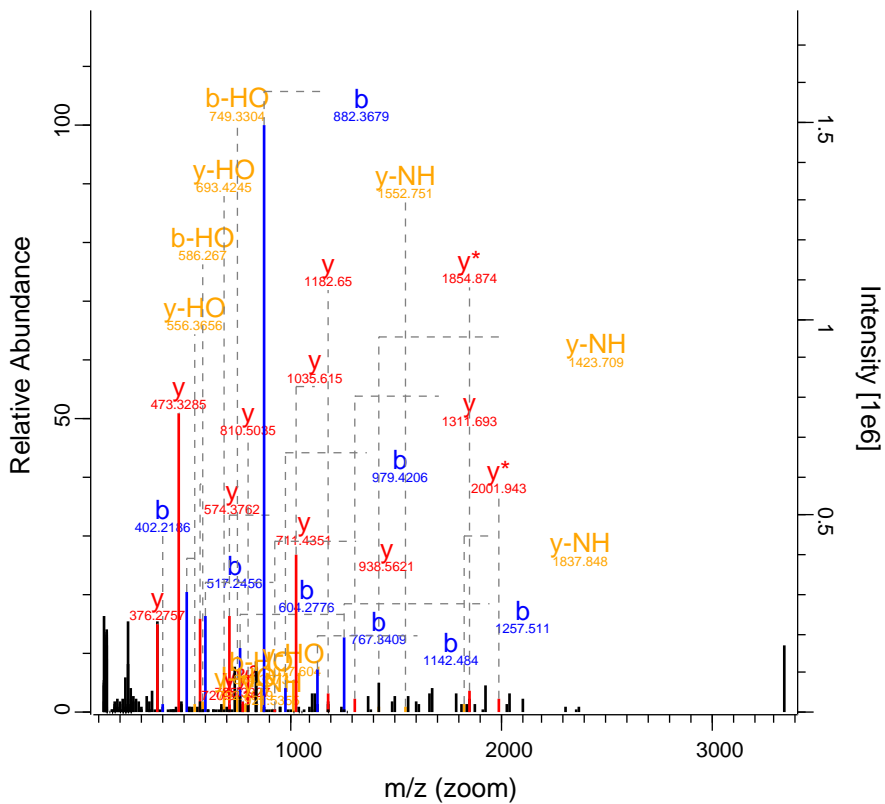

RO-QC-160121_ZackD_SS_Set_02_Fraction 22421 FTMS; HC 75.65 835.41 KIF23

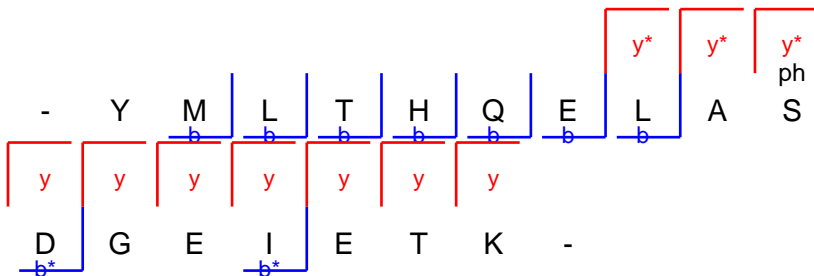
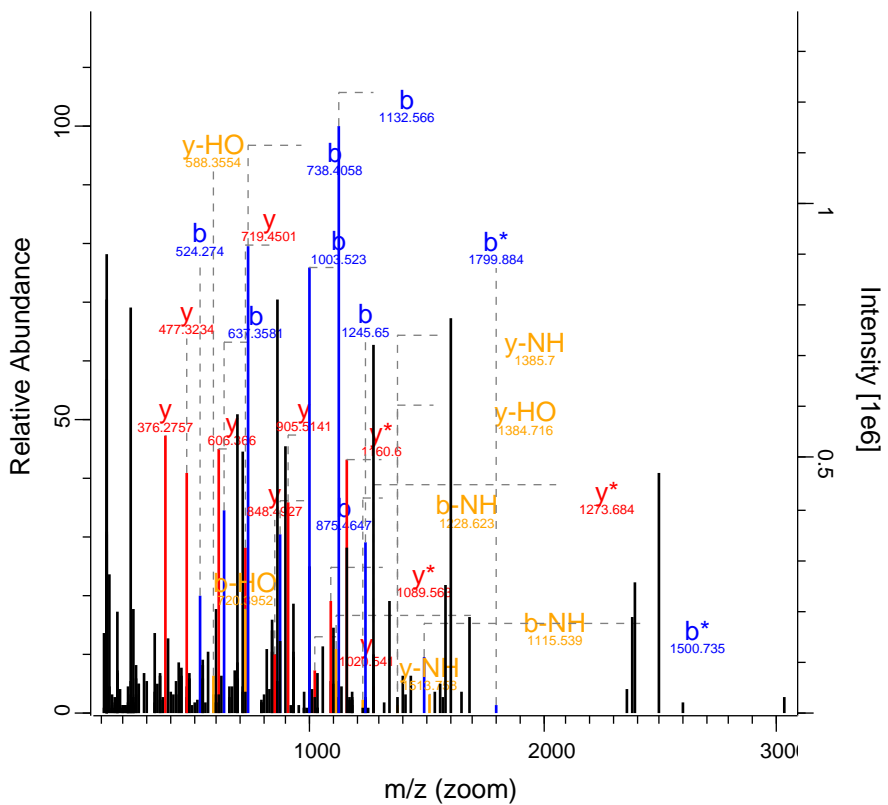

RO-QC-160121_ZackD_SS_Set_02_Fraction 22457 FTMS; HC 47.6 721.69 MOGAT2

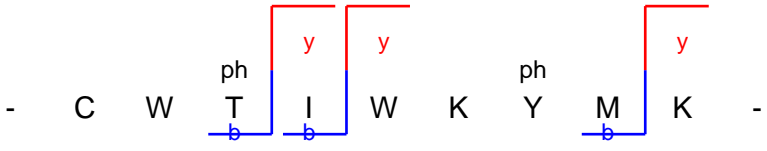
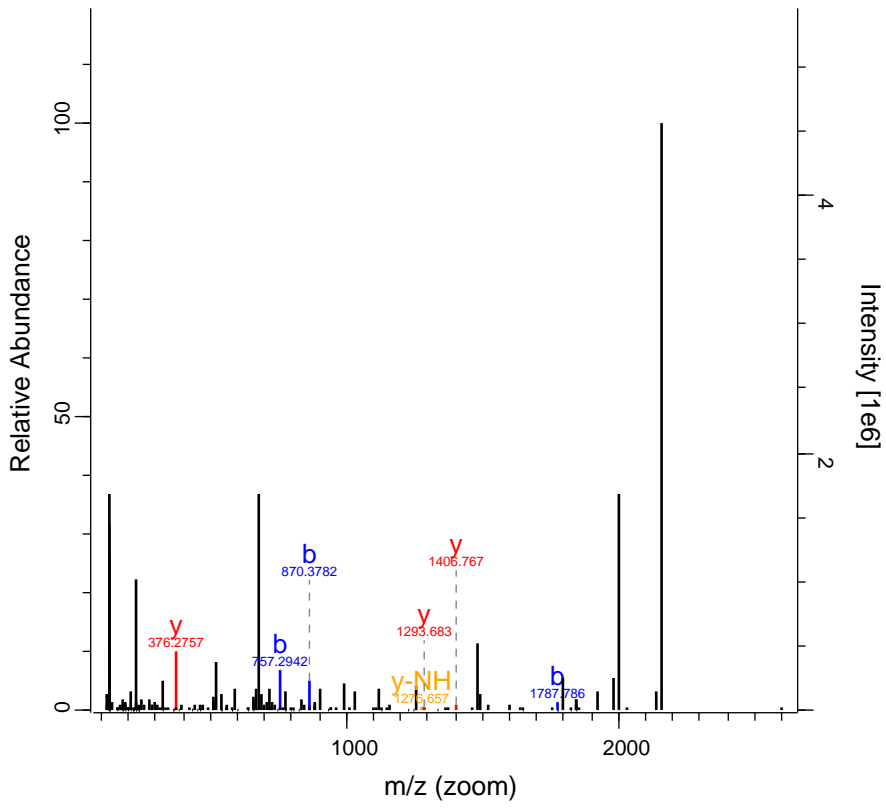

RO-QC-160121_ZackD_SS_Set_02_Fraccio 22494 FTMS; HC 101.59 852.78 NAV1

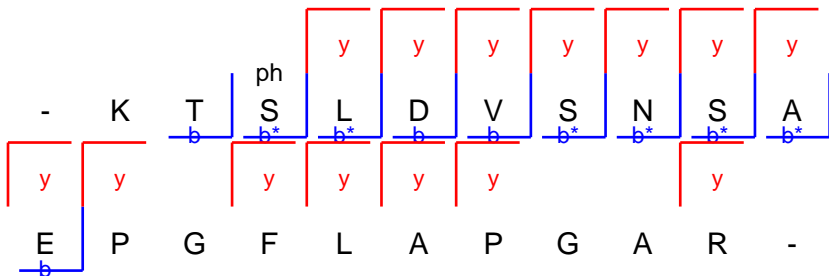
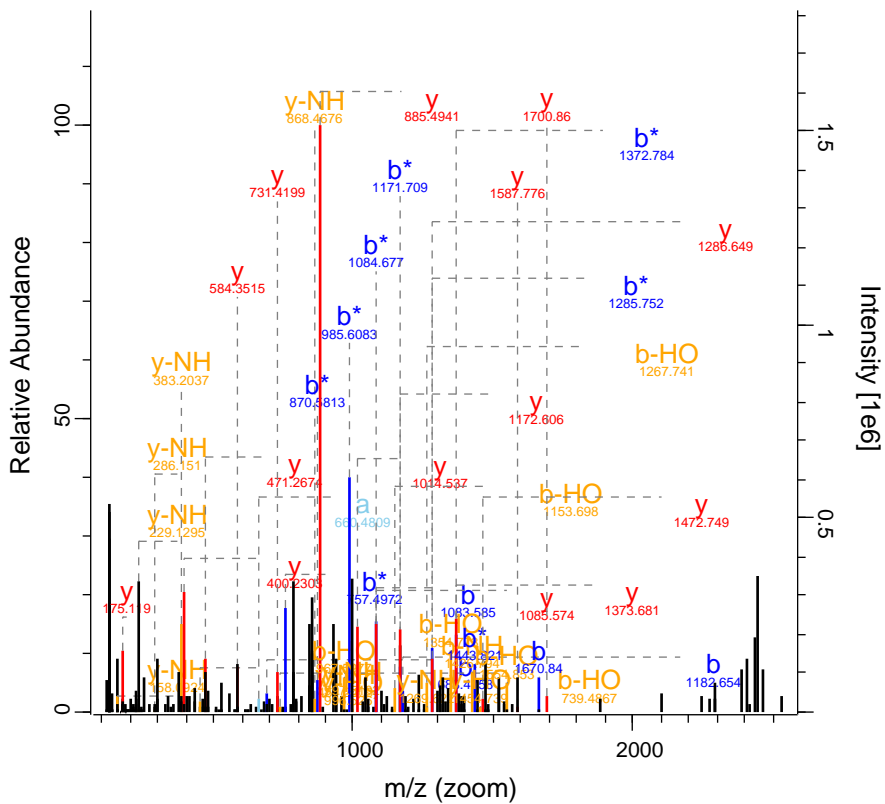

RO-QC-160121_ZackD_SS_Set_02_Fractic 23147 FTMS; HC 273.81 1065.25 MYRIP

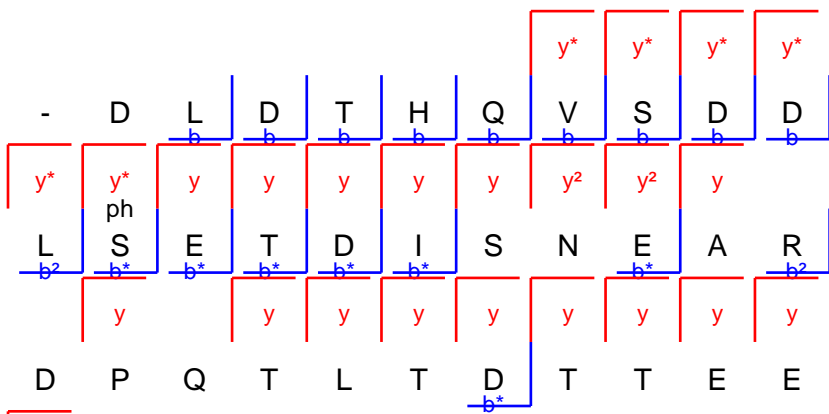
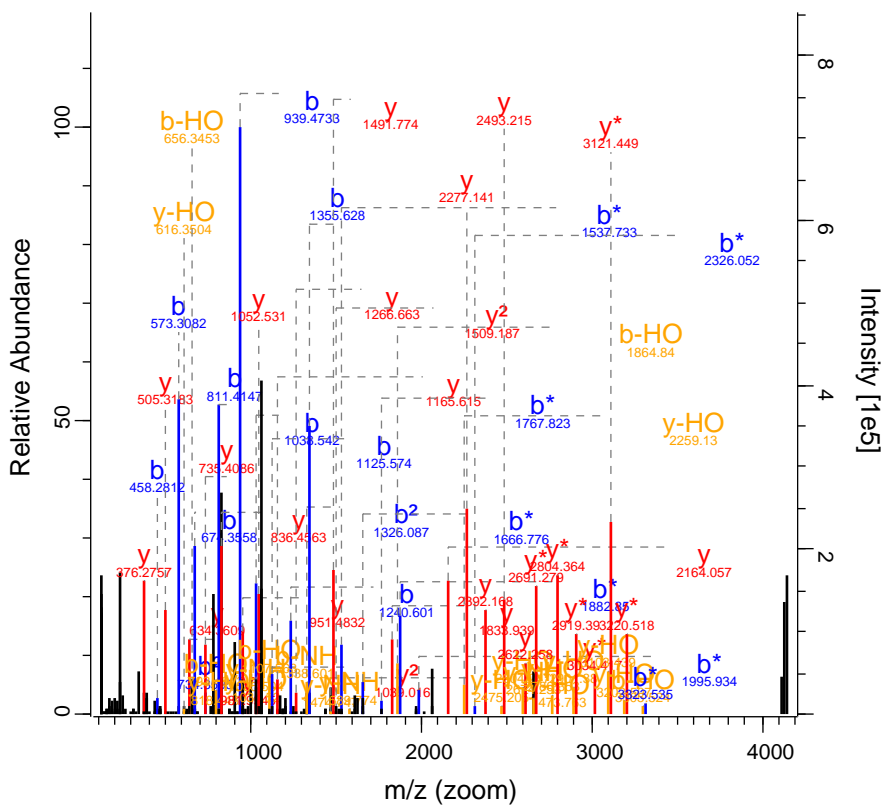

RO-QC-160121_ZackD_SS_Set_02_Fraction 23541 FTMS; HC 52.45 753.92 LIMK2

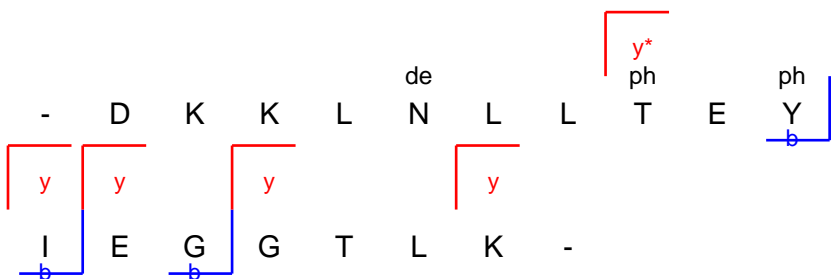
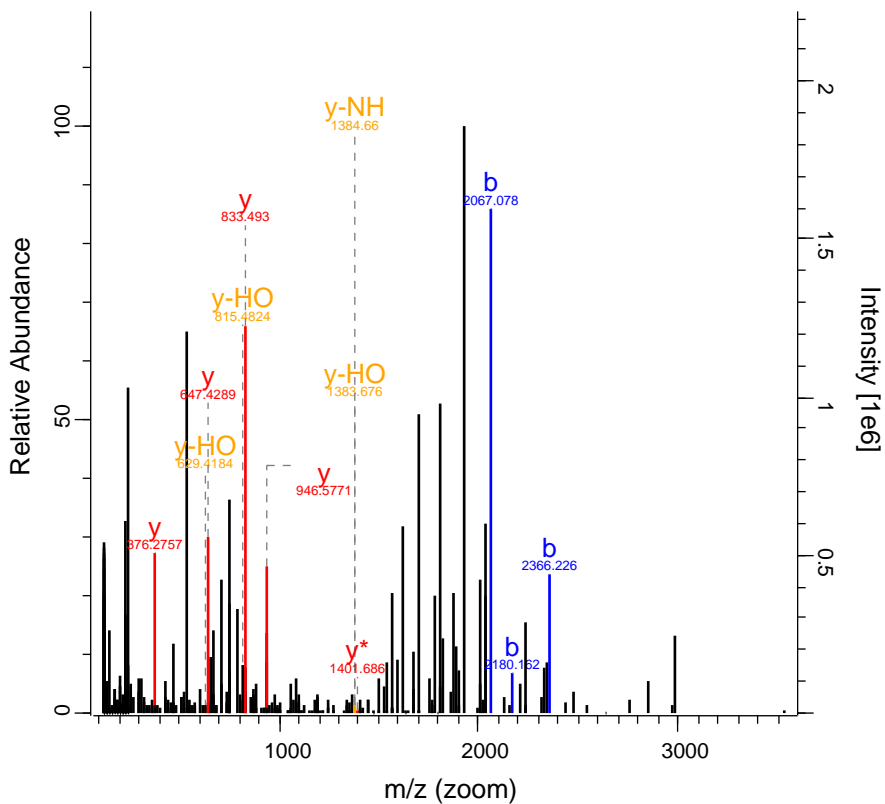

RO-QC-160121_ZackD_SS_Set_02_Fraction 23607 FTMS; HCl 135.04 849.1 NFIC

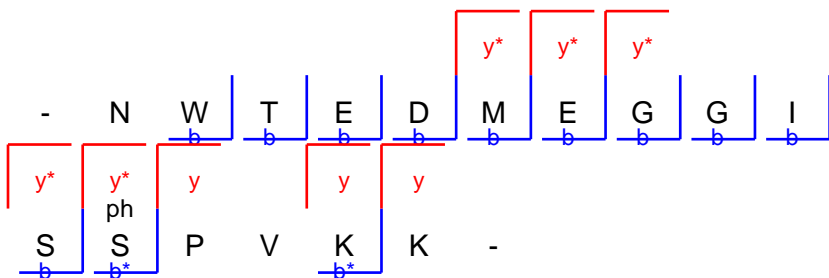
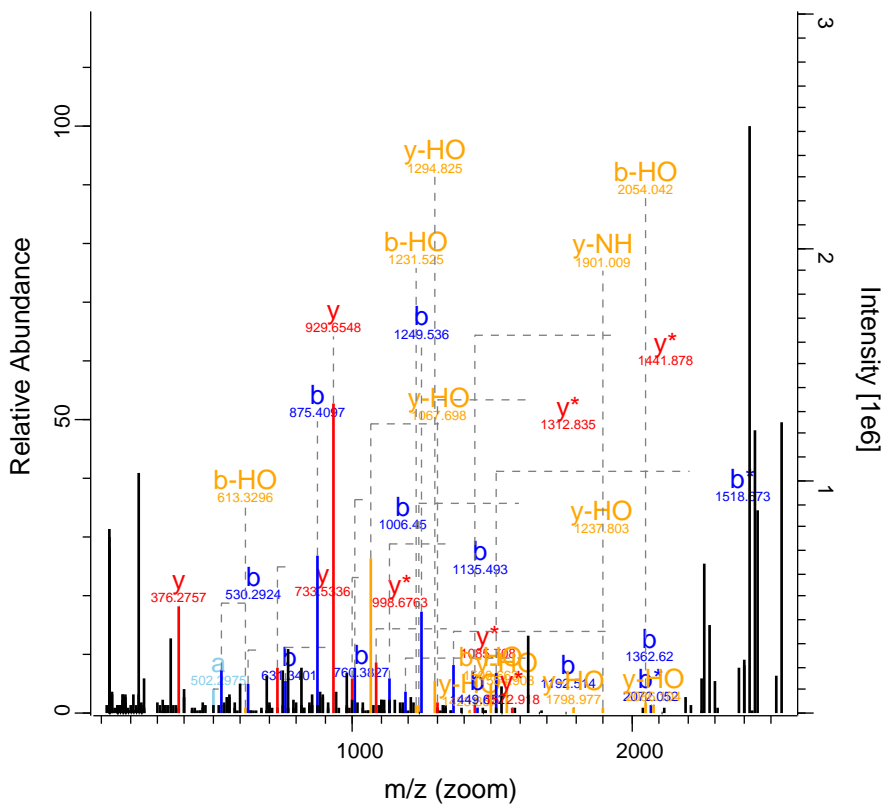

RO-QC-160121_ZackD_SS_Set_02_Fractio 23627 FTMS; HC 112.82 637.33 NFIC

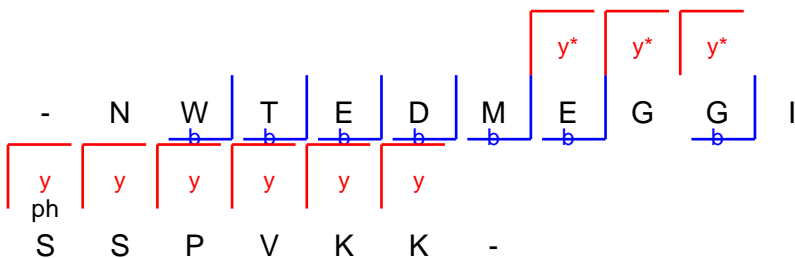
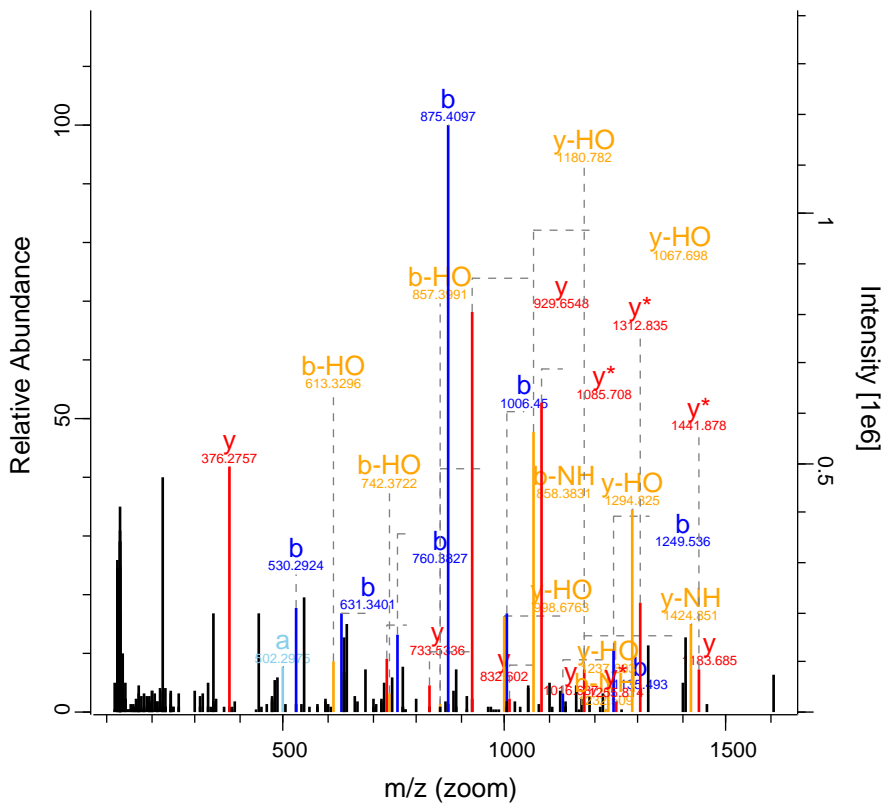

RO-QC-160121_ZackD_SS_Set_02_Fractio 24106 FTMS; HC 120.33 903.82 HS1BP3

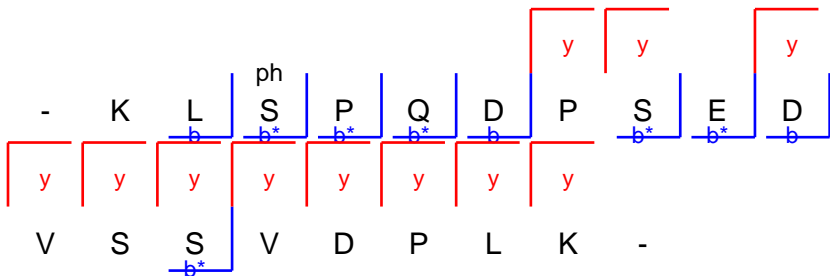
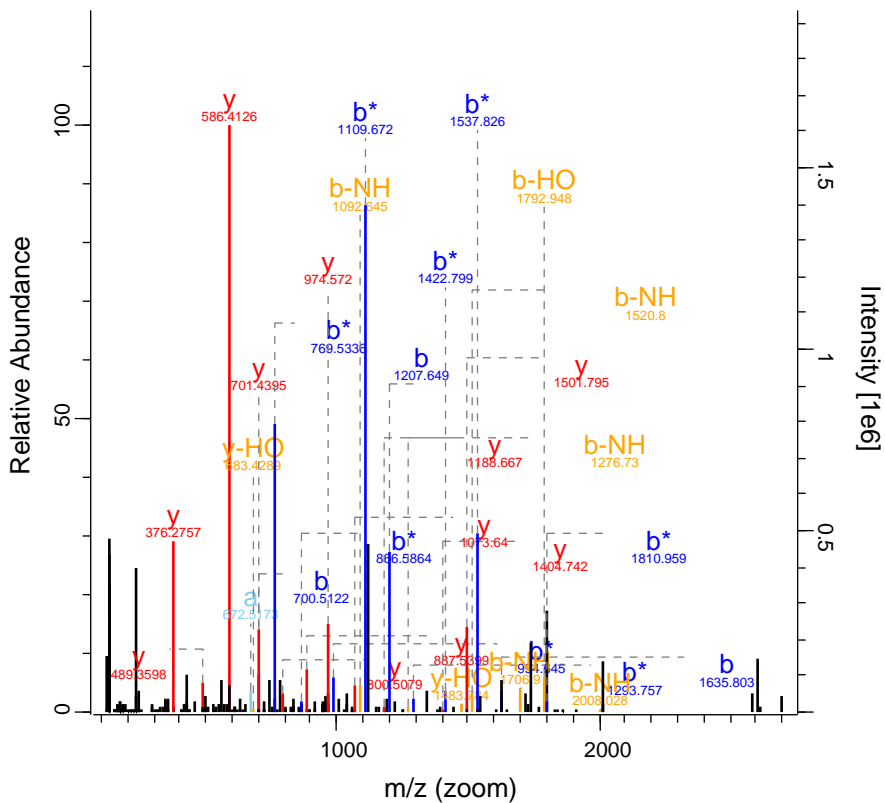

RO-QC-160121_ZackD_SS_Set_02_Fraction 24174 FTMS; HC 59.87 678.37 HS1BP3

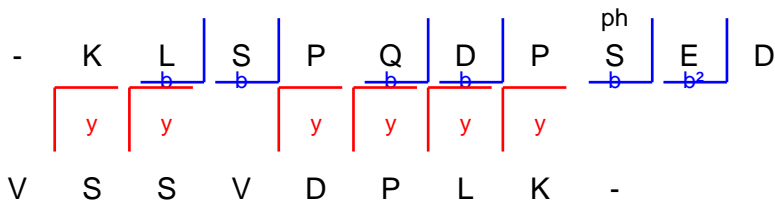
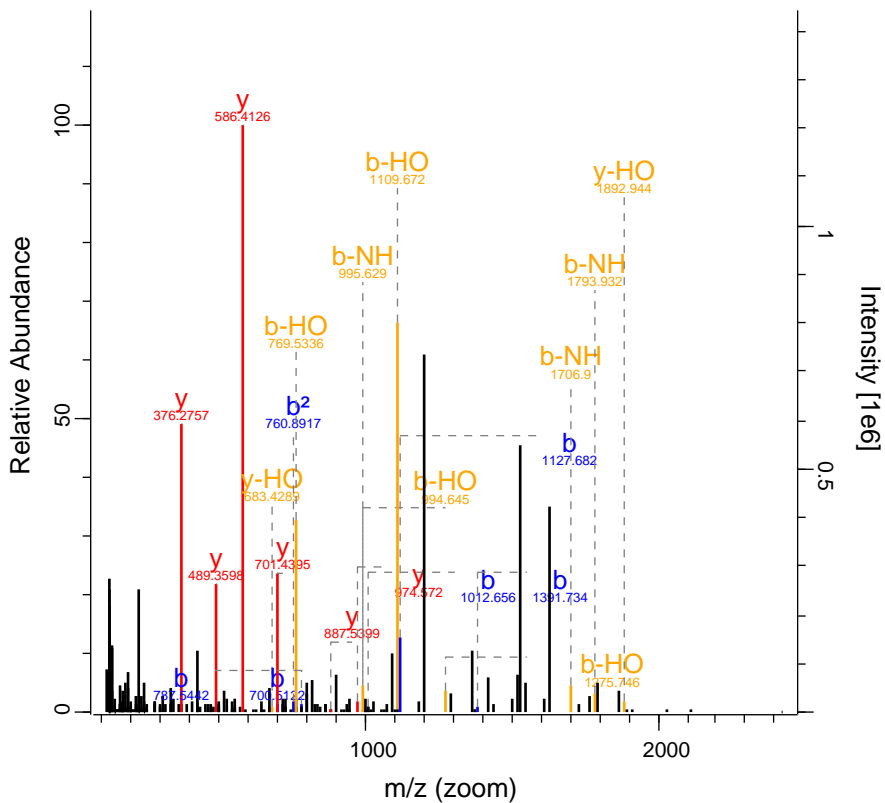

RO-QC-160121_ZackD_SS_Set_02_Fractio 24180 FTMS; HC 167.69 695.69 BCL2L13

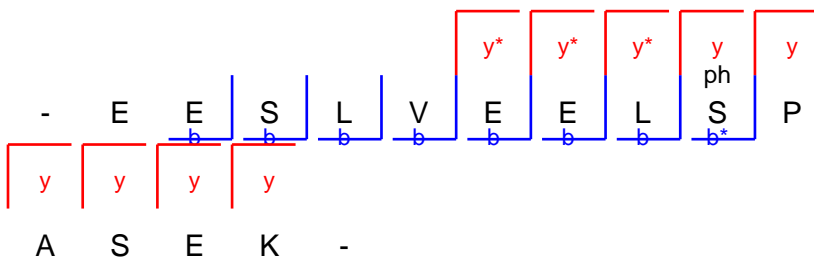
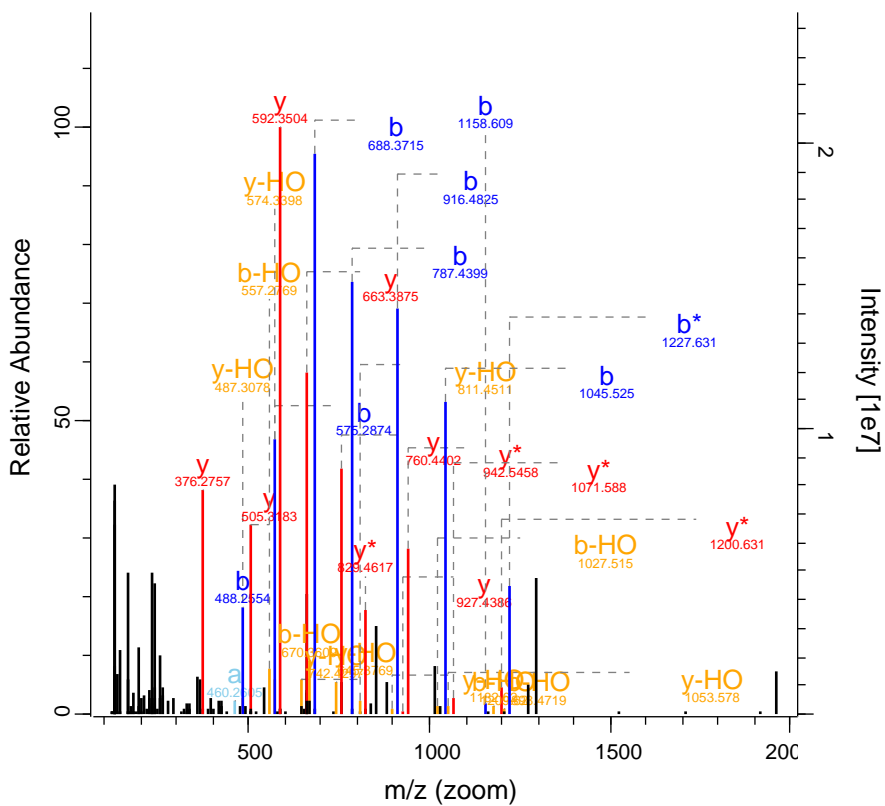

RO-QC-160121_ZackD_SS_Set_02_Fractio 24512 FTMS; HC 100.35 579.82 MAP4

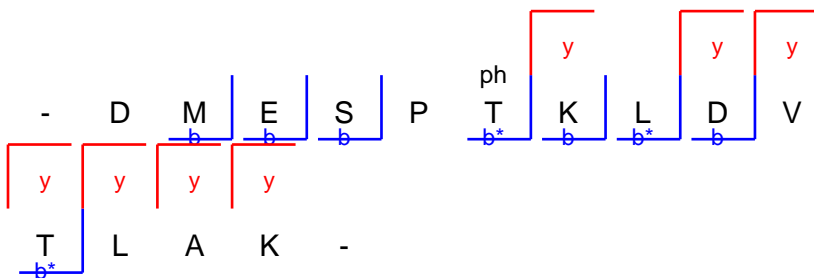
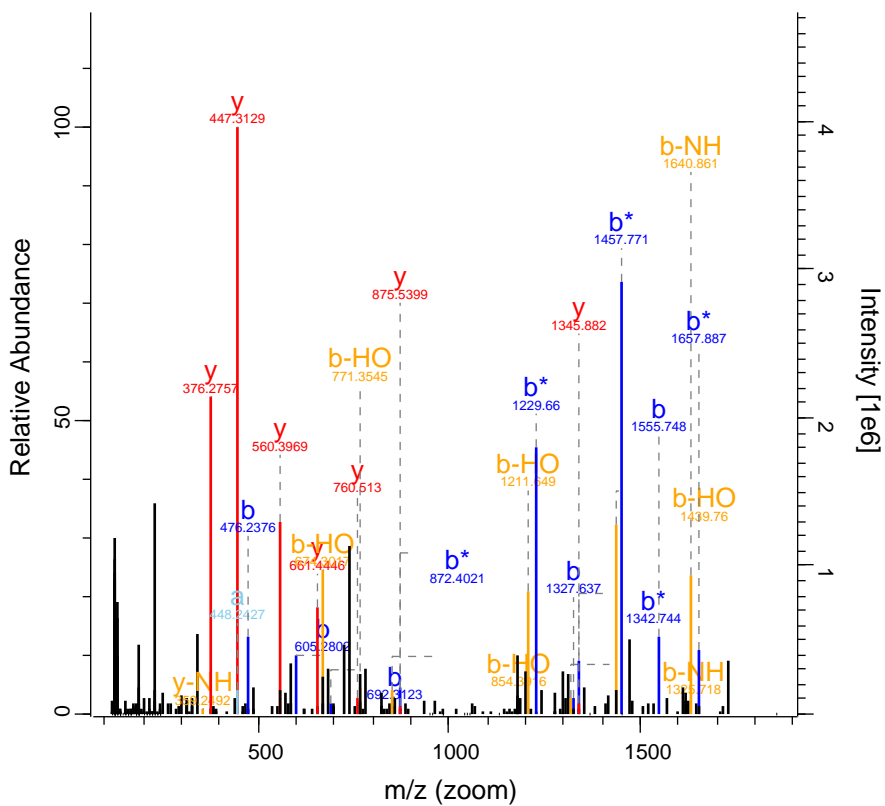

RO-QC-160121_ZackD_SS_Set_02_Fractic 24568 FTMS; HC 76.82 1057.16 MPP2

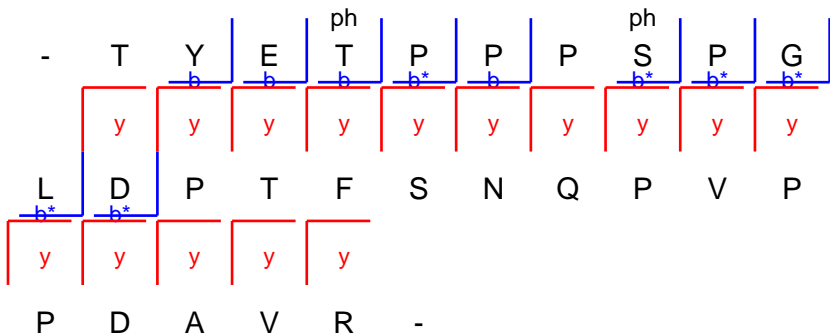
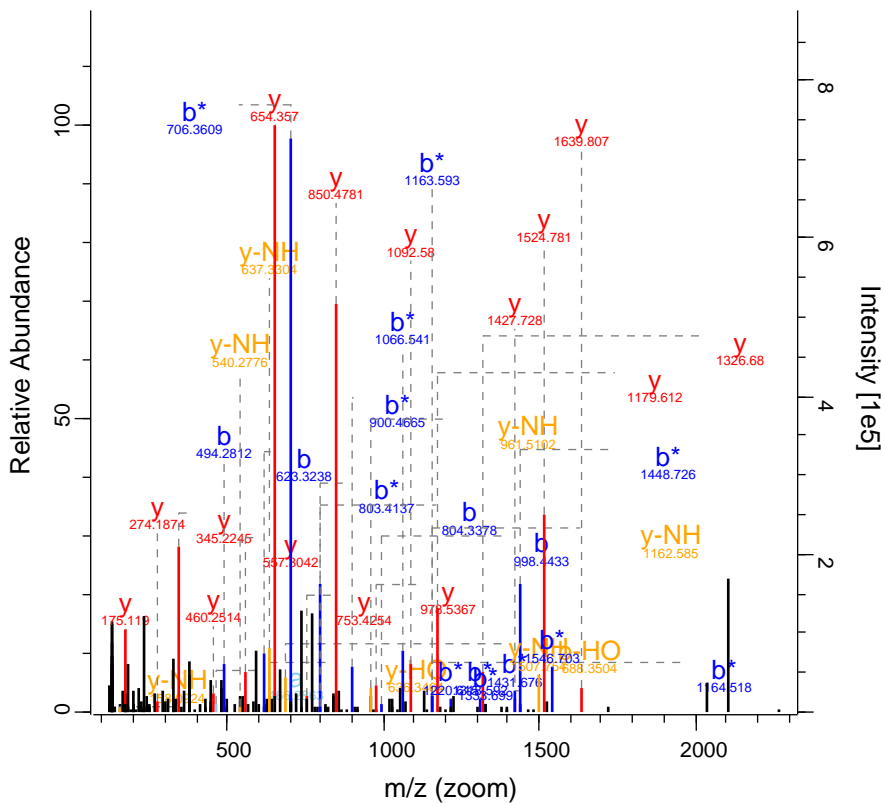

RO-QC-160121_ZackD_SS_Set_02_Fractic 24821 FTMS; HC 69.35 1035.56 GPR98

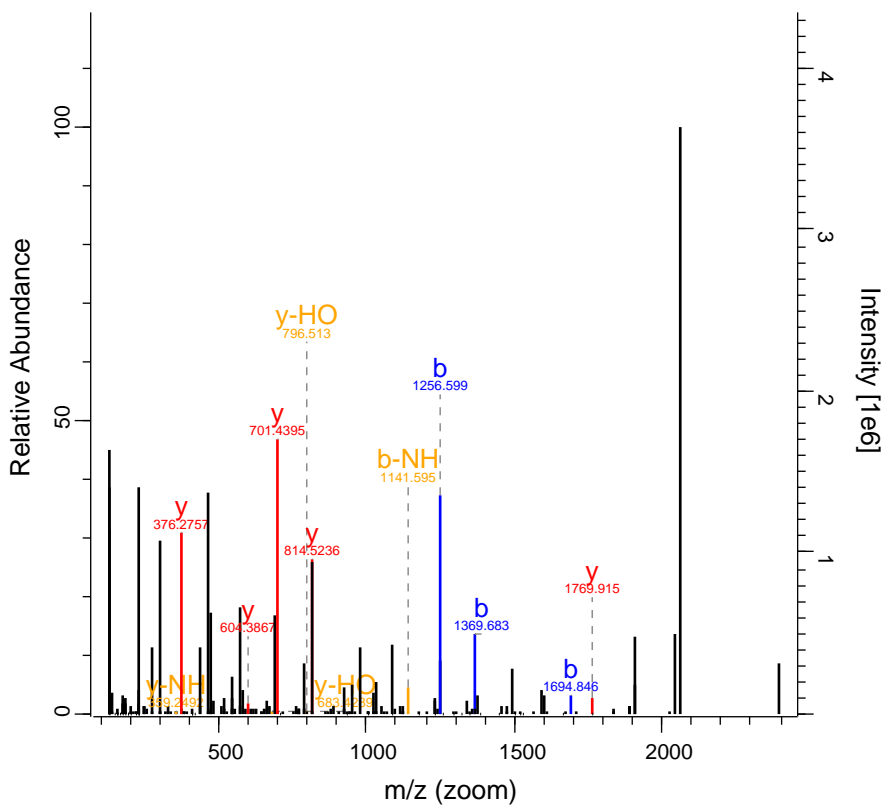

RO-QC-160121_ZackD_SS_Set_02_Fraction 24845 FTMS; HC 49.81 891.47 PRMT8

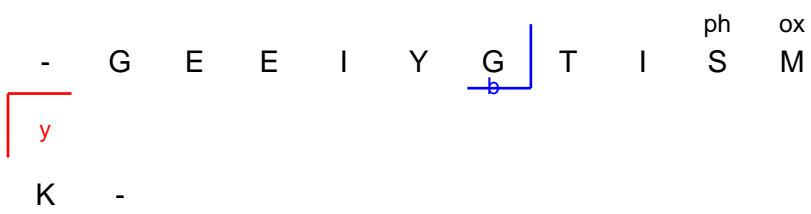
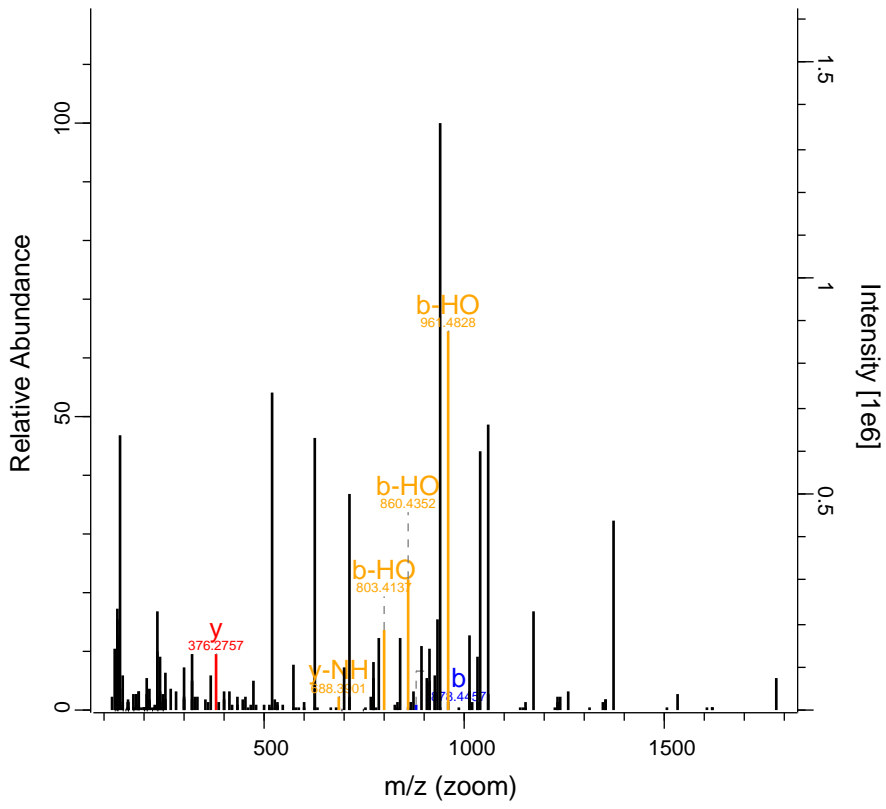

RO-QC-160121_ZackD_SS_Set_02_Fraction 24876 FTMS; HC 48.48 612.31 TSNAx

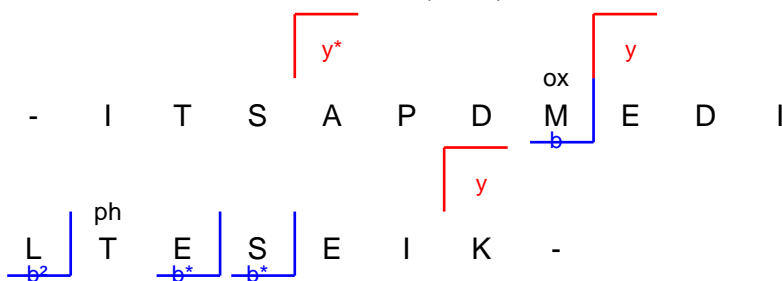
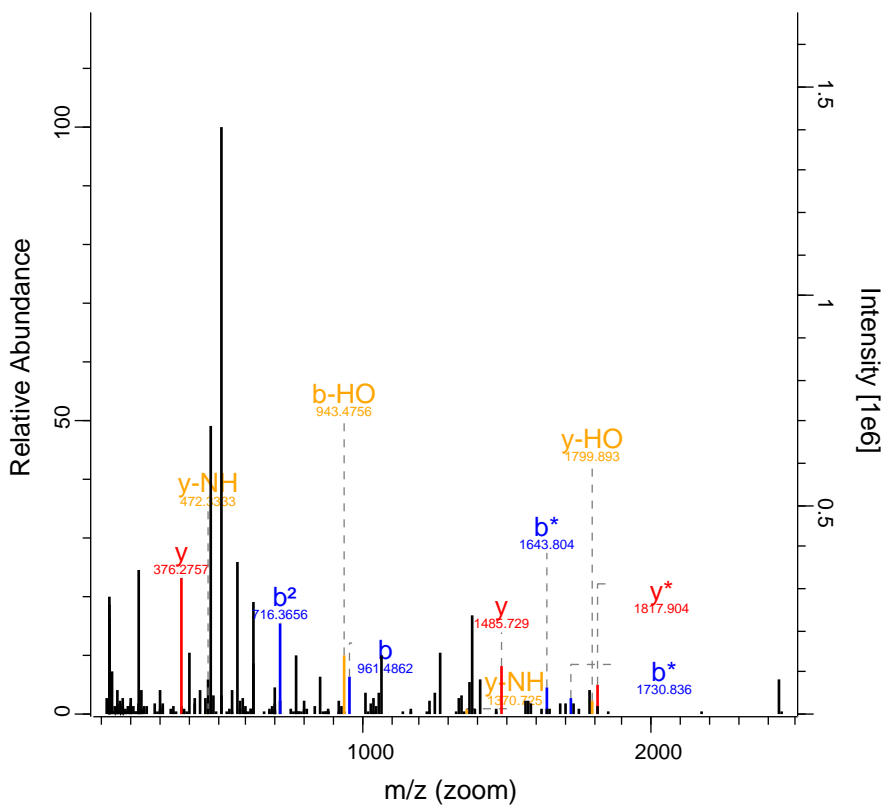

RO-QC-160121_ZackD_SS_Set_02_Fractio 26443 FTMS; HC 171.11 854.47 SSFA2

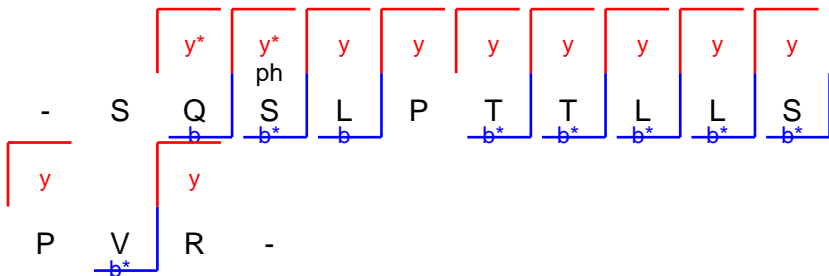
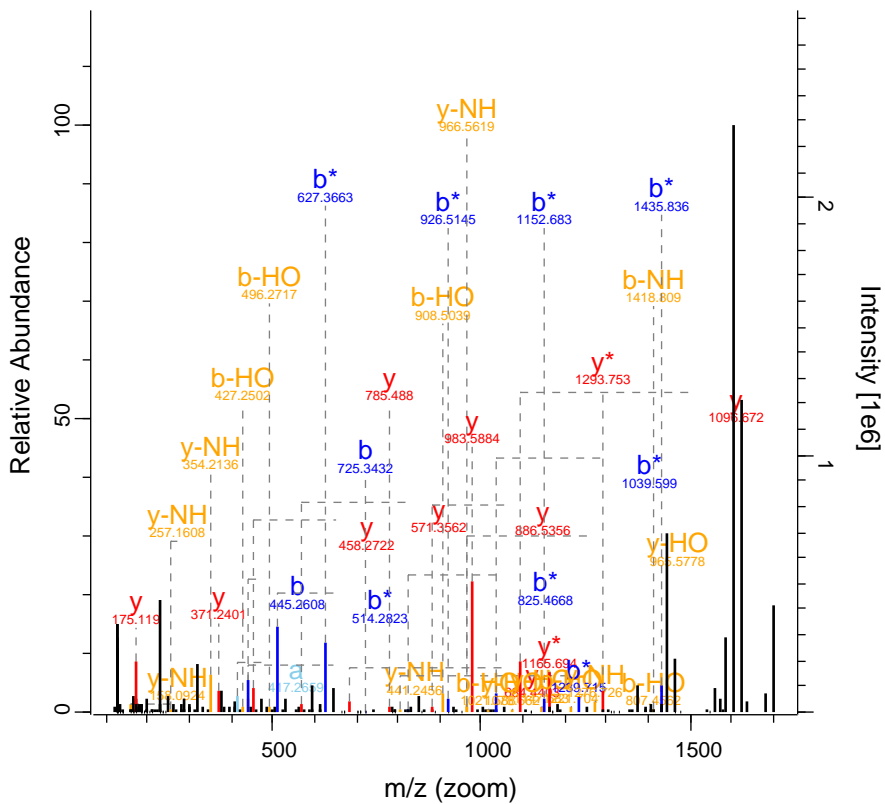

RO-QC-160121_ZackD_SS_Set_02_Fraction 27992 FTMS; HC 112.8 757.91 MRPS36

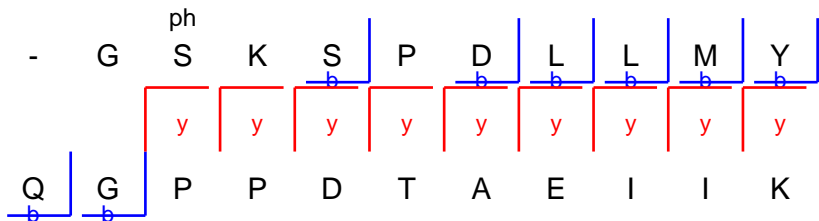
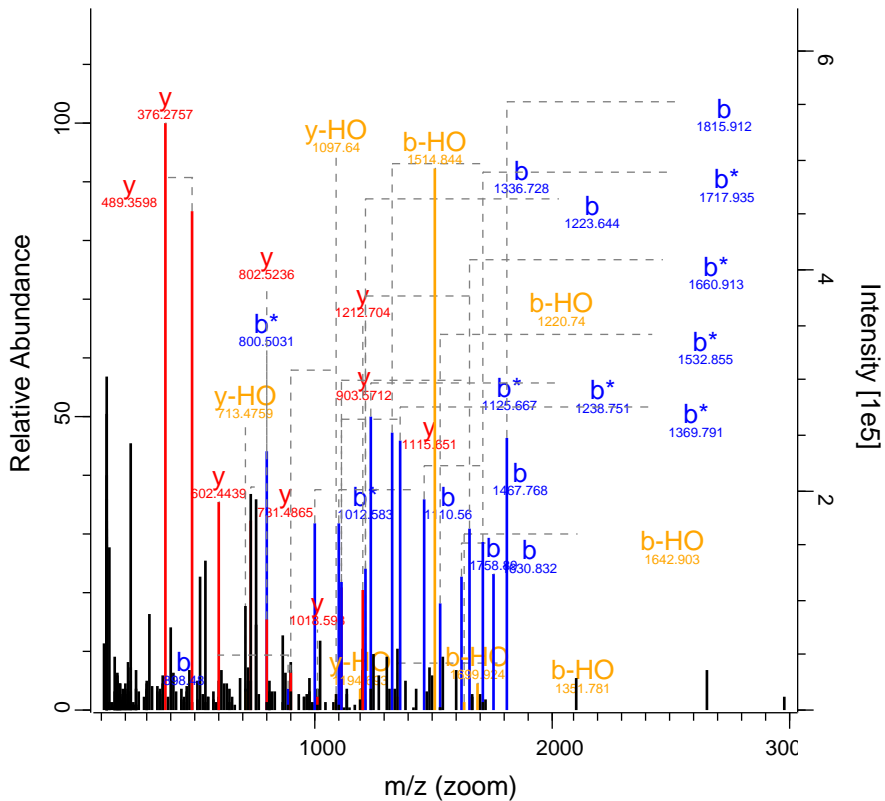

RO-QC-160121_ZackD_SS_Set_02_Fraccio 28380 FTMS; HC 117.88 982.45 EIF3J

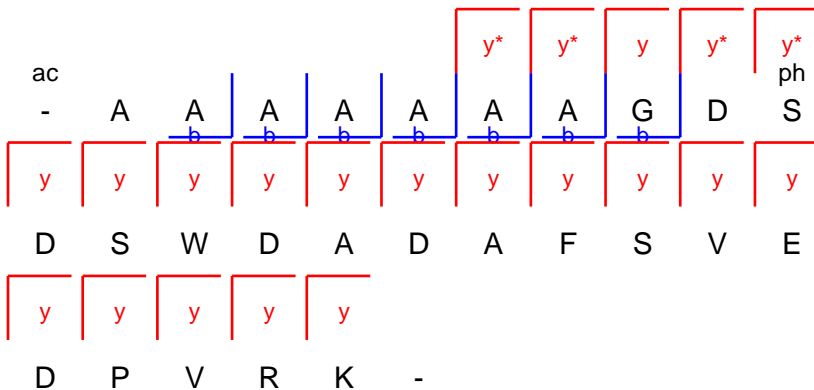
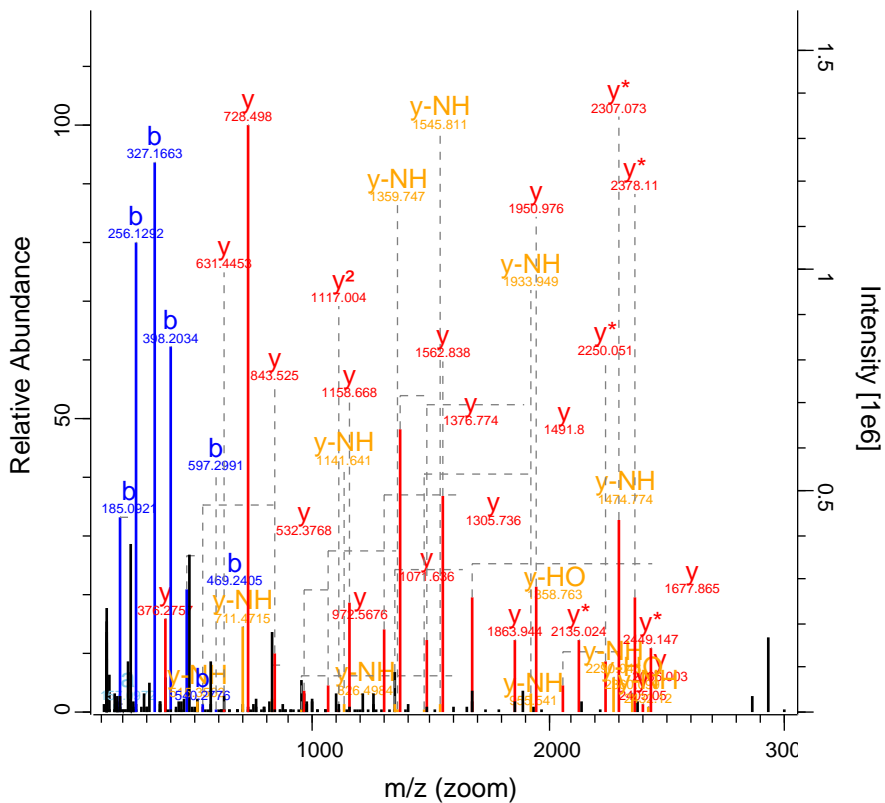

RO-QC-160121_ZackD_SS_Set_02_Fraction 28940 FTMS; HC 51.61 714.88 EHD1

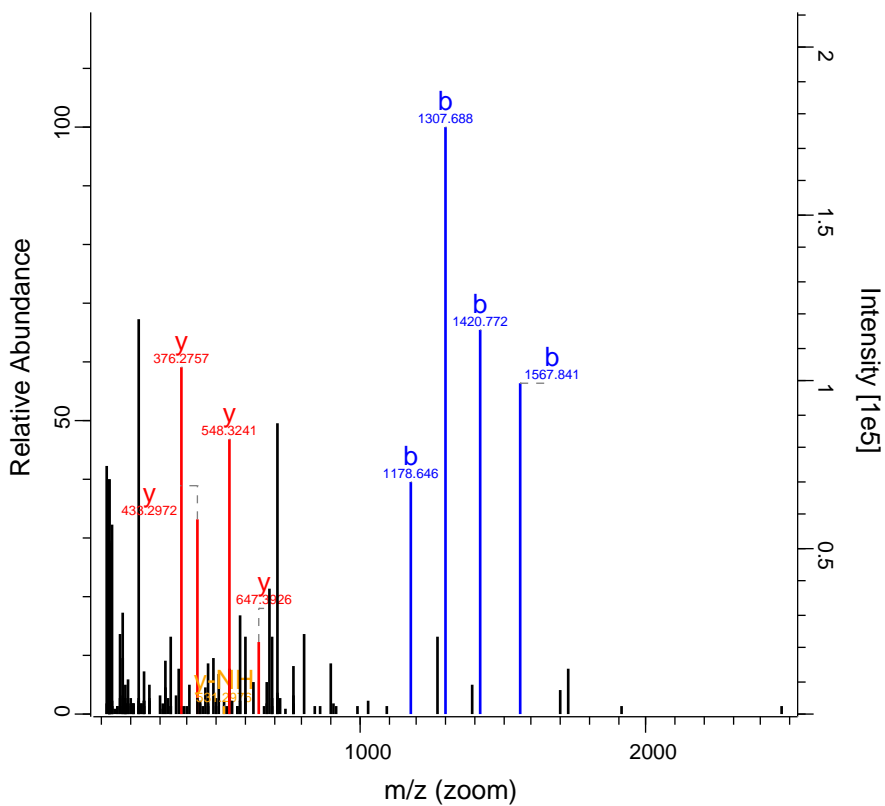

-	D	K	P	T	Y	D	E	I	F	Y
						b	b	b	b	
ph				y	de	y	y			
T	L	S	P	V	N	G	K	-		

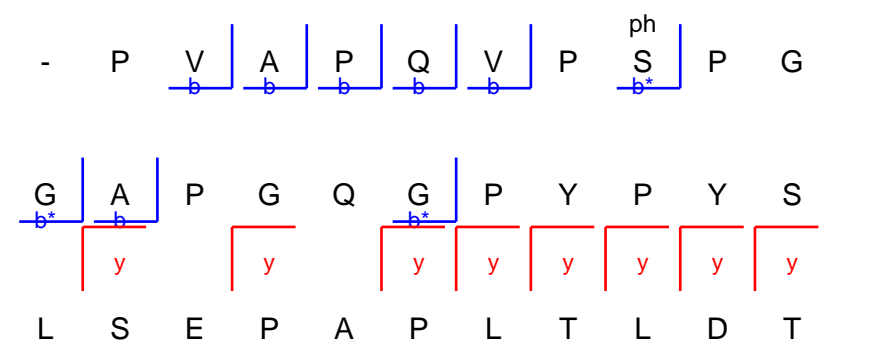
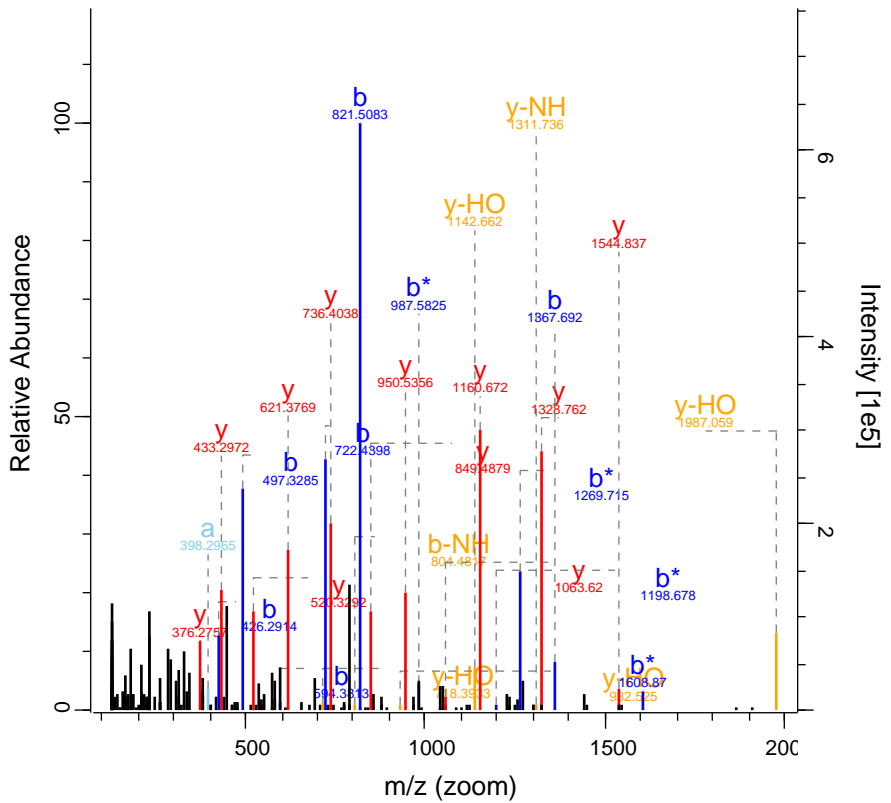

RO-QC-160121_ZackD_SS_Set_02_Fraction 31732 FTMS; HC 64.09 818.45 SMAD2

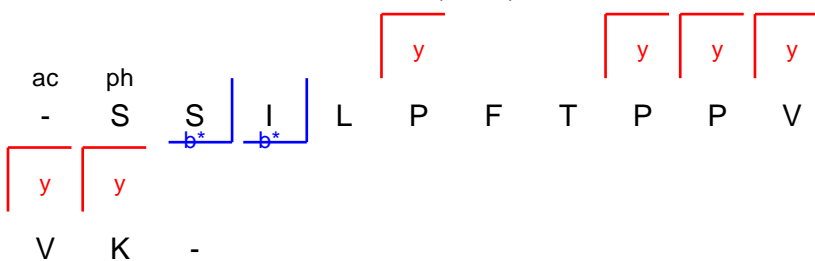
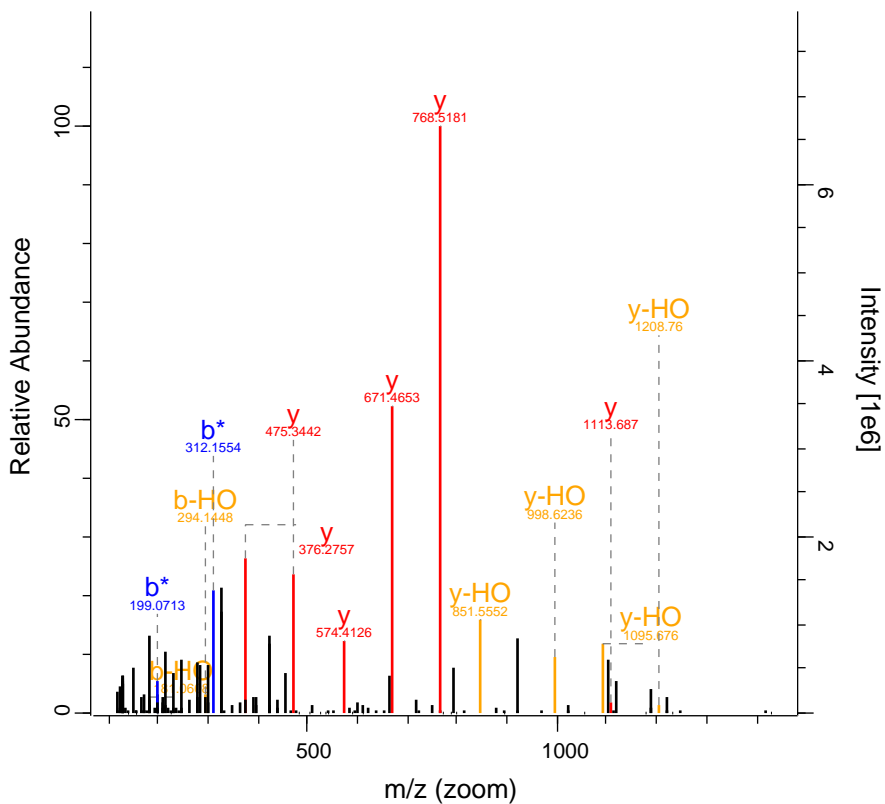

RO-QC-160121_ZackD_SS_Set_02_Fraction 4045 FTMS; HCl 67.46 466.01 BMP2K

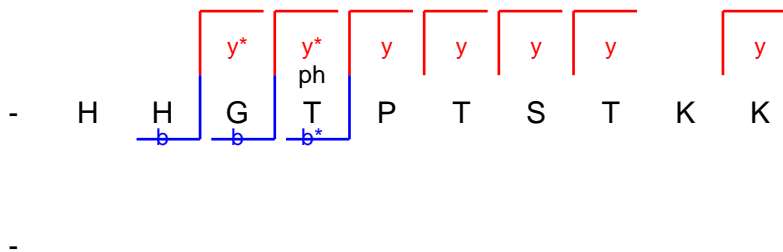
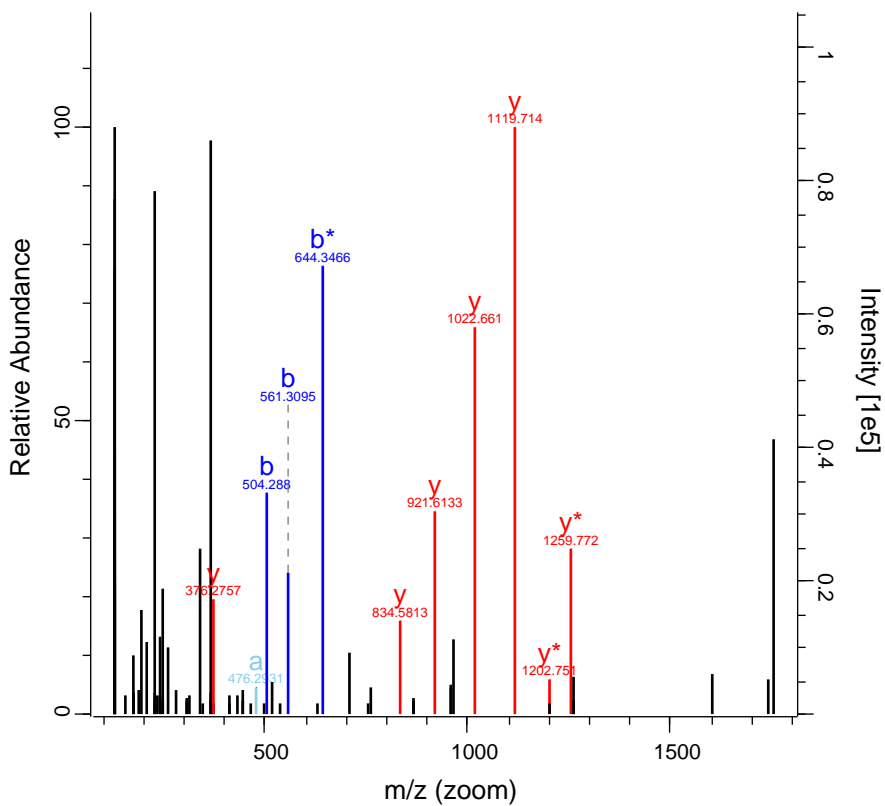

RO-QC-160121_ZackD_SS_Set_02_Fraction 5411 FTMS; HCl 60.92 690.72 PDS5A

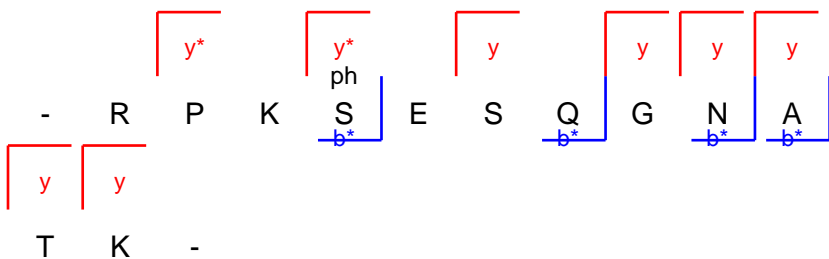
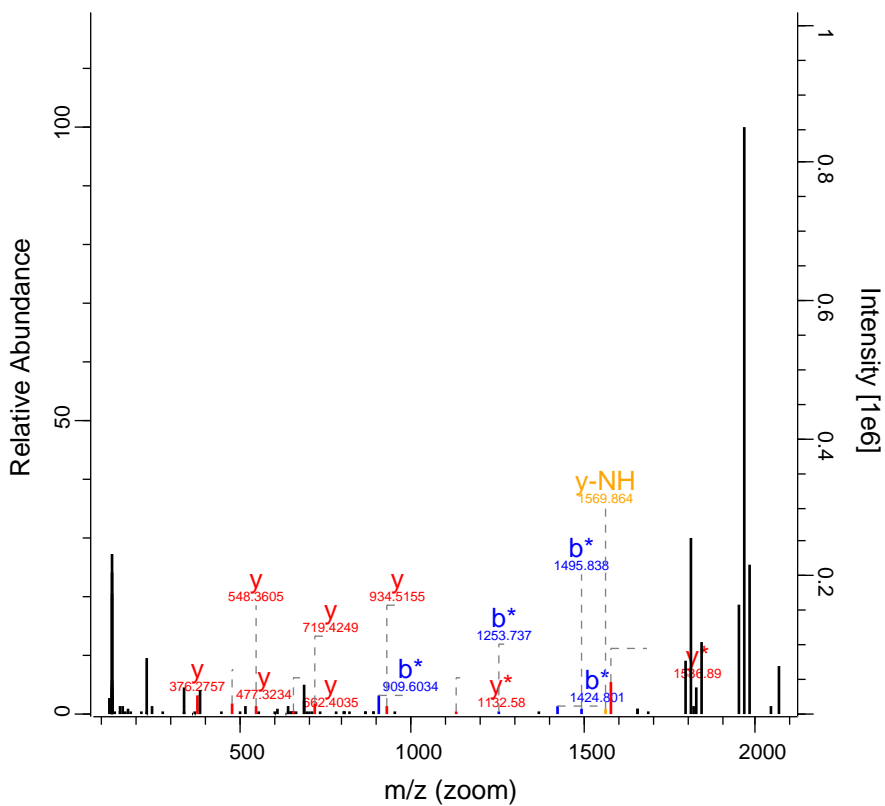

T K -

RO-QC-160121_ZackD_SS_Set_02_Fraction_5480 FTMS; HCl 103.22 430 ZNF638

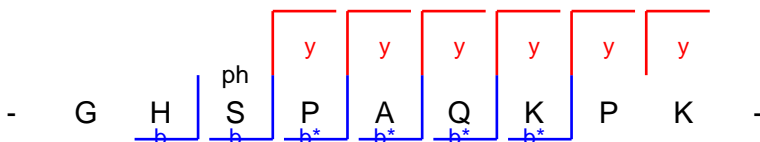
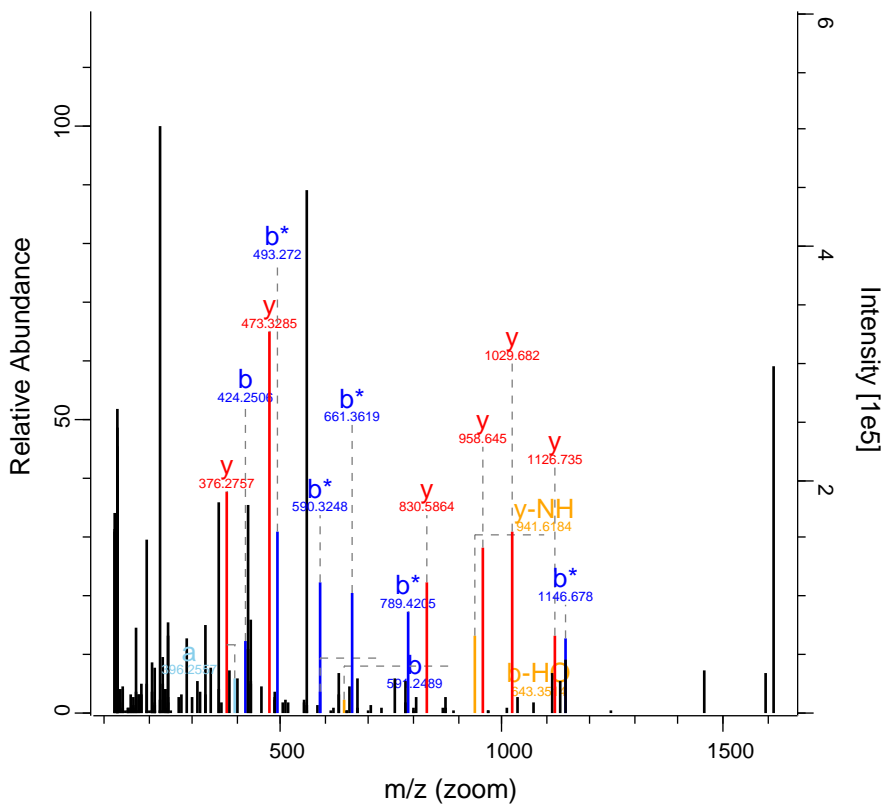

RO-QC-160121_ZackD_SS_Set_02_Fraction 5504 FTMS; HCl 90.97 934.77 LDB1

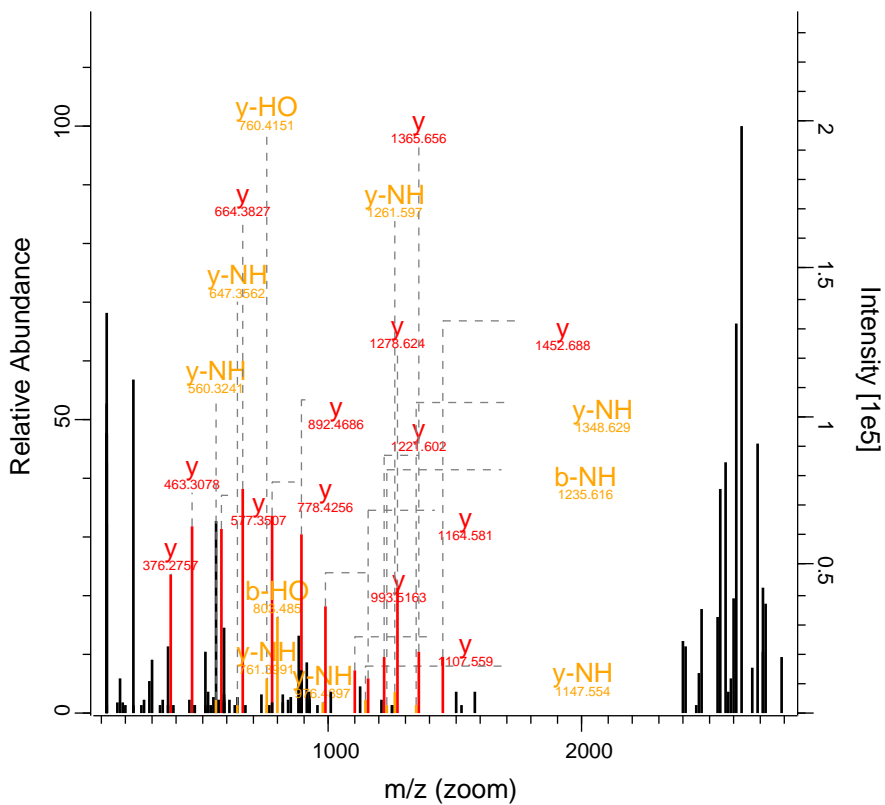

									ox	y	y
		ox				ph		ox			
-	K	M	S	G	G	S	T	M	S	S	
y	y	y	y	y	y	y	y	y	y	y	y
G	G	G	N	T	N	N	S	N	S	K	

RO-QC-160121_ZackD_SS_Set_02_Fraction 9640 FTMS; HCl 99.16 853.9 SF3B1

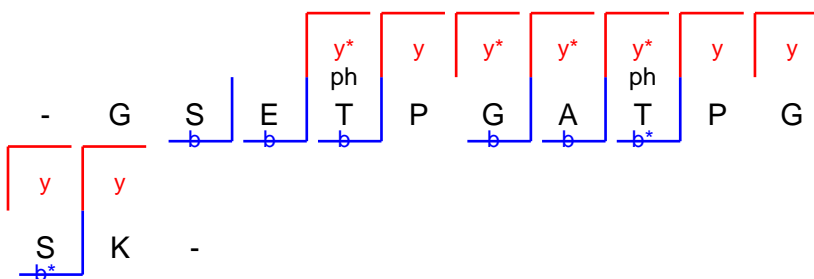
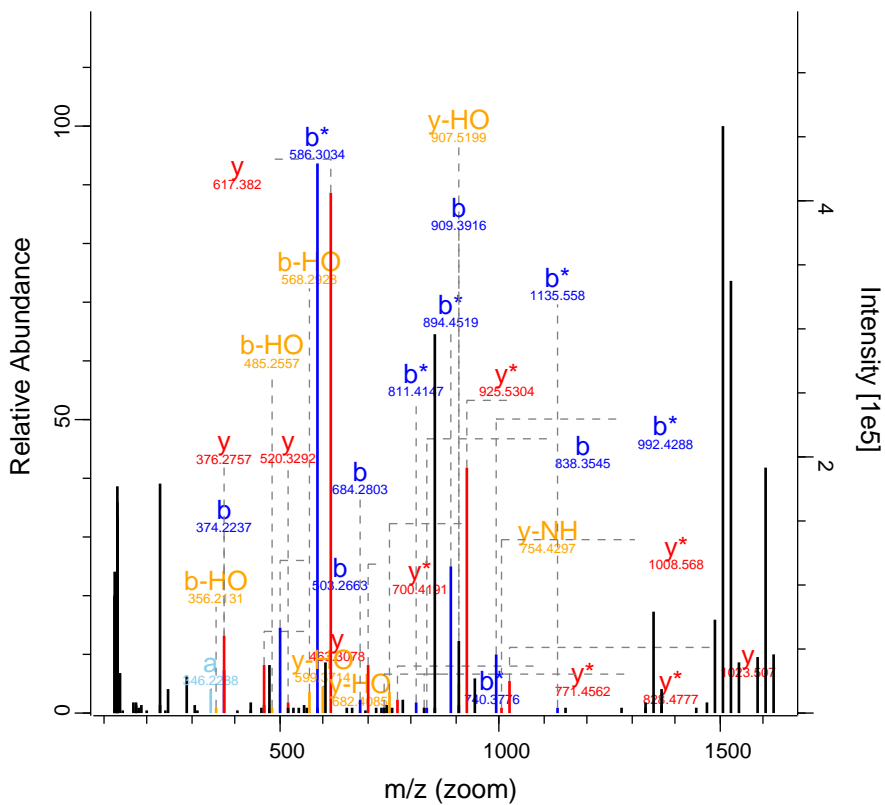

RO-QC-160121_ZackD_SS_Set_02_Fraction 9912 FTMS; HCl 42.82 584.67 OR2AE1

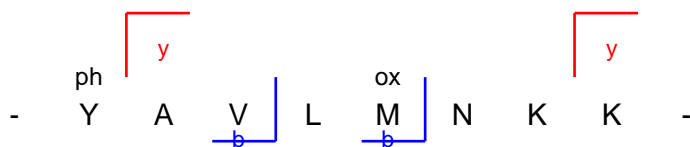
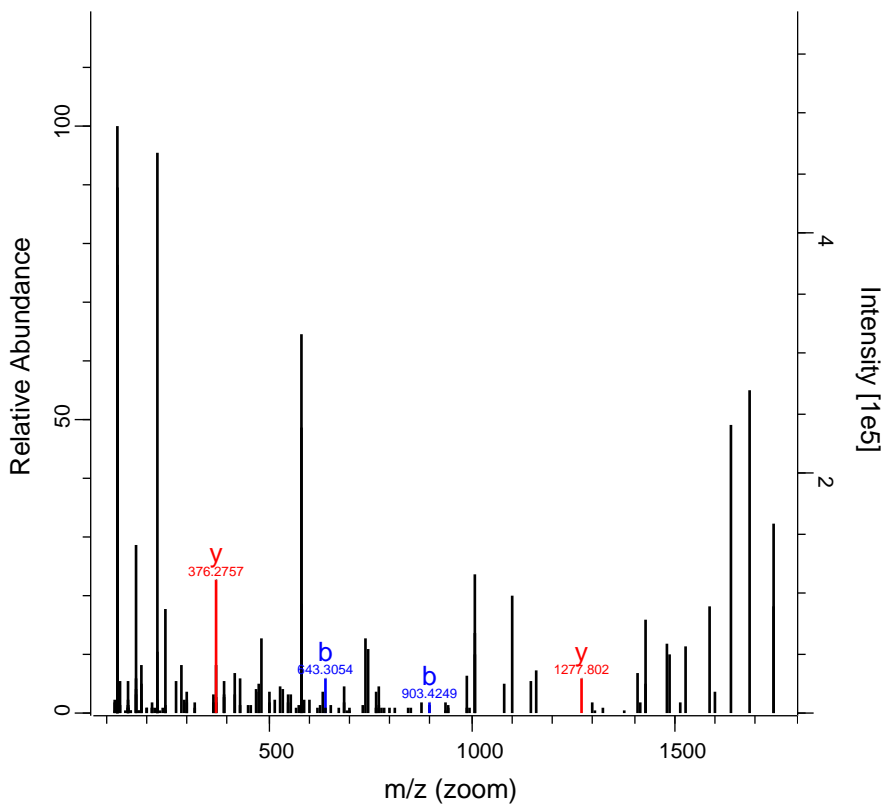

RO-QC-160121_ZackD_SS_Set_02_Fraction 9938 FTMS; HC 113.59 834.91 LMNA

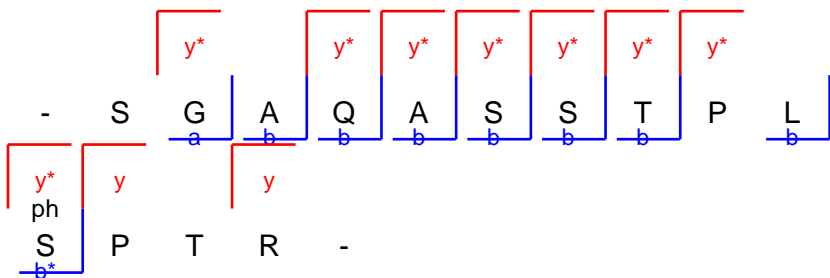
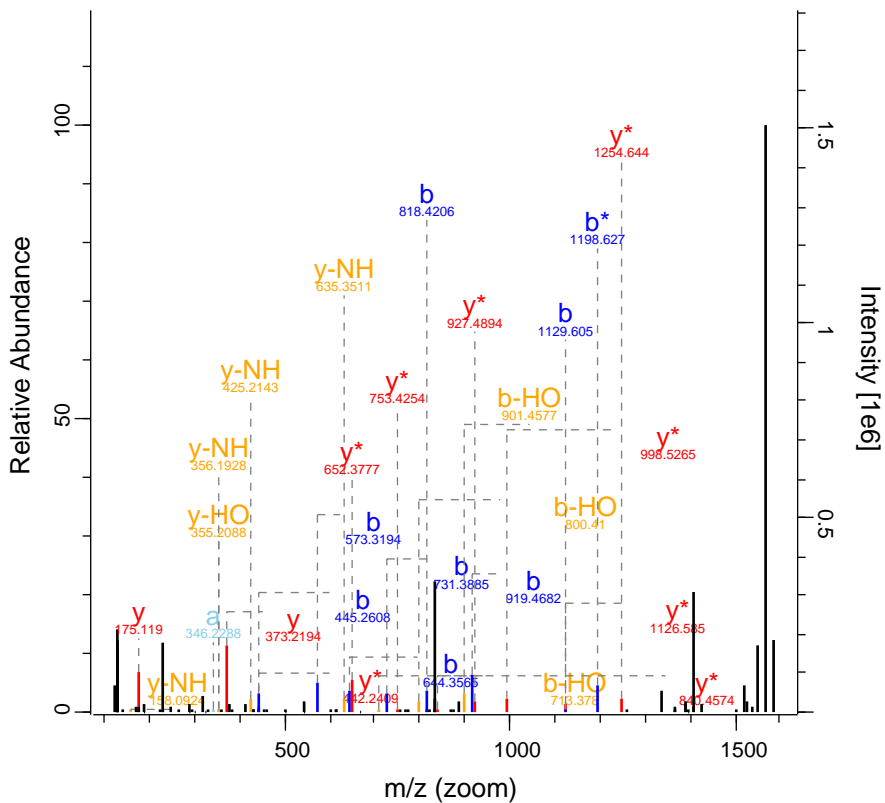

RO-QC-160121_ZackD_SS_Set_02_Fraction 10005 FTMS; HC 59.86 707.72 PRRC2A

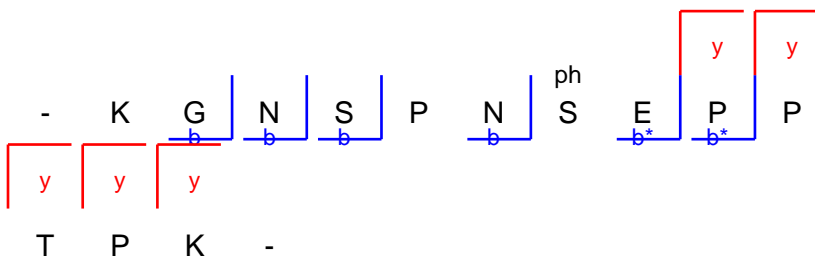
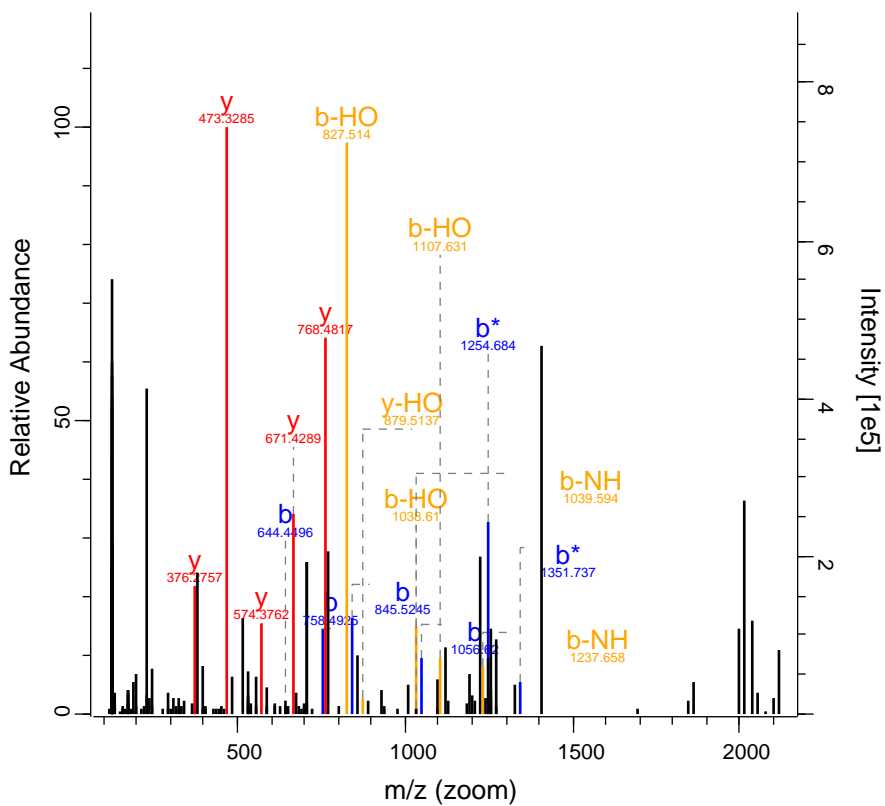

RO-QC-160121_ZackD_SS_Set_02_Fraction 10900 FTMS; HC 76.3 673.35 EGLN1

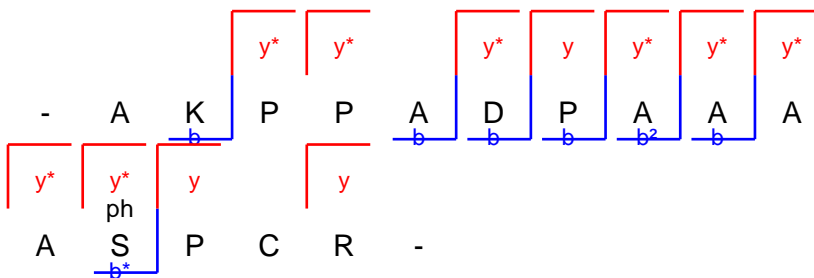
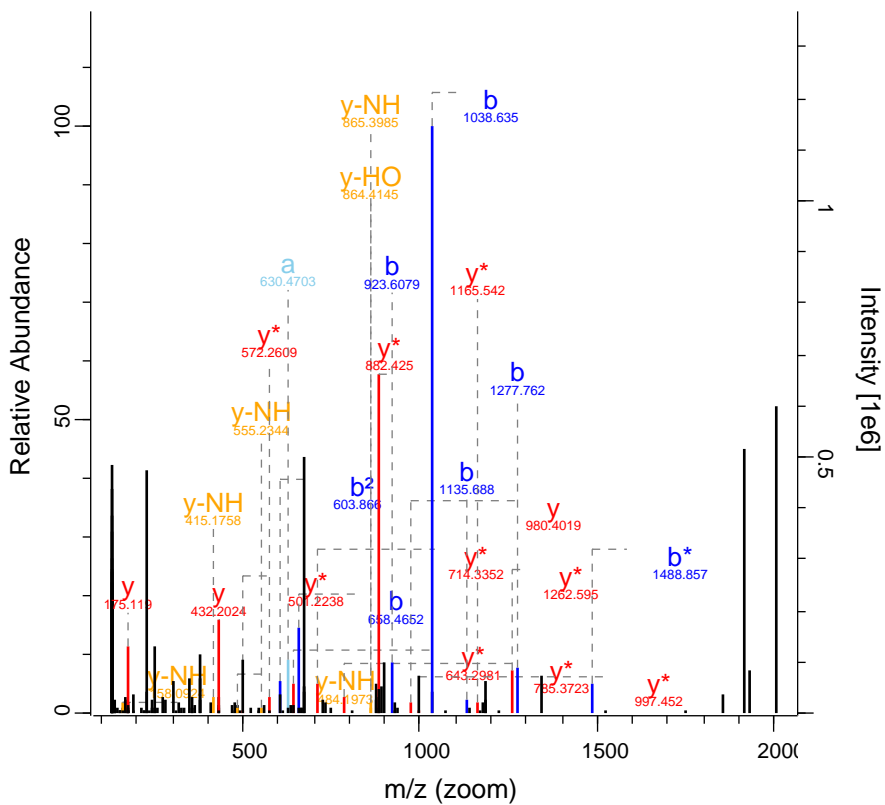

RO-QC-160121_ZackD_SS_Set_02_Fractio 11057 FTMS; HC 117.41 744.85 FNBP1

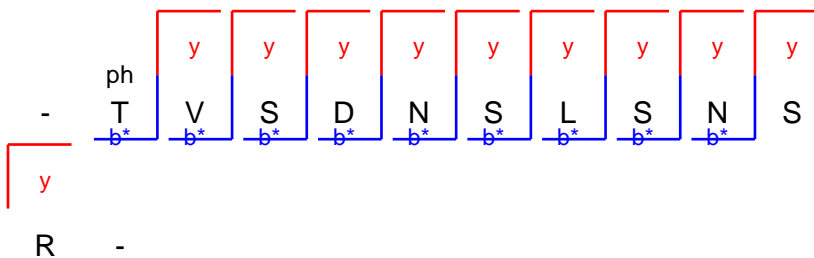
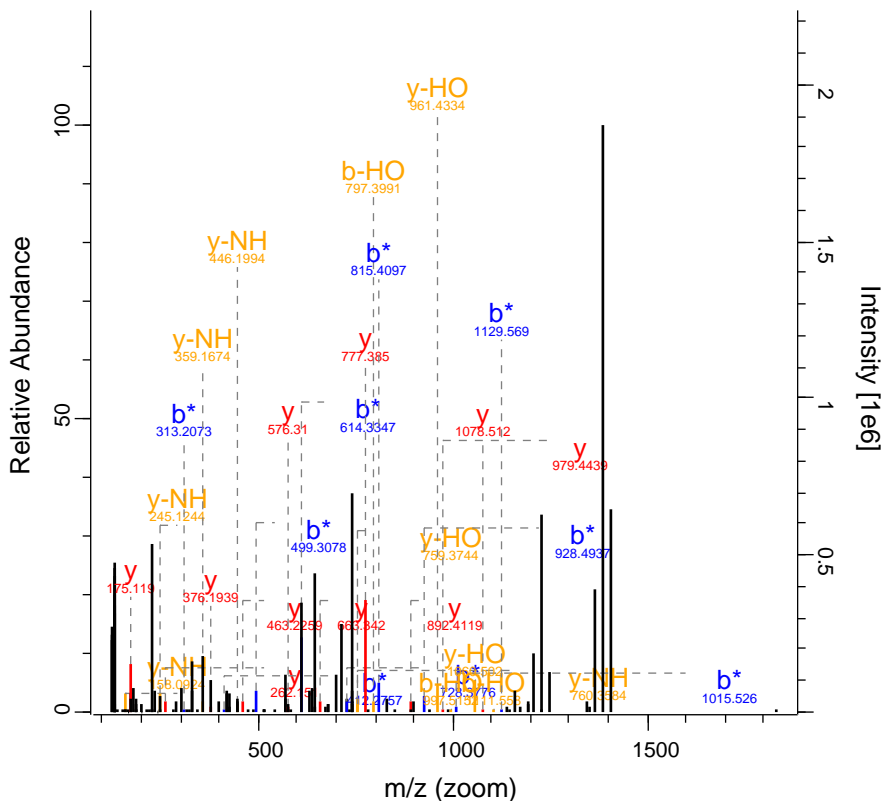

RO-QC-160121_ZackD_SS_Set_02_Fraction 12776 FTMS; HC 93.76 801.12 MAP1B

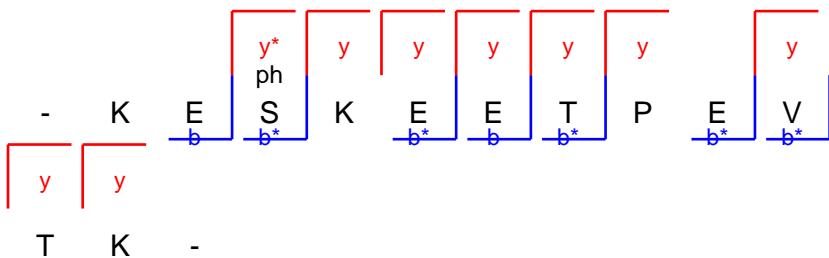
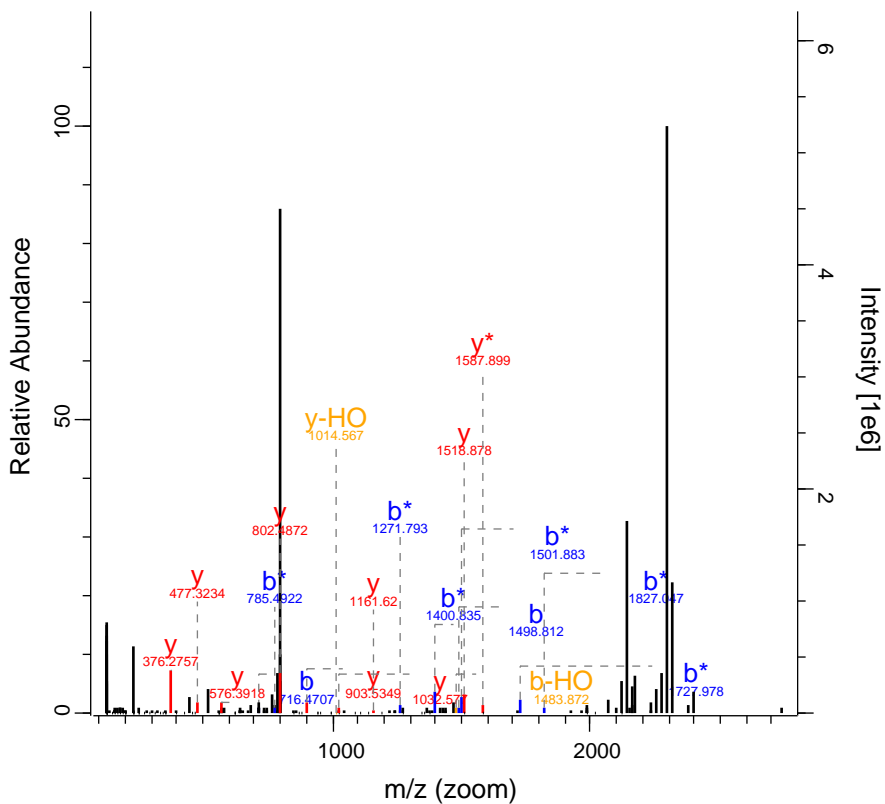

RO-QC-160121_ZackD_SS_Set_02_Fraction 12903 FTMS; HC 50.91 629.35 SLC7A14

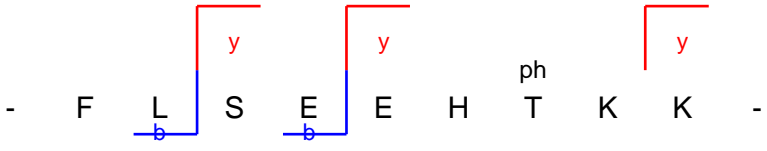
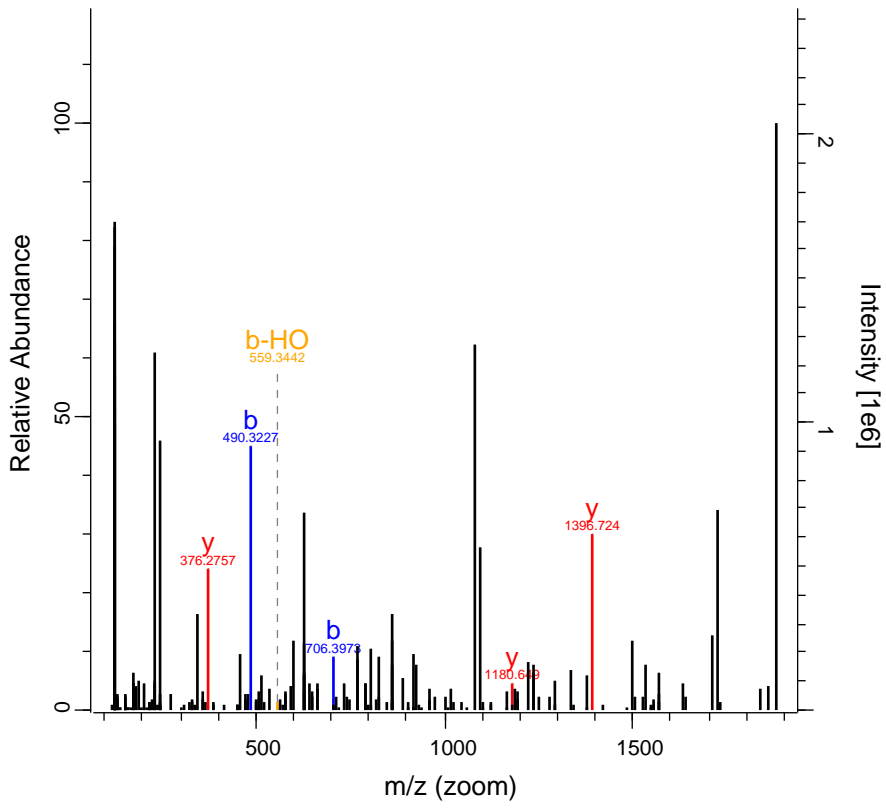

RO-QC-160121_ZackD_SS_Set_02_Fraction 15185 FTMS; HC 66.27 403.98 BPIFB4

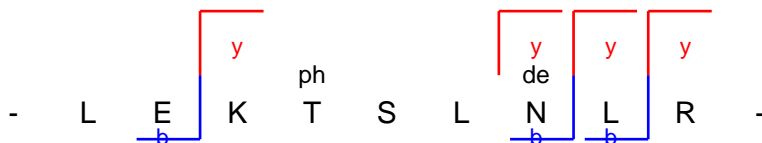
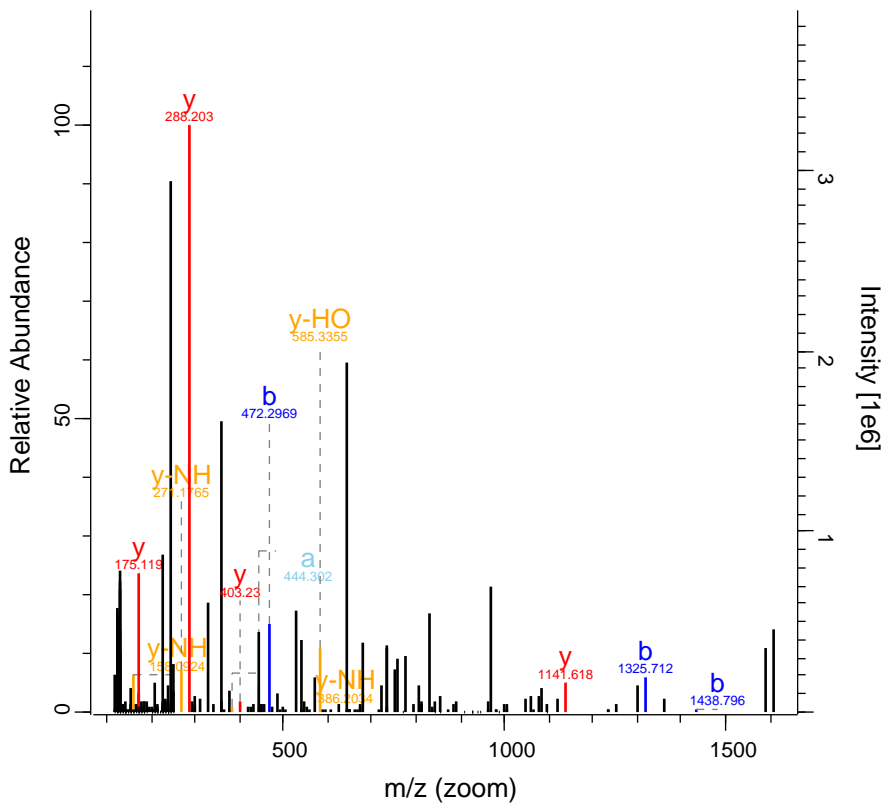

RO-QC-160121_ZackD_SS_Set_02_Fraction15359 FTMS; HC 40.07 704.33 TBX19

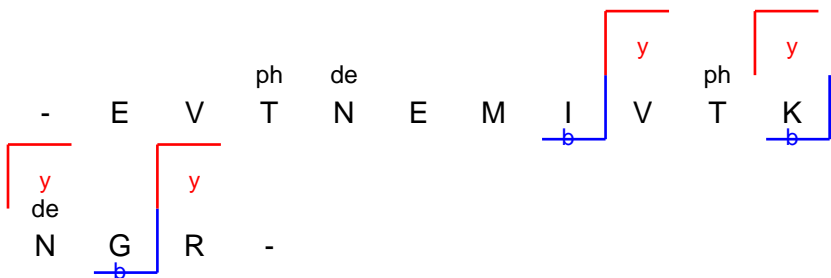
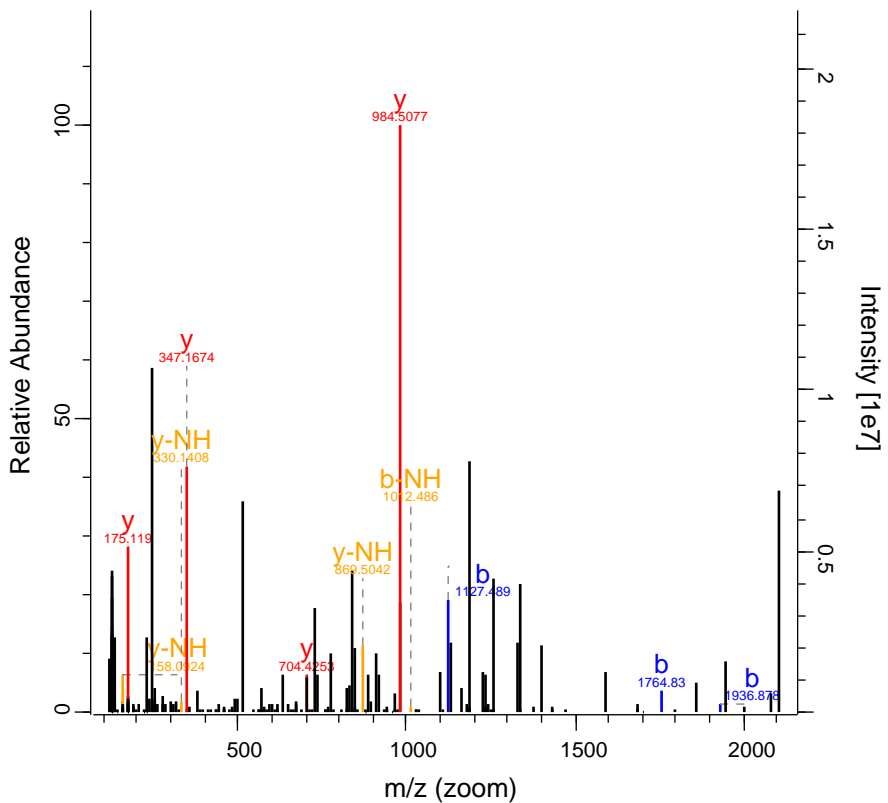

RO-QC-160121_ZackD_SS_Set_02_Fratio 15429 FTMS; HC 128.01 871.43 IRS2

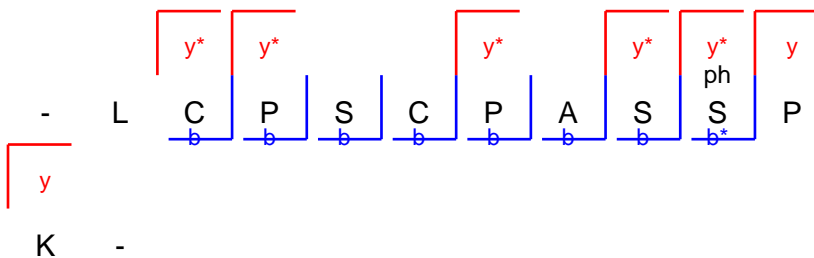
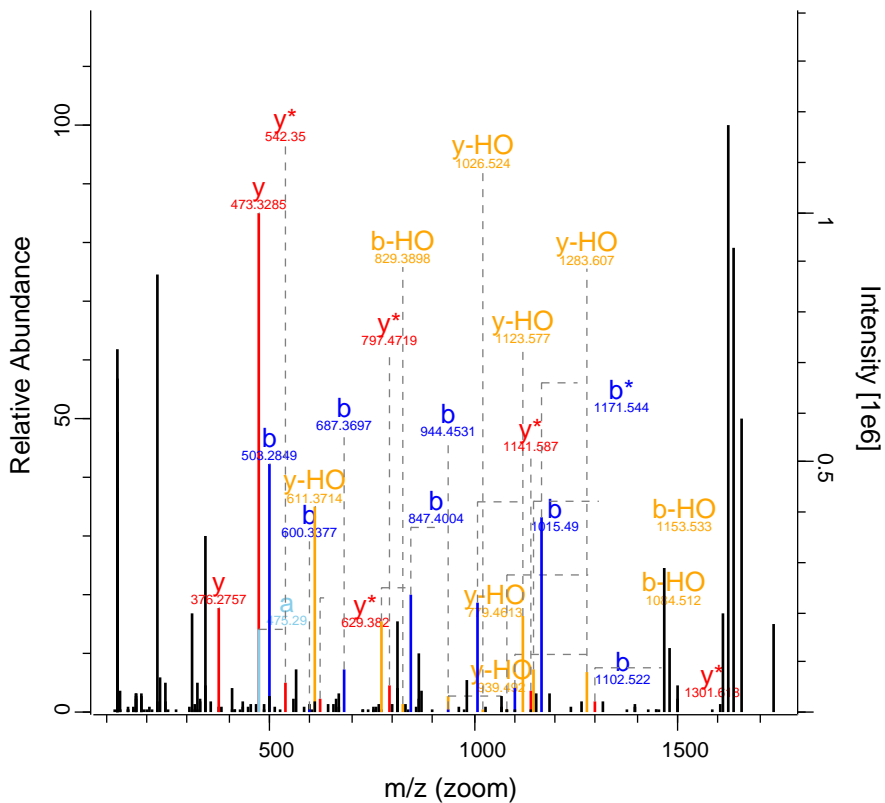

RO-QC-160121_ZackD_SS_Set_02_Fraction 15510 FTMS; HC 48 417.96 HOOK2

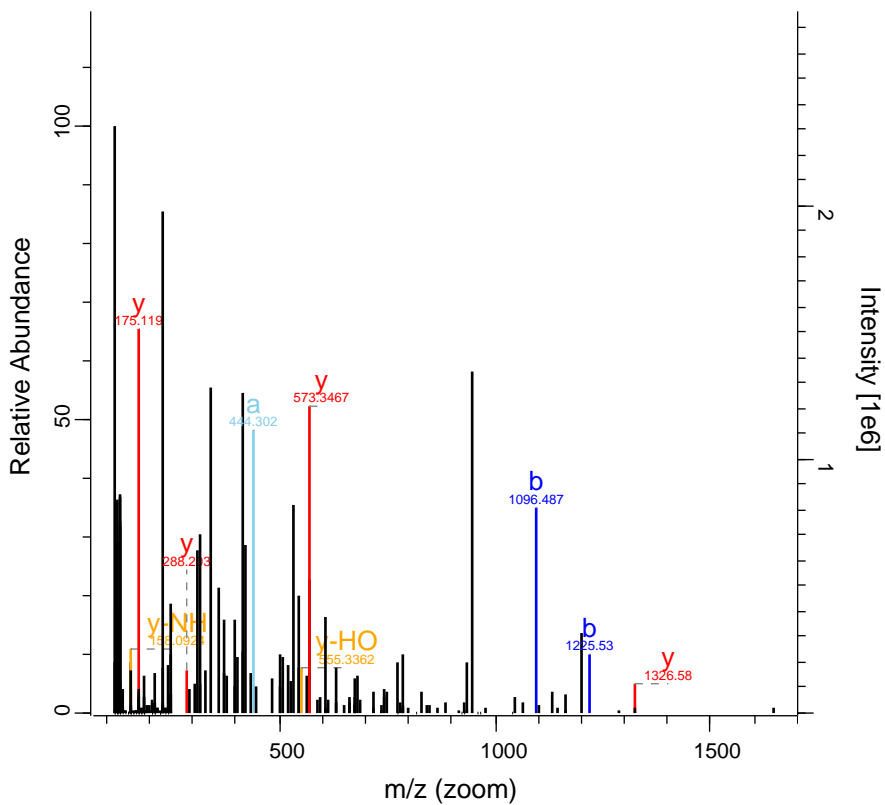

RO-QC-160121_ZackD_SS_Set_02_Fraction 15749 FTMS; HC 73.45 605.33 ABI2

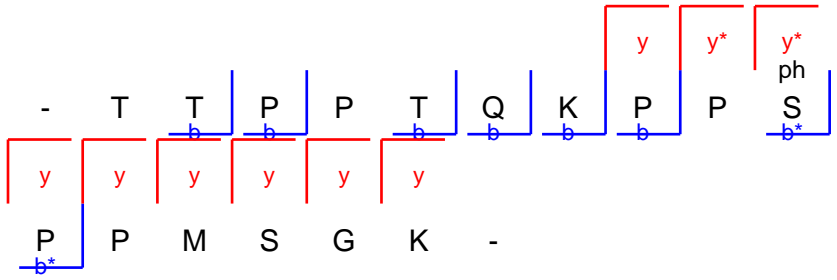
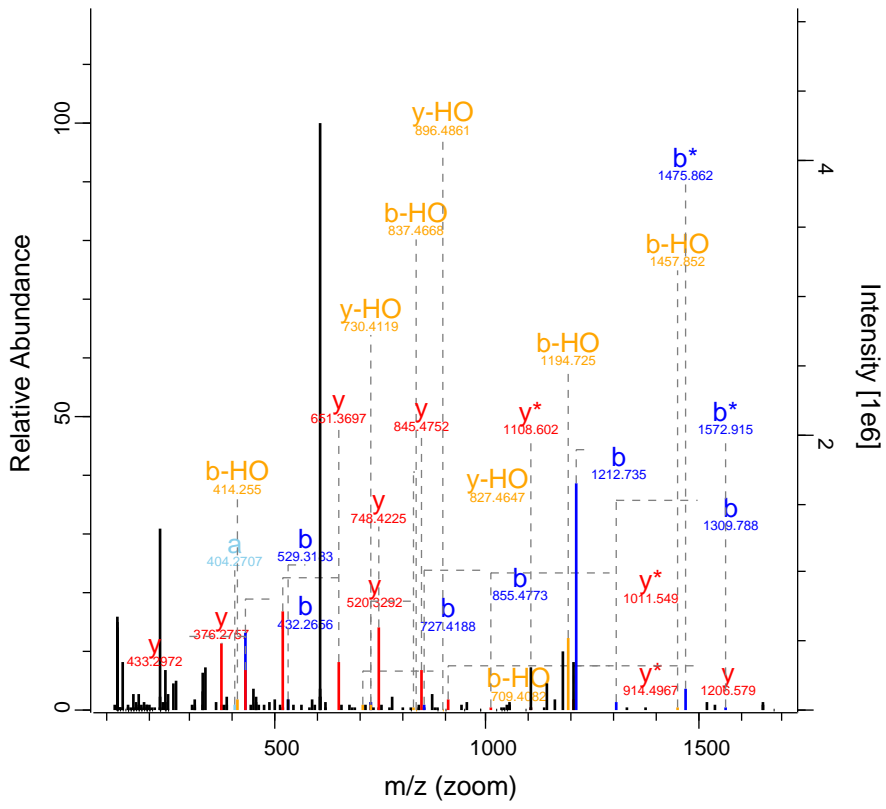

RO-QC-160121_ZackD_SS_Set_02_Fractic 16667 FTMS; HC 138.35 1002.49 HMGA1

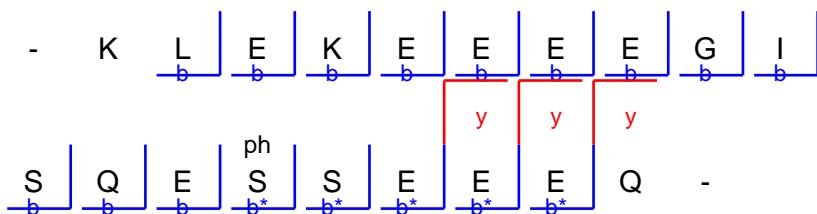
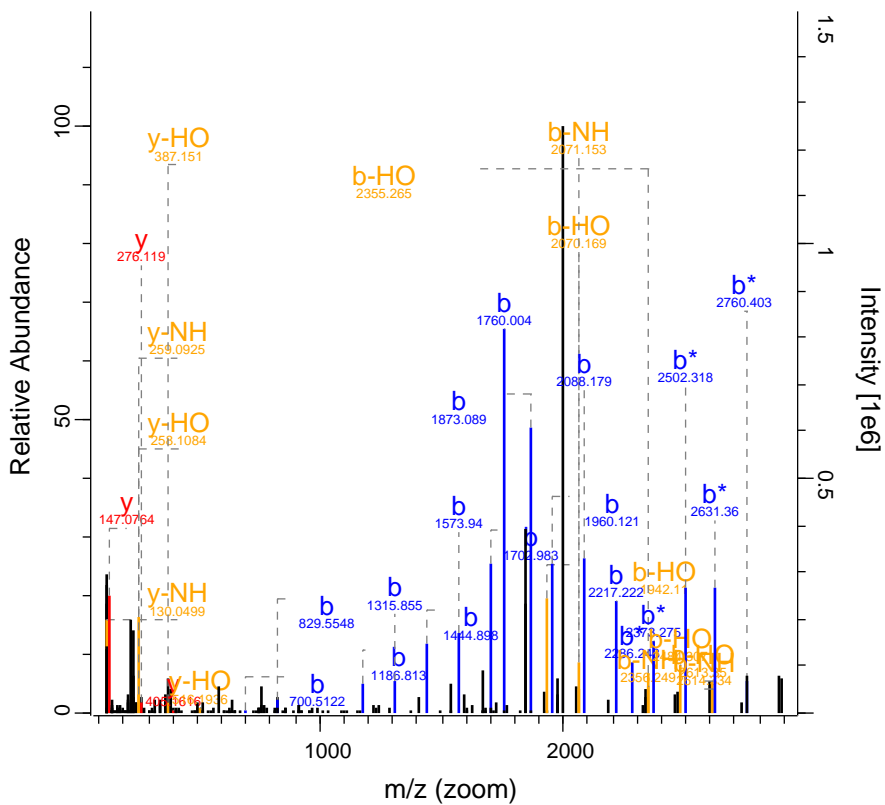

RO-QC-160121_ZackD_SS_Set_02_Fraction16751 FTMS; HC 76.48 853.43 TERF1

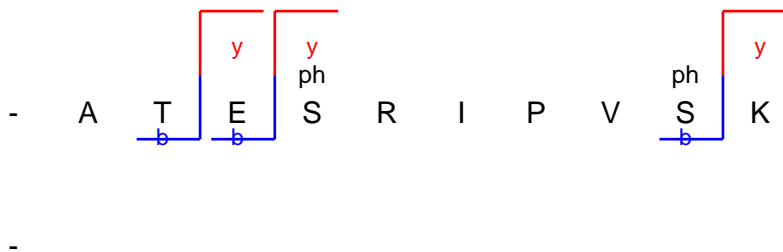
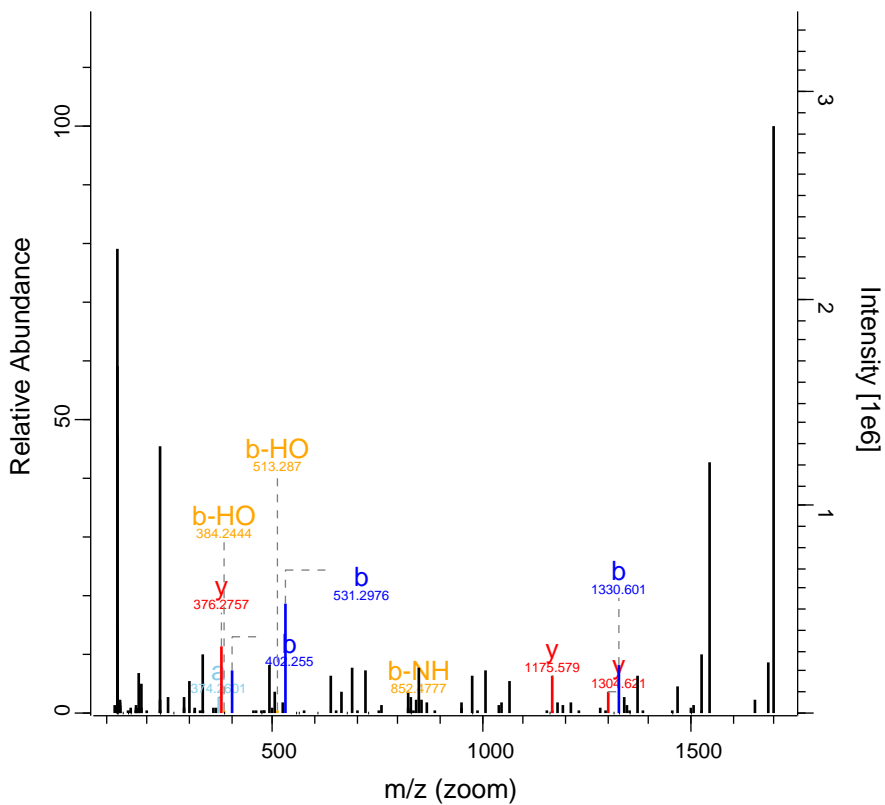

RO-QC-160121_ZackD_SS_Set_02_Fraction 16820 FTMS; HC 99.97 871.51 EIF4ENIF1

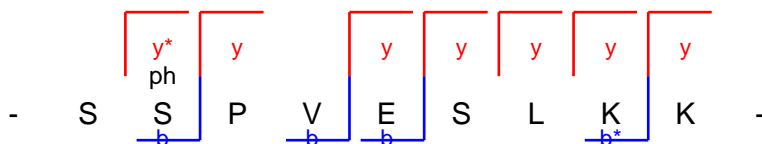
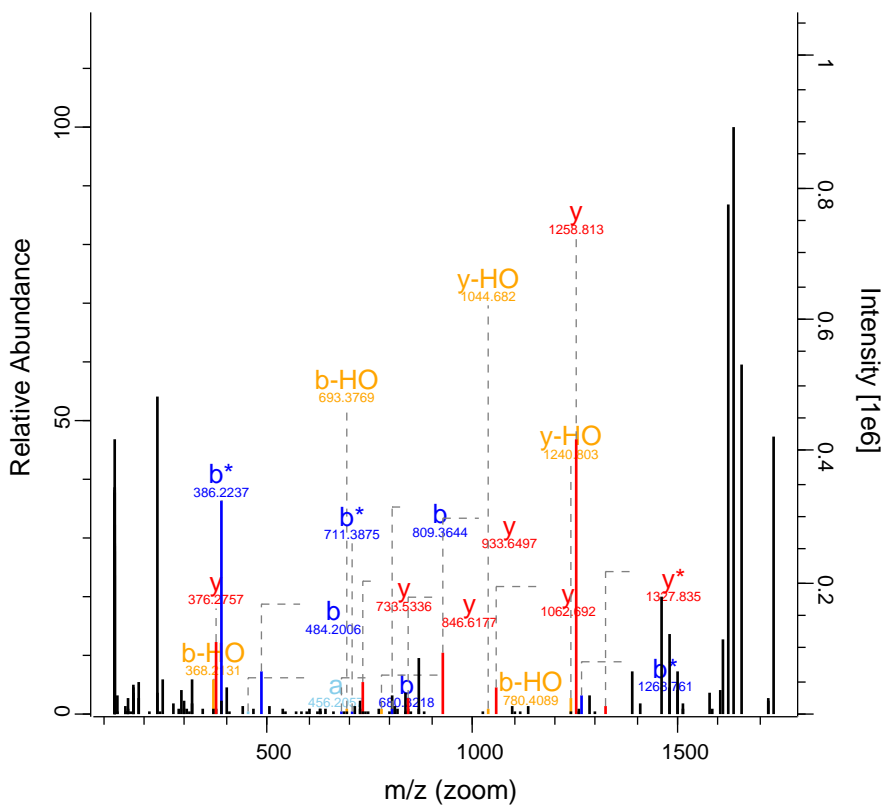

RO-QC-160121_ZackD_SS_Set_02_Fractic 17502 FTMS; HC 79.47 1213.12 DYNC1LI1

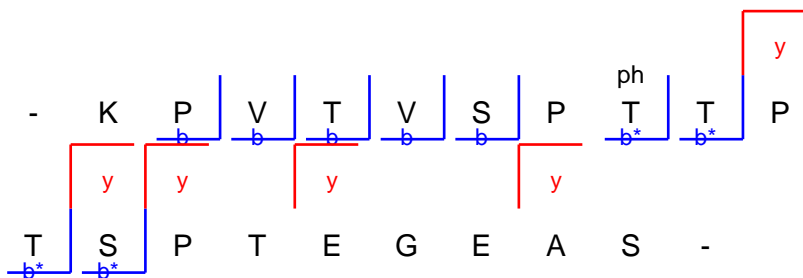
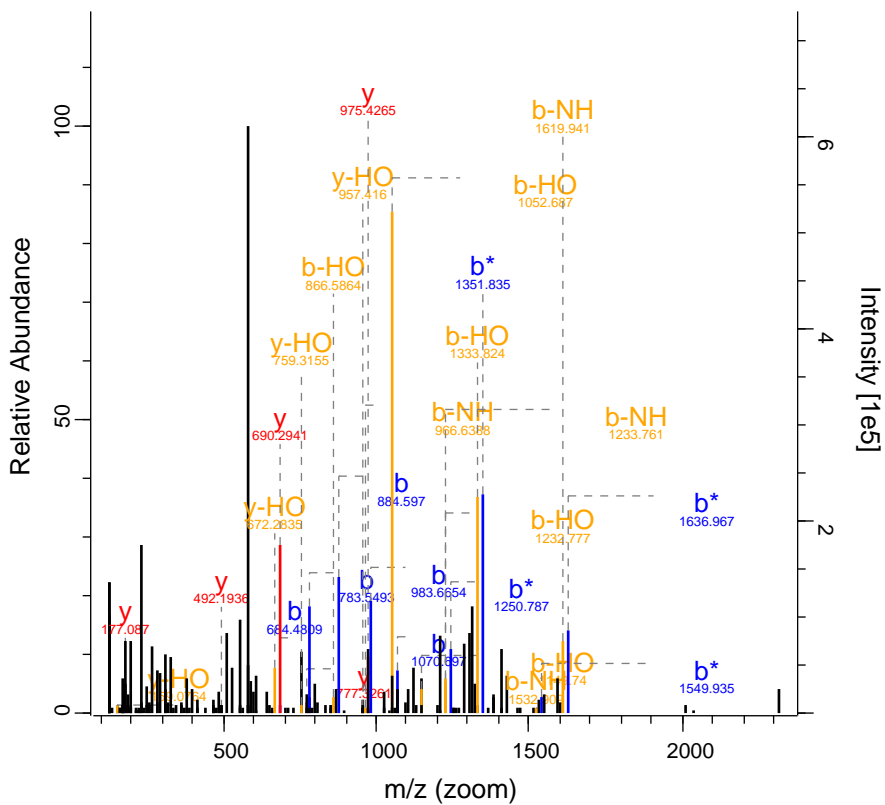

RO-QC-160121_ZackD_SS_Set_02_Fraction 18432 FTMS; HC 44.26 900.48 BCL2L13

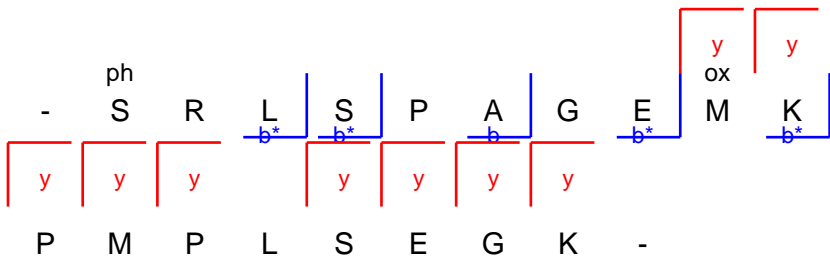
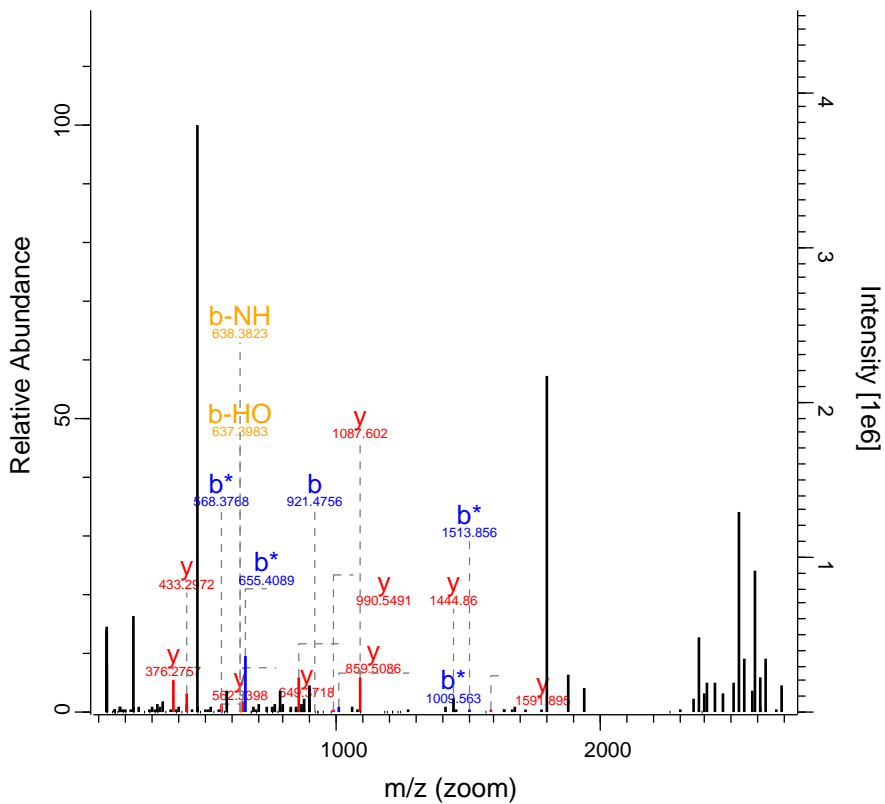

RO-QC-160121_ZackD_SS_Set_02_Fraction 18662 FTMS; HC 84.21 974.04 BBS1

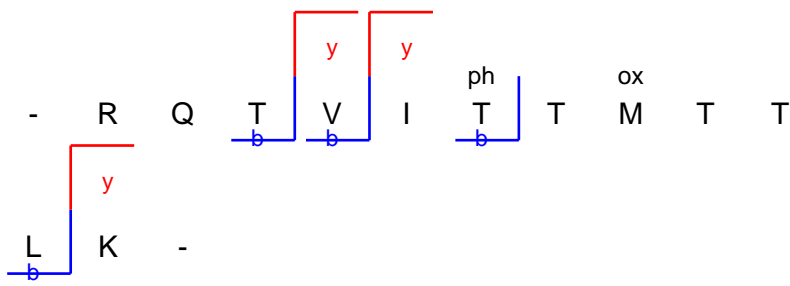
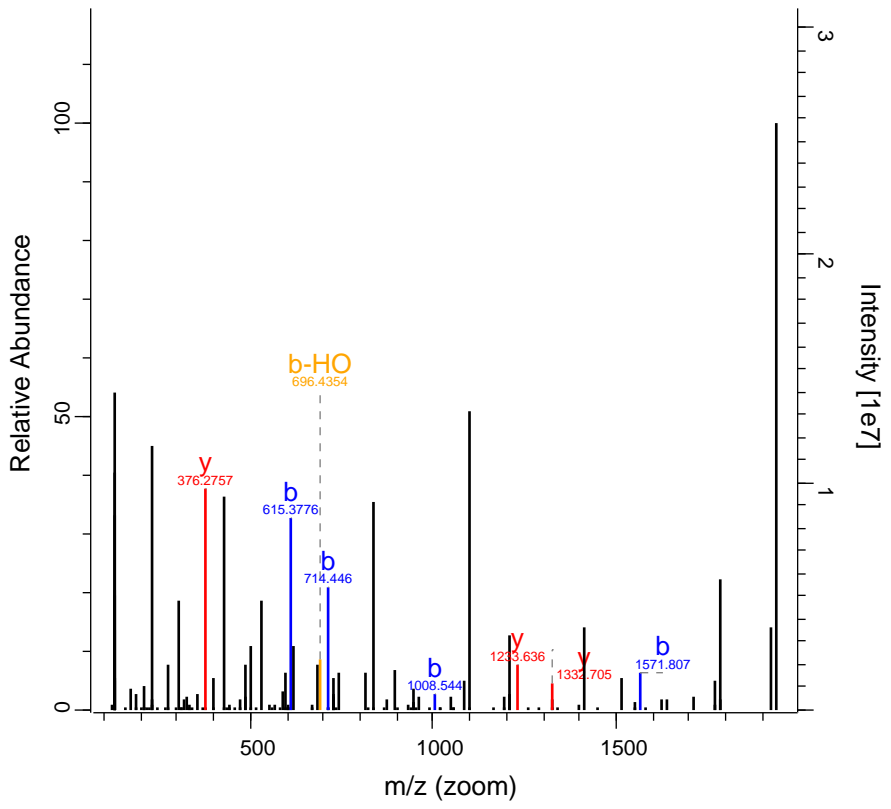

RO-QC-160121_ZackD_SS_Set_02_Fraction 19073 FTMS; HC 138.25 762.93 PDCD4

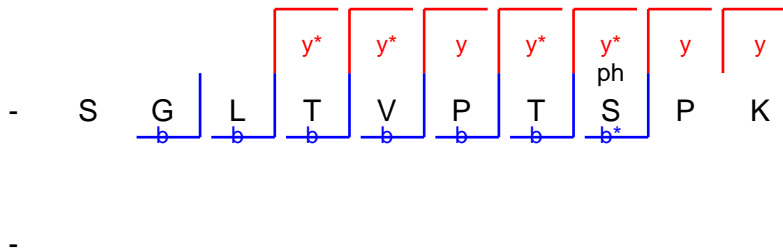
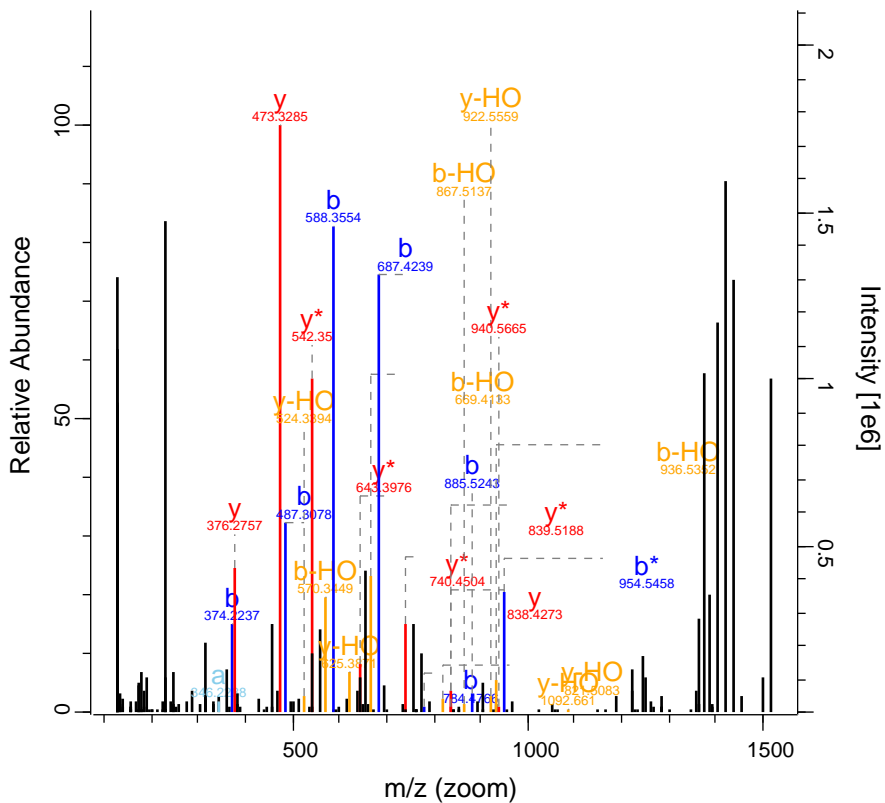

RO-QC-160121_ZackD_SS_Set_02_Fractio 19523 FTMS; HC 162.07 996.22 PAK4

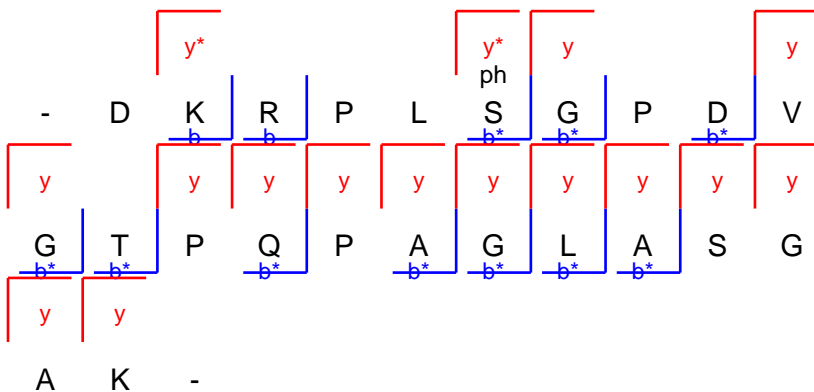
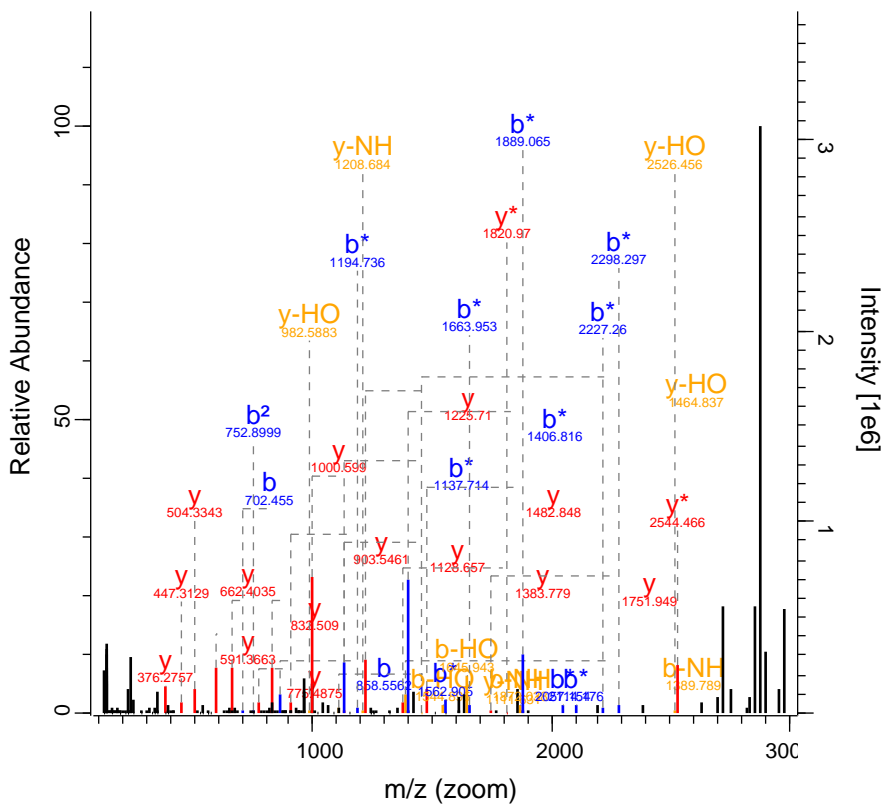

RO-QC-160121_ZackD_SS_Set_02_Fraction 19597 FTMS; HC 73.02 794.45 TRPV5

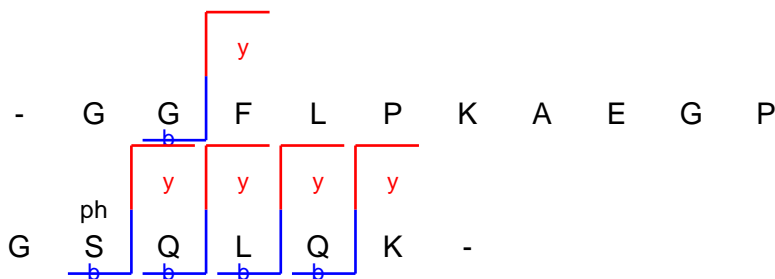
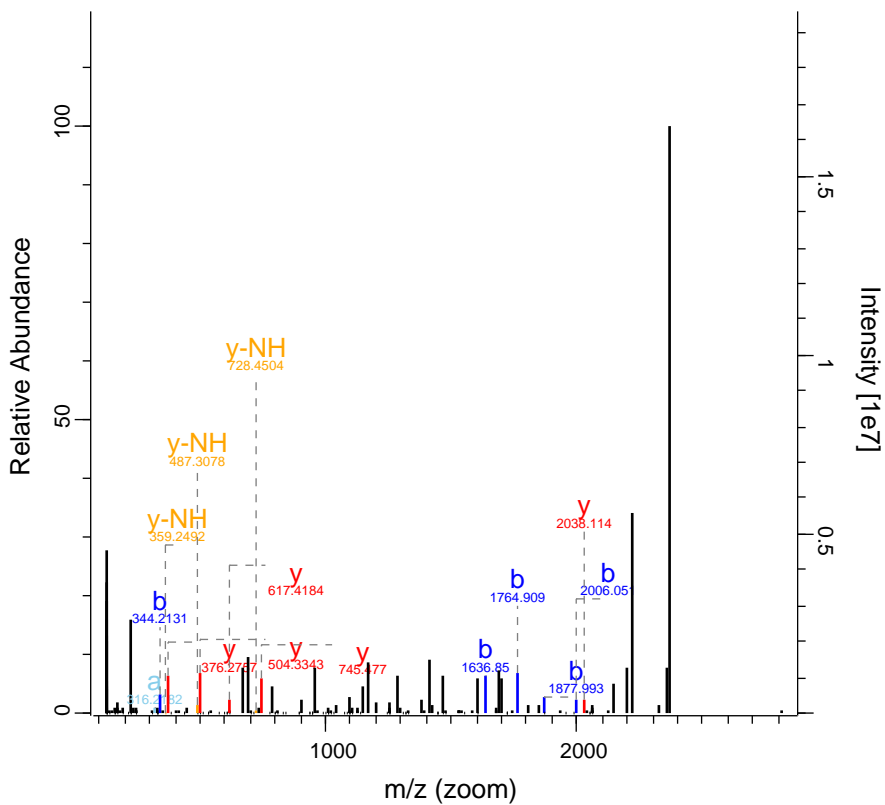

RO-QC-160121_ZackD_SS_Set_02_Fraction 20020 FTMS; HC 92.29 863.78 MAP1B

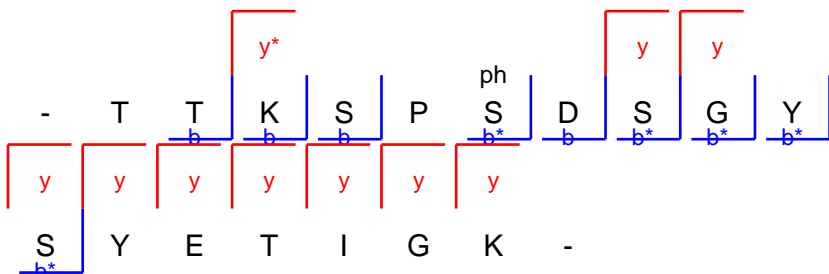
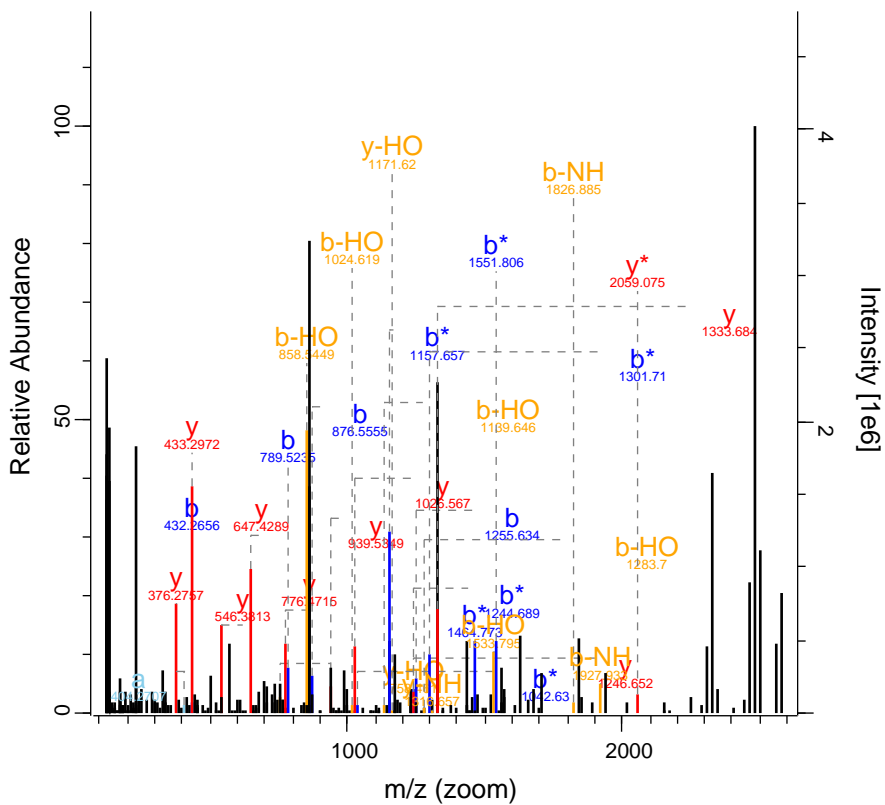

RO-QC-160121_ZackD_SS_Set_02_Fraction 20246 FTMS; HC 47.75 796.66 OR51F2

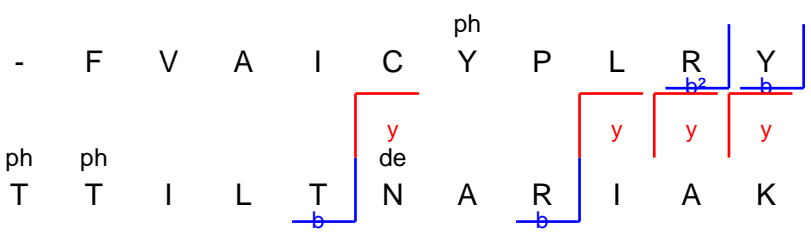
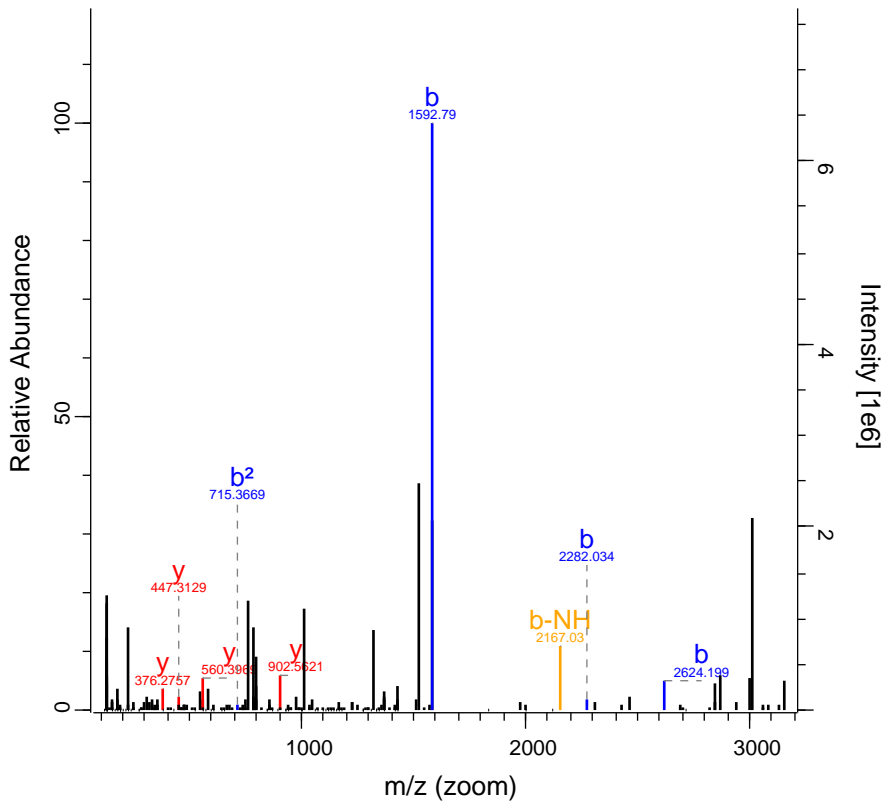

RO-QC-160121_ZackD_SS_Set_02_Fraccio 21482 FTMS; HC 114.86 752.89 MAP7

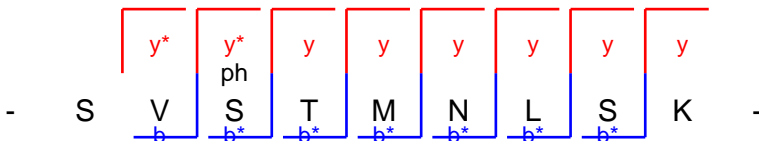
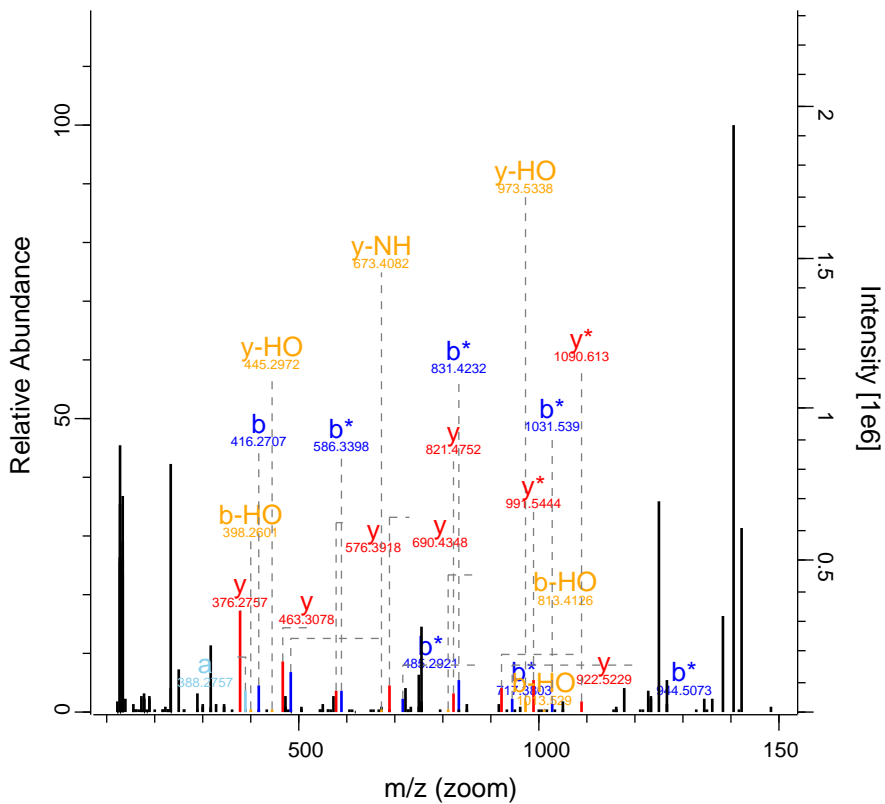

RO-QC-160121_ZackD_SS_Set_02_Fraction 22439 FTMS; HC 54.05 878.47 PPFIBP2

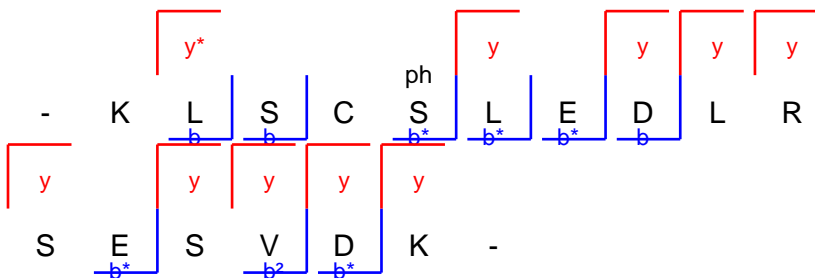
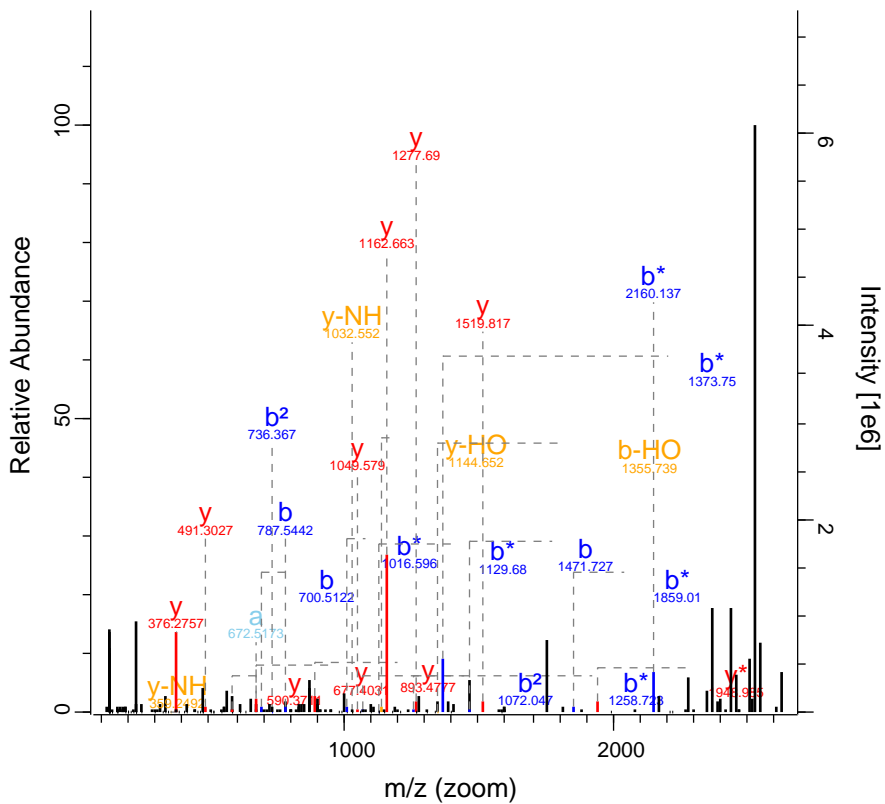

RO-QC-160121_ZackD_SS_Set_02_Fractio 22539 FTMS; HC 174.05 928.44 NCCRP1

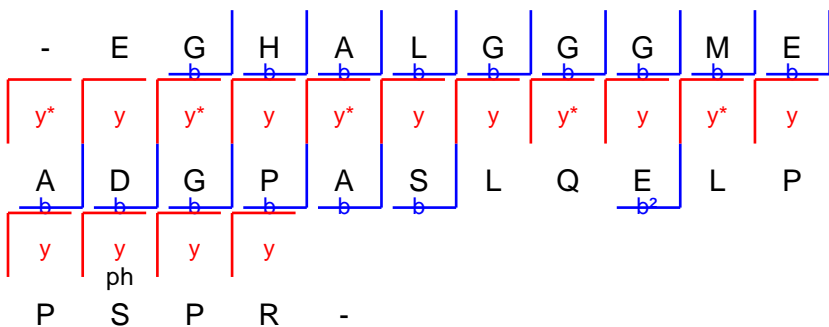
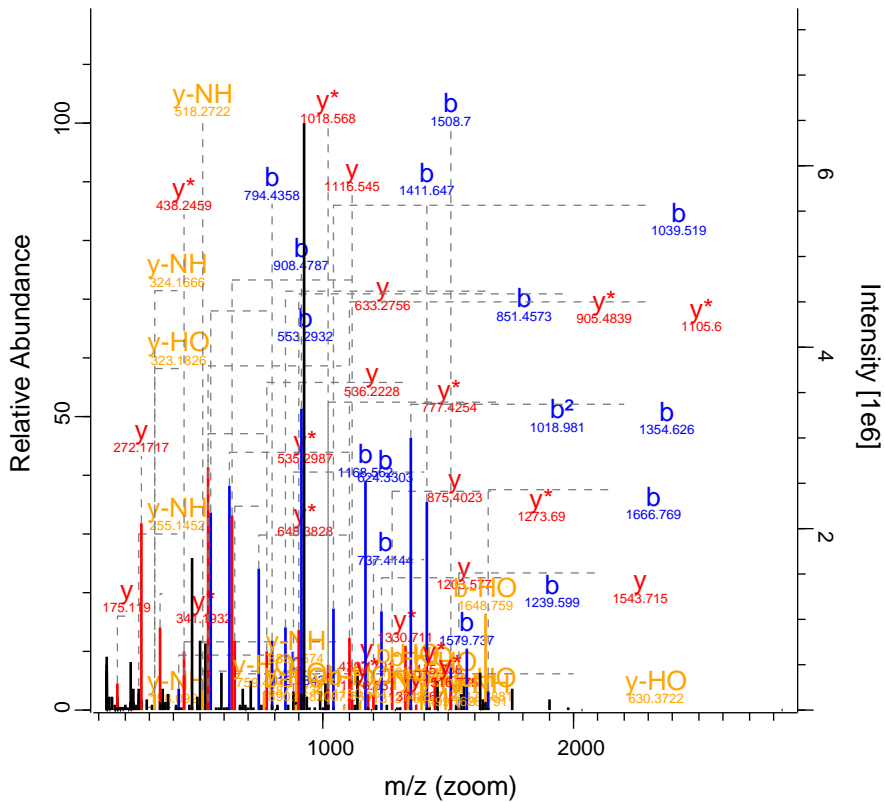

RO-QC-160121_ZackD_SS_Set_02_Fraction 22965 FTMS; HCl 101.64 829 TRDC

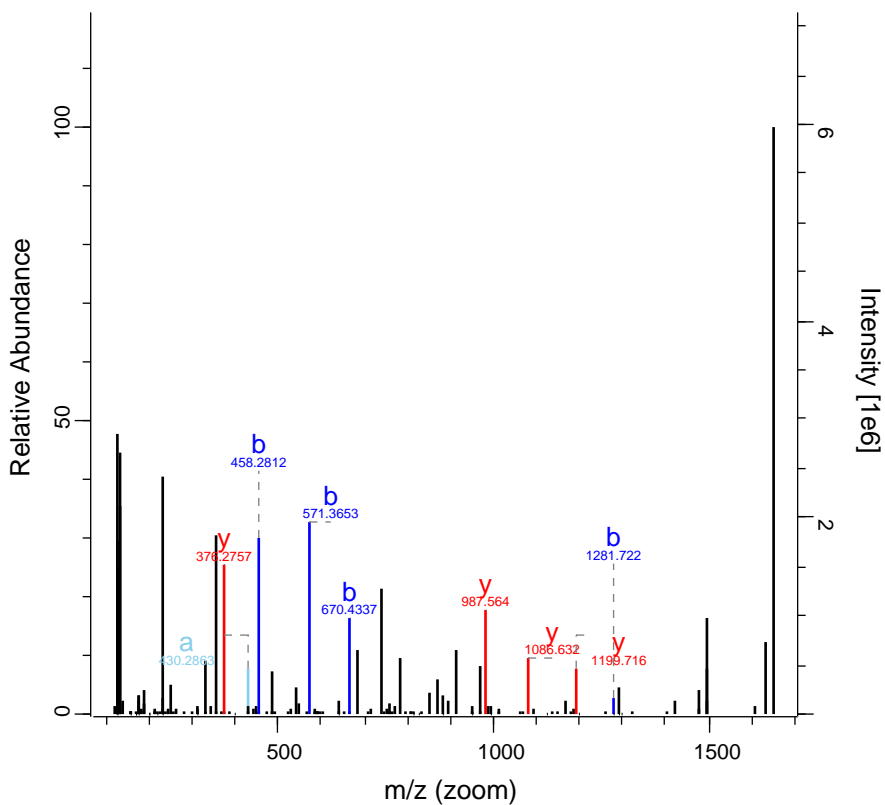

m/z (zoom)

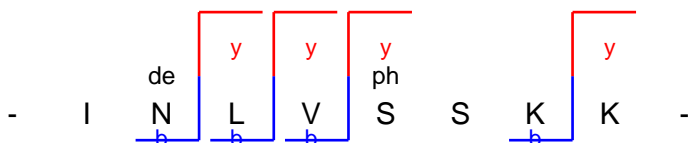

RO-QC-160121_ZackD_SS_Set_02_Fraction 24124 FTMS; HC 42.56 739.04 TRPM6

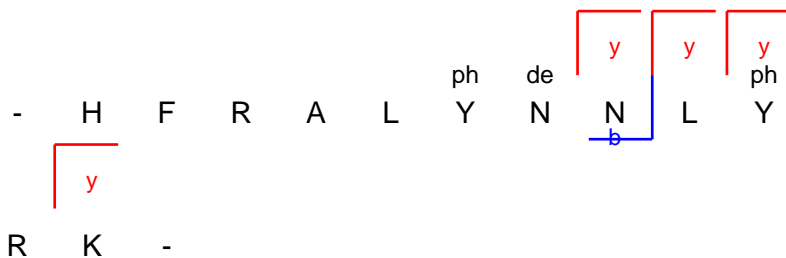
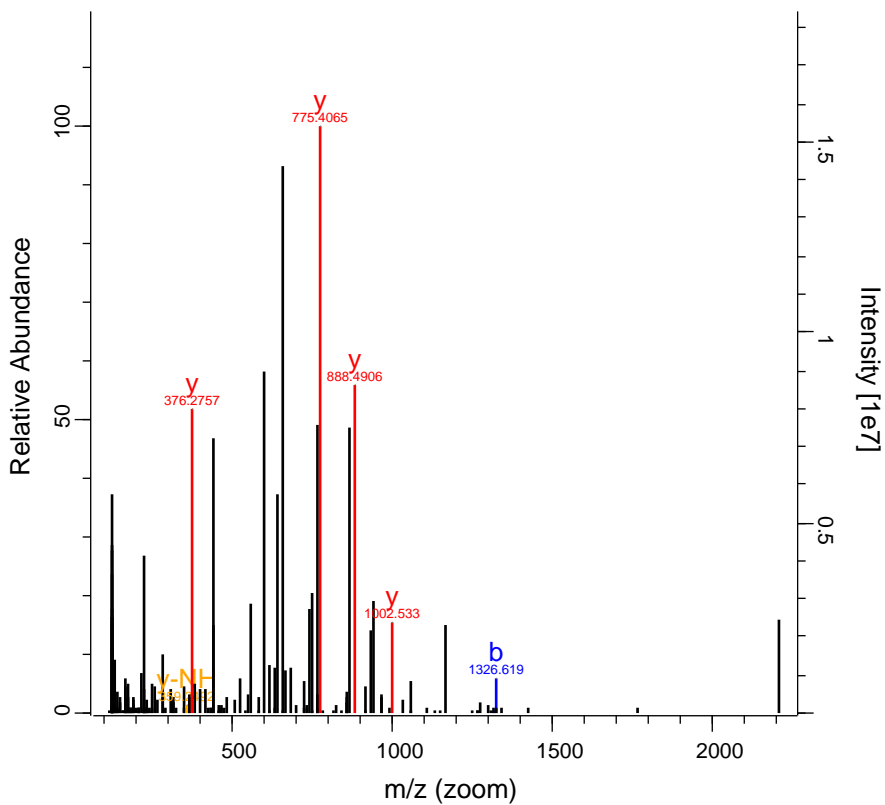

RO-QC-160121_ZackD_SS_Set_02_Fractio 24333 FTMS; HC 153.83 866.81 SPTBN1

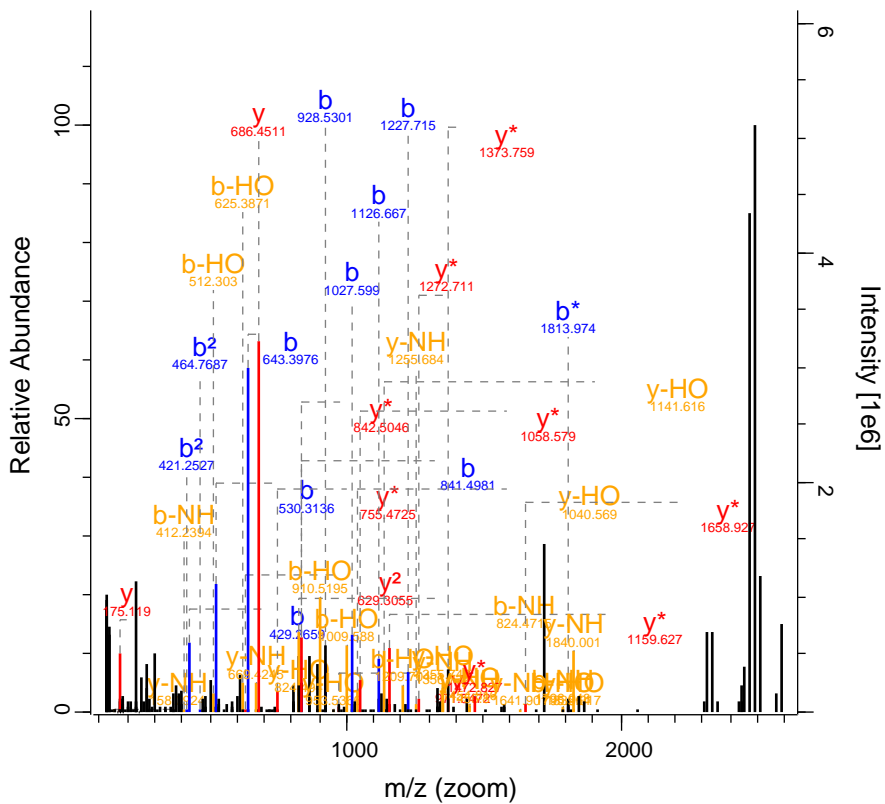

RO-QC-160121_ZackD_SS_Set_02_Fractio 25735 FTMS; HC 111.46 858.44 ERC2

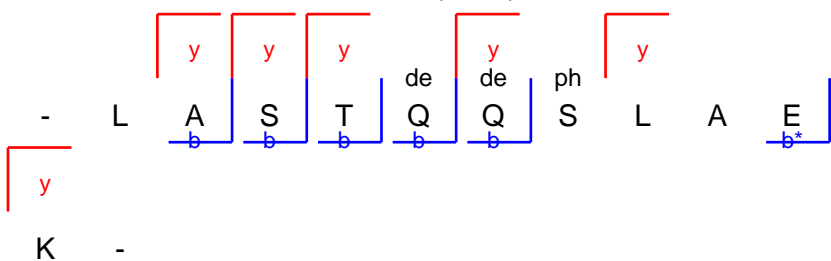
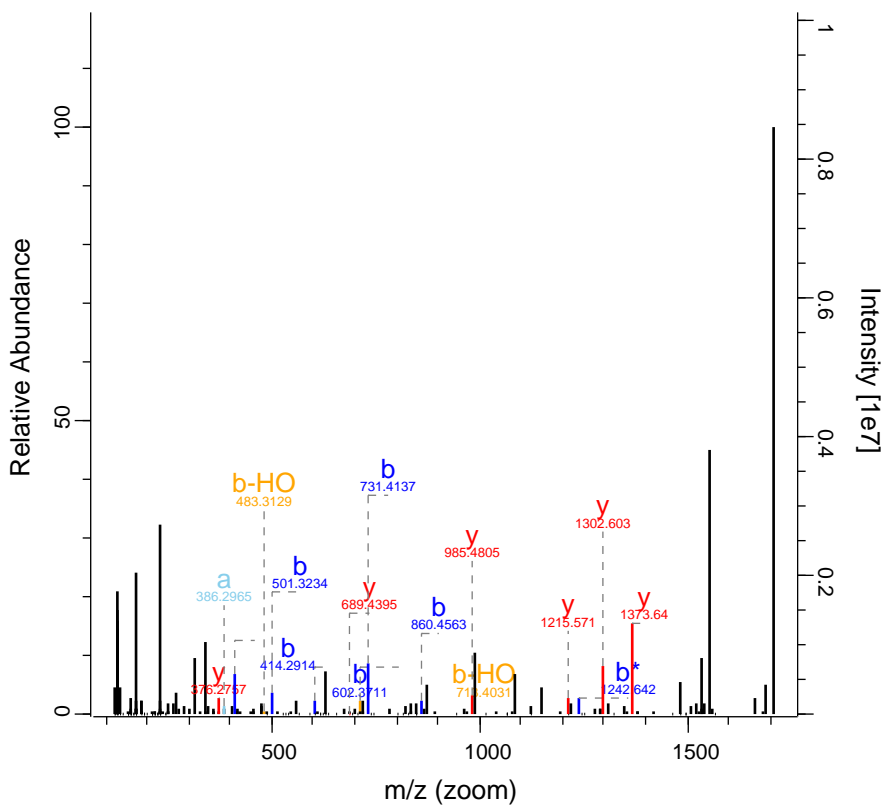

RO-QC-160121_ZackD_SS_Set_02_Fraction 26247 FTMS; HCl 75.29 1010 FTMT

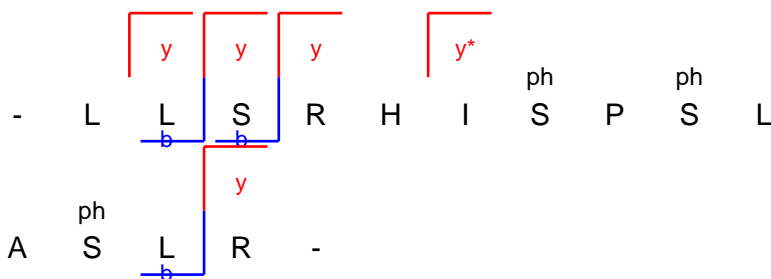
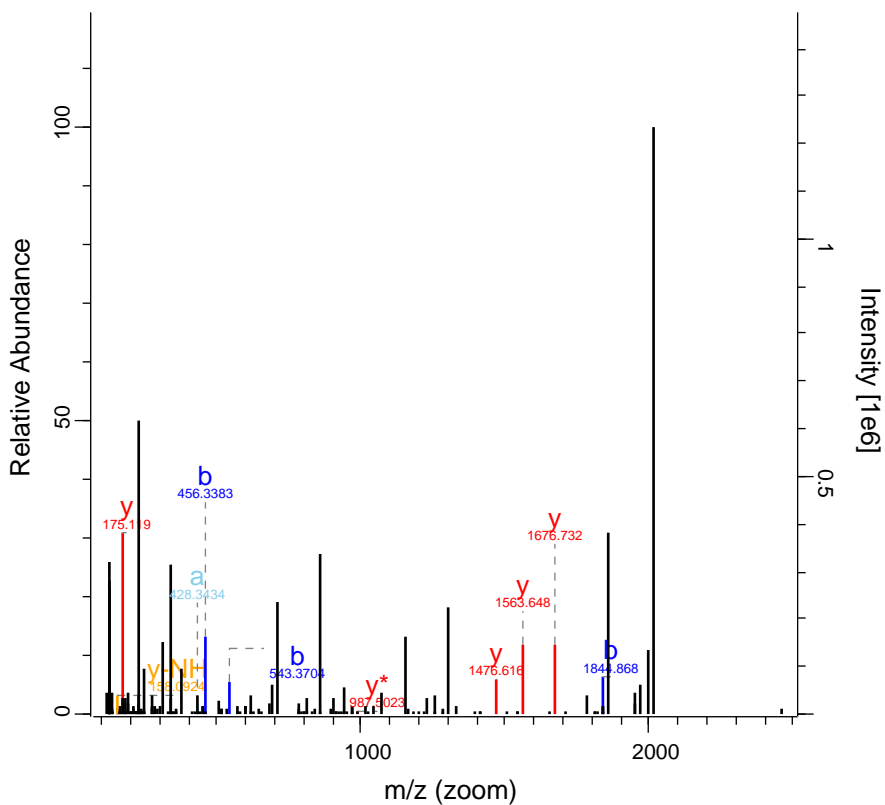

RO-QC-160121_ZackD_SS_Set_02_Fraction 26766 FTMS; HCl 99.09 706.4 EIF4G2

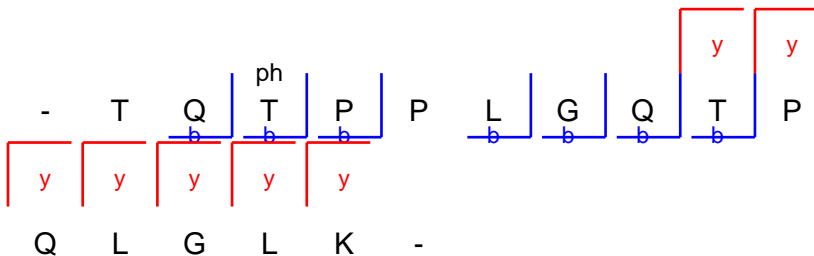
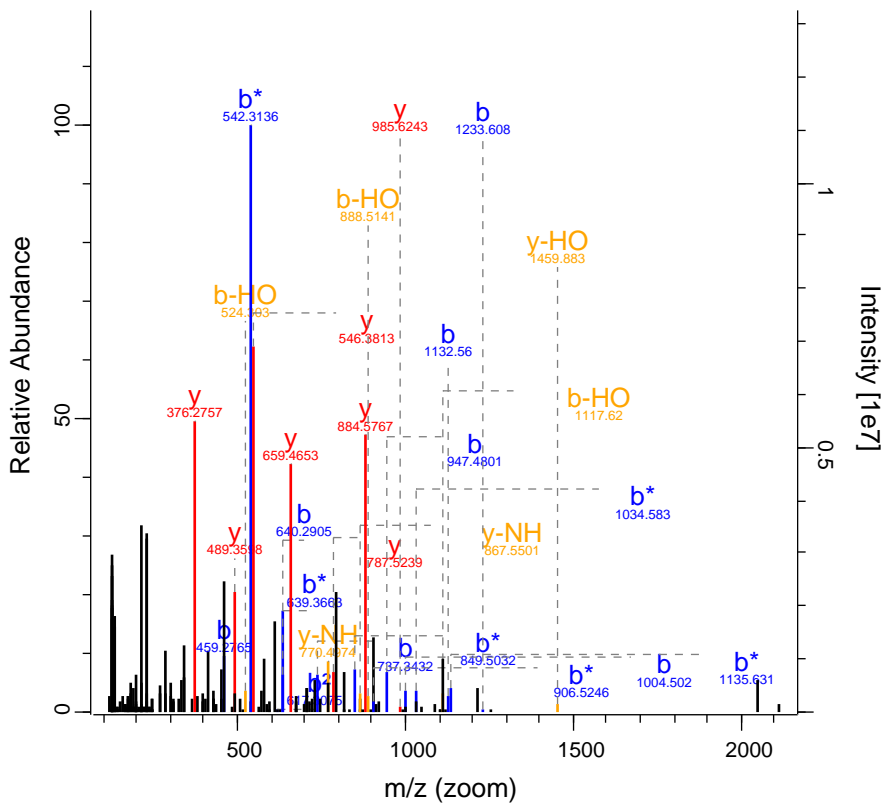

RO-QC-160121_ZackD_SS_Set_02_Fraction 26782 FTMS; HC 71.09 578.08 STMN1

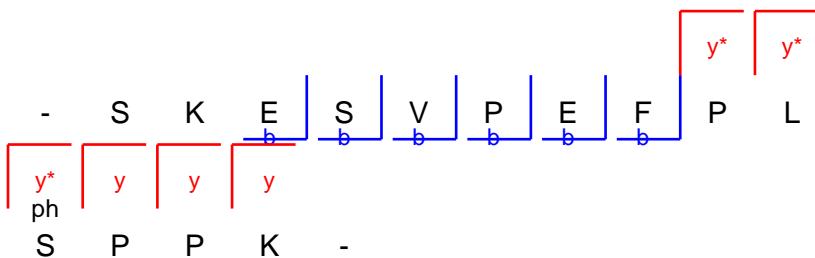
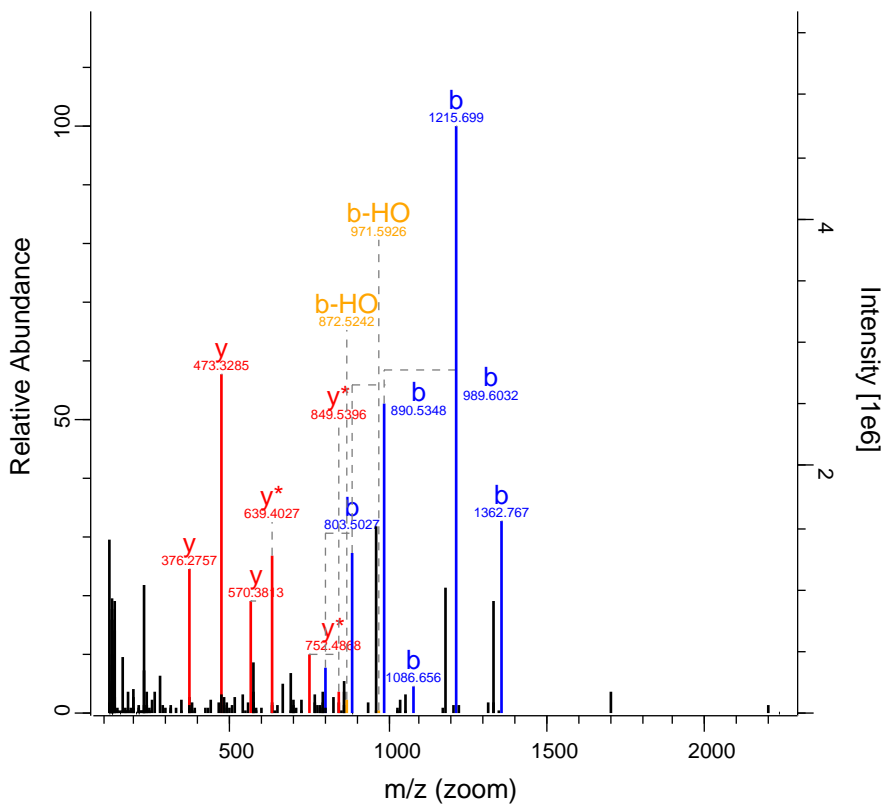

RO-QC-160121_ZackD_SS_Set_02_Fraction 27417 FTMS; HC 44.2 613.56 INADL

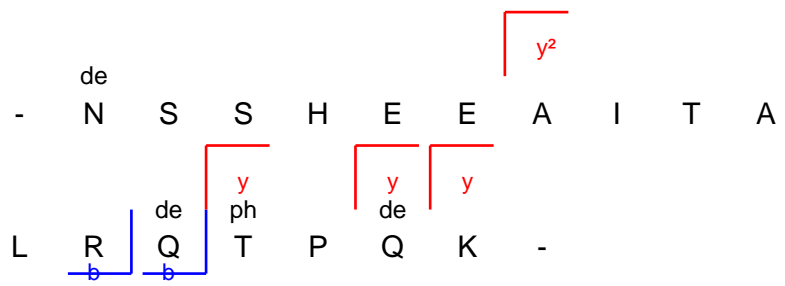
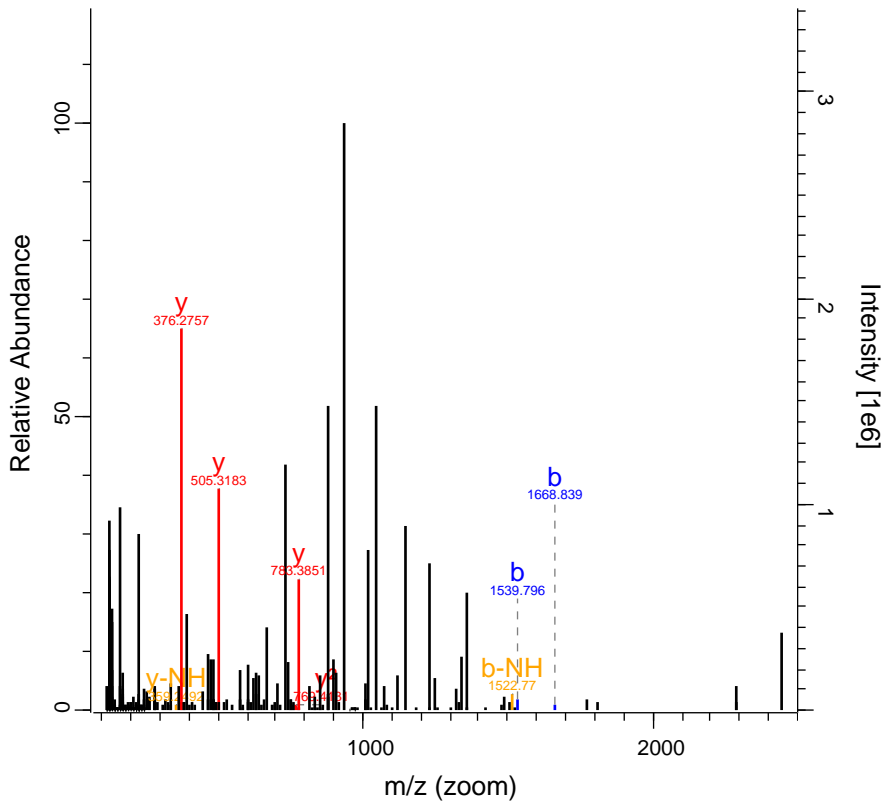

RO-QC-160121_ZackD_SS_Set_02_Fractio 27491 FTMS; HC 103.63 898.13 PGM5

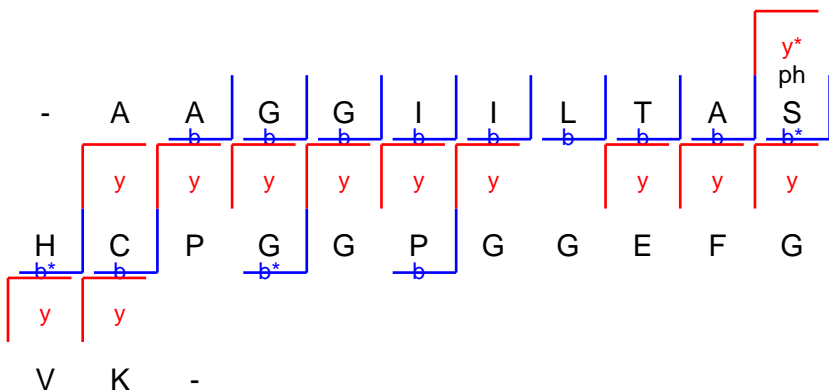
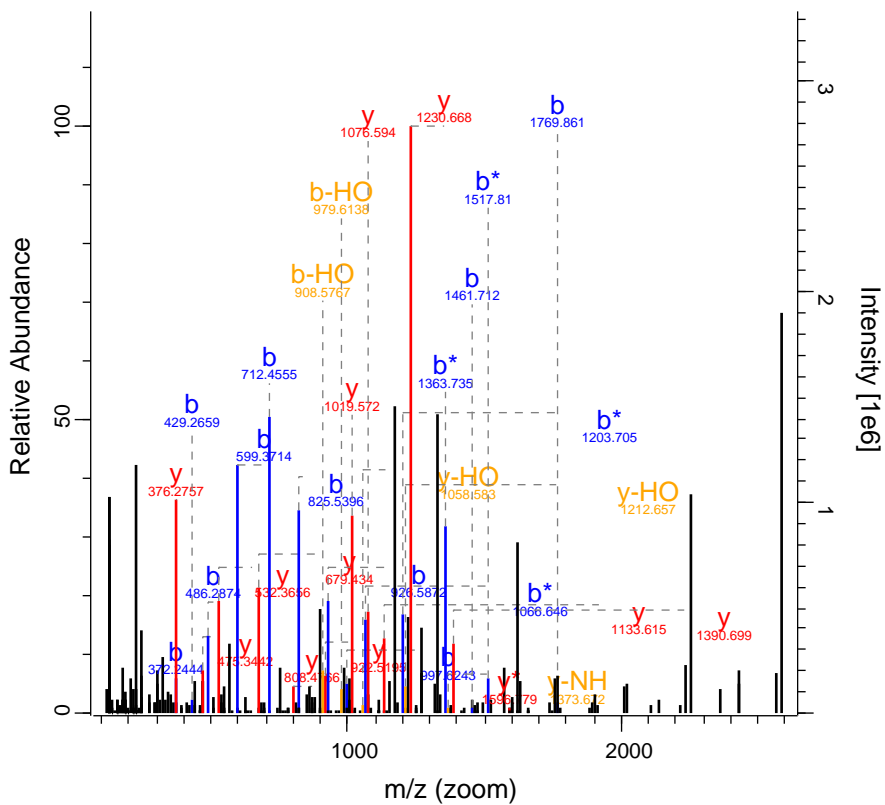

RO-QC-160121_ZackD_SS_Set_02_Fractic 27640 FTMS; HC 50.11 1226.12 LRRK1

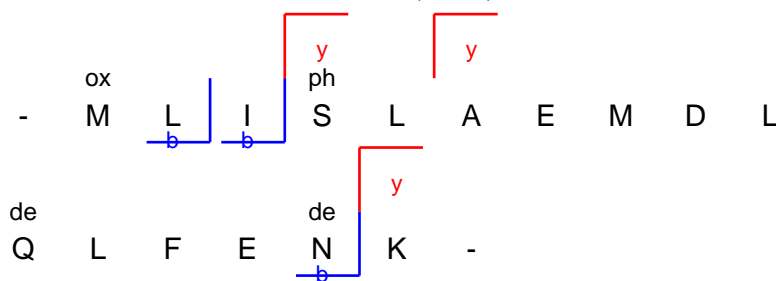
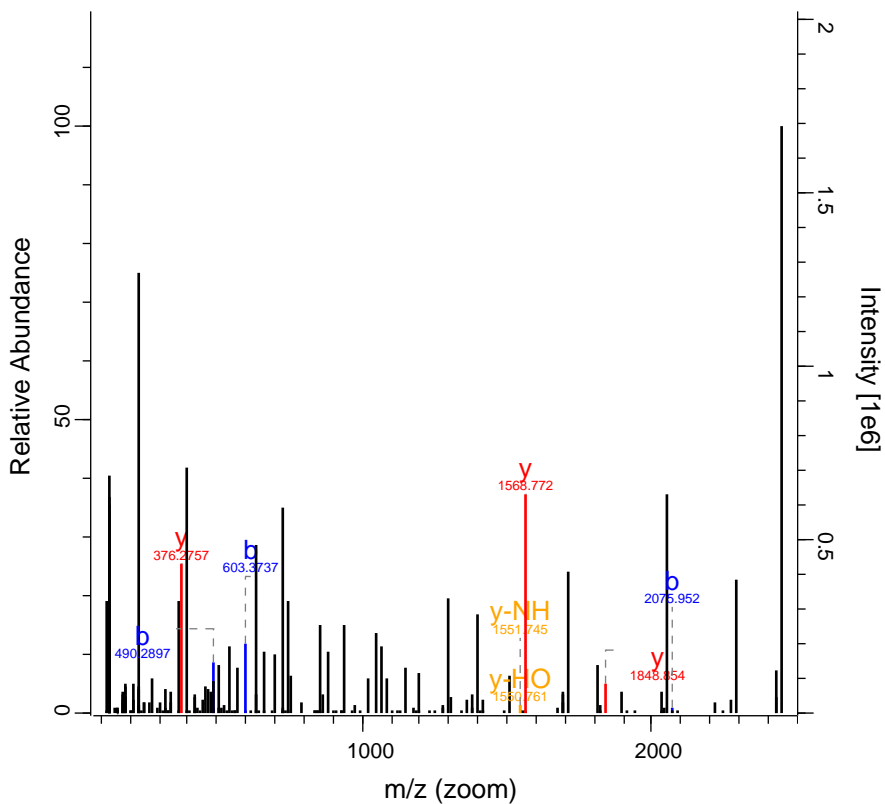

RO-QC-160121_ZackD_SS_Set_02_Fraction 29006 FTMS; HC 47.85 908.96 CCDC180

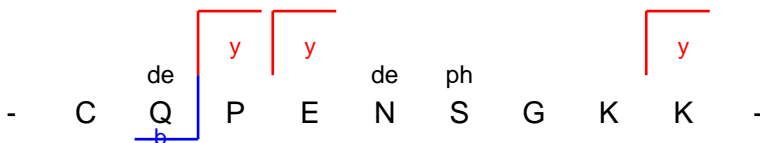
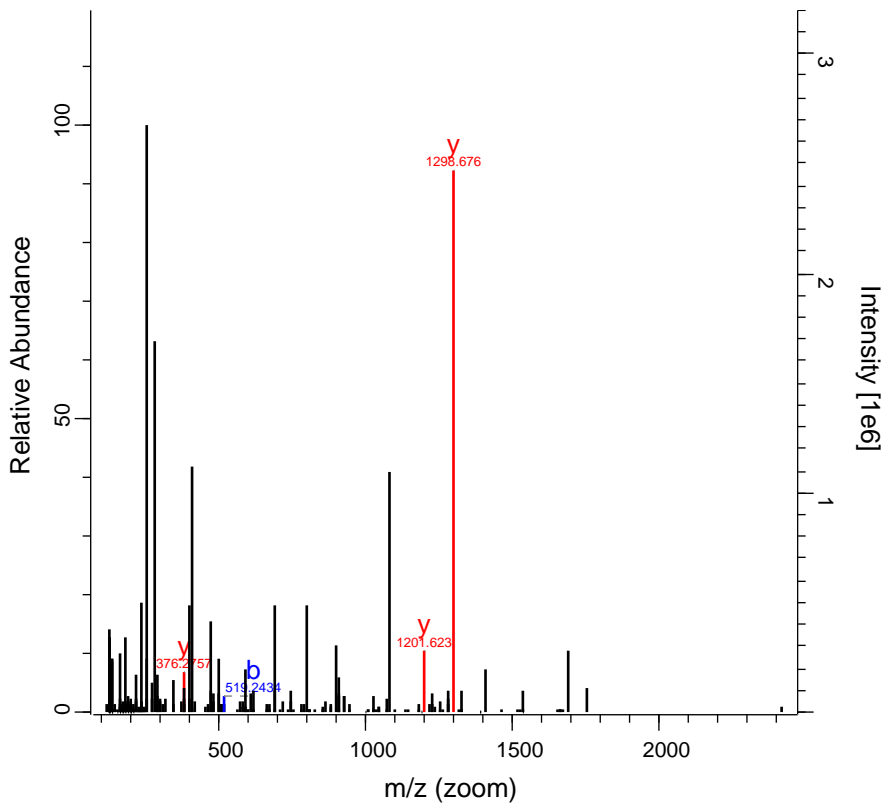

RO-QC-160121_ZackD_SS_Set_02_Fraction 29366 FTMS; HC 46.16 495.44 ACTBL2

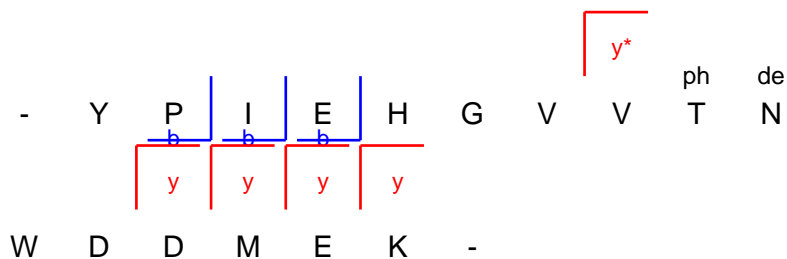
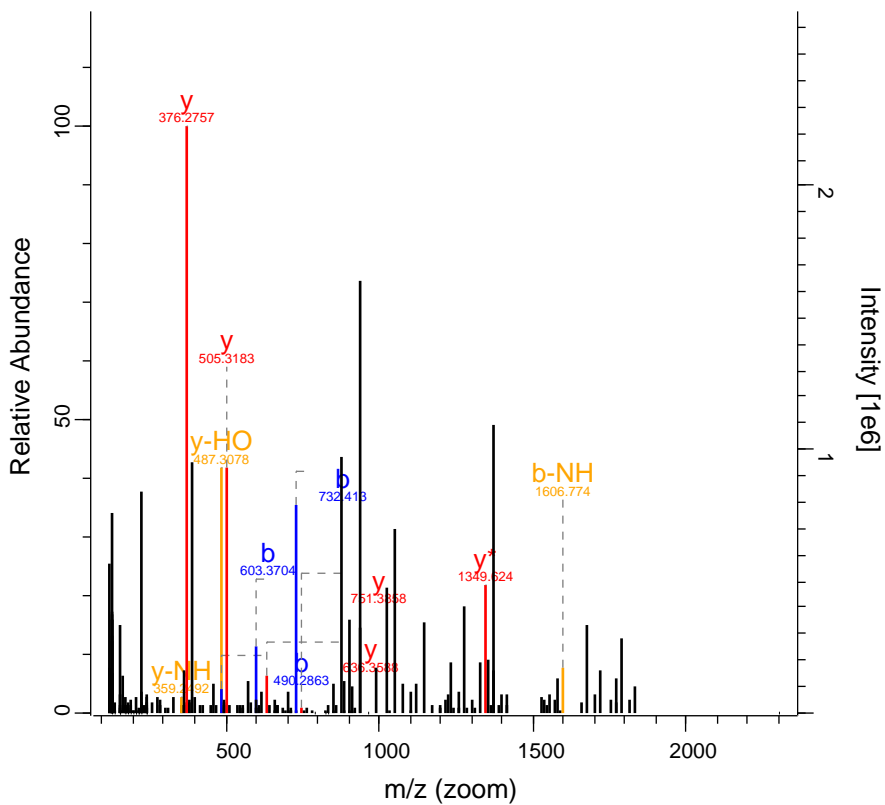

RO-QC-160121_ZackD_SS_Set_02_Fractic 31007 FTMS; HC 41.76 1046.18 ALPK3

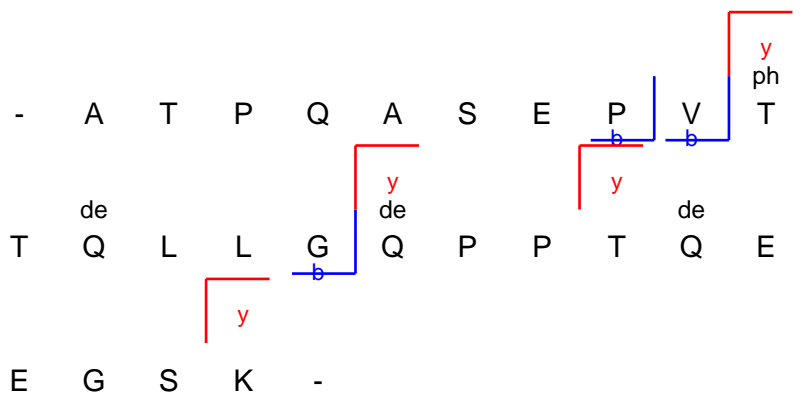
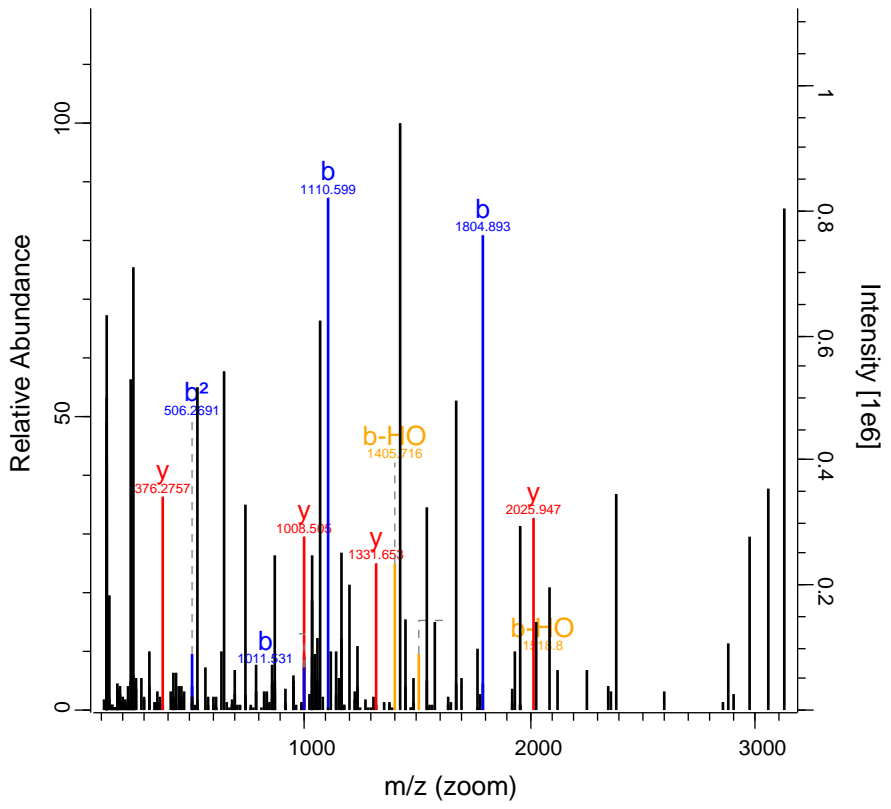

RO-QC-160121_ZackD_SS_Set_02_Fraction 32382 FTMS; HC 87.18 608.97 MTRF1L

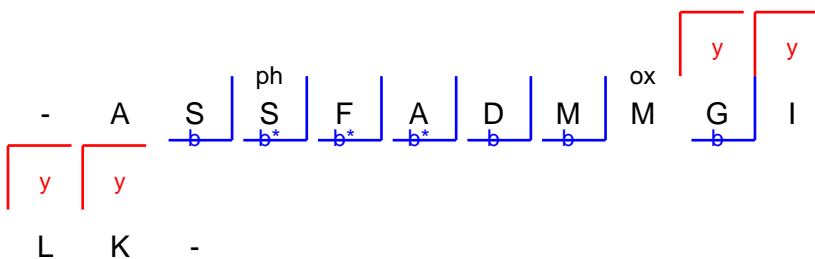
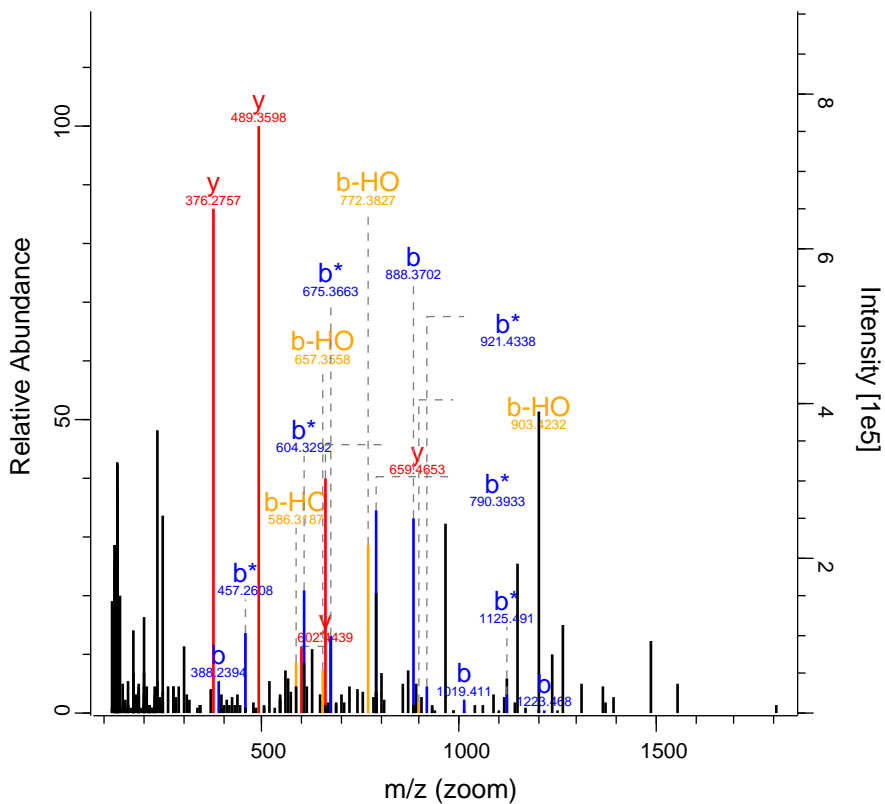

RO-QC-160121_ZackD_SS_Set_02_Fraction 32742 FTMS; HC 41.54 680.34 NPHS2

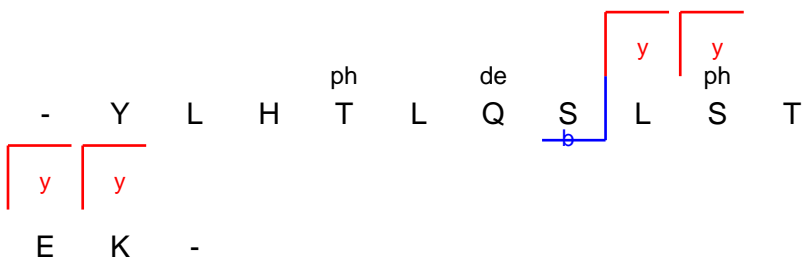
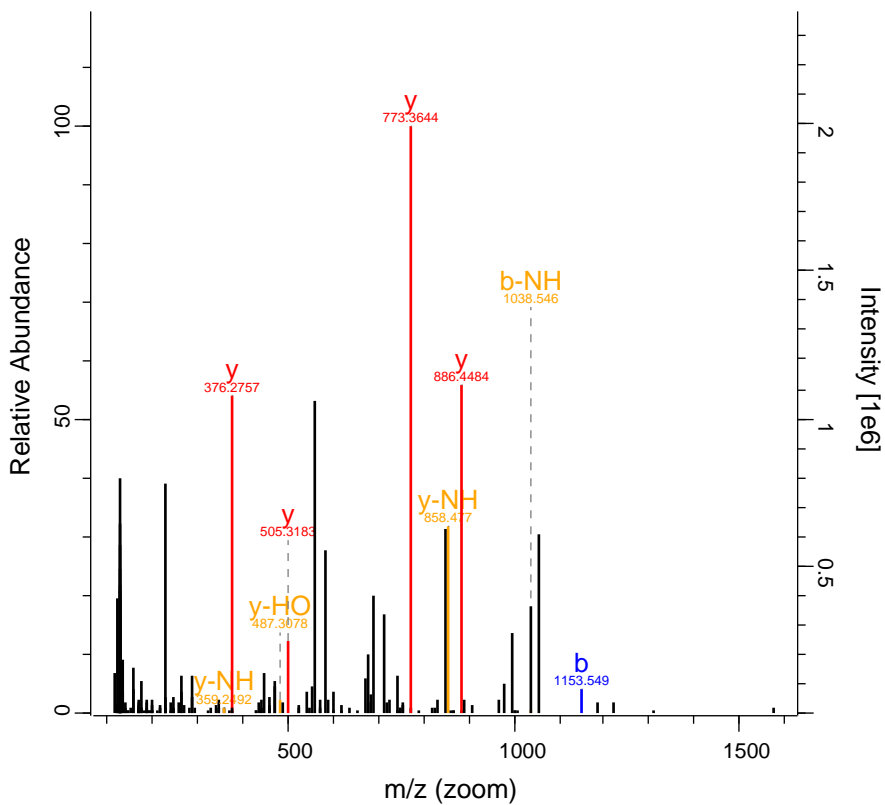

RO-QC-160121_ZackD_SS_Set_02_Fractic 32882 FTMS; HC 159.69 1014.53 AHNAK

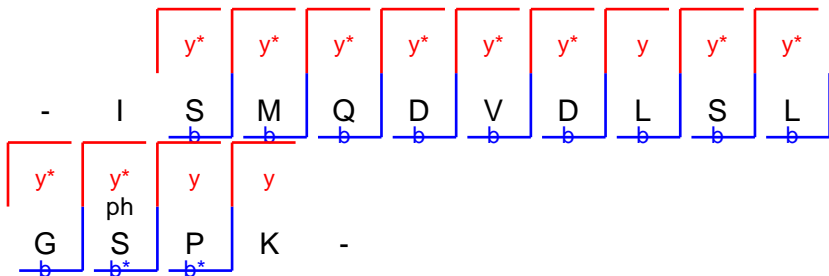
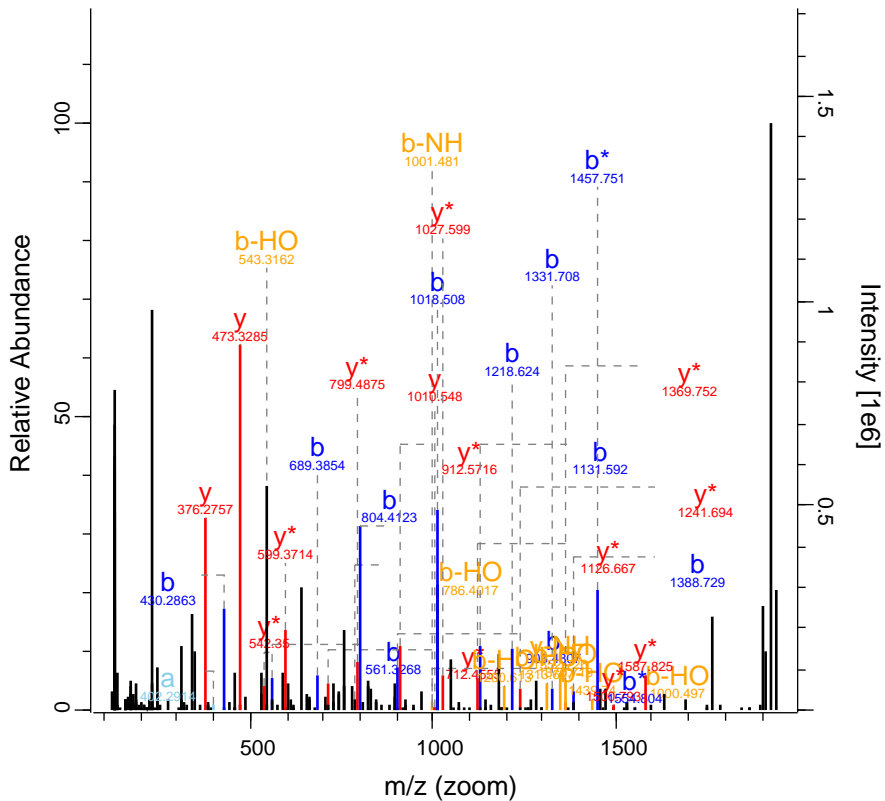

RO-QC-160121_ZackD_SS_Set_02_Fractic 33645 FTMS; HC 117.79 1212.12 SRRM2

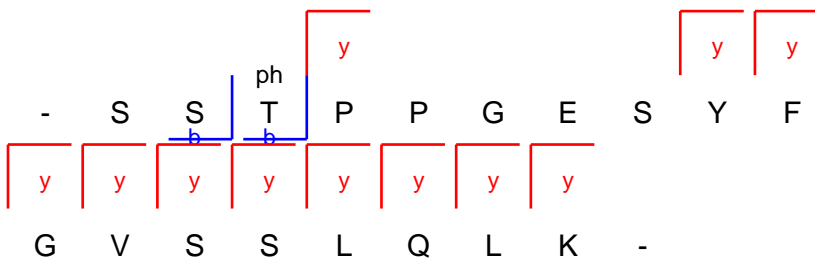
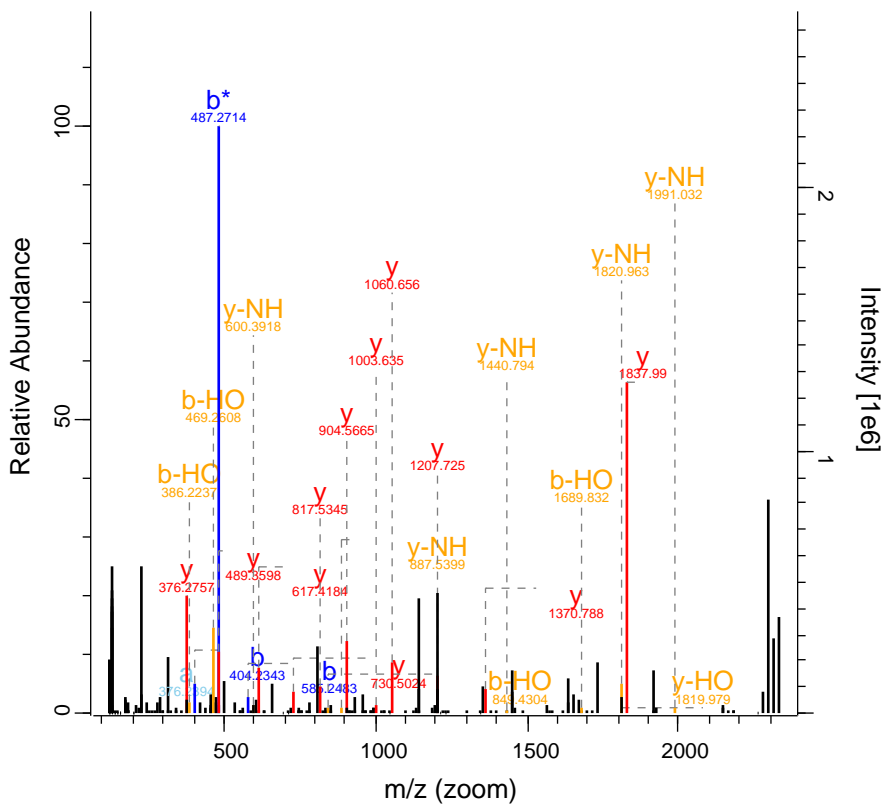

RO-QC-160121_ZackD_SS_Set_02_Fraction 34217 FTMS; HC 82.01 720.38 ANAPC1

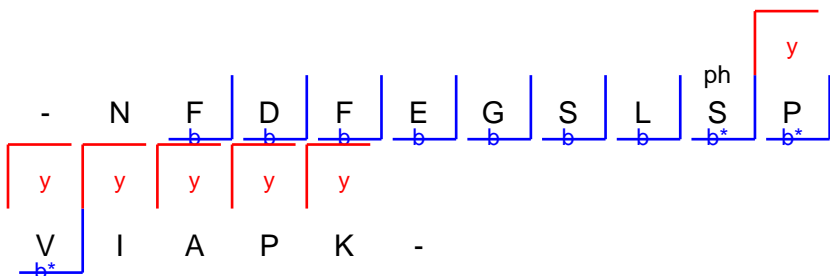
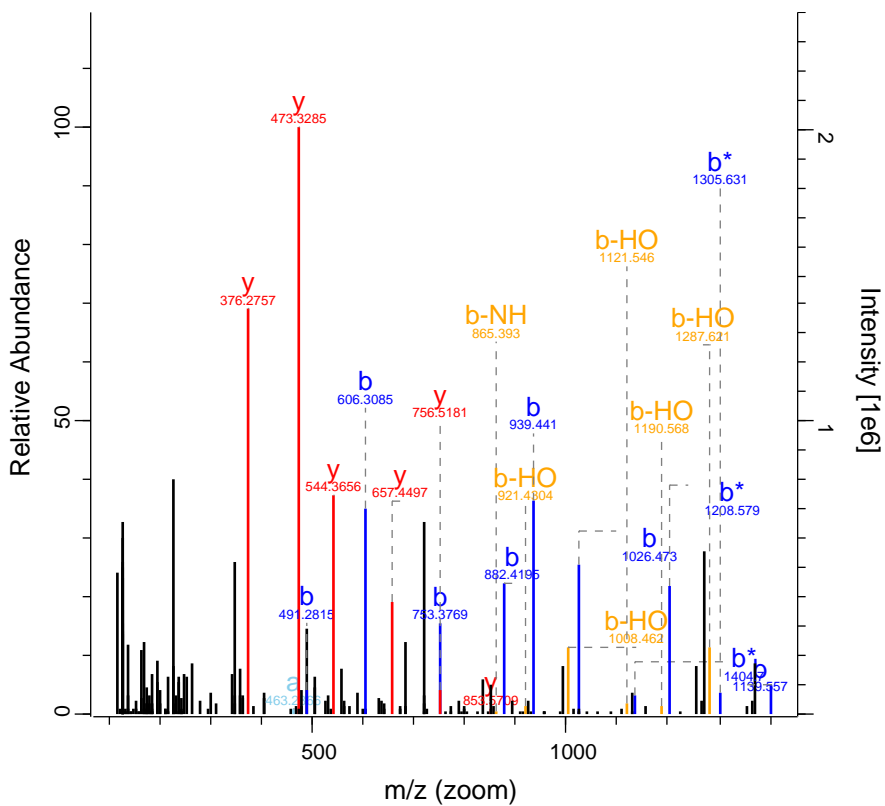

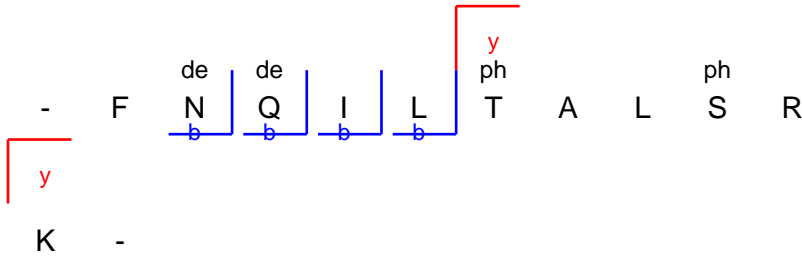
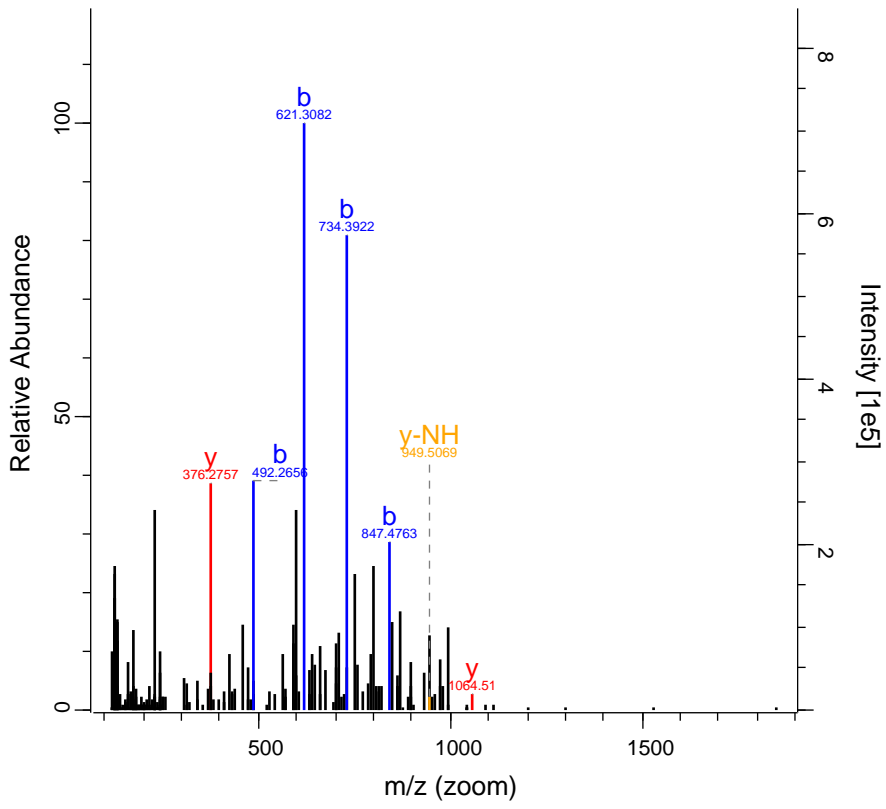

RO-QC-160121_ZackD_SS_Set_02_Fractic 34732 FTMS; HC 42.71 1122.55 KALRN

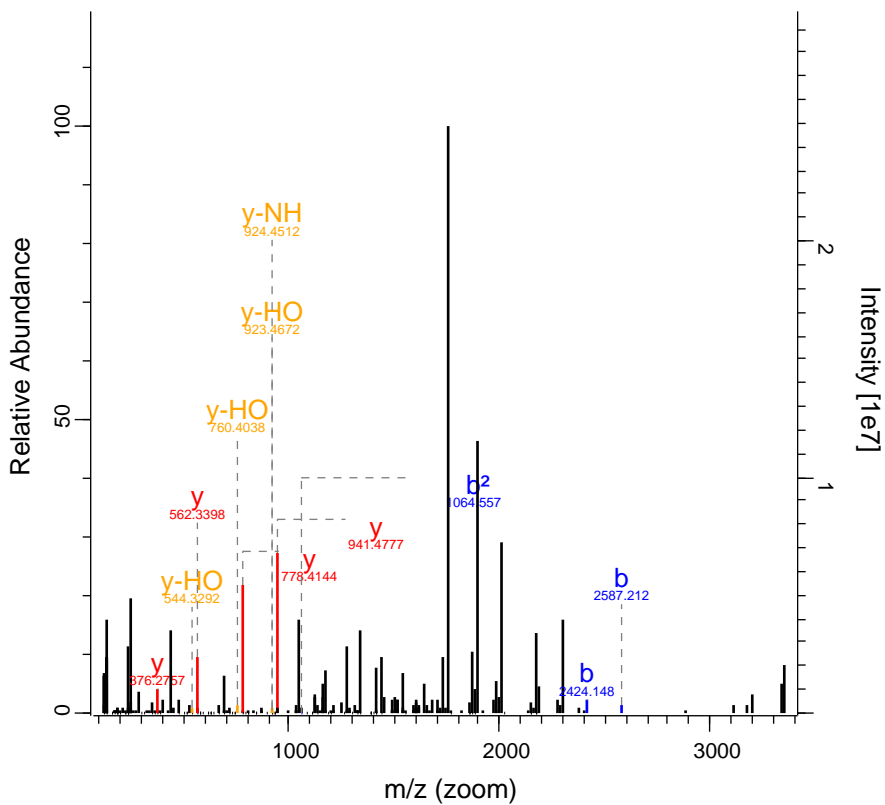

de
- A L Q K R H D D F E
E V A Q N T Y T N A D
y
K -

Fragmentation diagram showing peptide sequence: - A L Q K R H D D F E. The sequence is broken into fragments: A, L, Q, N, T, Y, T, N, A, D. The fragment QN is labeled with b² (blue), and the fragment Y is labeled with y (red). The fragment Y is also labeled with b (blue). The fragment Y is also labeled with y (red). The fragment Y is also labeled with y (red). The fragment Y is also labeled with y (red).

RO-QC-160121_ZackD_SS_Set_02_Fractic 35654 FTMS; HC 124.09 1092.06 FERMT2

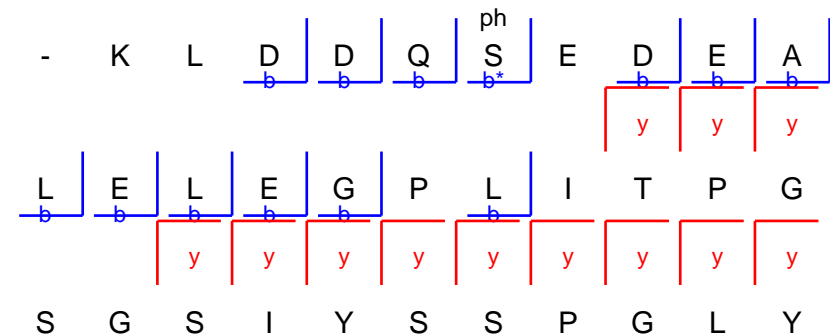
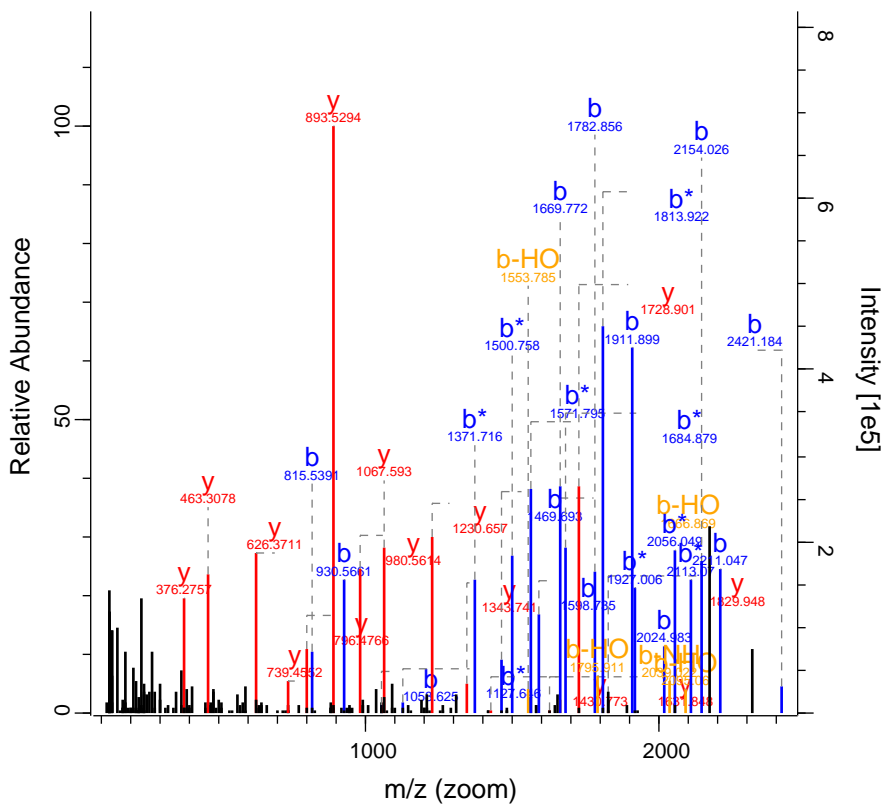

RO-QC-160121_ZackD_SS_Set_02_Fractic 35885 FTMS; HC 94.31 1145.64 SLC35A5

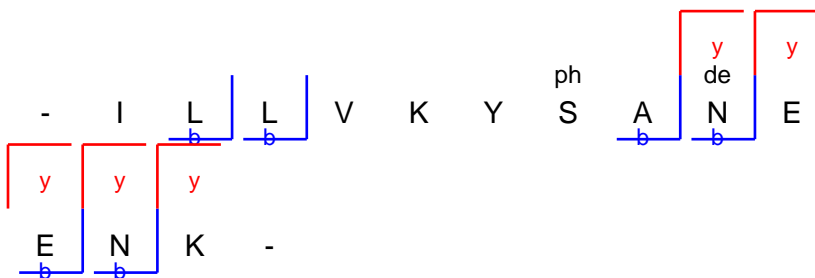
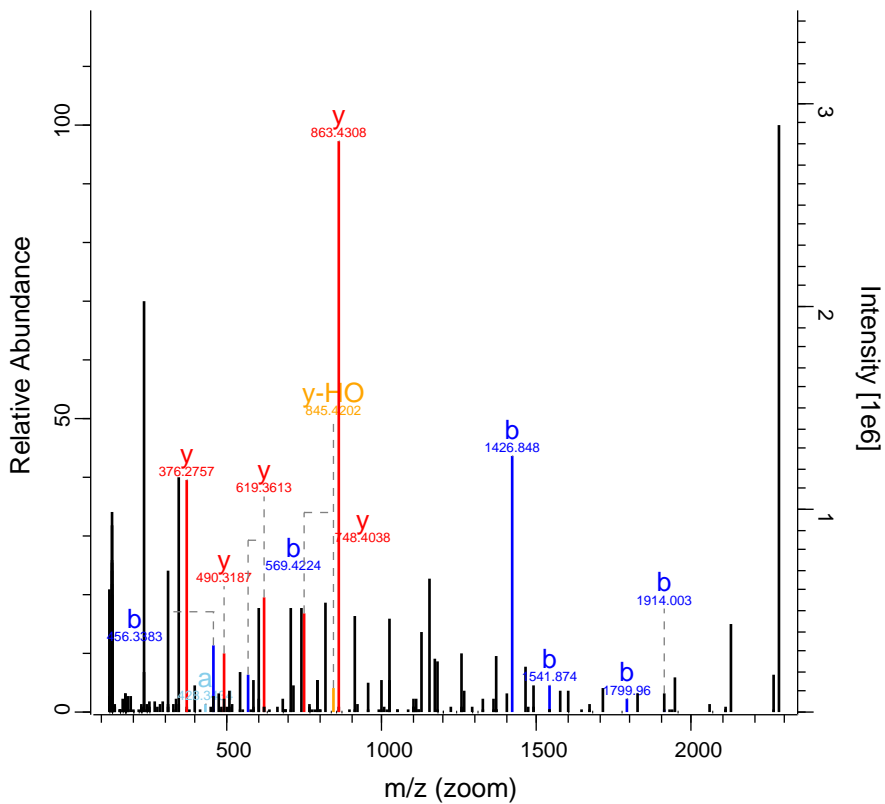

RO-QC-160121_ZackD_SS_Set_02_Fraction 36833 FTMS; HC 41.64 703.67 AHNAK

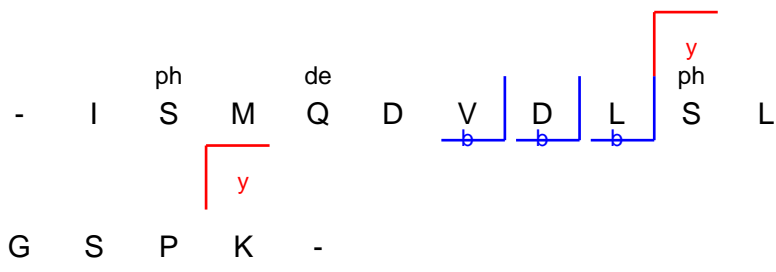
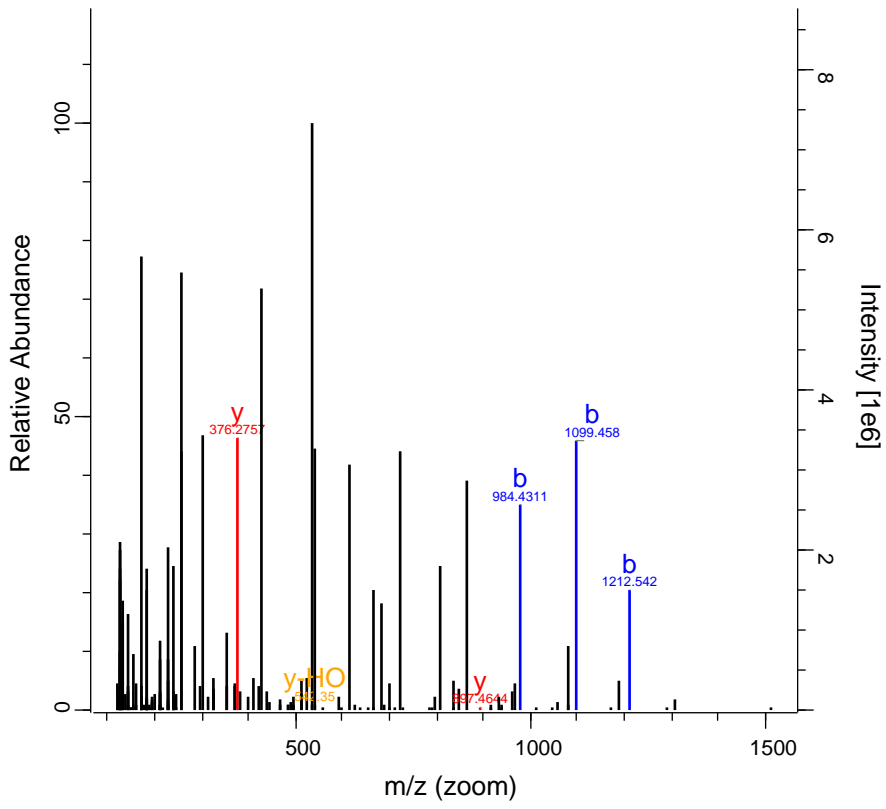

RO-QC-160121_ZackD_SS_Set_02_Fraction 37014 FTMS; HC 47.29 825.96 SMAD3

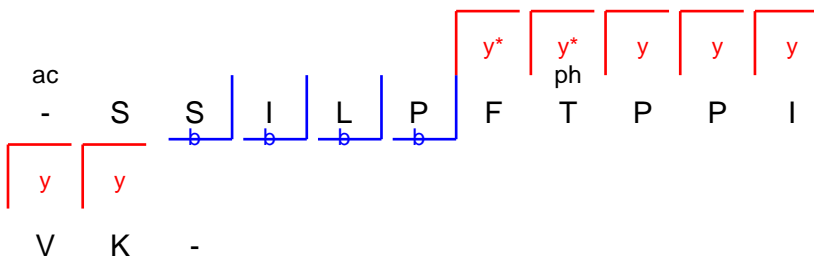
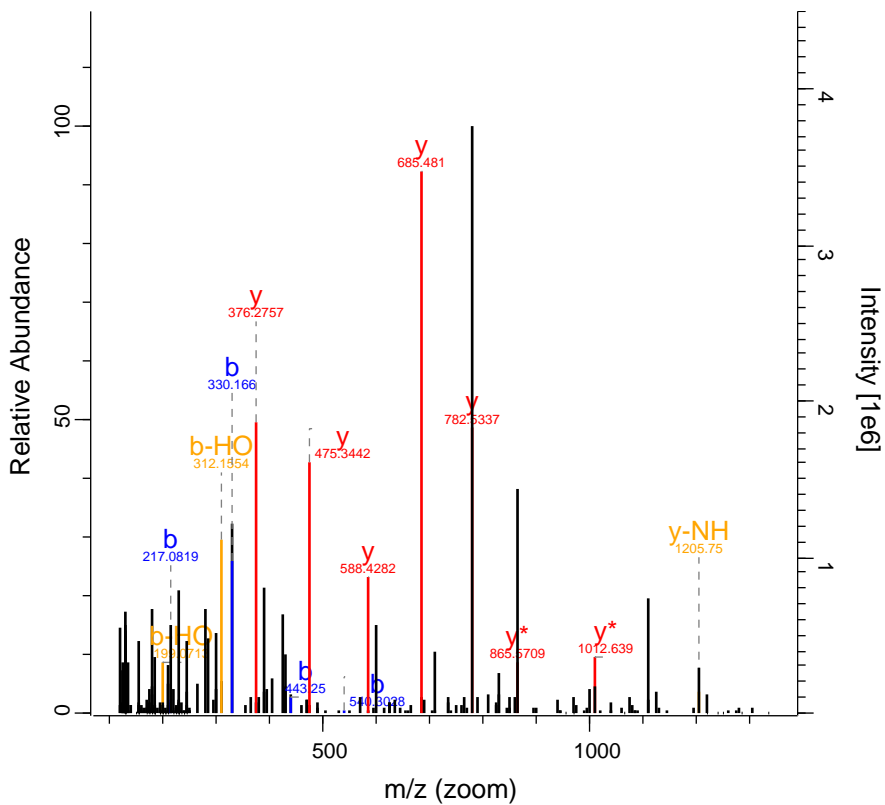

RO-QC-160121_ZackD_SS_Set_02_Fraction 37175 FTMS; HC 55.26 698.05 YWHAE

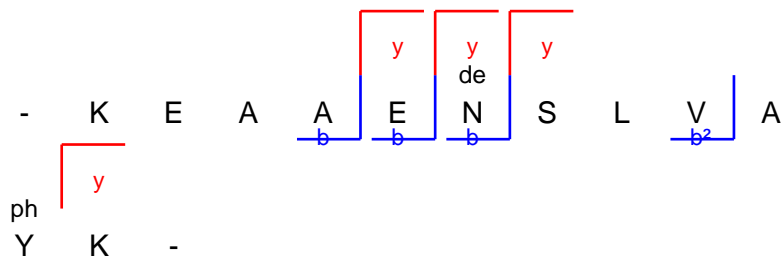
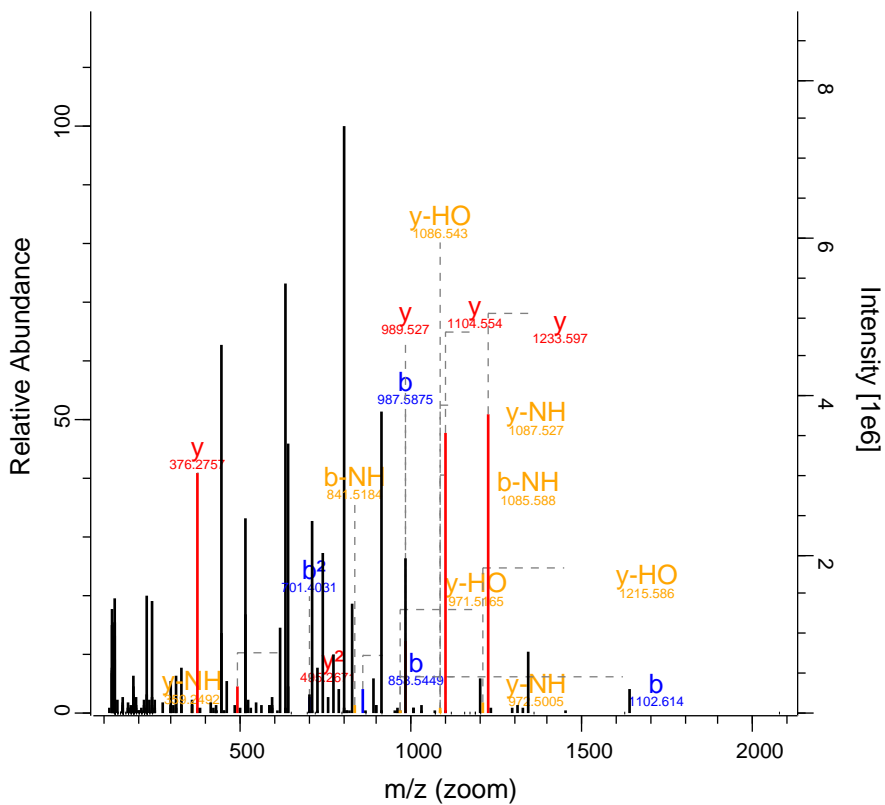

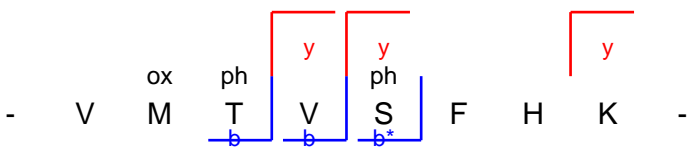
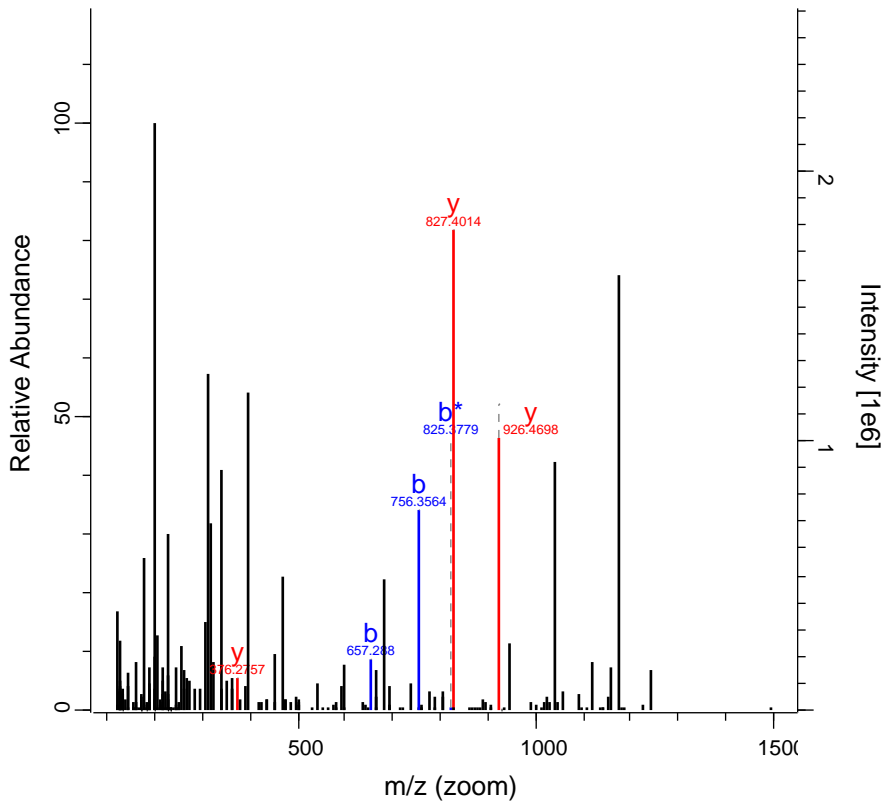

RO-QC-160121_ZackD_SS_Set_02_Fraction15277 FTMS; HC 113.54 749.58 AES

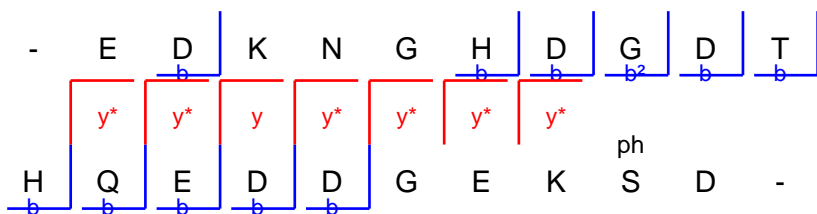
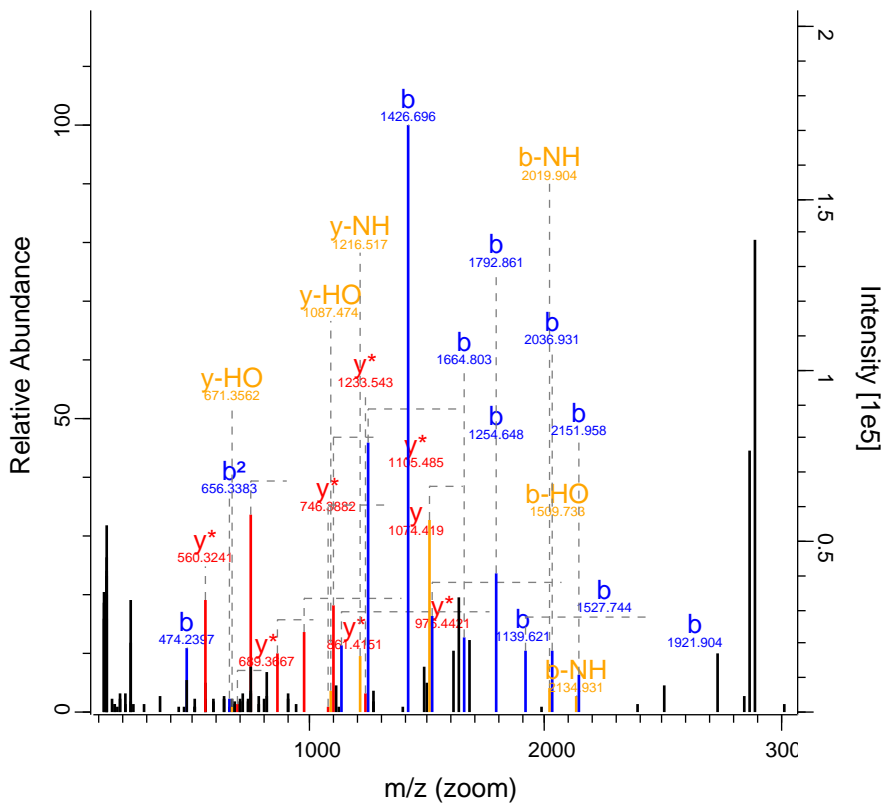

RO-QC-160121_ZackD_SS_Set_02_Fraction 5638 FTMS; HCl 52.79 440.5 FAM111B

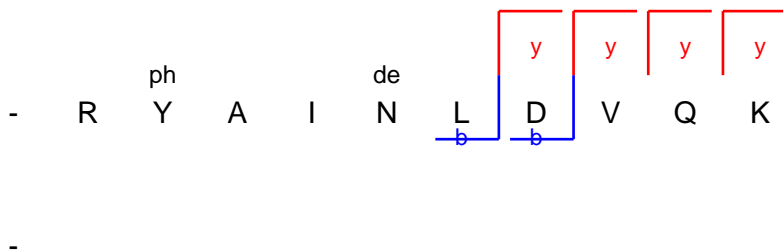
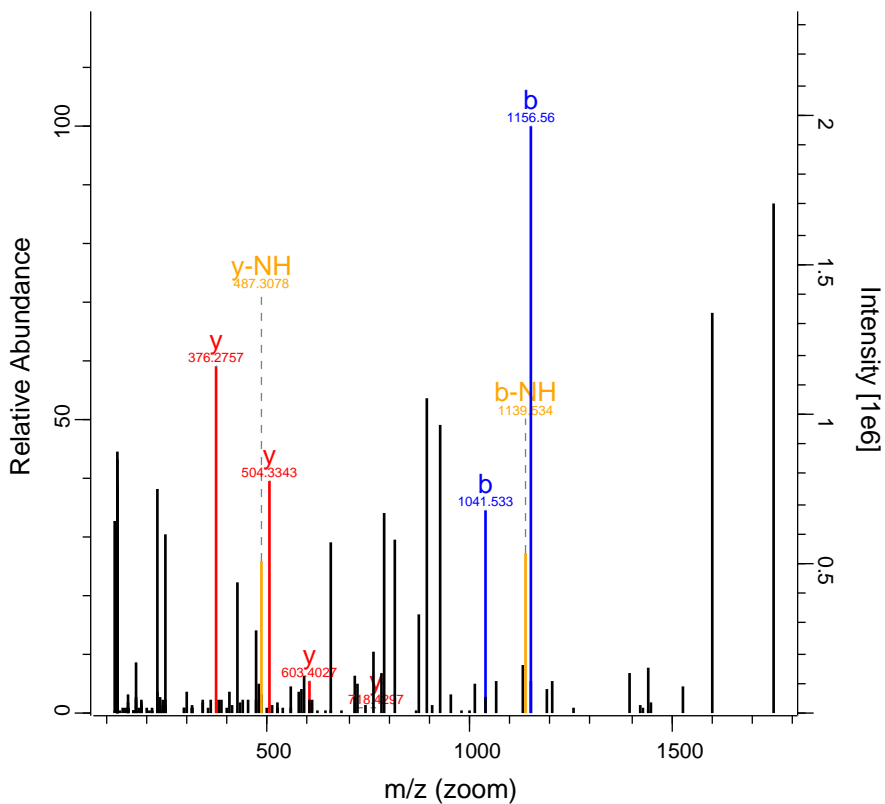

RO-QC-160121_ZackD_SS_Set_02_Fraction 6545 FTMS; HC 116.65 740.68 EIF4B

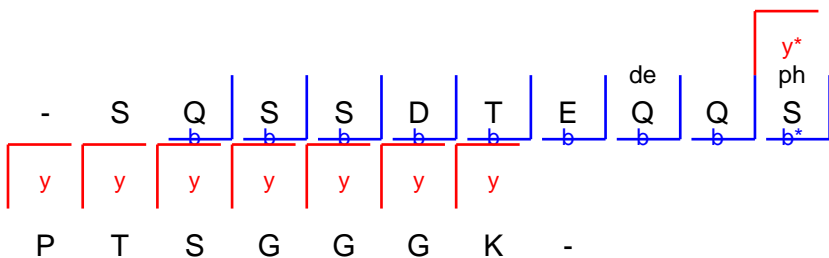
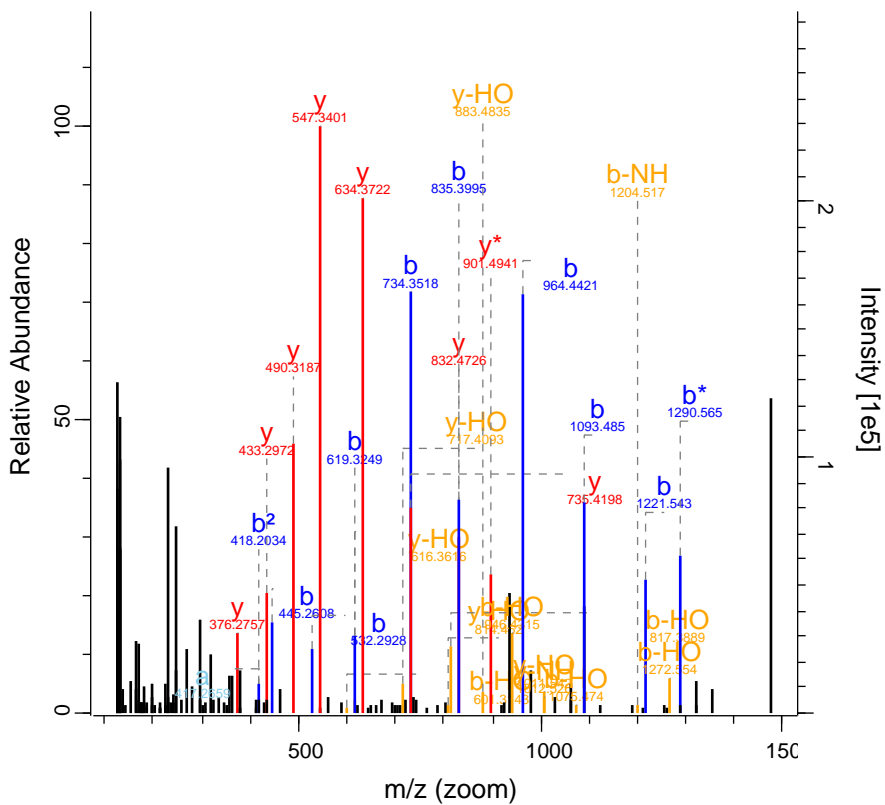

RO-QC-160121_ZackD_SS_Set_02_Fraction 6698 FTMS; HCl 78.1 453.51 AHCTF1

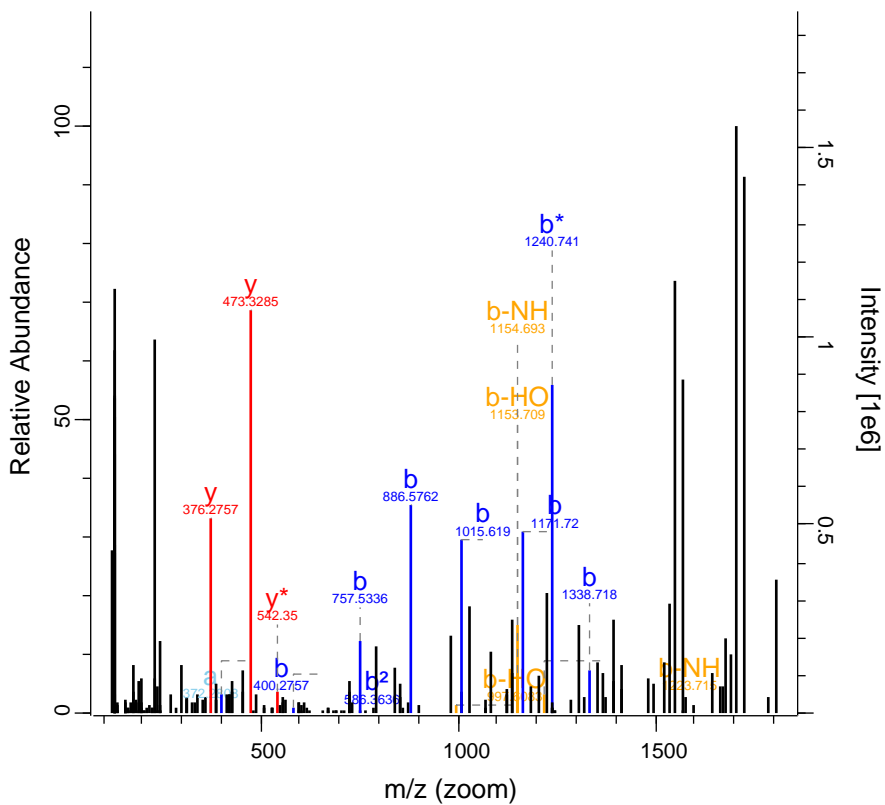

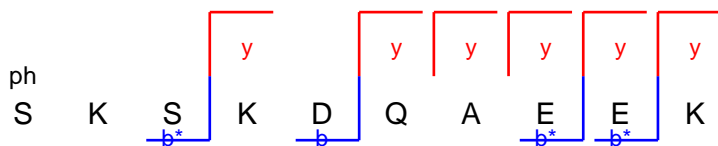
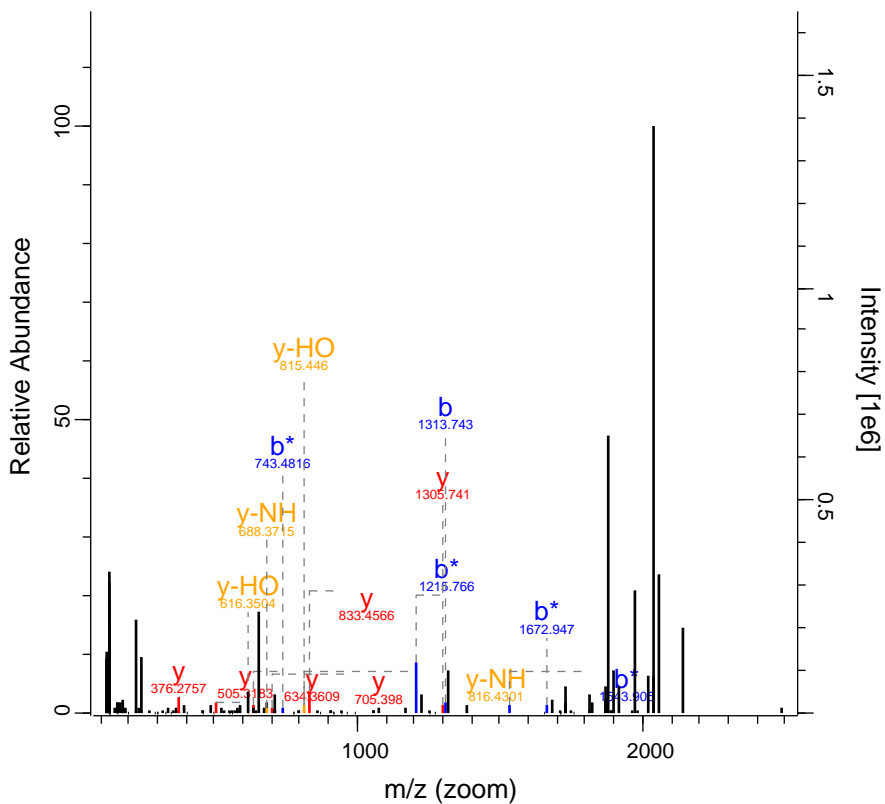

RO-QC-160121_ZackD_SS_Set_02_Fraction 8740 FTMS; HCl 78.32 666.06 PPIG

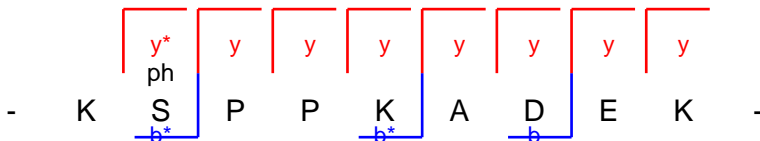
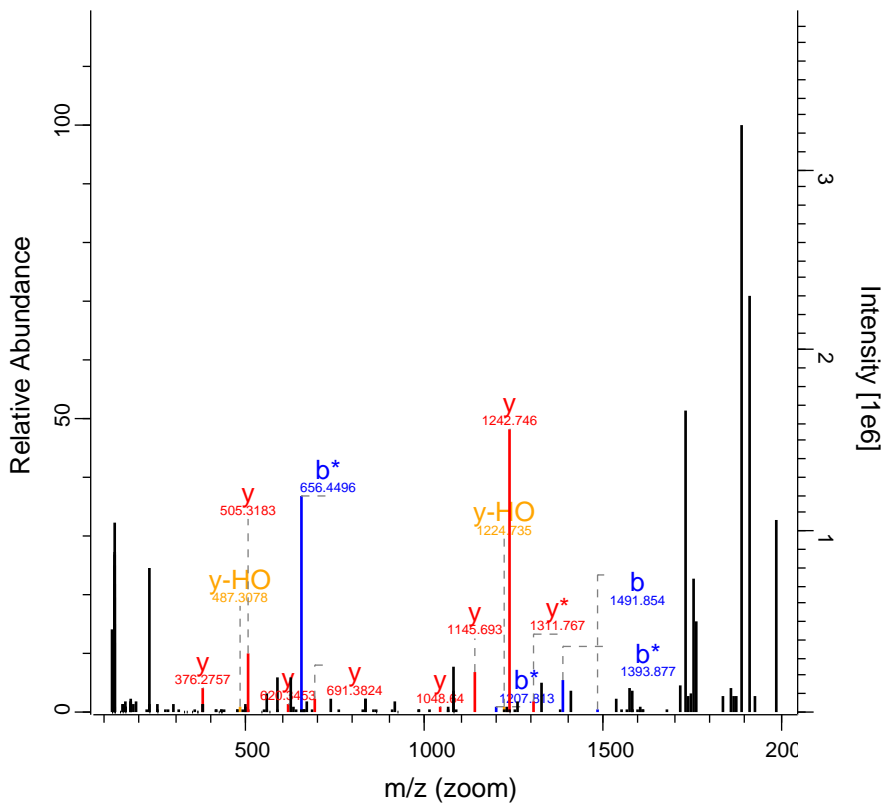

RO-QC-160121_ZackD_SS_Set_02_Fractic 10982 FTMS; HC 150.49 1023.56 PPIG

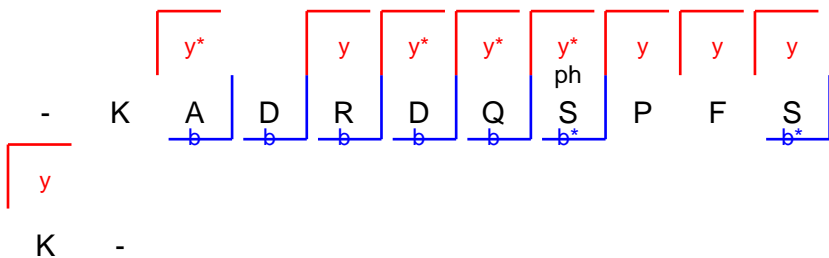
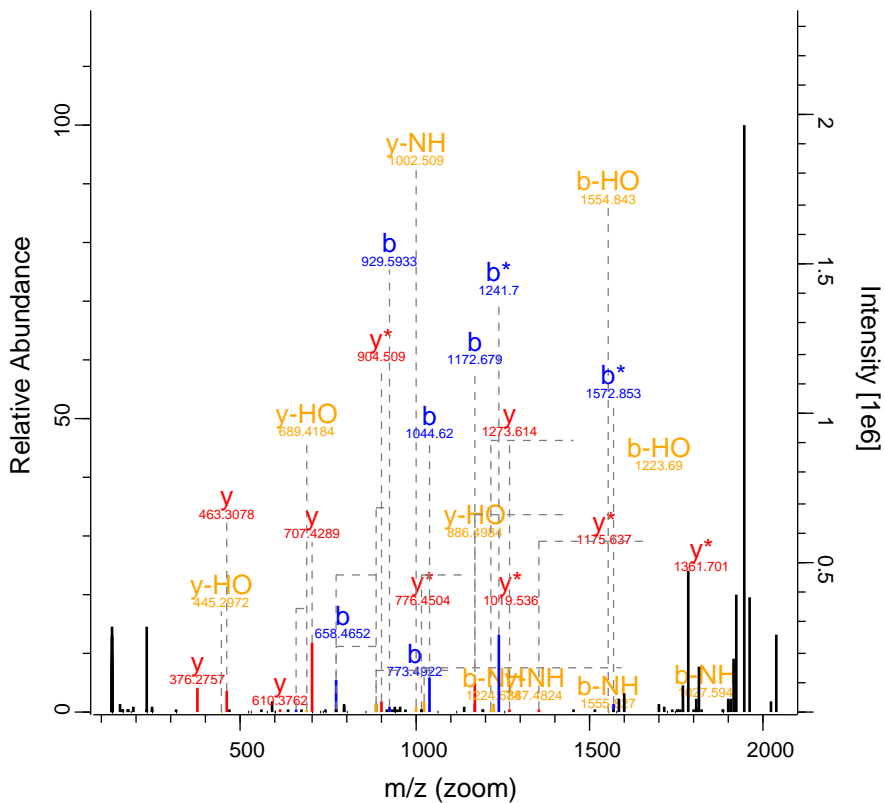

RO-QC-160121_ZackD_SS_Set_02_Fraction 12361 FTMS; HC 63.15 365.56 DIAPH2

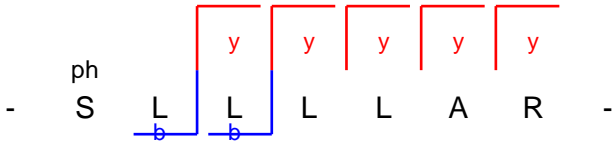
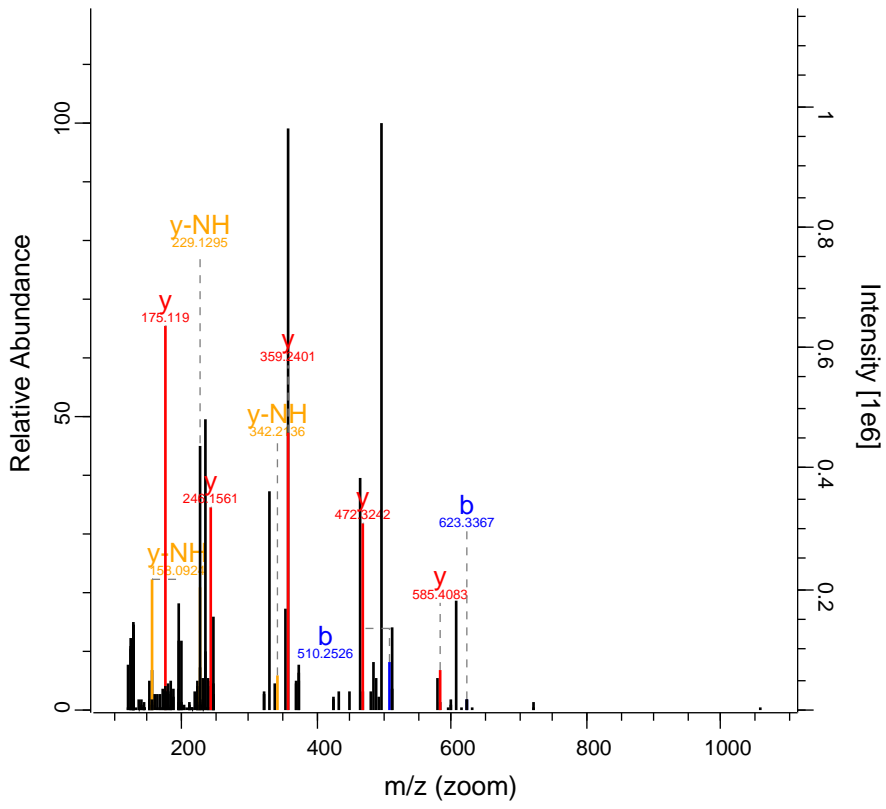

RO-QC-160121_ZackD_SS_Set_02_Fraction 12650 FTMS; HC 84.36 915.53 MAP4

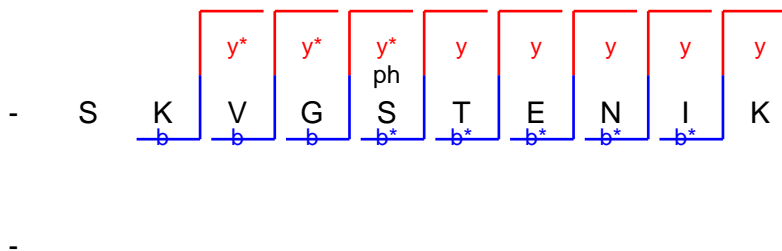
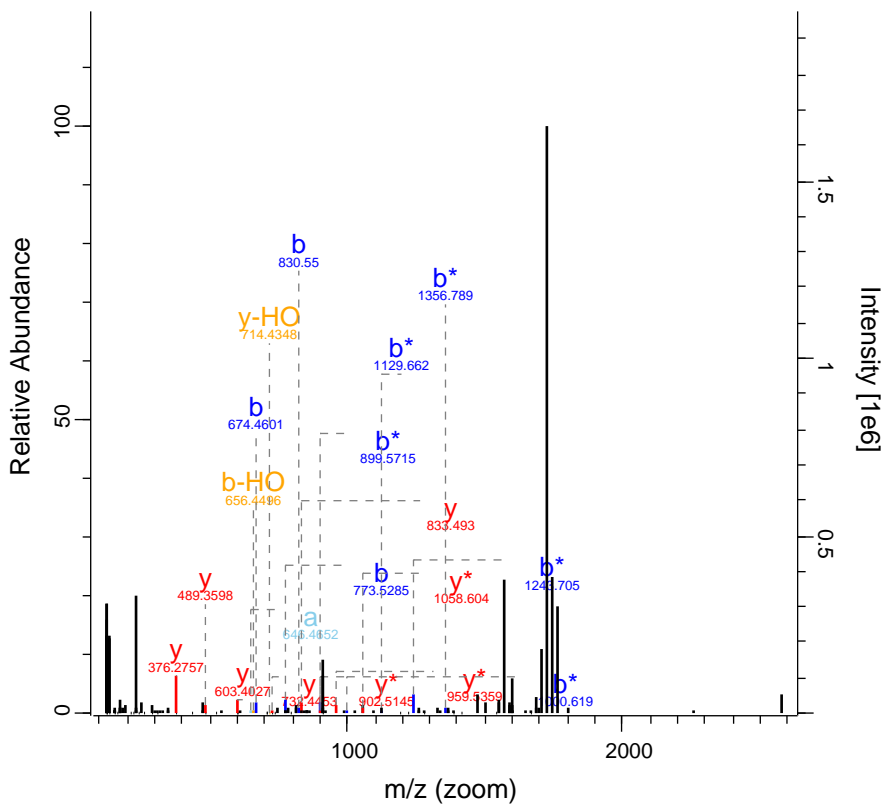

RO-QC-160121_ZackD_SS_Set_02_Fraction 12920 FTMS; HC 42.81 682.35 RRAS2

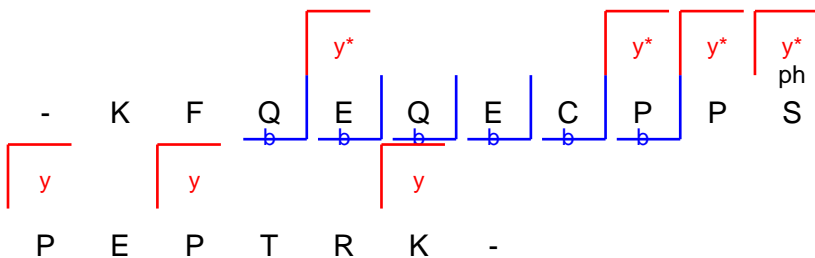
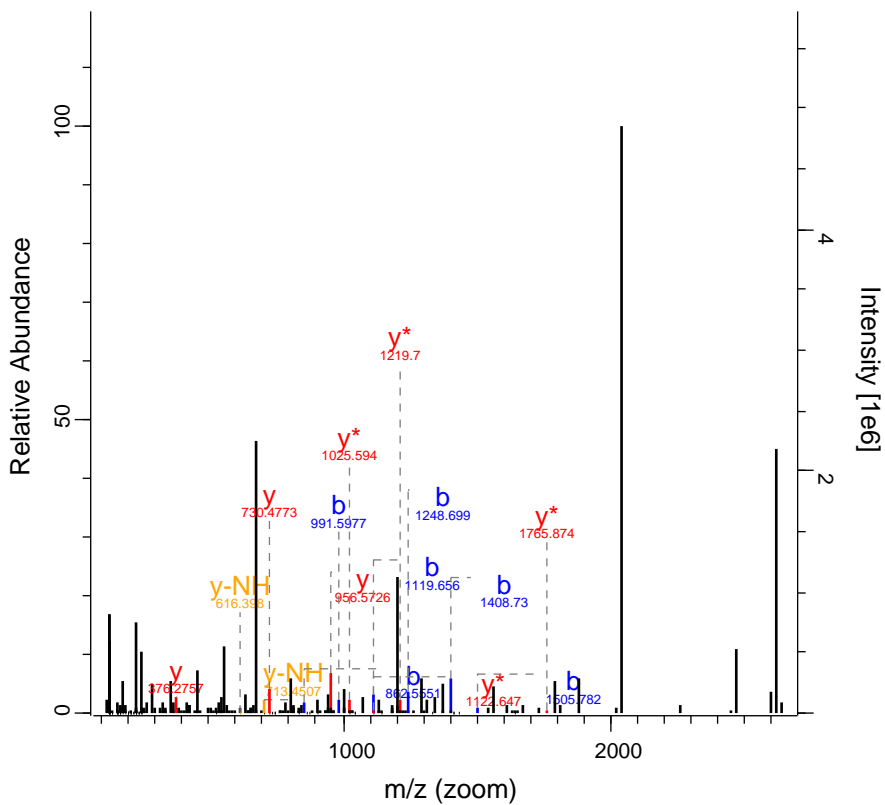

RO-QC-160121_ZackD_SS_Set_02_Fraction 13608 FTMS; HC 95.35 824.39 NDRG1

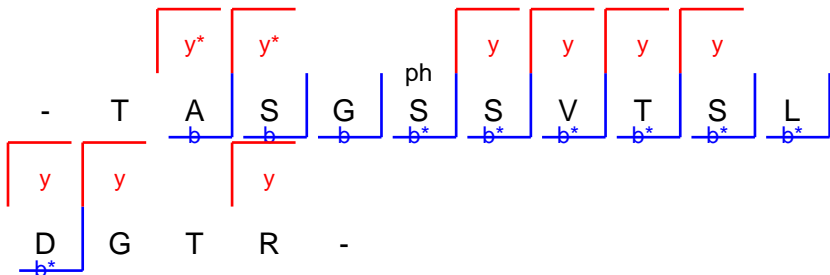
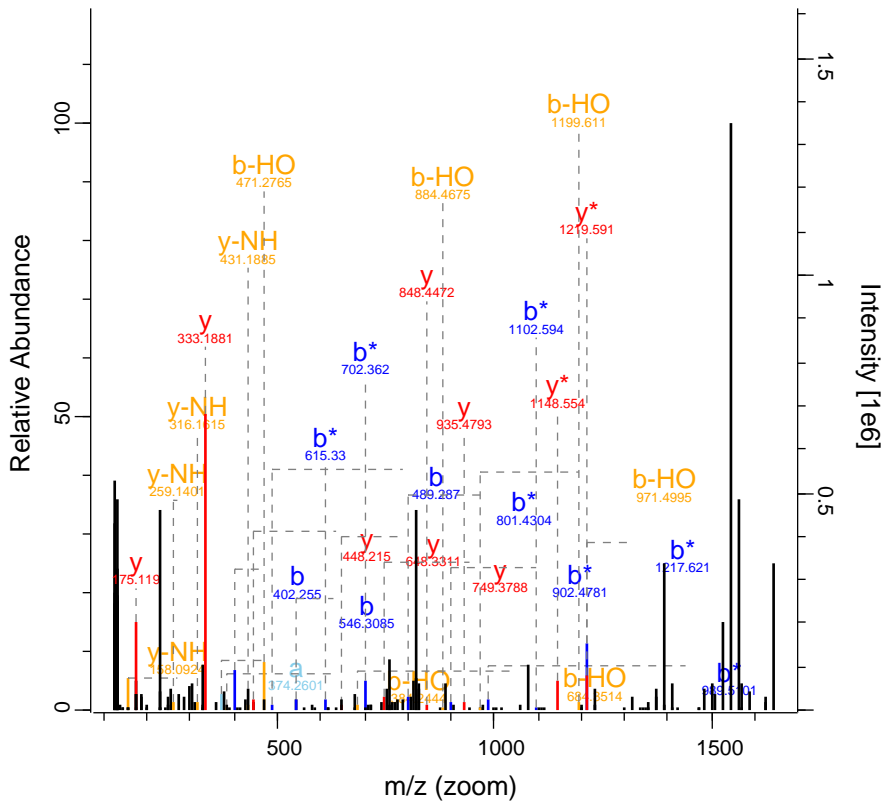

RO-QC-160121_ZackD_SS_Set_02_Fractic 15905 FTMS; HC 265.37 1208.09 PDS5B

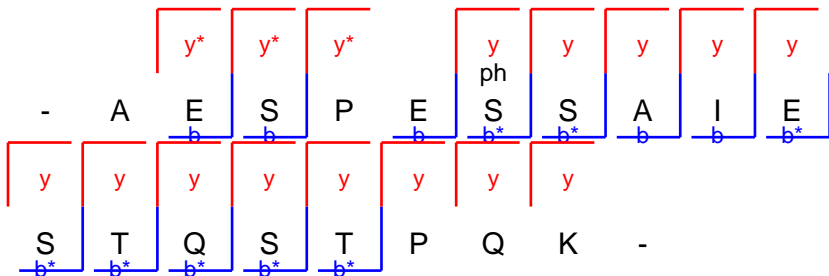
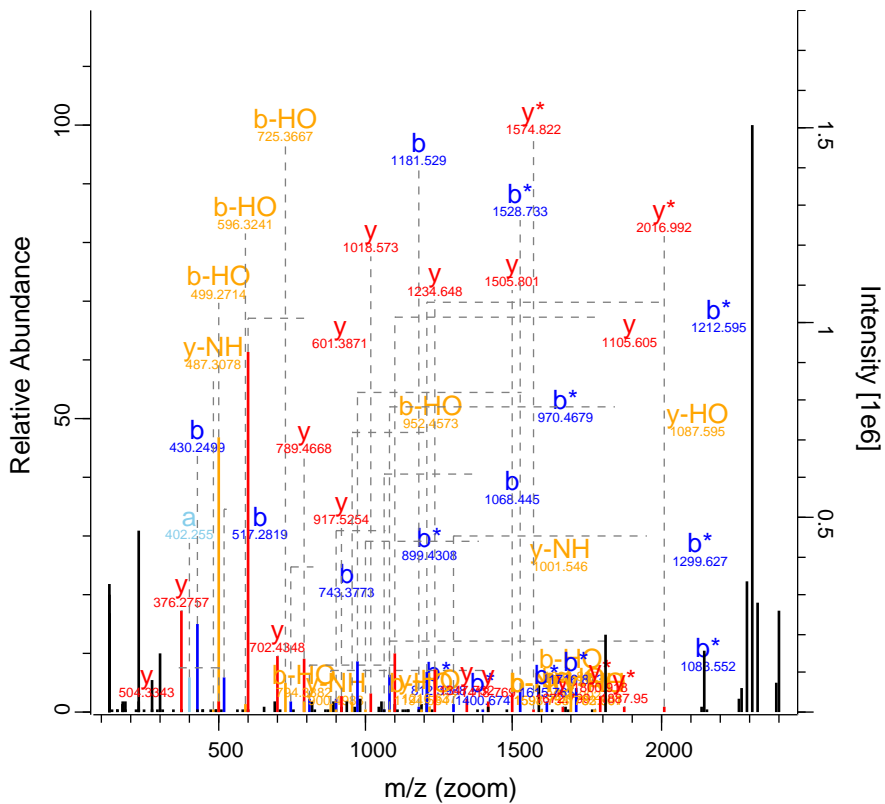

RO-QC-160121_ZackD_SS_Set_02_Fractio 16609 FTMS; HC 122.74 773.42 EXOC1

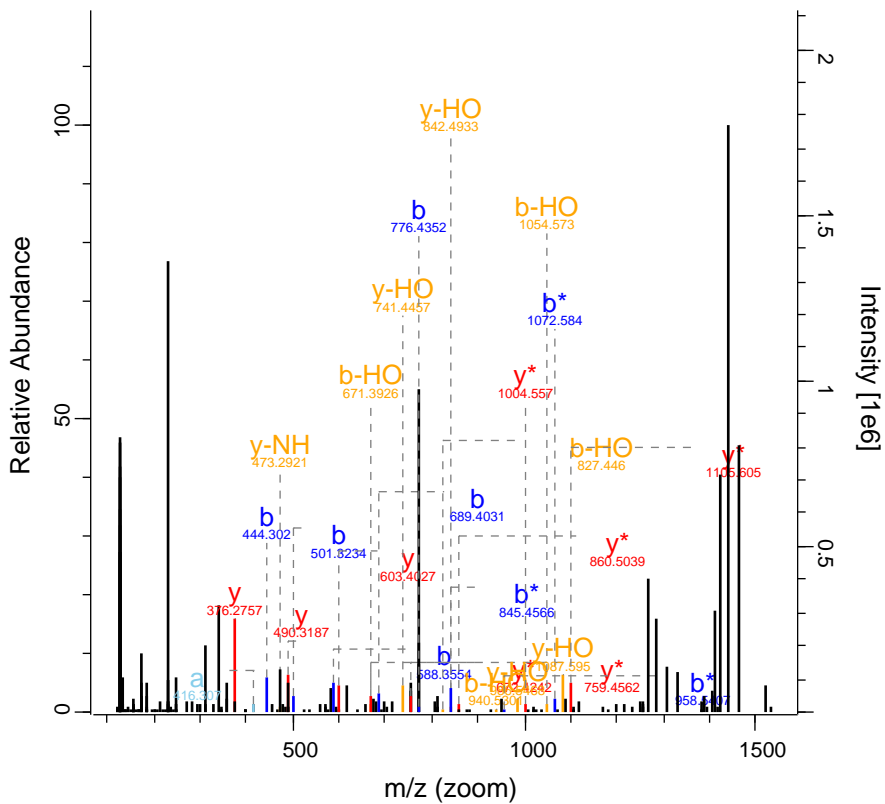

m/z (zoom)

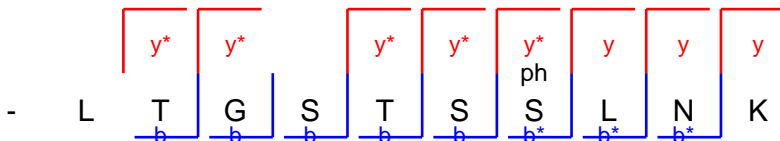

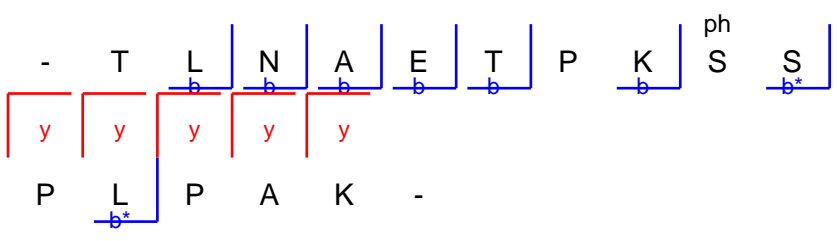
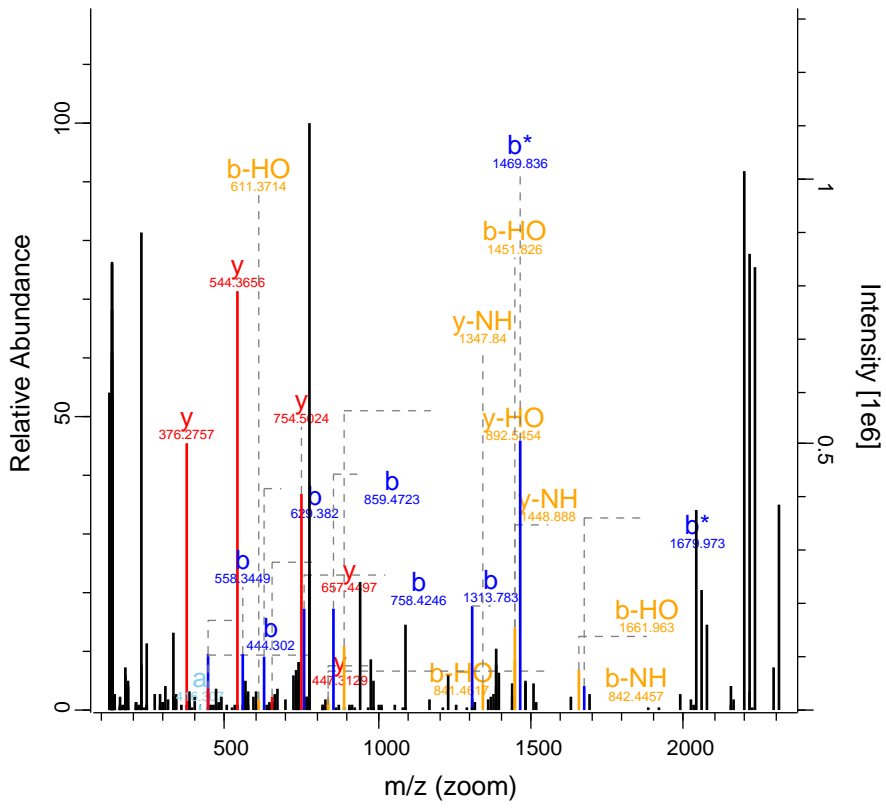

RO-QC-160121_ZackD_SS_Set_02_Fraction 18737 FTMS; HC 94.55 727.37 CCNY

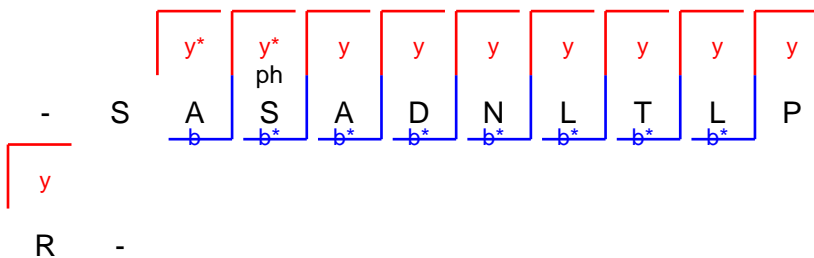
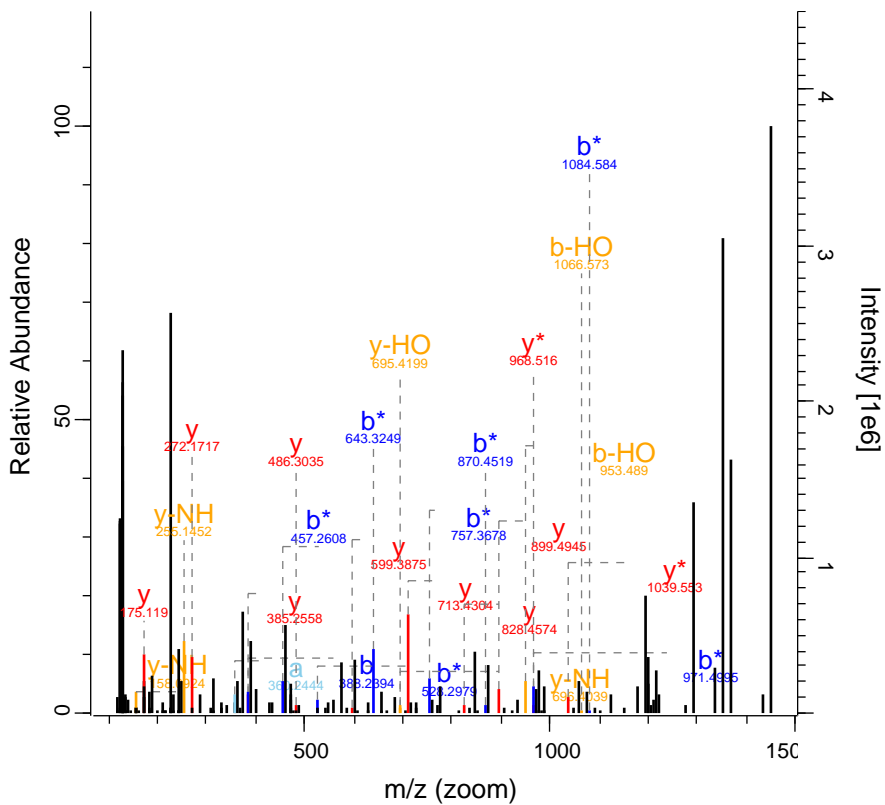

RO-QC-160121_ZackD_SS_Set_02_Fraction 18845 FTMS; HC 48.44 594.62 EXOC3L1

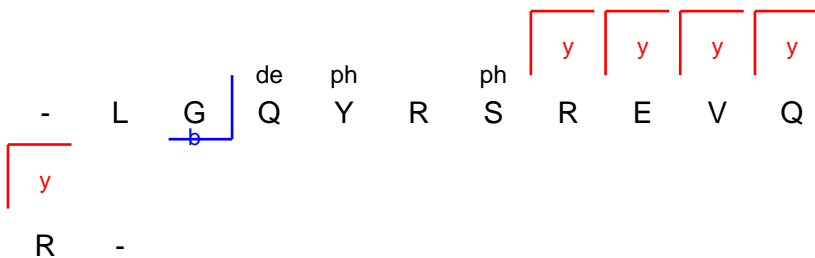
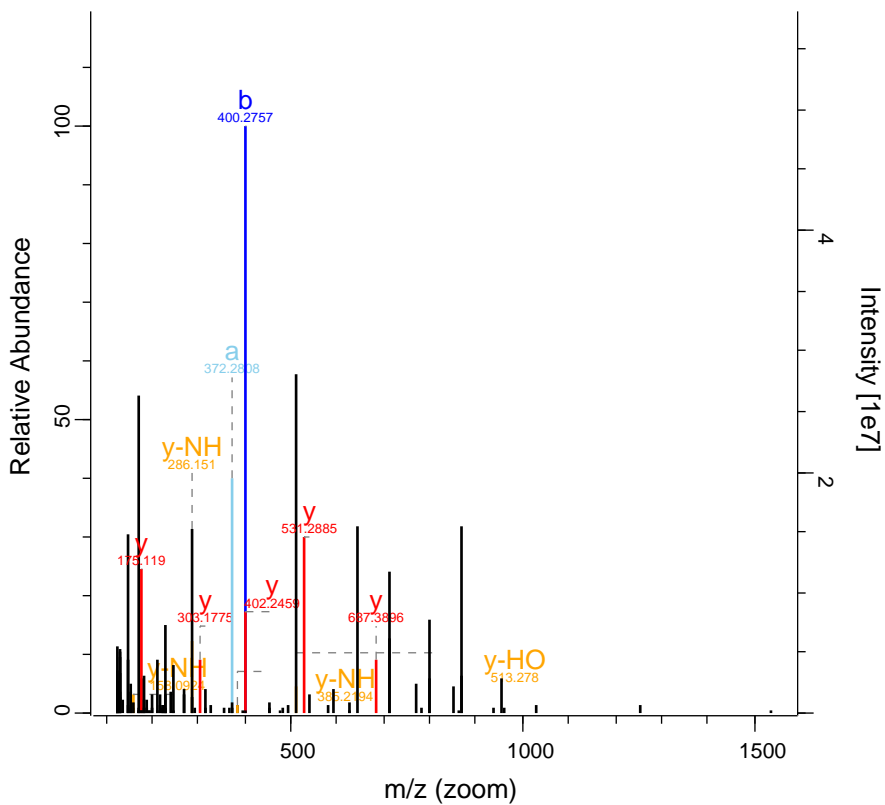

RO-QC-160121_ZackD_SS_Set_02_Fractio 19283 FTMS; HC 114.76 735.38 PRPH

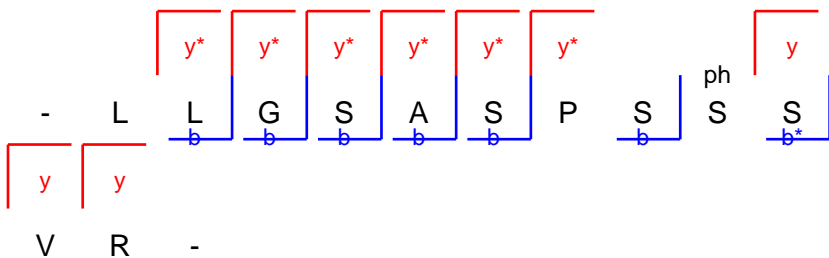
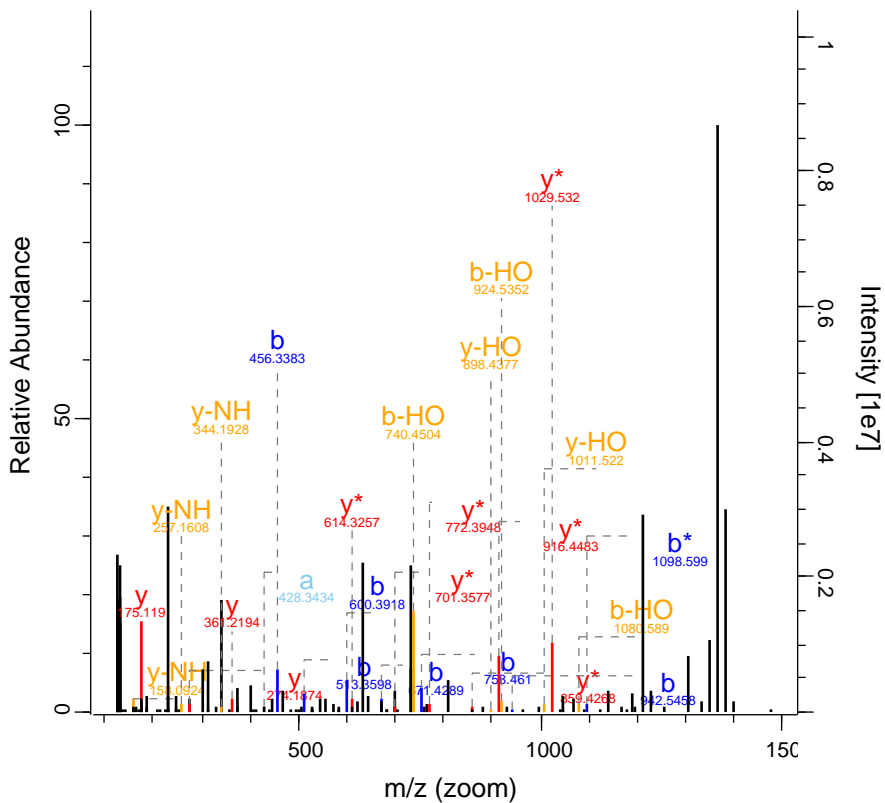

RO-QC-160121_ZackD_SS_Set_02_Fraction 20082 FTMS; HC 76.42 835.77 LIPE

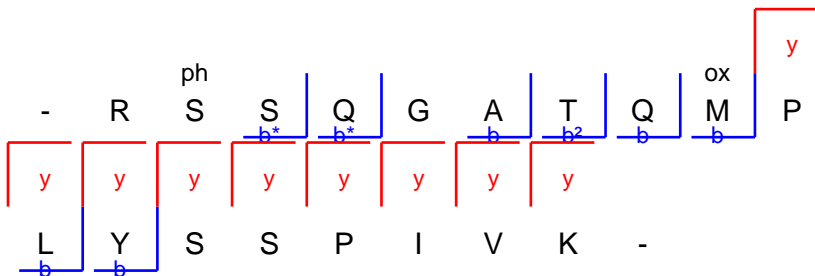
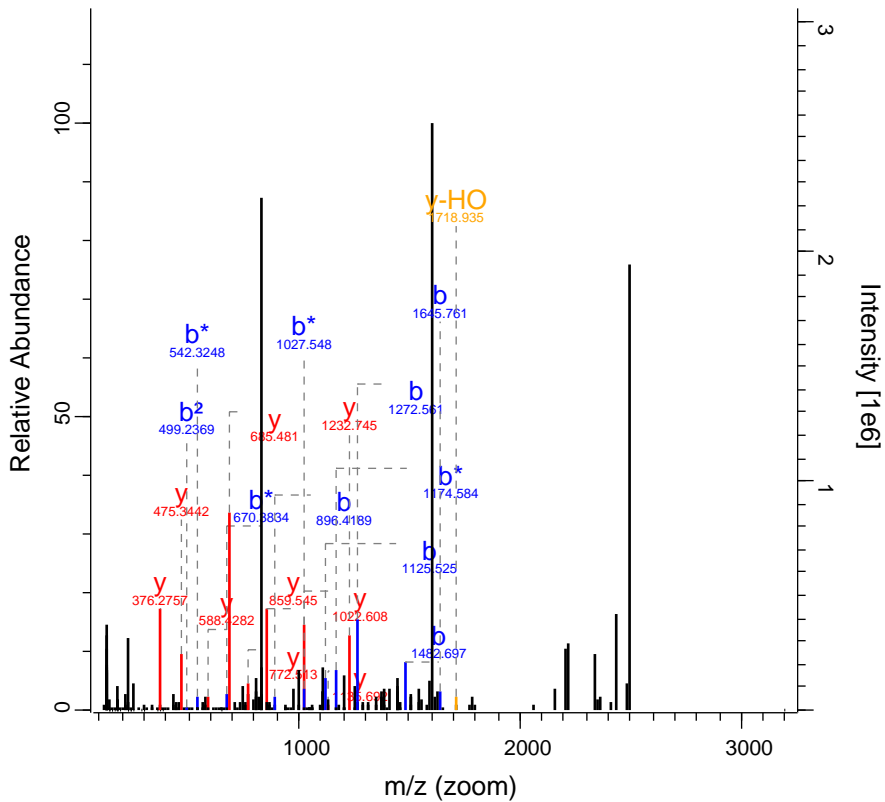

RO-QC-160121_ZackD_SS_Set_02_Fractic 20635 FTMS; HC 64.04 1029.98 ZNF215

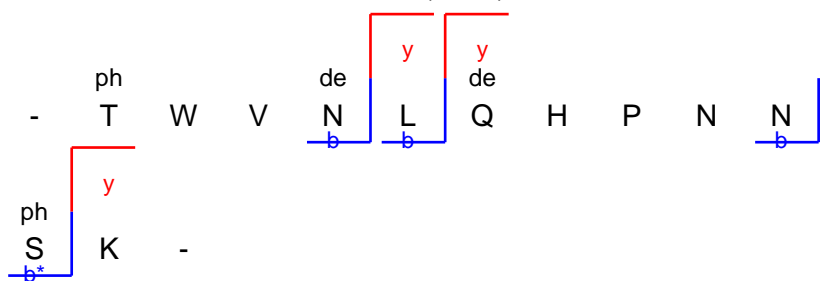
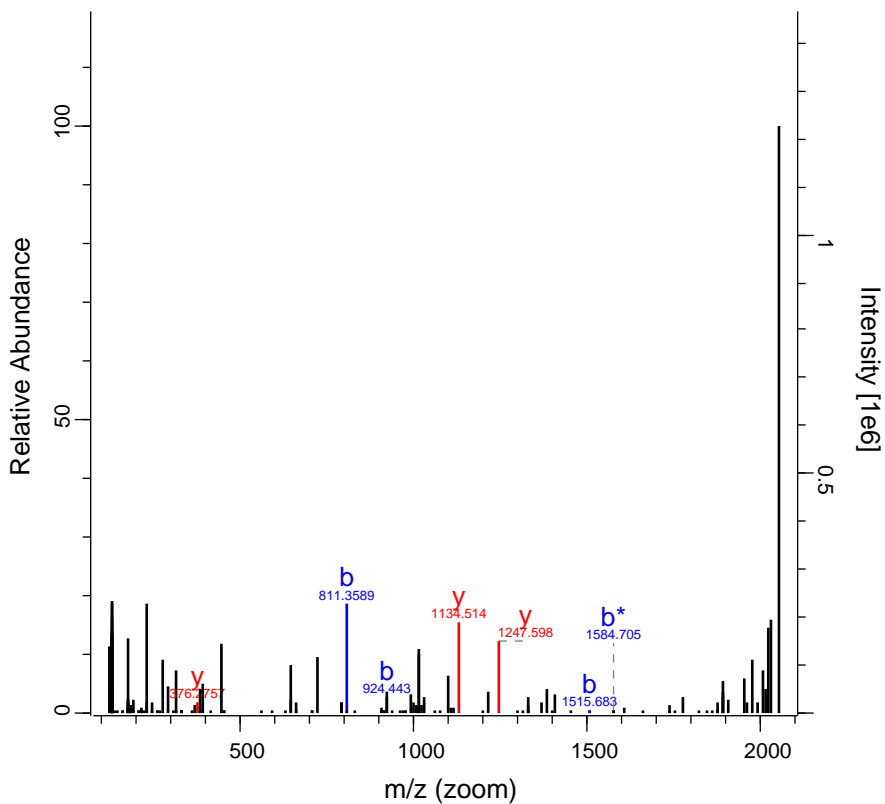

RO-QC-160121_ZackD_SS_Set_02_Fraction

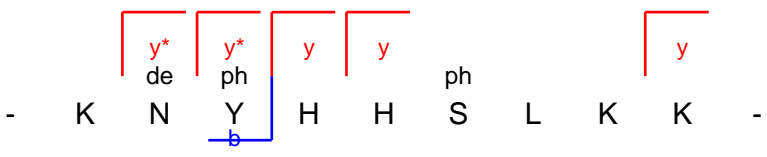
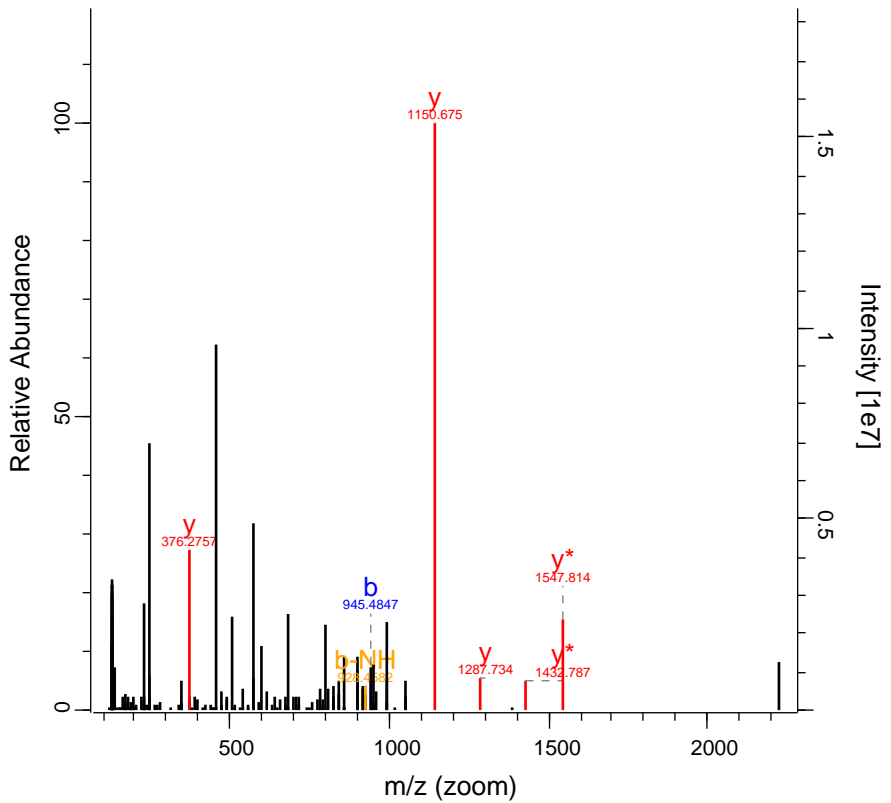

RO-QC-160121_ZackD_SS_Set_02_Fraction 21589 FTMS; HC 41.05 562.56 CYP17A1

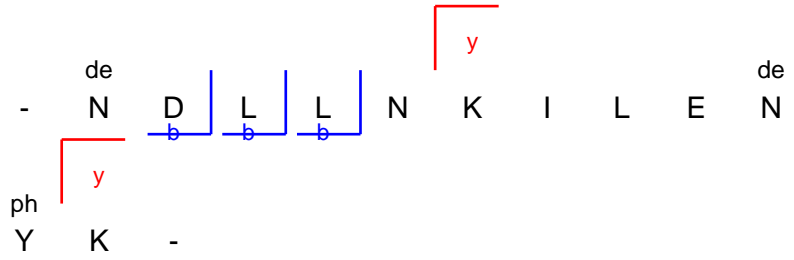
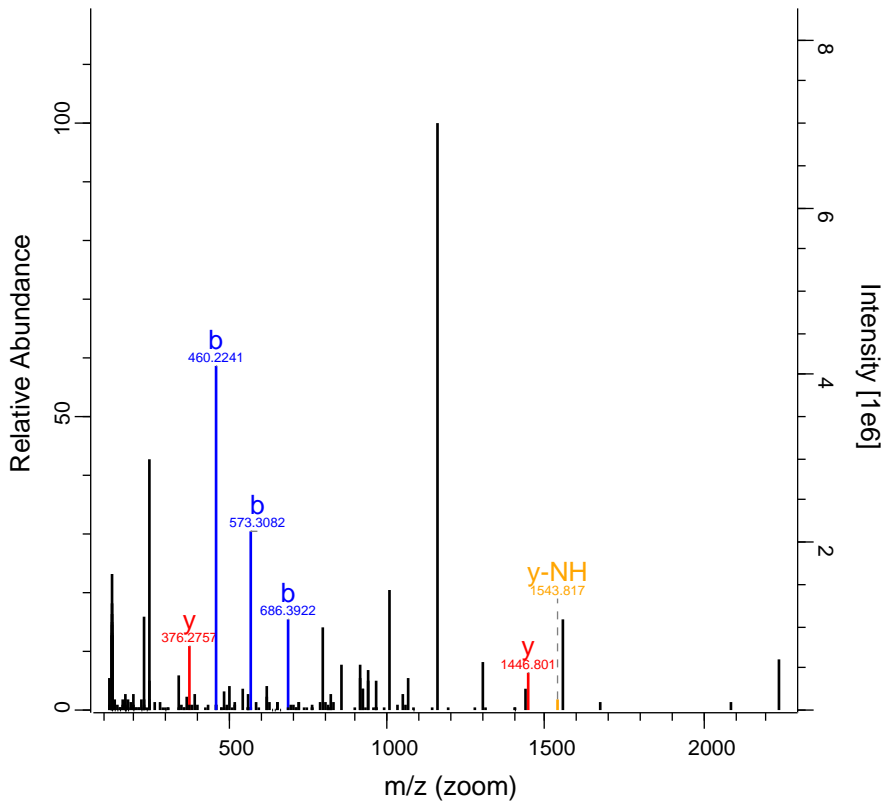

RO-QC-160121_ZackD_SS_Set_02_Fraction 23733 FTMS; HC 98.03 727.38 CFL1

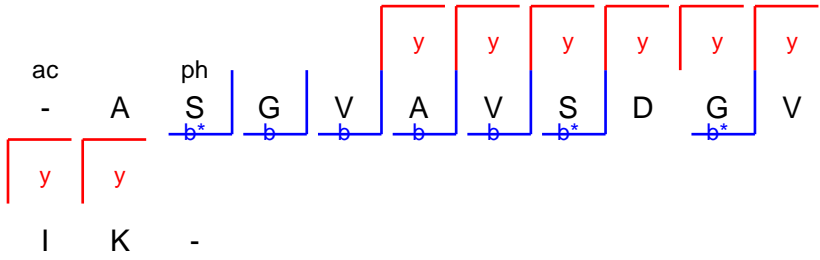
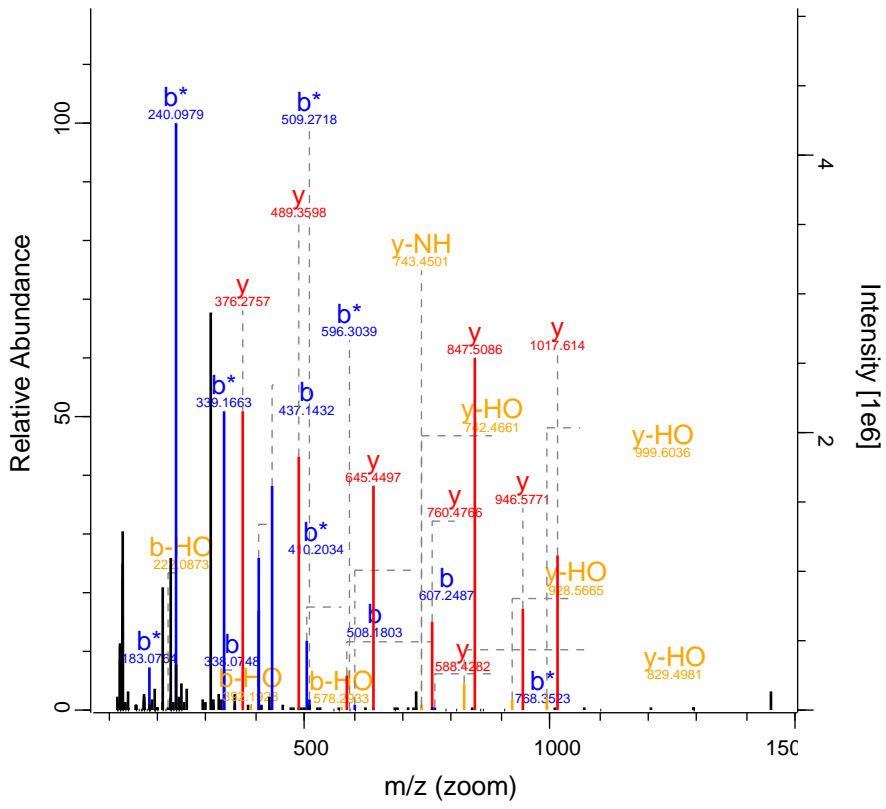

RO-QC-160121_ZackD_SS_Set_02_Fractic 24358 FTMS; HC 50.88 1026.83 FNDC1

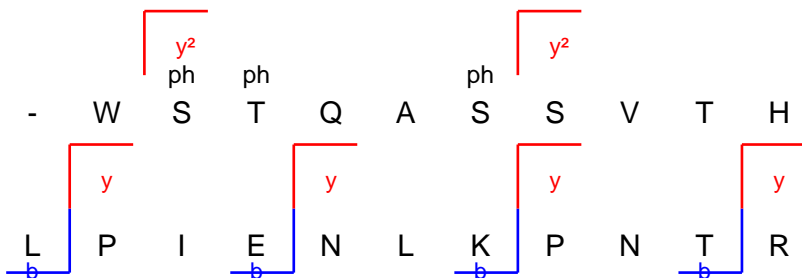
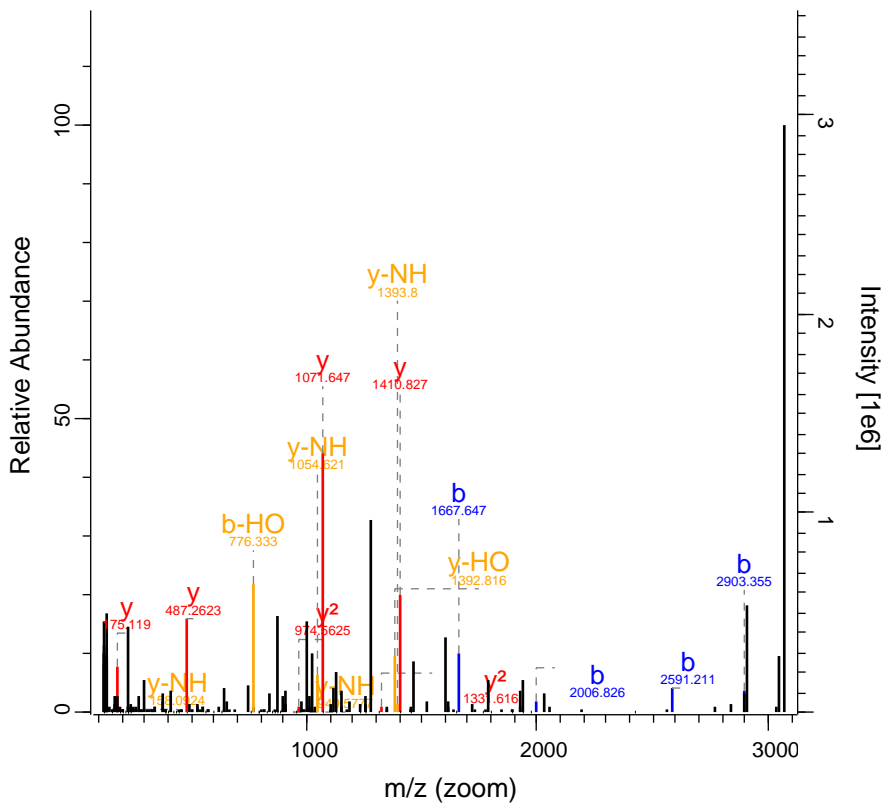

RO-QC-160121_ZackD_SS_Set_02_Fraction 24588 FTMS; HC 84.95 803.19 ADD3

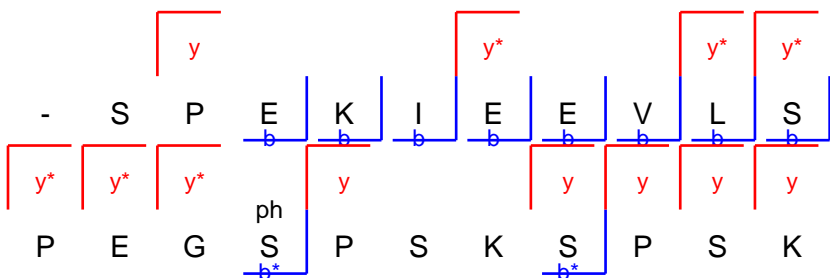
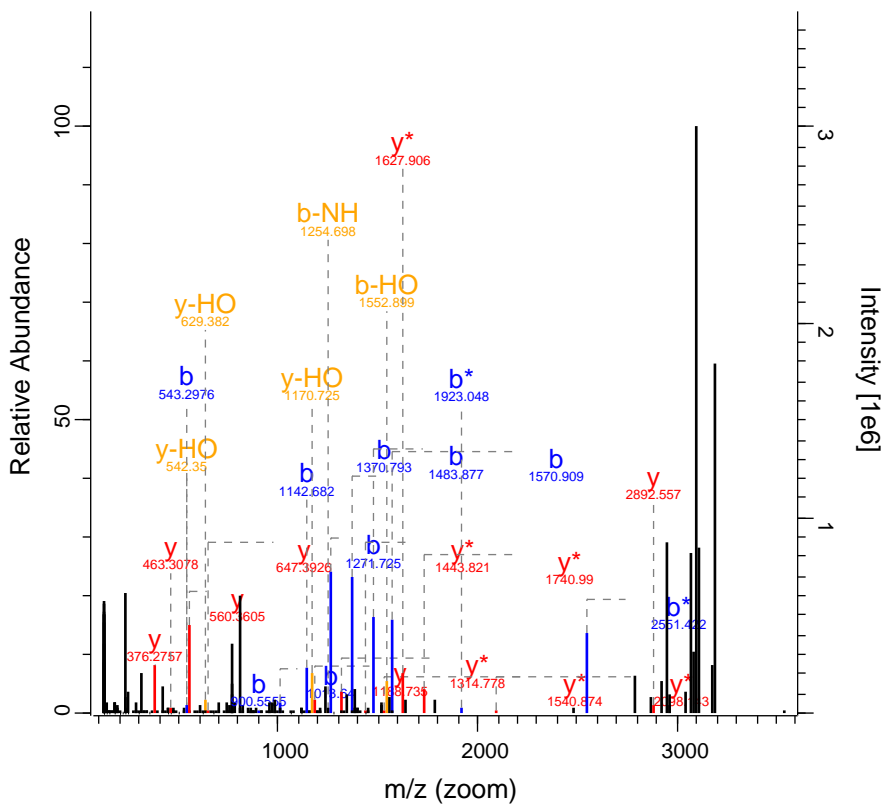

RO-QC-160121_ZackD_SS_Set_02_Fraction 28213 FTMS; HC 46.13 737.86 TRIL

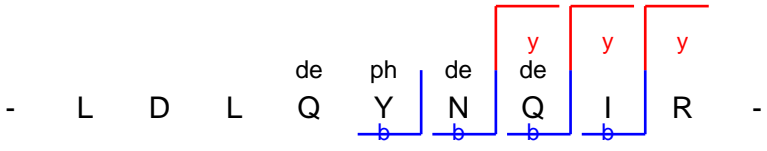
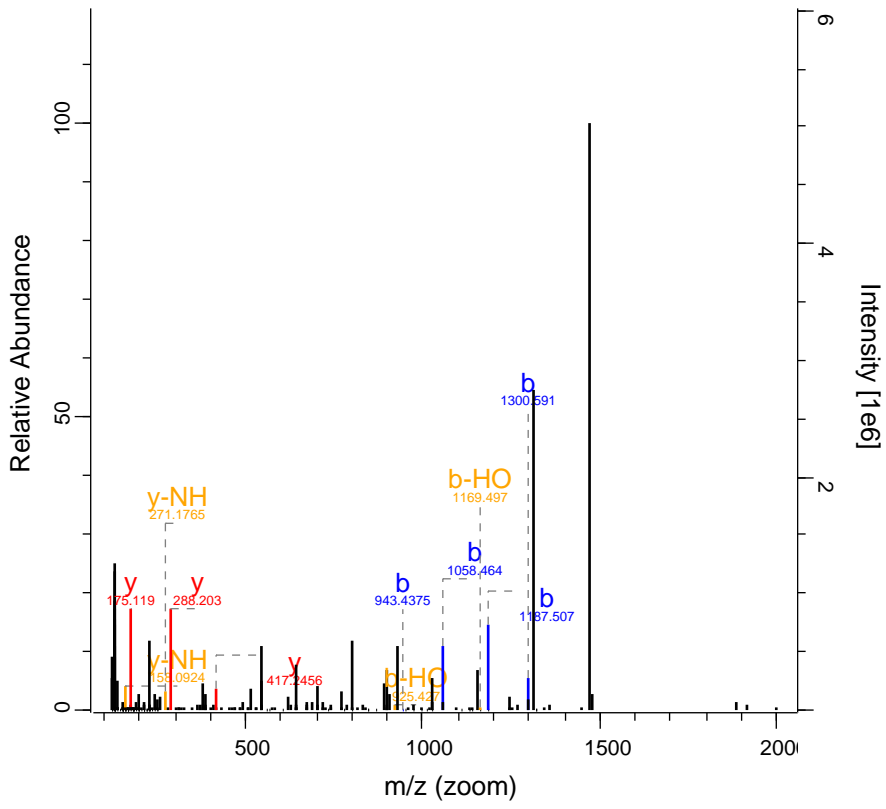

RO-QC-160121_ZackD_SS_Set_02_Fraction 28877 FTMS; HC 44.16 815.69 SLITRK4

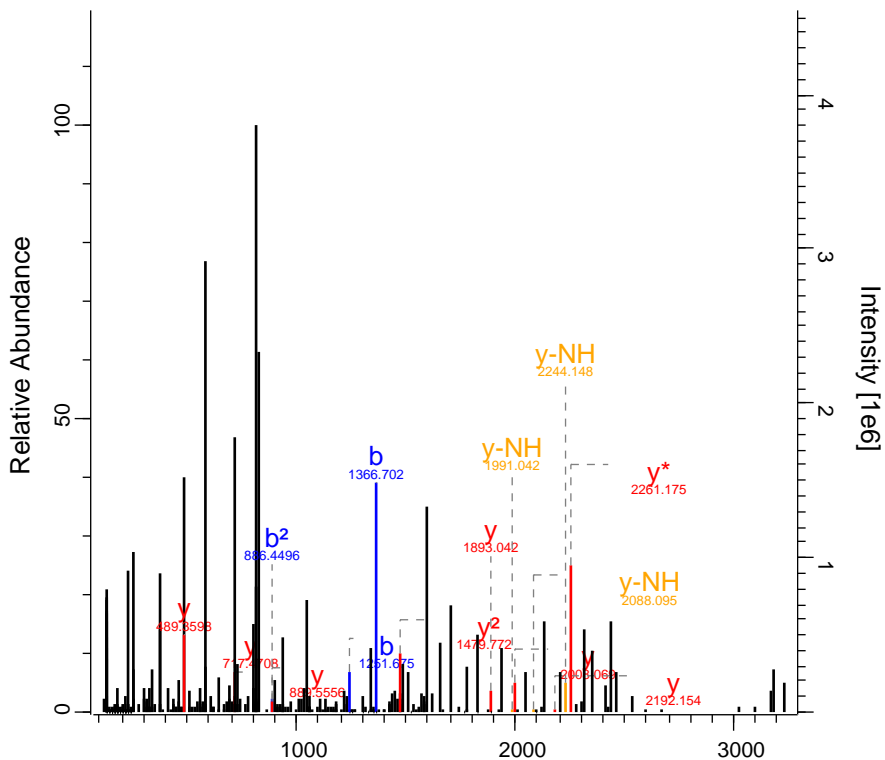

m/z (zoom)

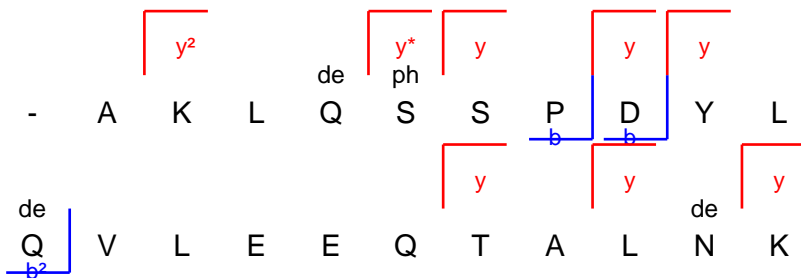

I -

RO-QC-160121_ZackD_SS_Set_02_Fraction 29805 FTMS; HC 56.26 972.51 TUBGCP2

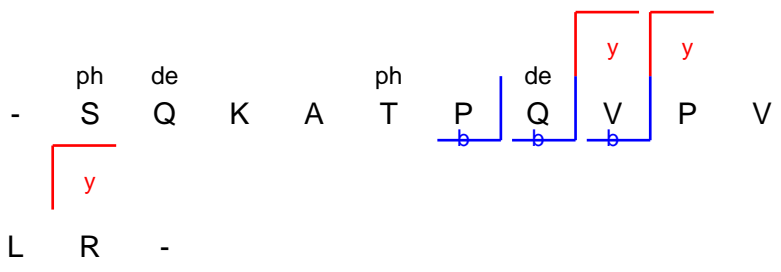
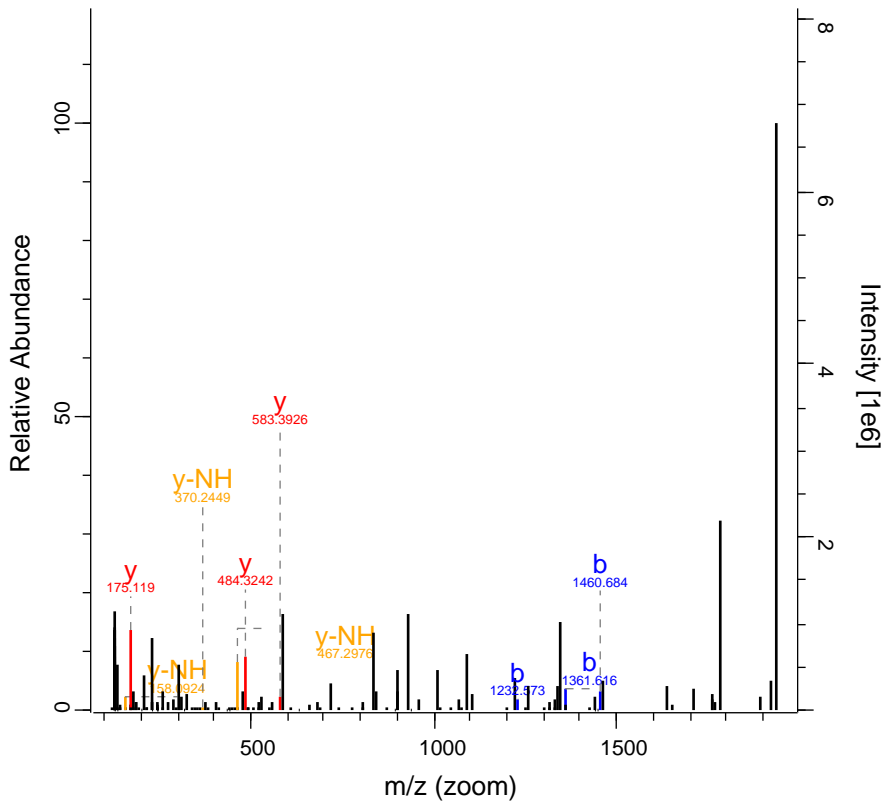

RO-QC-160121_ZackD_SS_Set_02_Fraction 30270 FTMS; HC 43.08 620.65 SLFN13

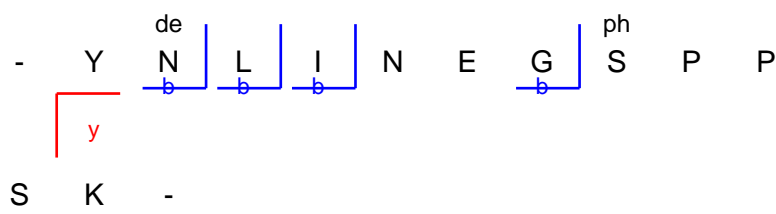
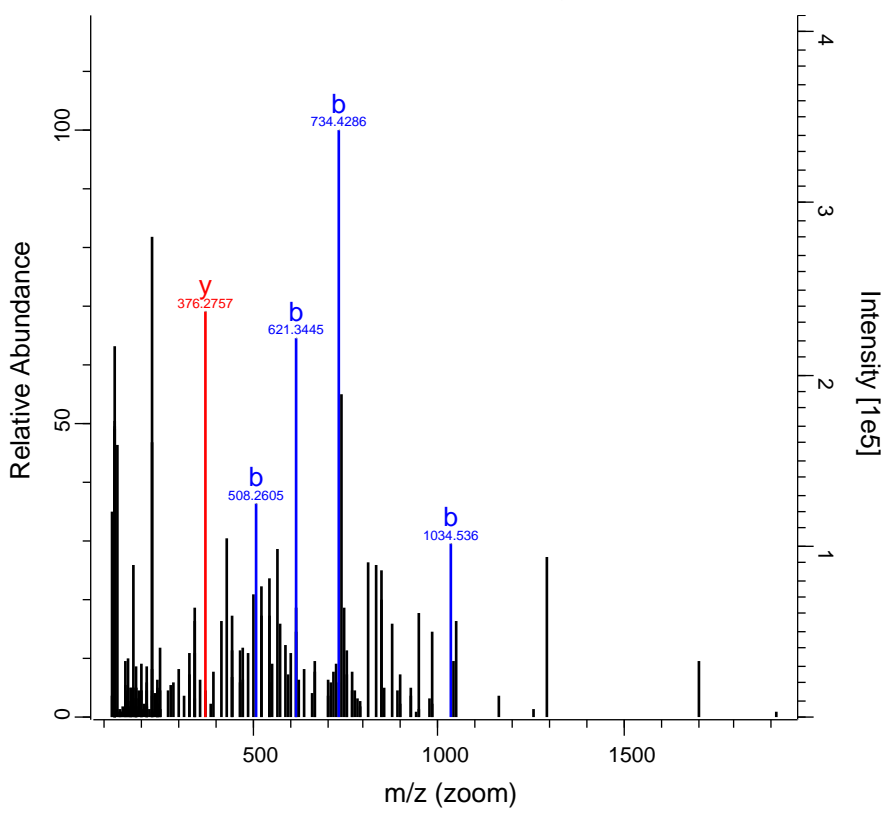

RO-QC-160121_ZackD_SS_Set_02_Fractic 30438 FTMS; HC 74.44 1122.57 DYNC112

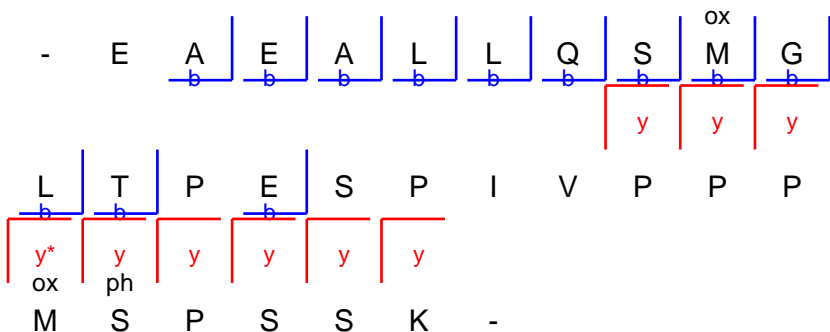
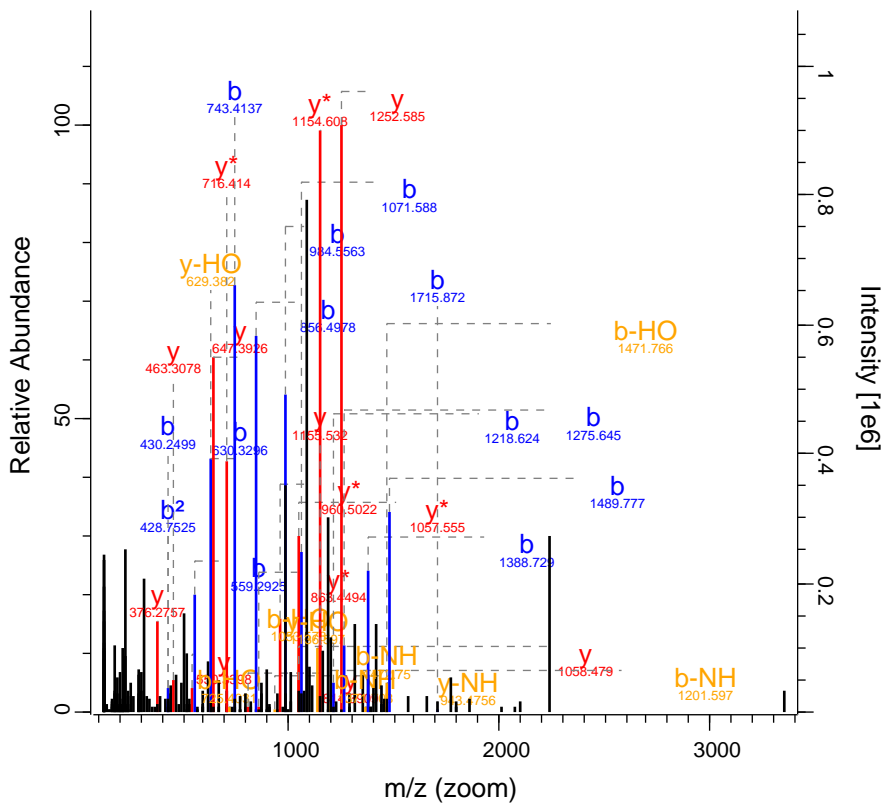

RO-QC-160121_ZackD_SS_Set_02_Fraccio 30706 FTMS; HC 136.63 954.51 RANBP2

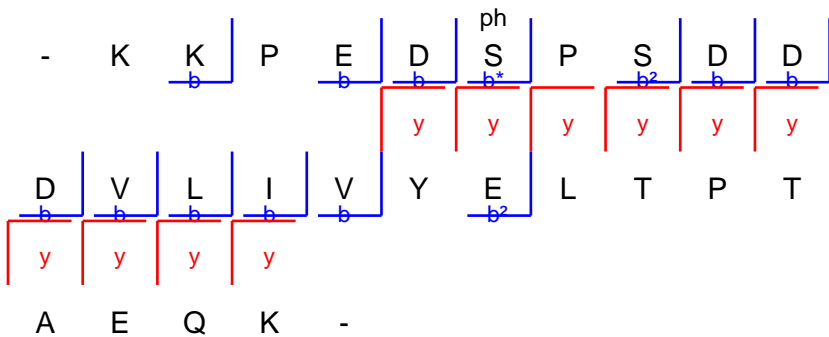
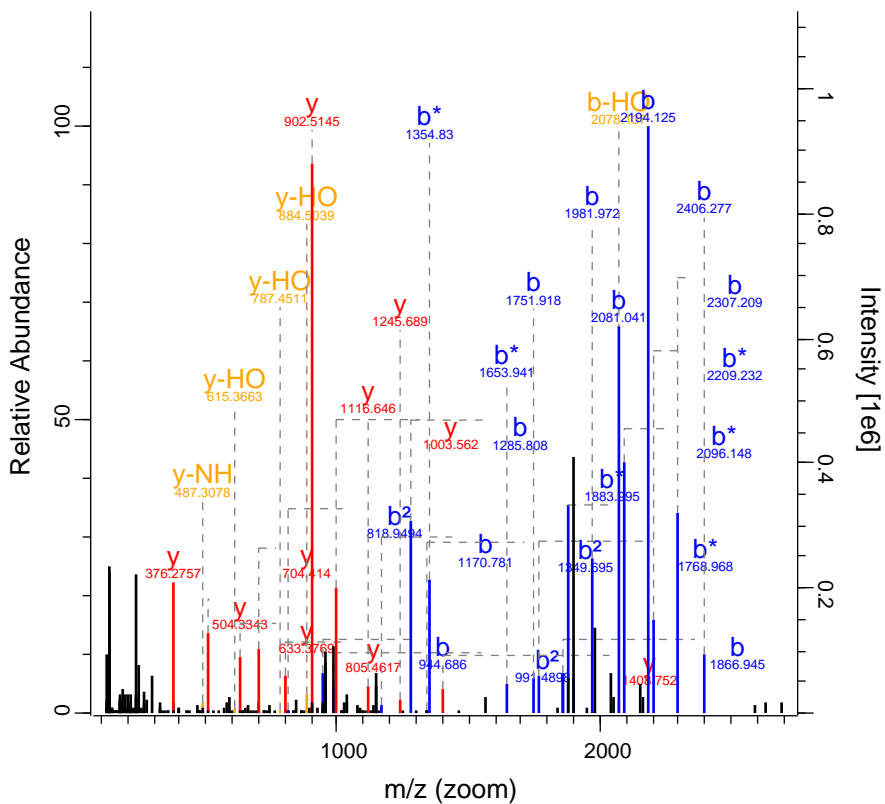

RO-QC-160121_ZackD_SS_Set_02_Fractic 30872 FTMS; HC 93.77 1381.13 LGALS3BP

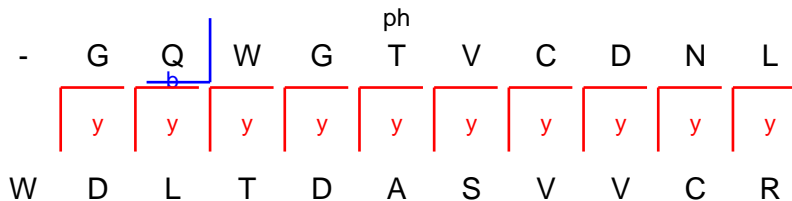
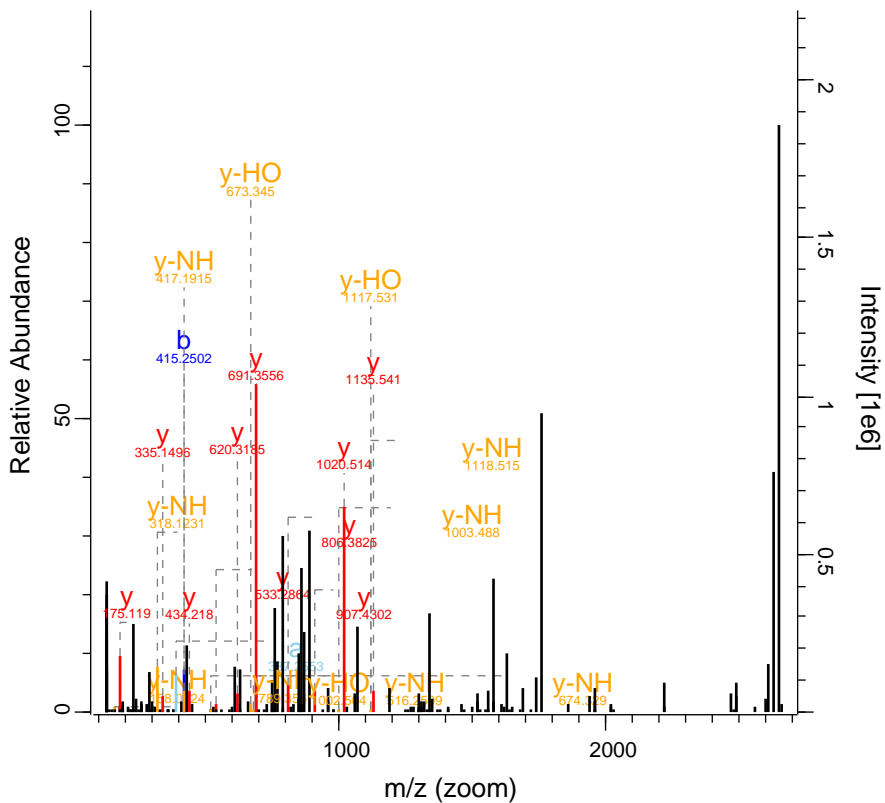

RO-QC-160121_ZackD_SS_Set_02_Fractic 33141 FTMS; HC 78.66 1083.09 RSL1D1

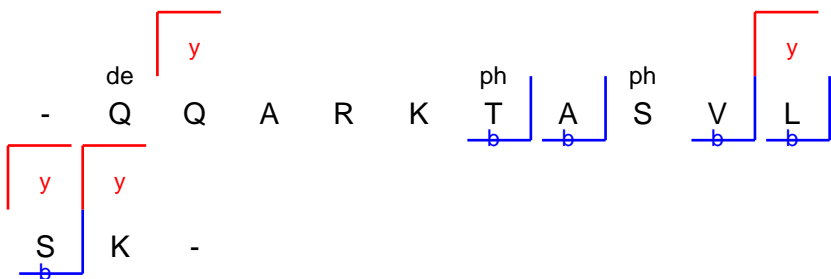
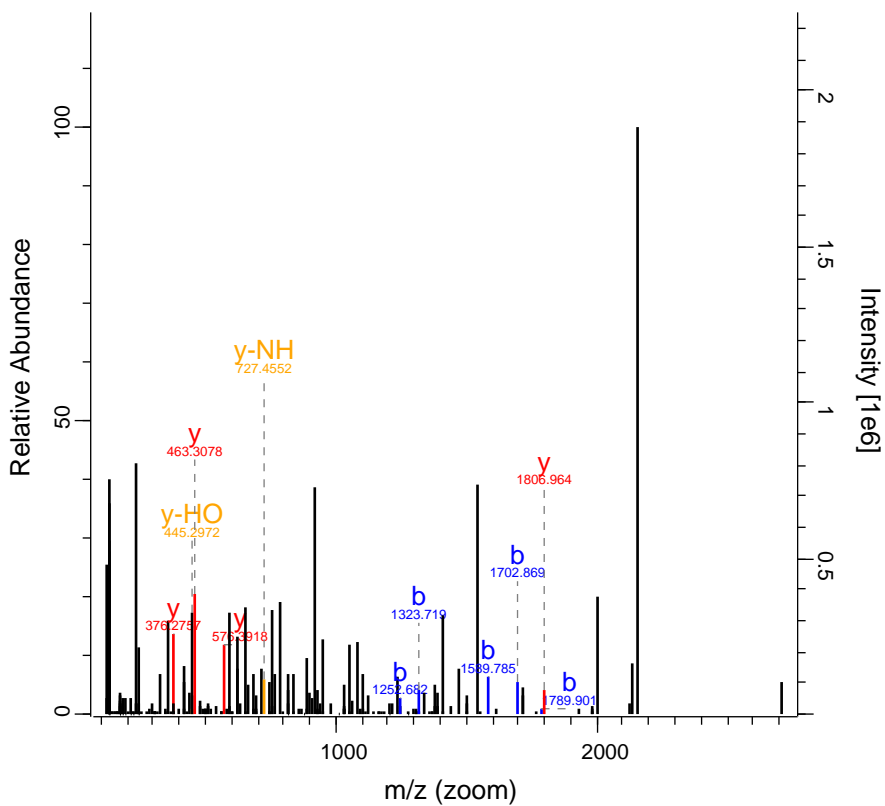

RO-QC-160121_ZackD_SS_Set_02_Fraction 33615 FTMS; HC 63.15 768.11 VIM

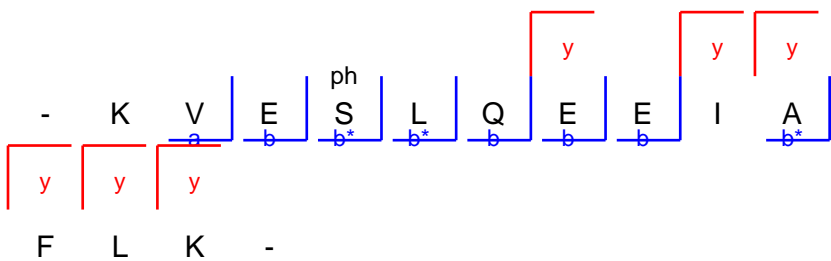
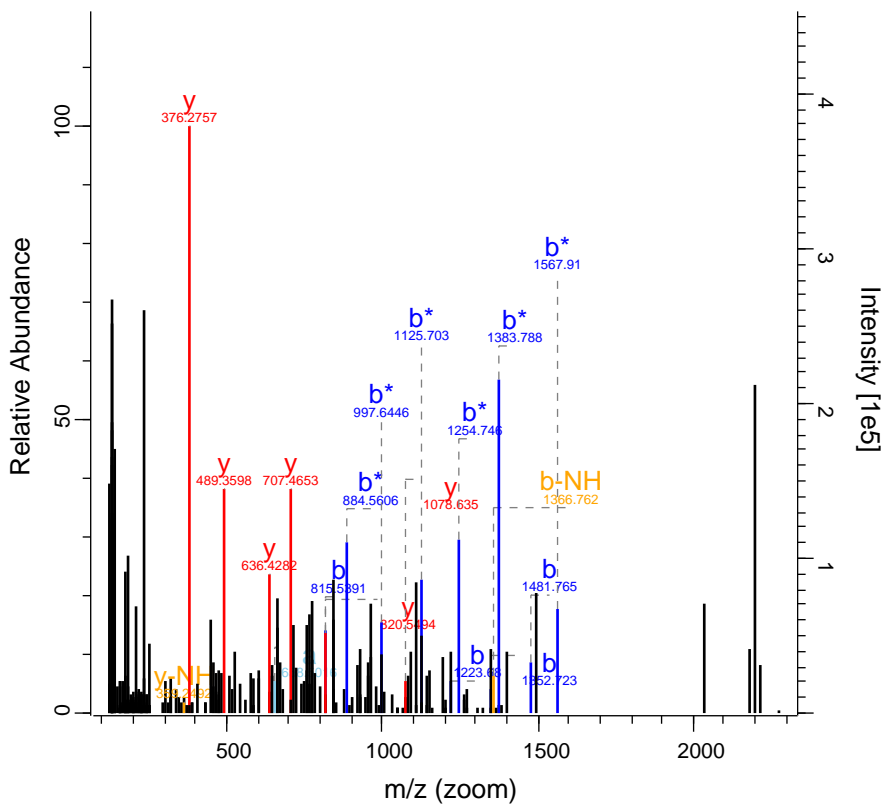

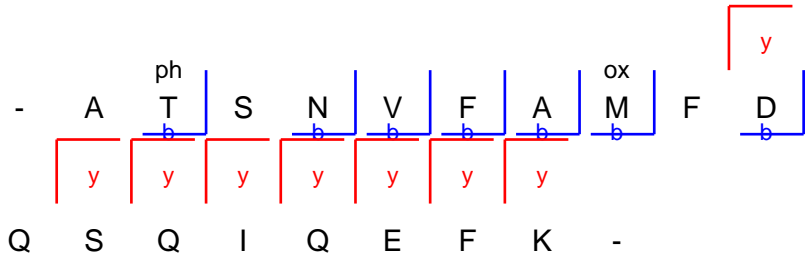
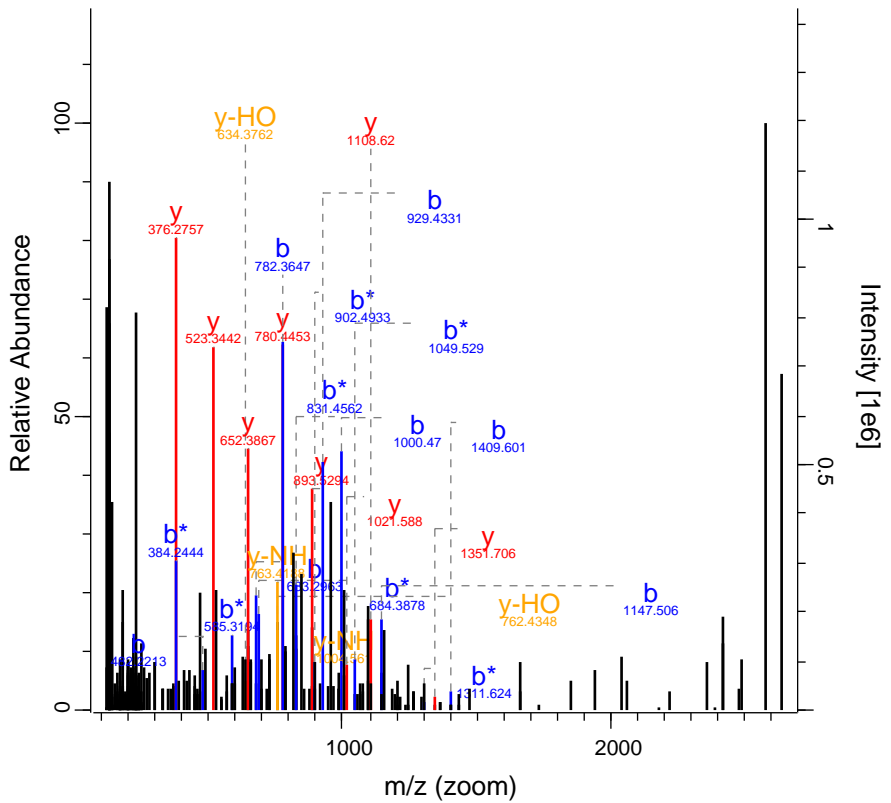

RO-QC-160121_ZackD_SS_Set_02_Fractic 34851 FTMS; HC 177.78 1034.58 NELFB

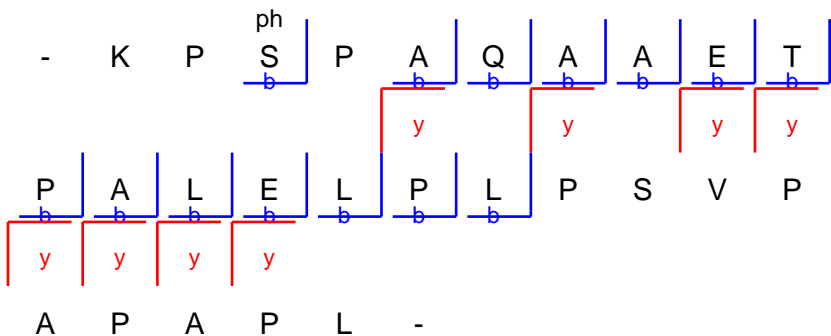
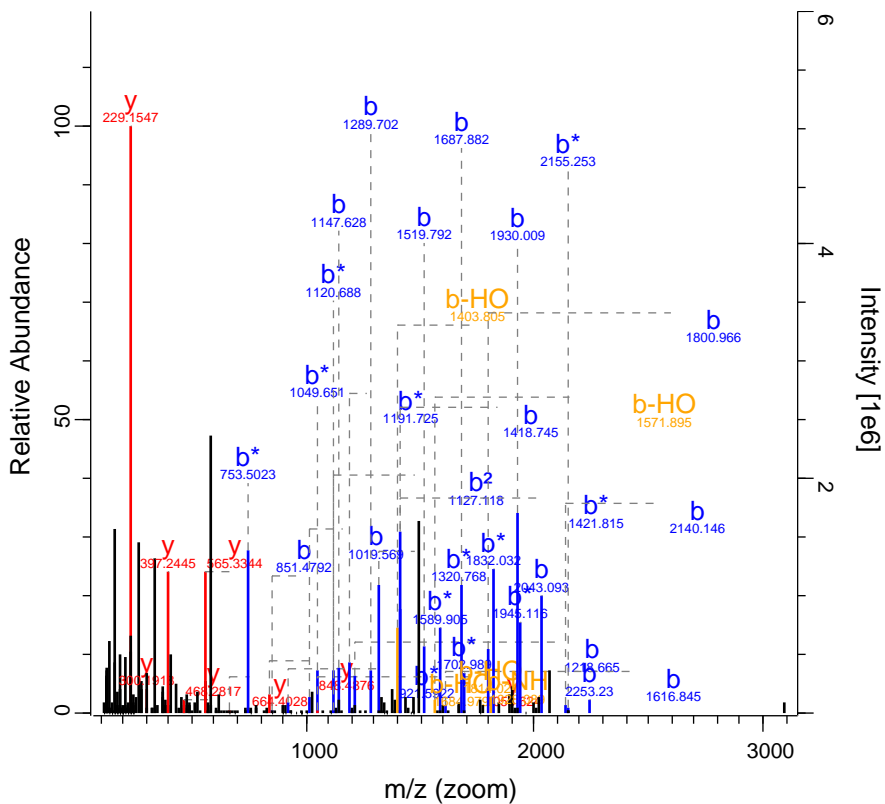

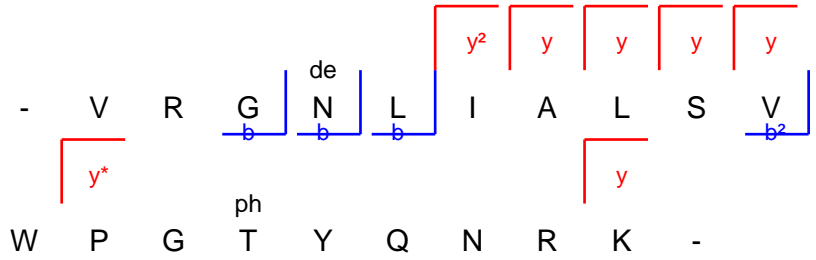
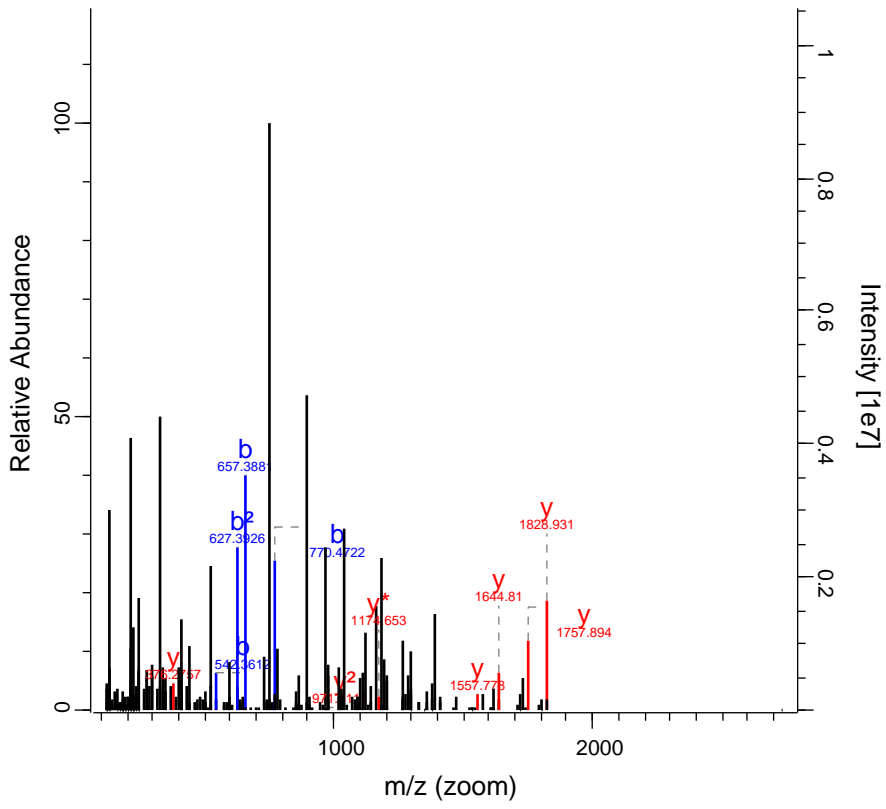

W P G T Y Q N R K -

RO-QC-160121_ZackD_SS_Set_02_Fractio 35076 FTMS; HC 105.79 627.31 YAP1

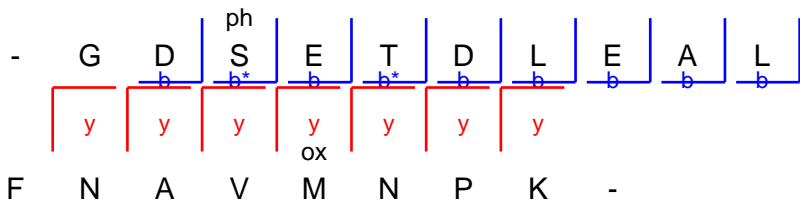
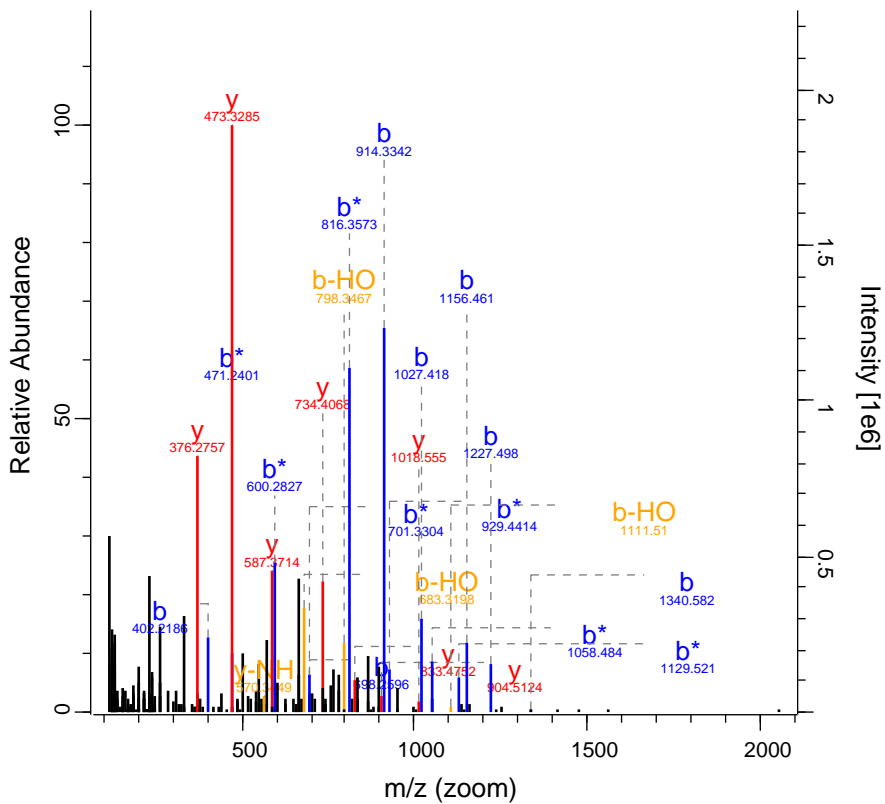

RO-QC-160121_ZackD_SS_Set_02_Fraction 35363 FTMS; HC 80.24 805.94 CCT2

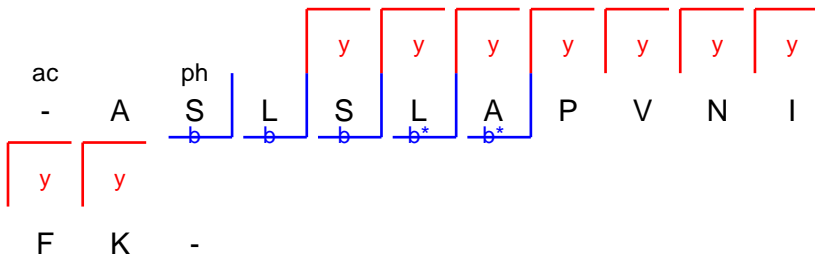
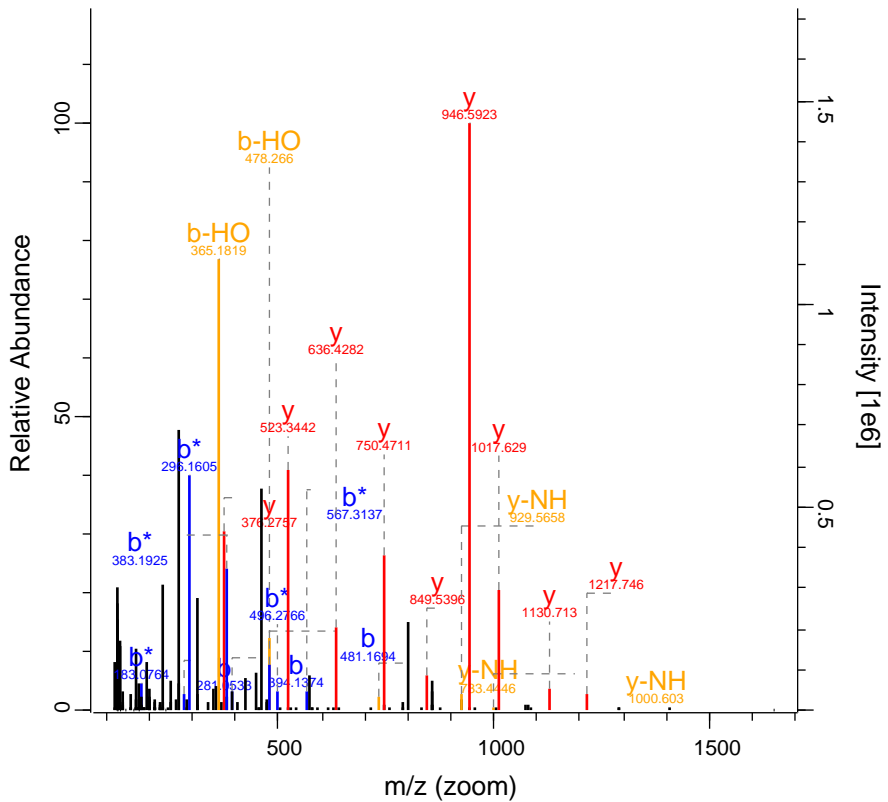

RO-QC-160121_ZackD_SS_Set_02_Fraction 4844 FTMS; HCl 80.74 673.67 APC

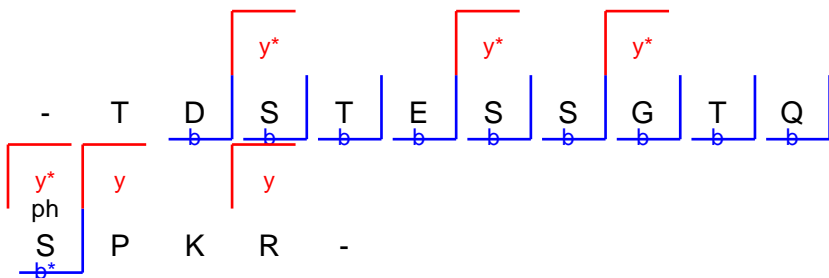
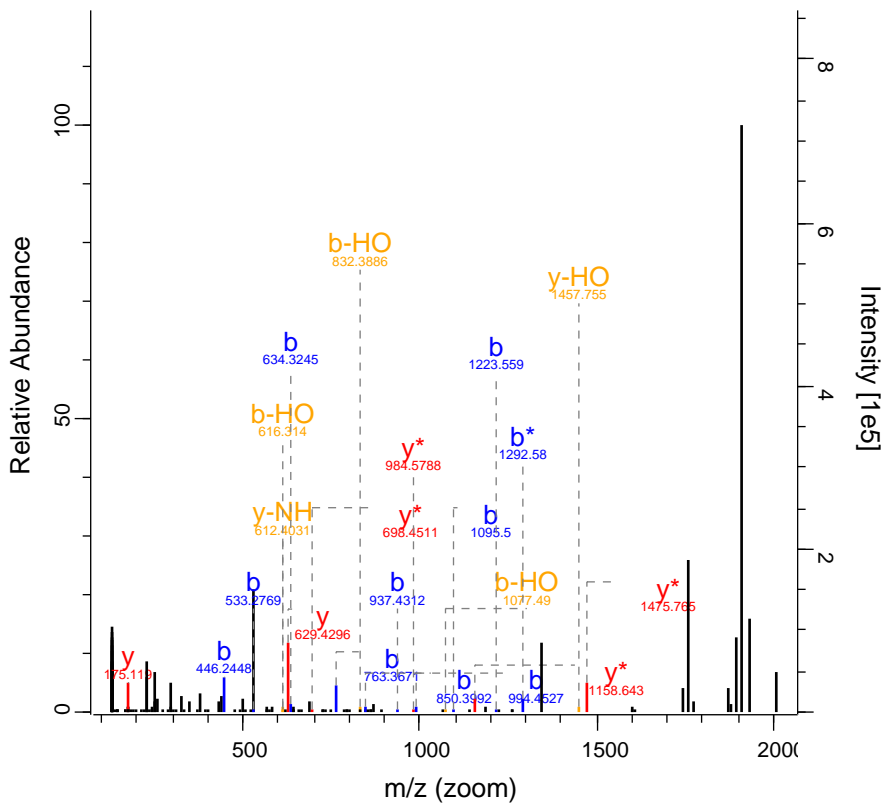

RO-QC-160121_ZackD_SS_Set_02_Fraction 4980 FTMS; HCl 67.46 628.02 RRBP1

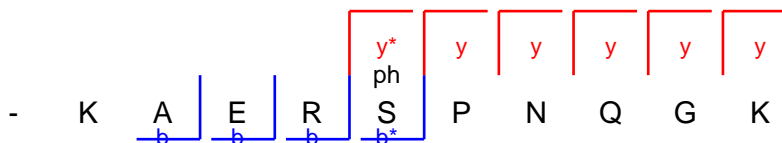
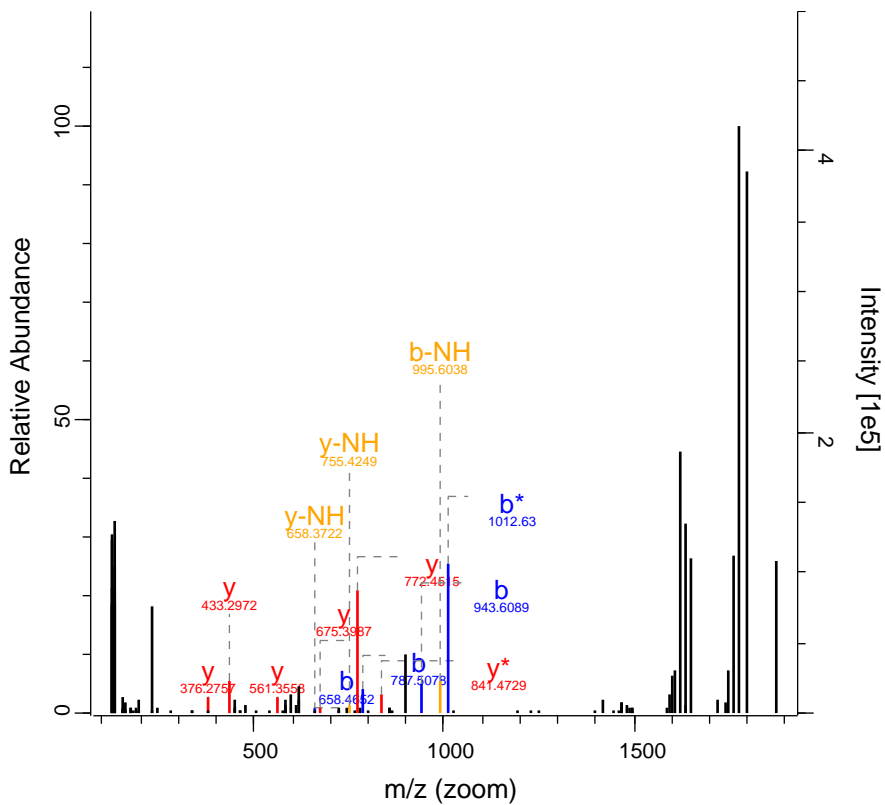

RO-QC-160121_ZackD_SS_Set_02_Fraction 6471 FTMS; HC 103.26 666.01 SRSF11

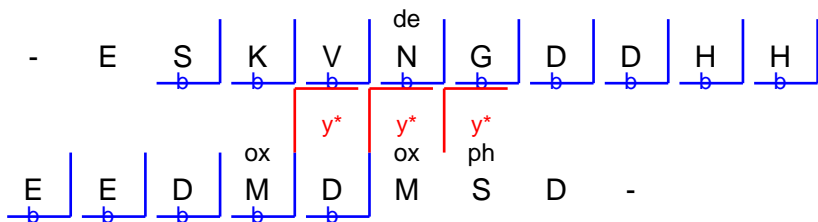
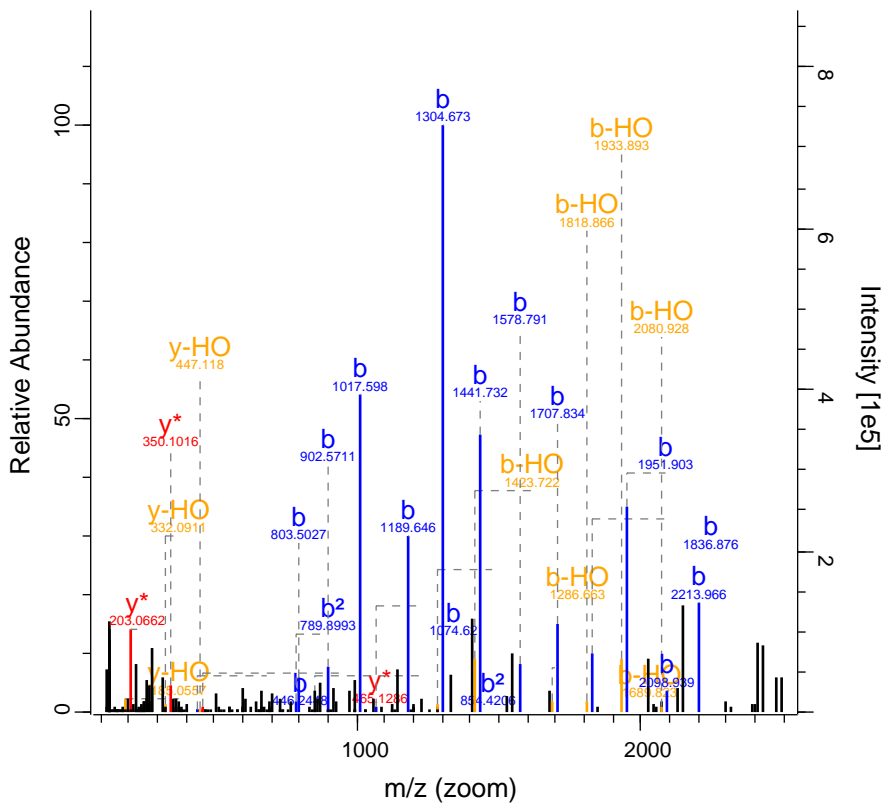

RO-QC-160121_ZackD_SS_Set_02_Fraction 6507 FTMS; HCl 71.08 711.69 LZTS3

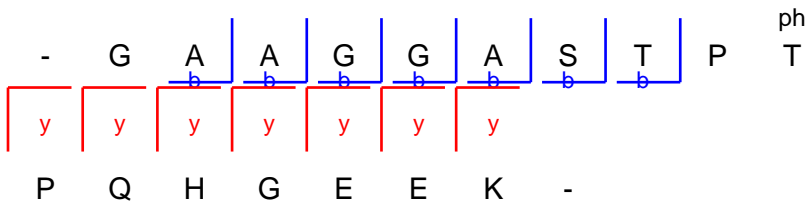
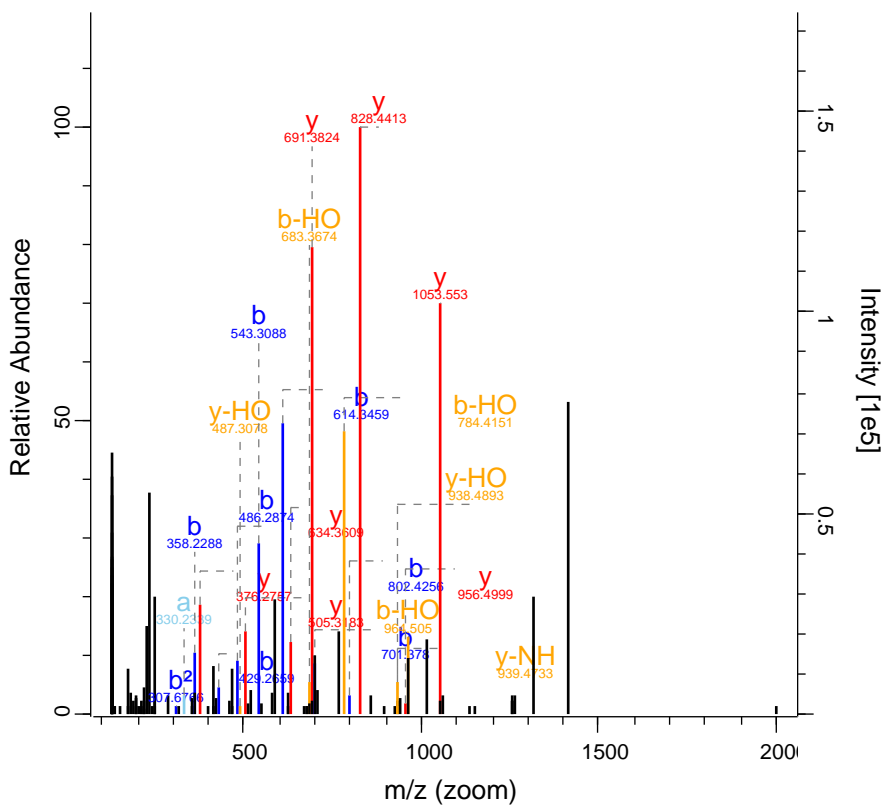

RO-QC-160121_ZackD_SS_Set_02_Fraction 6969 FTMS; HCl 78.08 605.67 CCDC86

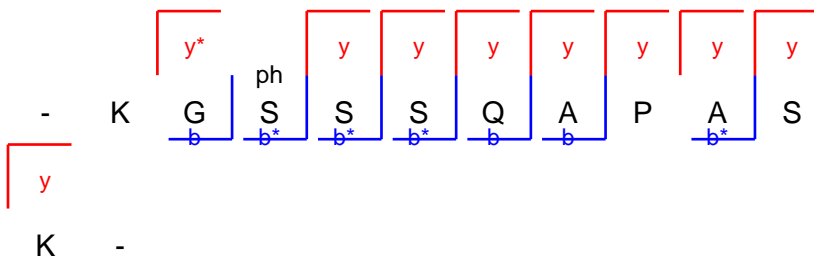
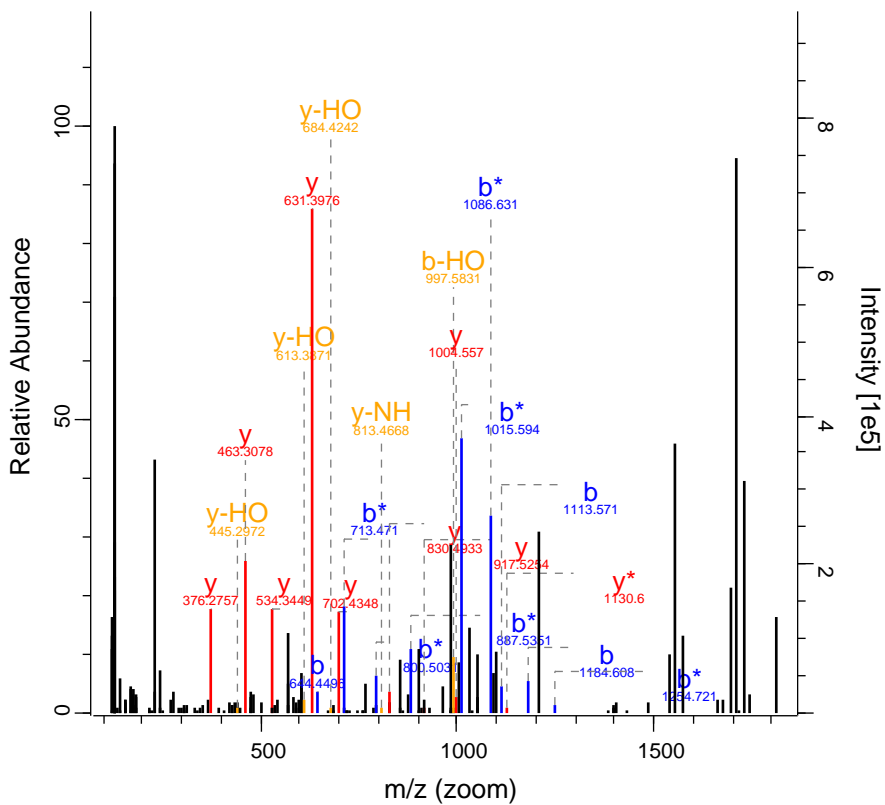

RO-QC-160121_ZackD_SS_Set_02_Fraction 7227 FTMS; HCl 50.08 648.36 SLTM

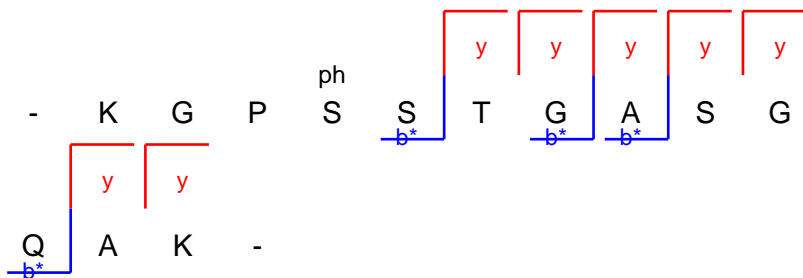
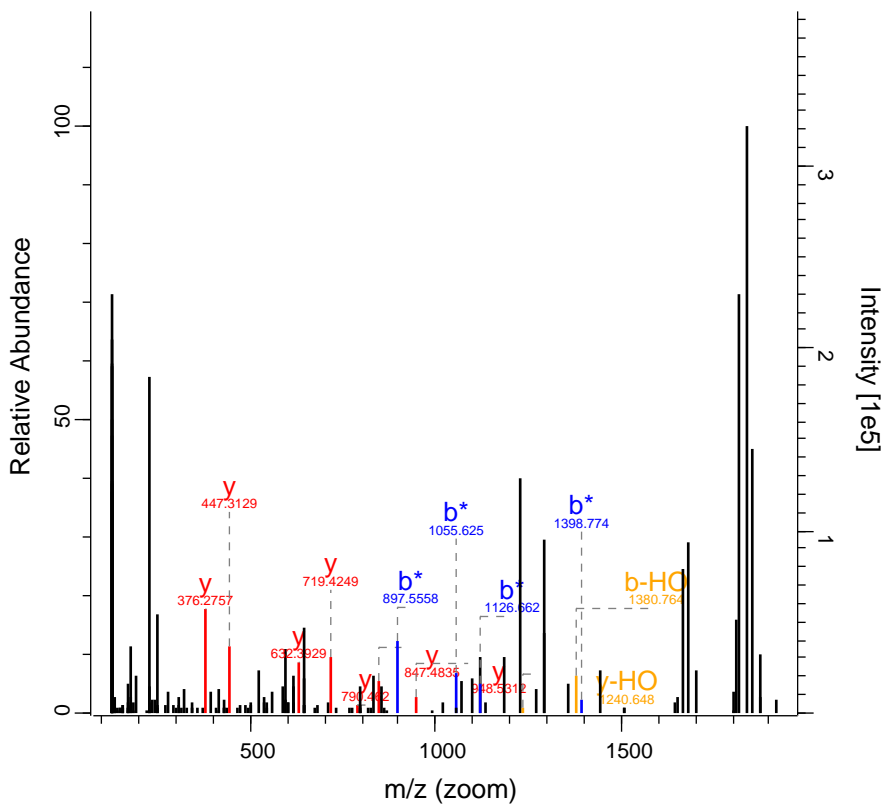

RO-QC-160121_ZackD_SS_Set_02_Fraction 7329 FTMS; HCl 85.32 722.86 SLC6A13

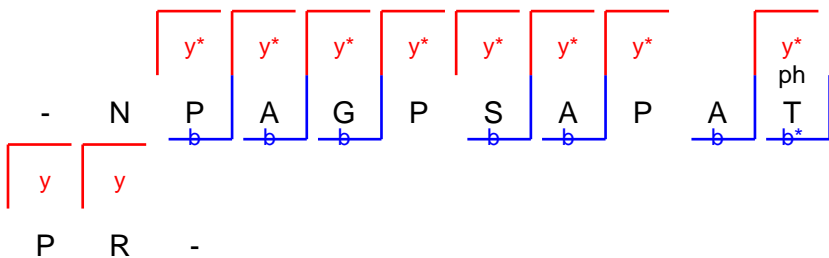
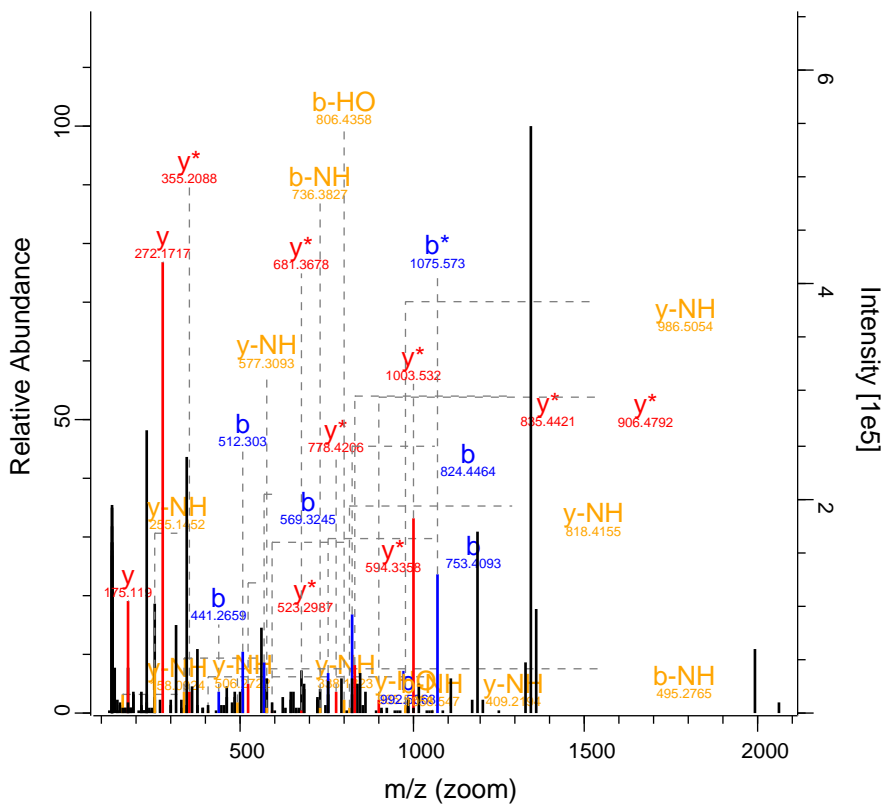

RO-QC-160121_ZackD_SS_Set_02_Fraction 8949 FTMS; HCl 84.87 757.74 ADD1

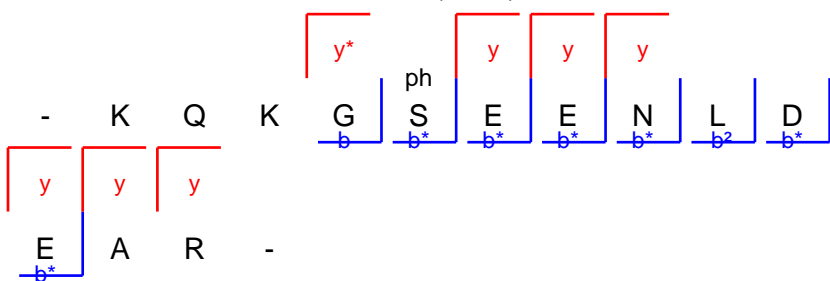
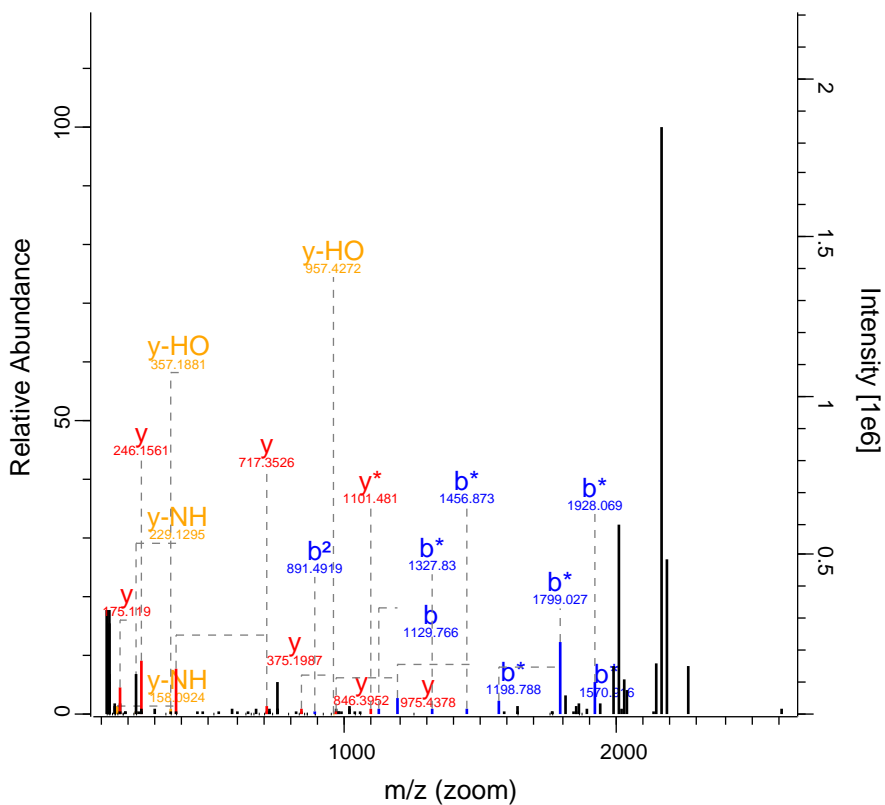

RO-QC-160121_ZackD_SS_Set_02_Fraction10674 FTMS; HCl 102.94 931.2 CLCC1

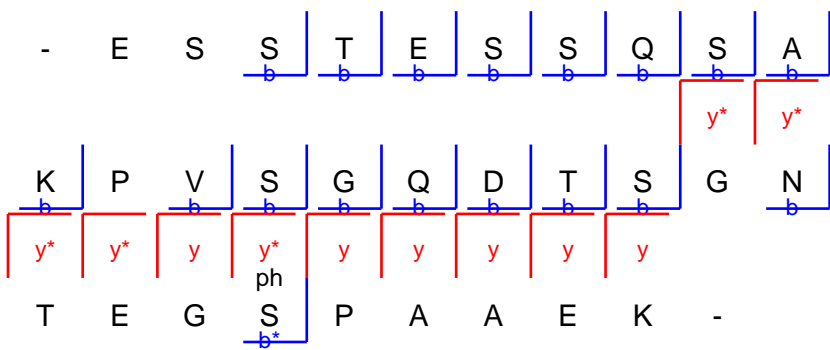
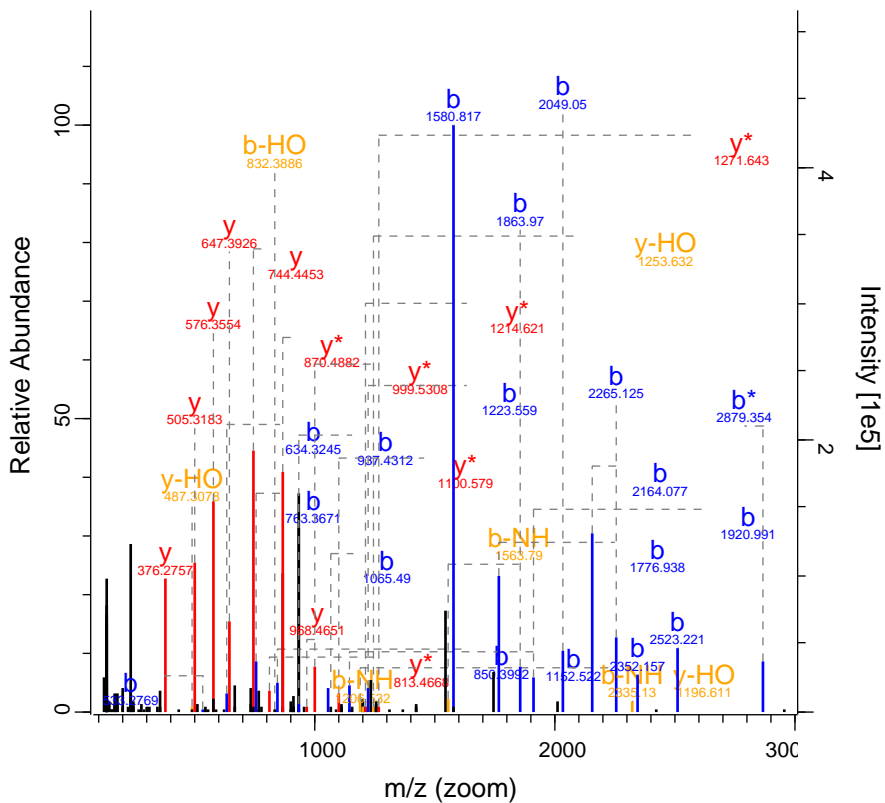

RO-QC-160121_ZackD_SS_Set_02_Fractio 10853 FTMS; HC 104.84 741.71 PI4KB

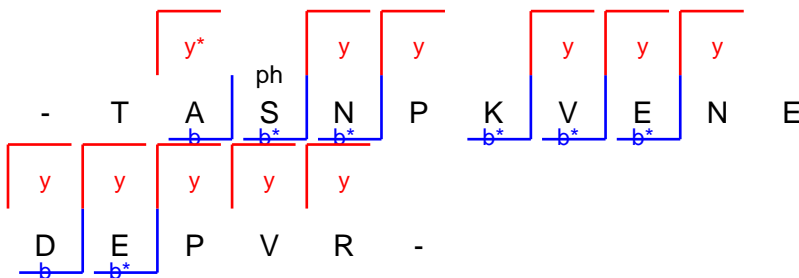
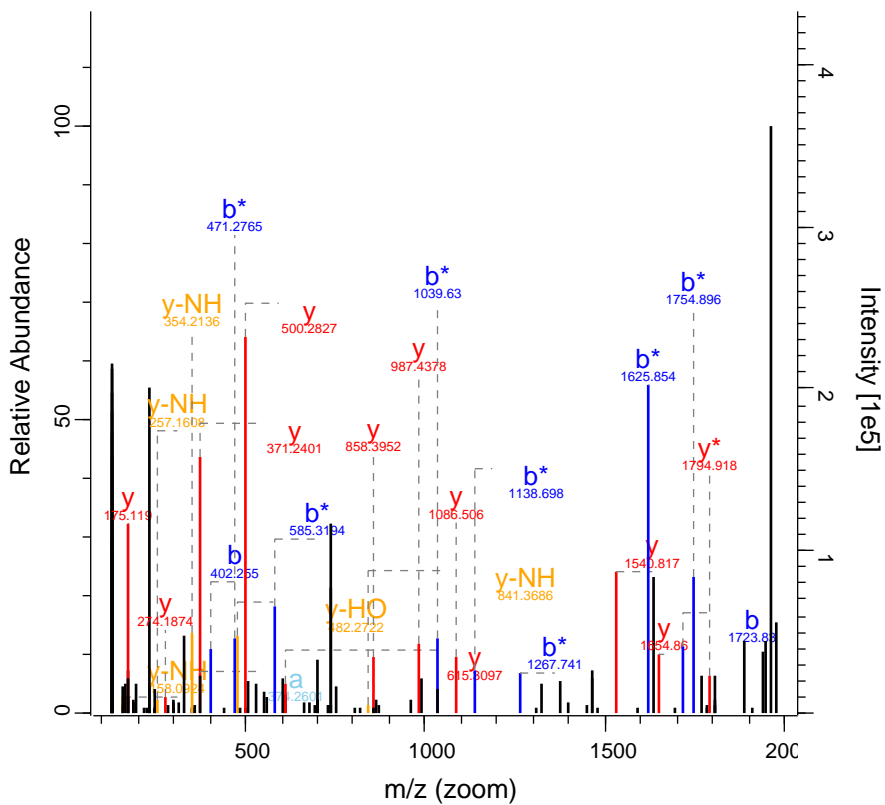

RO-QC-160121_ZackD_SS_Set_02_Fraction11597 FTMS; HC 93.27 858.05 NUCKS1

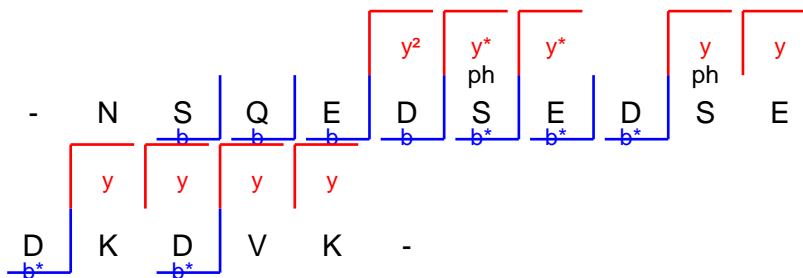
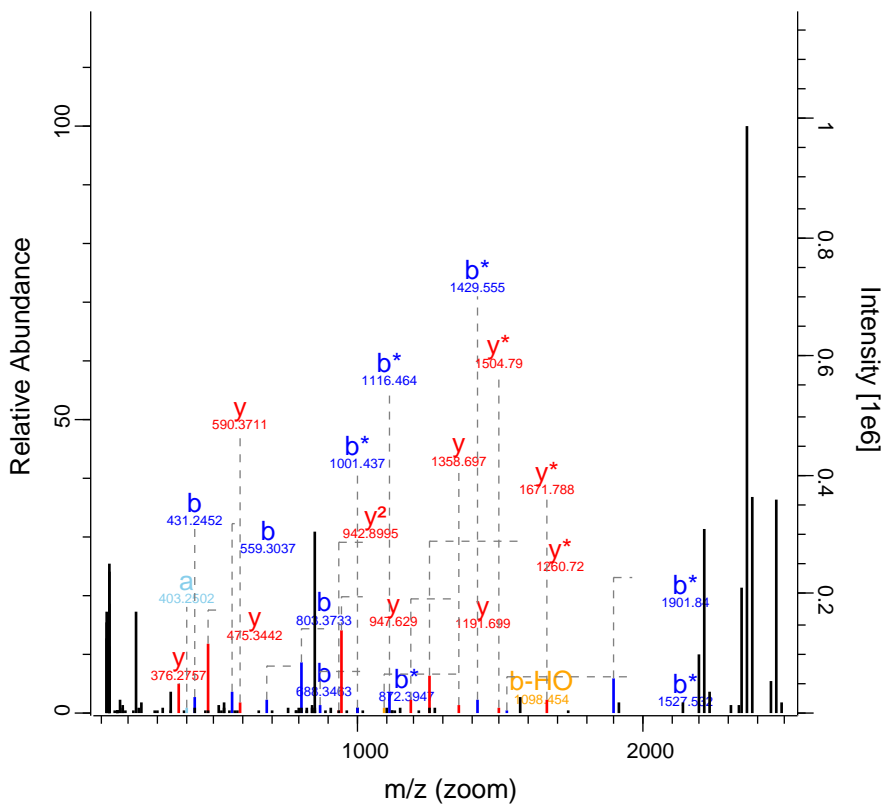

RO-QC-160121_ZackD_SS_Set_02_Fraction11639 FTMS; HC 41.82 519.04 SIPA1L1

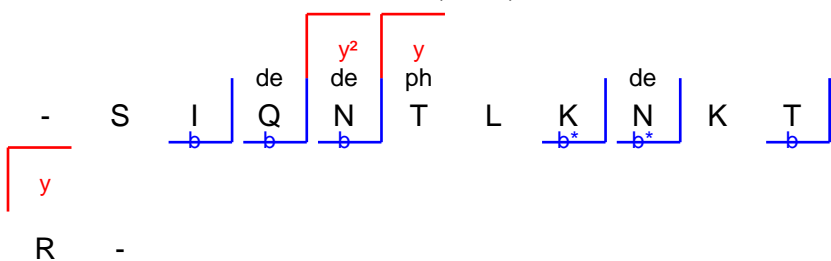
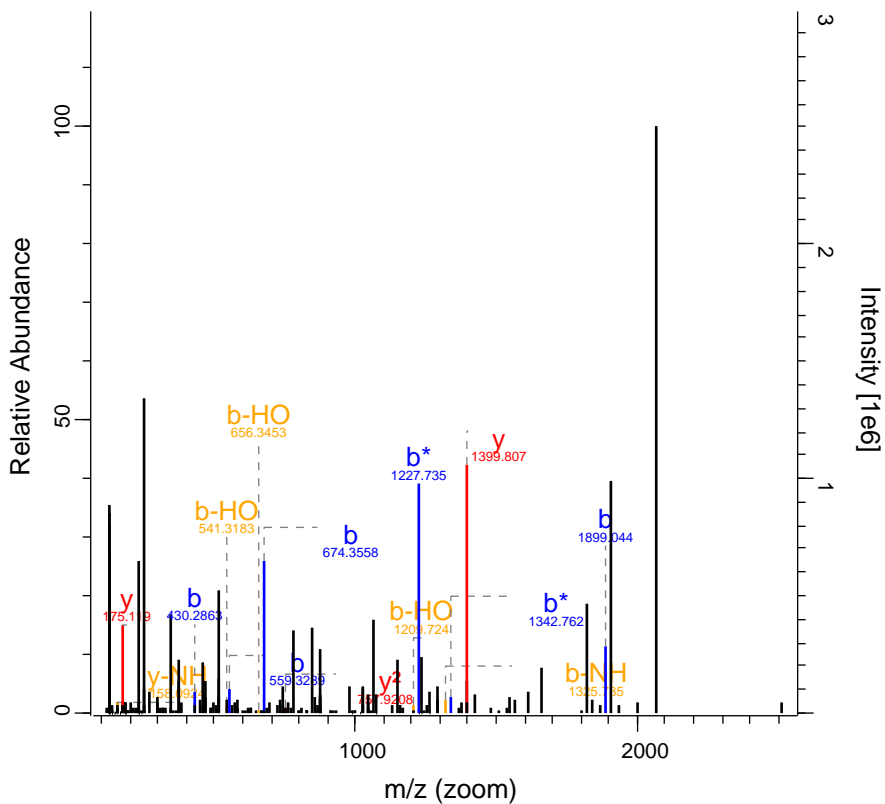

RO-QC-160121_ZackD_SS_Set_02_Fractic 13888 FTMS; HC 50.06 1077.48 TYRP1

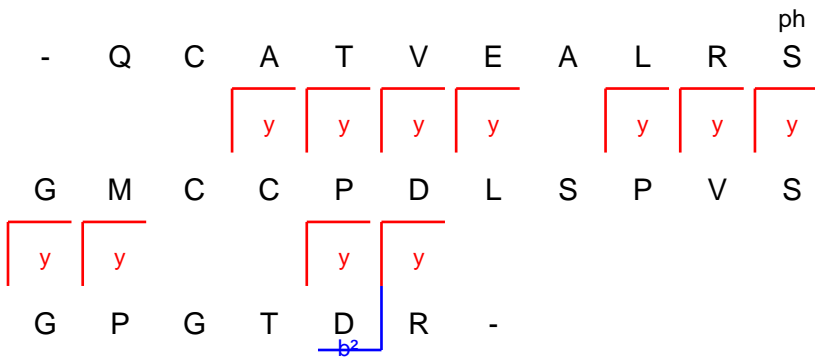
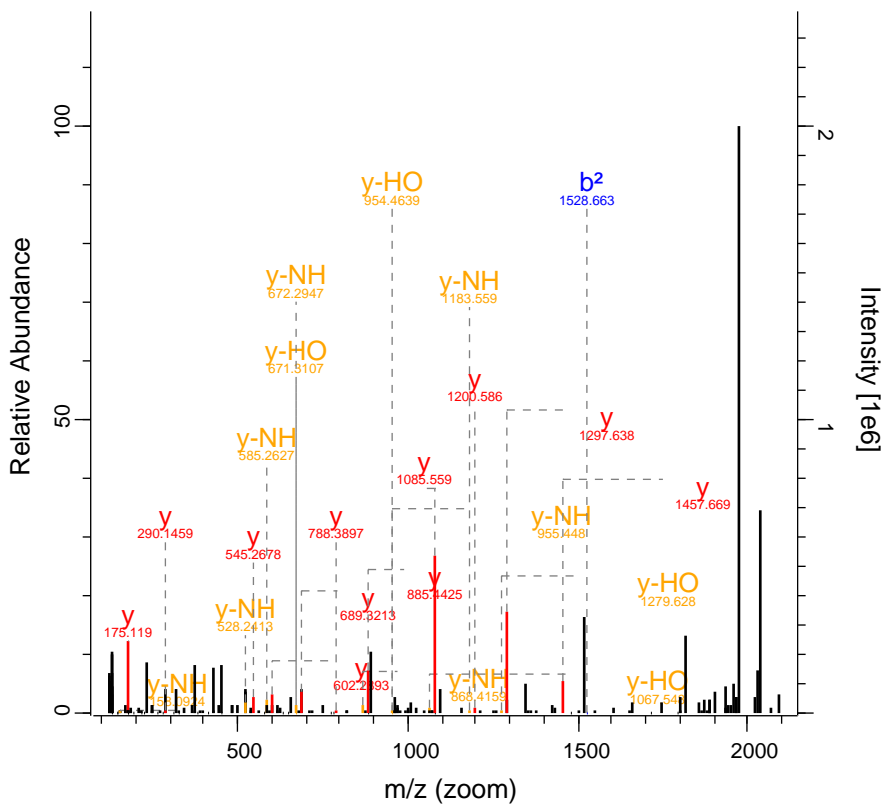

RO-QC-160121_ZackD_SS_Set_02_Fraction 14316 FTMS; HC 86.08 873.79 THRAP3

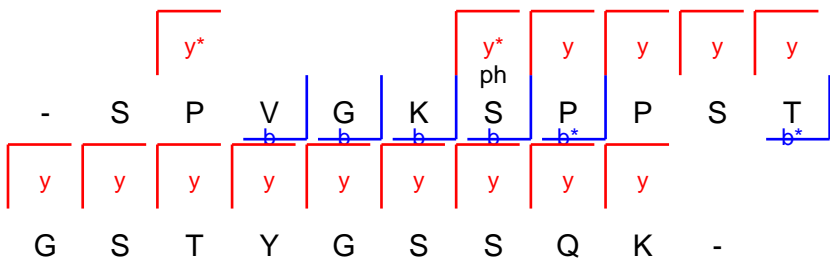
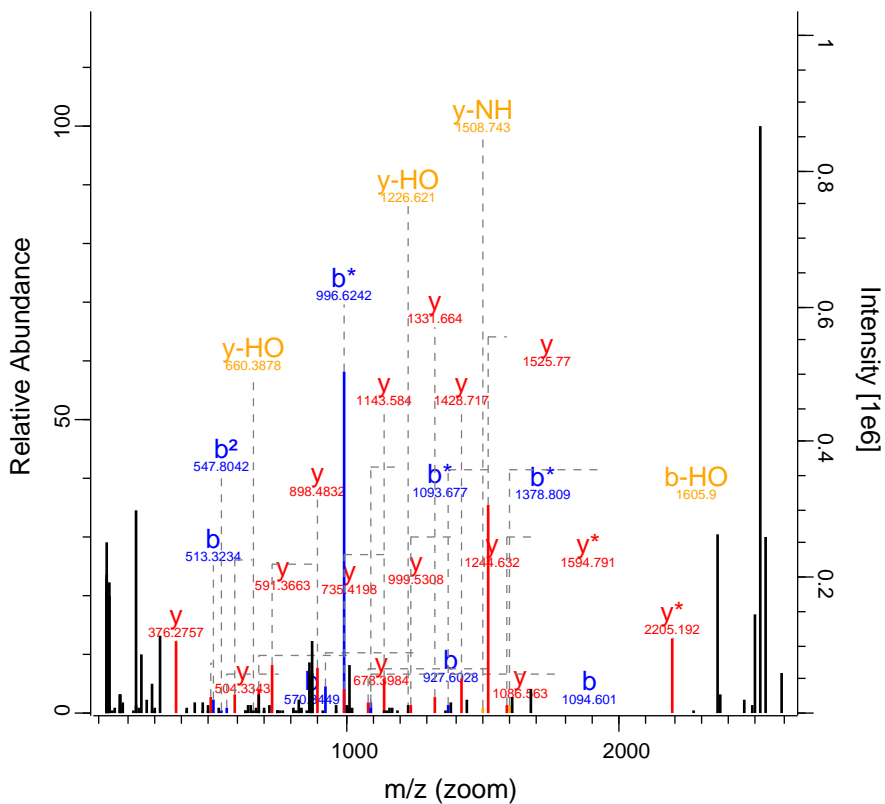

G S T Y G S S Q K -

RO-QC-160121_ZackD_SS_Set_02_Fraction 14694 FTMS; HC 50.19 633.71 KTN1

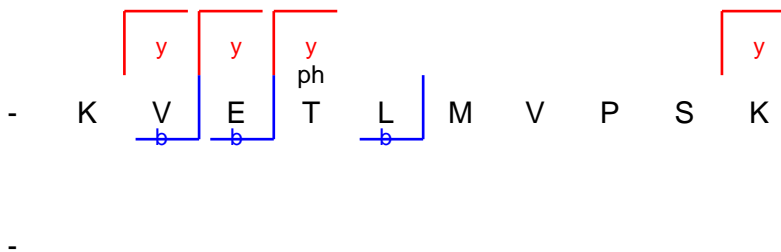
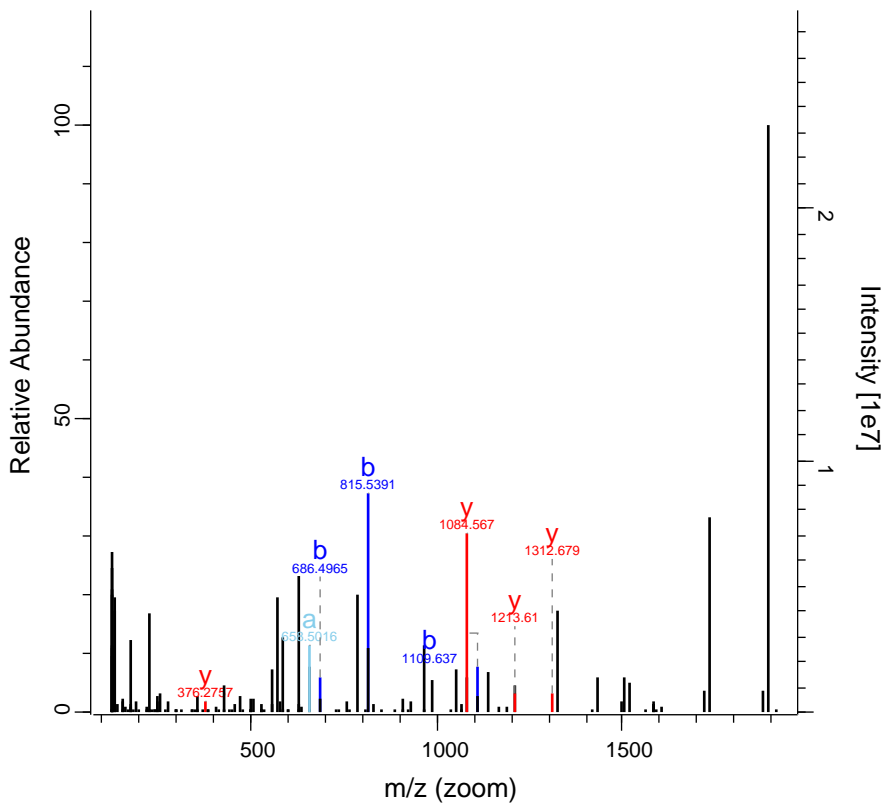

RO-QC-160121_ZackD_SS_Set_02_Fractic 15411 FTMS; HC 134.21 1281.66 HIST1H1B

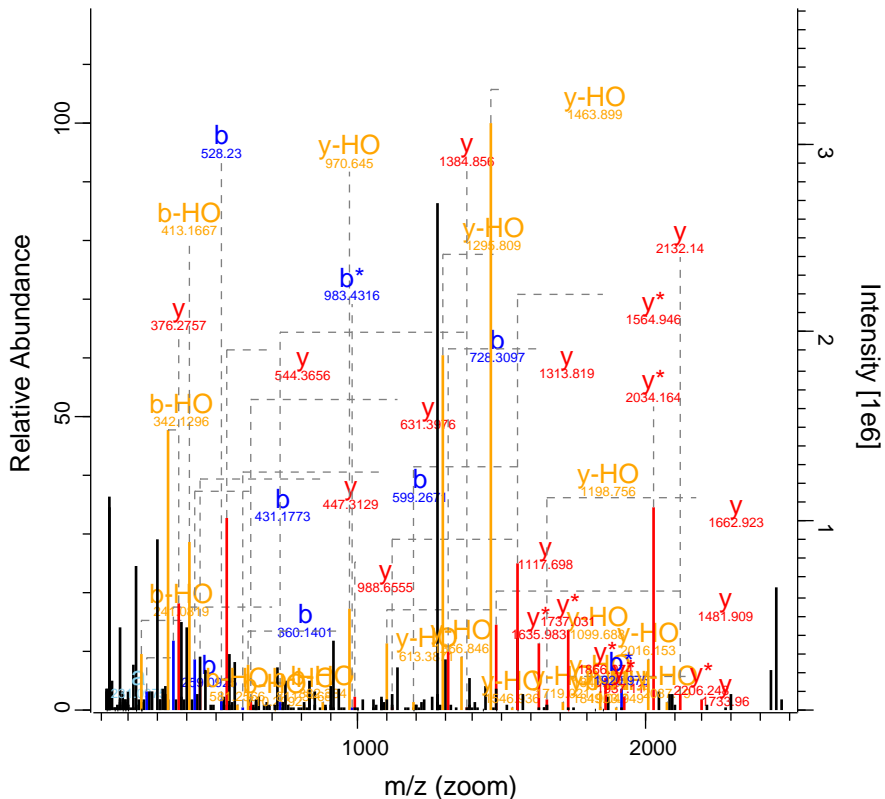

RO-QC-160121_ZackD_SS_Set_02_Fractic 16079 FTMS; HC 84.41 1212.62 DYNC1LI1

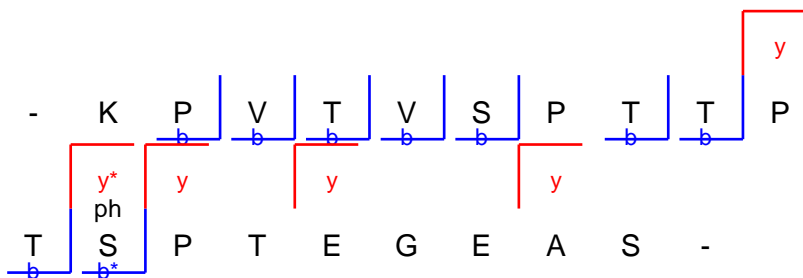
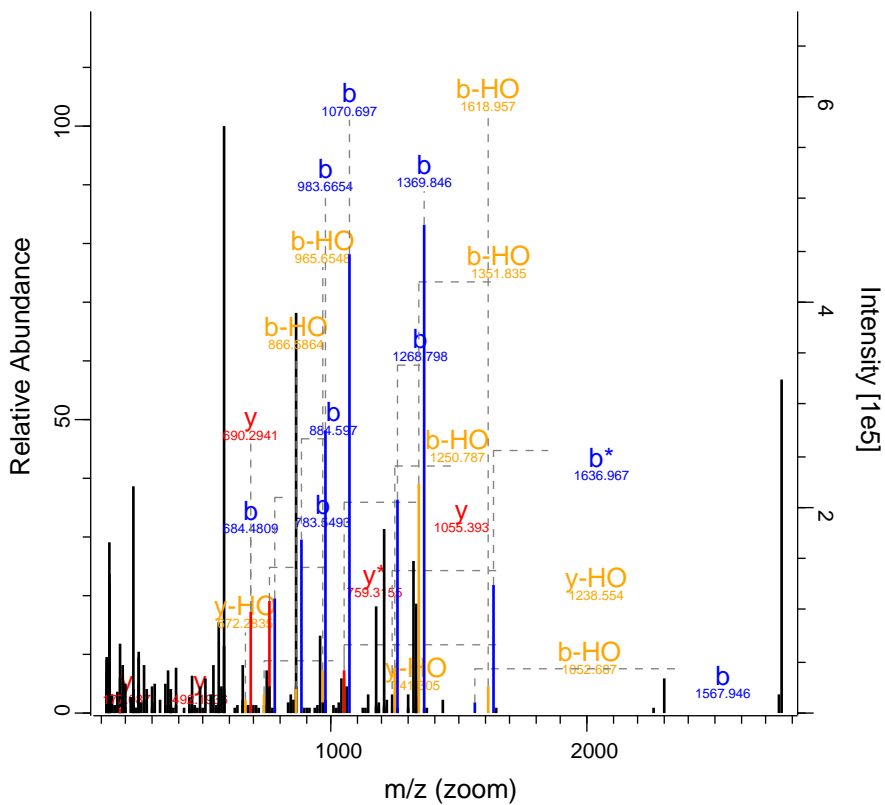

RO-QC-160121_ZackD_SS_Set_02_Fractio 16601 FTMS; HC 117.21 939.81 PNKP

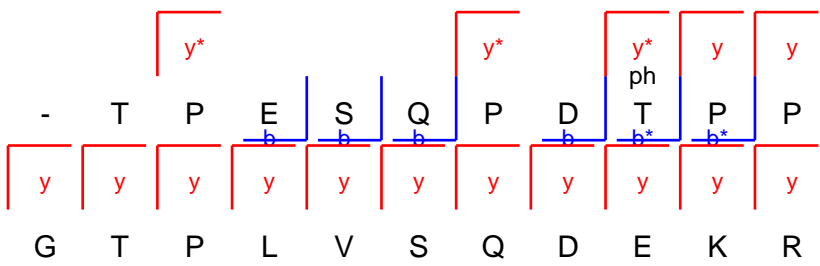
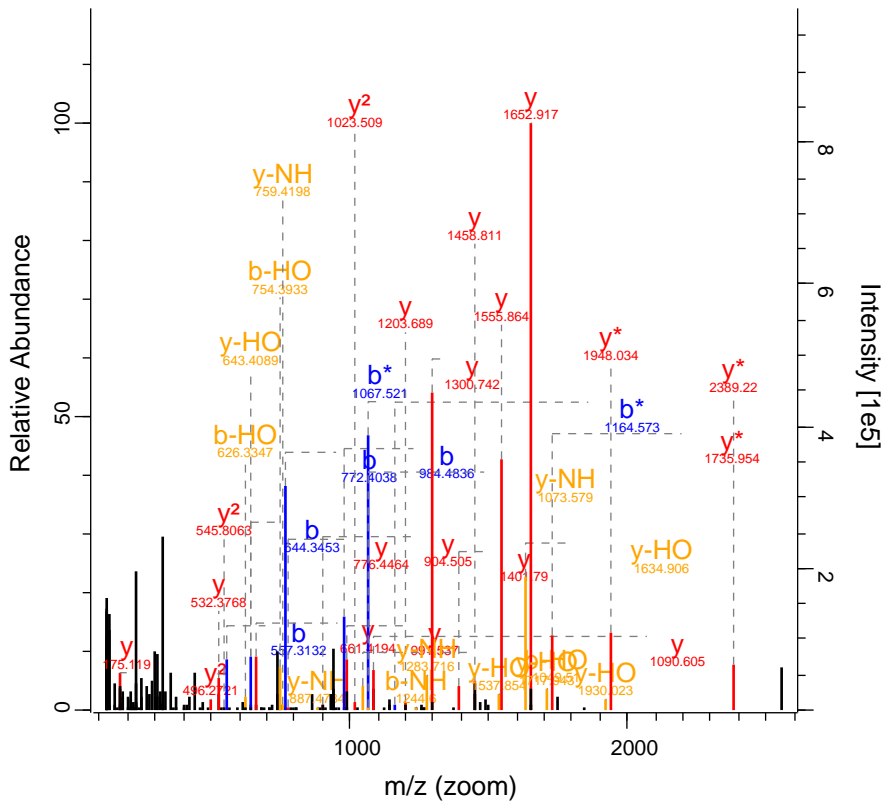

G T P L V S Q D E K R

RO-QC-160121_ZackD_SS_Set_02_Fractio 17297 FTMS; HC 128.85 692.86 HSPB1

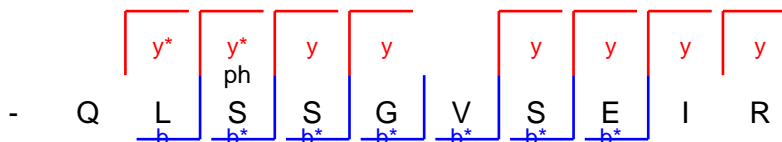
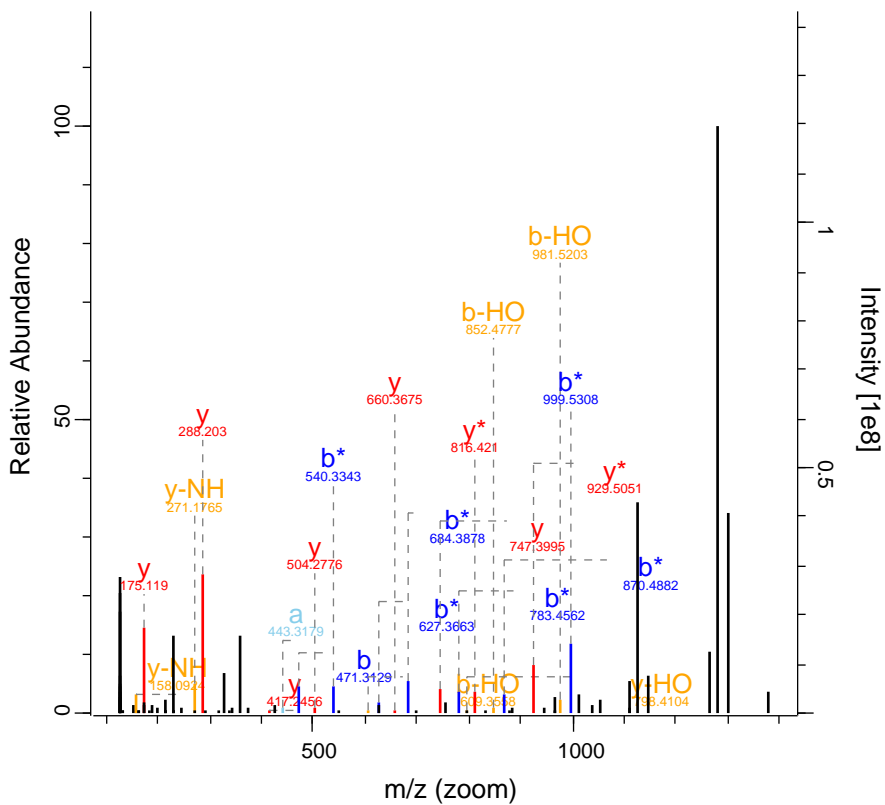

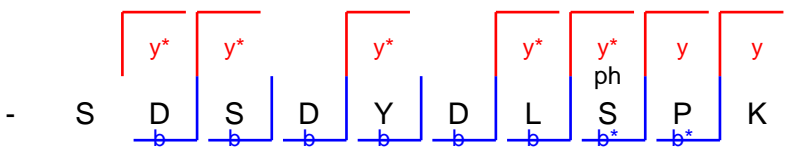
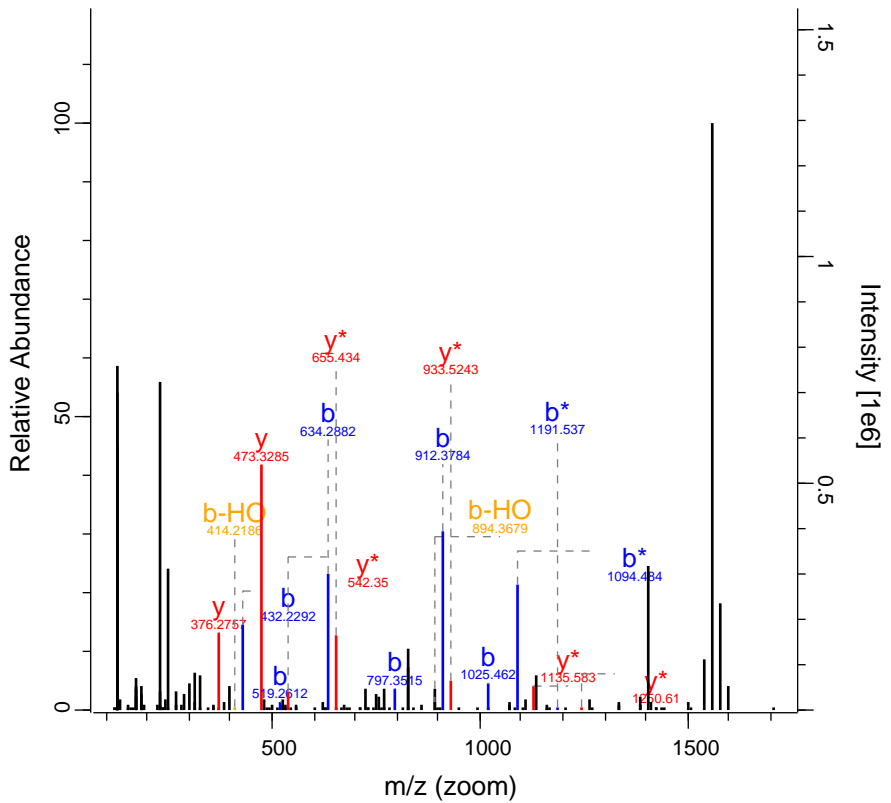

RO-QC-160121_ZackD_SS_Set_02_Fraction 17527 FTMS; HC 80.24 677.86 DOCK7

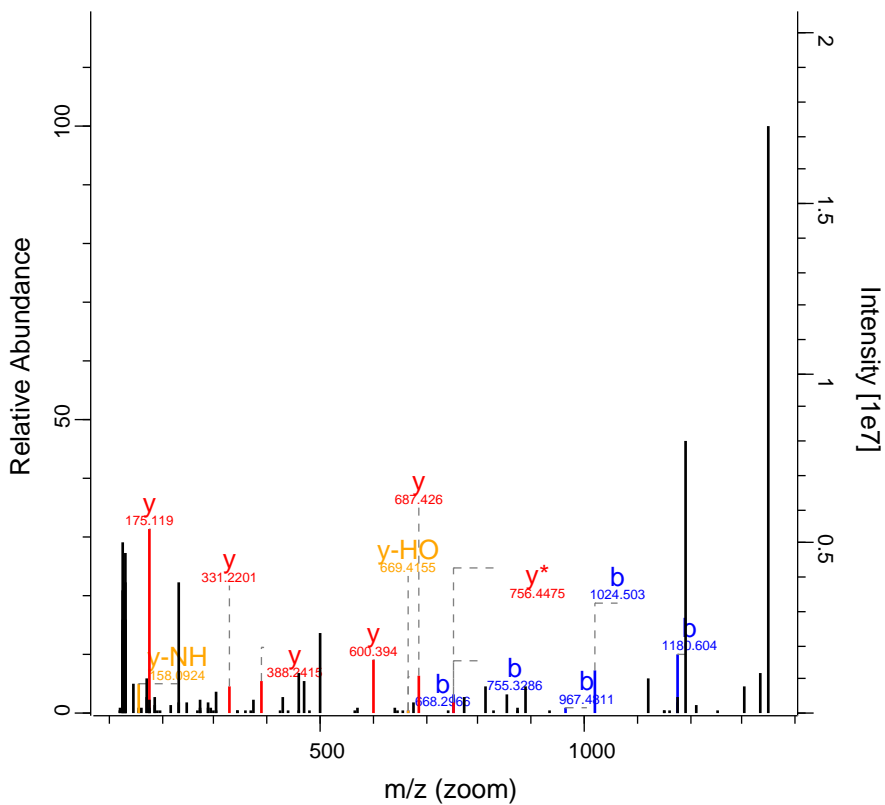

m/z (zoom)

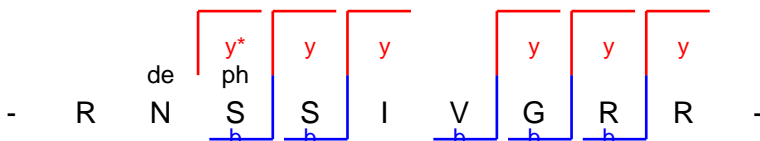

RO-QC-160121_ZackD_SS_Set_02_Fraction 19142 FTMS; HC 86.79 831.42 CDK19

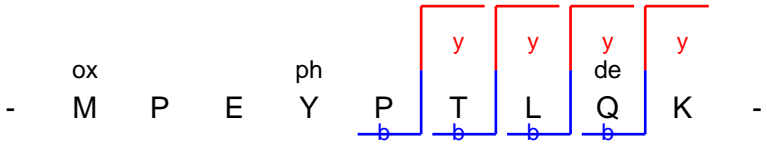
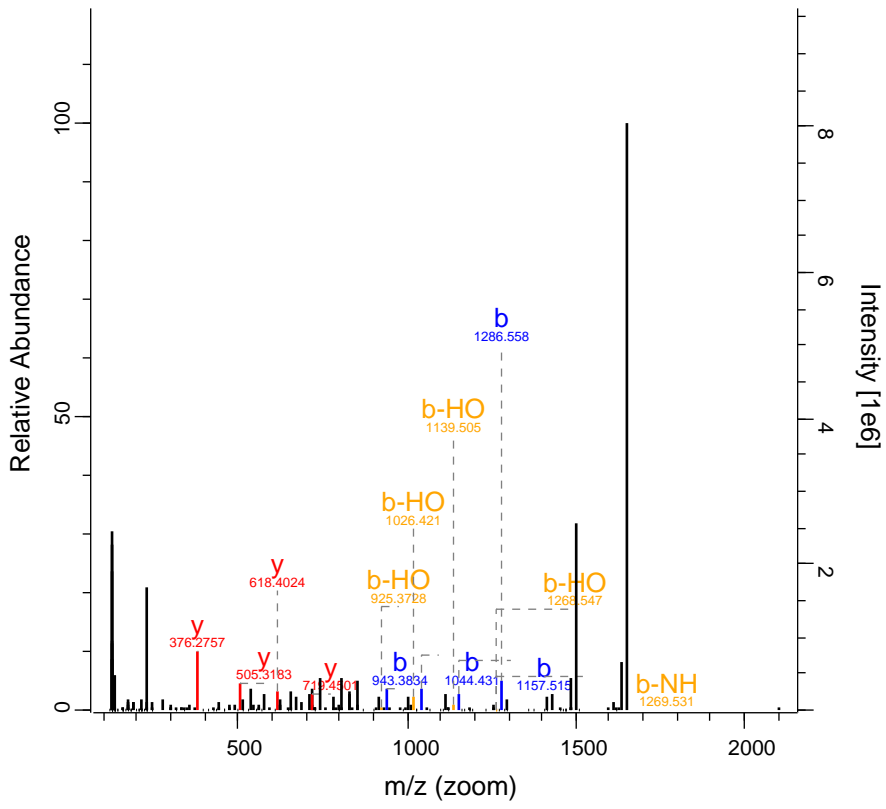

RO-QC-160121_ZackD_SS_Set_02_Fractic 20329 FTMS; HC 172.18 1018.46 MYH11

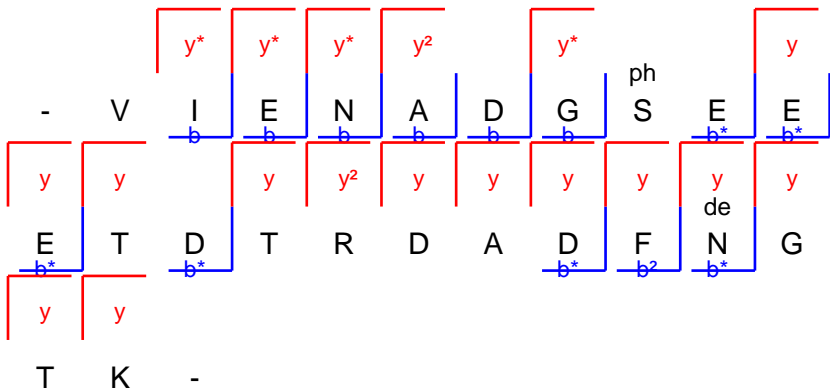
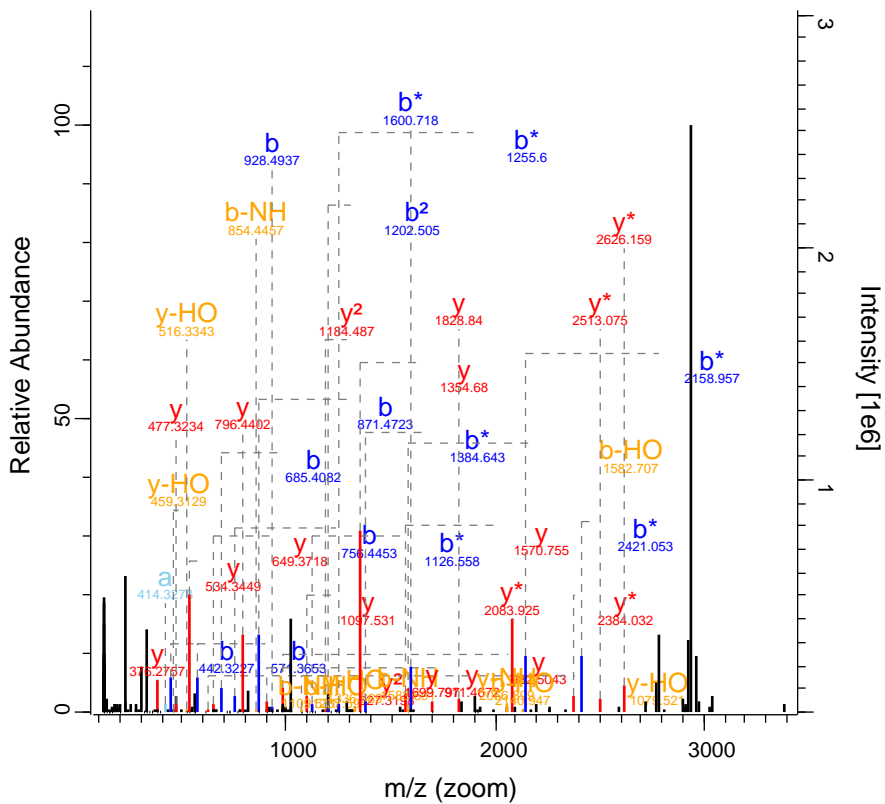

RO-QC-160121_ZackD_SS_Set_02_Fraction 21010 FTMS; HC 87.16 614.29 MAPK1

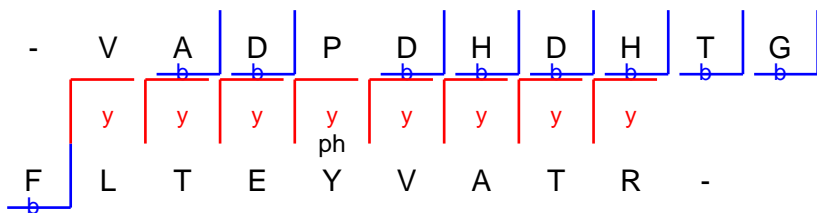
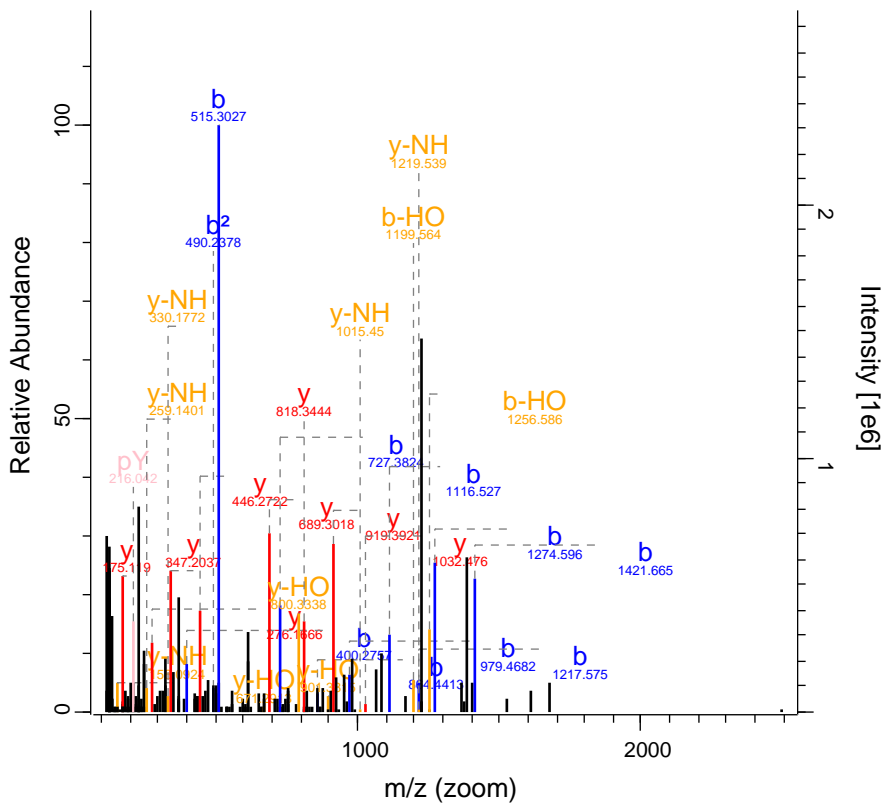

RO-QC-160121_ZackD_SS_Set_02_Fraction 23925 FTMS; HC 80.79 857.88 GJA1

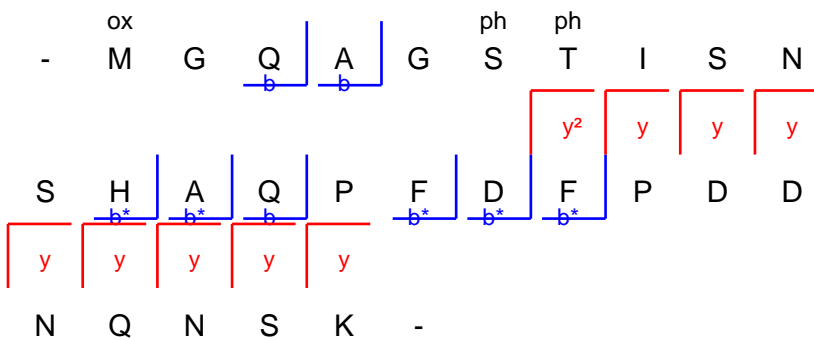
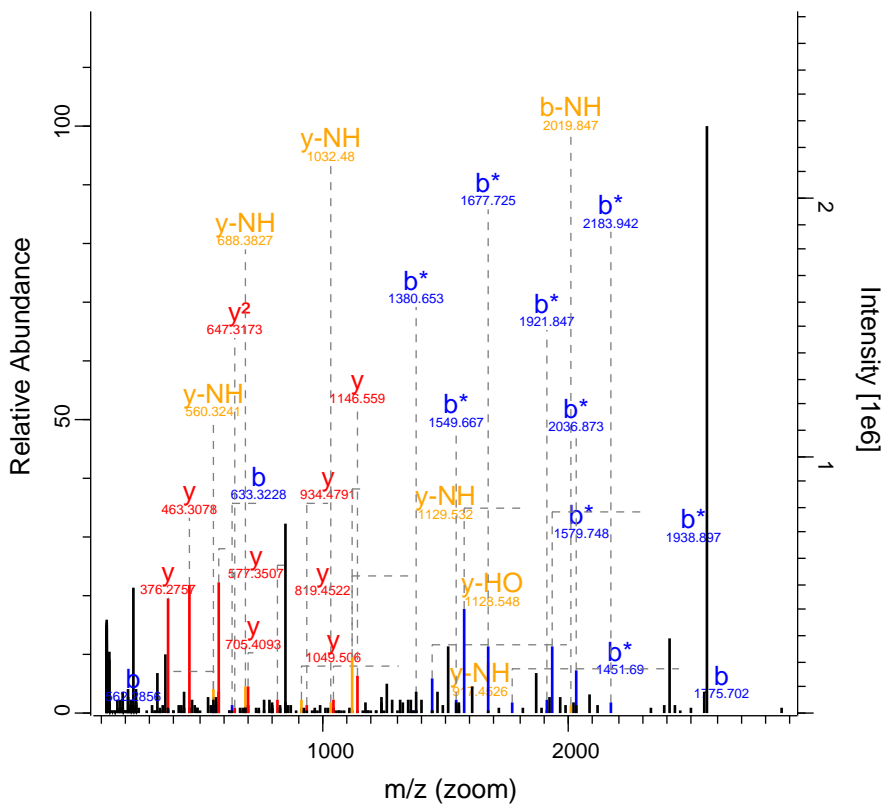

RO-QC-160121_ZackD_SS_Set_02_Fraction 26508 FTMS; HC 94.4 623.82 FLNC

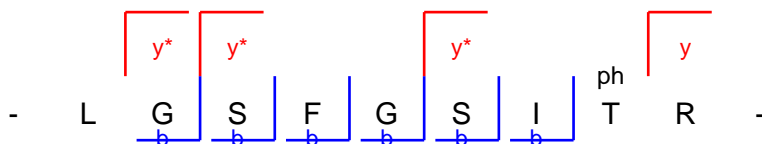
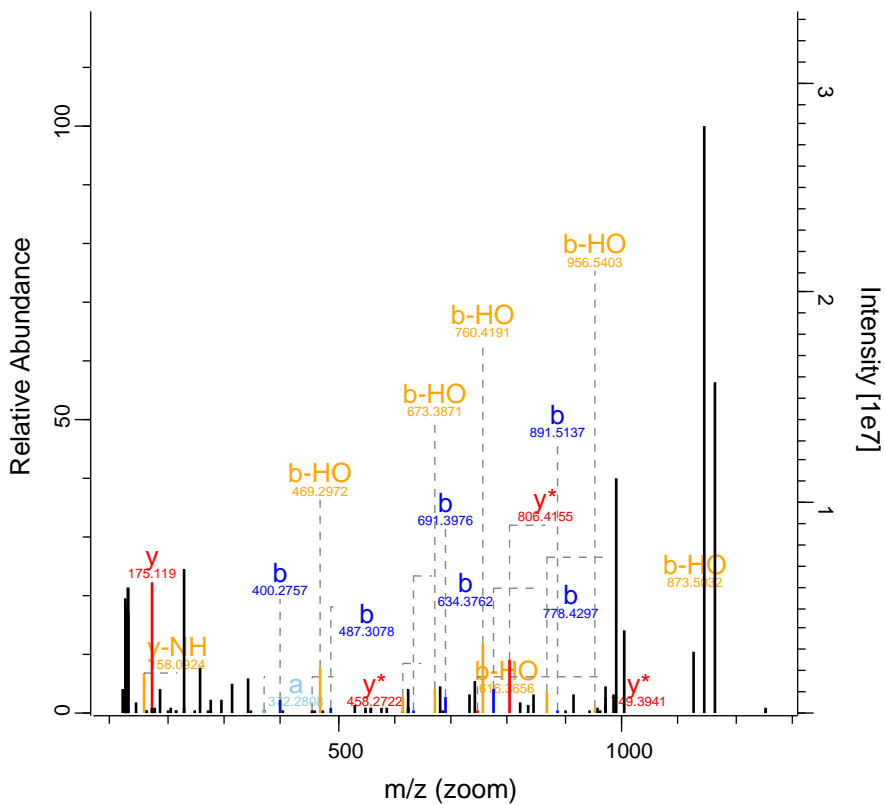

RO-QC-160121_ZackD_SS_Set_02_Fraction 28132 FTMS; HC 91.66 810.43 PAK2

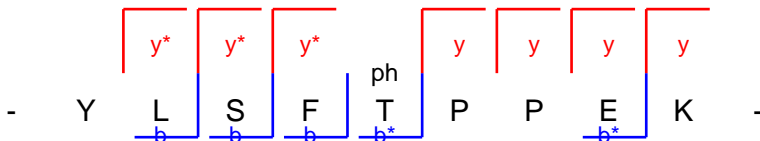
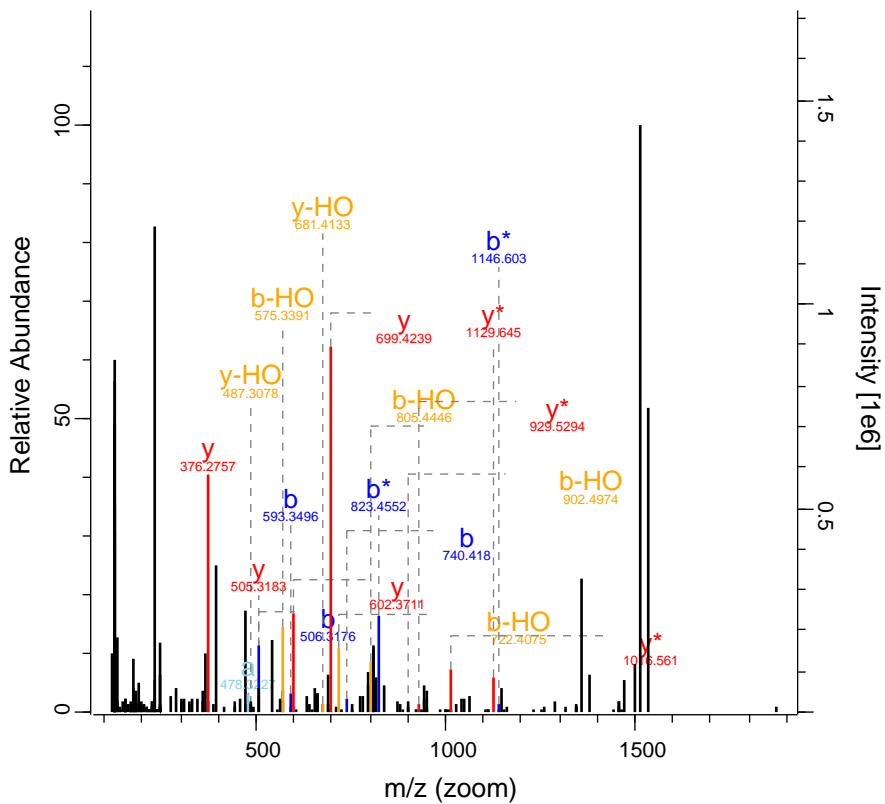

RO-QC-160121_ZackD_SS_Set_02_Fraction28232 FTMS; HC 83.36 730.15 EBAG9

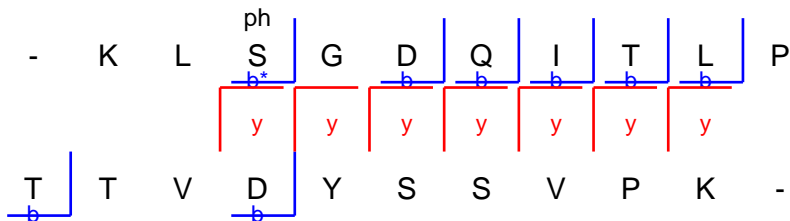
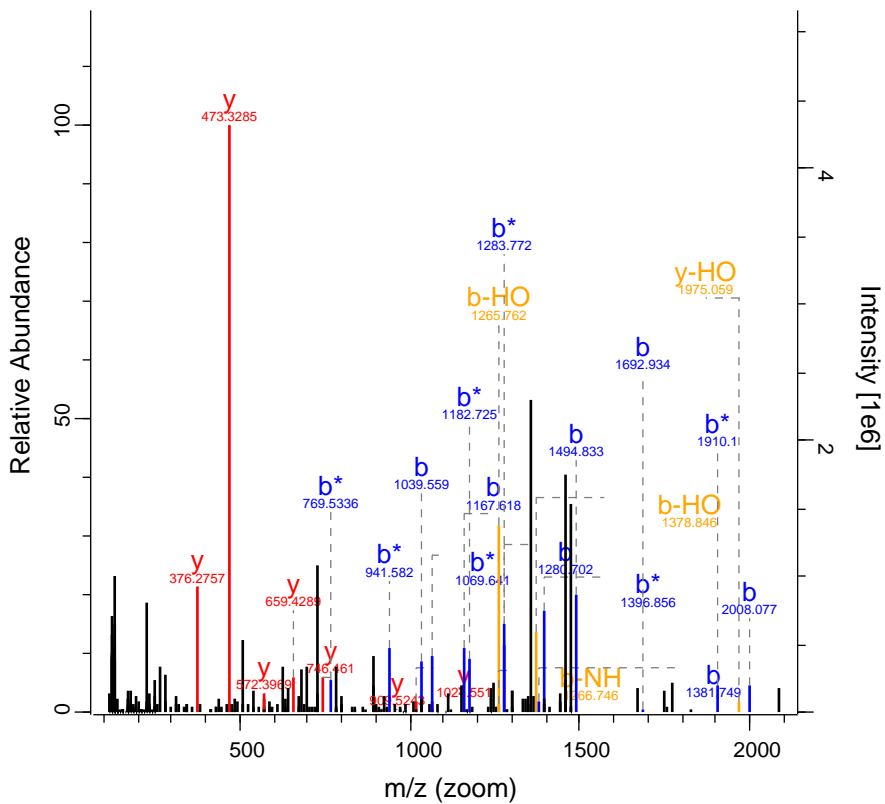

RO-QC-160121_ZackD_SS_Set_02_Fraction 28419 FTMS; HC 85.29 884.47 USP21

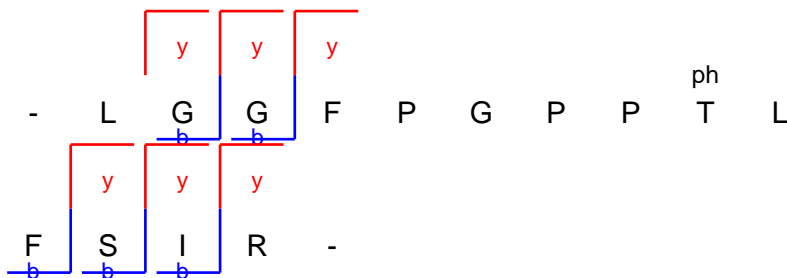
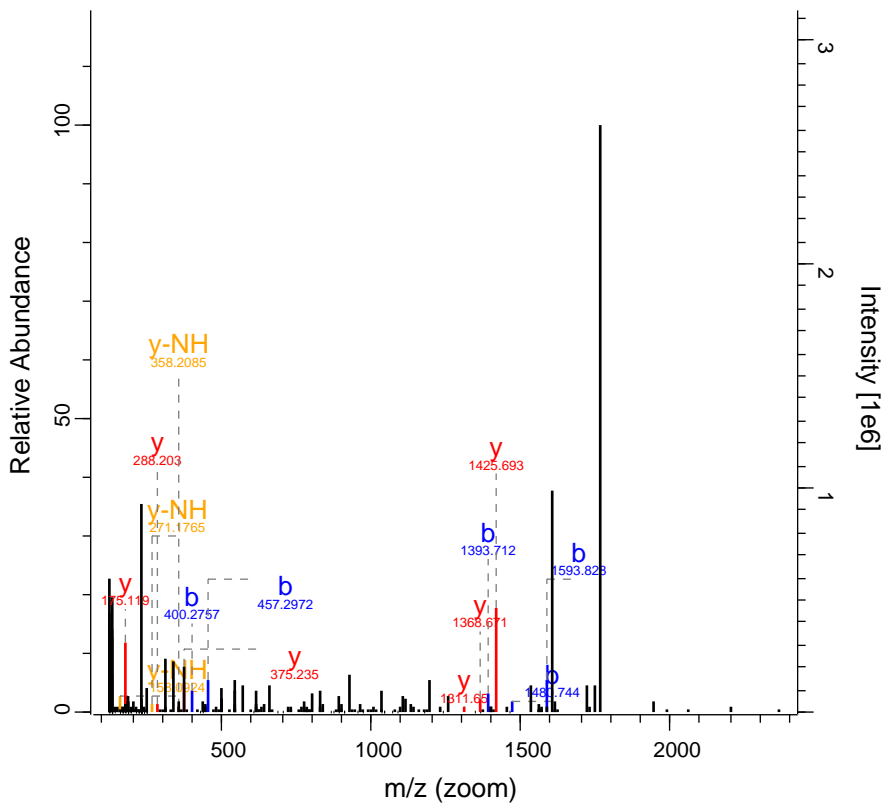

RO-QC-160121_ZackD_SS_Set_02_Fractio 28642 FTMS; HC 128.67 781.74 EGFR

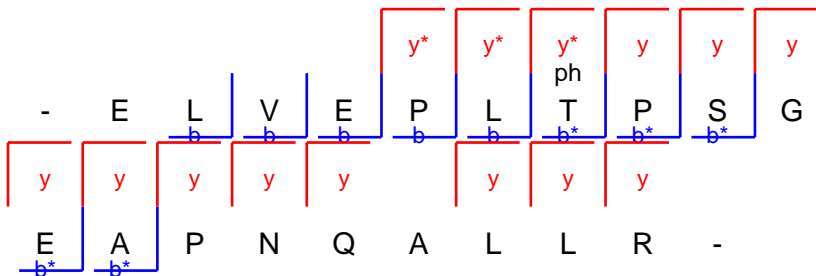
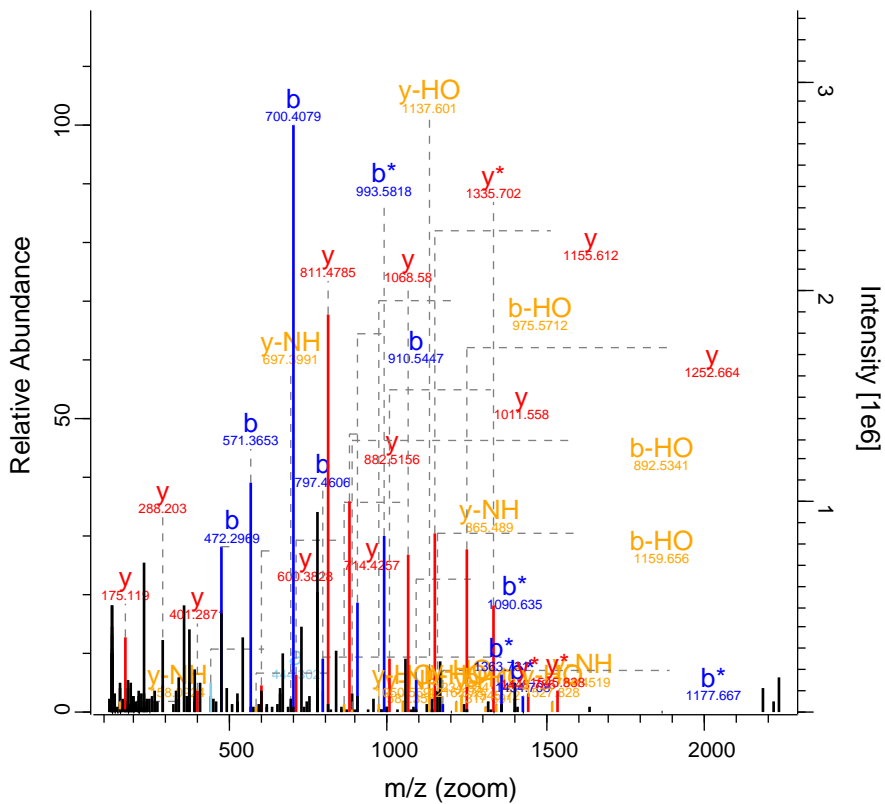

RO-QC-160121_ZackD_SS_Set_02_Fraction 29015 FTMS; HCl 50.15 629.6 KIAA1328

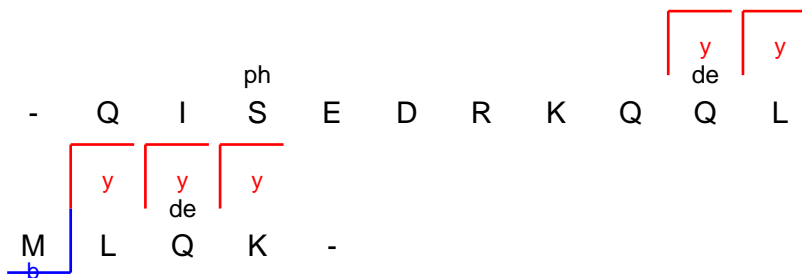
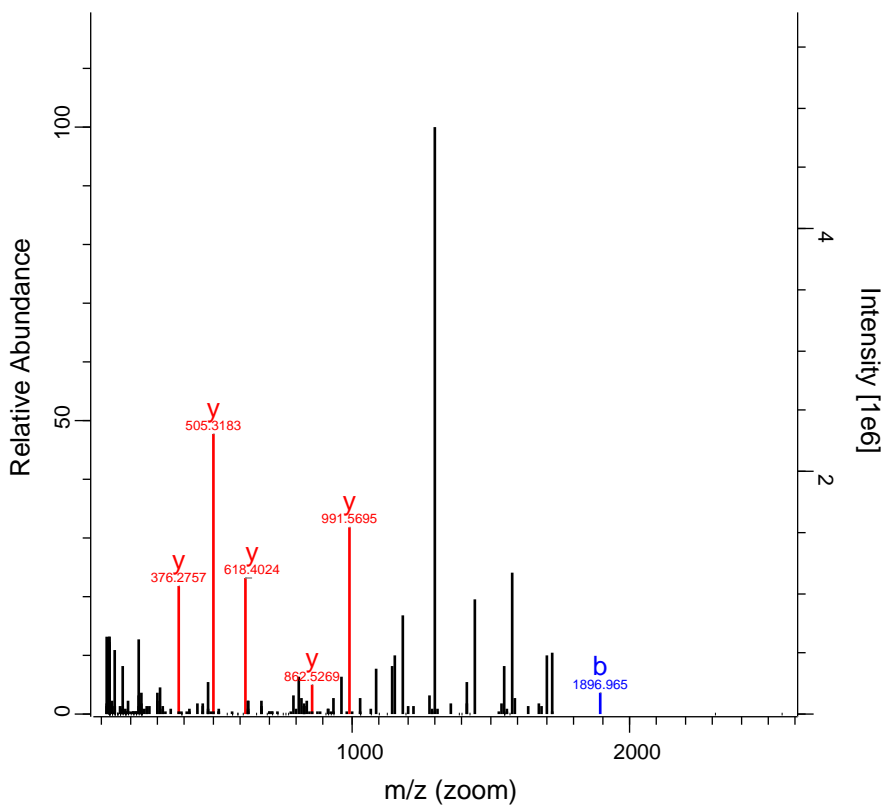

RO-QC-160121_ZackD_SS_Set_02_Fraction 29658 FTMS; HC 43.54 730.73 MAG11

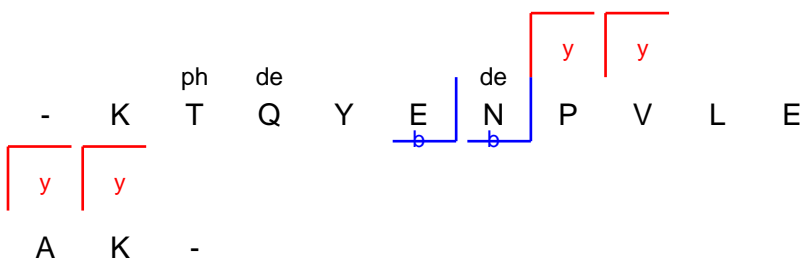
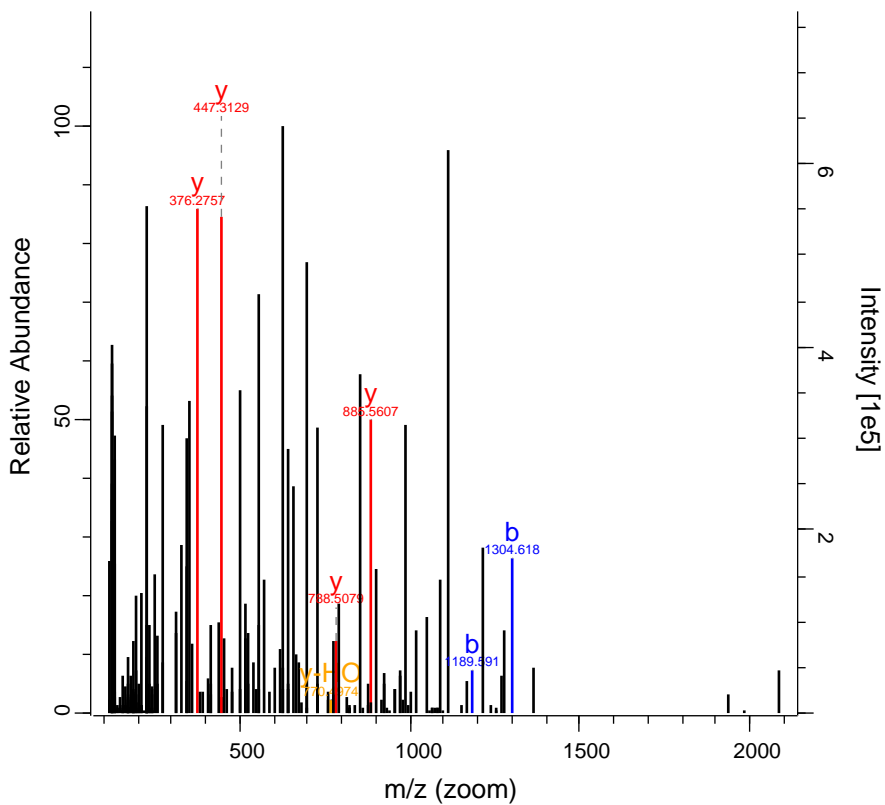

RO-QC-160121_ZackD_SS_Set_02_Fraction 29714 FTMS; HC 48.29 680.59 GCN1L1

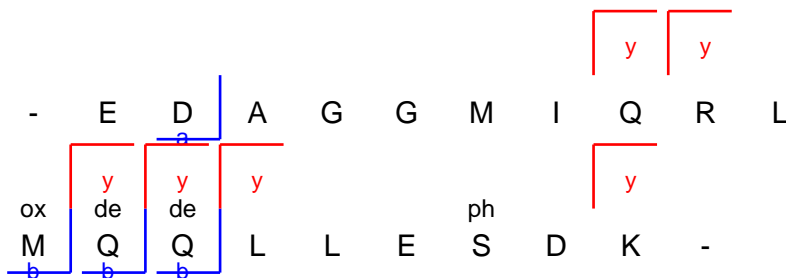
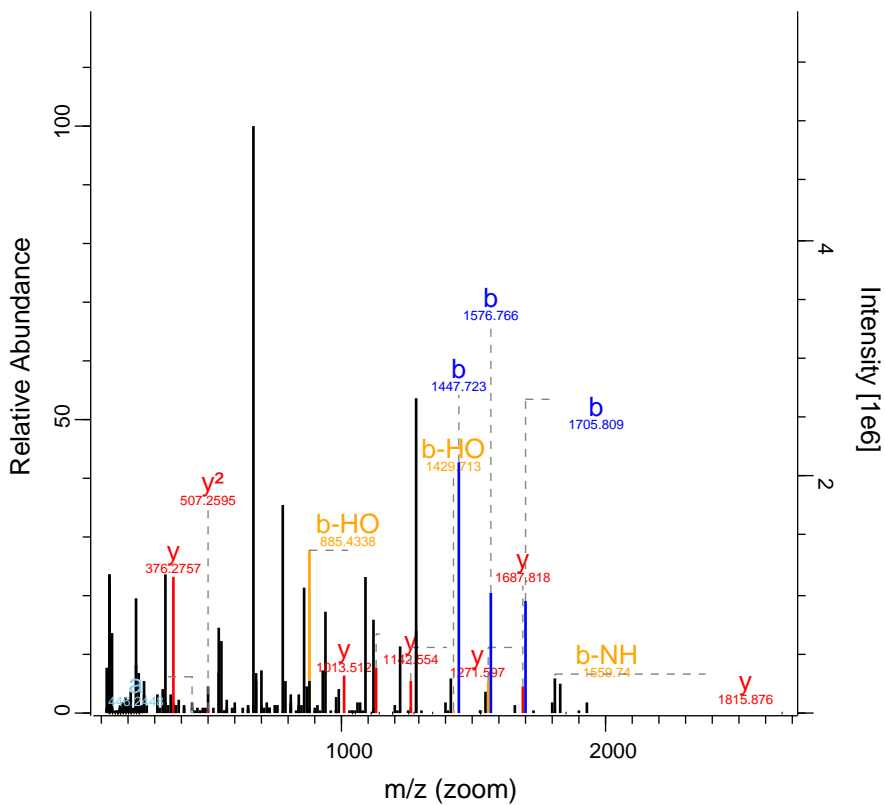

RO-QC-160121_ZackD_SS_Set_02_Fractio 29905 FTMS; HC 153.89 994.47 AHNAK

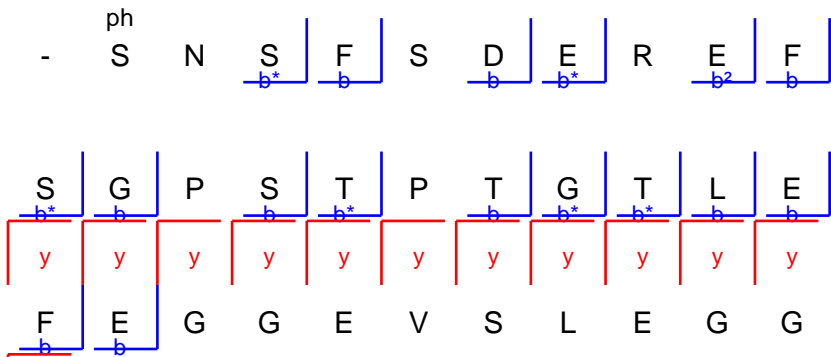
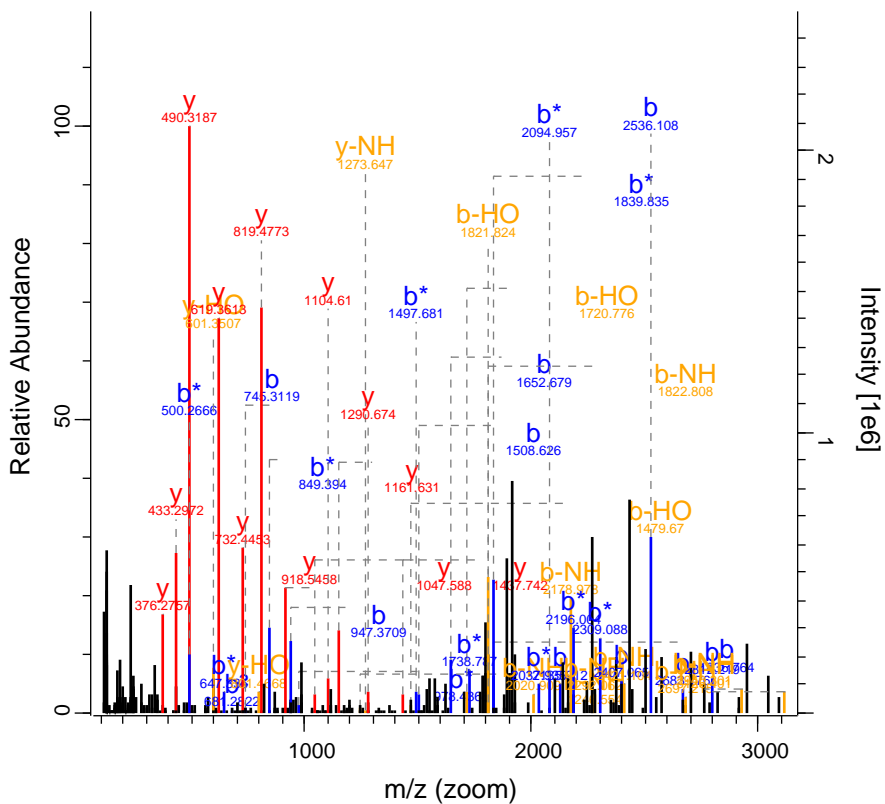

RO-QC-160121_ZackD_SS_Set_02_Fraction 30642 FTMS; HC 60.44 963.54 OR7A10

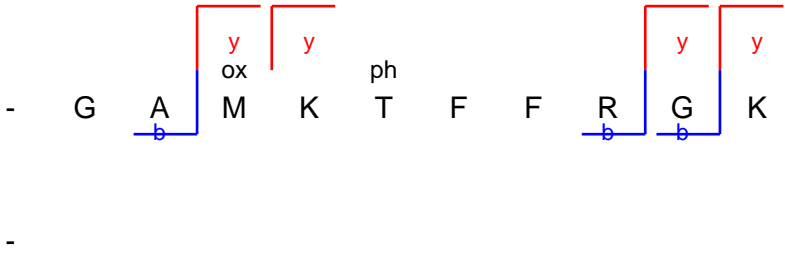
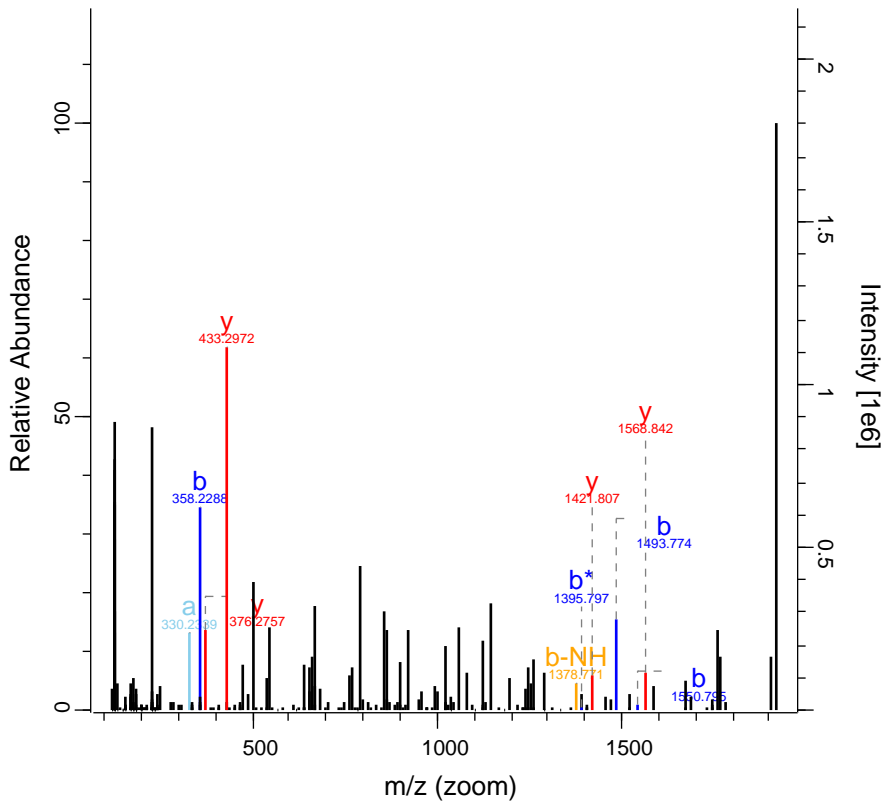

RO-QC-160121_ZackD_SS_Set_02_Fractic 30936 FTMS; HC 123.99 1038.14 WAPAL

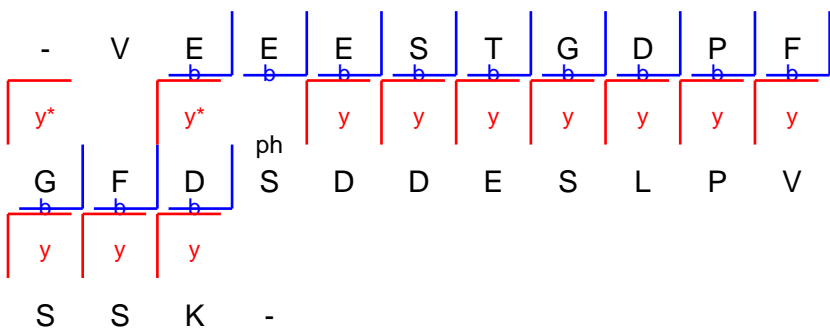
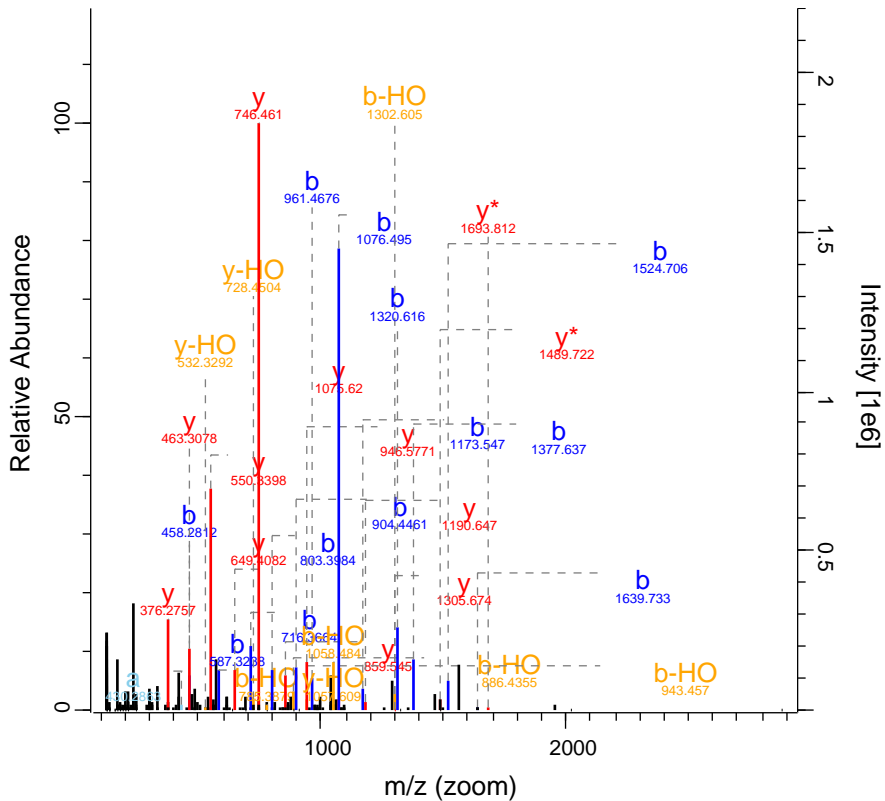

RO-QC-160121_ZackD_SS_Set_02_Fractic 30990 FTMS; HC 73.98 1172.14 TFPI2

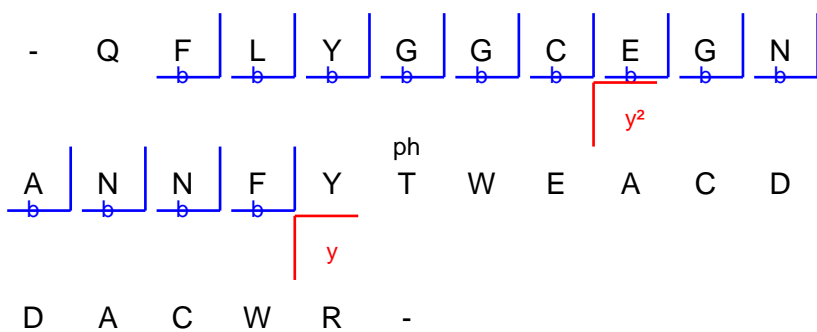
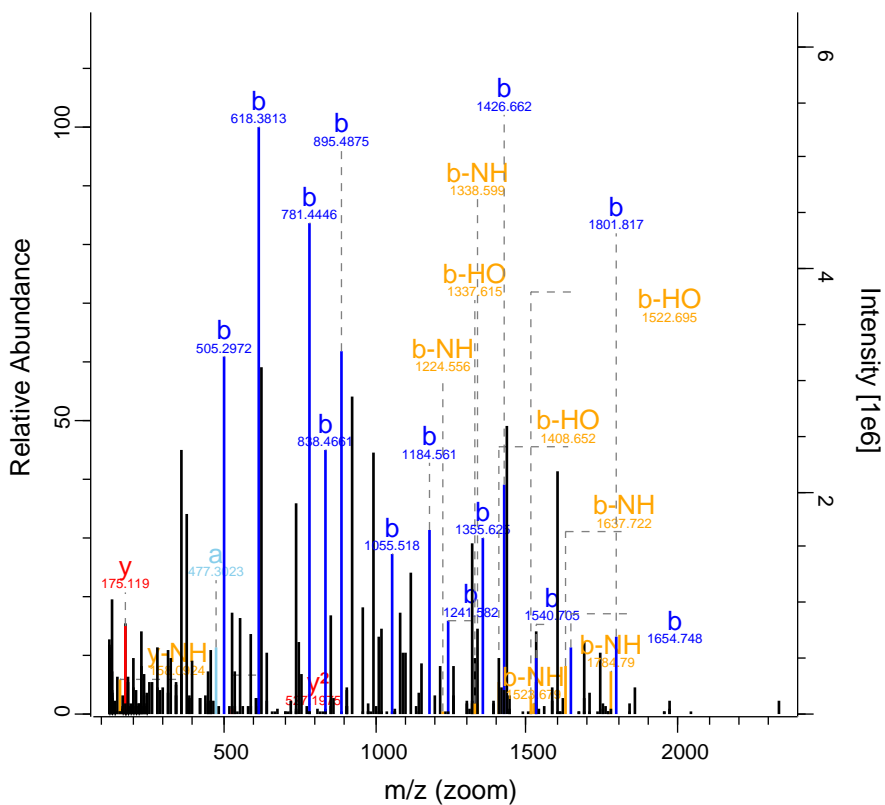

RO-QC-160121_ZackD_SS_Set_02_Fractic 31004 FTMS; HC 61.65 1160.56 SGOL2

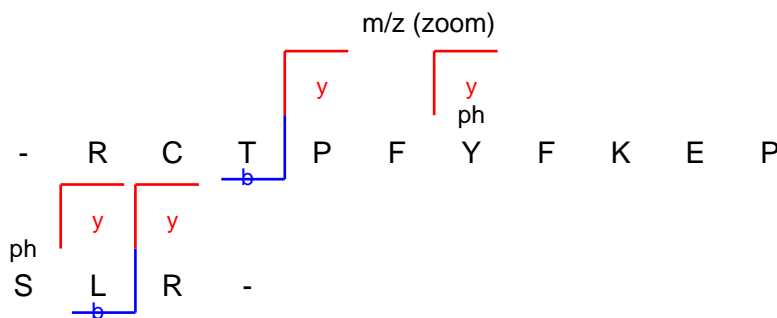
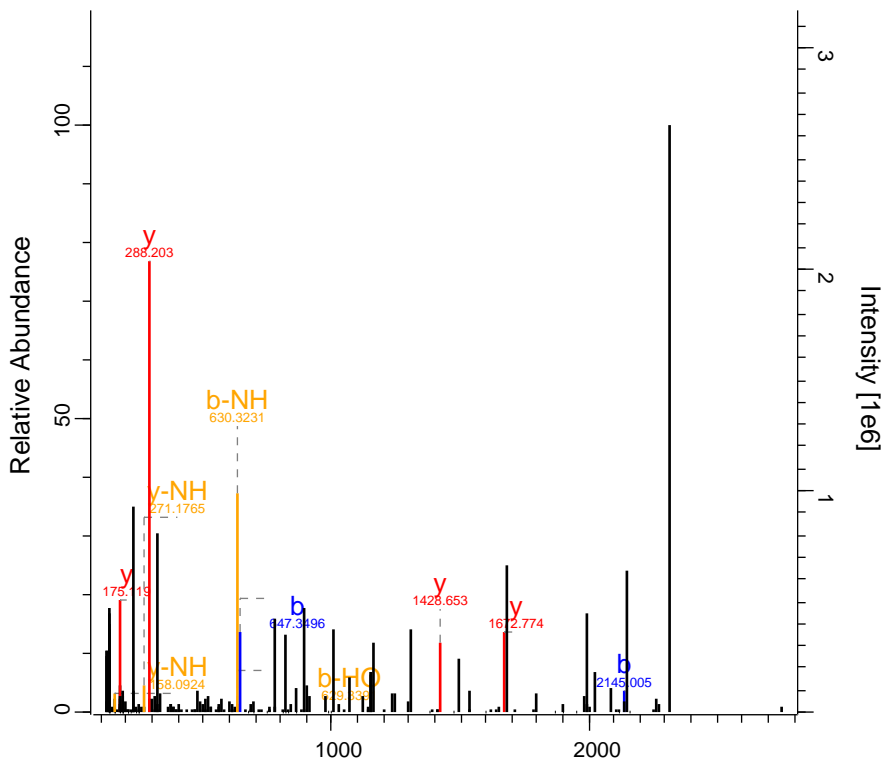

RO-QC-160121_ZackD_SS_Set_02_Fraction 32105 FTMS; HC 72.94 657.37 CD96

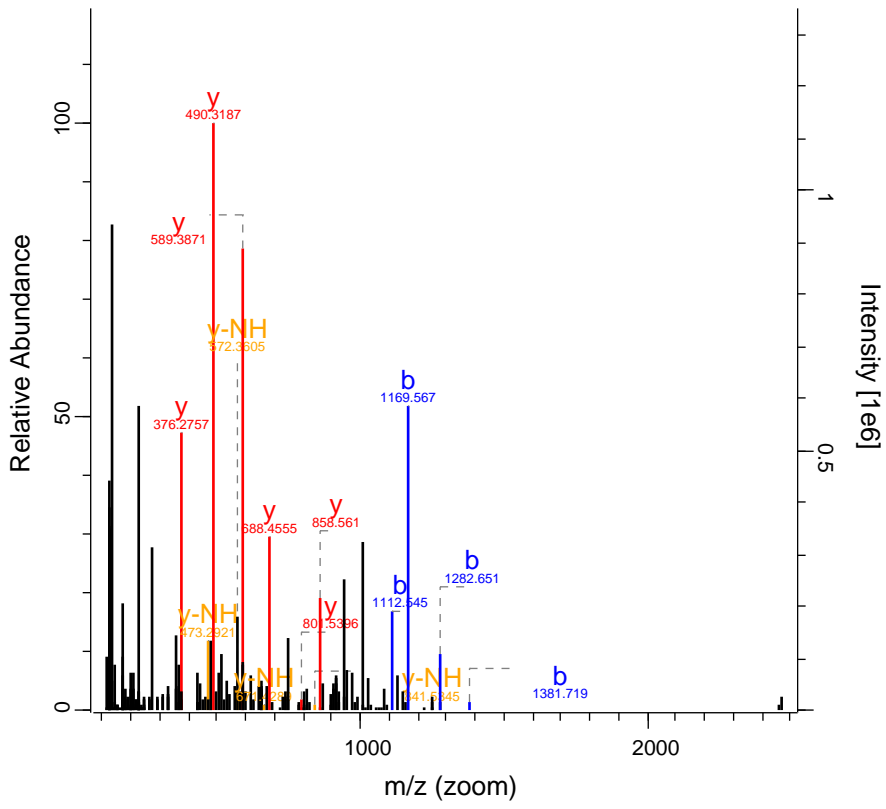

RO-QC-160121_ZackD_SS_Set_02_Fractic 32200 FTMS; HC 58.08 1004.21 SMARCC2

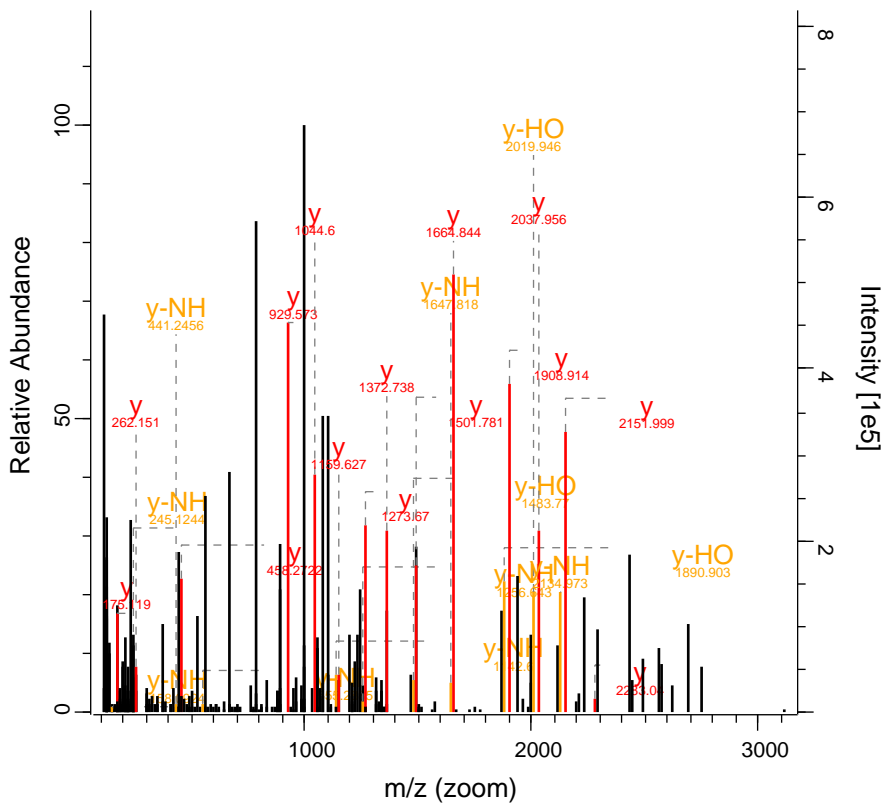

ph

-	W	I	L	D	T	D	T	F	N	E
	y	y	y	y		y	y	y	y	y
W	M	N	E	E	D	Y	E	V	N	D
y	y		y		y	y				
D	K	N	P	V	S	R	-			

RO-QC-160121_ZackD_SS_Set_02_Fractio 33675 FTMS; HC 113.93 671.85 GOLGA4

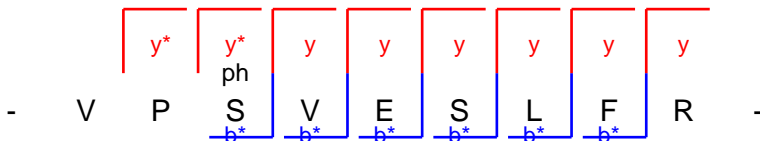
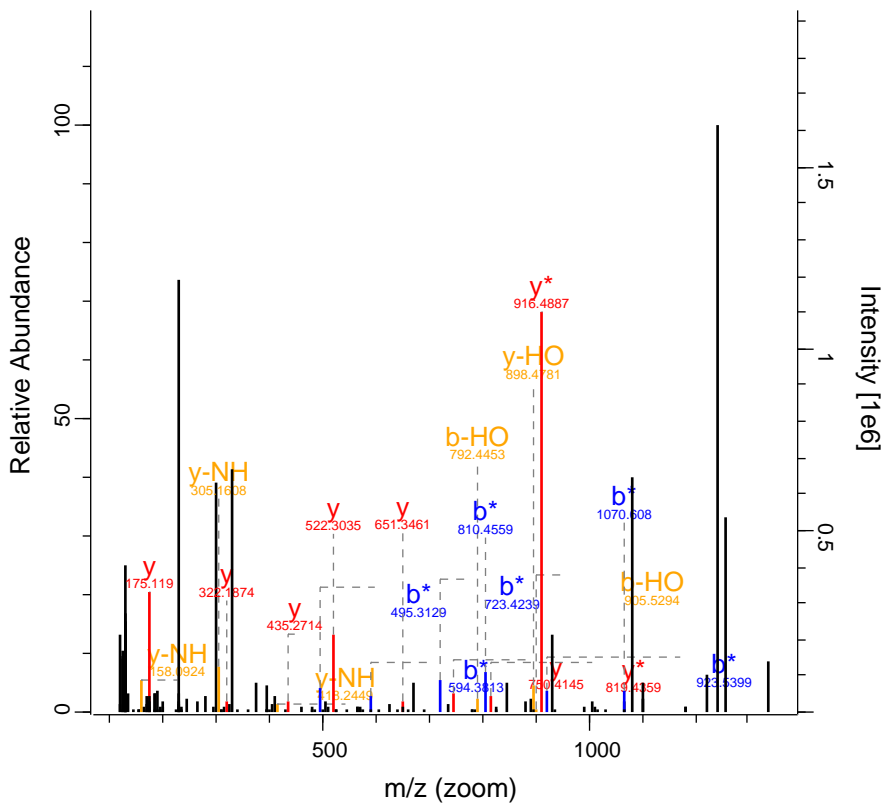

RO-QC-160121_ZackD_SS_Set_02_Fraction 33965 FTMS; HC 62.7 738.66 CLASP2

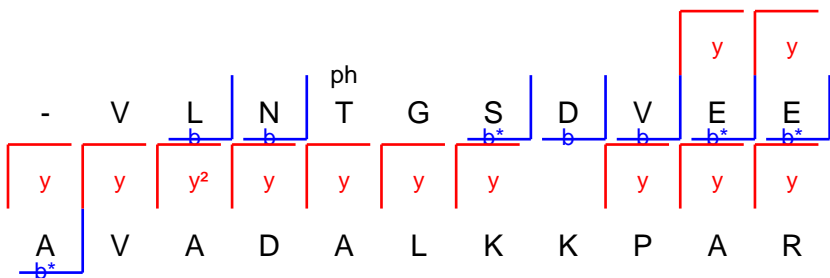
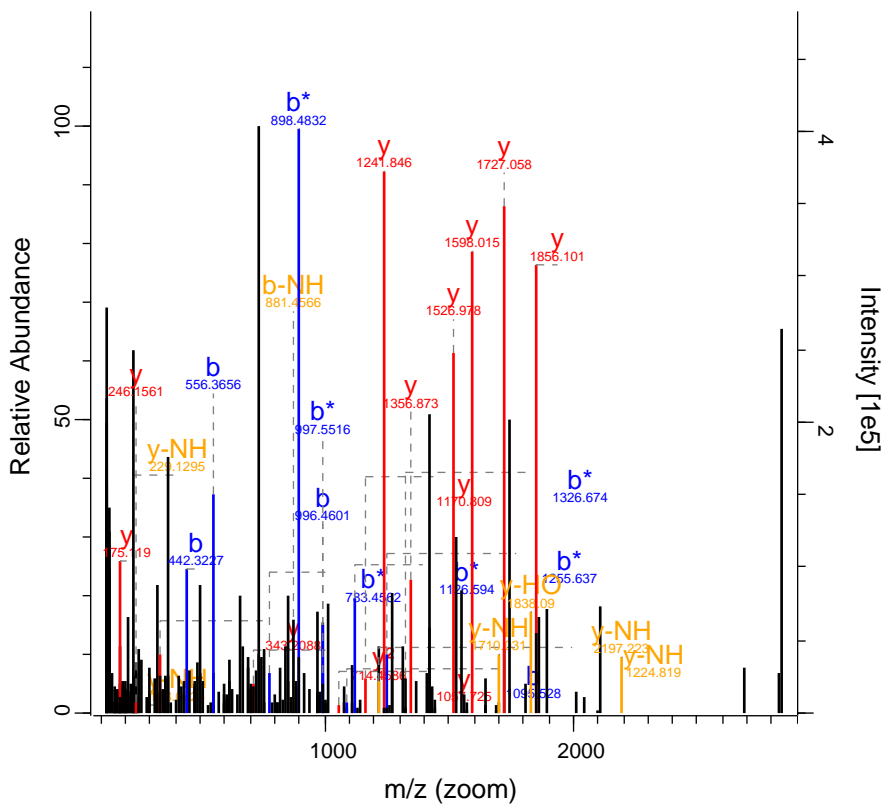

RO-QC-160121_ZackD_SS_Set_02_Fraction 34258 FTMS; HC 73.21 895.03 PPEF1

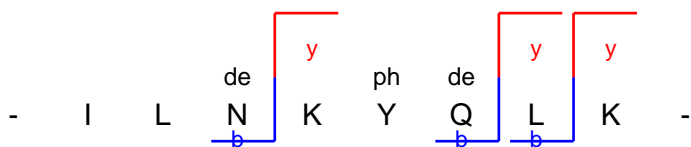
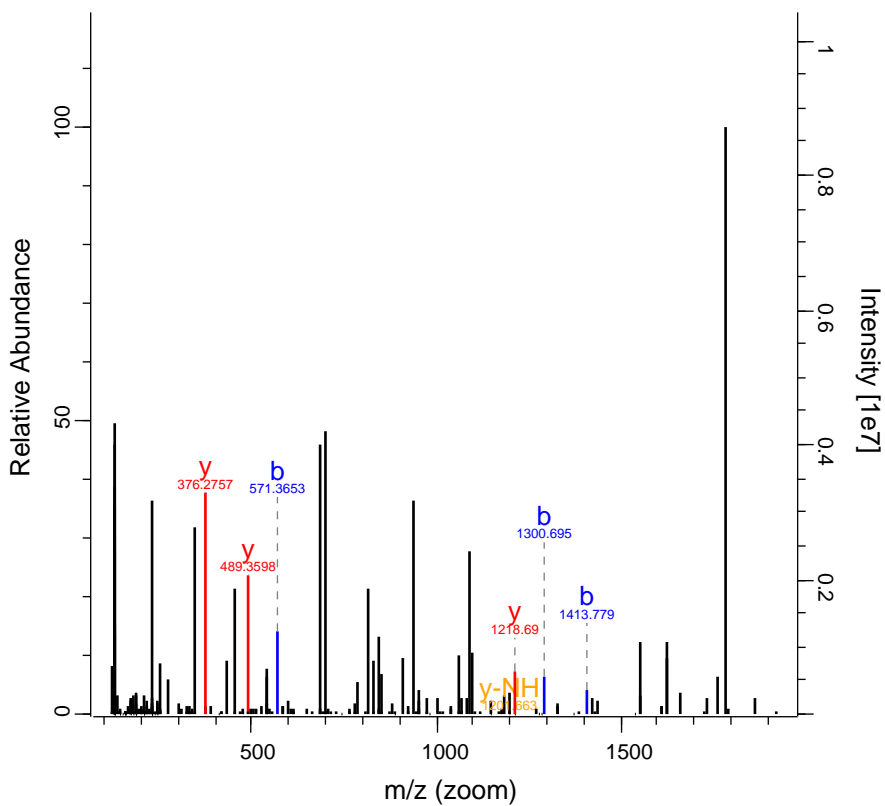

RO-QC-160121_ZackD_SS_Set_02_Fraction 6226 FTMS; HCl 82.42 720.37 RRBP1

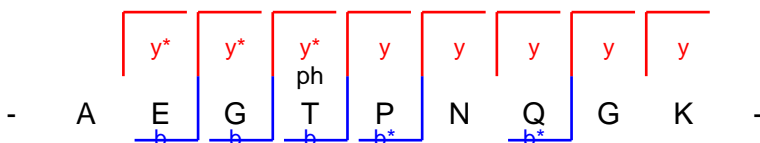
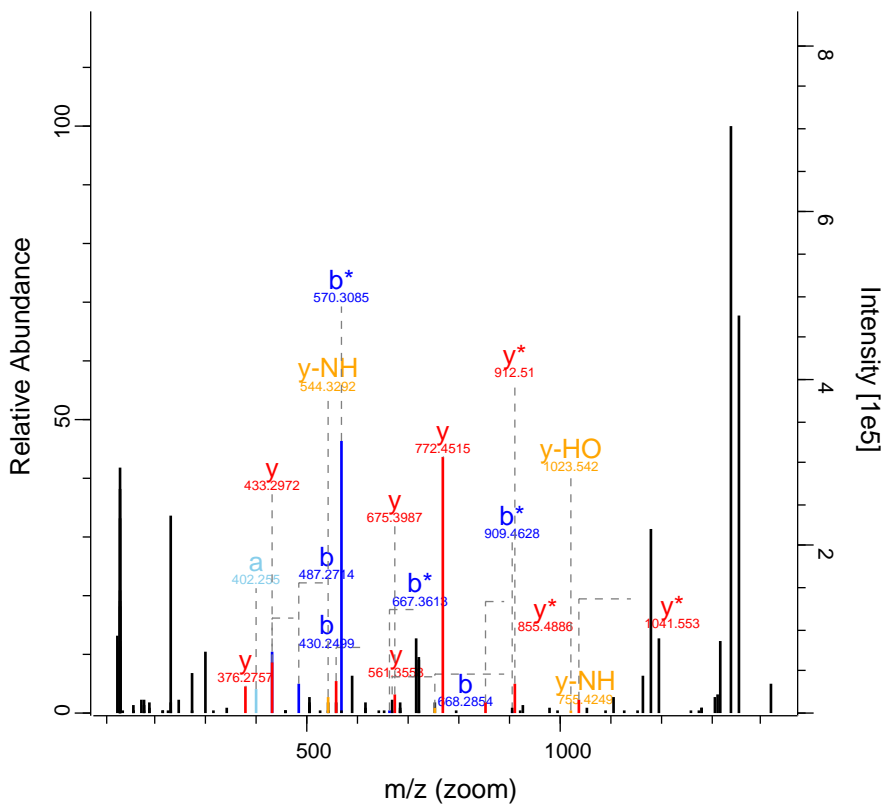

RO-QC-160121_ZackD_SS_Set_02_Fractio 8672 FTMS; HC 113.15 1029.48 UBAP2L

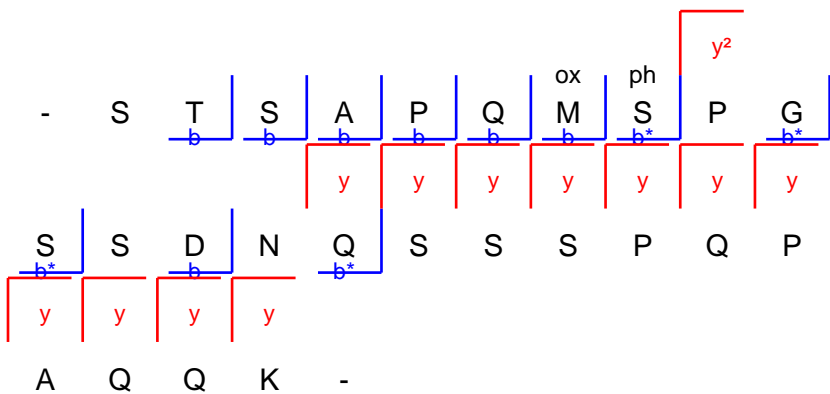
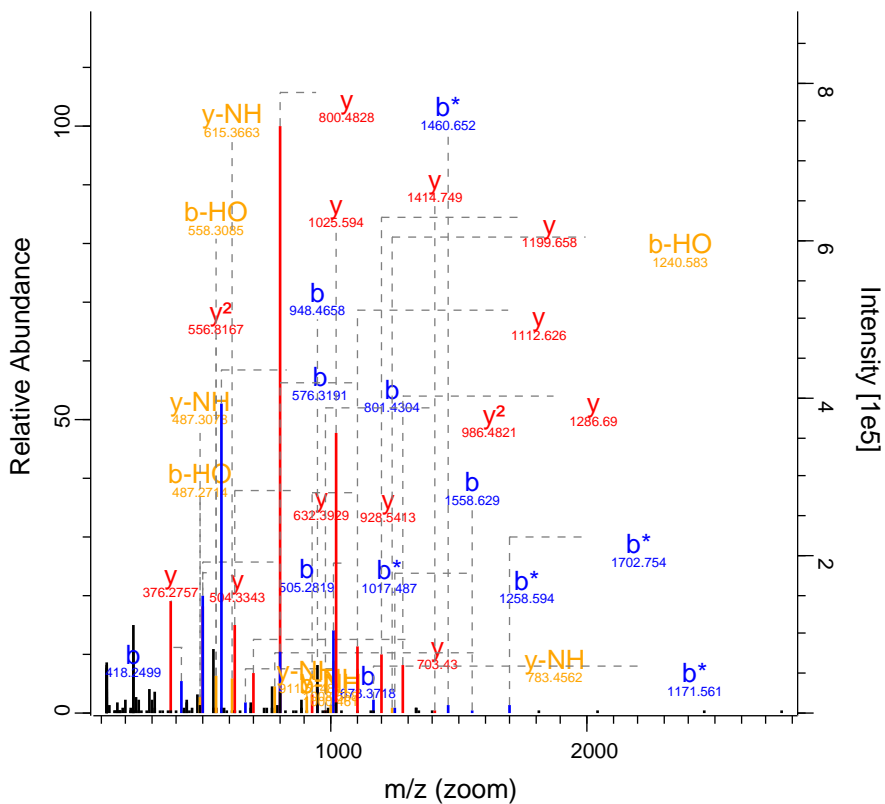

RO-QC-160121_ZackD_SS_Set_02_Fraction 10440 FTMS; HC 91.87 805.98 GTF3C2

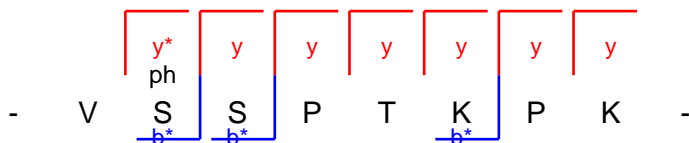
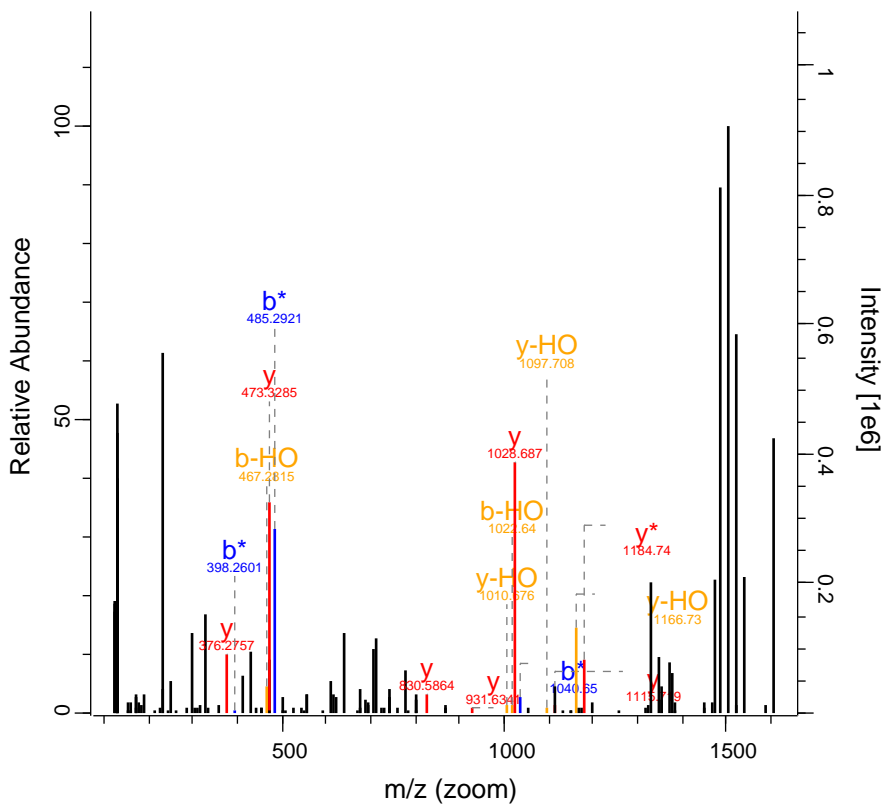

RO-QC-160121_ZackD_SS_Set_02_Fraction 10648 FTMS; HC 91.91 911.53 MICALL1

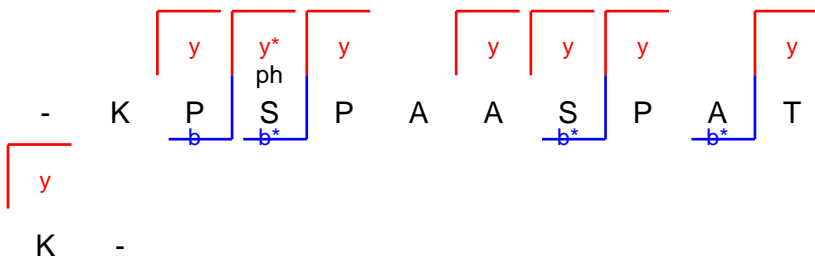
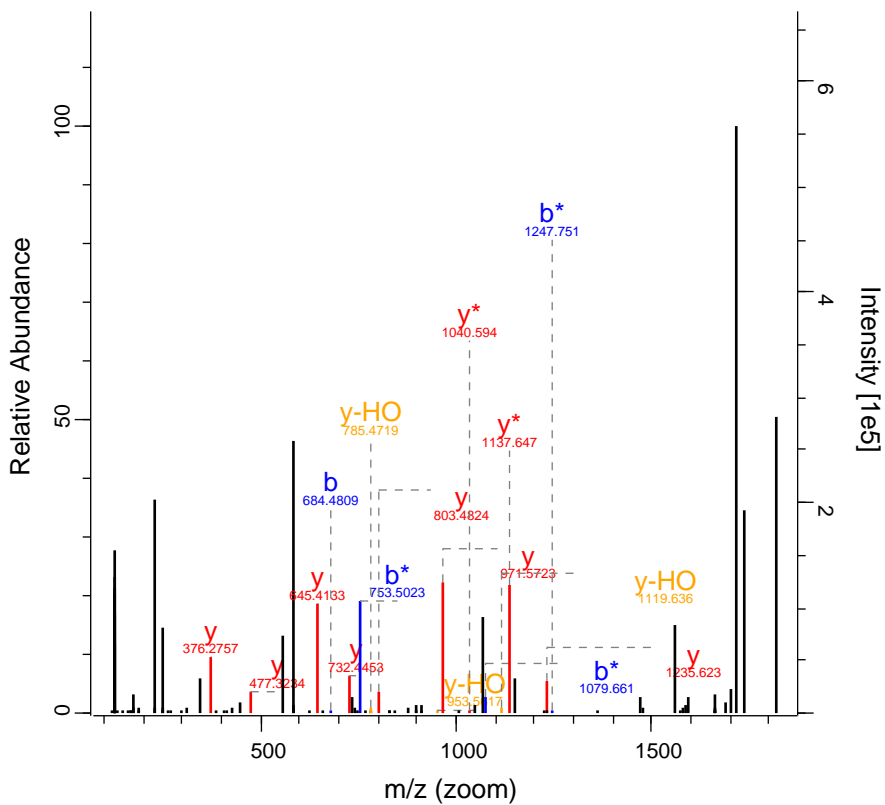

RO-QC-160121_ZackD_SS_Set_02_Fractio 10675 FTMS; HC 164.65 843.42 SON

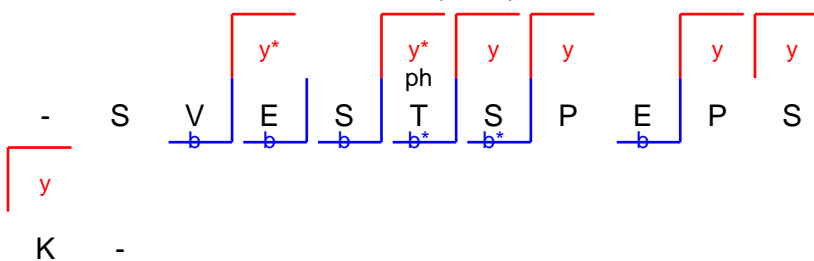
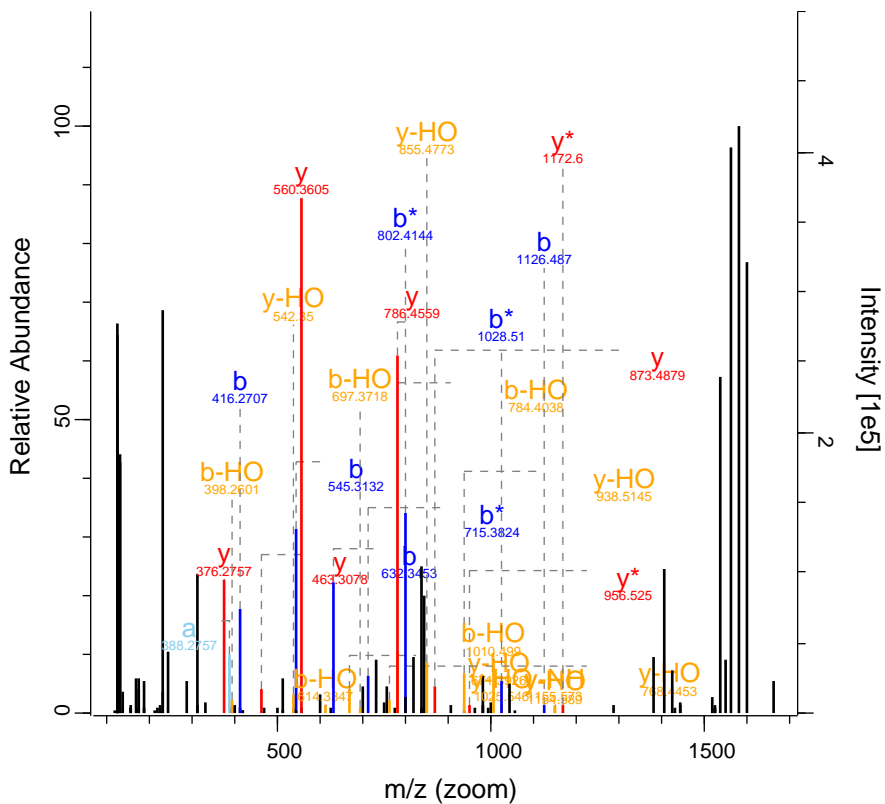

K

RO-QC-160121_ZackD_SS_Set_02_Fractic 11268 FTMS; HC 221.78 1114.54 EDC3

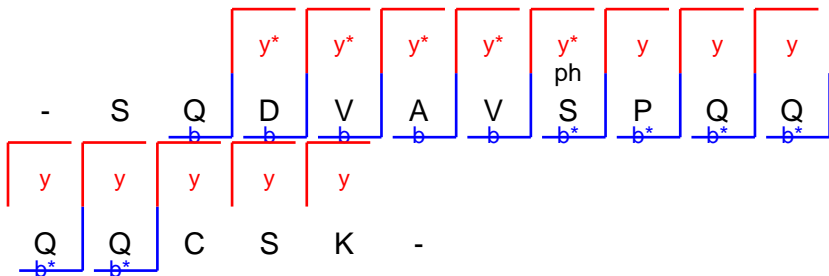
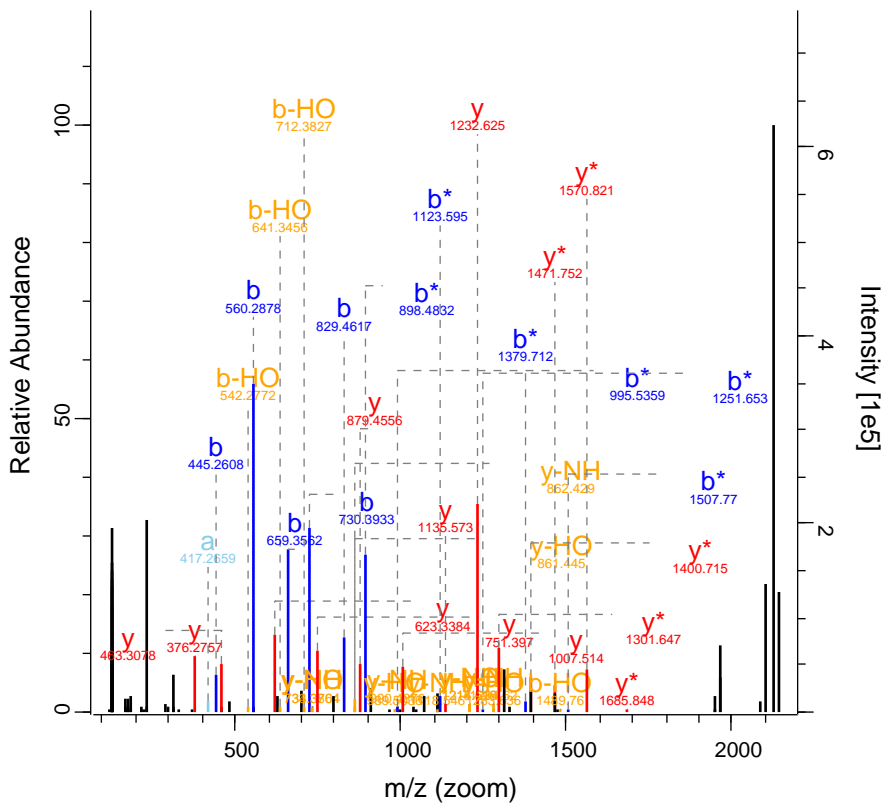

RO-QC-160121_ZackD_SS_Set_02_Fraction11341 FTMS; HC 95.48 445.89 CTNND1

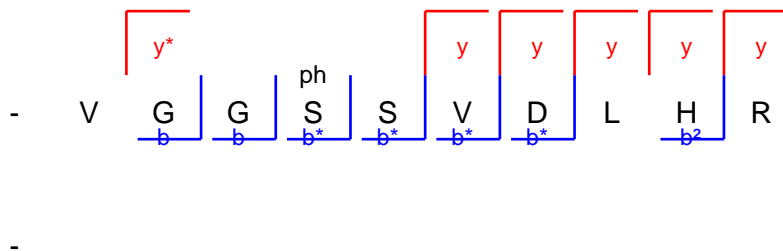
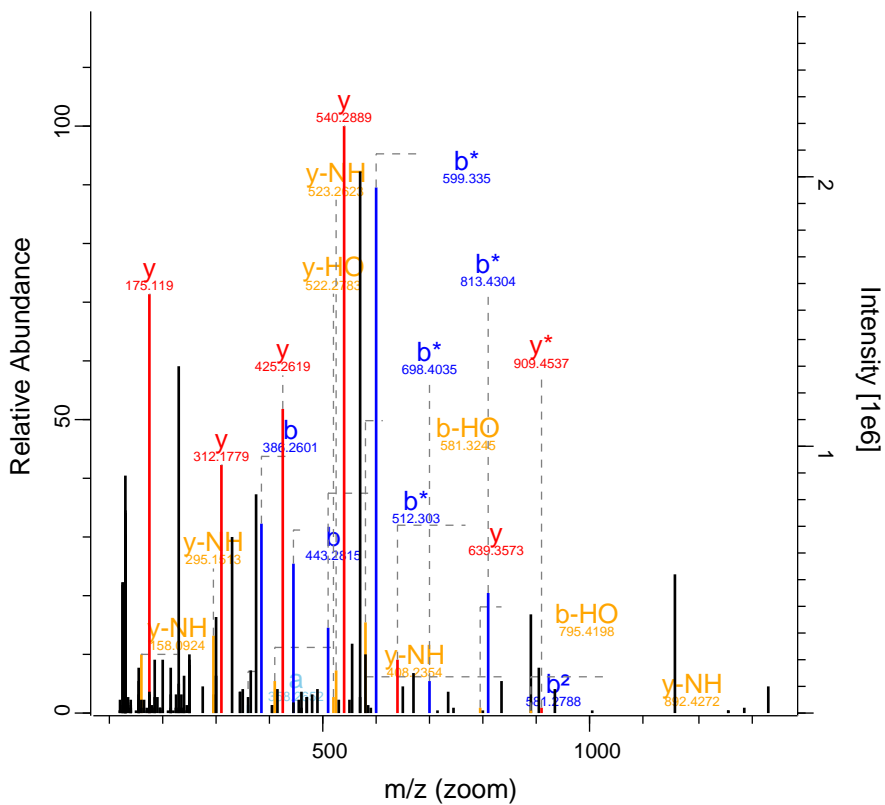

RO-QC-160121_ZackD_SS_Set_02_Fractio 11631 FTMS; HC 151.79 782.88 WWC1

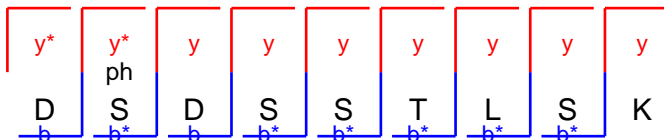
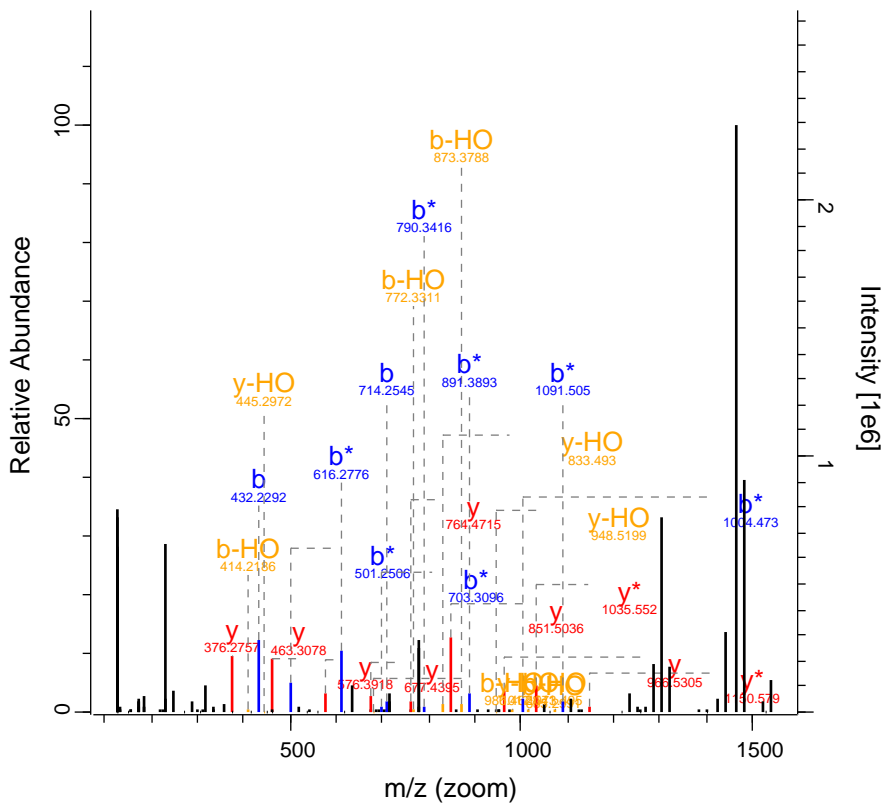

RO-QC-160121_ZackD_SS_Set_02_Fractio 12177 FTMS; HC 119.68 716.35 KLC1

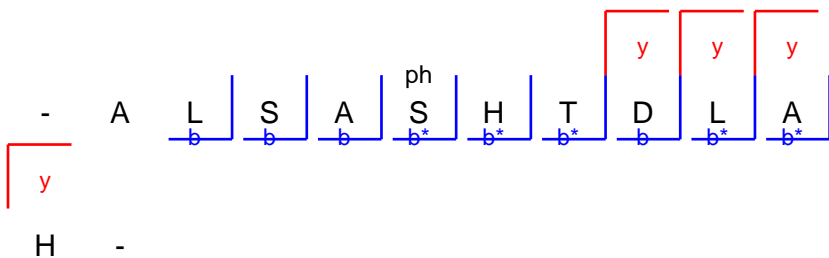
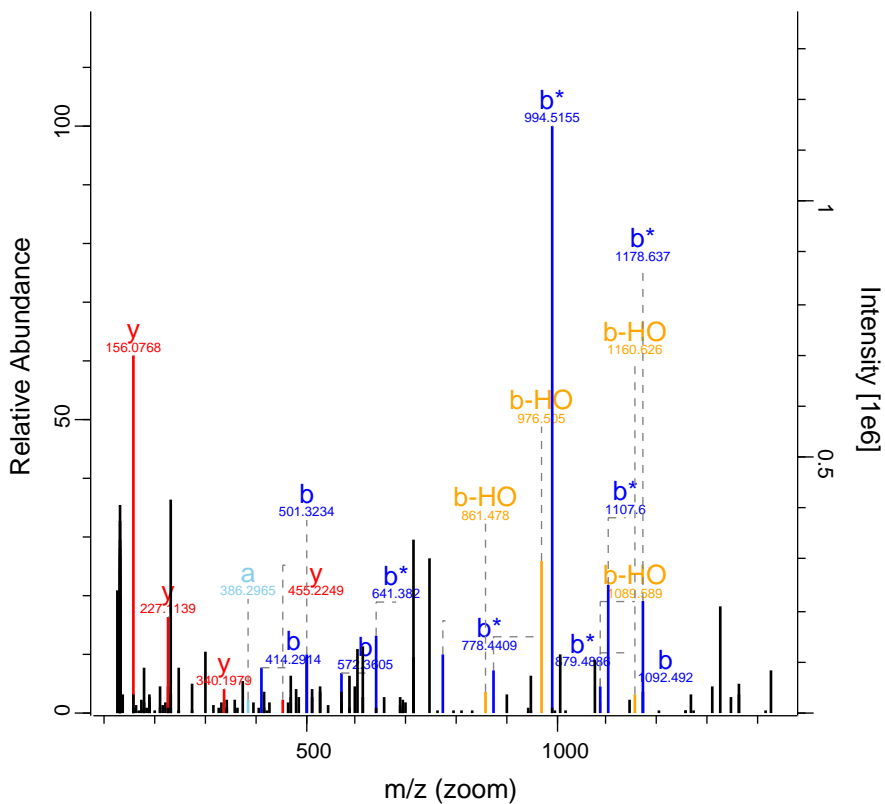

RO-QC-160121_ZackD_SS_Set_02_Fraction1 12525 FTMS; HCl 85.52 862.5 SRSF11

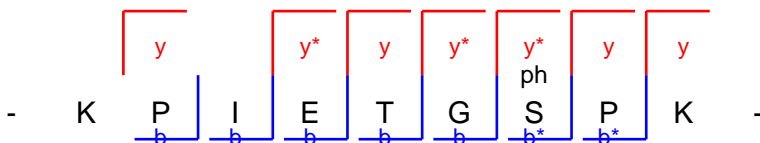
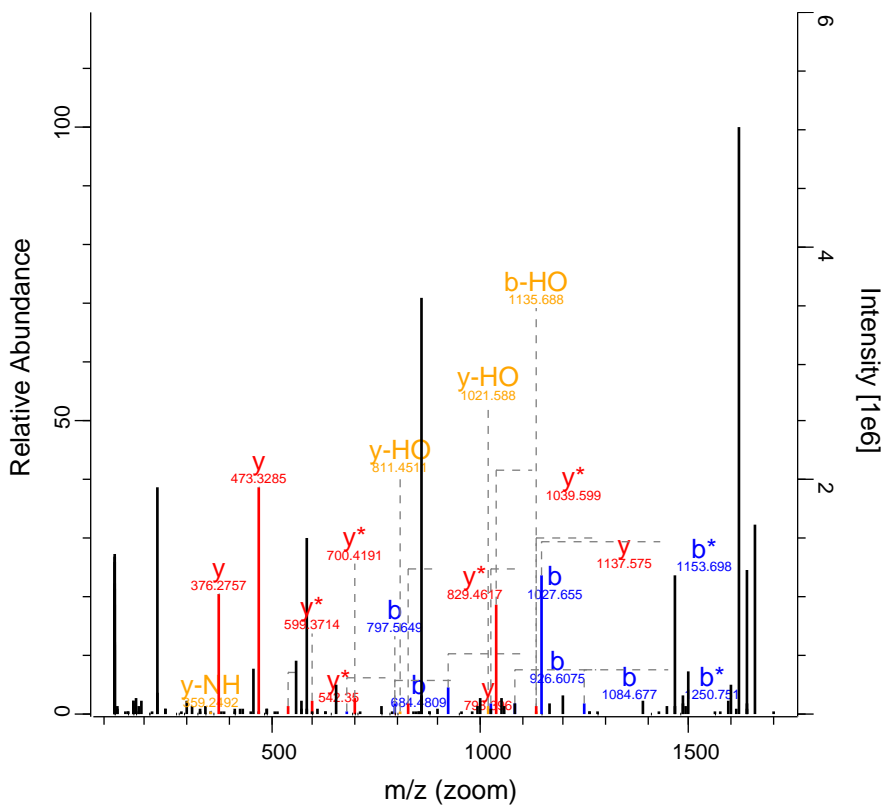

RO-QC-160121_ZackD_SS_Set_02_Fratio 12681 FTMS; HC 149.18 734.63 KTN1

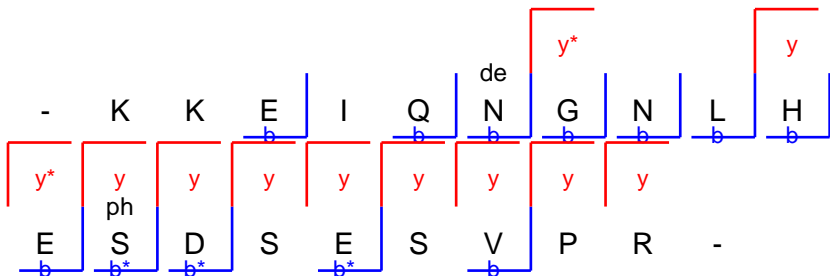
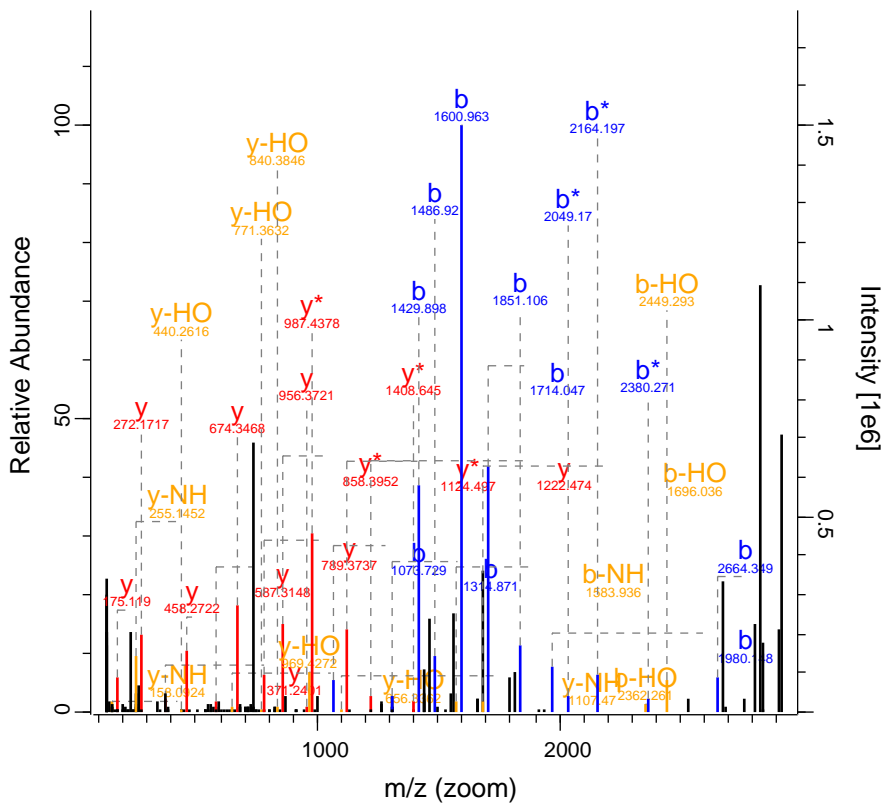

RO-QC-160121_ZackD_SS_Set_02_Fraction13344 FTMS; HCl 163.18 903.4 SSB

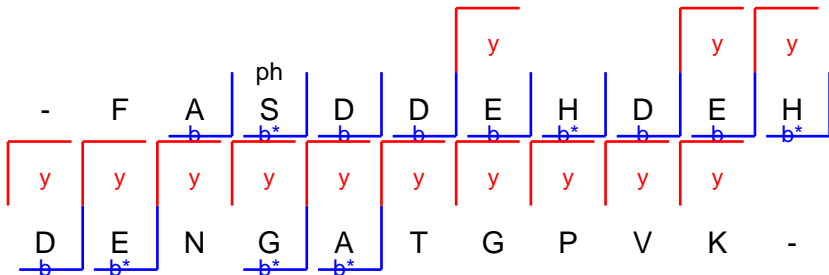
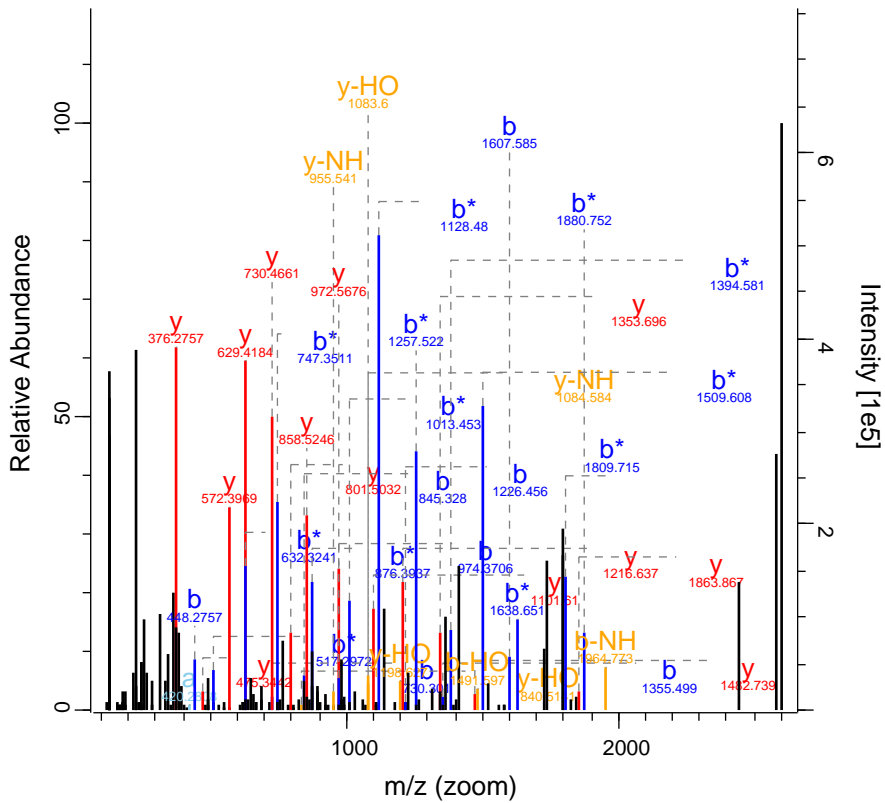

RO-QC-160121_ZackD_SS_Set_02_Fractio 13347 FTMS; HC 119.68 833.99 SCAMP3

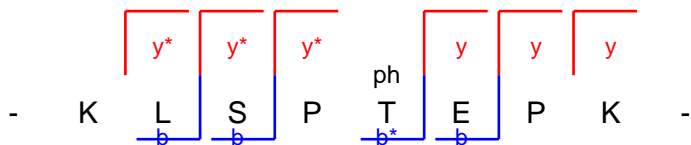
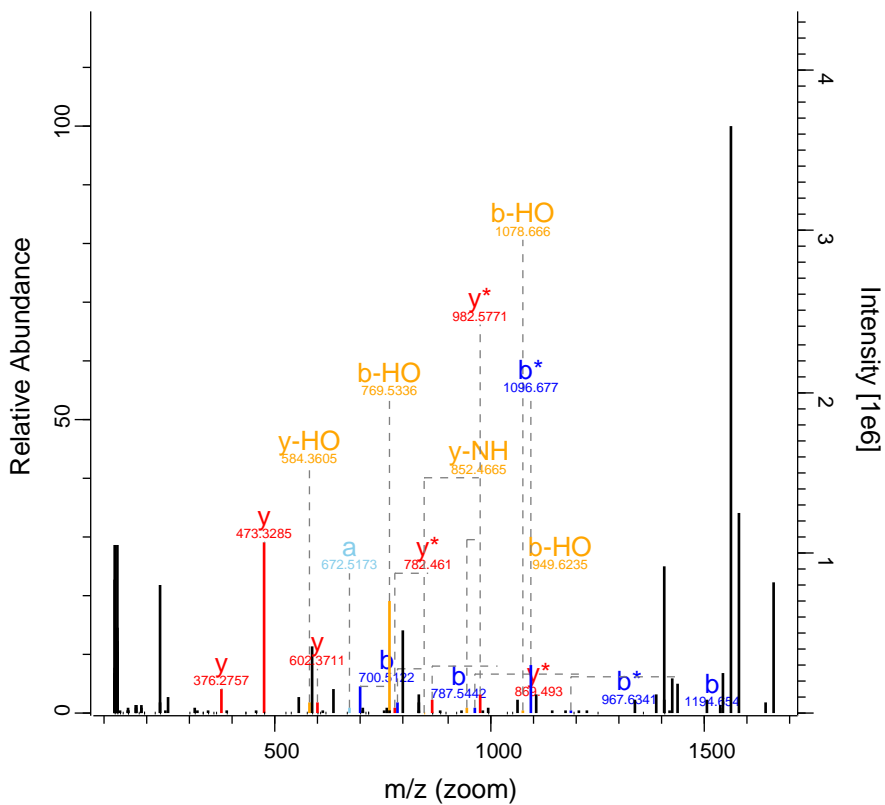

RO-QC-160121_ZackD_SS_Set_02_Fractic 13537 FTMS; HC 202.34 1136.58 SQSTM1

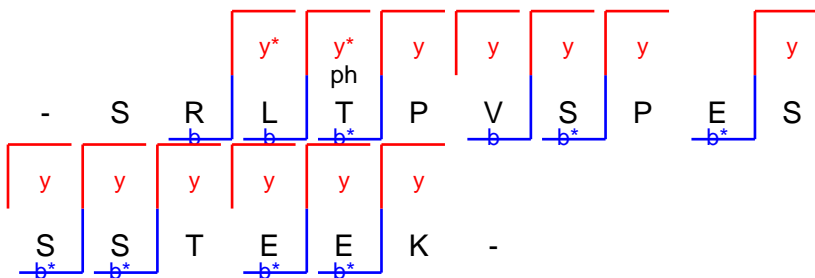
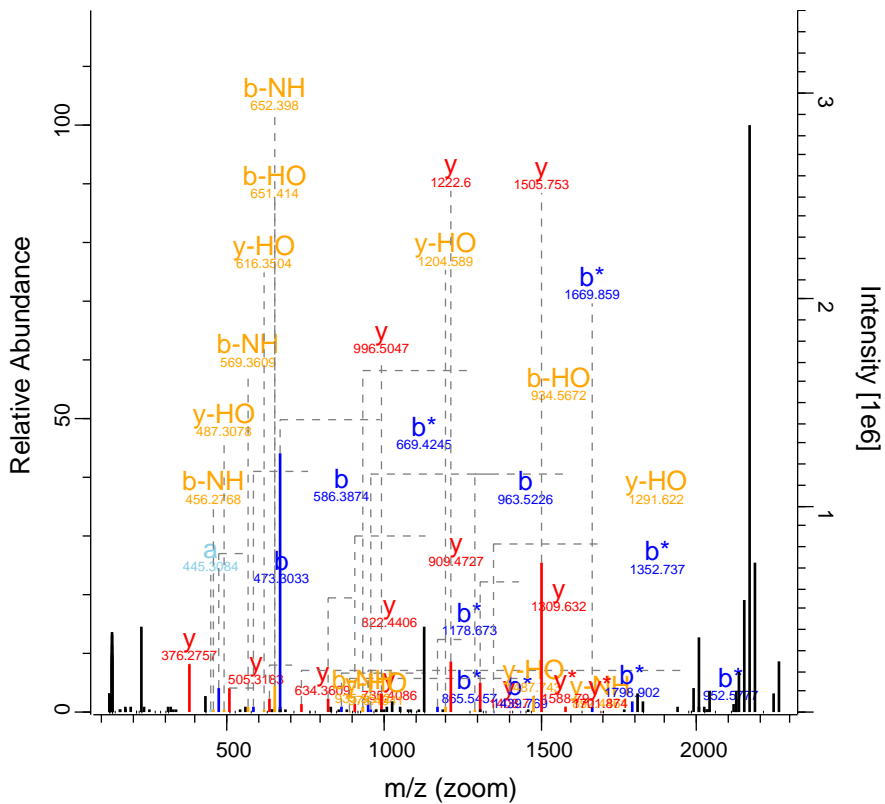

RO-QC-160121_ZackD_SS_Set_02_Fractio 13831 FTMS; HC 103.61 737.64 PSMA3

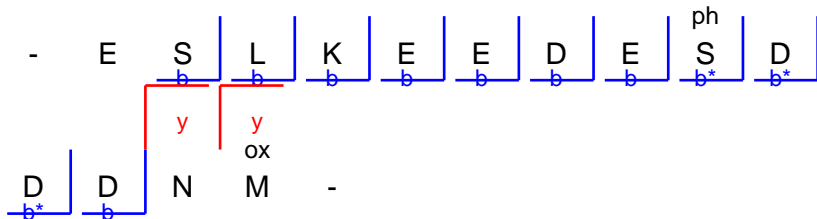
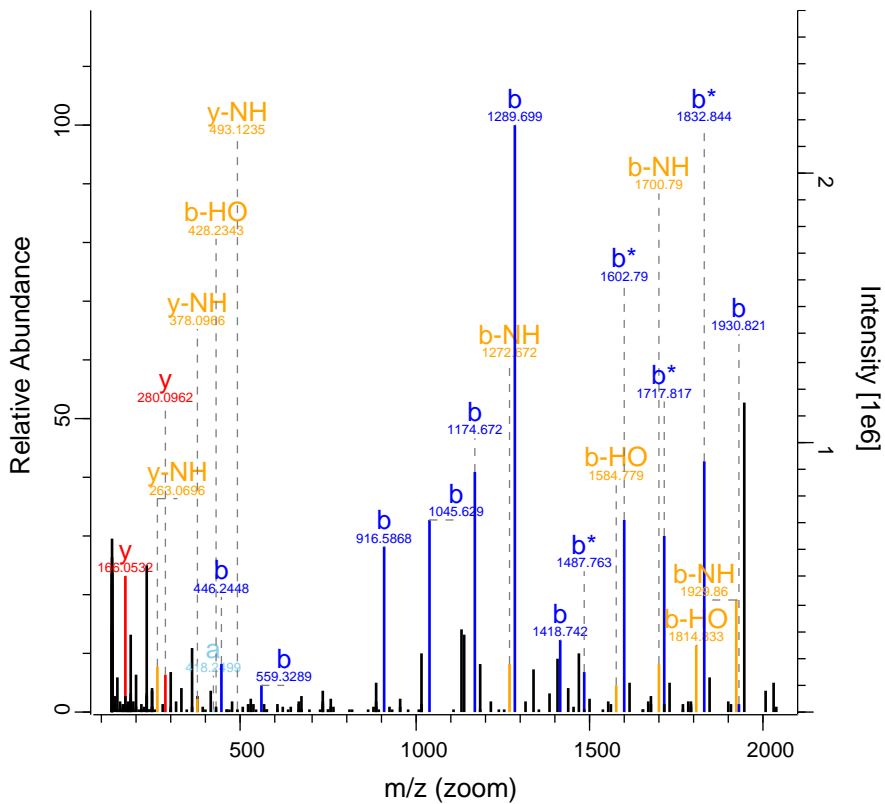

RO-QC-160121_ZackD_SS_Set_02_Fraction 14347 FTMS; HCl 58.98 899 CNTRL

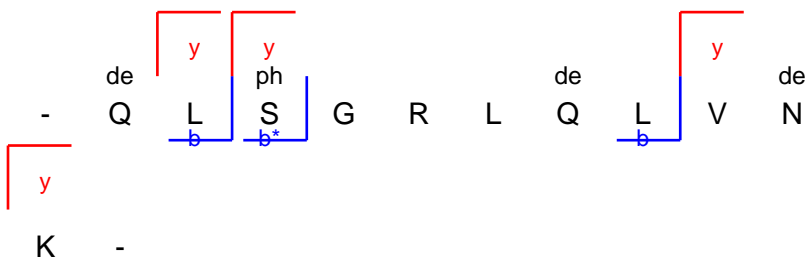
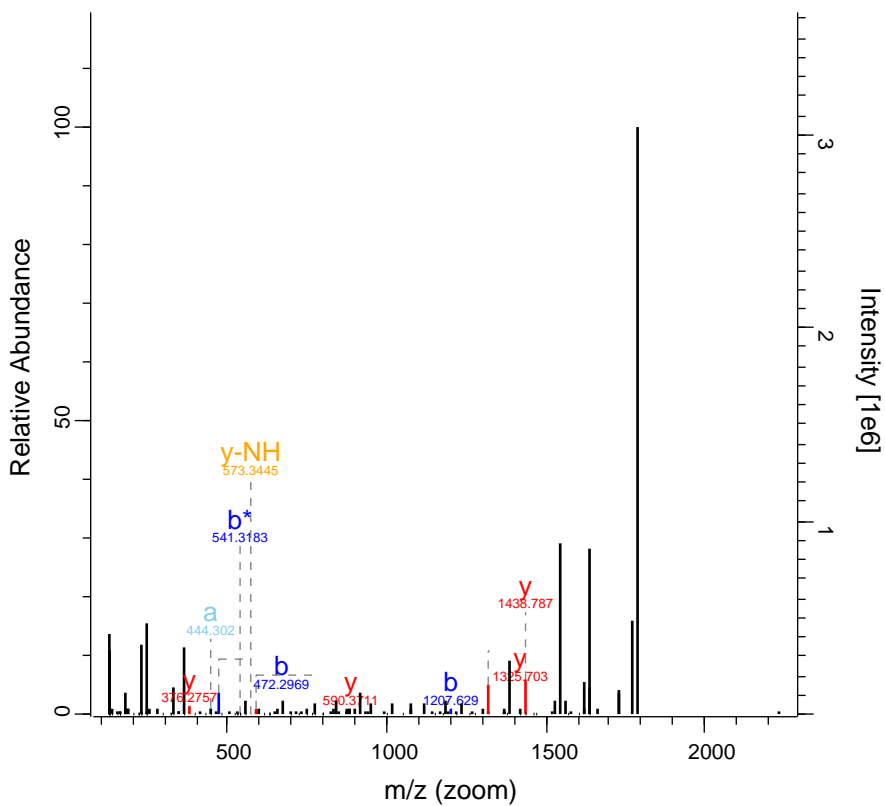

RO-QC-160121_ZackD_SS_Set_02_Fractic 14680 FTMS; HC 233.49 1152.55 CASK

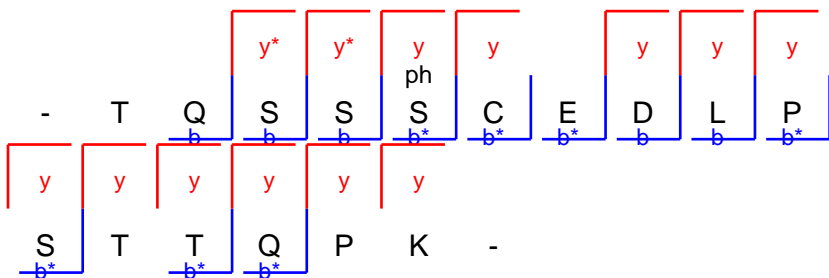
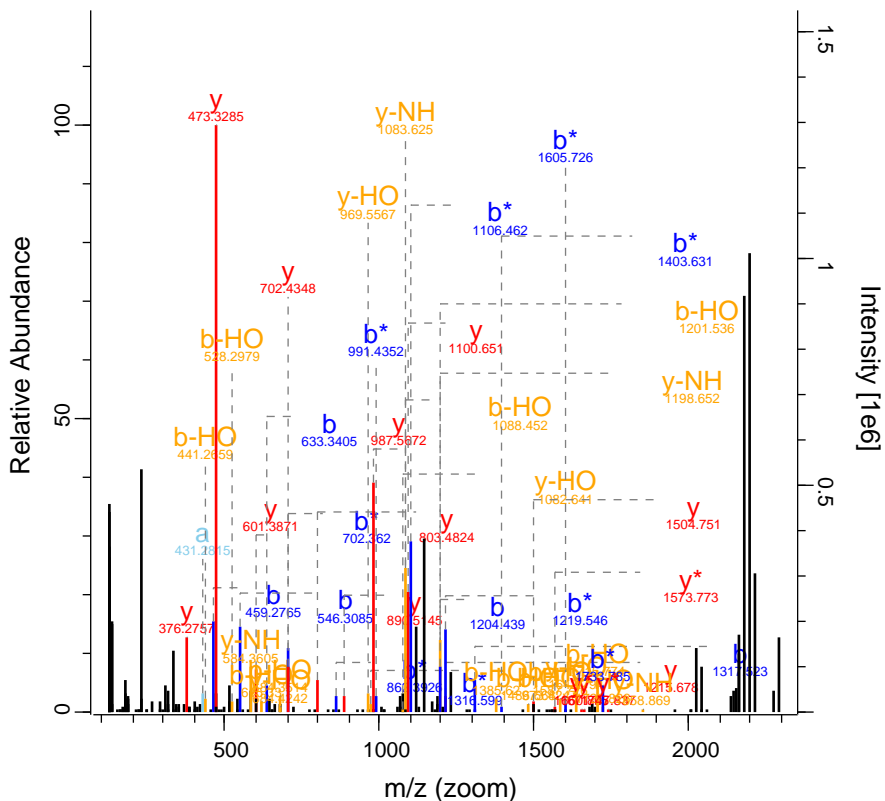

RO-QC-160121_ZackD_SS_Set_02_Fraction 15617 FTMS; HC 40.99 448.59 DDX23

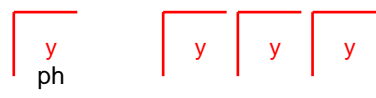
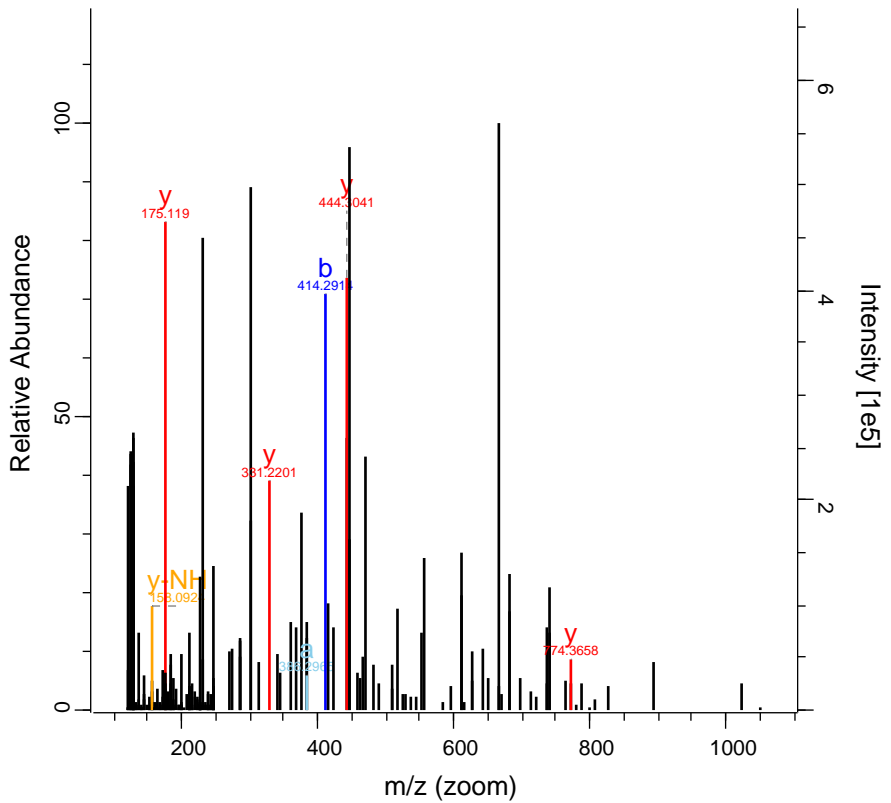

- L A R S Y L R R -

RO-QC-160121_ZackD_SS_Set_02_Fraction 15632 FTMS; HC 117.2 975.44 KIF13A

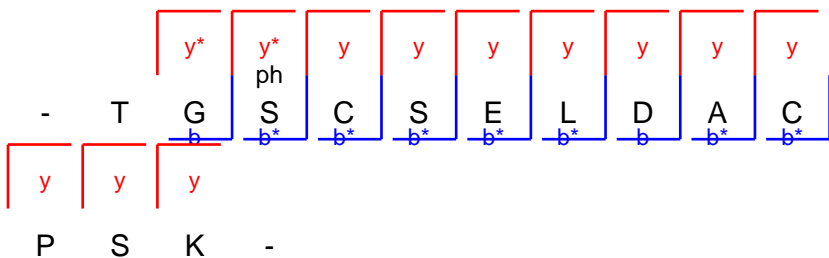
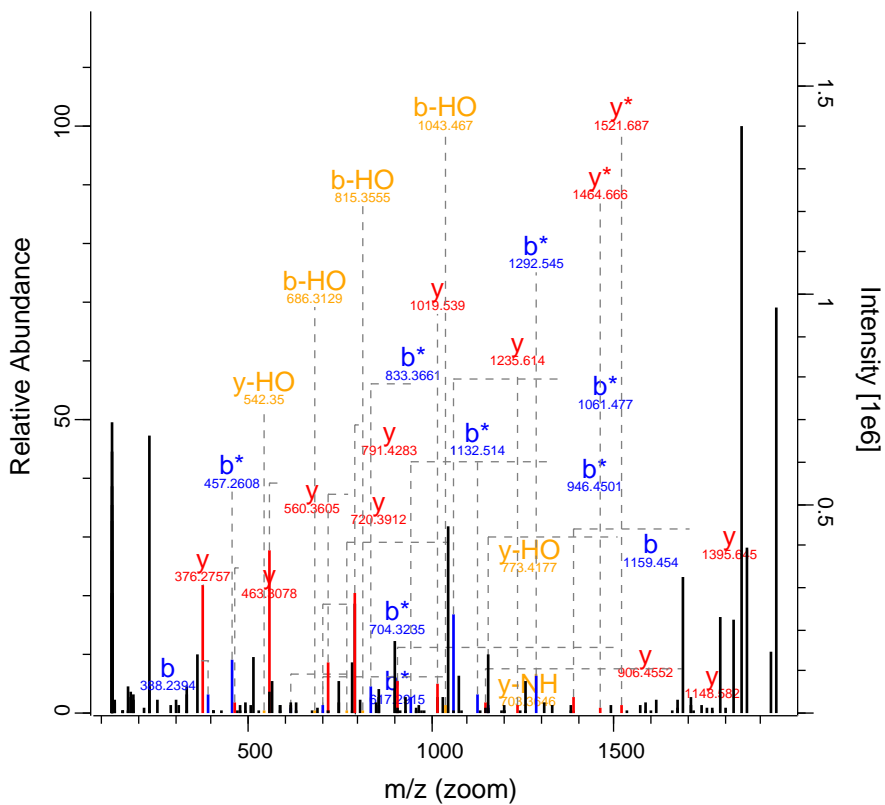

RO-QC-160121_ZackD_SS_Set_02_Fraction 15690 FTMS; HC 91.72 811.03 NUP98

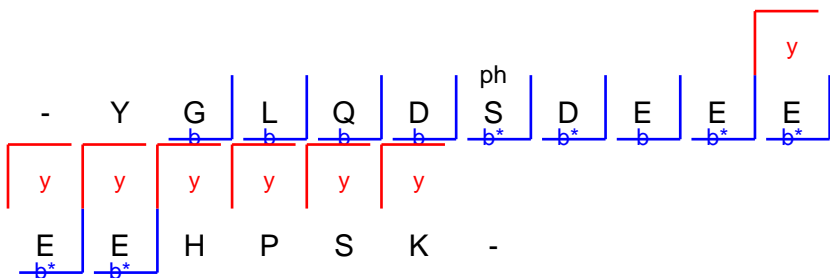
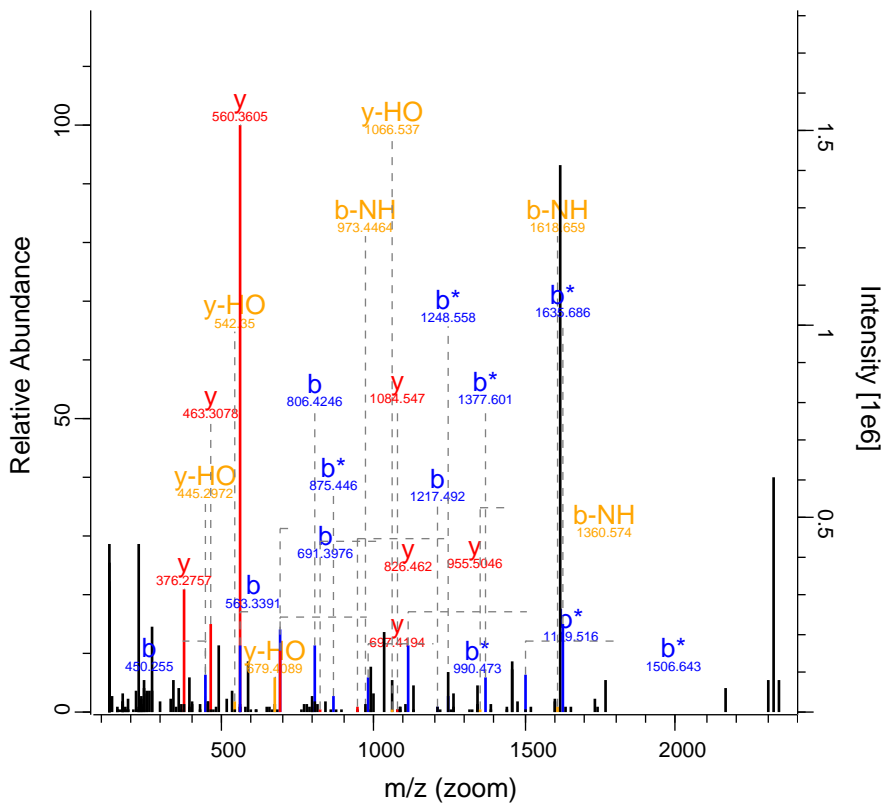

RO-QC-160121_ZackD_SS_Set_02_Fraction16254 FTMS; HC 67.73 572.82 CCDC173

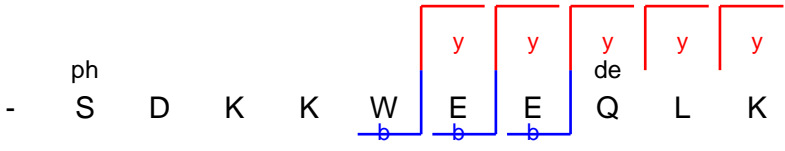
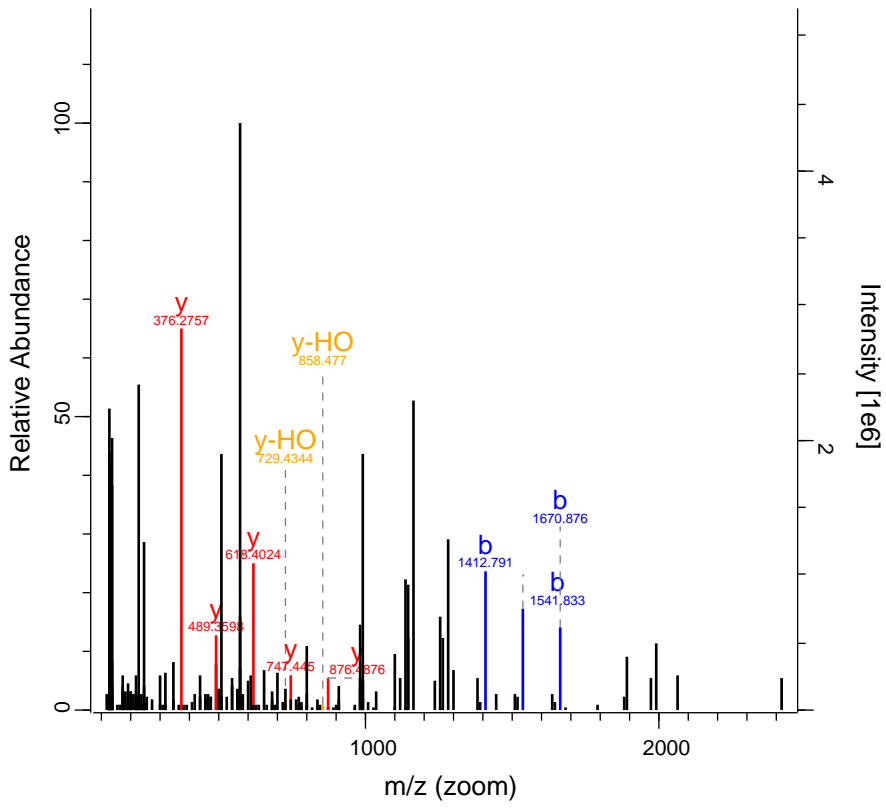

ph

S

D

K

K

W

E

E

Q

L

K

-

-

Raw File

Scan Method Score m/z

RO-QC-160121_ZackD_SS_Set_02_Fraction_6

17011 FTMS; HCD 42.79 748.75

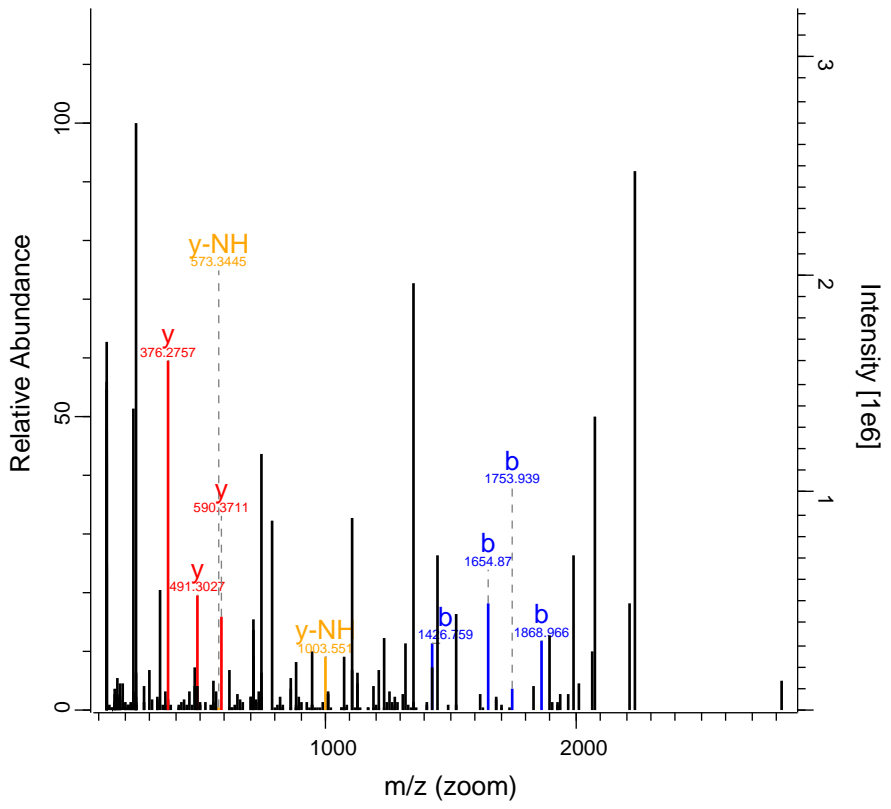

RO-QC-160121_ZackD_SS_Set_02_Fractic 17989 FTMS; HC 208.43 1258.15 PRKAR1A

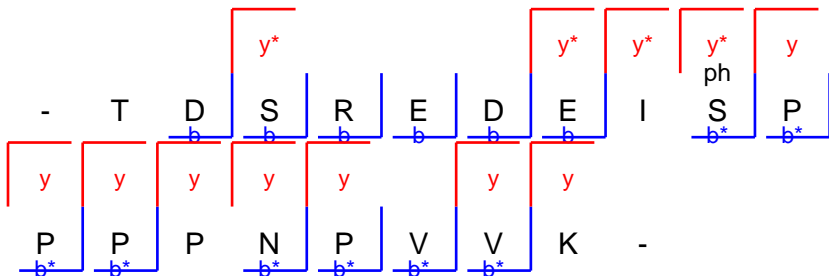
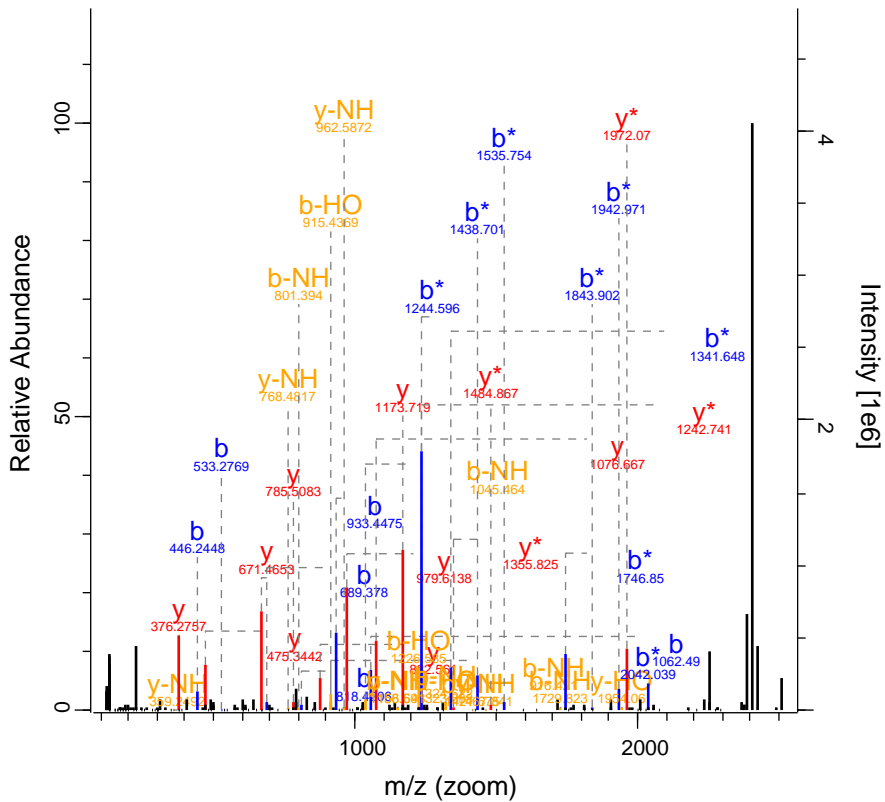

RO-QC-160121_ZackD_SS_Set_02_Fraction18271 FTMS; HCl136.35 1033 PLEC

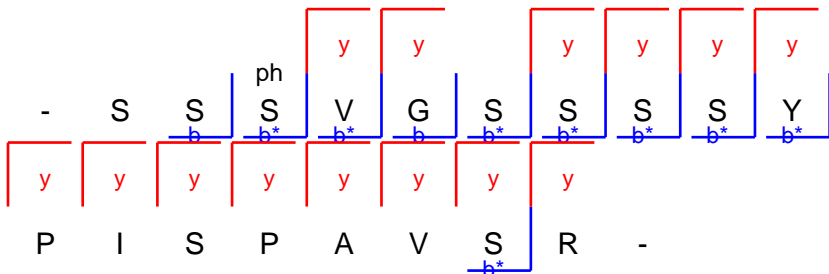
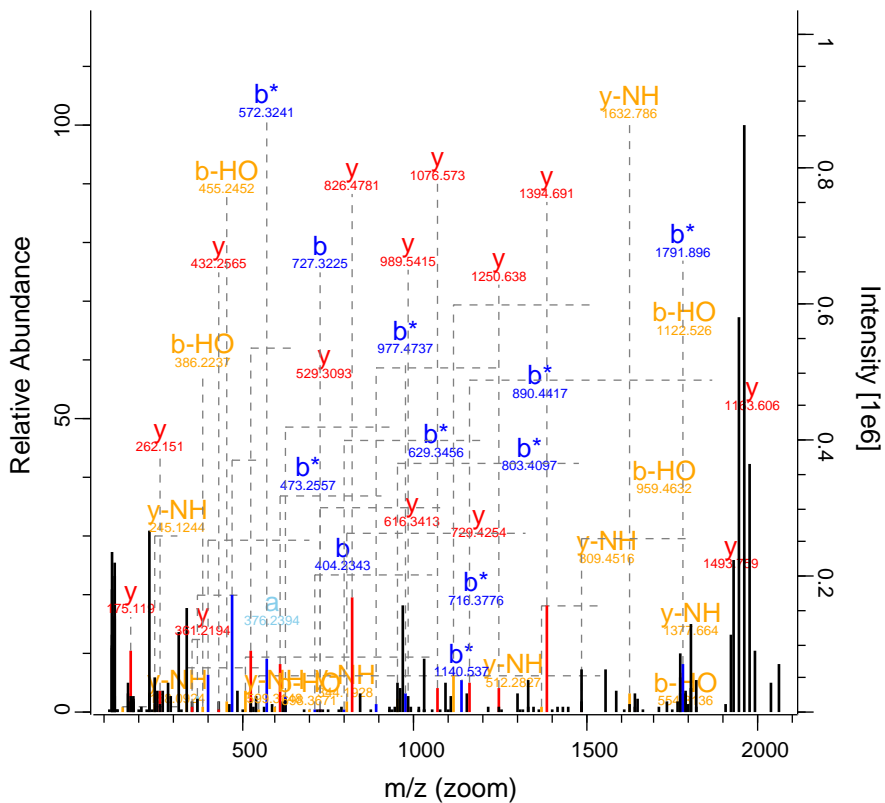

RO-QC-160121_ZackD_SS_Set_02_Fraction 18643 FTMS; HC 53.97 748.05 SCAF11

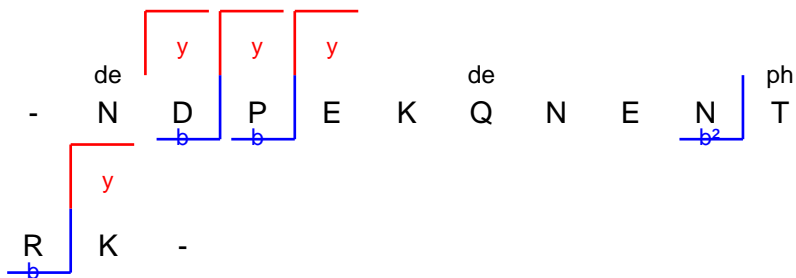
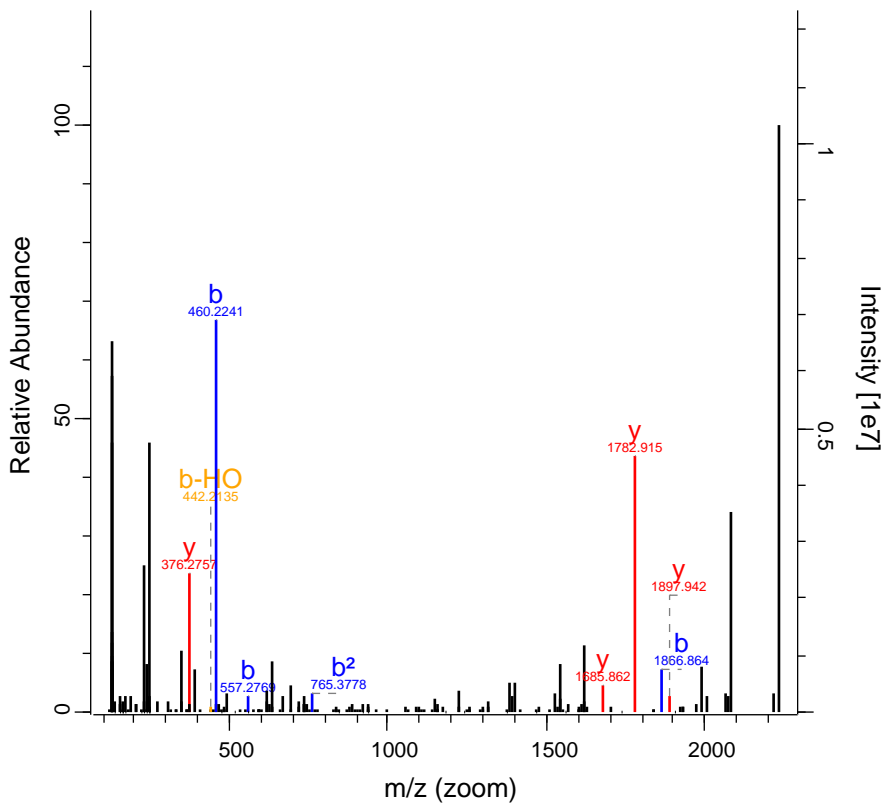

RO-QC-160121_ZackD_SS_Set_02_Fraction 19143 FTMS; HCl 83.4 726.4 NOP56

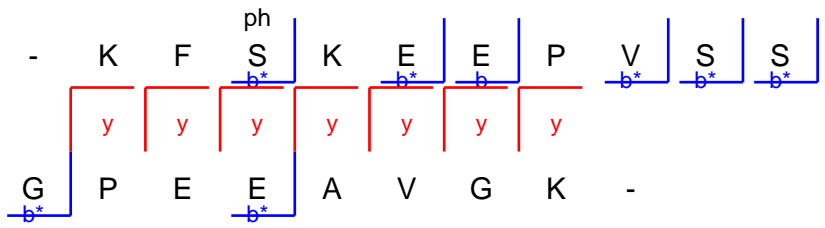
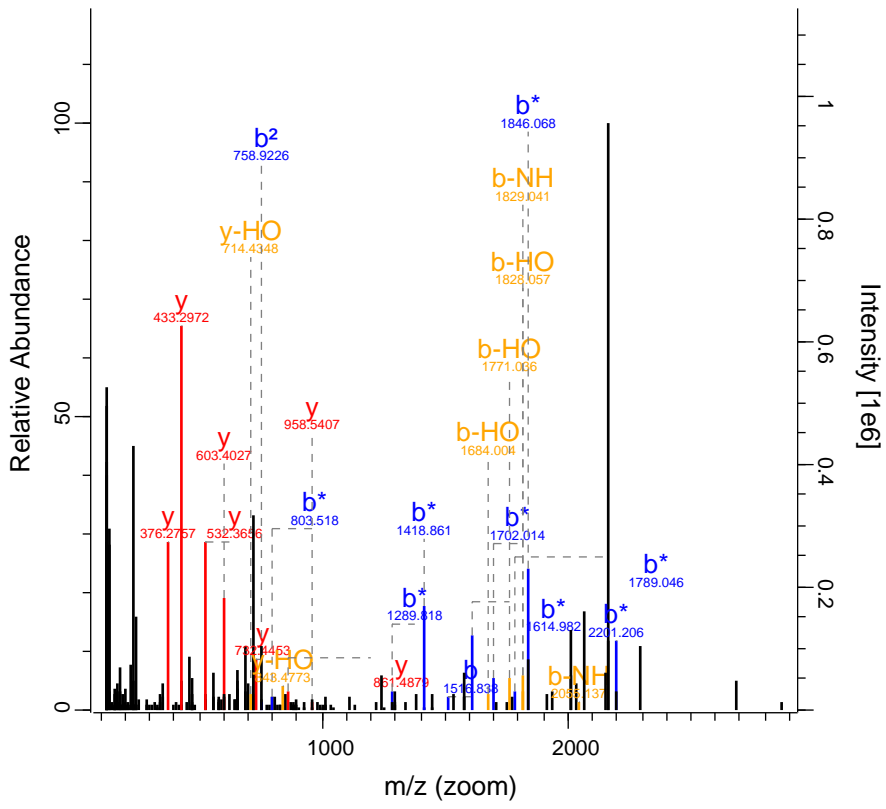

RO-QC-160121_ZackD_SS_Set_02_Fraction 19169 FTMS; HC 83.6 923.76 EIF5B

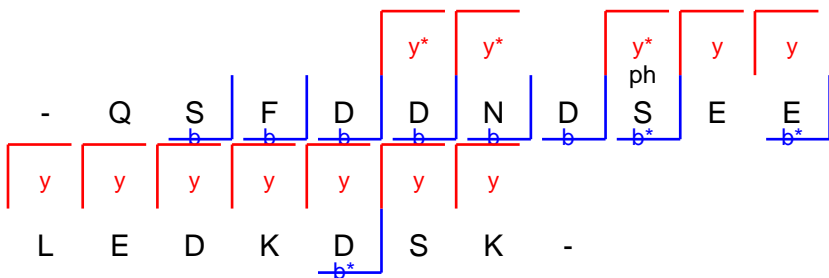
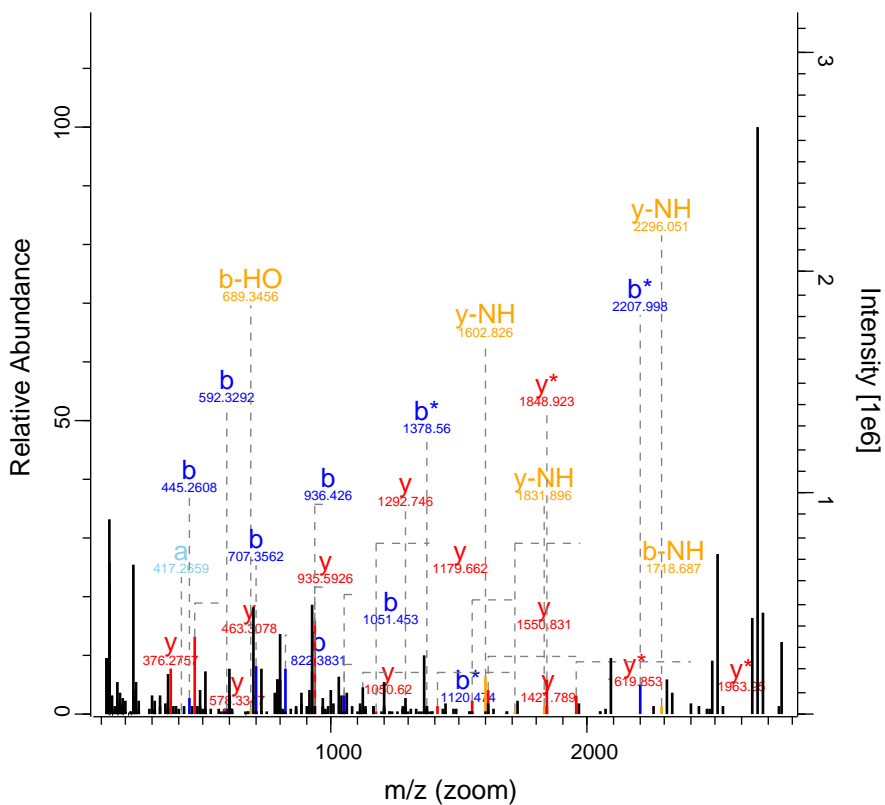

RO-QC-160121_ZackD_SS_Set_02_Fraction 19320 FTMS; HC 46.43 817.77 RTTN

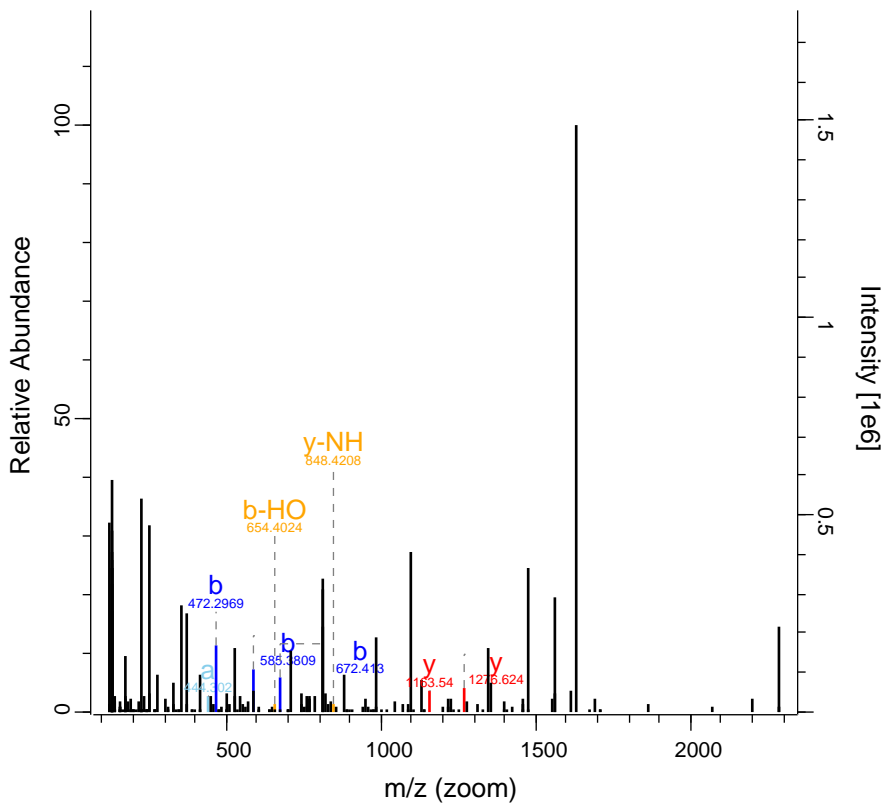

RO-QC-160121_ZackD_SS_Set_02_Fractic 19359 FTMS; HC 52.55 1056.53 SNRPA

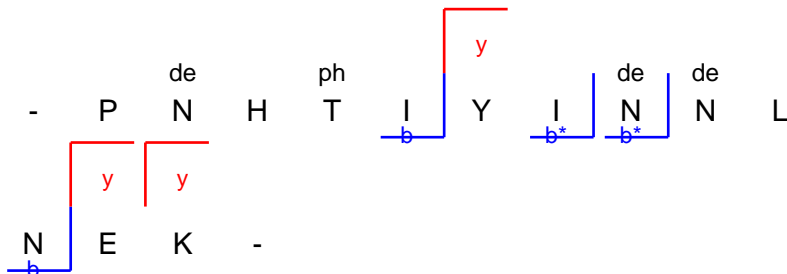
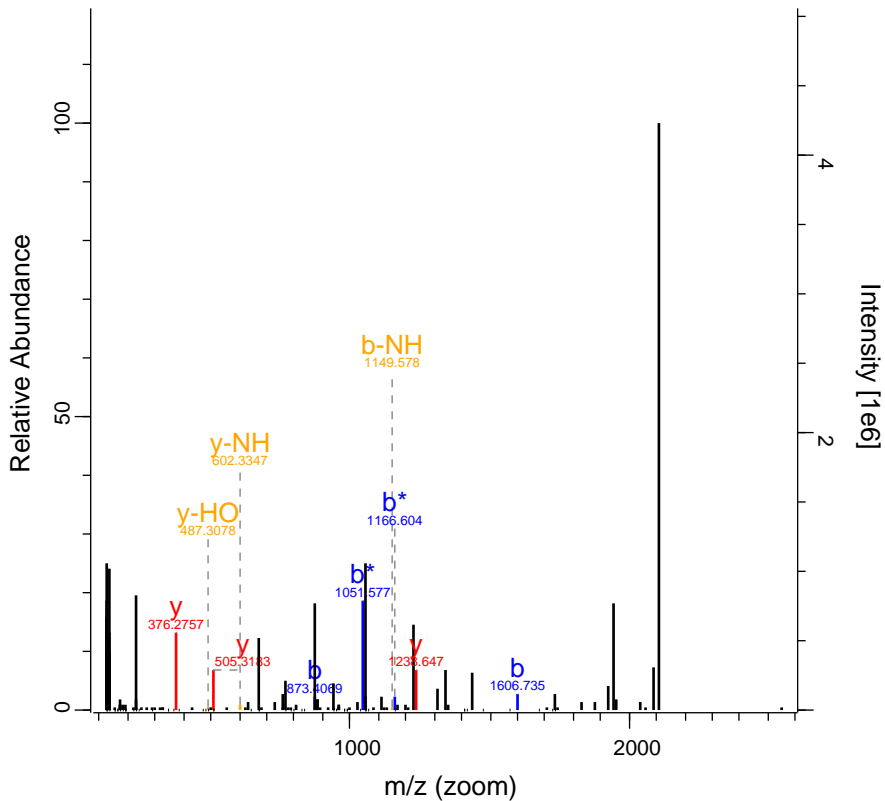

RO-QC-160121_ZackD_SS_Set_02_Fraction 19460 FTMS; HC 50.56 755.07 GIMAP7

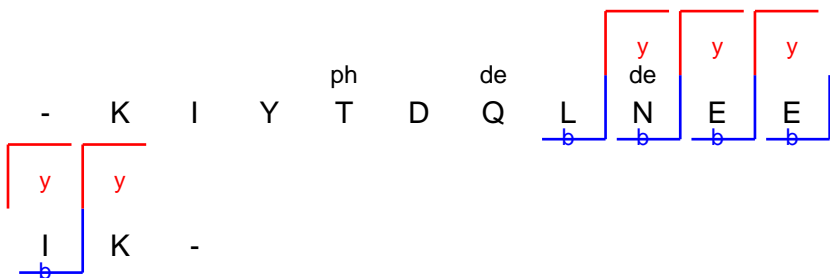
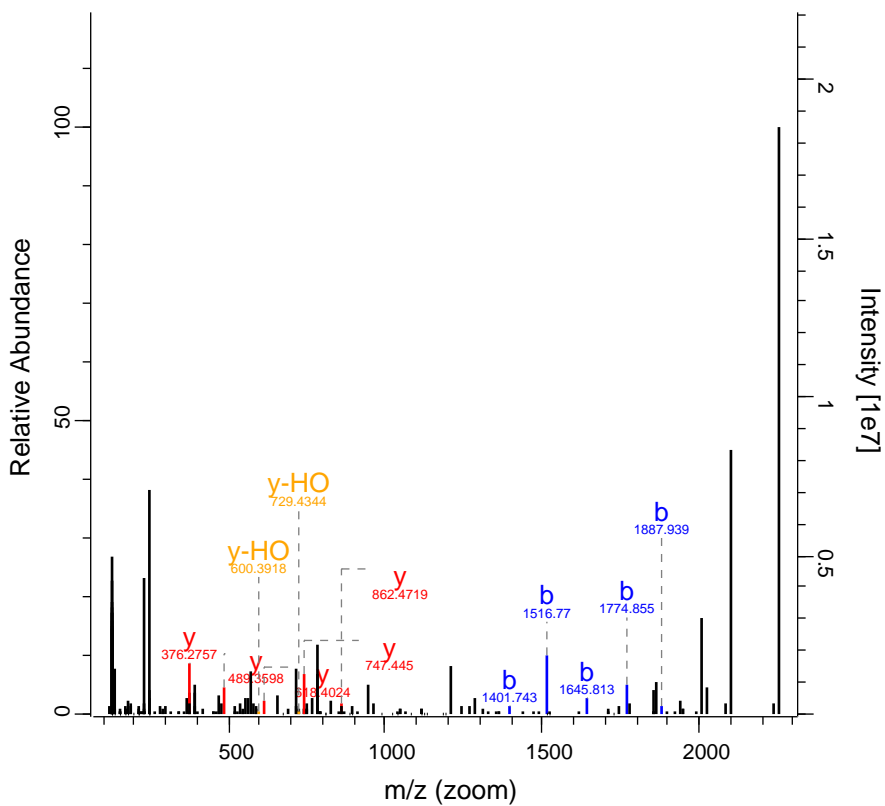

RO-QC-160121_ZackD_SS_Set_02_Fraction 25526 FTMS; HC 80.63 670.36 RPS3

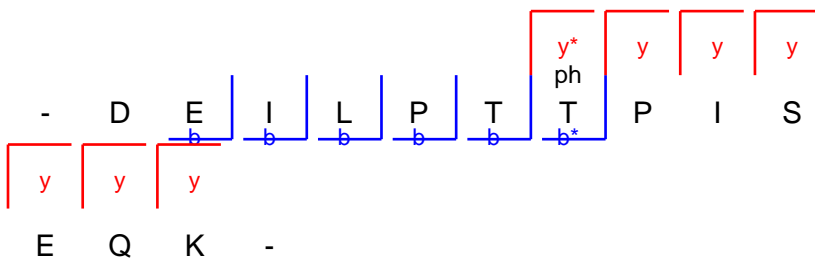
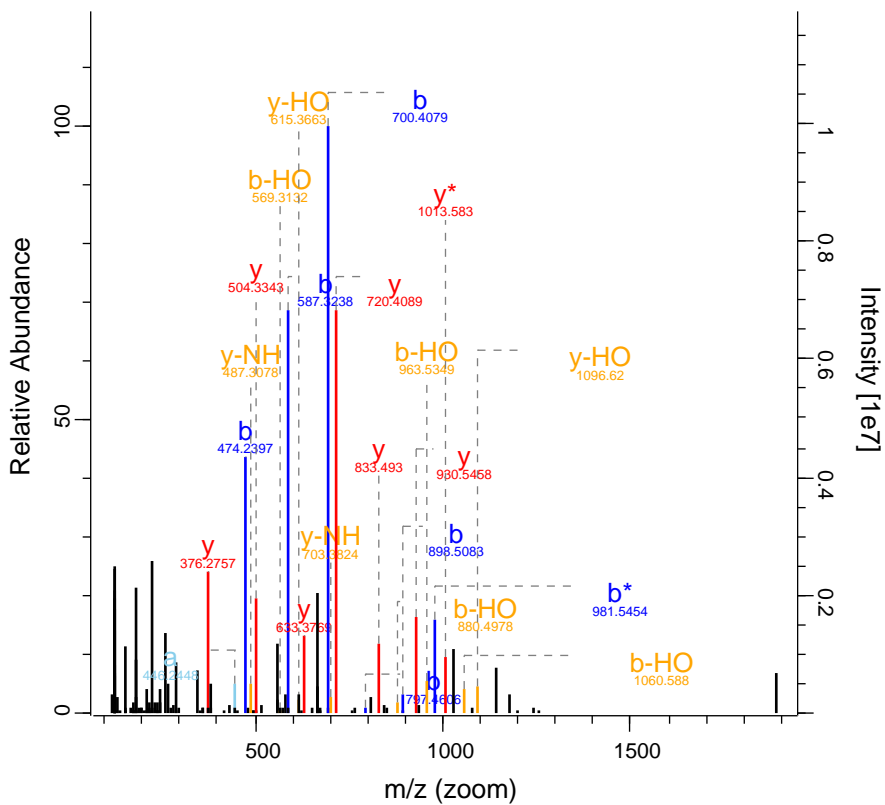

RO-QC-160121_ZackD_SS_Set_02_Fraction1 27590 FTMS; HCl 178.28 904.7 PRPSAP1

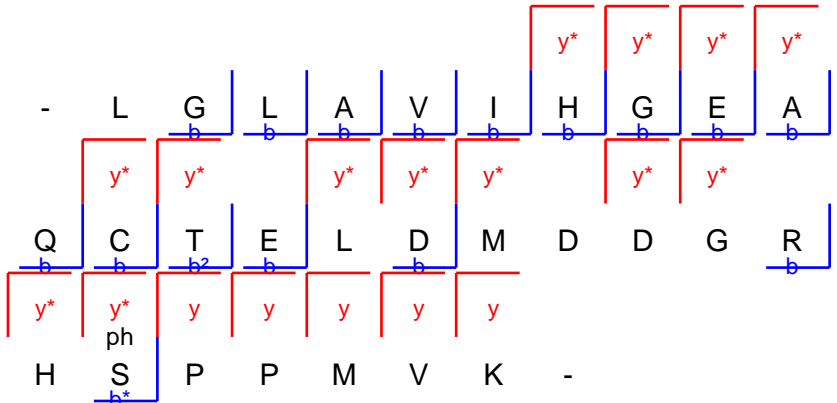
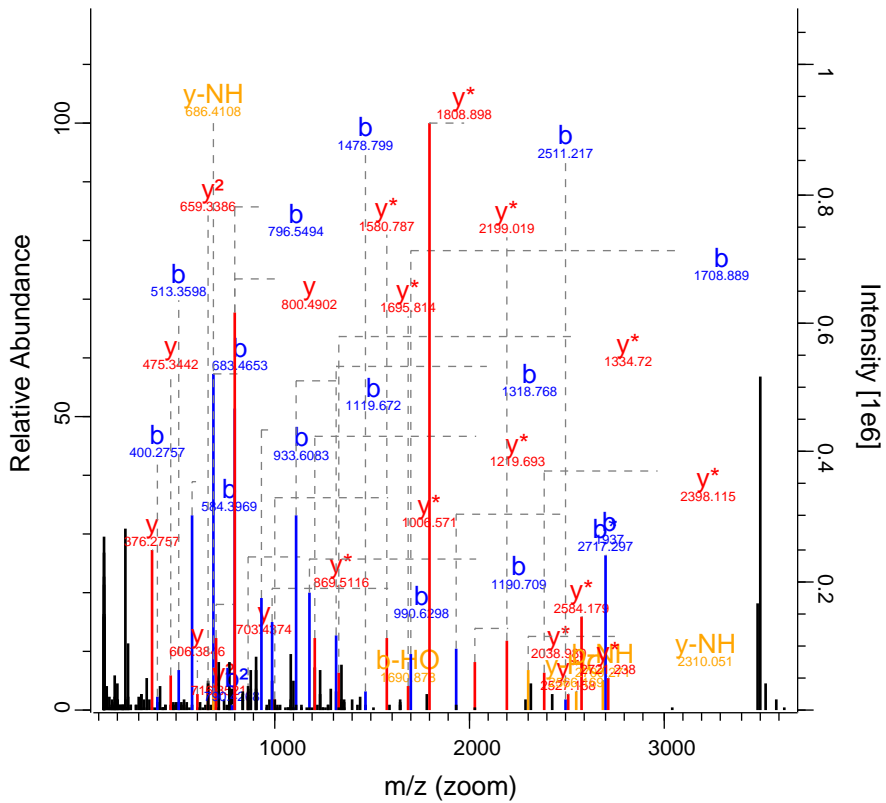

RO-QC-160121_ZackD_SS_Set_02_Fractic 28564 FTMS; HC 185.7 1053.55 CCNY

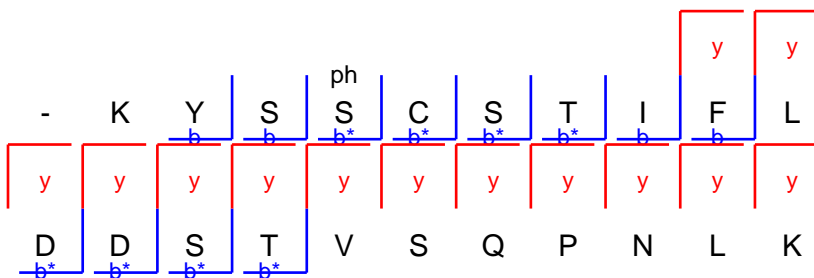
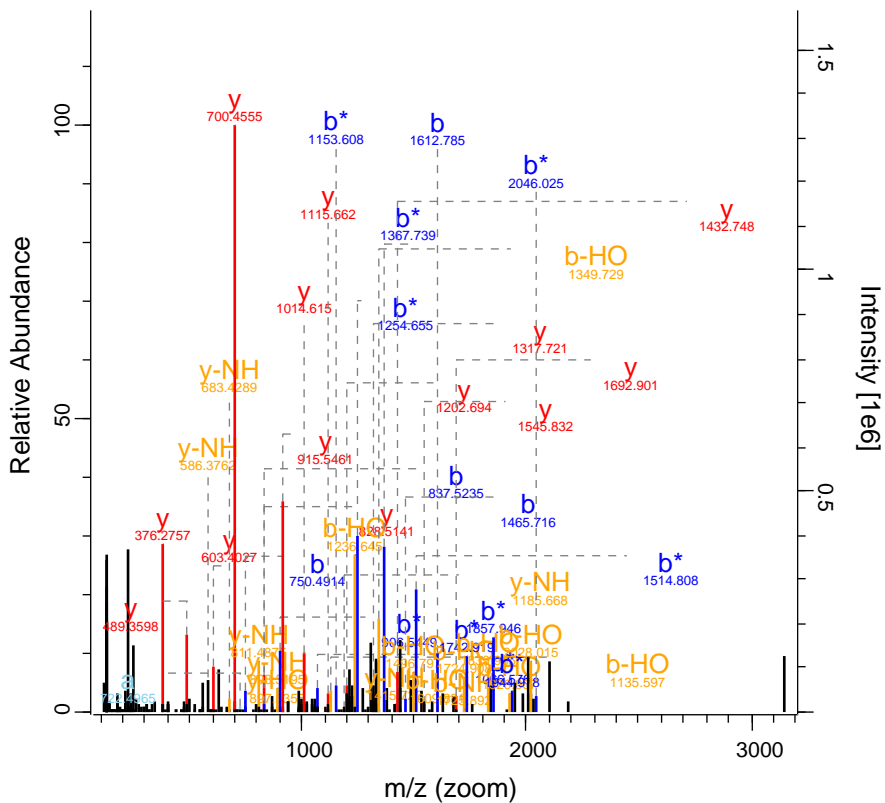

RO-QC-160121_ZackD_SS_Set_02_Fraction 28994 FTMS; HC 84.5 605.34 DHX29

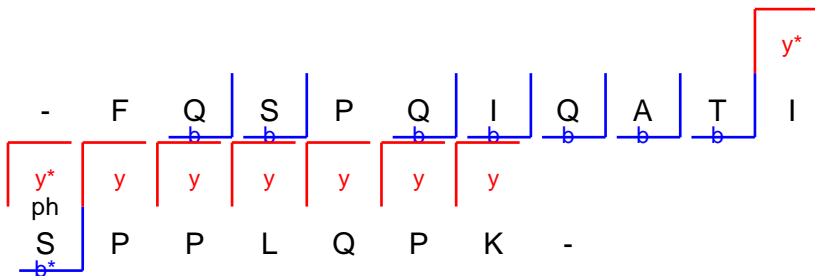
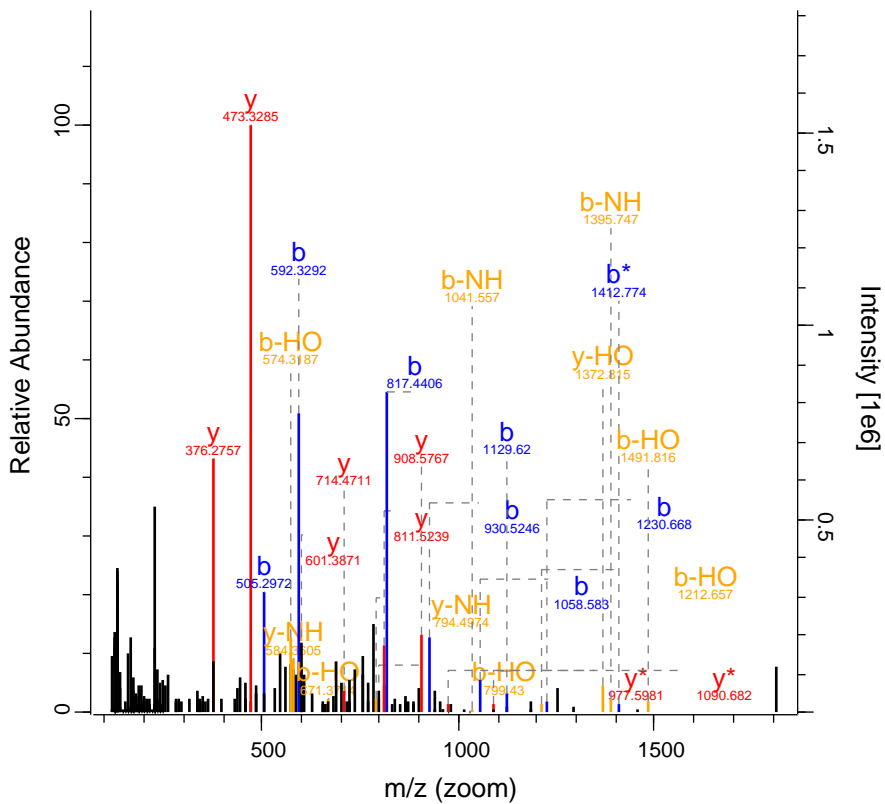

RO-QC-160121_ZackD_SS_Set_02_Fraction 29693 FTMS; HC 42.57 817.45 FAM73B

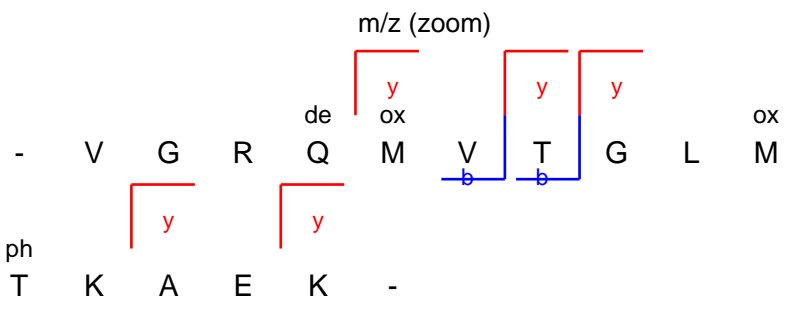
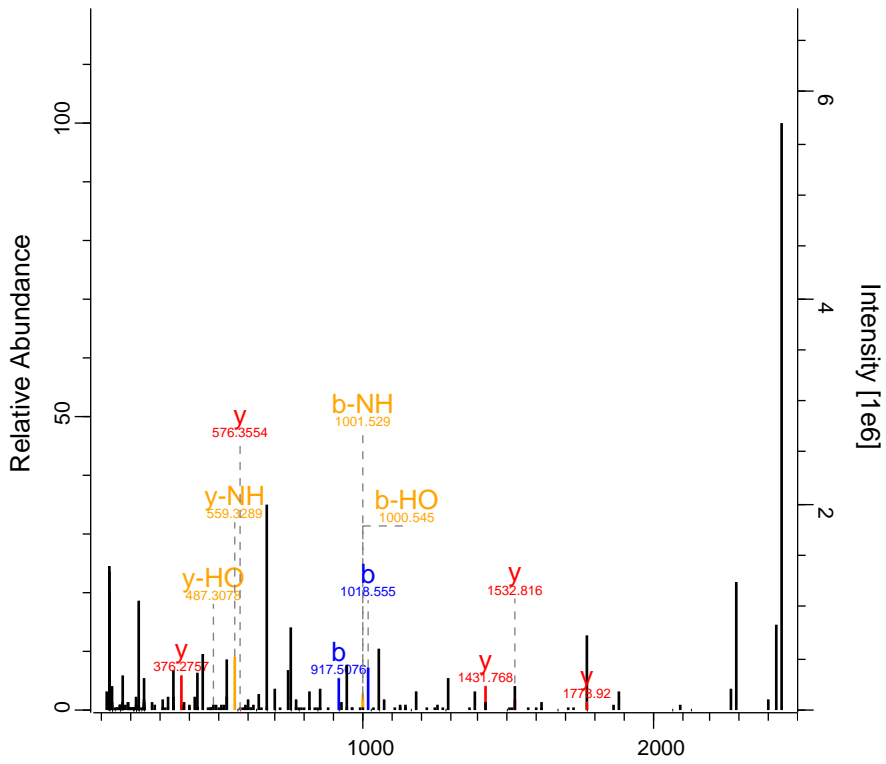

RO-QC-160121_ZackD_SS_Set_02_Fractic 30176 FTMS; HC 190.6 1067.84 BCLAF1

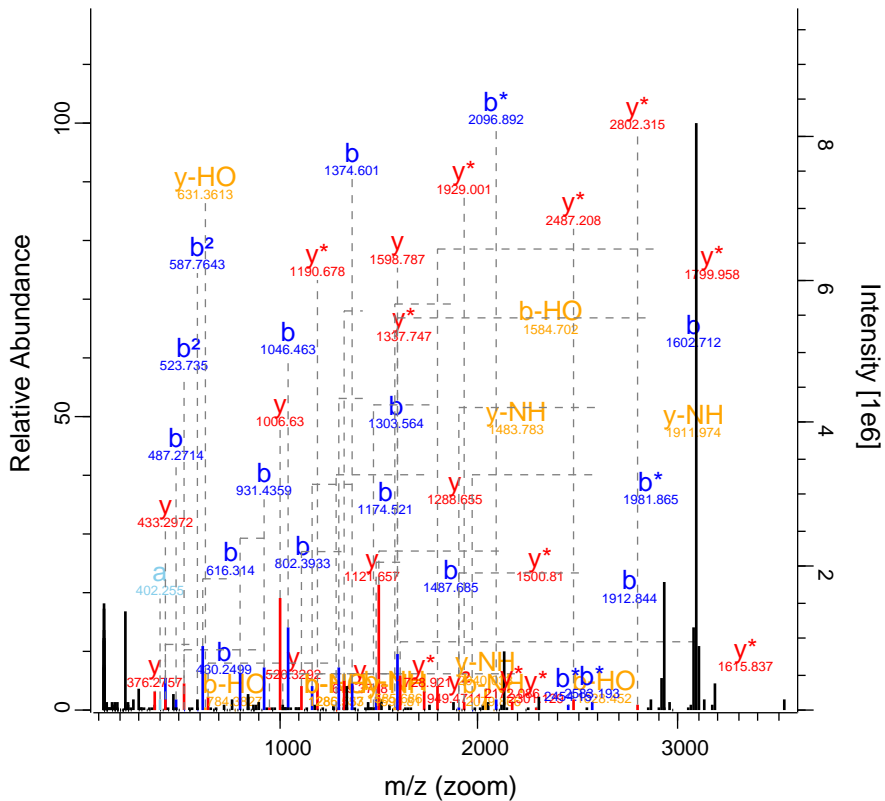

RO-QC-160121_ZackD_SS_Set_02_Fractic 30964 FTMS; HC 154.02 1017.24 SQSTM1

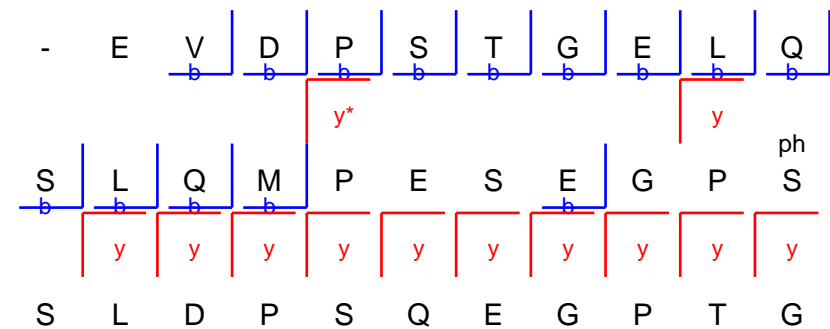
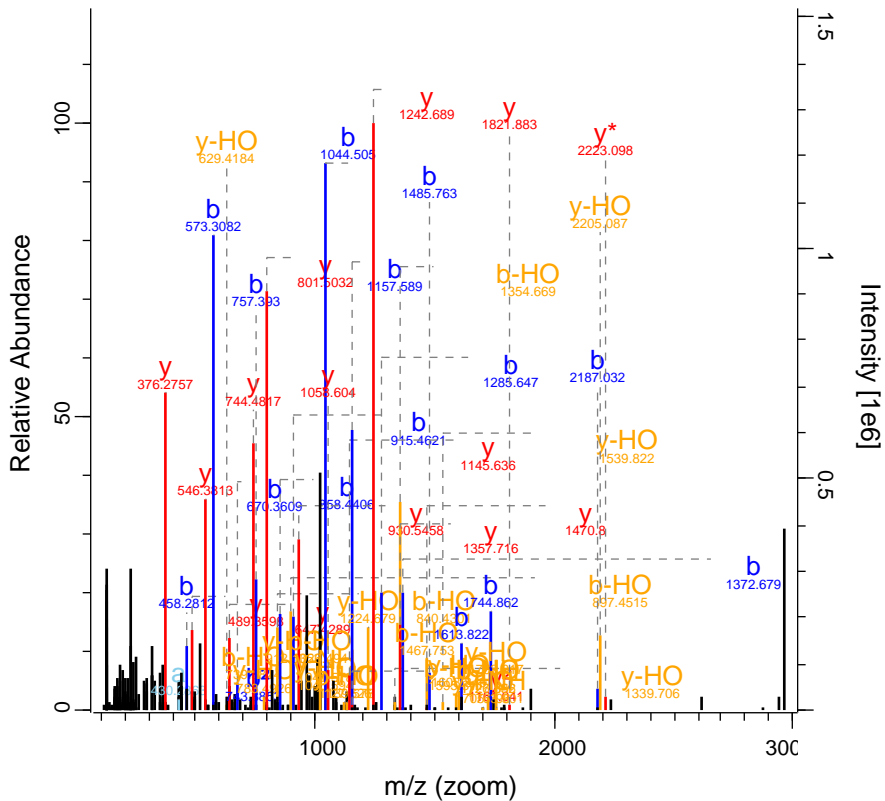

RO-QC-160121_ZackD_SS_Set_02_Fraction 31201 FTMS; HC 40.01 862.22 CCDC150

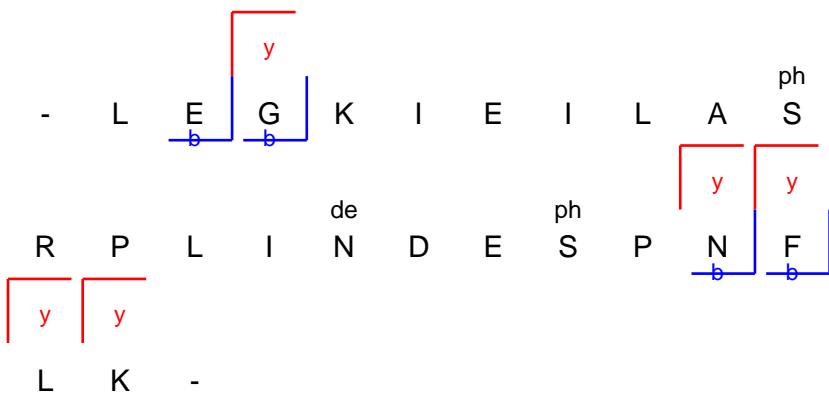
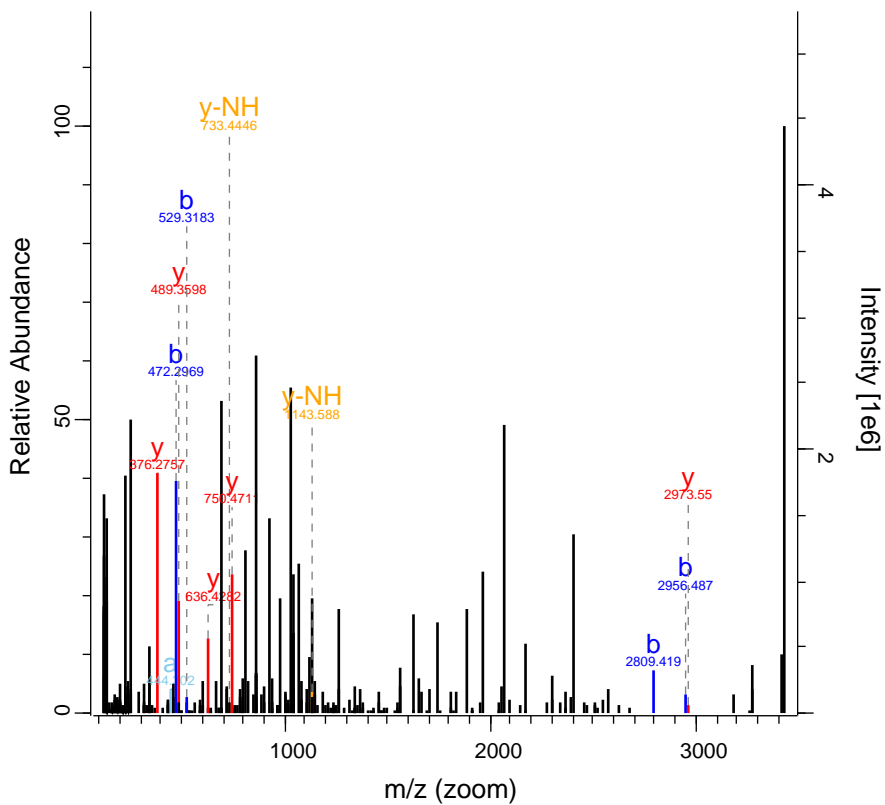

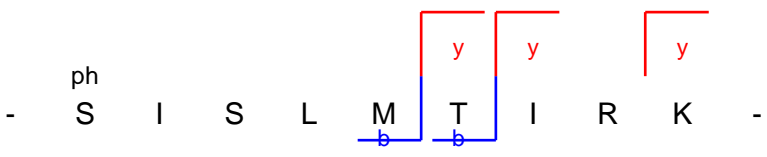
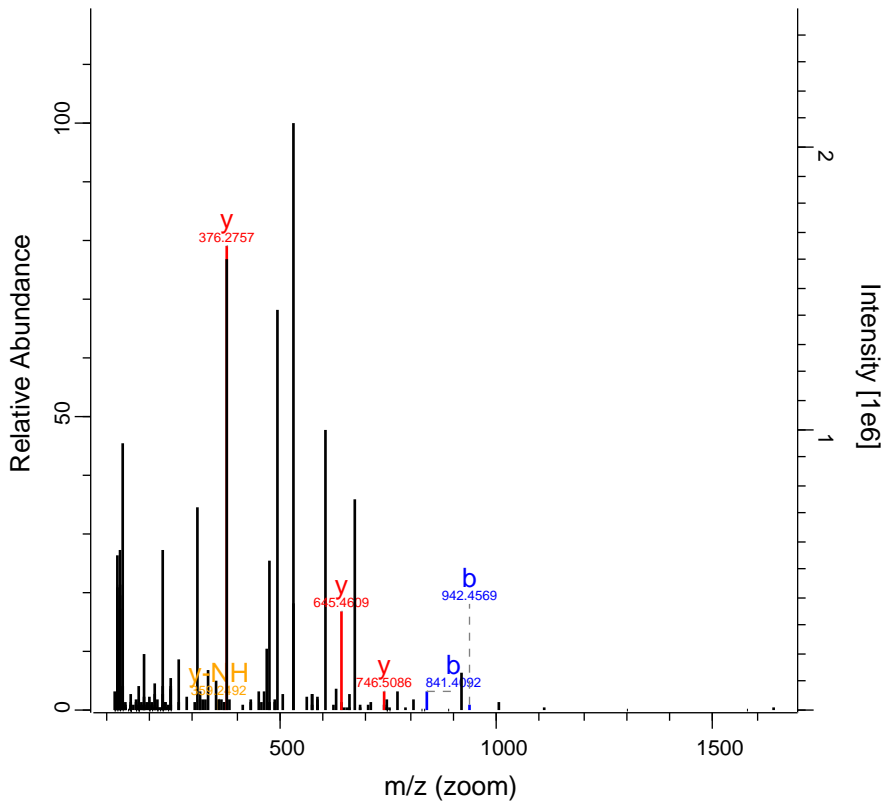

RO-QC-160121_ZackD_SS_Set_02_Fractic 32197 FTMS; HC 65.38 1006.47 PODXL

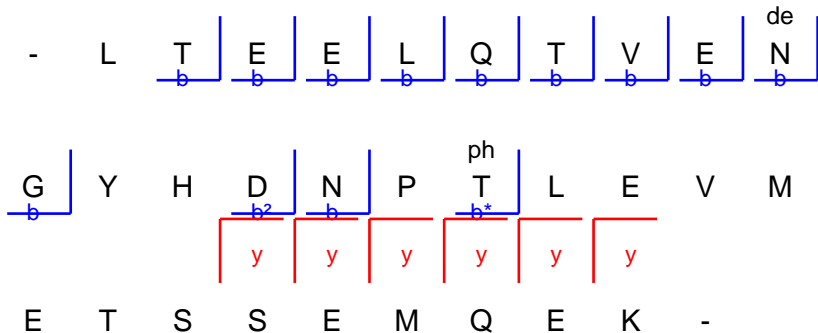
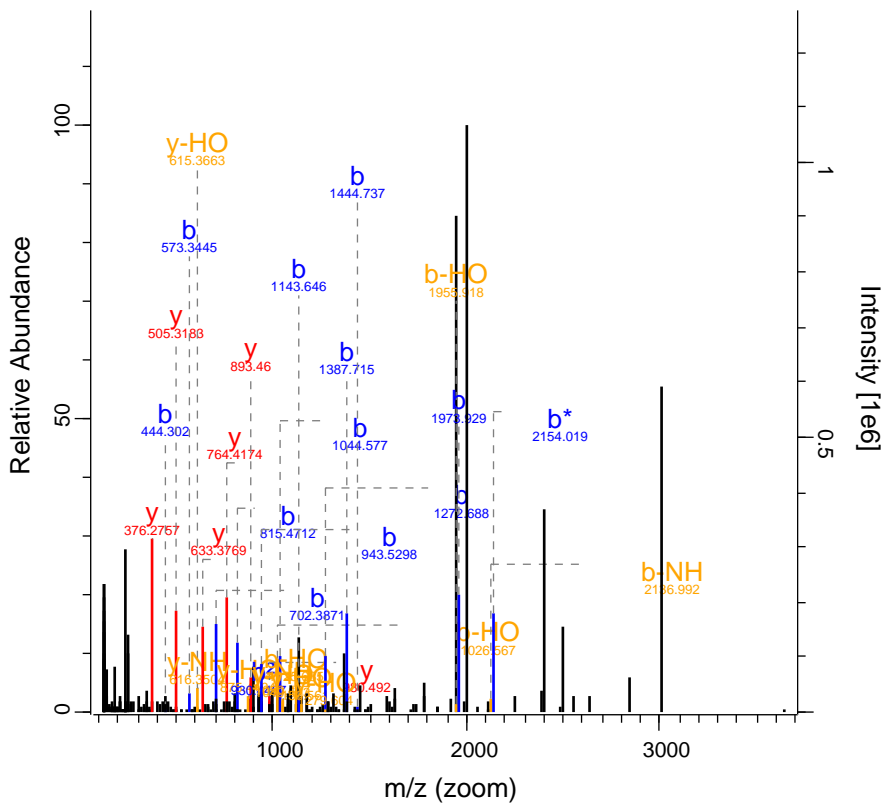

RO-QC-160121_ZackD_SS_Set_02_Fraction 32736 FTMS; HCl 45.26 754.9 CFTR

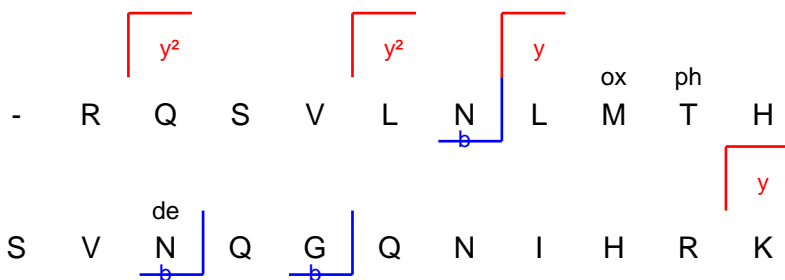
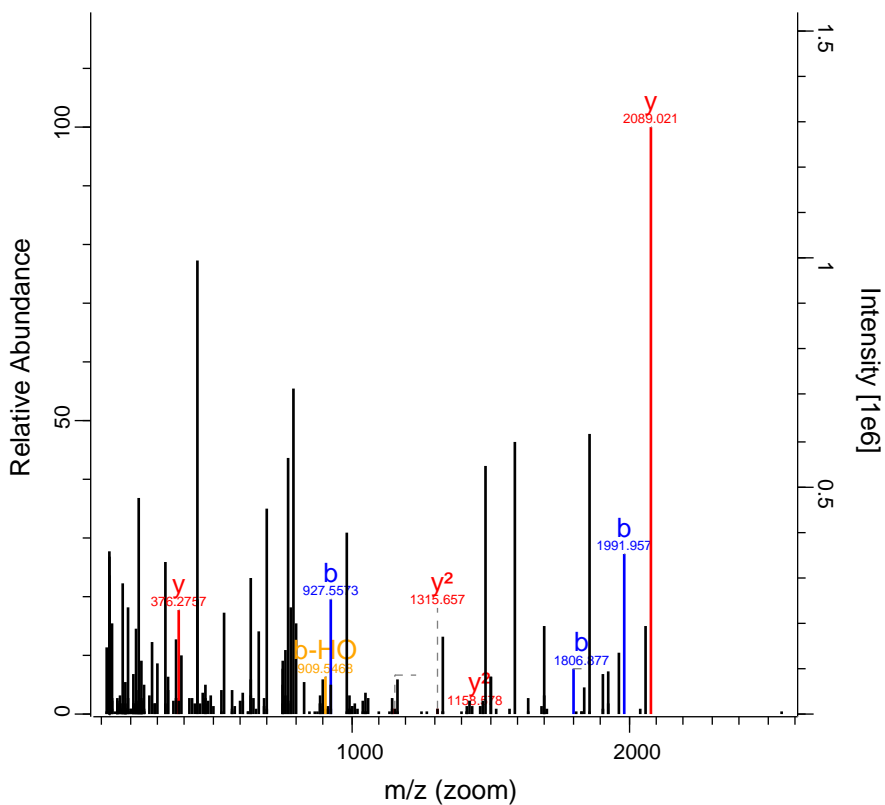

RO-QC-160121_ZackD_SS_Set_02_Fraction 32903 FTMS; HC 48.5 851.95 LMOD1

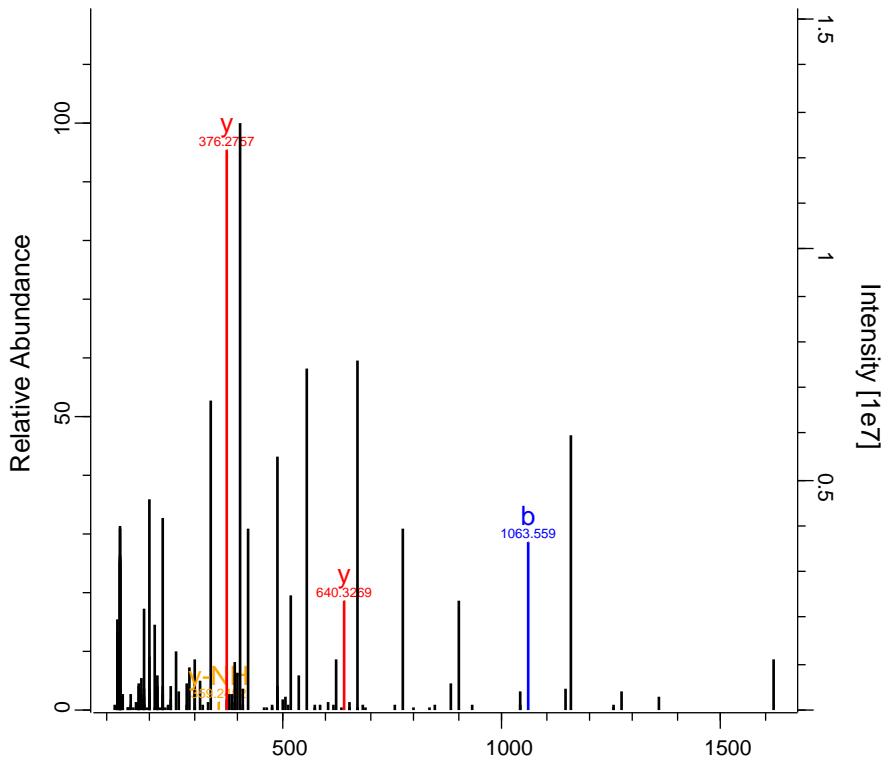

m/z (zoom)

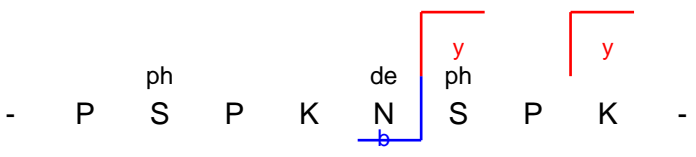

RO-QC-160121_ZackD_SS_Set_02_Fraction 33006 FTMS; HCl 40.24 908.8 CYP4F12

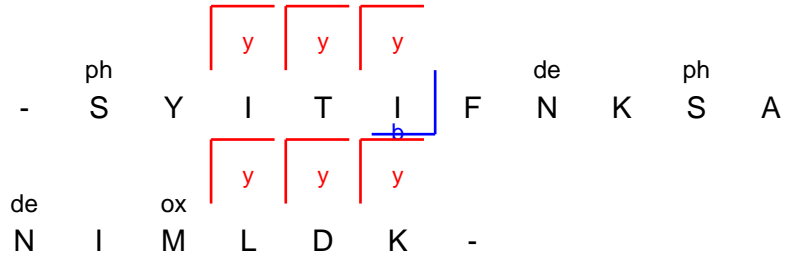
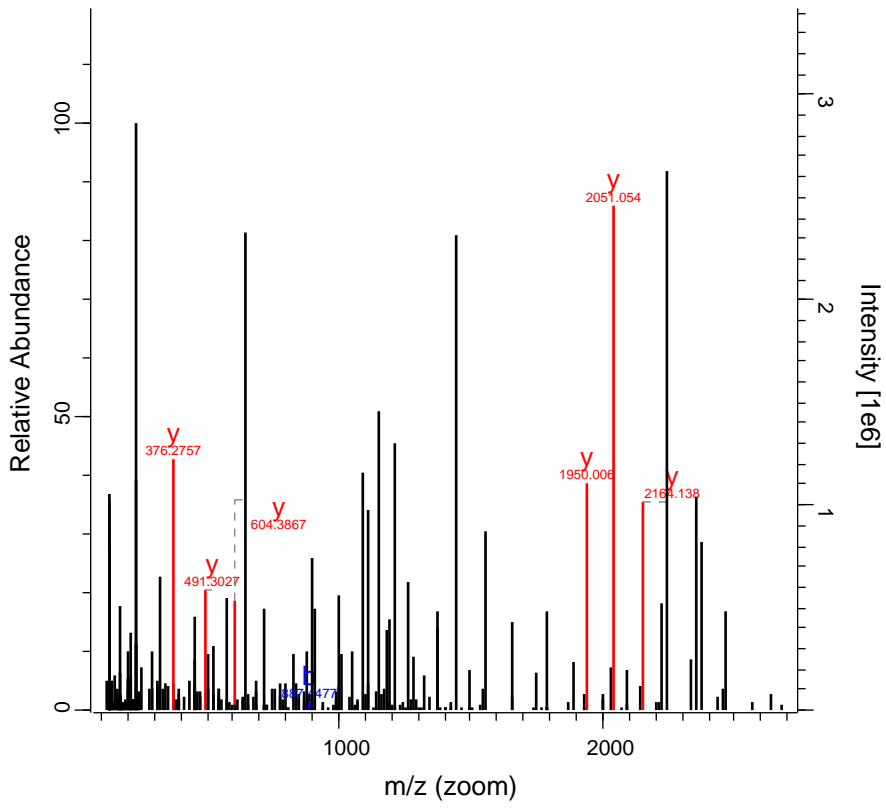

RO-QC-160121_ZackD_SS_Set_02_Fraction 34931 FTMS; HC 43.2 848.44 MYO1D

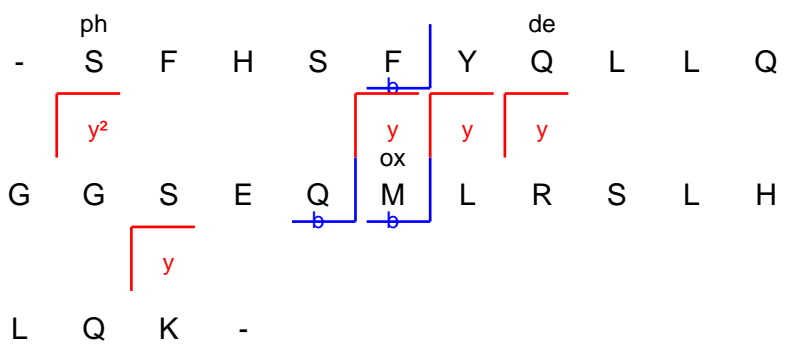
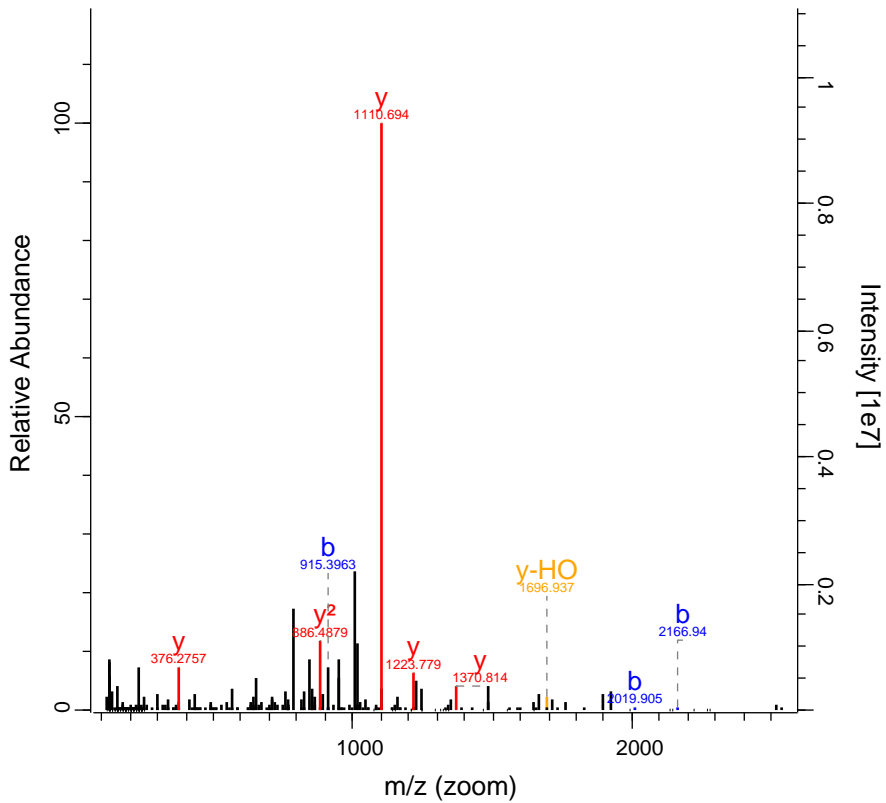

RO-QC-160121_ZackD_SS_Set_02_Fractic 35005 FTMS; HC 45.55 1243.66 LPPR5

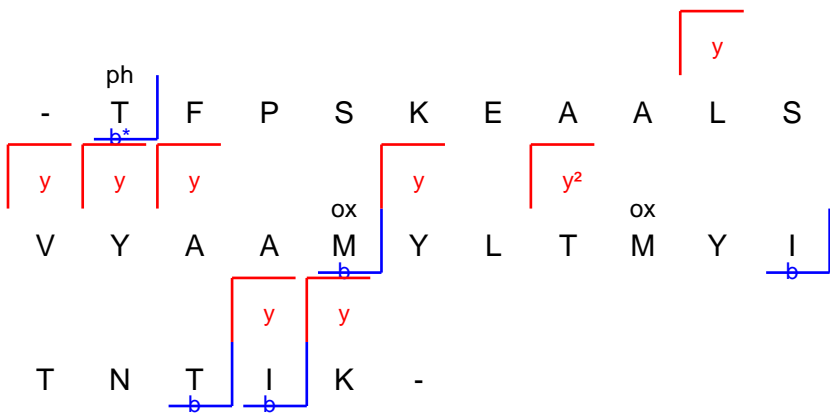
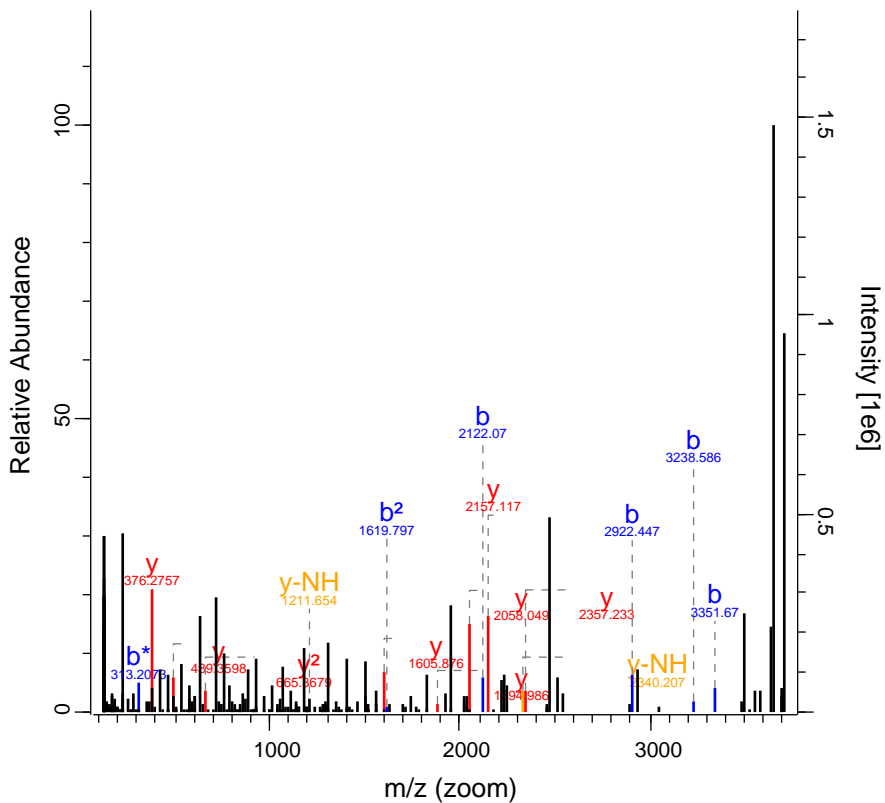

RO-QC-160121_ZackD_SS_Set_02_Fraction 35354 FTMS; HC 53.17 577.66 CABIN1

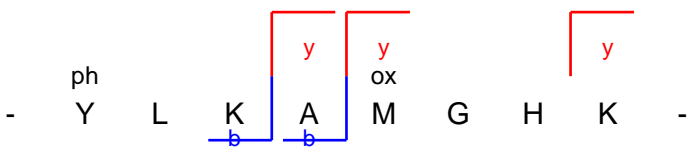
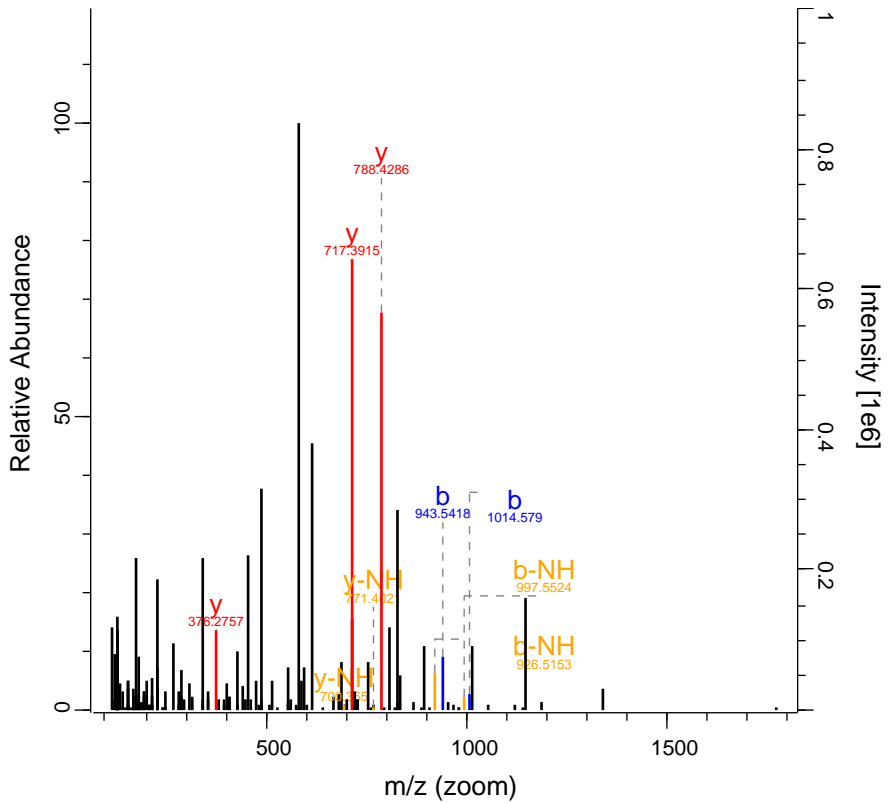

RO-QC-160121_ZackD_SS_Set_02_Fractio 35922 FTMS; HC 105.79 782.08 DNAJC5

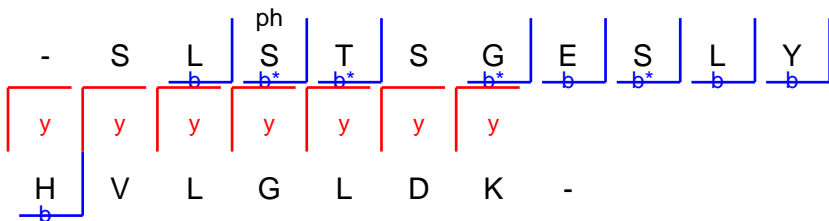
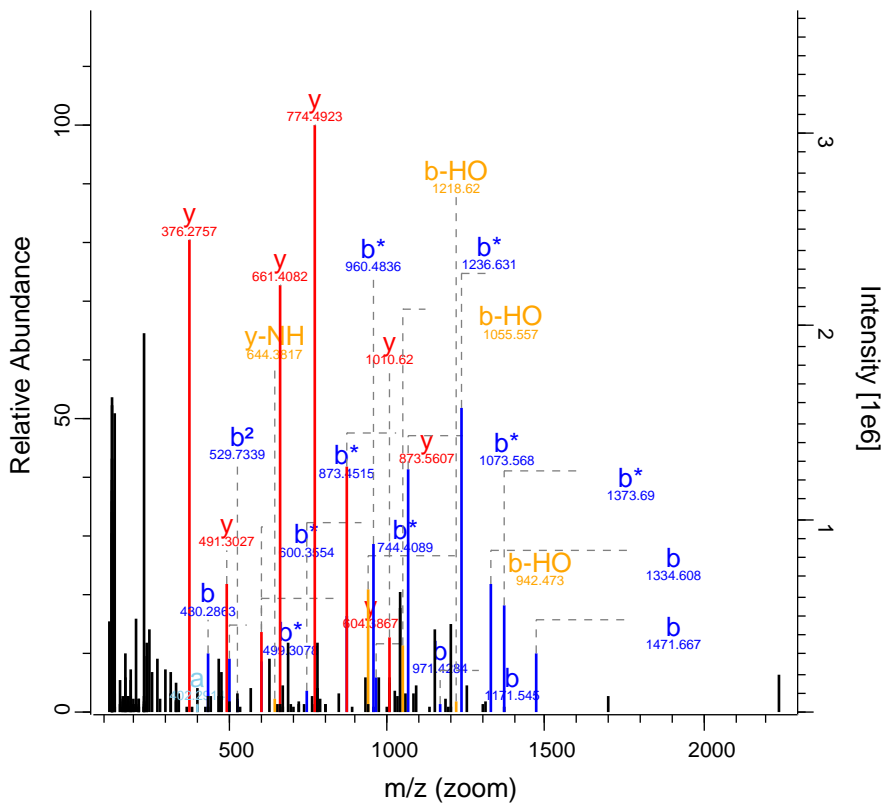

RO-QC-160121_ZackD_SS_Set_02_Fractio 36599 FTMS; HC 116.73 860.44 PRSS58

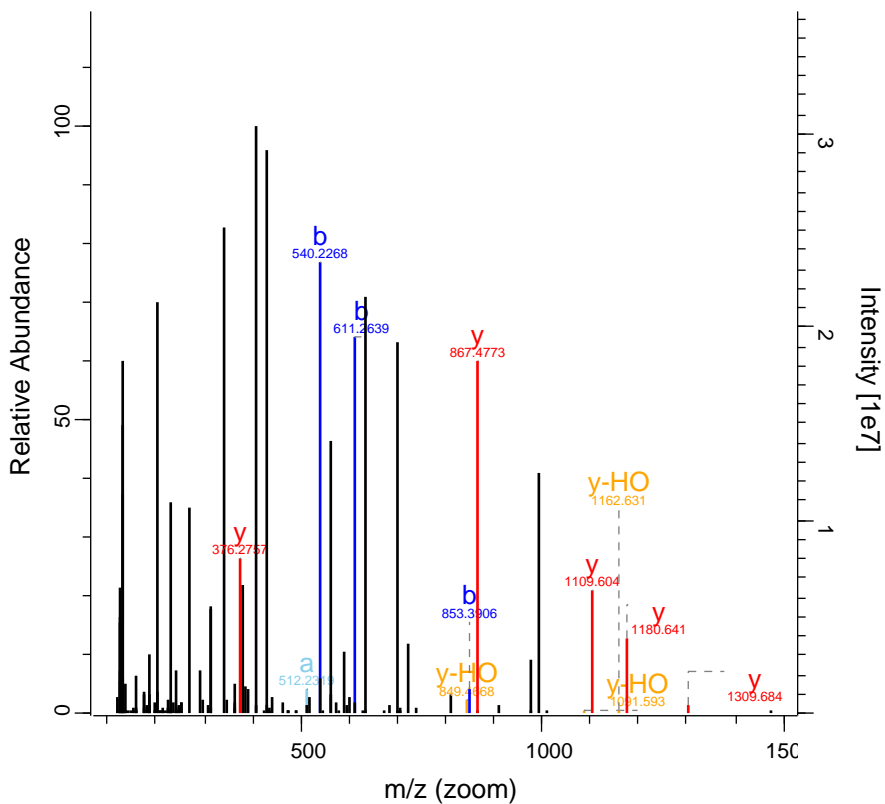

m/z (zoom)

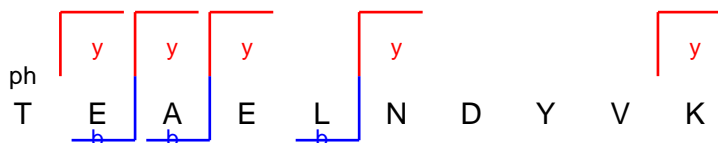

RO-QC-160121_ZackD_SS_Set_02_Fraction 36717 FTMS; HCl 129.46 754.4 VPRBP

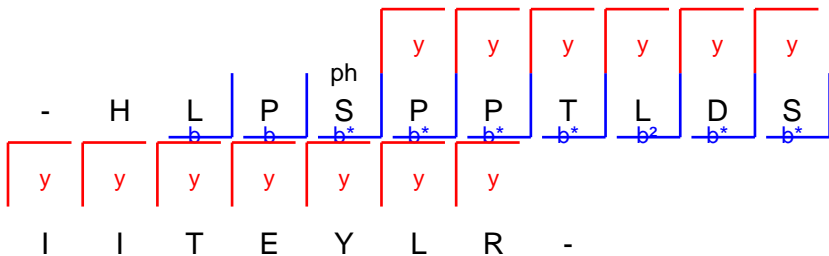
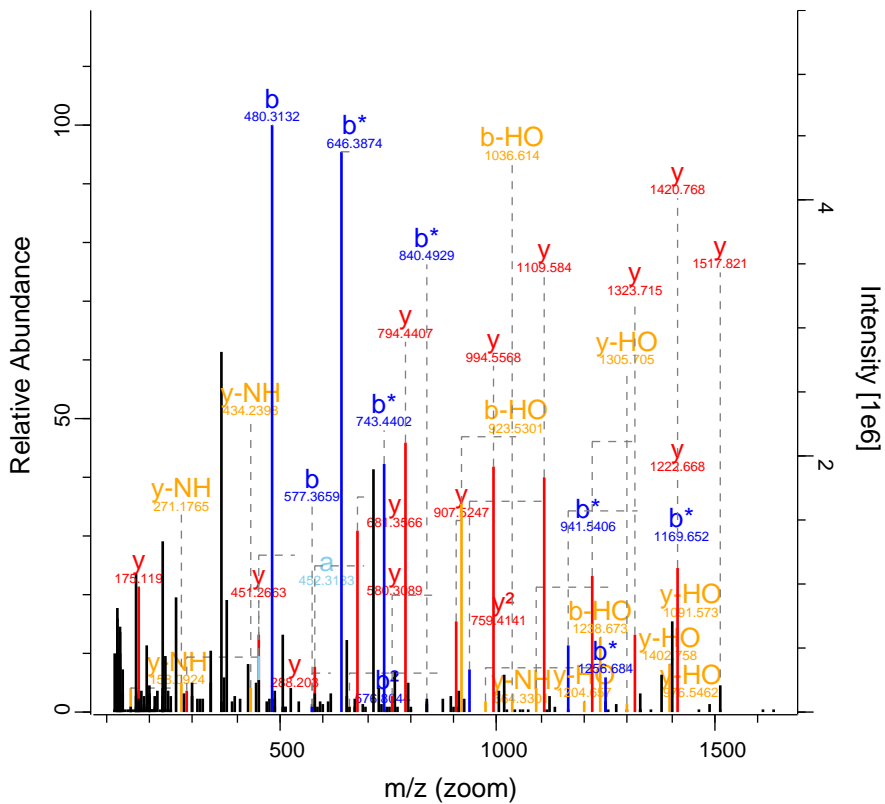

RO-QC-160121_ZackD_SS_Set_02_Fraction 36744 FTMS; HC 46.43 890.94 MIEF2

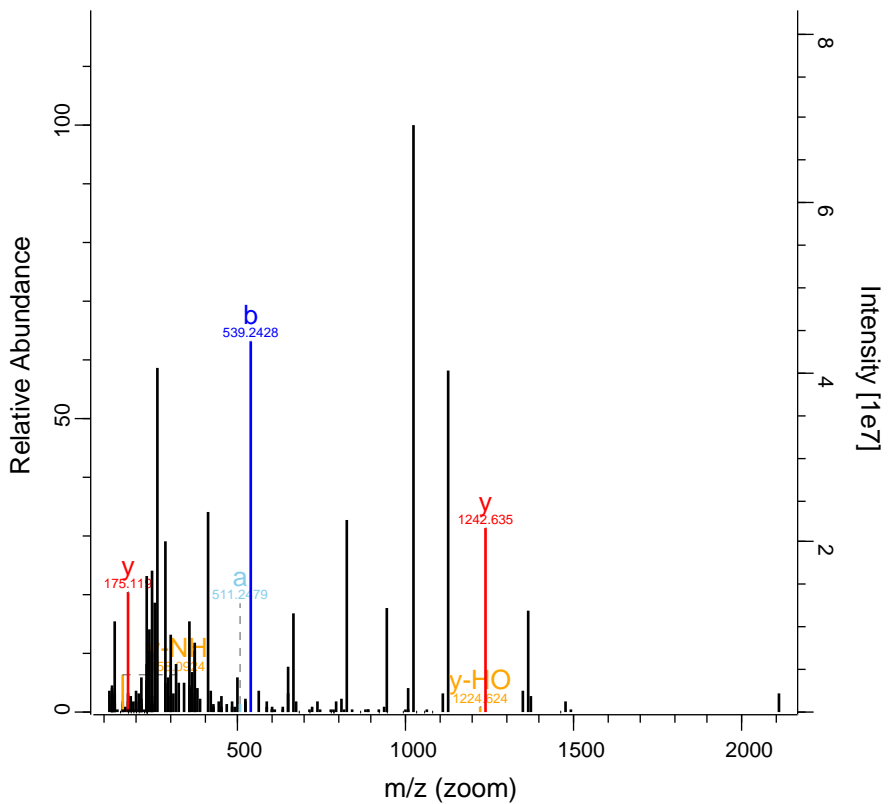

Fragmentation diagram showing the sequence of amino acids: Q, T, M, A, E, F, S, Q, K, R. The diagram indicates the presence of a **y** ion (red) and a **b** ion (blue) at the T position, and a **y** ion (red) at the R position. The sequence is shown as:

- Q T M A E F S Q K R

Fragmentation labels: **y** (red) above M, **ox** (red) above M, **b** (blue) below T, **y** (red) above R.

RO-QC-160121_ZackD_SS_Set_02_Fraction 36811 FTMS; HC 185.7 921.09 TNKS1BP1

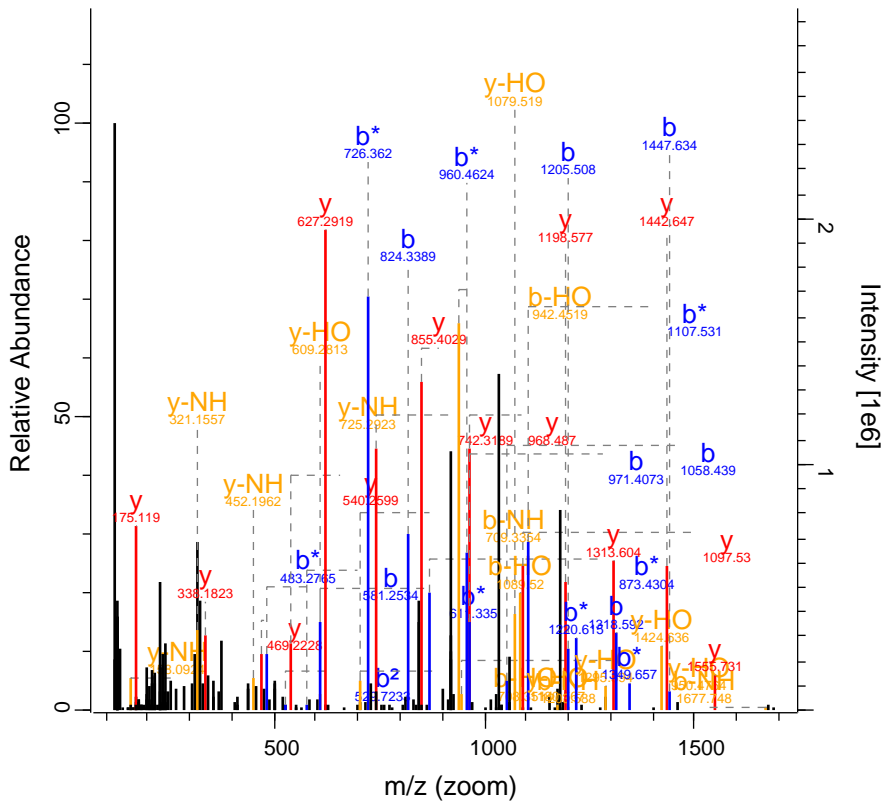

RO-QC-160121_ZackD_SS_Set_02_Fraction 37030 FTMS; HCl 40.96 998.5 ITGB6

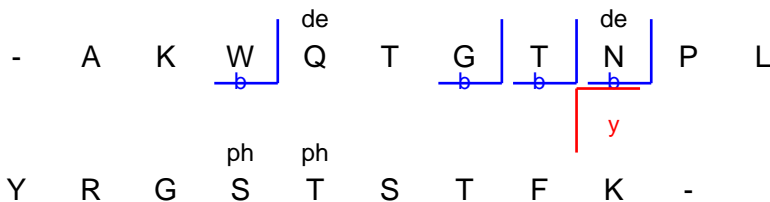
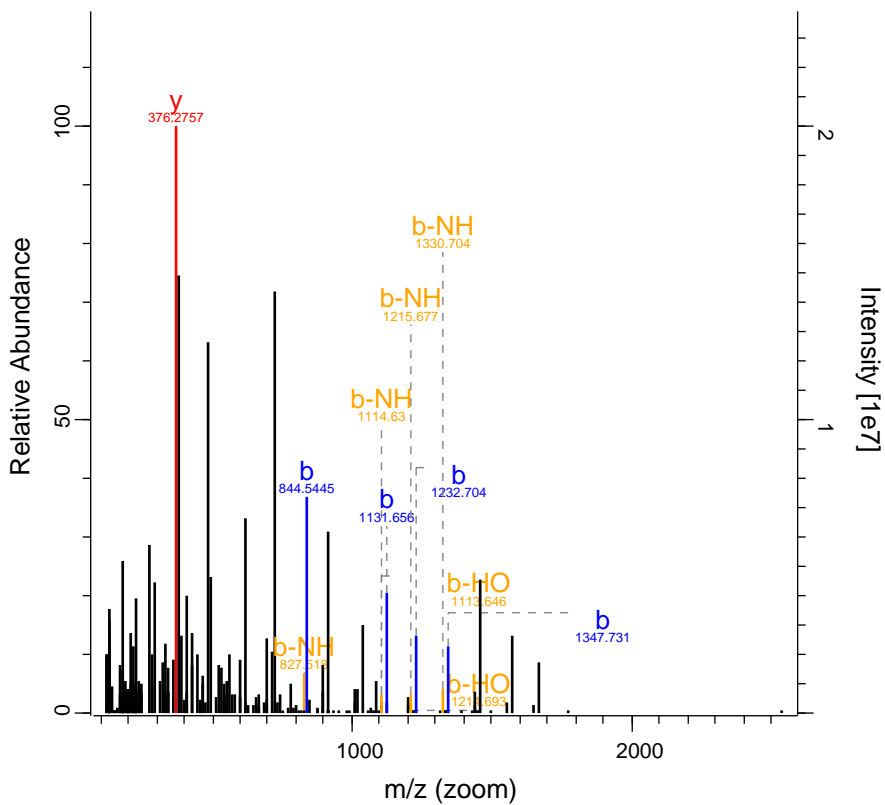

RO-QC-160121_ZackD_SS_Set_02_Fraction 5051 FTMS; HC 121.79 677.03 FLII

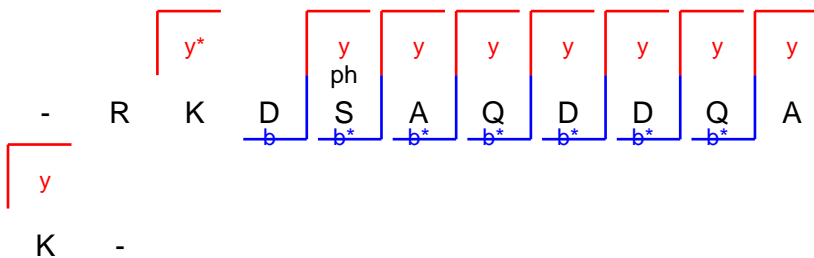
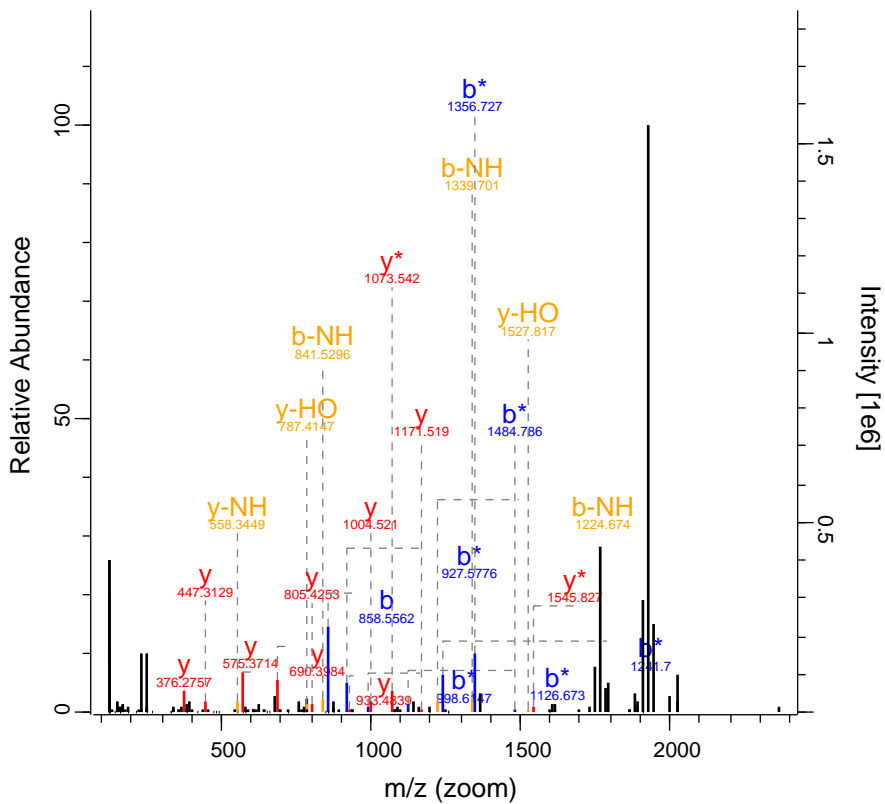

RO-QC-160121_ZackD_SS_Set_02_Fraction 5729 FTMS; HCl 44.93 593.81 NPM1

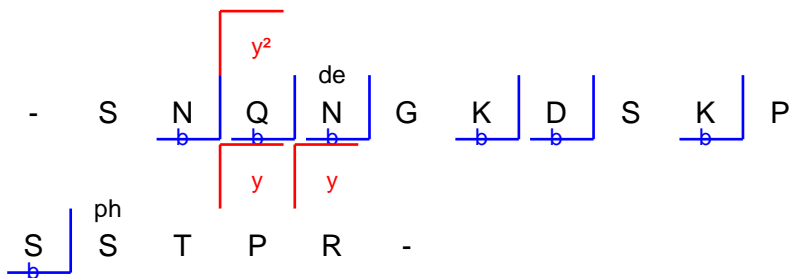
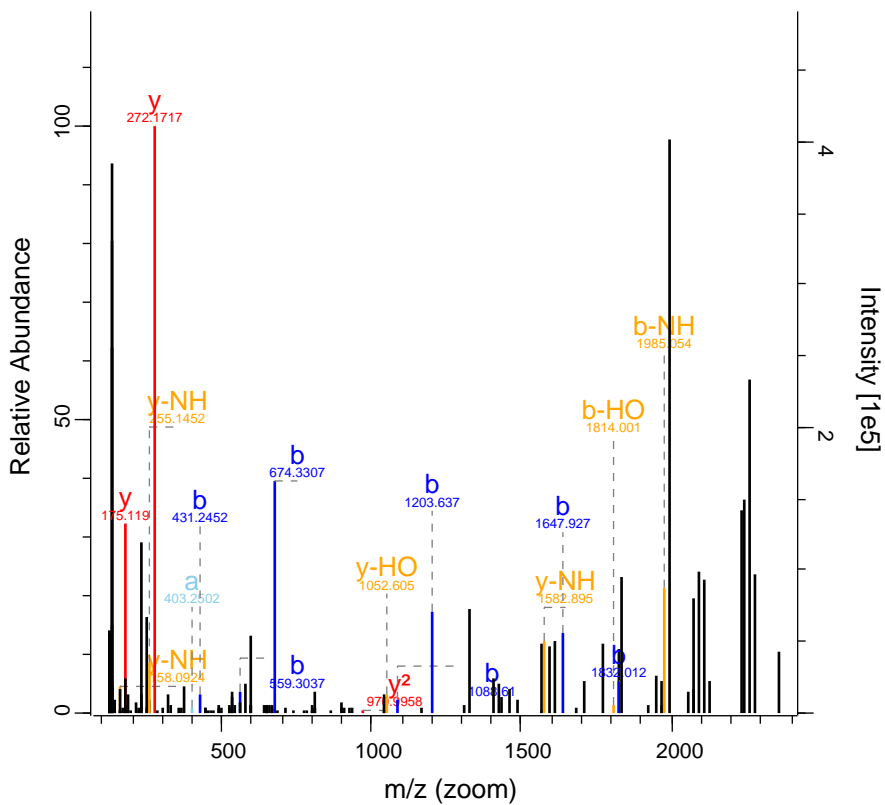

RO-QC-160121_ZackD_SS_Set_02_Fraction 6031 FTMS; HCl 86.8 594.99 RRBP1

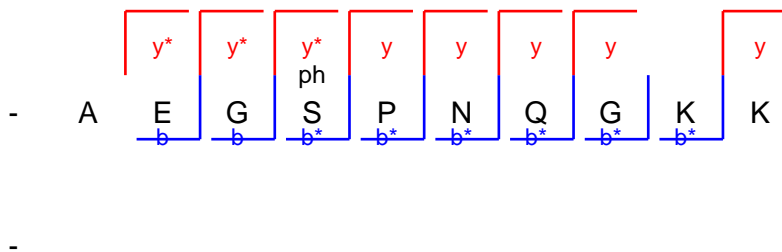
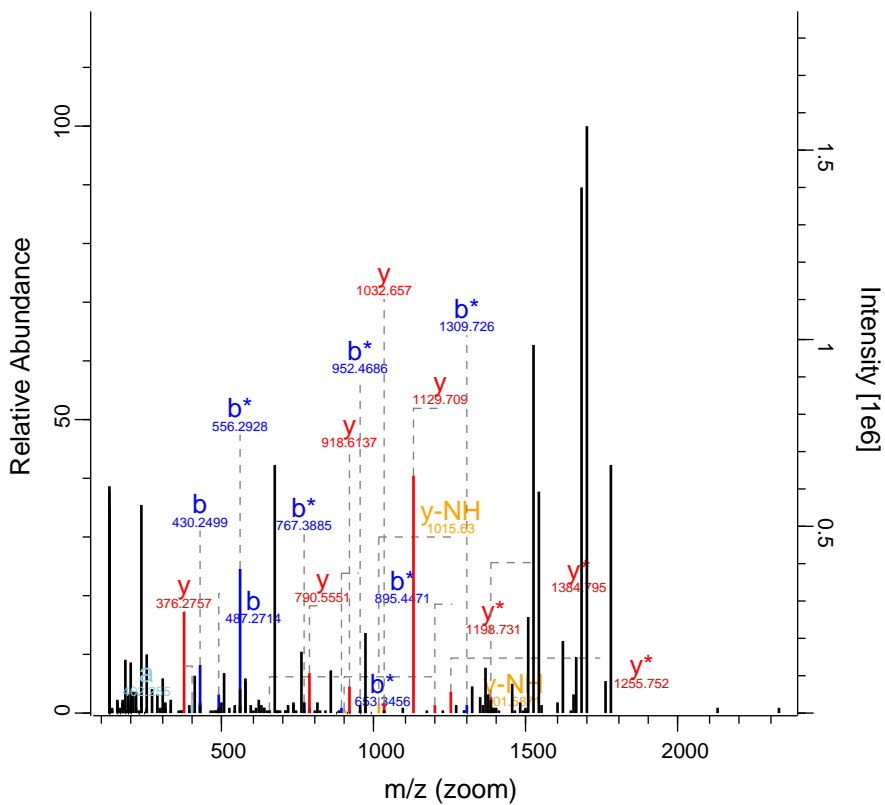

RO-QC-160121_ZackD_SS_Set_02_Fraction 6077 FTMS; HCl 69.15 551.63 PML

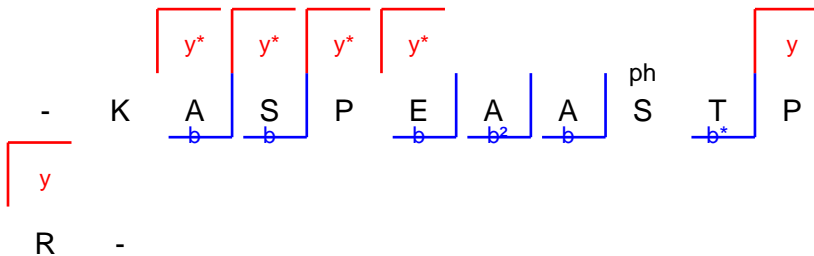
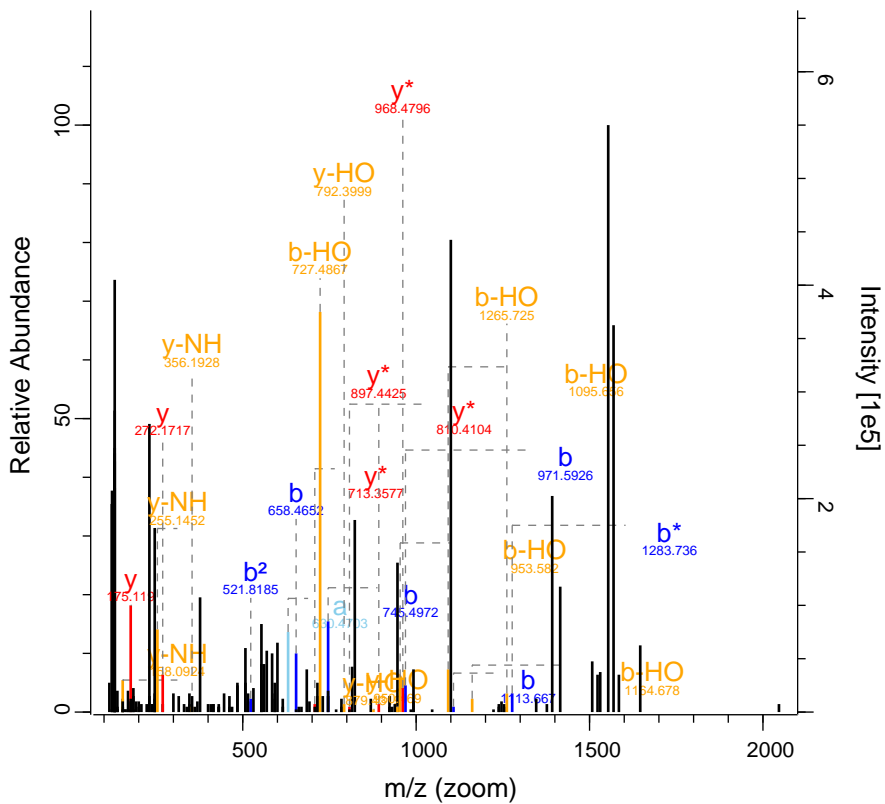

RO-QC-160121_ZackD_SS_Set_02_Fraction 7327 FTMS; HCl 54.61 393.63 FIG4

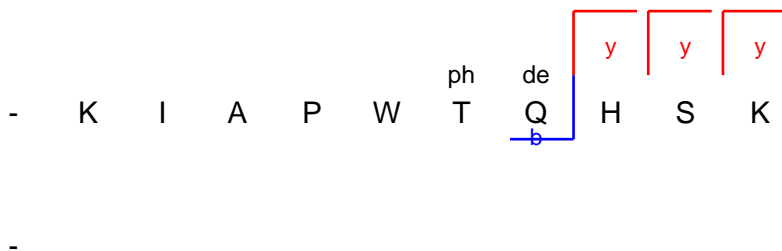
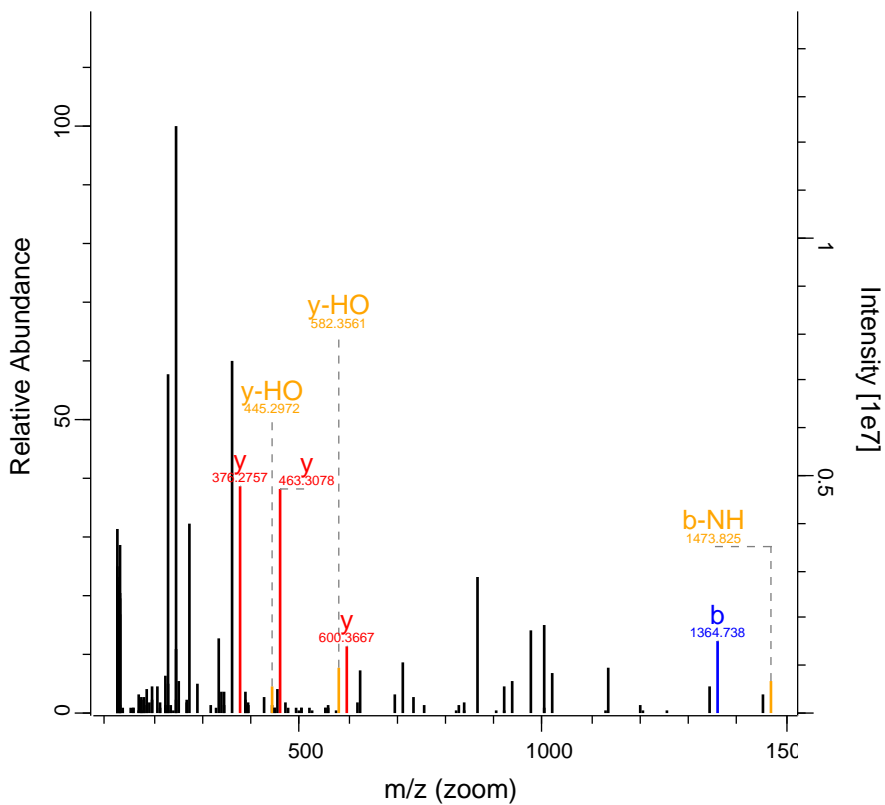

RO-QC-160121_ZackD_SS_Set_02_Fraction 7889 FTMS; HCl; 57.17 592.67 RBM6

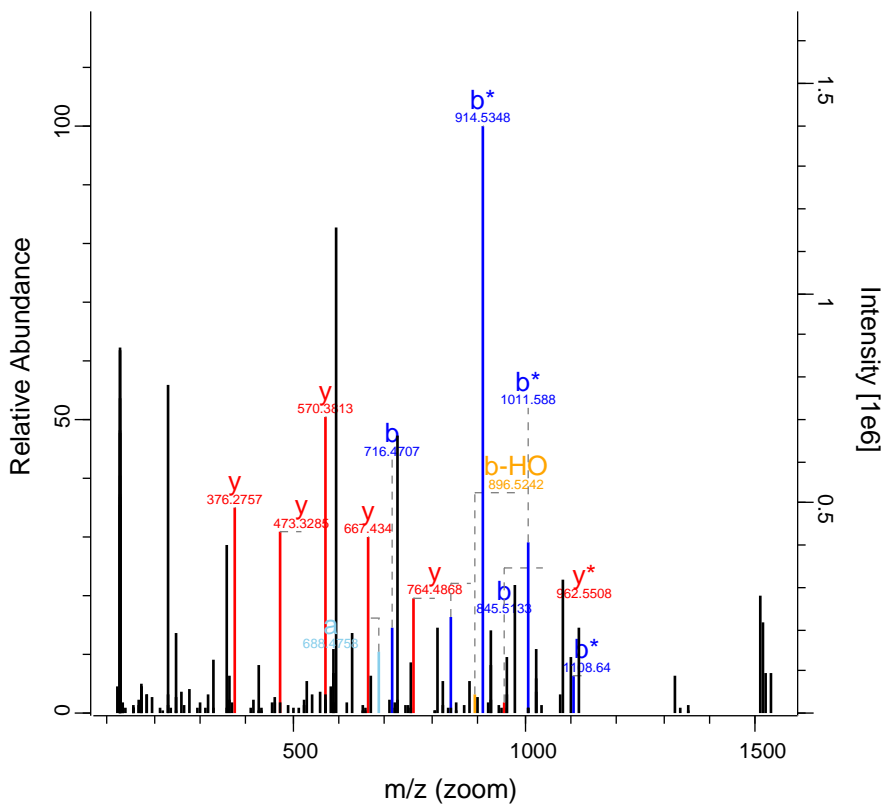

m/z (zoom)

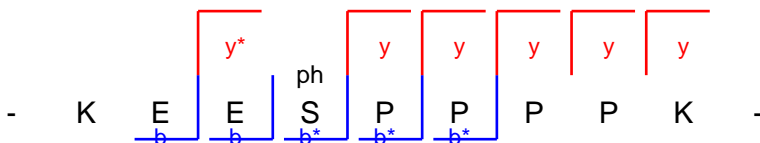

RO-QC-160121_ZackD_SS_Set_02_Fraction 8710 FTMS; HCl 87.24 680.03 IRF2BP1

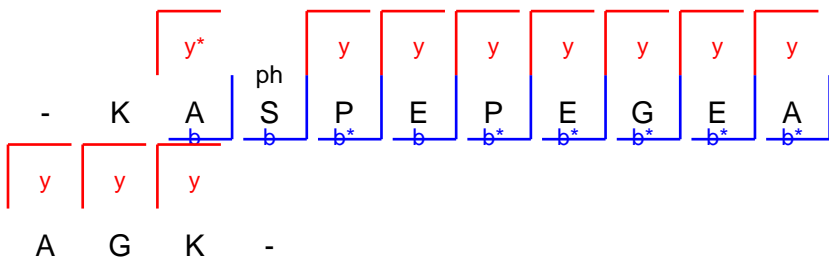
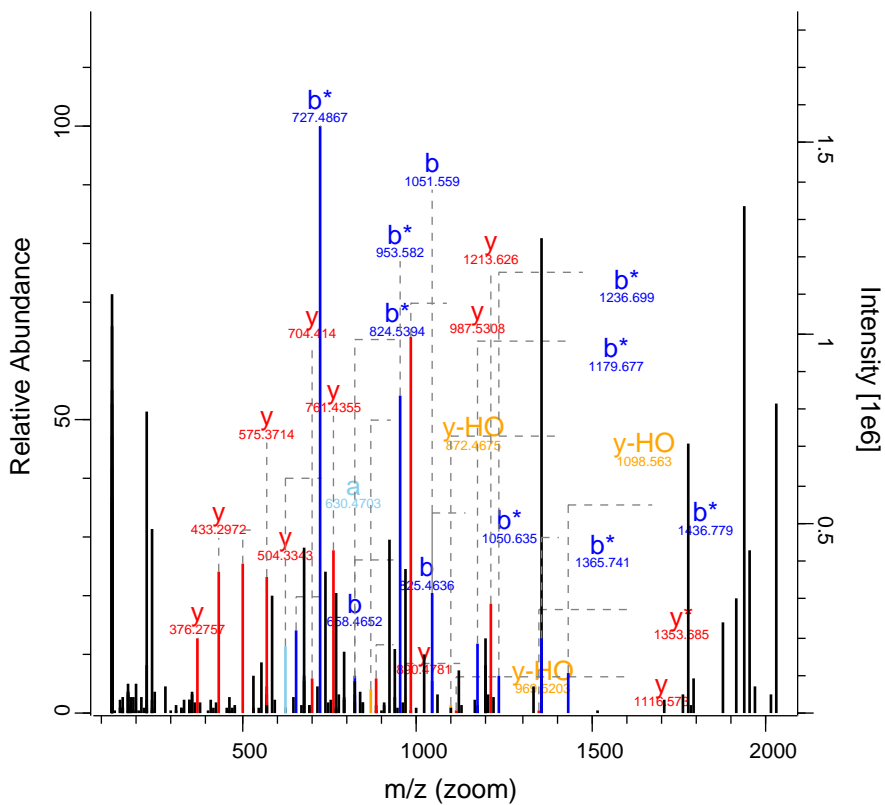

RO-QC-160121_ZackD_SS_Set_02_Fraction 9019 FTMS; HCl 67.52 529.97 SRRM2

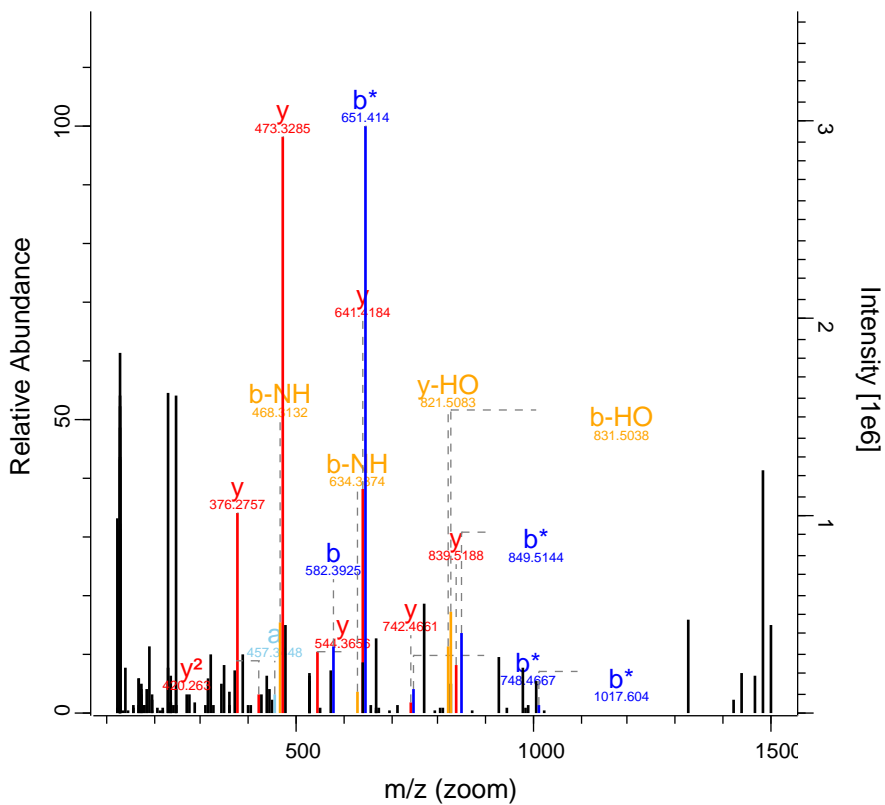

m/z (zoom)

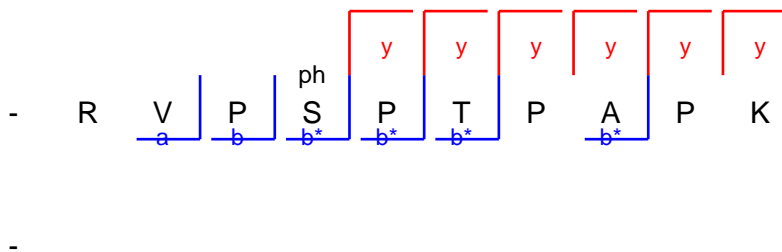

RO-QC-160121_ZackD_SS_Set_02_Fraction 9159 FTMS; HCl 91.46 818.7 IWS1

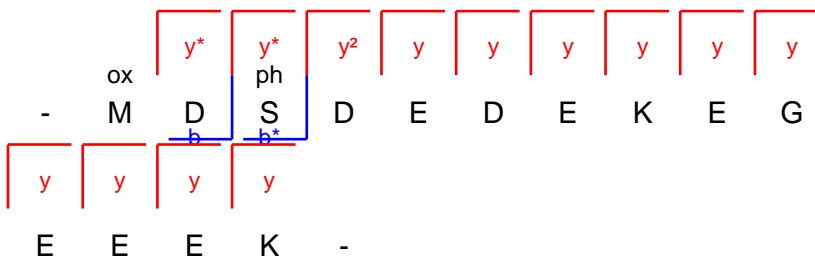
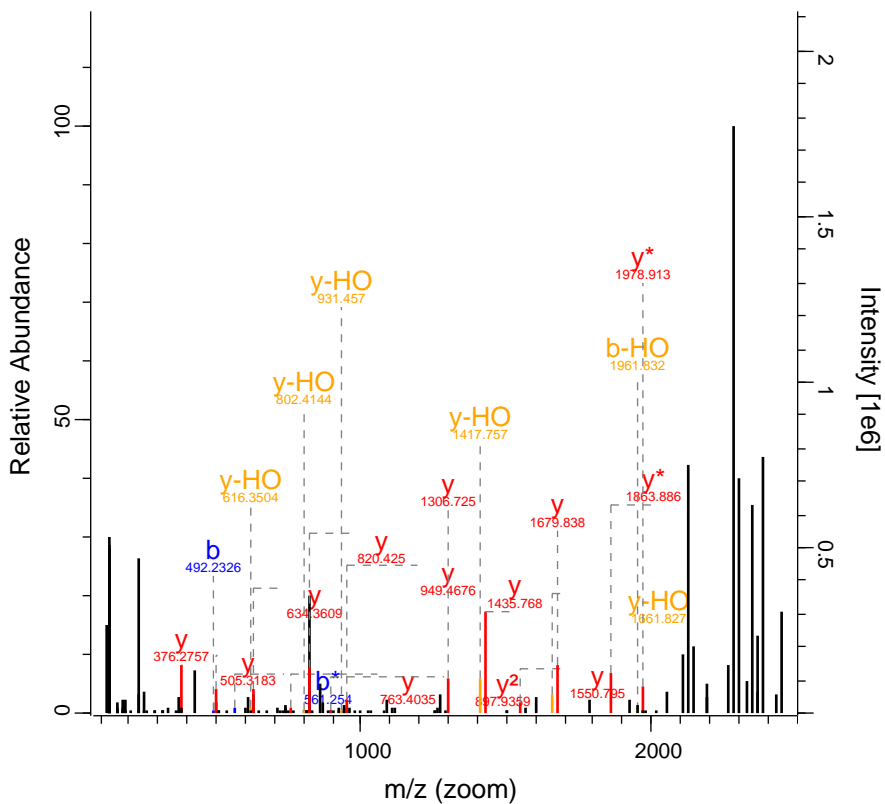

RO-QC-160121_ZackD_SS_Set_02_Fraction 9489 FTMS; HCl 63.49 764.4 LPHN2

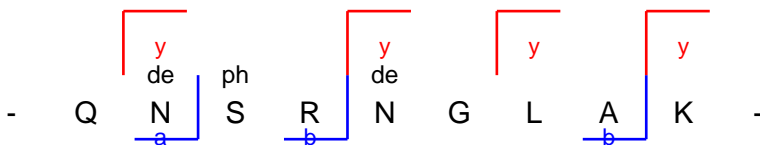
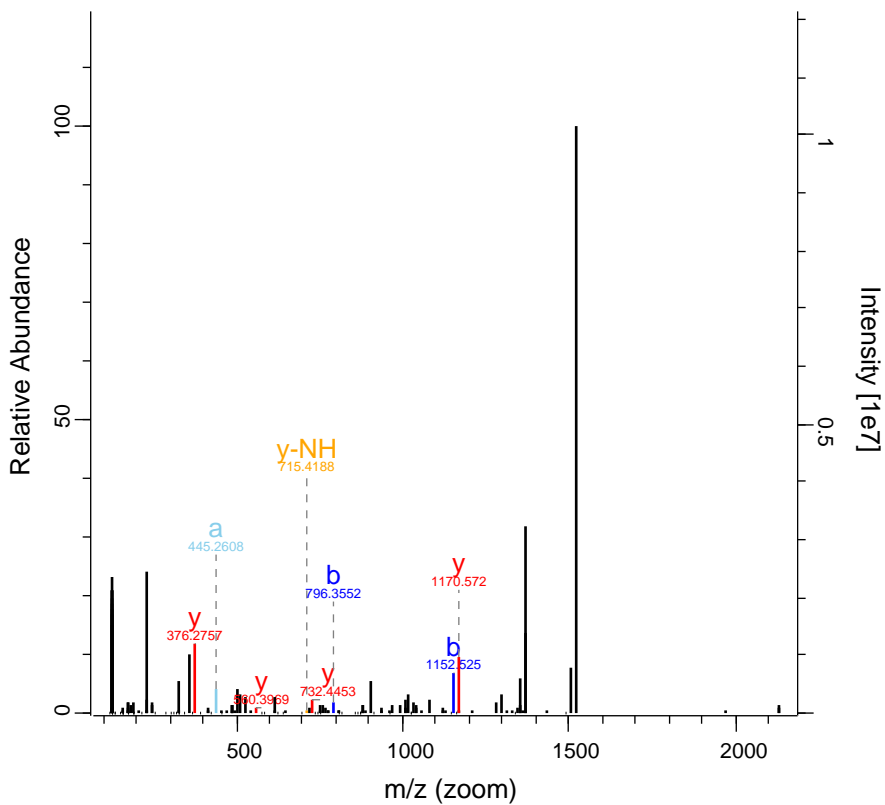

RO-QC-160121_ZackD_SS_Set_02_Fraction 10452 FTMS; HC 41.28 394.84 EFNB1

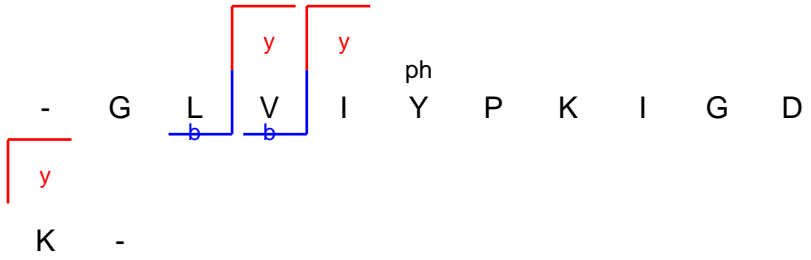
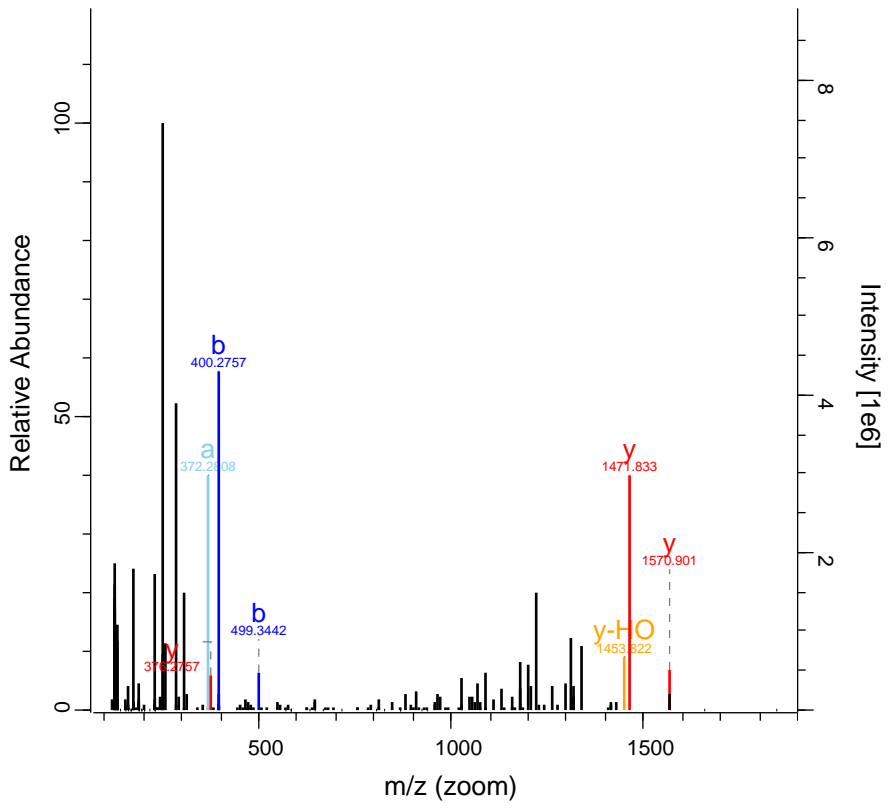

RO-QC-160121_ZackD_SS_Set_02_Fraction 12814 FTMS; HC 67.68 671.71 ADD1

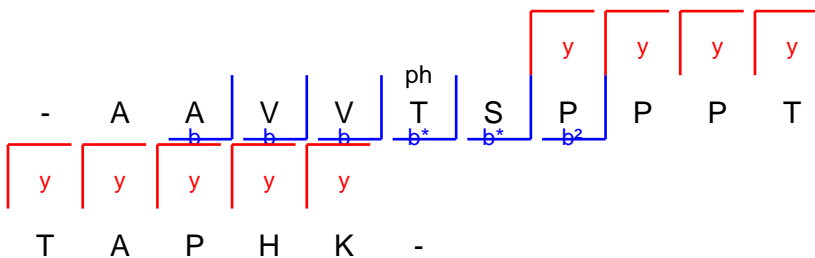
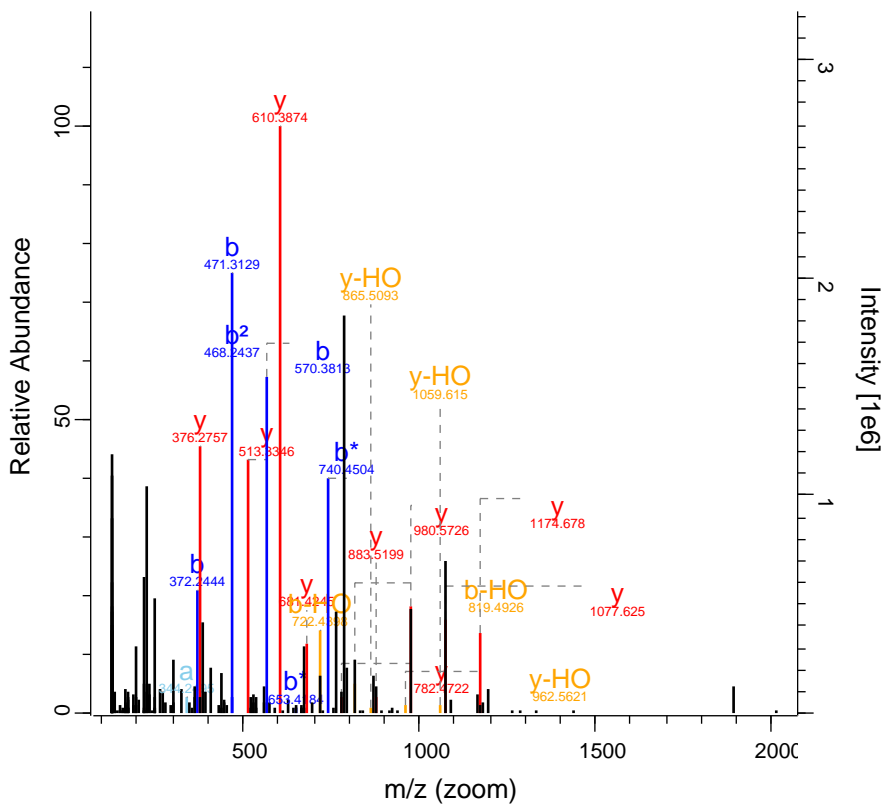

RO-QC-160121_ZackD_SS_Set_02_Fraction 13802 FTMS; HC 87.15 852.89 PRDX6

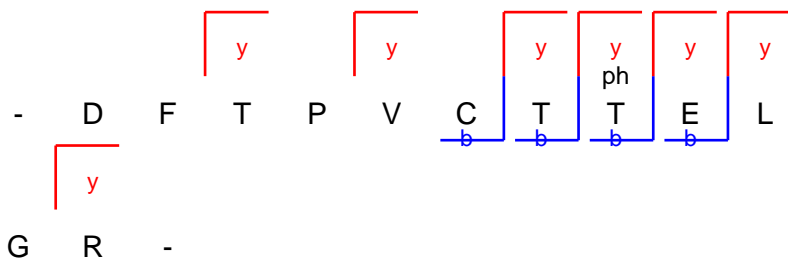
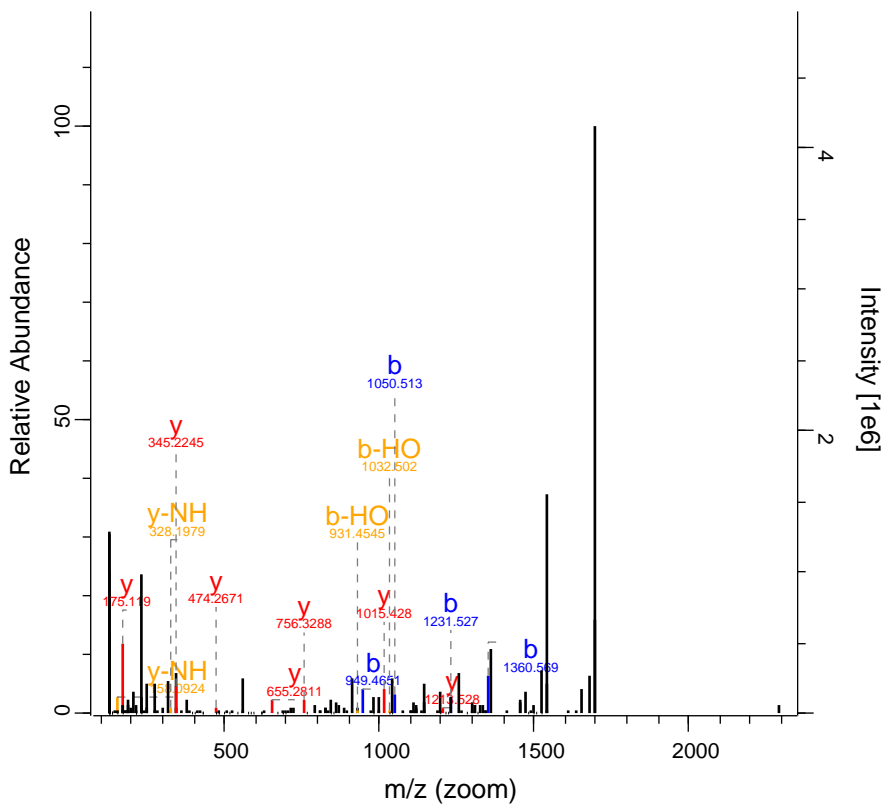

RO-QC-160121_ZackD_SS_Set_02_Fraction 14583 FTMS; HCl 87.31 998.5 DNAH3

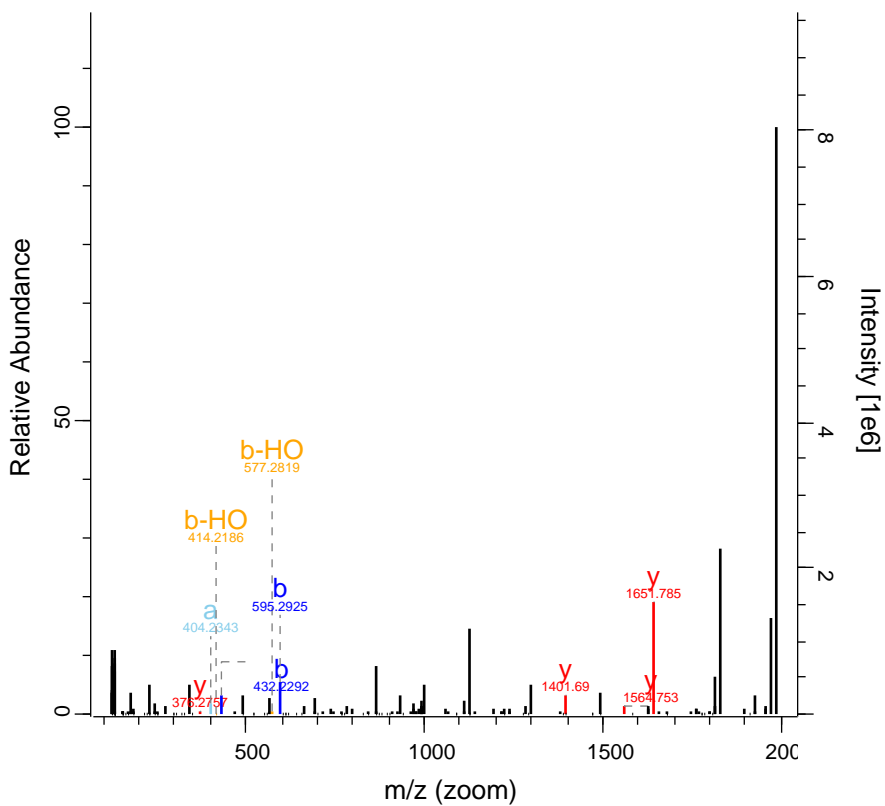

- D S Y M D T L P S S
 L T K -

Diagram illustrating the fragmentation pattern of the peptide sequence:

- D S Y M D T L P S S
 L T K -

The diagram shows the peptide sequence with fragmentation lines indicating the formation of b and y ions. The b ions are labeled in blue and the y ions are labeled in red. The fragmentation lines are shown as brackets above and below the sequence.

RO-QC-160121_ZackD_SS_Set_02_Fraction 15045 FTMS; HC 45.14 661.75 NCK2

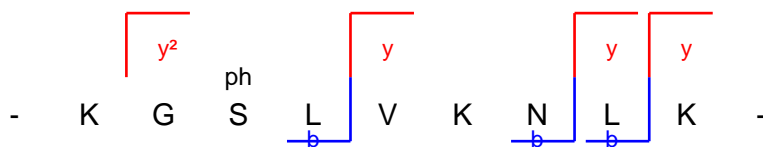
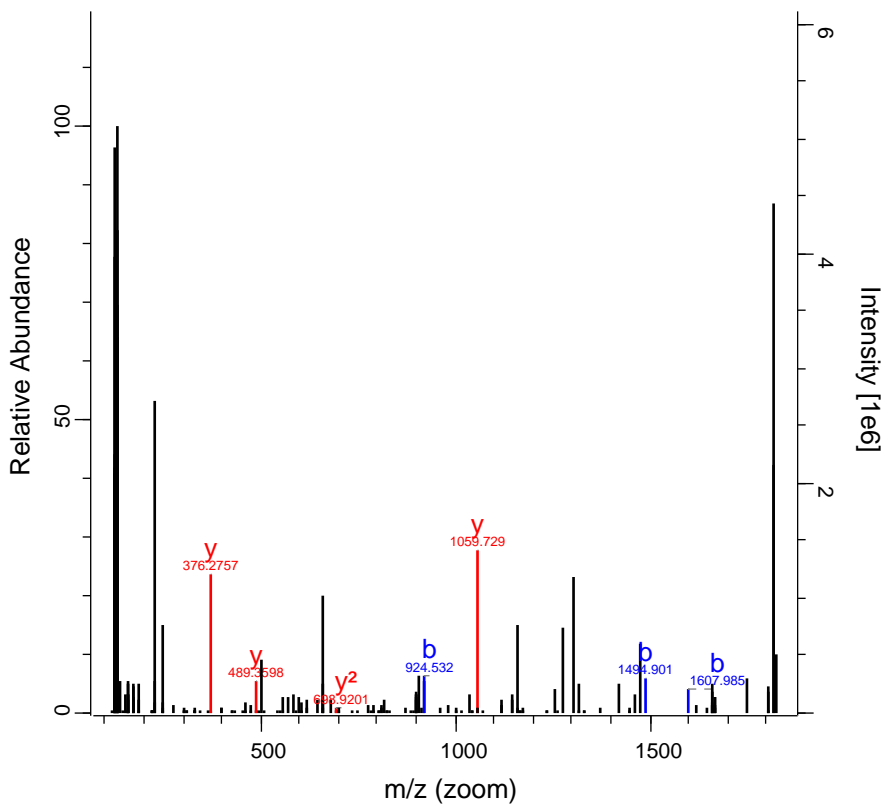

RO-QC-160121_ZackD_SS_Set_02_Fraction 18429 FTMS; HC 54.61 974.53 BBS1

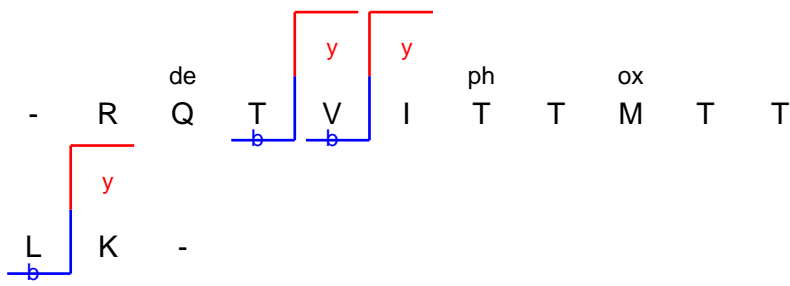
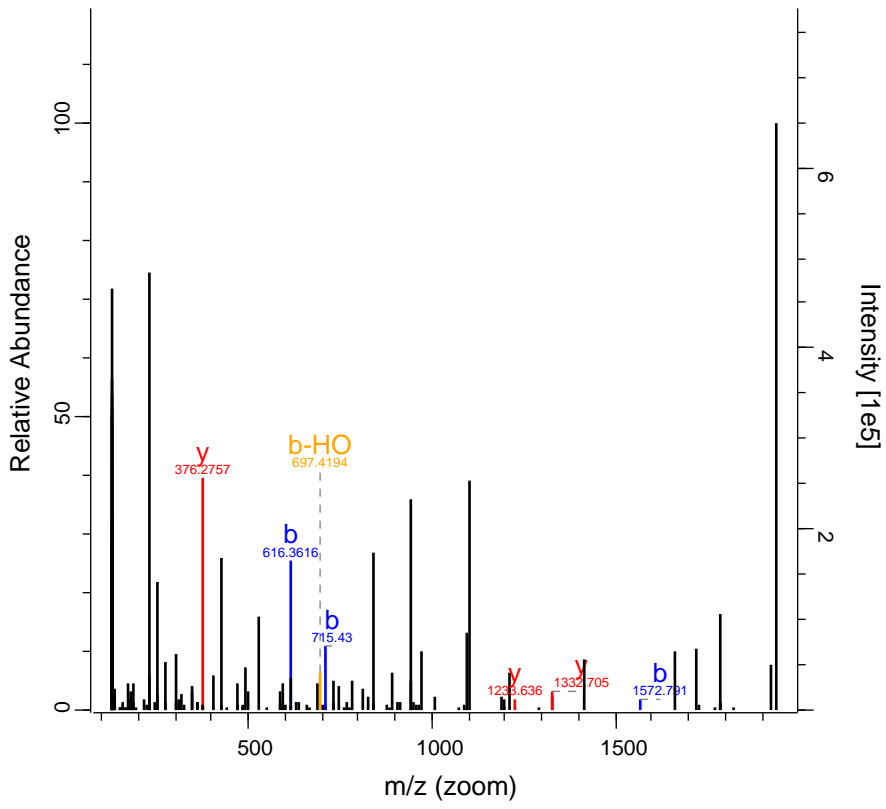

RO-QC-160121_ZackD_SS_Set_02_Fraction 18540 FTMS; HC 43.38 415.26 INTS9

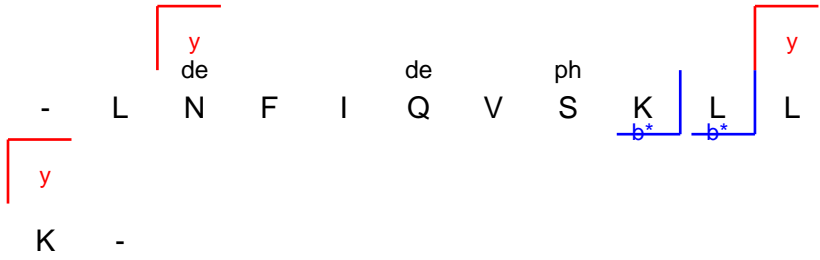
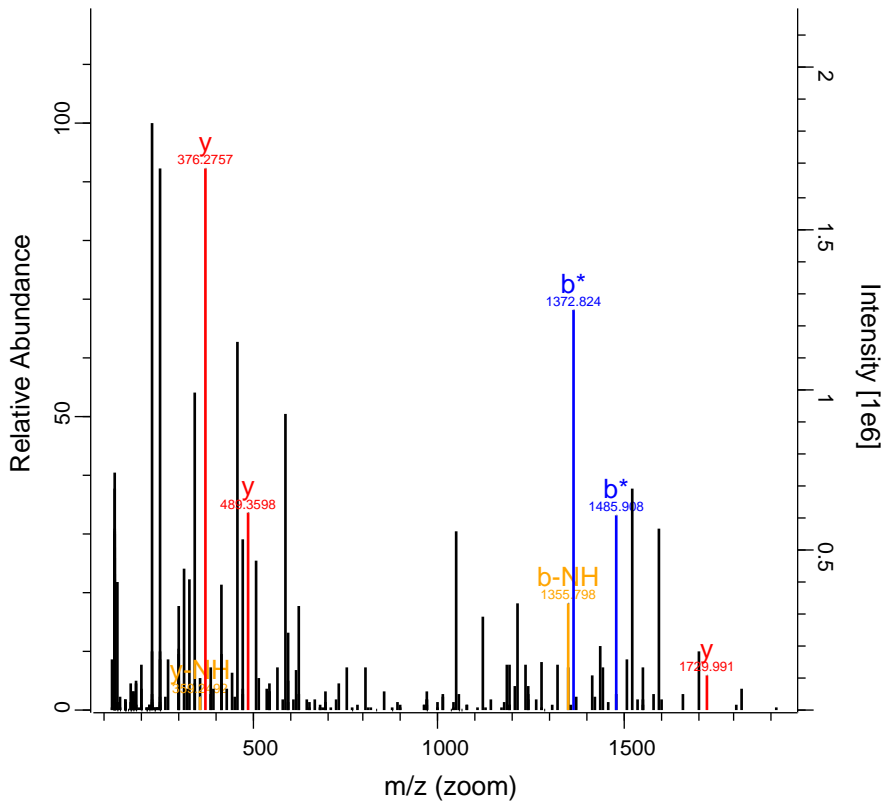

RO-QC-160121_ZackD_SS_Set_02_Fractic 18573 FTMS; HC 149.52 1250.17 UBAP2L

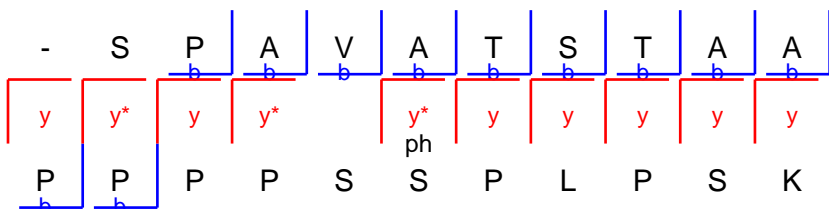
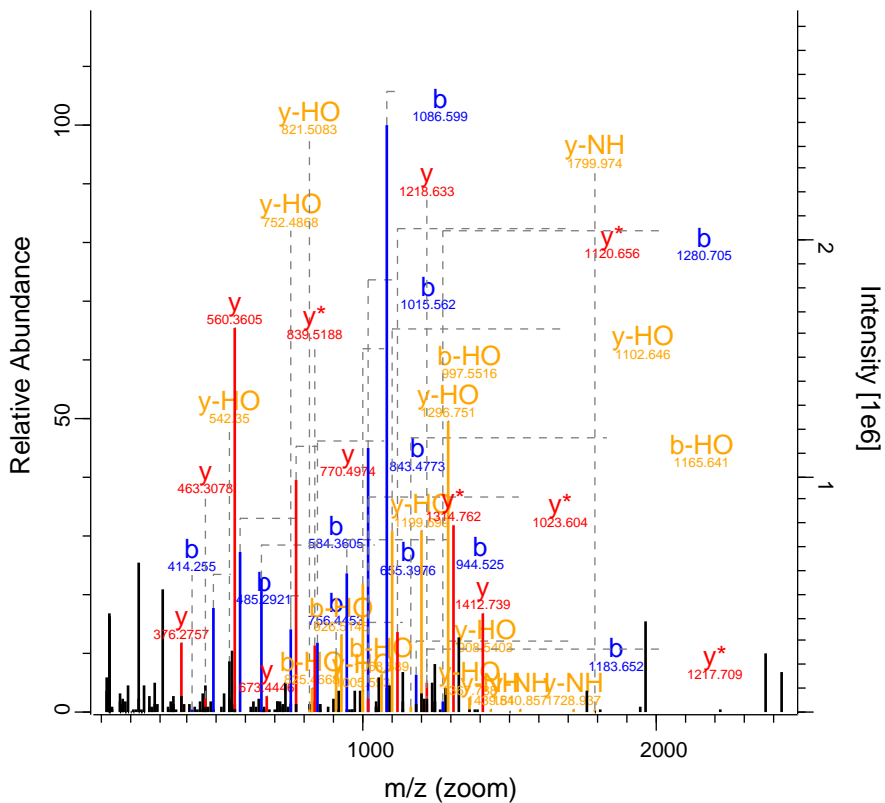

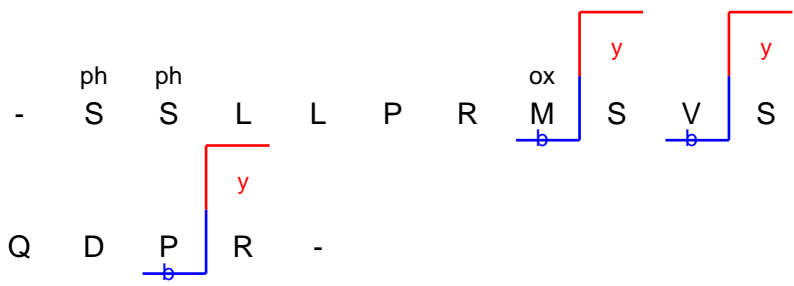
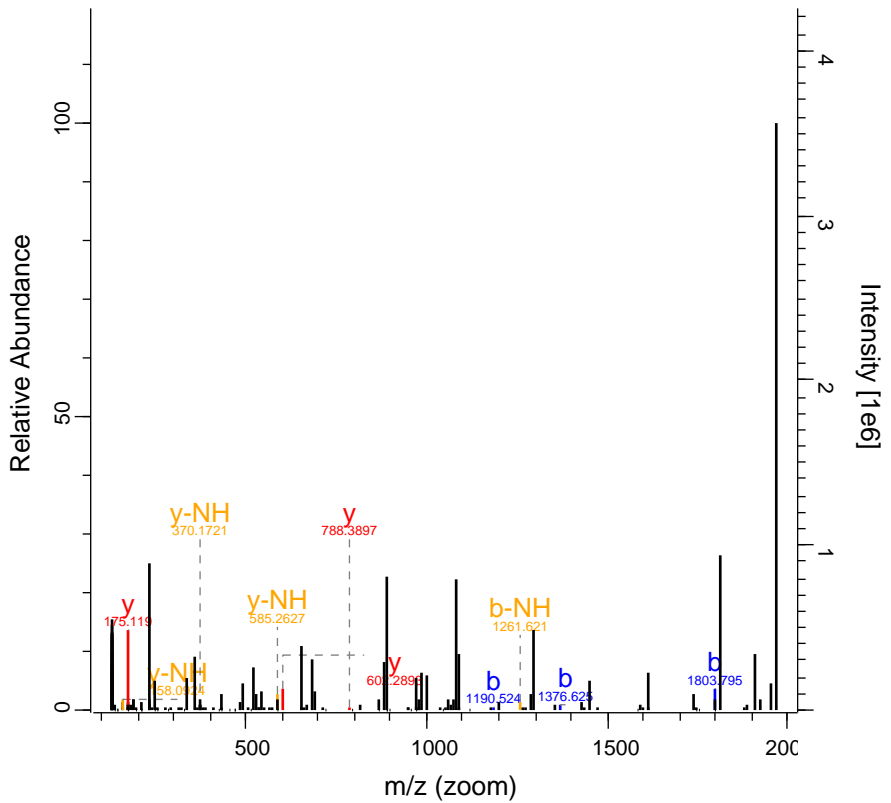

RO-QC-160121_ZackD_SS_Set_02_Fraction 20854 FTMS; HC 51.87 702.07 ZNF518A

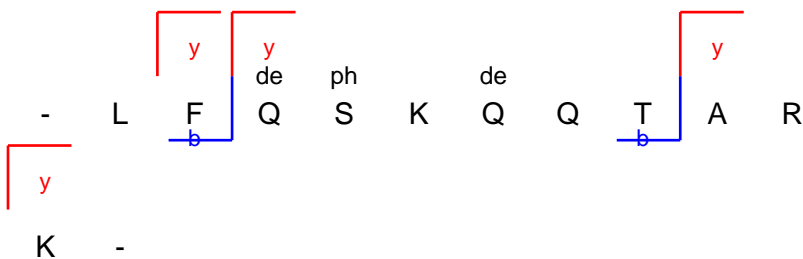
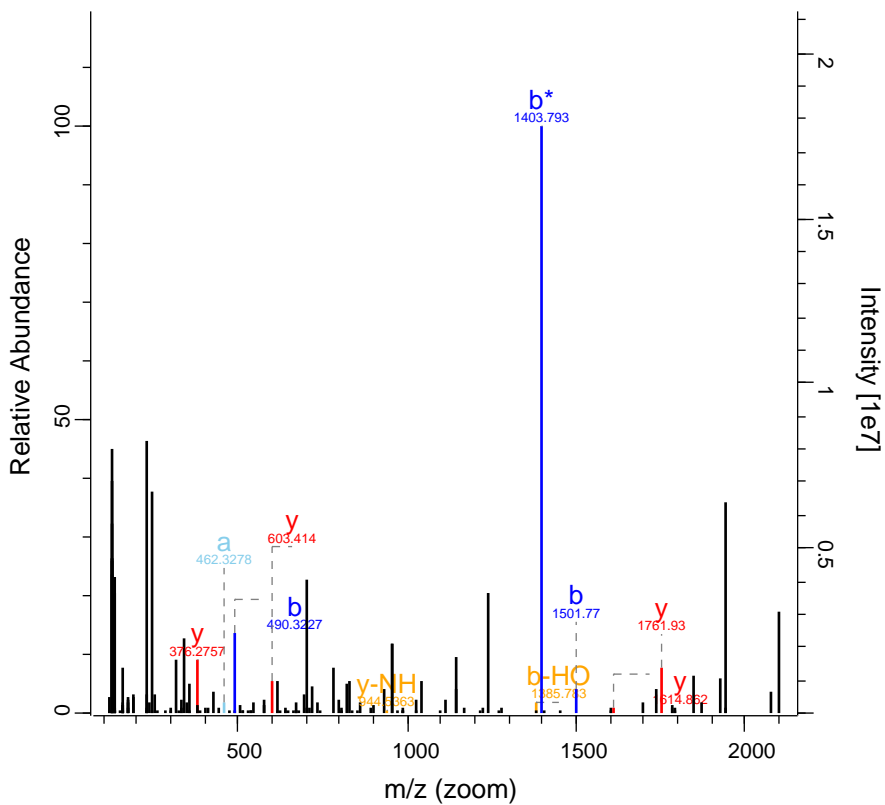

RO-QC-160121_ZackD_SS_Set_02_Fraction 20914 FTMS; HC 40.27 449.26 WAPAL

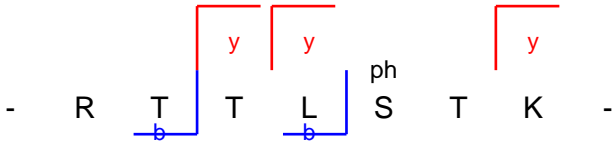
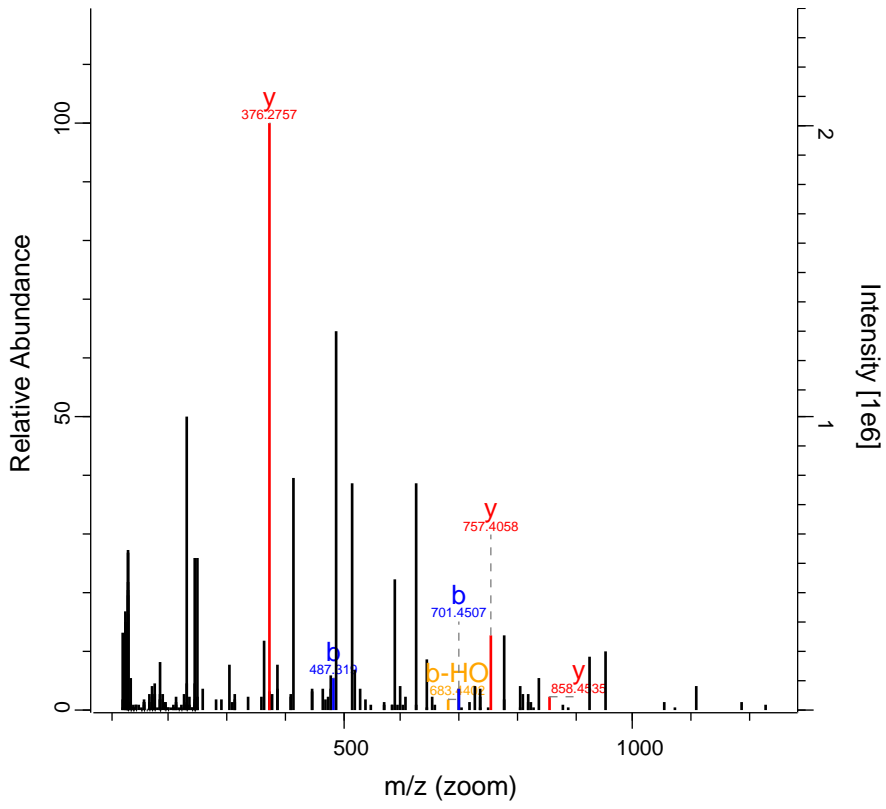

RO-QC-160121_ZackD_SS_Set_02_Fractic 21645 FTMS; HC 62.47 1078.05 NACA2

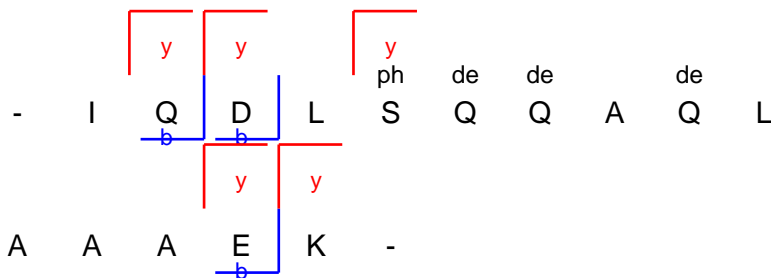
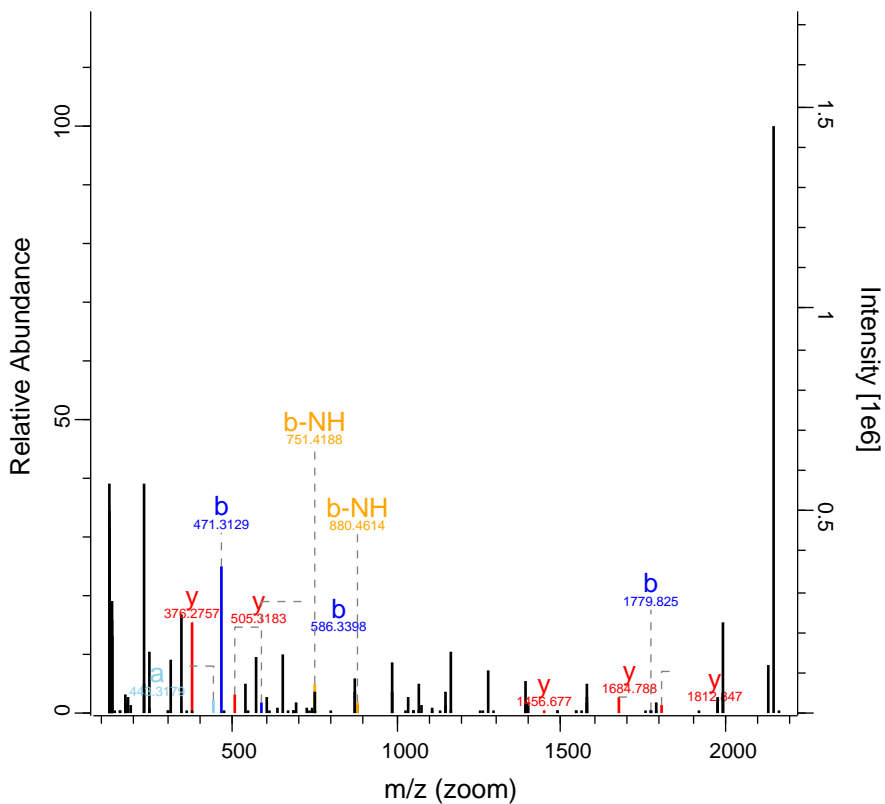

RO-QC-160121_ZackD_SS_Set_02_Fractio 22534 FTMS; HC 203.11 981.02 MAP1B

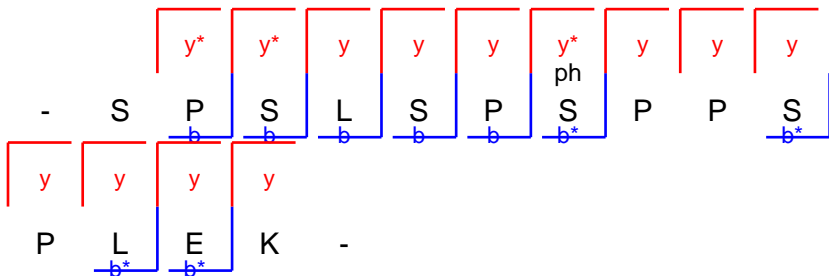
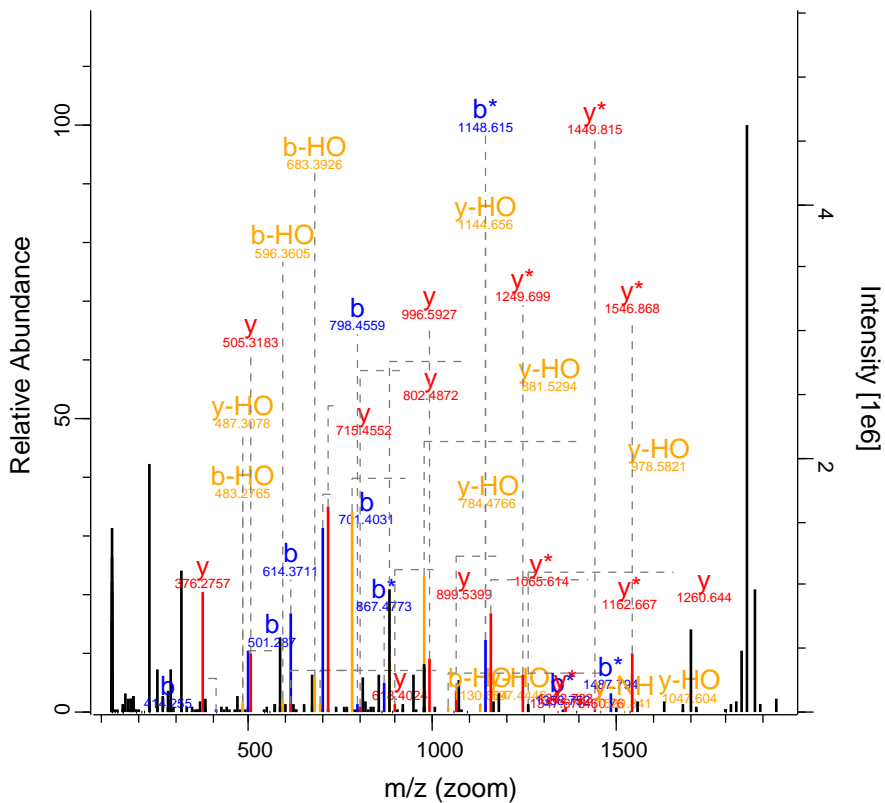

RO-QC-160121_ZackD_SS_Set_02_Fractic 23031 FTMS; HC 71.89 1052.08 DNAH17

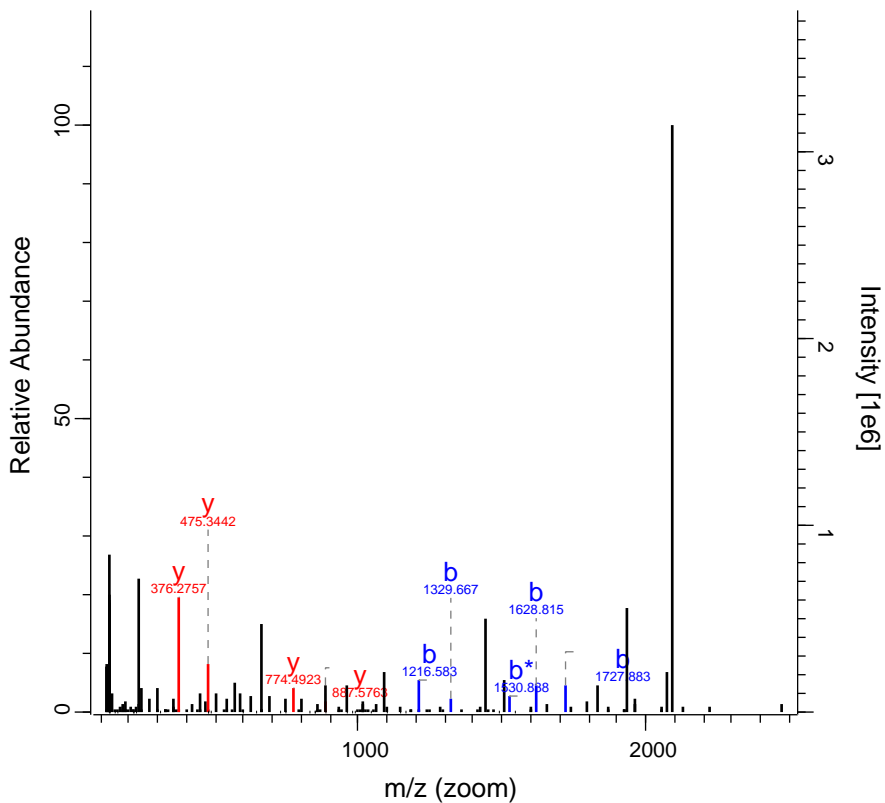

RO-QC-160121_ZackD_SS_Set_02_Fractio 23164 FTMS; HC 56.01 903.45 TOP2B

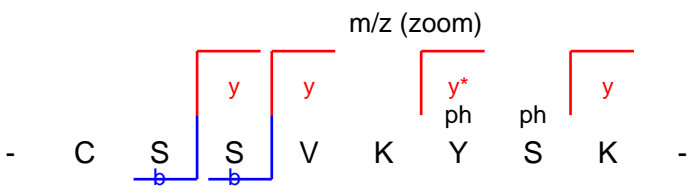
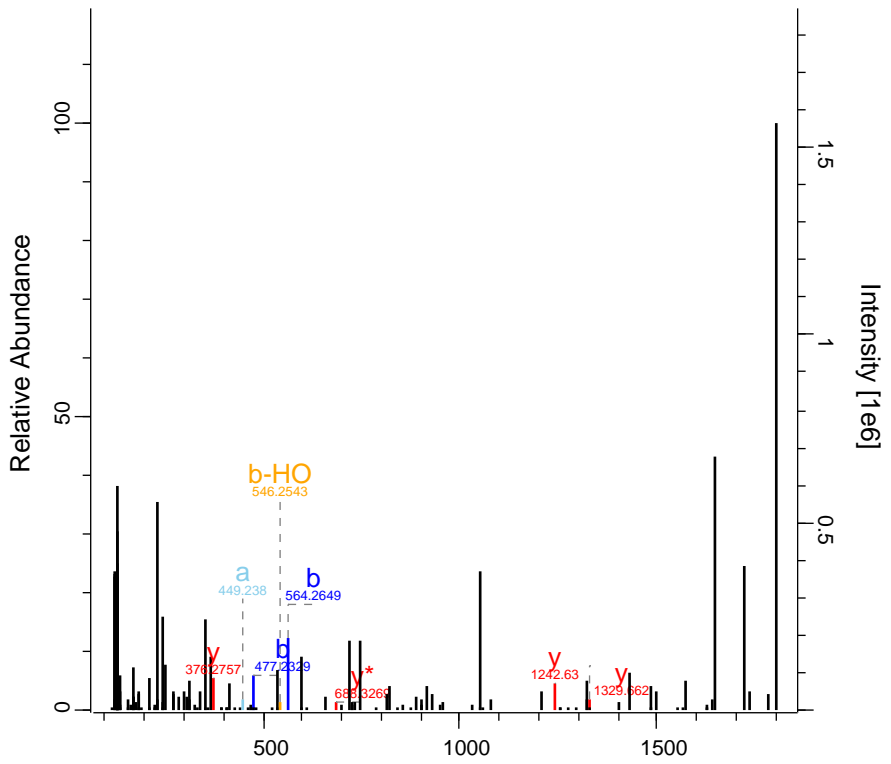

RO-QC-160121_ZackD_SS_Set_02_Fraction 23494 FTMS; HC 44.64 808.71 SCN9A

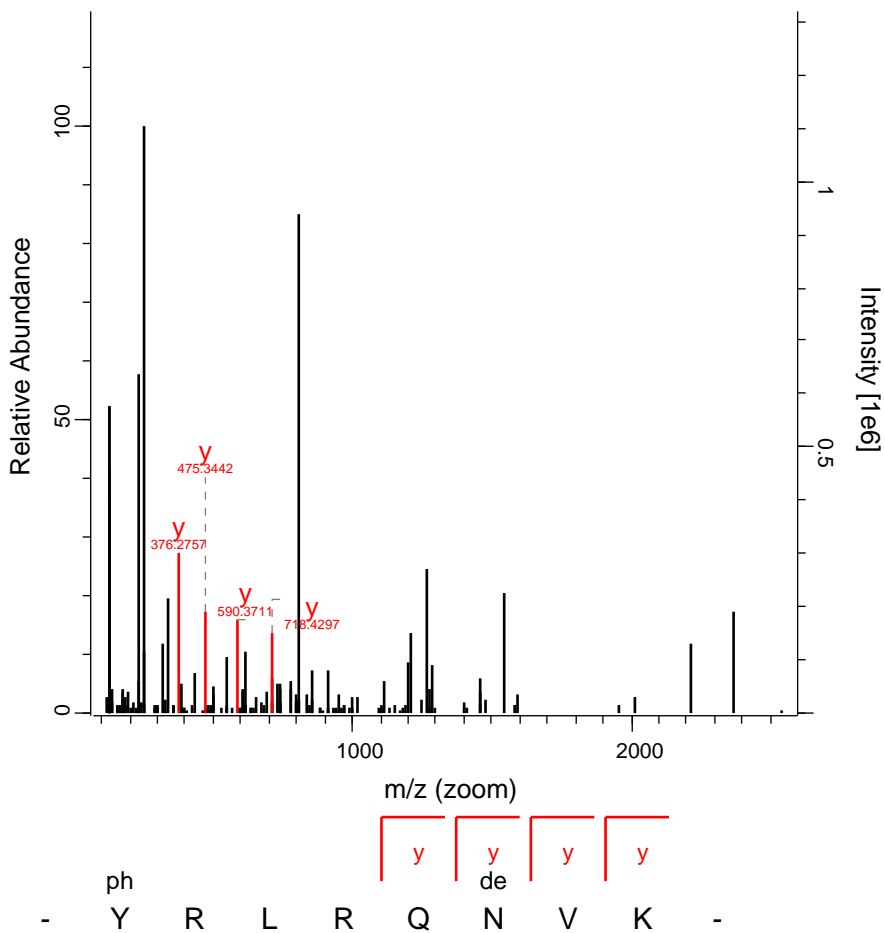

RO-QC-160121_ZackD_SS_Set_02_Fractic 25858 FTMS; HC 52.61 1065.22 CLC

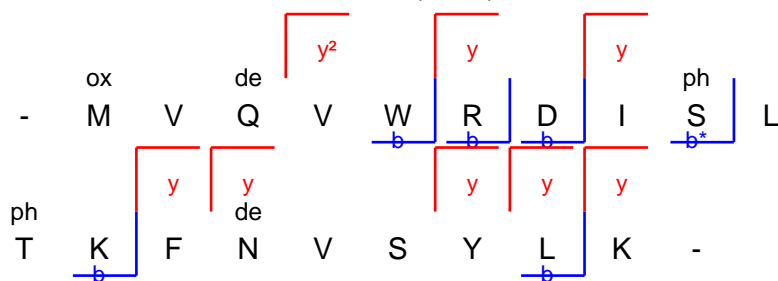
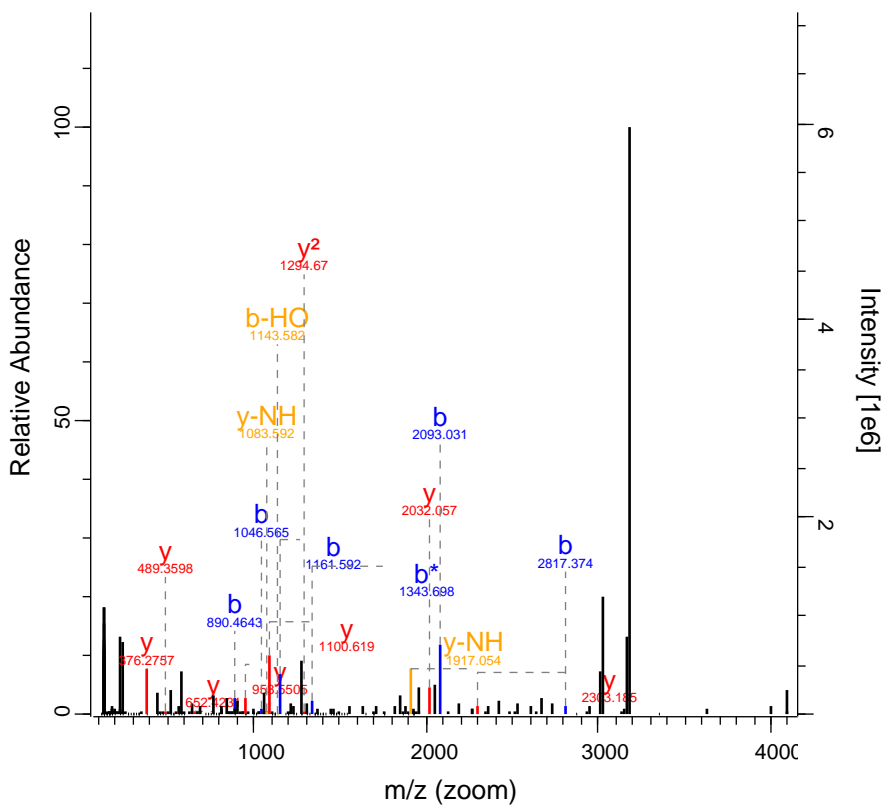

RO-QC-160121_ZackD_SS_Set_02_Fractic 26039 FTMS; HC 178.8 1128.02 MAP1B

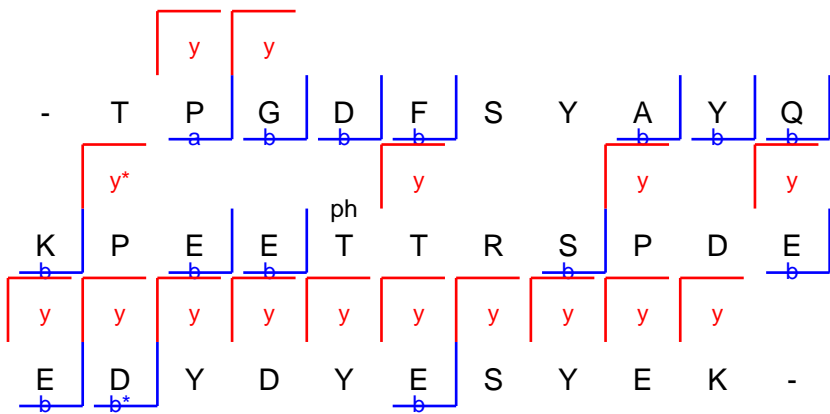
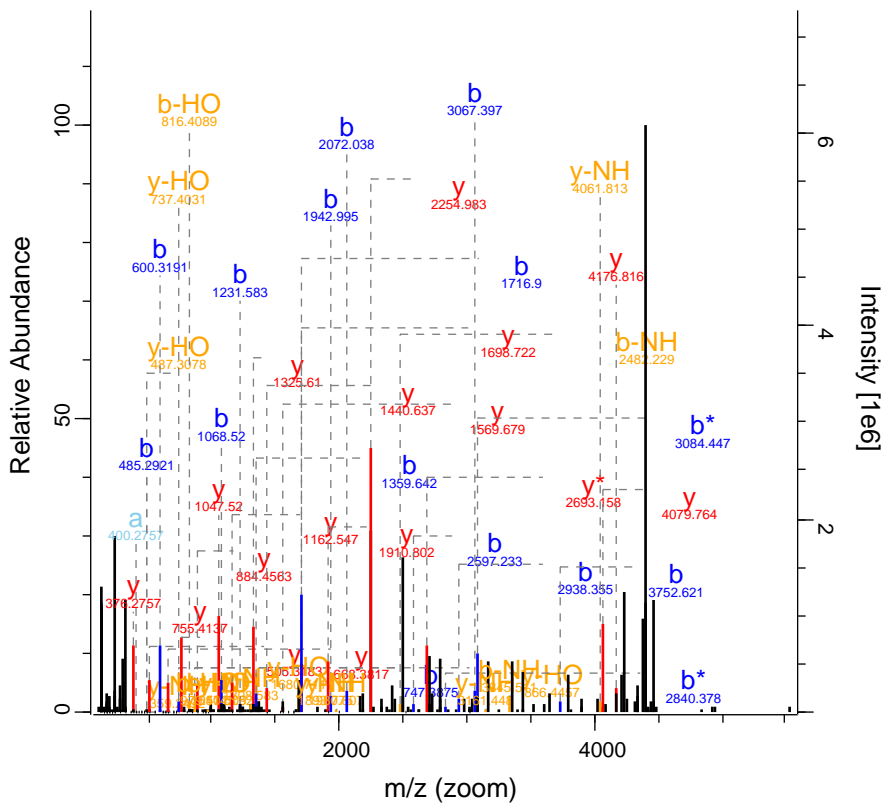

RO-QC-160121_ZackD_SS_Set_02_Fraction 26267 FTMS; HC 49.42 584.33 RMI1

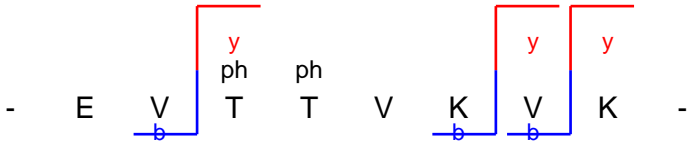
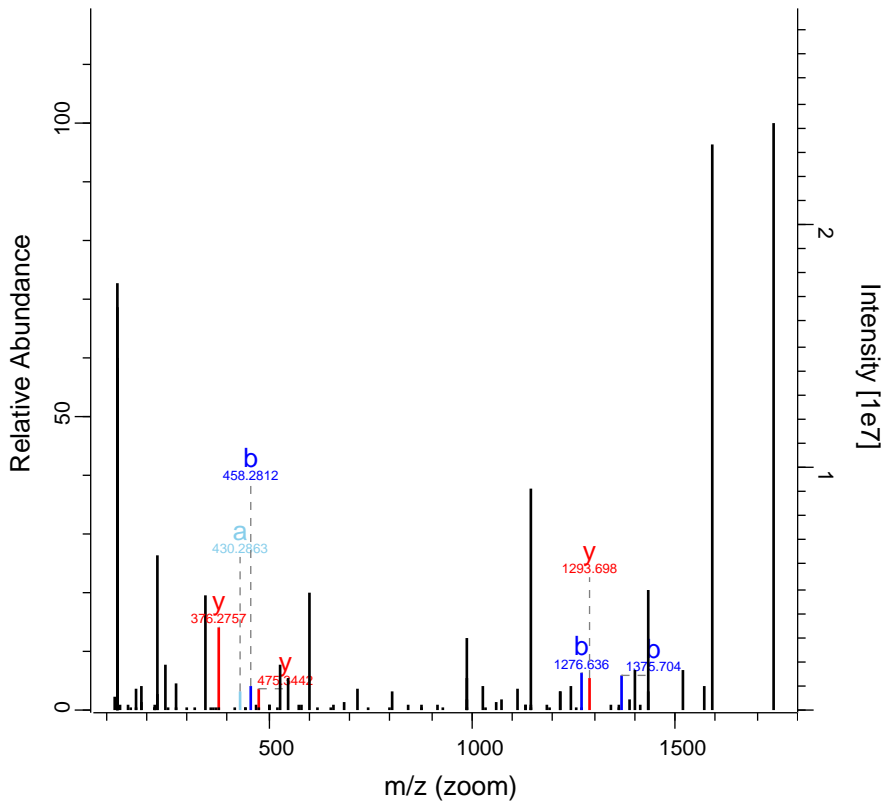

RO-QC-160121_ZackD_SS_Set_02_Fraction 26481 FTMS; HC 56.48 823.44 CHDC2

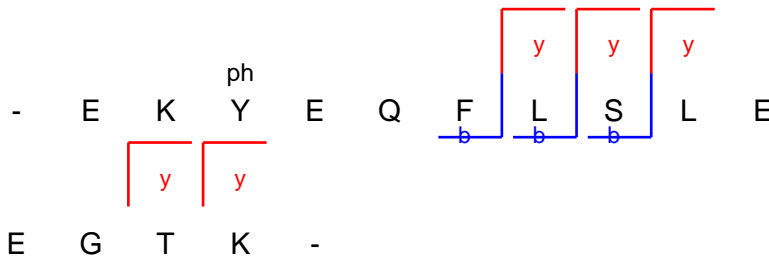
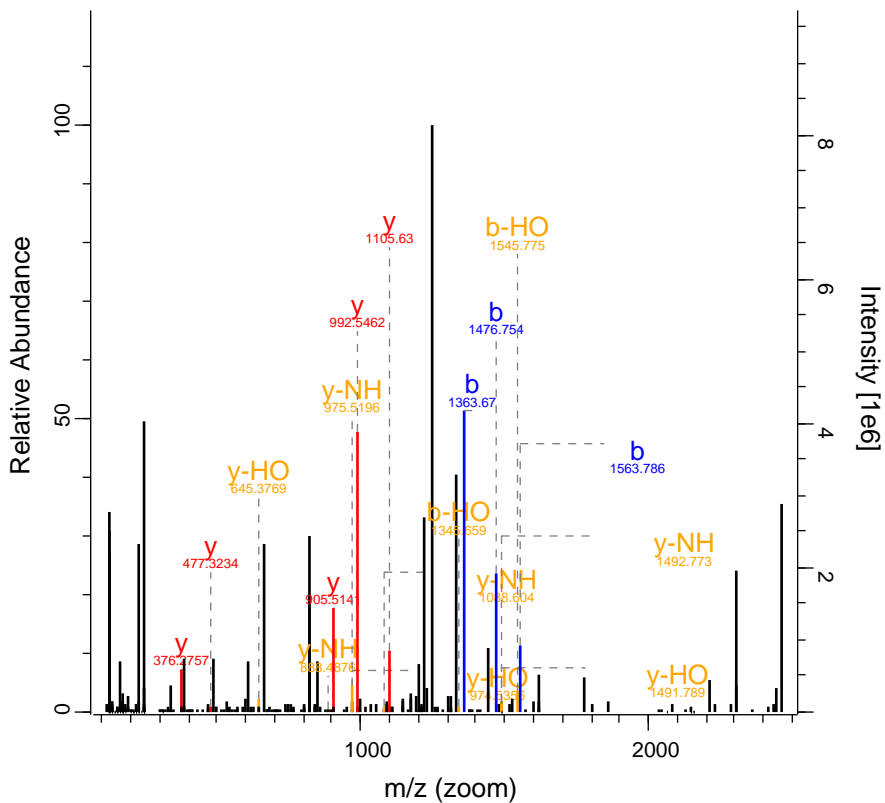

RO-QC-160121_ZackD_SS_Set_02_Fraction 27209 FTMS; HC 40.02 660.12 ABCA13

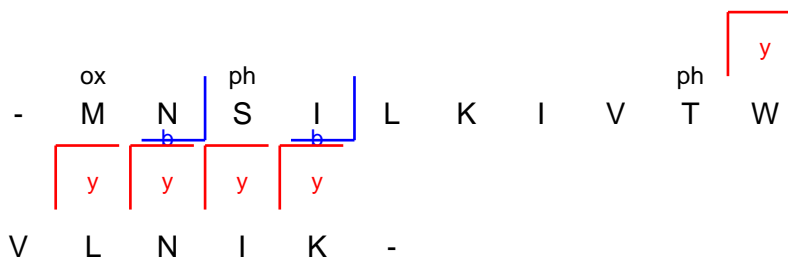
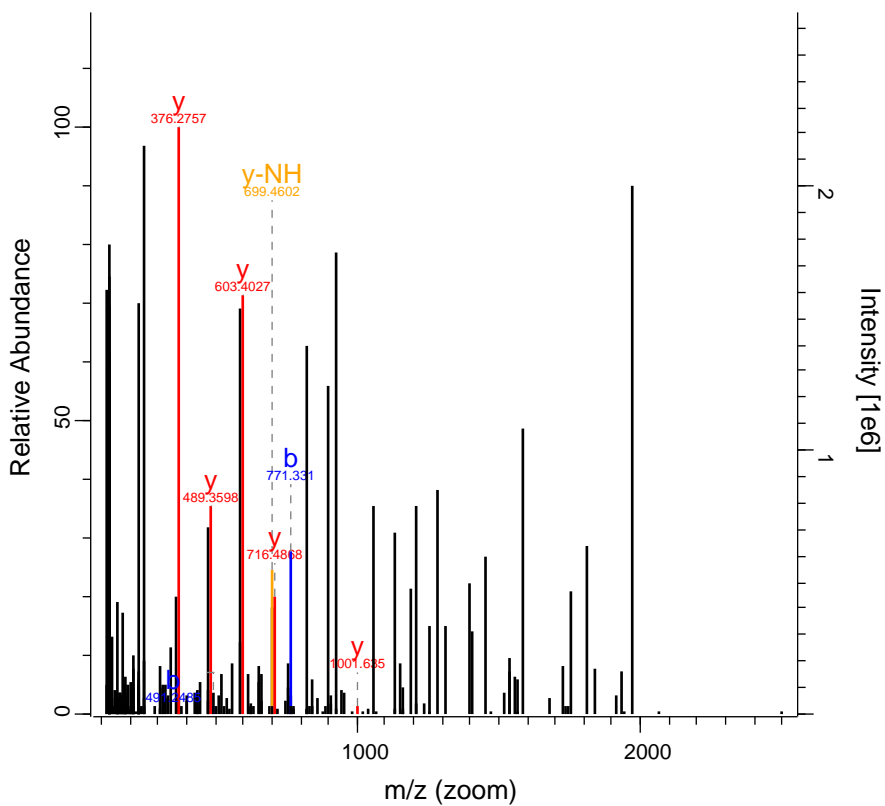

RO-QC-160121_ZackD_SS_Set_02_Fractic 28661 FTMS; HC 63.22 1124.62 FABP2

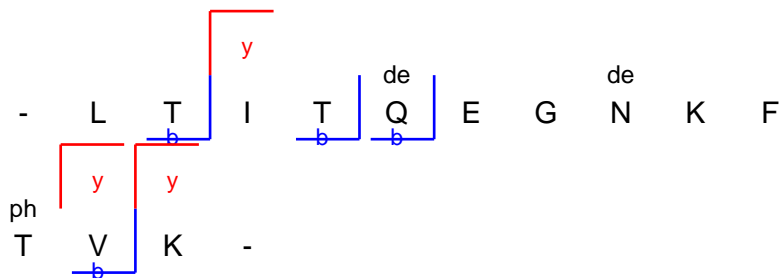
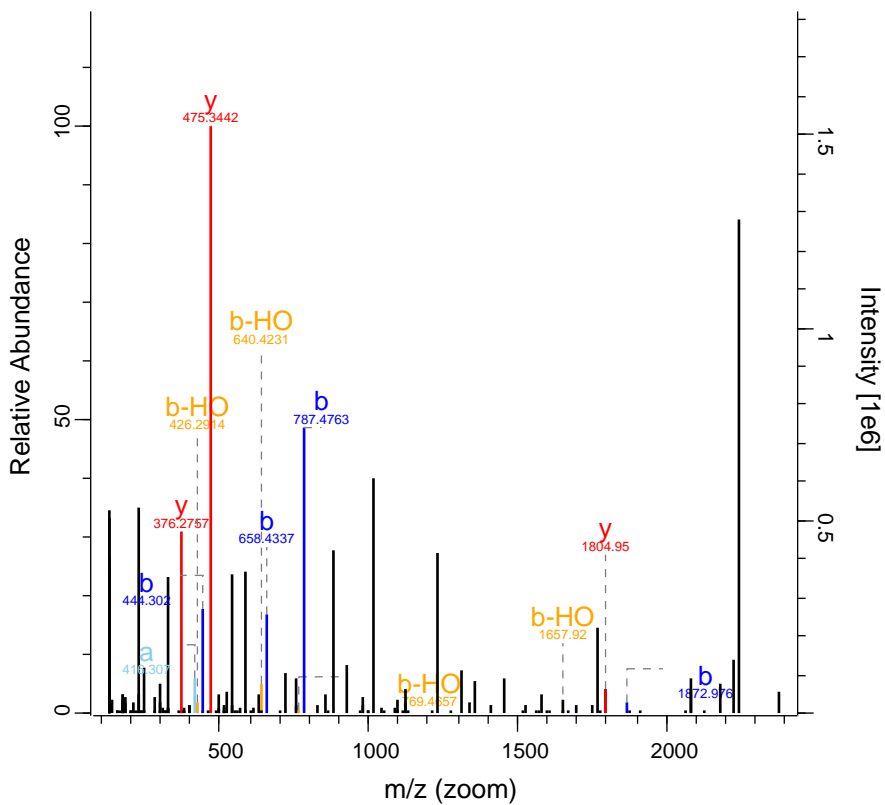

RO-QC-160121_ZackD_SS_Set_02_Fraction 33613 FTMS; HC 48.29 975.53 NCOA1

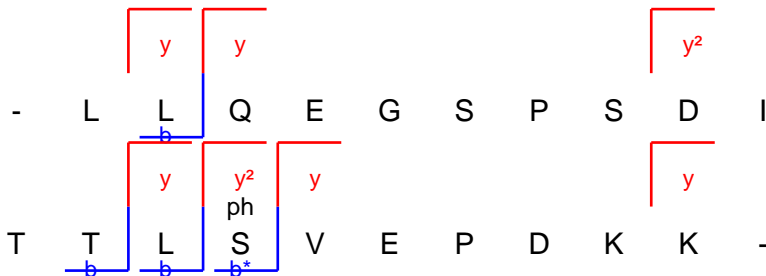
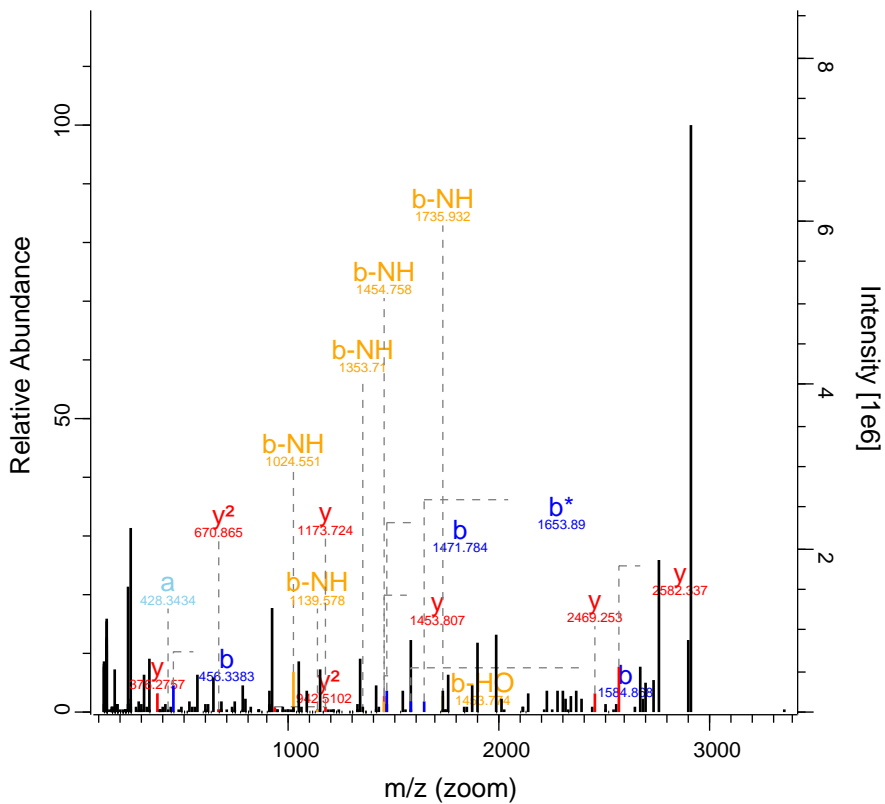

RO-QC-160121_ZackD_SS_Set_02_Fractio 33685 FTMS; HC 198.85 891.67 TOP2B

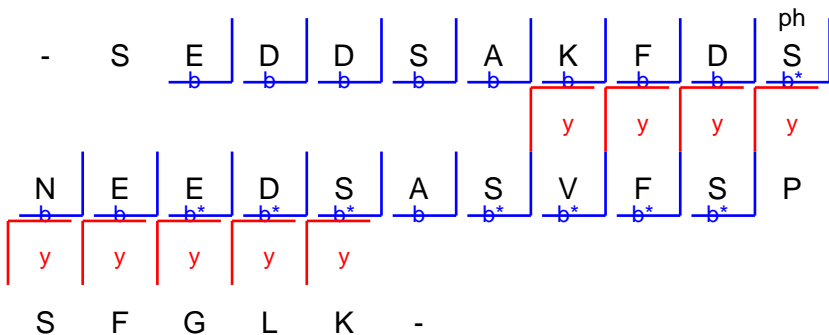
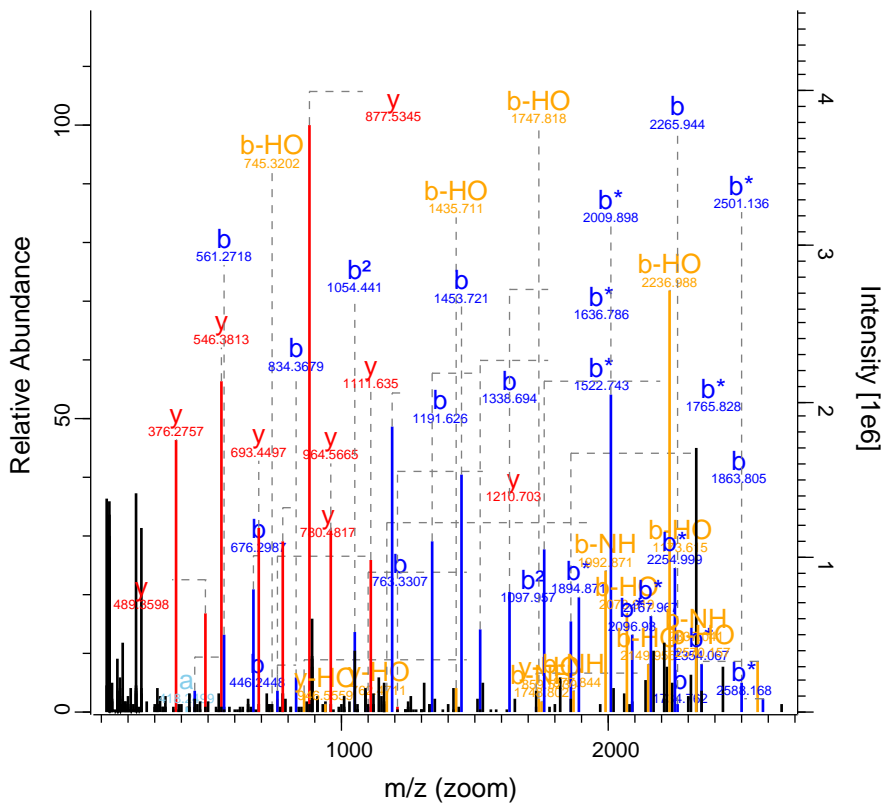

RO-QC-160121_ZackD_SS_Set_02_Fractic 34186 FTMS; HC 50.21 1155.63 EBF2

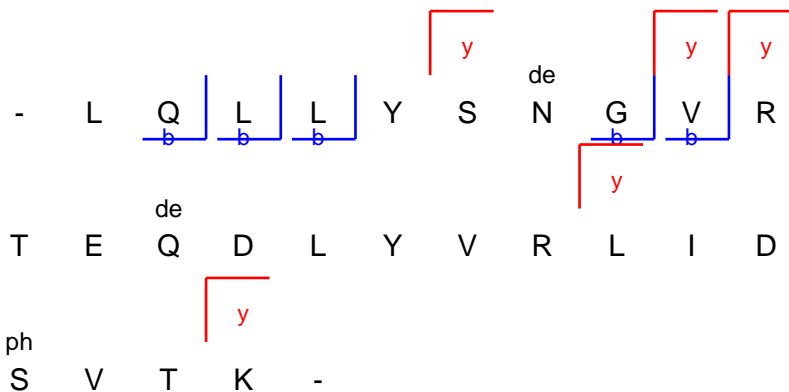
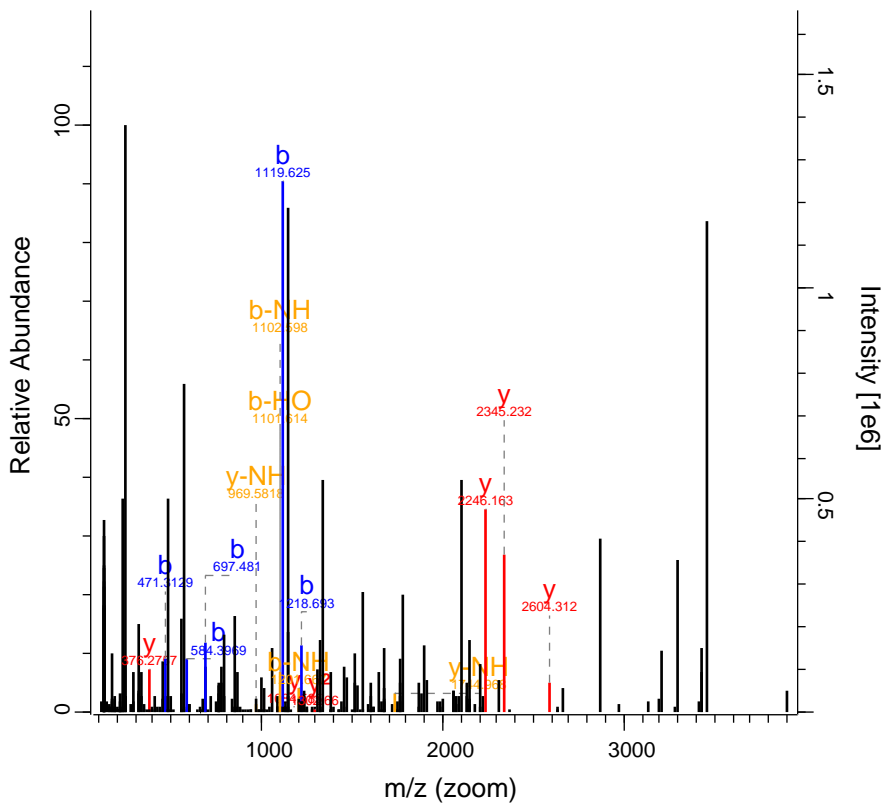

RO-QC-160121_ZackD_SS_Set_02_Fractic 35053 FTMS; HC 64.44 1248.11 KIAA1211L

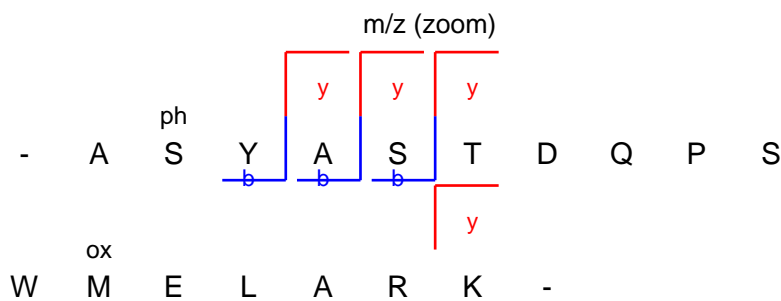
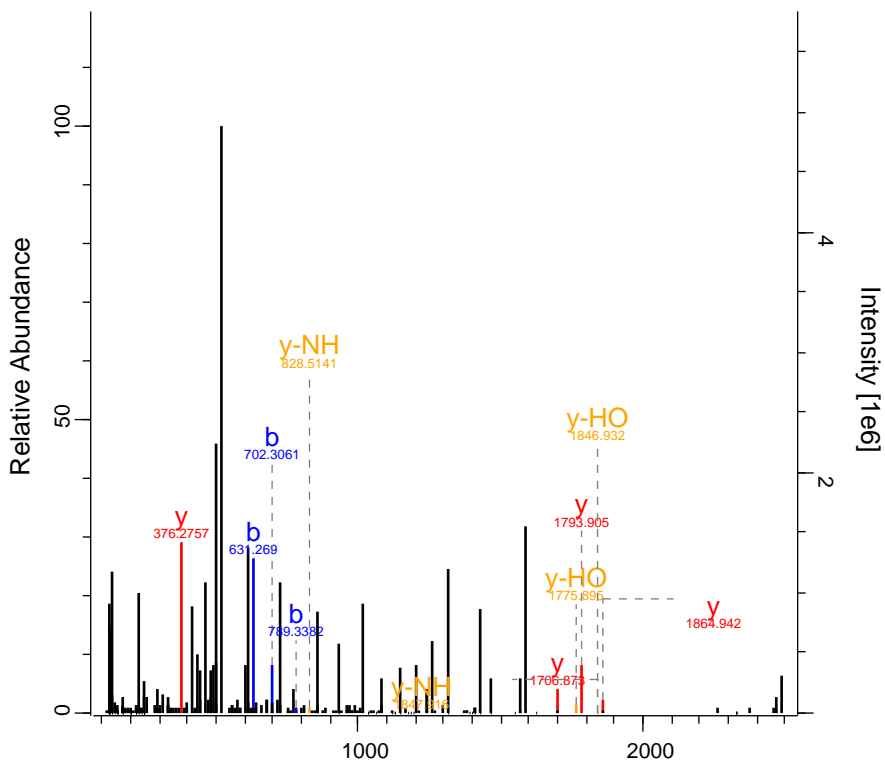

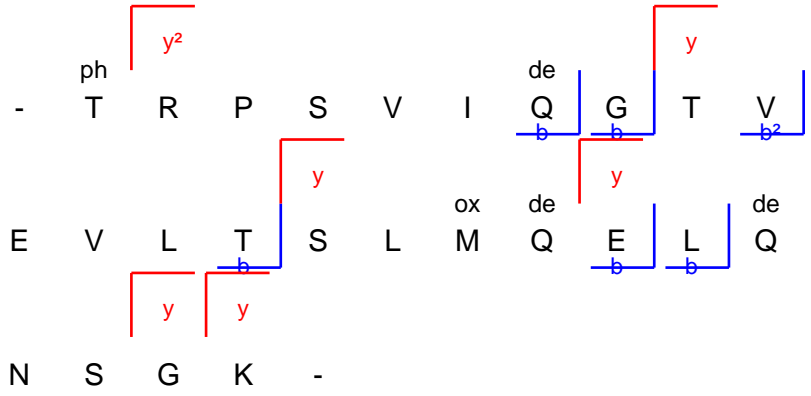
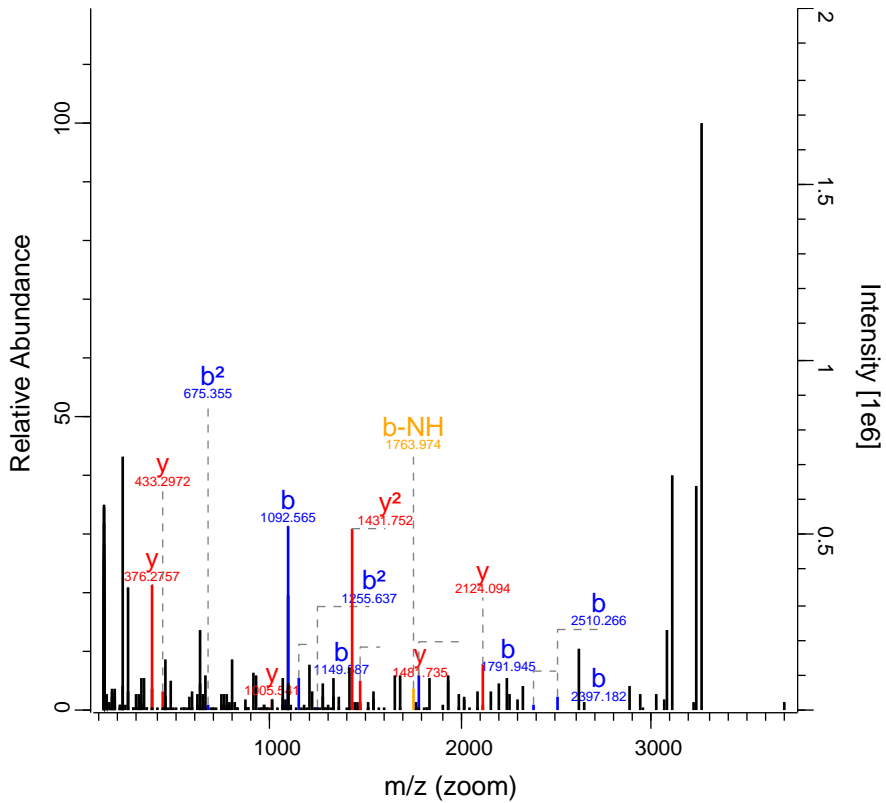

RO-QC-160121_ZackD_SS_Set_02_Fractic 38515 FTMS; HC 43.81 1431.71 RAG1

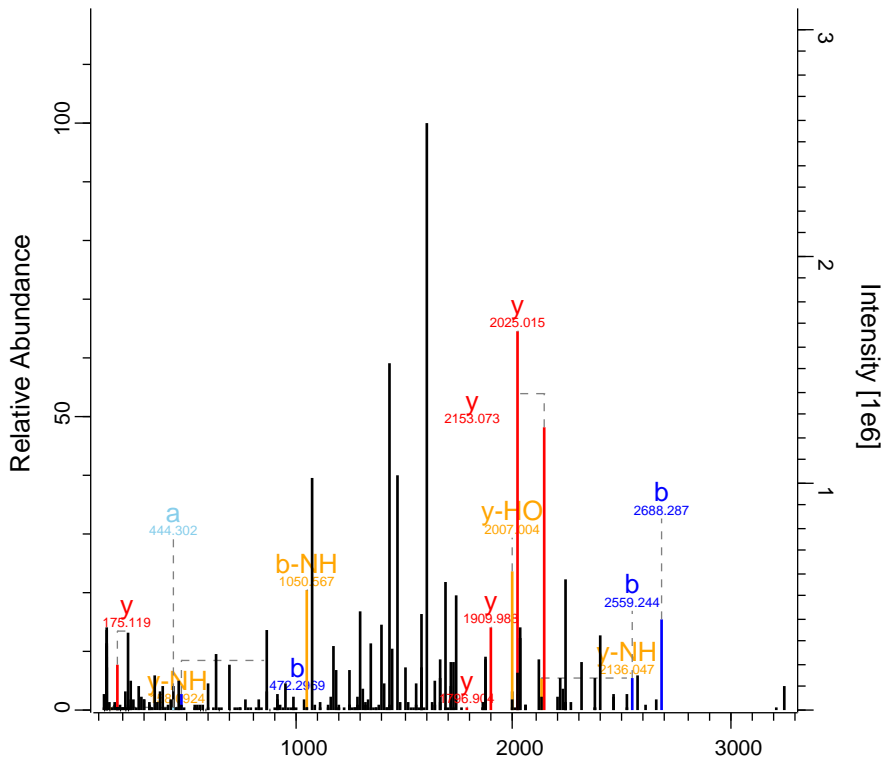

m/z (zoom)

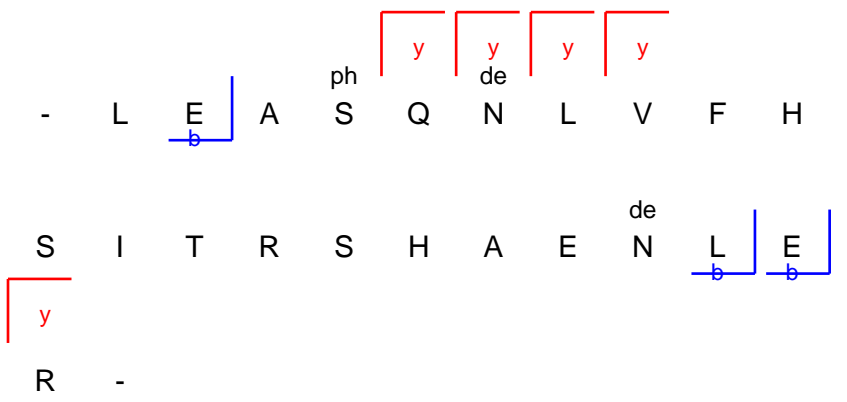

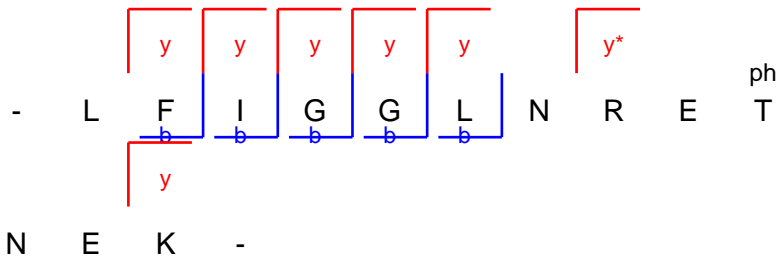
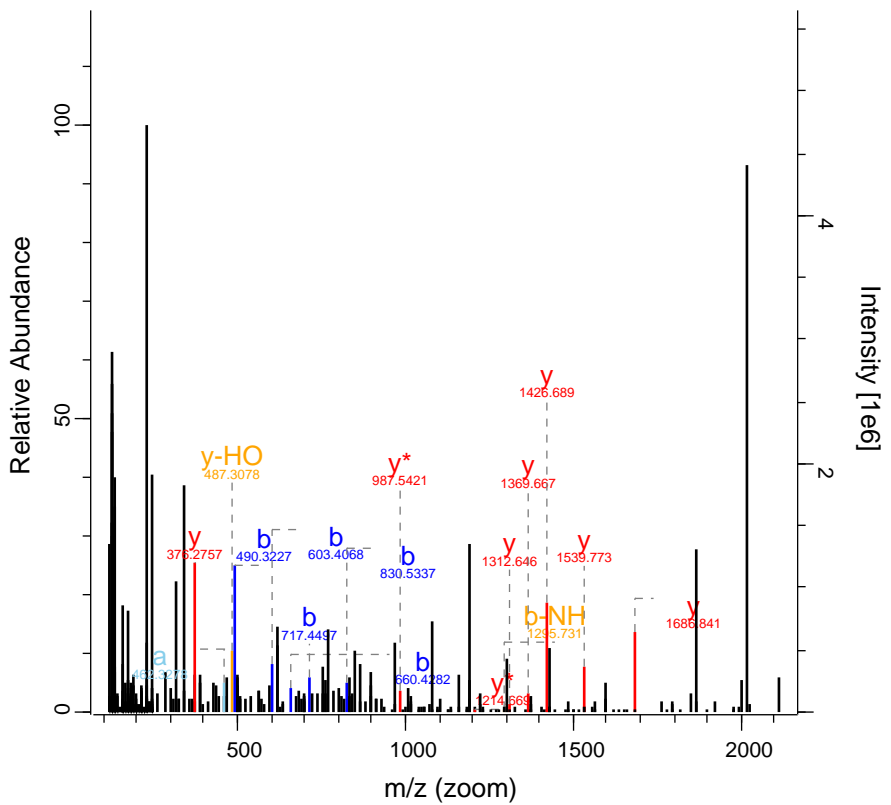

RO-QC-160121_ZackD_SS_Set_02_Fraction 40642 FTMS; HC 43.03 799.92 CENPF

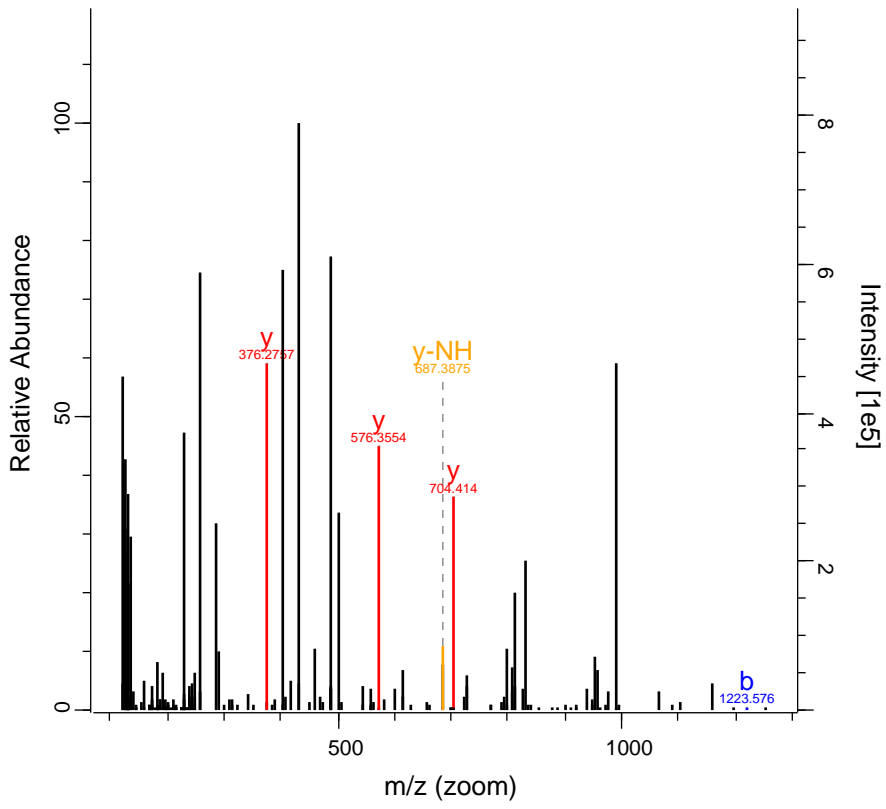

RO-QC-160121_ZackD_SS_Set_02_Fraction 5730 FTMS; HCl 57.8 495.78 NIPBL

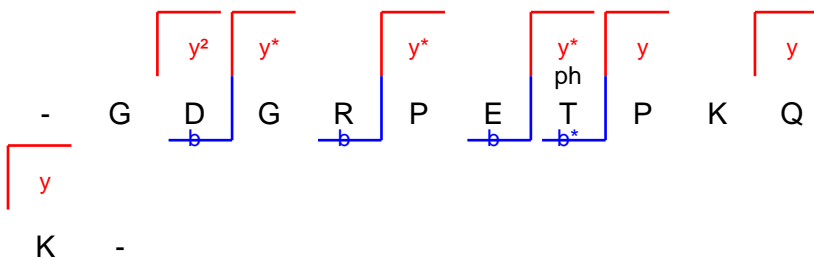
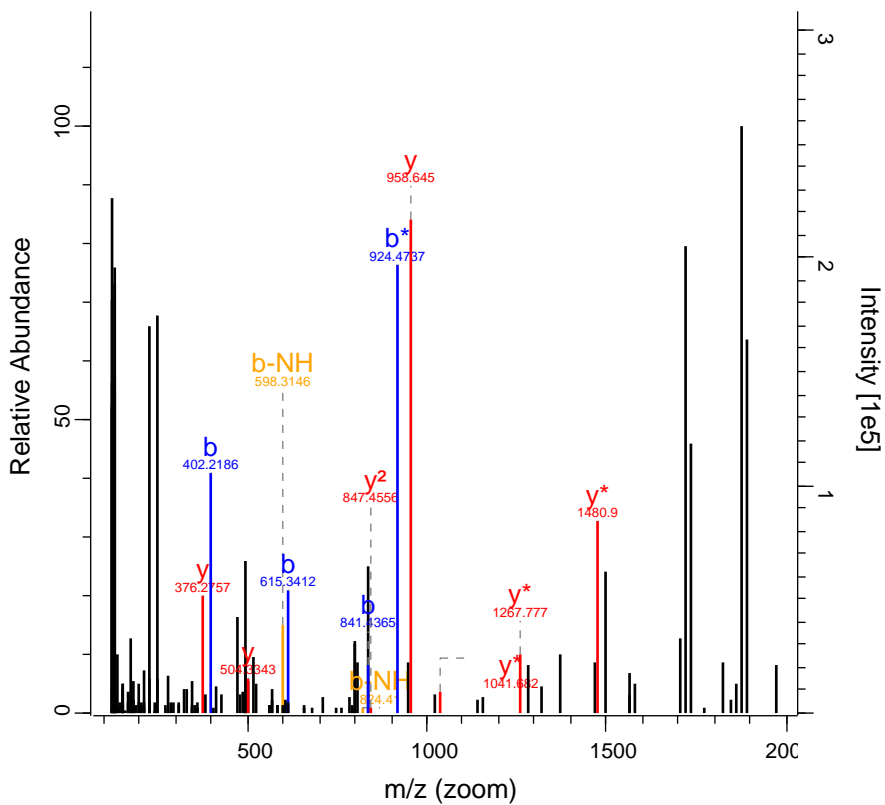

RO-QC-160121_ZackD_SS_Set_02_Fraction 5805 FTMS; HCl 60.63 506.78 NIPBL

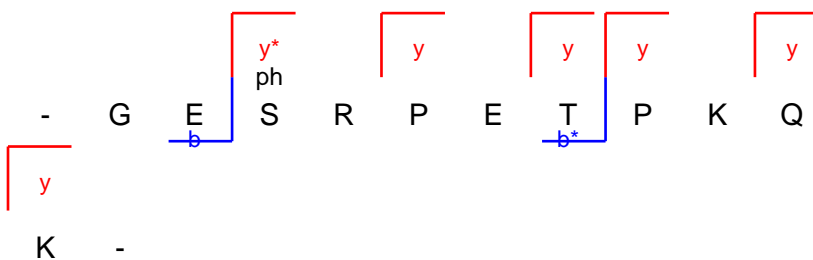
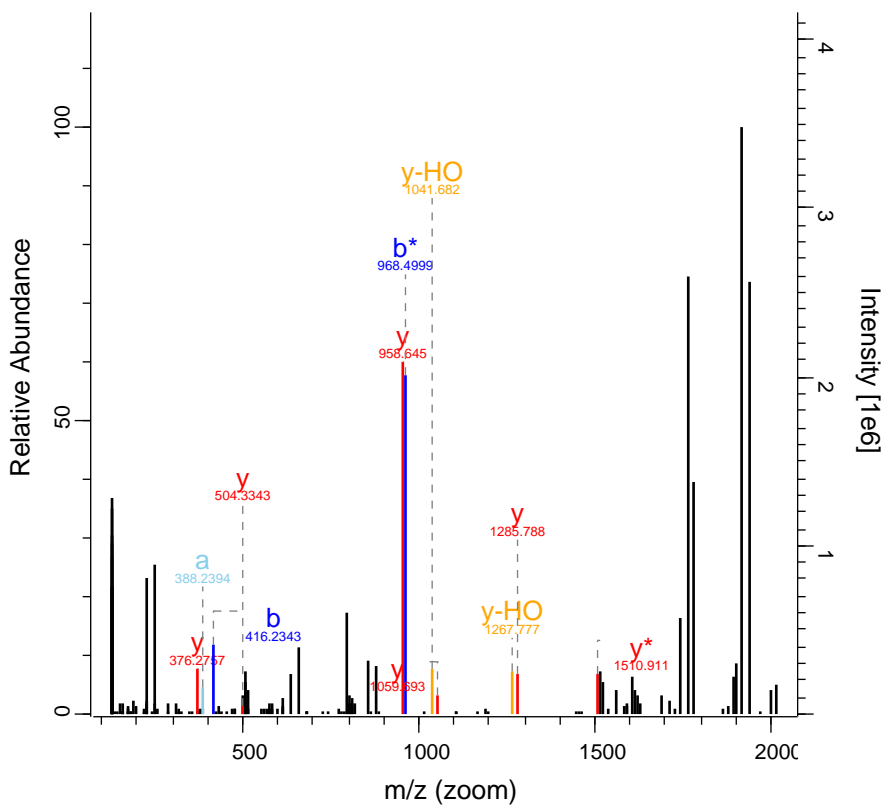

RO-QC-160121_ZackD_SS_Set_02_Fraction 5842 FTMS; HC 120.87 811.94 TCOF1

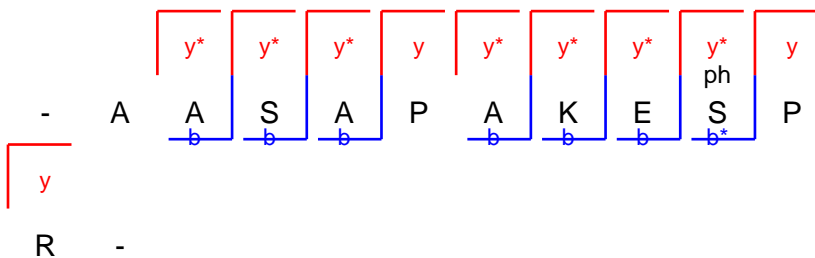
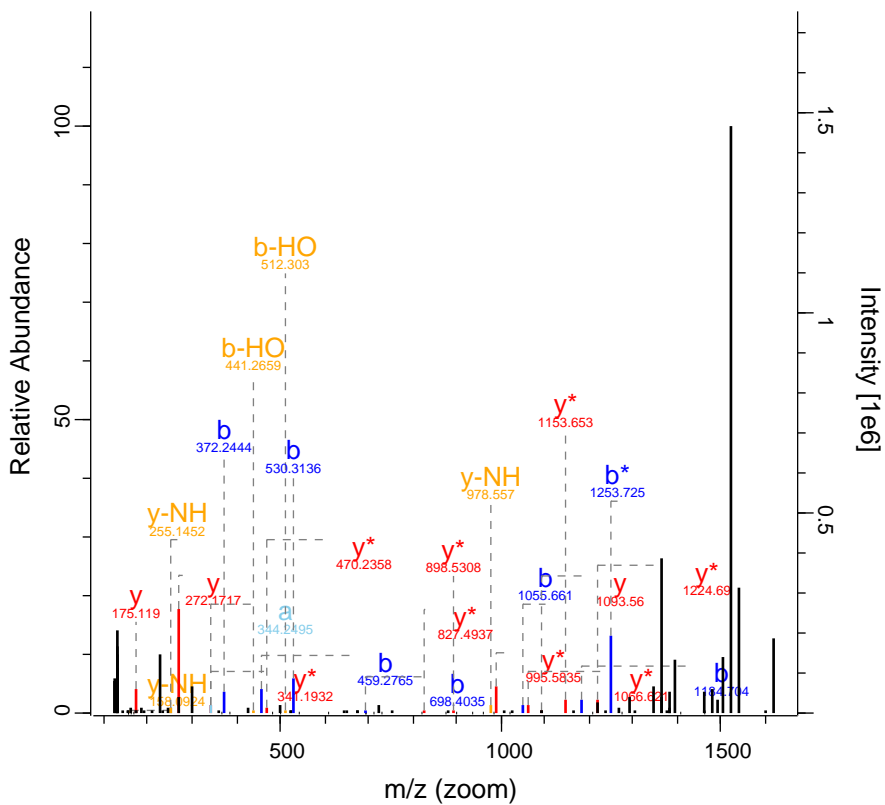

R

RO-QC-160121_ZackD_SS_Set_02_Fraction 5922 FTMS; HCl 61.41 677.69 U2SURP

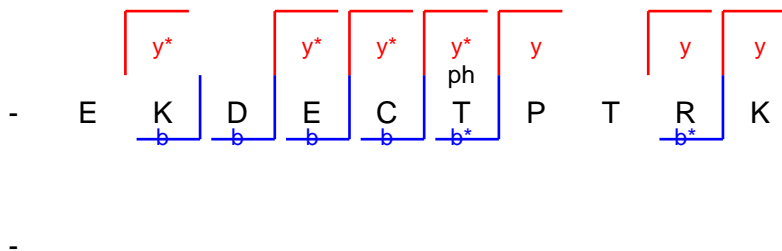
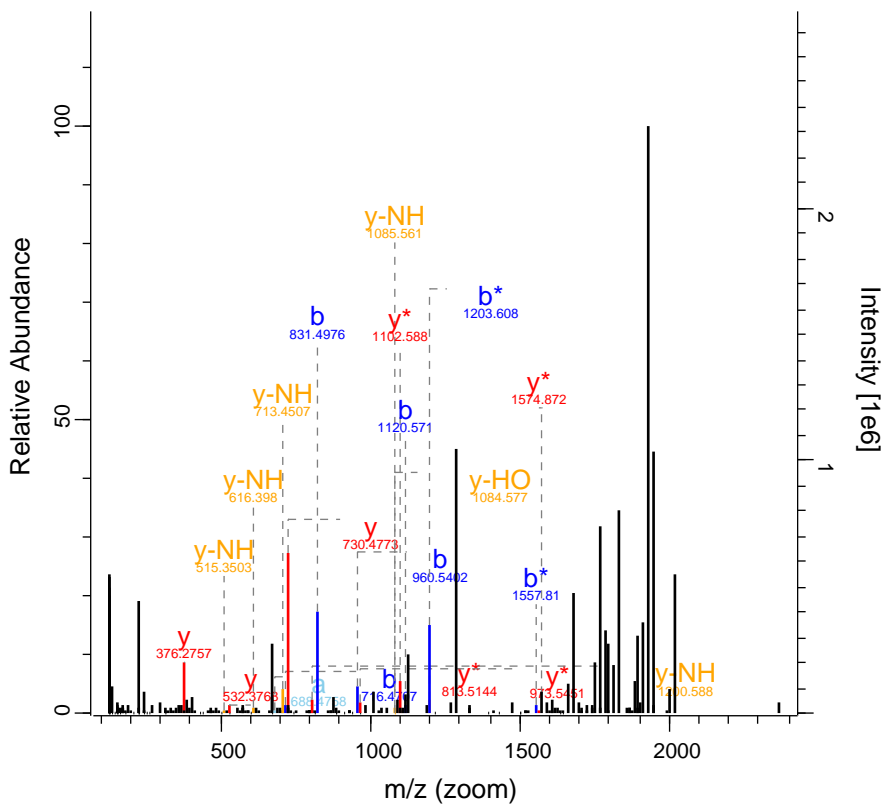

RO-QC-160121_ZackD_SS_Set_02_Fraction 6120 FTMS; HCl 79.01 677.64 ADD1

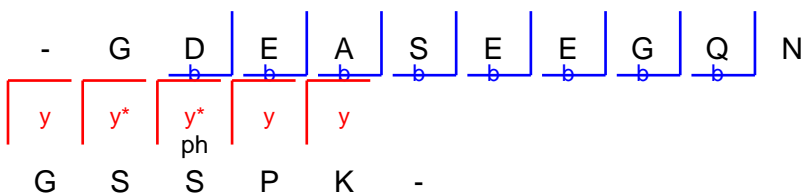
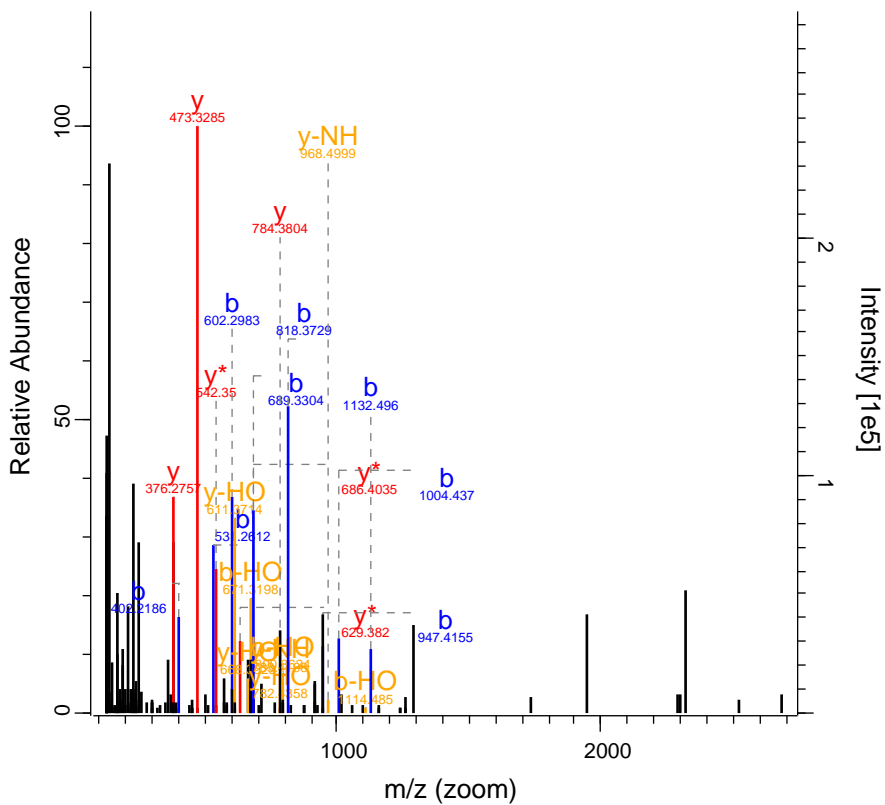

RO-QC-160121_ZackD_SS_Set_02_Fraction 6683 FTMS; HC 106.17 854.42 BMI1

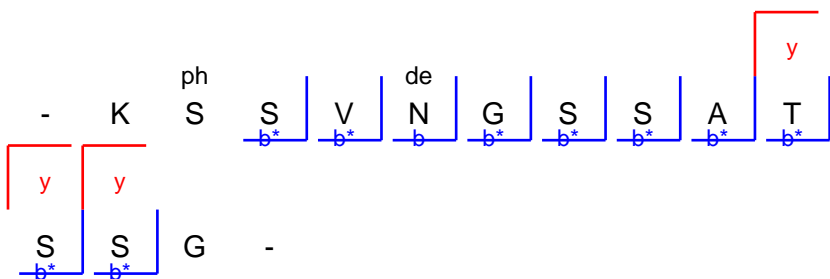
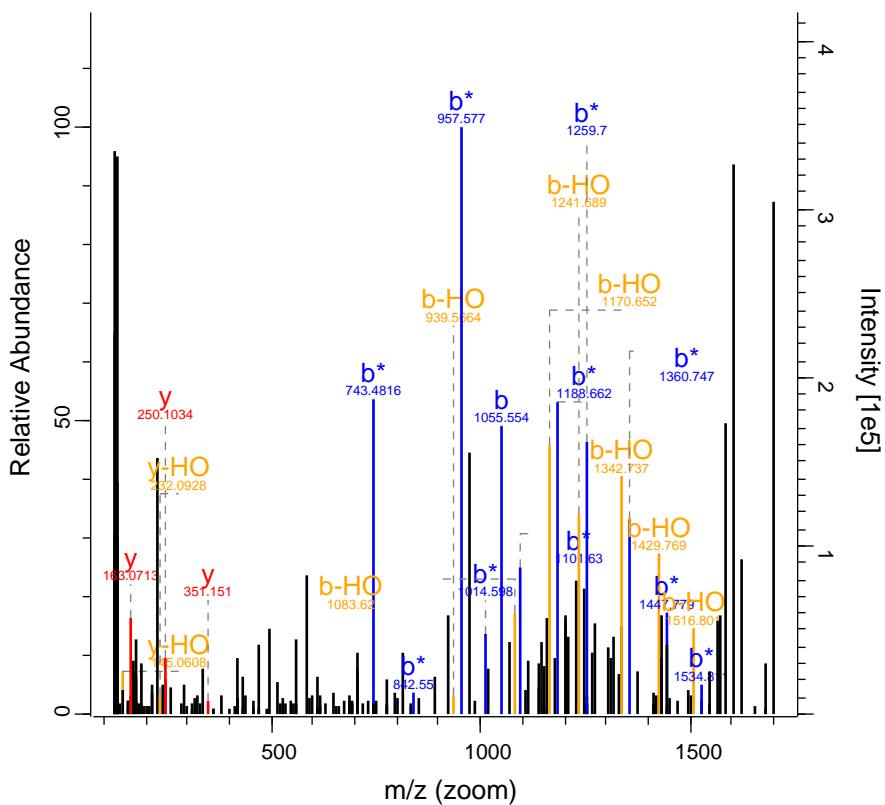

RO-QC-160121_ZackD_SS_Set_02_Fraction 6740 FTMS; HCl 44.76 456.54 HIST1H1E

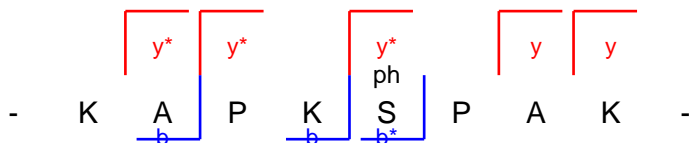
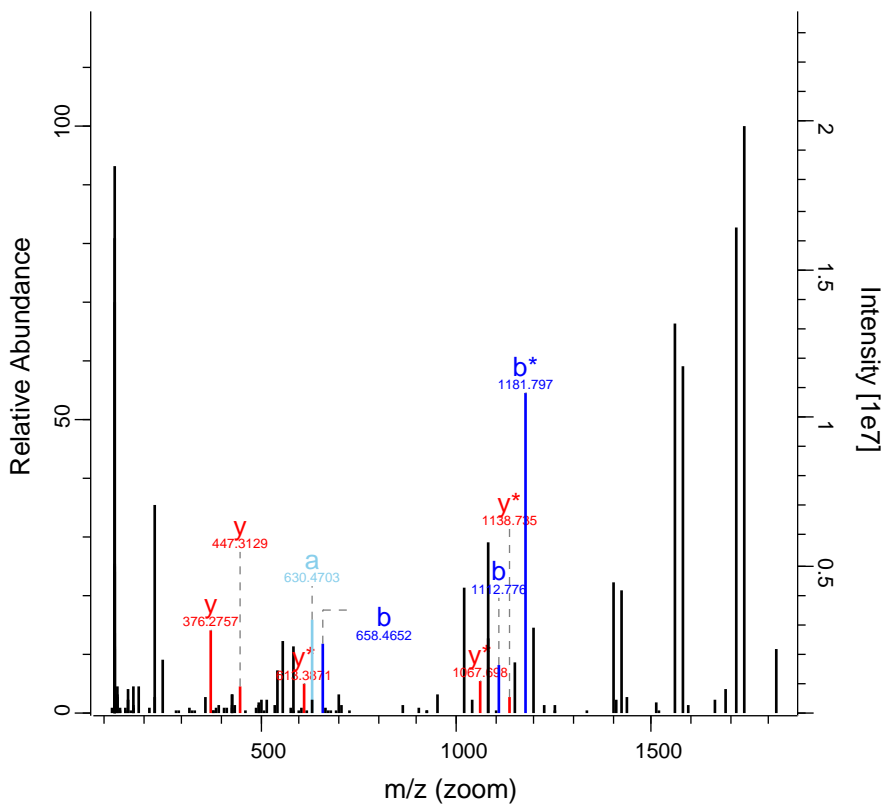

RO-QC-160121_ZackD_SS_Set_02_Fraction 7846 FTMS; HC 110.97 691.37 API5

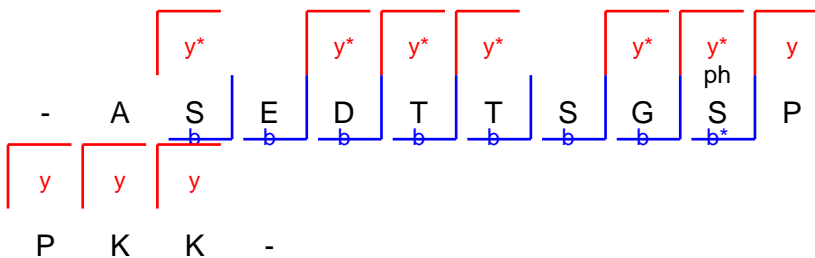
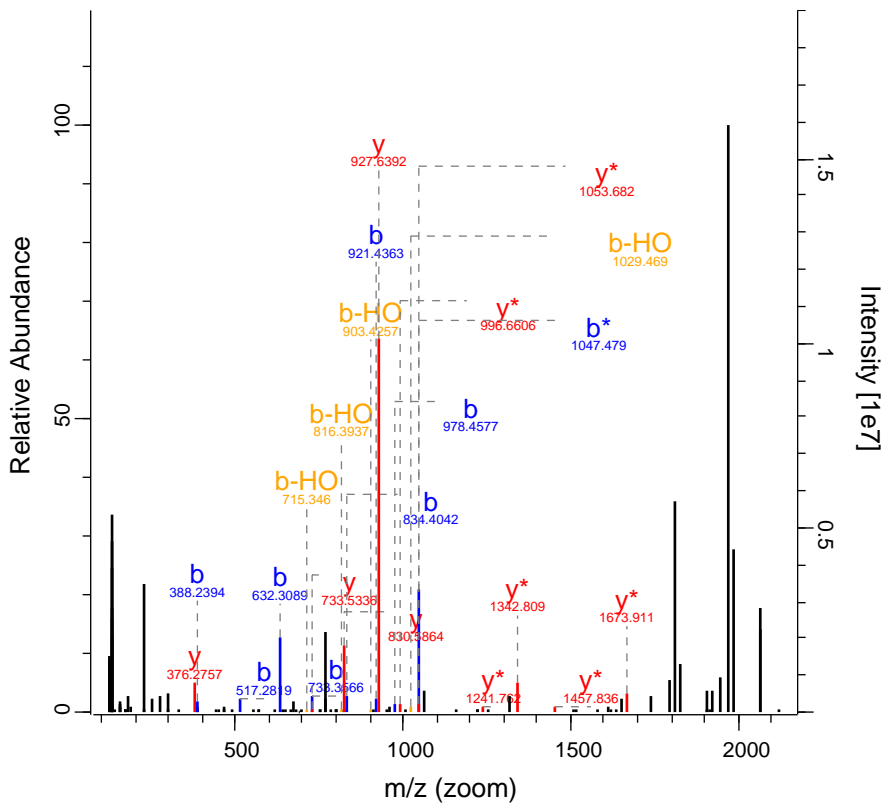

RO-QC-160121_ZackD_SS_Set_02_Fratio 7878 FTMS; HC 106.26 1037.05 API5

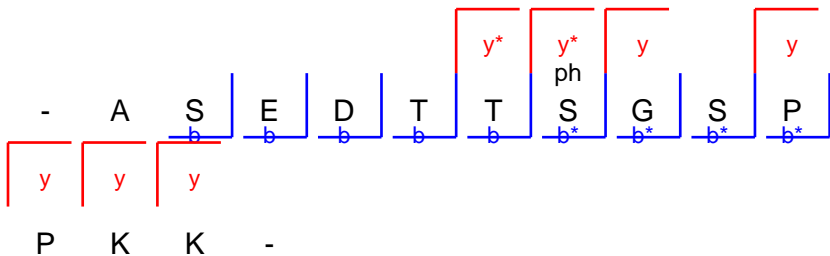
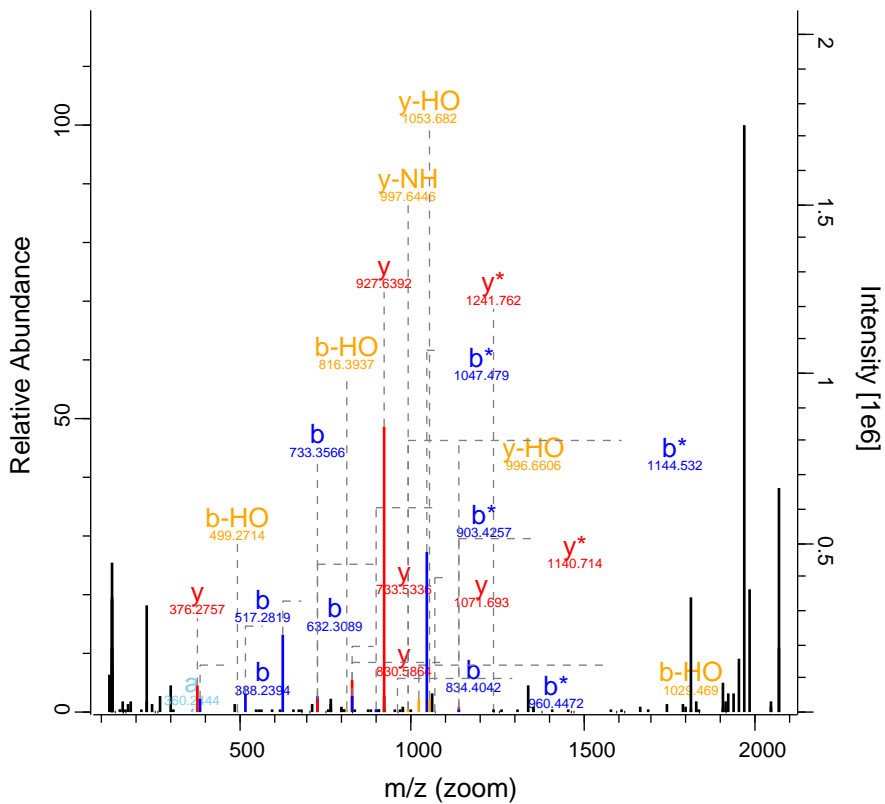

P K K -

RO-QC-160121_ZackD_SS_Set_02_Fraction 8656 FTMS; HCl 67.96 478.77 LMOD1

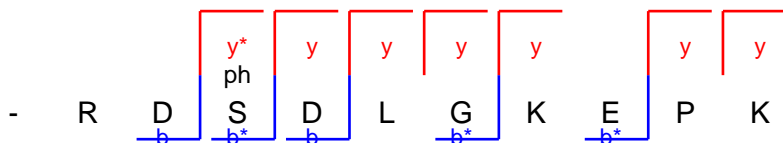
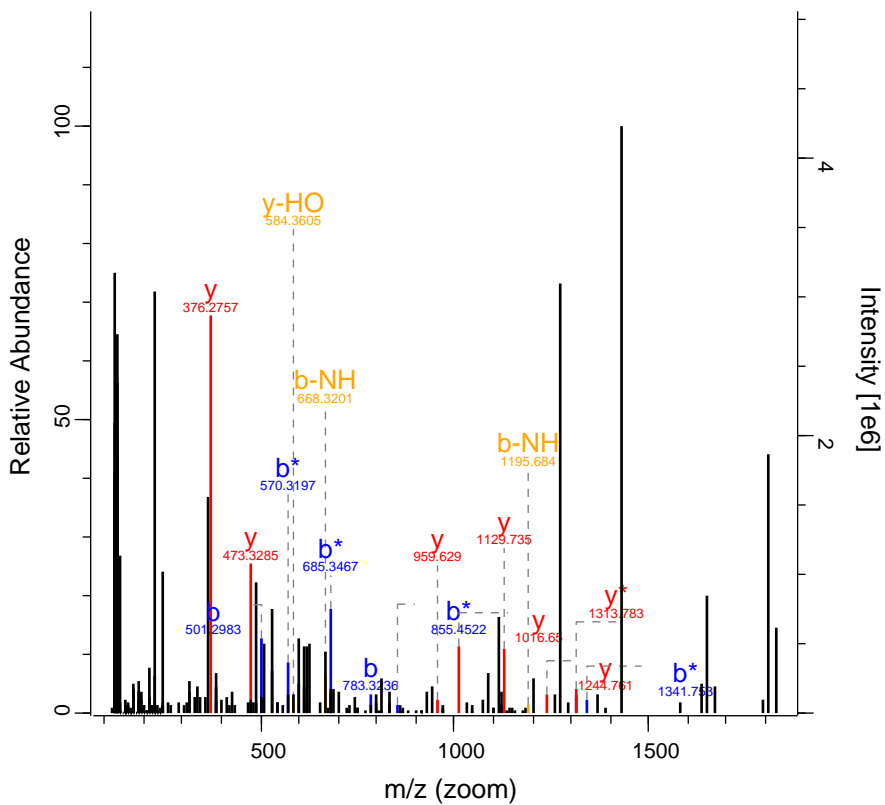

RO-QC-160121_ZackD_SS_Set_02_Fraction 9734 FTMS; HCl 67.99 663.38 RBM20

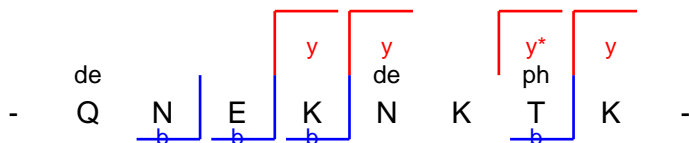
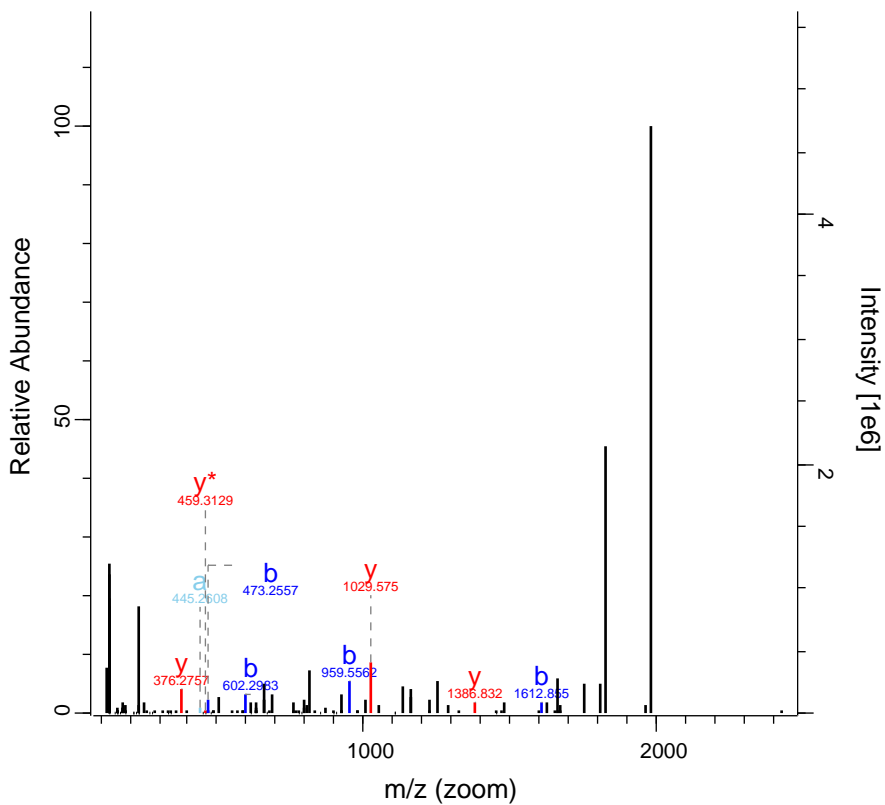

RO-QC-160121_ZackD_SS_Set_02_Fractio 11232 FTMS; HC 111.86 823.96 CCDC86

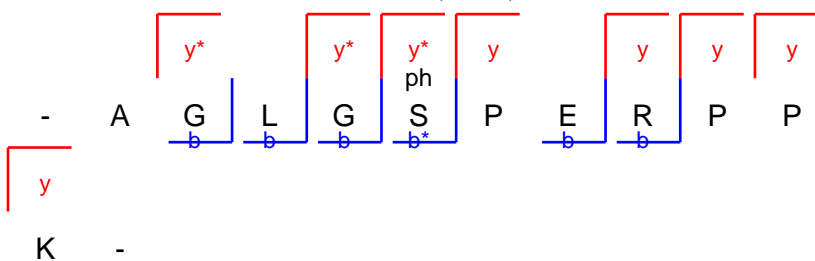
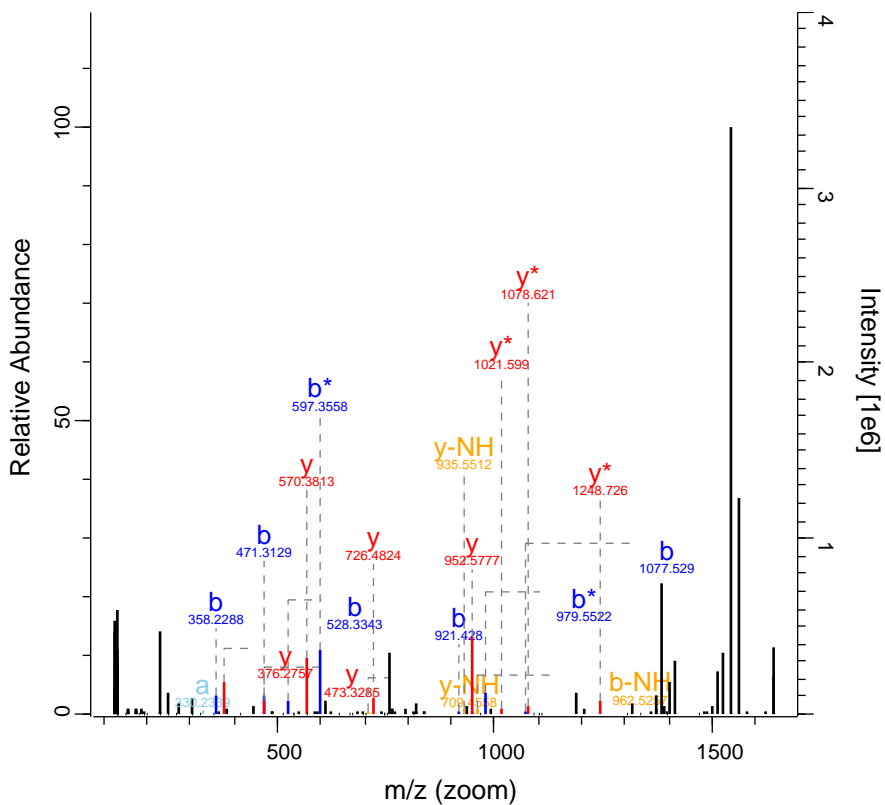

RO-QC-160121_ZackD_SS_Set_02_Fractio 11817 FTMS; HC 137.64 751.63 MYH9

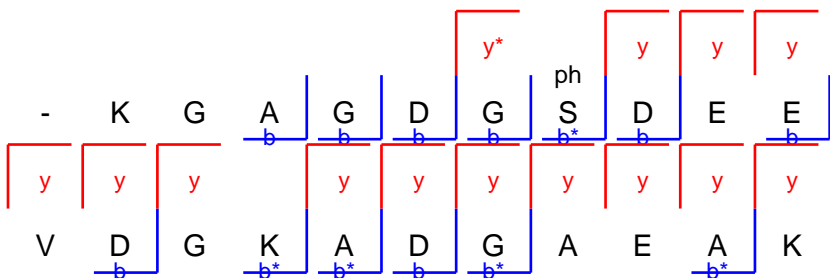
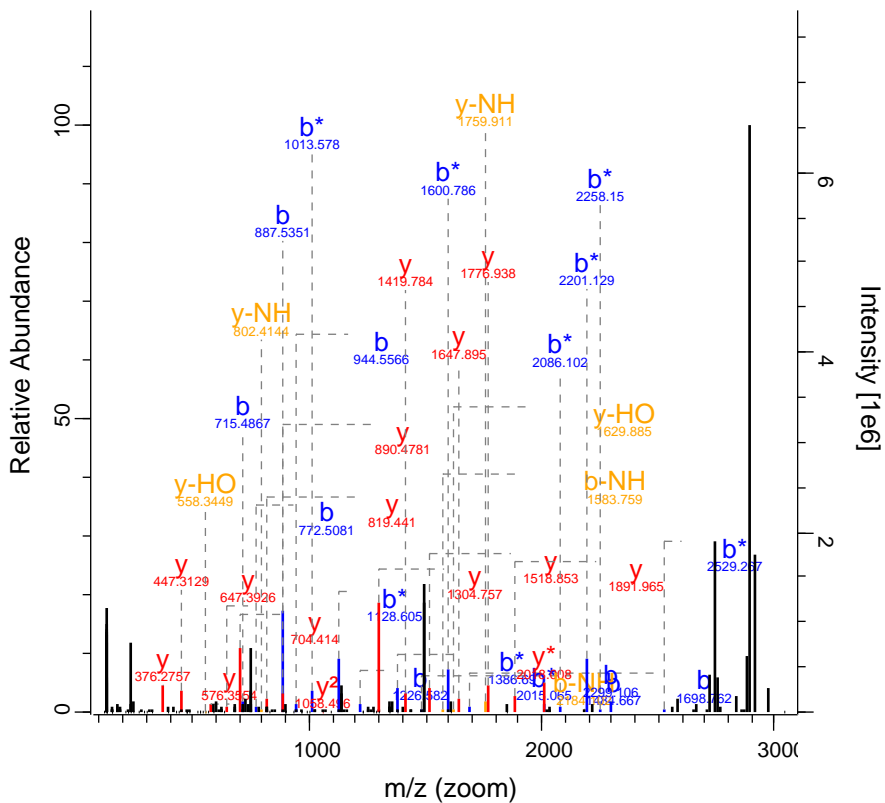

RO-QC-160121_ZackD_SS_Set_02_Fraction 12083 FTMS; HC 77.02 651.08 MATR3

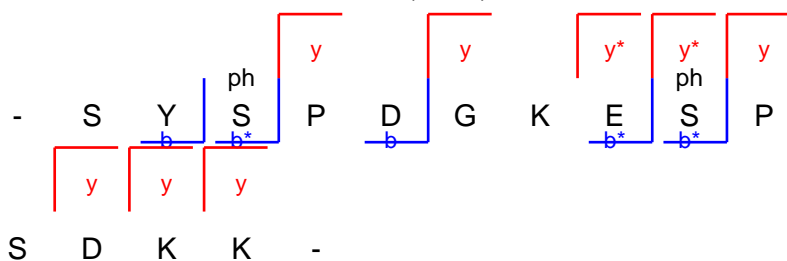
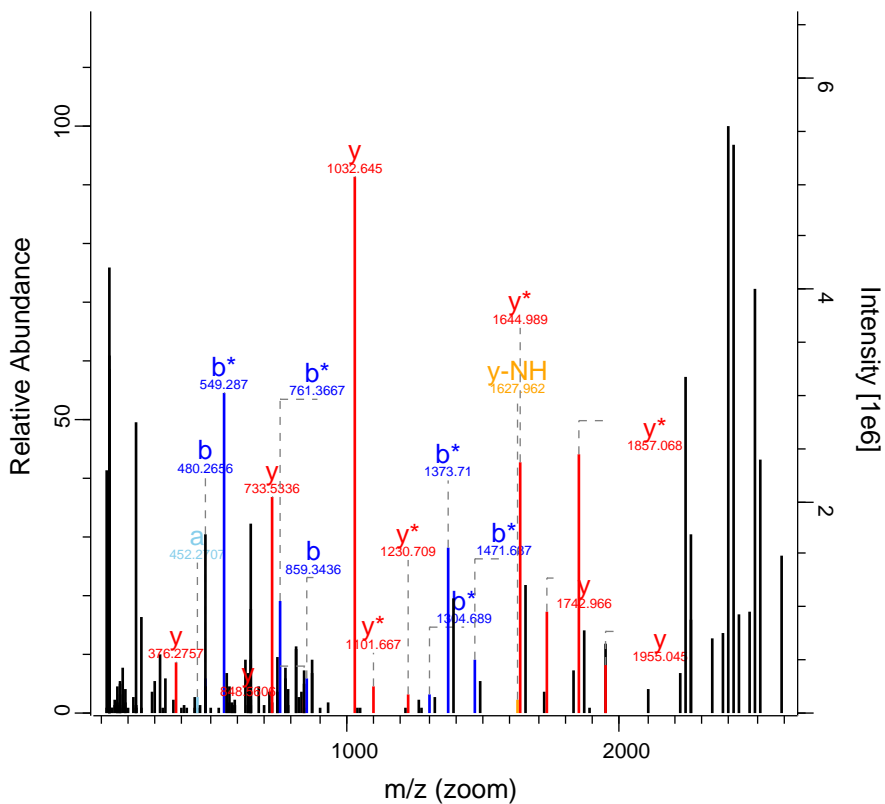

RO-QC-160121_ZackD_SS_Set_02_Fractio 12266 FTMS; HC 124.84 747.74 CALD1

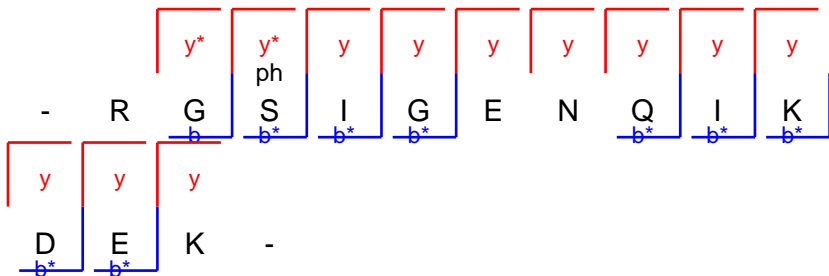
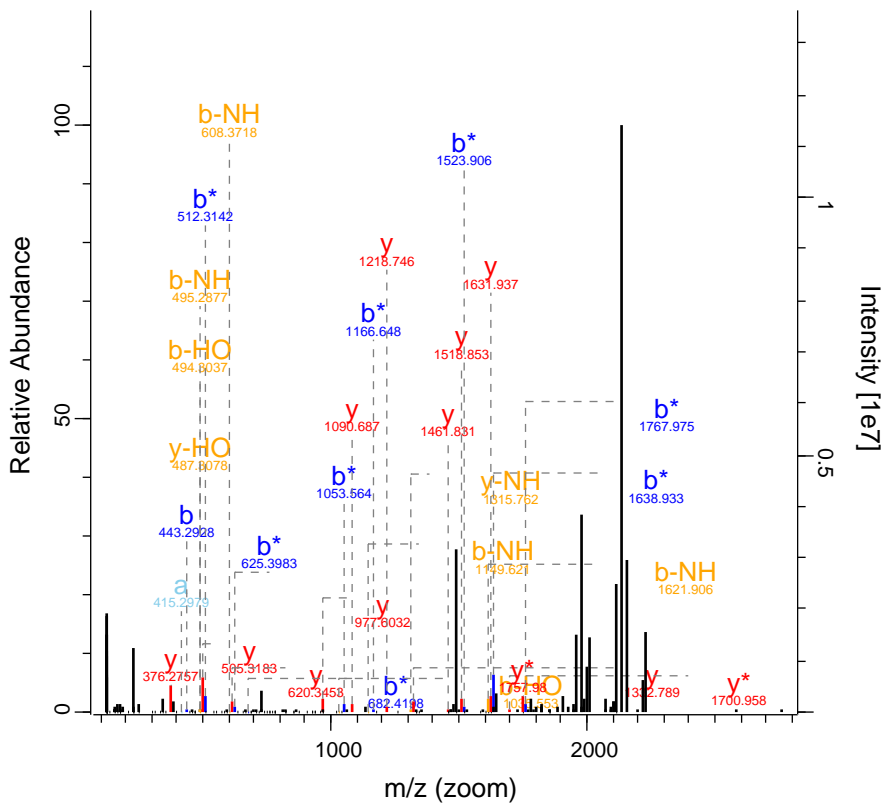

RO-QC-160121_ZackD_SS_Set_02_Fraction 12414 FTMS; HC 71.87 763.43 HNRNPU

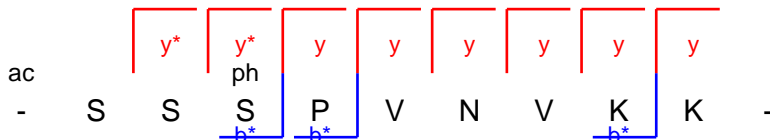
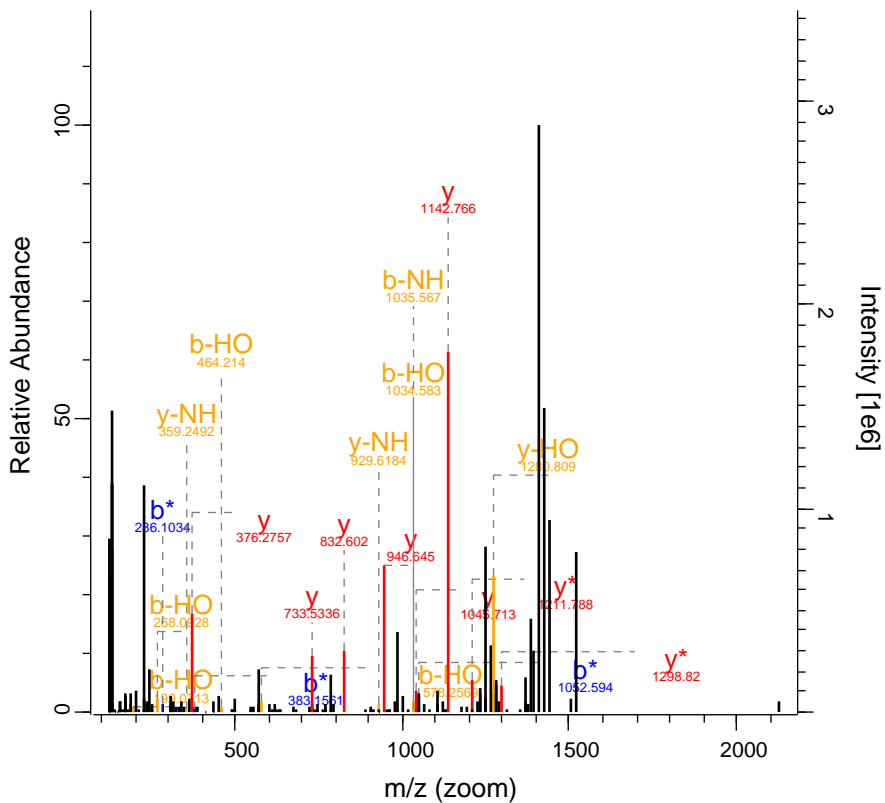

RO-QC-160121_ZackD_SS_Set_02_Fraction 13265 FTMS; HC 51.77 493.51 GABRE

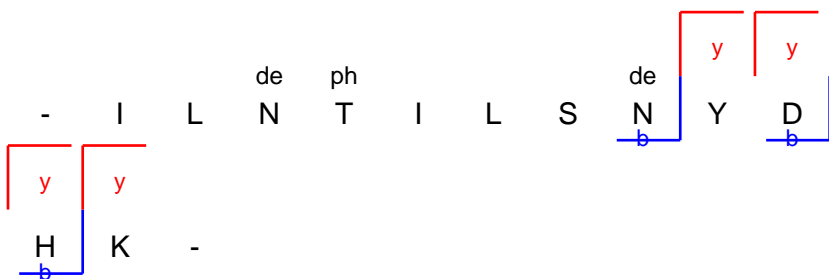
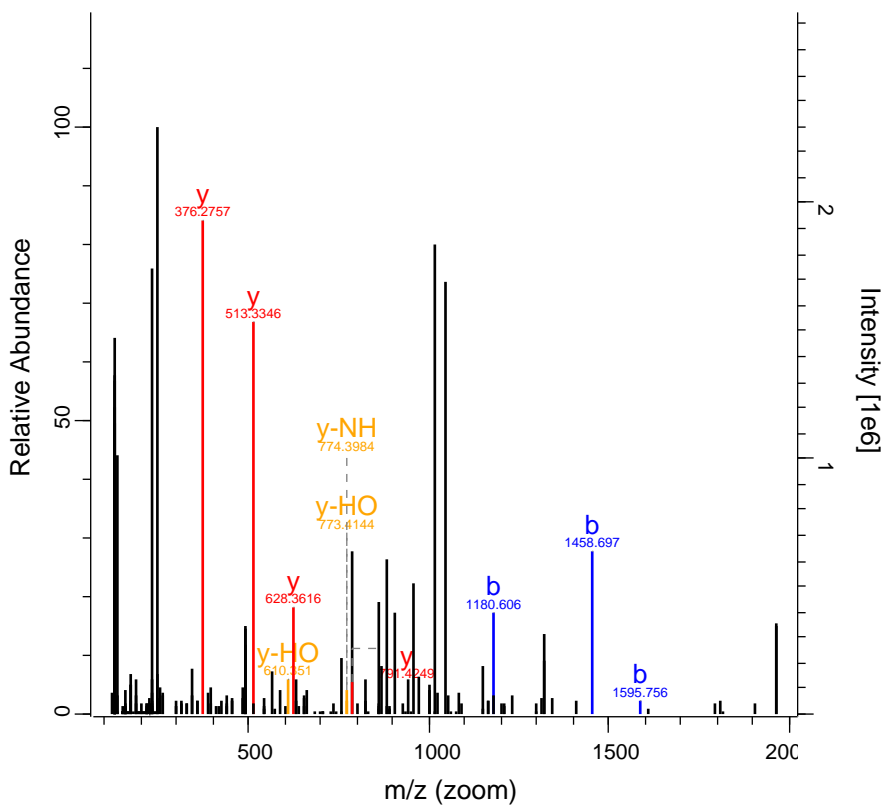

RO-QC-160121_ZackD_SS_Set_02_Fra 15337 FTMS; HC 178.75 955.15 HSP90AB1;HSP90A

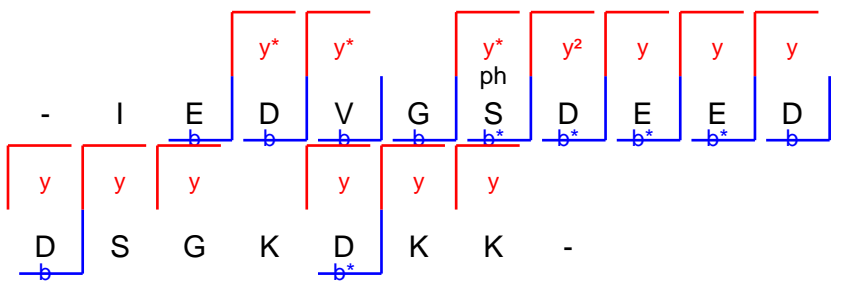
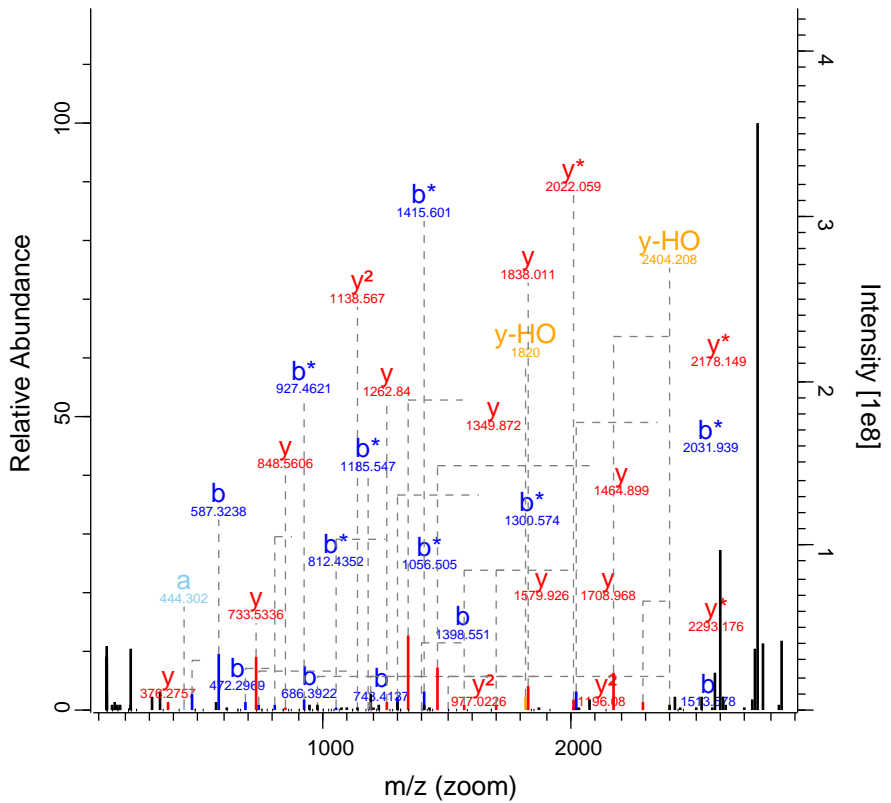

RO-QC-160121_ZackD_SS_Set_02_Fraction 16948 FTMS; HC 81.01 800.14 ZNF326

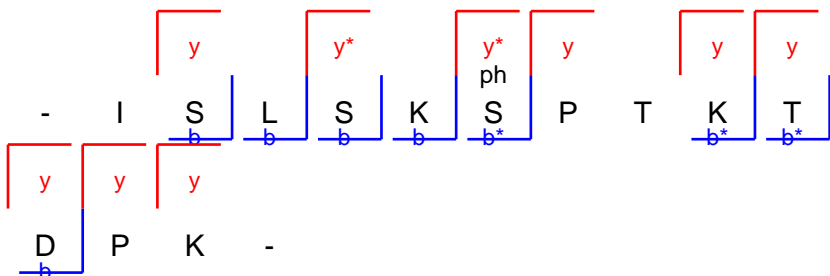
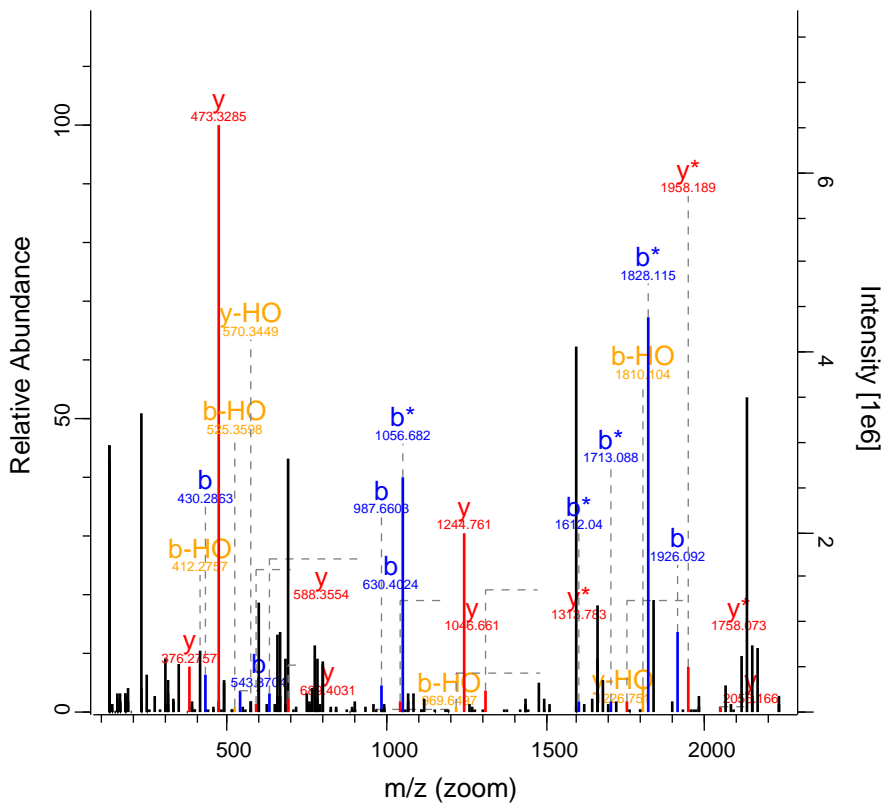

RO-QC-160121_ZackD_SS_Set_02_Fraction 16969 FTMS; HCl 122.08 957 TMX2

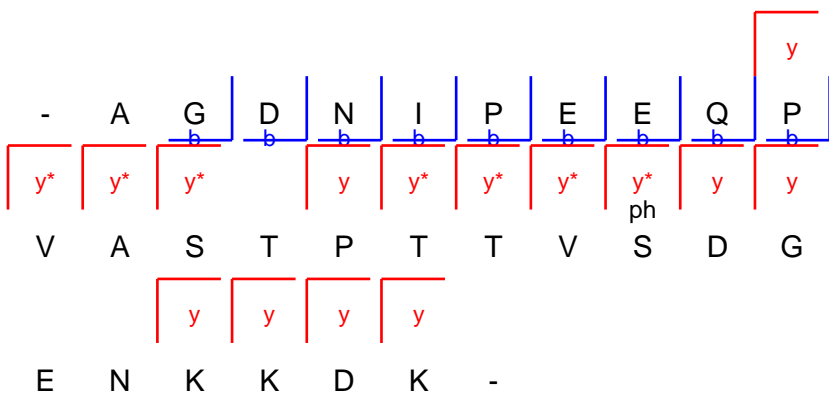
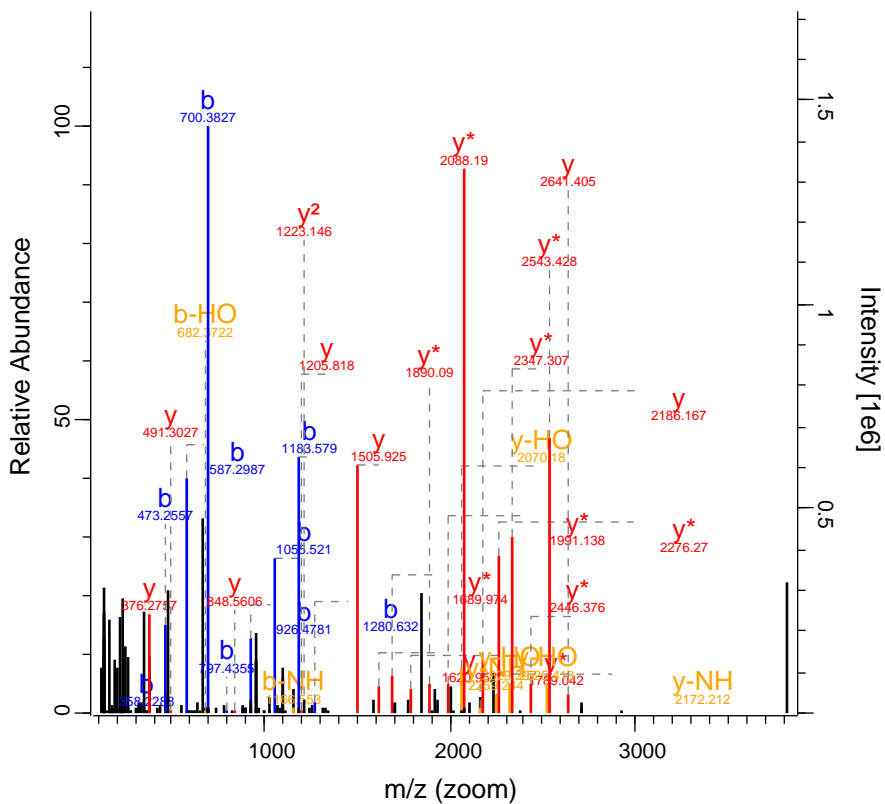

RO-QC-160121_ZackD_SS_Set_02_Fraction17535 FTMS; HC 51.09 496.55 TFRC

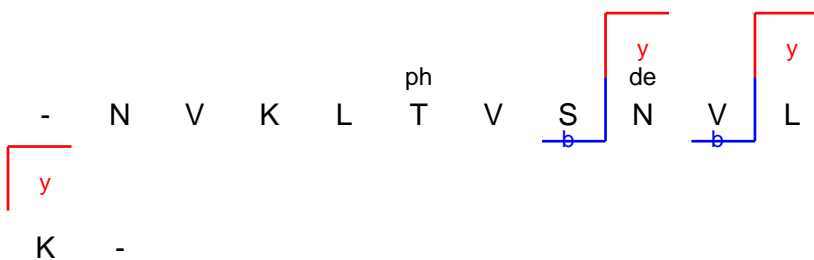
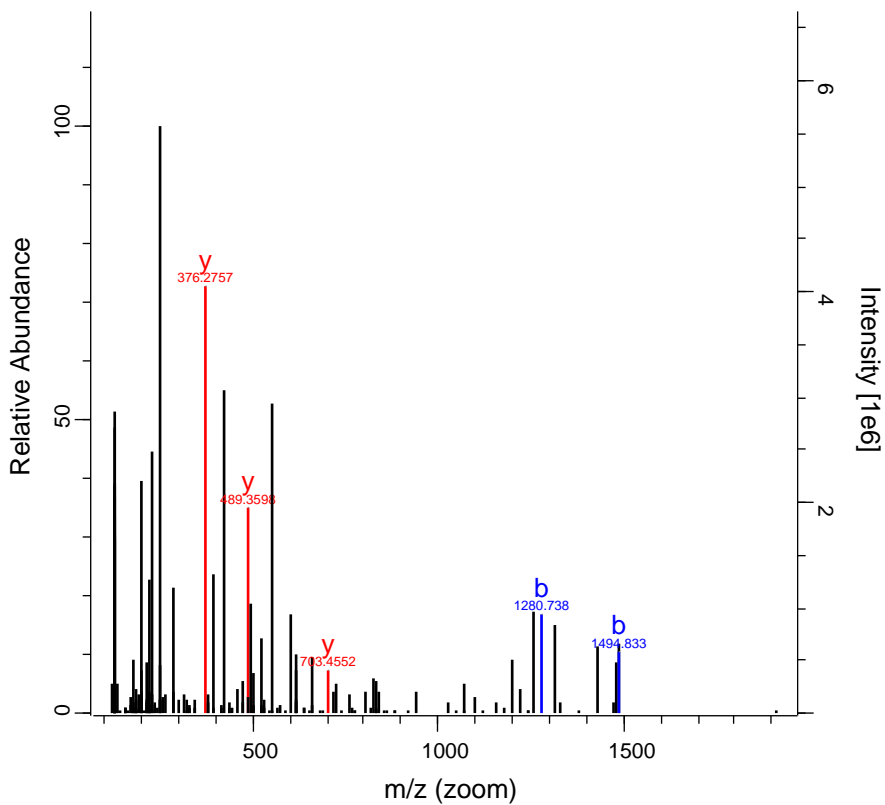

K -

RO-QC-160121_ZackD_SS_Set_02_Fractio 17821 FTMS; HC 139.79 983.88 MAP1B

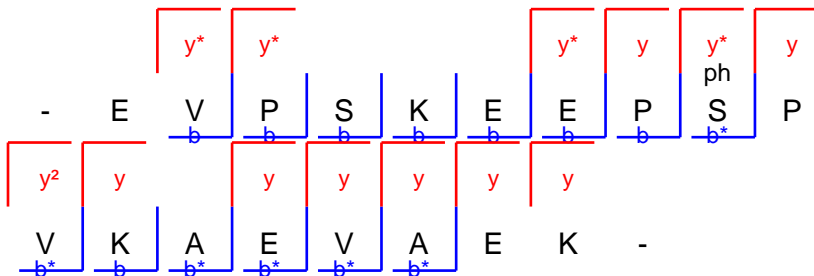
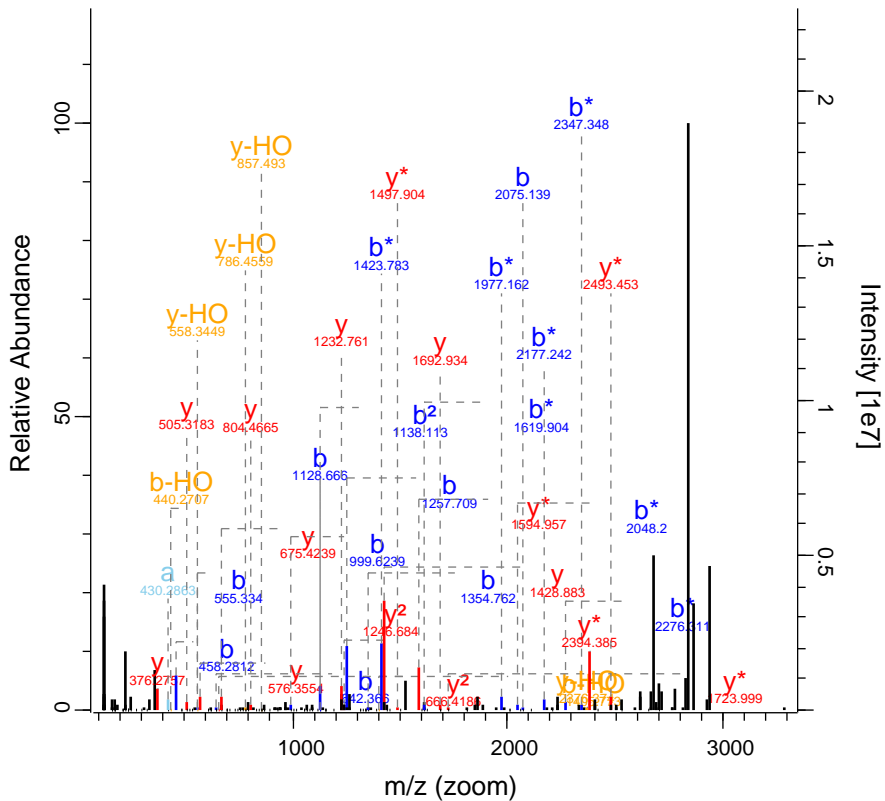

RO-QC-160121_ZackD_SS_Set_02_Fractio 18593 FTMS; HC 101.54 874.45 COL6A3

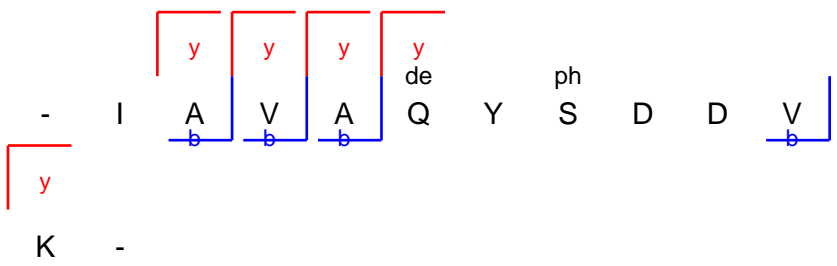
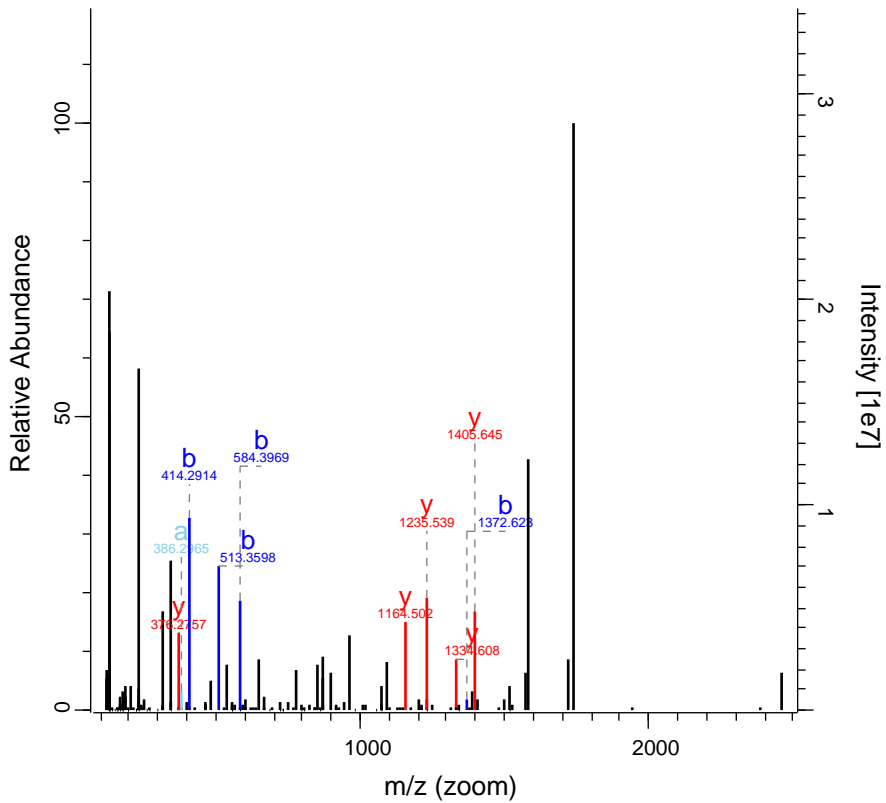

RO-QC-160121_ZackD_SS_Set_02_Fraction 19723 FTMS; HC 90.66 900.47 SYNE2

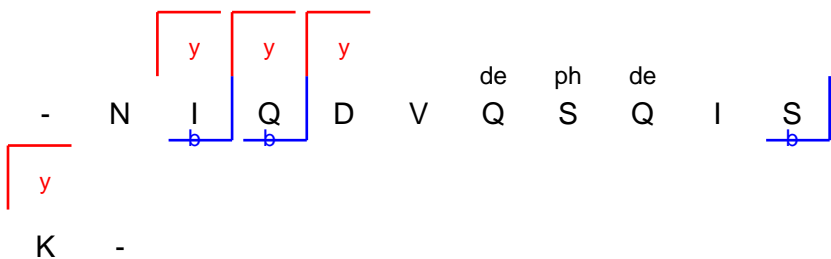
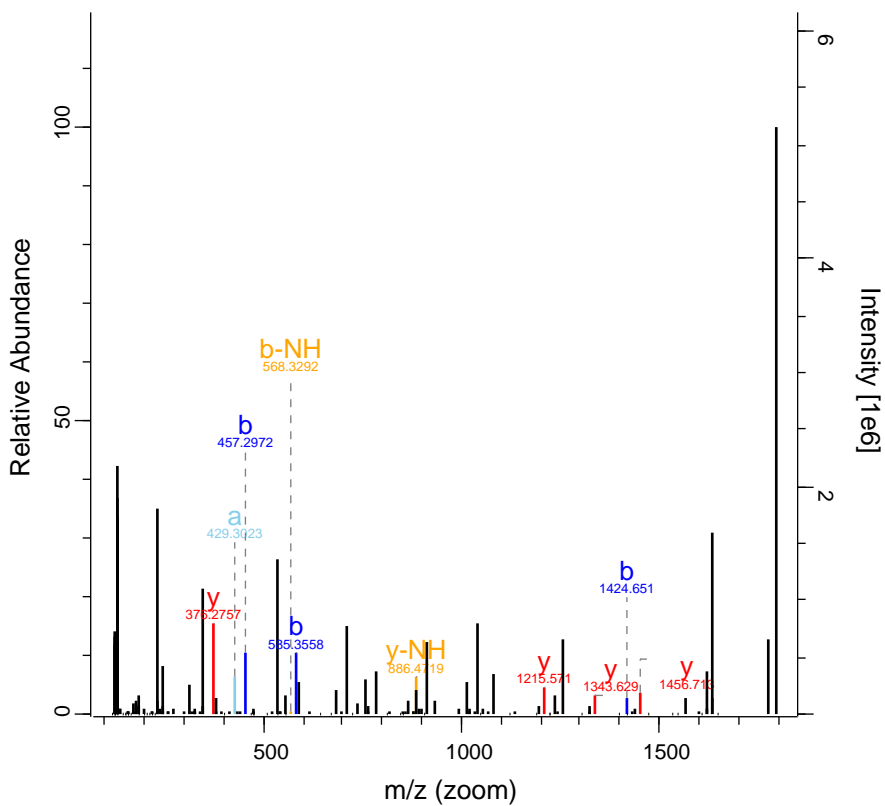

RO-QC-160121_ZackD_SS_Set_02_Fraction 20544 FTMS; HC 43.79 964.13 CTTNBP2

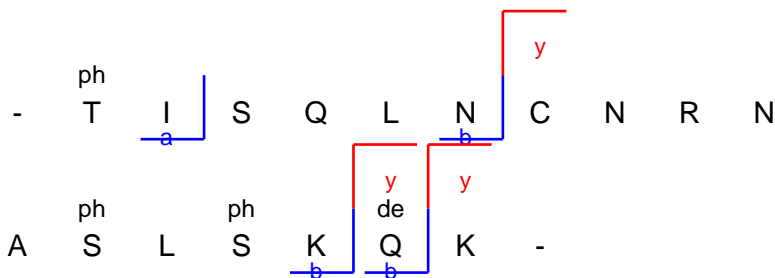
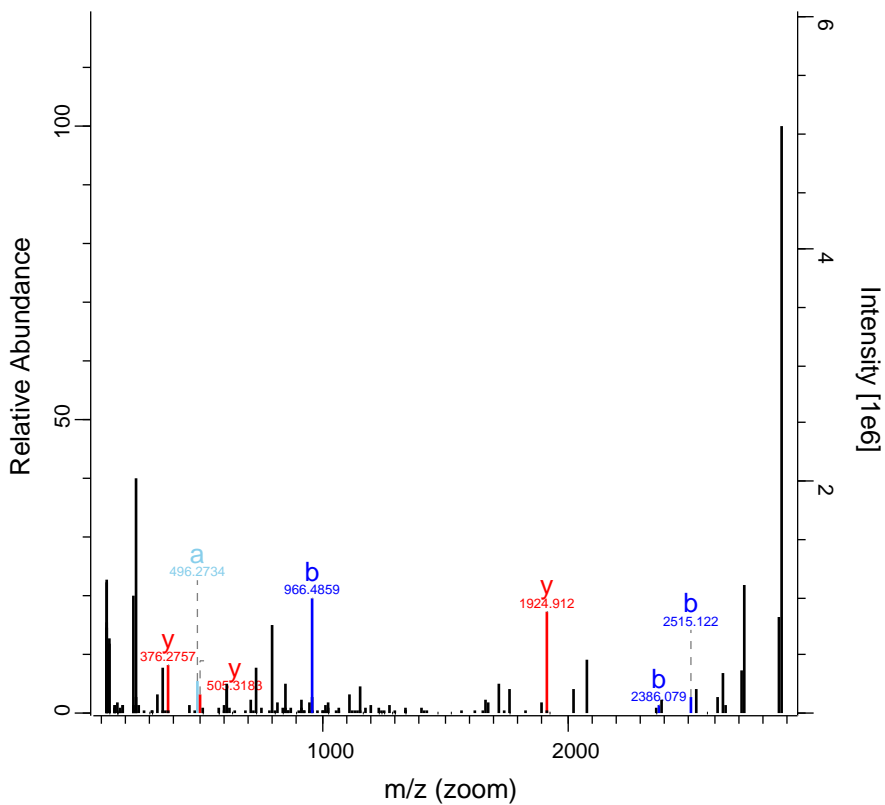

RO-QC-160121_ZackD_SS_Set_02_Fraction 20864 FTMS; HCl 94.69 831.5 C11orf71

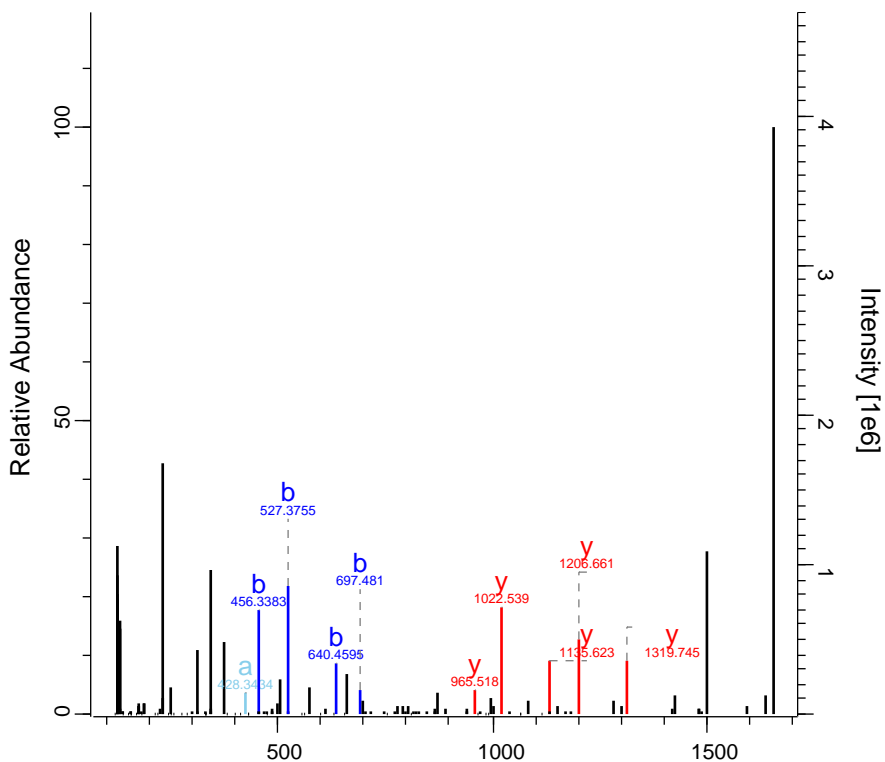

m/z (zoom)

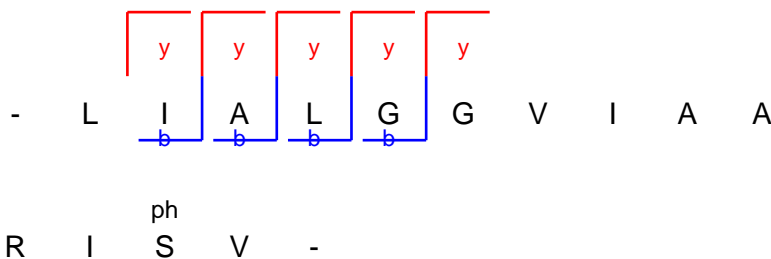

RO-QC-160121_ZackD_SS_Set_02_Fraction 23000 FTMS; HC 57.15 928.72 KIAA1143

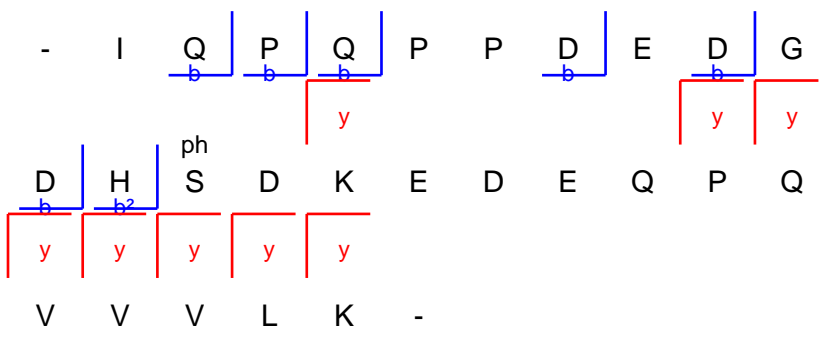
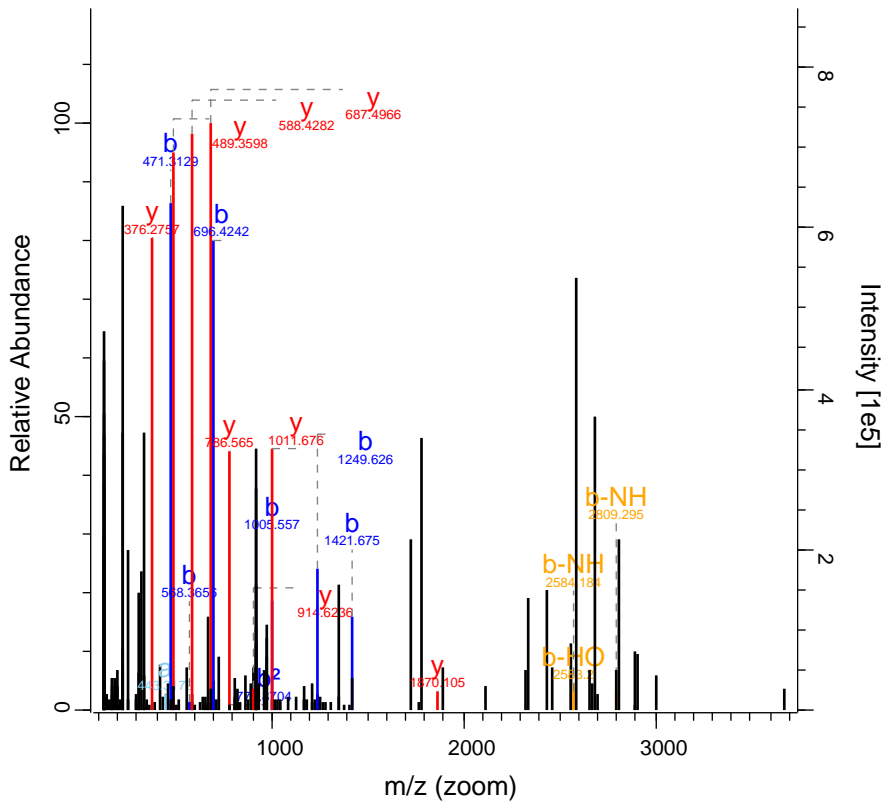

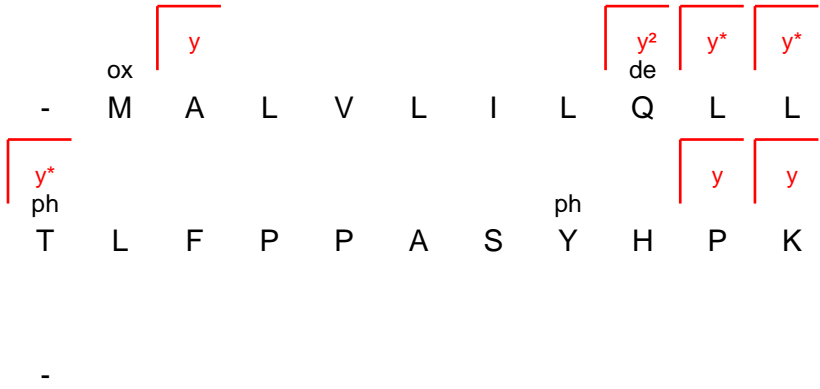
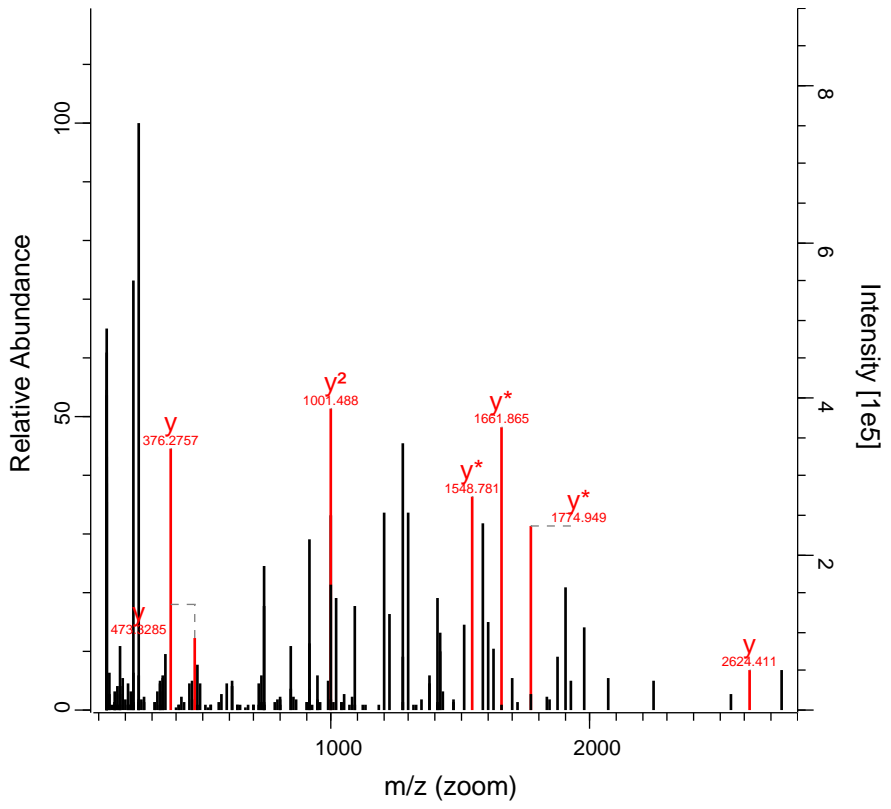

RO-QC-160121_ZackD_SS_Set_02_Fraction 28125 FTMS; HCl 46.75 870.8 CCDC168

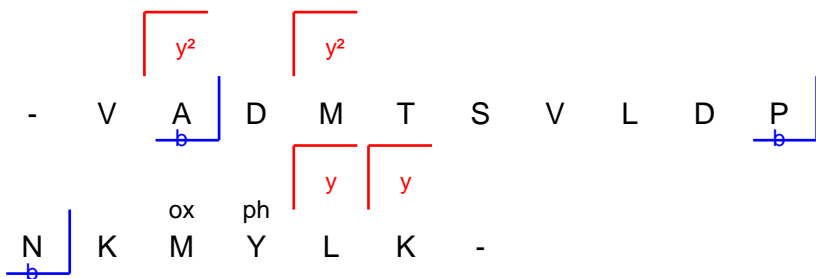
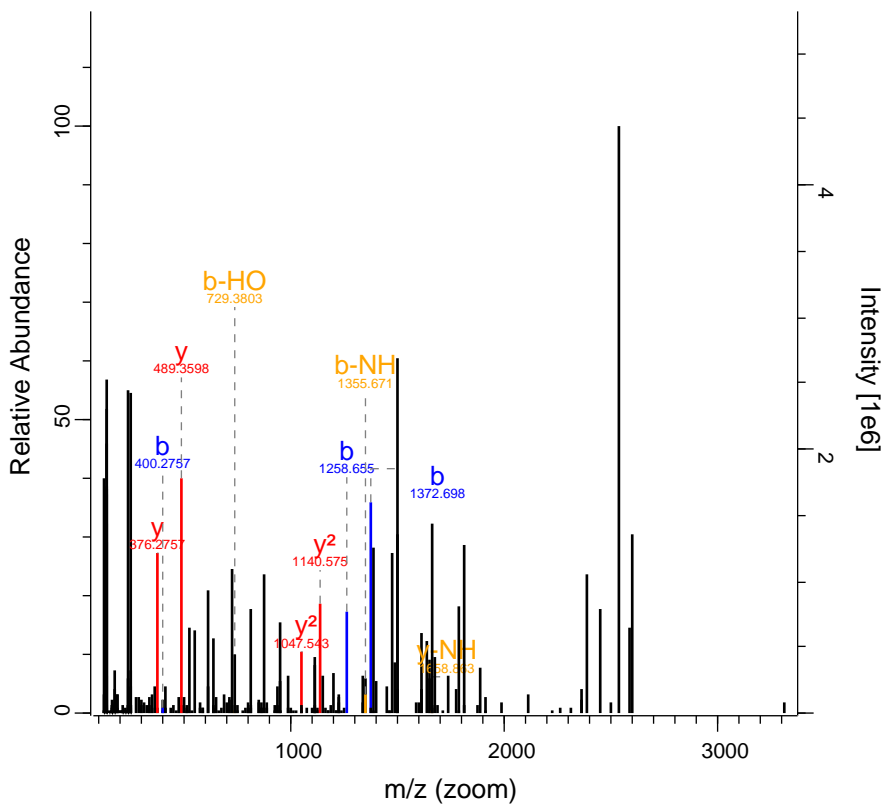

RO-QC-160121_ZackD_SS_Set_02_Fraction 30995 FTMS; HC 83.42 843.46 ABHD5

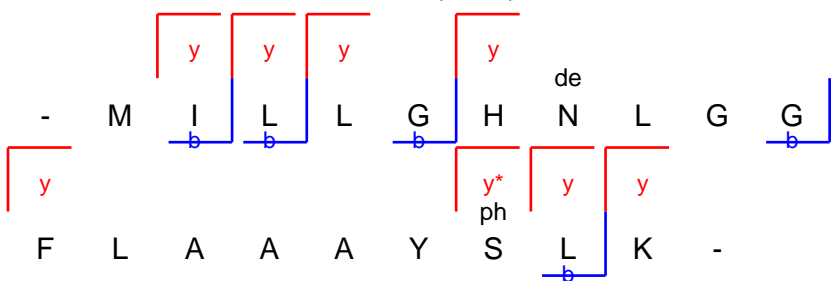
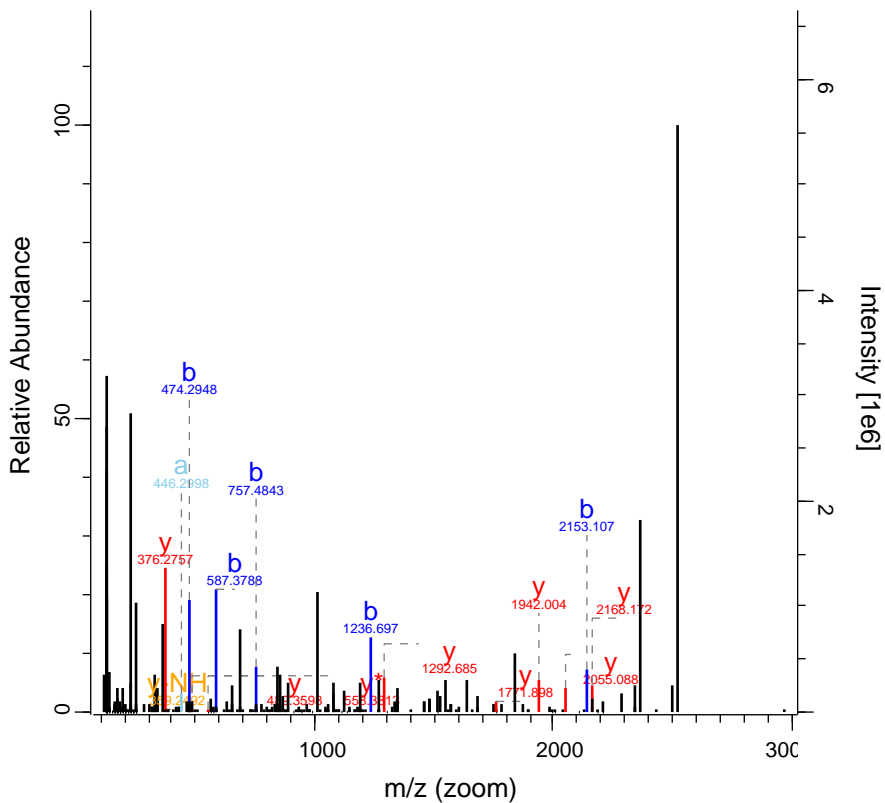

RO-QC-160121_ZackD_SS_Set_02_Fractic 31563 FTMS; HC 148.3 1042.18 CTR9

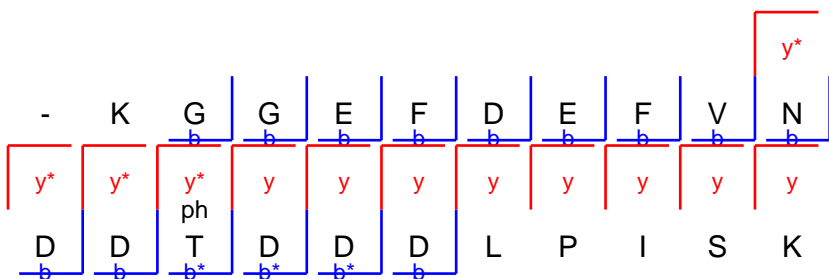
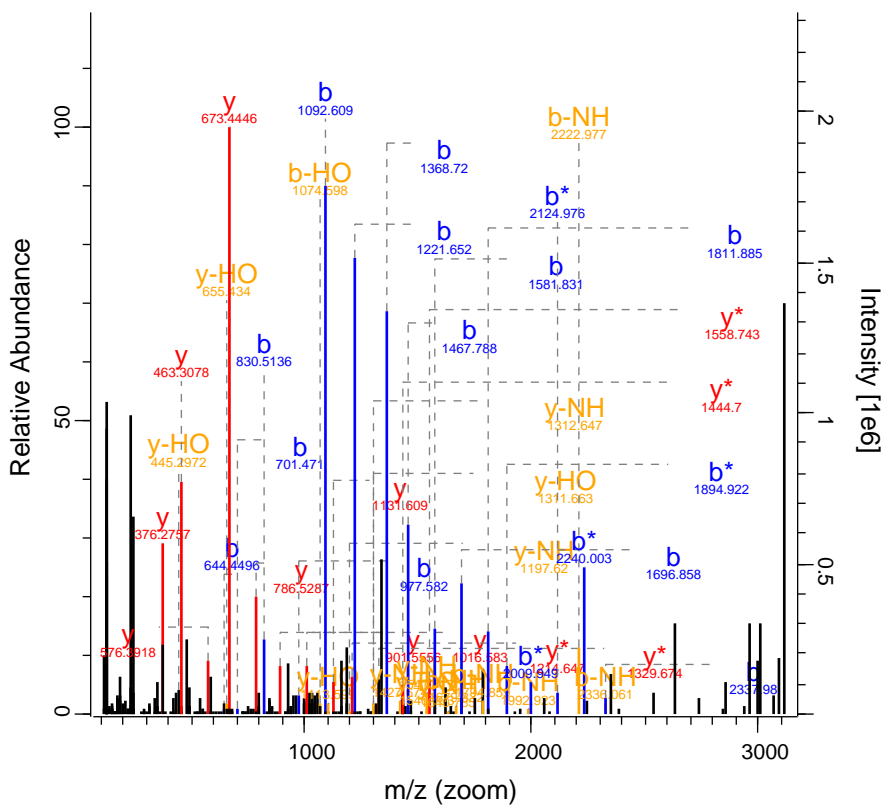

RO-QC-160121_ZackD_SS_Set_02_Fractic 31945 FTMS; HC 82.26 1094.08 UTP20

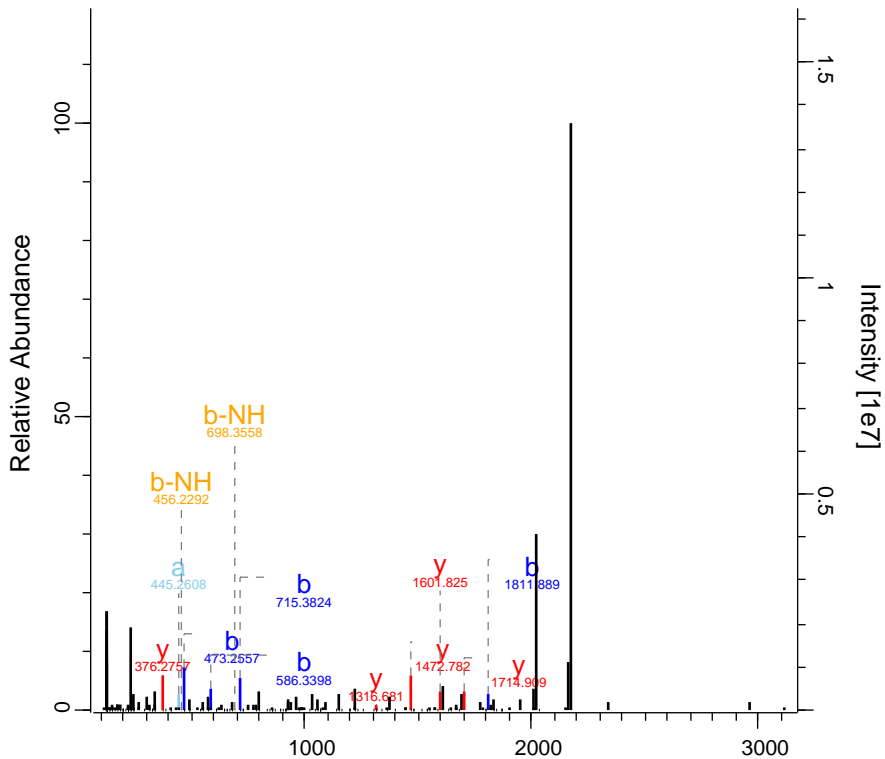

m/z (zoom)

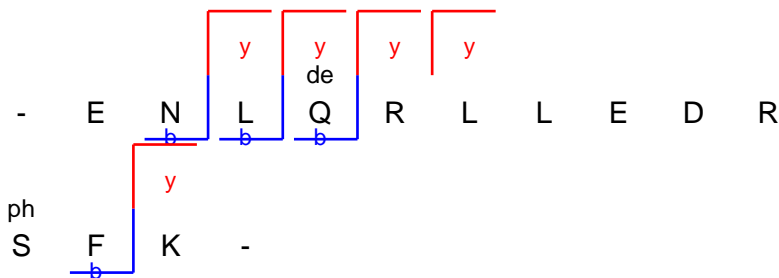

RO-QC-160121_ZackD_SS_Set_02_Fraction 32147 FTMS; HC 96.25 688.34 GFPT1

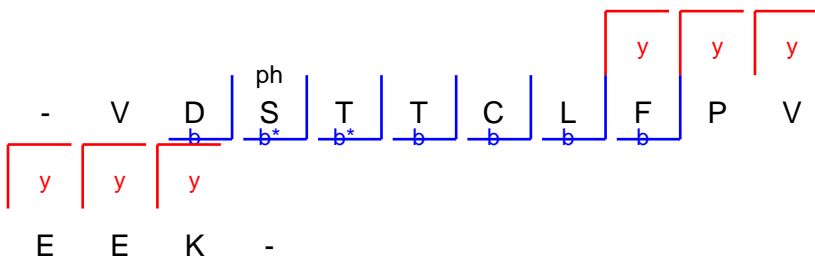
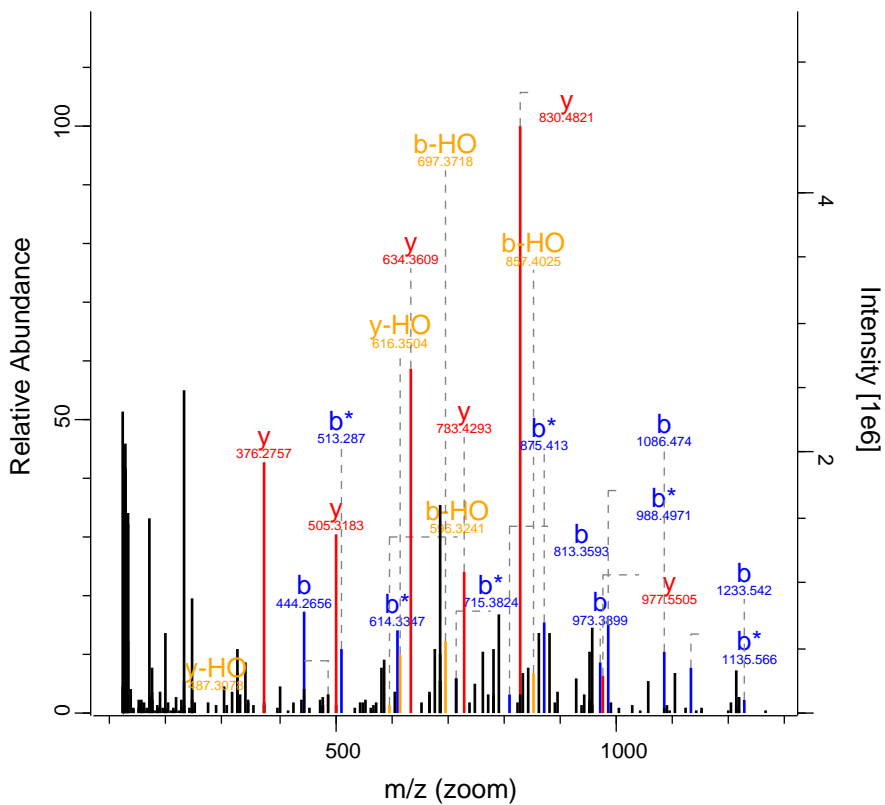

RO-QC-160121_ZackD_SS_Set_02_Fraction 33640 FTMS; HC 72.26 586.08 BCLAF1

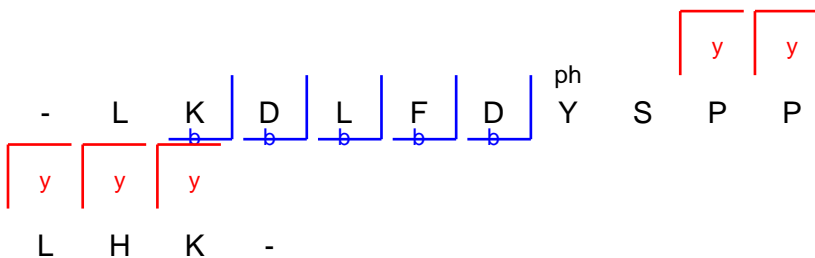
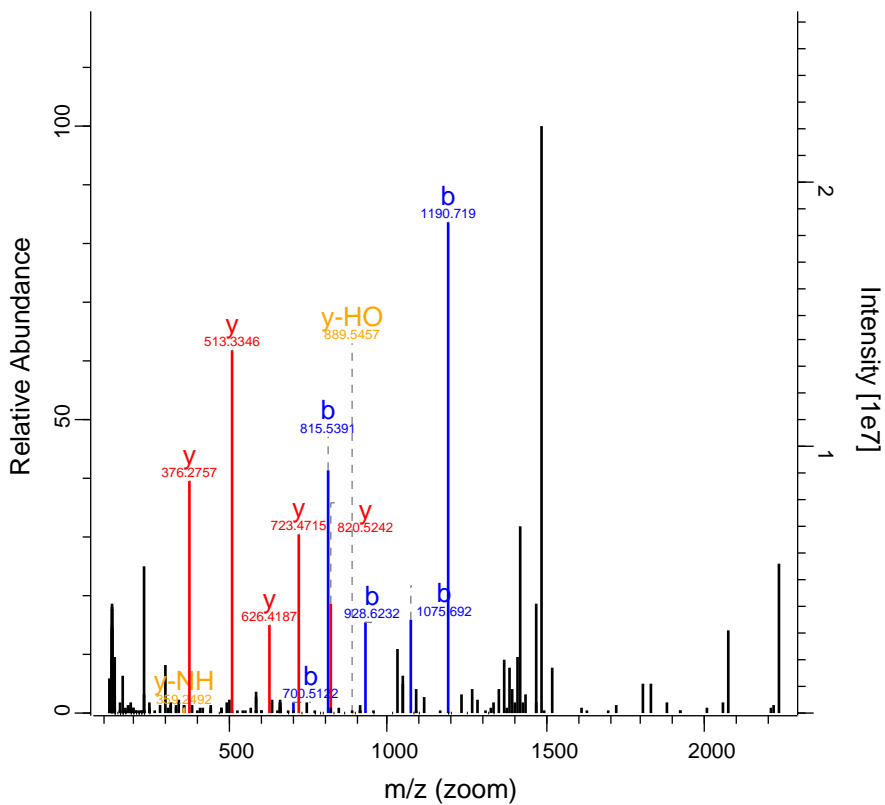

RO-QC-160121_ZackD_SS_Set_02_Fraction 34325 FTMS; HC 46.3 753.07 MAPK4

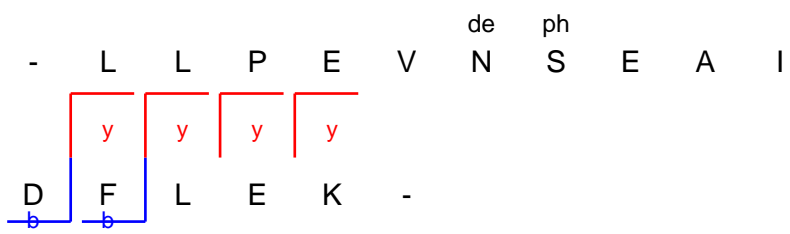
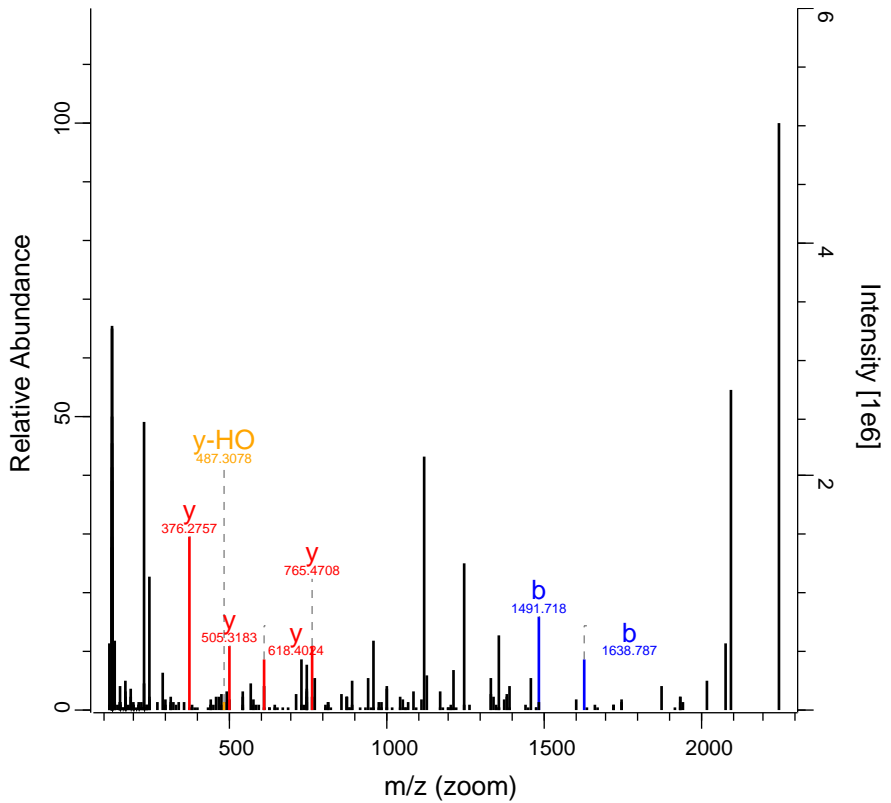

RO-QC-160121_ZackD_SS_Set_02_Fraction 35042 FTMS; HC 78.52 958.03 HDAC7

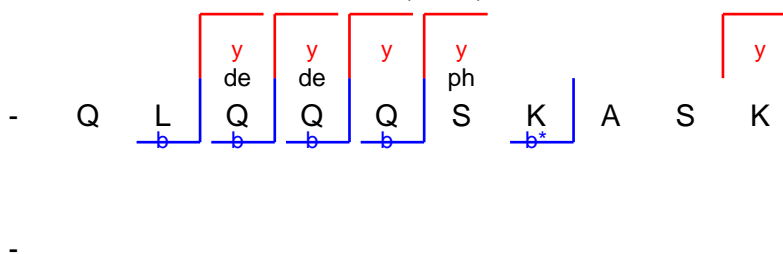
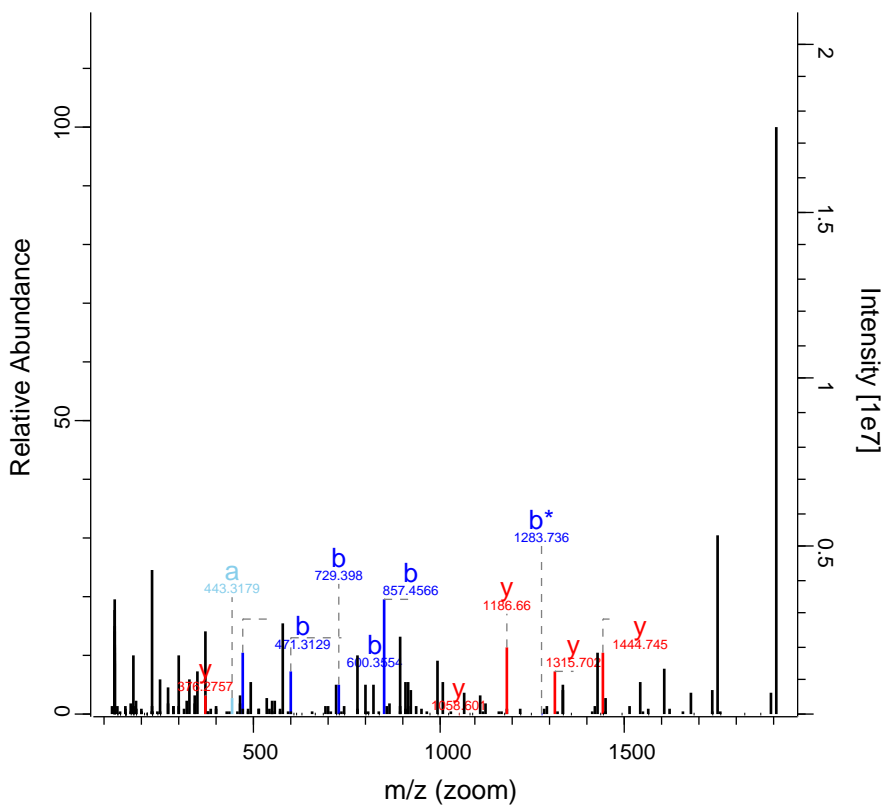

RO-QC-160121_ZackD_SS_Set_02_Fractic 40536 FTMS; HC 52.68 1466.81 GPNMB

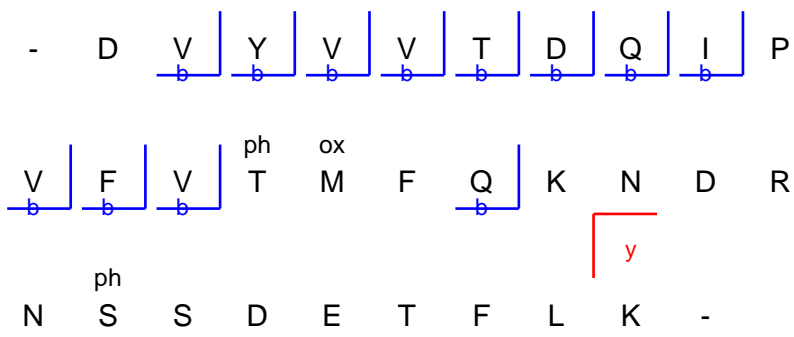
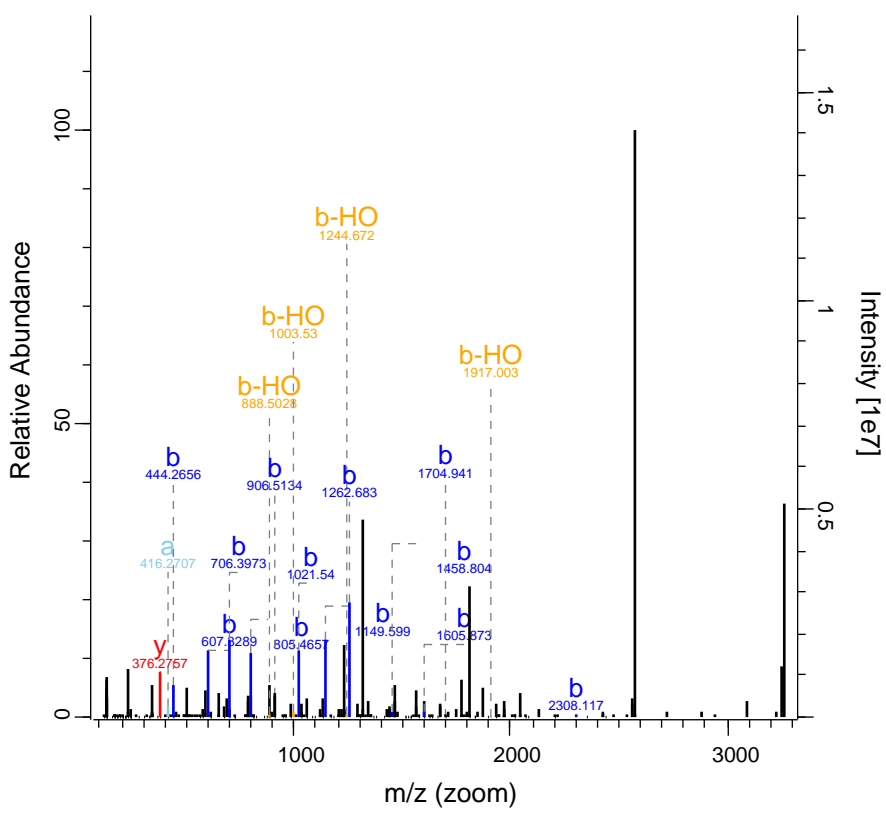

RO-QC-160121_ZackD_SS_Set_02_Fraction 5228 FTMS; HCl 59.18 654.66 GAPVD1

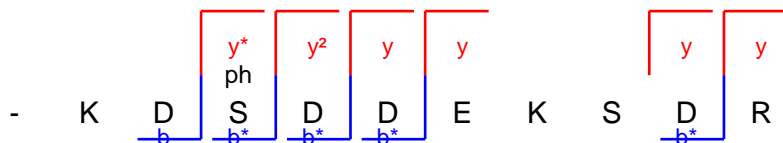
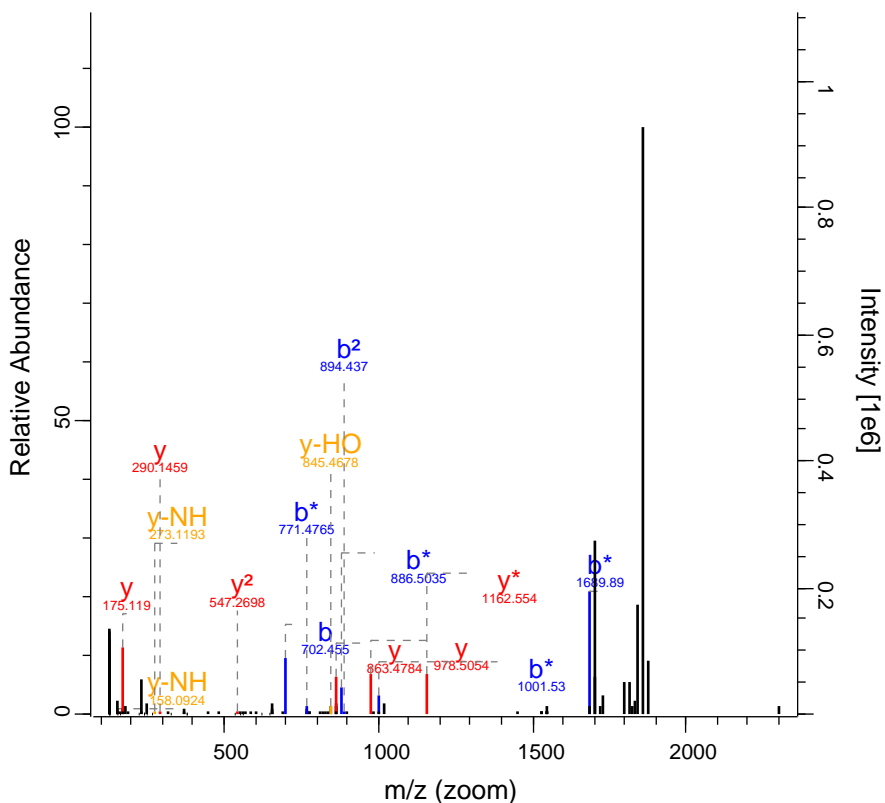

RO-QC-160121_ZackD_SS_Set_02_Fraction 5991 FTMS; HC 116.19 665.36 PAPOLA

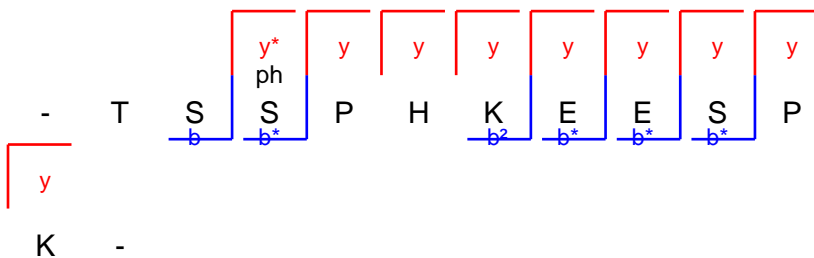
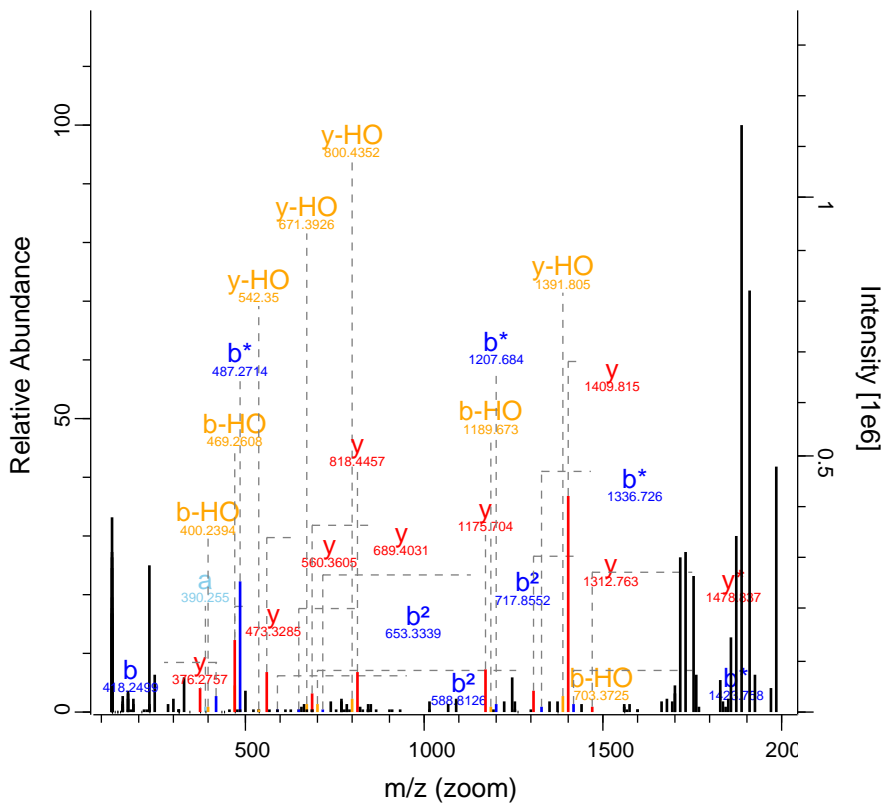

RO-QC-160121_ZackD_SS_Set_02_Fraction 9473 FTMS; HCl 44.72 811.39 STARD9

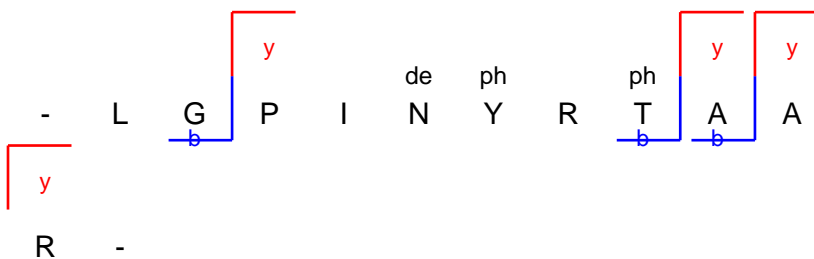
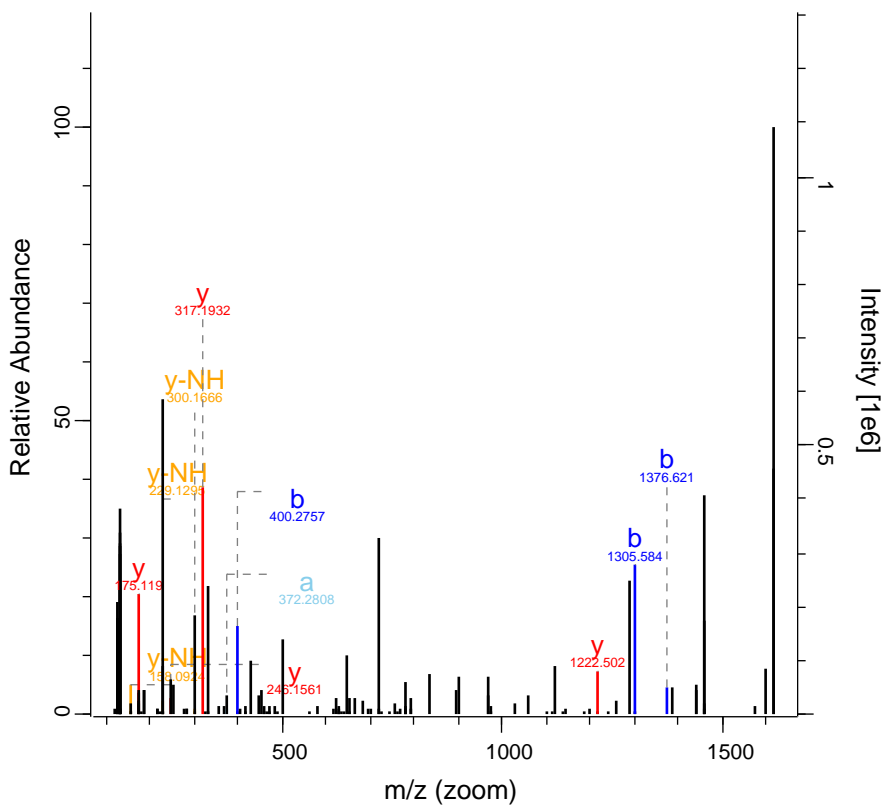

RO-QC-160121_ZackD_SS_Set_02_Fractic 10800 FTMS; HC 51.19 1038.53 USP43

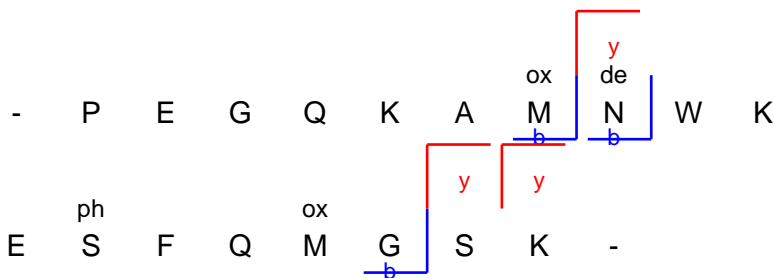
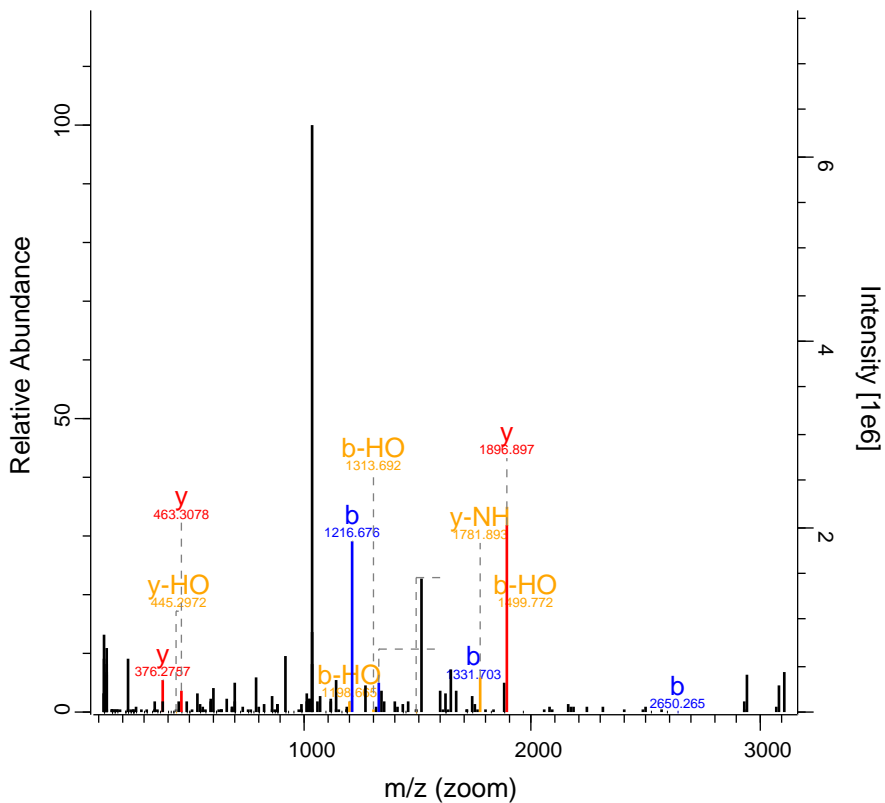

RO-QC-160121_ZackD_SS_Set_02_Fraction11258 FTMS; HC 89.87 718.03 CBX3

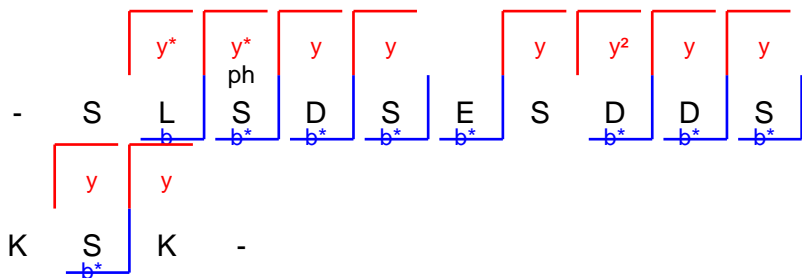
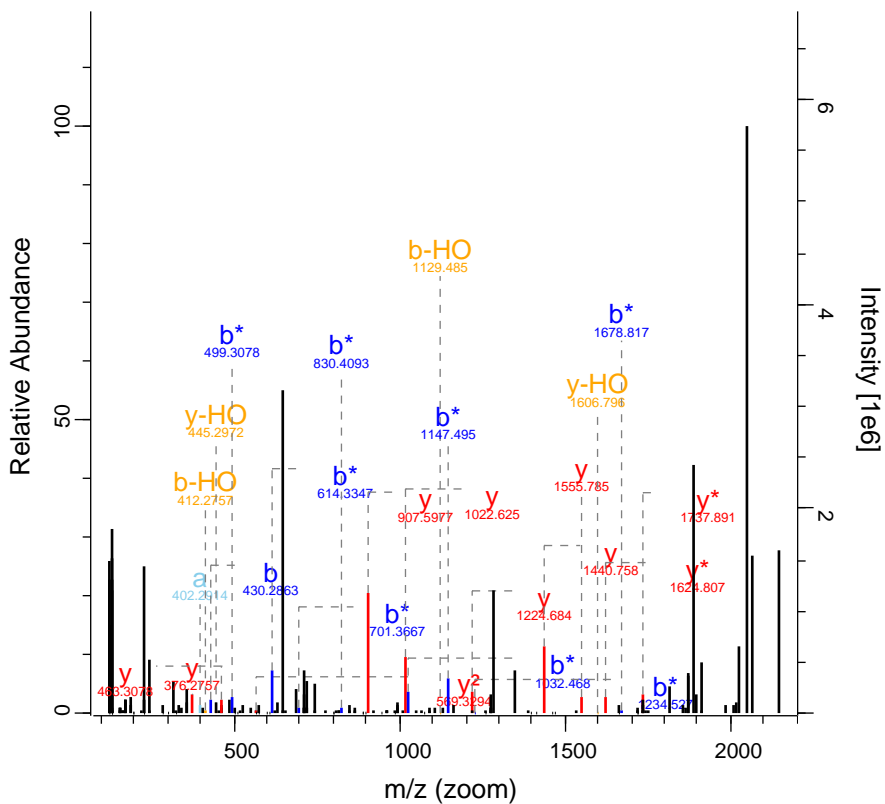

RO-QC-160121_ZackD_SS_Set_02_Fraction 13713 FTMS; HC 92.61 770.91 NAV1

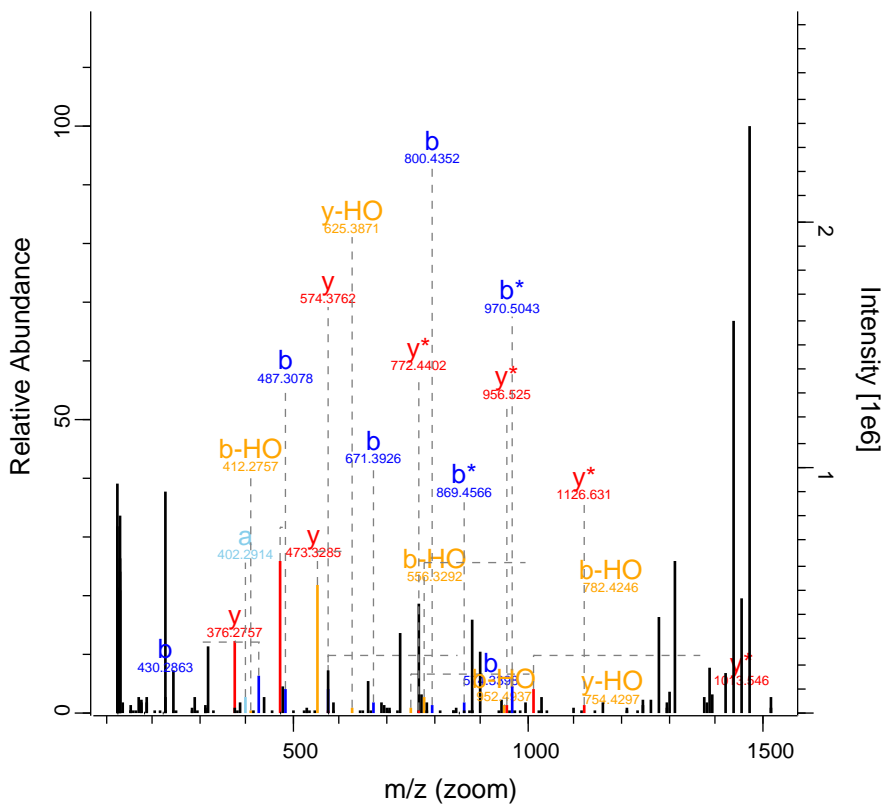

m/z (zoom)

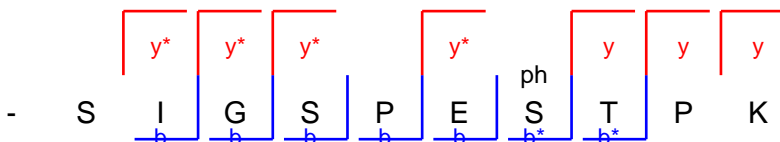

RO-QC-160121_ZackD_SS_Set_02_Fraction 13875 FTMS; HC 99.44 868.44 DKC1

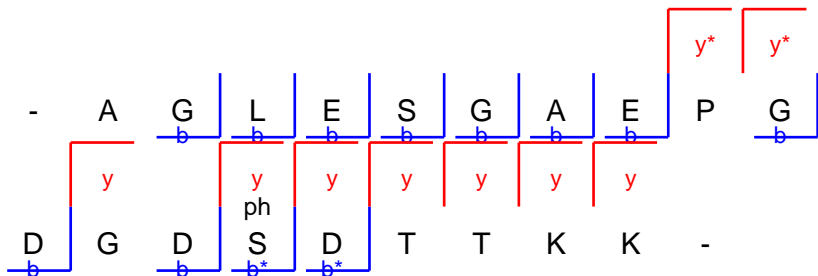
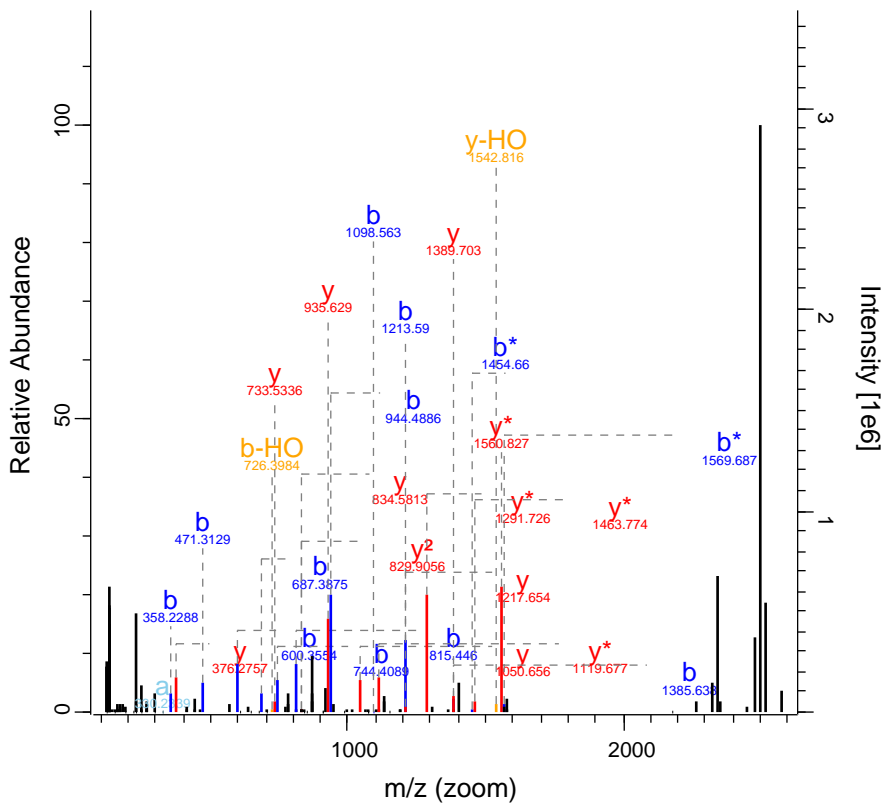

RO-QC-160121_ZackD_SS_Set_02_Fraction 15665 FTMS; HC 58.43 997.48 XPO5

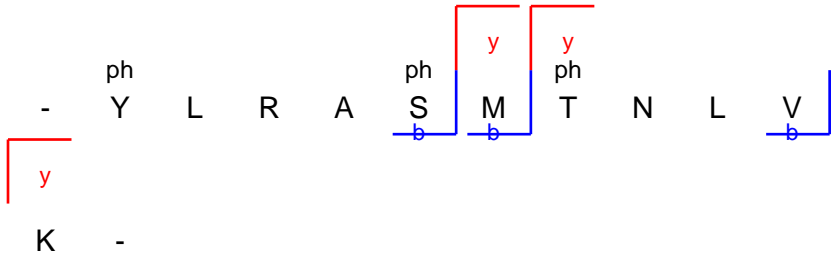
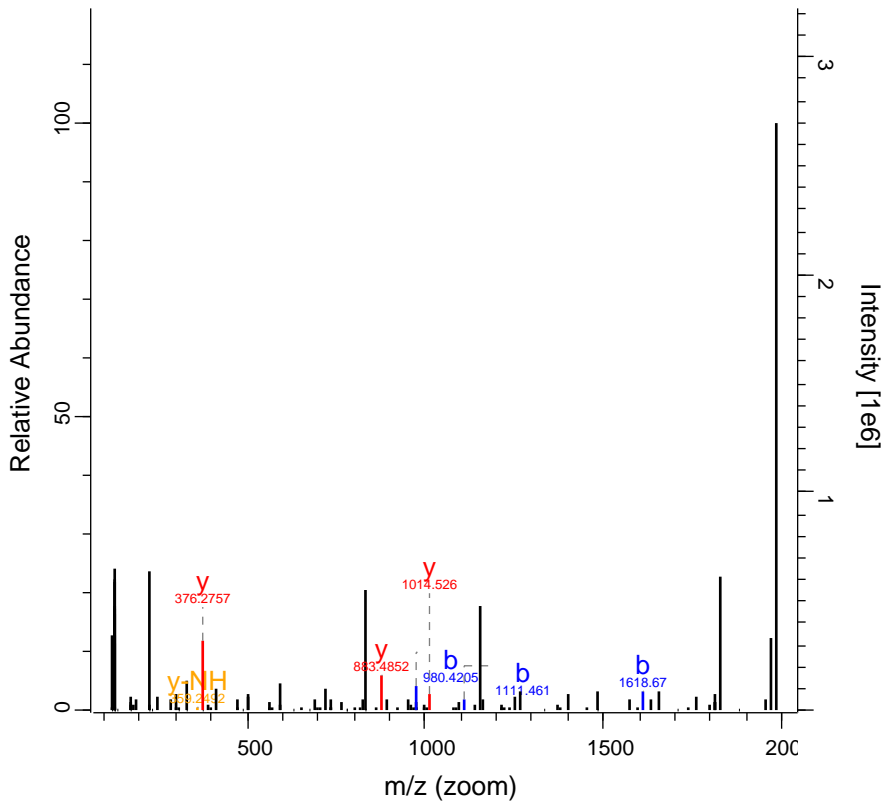

K -

RO-QC-160121_ZackD_SS_Set_02_Fractio 15727 FTMS; HC 106.43 676.86 SEC31A

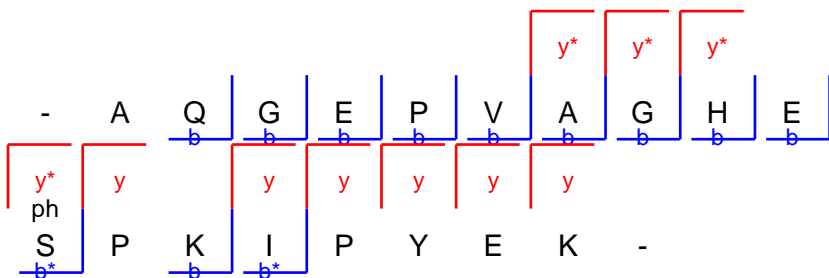
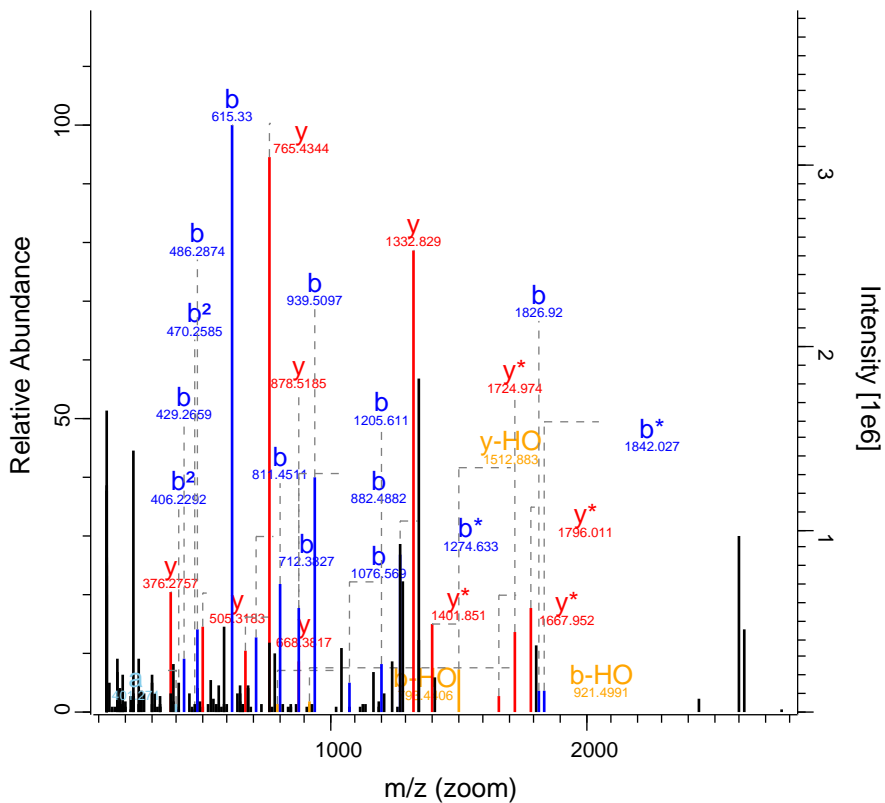

RO-QC-160121_ZackD_SS_Set_02_Fractic 16052 FTMS; HC 233.09 1219.12 MYRIP

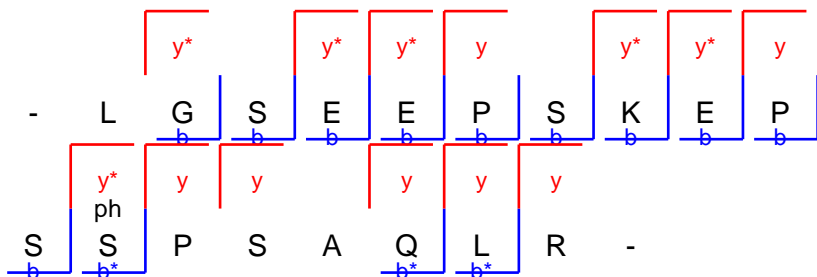
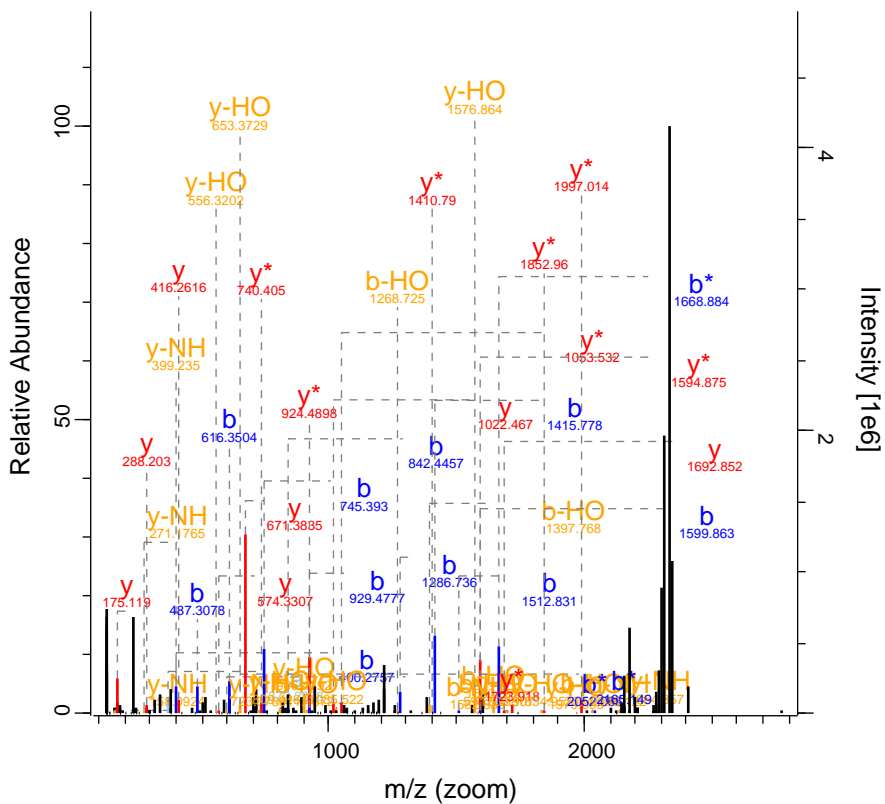

RO-QC-160121_ZackD_SS_Set_02_Fraction17100 FTMS; HC 47.28 670.74 HNRNPF

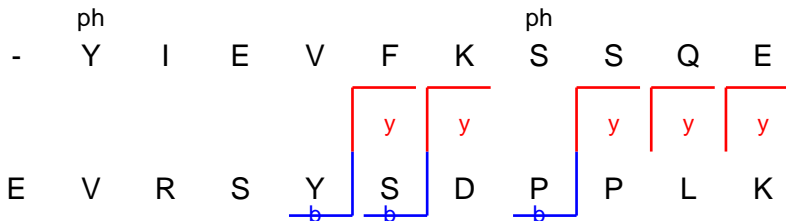
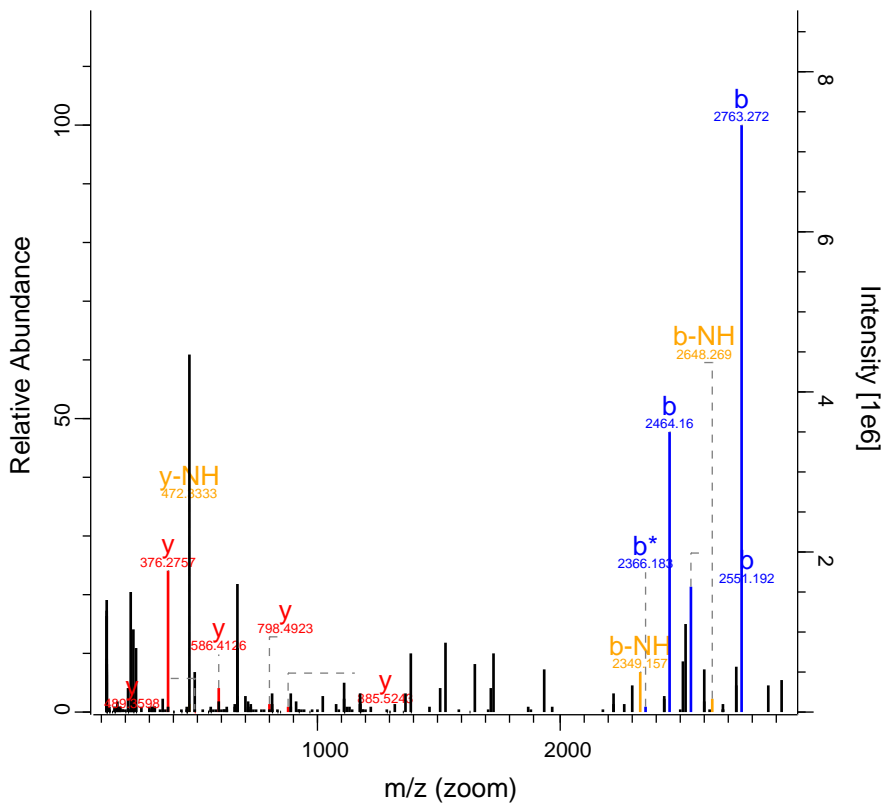

RO-QC-160121_ZackD_SS_Set_02_Fractic 17803 FTMS; HC 76.33 1110.54 TNFRSF10D

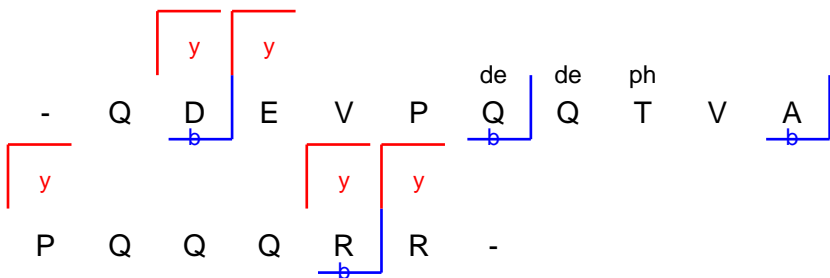
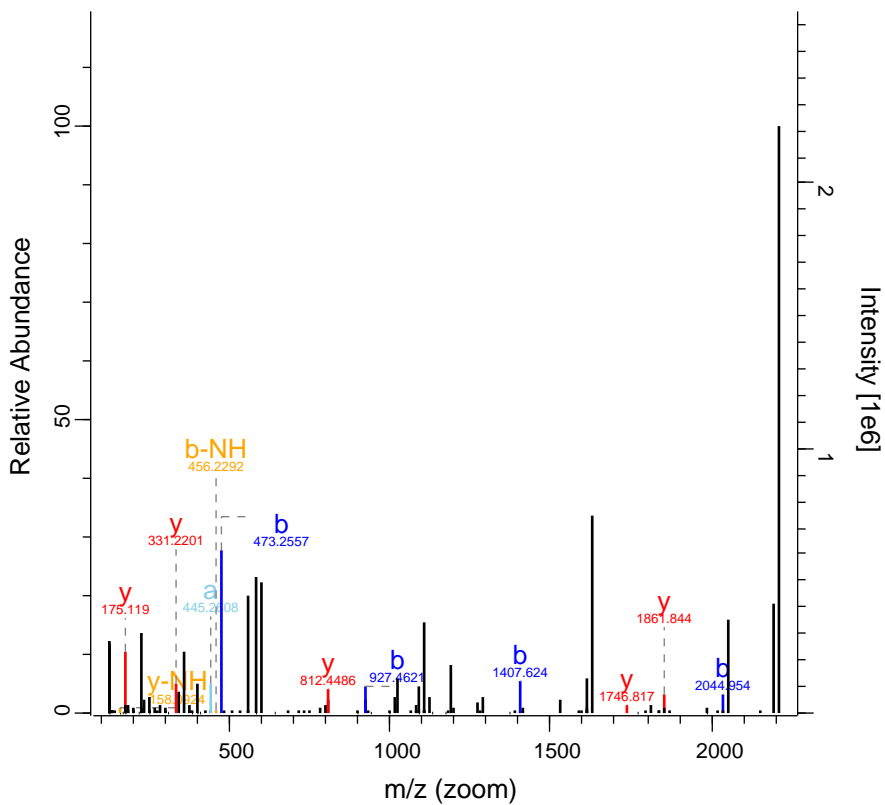

RO-QC-160121_ZackD_SS_Set_02_Fraction 18554 FTMS; HCl 156.94 935.4 PDCD5

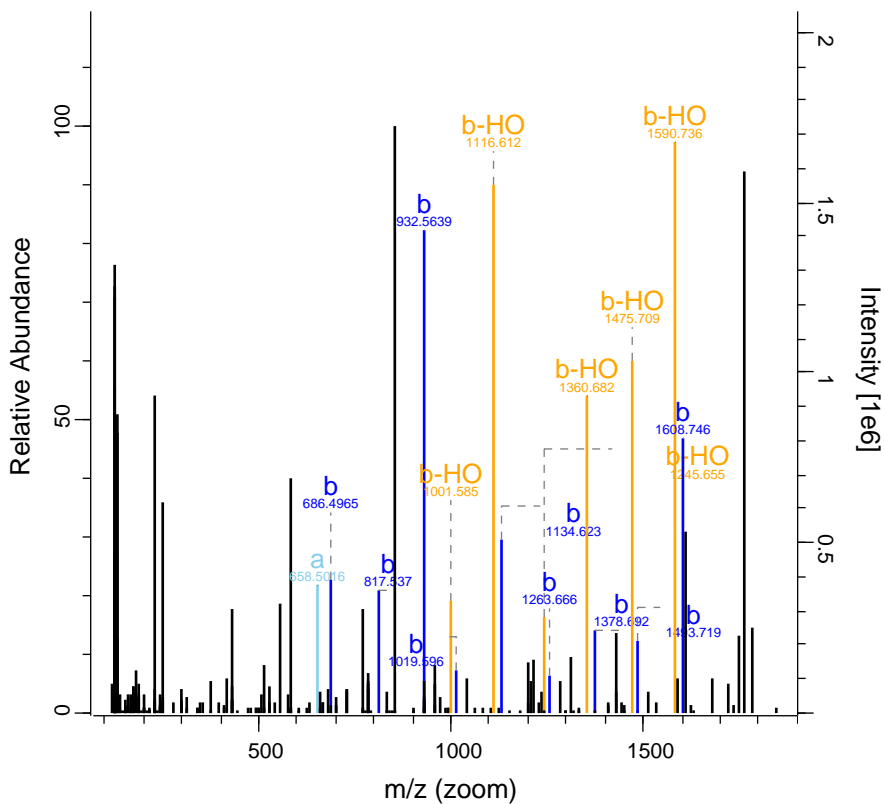

- K V M D S D E D D D

ph

Y -

RO-QC-160121_ZackD_SS_Set_02_Fractic 18640 FTMS; HC 104.43 1015.51 SQSTM1

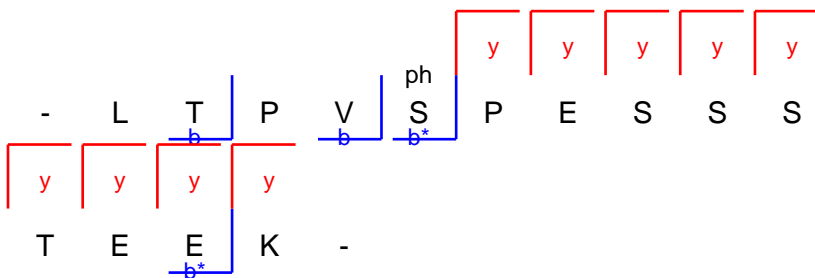
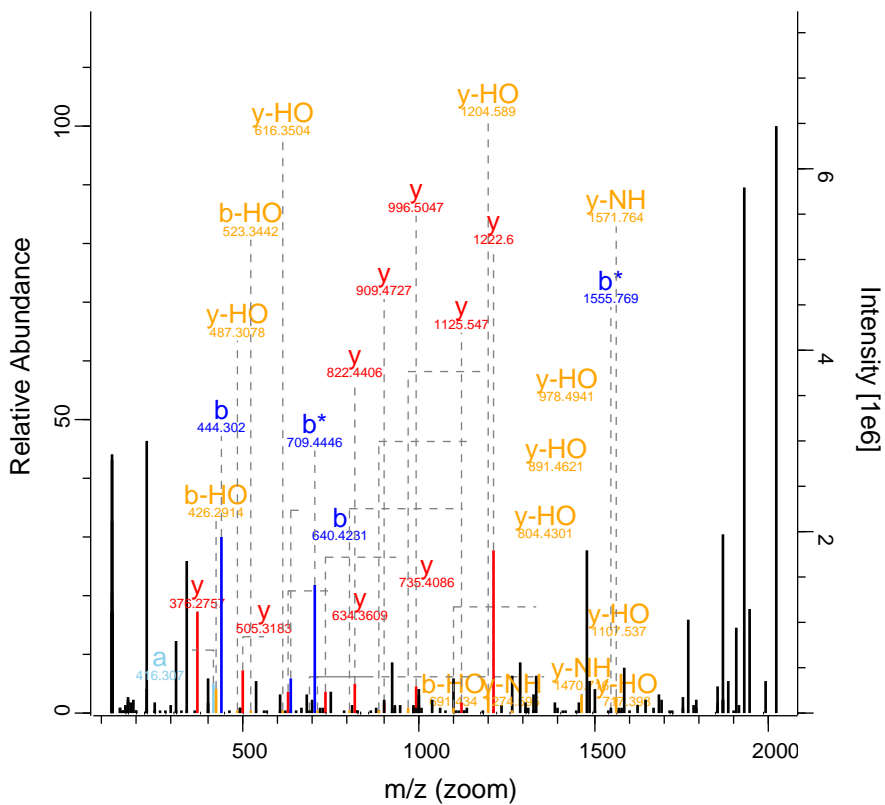

RO-QC-160121_ZackD_SS_Set_02_Fraction 18710 FTMS; HC 43.51 537.56 CCDC60

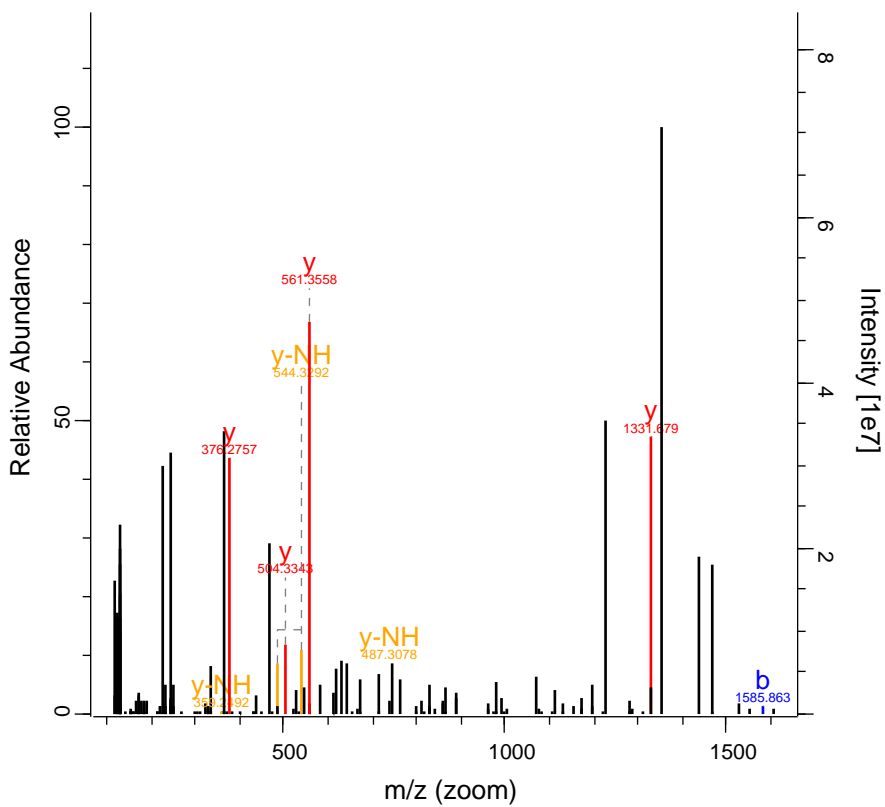

Fragmentation diagram showing the sequence of amino acids: I, N, K, D, K, S, M, G, Q, K. The diagram illustrates the fragmentation of the peptide sequence, with the following labels and fragmentation types:

- I
- N
- K
- D (y)
- K
- S
- M (b)
- G (y)
- Q (y)
- K (y)

RO-QC-160121_ZackD_SS_Set_02_Fractic 20174 FTMS; HC 76.94 1225.71 RAB11FIP1

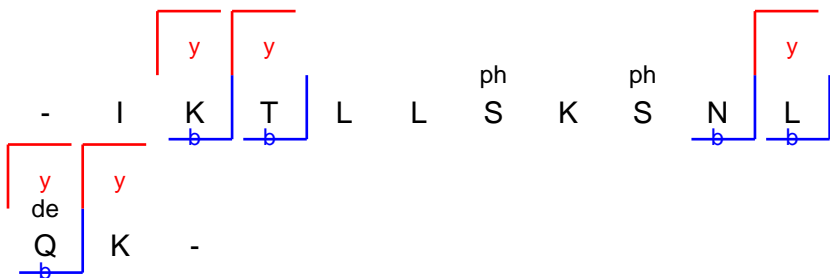
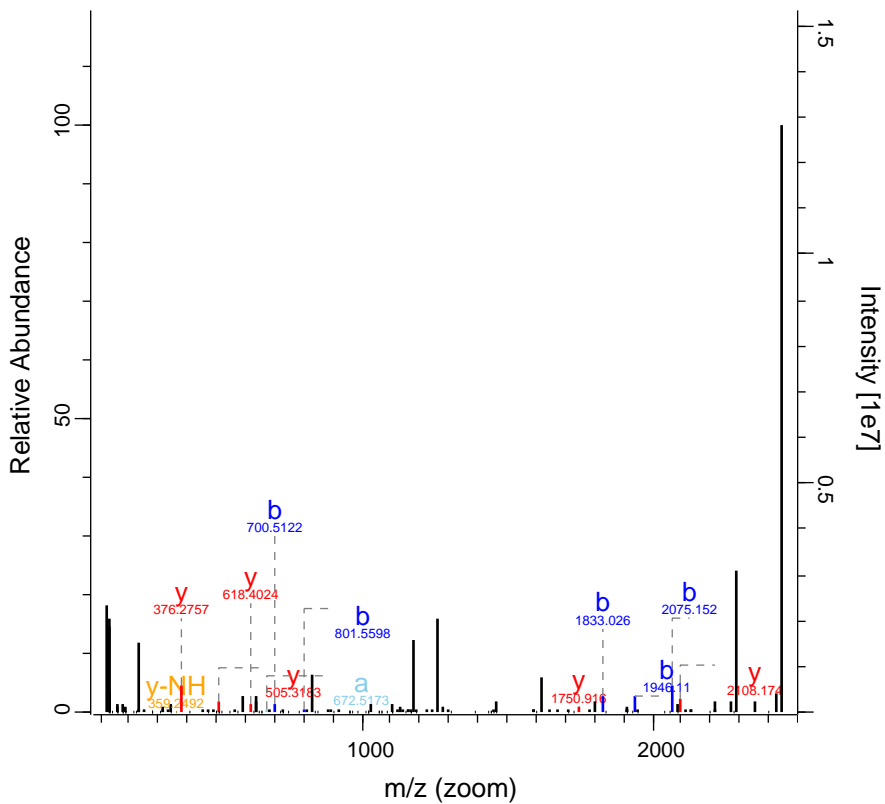

RO-QC-160121_ZackD_SS_Set_02_Fraction 21987 FTMS; HC 86.01 832.98 POSTN

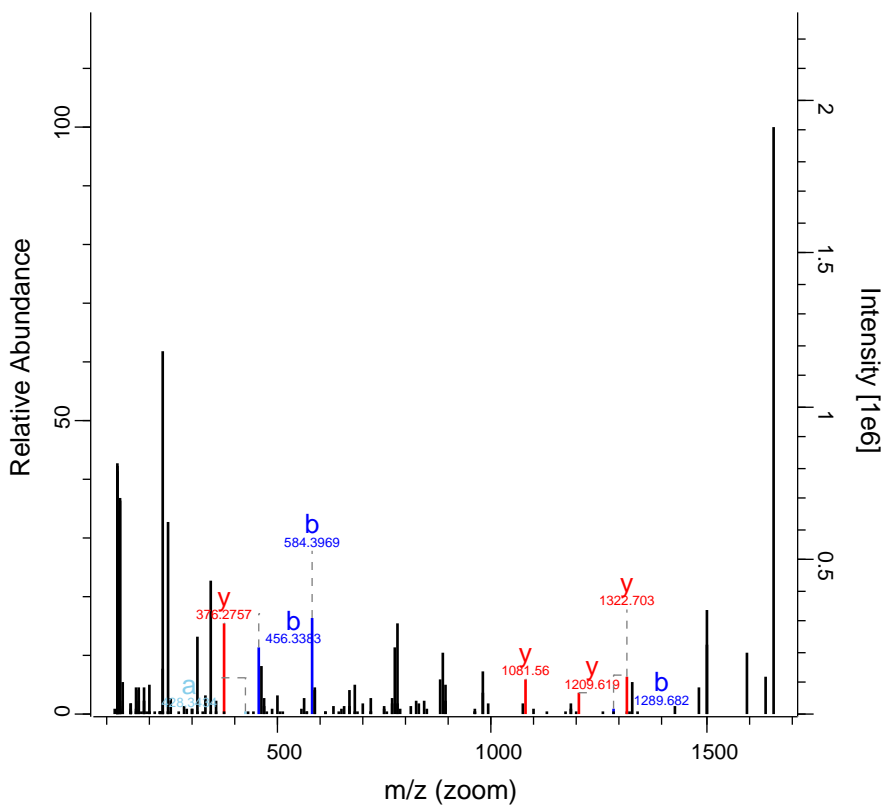

m/z (zoom)

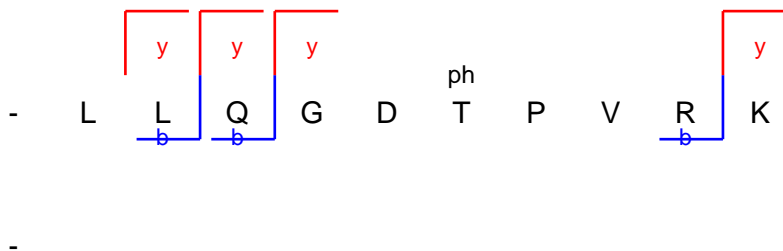

RO-QC-160121_ZackD_SS_Set_02_Fractic 26170 FTMS; HC 60.97 1133.14 BIRC6

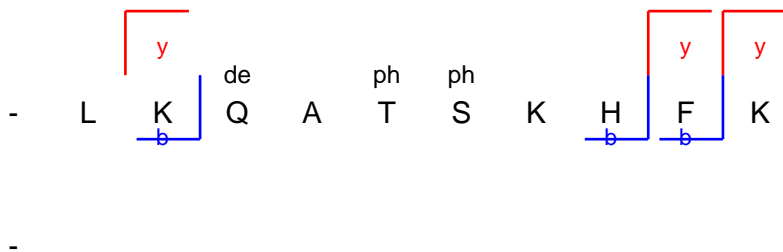
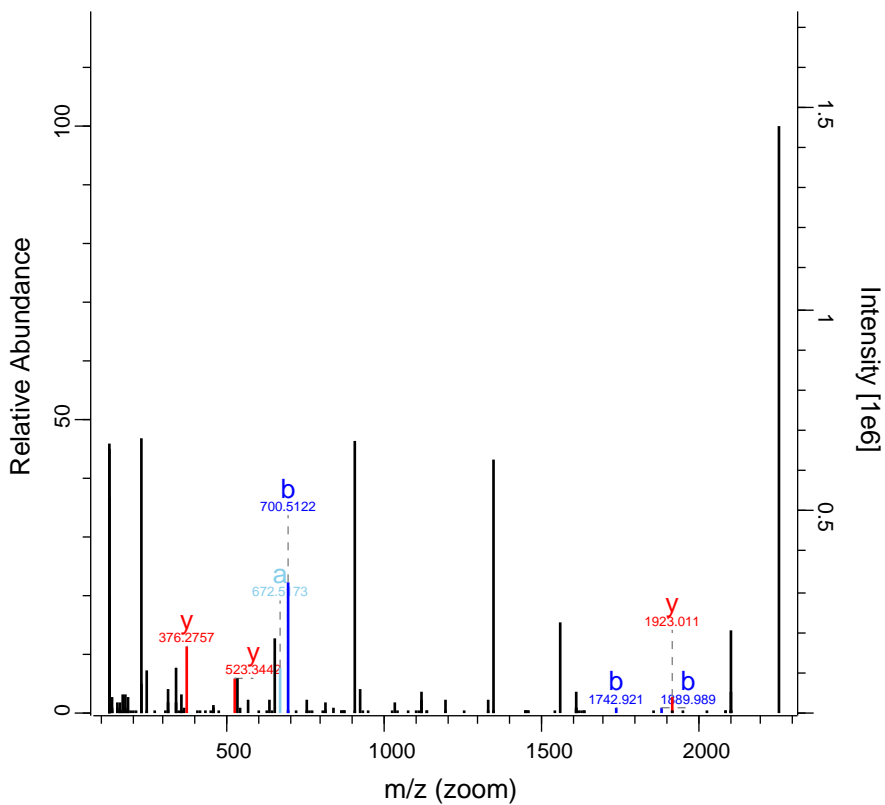

RO-QC-160121_ZackD_SS_Set_02_Fractic 26382 FTMS; HC 81.87 1168.63 BRD4

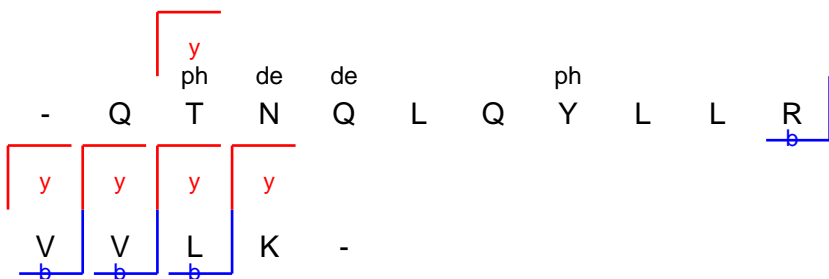
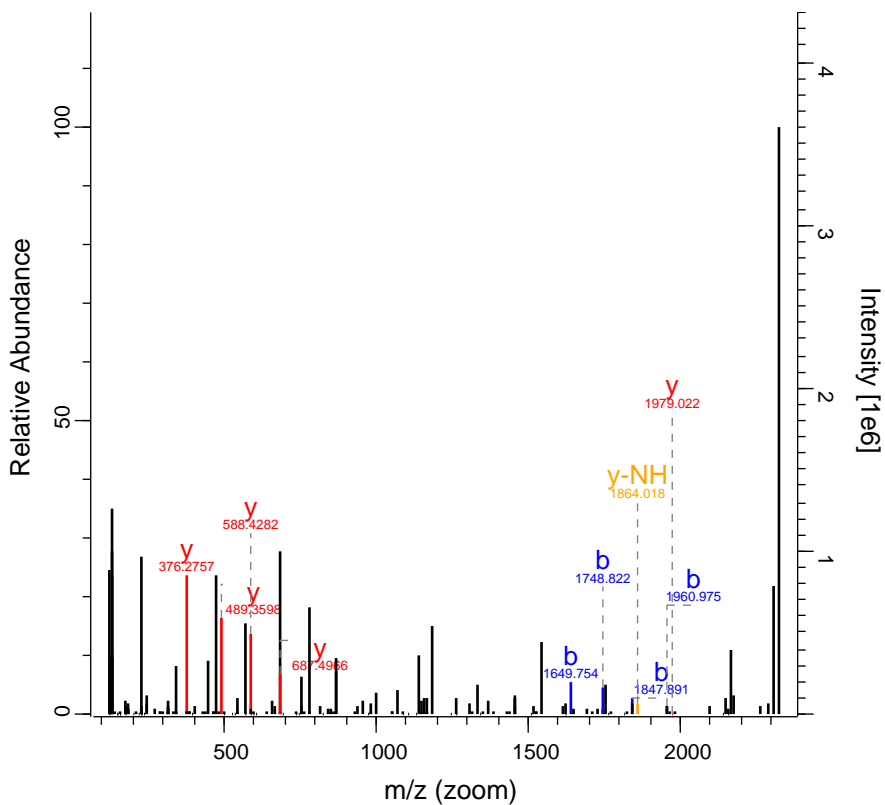

RO-QC-160121_ZackD_SS_Set_02_Fractio 27246 FTMS; HC 117.52 655.85 BCLAF1

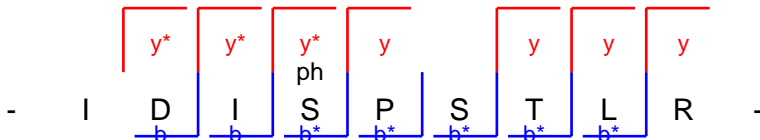
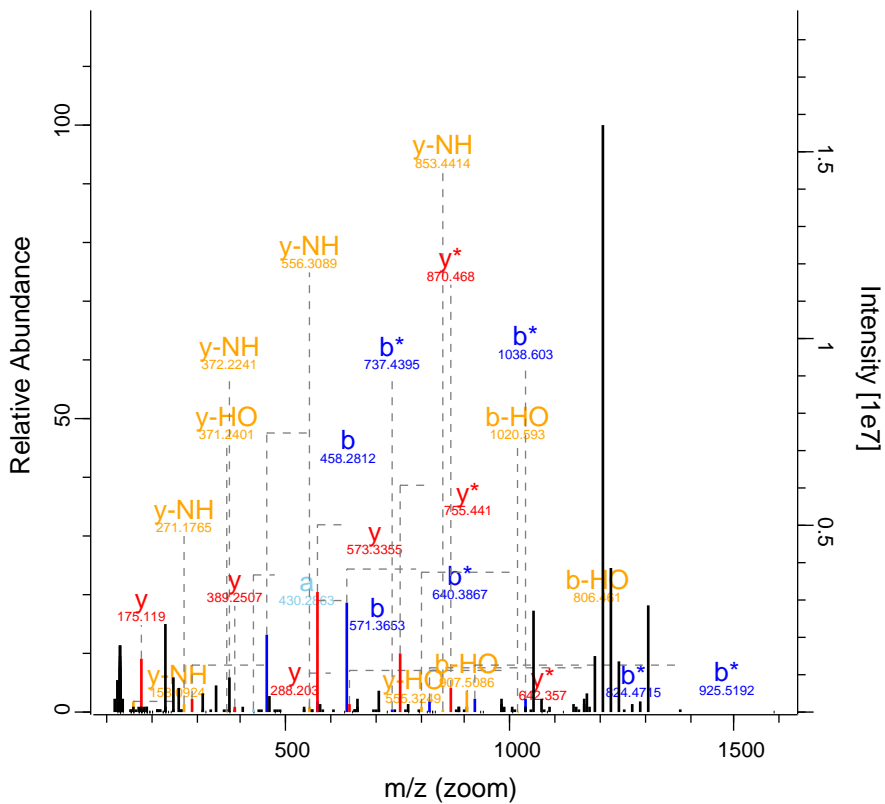

RO-QC-160121_ZackD_SS_Set_02_Fraction 29210 FTMS; HC 52.03 990.86 PMFBP1

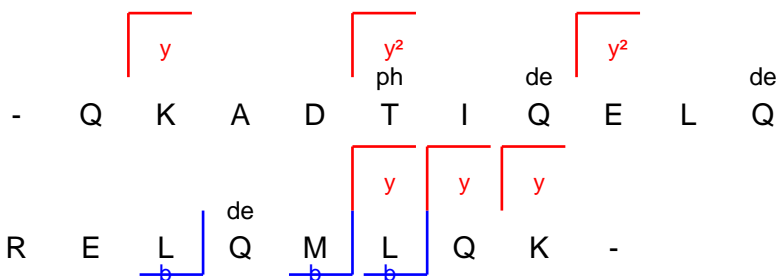
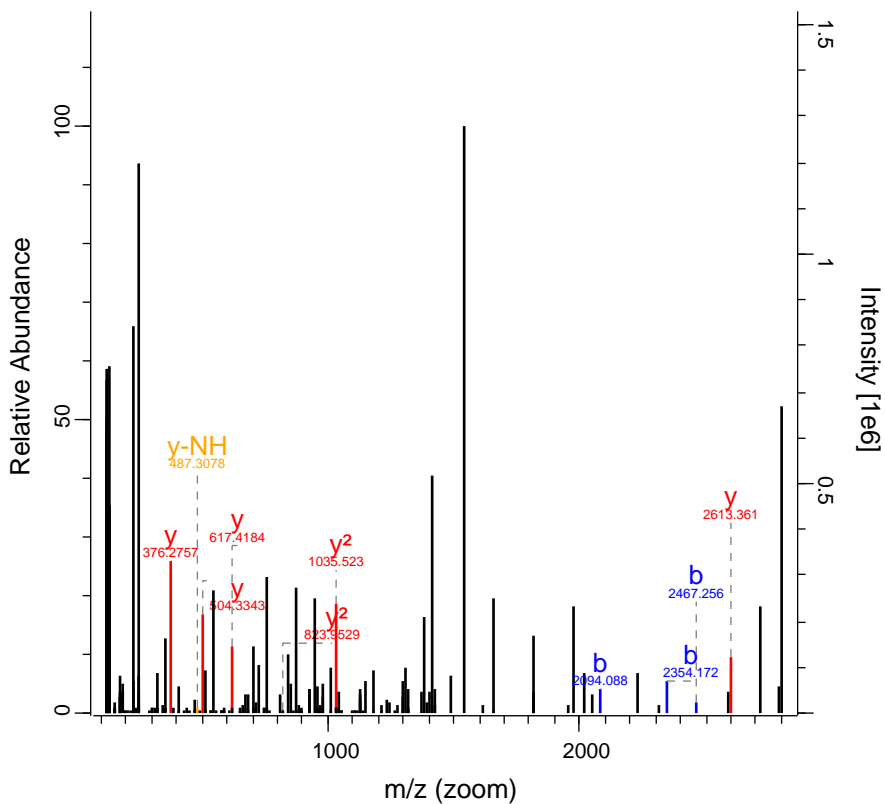

RO-QC-160121_ZackD_SS_Set_02_Fractic 29404 FTMS; HC 65.22 1101.62 RPS6KA5

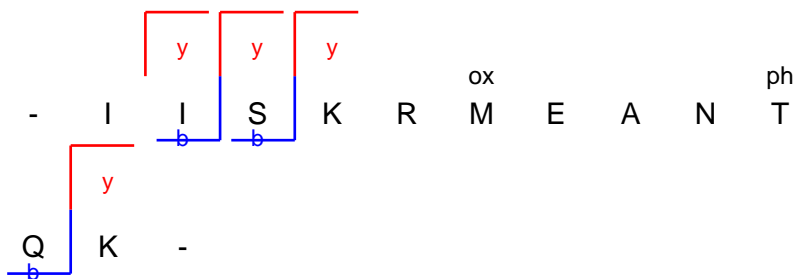
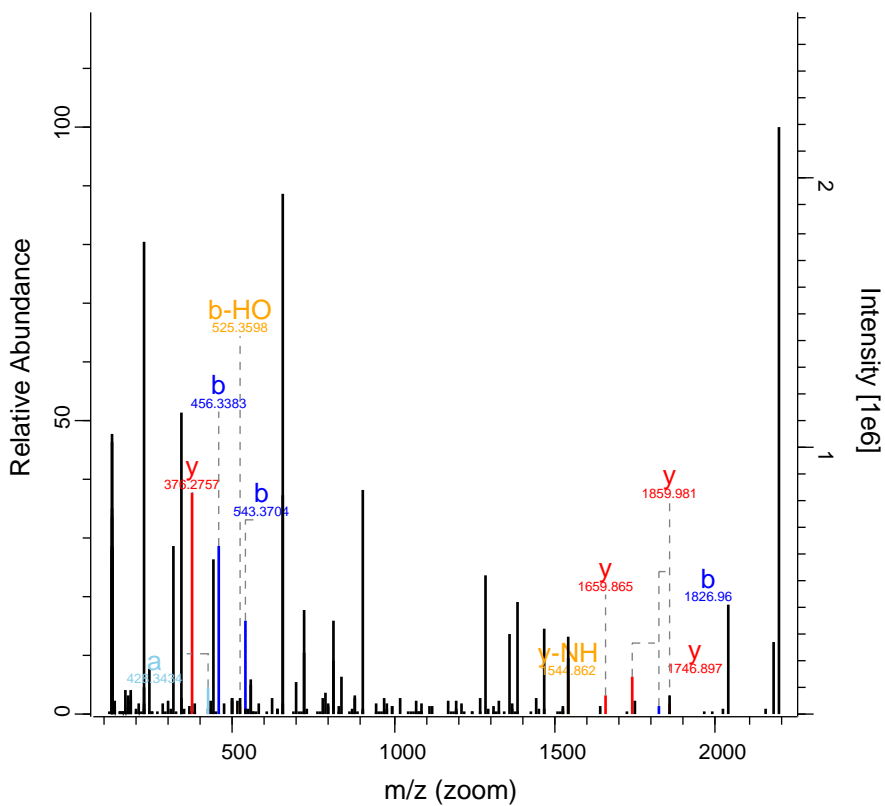

RO-QC-160121_ZackD_SS_Set_02_Fractic 29405 FTMS; HC 69.59 1255.17 CENPF

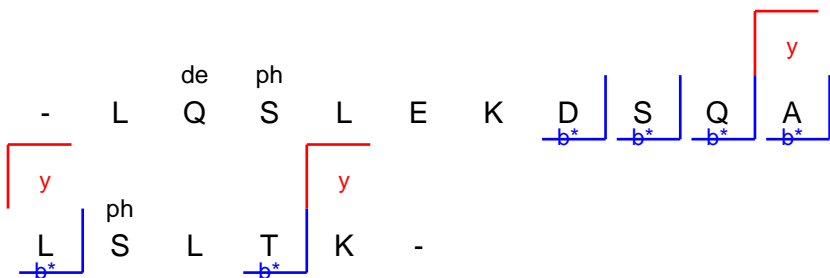
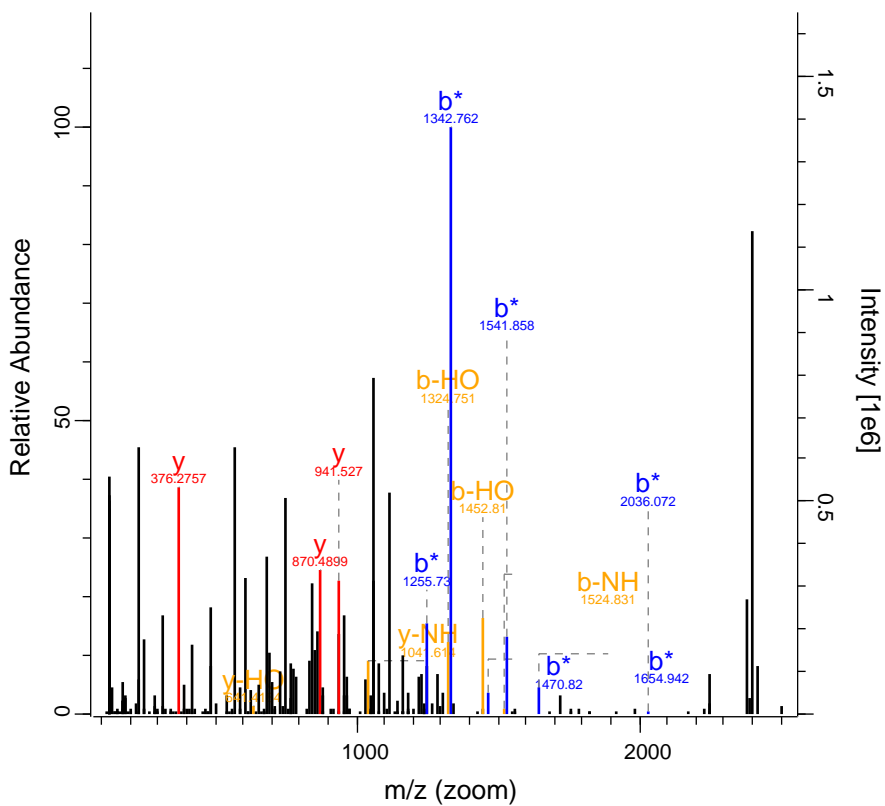

RO-QC-160121_ZackD_SS_Set_02_Fractic 30354 FTMS; HC 64.44 1383.24 CCDC158

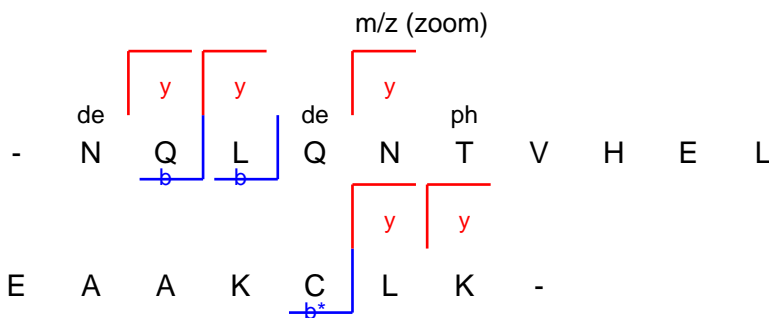
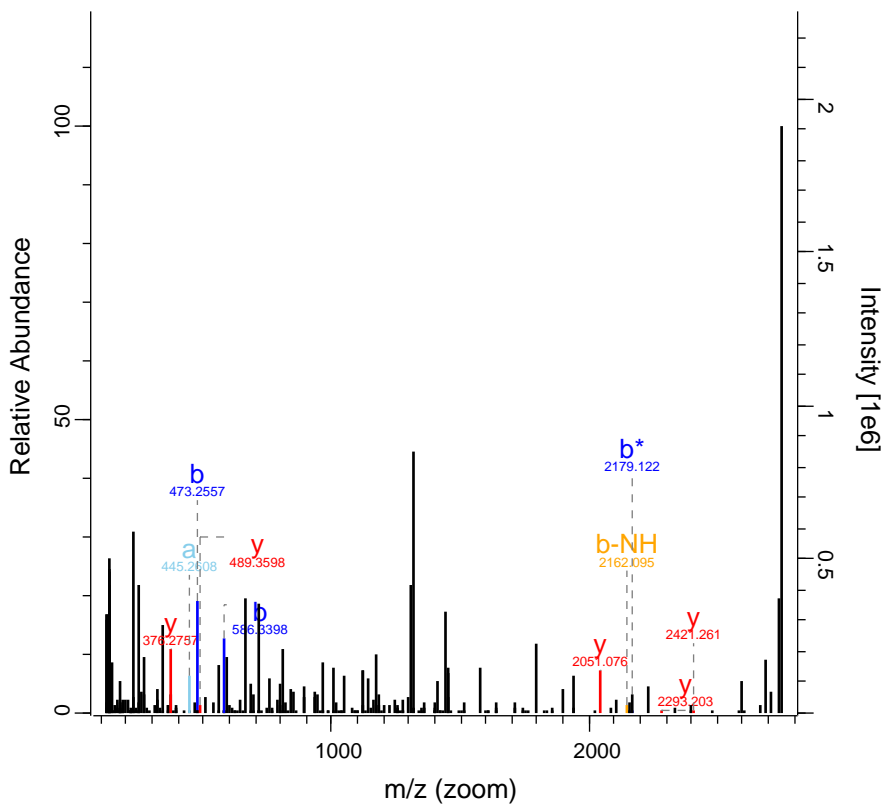

RO-QC-160121_ZackD_SS_Set_02_Fraction 31295 FTMS; HC 49.42 736.36 RRBP1

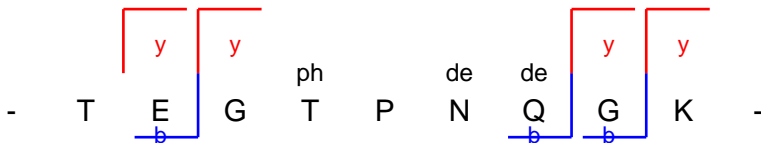
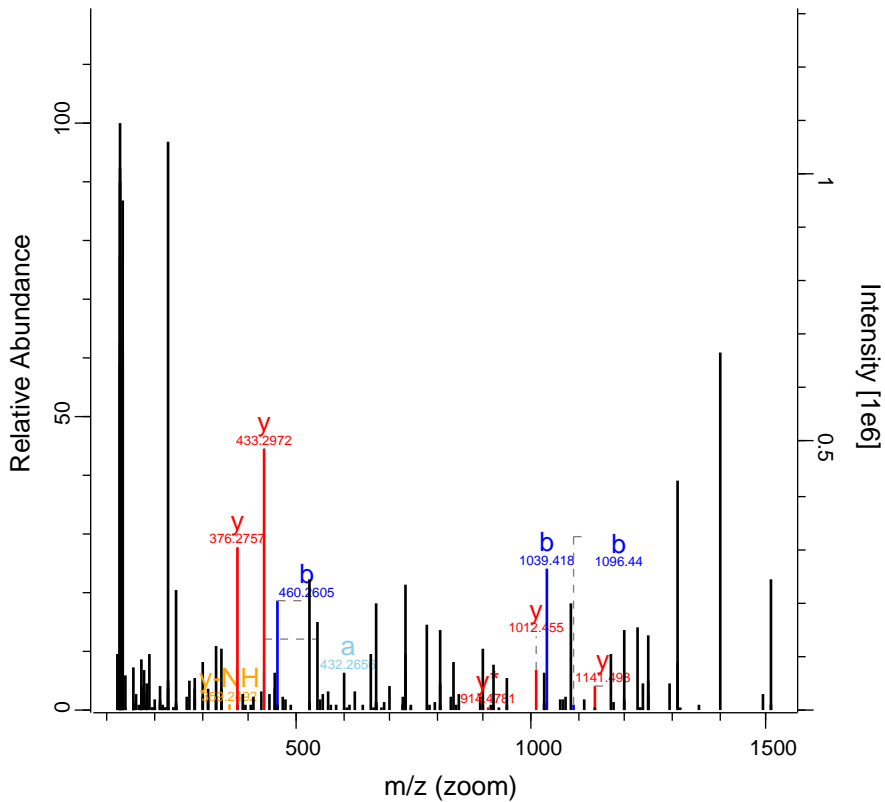

RO-QC-160121_ZackD_SS_Set_02_Fraction 32475 FTMS; HCl45.7 821.2 MMP1

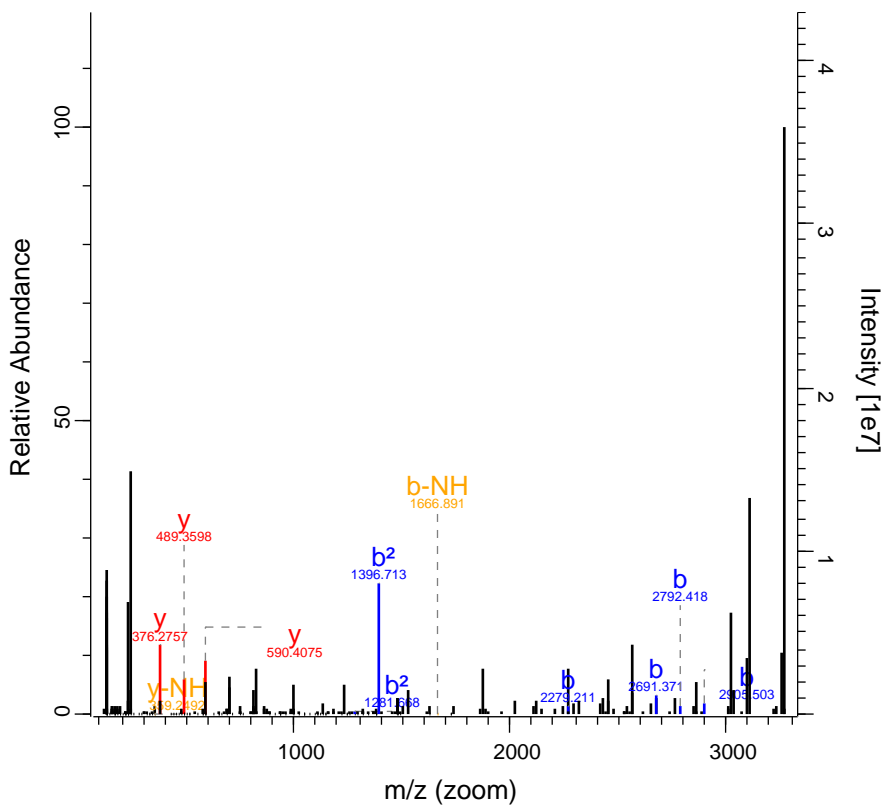

	de	ox								
-	Q	M	Q	E	F	F	G	L	K	V
ph										
T	G	K	P	D	A	E	T	L	K	-
		<u>b</u>			<u>b²</u>	<u>b</u>	<u>b</u>	<u>b</u>	<u>b</u>	
							y	y	y	

RO-QC-160121_ZackD_SS_Set_02_Fraction 32680 FTMS; HCl 47.2 821.2 TRMT44

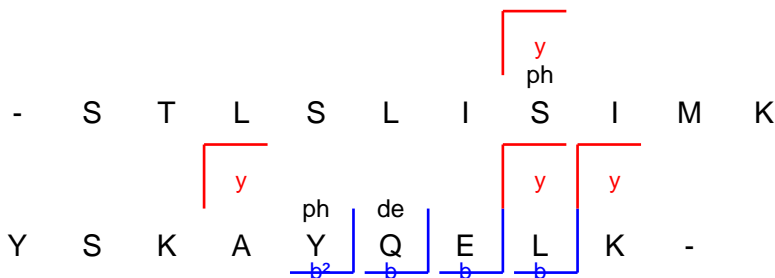
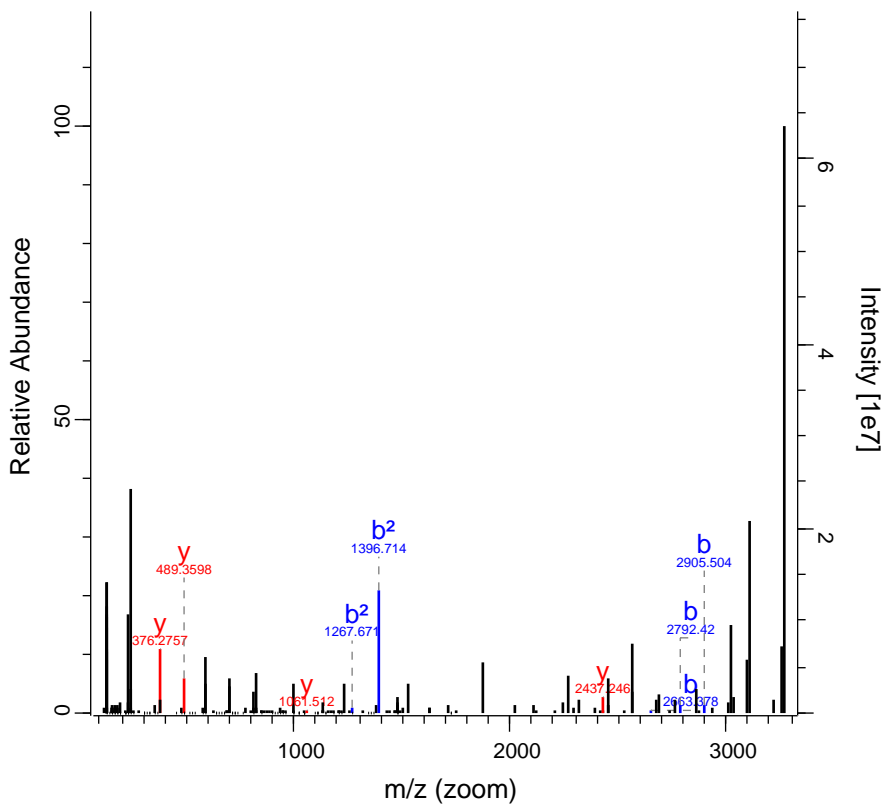

RO-QC-160121_ZackD_SS_Set_02_Fractic 33319 FTMS; HC 177.04 1190.12 RSL1D1

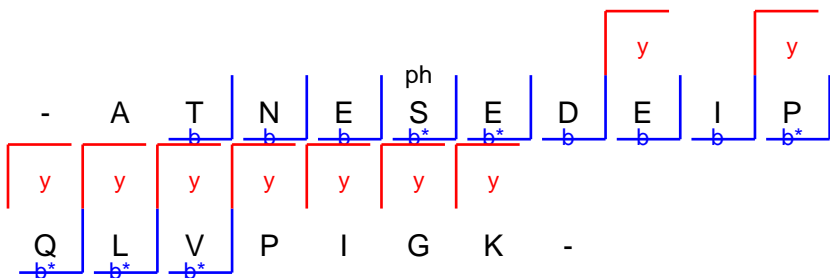
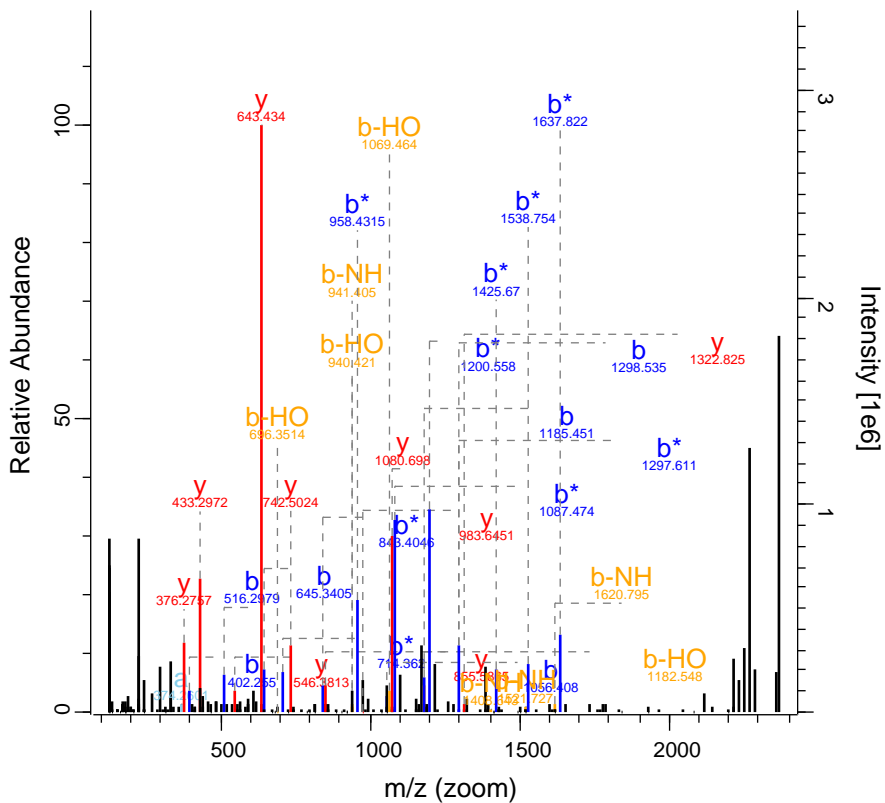

RO-QC-160121_ZackD_SS_Set_02_Fractic 36911 FTMS; HC 80.23 1081.62 C6

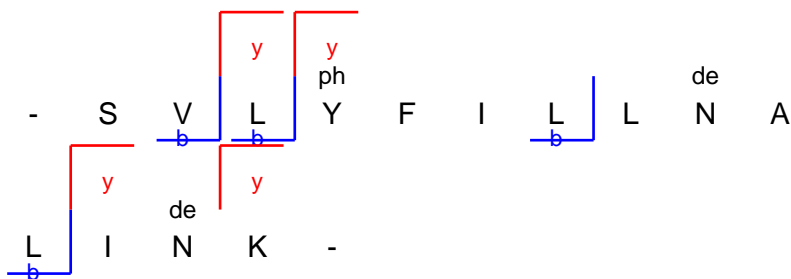
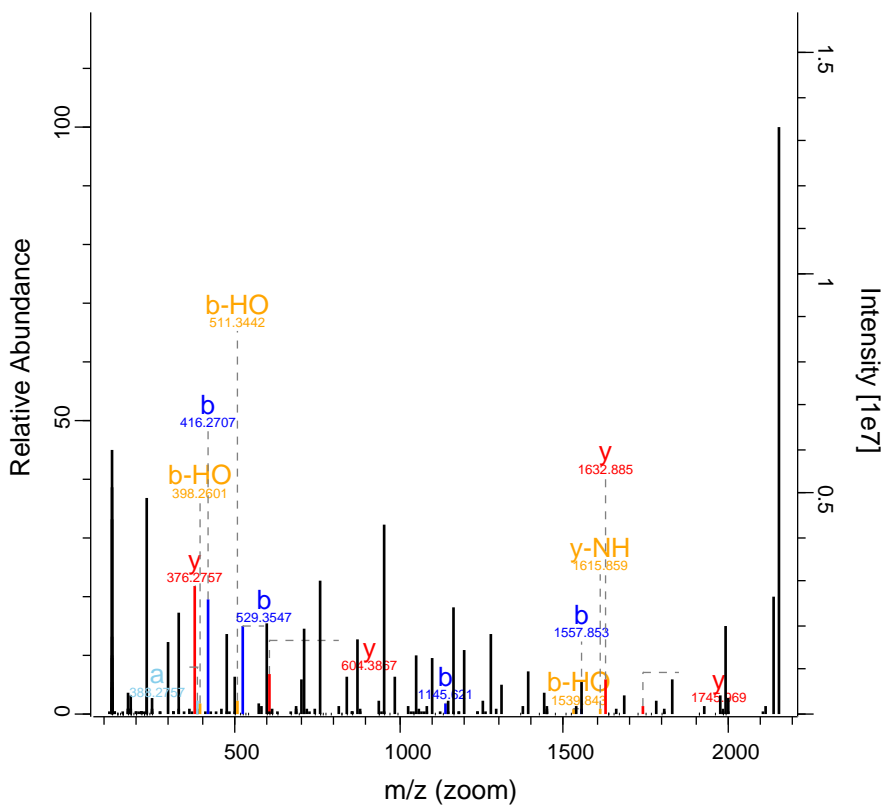

RO-QC-160121_ZackD_SS_Set_02_Fractic 37470 FTMS; HC 111.82 1028.59 ZKSCAN2

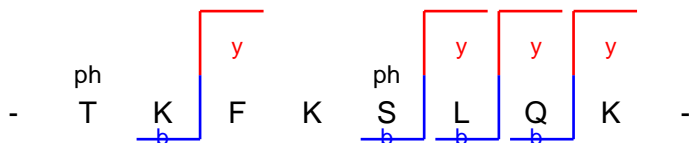
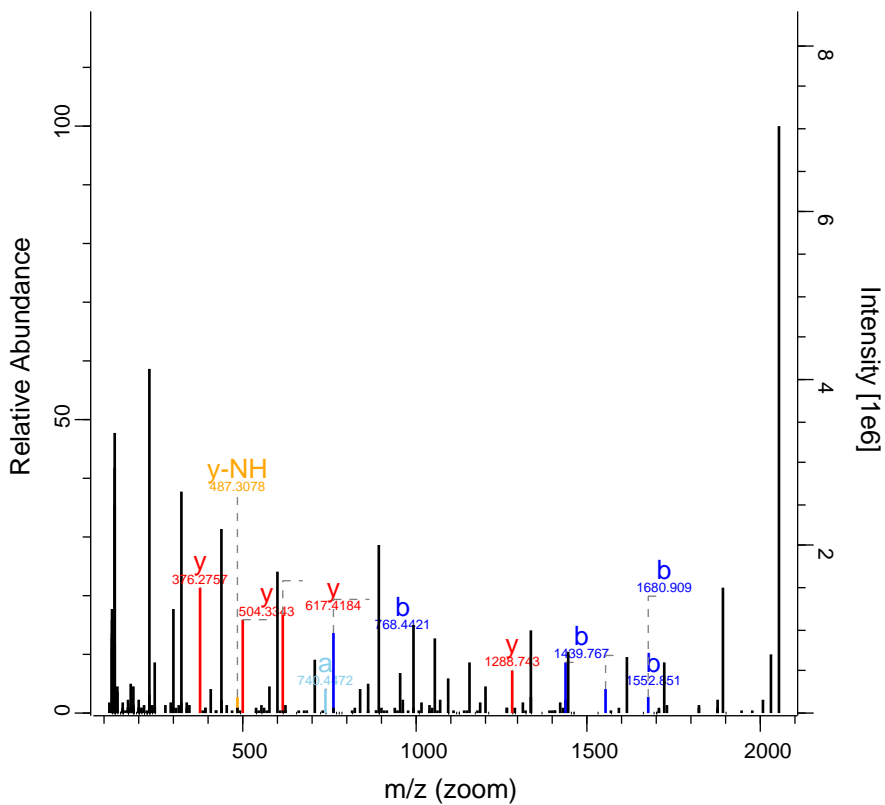

RO-QC-160121_ZackD_SS_Set_02_Fraction 38420 FTMS; HC 48.7 680.87 ASXL3

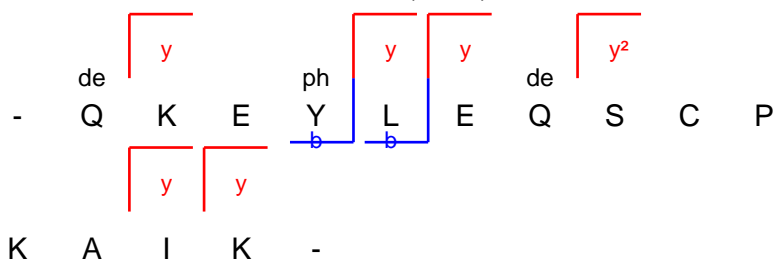
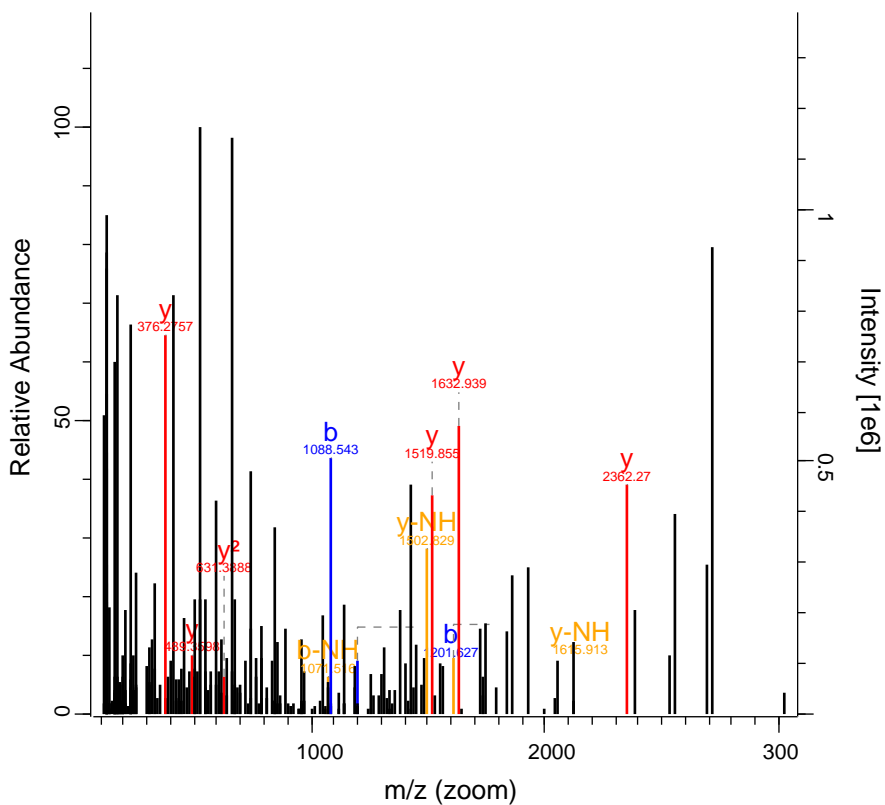

RO-QC-160121_ZackD_SS_Set_02_Fraction 39528 FTMS; HC 48.64 995.93 TRIM24

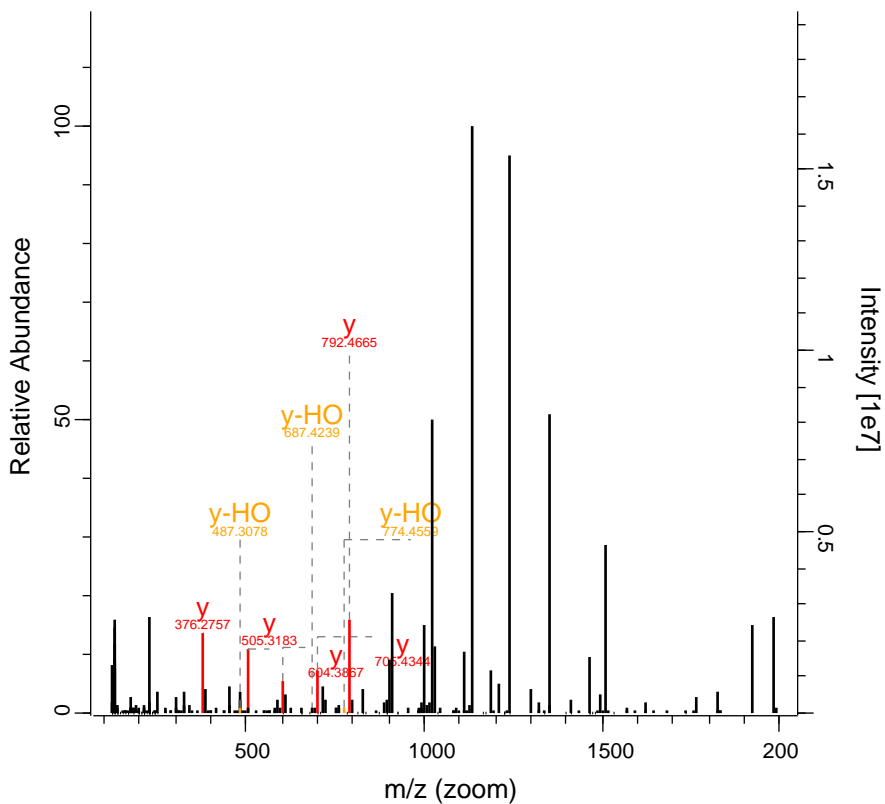

Fragmentation diagram showing the sequence of amino acids: E, D, T, T, E, V, P, S, S, T, V. The diagram includes labels for the amino acids and their corresponding fragmentation types (y, y-HO) indicated by red boxes and lines.

Fragmentation types (y, y-HO) are indicated by red boxes and lines above the amino acid sequence.

Fragmentation types (y, y-HO) are indicated by red boxes and lines below the amino acid sequence.

Fragmentation types (y, y-HO) are indicated by red boxes and lines below the amino acid sequence.

RO-QC-160121_ZackD_SS_Set_02_Fraction 4329 FTMS; HC 92.86 741.82 SORBS3

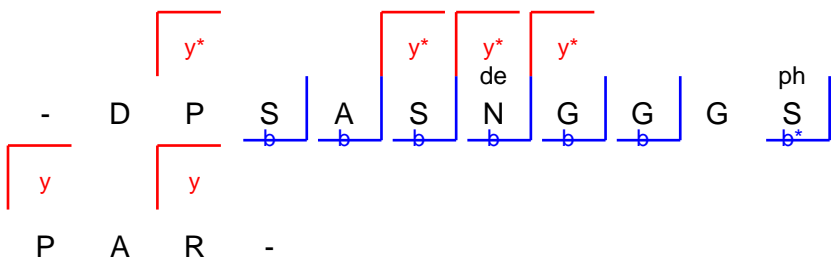
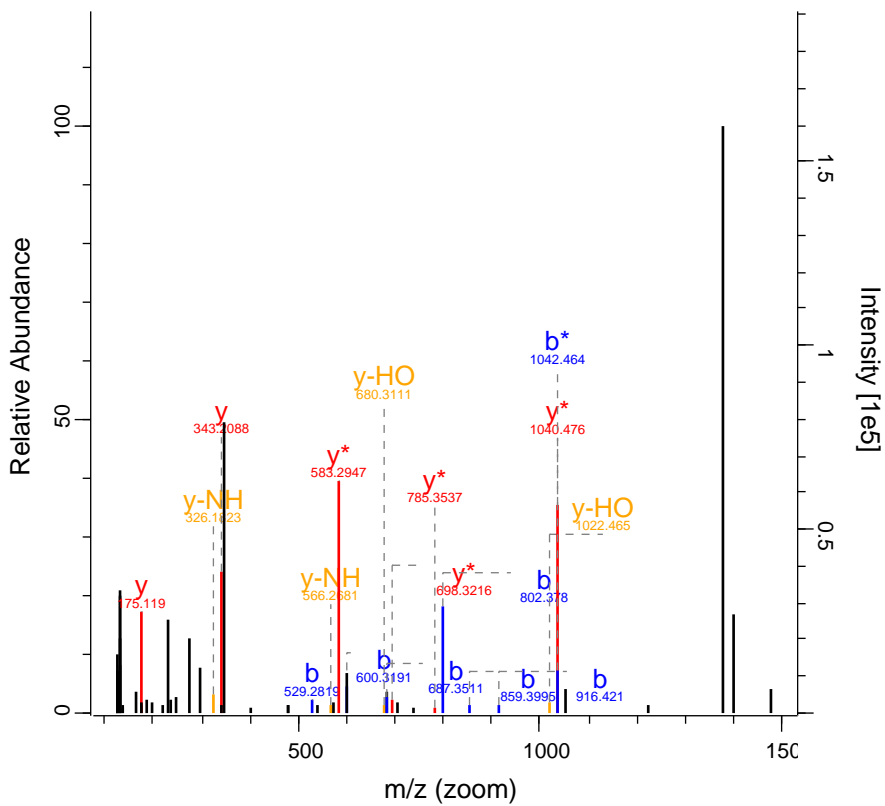

RO-QC-160121_ZackD_SS_Set_02_Fraction 4394 FTMS; HC 47.55 623.28 BCKDK

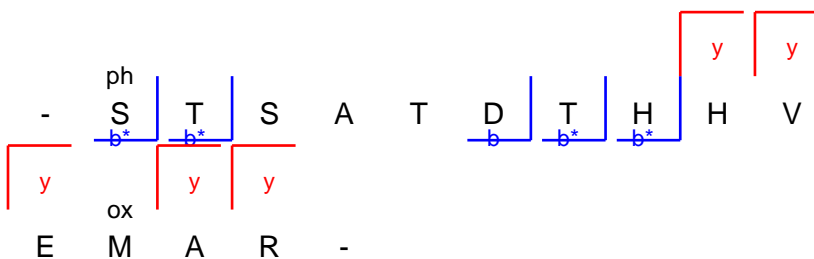
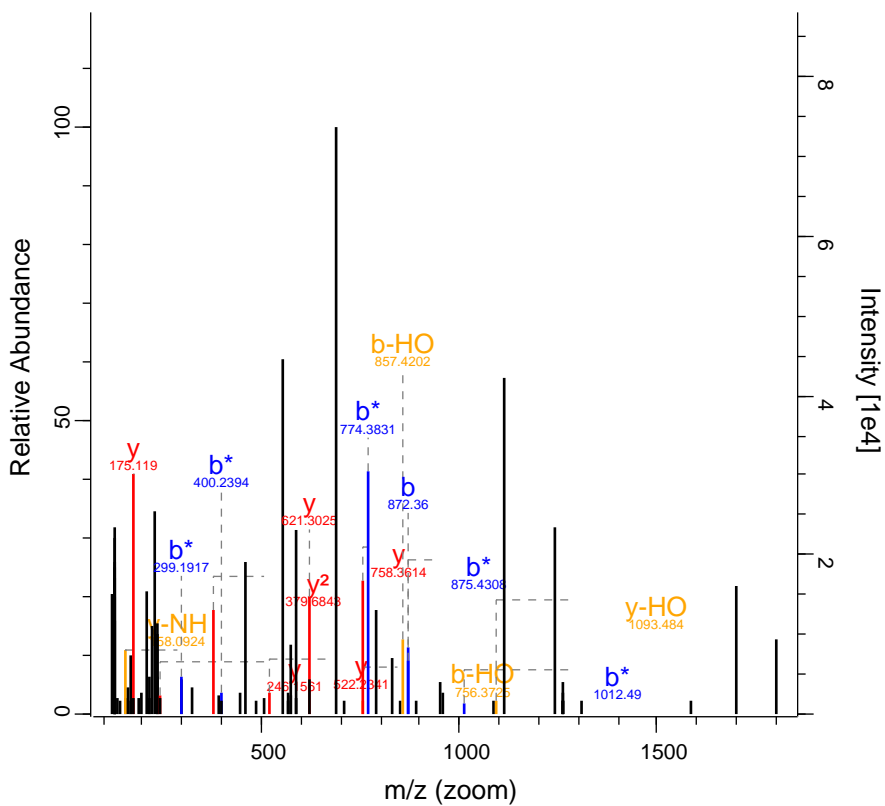

RO-QC-160121_ZackD_SS_Set_02_Fraction 4418 FTMS; HC 51.22 589.62 GYS1

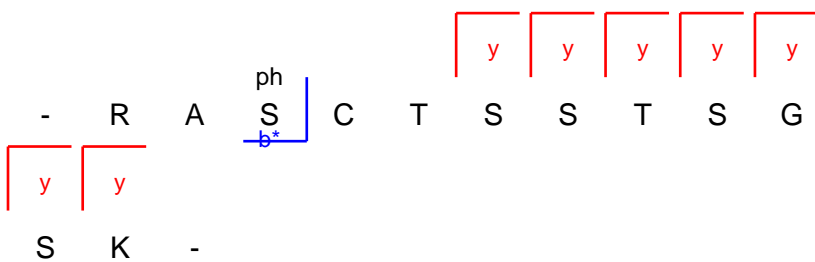
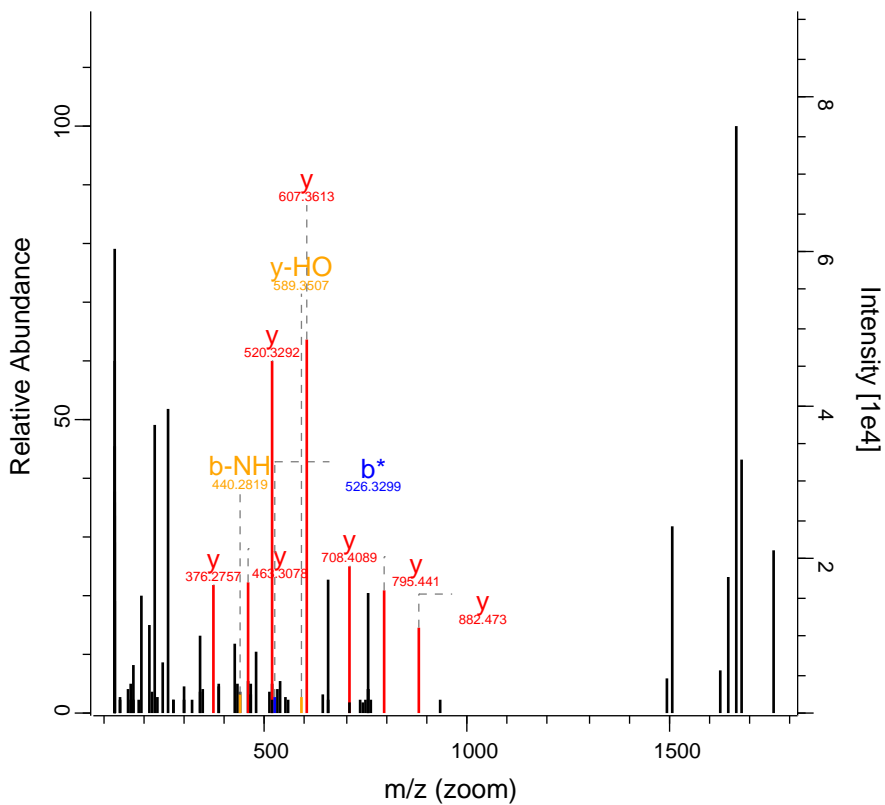

RO-QC-160121_ZackD_SS_Set_02_Fraction 5008 FTMS; HC 105.03 476.88 RBM15B

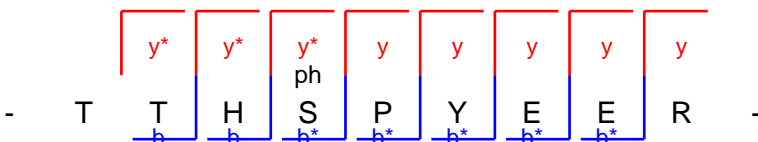
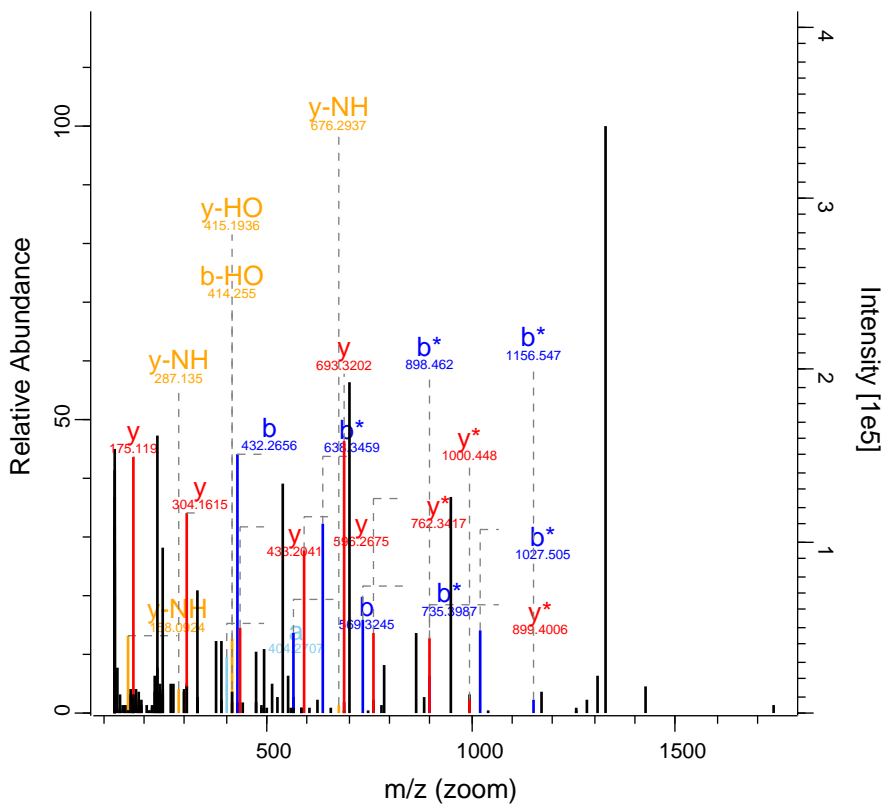

RO-QC-160121_ZackD_SS_Set_02_Fraction 5948 FTMS; HC 133.94 686.34 LMNA

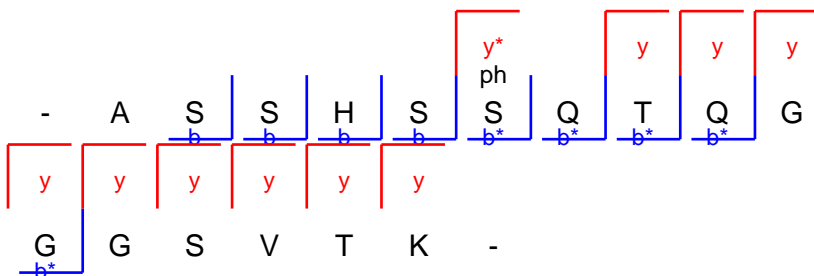
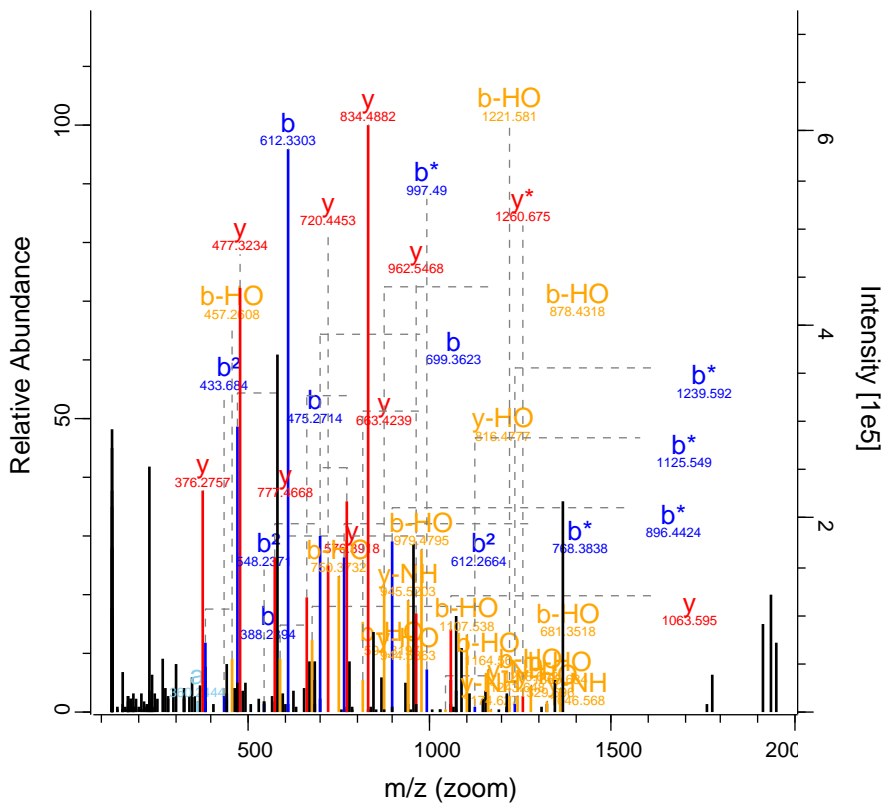

RO-QC-160121_ZackD_SS_Set_02_Fraction 6031 FTMS; HC 207.34 866.93 PRRC2C

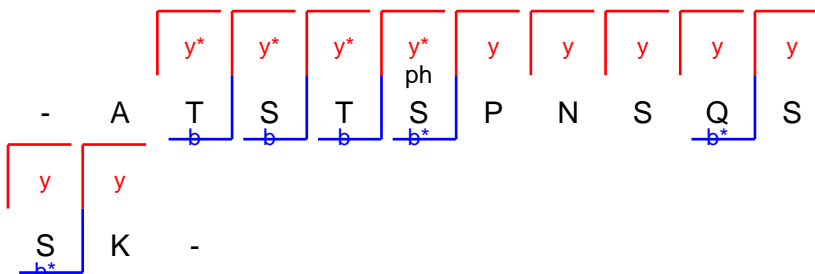
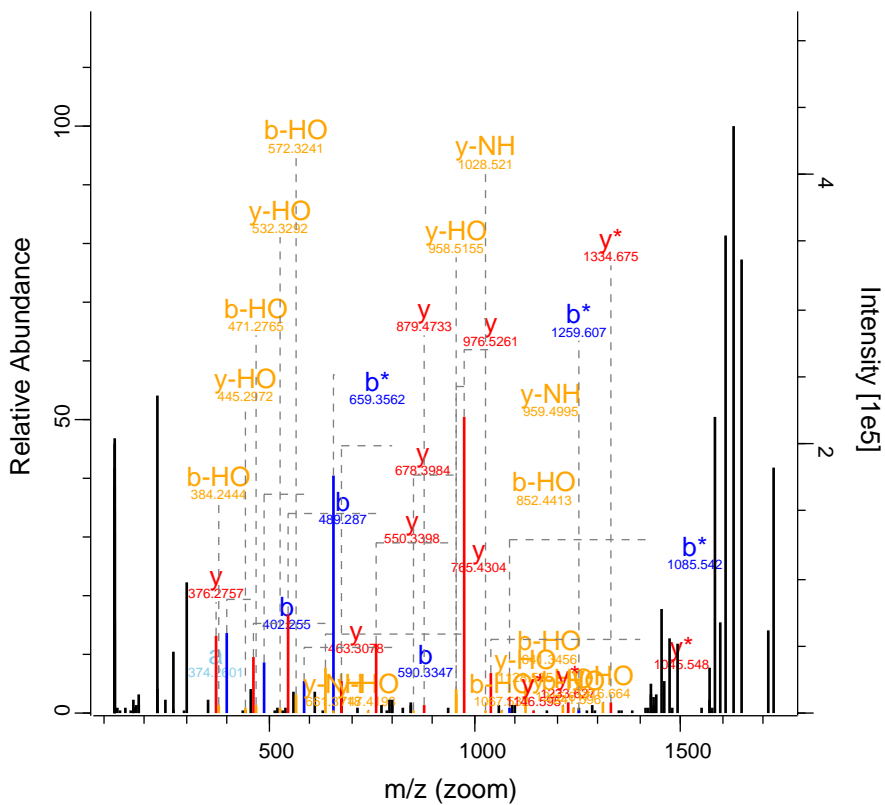

RO-QC-160121_ZackD_SS_Set_02_Fraction 6041 FTMS; HC 64.8 578.29 PRRC2C

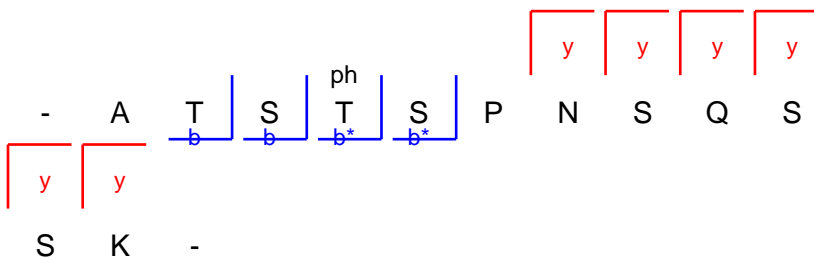
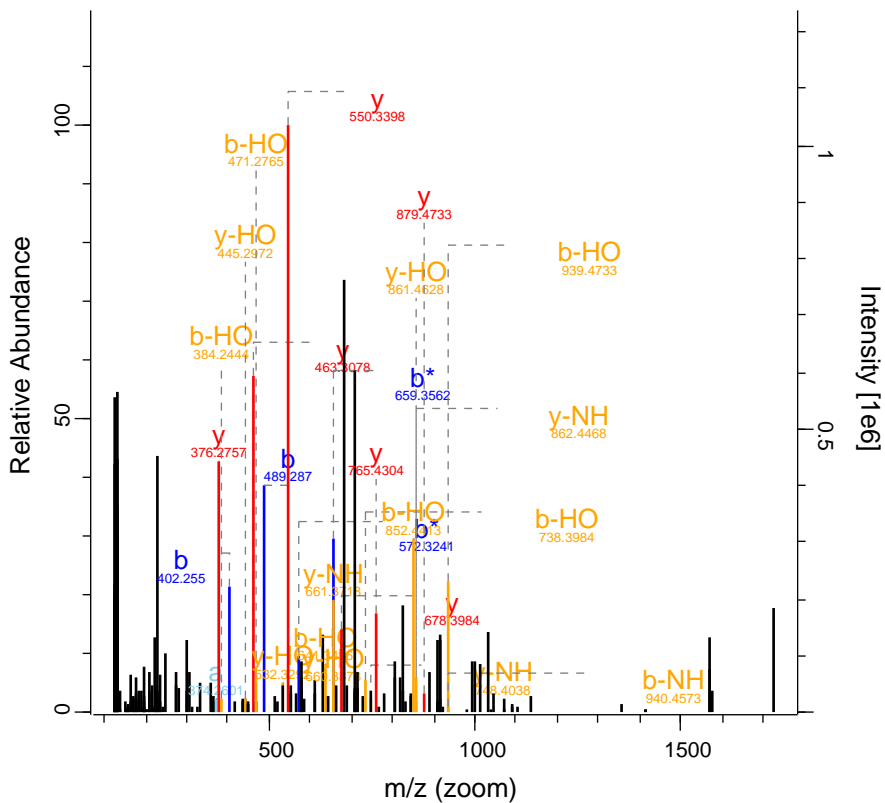

RO-QC-160121_ZackD_SS_Set_02_Fraction 6254 FTMS; HC 213.72 840.06 UFL1

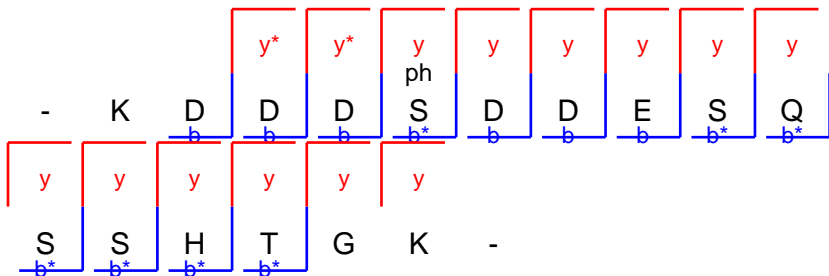
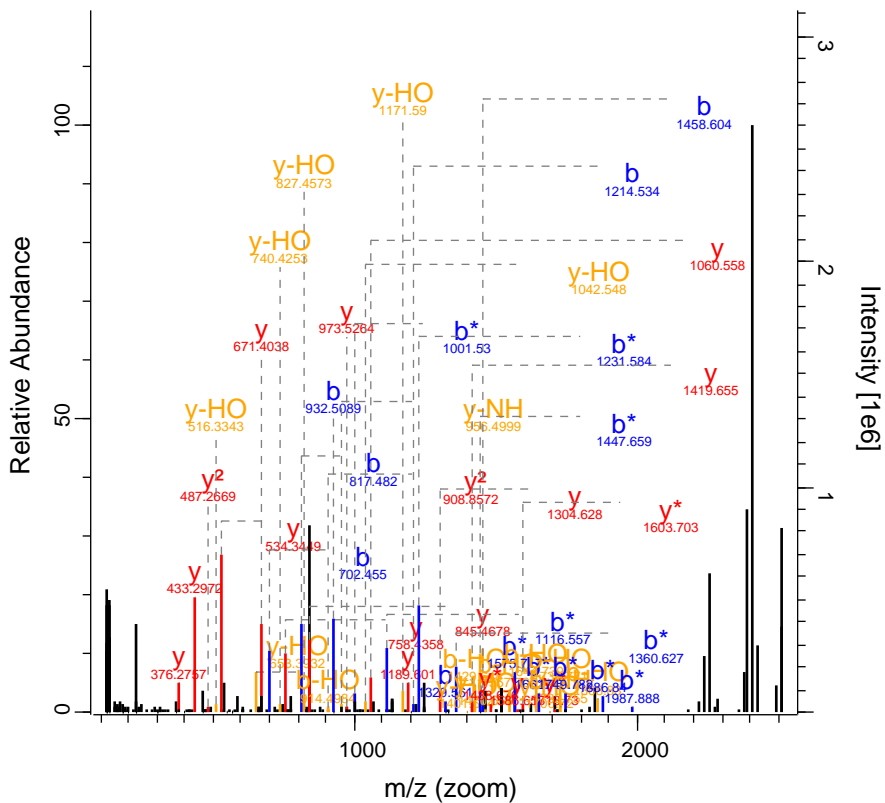

RO-QC-160121_ZackD_SS_Set_02_Fraction 6932 FTMS; HC 131.83 788.91 CAP2

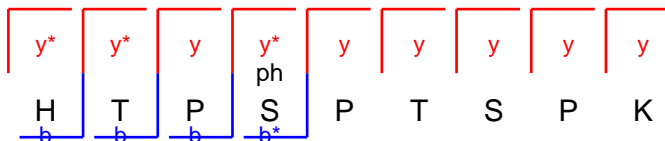
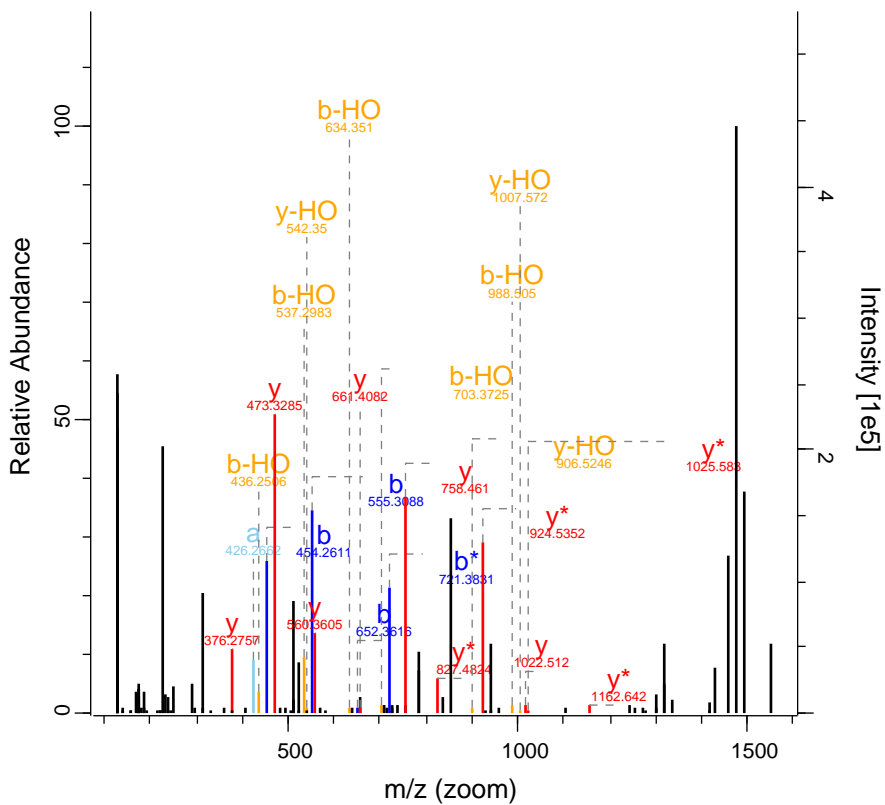

RO-QC-160121_ZackD_SS_Set_02_Fraction 7498 FTMS; HC 119.53 788.91 CAP2

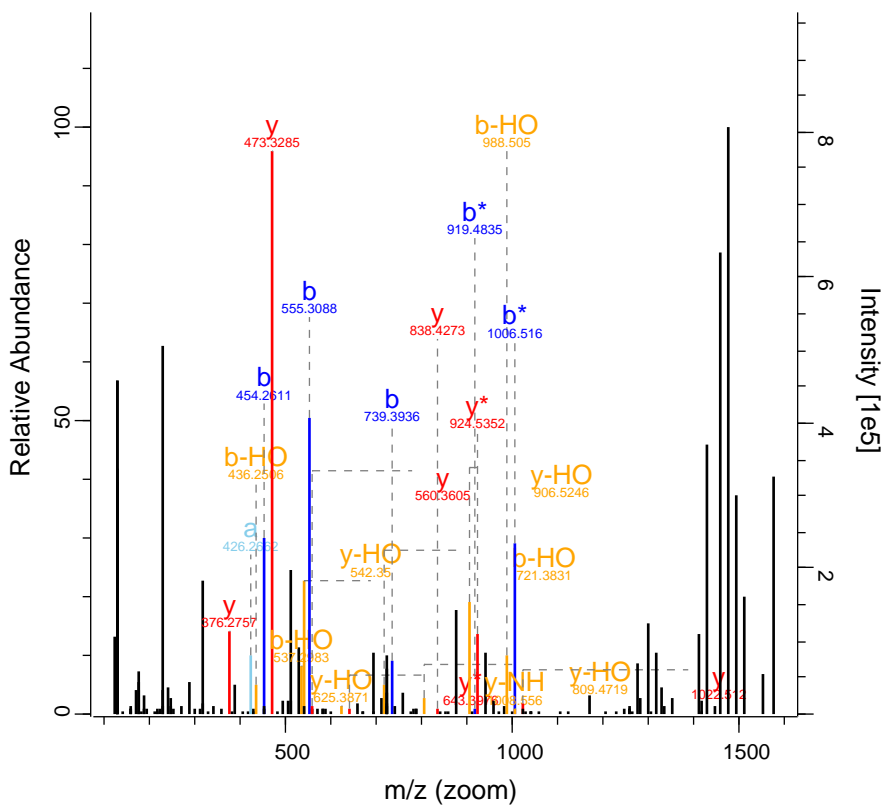

m/z (zoom)

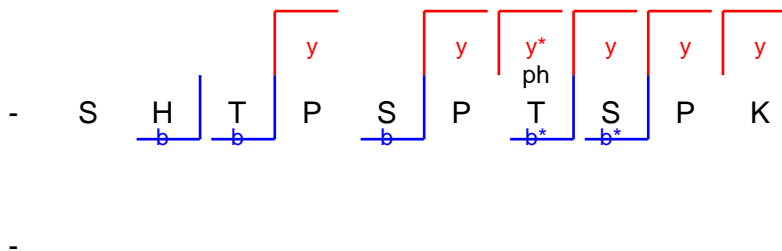

RO-QC-160121_ZackD_SS_Set_02_Fraction 8238 FTMS; HC 75.1 548.64 LRRC1

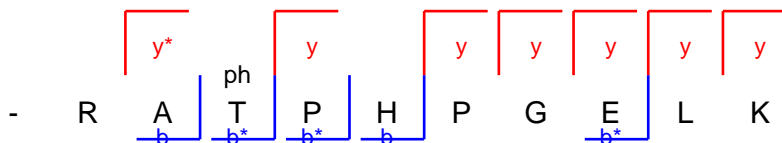
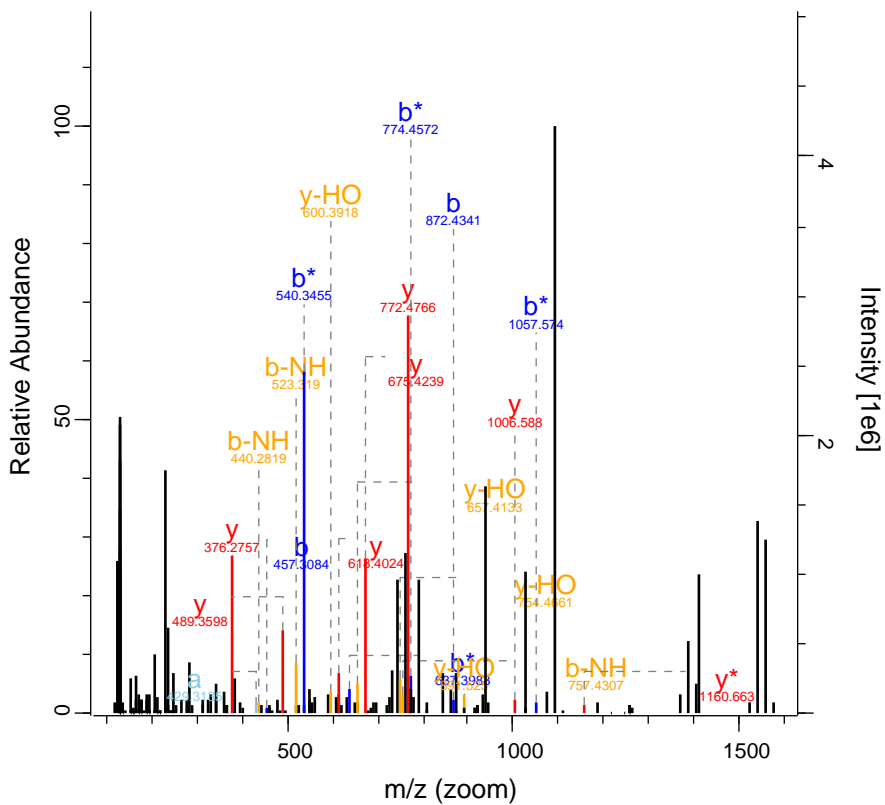

RO-QC-160121_ZackD_SS_Set_02_Fraction10784 FTMS; HC 55.72 647.05 PRPF4B

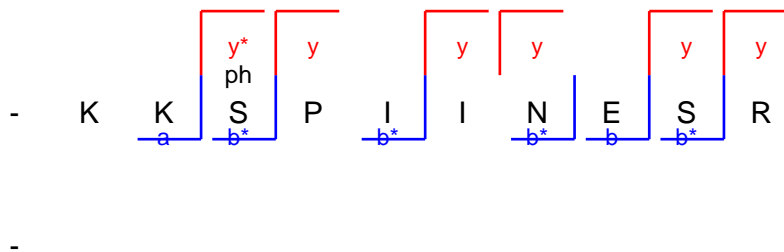
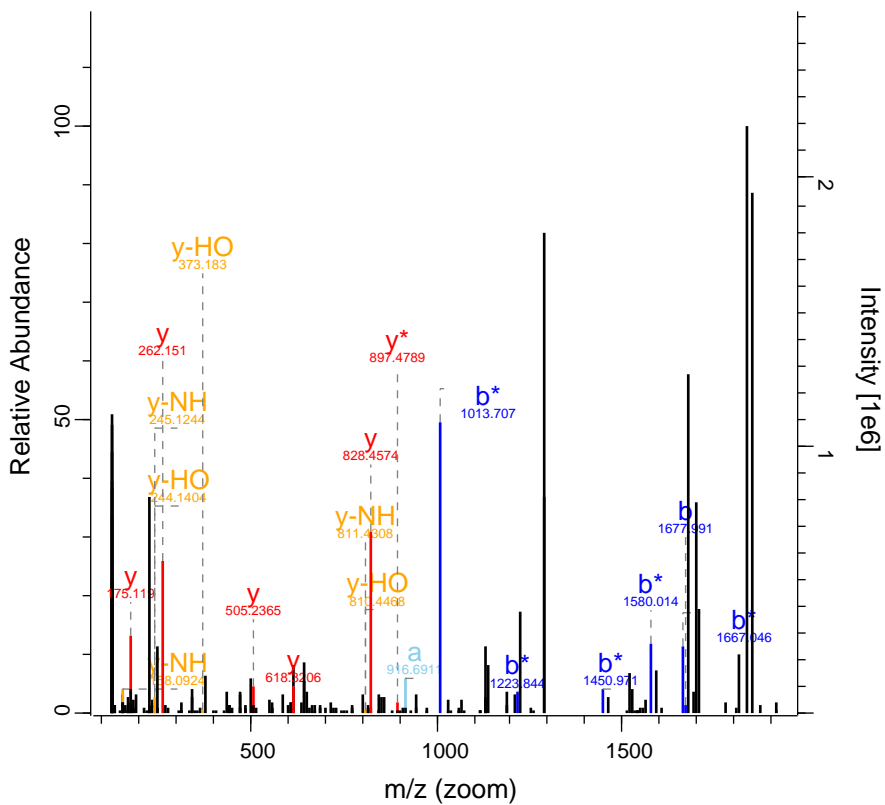

RO-QC-160121_ZackD_SS_Set_02_Fraction12062 FTMS; HC 106.3 988.01 MLLT4

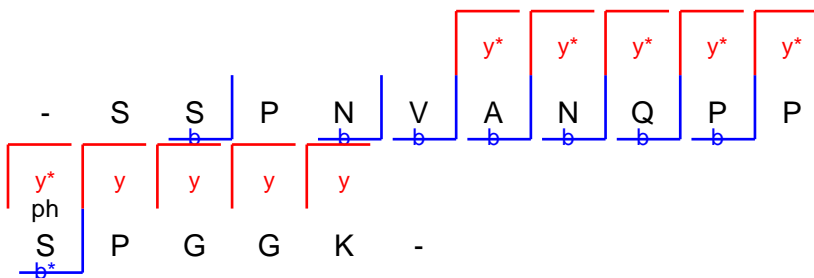
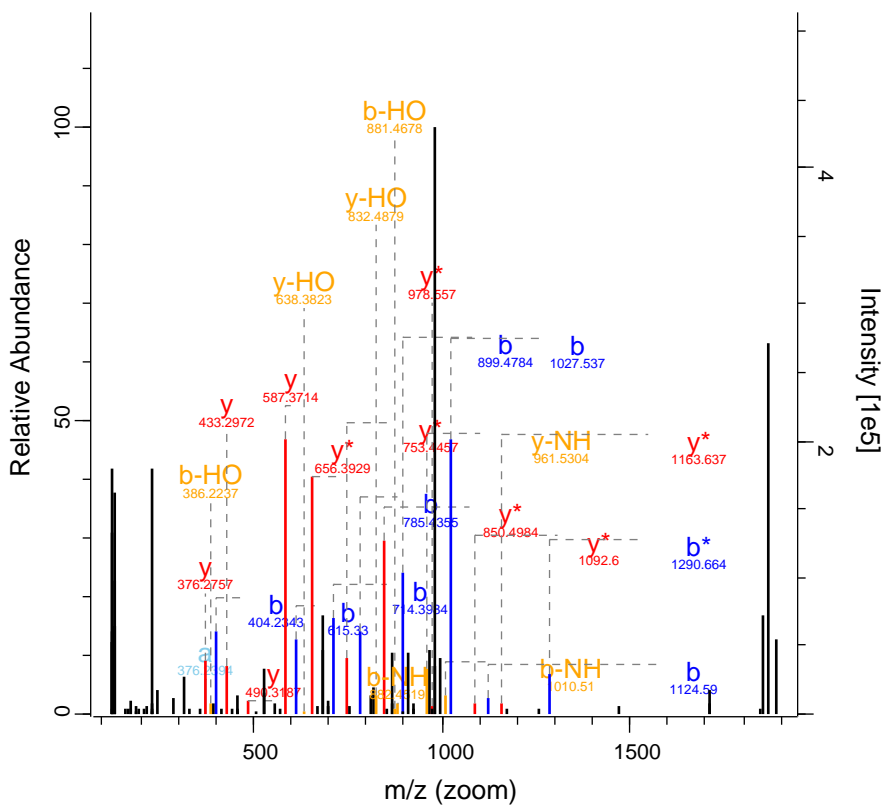

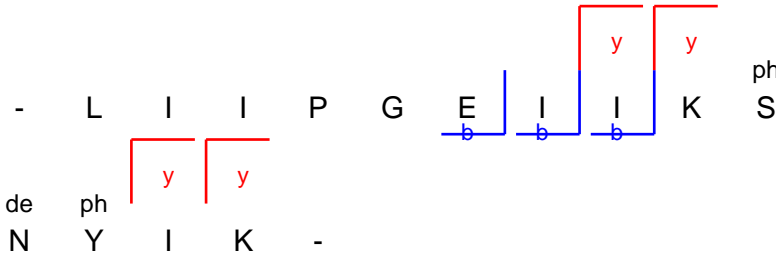
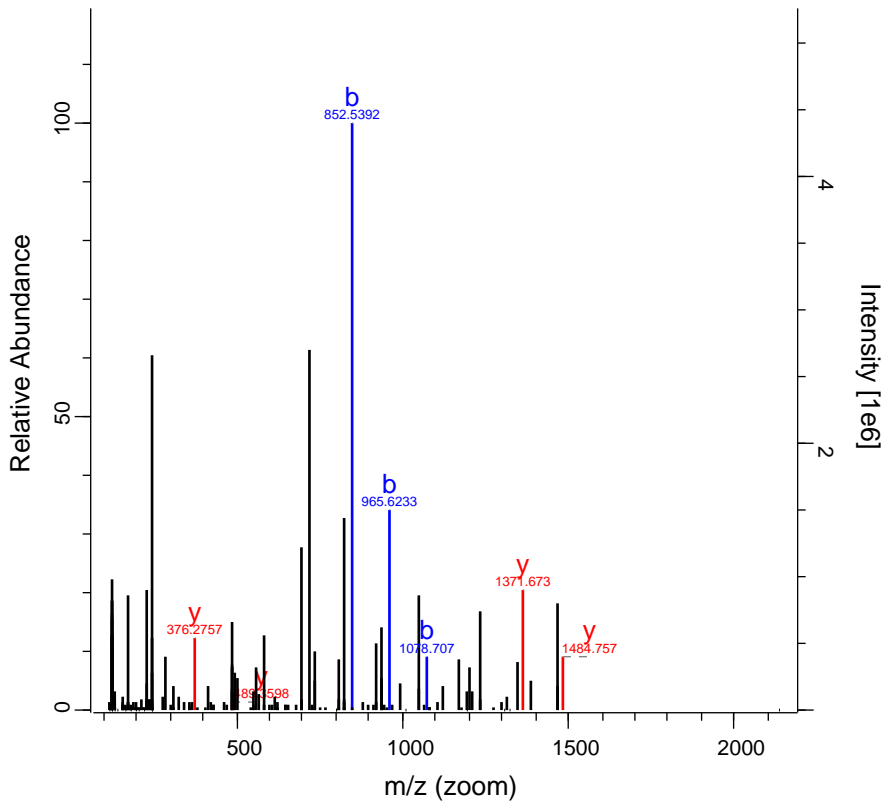

de ph
N Y I K -

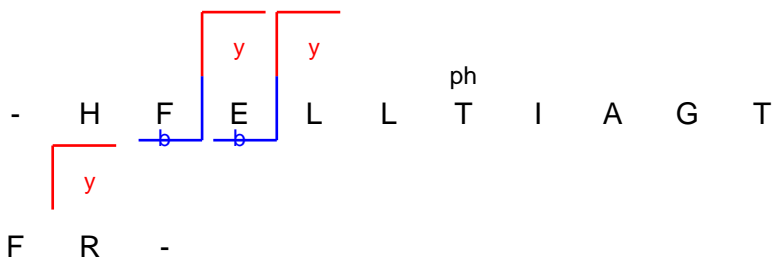
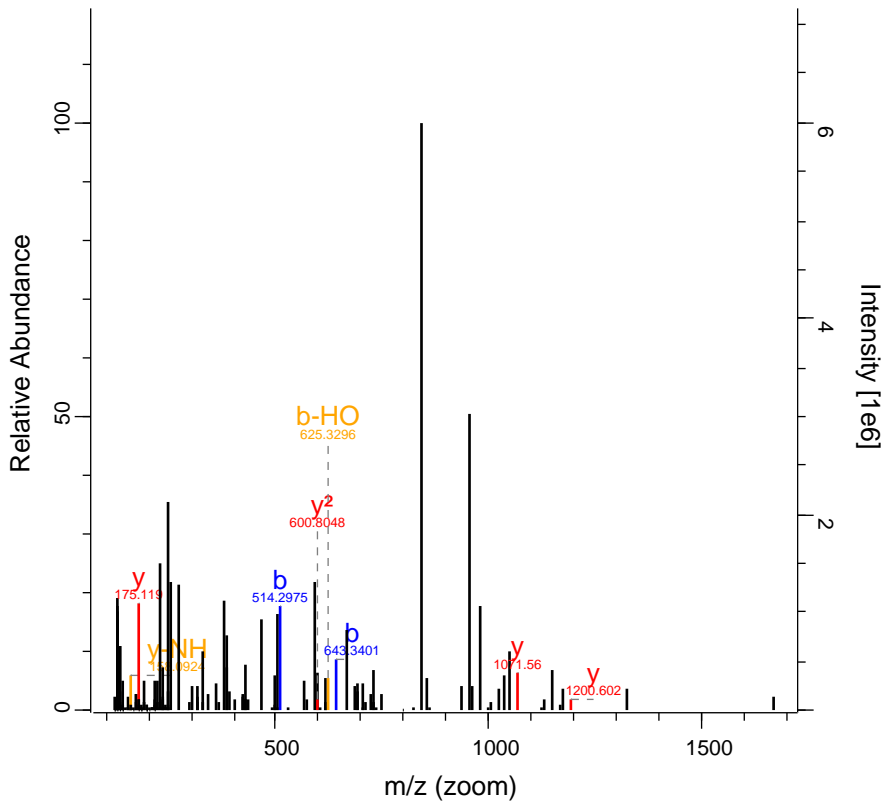

RO-QC-160121_ZackD_SS_Set_02_Fraction15370 FTMS; HC 101.49 748.12 SRSF11

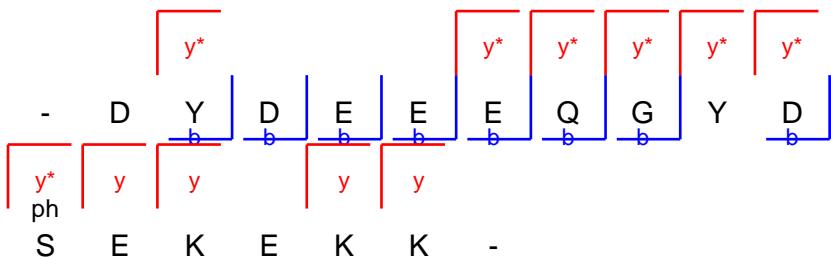
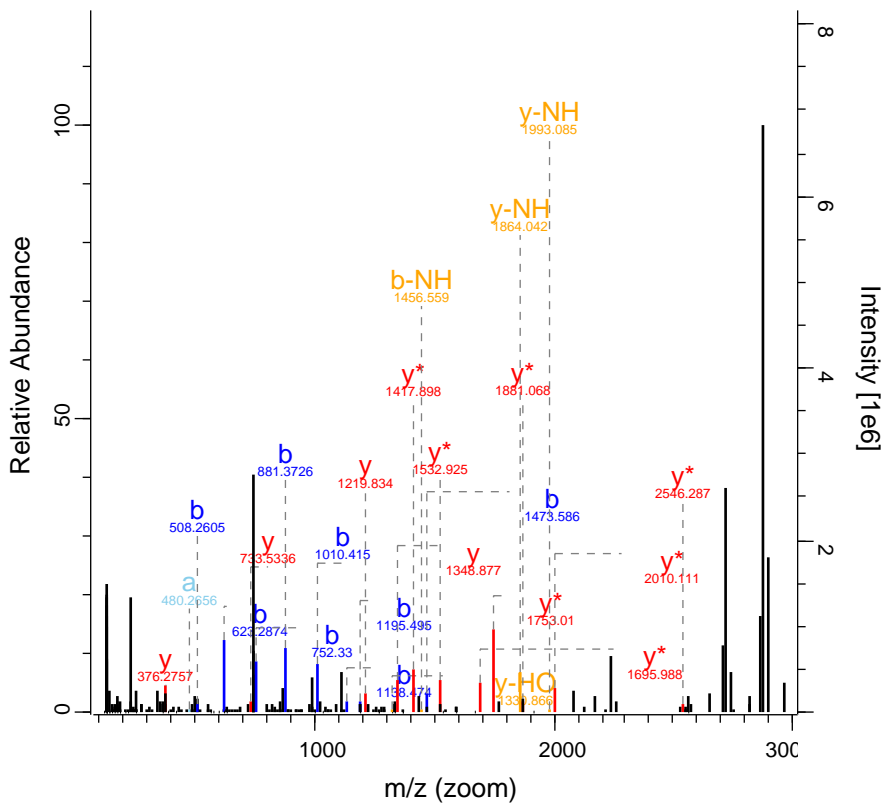

RO-QC-160121_ZackD_SS_Set_02_Fraction16477 FTMS; HC 62.82 649.59 TNIK

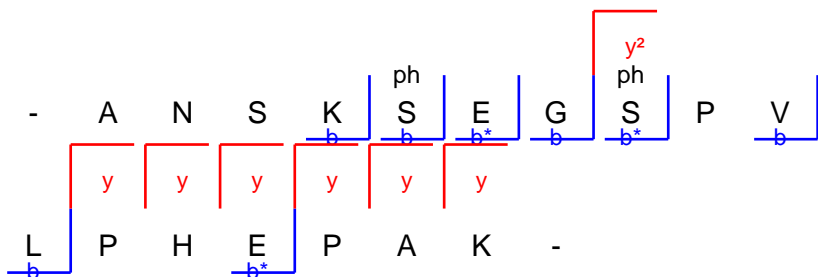
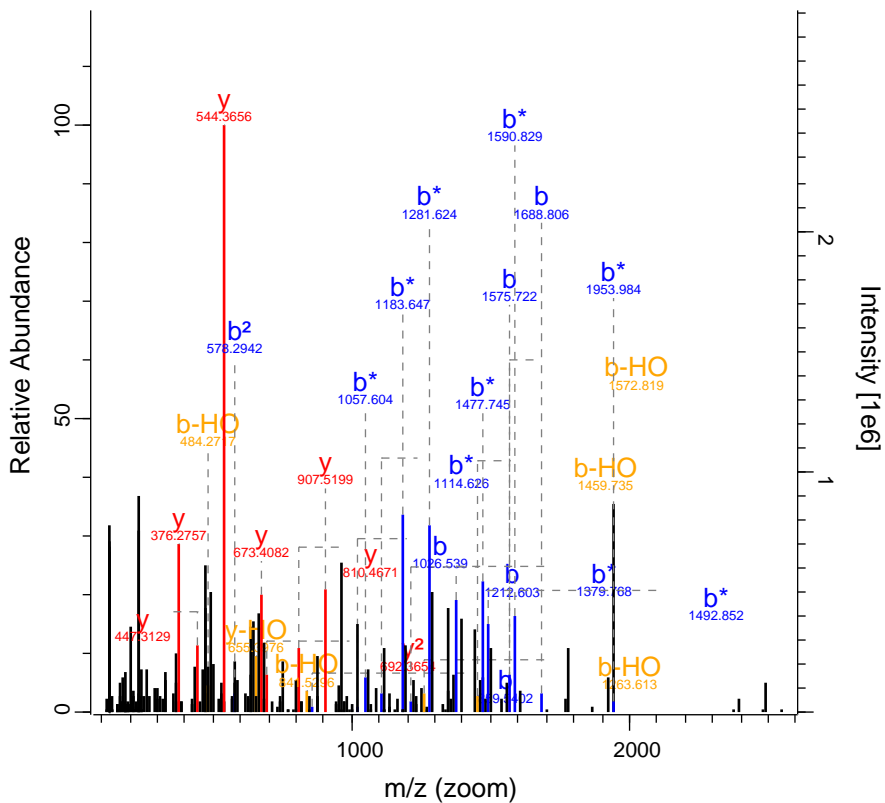

RO-QC-160121_ZackD_SS_Set_02_Fraction 16714 FTMS; HC 52.72 894.97 SYNE2

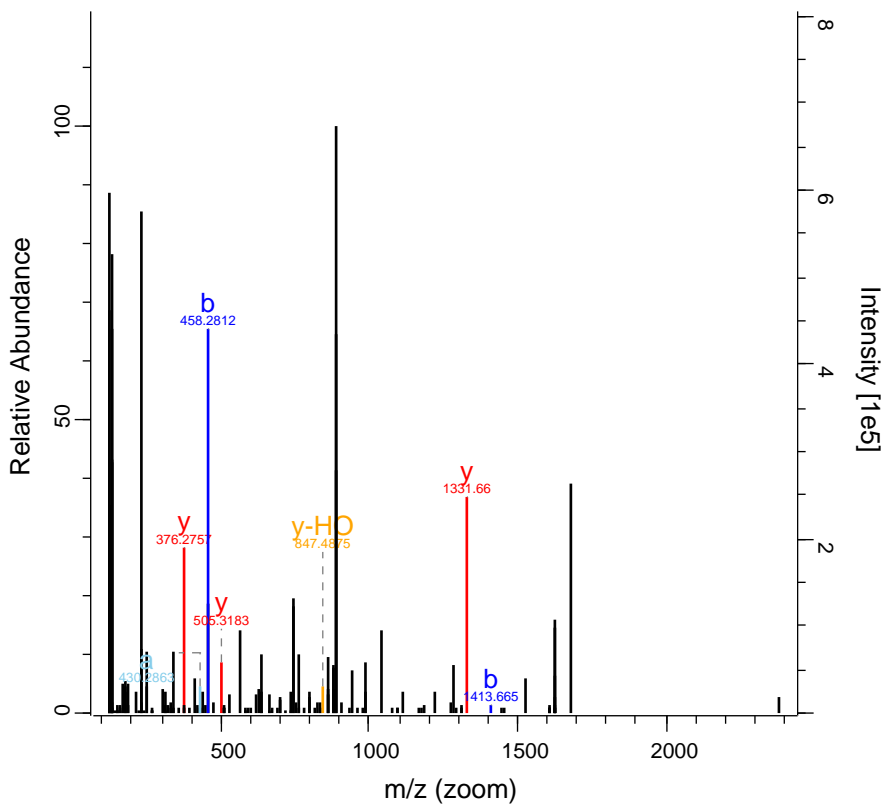

RO-QC-160121_ZackD_SS_Set_02_Fraction16811 FTMS; HC 194.68 980.53 SCAF8

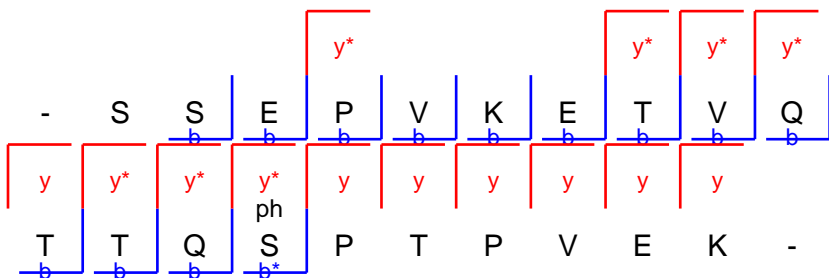
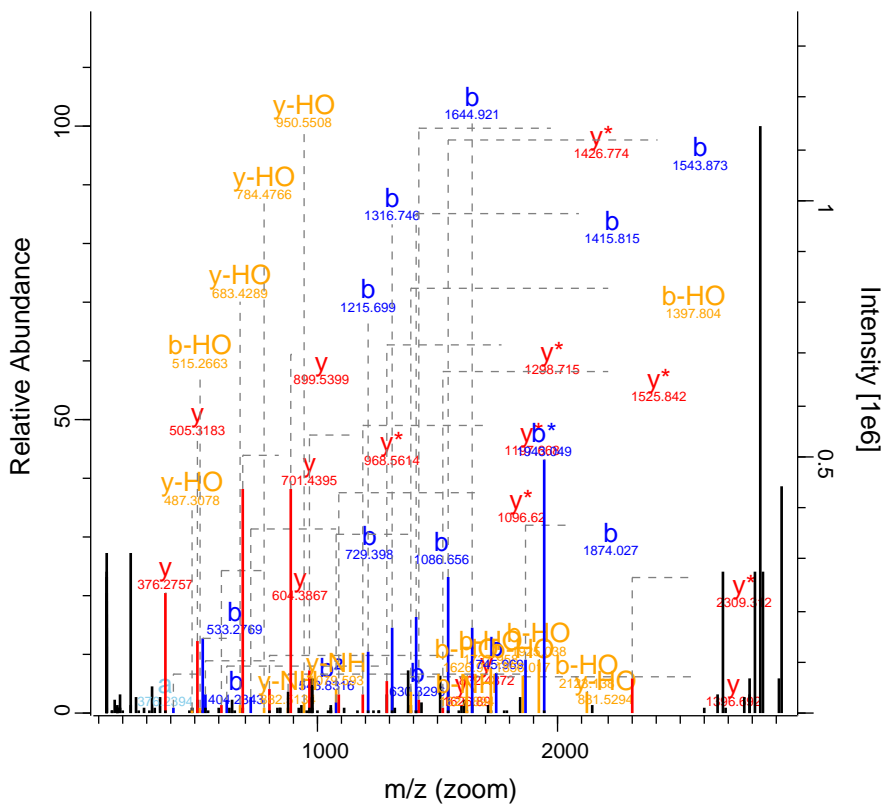

RO-QC-160121_ZackD_SS_Set_02_Fraction 17239 FTMS; HC 46.61 1157.6 JARID2

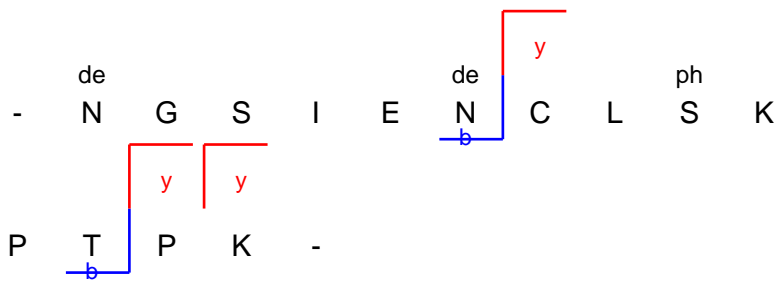
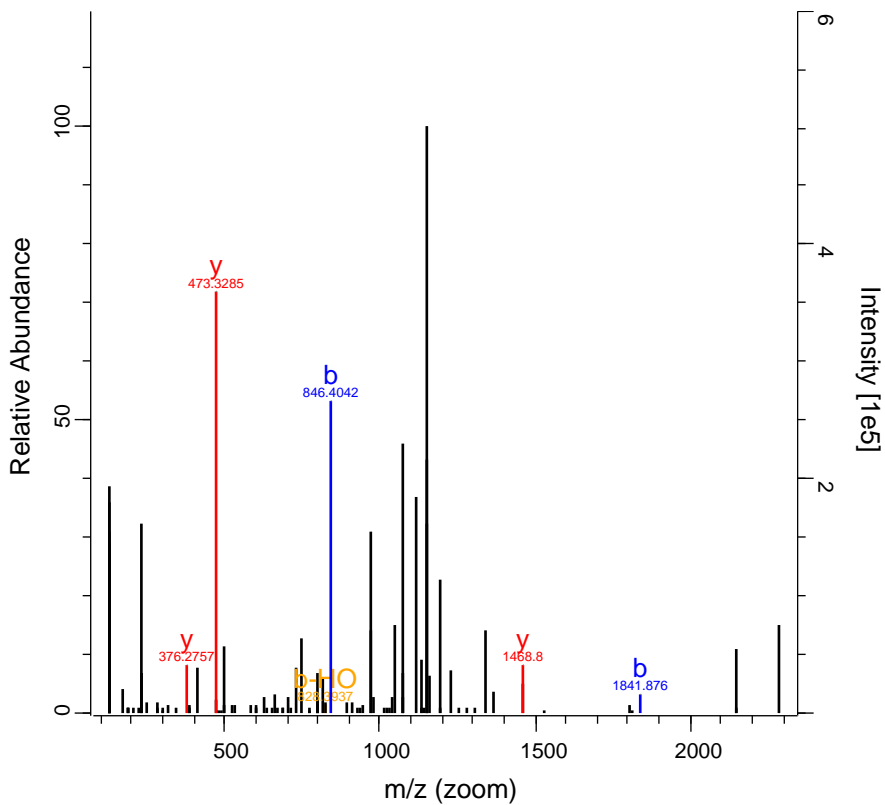

RO-QC-160121_ZackD_SS_Set_02_Fraction17902 FTMS; HC 69.03 939.51 WAPAL

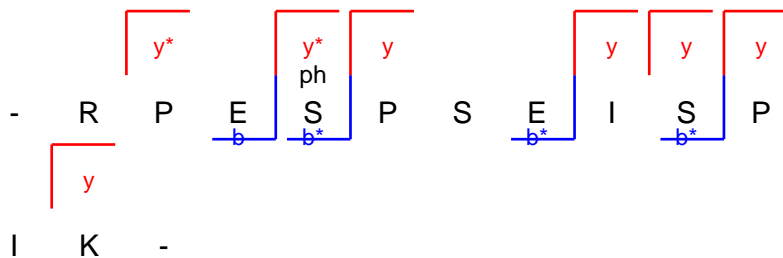
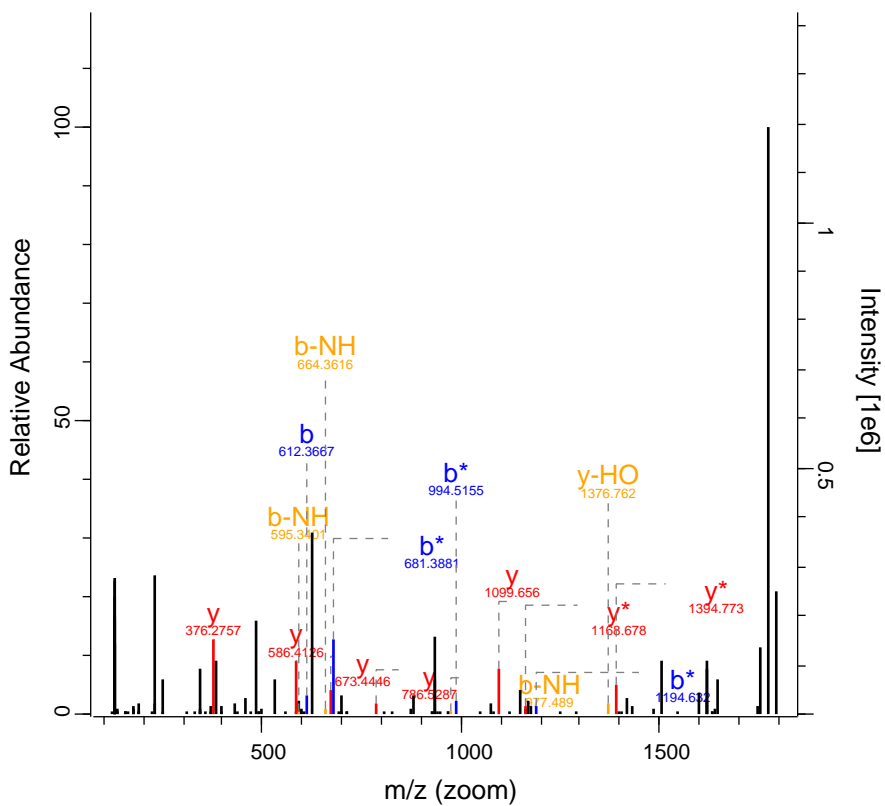

RO-QC-160121_ZackD_SS_Set_02_Fraction19526 FTMS; HC 96.8 748.36 ARL6IP4

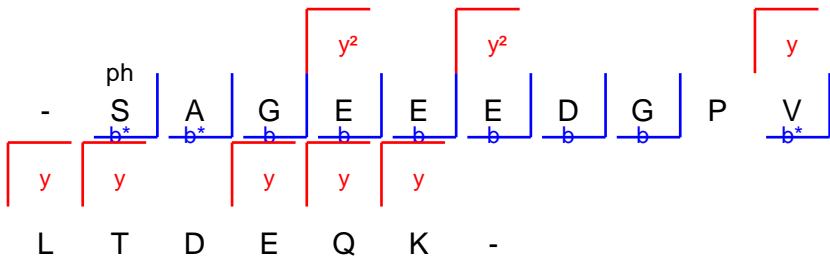
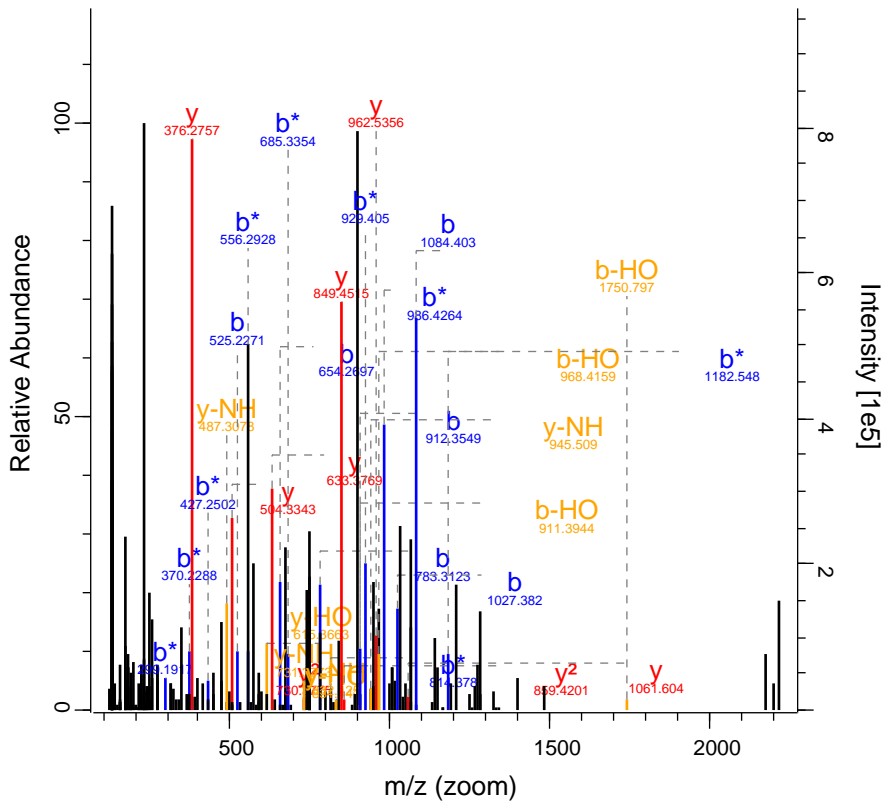

RO-QC-160121_ZackD_SS_Set_02_Fraction 19953 FTMS; HC 43.51 451.25 LIG3

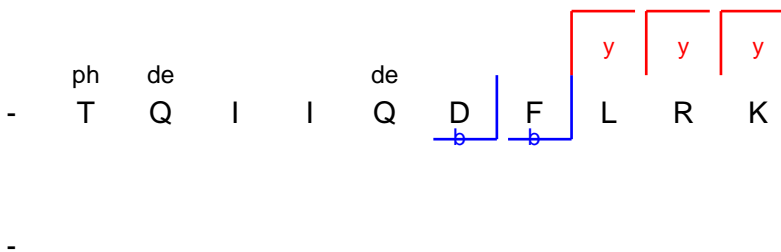
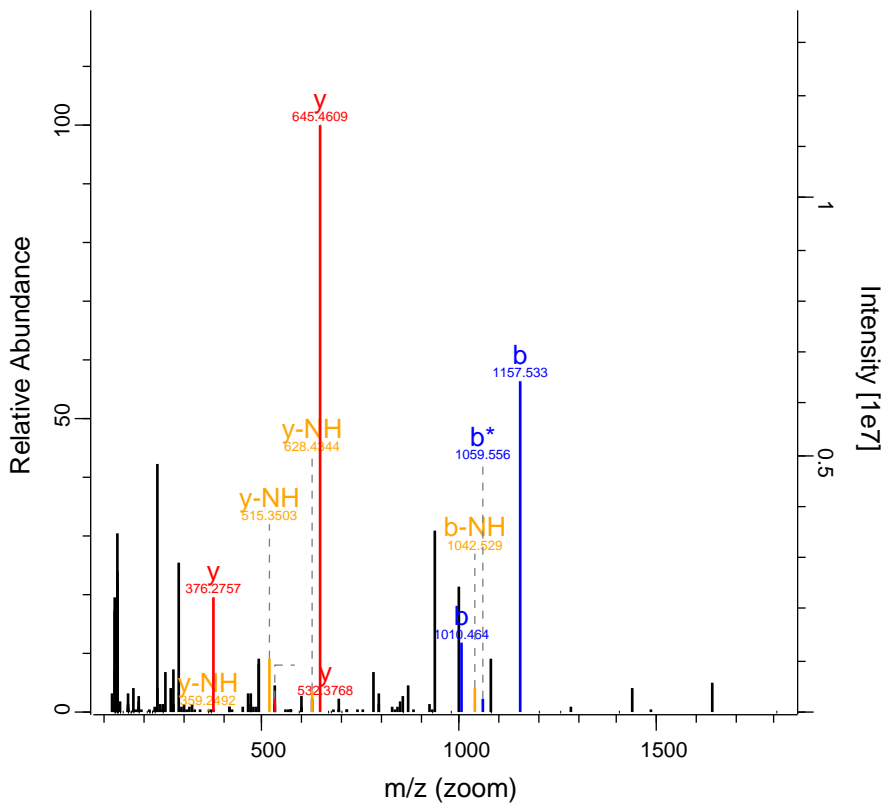

RO-QC-160121_ZackD_SS_Set_02_Fratio 20707 FTMS; HC 239.48 1038.01 PDLIM4

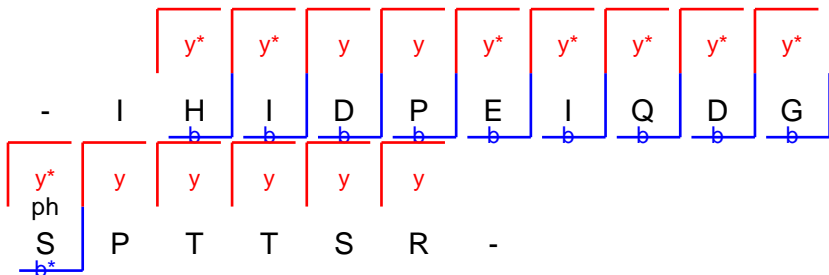
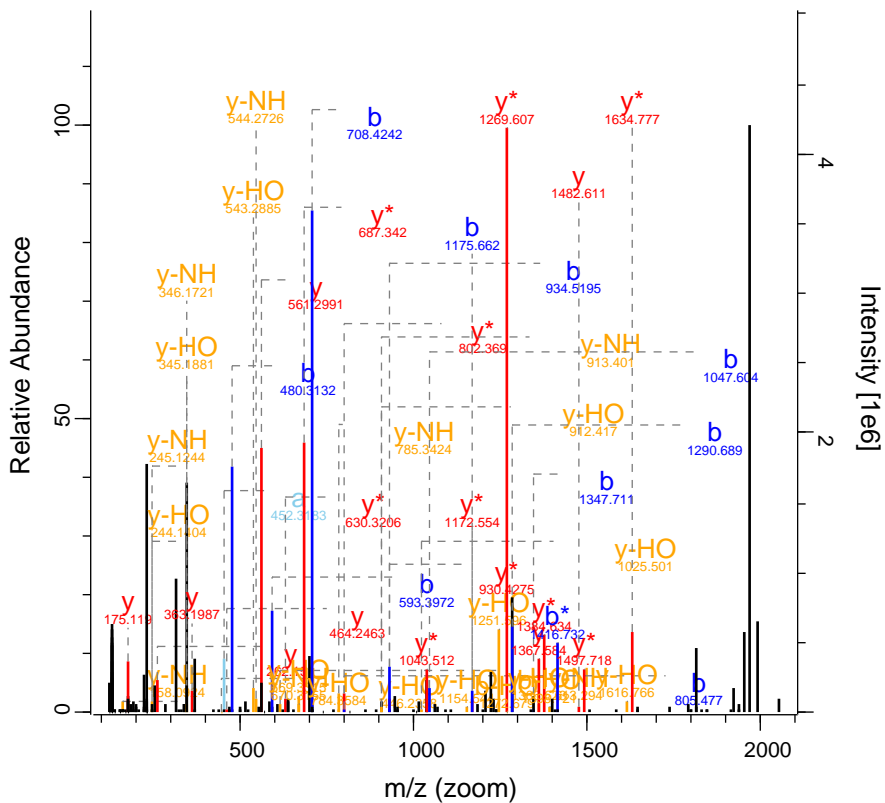

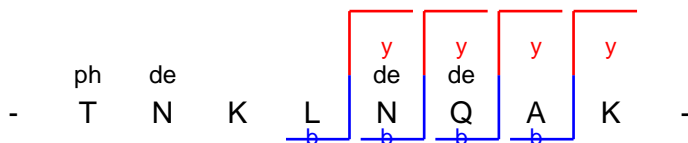
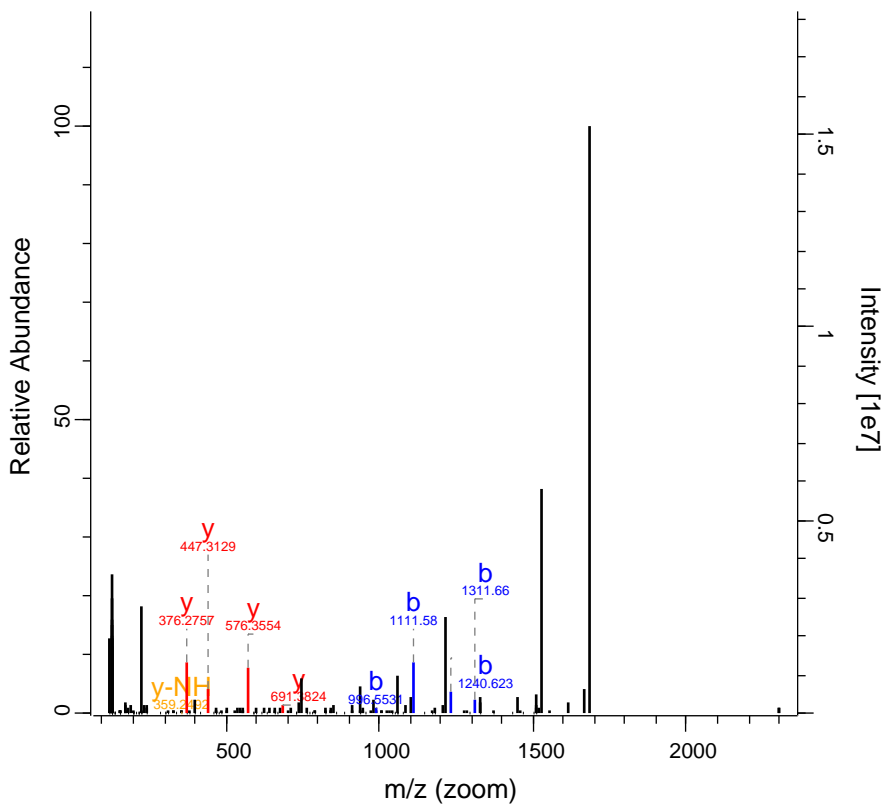

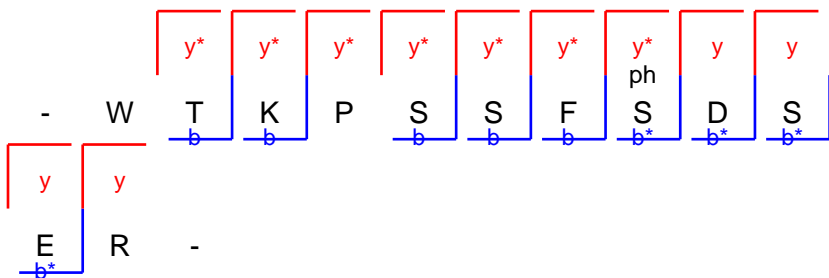
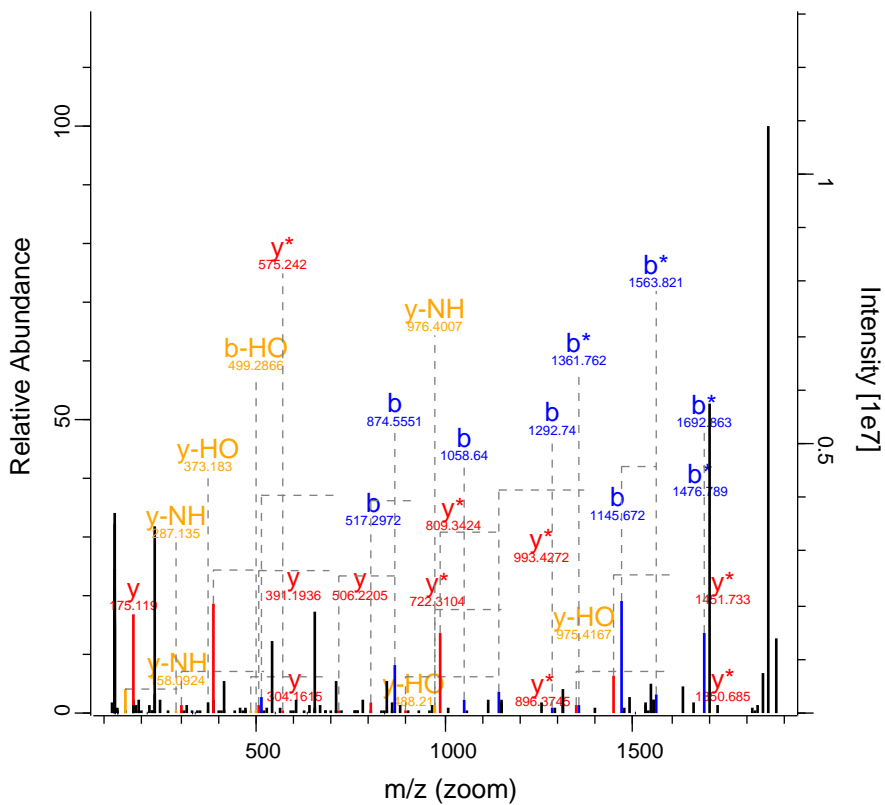

RO-QC-160121_ZackD_SS_Set_02_Fraction 21738 FTMS; HC 53.24 755.05 ADCY10

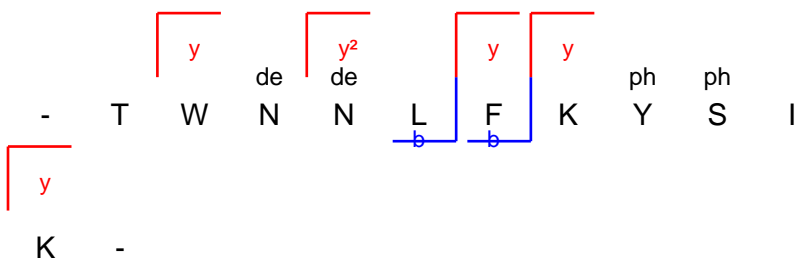
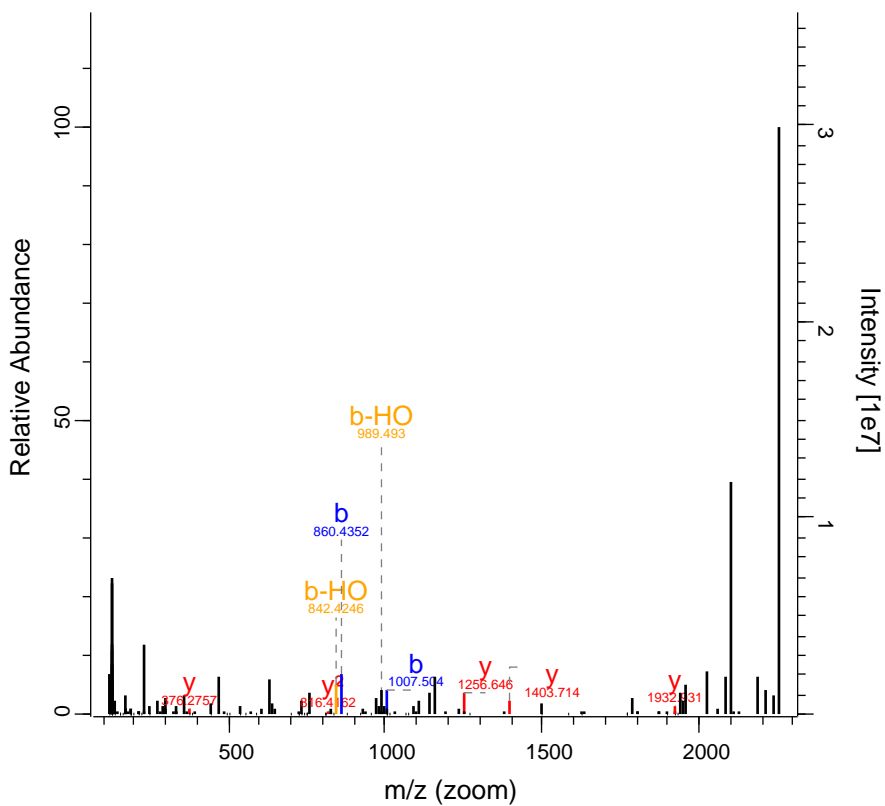

RO-QC-160121_ZackD_SS_Set_02_Fraction 22422 FTMS; HC 71.7 726.41 TPRN

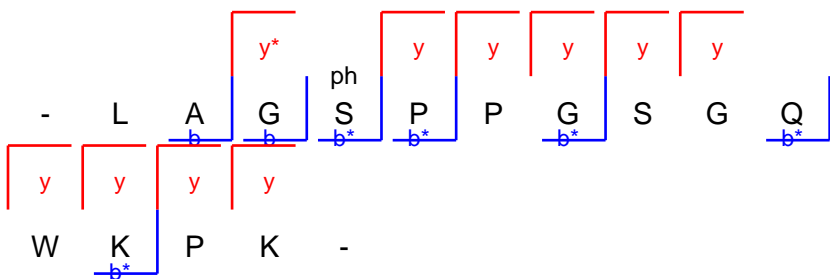
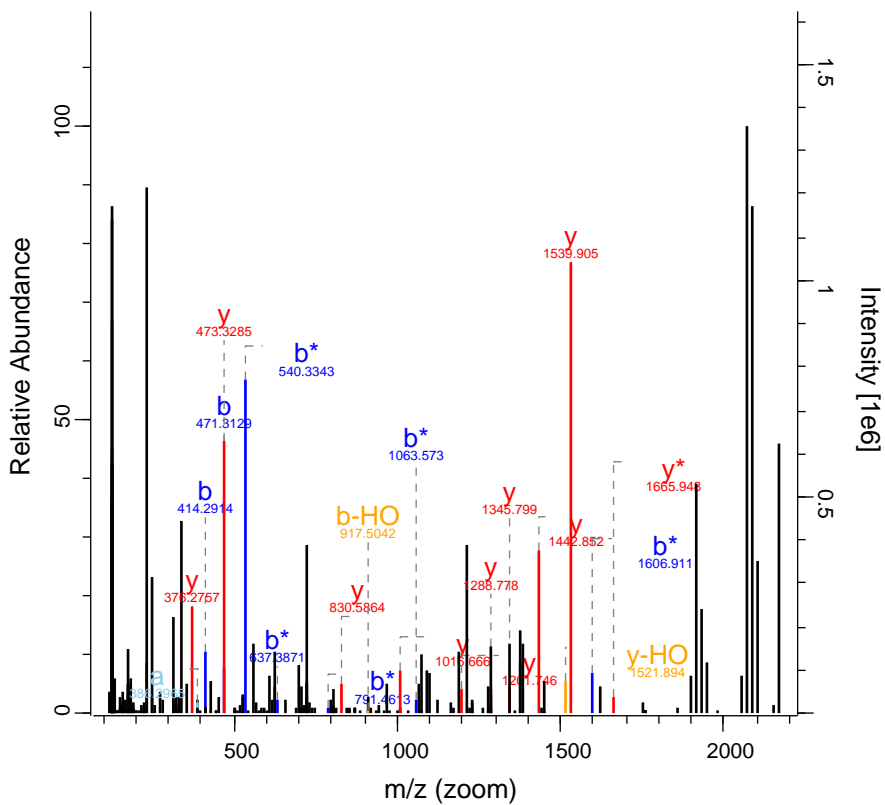

RO-QC-160121_ZackD_SS_Set_02_Fraction 22648 FTMS; HC 131.24 1051 ARFGEF2

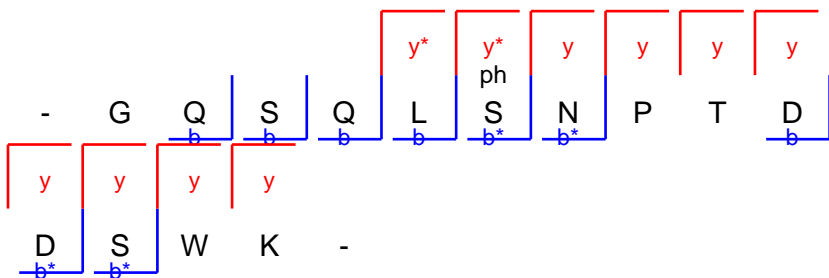
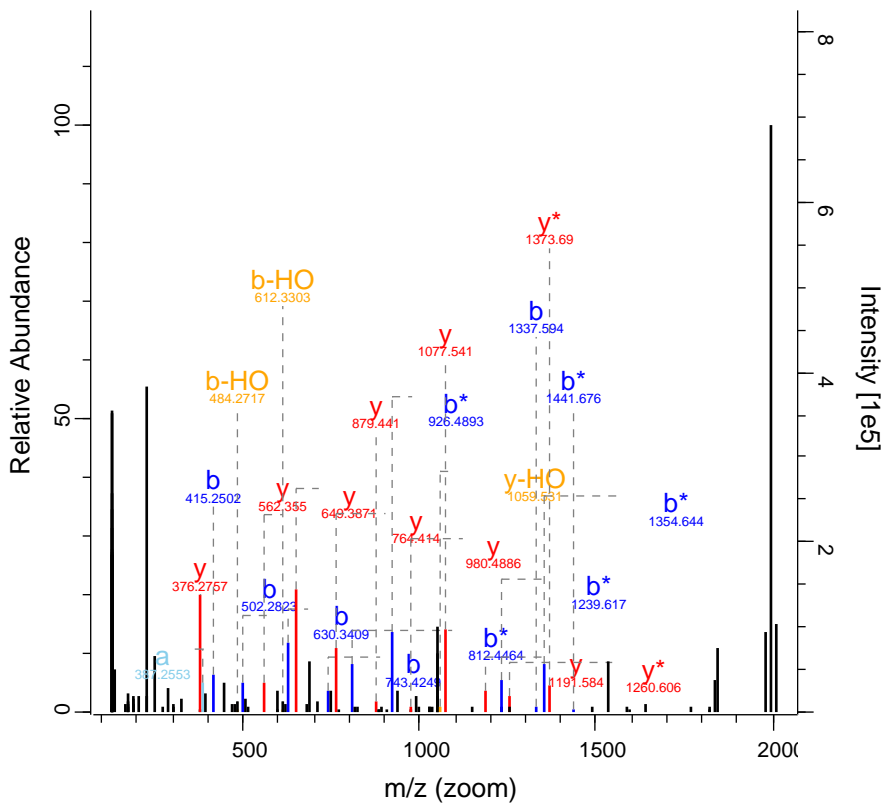

RO-QC-160121_ZackD_SS_Set_02_Fraction 22986 FTMS; HC 46.32 969.97 MAP1B

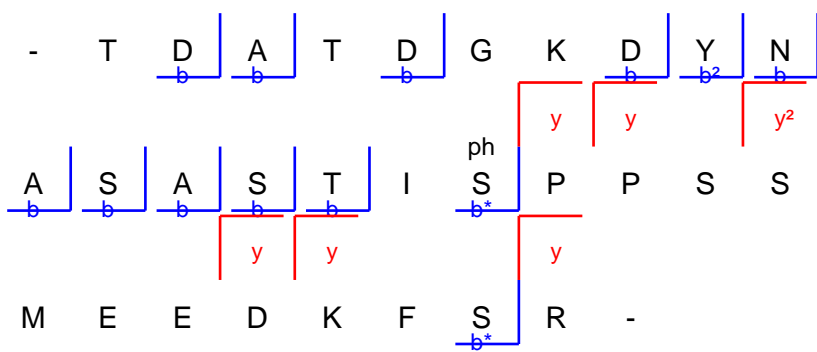
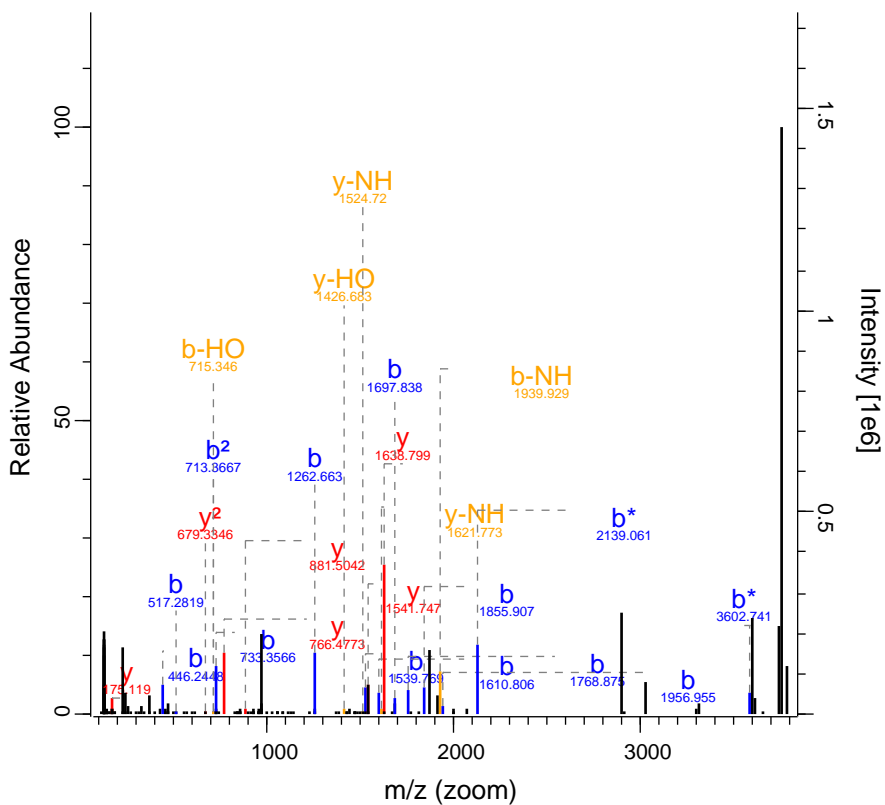

RO-QC-160121_ZackD_SS_Set_02_Fraction 27097 FTMS; HC 90.05 1147.56 SLC8A3

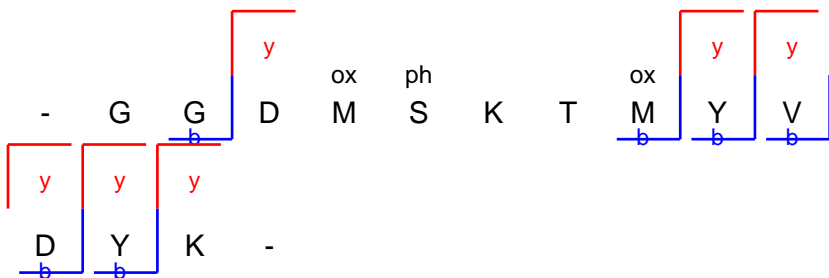
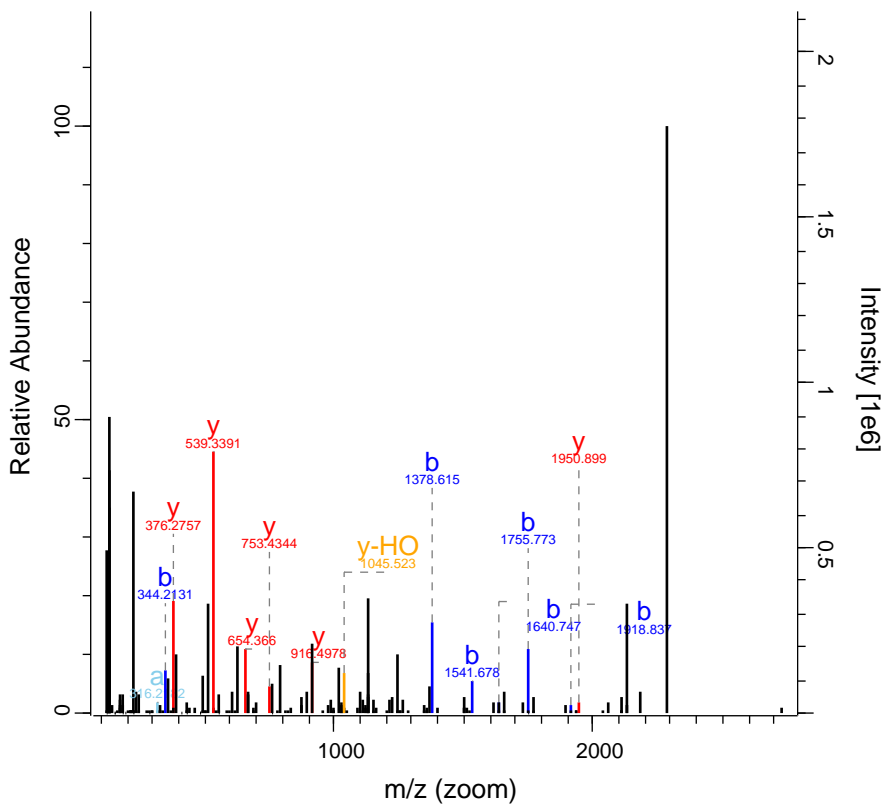

RO-QC-160121_ZackD_SS_Set_02_Fraction 27646 FTMS; HC 125.62 876.1 MYH10

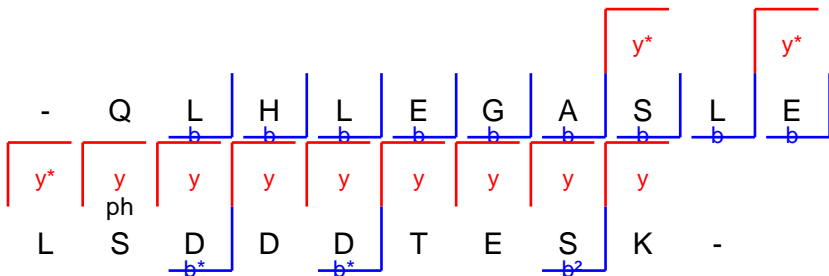
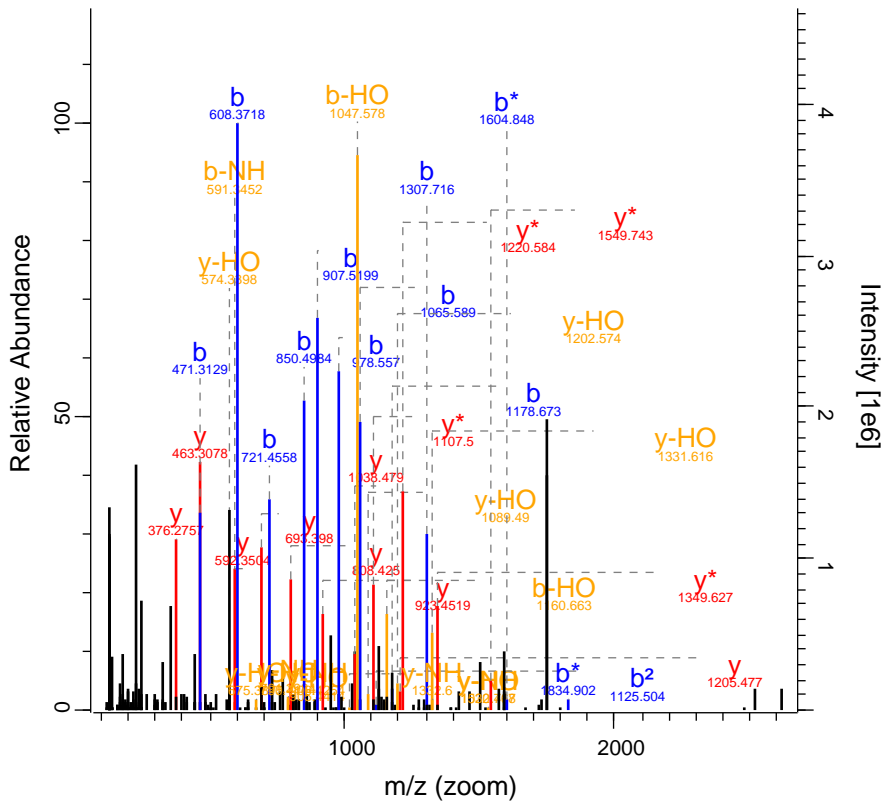

RO-QC-160121_ZackD_SS_Set_02_Fraction1 29859 FTMS; HC 281.63 1127.9 ARMC10

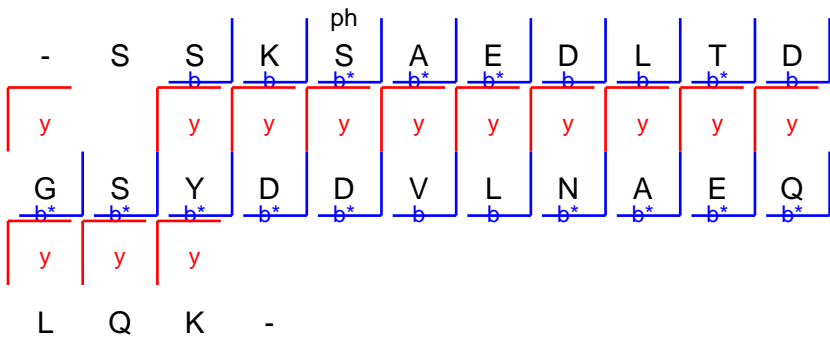
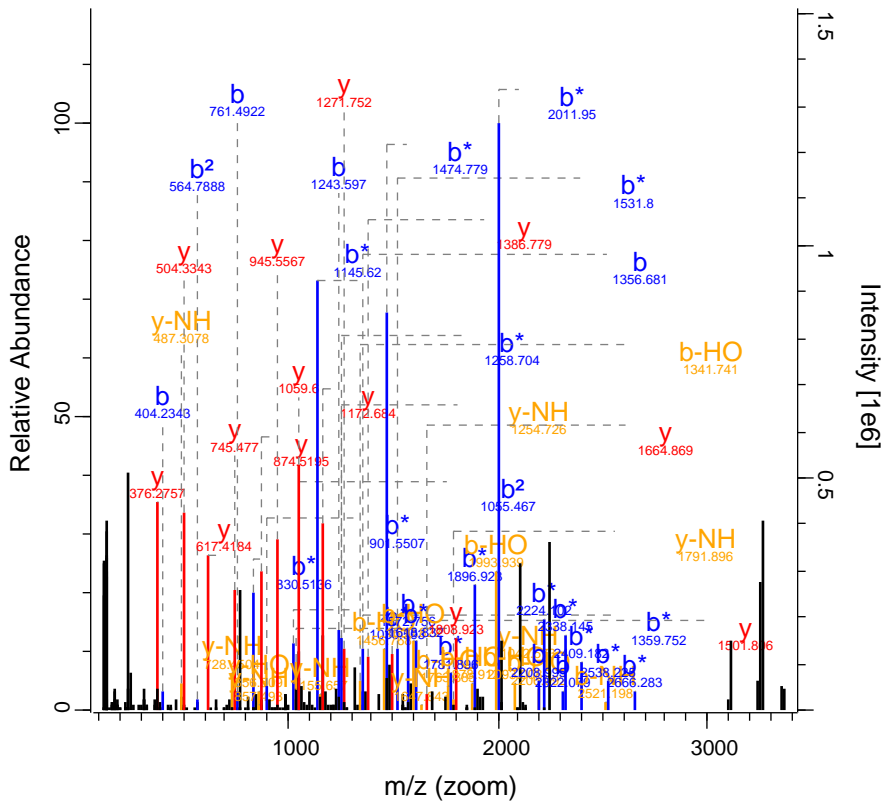

RO-QC-160121_ZackD_SS_Set_02_Fraction 31060 FTMS; HC 42.89 949.2 GPR143

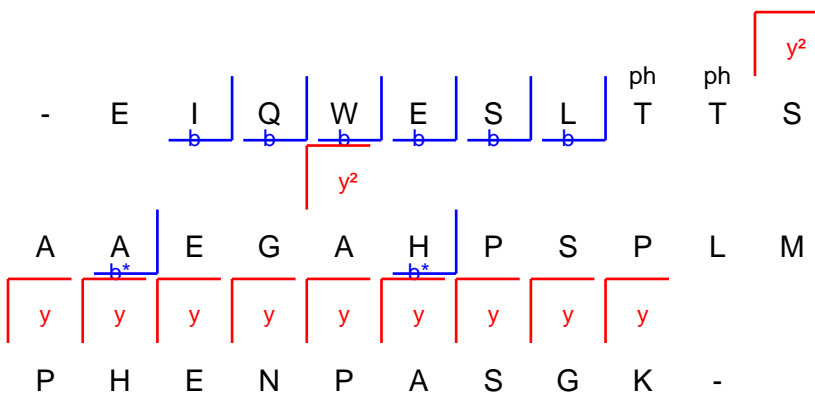
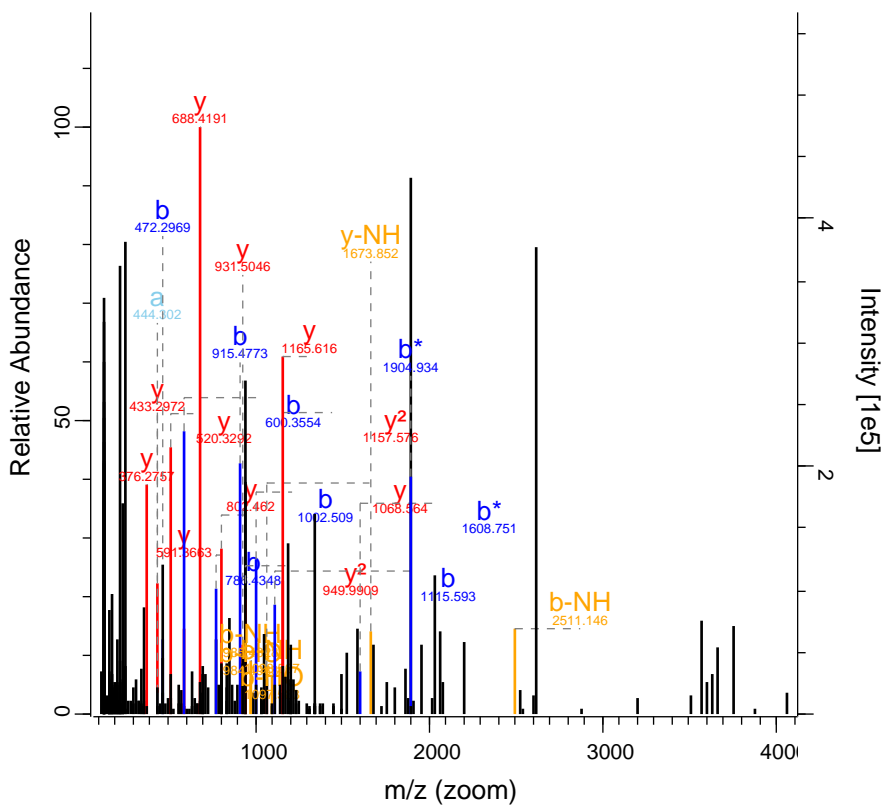

RO-QC-160121_ZackD_SS_Set_02_Fraction 33224 FTMS; HC 42.57 1236.67 BCAS3

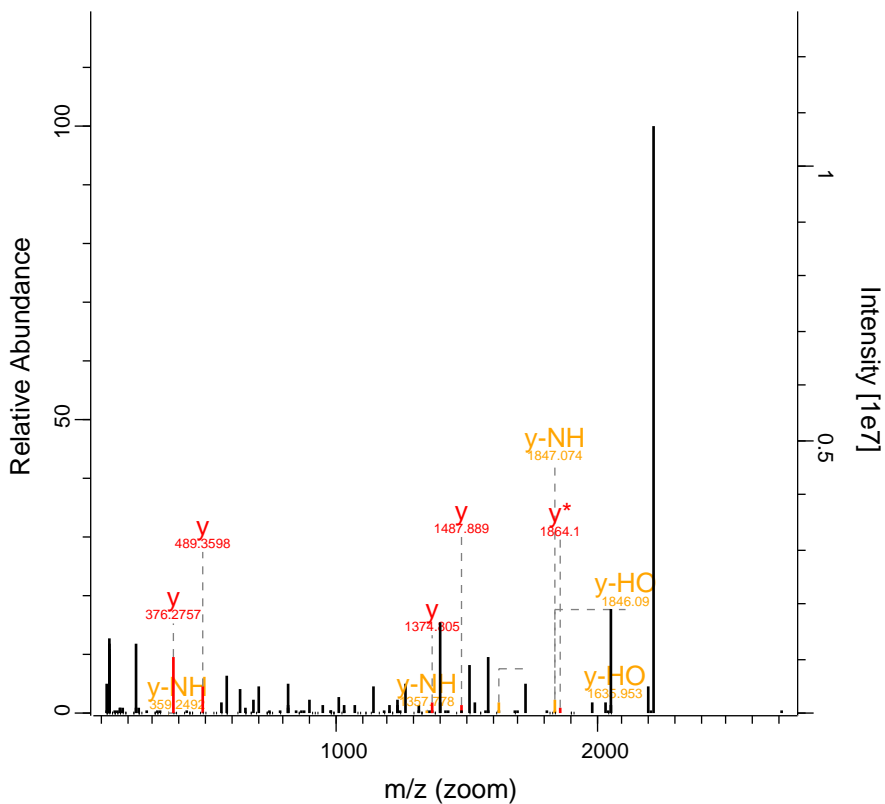

- L S P L P S L M V V
 M P L A Q I K -
 y* y y
 y y

RO-QC-160121_ZackD_SS_Set_02_Fraction 34036 FTMS; HC 58.98 1130.08 KLHL42

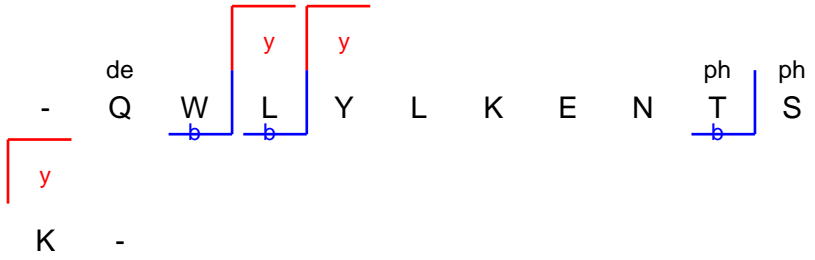
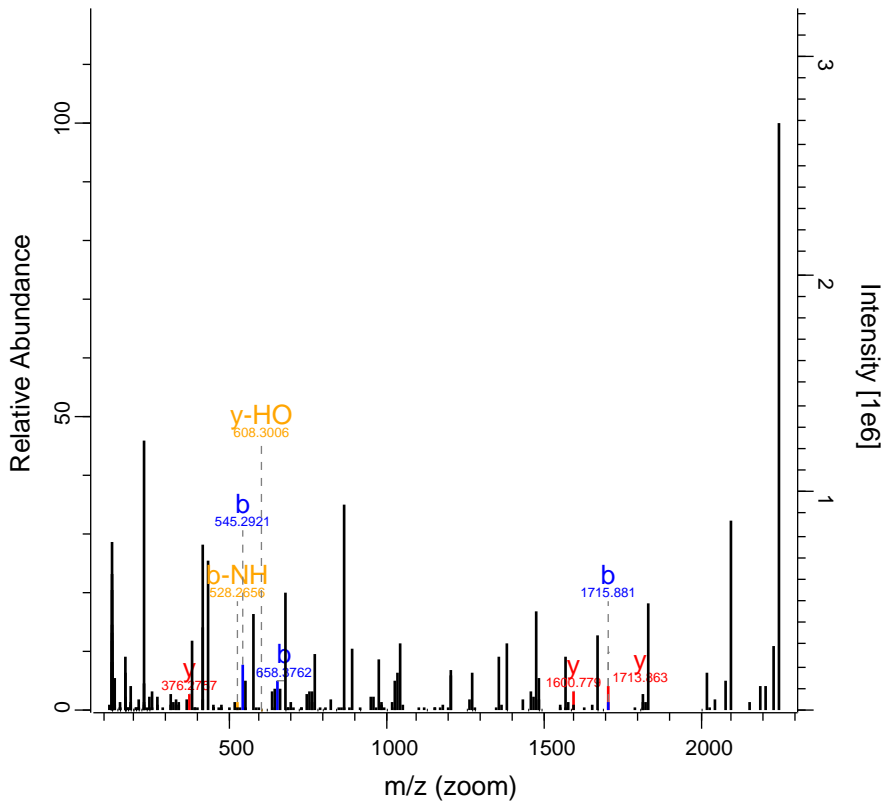

RO-QC-160121_ZackD_SS_Set_02_Fraction 34263 FTMS; HC 40.37 1139.57 ZNF846

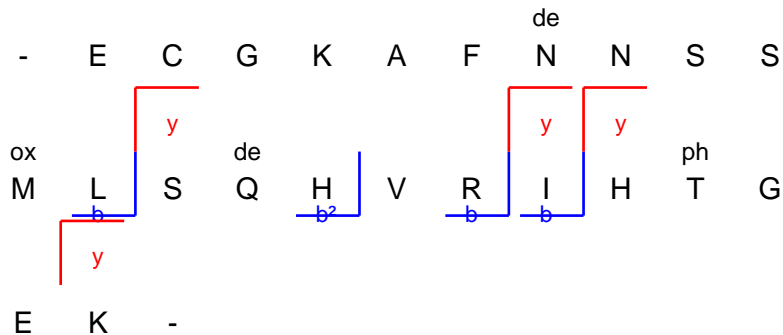
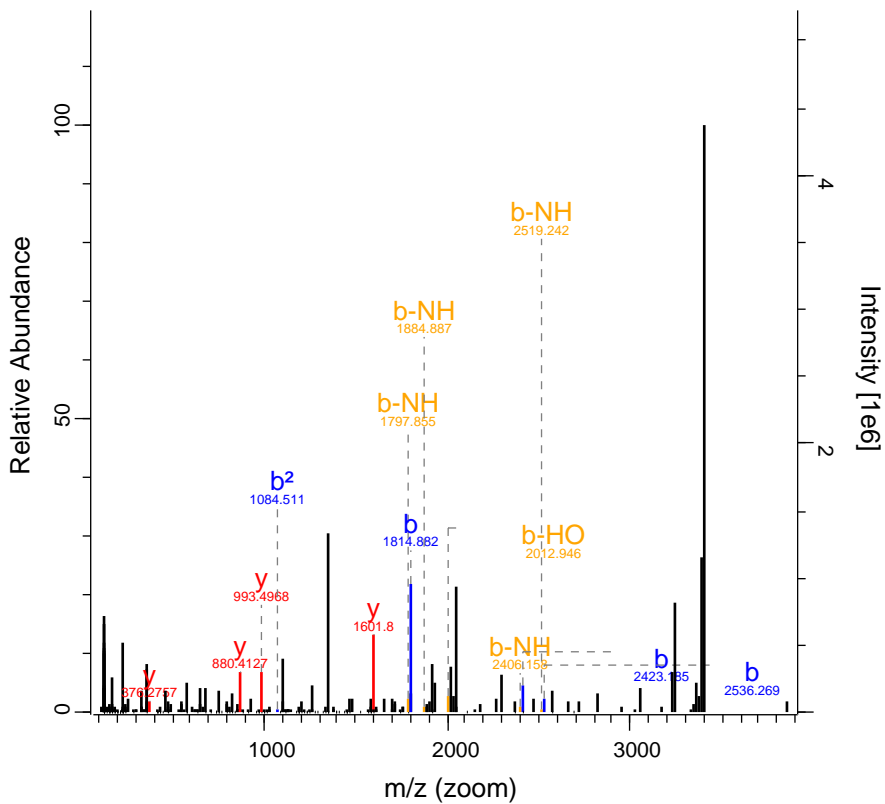

RO-QC-160121_ZackD_SS_Set_02_Fraction 34511 FTMS; HC 47.29 1360.16 CEP295

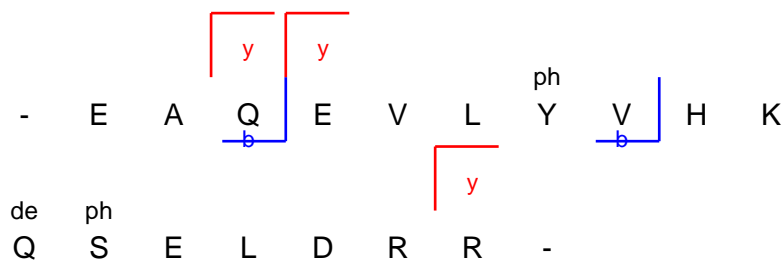
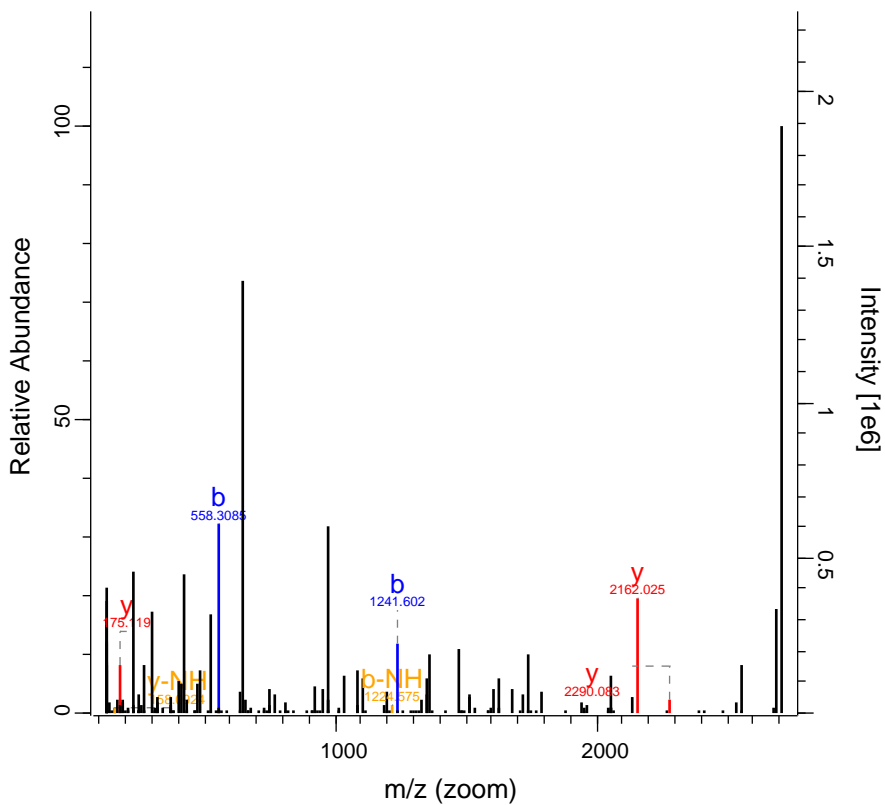

RO-QC-160121_ZackD_SS_Set_02_Fraction 34755 FTMS; HC 63.02 994.49 MAP1S

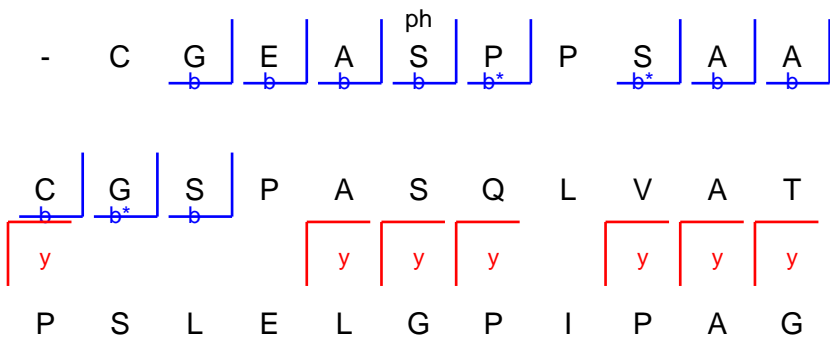
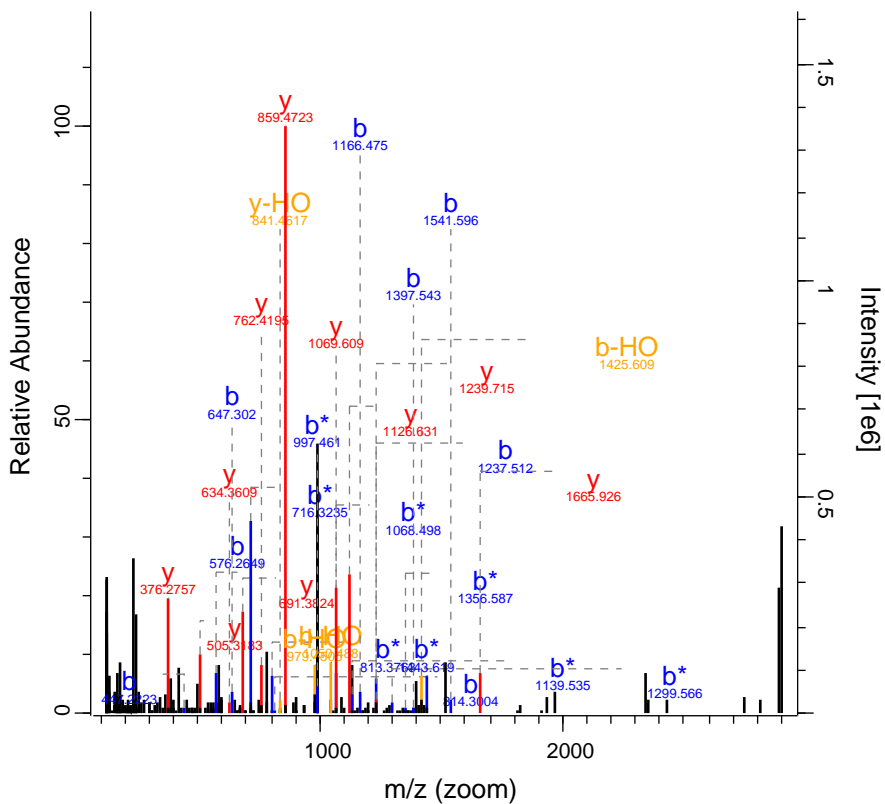

RO-QC-160121_ZackD_SS_Set_02_Fraction 35510 FTMS; HC 43.53 814.42 CCDC7

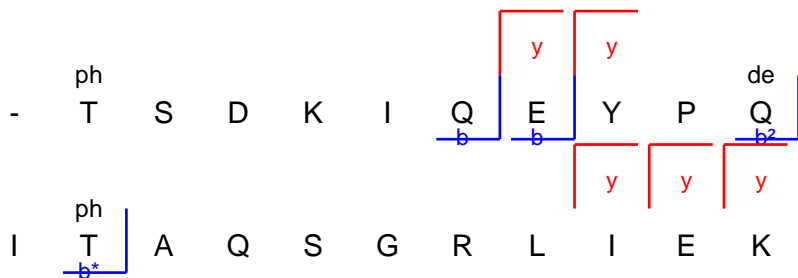
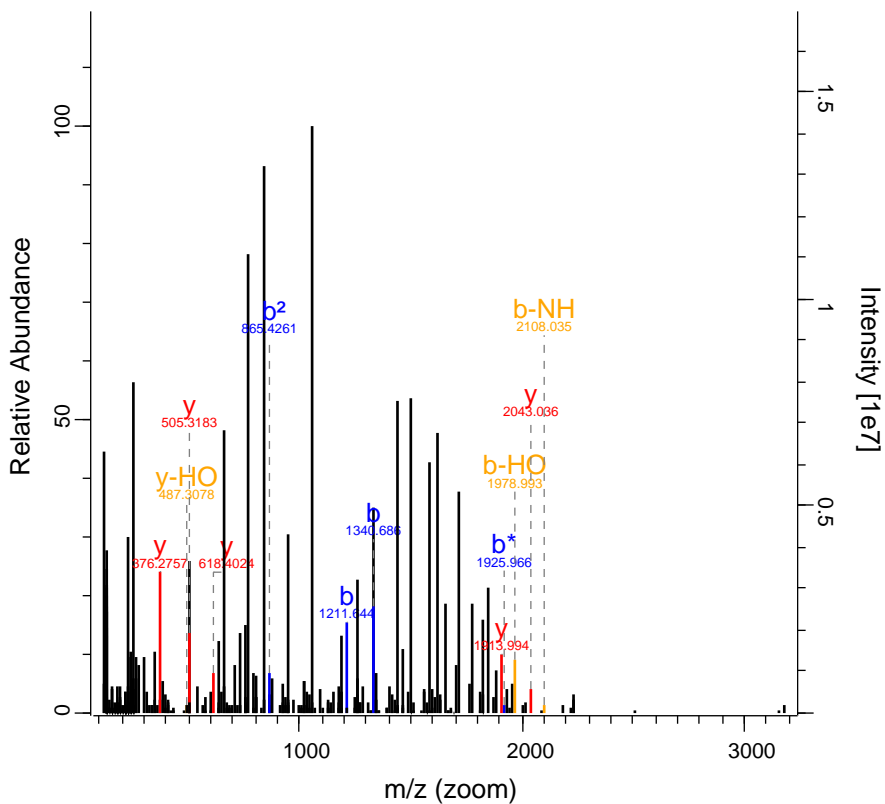

RO-QC-160121_ZackD_SS_Set_02_Fraction 36940 FTMS; HC 118.76 595.99 TMEM192

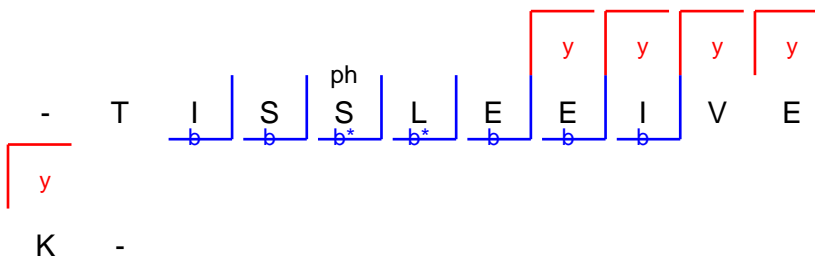
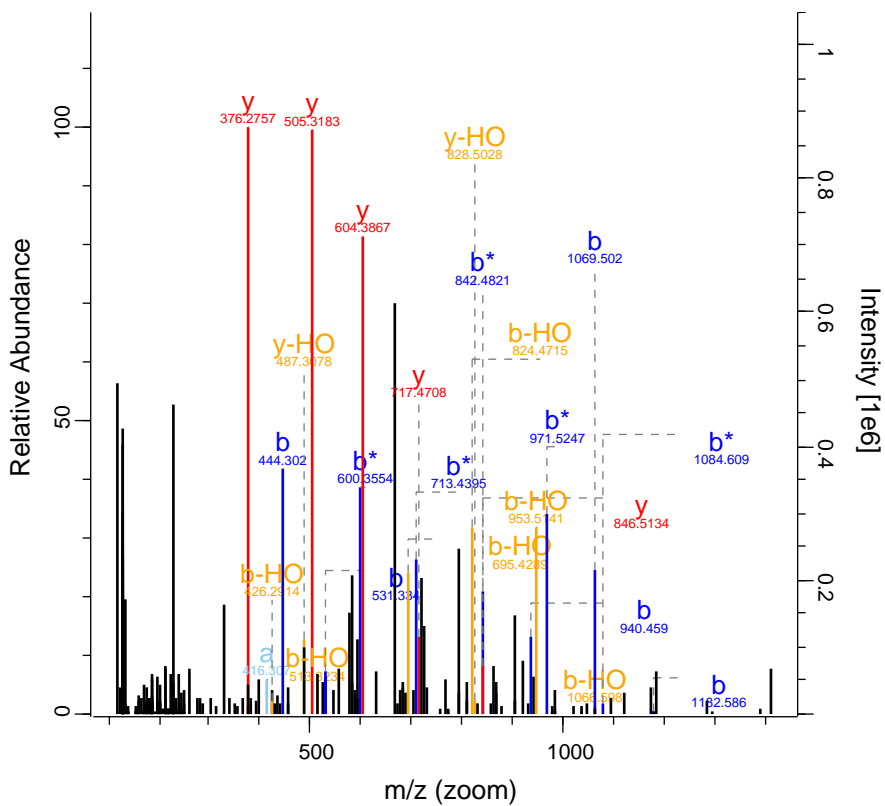

RO-QC-160121_ZackD_SS_Set_02_Fraction 38670 FTMS; HC 46.57 1366.8 ZNF532

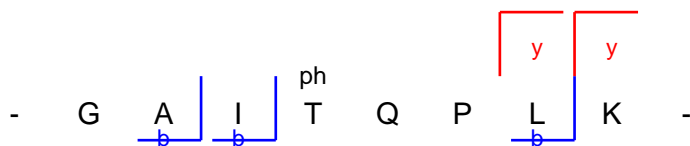
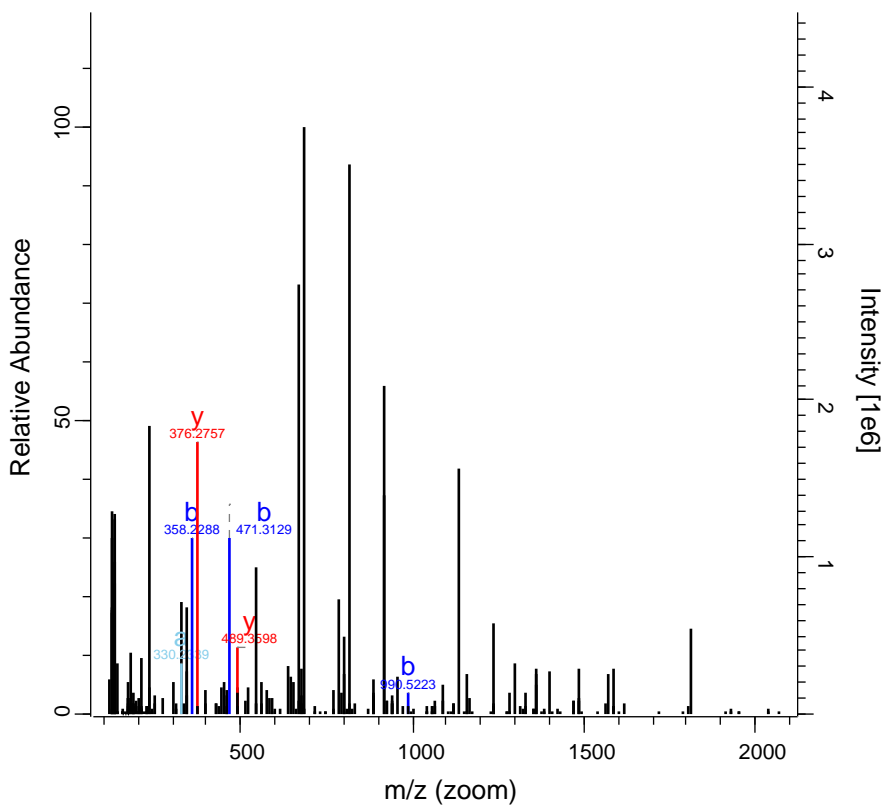

RO-QC-160121_ZackD_SS_Set_02_Fraction 39521 FTMS; HC 46.48 1359.67 DCLK2

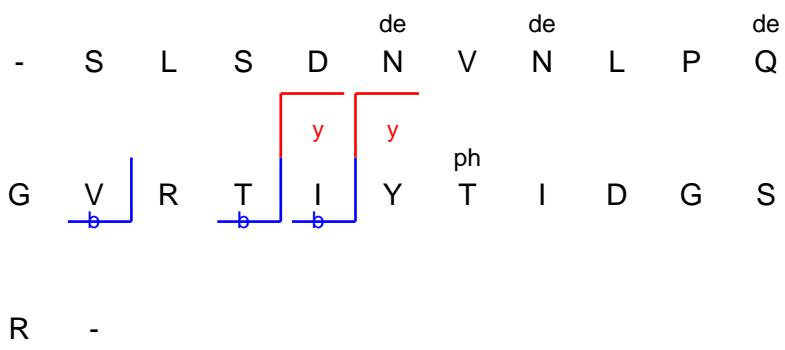
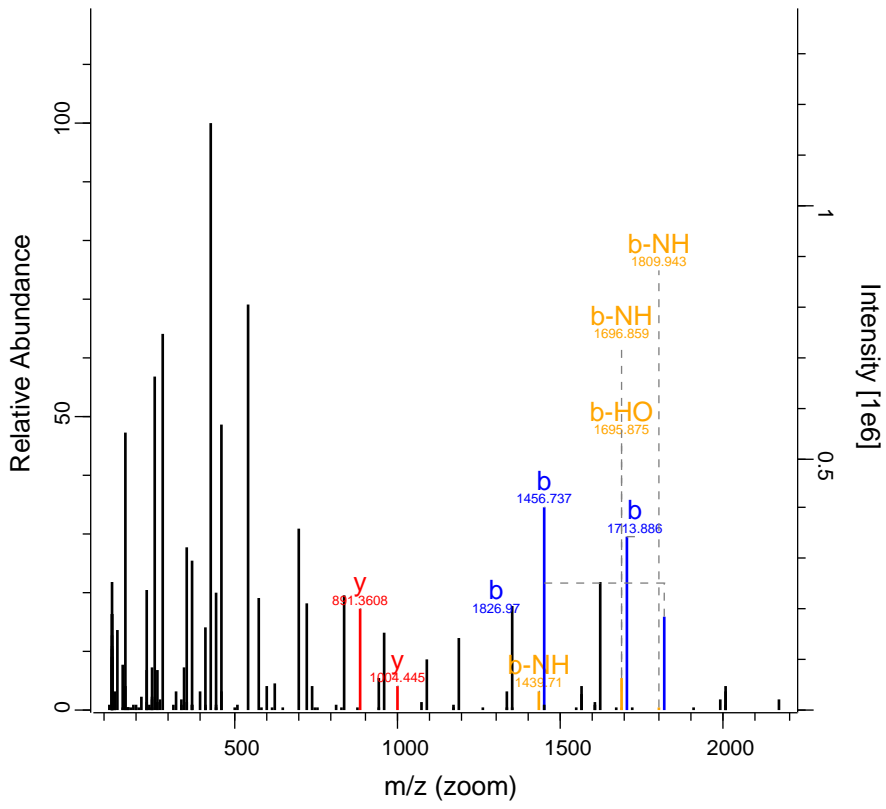

RO-QC-160121_ZackD_SS_Set_02_Fraction 39599 FTMS; HC 56.12 1440.69 TCF7L1

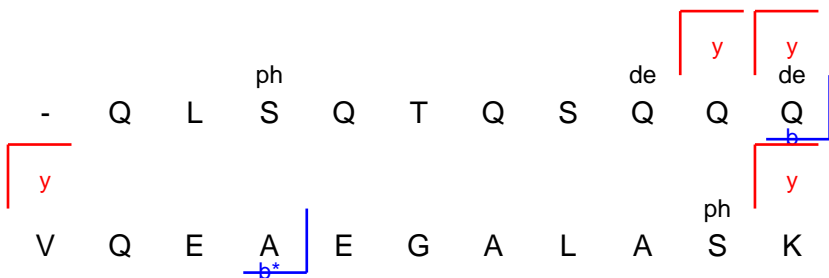
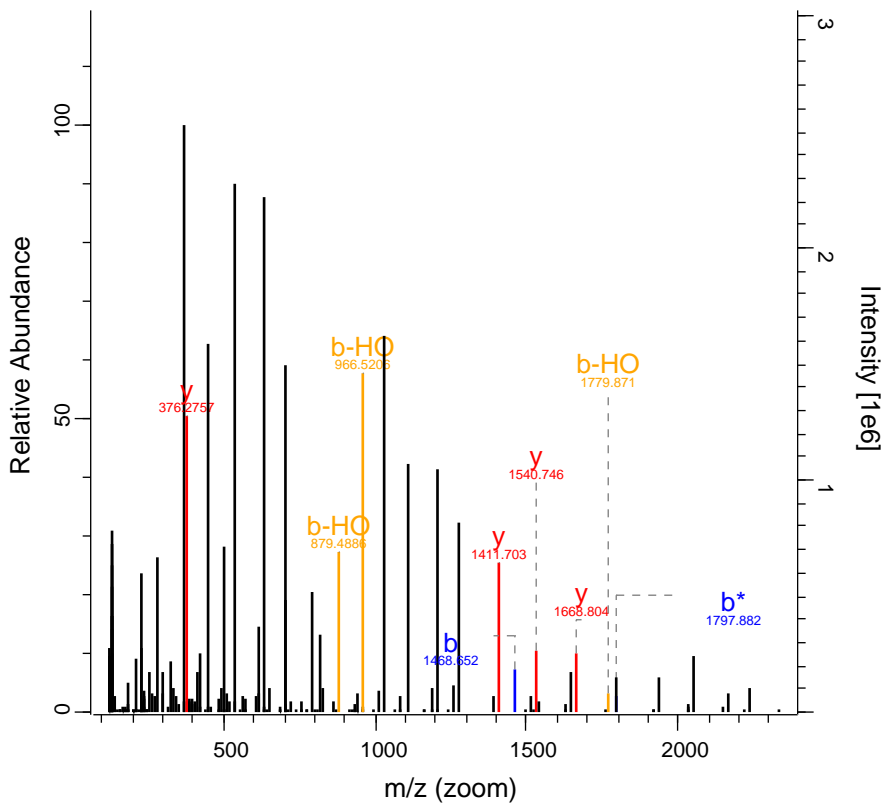

RO-QC-160121_ZackD_SS_Set_02_Fraction 5494 FTMS; HC 110.84 778.91 SNX17

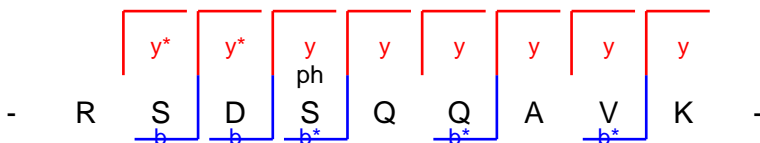
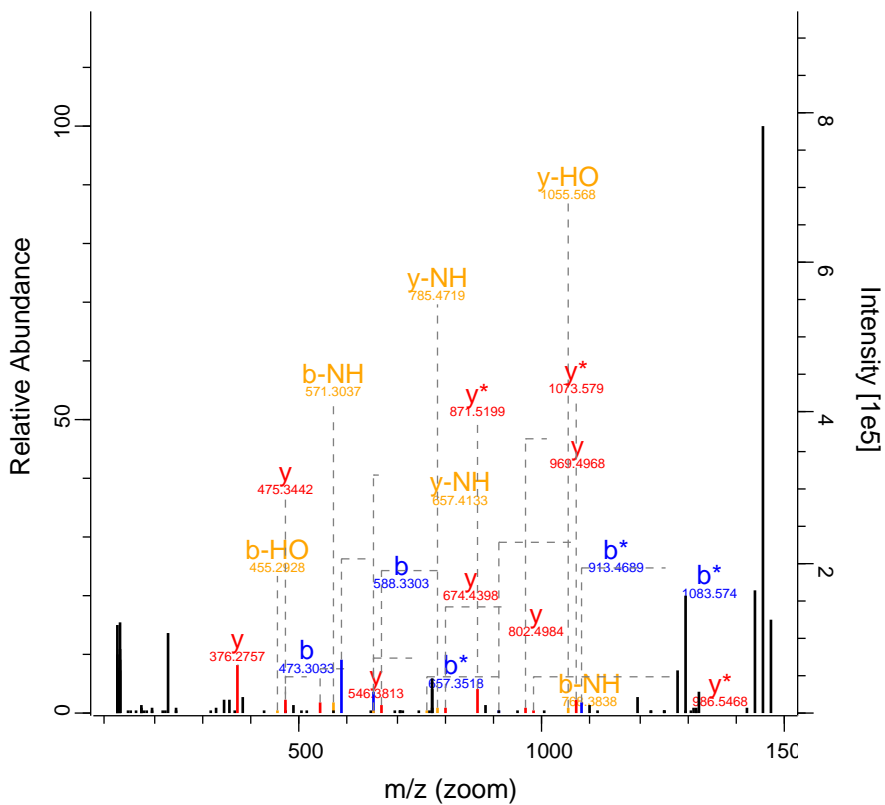

RO-QC-160121_ZackD_SS_Set_02_Fraction 5901 FTMS; HC 120.59 547.62 CAP2

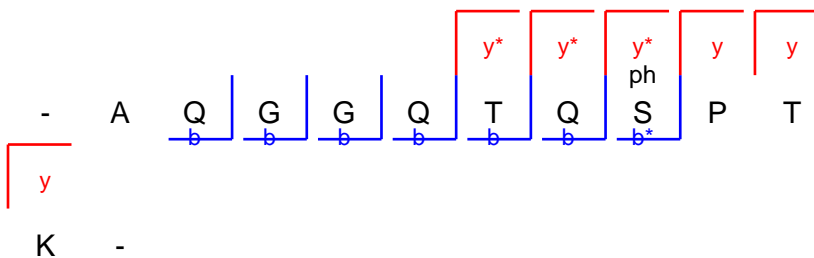
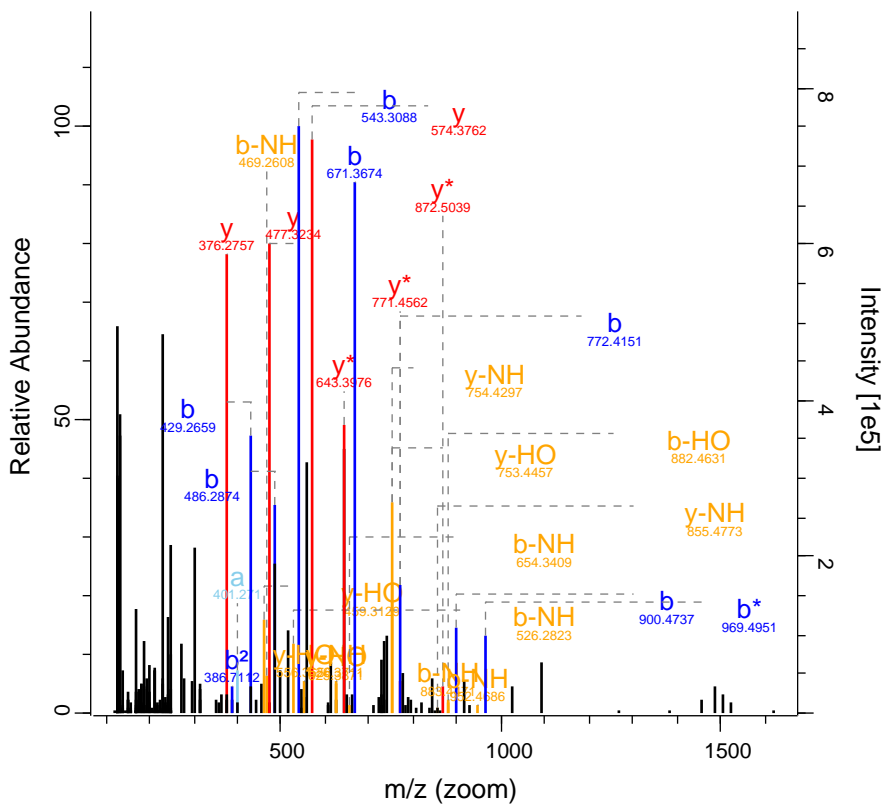

RO-QC-160121_ZackD_SS_Set_02_Fraction 8194 FTMS; HC 45.16 664.66 KLF2;KLF4

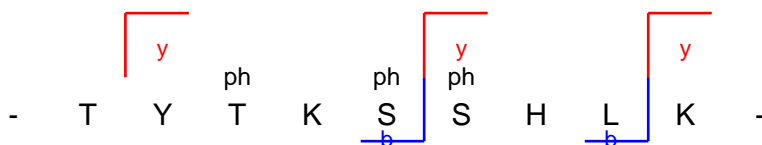
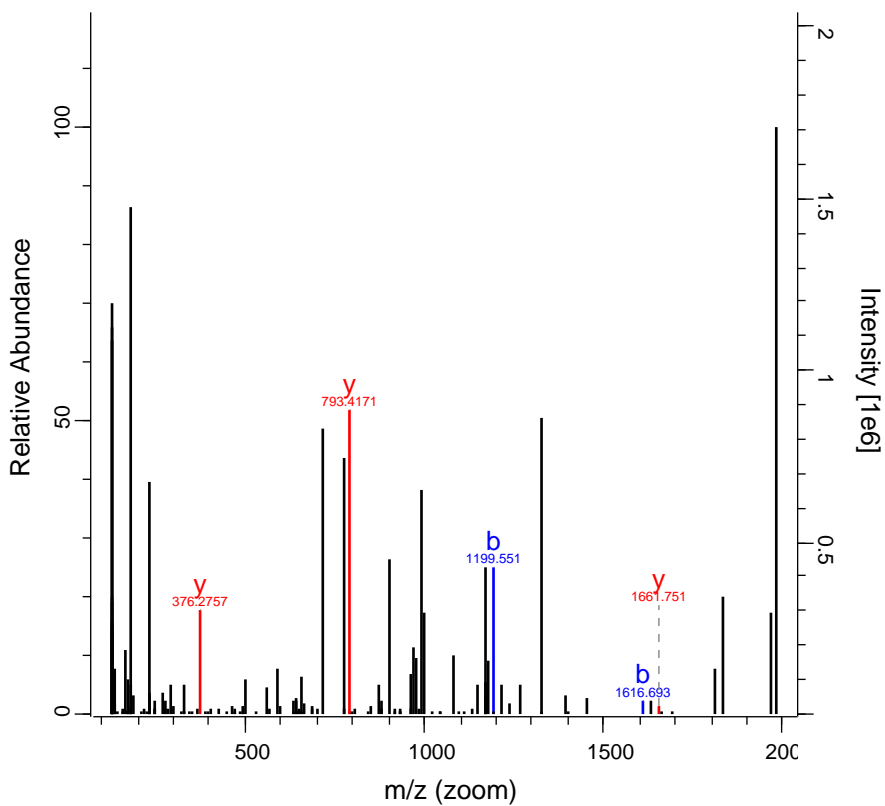

RO-QC-160121_ZackD_SS_Set_02_Fraction 8352 FTMS; HC 93.75 753.71 WBP4

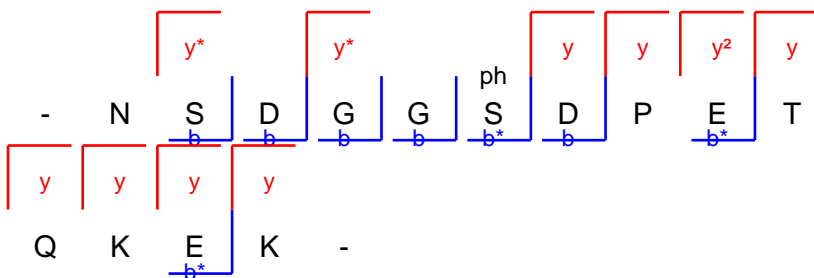
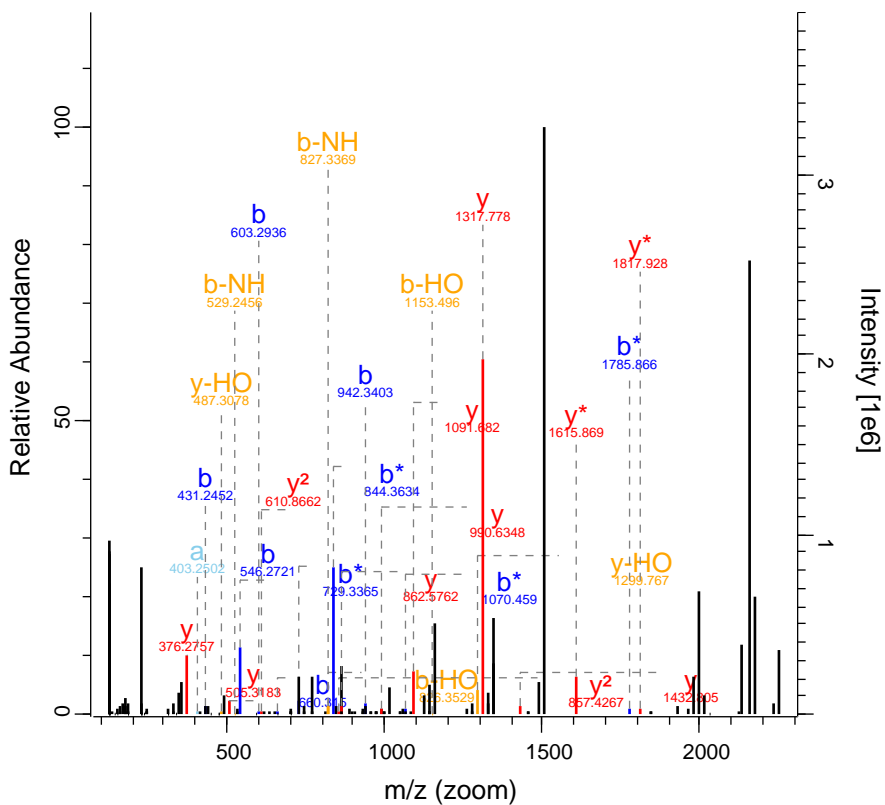

RO-QC-160121_ZackD_SS_Set_02_Fraction 8857 FTMS; HC 48.42 768.87 PALM

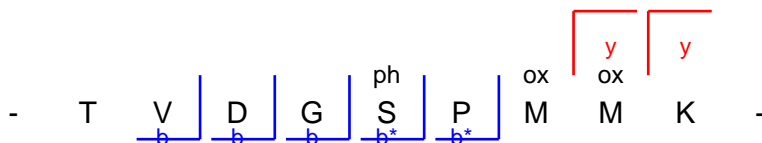
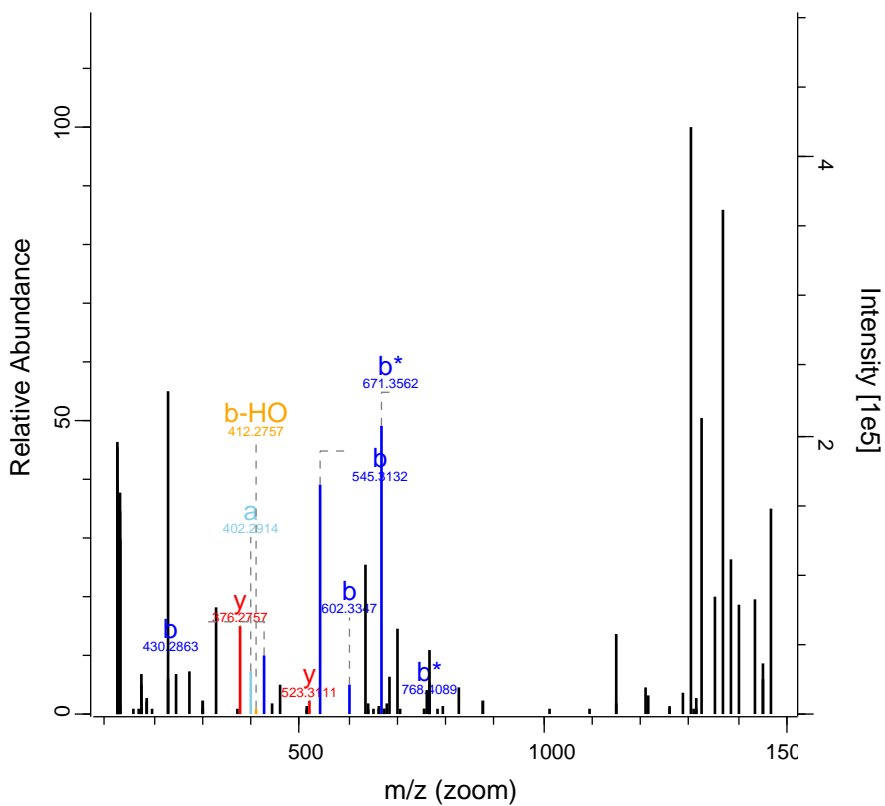

RO-QC-160121_ZackD_SS_Set_02_Fraction 9473 FTMS; HC 245.19 1161.08 HNRNPC

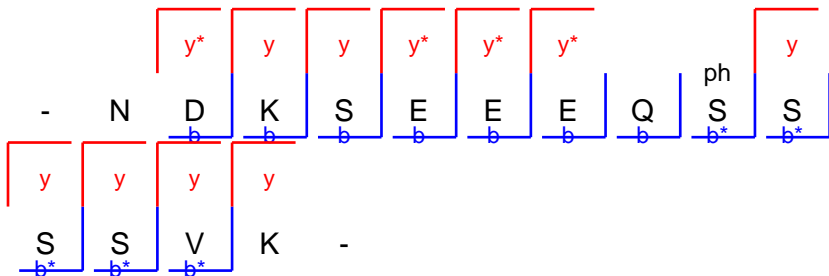
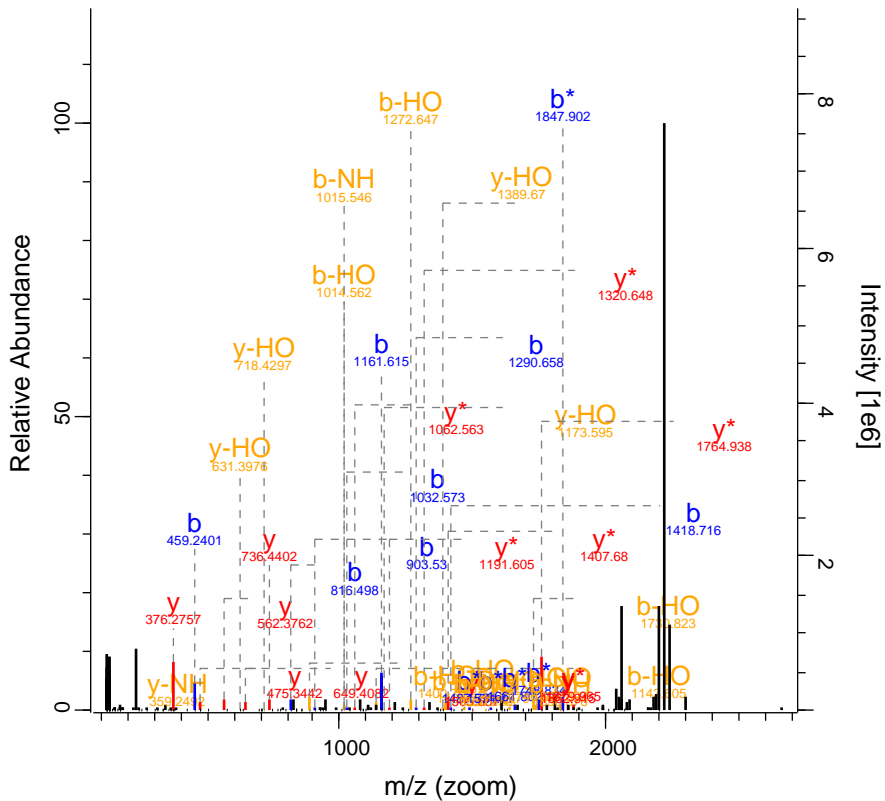

RO-QC-160121_ZackD_SS_Set_02_Fraction 9531 FTMS; HC 106.94 581.04 HNRNPC

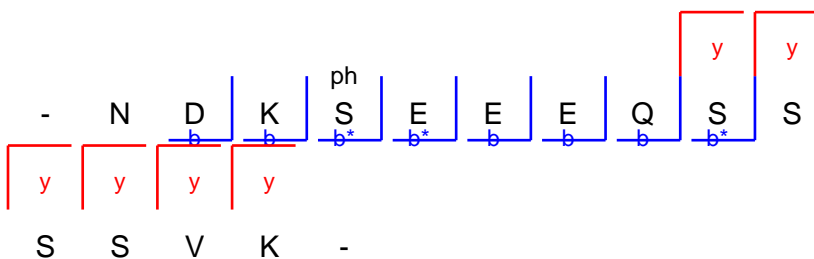
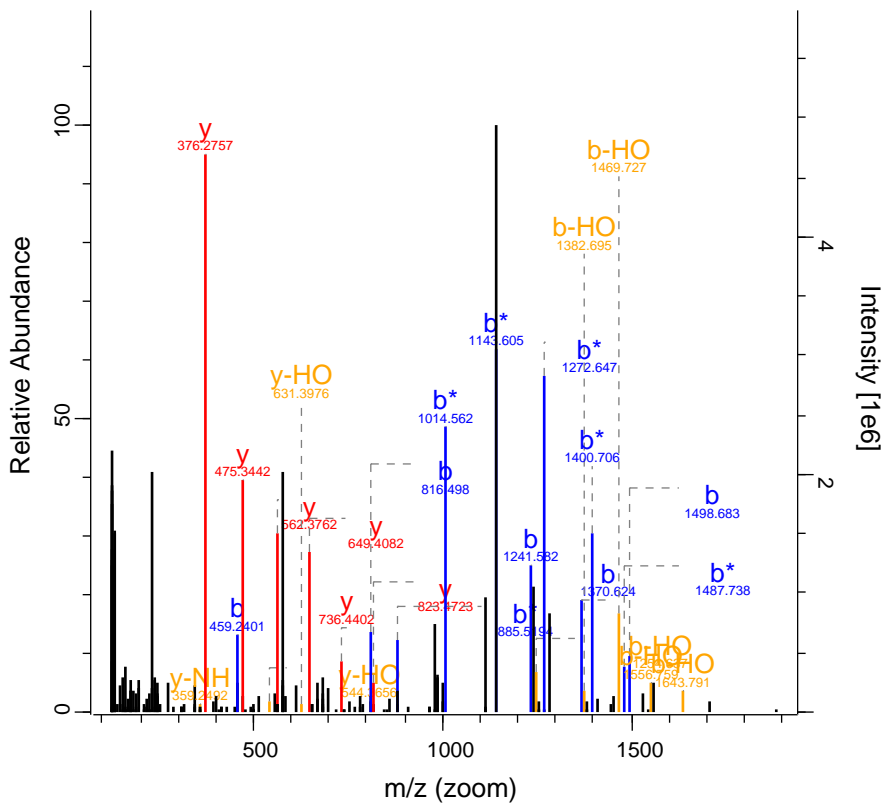

RO-QC-160121_ZackD_SS_Set_02_Fraction 10120 FTMS; HC 88.68 714.38 ATXN2

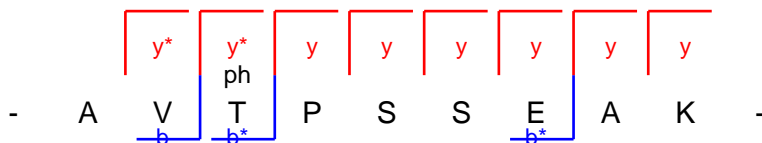
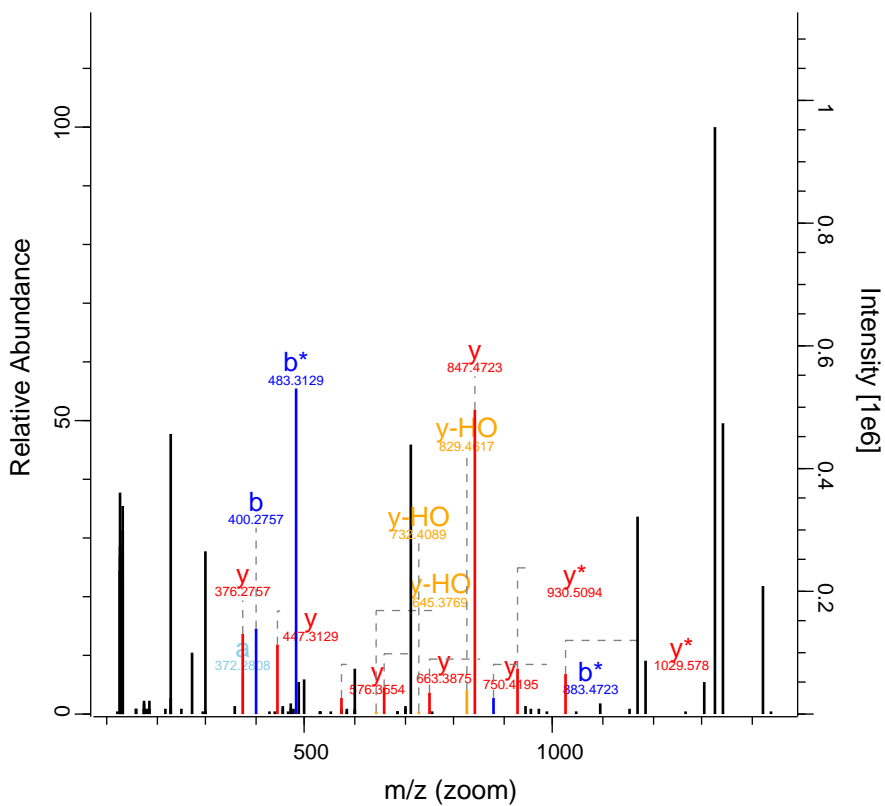

RO-QC-160121_ZackD_SS_Set_02_Fraction10557 FTMS; HC 127.18 796.44 IGF2BP1

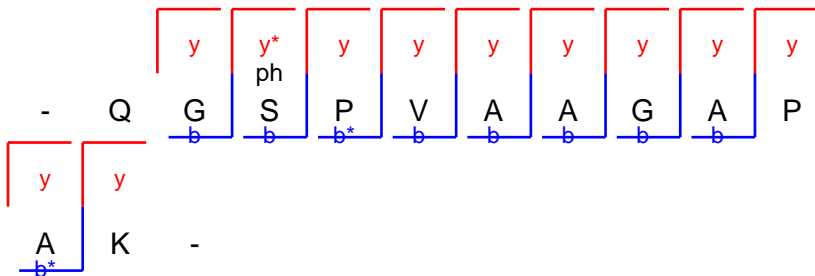
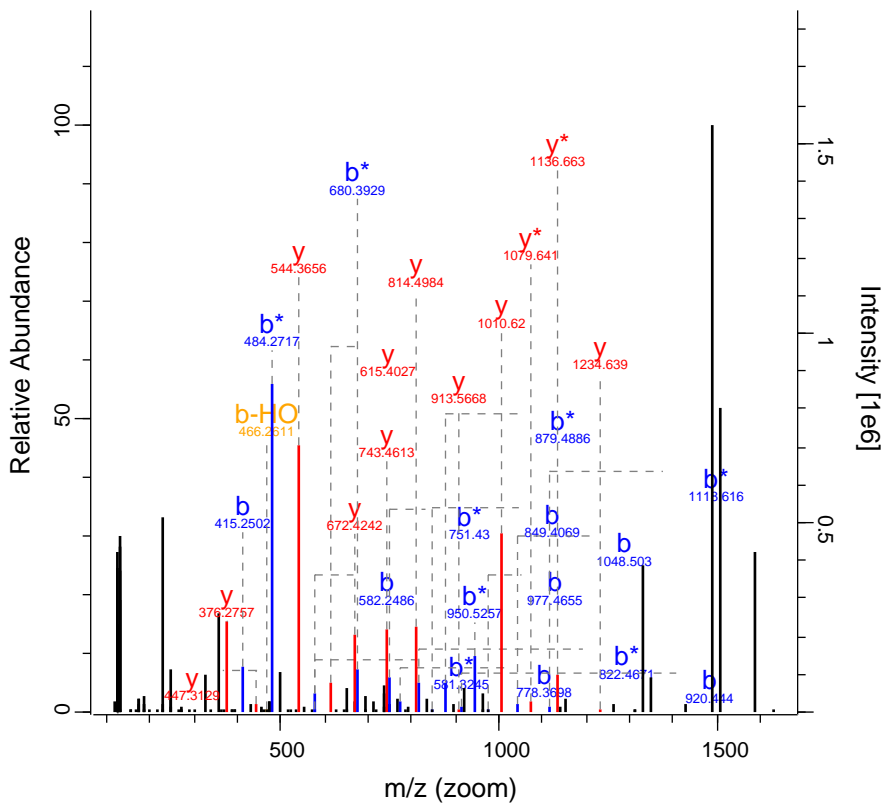

RO-QC-160121_ZackD_SS_Set_02_Fraction 11060 FTMS; HC 56.56 988.51 TNIP1

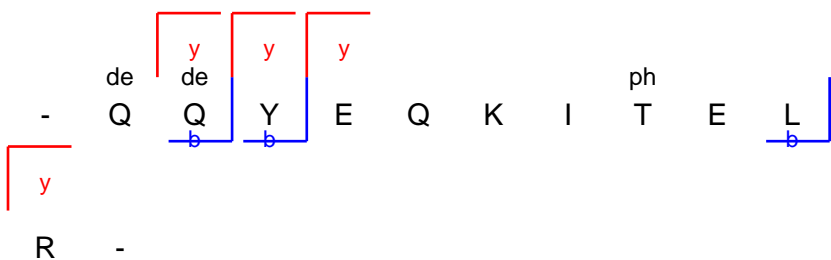
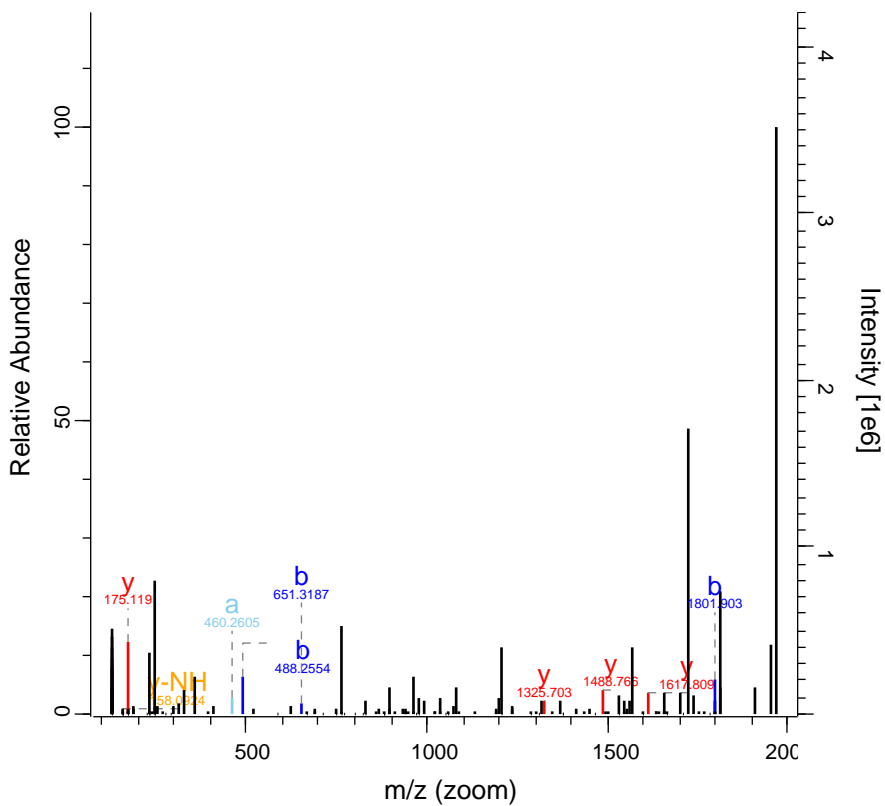

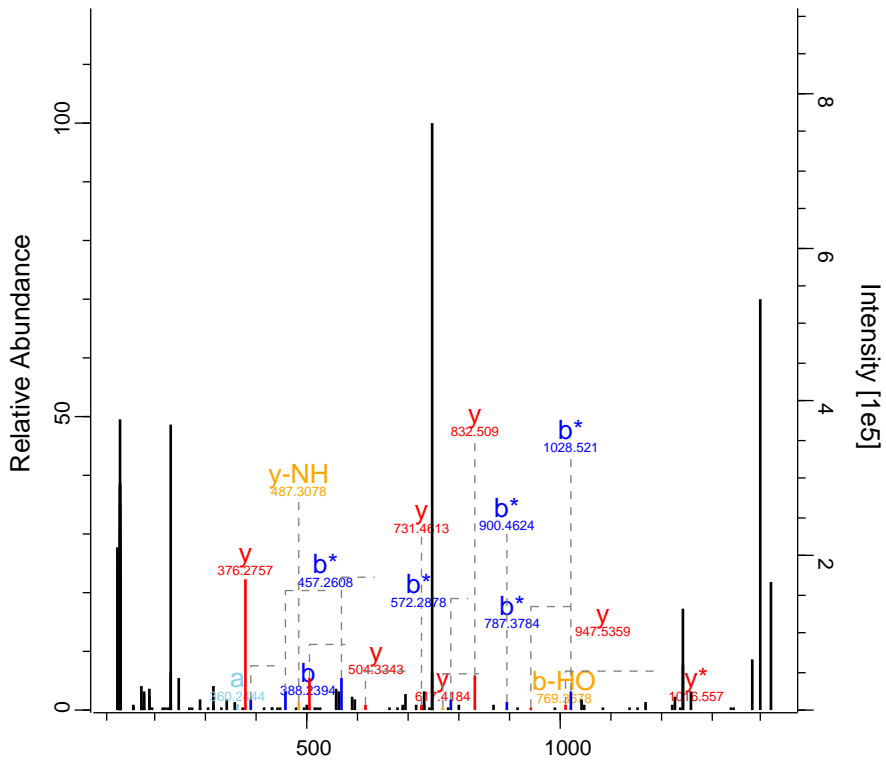

m/z (zoom)

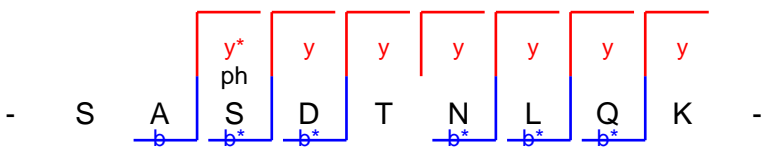

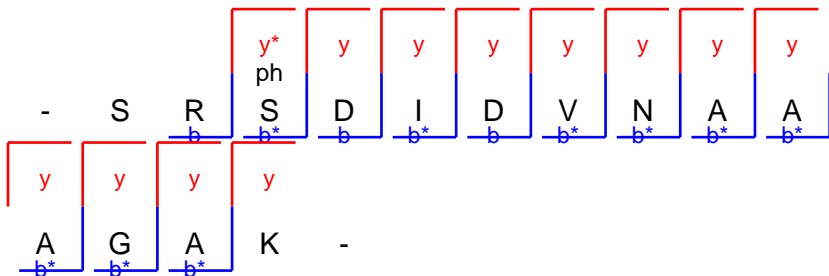
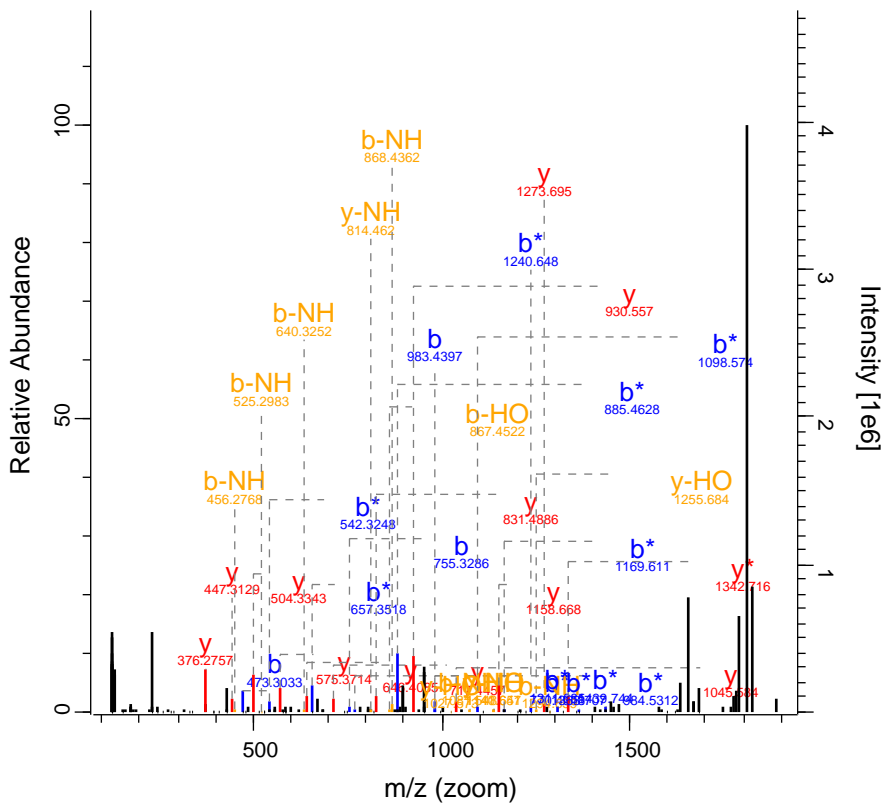

RO-QC-160121_ZackD_SS_Set_02_Fraction14237 FTMS; HC 125.52 972.01 CLASP1

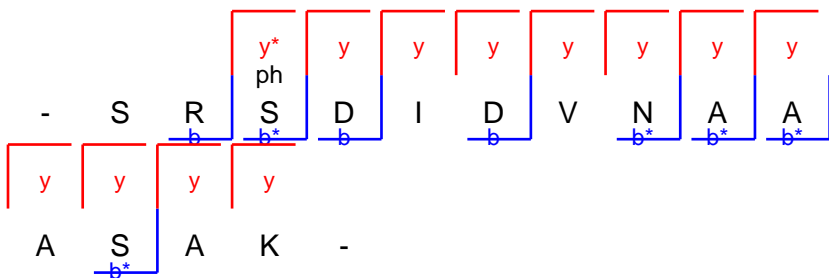
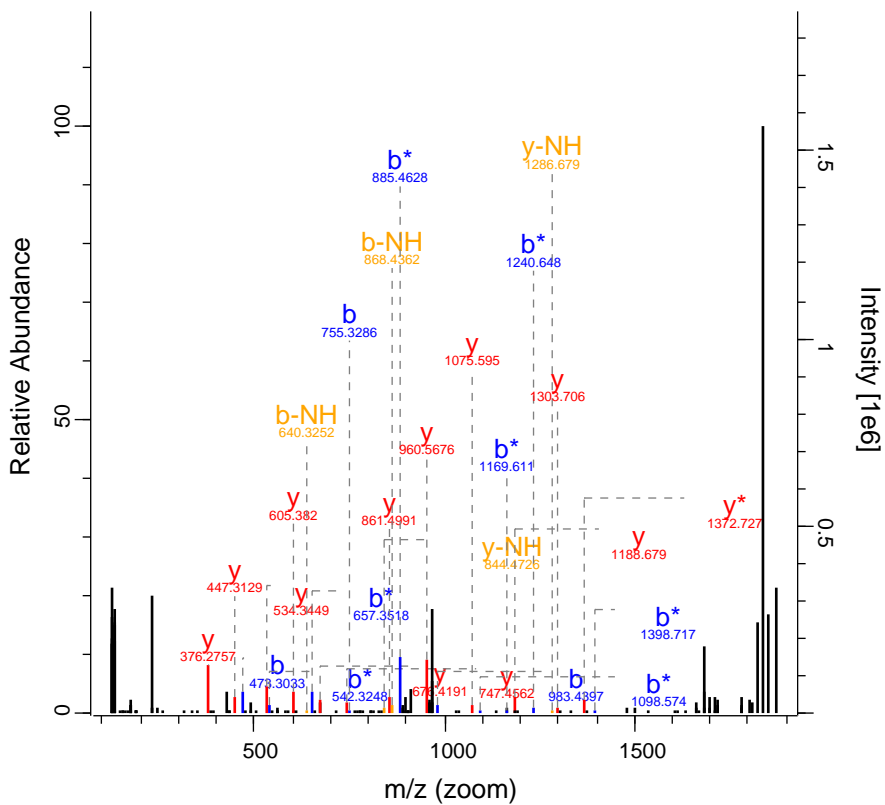

RO-QC-160121_ZackD_SS_Set_02_Fraction15195 FTMS; HC 146.64 768.15 MTDH

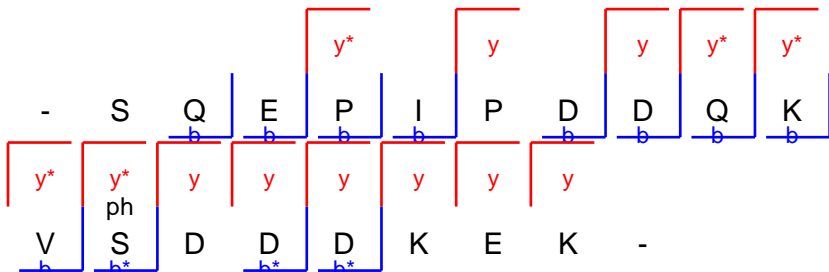
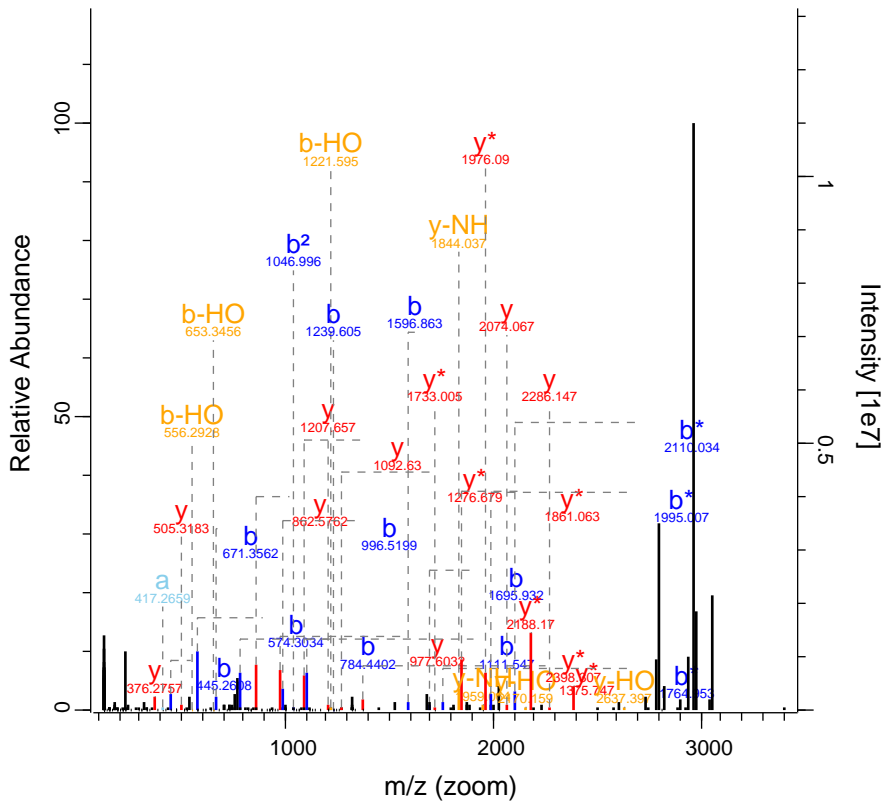

RO-QC-160121_ZackD_SS_Set_02_Fraction15644 FTMS; HC 101.72 651.72 PLEKHA7

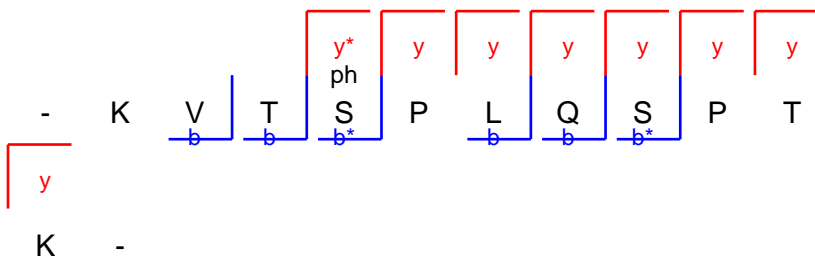
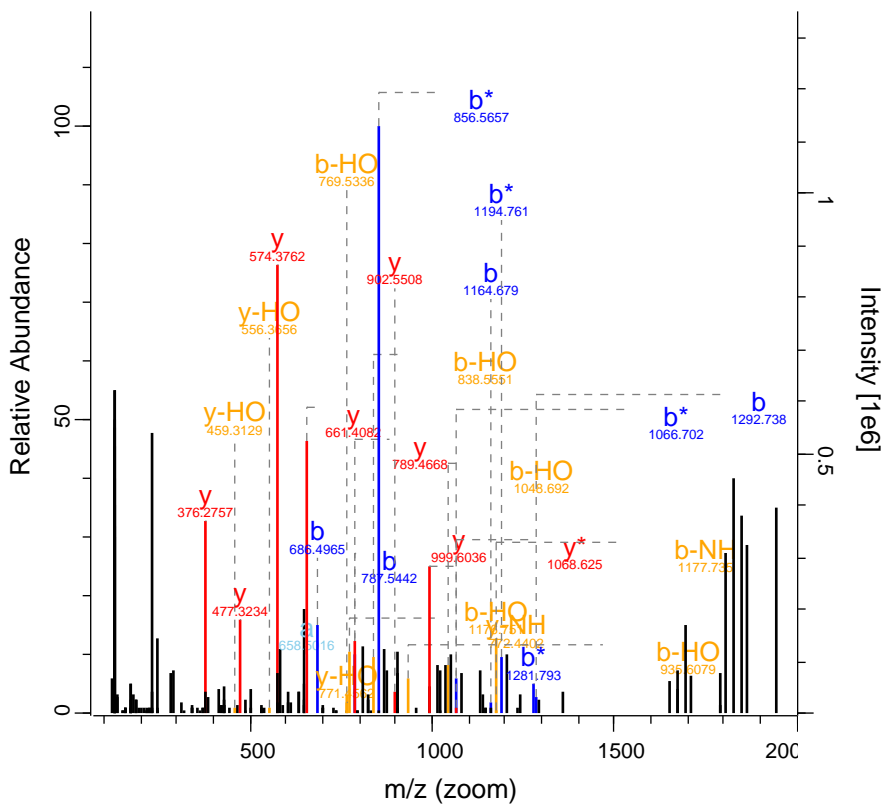

RO-QC-160121_ZackD_SS_Set_02_Fraction16819 FTMS; HC 92.58 853.11 SUMO1

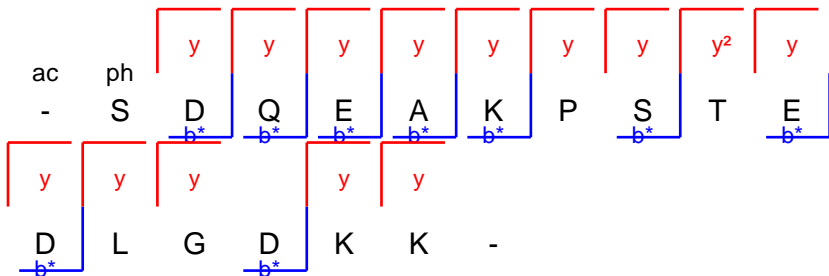
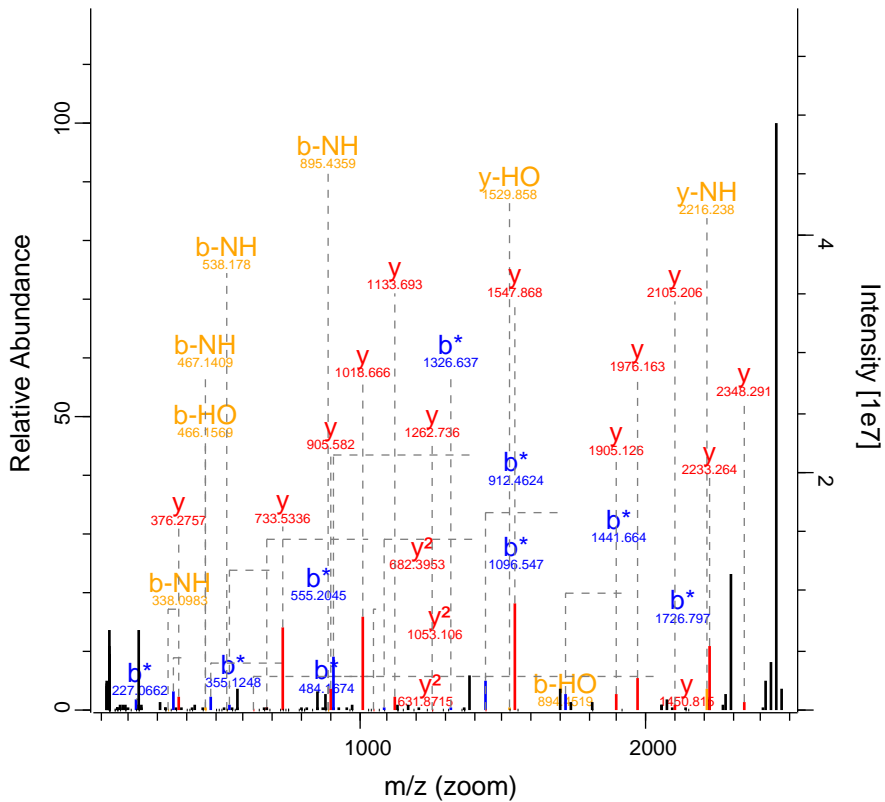

RO-QC-160121_ZackD_SS_Set_02_Fraction 17144 FTMS; HC 65.9 865.9 CYBRD1

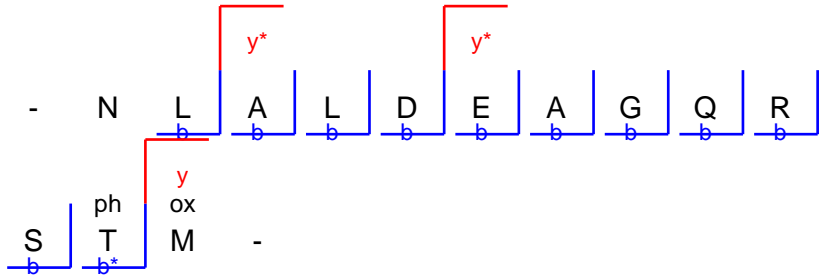
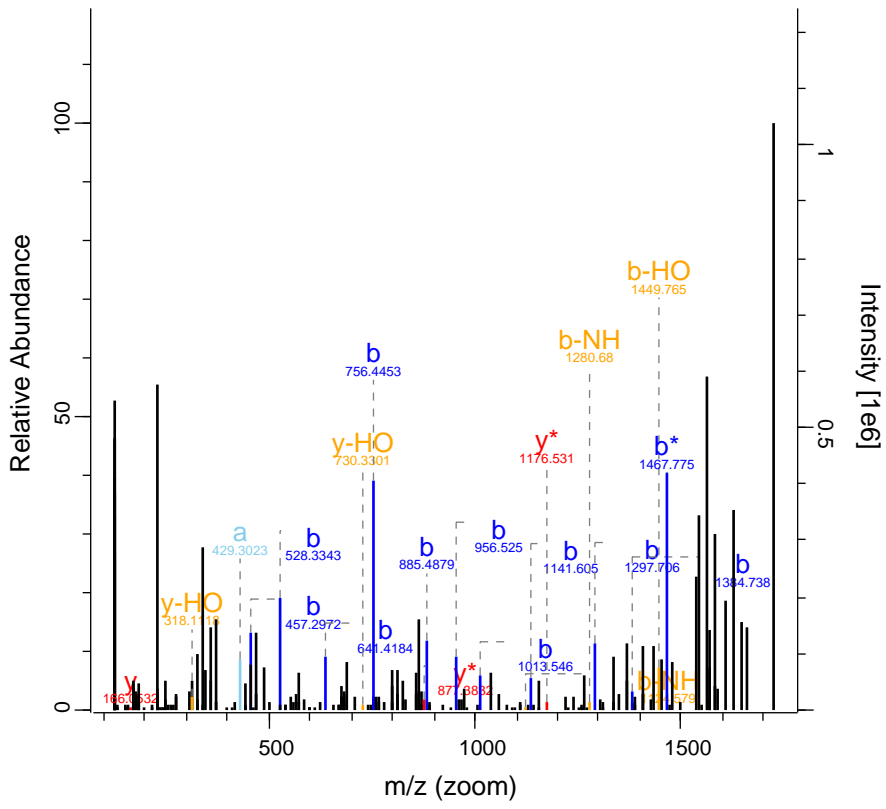

RO-QC-160121_ZackD_SS_Set_02_Fraction 18804 FTMS; HC 46.16 649.04 FTSJ3

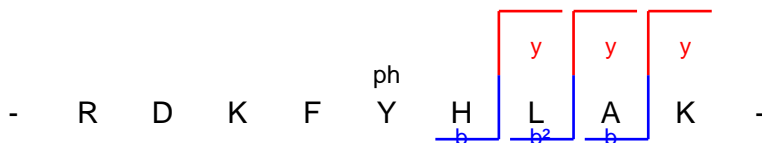
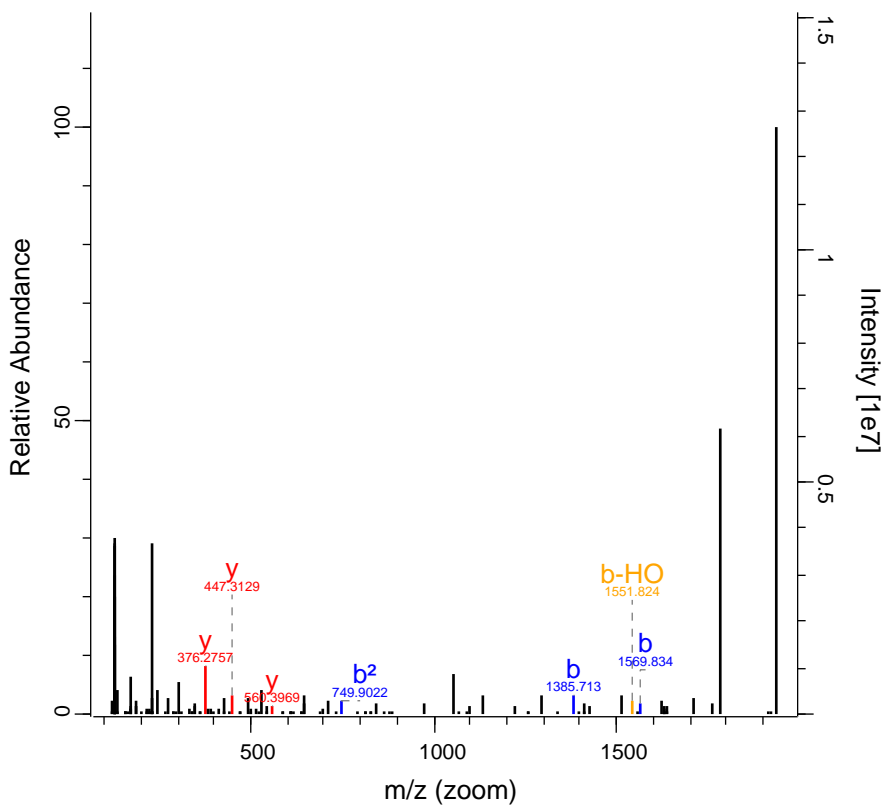

RO-QC-160121_ZackD_SS_Set_02_Fraction 20786 FTMS; HC 87.68 718.69 RBMX;RBMXL

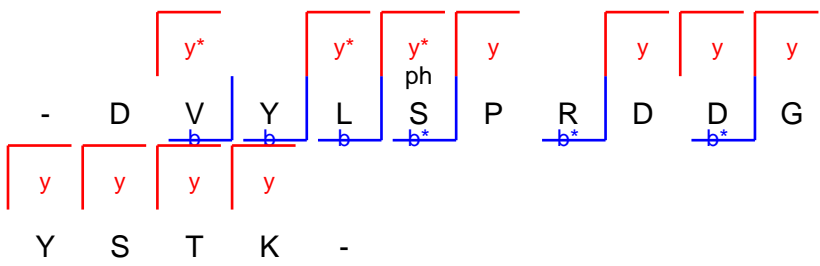
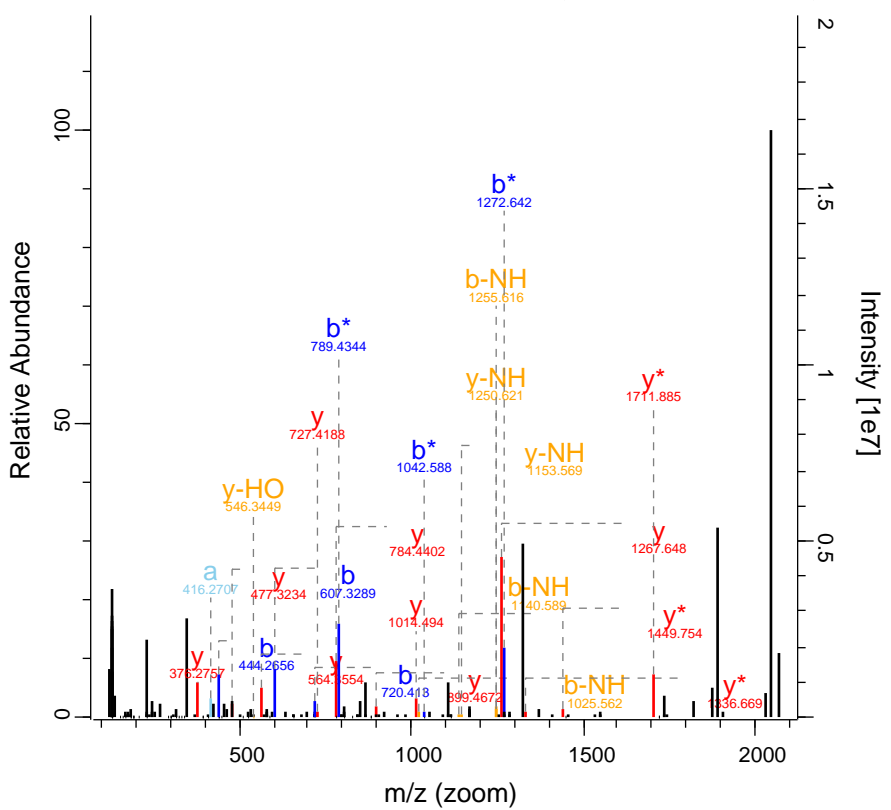

RO-QC-160121_ZackD_SS_Set_02_Fractio 21024 FTMS; HC 184.98 1042.01 MAP1B

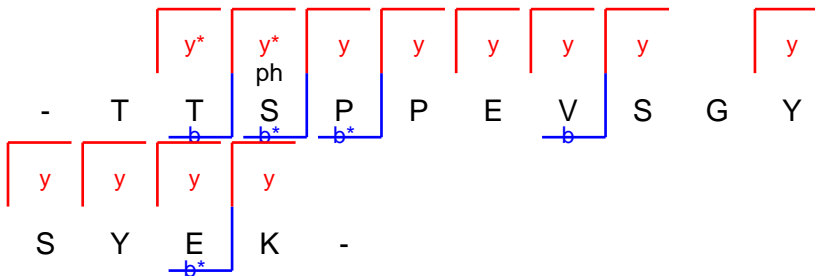
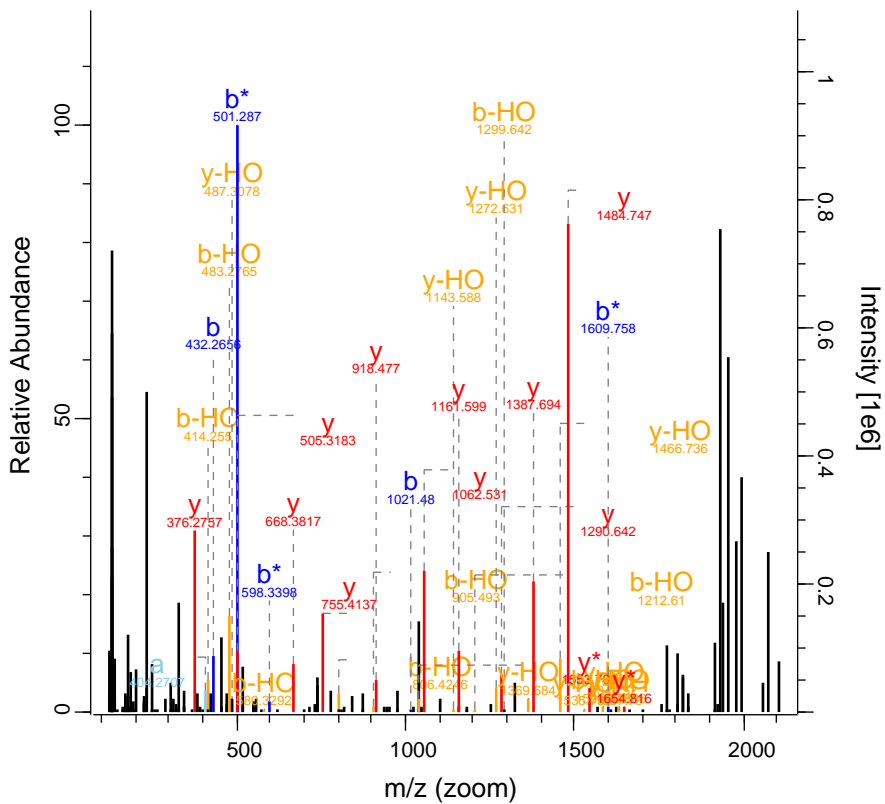

RO-QC-160121_ZackD_SS_Set_02_Fraction 21534 FTMS; HC 44.62 573.33 ORAOV1

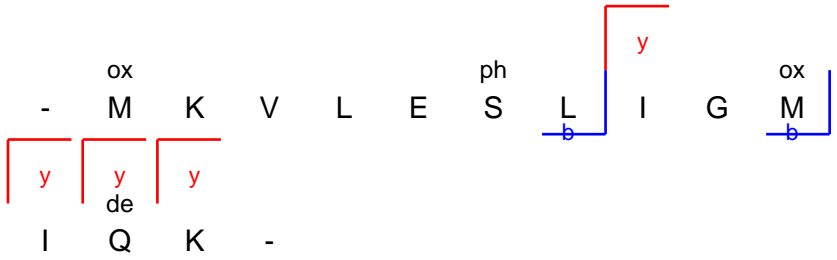
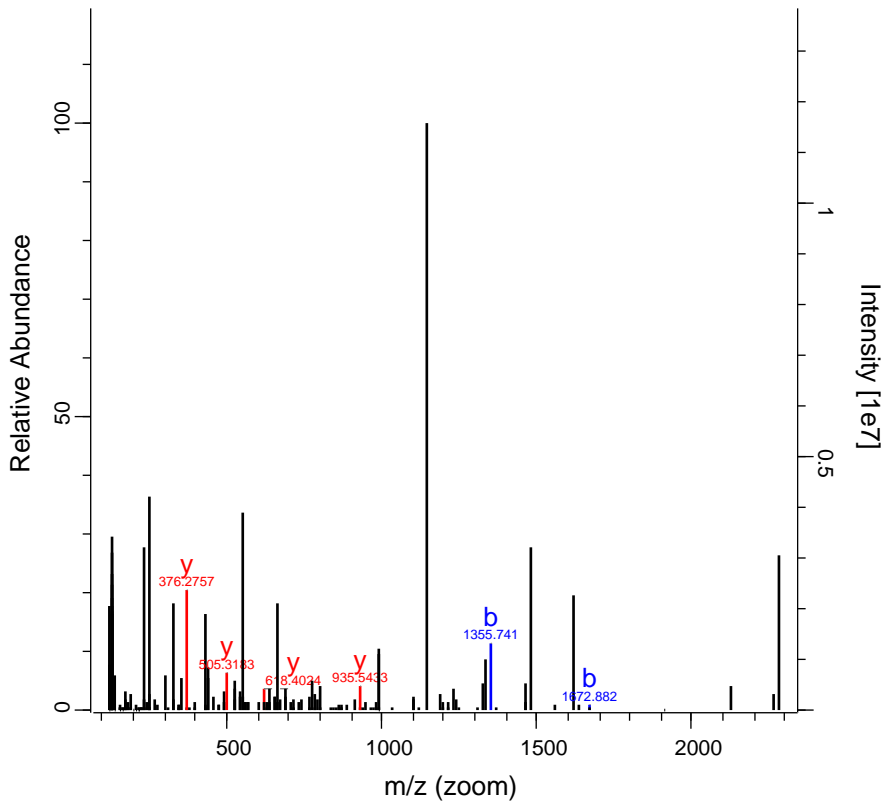

RO-QC-160121_ZackD_SS_Set_02_Fraction 22531 FTMS; HC 83.22 948.22 TFIP11

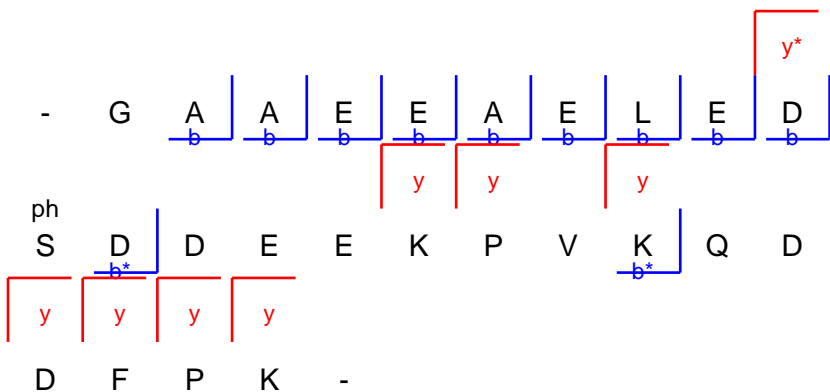
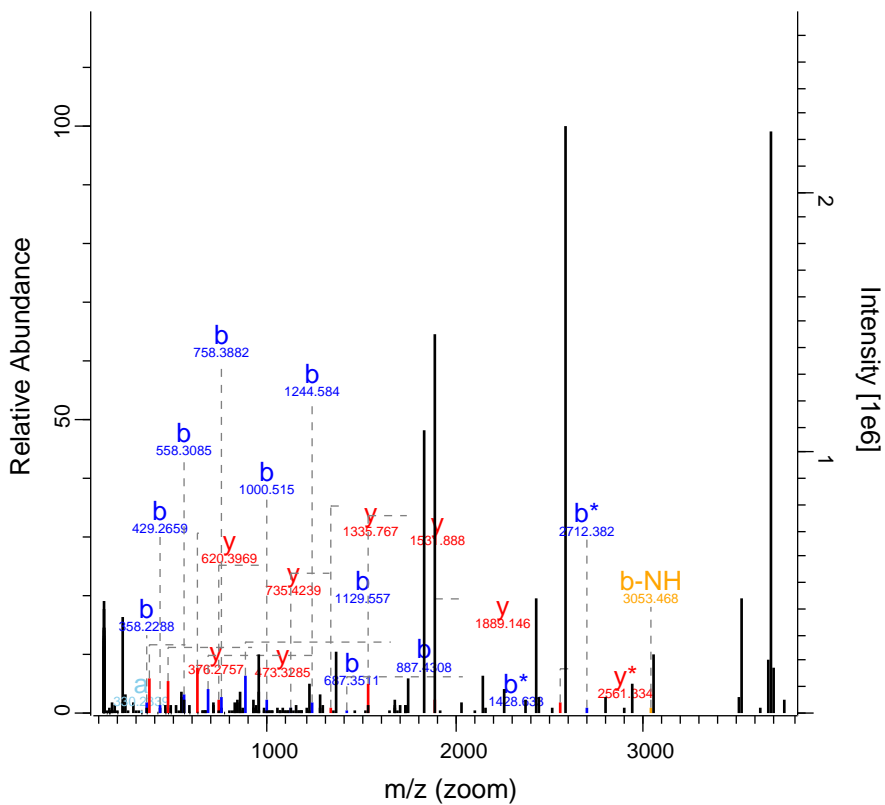

RO-QC-160121_ZackD_SS_Set_02_Fraction 22564 FTMS; HC 115.76 882.7 NAF1

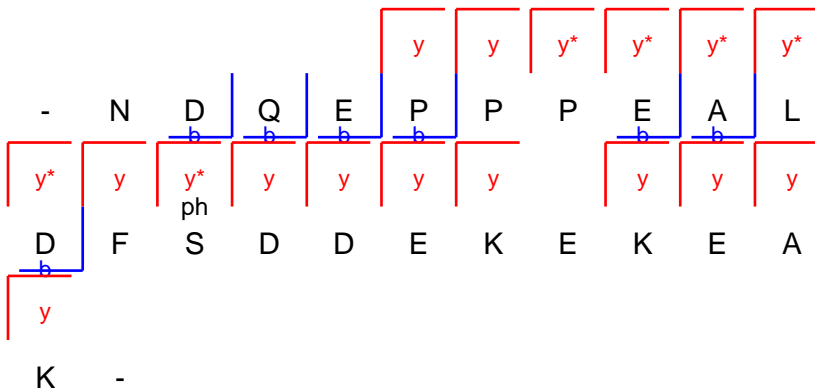
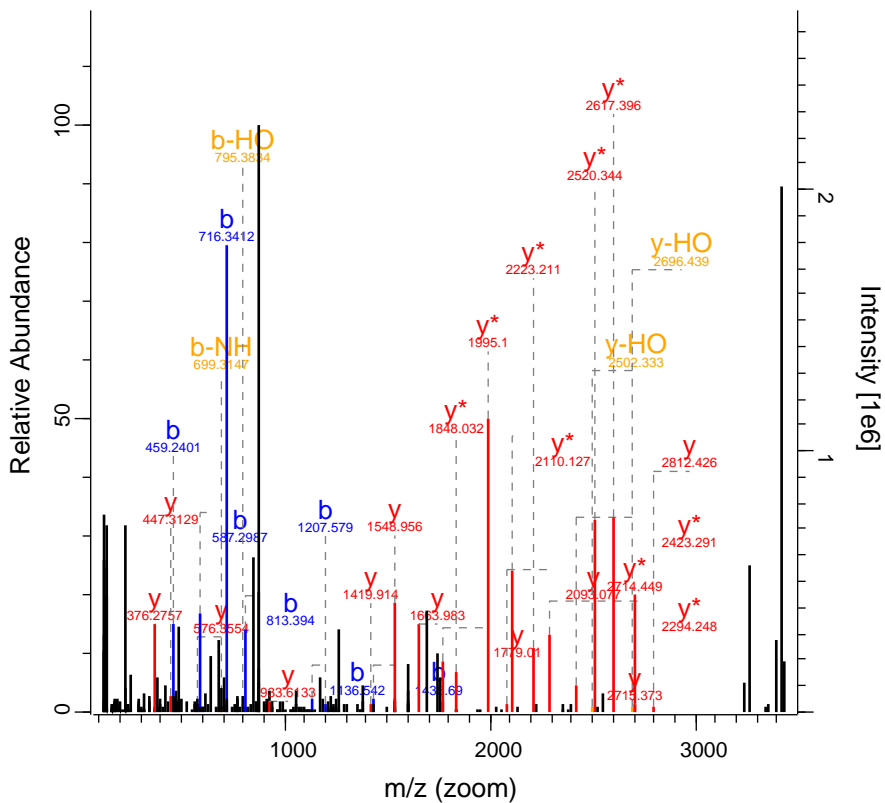

RO-QC-160121_ZackD_SS_Set_02_Fraction 22970 FTMS; HC 91.29 743.38 PIKFYVE

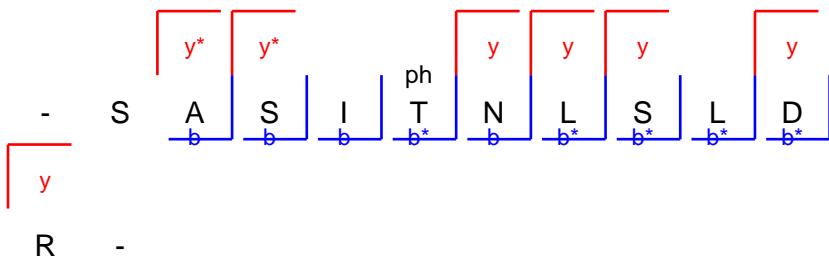
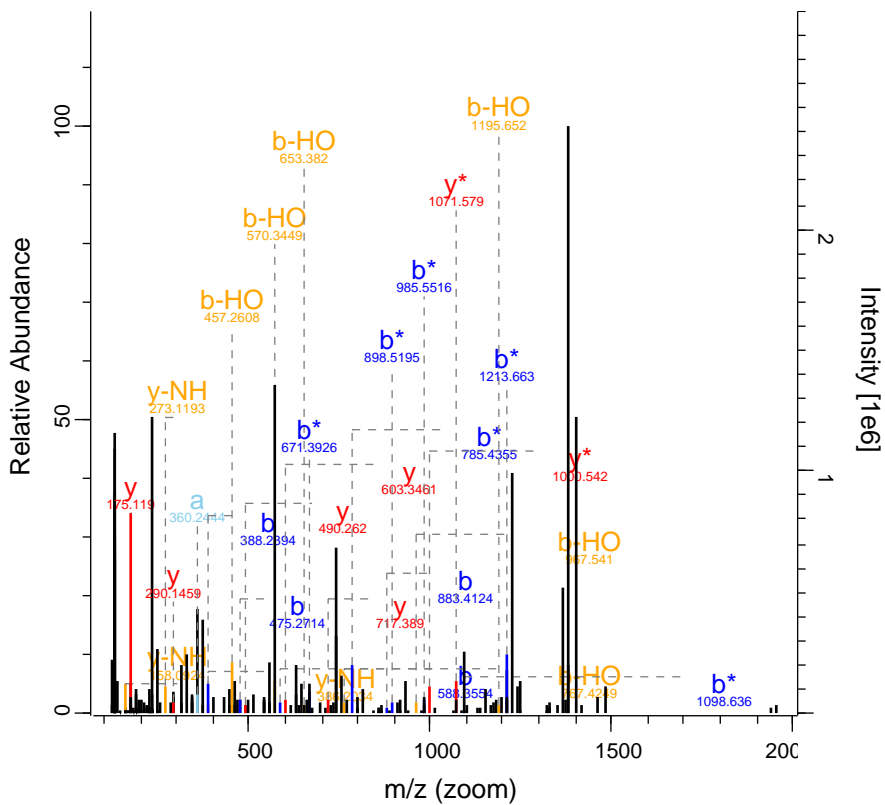

RO-QC-160121_ZackD_SS_Set_02_Fraction 24377 FTMS; HC 48.11 788.76 AARSD1

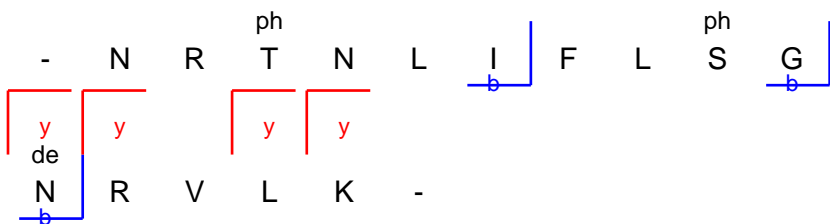
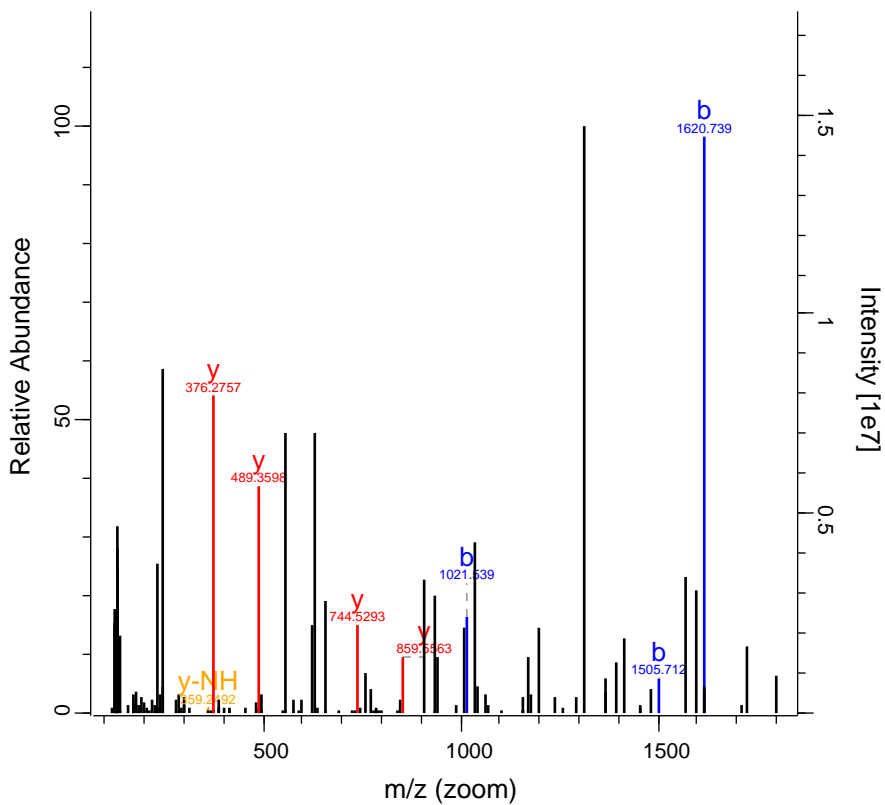

RO-QC-160121_ZackD_SS_Set_02_Fratio 24950 FTMS; HC 145.52 1000.83 UBR4

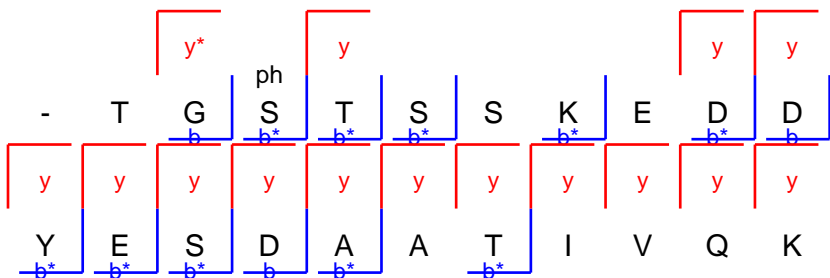
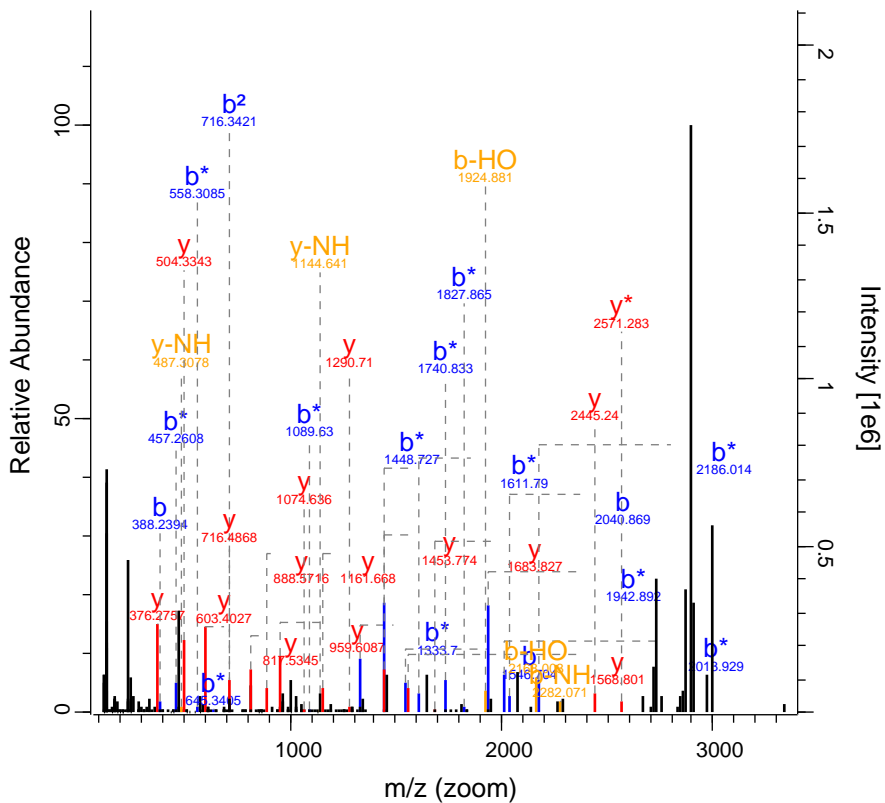

RO-QC-160121_ZackD_SS_Set_02_Fraction1 26336 FTMS; HC 319.33 1221.1 MAP1B

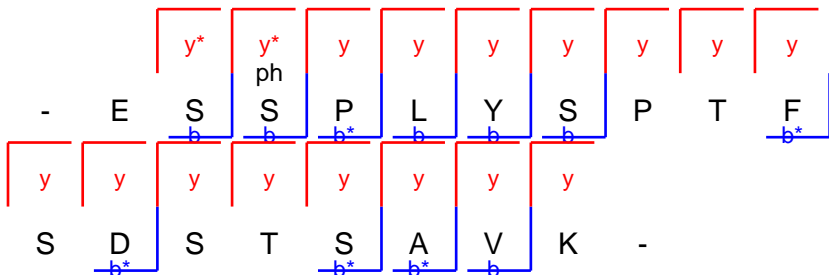
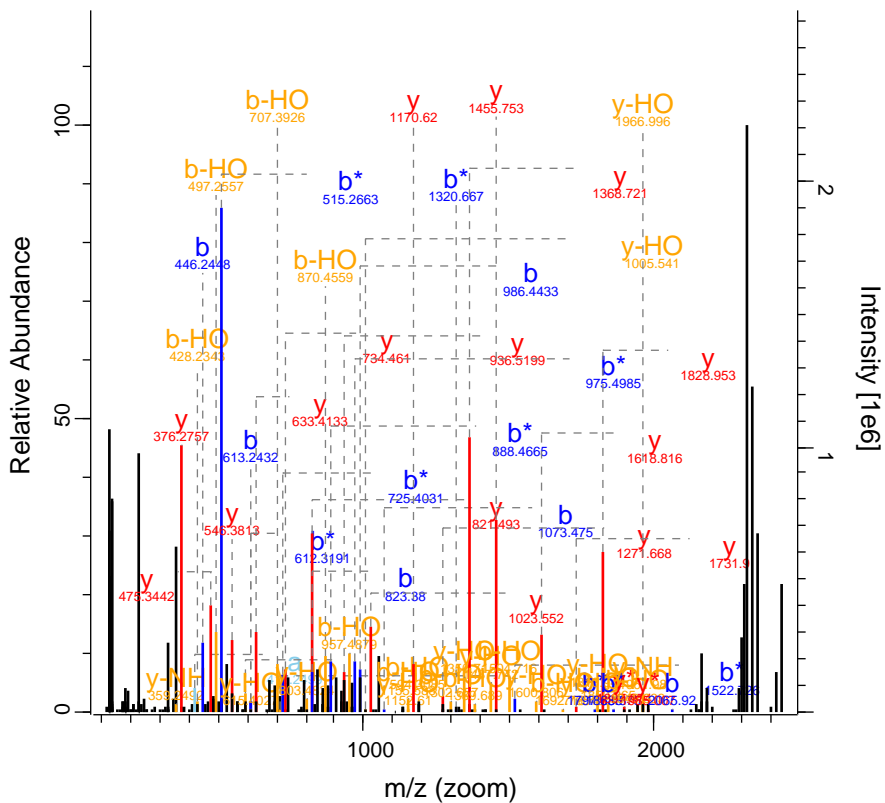

RO-QC-160121_ZackD_SS_Set_02_Fraction 27706 FTMS; HC 79.21 1138.5 GJA1

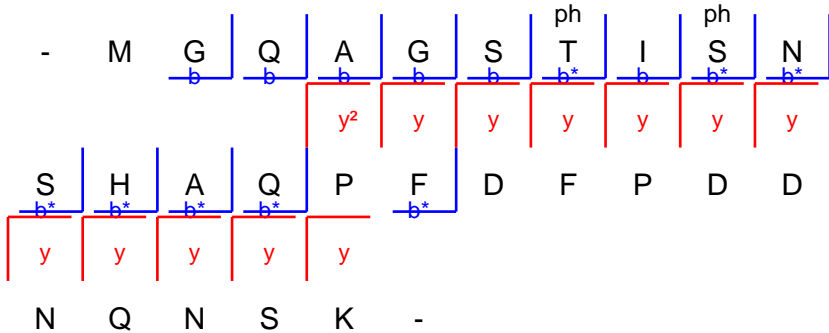
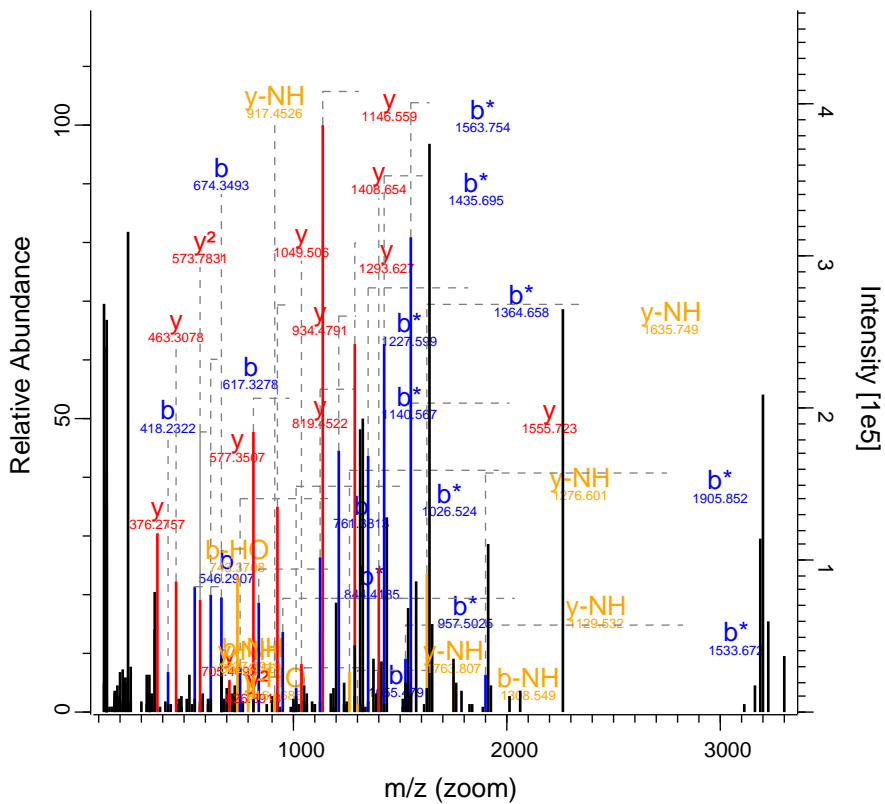

RO-QC-160121_ZackD_SS_Set_02_Fraction 28049 FTMS; HC 139.98 844.93 AHNAK

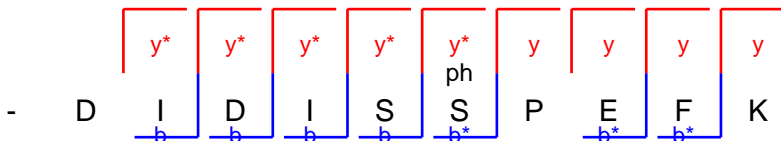
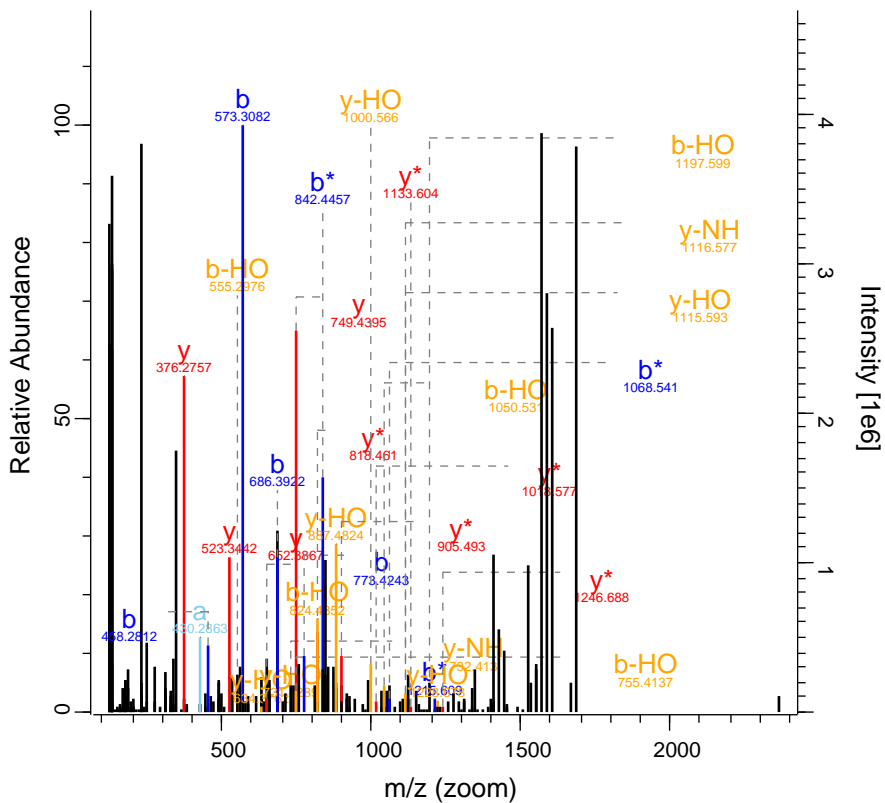

RO-QC-160121_ZackD_SS_Set_02_Fraction1 31222 FTMS; HC 162.71 936.17 TNS3

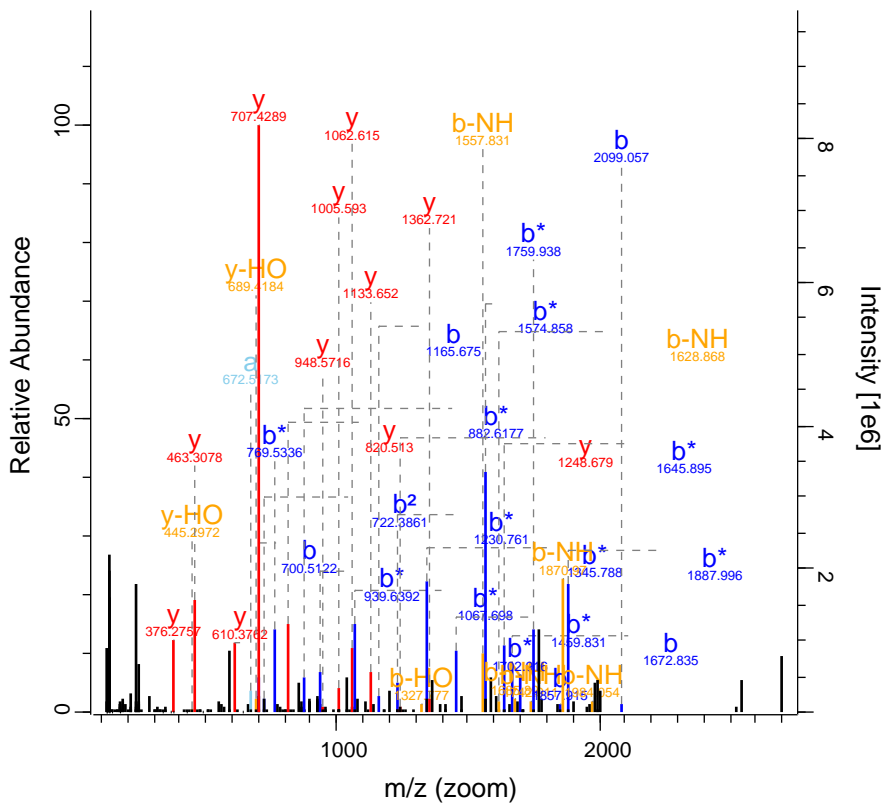

RO-QC-160121_ZackD_SS_Set_02_Fraction 32158 FTMS; HC 65.35 1090.55 APAF1

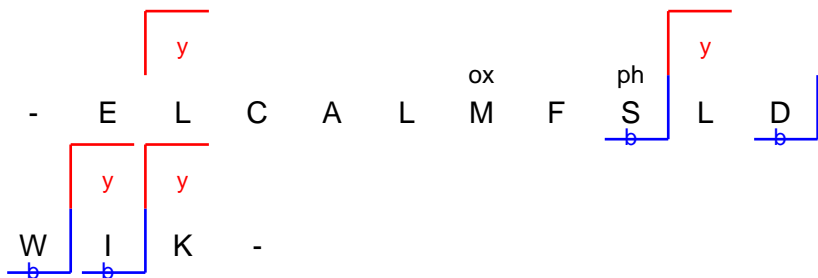
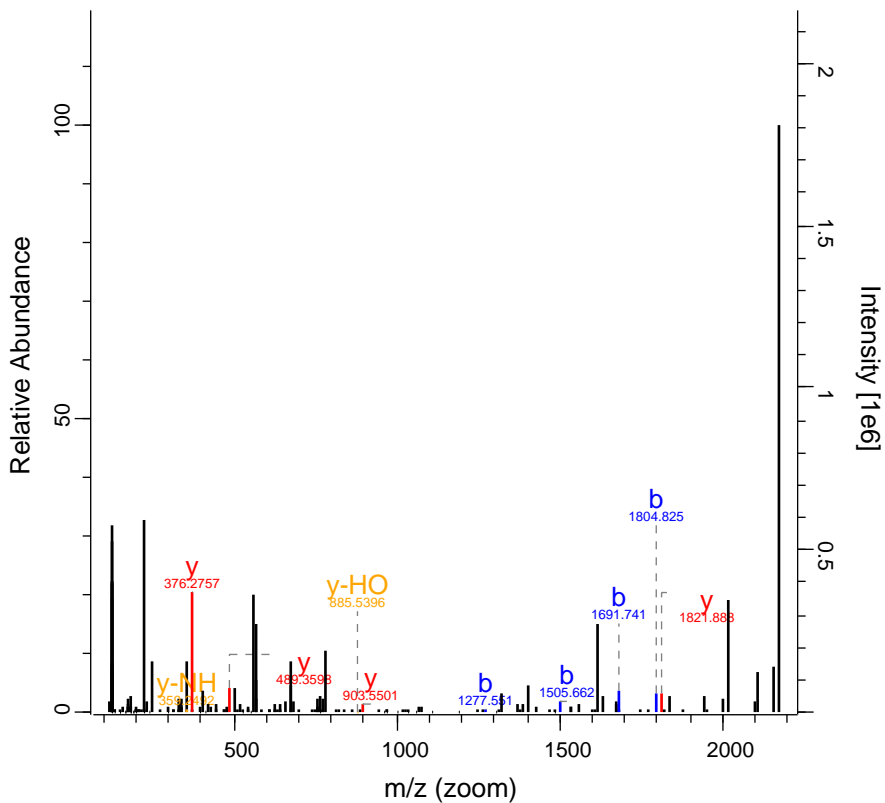

RO-QC-160121_ZackD_SS_Set_02_Fraction 32285 FTMS; HC 118.31 633.37 NSFL1C

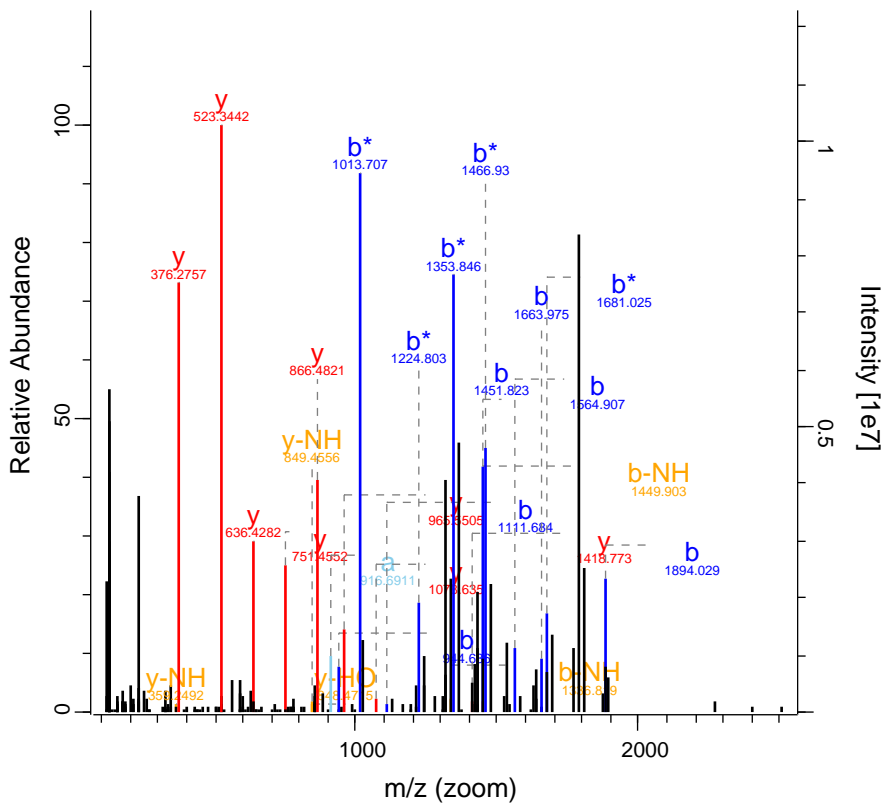

RO-QC-160121_ZackD_SS_Set_02_Fraction 32764 FTMS; HC 40.35 562.97 LMO2

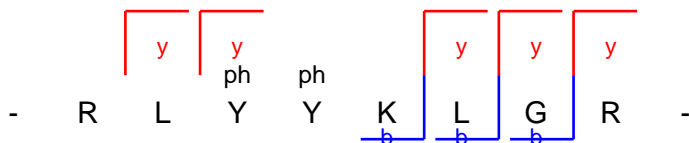
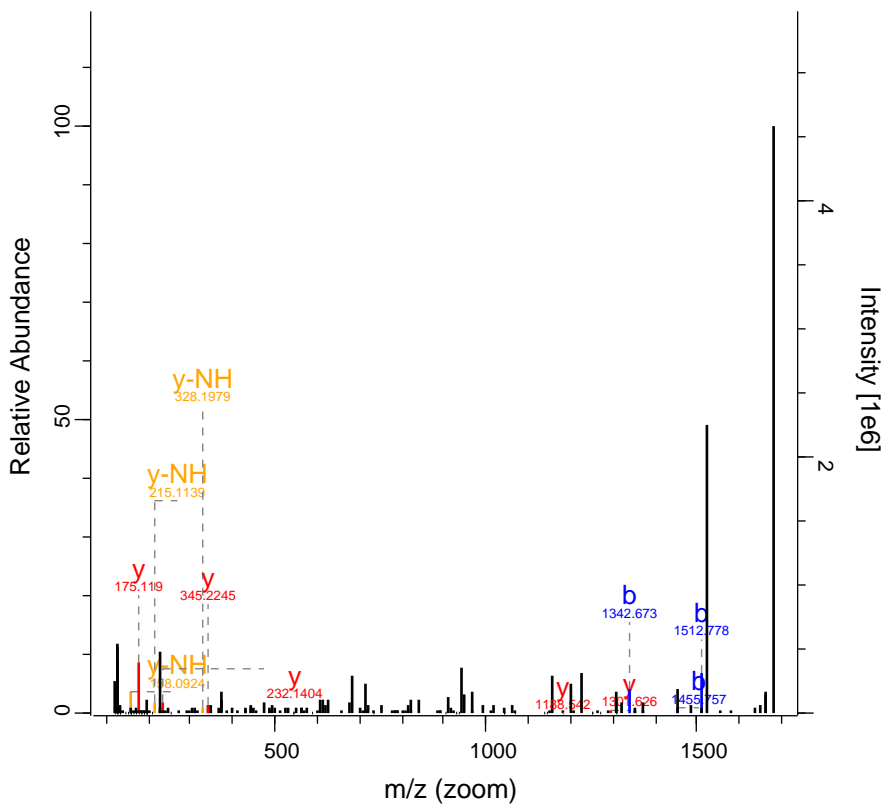

RO-QC-160121_ZackD_SS_Set_02_Fraction 33781 FTMS; HC 73.8 565.65 SCRIB

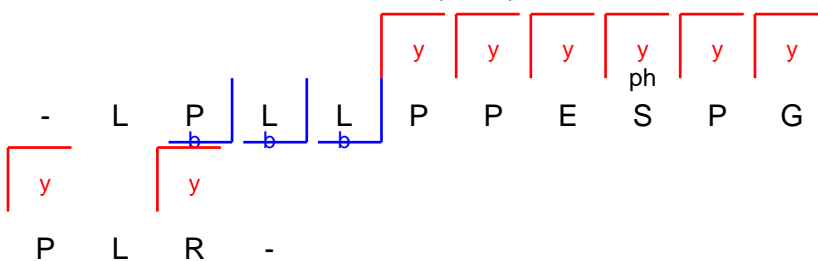
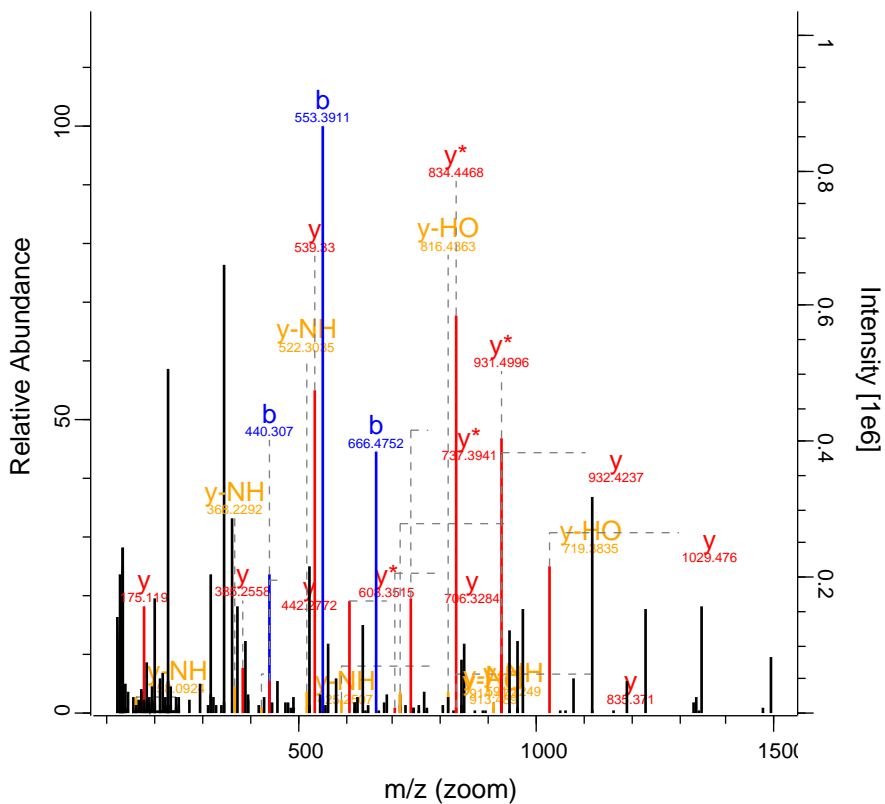

RO-QC-160121_ZackD_SS_Set_02_Fraction 35640 FTMS; HC 64.73 1081.54 SLC2A4

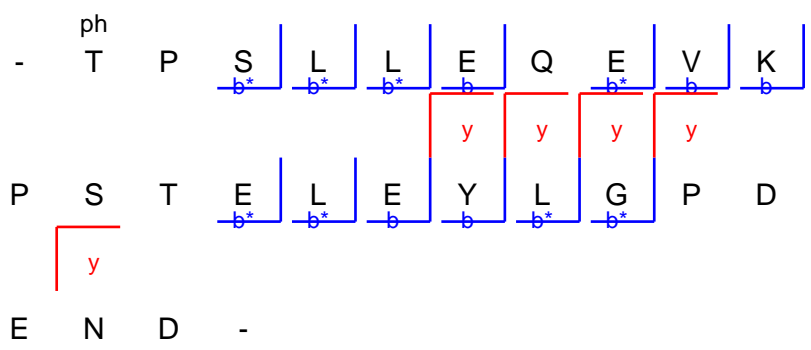
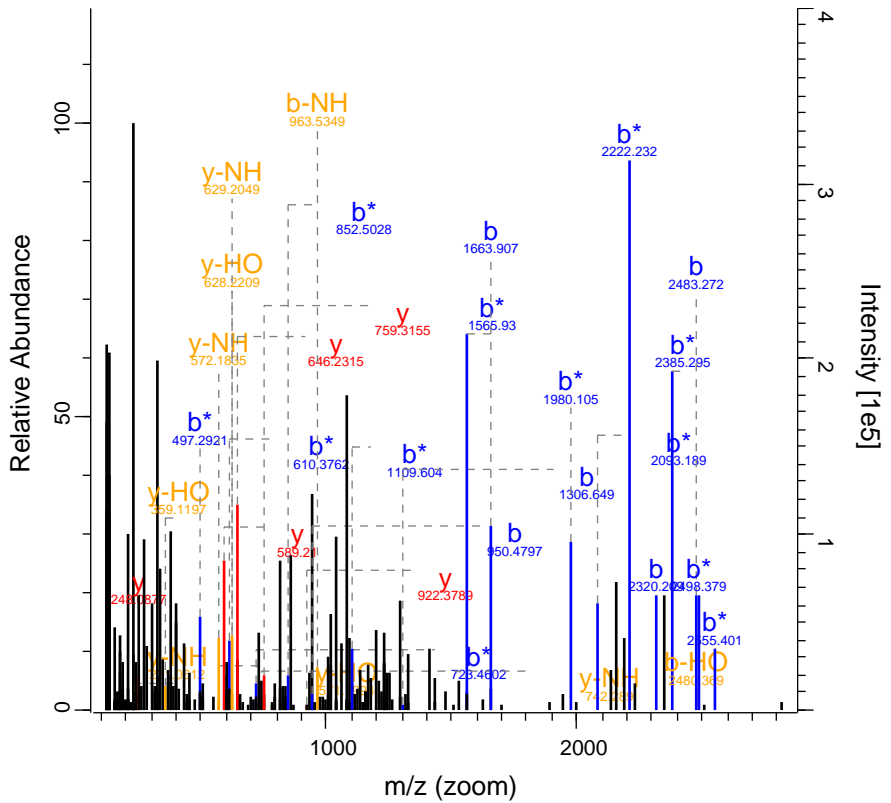

RO-QC-160121_ZackD_SS_Set_02_Fraction 35816 FTMS; HC 126.8 578.59 TP11

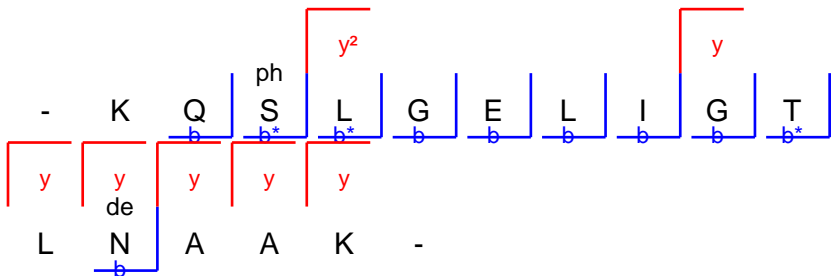
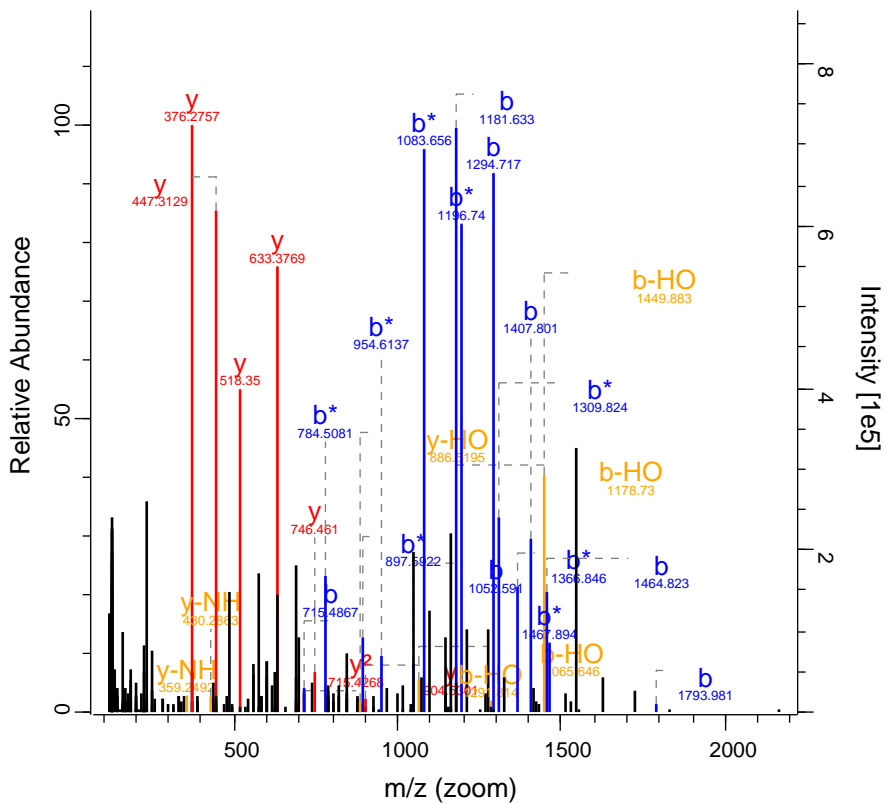

RO-QC-160121_ZackD_SS_Set_02_Fraction 36207 FTMS; HC 45.14 1272.66 ARID2

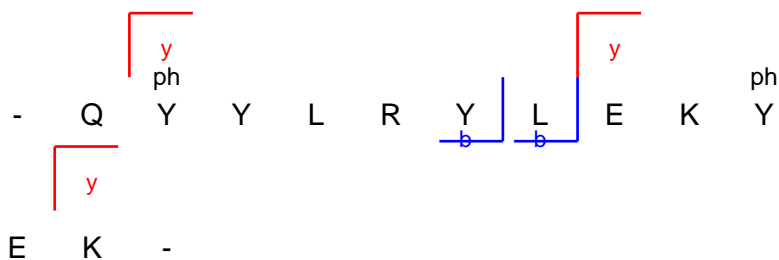
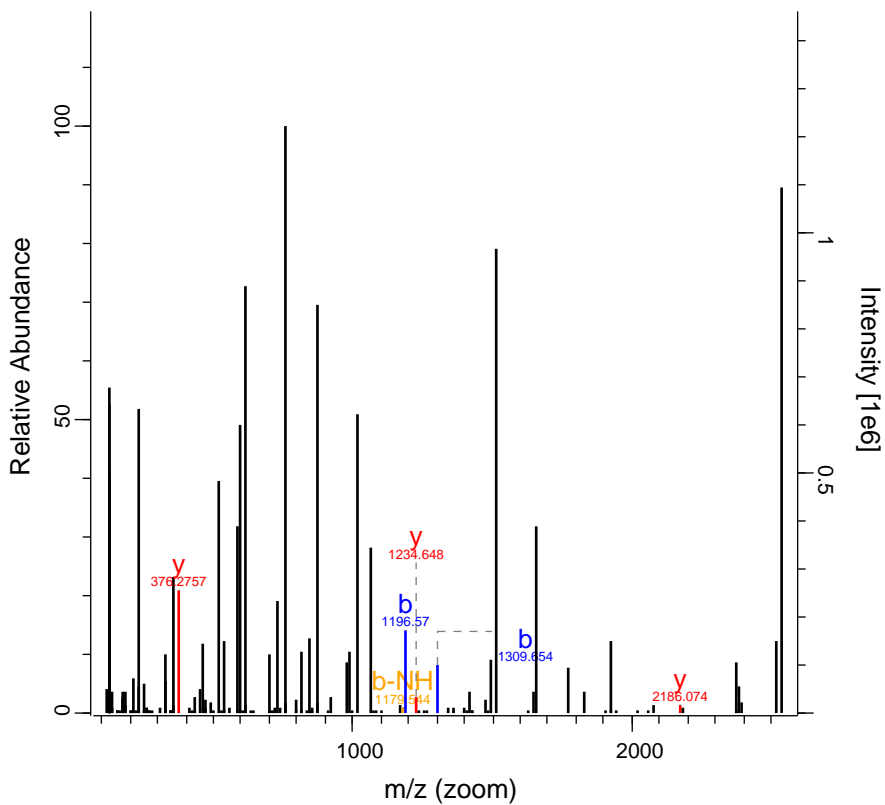

RO-QC-160121_ZackD_SS_Set_02_Fractio 36436 FTMS; HC 109.35 1245.04 RPLP2;RPLP1

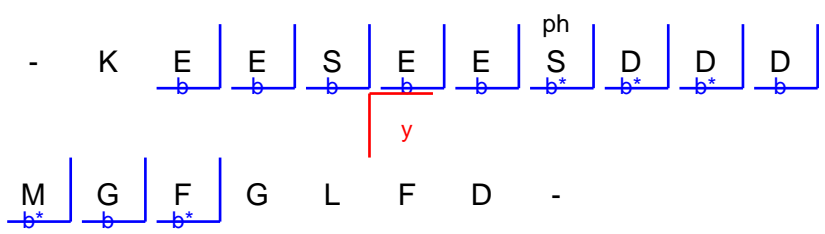
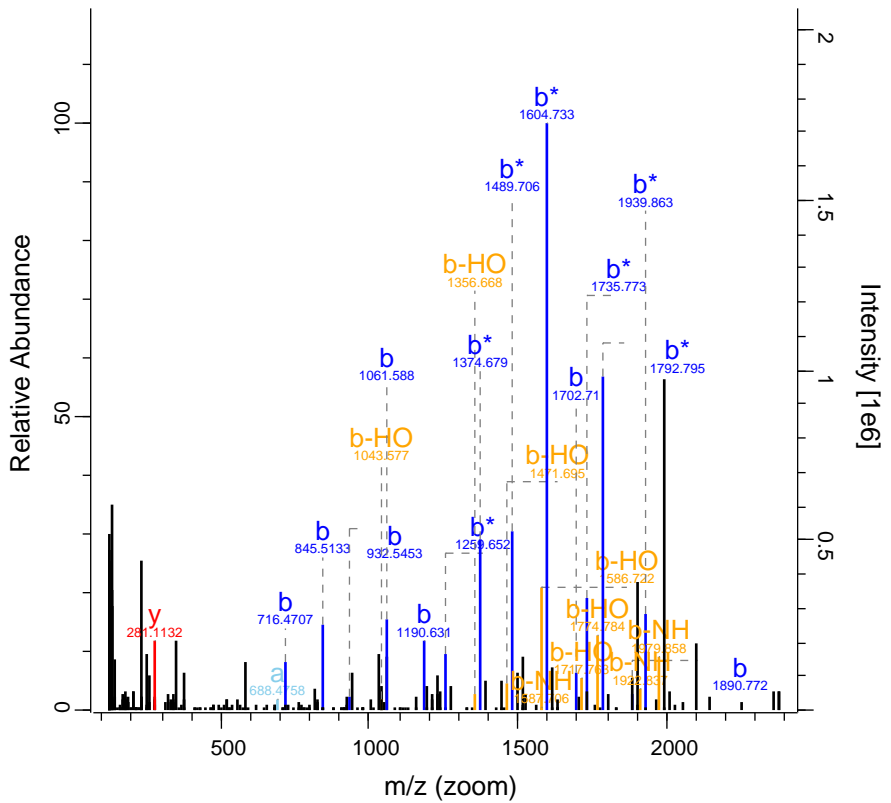

RO-QC-160121_ZackD_SS_Set_02_Fraction 36451 FTMS; HC 50.15 1196.08 DZIP3

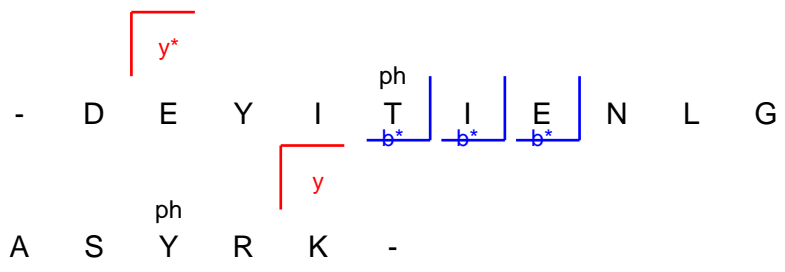
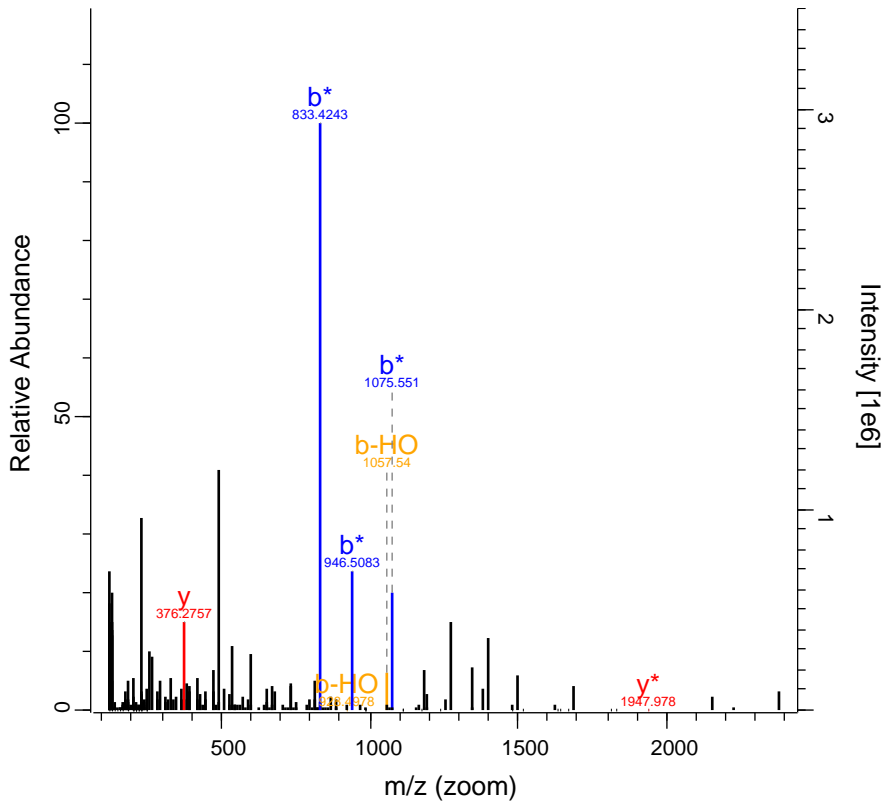

RO-QC-160121_ZackD_SS_Set_02_Fraction 36523 FTMS; HC 78.52 980.04 ST5

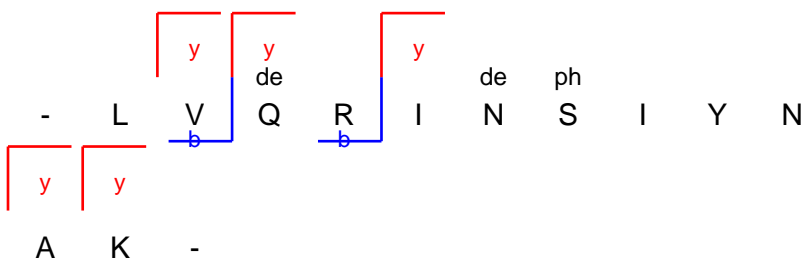
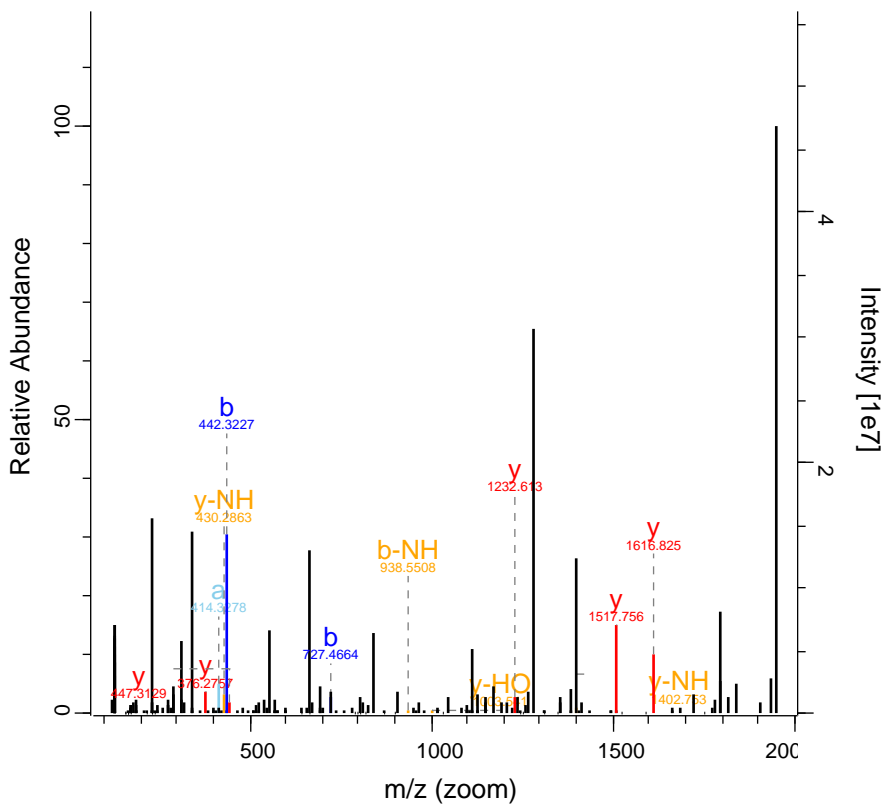

RO-QC-160121_ZackD_SS_Set_02_Fraction 36607 FTMS; HC 46.32 707.86 PTGES2

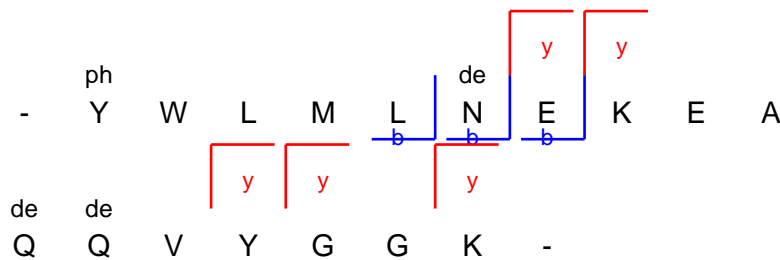
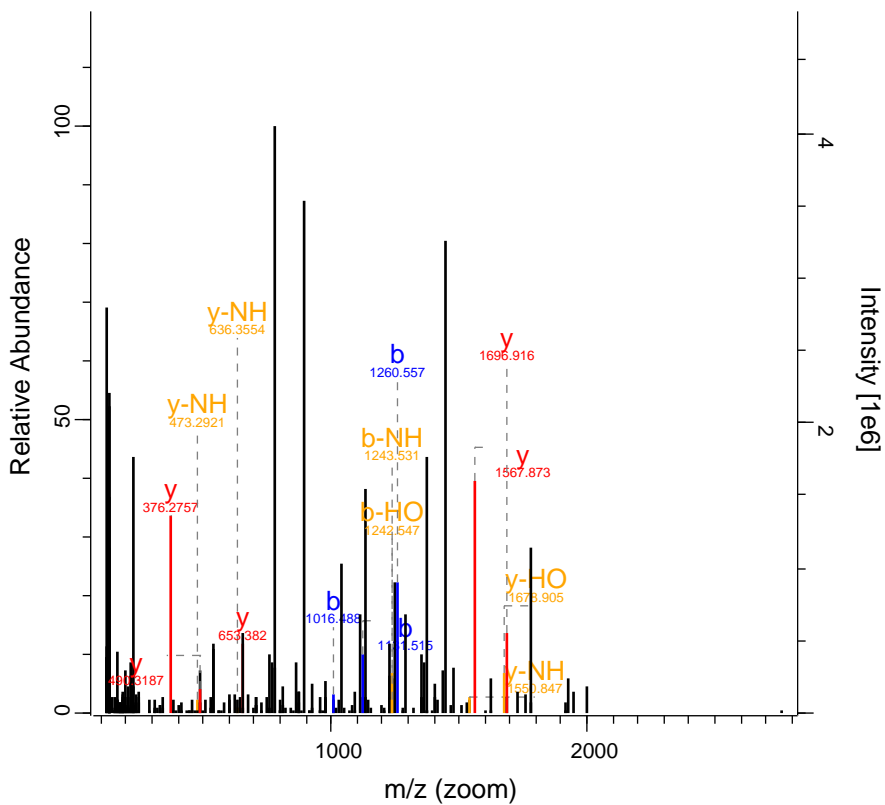

RO-QC-160121_ZackD_SS_Set_02_Fraction 37223 FTMS; HC 83.21 770.1 PGK1

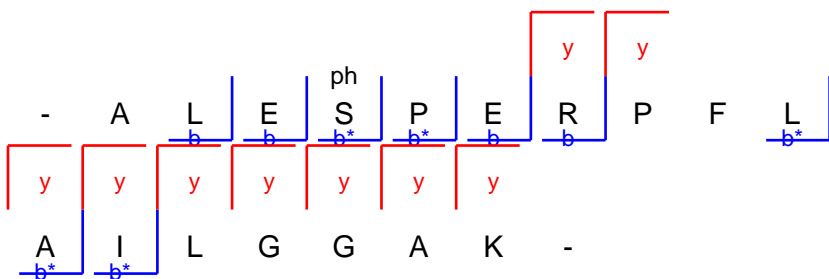
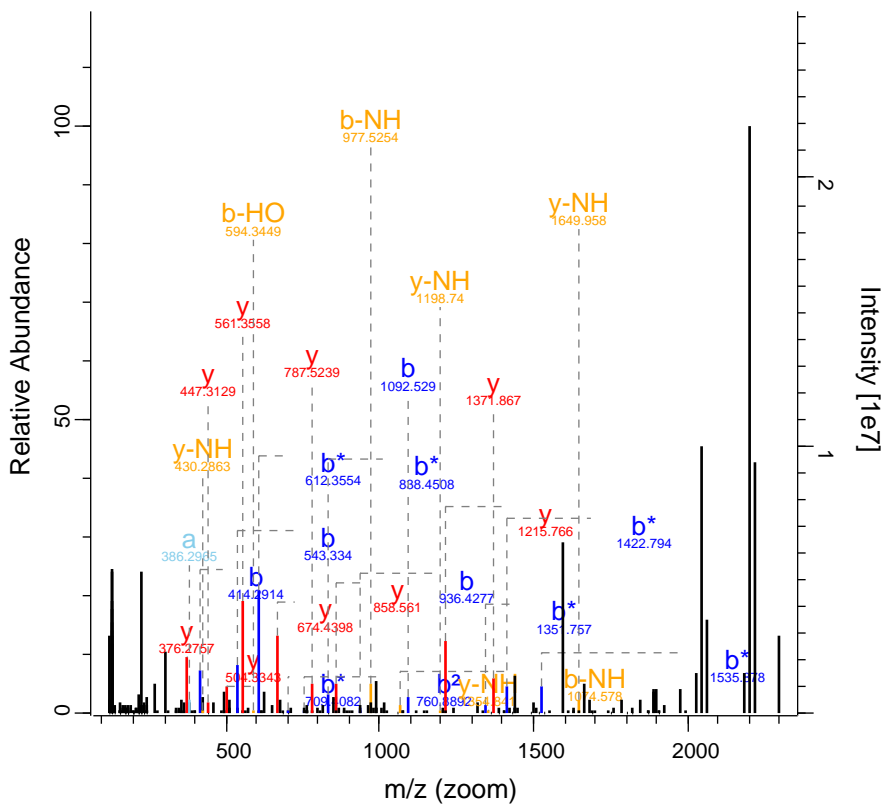

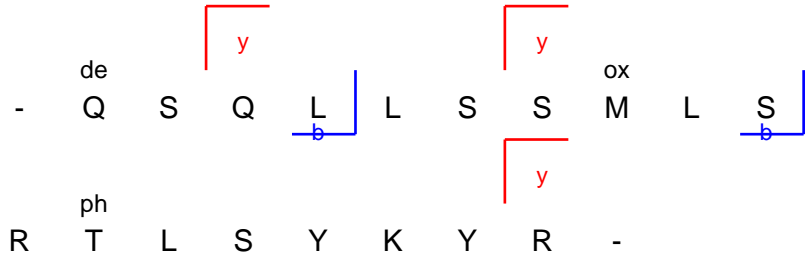
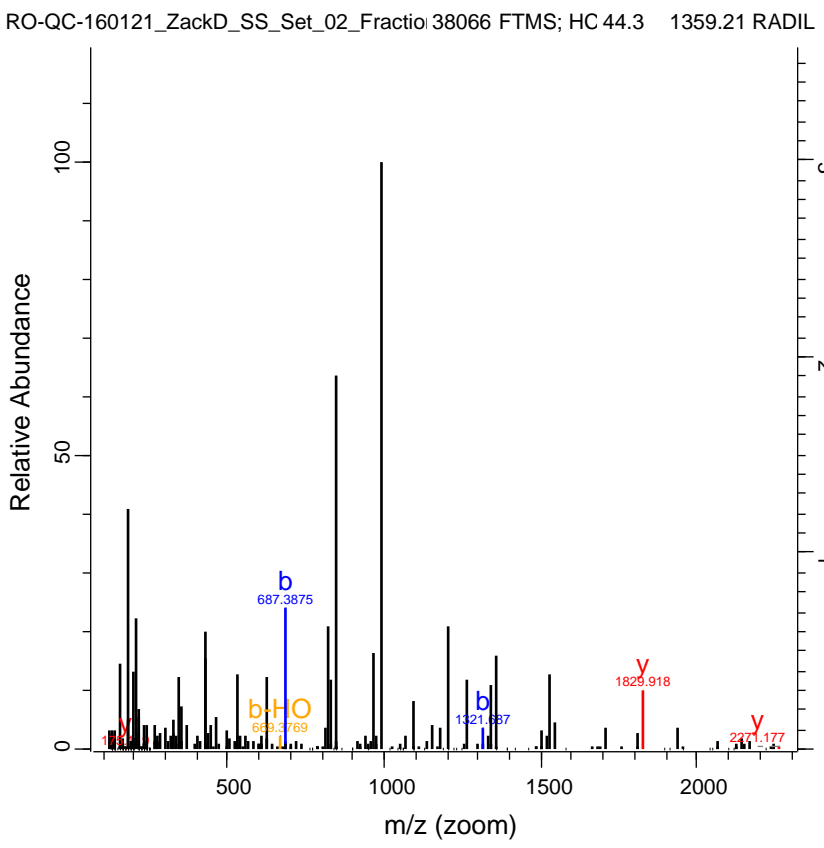

R ph
T L S Y K Y R -

RO-QC-160121_ZackD_SS_Set_02_Fraction 4818 FTMS; HC 56.2 436.25 RBM12

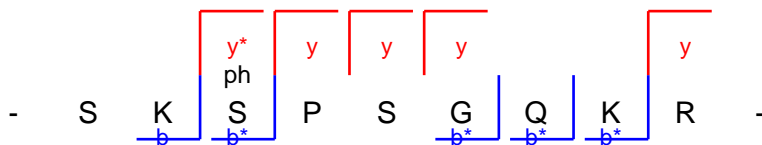
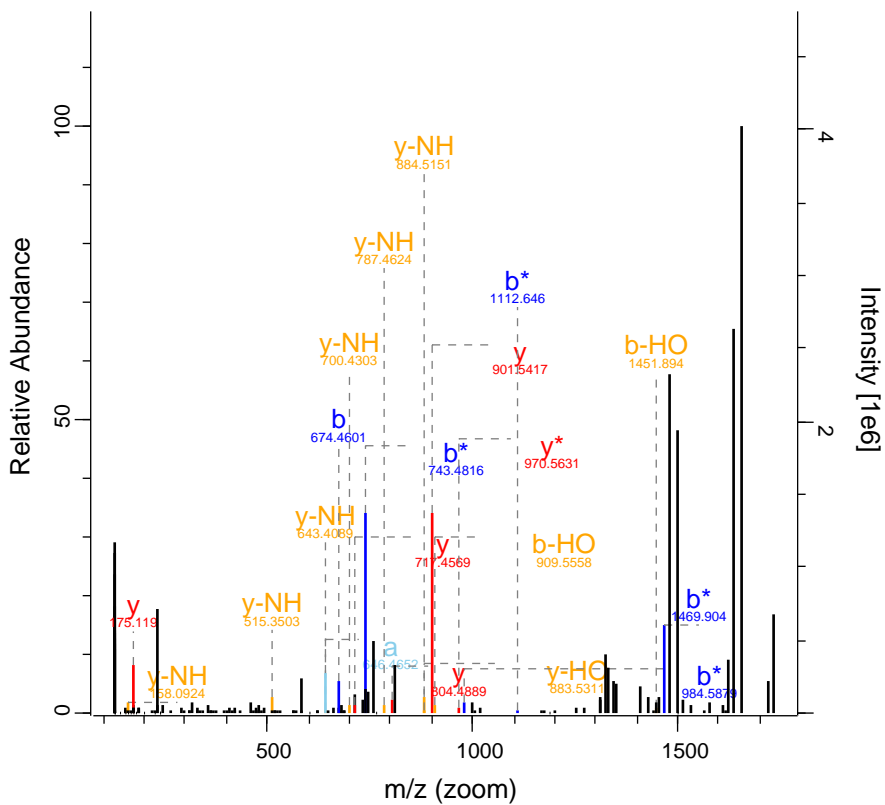

RO-QC-160121_ZackD_SS_Set_02_Fraction 5514 FTMS; HC 82.65 527.61 TNIP1

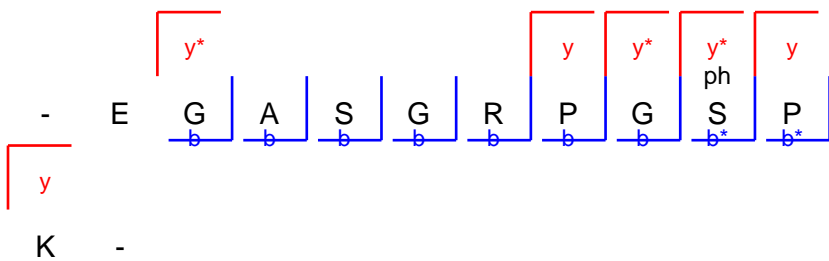
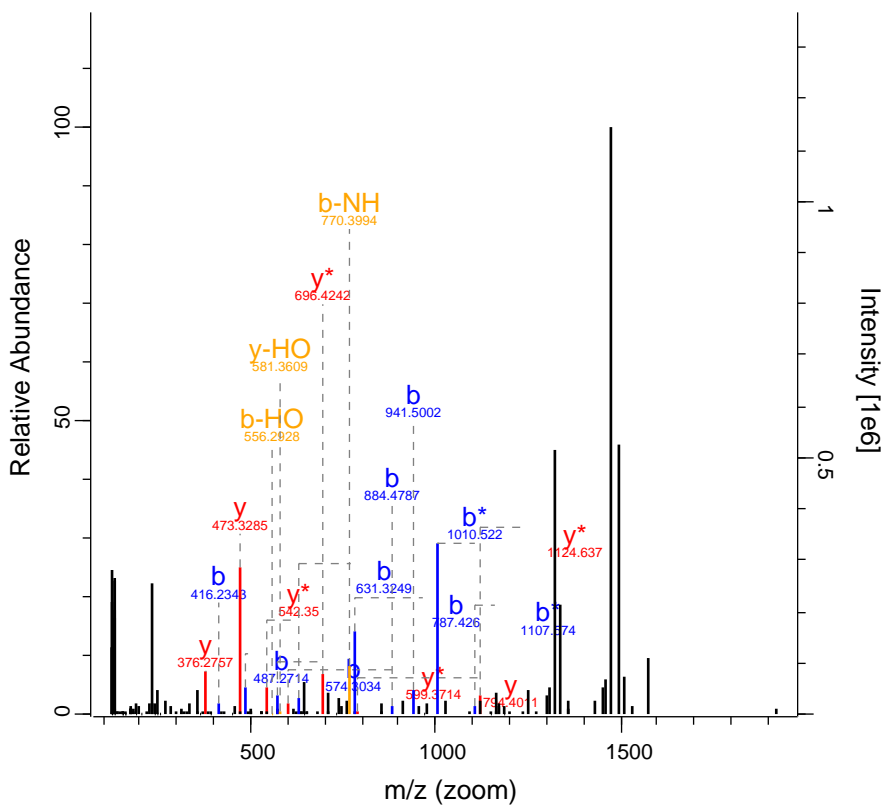

RO-QC-160121_ZackD_SS_Set_02_Fraction 5673 FTMS; HC 72.65 426.21 RRAGC

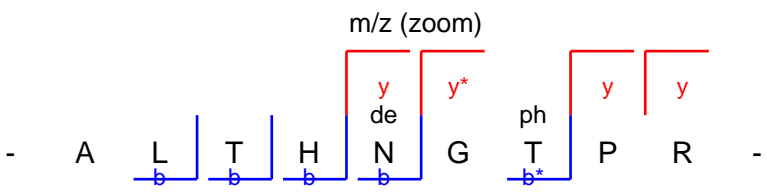
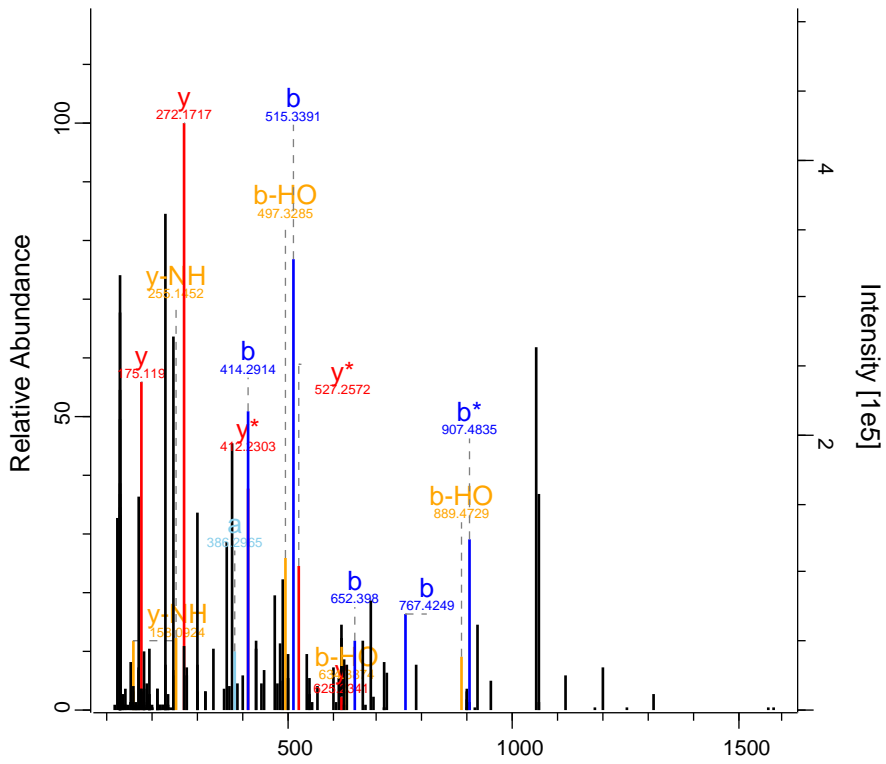

RO-QC-160121_ZackD_SS_Set_02_Fraction 5981 FTMS; HC 41.54 422.44 ZNF836

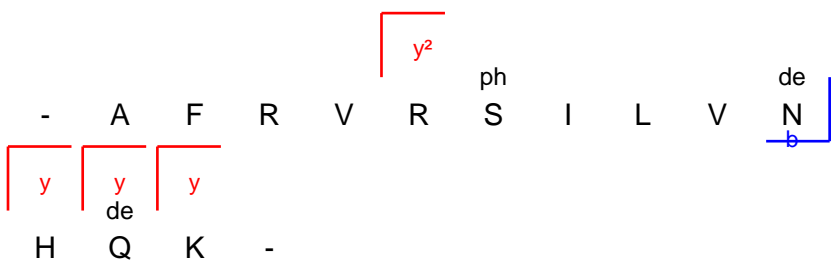
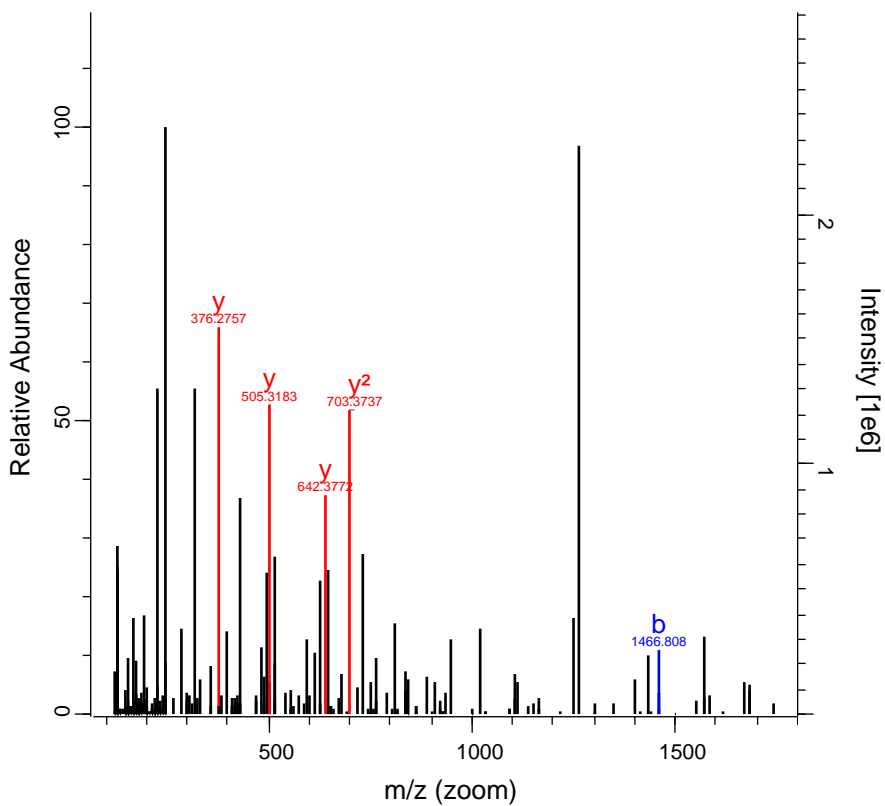

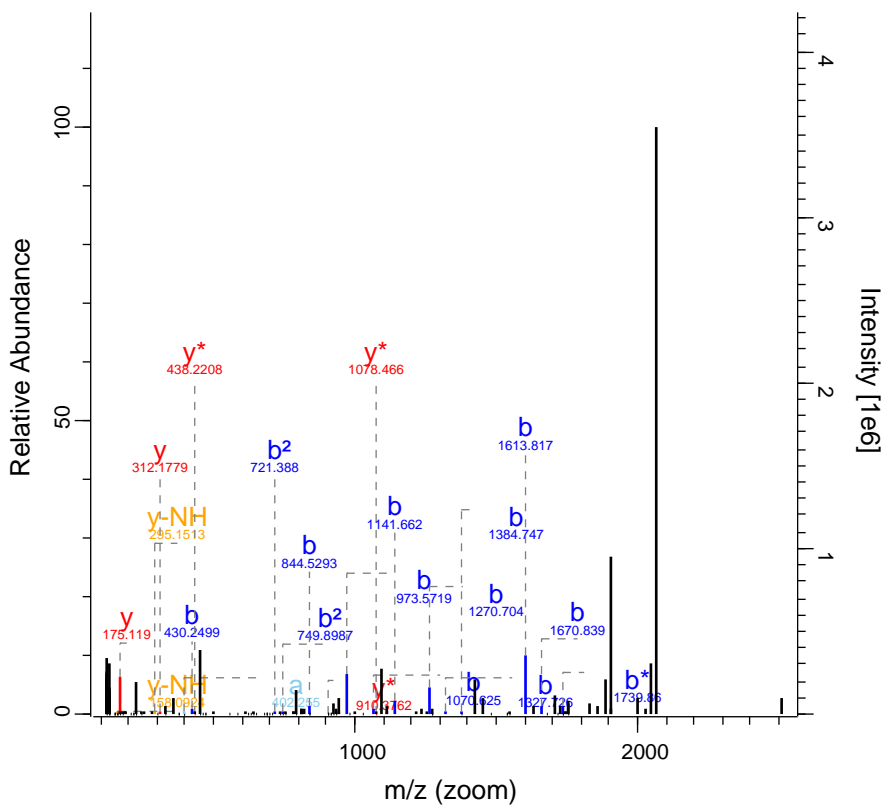

RO-QC-160121_ZackD_SS_Set_02_Fraction 6640 FTMS; HC 50.04 564.79 IGSF21

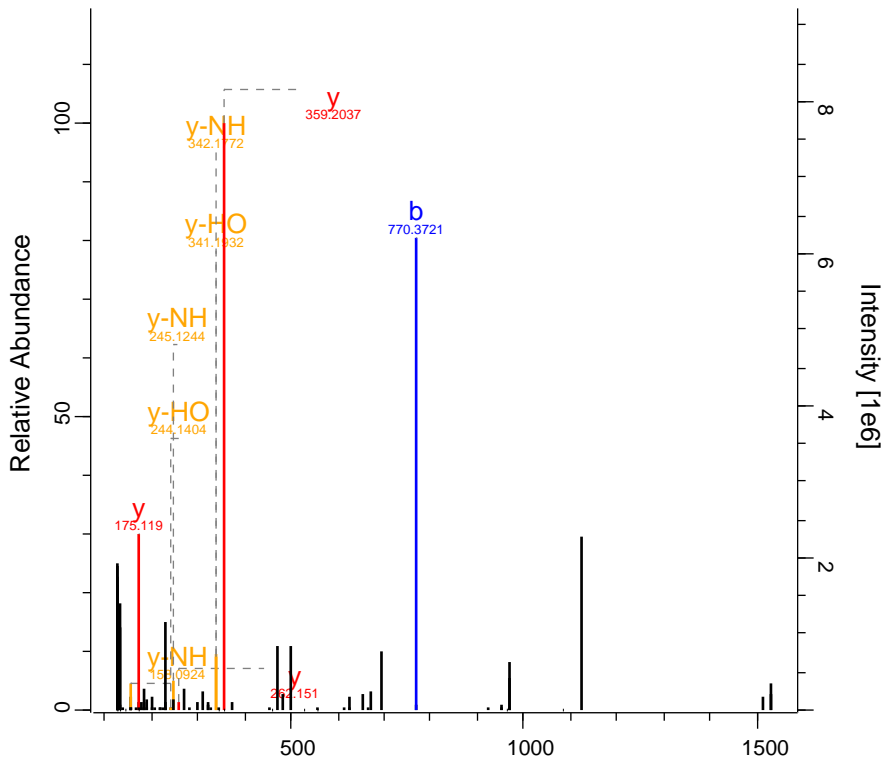

m/z (zoom)

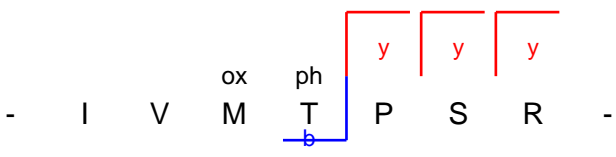

RO-QC-160121_ZackD_SS_Set_02_Fraction 6693 FTMS; HC 54.07 889.43 NIFK

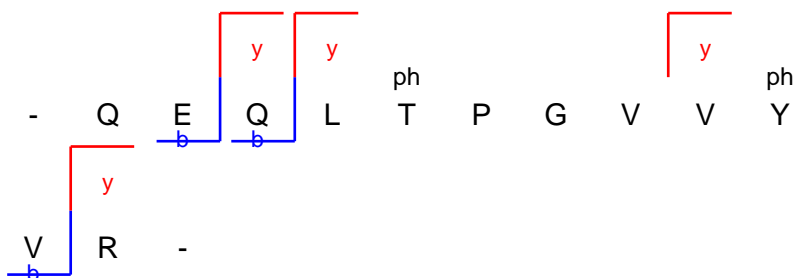
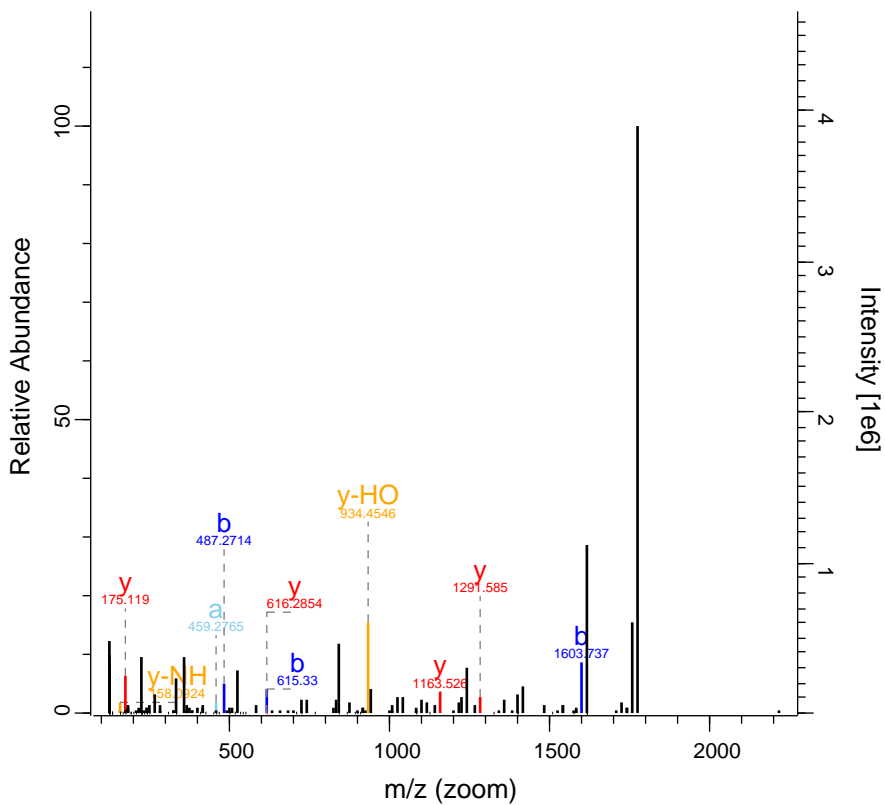

RO-QC-160121_ZackD_SS_Set_02_Fraction 7236 FTMS; HC 115.31 674.66 ERC1

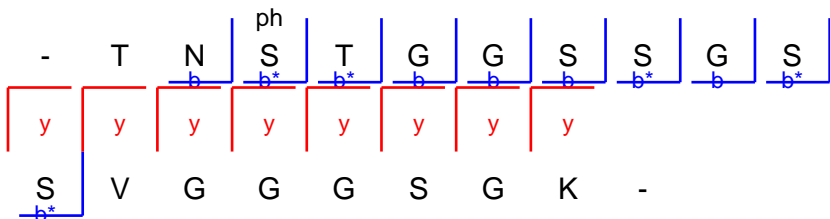
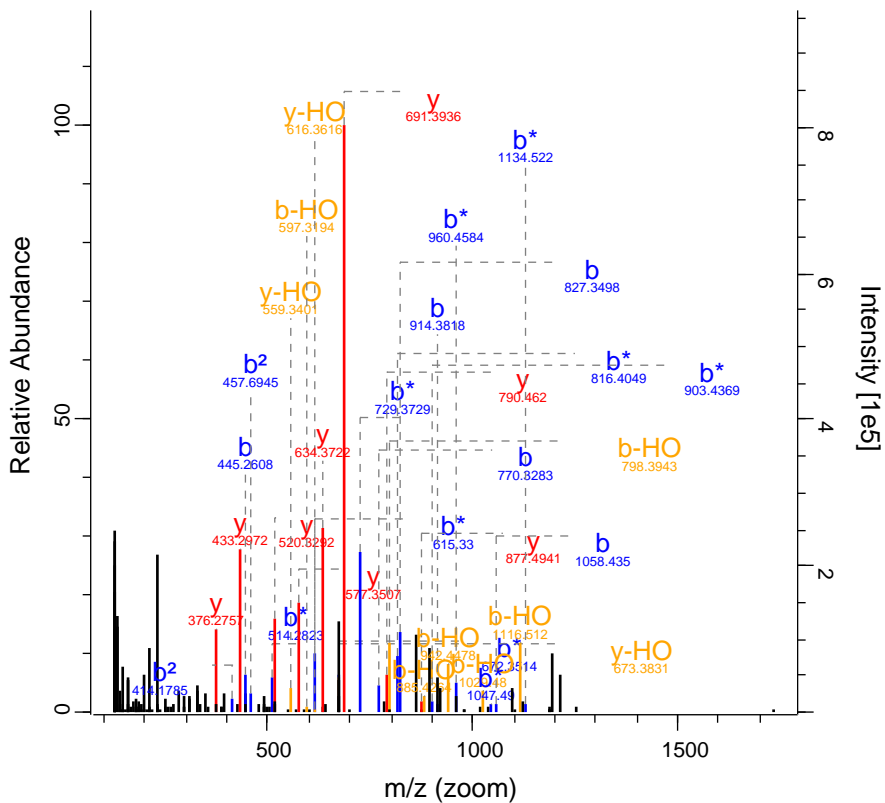

RO-QC-160121_ZackD_SS_Set_02_Fraction 7901 FTMS; HC 138.89 837.92 RALGAPA1

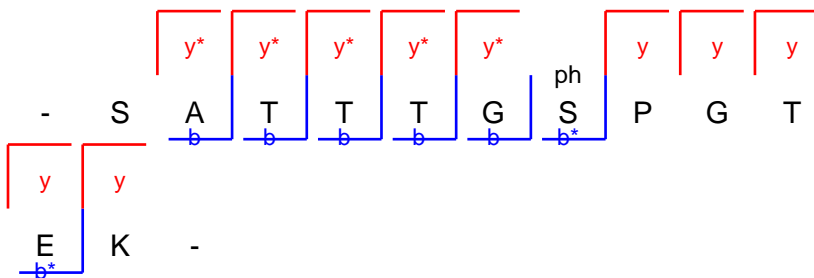
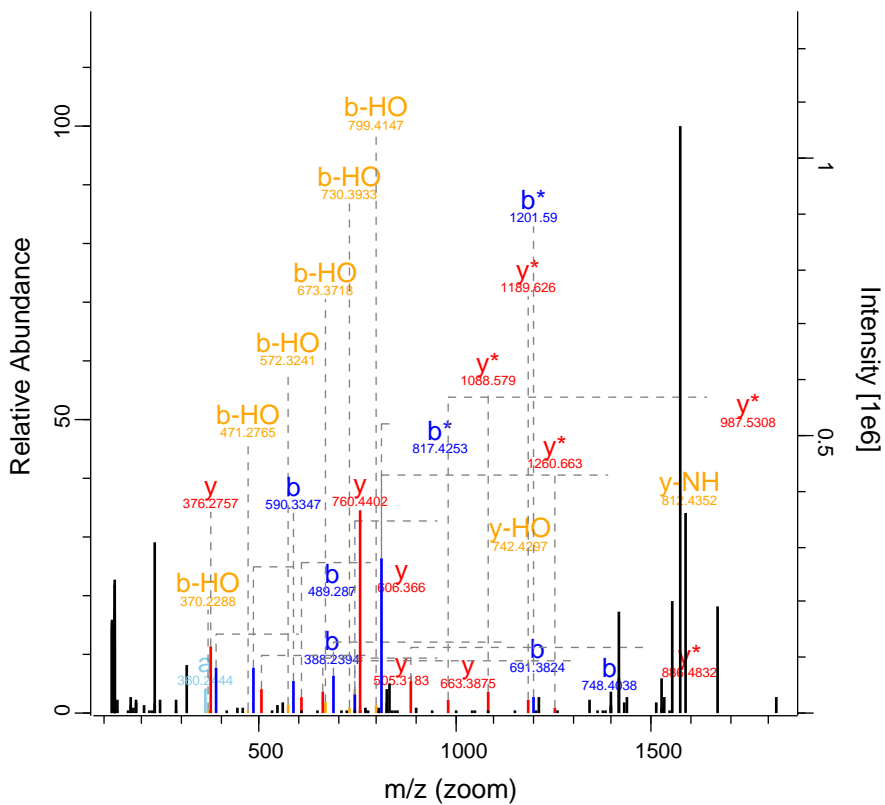

RO-QC-160121_ZackD_SS_Set_02_Fraction 8404 FTMS; HC 105.03 728.88 ASAP1

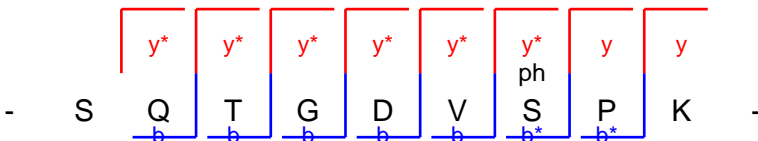
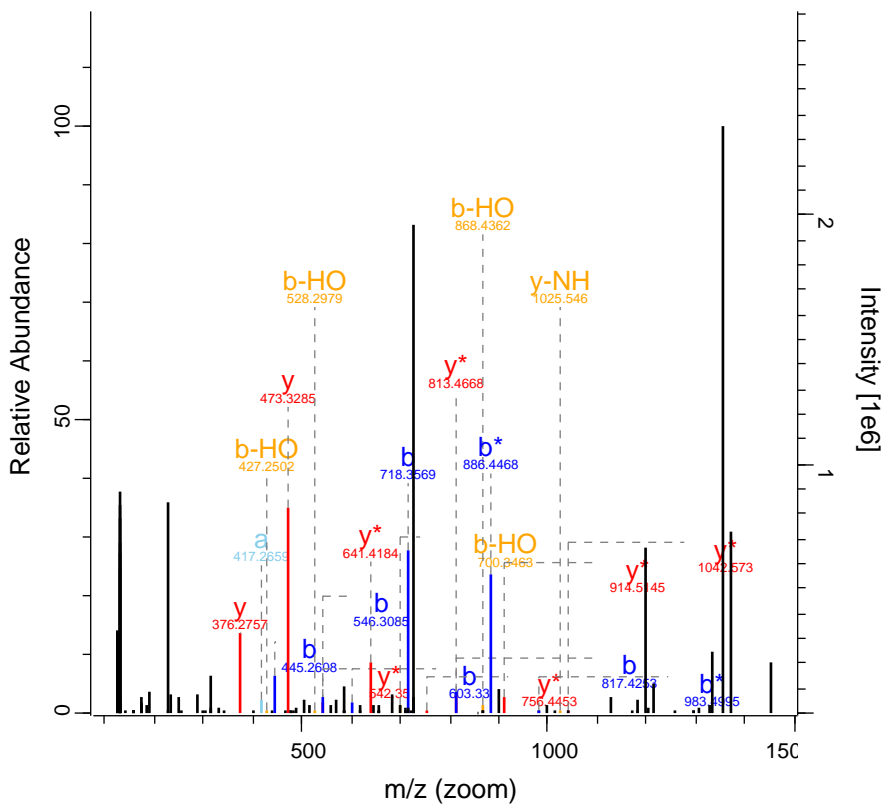

RO-QC-160121_ZackD_SS_Set_02_Fraction 8666 FTMS; HC 72.43 745.03 VPS4A

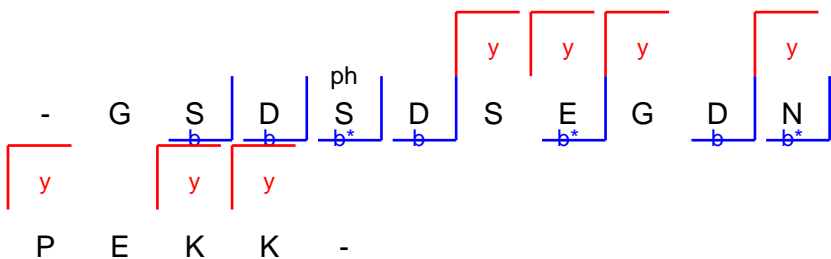
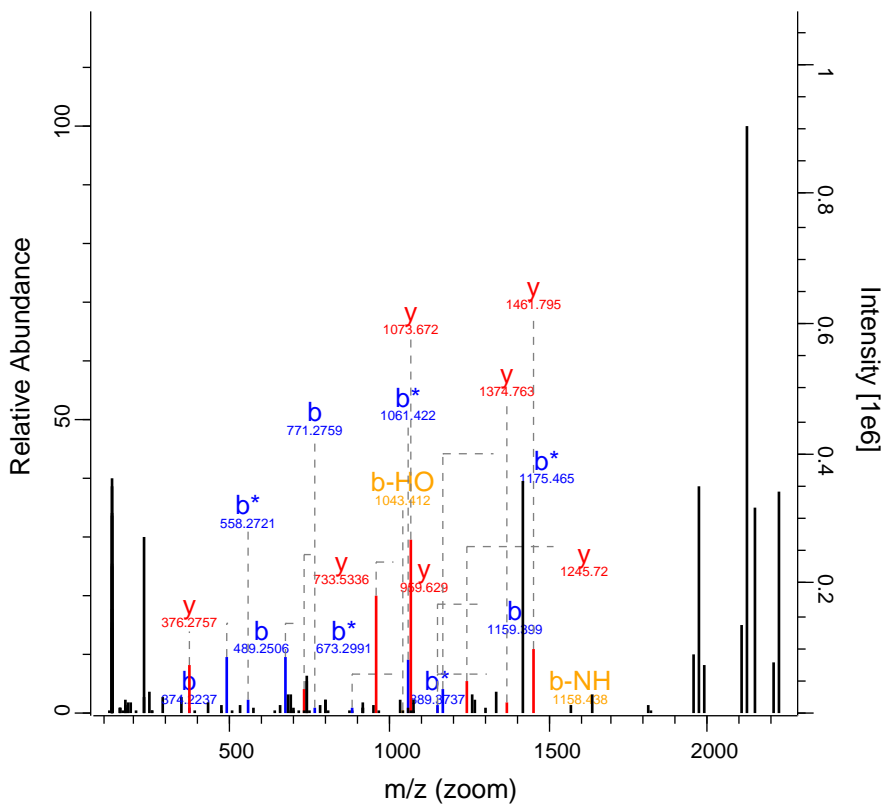

RO-QC-160121_ZackD_SS_Set_02_Fraction 8908 FTMS; HC 77.19 685.39 NSFL1C

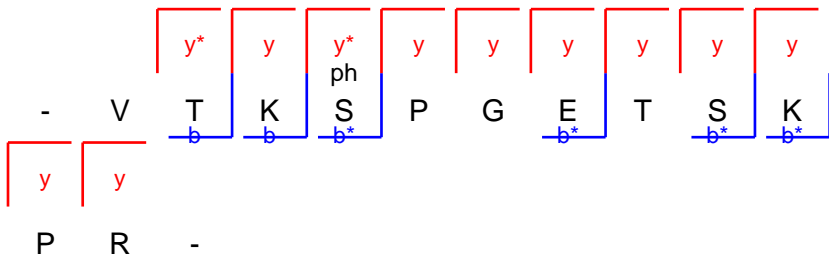
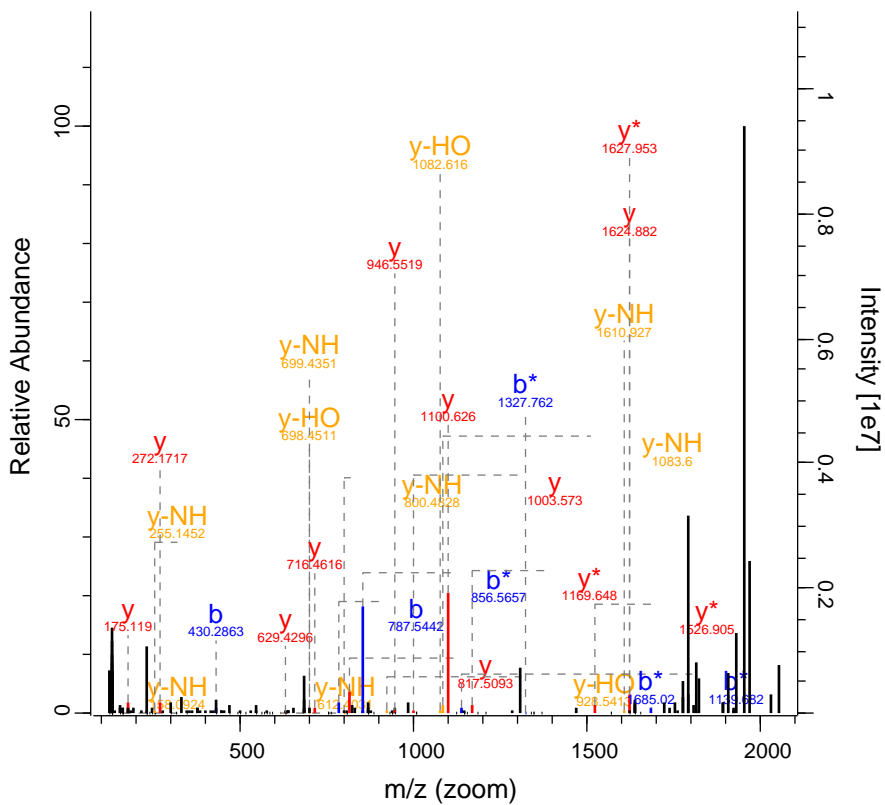

RO-QC-160121_ZackD_SS_Set_02_Fraction 9706 FTMS; HC 114.87 713.84 RSRC2

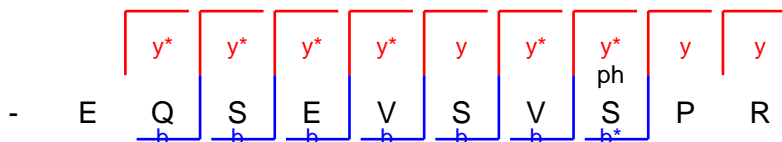
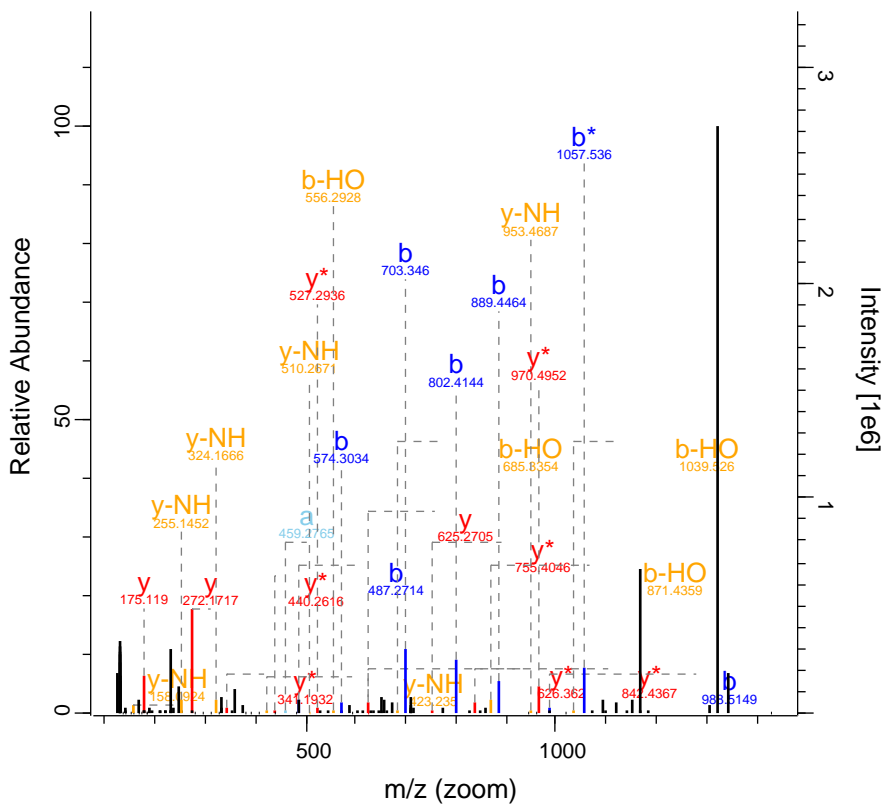

RO-QC-160121_ZackD_SS_Set_02_Fraction10242 FTMS; HC 82.01 858.08 CTR9

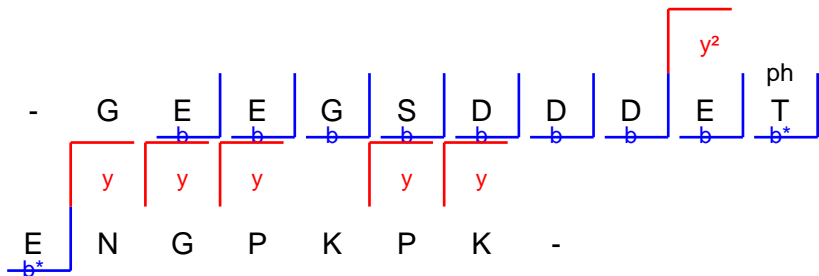
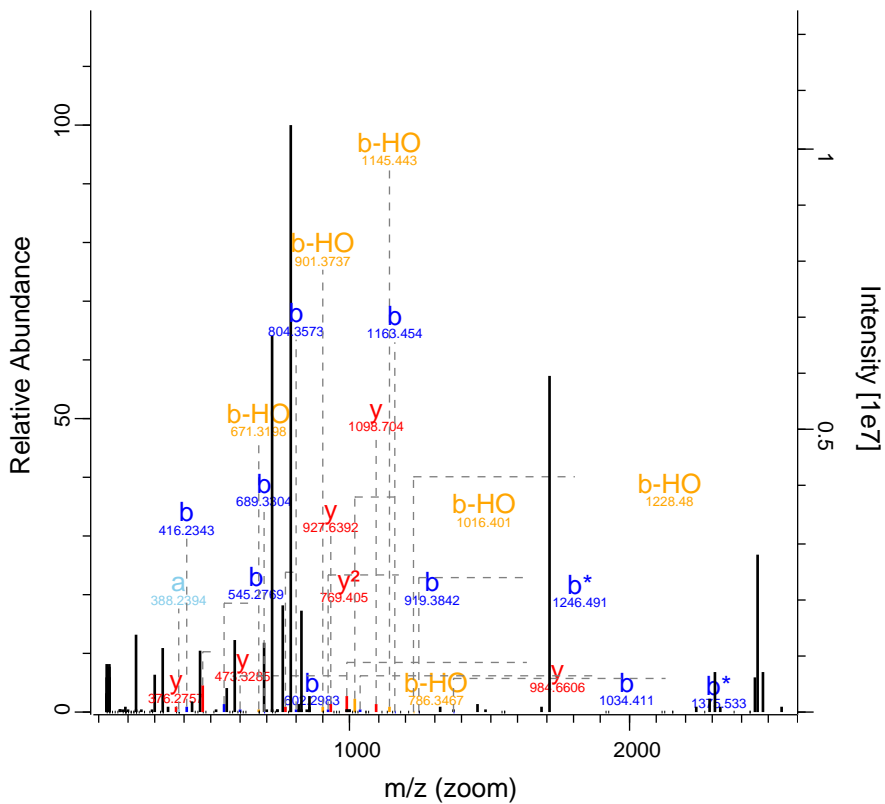

RO-QC-160121_ZackD_SS_Set_02_Fraction10289 FTMS; HC 132.79 643.56 CTR9

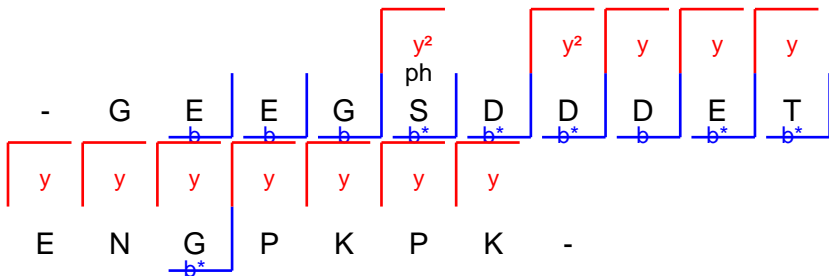
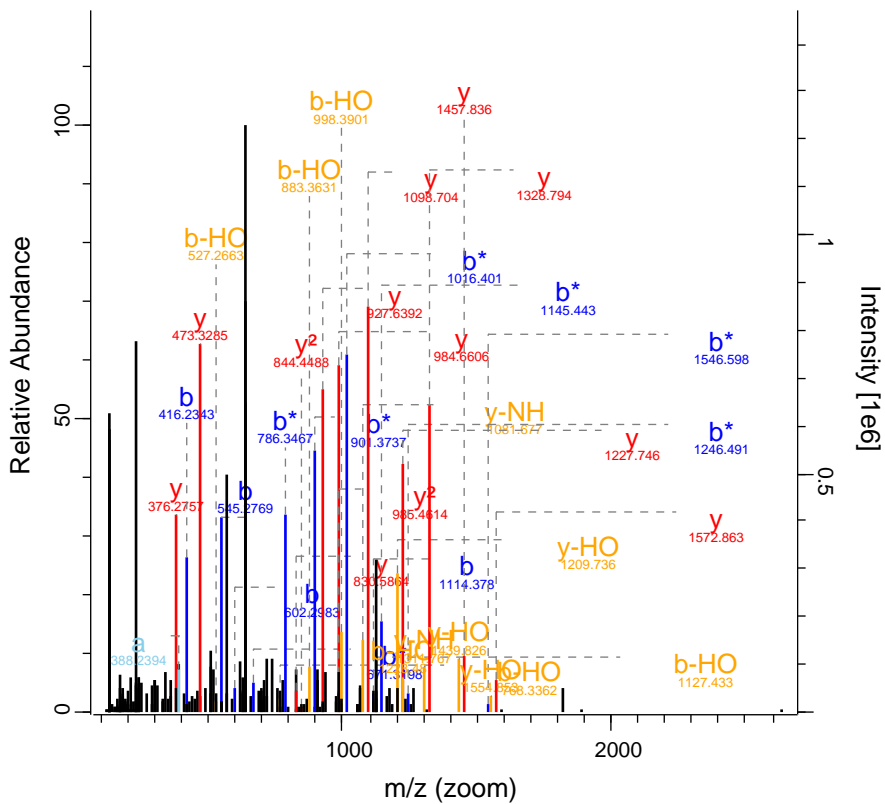

RO-QC-160121_ZackD_SS_Set_02_Fraction 10753 FTMS; HC 103.61 625.1 DDX21

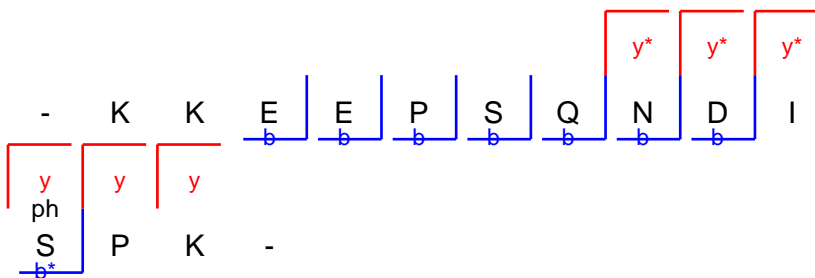
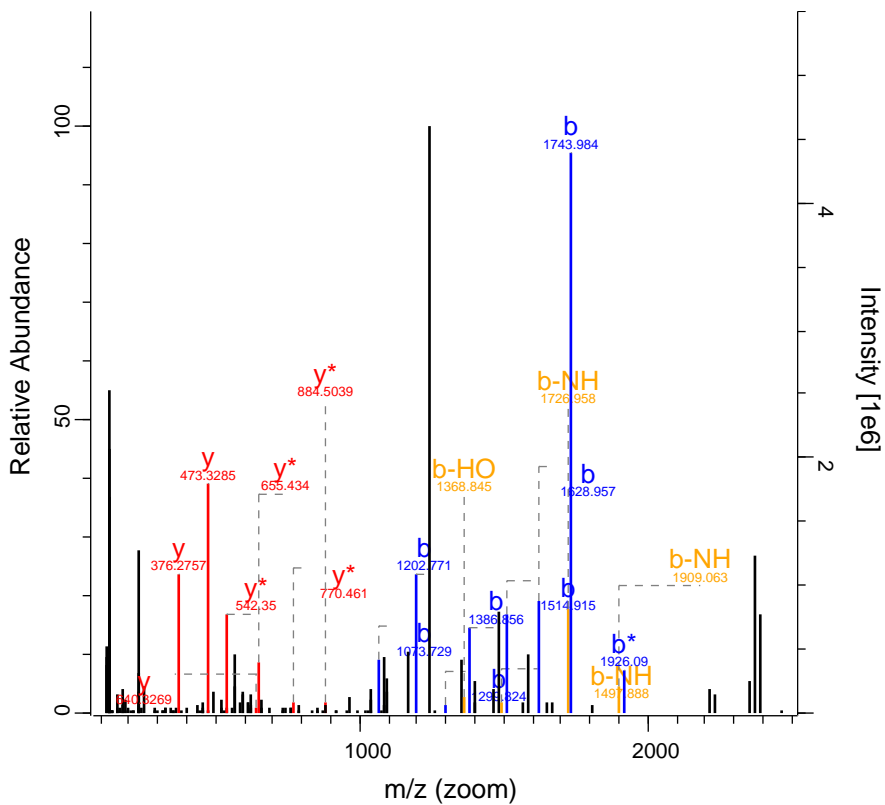

RO-QC-160121_ZackD_SS_Set_02_Fraction 12314 FTMS; HC 49.42 498.23 SRRT

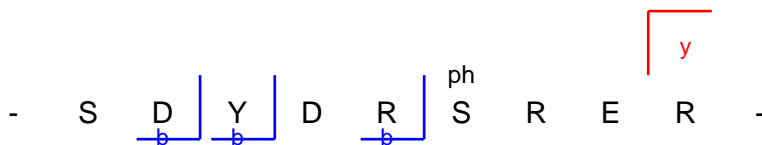
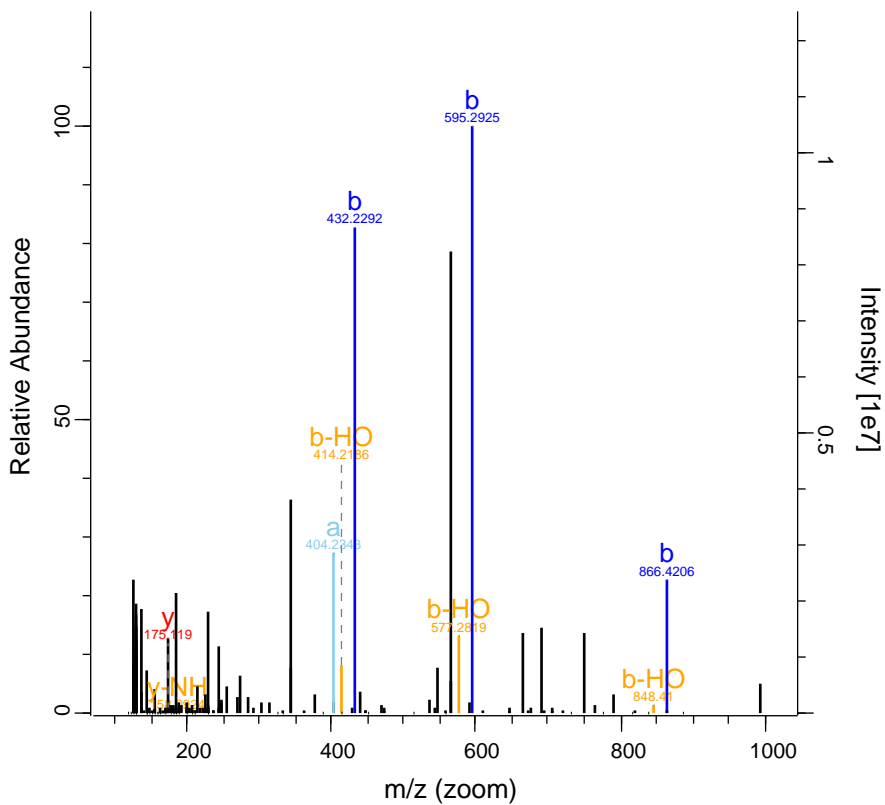

RO-QC-160121_ZackD_SS_Set_02_Fratio 13041 FTMS; HC 184.99 1185.61 SLTM

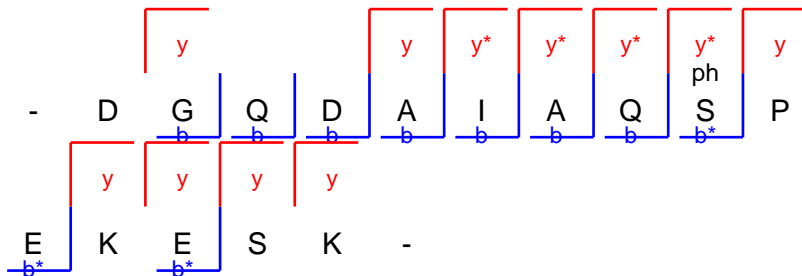
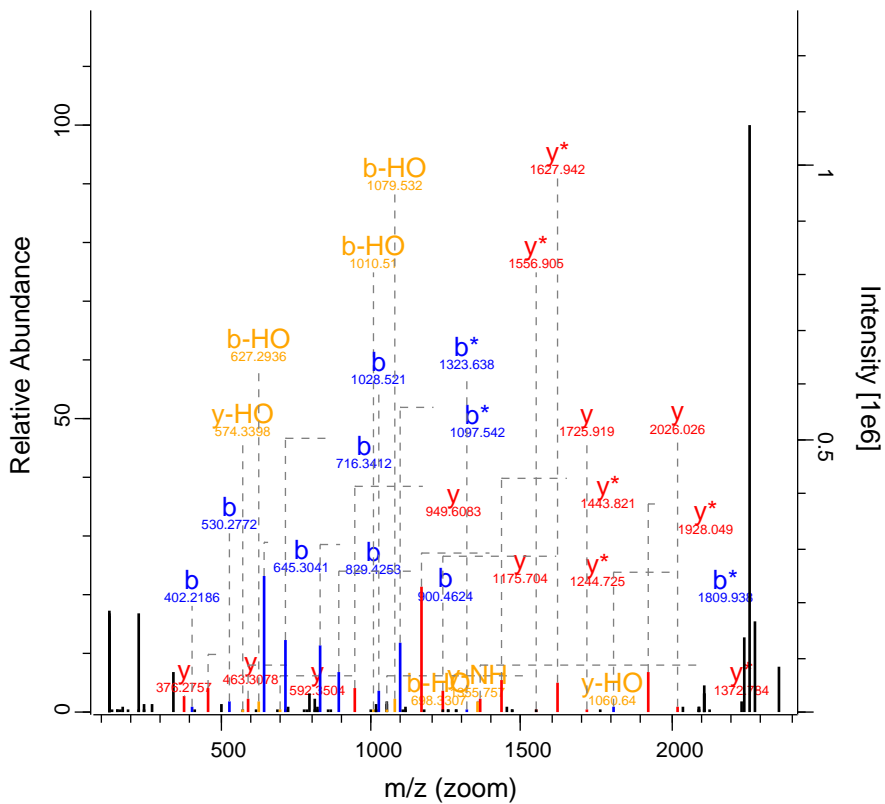

RO-QC-160121_ZackD_SS_Set_02_Fraction14100 FTMS; HC 119.25 927.49 SPECC1

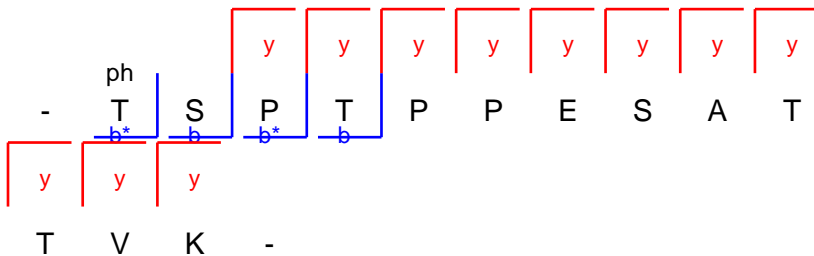
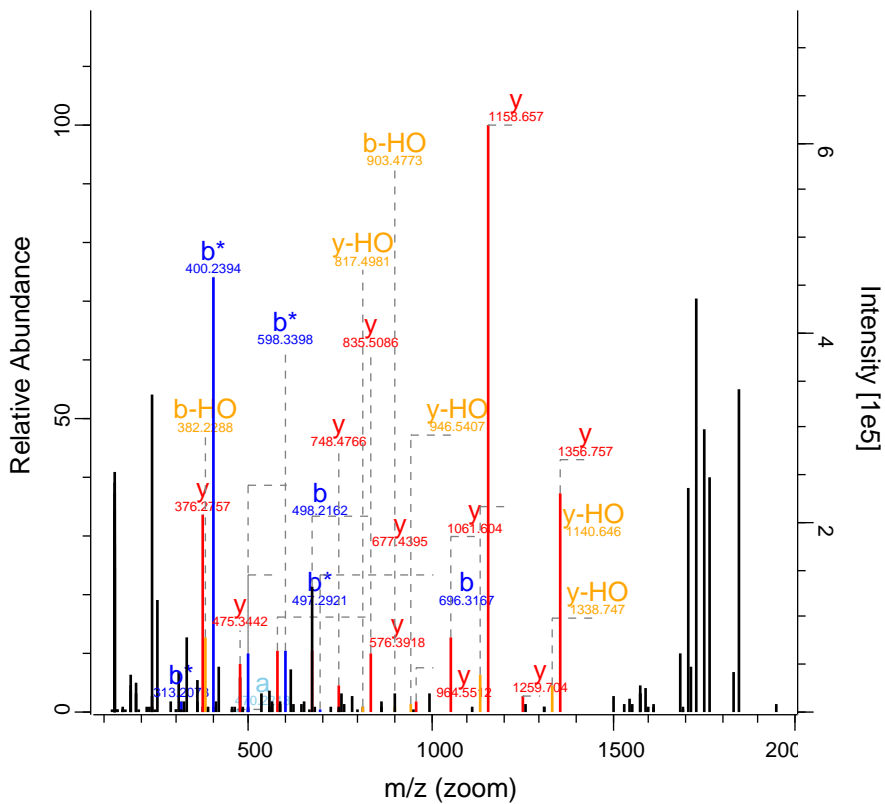

RO-QC-160121_ZackD_SS_Set_02_Fraction 14777 FTMS; HC 106.88 654.8 PDHA1

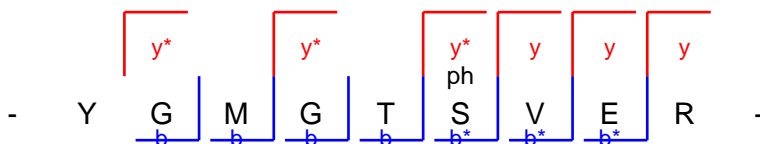
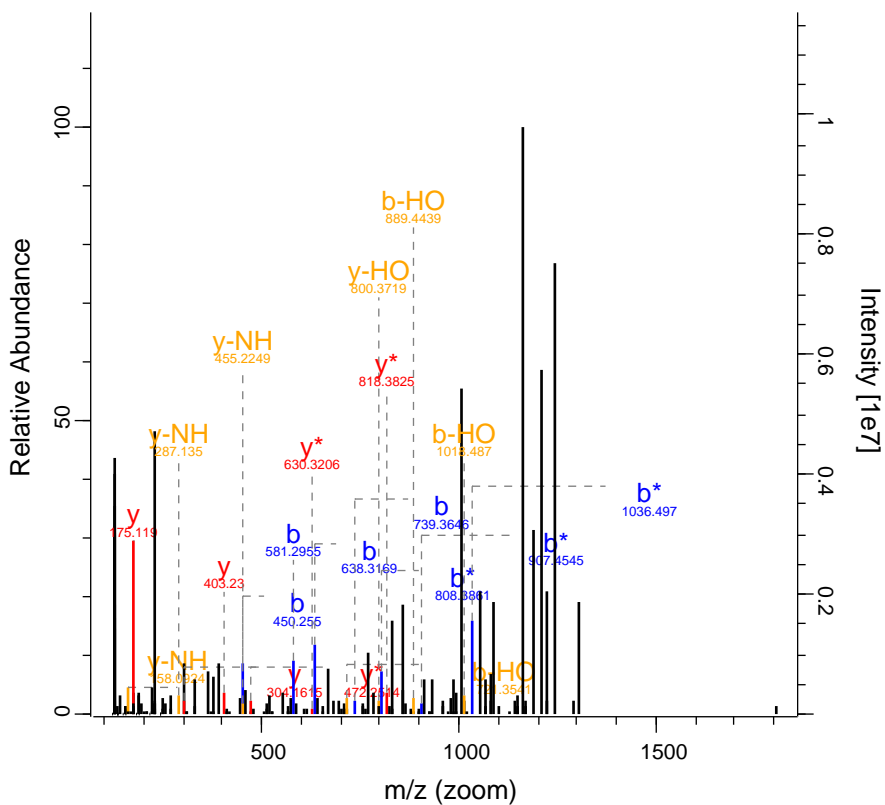

RO-QC-160121_ZackD_SS_Set_02_Fraction16437 FTMS; HC 106.49 827.09 DDX21

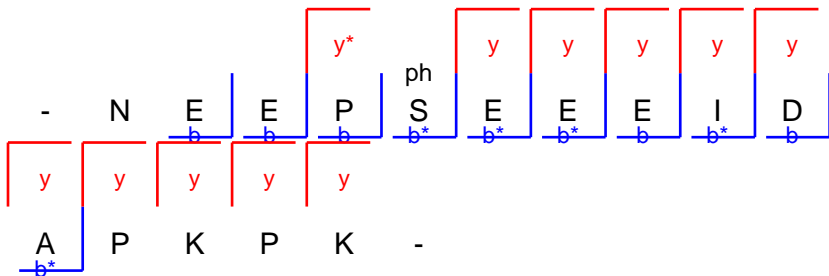
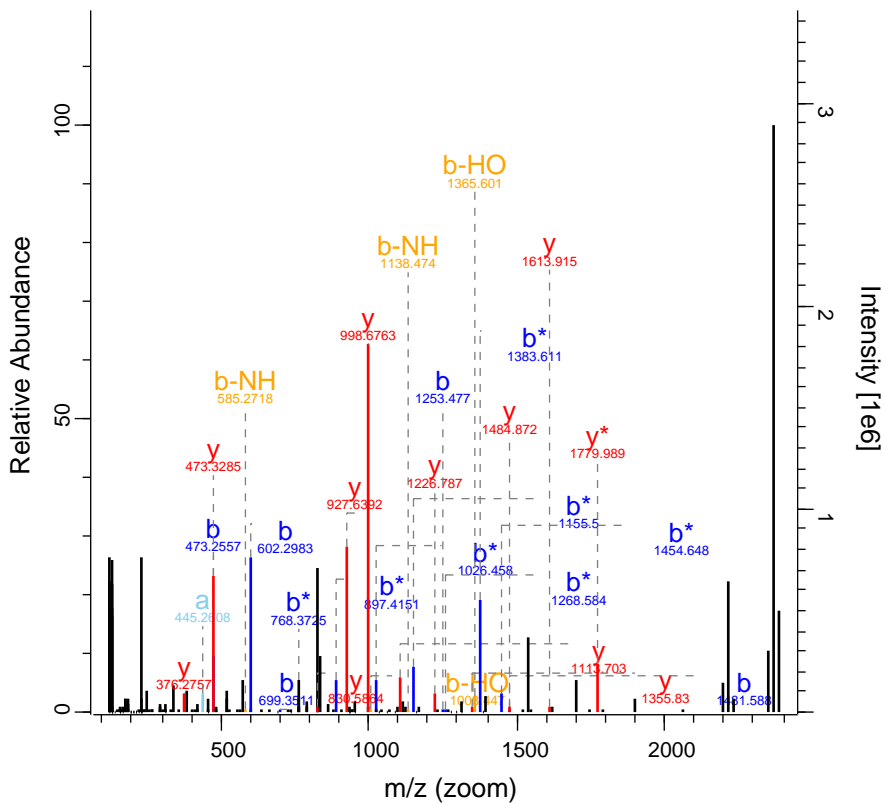

RO-QC-160121_ZackD_SS_Set_02_Fraction17386 FTMS; HC 136.96 810.92 TLN2

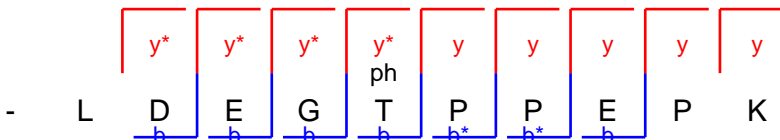
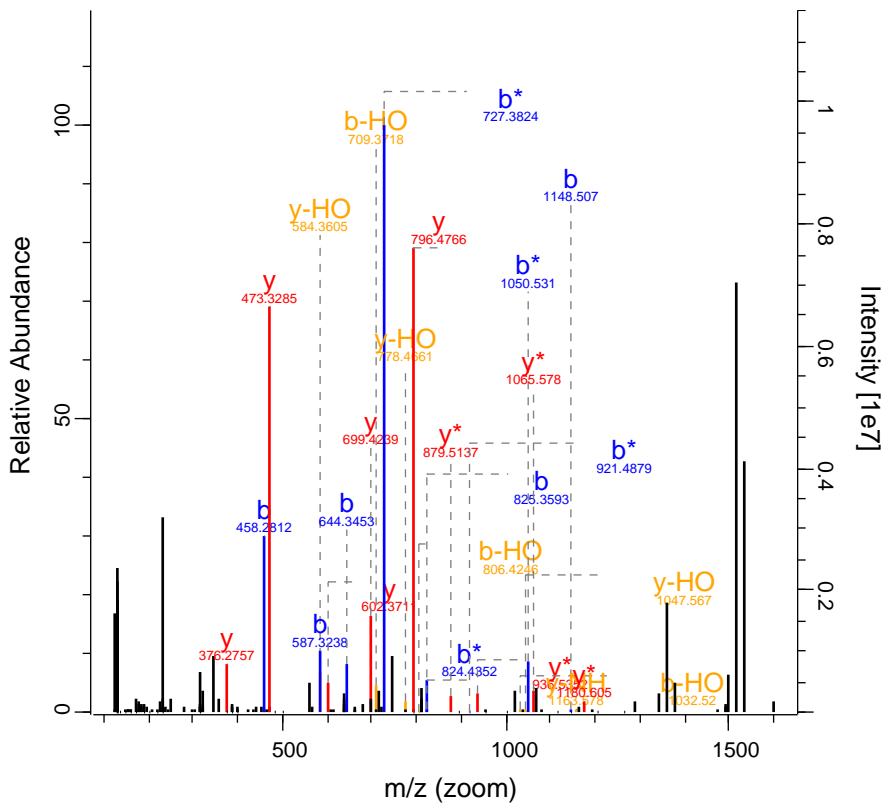

RO-QC-160121_ZackD_SS_Set_02_Fraction 18375 FTMS; HC 44.14 725.37 TLL6

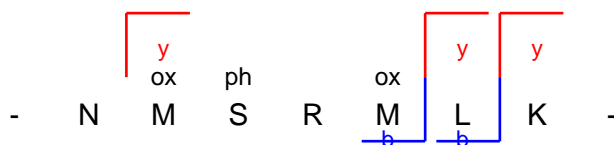
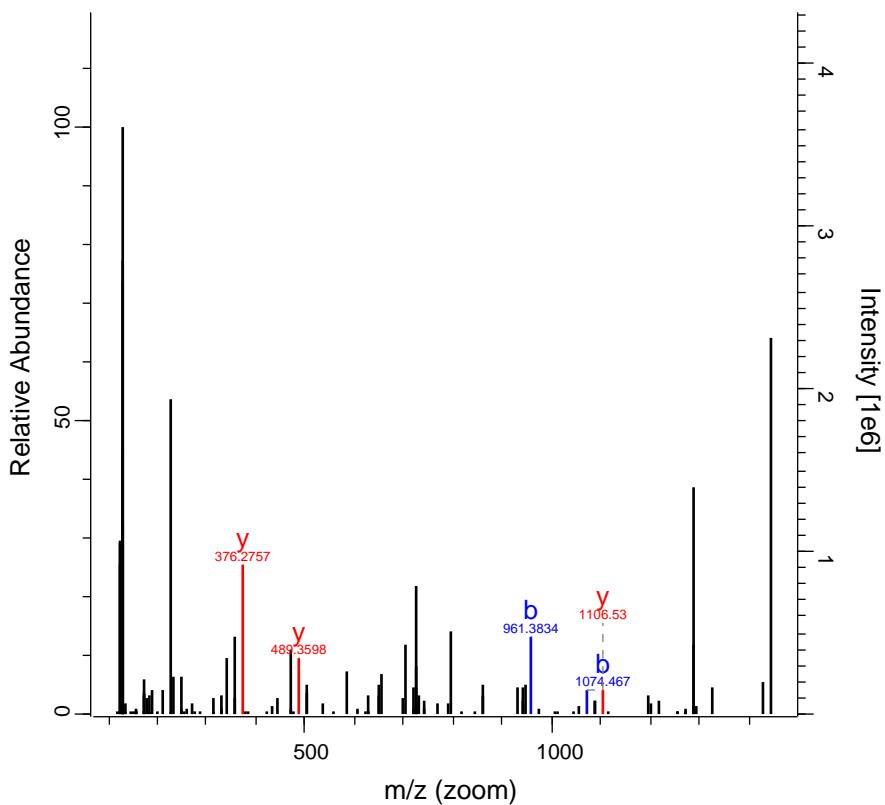

RO-QC-160121_ZackD_SS_Set_02_Fraction18640 FTMS; HC 125.61 864.95 PALLD

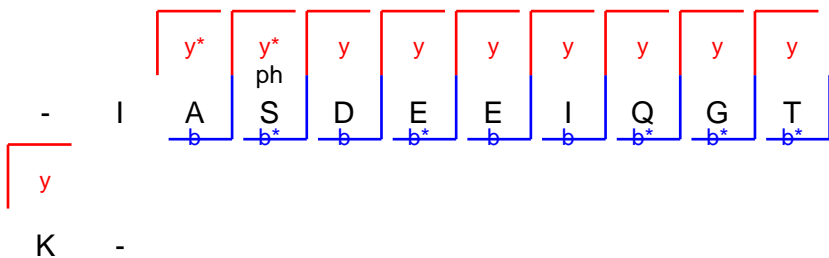
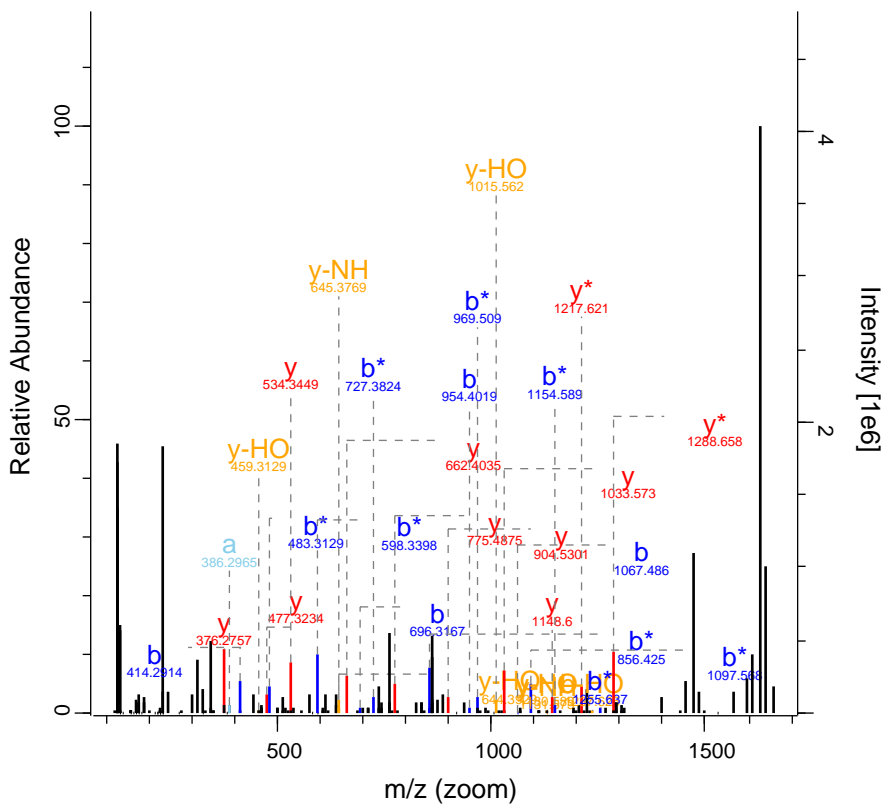

K

RO-QC-160121_ZackD_SS_Set_02_Fraction 19156 FTMS; HC 42.82 746.39 ZMYND8

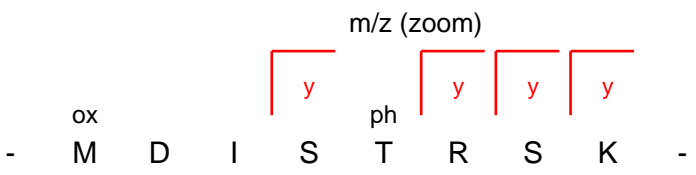
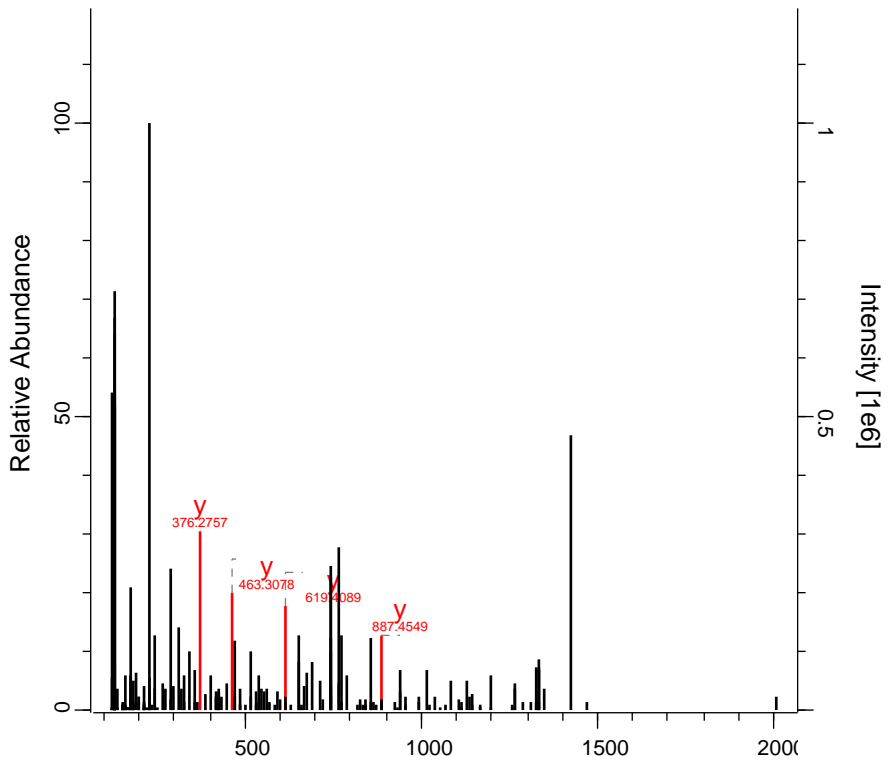

RO-QC-160121_ZackD_SS_Set_02_Fraction19876 FTMS; HC 68.92 888.48 G3BP2

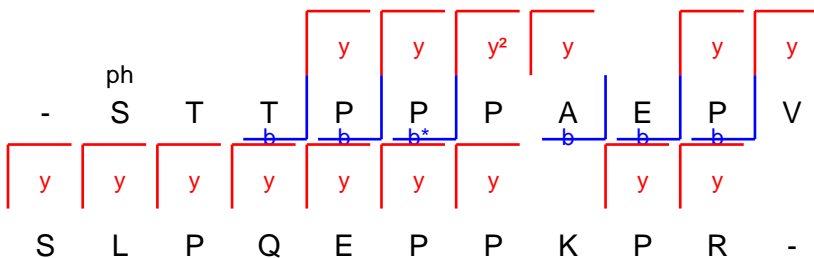
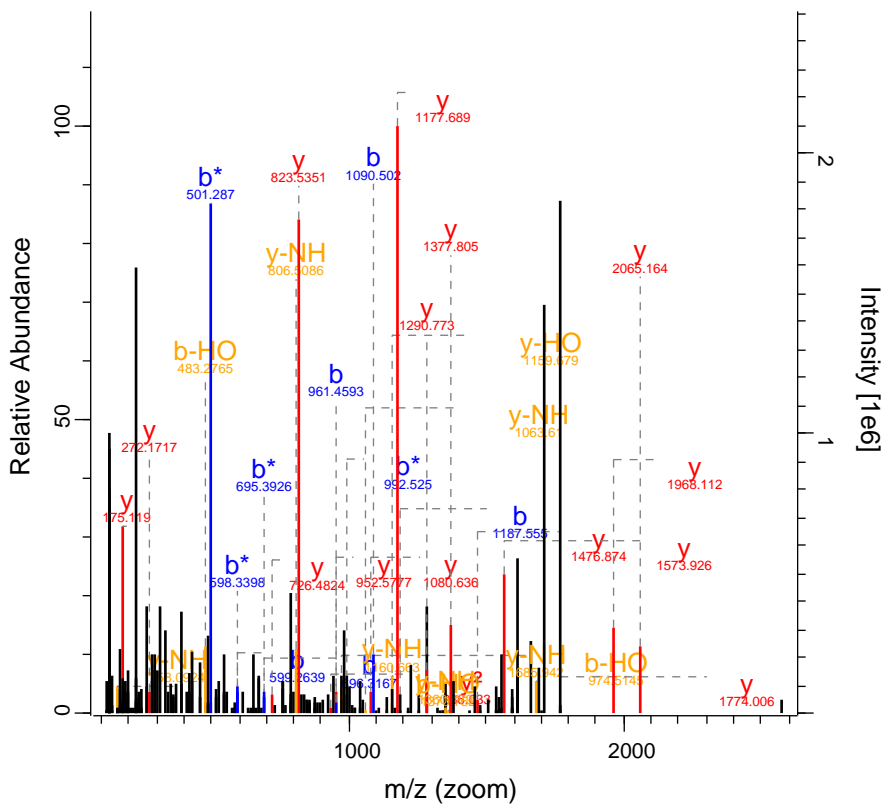

RO-QC-160121_ZackD_SS_Set_02_Fraction 20247 FTMS; HC 64.09 964.47 C3orf49

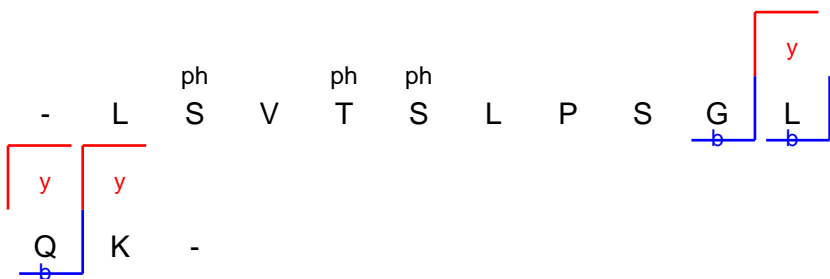
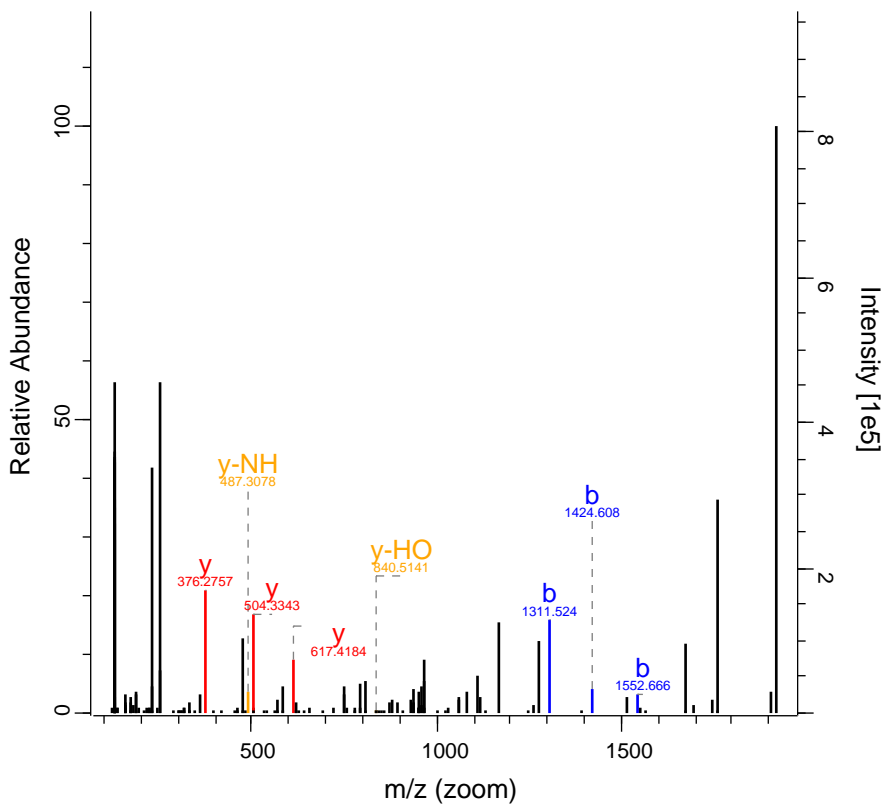

RO-QC-160121_ZackD_SS_Set_02_Fraction 20928 FTMS; HC 65.23 540.31 SAFB

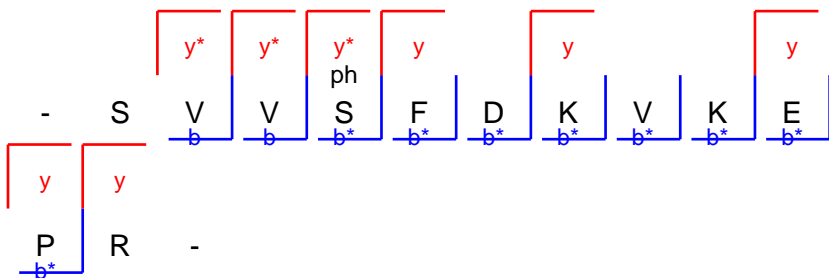
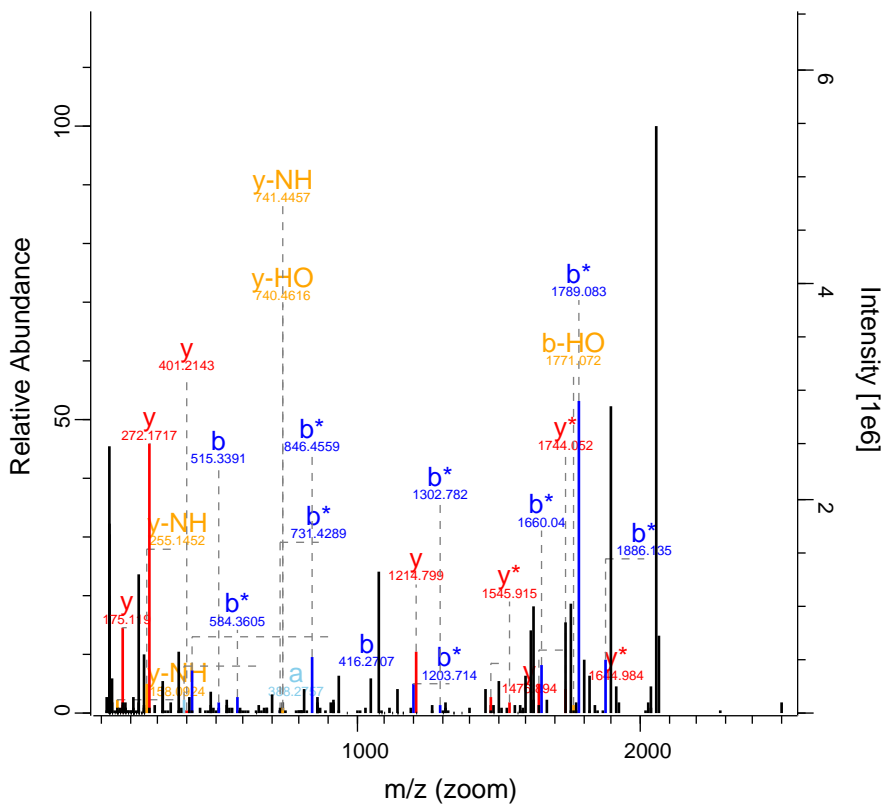

RO-QC-160121_ZackD_SS_Set_02_Fraction1 21730 FTMS; HC 136.53 967.46 SRRM2

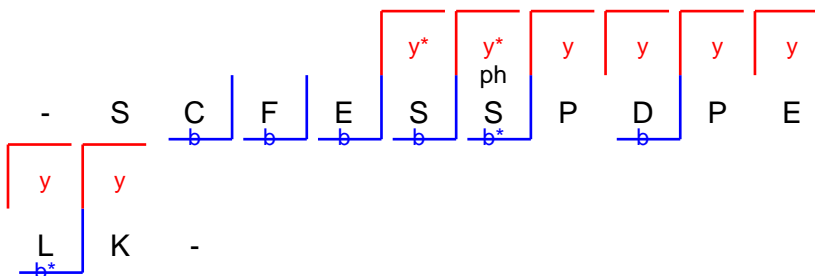
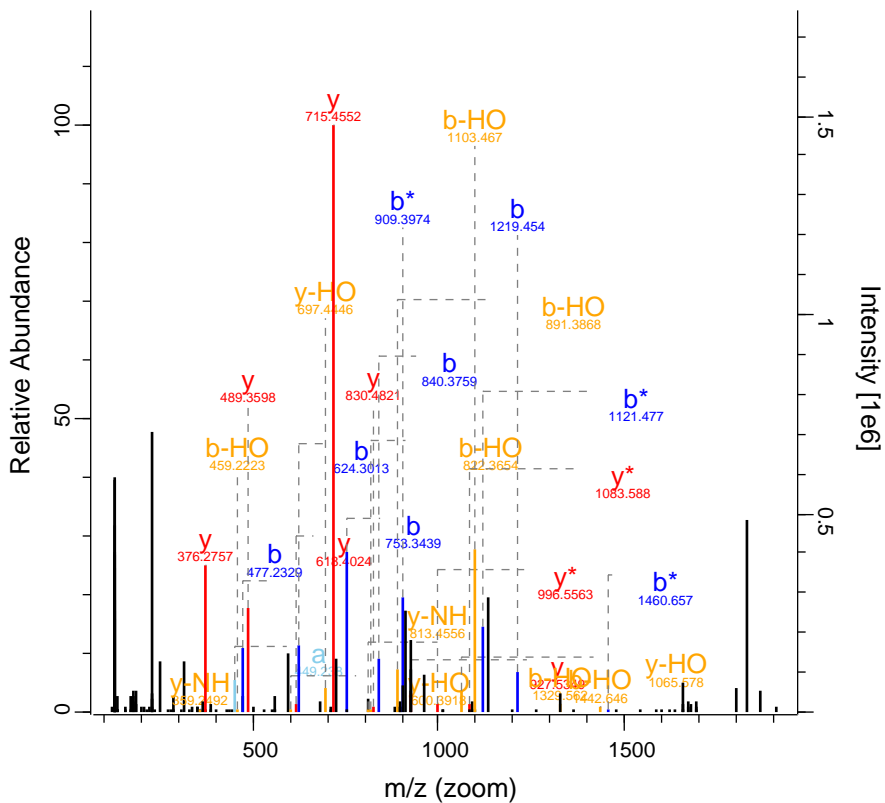

RO-QC-160121_ZackD_SS_Set_02_Fraction 22379 FTMS; HC 103.63 651.16 CD44

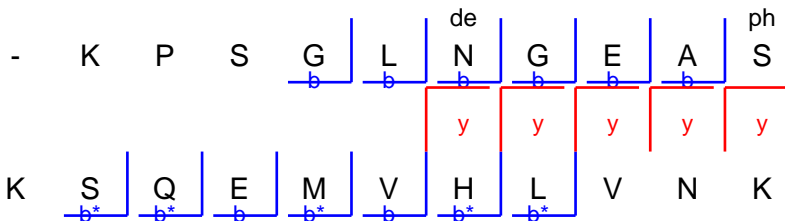
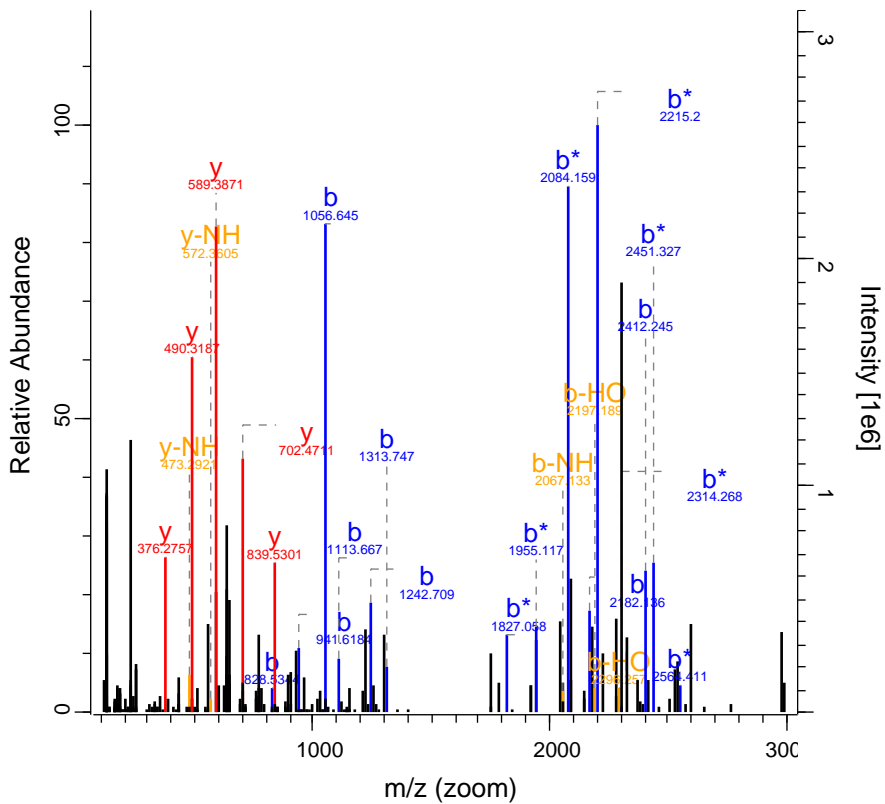

RO-QC-160121_ZackD_SS_Set_02_Fraction 22431 FTMS; HC 79.97 854.44 RABGAP1

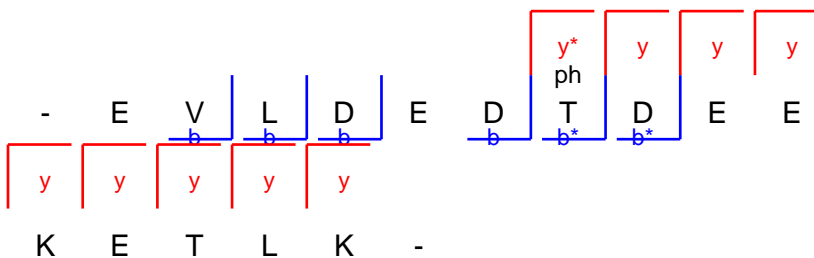
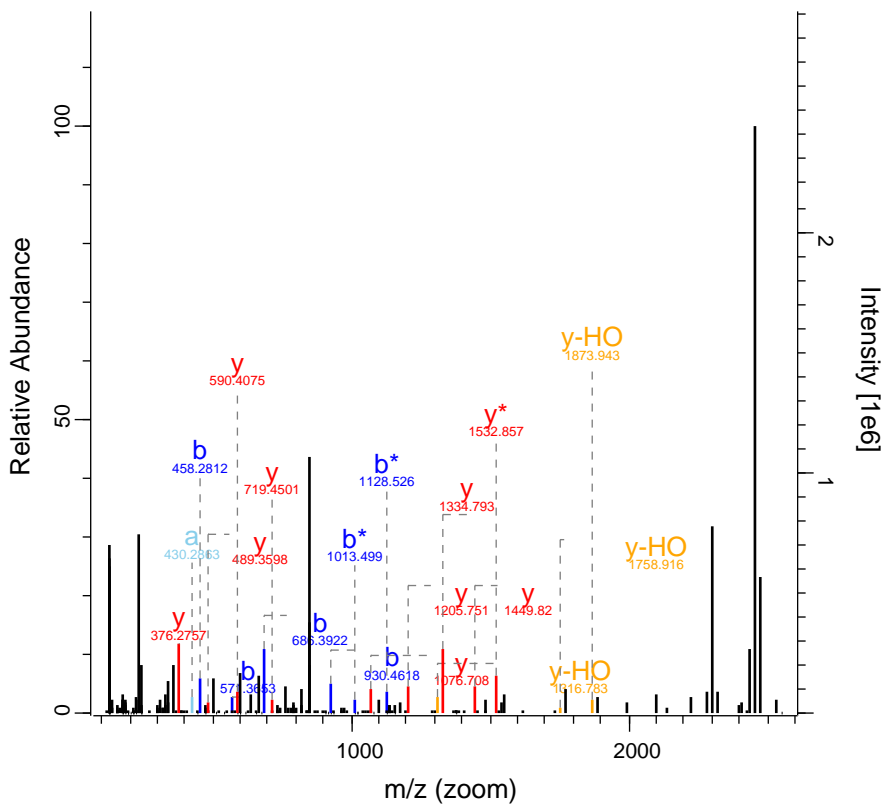

RO-QC-160121_ZackD_SS_Set_02_Fraction 22718 FTMS; HC 56.53 851.71 PRDX1

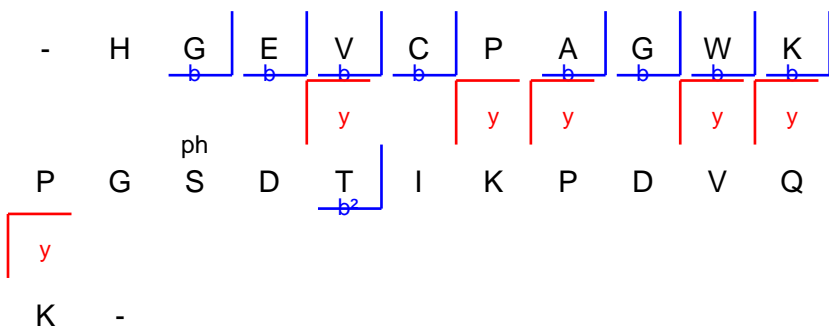
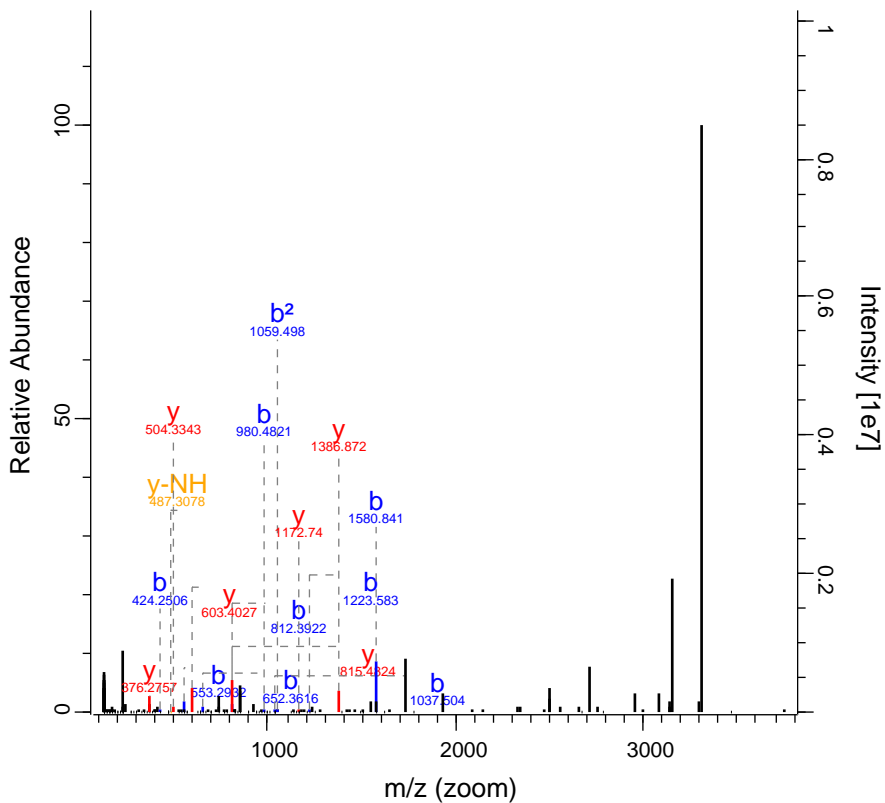

RO-QC-160121_ZackD_SS_Set_02_Fraction 23474 FTMS; HC 75.61 828.06 MAPK3

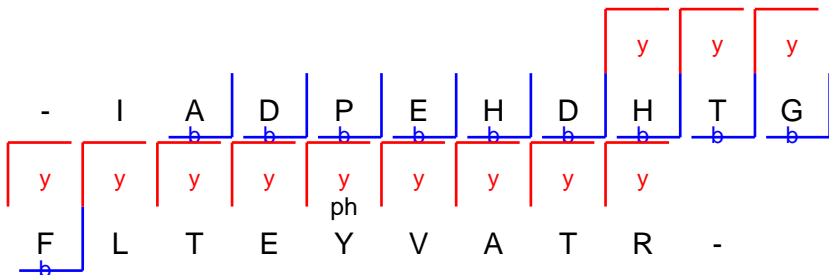
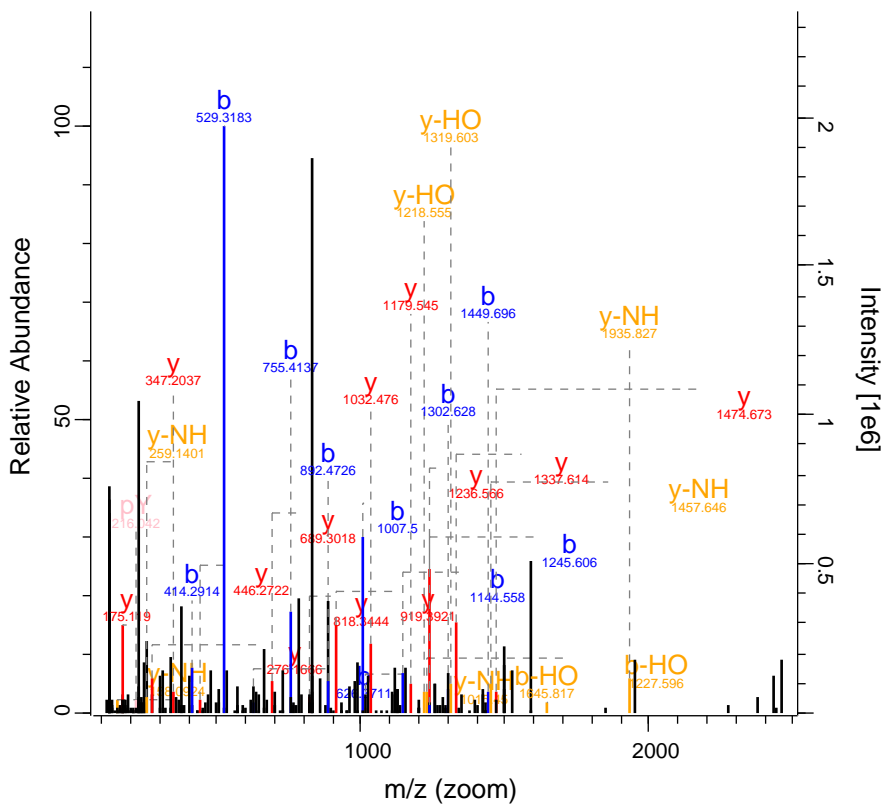

RO-QC-160121_ZackD_SS_Set_02_Fraction 23476 FTMS; HC 91.94 936.97 SAFB;SAFB2

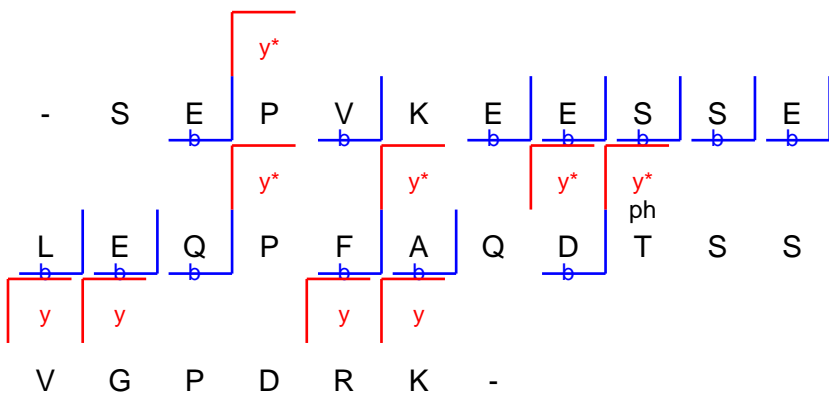
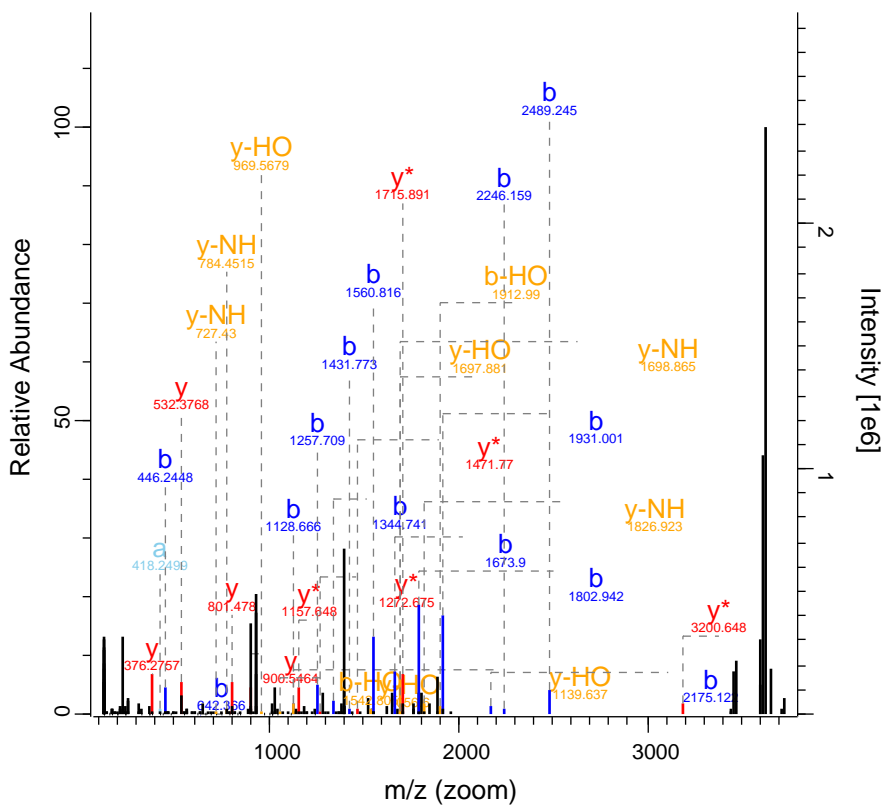

RO-QC-160121_ZackD_SS_Set_02_Fractio 24538 FTMS; HC 191.78 1057.51 CHCHD3

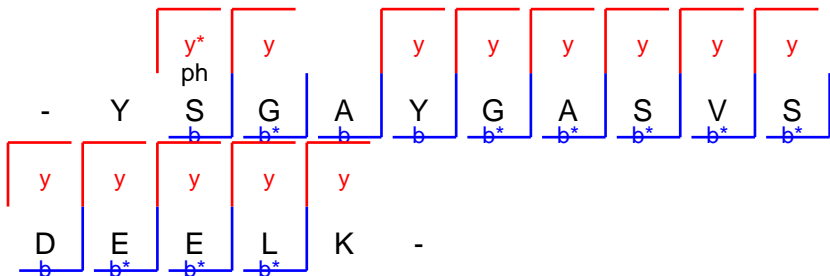
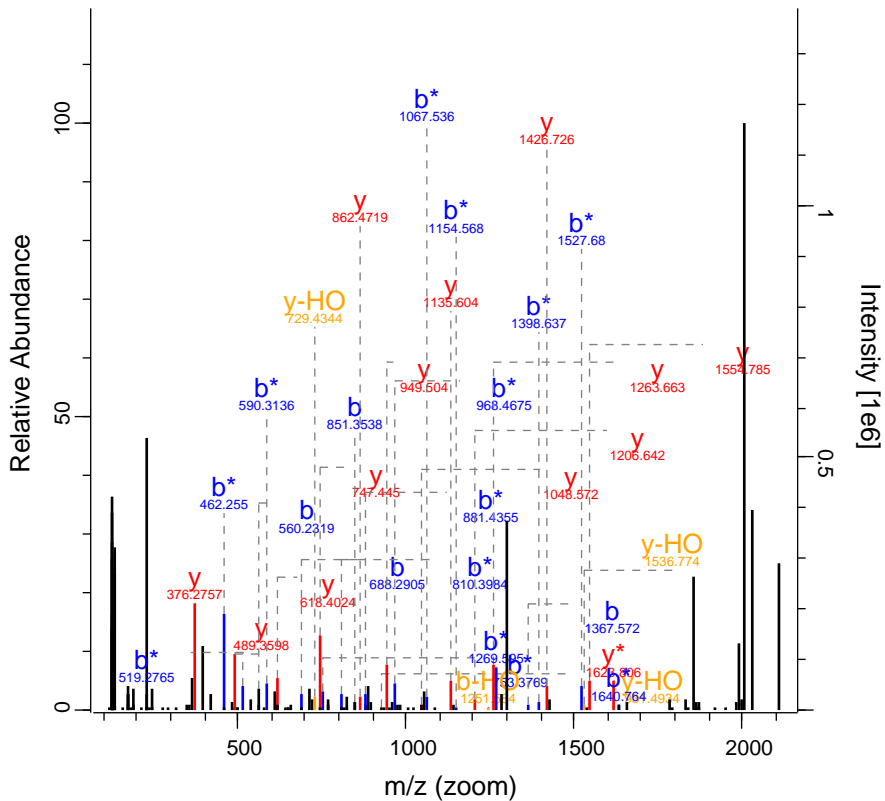

RO-QC-160121_ZackD_SS_Set_02_Fractio 24845 FTMS; HC 164.02 1157.56 AKAP2

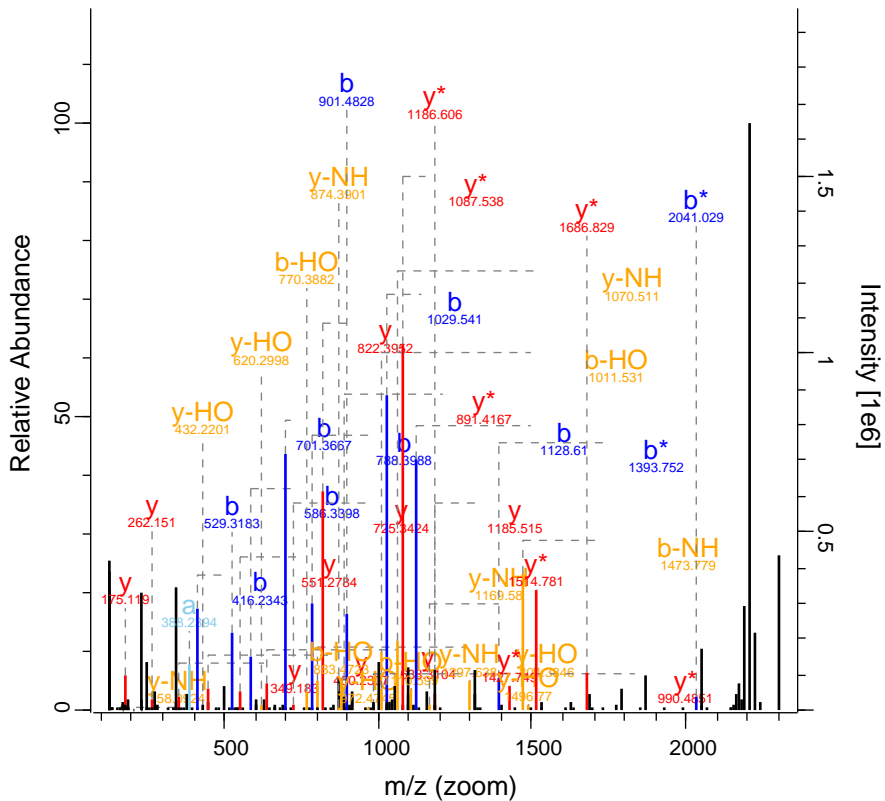

RO-QC-160121_ZackD_SS_Set_02_Fraccio 25371 FTMS; HC 284.88 1274.02 NUCKS1

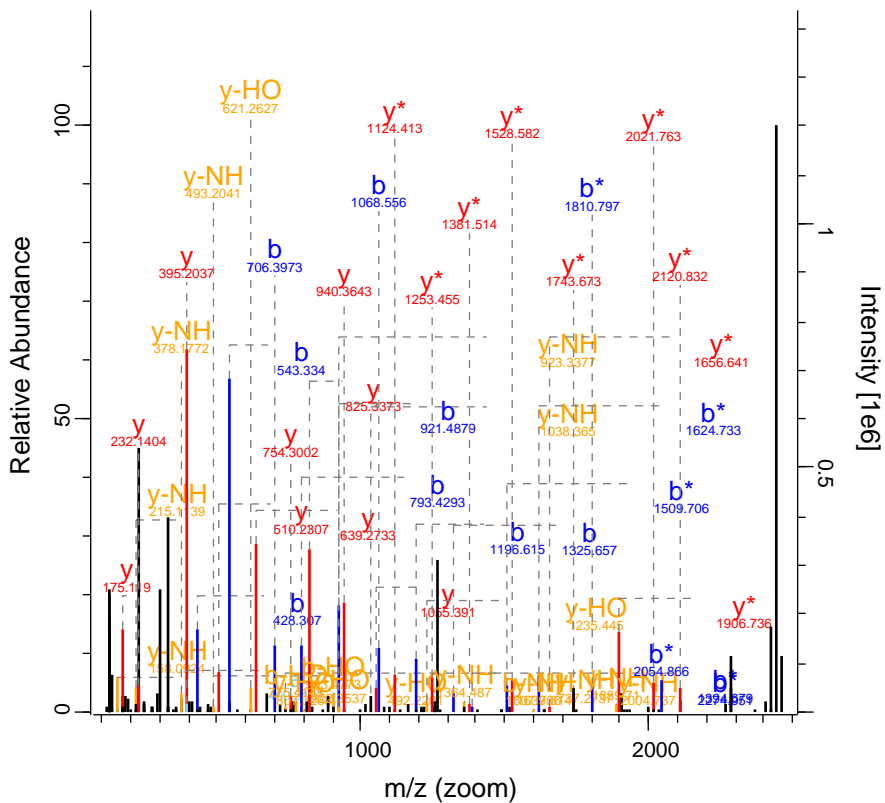

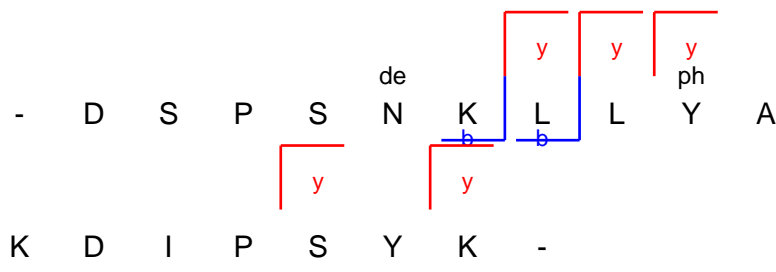
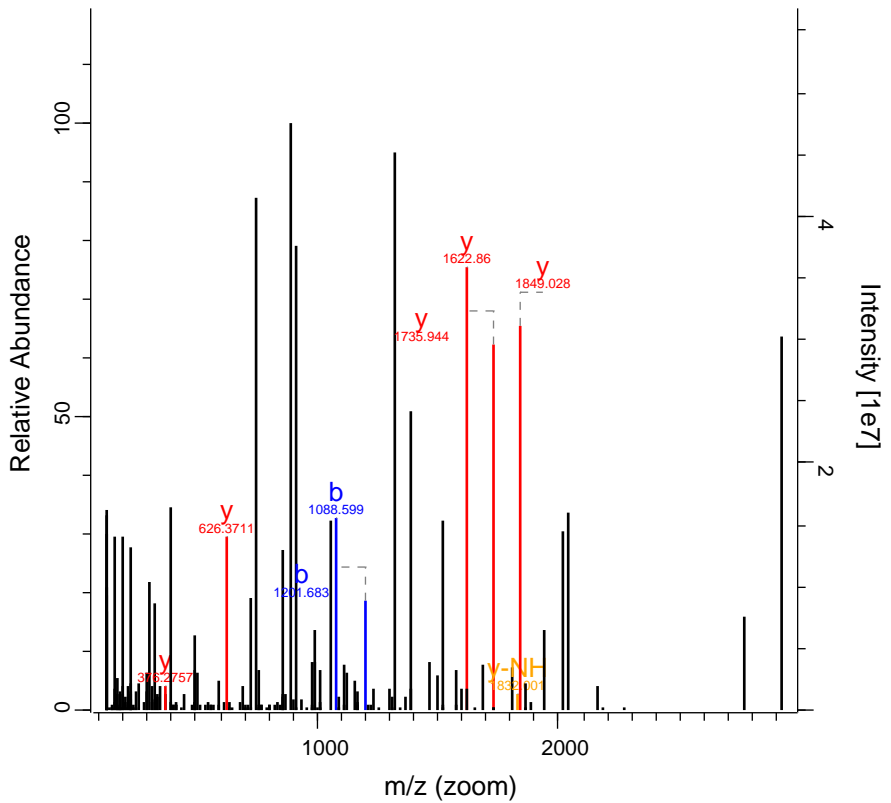

RO-QC-160121_ZackD_SS_Set_02_Fraction 27102 FTMS; HC 79.03 708.89 SLC6A15

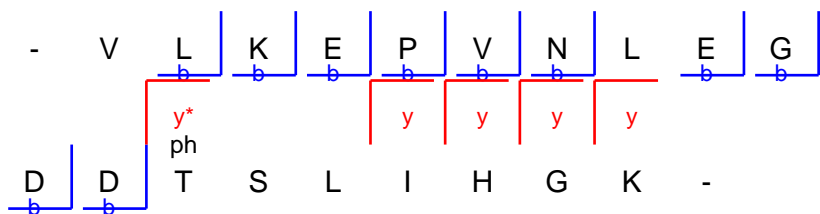
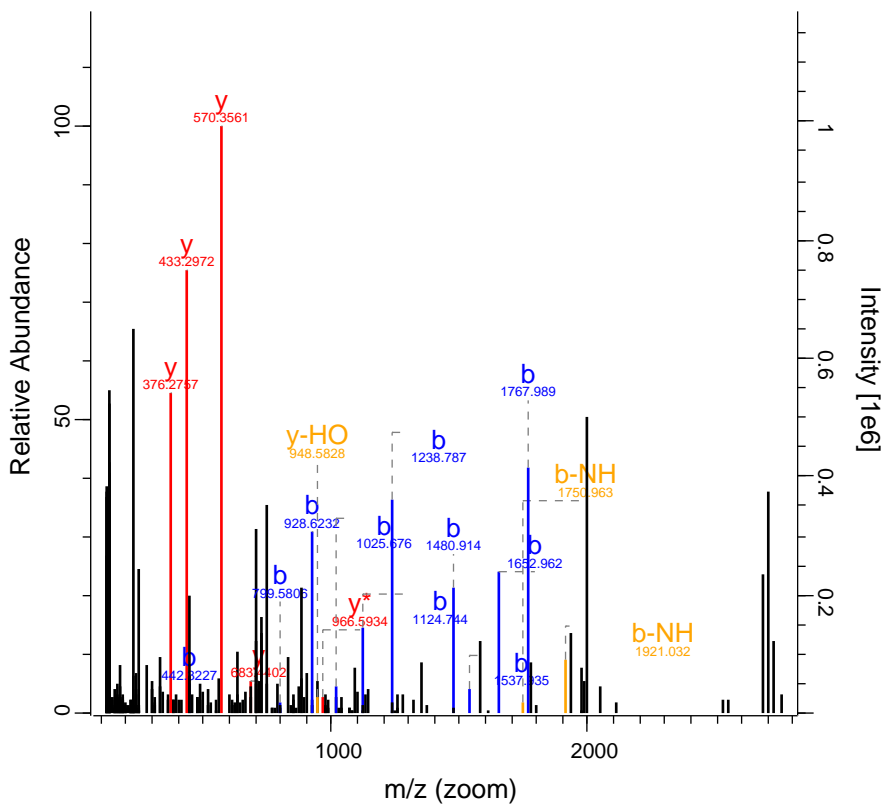

RO-QC-160121_ZackD_SS_Set_02_Fraction 27329 FTMS; HC 59.61 673.04 AKAP12

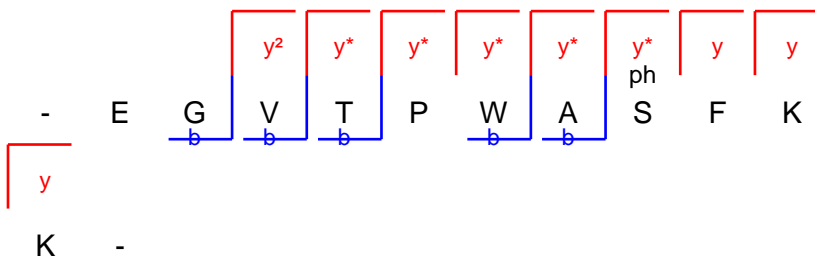
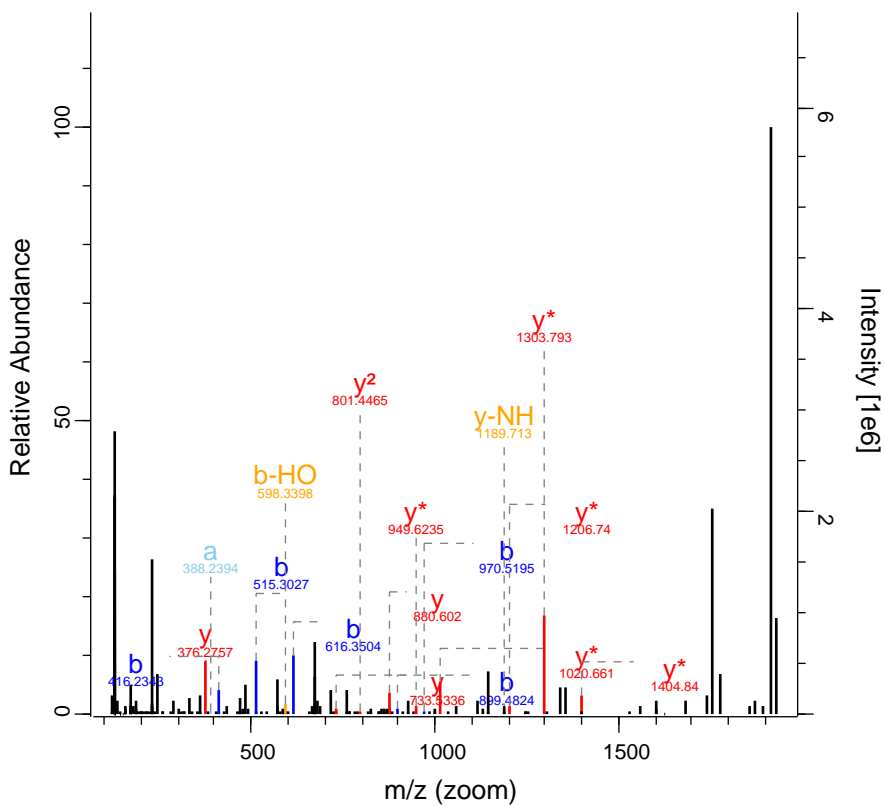

RO-QC-160121_ZackD_SS_Set_02_Fraction 27517 FTMS; HC 67.24 738.66 RSF1

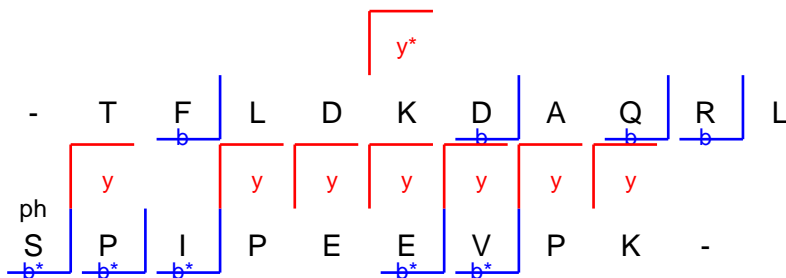
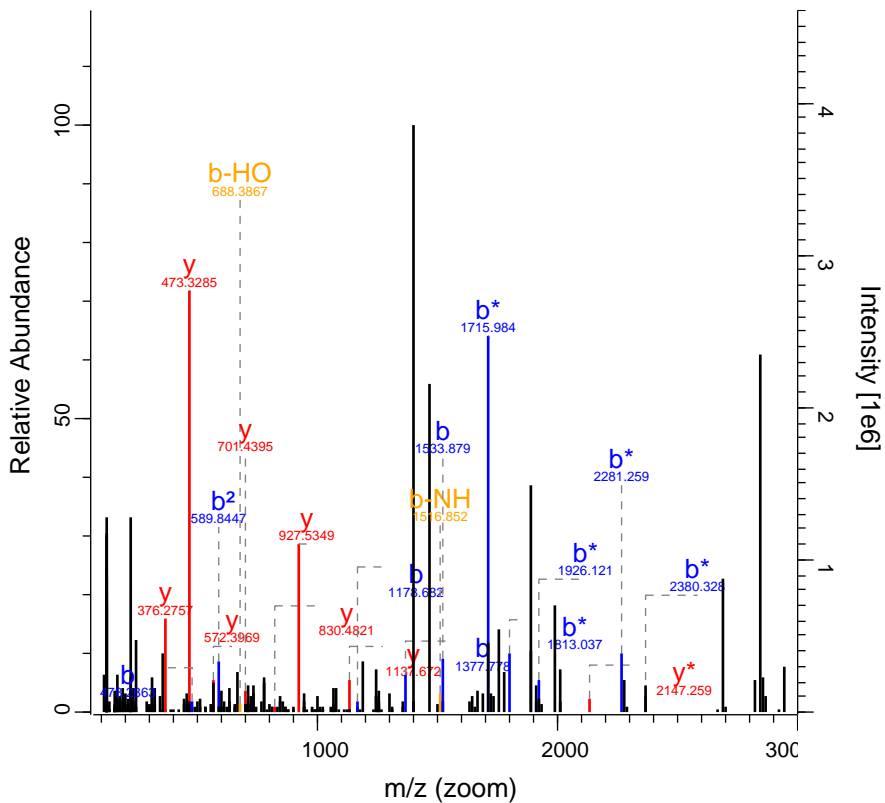

RO-QC-160121_ZackD_SS_Set_02_Fraction 29411 FTMS; HC 42.35 1085.25 NAP1L4

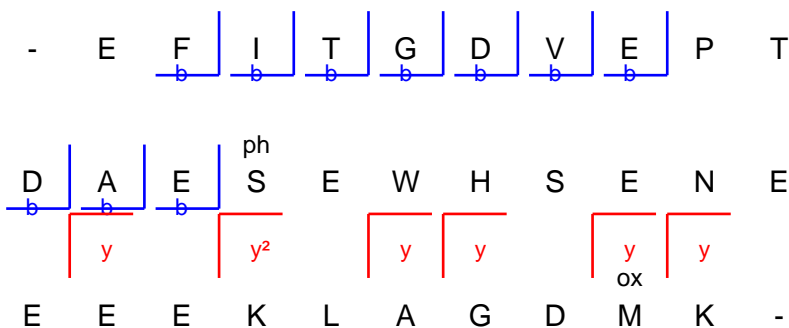
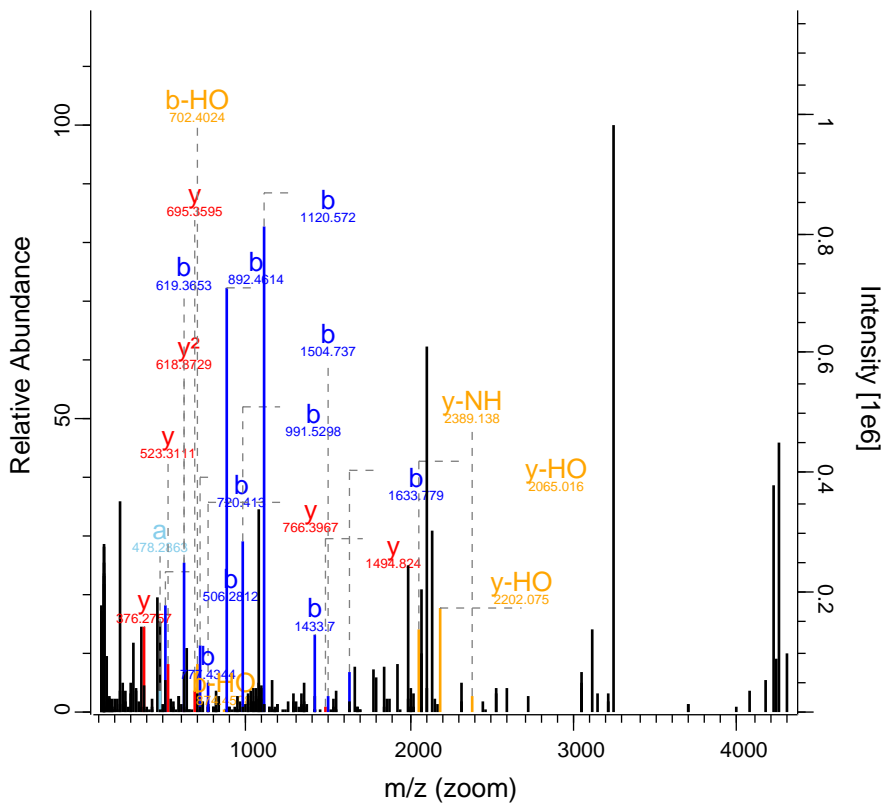

RO-QC-160121_ZackD_SS_Set_02_Fraction 30781 FTMS; HC 54.81 758.4 EFCAB10

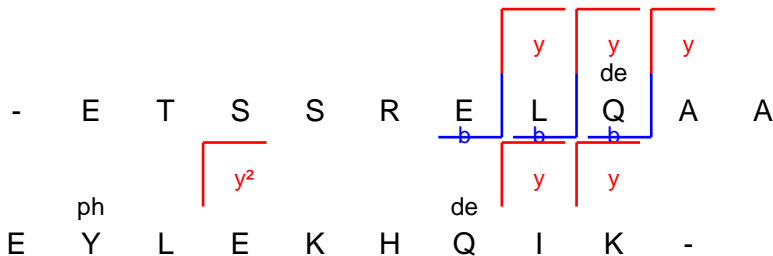
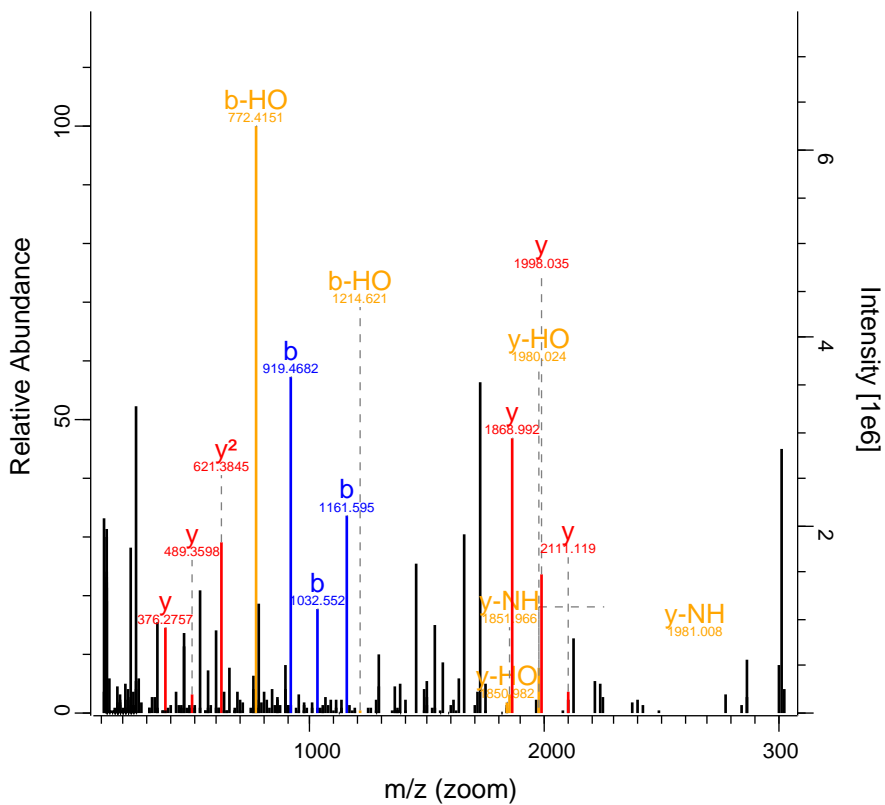

RO-QC-160121_ZackD_SS_Set_02_Fraction1 32135 FTMS; HC 102.69 915.82 PGM1

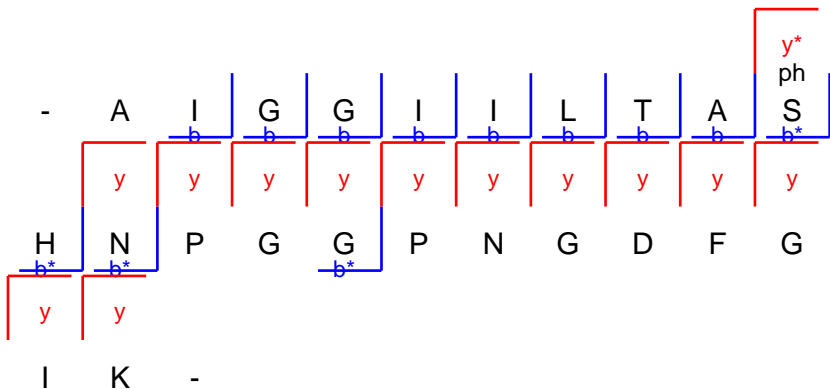
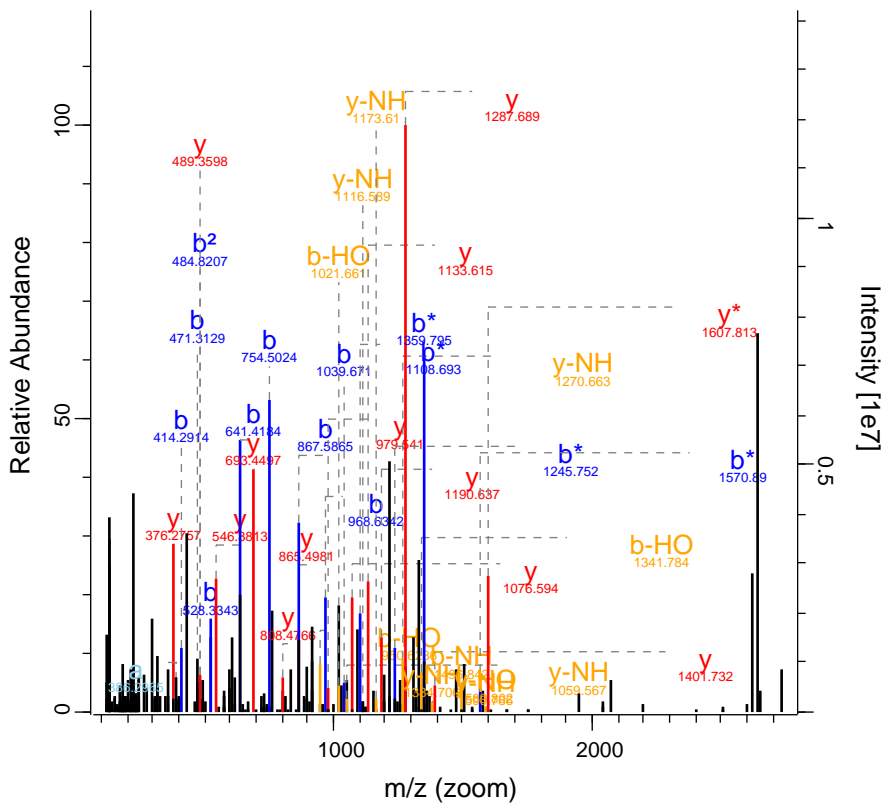

RO-QC-160121_ZackD_SS_Set_02_Fraction 33143 FTMS; HC 85.18 1017.83 AHNAK

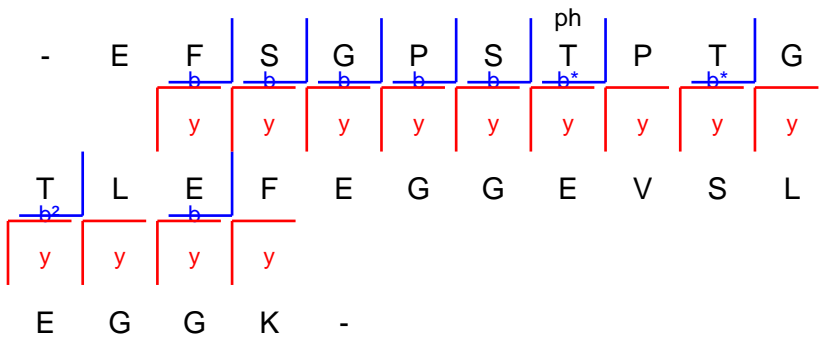
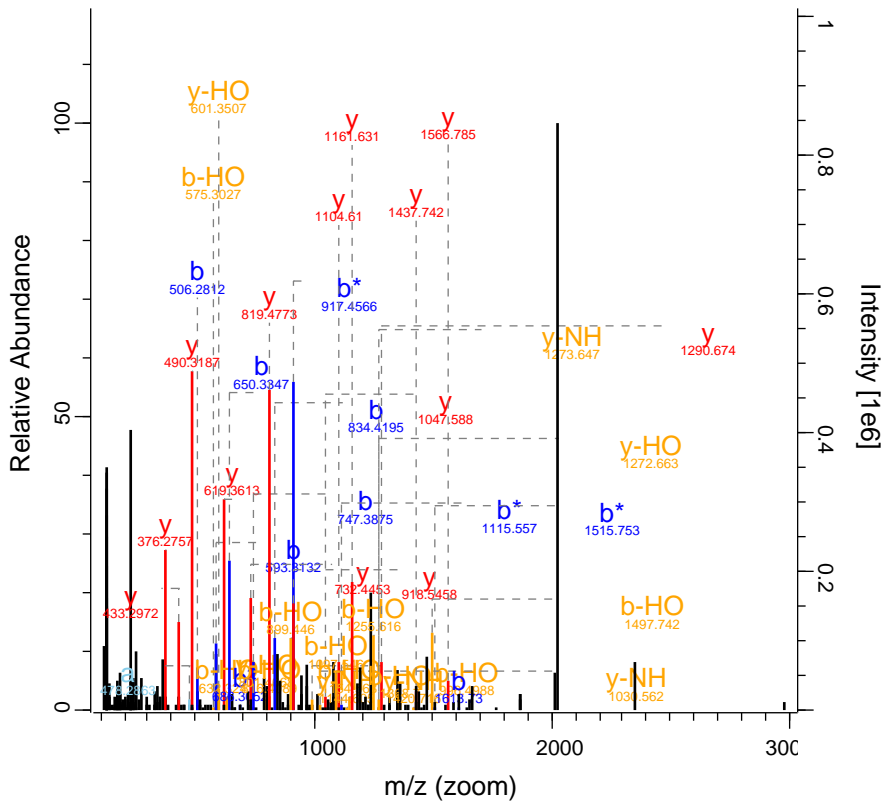

RO-QC-160121_ZackD_SS_Set_02_Fraction 33257 FTMS; HC 166.11 1339.6 PPP6R3

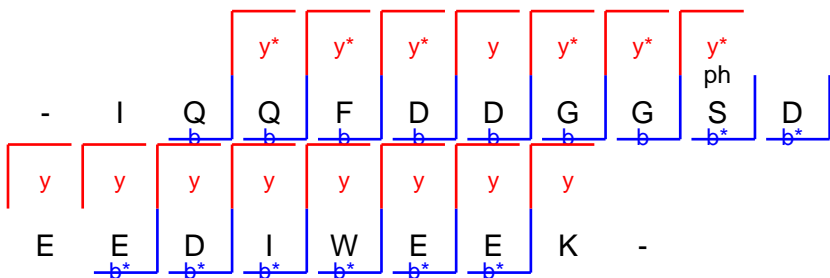
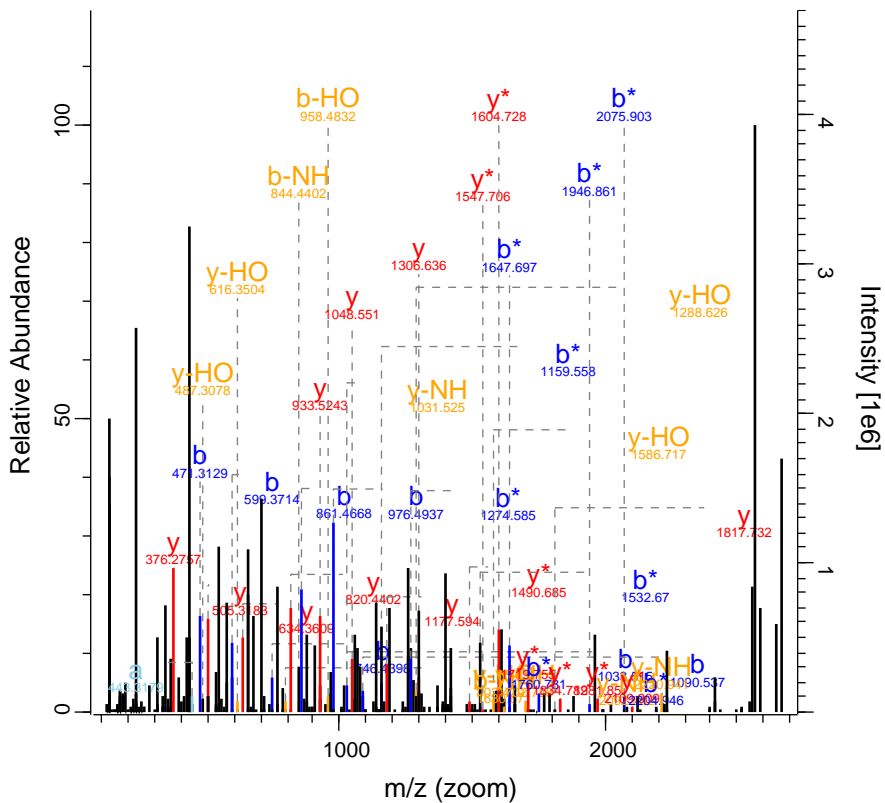

RO-QC-160121_ZackD_SS_Set_02_Fraction 33423 FTMS; HC 174.9 901.9 HACD3

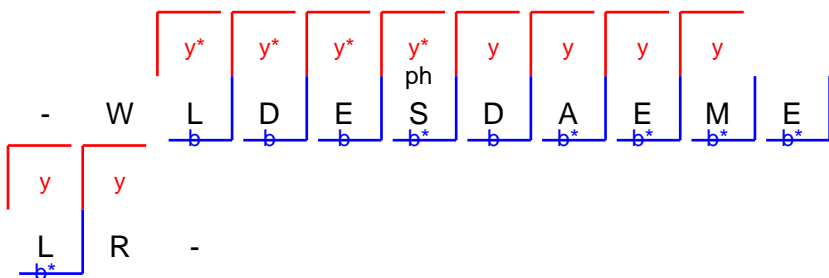
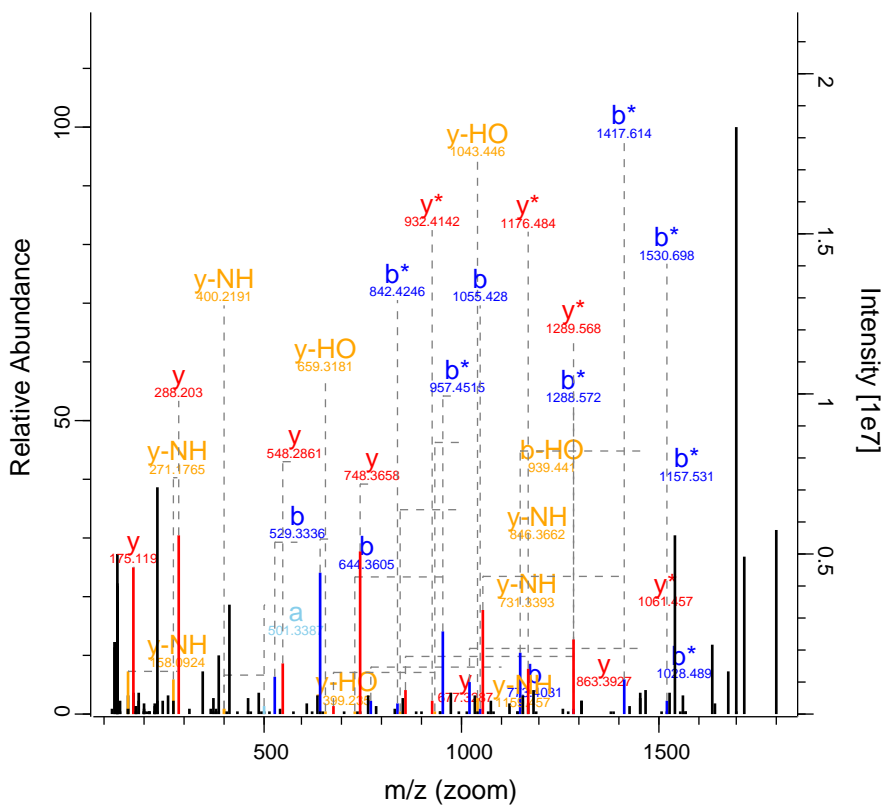

RO-QC-160121_ZackD_SS_Set_02_Fractio 34776 FTMS; HC 194.29 1377.33 RANBP2

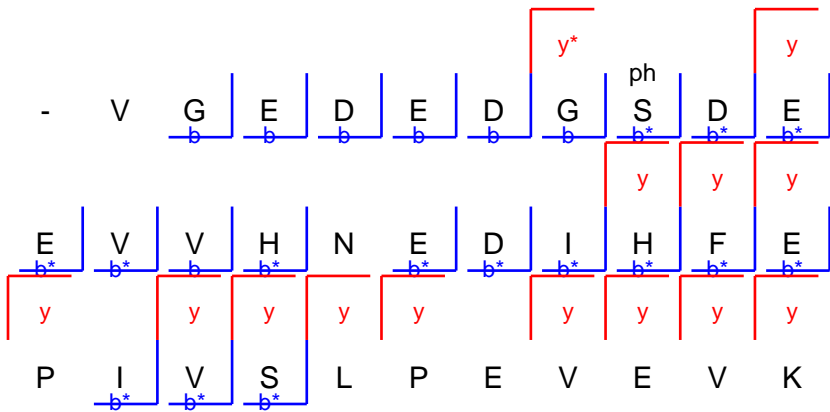
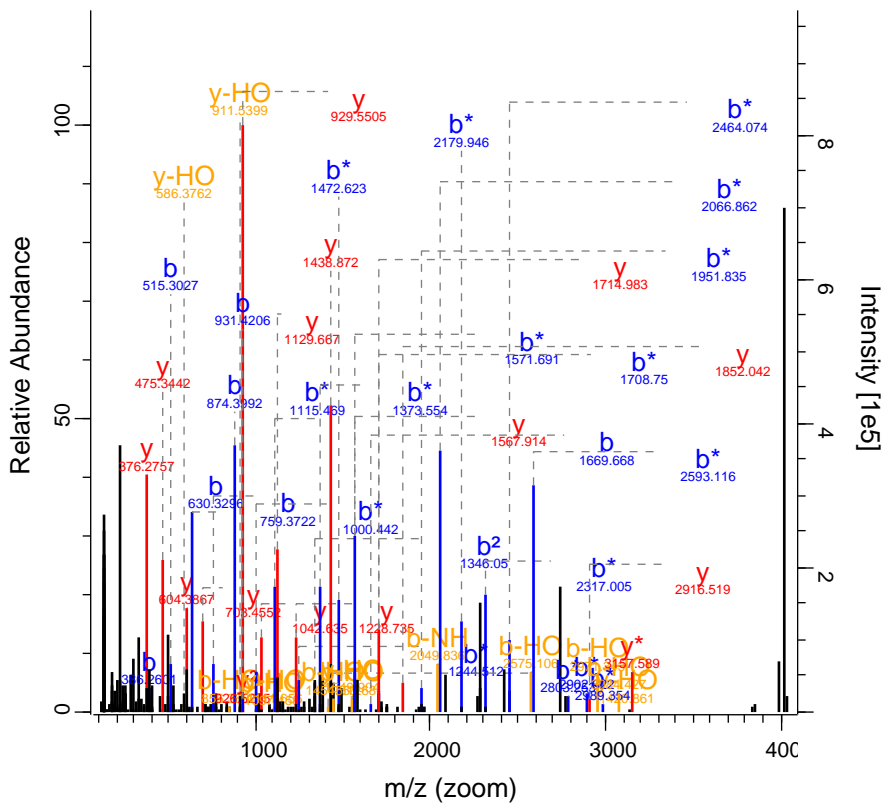

RO-QC-160121_ZackD_SS_Set_02_Fraction_35330 FTMS; HC 108.46 559 CLU

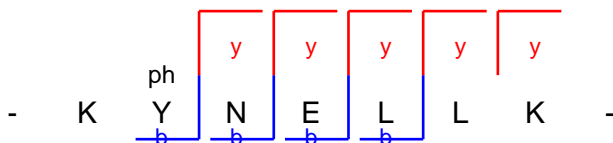
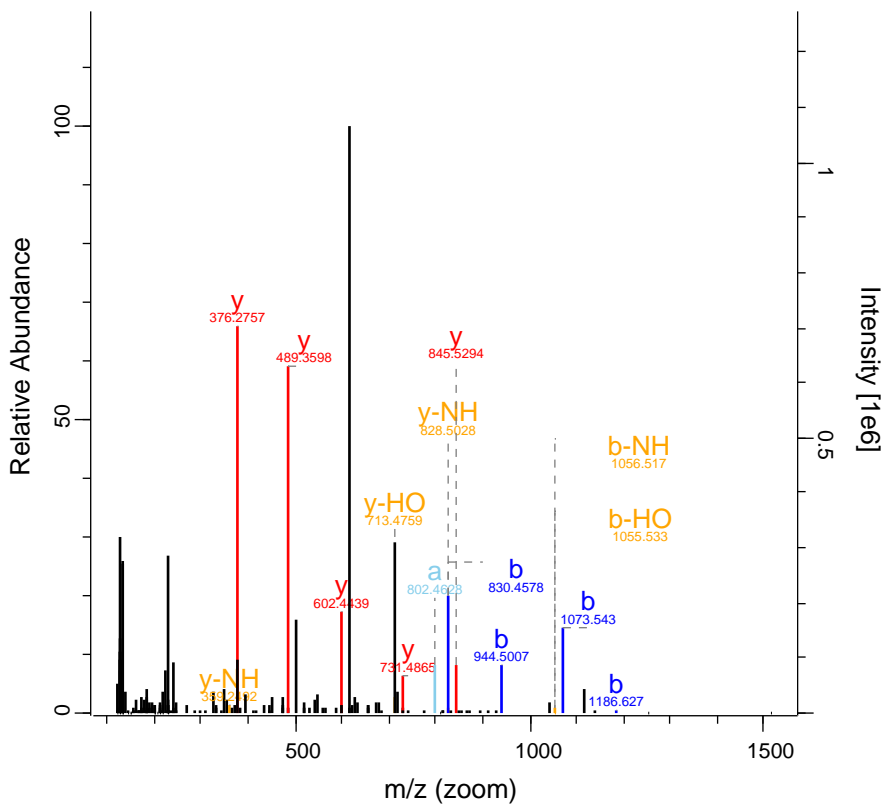

RO-QC-160121_ZackD_SS_Set_02_Fraction 35892 FTMS; HC 45.33 600.1 HMGXB3

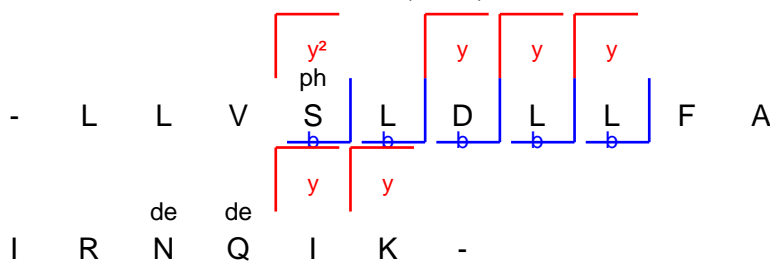
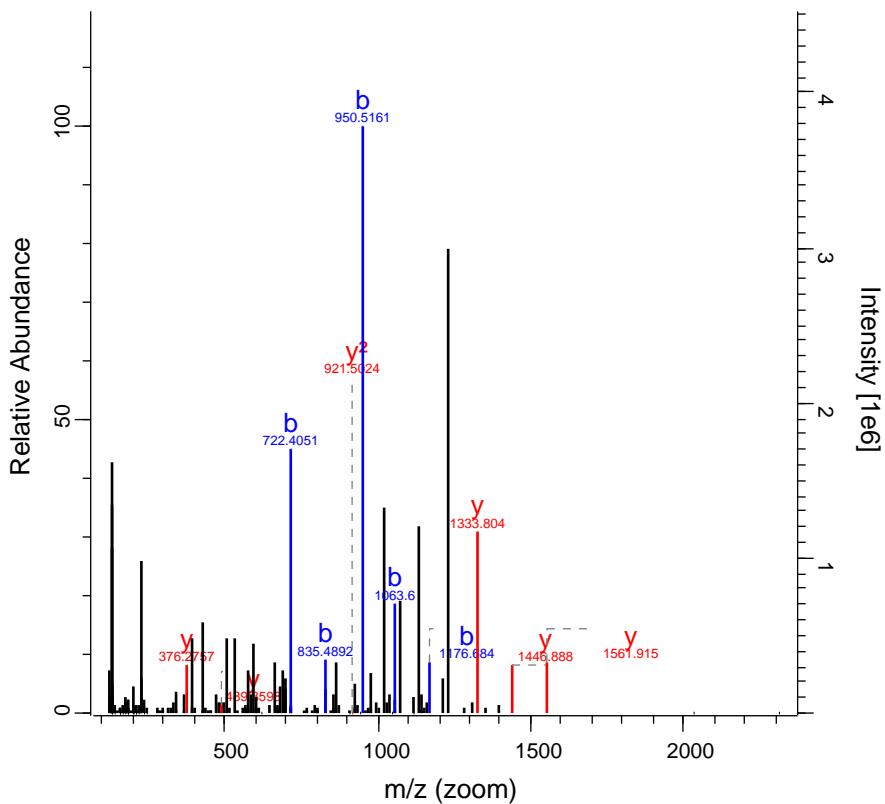

RO-QC-160121_ZackD_SS_Set_02_Fratio 36197 FTMS; HC 133.23 1029.51 RAB11FIP1

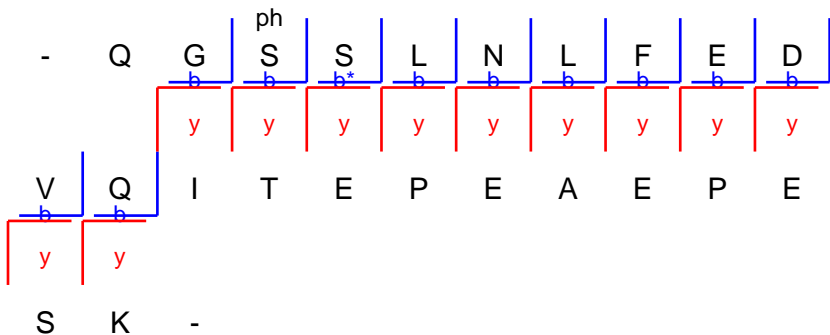
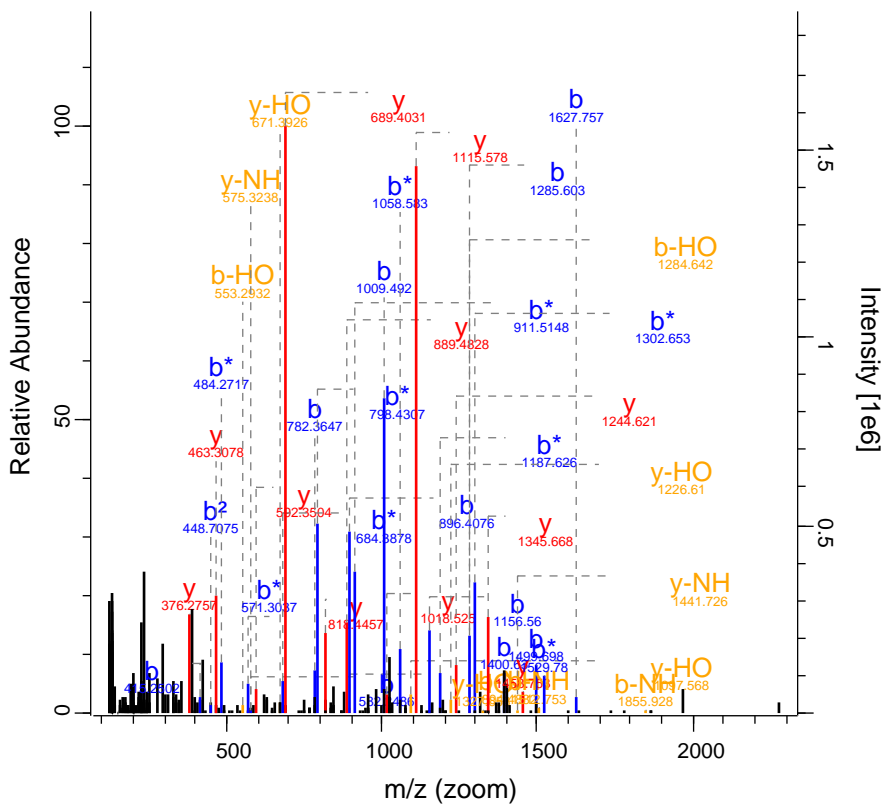

RO-QC-160121_ZackD_SS_Set_02_Fratio 36388 FTMS; HC 131.03 1071.25 SRRT

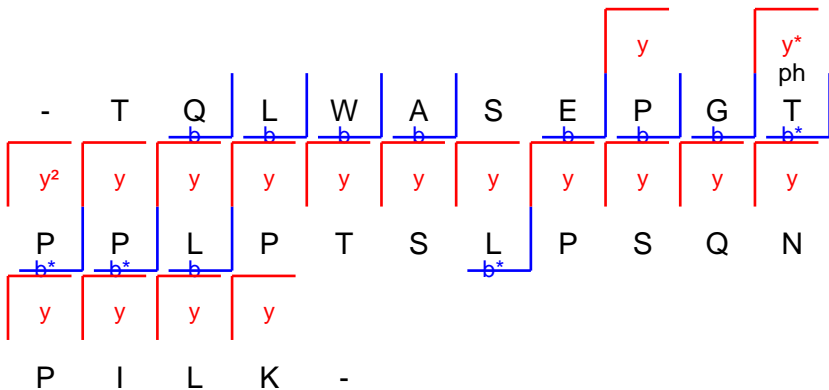
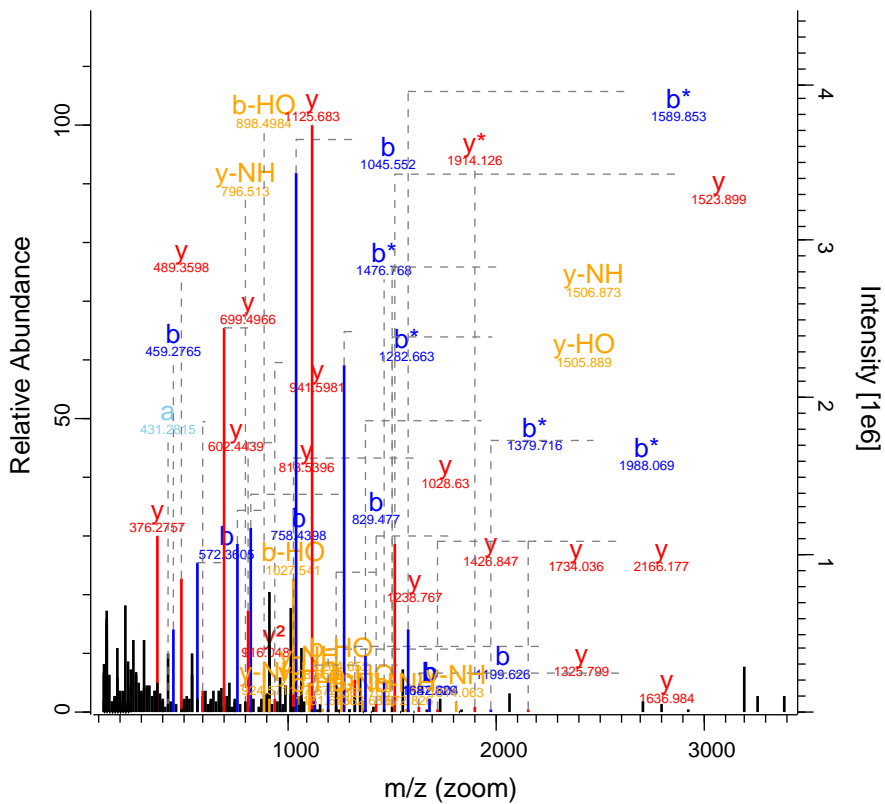

RO-QC-160121_ZackD_SS_Set_02_Fraction 37145 FTMS; HC 50.56 1565.81 CHRNA1

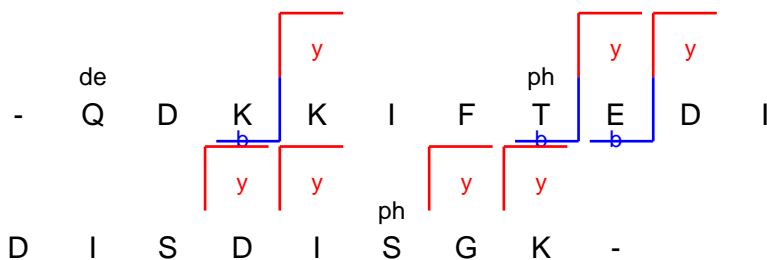
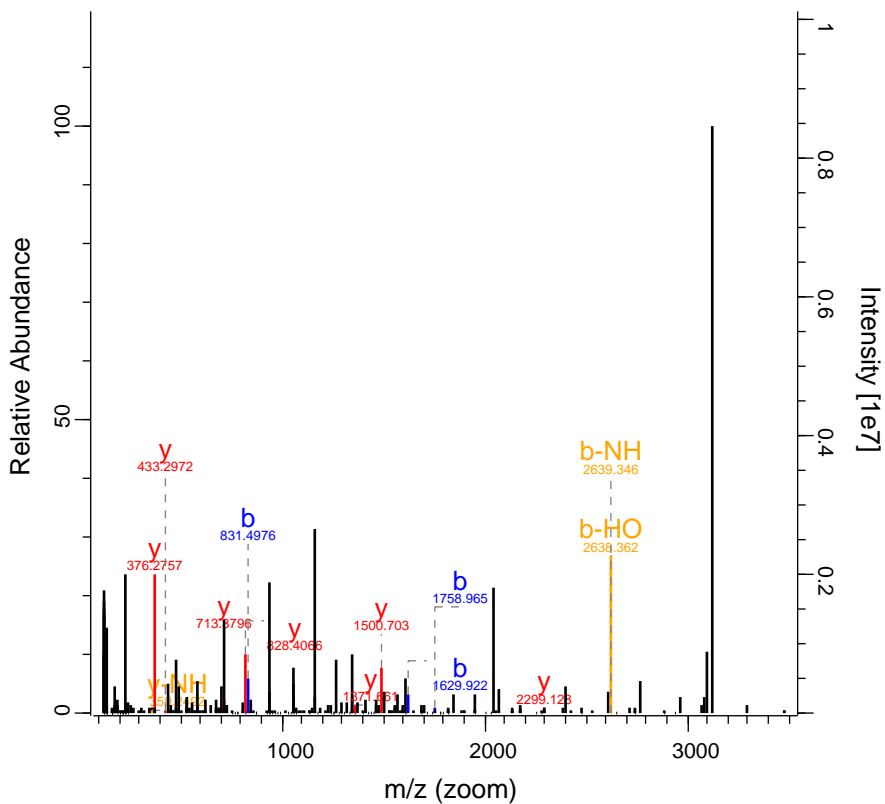

RO-QC-160121_ZackD_SS_Set_02_Fraction 37564 FTMS; HC 51.93 1337.16 CHD5

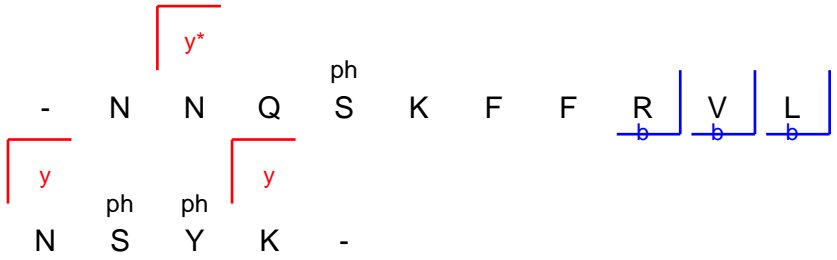
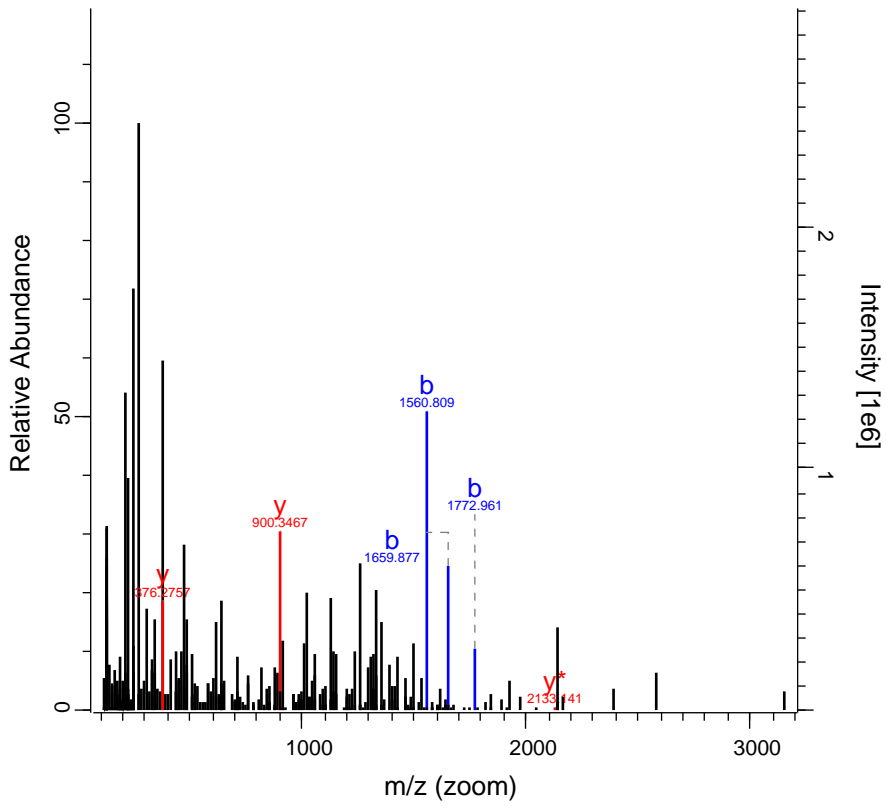

RO-QC-160121_ZackD_SS_Set_02_Fraction 37627 FTMS; HC 49.5 989.82 TMEM2

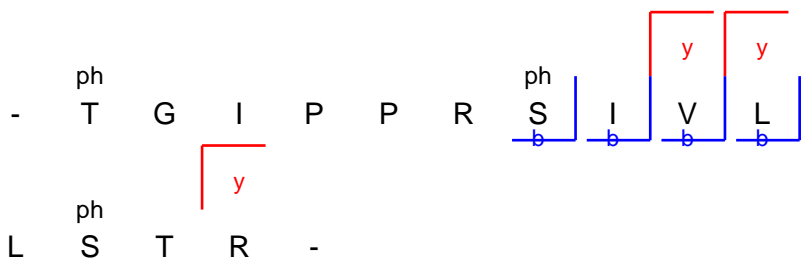
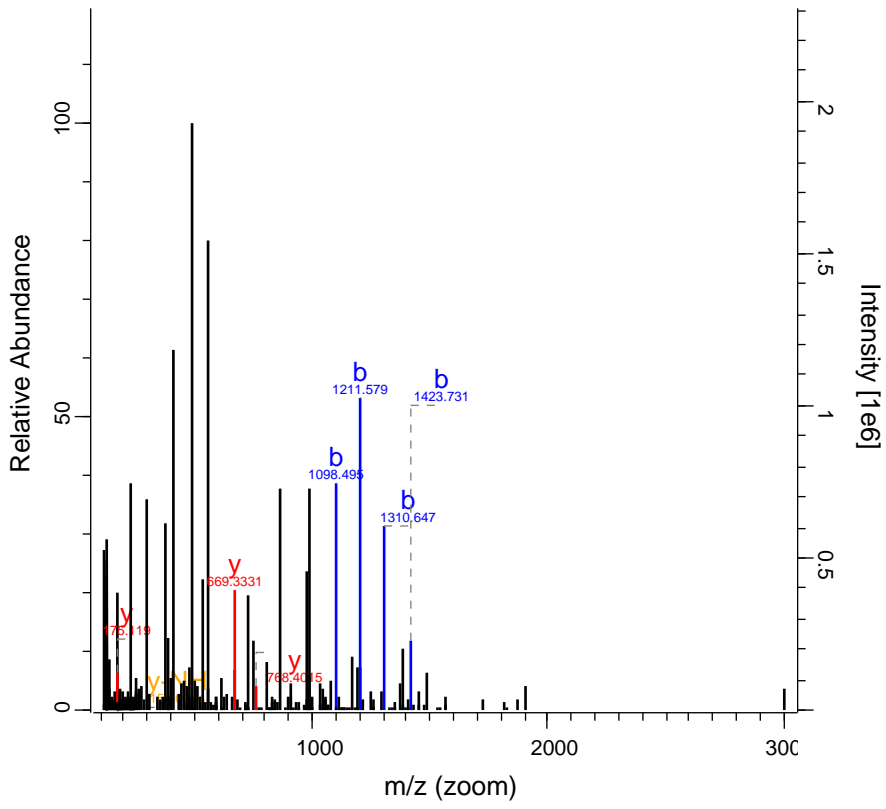

RO-QC-160121_ZackD_SS_Set_02_Fraction 37969 FTMS; HC 69.72 1132.13 FCHO1

