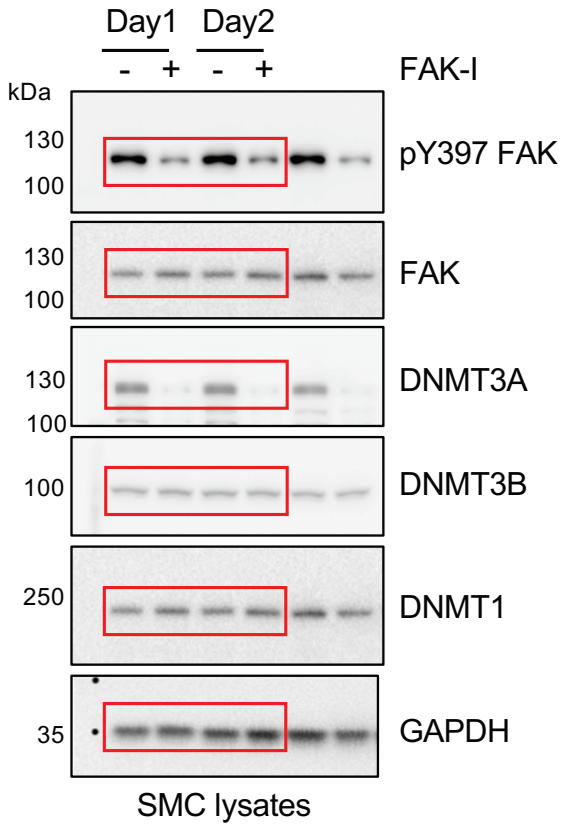
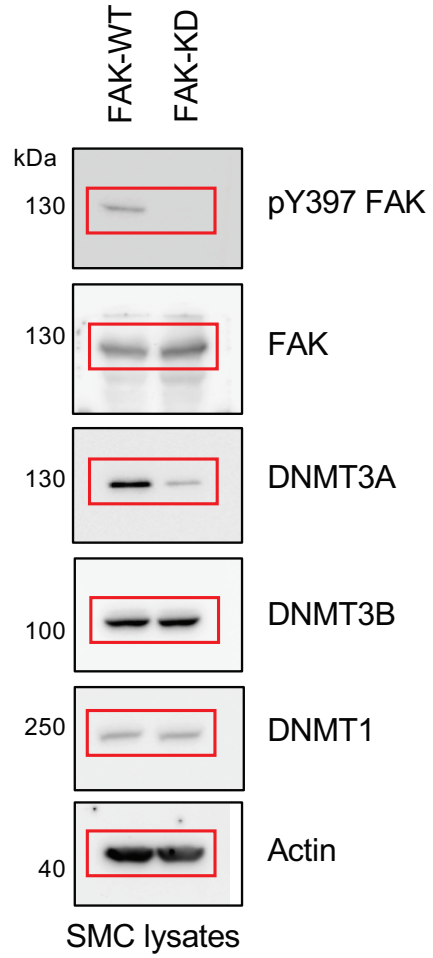

Figure 1

D**E****Figure 2**

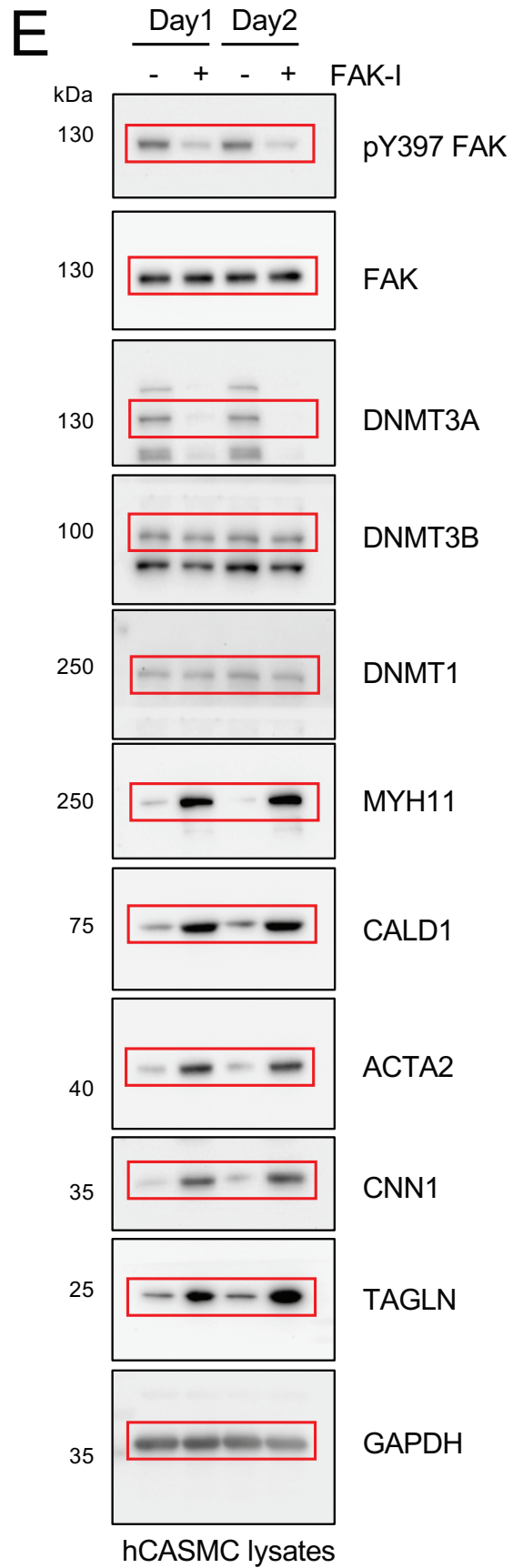
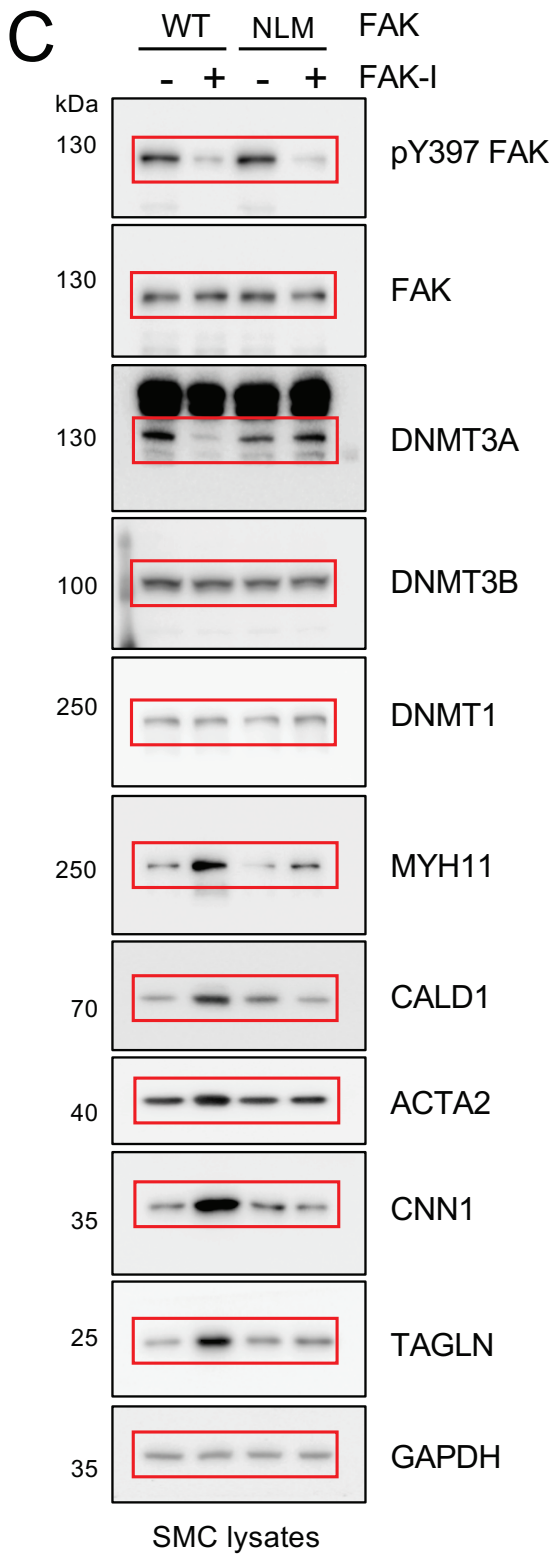

Figure 3

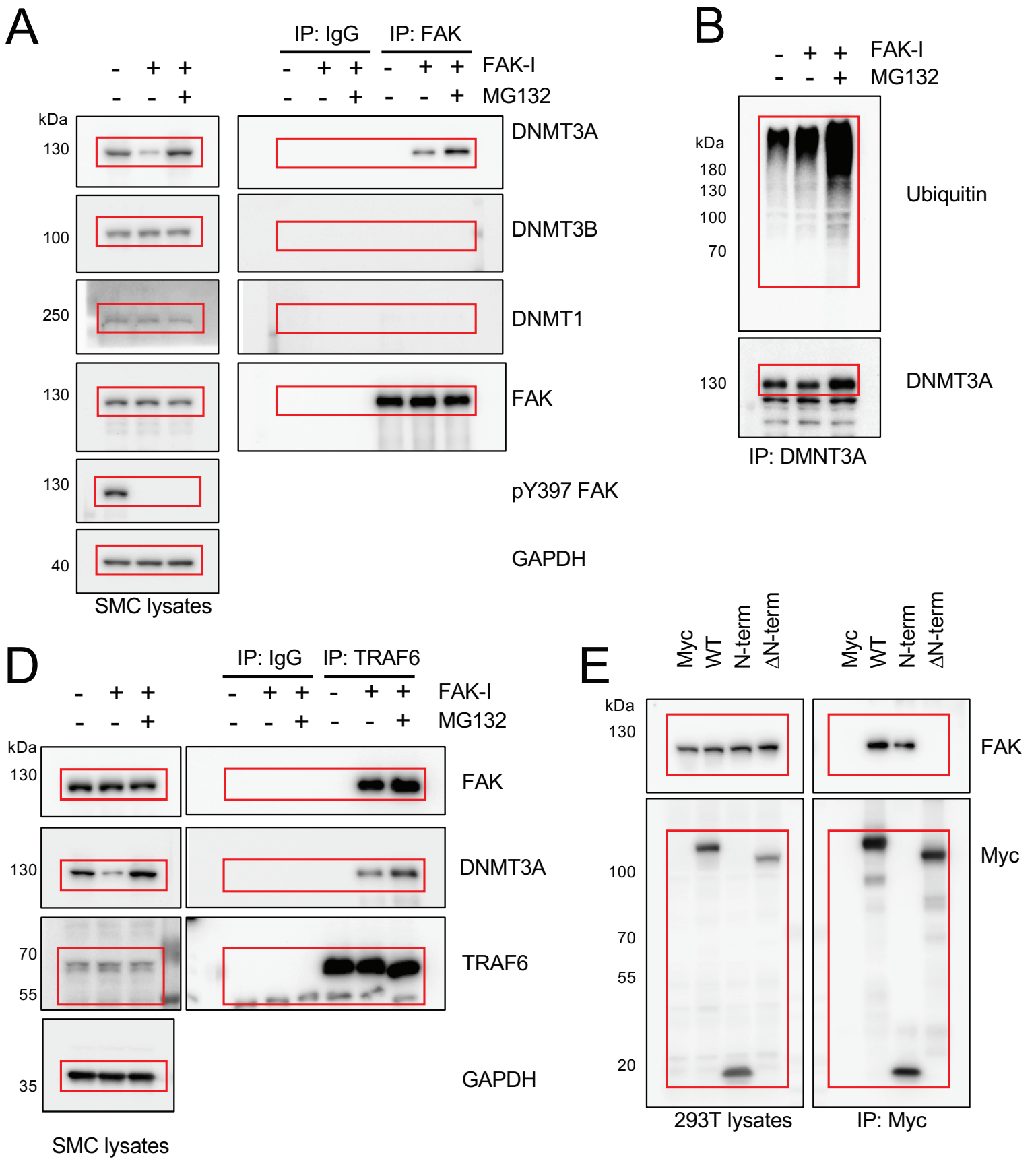

Figure 4

F

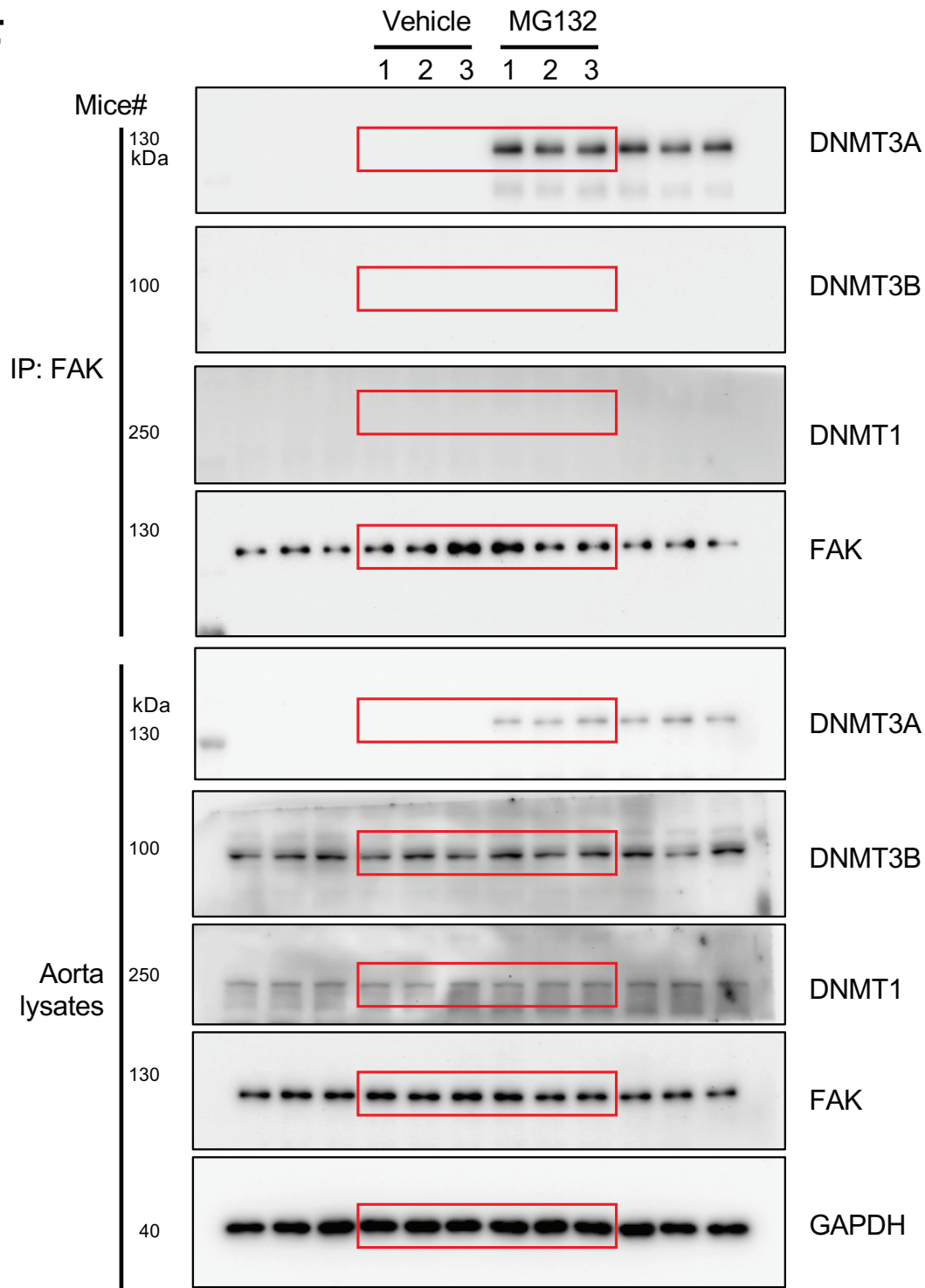

Figure 4

G

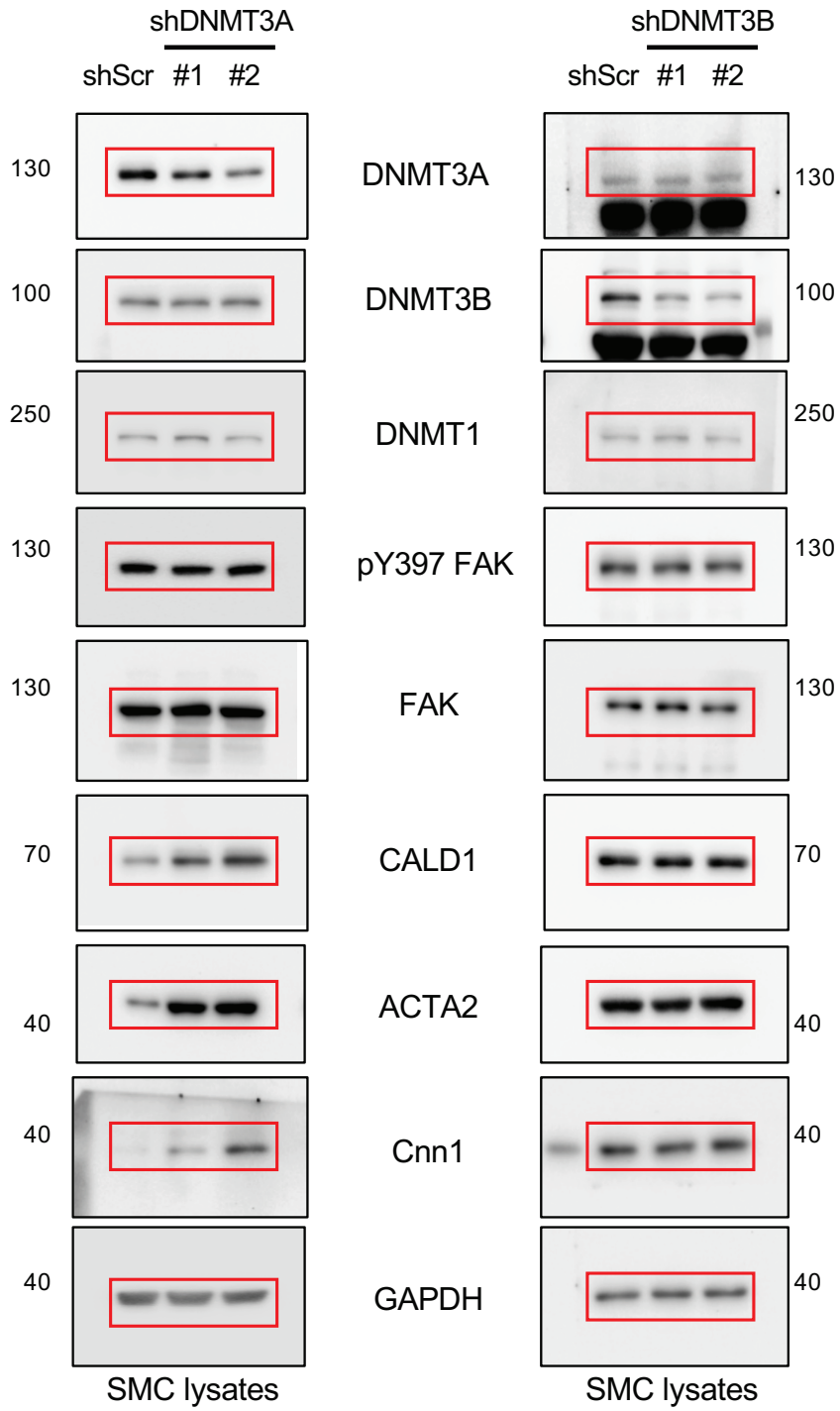

Figure 4

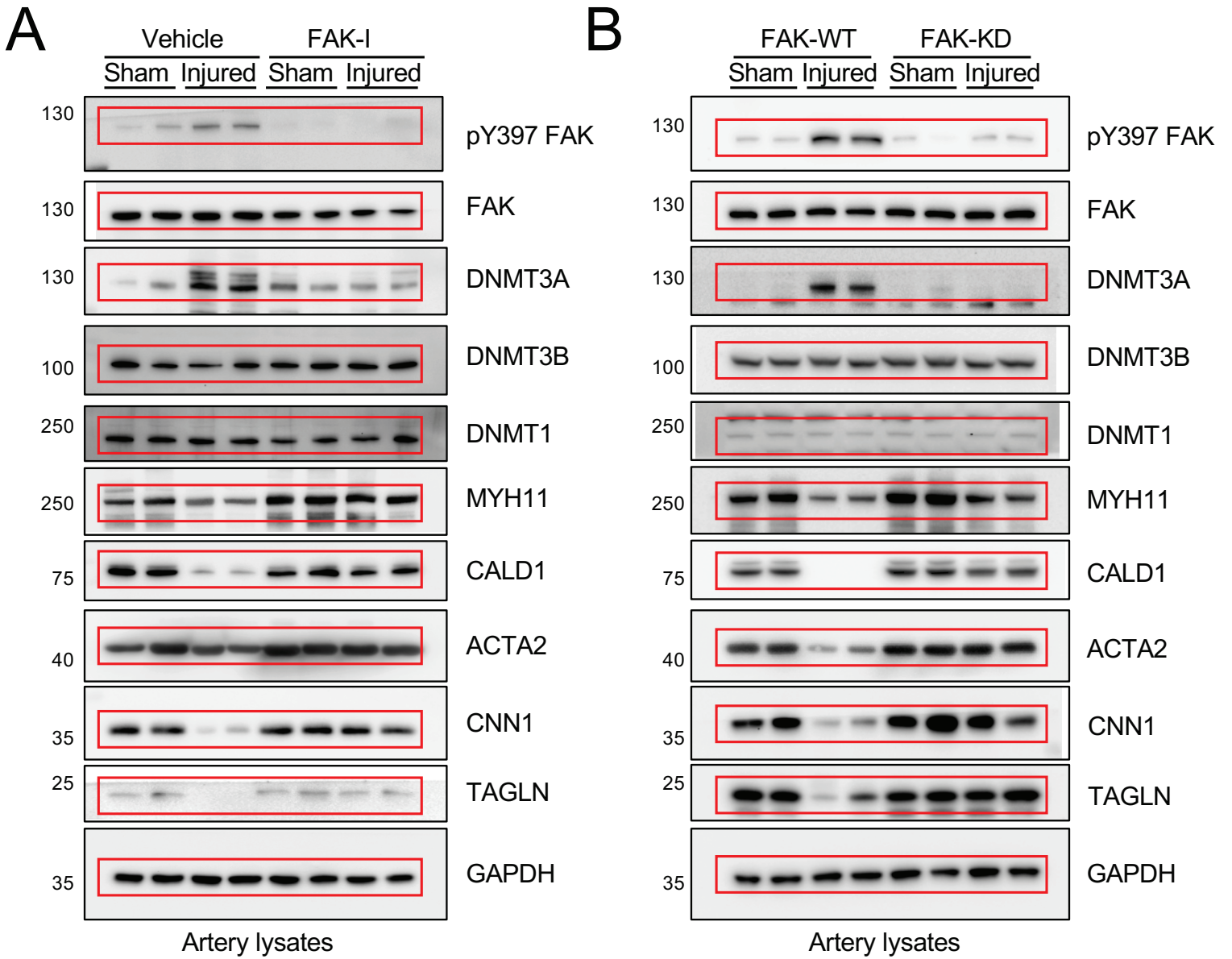
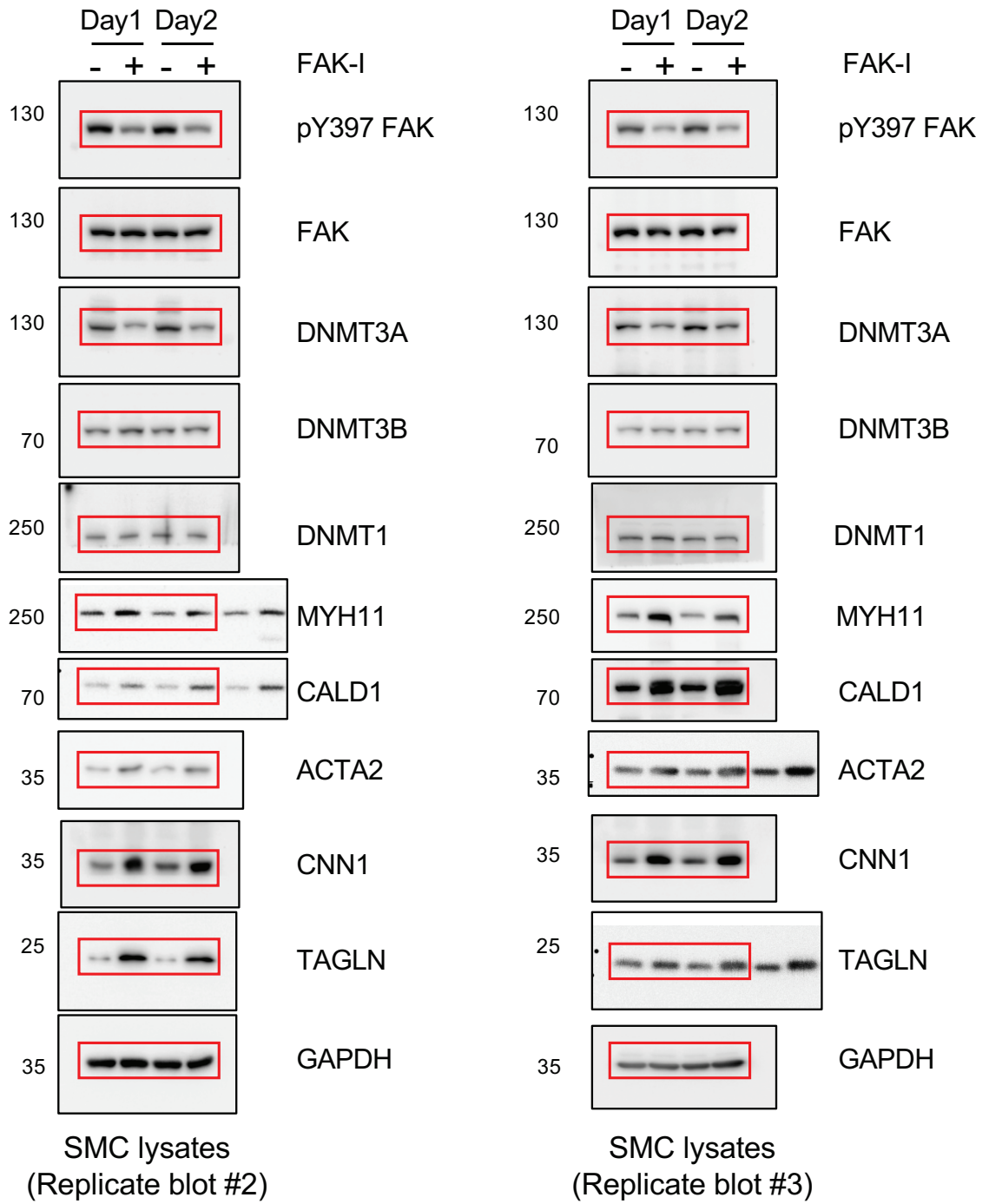
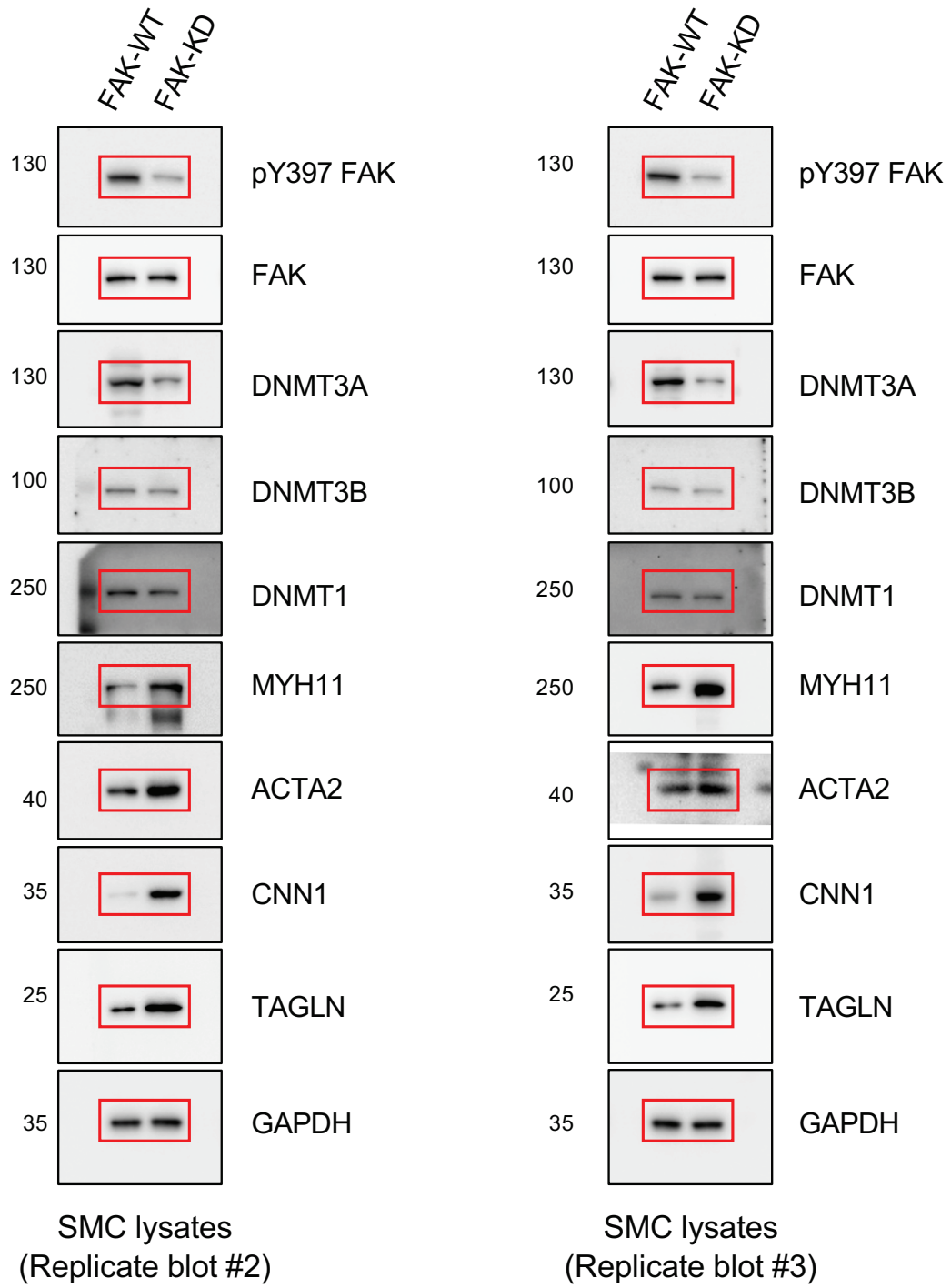

Figure 7

A



B



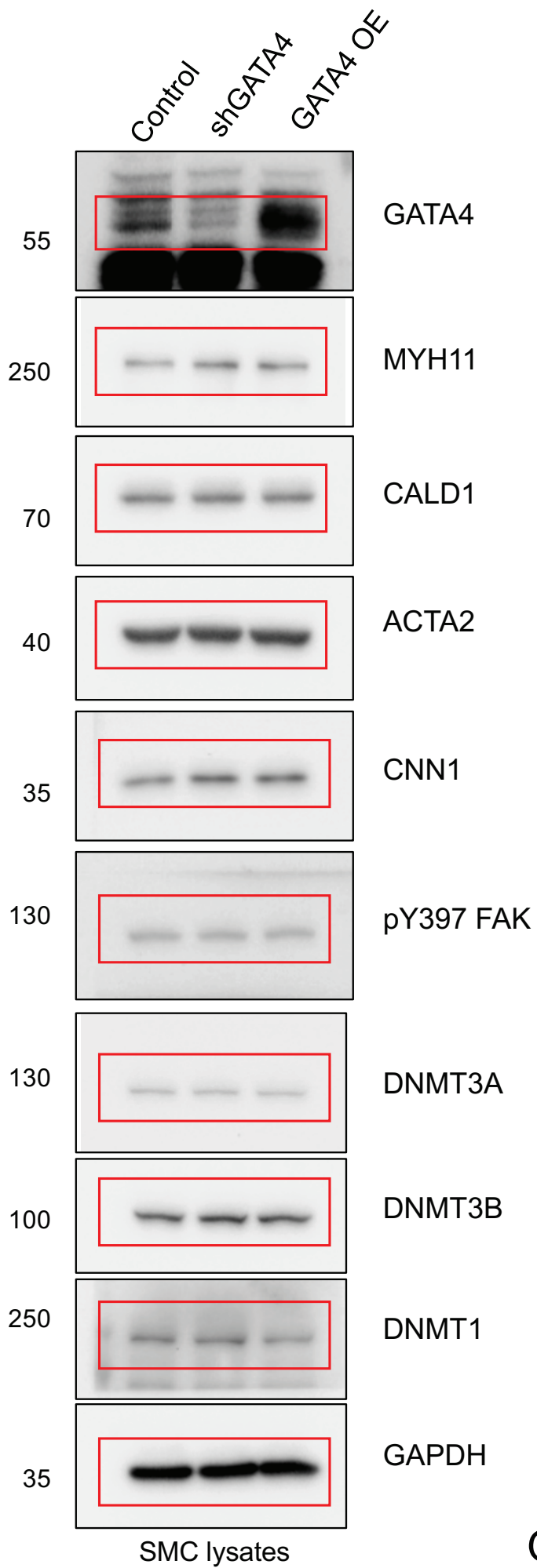

SMC lysates

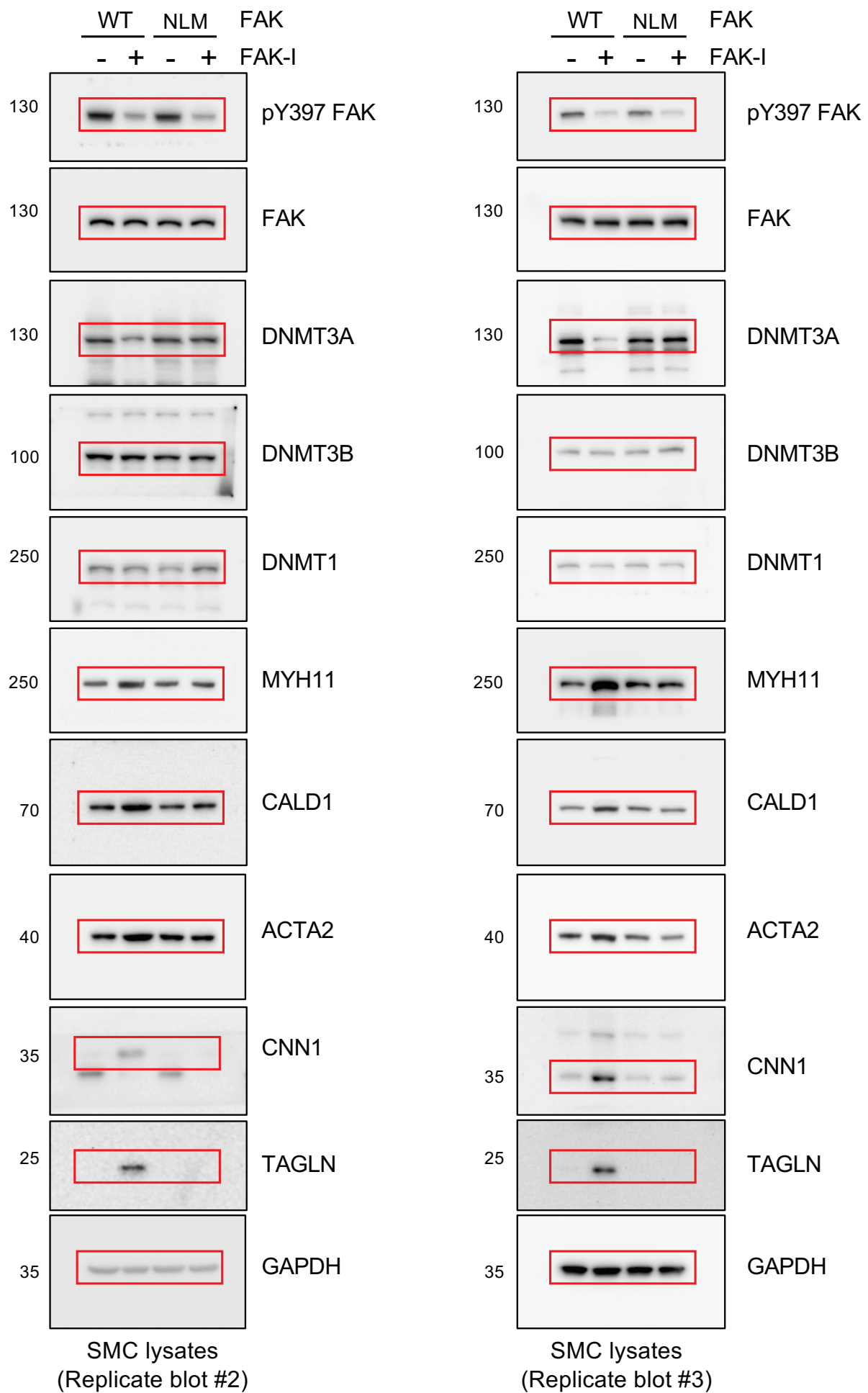

Online Figure XVII

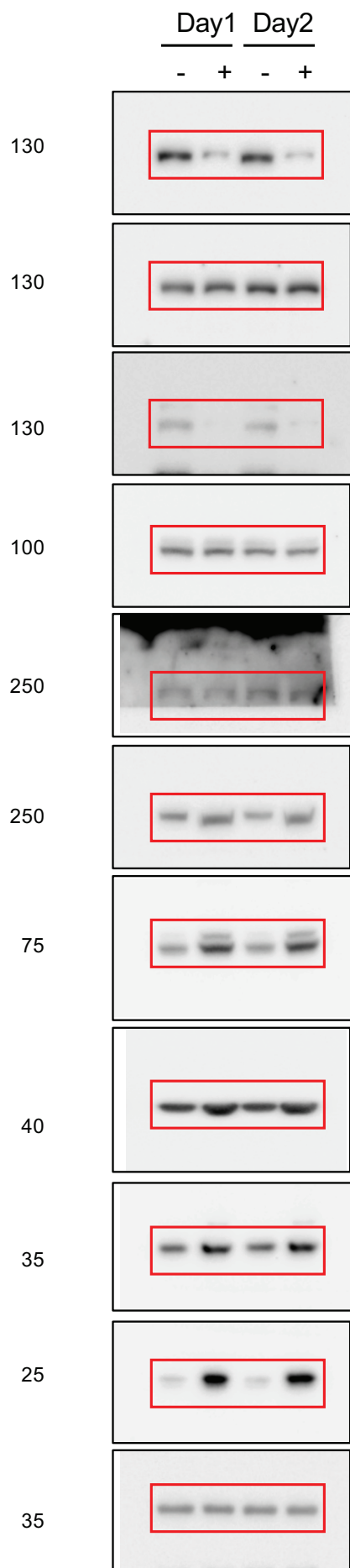

hCASMC lysates
(Replicate blot #2)

FAK-I
pY397 FAK
FAK
DNMT3A
DNMT3B
DNMT1
MYH11
CALD1
ACTA2
CNN1
TAGLN
GAPDH

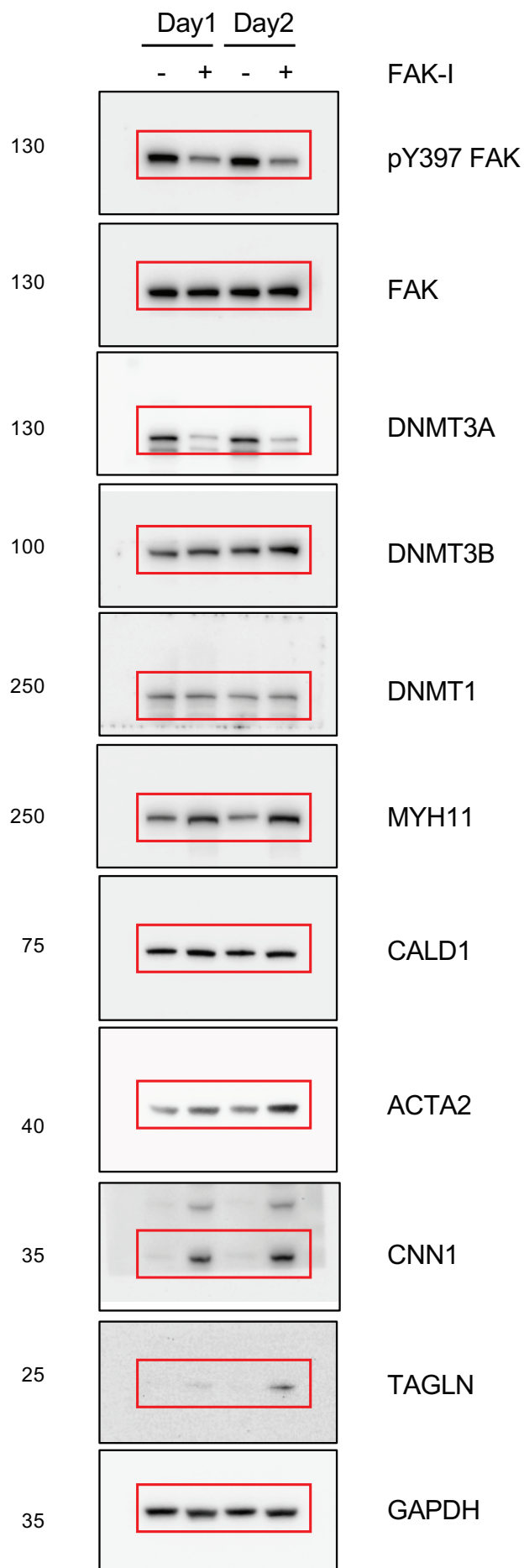

hCASMC lysates
(Replicate blot #3)

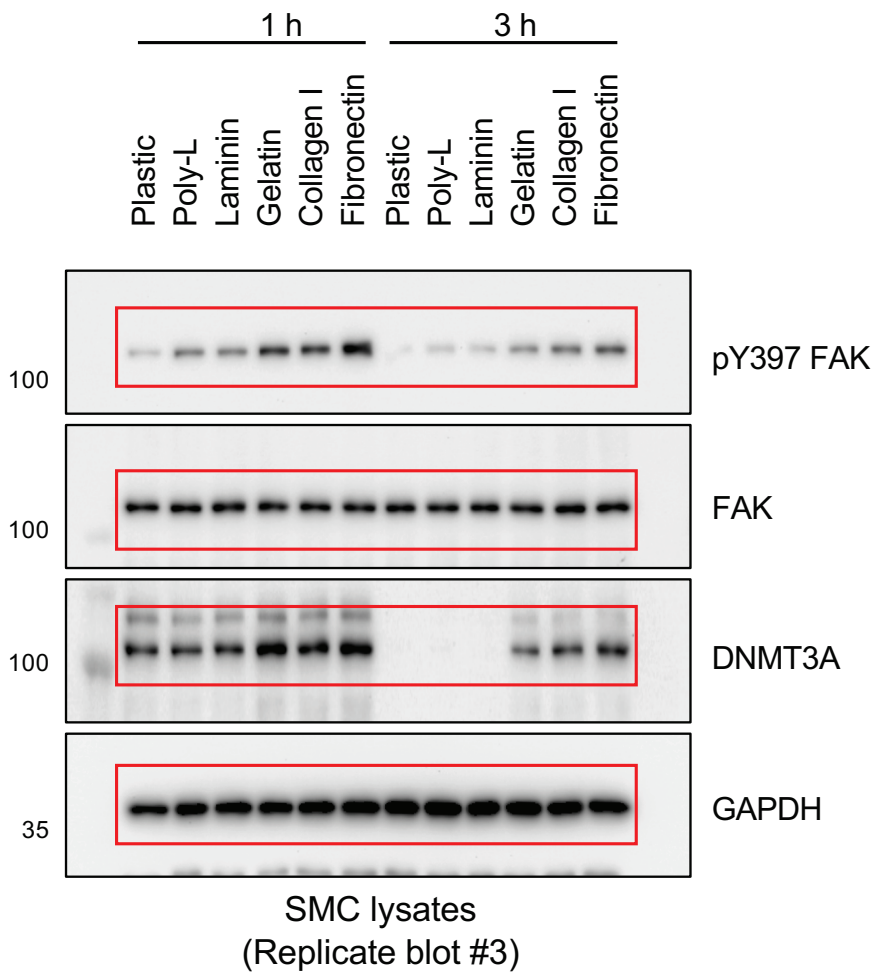
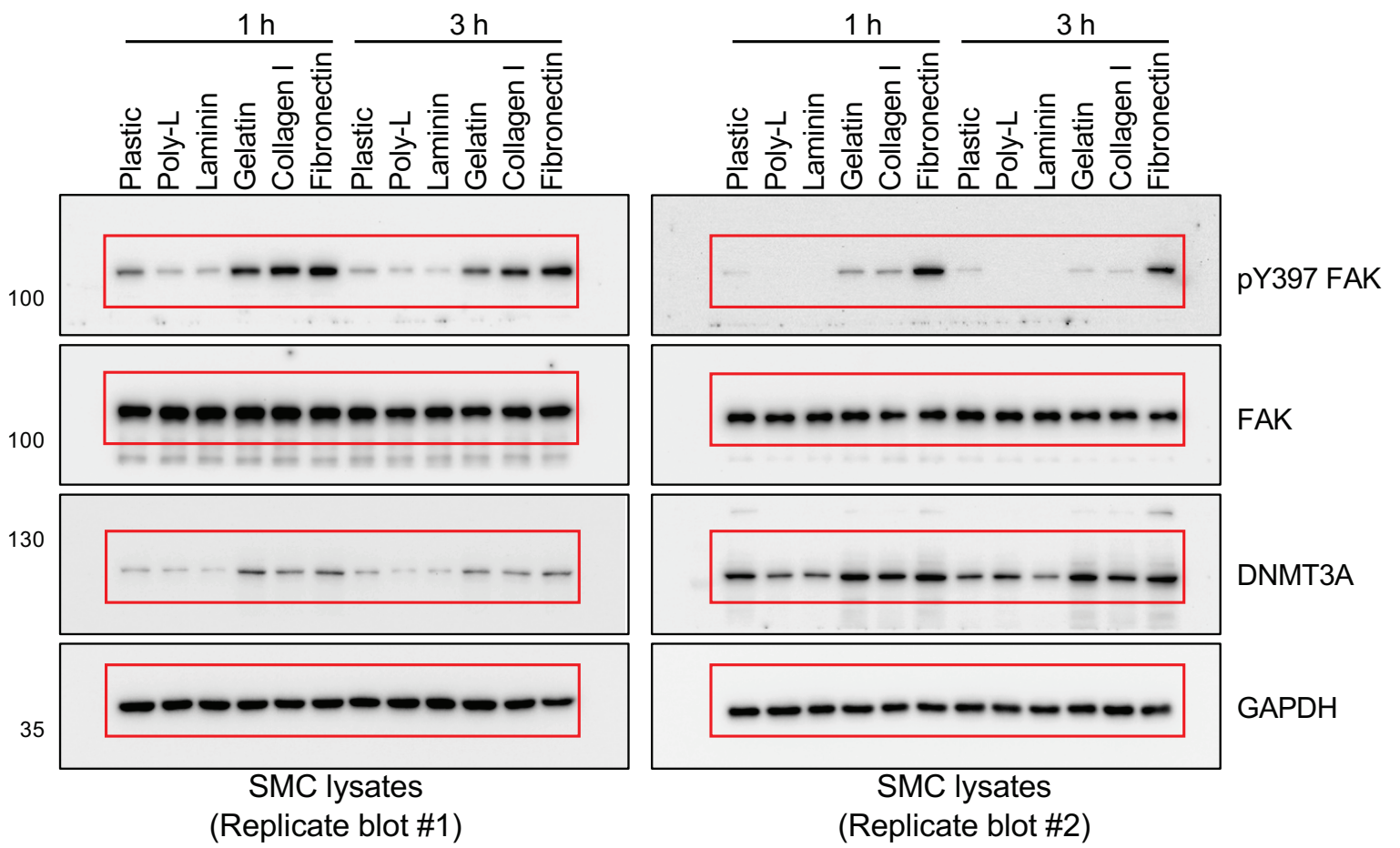

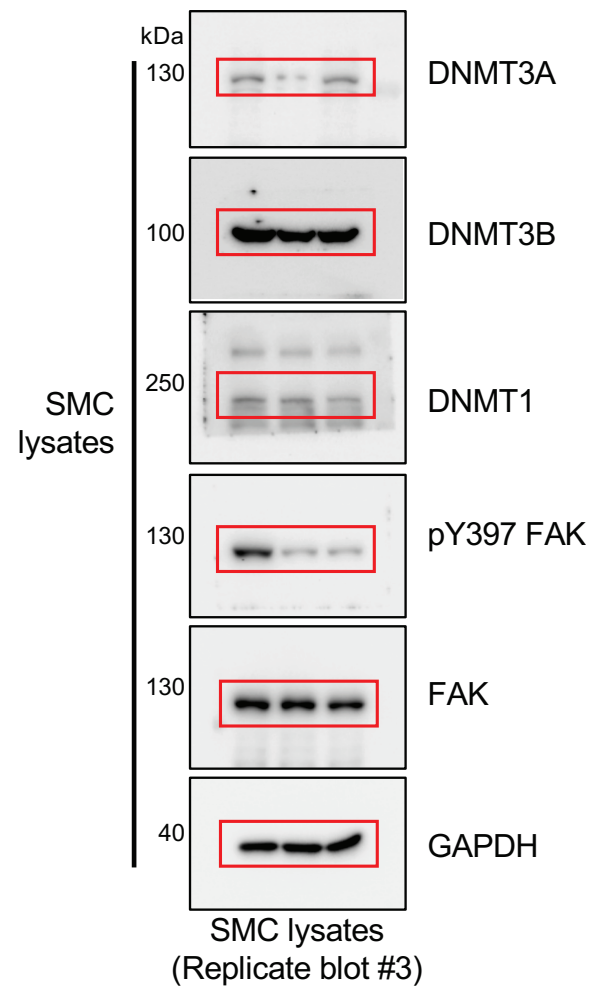
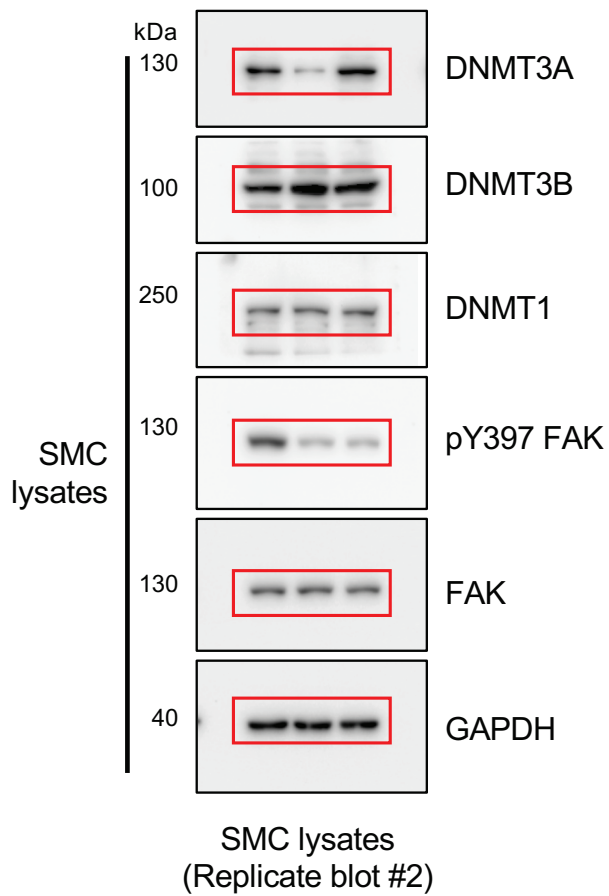
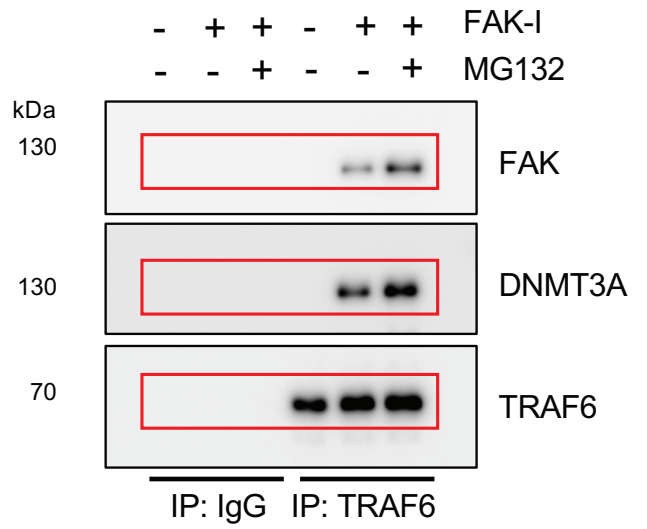
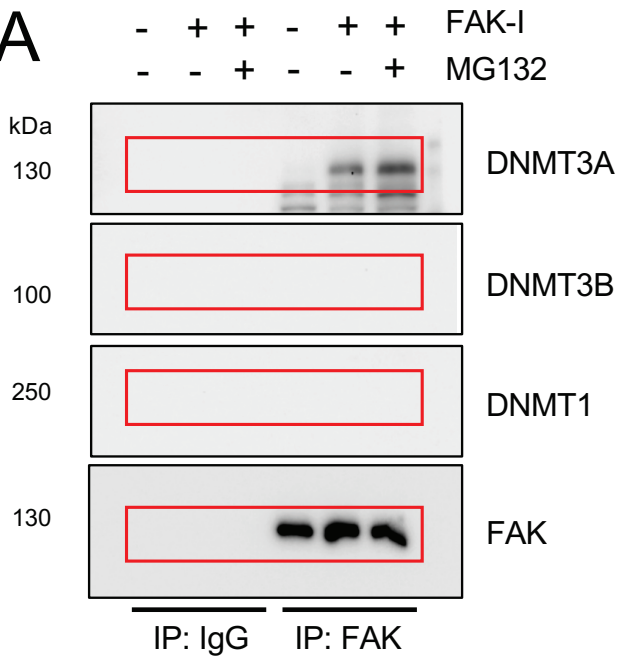
A

A

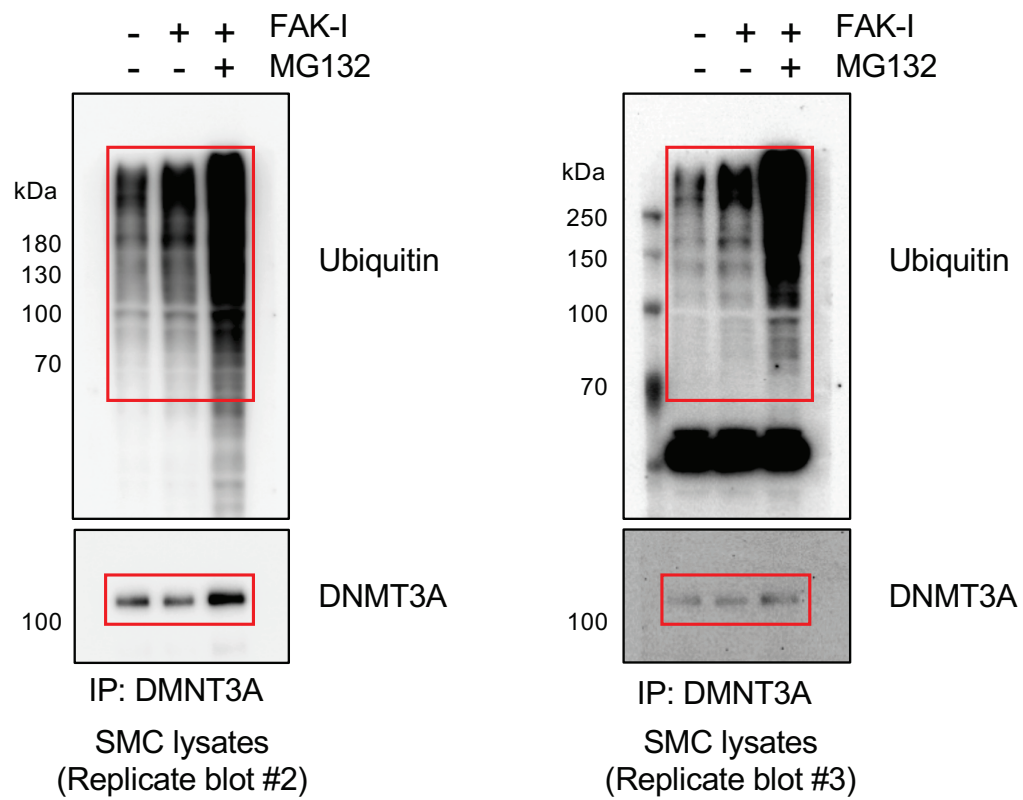

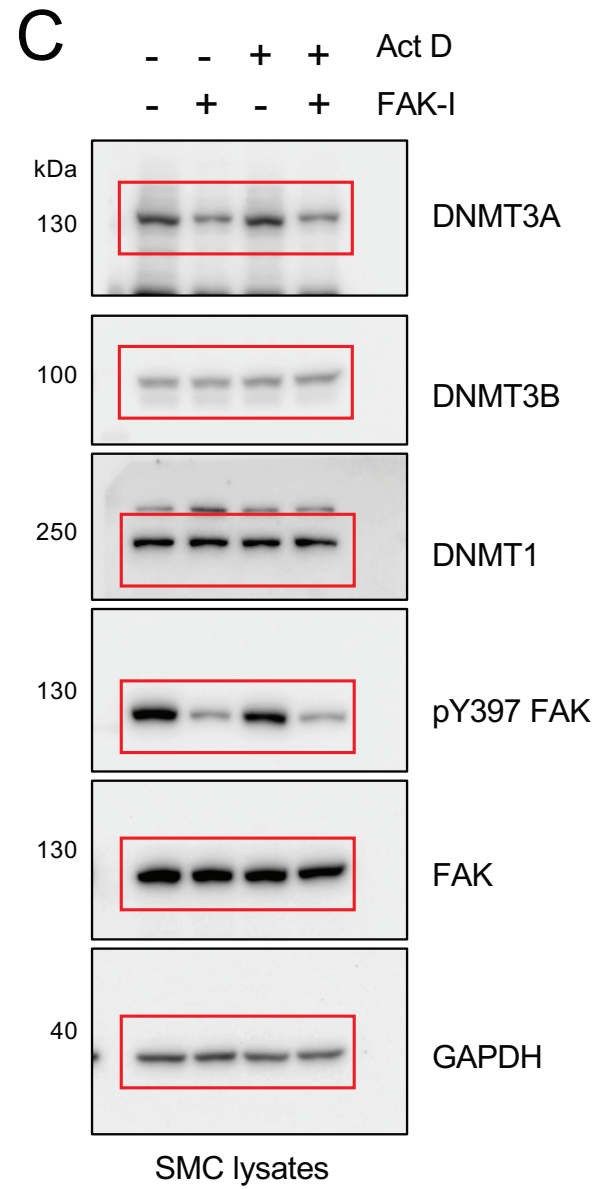
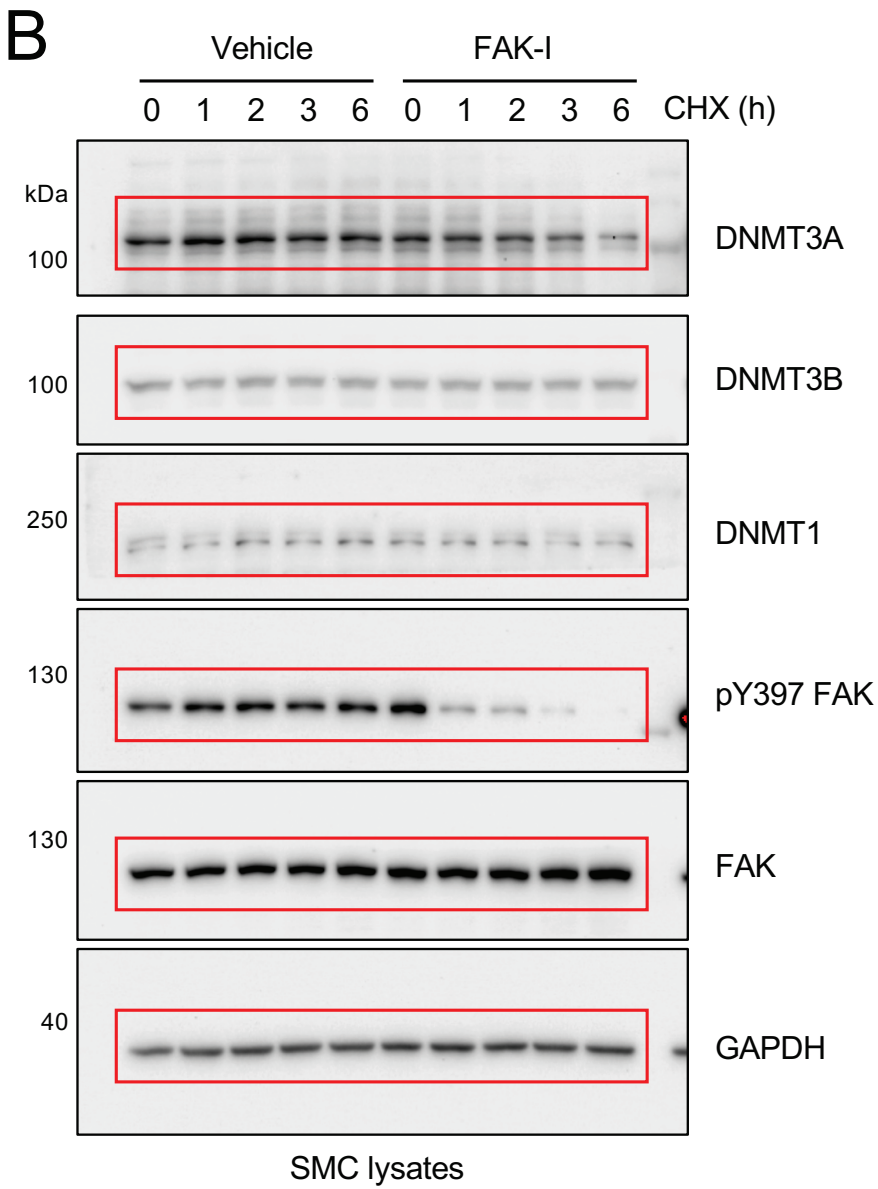

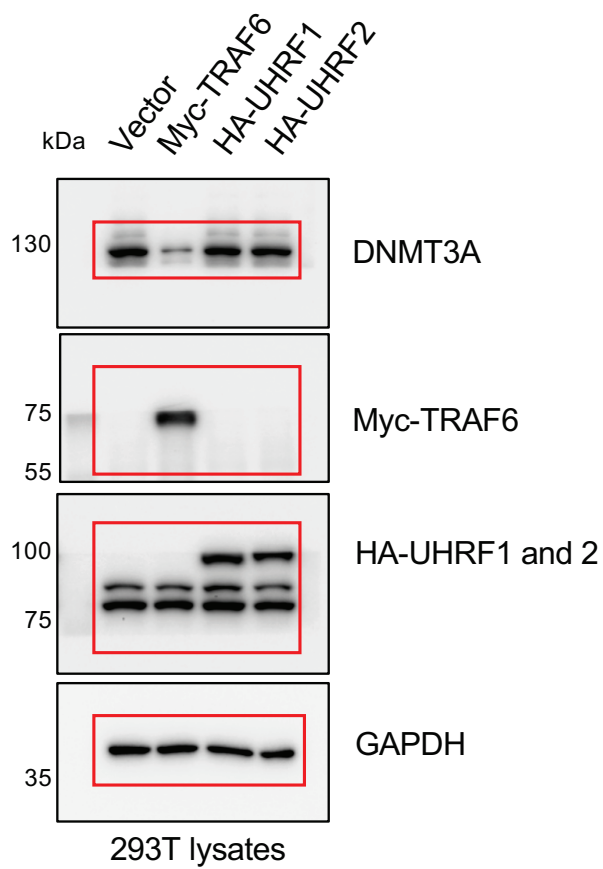
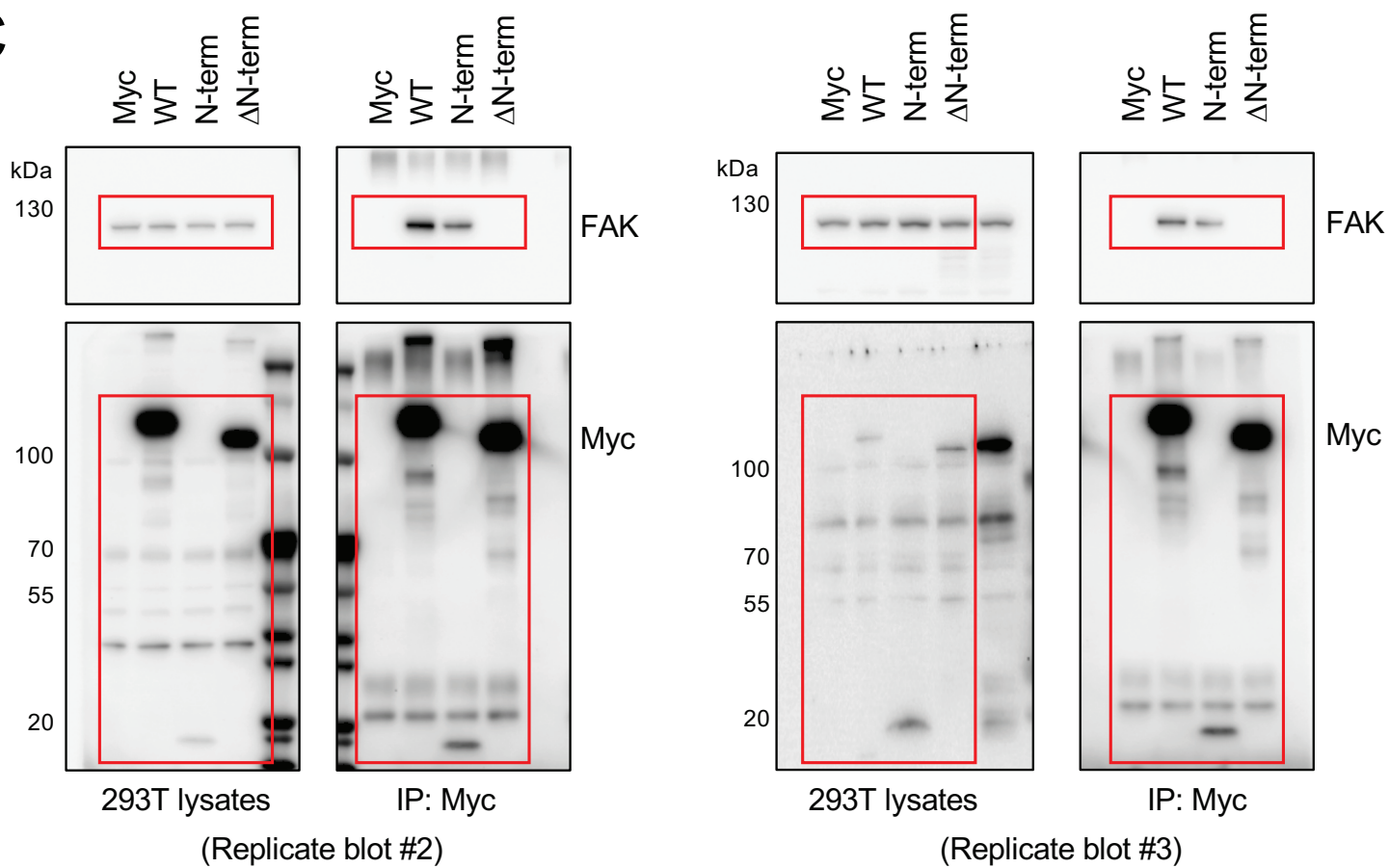
A**C**

D

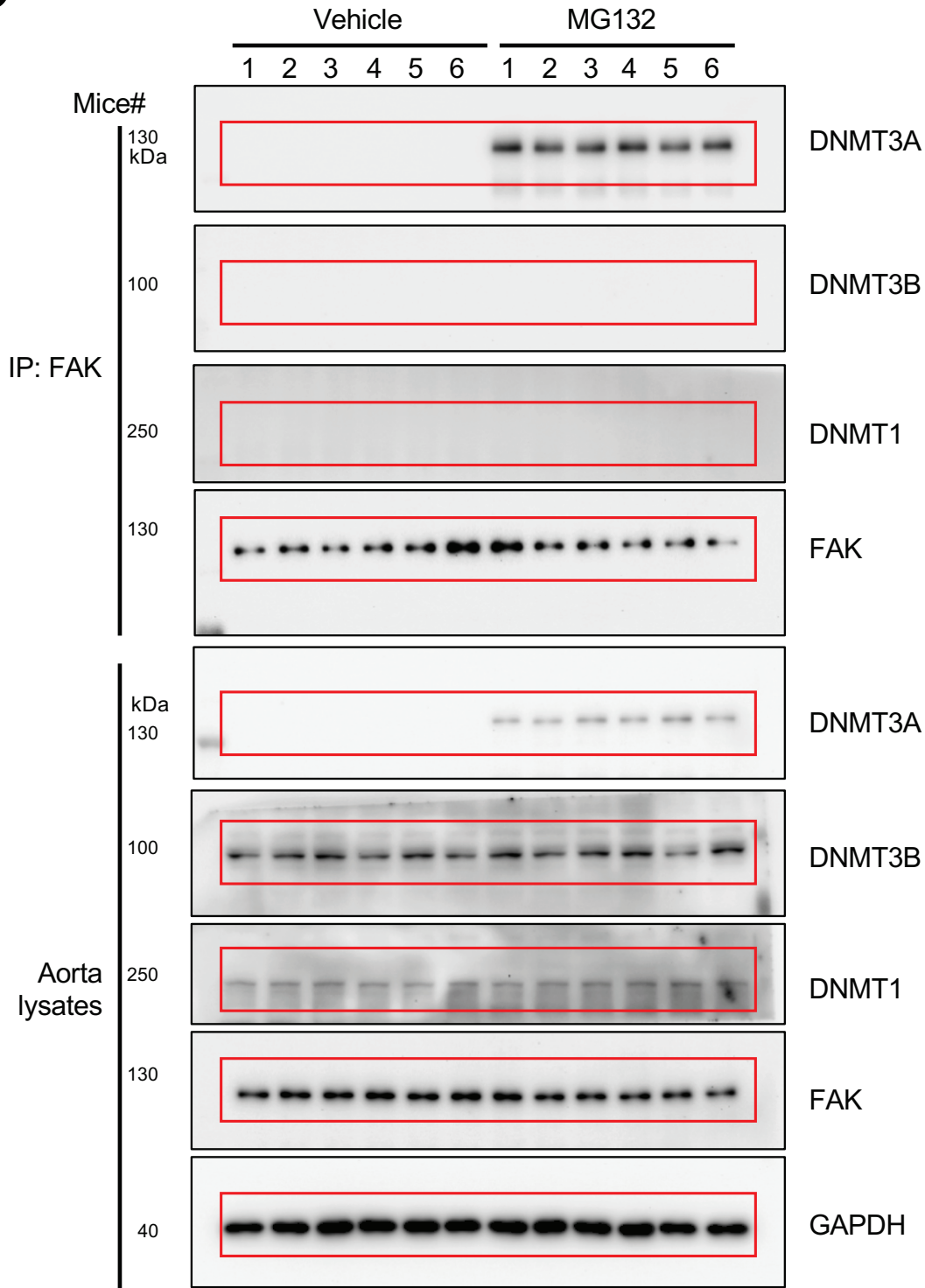

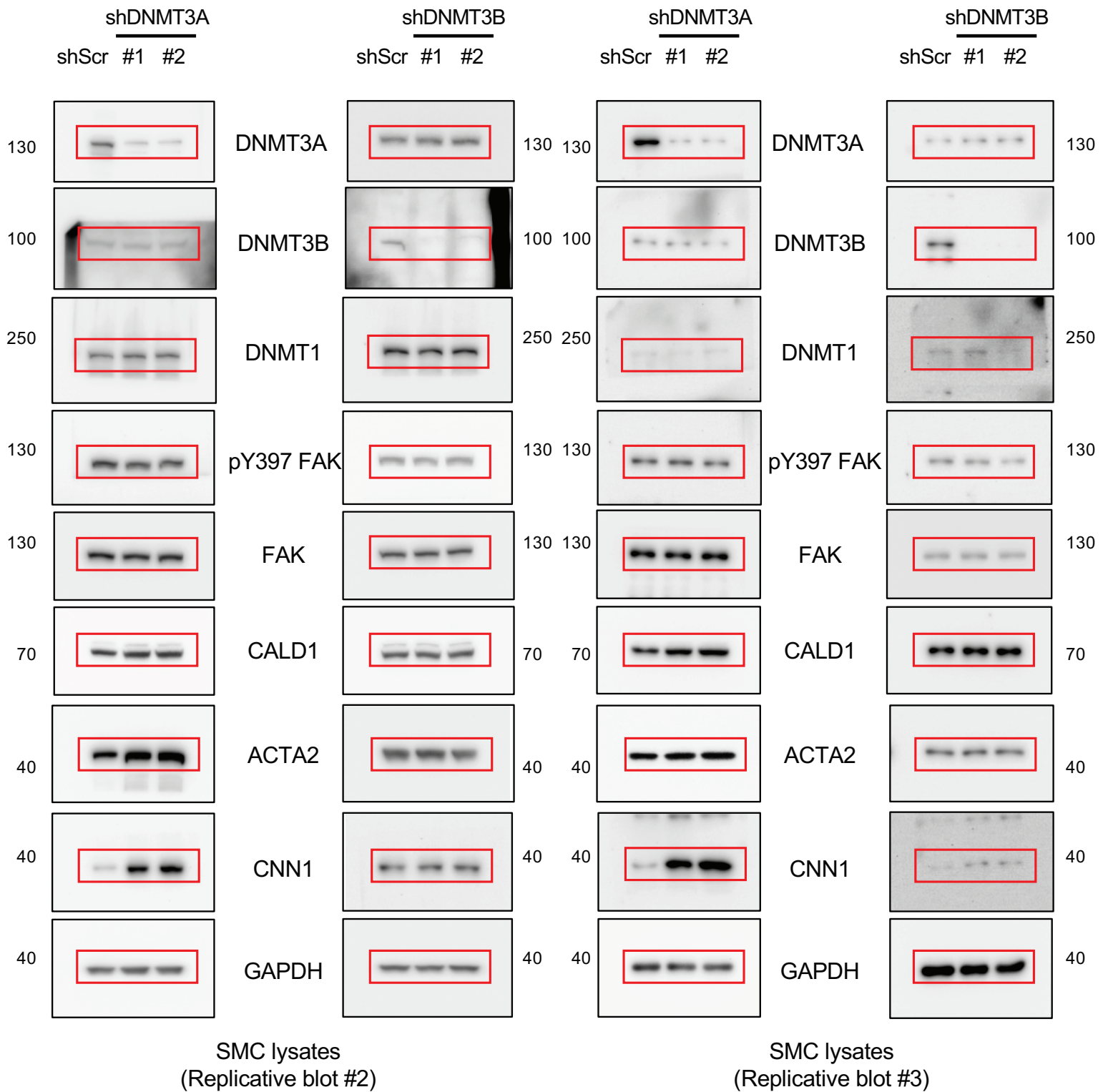

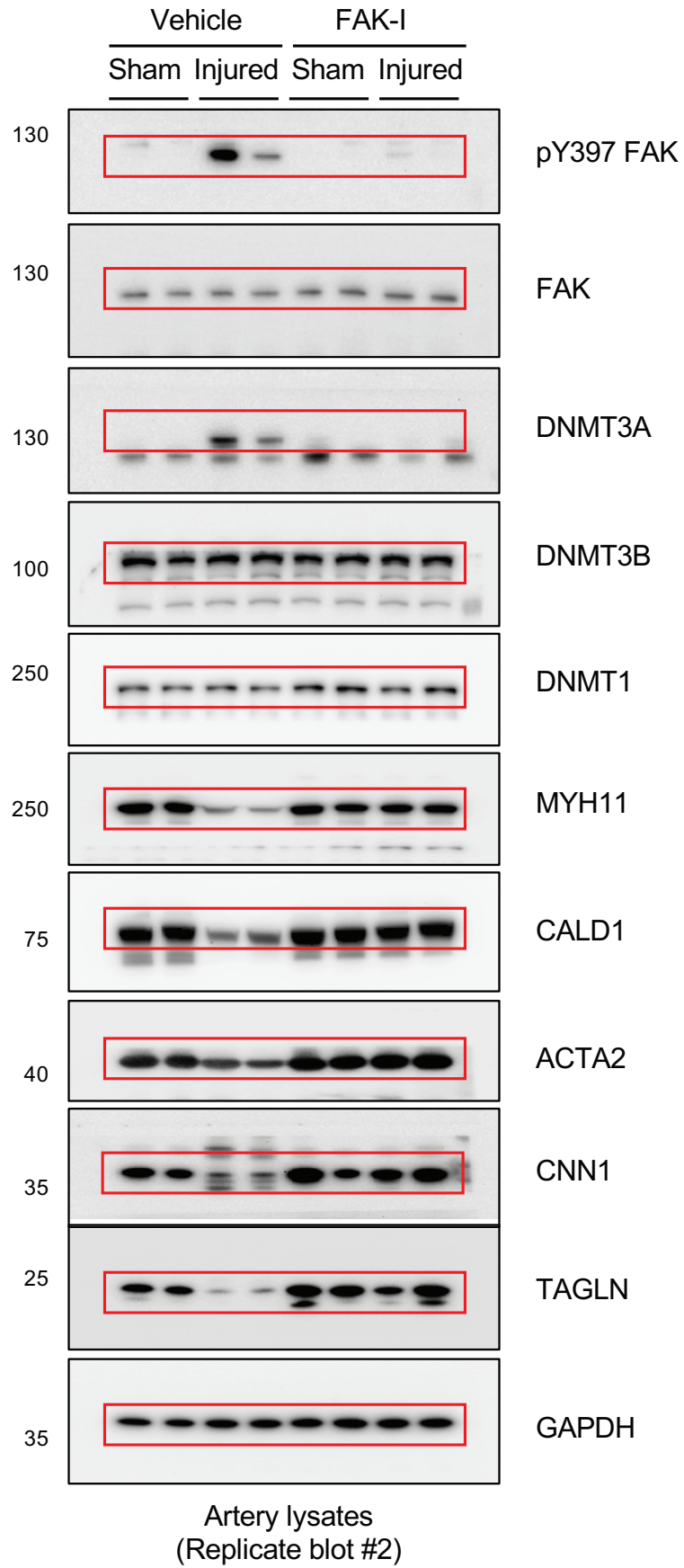

Artery lysates
(Replicate blot #2)

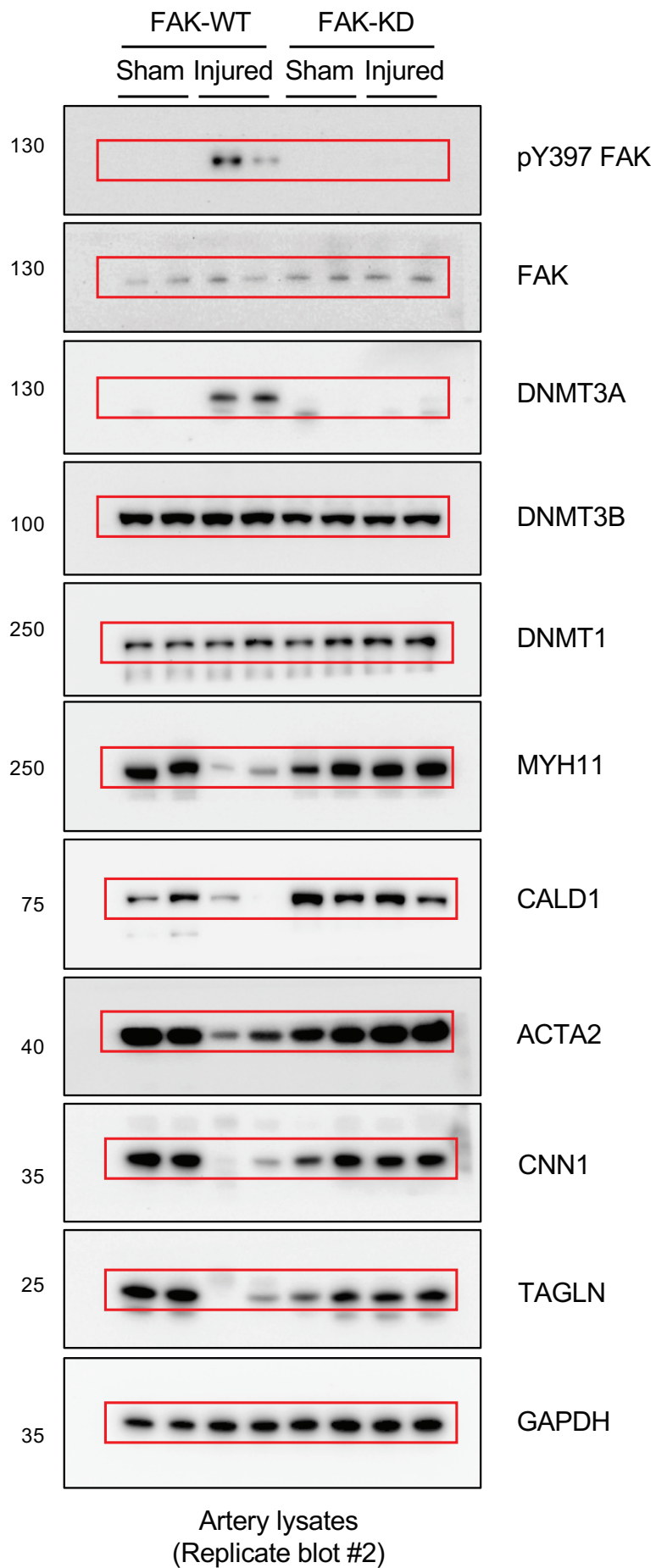

Artery lysates
(Replicate blot #2)